

TWILIGHT: 2000™ 2nd Edition

2006

BANGKOK™

Cesspool of the Orient

Loren K. Wiseman

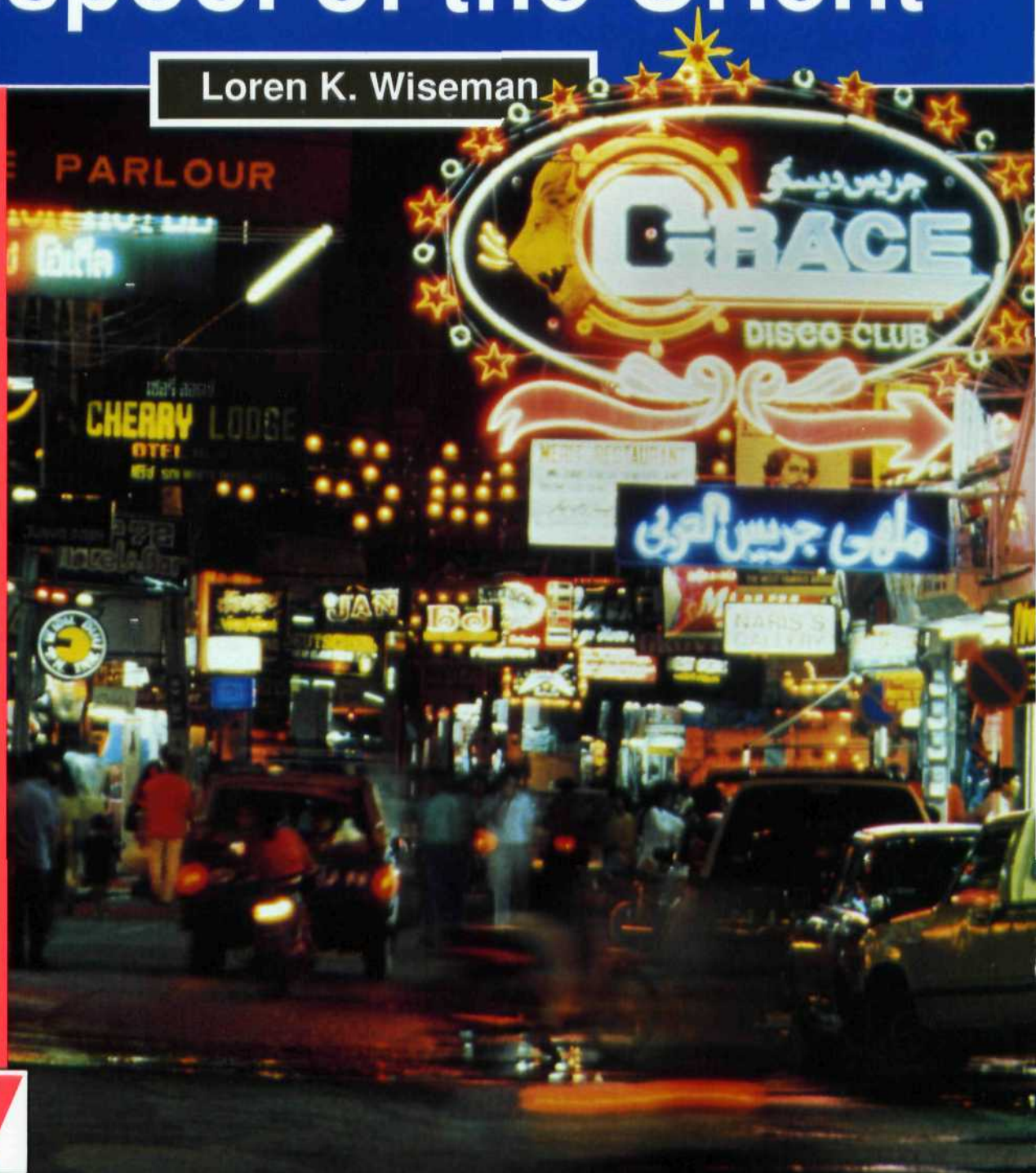

GDW
GAMES

BANGKOK

Loren K. Wiseman



GDW

GAMES

CREDITS

Design and Development: Loren K. Wiseman

Art Direction: Amy Doubet

Cover Photography: Peter and Georgina Bowater

Cover Photograph Supplied By: The Image Bank, Chicago

Interior Art: Grant Goleash

Geographical Maps: Kirk Wescom

Graphic Design and Production: LaMont Fullerton, Jeff Kohl and Steve Bryant

Text Manager: Michelle Sturgeon

Text Processing: Julia Martin and Stephen Olle

Bangkok

Copyright©1991 GDW, Inc.

Made in USA. Printed in USA. All rights reserved.

ISBN 1-55878-074-2.

Twilight: 2000 is GDW's trademark for its roleplaying game of World War III.

Merc: 2000 is GDW's trademark for its roleplaying game of modern soldiers of fortune.

S I N C E 1 9 7 3



P.O. Box 1646
Bloomington, IL 61702-1646

TABLE OF CONTENTS

Introduction	4	Buddhism.....	24	Mine Maps.....	55-57
Getting There.....	5	Superstitions.....	24	Equipment	58
Being There.....	5	Languages.....	25	M18A1 57mm Recoilless Rifle.....	58
Maps and Further Information.....	5	Language List (Expanded).....	25	75mm Pack Howitzer.....	58
Using Bangkok With Merc: 2000	5	Generating Characters	26	M20 75mm Recoilless Rifle.....	59
Conclusion.....	5	Hill Tribe.....	26	M27A1 105mm Recoilless Rifle.....	59
Land of the Free	6	Hunter.....	27	Commando V-150.....	60
Rivers.....	6	Warrior.....	27	EE-9 Cascavel.....	61
Climate.....	6	Nationality/Language Chart.....	27	FV101 Scorpion.....	62
Ethnolinguistic Divisions Map.....	7	Starting Vehicles Chart.....	27	AAVP7A1.....	63
Ethnolinguistic Breakdown.....	7	Hill Tribe Secondary Activities.....	27	M24 Chaffee.....	64
Thailand Map.....	8-9	Personal Weapons Chart.....	27	M41.....	65
Thailand Encounter Terrain Types.....	10	Central Thailand	28	Saracen.....	66
Encounters.....	11	Central Thailand Map.....	28	Shorland Mk 3.....	67
Group Encounter Descriptions.....	11	Communities.....	29	Type 531.....	68
Animal Encounters.....	11	Ayuthaya Map.....	29	Type 62.....	69
Encounter Equipment Chart.....	11	Lopburi Map.....	30	Type82 MRL.....	70
Animal Encounters—		Other Points of Interest.....	30	Sampan/Motorpan.....	71
Southeast Asia.....	11	Economy.....	31	Fishing Boat.....	72
Animal Data Chart—		Encounter Specifics.....	31	Long-Tailed Boat.....	73
Southeast Asia.....	11	<i>Viper's Nest</i>	32	Thailand as a Campaign Setting ...	74
History	12	The Pirates' Islet.....	33	Summary.....	74
Prehistory.....	12	Ransom.....	34	Campaign Flow Chart.....	75
Khmer (Lobpuri) Period.....	12	Deserted Mountain Village.....	35	Pan Yu Sung.....	75
NanChao.....	12	Northeastern Plain	36	Glossary	76
Srivijaya Empire.....	12	Northeastern Plain Map.....	36	Thai Alphabet.....	77
Sukhothai Period.....	12	Communities.....	37	NPCs	78
Ayuthaya Period.....	12	Khon Kaen Map.....	37	Developed NPCs.....	78
European Contact.....	12	Economy.....	39	General Phra Duriyanga.....	78
18th Century and the Chakri Dynasty.....	12	Encounter Specifics.....	39	General Pai Luang.....	78
19th Century.....	12	The Golden Triangle	40	General Nong Khai.....	78
Early 20th Century.....	13	Northern Thailand Map.....	40	Hua Derong.....	78
WWII.....	13	Drug Warlords.....	41	Zheng Desheng.....	79
Post-WWII and Vietnam.....	13	The Drug Trade.....	41	Li Dezhi.....	79
Post-Vietnam.....	13	Hill Tribes.....	41	YuQiuli.....	79
The War.....	13	Kamphaeng Phet Map.....	42	Yosuke Asukata.....	79
City of Angels	14	Communities.....	42	Hideki Sasaki.....	80
The Layout of the City.....	14	Encounter Specifics.....	43	Tadashi Kono.....	80
Bangkok and Environs Map.....	16-17	<i>Science Project</i>	44	Stock NPCs.....	80
Money.....	18	Laboratory Map.....	44	Chinese Merchant.....	80
Politics and Government.....	18	Lab, Village,		Japanese Enforcer.....	80
The Triads.....	18	and Surrounding Terrain.....	45	Thai Soldier.....	81
Life in Bangkok.....	18	Southern Thailand	46	Thai Military Officer.....	81
Accommodation Rates Table.....	18	Southern Thailand Map.....	46	Thai Fishing Captain.....	81
Political Organizations.....	19	Communities.....	47	Hill Tribe Headman.....	81
The Yakuza.....	19	Phuket Map.....	47	Thailand in Merc: 2000	82
Bonded Labor.....	19	Pattani Map.....	48	A Merc's Thailand.....	82
<i>Street of the Seven Brothers</i>	20	Other Areas of Interest.....	48	Thai Settings	84
Warehouse Grounds Map.....	20	Economy.....	48	Villages.....	84-85
Abandoned Warehouse/Office.....	21	Pattani United Liberation Organization.....	49	Buildings.....	86-89
<i>Smash-n-Grab</i>	22	Encounter Specifics.....	49	Hotels.....	90-95
Townhouse Grounds Map.....	22	<i>Cookin' With Gas</i>	50	Wat.....	96-97
Townhouse.....	23	Platform Maps.....	51-53	LST.....	98-99
Culture	24	<i>Miner Problems</i>	54	Military Organizations.....	100-103



SWATSI
© 1991

BANGKOK

For years, I'd heard about the white elephants of Thailand. You know the ones, right? They're considered so sacred that only the king can own them, and even he can't put them to work like normal elephants. They can't be killed—the only thing you can do with the suckers is feed 'em and breed 'em.

I got to see a bunch finally. They aren't even white; they're kind of a faded pinkish-brown. Some of them have mottled grey patches. Some local told us that the word white doesn't refer to the color anyway, it just means the elephant is considered "auspiciously significant." I was disappointed.

What a place! In the dry season you can go fishing with a shovel, I haven't seen a single Siamese cat since we got here, the major spectator sport is called "boxing" but nobody in their right mind throws a punch during a match, and the second most popular spectator sport is watching two fish fight in a bucket! Nothing in this place is what you expect it to be.

Bangkok is the first adventure/campaign sourcebook written especially for the revised **Twilight: 2000** game system, and presents players and referees with a totally new and different background against which to adventure: Thailand. **Bangkok** describes the geography, climate, peoples, and culture of Thailand, giving maps of the major cities, a rundown on the three main political factions, and complete organizational details of the various armies. From the opium warlords of the Golden Triangle to the "sea gypsies" of the Gulf of Thailand, from the primitive hill tribes of the northeast to the sophisticated mercantile/criminal syndicates of Bangkok itself, each section of the country is fully described. Each section also includes a short folio-type adventure set in that part of the country.

The modern Thai name for their homeland is rendered in roman letters as *Prathet Thai*, which means "Land of the Thai," but also means "Land of the Free" (a pun of a sort). Until well into the 20th century, Thailand was known as the Kingdom of

Siam (best known to English-speaking audiences as the location of the musical *The King and I*, which has long been banned in Thailand due to its historical liberties).

Thailand is the world's premier rice exporter, and until recently was a leading exporter of tin, teak, and rubber, but as the forests recede and the mines begin to run out, the country has turned to other sources of hard currency. Tourism and textiles are replacing teak and rubber as the main sources of national income, and a massive economic transformation is under way.

We chose Bangkok as the setting for this book for several reasons. It is an exotic, foreign locale to most of our customers, and will give them a background for adventuring radically different from the previous European and American backgrounds. We wanted the opportunity to show players and referees a different sort of city from Krakow, a city that was just as organized, but where corruption and villainy were rampant. Also, we wanted to show how radically a country can be changed by the events in the **Twilight: 2000** chronology, even if not directly involved in the war. (There seems to be a feeling among **Twilight: 2000** players that "if it wasn't nuked it's completely intact," a notion we are attempting to dispel here.)

GETTING THERE

The setting of **Bangkok** is so far from the previous series of **Twilight: 2000** modules that it is almost not worth the effort to try to explain in any depth how the characters got there. Players who wish strict continuity to be maintained may work out with their referee some means by which they have arrived in Bangkok: perhaps they arrived as a result of the **Last Submarine** trilogy of adventures, perhaps by the sailing ship described in **Spanish Main**, perhaps as a result of some mission gone awry.

Players might wish to generate characters from the US 2nd Infantry Division, stationed in Cam Ranh Bay at the start of the war and now seeking their fortunes in Bangkok.

BEING THERE

Several of the adventure situations described in **Bangkok** lend themselves to development as continuing campaigns. The chapter beginning on page 74 contains a discussion of how referees can set campaigns in Bangkok or Thailand.

MAPS AND FURTHER INFORMATION

Those wanting more detailed street maps of Bangkok should write to the Thai embassy in Washington. Tourist guidebooks to Thailand can be had for less than \$10 at most large bookstores (smaller ones may have to order them) or from the local library. JNC maps JNC-XX37 and JNC-XX54, and ONC maps ONC-XXJ10, ONC-XXJ11, ONC-XXXK9, ONC-XXXK10, and ONC-XXLIO cover Thailand and Indochina. They are available from the Defense Mapping Agency CSC, Washington DC, 20315-0010. Ask for their latest price list.

The chapter on the various cultures of Thailand is necessarily brief, and referees will probably want to conduct further investigations in the local library if an extensive campaign is planned. The chapter touches on most of the cultures present in Thailand, and that should be enough to get you started.

USING BANGKOK WITH MERC: 2000

It is possible to use **Bangkok** with **Merc: 2000** because it was designed with that in mind. The appendix at the end of the book describes the differences between the **Twilight: 2000** Bangkok and the **Merc: 2000** Bangkok. The situation we have outlined is such that much of the political intrigue and infighting described as a part of the **Twilight: 2000** universe can be applied virtually unchanged to the **Merc: 2000** universe.

CONCLUSION

Bangkok is an experiment in a new type of sourcebook for **Twilight: 2000**. It has been a challenge to prepare, and I think you'll enjoy it.

LAND OF THE FREE

Some see the shape of Thailand as resembling the head of an elephant with a dangling trunk and flopping ears, a funnel, or a flower with stem and petals. In any case, Thailand can be divided into four geographic regions:

Central Plain: The central plain consists of the river floodplains and delta of the Chao Phraya River. This region runs from Chumphong Province in the south northward to the foothills of the northern mountains near the city of Nakhon Sawan, and eastward along the edge of the so-called Khorat plateau to the Cardamom Mountain region.

Most of this region is under the control of the ruling military junta centered in Bangkok, and the bulk of the present-day Thai population is located here.

Northeastern Plain: This area is sometimes called the Khorat plateau, but the region is really a fairly low-lying region with no abrupt elevation changes (which a "plateau" would seem to require). The region runs from the edge of the central plain (essentially the watershed of the two river deltas in the country) north and east to the Mekong River, the border with Laos, and southeast to the boundary with Kampuchea. The region receives a fair amount of rain, but the soil does not retain it very well, and agriculture in the region, particularly rice cultivation, depends heavily upon extensive irrigation projects.

During the Vietnam War, the United States constructed several air bases in northeastern Thailand, both for overt bombing raids and for covert CIA operations. These air bases are no longer in operation (the Thai Air Force has effectively ceased to exist). Of the thousands of American service personnel stationed here, several hundred chose to stay after the end of the war.

Northwestern Mountains: The northwestern region of Thailand is part of the infamous Golden Triangle, a center of world opium production and home to numerous primitive hill tribes and drug-dealing warlords.

Southern Peninsula: Thailand's west-

ern mountain ranges (the elephant's trunk or the flower's stem) form the spinal column which supports the rest of Thailand. Sparsely settled before the war, the peninsula is even more depopulated in 2000, except for the coastal villages and a few of the more easily worked tin mines. Environmental concerns in the 1990s resulted in the replacement of large-scale lumber operations with a tourist industry which was less destructive of the rain forest and a good deal more lucrative. With the war, however, tourism has ceased.

The Junta maintains a few cantonments in the the peninsula and is nominally in control. In the south, this control is contested by various Malay independence groups and independent communities. Many of the coastal villages serve as bases for the fishing/pirate boats of the Gulf of Thailand in the east and the Indian Ocean in the west.

RIVERS

Settlement in Thailand is largely limited to the floodplains of the various river systems due to the lack of rainfall in the dry season. Thailand consists of two main floodplains, those of the Chao Phraya and Mekong rivers. The Chao Phraya basin is completely contained within Thailand, and drains the the central plain and the northeast region. The Mekong forms the Thai-Laotian border, and drains the area east of the Phetchabun Mountains. Both rivers were subject to extensive irrigation and hydroelectric projects in the decades after WWII, with the result that most of the lakes in Thailand are artificial.

The electronic equipment of the various hydroelectric projects (mainly the regulatory and control circuitry for the massive turbines and the generators connected to them) was heavily damaged by electromagnetic pulse (EMP) during the war, mostly from high-altitude nuclear detonations over China and India. (It was a great surprise to most scientists that EMP effects propagated themselves for thousands of miles further than the experiments in the 1950s indicated.) Since much of the nation's energy

came from these projects, electrical power in Thailand in 2000 is a scarce commodity. Efforts are underway to rebuild the nation's power grid, but are proceeding slowly due to lack of financial, material, and human resources.

CLIMATE

Thailand is located in the middle of the Southeast Asian tropical monsoon climate zone, but the placement of the mountain ranges means that a significant dry season occurs due to the rain shadow of the Tenasserim Mountains. Effectively, this means that most of Thailand is a tropical savannah, except for the southern peninsula and the Tenasserim Mountain range, which are tropical rain forest of one sort or another. Temperatures are warm enough that crops can be grown year-round if sufficient water is available. With the exception of the peaks of the various mountain ranges, snow does not occur, but frost is occasionally experienced in some of the northern valleys.

Thailand has three seasons:

Wet: The extremely wet monsoon season lasts from June through October, except on the southern peninsula, where it lasts through January. Temperatures are in the 25-30°C range, and rainfall in excess of 1300 millimeters for the season is not unusual. This is 85% of Thailand's annual rainfall. The prevailing winds during this period are from the southwest.

Dry: The post-monsoon, cool-and-dry season lasts from November to February (although some from more temperate climates would dispute that Thailand ever has a "cool" season). Temperatures are in the 10-20°C range (as cool as it gets except in the highest reaches of the mountains); rainfall is less than 50 millimeters total for the season.

Hot: The pre-monsoon, hot season lasts from March to May. Temperatures are in the 30-38°C range; rainfall is less than 50 millimeters total. Many people consider this to be the most inhospitable time of year in Thailand.

Ethnolinguistic Divisions

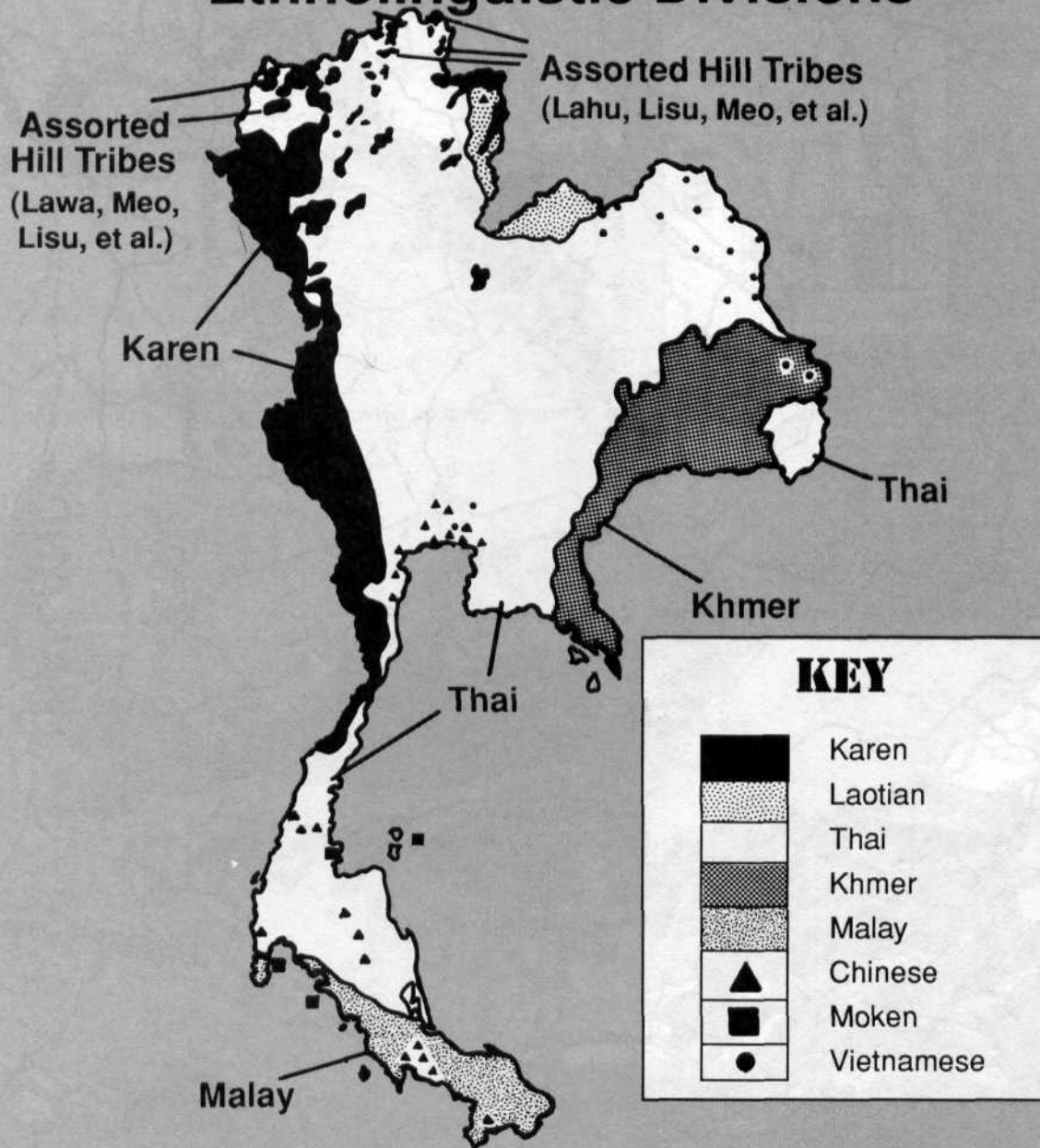

ETHNOLINGUISTIC BREAKDOWN

See page 25 for an expanded Language List covering the languages spoken in Thailand. The predominant language in Thailand is Thai (also known as Siamese), spoken by the vast majority of the populace.

Several dialects of Burmese are spoken in the north and northwestern regions of Thailand, primarily by displaced Burmese and some of the hill tribes.

About 4% of the population speaks Malay. Almost all of these people live in the extreme southern part of the country (as noted on the map).

A number of dialects of Chinese are spoken by ethnic Chinese, primarily in the area in and around Bangkok, although a few Mandarin-speaking Yunnanese exist in the north.

Cambodian (also known as Khmer), Hmong and a number of hill tribe dialects are spoken in various regions. The latter are discussed under the various hill tribe entries later in this book.

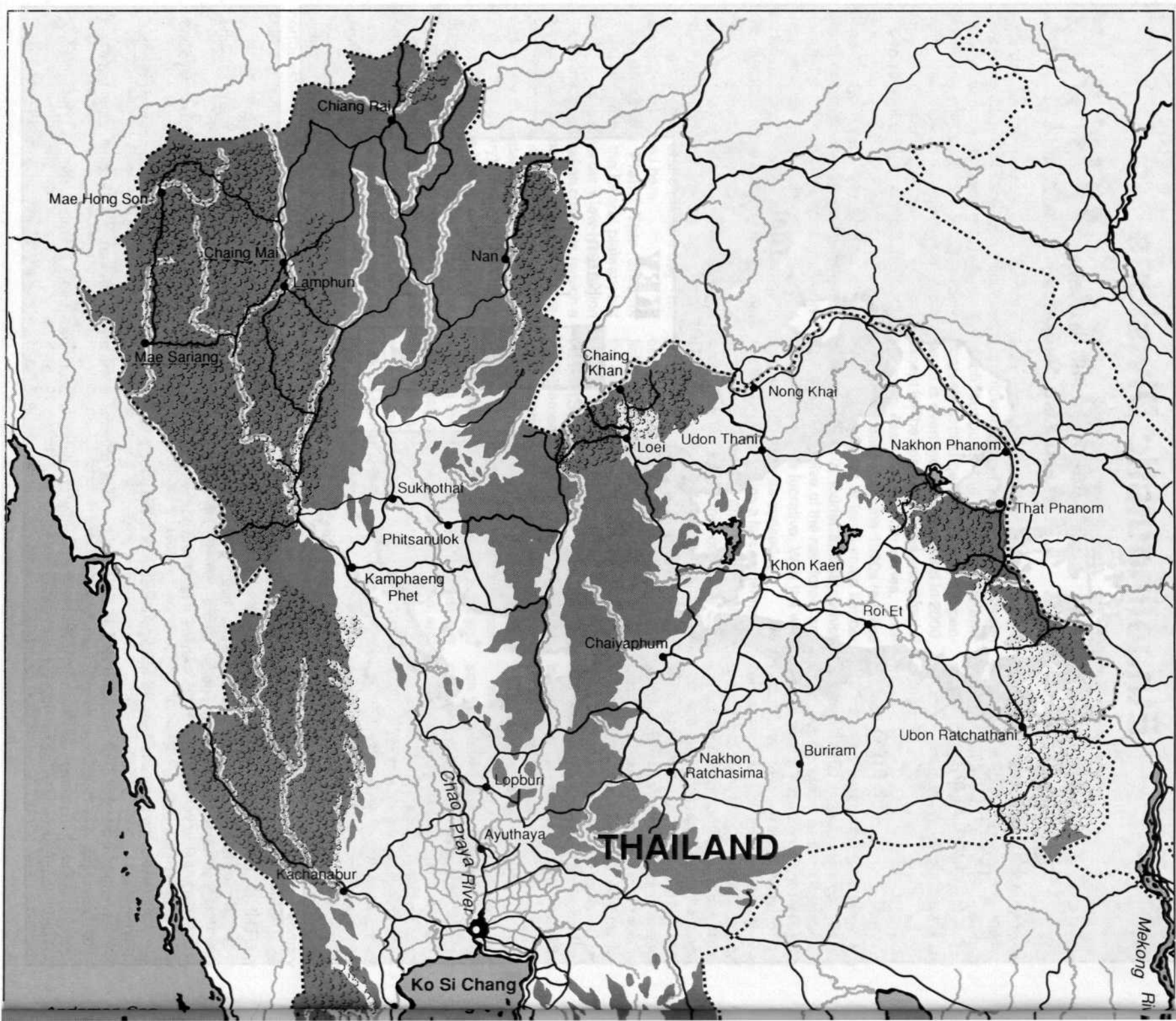

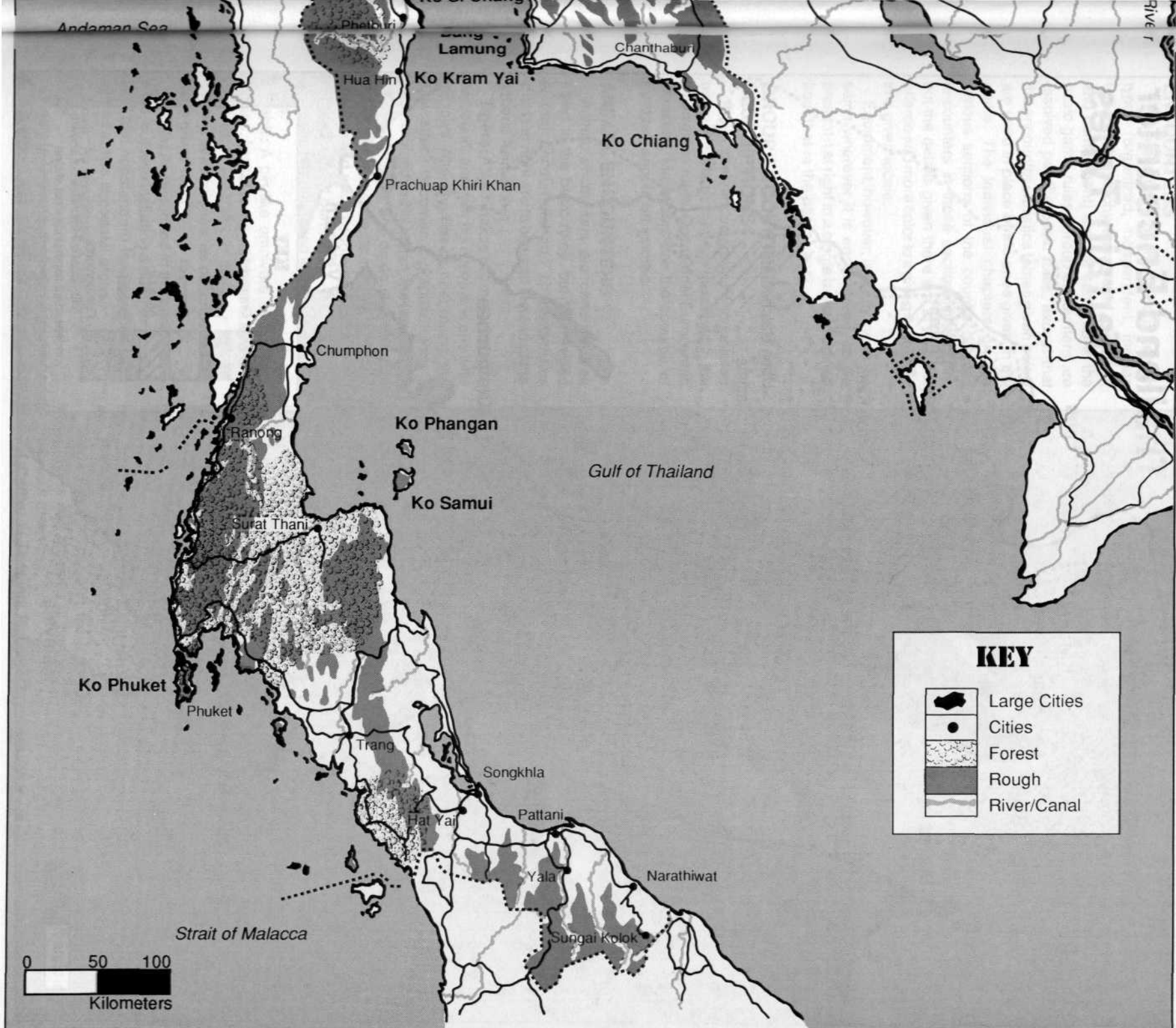



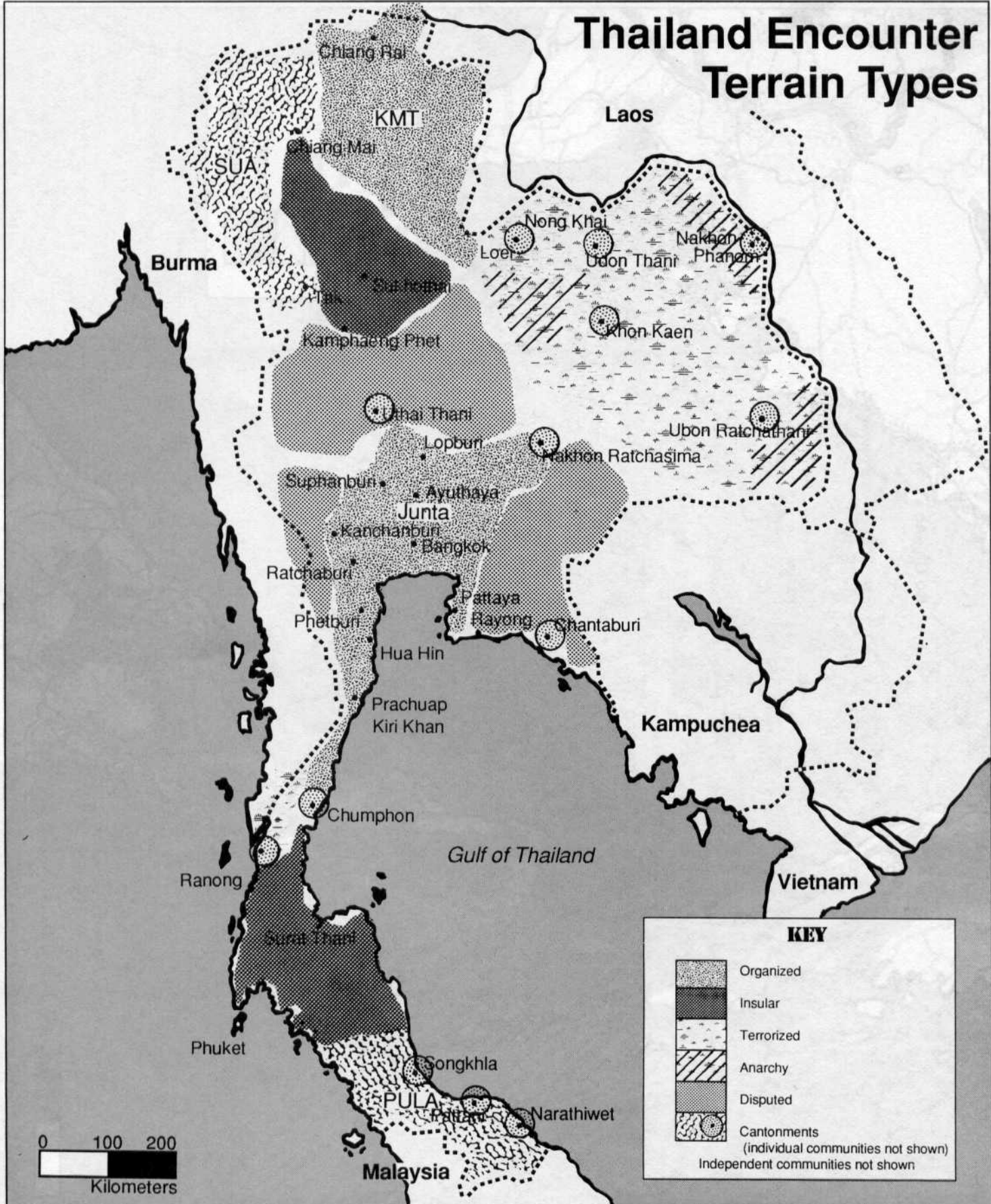



Thailand Encounter Terrain Types



KEY

-  Organized
-  Insular
-  Terrorized
-  Anarchy
-  Disputed
-  Cantonments
(individual communities not shown)
Independent communities not shown

0 100 200
Kilometers

ENCOUNTERS

The definitions of the various terrain types (organized, independent, insular, terrorized, anarchy, devastated, disputed, and cantonment) are the same as in the basic game rules. Group encounters are resolved per the basic rules, except that the encounter statistics tables given below are used in place of the ones given in the game. The individual chapters on the various sections of the country discuss encounters in those sections more fully, but the details given there are to help the referee add more color to a given encounter in a given locale.

Equipment, however, is pretty much the same wherever it is encountered, so we present it at right in a single table (modified from that in the basic rules).

GROUP ENCOUNTER DESCRIPTIONS

Again, the various groups encountered by players are as they are described in the basic game rules. Occasional Eurocentric phrases ("Marauders are the scourge of Europe") should be ignored.

ANIMAL ENCOUNTERS

Animal encounters are conducted as noted in the basic rules, but the revised animal encounters and characteristics charts at right are to be used instead of the generic Asia charts.

Tigers: A tiger makes two melee attacks per round, one with his claws and one with his jaws. After the first combat round, the claw attack becomes a grapple. Once a tiger has subdued its victim, the jaw attacks automatically hit, and do double damage.

Elephant: Elephants make only diving attacks, and each counts as a charge for the purposes of panic.

Grazer: As described in the basic game rules.

Tapir: A pig-like omnivore of the Thai jungles, similar to the wild boar in size and behavior.

Dog: Wild canines, as described in the basic game rules.

Game: As described in the basic game rules, but also including a number of monkeys and nonstandard food sources such as sea turtles in coastal areas.

Fowl: As described in the basic game rules.

Bear: In Thailand, the bear encounter is with the Himalayan black bear or the honey

ENCOUNTER EQUIPMENT CHART

	<i>Heavy</i>		<i>Motor</i>	<i>Armored</i>	<i>Military</i>	<i>MERCHANT</i>
<i>Die</i>	<i>Weapons</i>	<i>Artillery</i>	<i>Vehicles</i>	<i>Vehicles</i>	<i>Cargo</i>	<i>Cargo</i>
1	AT missile	Mortar	5-ton	Lt. AFV	Ammo	Scrap metal
2	AT rocket	Mortar	5-ton	Lt. AFV	Parts	Machinery
3	Grenade launcher	Mortar	272-ton	Lt. AFV	Medical	Food
4	Machinegun	Pack how.	2 1/2-ton still	APC	Food	Wool
5	Machinegun	Pack how.	3/4-ton	APC	Fuel	Clothing
6	Machinegun	Howitzer	UAZ-469	IFV	Weapons	Furnishings

Light AFV: Any light combat vehicle in the equipment lists.

Pack How.: Pack howitzer. Substitute a mortar at the referee's option.

APC: Any armored personnel carrier in the equipment list except those listed under IFV.

IFV: Infantry fighting vehicle (infantry carriers equipped with autocannons and sometimes antitank missiles.)

Other weapons are chosen from the listings given in the Equipment chapter (beginning on page 58).

ANIMAL ENCOUNTERS—SOUTHEAST ASIA (1D6)

	<i>Terrain</i>			
<i>Pig</i>	<i>Wood</i>	<i>Swamp</i>	<i>W/W</i>	<i>Clear</i>
1	Tapir	Crocodile	Tapir	Large cat
2	Fowl	Fowl	Fowl	Fowl
3	Game	Game	Fowl	Game
4	Large cat	Grazer	Grazer	Grazer
5	Tiger	Dogs	Large cat	Wild cattle
6	Elephant	Game	Game	Dogs

ANIMAL DATA CHART—SOUTHEAST ASIA

<i>Animal</i>	<i>Meat</i>	<i>Move</i>	<i>Appearing</i>	<i>Hits</i>	<i>Attack</i>	<i>Hit#</i>	<i>Damage</i>	<i>CON</i>
Grazer	1 D6x5 kg	10/20/60	2D6	8	No	—	—	—
Tiger	1D6x30kg	10/20/40	1	40	50%	8	3D6	18
Elephant	1D6x80kg	10/15/30	1D6	60	20%	4	5D6	26
Tapir	1D6x10kg	10/15/30	1	25	80%	4	2D6	16
Dog	1D6x2kg	15/30/60	3D6	5	60%	6	1D6	2
Game	1D6x1 kg	10/20/40	2D6	3	No	—	—	—
Fowl	1D6x1 kg	5/20/80	4D6	3	No	—	—	—
Bear	1D6x12kg	10/20/40	1	25	40%	6	2D6	20
Large cat	1D6x10kg	10/30/60	1D6+3	25	40%	8	2D6	10
Wild cattle	1D6x5 kg	10/20/40	3D6	4	No	4	3D6	20
Crocs	1D6x4kg	8/12/24*	1D6+2	25	30%	4	3D6	24

*Crocodiles move 40 in the water

bear, both of which are smaller than average ursines.

Large Cat: In Thailand, the large cat encounter is with leopards or panthers at the referee's discretion.

Wild Cattle: In Thailand, this category

of animal includes gaur and banteng, as well as escaped water buffalo, etc.

Crocodiles: Crocodiles are four-legged aquatic reptiles, whose lethargic nature fools people into thinking they are equally slow in the water. This is not true.

HISTORY

Thailand has the distinction of never having been colonized by a European power (although it has been conquered by several Asiatic powers), which makes it unique in Southeast Asia. Although heavily influenced by outside cultures (both Eastern and Western), the Thai people have managed to retain a unique and individual culture. All dates referred to are A.D. unless otherwise specified.

PREHISTORY

Until very recently, little was known of the prehistory of the area that was to become known as Thailand. No written records from the region survive from before the 13th century of the present era. The region was settled at a very early date. Recent archaeological investigations have brought to light evidence of very early agriculture and metalworking in prehistoric Thailand, evidently invented independent of outside influences. The people who made these innovations were not the modern Thai, however. As is the case in many lands, the present inhabitants arrived there from somewhere else.

Buddhism probably entered the region in the 3rd-2nd centuries B.C., when missionaries from India were sent to a land called *Suvarnabhumi* (Sanskrit: "land of gold"), believed to be the fertile area of central Burma, central Thailand and Kampuchea. By the 6th century, a loose network of city-states collectively referred to as *Dvaravati* (Sanskrit: "place having gates") had arisen and current thinking (although still controversial) holds these to have been primarily Mon or Mon-Khmer in ethnic makeup. The *Dvaravati* culture lasted into the 11th or 12th century of the present era, when invading Khmers from the east gradually absorbed them.

KHMER (LOBPURI) PERIOD

The period of Khmer domination saw a tremendous influx of Khmer culture to the region, including elements of both Theravada and Mahayana Buddhism, as well as some Brahman influences. Khmer art, architecture, and court ceremonies were also introduced during this period.

NAN CHAO

Over the years, the Thai continued their gradual southern movement, and many were

employed as mercenaries by the Khmer, who called them *Syams* (Sanskrit: "swarthy") from which the word Siamese would appear to be descended.

Physically and linguistically, the Thai resemble the Chinese in many particulars, and this has led historians to believe that Chinese references (as early as the 6th century B.C.) to barbarians living south of the Yangtze-Kiang Rivers refer to the Thai. As Chinese hegemony was extended, the Thai were pushed southward into the modern Chinese provinces of Sichuan and Yunnan. Here they established the first singularly Thai state, Nan Chao, in the 7th century.

By the 8th century, Nan Chao had come under increasing Chinese influence (both culturally and politically) and the kingdom's independence ended in 1252, when it was conquered by the Mongols under Kublai Khan.

SRIVIJAYA EMPIRE

In the south, the Malay peninsula was dominated by the Sumatran-based Srivijaya Empire from the 8th through the 13th centuries. Malay art and architectural style remain influential to this day. The ethnic Malays are Muslim, which has caused (and continues to cause) some tension with the Buddhist majority.

SUKHOTHAI PERIOD: 13TH-14TH CENTURIES

In 1238, two Thai chiefs took control of the city of Sukhothai, establishing the kingdom that was to become the paramount power in the area that was to become modern Thailand. By the 1280s, the Sukhothai kingdom's primary rival (the Burmese empire of Pagan) had fallen to the Mongols and the only other power center in the region (the Khmer kingdom of Angkor) was also waning.

The period under King Ramkhaeng (1275 to circa 1317) is considered to be the foundation of modern Thai civilization and culture. The second great Sukhothai *Dhammaraja* (karma-king), Ram Khamheng, codified the Thai version of Theravada (Sinhalese) Buddhism, and established a system of writing that forms the basis of modern Thai. This period tends to be viewed as a golden age by modern Thais, looked back on as a period of peace and plenty.

AYUTHAYA PERIOD: 14TH-15TH CENTURIES

The Thai rulers of the southern city of Ayuthaya took over the Sukhothai kingdom in 1376. These kings were culturally less sophisticated but more adept at political and military activities than their neighbors to the north. In 1431, the Ayuthaya kings had absorbed the Khmer kingdom to their east, and parts of the modern nations of Burma and Laos. They also adopted more autocratic court customs (mostly from the Khmer) typified by their usage of the title *Devaraja* (god-king) rather than the earlier (and less imperial) *Dhammaraja*.

It was with the Ayuthaya kingdom that Europeans first made contact, when a Portuguese diplomatic mission arrived in 1511. At the time, the Thai kingdom of Ayuthaya was the most important in southeast Asia.

EUROPEAN CONTACT

The Ayuthaya kingdom already had mercantile connections with China, Japan, and other oriental nations when the Europeans arrived. After the Portuguese trade/diplomatic mission mentioned above was established, English and Dutch merchants were quick to establish trading posts as well. The Dutch position became so strong that King Narai sought help from the French, which Louis XIV was only too happy to provide, sending a naval squadron, several land garrisons, and a large number of Jesuit missionaries in an attempt to convert King Narai to Christianity. The only reason the French were allowed to land was that Constantine Phaulkon, a pro-French Greek, had managed to work his way into a position of tremendous power in the Siamese government by 1687. After a short naval war with the English (during which a massacre of English subjects in Siam occurred), King Narai died in 1688, and an anti-foreign general seized the throne, executed Phaulkon, and adopted a policy of restricted relations with outsiders. The French were held in particular distaste; to this day, the Thai word for foreigner is *farang*, a shortened form of *farangset*, the Thai word for French.

18TH CENTURY AND THE CHAKRI DYNASTY

This self-imposed semi-isolationism did

not prevent Siam from engaging in military campaigns against its neighbors, however. Throughout the first half of the 18th century, Siam crossed swords with the expanding state of Vietnam (over the Laotian territories of the upper Mekong and Siamese territories in Cambodia) and with the resurgent Burmese kingdom. The latter proved so competent that only a Chinese invasion of Burma in the 1760s and the brilliant generalship of a Thai/Chinese general (soon to be king) Takh Sin prevented complete disaster.

Within a few years, the Burmese were expelled, Cambodia was regained, and Vietnam was submerged in dynastic struggles. Takh Sin ruled another two decades, but went insane in 1782 and was deposed by General Chakri, who took the throne as King Rama I, founder of the modern Thai dynasty. Rama I managed to hold the external threats at bay, but was forced to spend most of his reign (1782-1809) in internal consolidation.

19TH CENTURY

Rama II and Rama III renewed commercial relations with the West, to a limited extent. Rama III was forced to agree to a joint occupation of Cambodia with Vietnam. Both monarchs resisted Western influences on Thai culture.

When Rama III died, his brother, Mongkut, took the throne as Rama IV (1851-68), perhaps the most famous king in the history of Siam (he was the subject of the musical *The King and I* and the book upon which it was based, *Anna and the King of Siam*). In addition to establishing his own school of Buddhist monastic discipline, Rama IV abandoned his predecessors' policy of isolation. He welcomed Western commerce and sought Western help in reorganizing Siam's semi-medieval administrative system.

The king concluded treaties of friendship with Great Britain, other European powers, and the United States. (Rama IV's gift of friendship to President Abraham Lincoln was a small herd of elephants). His major foreign policy setback was with the French, who annexed Vietnam beginning in 1859 (eventually to combine it with other territories and rename it Indochina). A treaty with the French in 1867 forced Siam to surrender its claim over most of Cambodia. Laos would follow in the 1890s.

Upon the death of Rama IV, his son Chulalongkorn ascended the Siamese throne as Rama V, continuing and expanding his father's pro-Western policies. He brought in hundreds of Americans and Europeans to build railroads, schools, mines, and to improve his governmental institutions. As was the

case with his father, however, Rama V continued to have trouble with France.

French insistence that Indochina should possess all territories east of the Mekong River and a number of "incidents" with French gunboats brought France and Siam to the edge of crisis on several occasions in 1893, 1895, and 1896. Each time, war was averted only by British intervention, but usually at some territorial cost to Siam. In 1909 the last of a series of treaties fixed Siam's boundaries largely in their modern locations.

EARLY 20TH CENTURY

The early 20th century was a quiet one for Siam. In 1917, Siam joined with the Allies in the First World War, but did little more than seize German merchant ships in its waters. Fiscal irresponsibility coupled with the collapse of the Asian rice market as a result of the Great Depression caused a crisis in public confidence. This crisis was exploited by a group of European-educated students and the more forward-looking military officers who overthrew the absolute monarchy in a bloodless June 1932 coup. Constitutional limits were placed on the monarchy and a unicameral legislature (half elected, half appointed) was established. Since 1933, there have been an average of two coups or coup attempts per decade.

In 1939, the nation entered into a program of economic nationalism in an attempt to revitalize itself and undertook a number of reforms. One of these was to change the formal name of the kingdom from Siam to Thailand.

WWII

In 1941, Japanese pressure caused French Indochina to cede back to Thailand some of the territories east of the Mekong River lost in the 1890s. Japan occupied Thailand on 8 December 1941 and used the country as a base for the invasion of British Burma.

Thailand declared war on the United States and Great Britain in January 1942, but only Great Britain responded with a counter declaration. In America, the Thai minister convinced Roosevelt that the declaration did not represent the true will of the Thai people, and founded a "Free Thai" movement among Thai students attending American schools.

Thailand remained occupied by the Japanese during the war. After the defeat of Japan in 1945, the 1942 declaration of war was declared null and void. In 1946, a treaty ending hostilities was concluded with Great Britain, Thailand returned the areas ceded to it during the war and became a member of the United Nations.

POST-WWII AND VIETNAM

New constitutions came into effect in 1946, 1947, 1948, and 1949, mostly as a result of various military coups. The 1932 constitution was put back into effect in the coup of 1951, only to fall to the coup of 1957. Finally, in 1959, the present constitution was promulgated.

Thailand sent troops to Korea in 1950, and joined SEATO (the South-East Asian Treaty Organization) at the urging of the United States in 1954. In the 1950s and 1960s, Thailand (with the support of the United States) took strong measures opposing the spread of communism in Southeast Asia. During the Vietnam War, Thailand served as a rest and recreation center for US troops and as a base for US aircraft on both overt and covert missions into Cambodia and Laos. Thailand also sent troops to Vietnam.

POST-VIETNAM

The end of the Vietnam War and the subsequent removal of US troops and bases had less of an effect on the Thai economy than the growth of the illegal drug trade after the war. CIA-sponsored drug smuggling (as a covert fund-raising measure) allowed the drug lords of the so-called Golden Triangle (the area where the three borders of Thailand, Burma, and Laos met) to penetrate to worldwide markets.

The year 1989 brought the global collapse of communism, and local communist insurgencies in Thailand found their foreign financial support drying up. Ethnic strife, however, soon replaced political strife, and antigovernment minority independence movements arose to replace the communists.

THE WAR

The war itself did not touch Thailand, but the repercussions of the war did. The global economic collapse shattered the world trade network, and precipitated the collapse of the global economy, plunging many regions into a depression. The offshore natural gas platforms and the pipeline under the Gulf of Thailand were abandoned during this economic distress, for fear that they would become targets. There was a short period of civil disorder during which time the king and the royal family disappeared. A junta of military officers took over the country and soon located a successor, now on the throne as King Rama X.

The main effect of the war was to disrupt the civil order and radically reshape the political landscape. Order was soon restored in most places, but the government is incredibly corrupt, and other powers now exist besides the military. This will be more fully explained in later chapters.

CITY OF THAI ANGELS

When we arrived, I asked Piri (our native guide/translator) who was in charge. He told me that the king was in charge. Except for the Junta, which really ran things. Except for the criminal syndicates (the Chinese, the Japanese, and the Burmese), which controlled most of town. Except for the gangs which were lucky enough to represent one of the drug warlords from up north. And, of course, the pirates and the technical unions, and the various mercenary units (including your humble author).

It's like everything else in this country: The Junta runs things, except when it doesn't. It's a wet, tropical climate, except when it doesn't rain for months on end. Buddhists are nonviolent, except when they fight.

Bangkok is Thai for "Place of Olives" and technically refers only to the old city (the portion of the city between the river and the railroad), not the newer additions, but for convenience, this book uses the word to refer to the whole city. *Krung Thep*, the shortened Thai name for the city, means "City of the Angels." The full Thai name is *Krung thep mahanakorn boworn rattanako-sin mahintarayuthayama hadilok popnop-paratrat chathaniburi romudom ratchaniwet-mahsasthan* (don't ask what it means).

THE LAYOUT OF THE CITY

Old Bangkok dates back to the late 18th century, when it became the capital. The royal palace and numerous temples and monuments dominate the architecture of the old city. East of the railroad, Bangkok is a more modern city, with a less picturesque architectural style and a seamier quality overall. Old Bangkok consists of the royal palace, the older government buildings and wats, the Pahurat and Banglamphu districts, and Chinatown.

Royal Palace: Although it may seem odd, the royal palace is one of the areas in Bangkok where the electric supply is least reliable. Rama X is not concerned with worldly comforts, and the other occupants (the royal guards and servants) are well paid for their sacrifice.

The Grand Palace of Thailand is rather small compared to the nearby wats, and was relegated to ceremonial duties before the war (the royal family took up residence in a more modern structure on Bangkok's north side; the new king was persuaded to return to more traditional quarters where he could be watched more conveniently). Sharing common ground with the Wat Phrae Kaew (also known as the Temple of the Emerald Buddha), the grand palace is a jumble of 18th-century Thai buildings with high, peaked roofs, and the narrow, pointed towers whose gilded tops are reminiscent of the headdresses of the Thai temple dancers.

One of the first things we noticed was that there are these temple things and shrines everywhere in the city. Gold, silver, ivory, jade, jewels—all kinds of stuff just sitting around, sometimes out in the middle of the street. I asked Piri why nobody had walked off with the stuff. He took us over to a faint stain on the stone pavement.

"Last year, a farang tried to steal a relic from the Wat Saket," he said. "The mob caught up with him here. His comrades couldn't find enough of him to bury."

Wats: Bangkok has over 400 wats, or Buddhist temple/monasteries, ranging in size from the massive Wat Pho (containing the largest reclining Buddha statue in Thailand and a collection of thousands of other statues and relics) to small shrines containing one or two monks and a few statues. Some of the relics and statues are made of gold, jade, or other precious materials, and many of them are gigantic. The reclining Buddha of the Wat Pho is almost 45 meters long and 15 meters in height, and all of it is covered in gold leaf. The so-called Emerald Buddha (it is probably made of jade) of the Wat Phra Keo is almost a meter in height. The Wat Traimit contains a Buddha over three meters in height, said to be made of more than five tons of gold.

Each wat consists of a central chapel or sanctuary, called a *bot*, which can only be entered barefoot and bareheaded. Cameras, radios, and weapons are forbidden in

the bot, and non-Buddhists are discouraged. Surrounding the bot is an outer, public area containing the monks quarters and whatever else is associated with the wat. Larger wats may also contain libraries, museums, dormitories, shrines, reliquaries, and more than one bot. The largest have permanent staffs, consisting of groundskeepers, janitors, librarians, museum curators (if the wat has a museum associated with it—most large ones do), and musicians and dancers for ceremonies.

Worshippers at a wat bring offerings of fruit and/or flowers, and burn incense while praying. Musicians and/or dancers may be hired for an especially important ceremony.

Shrines: Smaller holy places, called shrines, are also scattered throughout the city (and the countryside). People may worship at these in the same way as at wats, leaving offerings, hiring dancers, and so on.

Canals: Bangkok is a city built on a swamp, and the city was once crisscrossed by a network of canals. Some were covered over and converted into broad streets, others are still open and in use (much as those of the Italian city of Venice). A disadvantage of the city's location is this: Bangkok has been subsiding continuously for decades. Massive engineering projects in the 1990s only slowed the process, and with the abandonment of these projects, the subsidence has begun again. Buildings have collapsed when their foundations were undermined or have sunk so far into the ground that their ground floors flood with the slightest rain. Some waterfront buildings become islands during the rainy season.

Bangkok's canals always served double duty as sewers and still do in 2000. One advantage of the present situation, however, is that the level of industrial waste dumped into the canals has dropped considerably in the last few years.

Floating Markets: The riverside and the large number of canals in Bangkok have created a large number of floating market places, which shift location as weather and tide dictate. Before the war, the markets tended to be dominated by produce farm-

ers. Nowadays, fishermen from the gulf, farmers, and merchants from upriver bring their wares into the city to sell. Also, there are floating taverns, barber shops, greengrocers, gun repair shops, casinos, butchershops, and even a floating red light district.

Floating merchants (mostly native Thais who pay protection money to one of the river- or canal-side gangs) can be found along the Chao Praya River, and along any canal in town almost every hour of the day (the local gangmembers protect them from thieves). Because they tend to be under a particular gang's protection, the same merchant will tie up in the same spot for weeks on end (or until he sells out).

Pahurat District: This small section of town, which borders on Chinatown, is the Indian quarter, formerly a retail/wholesale fabric center before the war. It is now the center of the Bangkok silk trade, the one aspect of the economy not dominated by the Chinese or Japanese. Silk factories process the raw silk brought in from the northeast, dyeing it, weaving it, and (sometimes) making it into garments. The factories of the district are small, labor-intensive sweatshops in the worst tradition of such things. The weavers and master dyers are well treated, but the unskilled labor needed to provide the motive power for the looms or to stir the dye vats, consists of oppressed, exploited bonded laborers from the countryside or from the poorer districts of the city.

Banglamphu District: Before the war this was the cheap hotel section of the city. Now, it is the place where the *farang* (foreigners) are sequestered, more by custom than for any other reason. Since most of the signs were already in English and French, and most of the buildings were already hotels, it was easier to accommodate Europeans in this section of town than elsewhere. Foreign soldiers tend to concentrate here between jobs.

Chinatown: In Bangkok, as in most non-Chinese cities in Southeast Asia, there exists a sizable Chinese community. Before the war, the local Chinese were almost all engaged in some form of small business (jewelry, hardware, wholesale food, clothing, etc.), showing the same entrepreneurial spirit they demonstrate almost everywhere but China. Even before the war, however, the underground criminal organizations known to outsiders as triads (almost like



family businesses in themselves) were a strong power. The chaos of the postwar world has strengthened them tremendously, although the majority of Chinese do not belong to any such association. In combination with the Junta and the Japanese yakuza mercantile/criminal associations, the Chinese effectively run Bangkok.

The new city can be divided into the old business district, the old residential districts, and the newer areas like the Patpong District which do not resemble the rest of the city very much at all.

Old Business District: Before the war, this was the center of a vibrant downtown business area, filled with banks, hotels, currency exchanges, and business offices of all sorts. A few of these buildings are now deserted, but many are still occupied and serve as the center of town. The district is now divided into various neighborhoods controlled by one of the Japanese or Chinese mercantile/criminal conclaves, by one of their associated gangs, or (to a lesser extent) by soldiers of the Junta.

Old Residential Districts: Many of these stand empty now, deserted and long since stripped and looted of things of value by the systematic street gangs in the employ of one of the large criminal cartels. The gangs (mostly ethnic Thais affiliated with one of the three main yakuza groups in the

city) also protect occupied neighborhoods from similar depredations—for a price.

Patpong District: The Vietnam War brought large numbers of American military personnel to Thailand, including Air Force units and soldiers on R&R (rest and recreation). The area of the city that became the center of GI entertainment during the late '60s and early '70s came to be called Patpong Road after the Chinese millionaire (Phat Phong) who owned most of the land in the neighborhood. The district's bars, strip clubs, massage parlors, and brothels changed clientele after 1975 when the Vietnam War ended, but continued to conduct business as usual. The war has changed little in the district, except that plumbing and electrical power are now less dependable than they once were, and the variety of "entertainment" available has expanded to include many formerly illegal activities. In the Patpong of 2000, the value of human life has dropped considerably—the death or disfigurement of a prostitute is of concern only in that it represents lost revenue for the owner (unless the patron pays extra). Kick-boxing matches often go to the death (as they did in past centuries).

Patpong is the largest area where such operations take place and is still controlled by the Chinese conclave (discussed on page 18). It serves as a steady market for some of the drugs from the north. Similar, but transitory, operations exist in other neighborhoods.

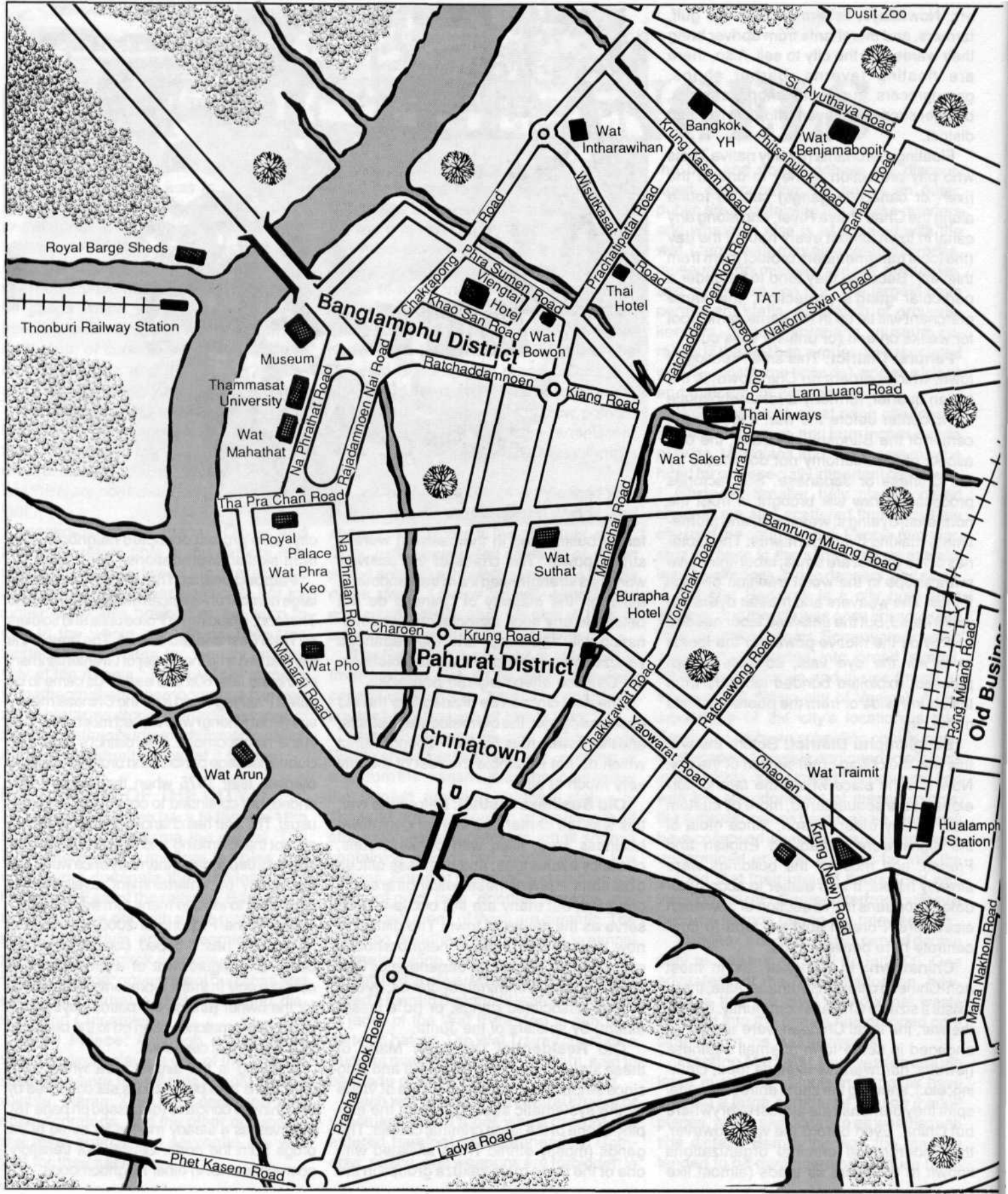

Dusit Zoo

Si Ayuthaya Road
Wat Benjamabopit

Bangkok YH
Wat Intharawihan

Royal Barge Sheds

Thonburi Railway Station

Banglamphu District

Museum
Thammasat University
Wat Mahathat

Phra Sumen
Viengtai Hotel
Khao San Road
Wat Bowon

Thai Hotel
TAT

Larn Luang Road
Thai Airways

Tha Pra Chan Road

Royal Palace
Wat Phra Keo

Wat Suthat

Wat Saket

Bamrung Muang Road

Pahurat District

Wat Pho

Burapha Hotel

Chinatown

Wat Arun

Wat Traimit

Old Business

Hualamph Station

Phet Kasem Road

Ladya Road

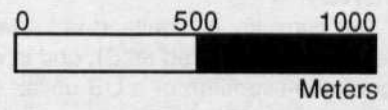

Bangkok and Environs

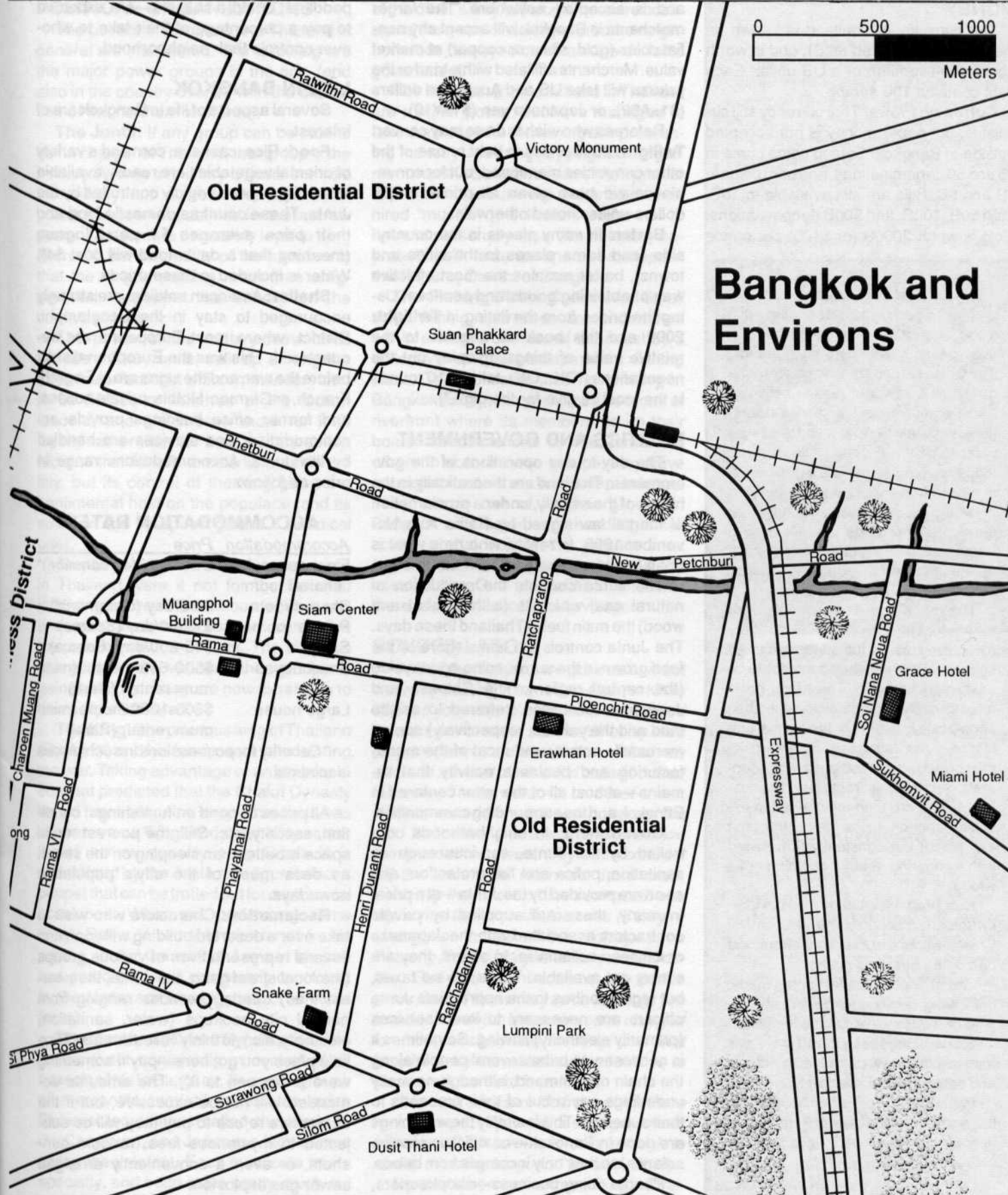

Old Residential District

Victory Monument

Suan Phakkard Palace

Muangphol Building

Siam Center

Old Residential District

Erawhan Hotel

Grace Hotel

Miami Hotel

Lumpini Park

Dusit Thani Hotel

Business District

ong

Si Phya Road

Surawong Road

Silom Road

Charoen Muang Road

Rama VI Road

Rama IV Road

Rama I Road

Phayathai Road

Henri Dunant Road

Ratchadamri Road

Ratchaprarop Road

New Petchburi Road

Soi Nana Neua Road

Sukhomvit Road

Expressway

MONEY

The currency in Thailand is known as the *baht* (abbreviated as B), and is worth about one-twentieth of a US dollar. Each baht contains 100 *satang*.

Currency: Prewar Thai currency still circulates, but paper money is not accepted outside of Bangkok. Satang coins come in 25 and 50 denominations, and baht coins in 1B and 5B. Bills are still available in 10B, 20B, 50B, 100B, and 500B denominations. Gold is worth 2000B (or \$100) per ounce

THE TRIADS

The Chinese syndicate consists of a loose cooperative of smaller organizations, primarily extended-family groups. The Chinese triads tend to concentrate on small-scale mercantile activities (mostly "legitimate") and vice operations such as the bars and pleasure palaces of the Patpong District. The triads have no single leader, merely a number of powerful heads of families who form a sort of ruling council. Like the Junta, the triads present a solid front to outsiders, but there is considerable infighting among the council members.

The triads profess a strong dislike for foreigners (non-Chinese) but they particularly dislike the Japanese (their chief rivals), whom they consider to be crude and barbaric. The triads go in more for subtle manipulation rather than large-scale mayhem or the strong-arm tactics of the Japanese. For example, their preferred method of gaining cooperation from recalcitrants is to take hostages, who are then maintained in exquisite comfort (considering the time and place) but constantly threatened with a lingering death if anything goes wrong.

Hua Triad: Headed by the Hua family, this triad controls the east half of Chinatown, its associated riverfront, and part of the business district.

Zheng Triad: Smallest of the triads, the Zheng family controls about one-third of the Bangkok business district.

Li Triad: Headed by the Li family, this triad controls the west half of Chinatown and its associated riverfront.

Phat Triad: The Yu family inherited this district from the heirs of Phat Phong, although the triad is still known by the old name.

and is accepted anywhere. The larger merchants in Bangkok will accept any non-fiat coins (gold, silver or copper) at market value. Merchants affiliated with a triad or the yakuza will take US and Australian dollars (\$1=A\$2), or Japanese yen (\$1=¥10).

Referees who wish to do so may convert **Twilight: 2000** prices to baht or one of the other currencies mentioned, but for convenience we have given all prices in US dollars unless noted otherwise.

Barter: In many places in the countryside (and some places in the cities and towns), barter remains the most effective way of obtaining goods and services. Using the prices from the listing in **Twilight: 2000** and this book as a guide to the relative value of things, roleplay out the negotiations ("OK...OK...tell him 10 rounds is the most I'll give for the pig...").

POLITICS AND GOVERNMENT

The day-to-day operations of the government in Thailand are theoretically in the hands of the military, under a proclamation of martial law signed by Rama X in November 1998. In reality, who runs what is open to some debate.

The Junta controls the production of natural gas, which is (with alcohol and wood) the main fuel in Thailand these days. The Junta controls the lion's share of the food grown in the surrounding countryside (the central region). The Chinese and Japanese collectives (referred to as the triad and the yakuza, respectively) control mercantile activity and most of the manufacturing and business activity that remains—almost all of the latter centered in Bangkok and the surrounding communities.

Government: In neighborhoods controlled by the Junta, services such as sanitation, police and fire protection, and soon are provided by the Junta—at a price. In many, these are supplied by private contractors associated with the Japanese or Chinese collectives. In others, they are simply not available. There are no taxes, but regular bribes to the appropriate Junta officers are necessary to keep services (primarily electricity) flowing. Sometimes it is necessary to bribe several people along the chain of command, although normally underlings pay a cut of their proceeds to their superiors. This is simply the way things are done in Bangkok—no officials receive salaries, so their only income is from bribes. People doing business—shopkeepers,

peddlers, or hired soldiers—are expected to pay a percentage of their take to whoever controls their neighborhood.

LIFE IN BANGKOK

Several aspects of life in Bangkok are of interest.

Food: Rice, cassava, corn and a variety of oriental vegetables are readily available in the city, at prices rigidly controlled by the Junta. These count as domestic food and their price averages \$2 per kilogram (meaning that a day's food will cost \$4). Water is included in these prices.

Shelter: American soldiers are strongly encouraged to stay in the Banglamphu District, where most Europeans are sequestered. This was the European district before the war, and the signs are in English, French, or German. Hotels, private houses, and former office buildings provide accommodation, and services are handled by the Junta. Accommodations range in price as follows:

ACCOMMODATION RATES

<i>Accommodation</i>	<i>Price</i>
Floor space, shared room	\$1-3/day (Very common)*
Shared room	\$3-5/day (Common)*
Private room	\$15-50/day (Scarce)
Suite	\$45-200/day (Scarce)
Small house	\$500-800/month (minimum rental) (Rare)
Large house	\$600-1000/month (minimum rental) (Rare)

* Security for possessions in such places is minimal.

All prices depend on furnishings, condition, security, etc. Still, the poorest rental space is better than sleeping on the street, as does much of the city's population nowadays.

Reclamation: Characters who wish to take over a deserted building will soon find several representatives of various groups (the local street gang, the Junta, the nearest triad) offering services ranging from normal city hookups (water, sanitation, electricity, etc.), to thinly veiled threats ("Nice little place you got here—pity if something were to happen to it"). The amounts demanded will not be excessive, but if the characters refuse to pay they will be subjected to mysterious fires, random gunshots, or even a conveniently arranged sewer gas explosion.

POLITICAL ORGANIZATIONS

The politics of Bangkok and Thailand in general are intertwined. The following are the major power groups in the city, (and also in the country overall, with the exception of the northern warlords).

The Junta: If any group can be said to be "in charge" of Thailand, that group is the military. A junta of military officers controls the military, and a precarious balance of power has been maintained for the last few years. The Junta is ostensibly loyal to King Rama X, but the reality of the situation is that the king is nothing more than a figurehead—a puppet that dances on the Junta's strings.

The power of the military rests in its various military units, split up among the three major factions. Unit commanders tend to be friends or relatives of the faction leaders, and are chosen more for their loyalty rather than for their military ability. Most of the Junta's assets lie outside the city, but its control of the king gives it a sentimental hold on the populace (and its soldiers and weapons give it a practical one).

The Junta would be the sole power base in Thailand were it not for the fact that infighting between the various factions and a deep-seated, top-to-bottom corruption has weakened the military. The situation has allowed the various other groups to gain power, and they are now too strong to be easily eliminated.

The King: The previous king of Thailand (Rama IX) and his family were killed during the war. Taking advantage of an old prophecy that predicted that the Chakri Dynasty would have only nine kings, the Junta has chosen a new "king" and ostensibly established a new dynasty. King Rama X is maintained by the Junta as a figurehead, a puppet that can be trotted out for ceremonial occasions. When not performing some ritual, Rama X remains cloistered in his palace, under the watchful eye of his palace guard (which is completely controlled by the Junta) and a small group of servants (ditto).

The Merchant/Crime Syndicates: The Junta is not completely in control of all aspects of life in Bangkok. Two main groups of mercantile/criminal syndicates exist: Chinese (sometimes called the triads or the Conclave), and Japanese (sometimes called the yakuza). Each syndicate has a specialty, and each stays pretty much out

of the other's way, although there are occasional flare-ups of violence. In some neighborhoods, the syndicates are the de facto government.

The Indians: Ethnic Indians in Thailand are a minor power, but have managed to take control of the remaining silk processing industry (weaving, dyeing, some garment manufacture) because of their prewar expertise in the business. Indians and their hired "muscle" (the Indians prefer not to have to personally resort to violence) operate the silk factories and sweatshops in the Pahurat District of Bangkok.

The Fishing/Pirate Collective: Small scale fishing operations are undertaken within a couple of miles of the coast by a collective of quasi-independent fishing clans. This collective has no territory in Bangkok except the unclaimed sections of riverfront where its members tie up their boats. Despite efforts by the Junta and others to absorb these groups, they have managed to maintain their independence. They remain one of the few groups in Bangkok with expertise in handling small boats, a vital skill at the present time. Several such collectives exist along the coast of the Gulf of Thailand, wherever there are clusters of fishing villages.

BONDED LABOR

One of the first jobs we got was to meet a convoy coming in from Can-Can (or Khan Kaen, if you will). We got there and picked up a couple of stake trailers full of liquified propane, about a dozen ox carts full of raw silk, and a crowd of what Piri called bonded laborers. There were 40 or 50 of them. Walters asked Piri what was going on. Piri said that when a peasant family has too many mouths to feed, they often contract off the excess in return for hard cash. Evidently they work off the contract in one of the rice farms or silk factories (if they're strong), or in one of the nightspots on Patpong Road (if they're female and attractive). Seems the contract is usually for five years, but all the while you're working, you accumulate debts because you're recharged for food, shelter, and clothing, and that lengthens the term, because you have to serve until the debt is paid off.

"It is an unpleasant life from which there is no escape," Piri said, a strange note to his voice. "Unless one is lucky enough to speak a farang tongue..." he said, finally.

Bonded labor is a common thing in Thai-

THE YAKUZA

The yakuza, as the Japanese criminal/mercantile cartels are known, differ from their Chinese counterparts in that they tend to concentrate on the extortion/protection of smaller operations rather than engage in the operations themselves. Like the Chinese triads, all the yakuza groups in Bangkok have formed a cooperative ruling council of powerful leaders. The three main groups are the *Ni Tora*, headed by the Asukata family, the *Hana*, headed by the Sasaki family, and the *Juuku Rinjin*, headed by the Kono family. The yakuza or their associated gangs control portions of the business district and most of the old residential district.

The yakuza despise the Chinese as effete and overly sensitive, and their operations tend to be more more violent than the triads' (the yakuza preferring arm-twisting and terror to more subtle methods—in this way they resemble Americans). The yakuza do their own fighting, and seldom hire foreigners (non-Japanese) except for special cases and where they do not wish to be connected with a particular incident.

land in the year 2000, a reflection of the desperation of existence in some circles. Bonded laborers working in the farms of the Junta or one of the independent communities are not much worse off than most peasant farmers in the country. Life is less pleasant for those working in the silk factories or the Patpong District in Bangkok. Those unfortunate to be sent to the tin mines in the south have much reduced life spans.

In essence, a person wanting a worker will pay a sum of money in advance in return for a fixed period of service. A written contract is usually (but not always) maintained, but this is often in the hands of the hirer, with all the possibilities for abuse of the terms that implies. The laborer then works until the "loan" is paid off, usually for a specified period of from five to seven years. At the end of this time, however, the laborer has usually accumulated more debts (since these laborers are billed for food, clothing, and other necessities) and must work to pay off that debt—in a continuing cycle. Most contracts are effectively for life—slavery, in other words.

Street of the Seven Brothers

The group has been hired to "whomp on" a street gang that has delusions of grandeur. The only problem is that the "Street" of the Seven Brothers is a canal, and its headquarters building an island.

BACKGROUND

The Technical Union is a conglomerate of small "guild" associations of vitally needed craftsmen and technicians, who own no territory, but wield tremendous power notwithstanding. With the passage of time, technical expertise is becoming increasingly scarce. These groups include people who have found that the common bonds of their knowledge and skills are stronger than their racial and ethnic ties. The unions stay independent mainly because no power group in Bangkok can afford to allow them to be controlled by a rival.

The group has been hired to act as "muscle" for the Technical Union: One of the small roving gangs, consisting mostly of ethnic

Japanese, but not affiliated with the yakuza, is attempting to settle in a union neighborhood, forcing out the technicians and their families. The gang has begun to terrorize the neighborhood, demanding extortionate "insurance fees" to guarantee the continued safety of the inhabitants.

The union has recently learned where this gang makes its headquarters and has hired the players' group to raid this area, destroy its headquarters and scatter the gang members.

APPROACH

The major complication to this adventure is that the building the gang has chosen for its headquarters is located on the edge of a canal and is low enough in the water that flooding and subsidence have effectively made it an island, surrounded on all sides by at least 1.5 meters of water. The water on the side of the building facing the canal is more than three meters deep.

Wading through water 1.5 meters deep can only be accomplished at the crawling rate, even though the characters are standing upright in the water. Because he cannot see where he put his feet, any wading character must roll every five-second combat

phase (Average: Agility) to avoid tripping on an unseen obstruction. Failure means the character trips and must spend three phases regaining his or her footing. Catastrophic failure means the character trips, drops his or her weapon, and takes six phases to regain footing and retrieve the dropped weapon.

MAP DESCRIPTION

The map shows the building, the abandoned warehouse/office of a small riverfront trading company, at the two-meter tactical scale.

REFEREEING THE SCENARIO

Fishing boats can only approach in the canal, but vessels with shallower draft (such as motorpans, sampans, or long-tailed boats) can approach from any direction. Players who can swim may approach from any direction. All normal swimming modifiers apply (as outlined in the **Twilight: 2000** rules).

Spotting: Any boat is automatically spotted when it enters the map if it does so during daylight, and is Easy: Observation to spot at night. Spotting tasks for characters wading or swimming are Average: Observation during the day and Difficult: Observation at night. Characters with a Stealth of 6 or higher are one level more difficult to spot (they swim underwater, breathe through reeds, or whatever).

NPCS

The gang consists of 27 members. Eighteen are presently in the building. The gang leader is a Veteran NPC (armed with an AK-74 and a 9mm Makarov pistol). Five of the gang members are Experienced (and are armed with two shotguns, two M16s and one FN-FNC). The remaining six members of the gang are Novices (armed with assorted melee weapons: knives, clubs, etc.). Each weapon comes with 50 rounds of ammunition appropriate to it. In addition, the roof of the headquarters building has a PK machinegun and six belts of ammunition, and a dozen homemade fragmentation grenades (tin cans filled with plastic explosive and nails) with which the gang can attack any approaching assailants.

Four members of the gang, stationed on the roof, are on watch at any given moment, each watching a different direction.

Equipment: The gang has a collection of booty looted from various merchants, including 10 liters of gasoline and various tools, articles of clothing, and food. The gang also has a motorpan (seldom used) and three sampans sheltered inside the "docking bay" formed by the flooded first floor.

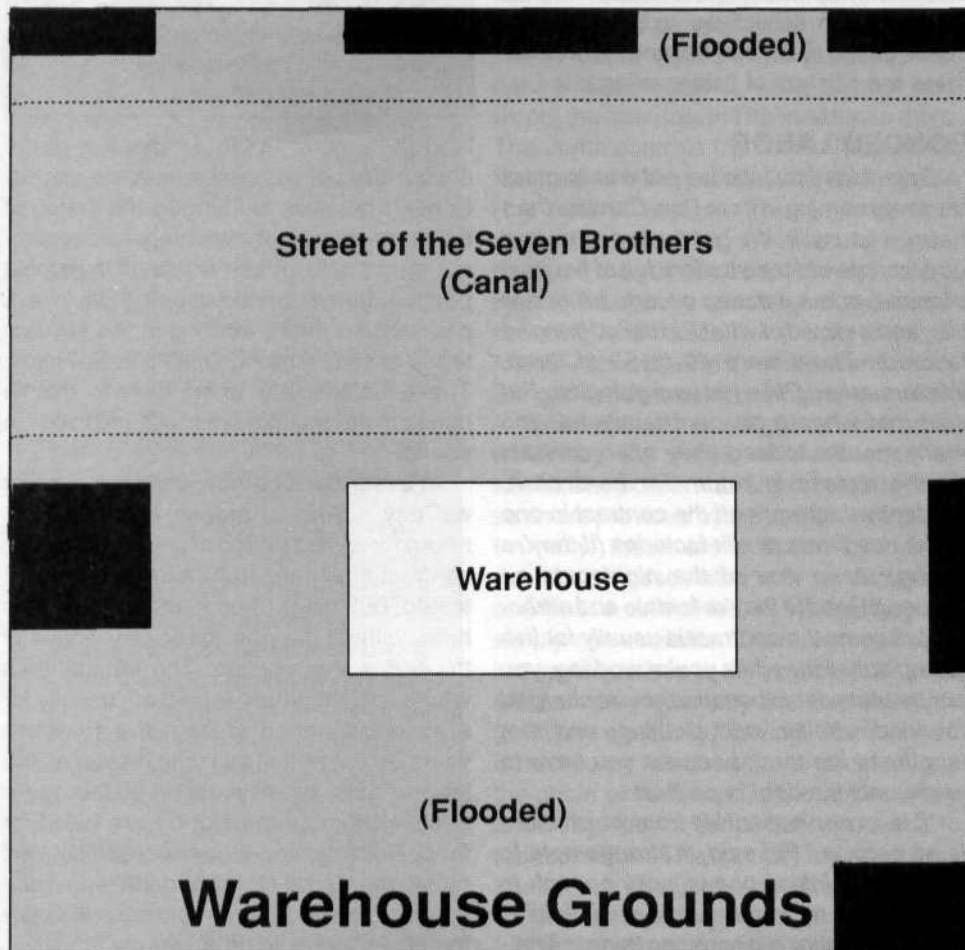

Abandoned Warehouse/Office

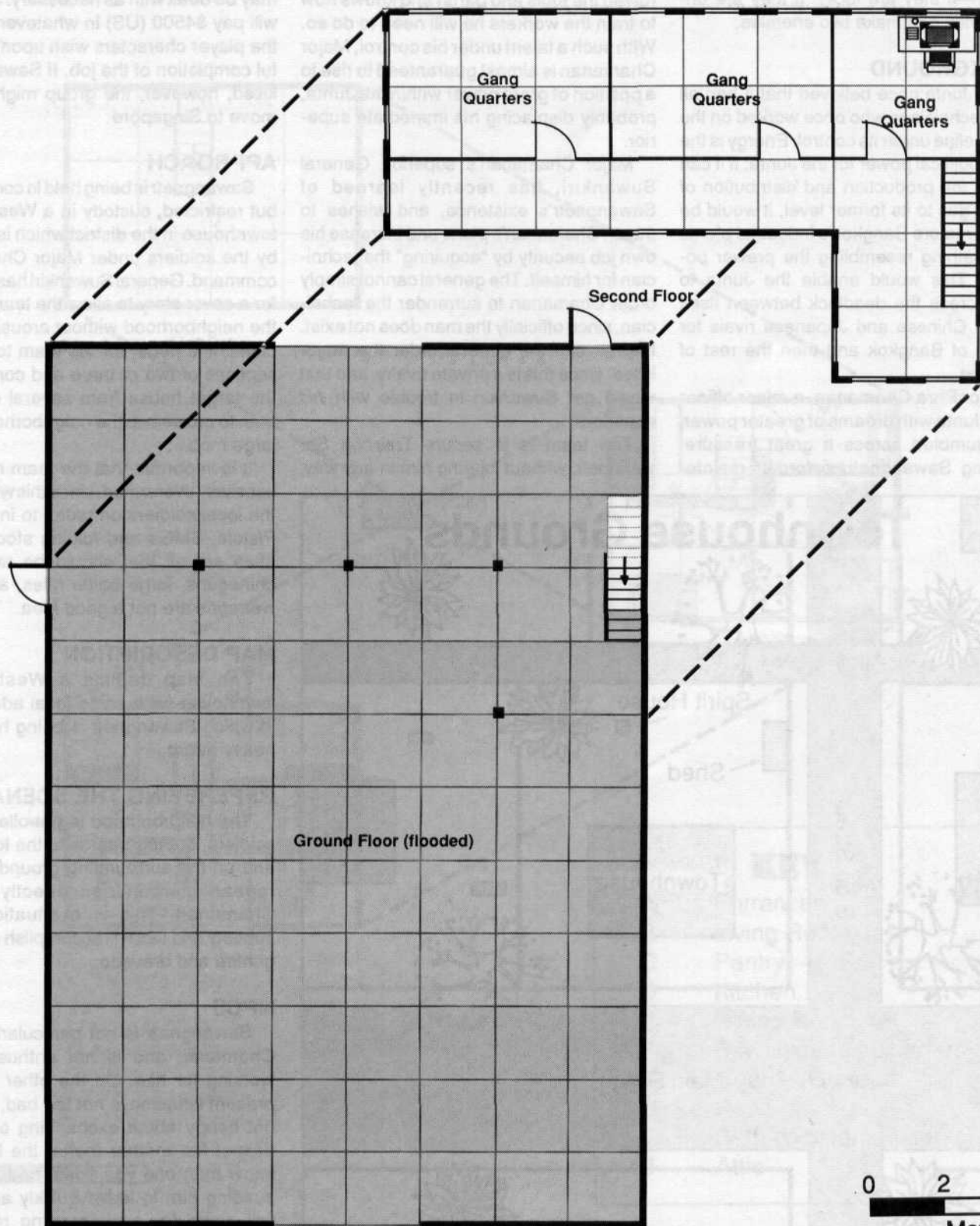

Smash-n-Grab

In this scenario, the players are granted the opportunity to make one friend and one enemy—if they are lucky. If they are unlucky, they can make two enemies.

BACKGROUND

The Junta once believed that it had all living technicians who once worked on the gas pipeline under its control. Energy is the key to political power for the Junta: If it can restore the production and distribution of natural gas to its former level, it would be able to restore Bangkok's industrial plants to something resembling the prewar potential. This would enable the Junta to finally break the deadlock between itself and its Chinese and Japanese rivals for control of Bangkok and then the rest of Thailand.

Major Phra Chamanan, a minor officer in the Junta with dreams of greater power, has stumbled across a great treasure: Trairong Sawangnetr, a former mainte-

nance crew chief for the gas pipeline with considerable experience on the offshore well platforms themselves. Sawangnetr knows how to get them running again (given the tools and parts) and knows how to train the workers he will need to do so. With such a talent under his control, Major Chamanan is almost guaranteed to rise to a position of great power within the Junta, probably displacing his immediate superior.

Major Chamanan's superior, General Suwankiri, has recently learned of Sawangnetr's existence, and wishes to thwart Chamanan's plans and increase his own job security by "acquiring" the technician for himself. The general cannot simply order Chamanan to surrender the technician, since officially the man does not exist. Neither can the general order the major killed, since this is a private rivalry, and that would get Suwankiri in trouble with *his* superiors.

The team is to secure Trairong Sawangnetr, without injuring him in any way,

and bring him safely to General Suwankiri's headquarters. Thai soldiers are not to be killed unless it is unavoidable, but any foreign mercenaries in Chamanan's service may be dealt with as necessary. Suwankiri will pay \$4500 (US) in whatever currency the player characters wish upon successful completion of the job. If Sawangnetr is killed, however, the group might as well move to Singapore.

APPROACH

Sawangnetr is being held in comfortable, but restricted, custody in a Western-style townhouse in the district which is patrolled by the soldiers under Major Chamanan's command. General Suwankiri has arranged for a cover story to allow the team to enter the neighborhood without arousing suspicions. It is better for the team to split into sections of two or three and converge on the target house from several directions than to cruise into the neighborhood in one large mob.

It is important that the team not be excessively overarmed, since this will provoke the local soldiers on patrol to investigate. Pistols, SMGs and folding stock assault rifles are all that should be taken. Machineguns, large battle rifles, and heavy weapons are not a good idea.

MAP DESCRIPTION

The map depicts a Western-style townhouse (with some local adaptations) in which Sawangnetr is being held under heavy guard.

REFEREEING THE SCENARIO

The neighborhood is patrolled by Thai soldiers, but the guards at the townhouse and on the surrounding grounds are European mercenaries directly loyal to Chamanan. This is a situation where subtlety and tact will accomplish more than gunfire and bravado.

NPCS

Sawangnetr is not particularly loyal to Chamanan and is not enthused about working for him. On the other hand, his present situation is not too bad, and he is not happy about exchanging one quasi-despot for another (better the tyrant you know than one you don't, he feels). Persuading him to leave quickly and quietly will make for an interesting roleplaying session.

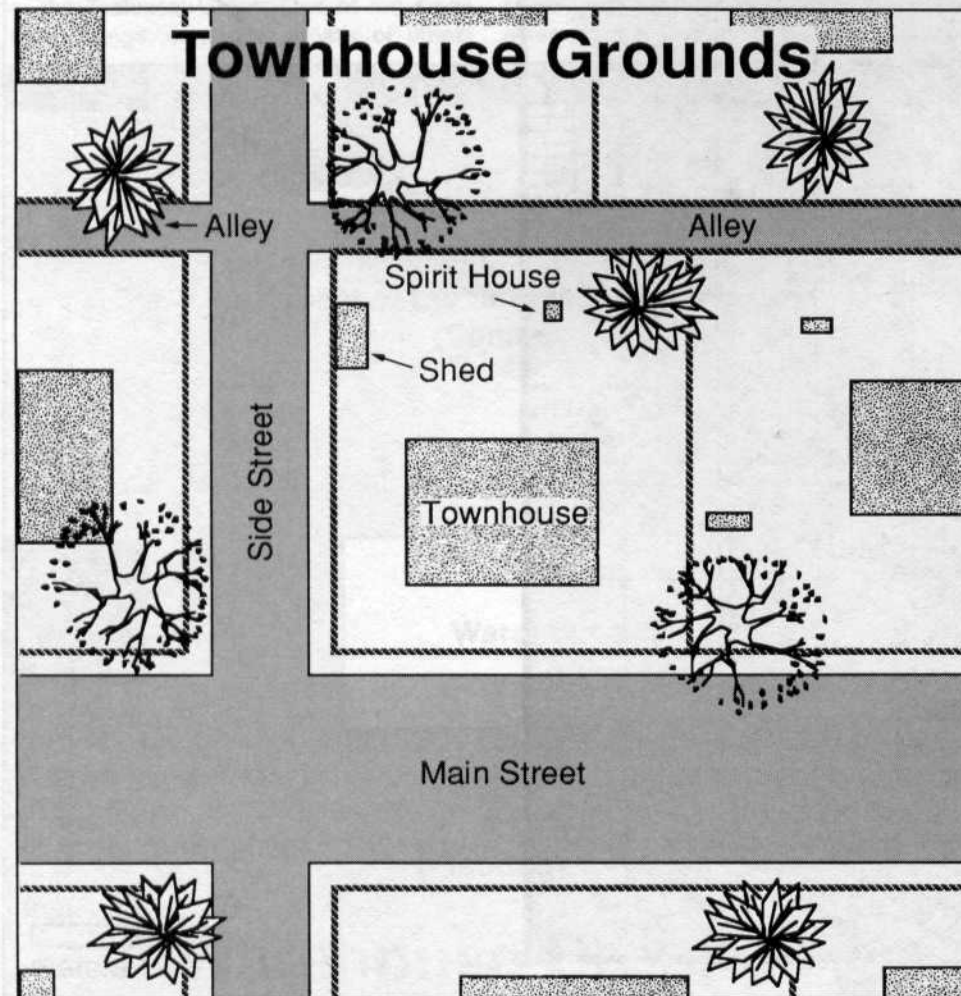

Western-Style Townhouse

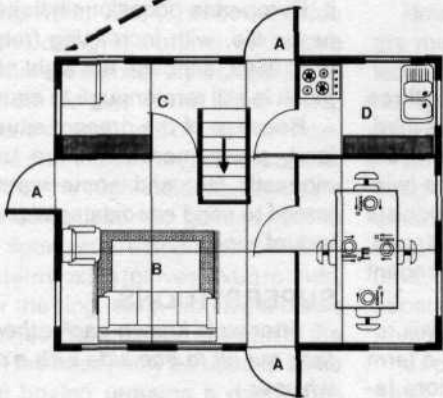
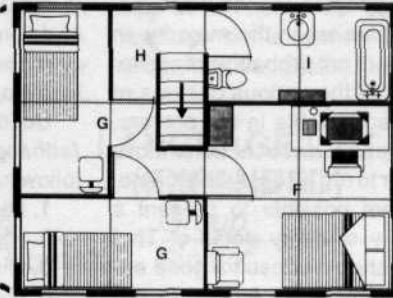
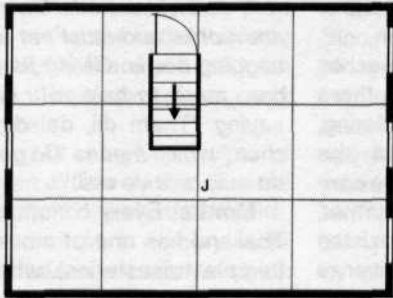

KEY

- A Entrances
- B Living Room
- C Pantry
- D Kitchen
- E Dining Room
- F Sawangnetr's Quarters
- G Guards' Quarters
- H Hall
- I Bath (Western Fixtures)
- J Attic

0 2 4
Meters

CULTURE

After we settled into the abandoned hotel, we found this little dollhouse thing in the lobby. Piri, the Thai guide we hooked up with, said that each Thai house (including hotels) has a spirit house, where the spirits of the site live. You have to have a spirit house, because otherwise the spirits will take up residence in your house, and that can only mean trouble for all concerned. Evidently it's pretty easy to fool the little suckers into thinking the spirit house is a better deal—just leave them some food and burn a little incense once in a while. I wish the freakin' mosquitos were that easy to deal with.

Many different peoples inhabit Thailand, although ethnic Thais are in the majority. In any case, our readers are probably unfamiliar with most aspects of the various cultures of Thailand. This is acceptable in the players, but the referee must have a little more knowledge in order to run an enjoyable game. Of course, it is not possible to present a complete summary of every detail of Thai culture. Referees should consult a good encyclopedia at the very least. A good tourist guidebook (such as *Fodors*) from a bookstore will prove a worthwhile investment for the referee planning an extensive campaign.

BUDDHISM

Ninety-five percent of all Thais are Buddhists, and Buddhism permeates nearly every facet of life in Thailand. Buddhism was founded in the 6th century B.C. by Gautama Buddha, an Indian prince turned ascetic, although it never took hold as deeply in India as it did elsewhere in Asia. Buddha means "the enlightened one," and is a title granted to Gautama, not a name, as many non-Buddhists believe.

The dominant school of Buddhism practiced in Thailand, *Theravada*, is the oldest and purest form (at least, according to its adherents). Followers of the *Mahayana* school (another form of Buddhism common in Thailand) call the *Theravada* school *Hinayada* (the "lesser wheel"—*Mahayana* meaning "greater wheel"), and consider their form to be superior. Nobody really makes a federal case about it, and doctrinal differences are minimal. Buddhism is largely free of the sectarian strife that afflicts some other religions. Indeed, many Buddhists see nothing particu-

larly wrong with following the beliefs of one or more religions in addition to Buddhism.

Buddhism in Brief: *Theravada* teaches that Gautama Buddha discovered three principal aspects of life: *Dukkha* (suffering, dissatisfaction, and disease), *Anicca* (the transience of all things), and *Anatta* (the non-substantiality of the human soul). Further, Gautama Buddha taught that there existed four "noble truths" which had the power to liberate anyone who had complete understanding of them. These were:

- Existence is suffering.
- The cause of suffering is desire.
- Suffering will cease with the elimination of desire.
- The elimination of desire will result from following the eight-fold path.

Buddha then outlined the eight-fold path (*atthangika-magga*), which consists of the following "limbs":

1. Right understanding
2. Right-mindedness
3. Right speech
4. Right bodily contact
5. Right livelihood
6. Right effort
7. Right attentiveness
8. Right concentration

The eight limbs of the path belong to three "pillars" of practice: *sila* (morality—the third, fourth, and fifth), *samadhi* (concentration—the sixth, seventh and eighth), and *panna* (wisdom—the first and second). Some Buddhists believe that the path can be taken in stages, some hold that each limb is interdependent with the others.

The complete extinction of desire will result in *nibbana* (*nirvana* in Sanskrit, a term with which some readers may be more familiar), the ultimate objective of Buddhism. *Nirvana* is an end to the cycle of birth and rebirth, and an end to karma (suffering and action—in Buddhism karma is only negative). The cycle of birth and rebirth, or reincarnation, is commonly accepted in Thailand, even among non-Buddhists.

Many Thais seem to believe that they will never be able to achieve *nibbana*, and are willing to settle for a reduced number of reincarnations, achieved by good works such as donations to temples and almsgiving to monks.

One morning as we were moving through the market, we passed a couple of guys in orange robes walking along the road. They looked pretty scraggly, and they each held a wooden bowl in front of them, so I figured them for some kind of beggars. I was going to drop a couple of coins in their bowls when Piri (our guide) stopped me.

"Food..." he said. "Give them food. They are monks and must eat what is put in their begging bowls. Giving them food gains you bun, merit, to help your karma. We have a saying: 'Tham dii, dai dii; tham chua, dai chua,' which means 'Do good, receive good, do evil, receive evil.'"

Monks: Every community of any size in Thailand has one or more associated *wats* (temple/monasteries), where the local Buddhist monks spend their time in meditation, study, and worship. Each *wat* has a public section and a chapel (the *bot*), or area of sacred ground (visitors must remove their shoes). Buddhist monks are readily identified by their orange robes, their shaven heads, and their begging bowls. Monks are completely dependent on the largess of others, and each morning go out of the *wat* on their alms rounds. Monks may eat only what is put in their begging bowls and may only eat solid food in the morning. Every Thai male is supposed to be a monk for a short time (three months is the traditional period, although some remain in the *wat* as little as seven to 10 days) but some choose to devote their lives to it. Europeans occasionally take up the monastic life, with increasing frequency since the 1960s, although the sight of a European monk is still rare enough to cause comment.

Because of the present situation in Thailand, many more men are taking up the monastic life, and some *wats* have been forced to send candidates elsewhere due to lack of room.

SUPERSTITIONS

After we'd known each other a while, Piri took me off to one side with a conspiratorial whisper.

"Don't let anyone know where you got this," he said, pressing something into my hand. "It will keep you safe. It was made many years ago by a holy man from Three Pagodas Pass named *Utama*, which means fortunate."

I looked at it. It was a little medallion on a gold chain, and didn't look like much of anything really. About then I noticed that Piri had a neckful of the little things. I reached to put it into my pocket, and Piri stopped me.

"No, No. In your shirt pocket or around your neck. In battle, you should carry it in your mouth, it will work better."

I put it on the chain with the St. Christopher medal my Aunt Maria gave me when we shipped out. Does it work? One of 'em must—I'm still here.

Many Thais are very superstitious, and almost every one carries at least one good-luck amulet, sometimes called a *hai-huang* ("worries away"—other varieties serve other purposes). Amulets are made by holy men (the more stoic the maker the better the luck) and must be worn higher than the heart to be effective. In battle, Thais sometimes carry them in their mouths.

To Thais, the feet are a very unlucky part of the body, and it is an extremely ill-mannered thing to do to point them directly at someone. (Licking the fresh fruit in a grocery store would evoke about the same level of revulsion in Western eyes.) Pointing at an object with the feet is even worse (don't ask). In some rural areas, the reaction will be stronger.

Sports: Many Thais are soccer fanatics, and public games are still put on in the national stadium in Bangkok from time to time to keep the populace happy. The game should be familiar to most readers.

Street-corner fighting fish matches are also very popular, and provoke heavy wagering. Two specially bred fish are dropped into a bucket and try to tear each other apart while the dozen or so spectators place bets on the winner. Similar matches between fighting cocks are less common (by 2000, chickens are for eating, not fighting).

Thai Boxing: *Muay Thai* (Thai boxing, also known as kick-boxing) is a branch of the tree of oriental unarmed combat styles, and dates back to the 15th century of the present era, when it appears in accounts of the Burmese/Thai wars. The sport has always been popular in Thailand, but the high incidence of death during matches caused the government to regulate the sport with restrictions similar to those of Western boxing (gloves, fixed rounds, a set size for the ring, etc.). No illegal blows were established, though, and any part of the body (except the head) may be used to strike a blow. Thai boxing remains a dangerous sport for the participants, especially after the war, when fewer restrictions are observed and matches are once again becoming deadly.

Music: Thai music sounds strange to Western ears because it uses a different scale. The instruments it uses are similar in overall principles (drums, strings, woodwinds, etc.) but are tuned to the Eastern scale.

LANGUAGES

Some of the languages covered in this book are not listed on the **Twilight: 2000** language table. We have reproduced the

expanded Language List elsewhere on this page. The same definitions and rules apply as in the basic rules. The Ethnolinguistic Map on page 7 shows where the various languages are spoken. Players and referees may not be familiar with some of the languages dealt with in this book, and a short discussion of each is therefore in order.

Mandarin and Cantonese: These are two Sino-Tibetan languages which use the same ideograph writing system but are mutually unintelligible each other otherwise. What this means is that a speaker of Cantonese and a speaker of Mandarin cannot talk to each other, but each could easily read the other's newspaper (in the same way that the numerals 1, 2, 3, etc., can be read and understood by both a French speaker and a German speaker).

Thai: Thai (also known as Siamese) is spoken by 95% of the population of Thailand and has its own script, which means that even fluent speakers of Thai may not be able to read books, letters, street signs, and so on.

Lisu, Lahu, and Akha: These are minor hill tribe dialects of the Tibeto-Burman family. They have no native written form.

Karen, Kayah: These are minor hill tribe dialects of the Karenic family. They have no native written form.

Hmong, Mien: These are minor hill tribe dialects of the Austro-Thai family. They have no native written form.

Laotian: The language of the various ethnic Laotians in the extreme north of Thailand. Laotian has a separate written form from other languages.

Japanese: Japanese is seldom encountered outside of Bangkok, where it is spoken by the merchant criminal cartels known as the *yakuza*. Japanese uses a combination of a syllabary (where a single symbol represents a syllable instead of a whole word) and Chinese-style ideographs, although it can also be written in Latin

letters as well.

Hindi-Urdu: The language of the Indians in Thailand, Hindi-Urdu is seldom encountered outside of Bangkok. It has its own unique script.

Vietnamese: This language is spoken by a small number of Vietnamese refugees fleeing the fighting in Kampuchea who are located along the eastern border of Thailand. It uses primarily Latin letters in its written form.

Cambodian: The language of the numerous Cambodian refugees fleeing the fighting in Kampuchea. It has a unique script.

Malay: The language spoken by ethnic Malays in the southern peninsula of Thailand.

Pidjin: Pidjin is a trade language consisting of numerous words and phrases borrowed from English and a number of other European and Asian languages, which uses an extremely simple grammar. No one is a native speaker of Pidjin, but most merchants, storekeepers, and village headmen will have it at levels 3-8 (1 D6f 2). Pidjin may be learned in the same way any other language skill is learned (see the basic rules under **Acquired Skills**).

LANGUAGE LIST (EXPANDED)

<i>Family</i>	<i>Group</i>	<i>Language</i>
Sino-Tibetan	Sinitic*	Mandarin Cantonese
	Tibeto-Burman	Thai Lisu Lahu Akha Burmese Laotian
	Karenic	Karen Kayah
	Austro-Thai	Hmong Mien
Indo-Iranian	Indic	Hindi-Urdu
Japanese	Japanese	Japanese
Vietnamese	Vietnamese	Vietnamese
Mon-Khmer	Mon-Khmer	Cambodian
Malayo-Polynesian	W. Malayo-Polynesian	Malay Semang Indonesian
Pidjin	Pidjin	Pidjin

*All languages of the Sinitic group are mutually unintelligible in their spoken form, but they are 100% mutually intelligible in their written form, since they all use the same characters.



GENERATING CHARACTERS

In order to accommodate those who wish to play Thai characters and to assist referees in creating Thai NPCs, we provide this chapter. Character generation for **Bangkok** follows the basic rules, with the following exceptions:

Background: The most playable characters will be native Thais or one of the other cosmopolitan ethnic groups. Thai military characters will undoubtedly be the most popular. Naturalized Thai citizens of non-Thai background are also possibilities. Hill tribesmen characters will not be as interesting to the mainstream, but still may appeal to some.

American soldiers, sailors, marines and airmen from the enclave at Cam Ranh Bay, Vietnam, can be generated using the basic rules with slight modifications to their service history.

Native Language: Thai characters receive Thai as their native language. Other ethnic groups may receive Thai as a secondary language (consult the Nationality/Language Chart on the facing page).

Secondary Activities: Use the secondary activities listing on page 20 of the basic rules, except for hill tribe characters, who use

the list on page 27.

Military Careers: Army, navy, air force and marine careers are open to Thai characters. The rule on reserves (page 20 of the basic rules) applies. Ranks are the same as in the US military.

Army: Thai characters may choose from among the infantry, artillery, armor, airmobile, engineers, special forces, and support branches. Basic training in all branches is the same as for the US.

Navy: Branches and basic training are the same as for the US Navy, as noted in the basic rules, except that there is no SEAL branch.

Air Force: Branches and basic training are the same as for the US Air Force, as noted in the basic rules. Because of its traditional attachment to the royal family, the Thai air force opposed the Junta in 1997-1999. Because of this, the air force was disbanded (the planes are now the responsibility of the navy), and no member or former member of the Thai air force may be a member of the Junta.

Marines: Branches and basic training are the same as for the US Marines, as noted in the basic rules, except that there are no force

recon branches in the Thai marines.

Thai military personnel will have seen combat only against the drug warlords or one of the antigovernment insurgent groups before the war. After 1998, antimarauder (army) and antipirate (navy, marines) actions are increasingly likely.

Civilian Careers: All civilian occupations listed in the basic rules are available to characters of every ethnic background except hill tribe. Only hill tribe characters may choose the hill tribesman career. Likewise, hill tribesman is the only civilian career open to a hill tribe character.

Contacts: Care must be taken to formulate contacts appropriate to the background.

Vehicles: Characters in the Thai military receive vehicles according to the Starting Vehicles table in the sidebar on the next page.

Equipment: Use the right hand availability rating when purchasing equipment.

HILL TRIBE

Hill tribe characters have two occupations available to them: hunter and warrior. Hill tribe characters do not get vehicles unless

Nationality/Language Chart

Nationality	Language
Thai	Thai (5 English) (3 Cantonese) (1 Japanese)
Chinese	Cantonese (8 Mandarin) (5 English) (1 Pidjin)
Japanese	Japanese (5 English)
Malay	Malay (1 Pidjin)
Burmese	Burmese (2 English)
Indian	Hindi-Urdu (5 English)
Laotian	Laotian (1 Pidjin)
Vietnamese	Vietnamese (1 Pidjin)
Cambodian	Cambodian (1 Pidjin)
Hill tribe	* (3 Thai) (1 Pidjin)

* Use the language appropriate to the specific hill tribe in question (see page 25).

they buy them. Players should pick a tribe and a language according to their preferences. Hill tribe characters receive only half the normal amount of money, but receive extra skills to make up for it.

Starting Vehicles

Die	Vehicle
1	³ A-ton truck
2	³ Mon truck
3	³ /4-ton truck
4	272-ton truck
5	272-ton truck
6	272-ton truck
7	5-ton truck
8	M113
9	M113
10	EE-9
11	Shorland Mk 3
12	Shorland Mk 3
13	M24 Chaffee
14	AAVP-7A1
15	Saracen
16	Type 531
17	Type 62
18	M41

Hunter

Entry: None.

First Term Skills: The character receives the following skills in the first term:

- Foraging: 1
- Hunting Bow: 1
- Mountaineering: 1
- Observation: 1
- Tracking: 1

Subsequent Term Skills: A total of five levels from any one or a combination of the following:

- 1 • Fishing
 - 2 • Foraging
 - 3 • Hunting Bow
 - 4 • Mountaineering
- Observation
 - Small Arms
 - Swimming
 - Tracking

Contacts: One per term. Roll 1D10 for 8+ for a contact to be a manager (in this case, a representative of one of the criminal conclaves in Bangkok); otherwise, it is another hill tribe character from a different tribe (the character is presumed to have friends among his own tribe).

Special: None.

Warrior

Warriors are those hilltribesmen who have spent some time working for one of the drug warlords as a fighter.

Entry: Strength: 6+.

First Term Skills: The character receives the following skills in the first term:

- Mountaineering: 1
- Observation: 1
- Small Arms: 1
- Melee Combat (Armed): 1
- Melee Combat (Unarmed): 1

Subsequent Term Skills: A total of five levels from any one or a combination of the following:

- 1 • Fishing
- Foraging
- Hunting Bow

Hill Tribe Secondary Activities

- Fishing
- Foraging
- Hunting Bow
- Mountaineering
- Observation
- Small Arms
- Swimming
- Tracking
- STR+1

- Mountaineering
- Observation
- Small Arms
- Melee Combat (Armed)
- Melee Combat (Unarmed)
- Swimming
- Tracking

Contacts: One per term. Roll 1D10 for 6+ for a contact to be a criminal (in this case, a representative of one of the drug warlords); otherwise, it is another hill tribe character from a different tribe (the character is presumed to have friends among his own tribe).

Special: If more than one term is served, add +1 to Initiative.

Personal Weapons

Royal Thai Army

- M177 submachinegun
- M16A2, FN-CAL assault rifle
- SAW automatic rifle
- M60 machinegun
- M1911A1.HP-35 pistol

Shan United Army

- M16, AK-74 assault rifle
- SVD sniper rifle
- RPK automatic rifle
- M60, PK, KPV machineguns
- Makarov and Tokarev pistols

KMT

- M16, AK-74 assault rifle
- PK, KPV machineguns
- Makarov and Tokarev pistols

PULO

- M16, FN-CAL, AK-74 assault rifle
- SVD sniper rifle
- RPK automatic rifle
- PK, KPV machineguns
- Makarov and Tokarev pistols

Kachin

- M16, FN-CAL, AK-74 assault rifles
- PK, KPV machineguns
- Makarov and Tokarev pistols

Other Hill Tribes

- M16, FN-CAL, AK-74 assault rifles
- PK, KPV machineguns
- Makarov and Tokarev pistols

Kampuchean Marauders

- M16, AK-74 assault rifles
- RPK automatic rifle
- PK, KPV machineguns
- Makarov and Tokarev pistols

CENTRAL THAILAND

KEY

- Road
- Railroad
- City
- Town
- * Independent
- Limits of Junta Control (Organized)
- Terrorized Area
- Cultivated Area

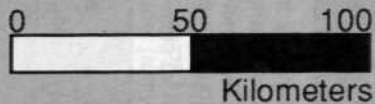
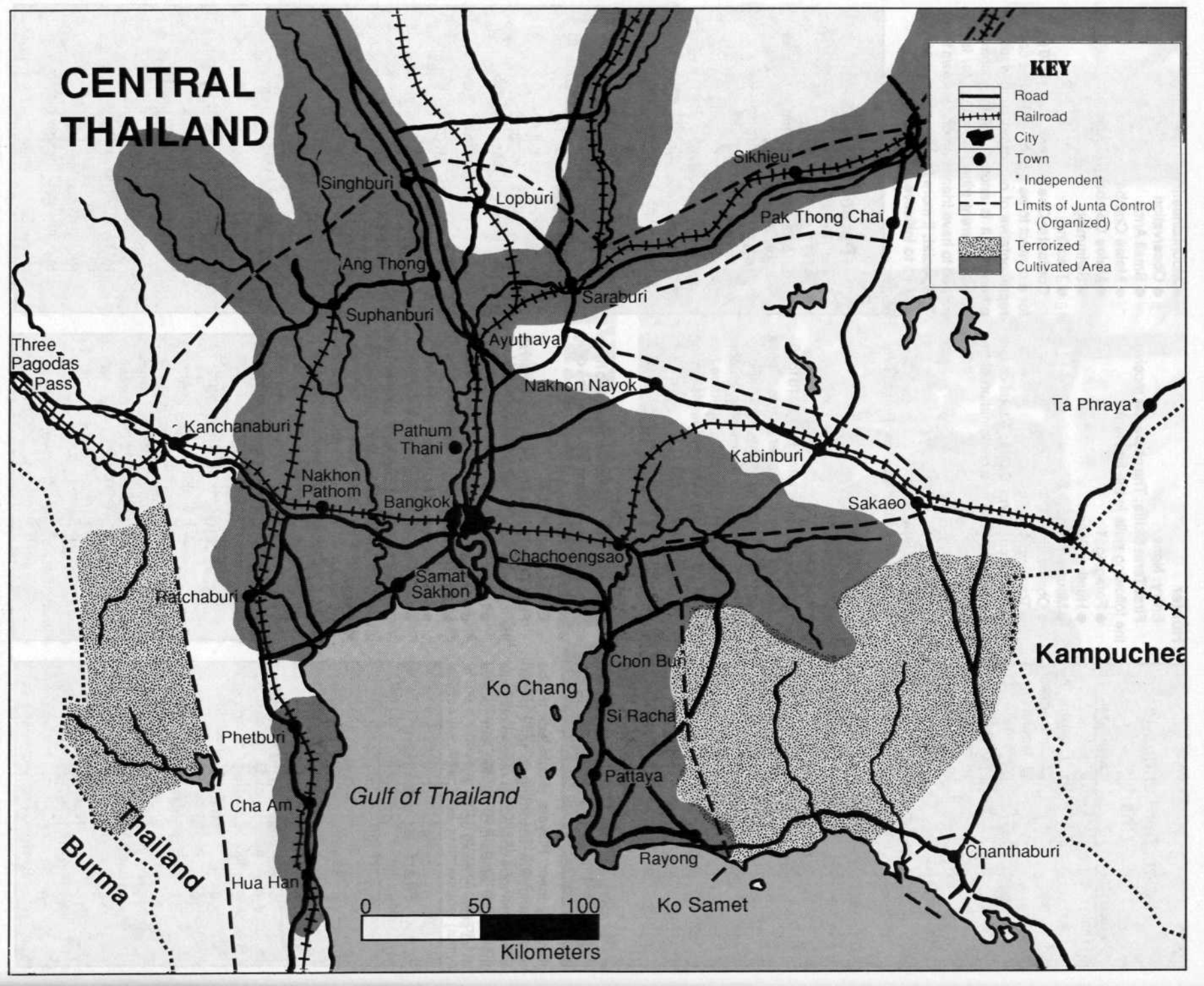

CENTRAL THAILAND

The central region of Thailand (also called the central plain) is the home of the "standard" Thai linguistic dialect, but this is only because the dialect spoken in the capital is by definition standard. The central plain has been called the core of Thailand, and with good reason. The heavy clay of the riverdelta retains water well, and the region is Thailand's breadbasket. Over two-fifths of the nation's rice cropland is on the central plain and more than half the rice, most of the cassava, and almost half the corn grown in Thailand is grown here. Sugar cane is also grown in the region east of Kachanaburi.

At 104,000 square kilometers, the region contains about one-fifth of Thailand's land area, and (as of 2000) contains just under half the population (due to the presence of Bangkok). The economic, political, social, and religious life of the country is concentrated here. Control of the central plain is vital to the present Junta, and the majority of the remain-

ing military forces are stationed in this section of the country.

COMMUNITIES

The following is a description of the major cities and towns in central Thailand.

Ayuthaya: The city of Ayuthaya, located north of Bangkok along the Chao Praya River, was the capital of the country from 1350-1767. The name Ayuthaya comes from the Sanskrit for *undefeatable*. Ayuthaya is located at the junction of the Chao Praya, Pa Sak, and Lopburi rivers, and thus it serves as a collection point for waterborne traffic on all of these streams, primarily agricultural produce heading for Bangkok.

The city of Ayuthaya has always been known in Thailand for its "gangster" activity, and it is one of the few cities where the Chinese and Japanese cartels have been unable to take over from the local Thai criminal infrastructure. The former leader of the

local Thai criminal cartel, Phra Duriyanga, now rules the city for the Junta, also serving as commander of the local garrison (he has been commissioned as a general for this purpose). Ayuthaya is garrisoned by the 3rd and 5th Royal Thai Infantry divisions, the largest single troop contingent outside Bangkok itself.

The reason for this is simple: The city is the administrative center of the rich food producing region of the lower Chao Praya floodplain. Its massive warehouses hold most of Bangkok's food supply. Its position astride the river enables it to completely control commerce headed south to Bangkok, both by land and by water. If General Duriyanga were not a very important member of the Junta, he would be one of its most dangerous adversaries.

Lopburi: Formerly called Lavo, Lopburi is one of the oldest inhabited sites in Thailand. In the old city, portions of the city's 17th-century fortified walls still stand in some

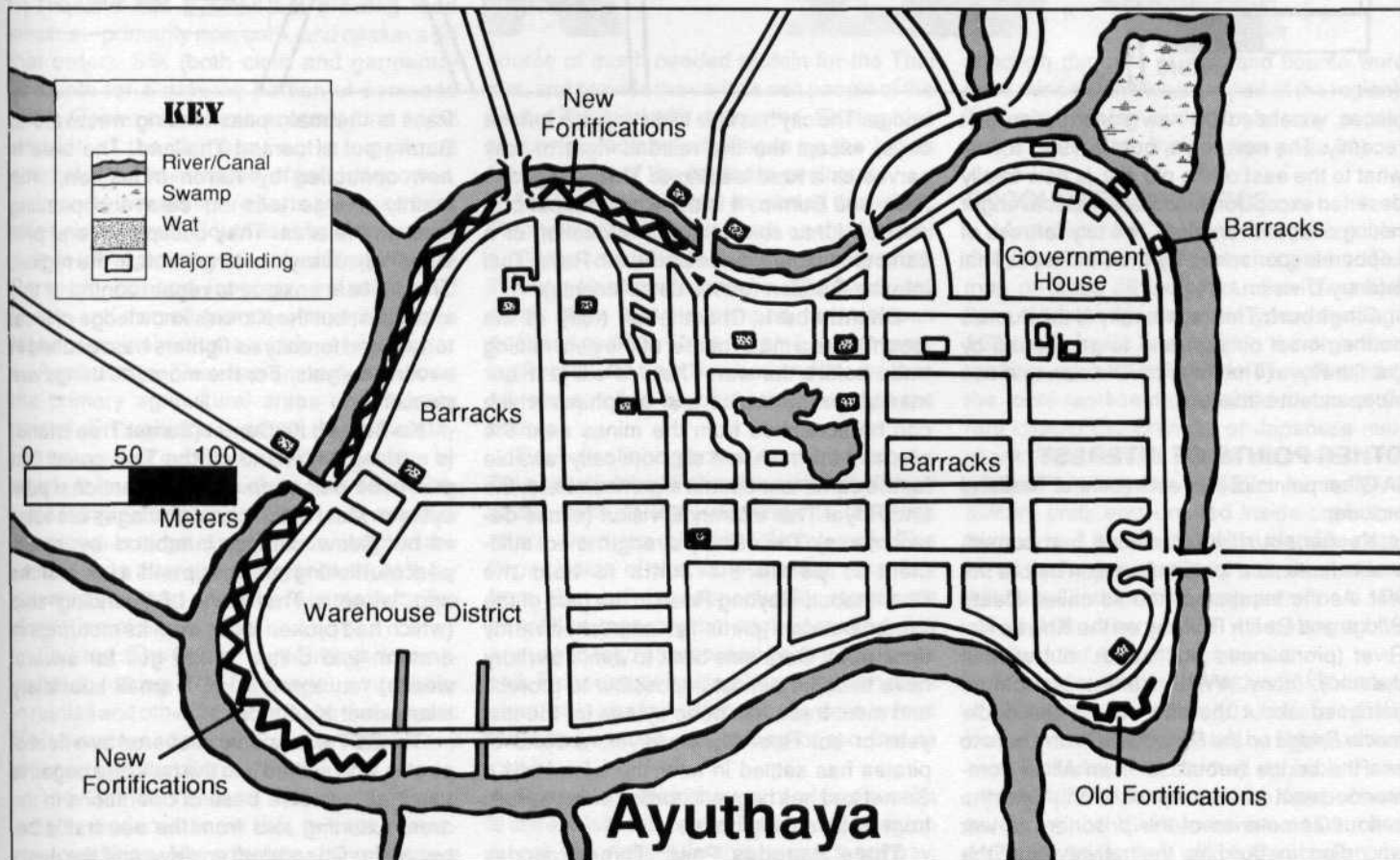

Lopburi

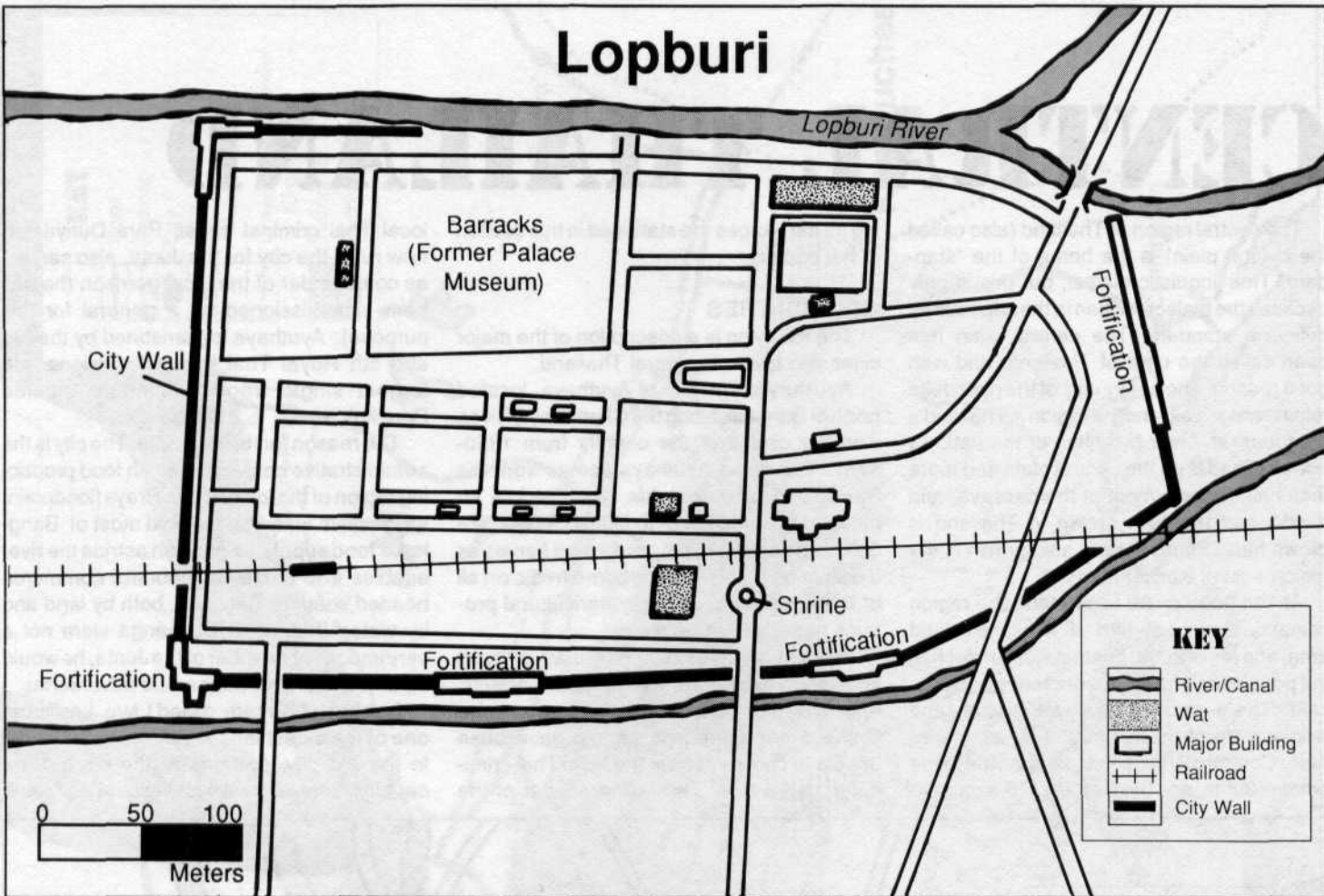

places, extended by new construction just recently. The new town, built in 1940 somewhat to the east of the old city, is now totally deserted except for the occasional scavenger raking over the remains. The city/fortress of Lopburi is garrisoned by the 4th Royal Thai Infantry Division.

Singhuri: This community is the Junta's northernmost outpost and is garrisoned by the 6th Royal Thai Infantry Division and two independent battalions.

OTHER POINTS OF INTEREST

Other points of interest in central Thailand include:

Kachanaburi: Kachanaburi had considerable fame as a tourist attraction before the war. As the location of the so-called Death Bridge and Death Railway on the Khwae Noi River (pronounced like "quack" but without the "ck"), many WWII veterans and others (intrigued about the site due to the book/movie *Bridge on the River Kwai*) came here to see the bridge (rebuilt after an Allied commando team blew it up in WWII) and the various cemeteries of the prisoners of war who died in building the railway and the

bridge. The city has little to distinguish it these days, except the the railroad right of way serves as a road leading to Three Pagodas Pass and Burma. It is the westernmost outpost of Junta control and the location of a cantonment garrisoned by the 6th Royal Thai Infantry Division (minus detachments).

Chanthaburi: Chanthaburi ("city of the moon") was a major center of the gem mining trade before the war. There is still a minor market for the rubies and sapphires which can be scratched from the mines near the city, and this makes it economically feasible for the Junta to maintain a garrison here, the 2nd Royal Thai Infantry Division (minus detachments). The military strength is not sufficient to permit the Junta to hold the Chanthaburi-Rayong Road in the face of the local marauders (primarily Kampuchean army deserters). Caravans back to Junta territory have become almost impossible to protect, and most trade has been by sea for the last year or so. Recently, however, a band of pirates has settled in near the island of Ko Samet and has begun extorting onerous tolls from Junta supply boats.

Three Pagodas Pass: Three Pagodas

Pass is the main pass leading westward to Burma out of central Thailand. The area is now controlled by Karen tribesmen, who mainly charge tolls on caravans passing through the area. They occupy several pre-war Thai military encampments in the region. The Junta is anxious to regain control of this vital pass, but the Karen's knowledge of local terrain and ferocity as fighters has resulted in several defeats. For the moment, things are peaceful.

Ko Samet: Ko Samet (Samet Tree Island) is a triangular island off the Thai coast that was once part of an extensive national park system. Most of the coastal villages are tourist-bungalow camps, inhabited by small, peaceful fishing families up until a few months ago, when a Thai navy LST landing ship (which had broken loose from its moorings in a storm and drifted in the gulf for several weeks) ran aground on a small subsidiary island near Ko Samet.

The LST was soon discovered by a fleet of pirates who settled into the hulk and began to use it as a secure base of operations in the area, extorting tolls from the sea traffic between the Chanthaburi enclave and the Junta

ports to the west. The pirates are an infestation the Junta would very much like to clear out. It has been unable to do so thus far.

Ko Chang Island: Ko Chang Island (another former marine park, this one located near the border with Kampuchea) and the smaller islands around it are home to a large, independent fisher/pirate settlement. Fishing has been good of late, and the clan has almost completely given up nautical brigandage in favor of less criminal pursuits over the last few months. In recent months, however, large numbers of marauders (Kampuchean army deserters) have begun to arrive along the mainland coast, and are starting to raid the islands.

ECONOMY

As the breadbasket of Thailand in 2000, the central region is now primarily important for its agricultural assets, but there are other important aspects of the region.

Remaining Overseas Trade: Although severely disrupted by the war, trade has begun to return in Southeast Asia, and Thailand has several exports which it sends to its neighbors in Burma, Laos, and Vietnam as well as to ports farther afield in Indonesia, Singapore, Malaya, and (increasingly) western Australia.

Thailand has a small but growing food surplus—primarily rice, corn, and cassava (in that order). Silk (both cloth and garments) accounts for a growing portion of overseas trade. Opium and heroin account for a small amount of the tonnage, but a significant amount of the dollar value, of goods exported.

Imports include spare parts salvaged from cities elsewhere in Southeast Asia, raw materials for the growing manufacturing area of Bangkok, bonded laborers, manufactured goods, and a small quantity of luxuries for the higher-ups in the Junta, triads, and yakuza.

Agriculture: The map on page 28 shows the primary agricultural areas under Junta control. Enough rice is grown that a quantity can be used for export, although the routes by which this is accomplished are becoming increasingly dangerous. Corn and cassava are grown in large quantities as well, but the second crop after rice is sugar cane, both for its value in export and as a feedstock for the distillation of alcohol fuel.

Fishing: The Chao Praya River is not well-suited to fishing. The tremendous variability in rainfall and other factors means that aquatic life is scarce, and not sufficient to support any extensive aquaculture.

The Gulf of Thailand, like most tropical waters, produces some fish, but not in massive quantities. Nevertheless, fish provide a



source of much-needed protein for the Thai diet, and provide the various sea people of the Gulf of Thailand with an income. Fishing also supports a number of villages on the Indian Ocean coast of the southern peninsula.

Small fishing boats (operated by ethnic Thai and other groups, such as the Moken) run in the coastal waters, and are pretty much immune from pirate attacks. The boats are small (they are the sampan or motorpan described on page 71), with family crews ranging from four to six in number, and the catches are too small to be of much interest to the pirates.

Deep-seafishing boats (described on page 72) either belong to one of the informal fisher/pirate clans or are independents (and risk attack from the clans if discovered). The larger boats of the various clans take fish from the gulf in economically significant quantities, meaning that each boat can pull in enough to feed its crew and have a surplus to sell. Fisher/pirates also charge tolls on merchant ships passing through the area unless the latter are too well armed or too fast to catch.

Minerals: Little in the way of mineral wealth is still exploited in central Thailand (the region is not the richest in this respect anyway,

although deposits of zinc and fluorite were once mined in the western part of the region). The only mining operation of any consequence is in Chanthaburi (see page 30).

ENCOUNTER SPECIFICS

Most of central Thailand is organized territory for the purposes of encounters. The map on page 28 indicates other classifications. All urban government types (see page 162 of the basic rules) within the organized territory are result 7 (warlord) representing the local representative of the Junta or (in rare cases) the Chinese or Japanese merchant/crime cartels. Settlements outside organized territory are rolled for normally. All military units encountered inside organized territory will be Junta units. Outside organized territory, any military unit encountered will be a Junta unit on deep patrol on a 1D6 roll of 1-3; otherwise, it will belong to the militia of the nearest community.

Marauder encounters within 20 kilometers of Chanthaburi or within 50 kilometers of the border with Kampuchea will be Kampuchean army deserters, and armed as such. Refugees within 50 kilometers of the Kampuchean border will be Vietnamese on a 1D6 roll of 1-2; otherwise, they will be Cambodian.

Viper's Nest

The group has been hired to clear out a small pirate stronghold on a small islet near the coastal island called Ko Samet. The group will have to arrive and depart by sea, which will require more planning than normal.

BACKGROUND

Several months ago the lack of a functioning weather prediction network meant that one of the seasonal storms that afflict the region caught a Junta LST (Landing ship, tank) by surprise at sea between coastal ports. The ship's captain was unable to persuade the crew, which consisted largely of inexperienced recruits, to put out to sea and ride out the storm as his experience indicated. Instead, the crew mutinied and deserted the ship before the full strength of the storm hit, and the vessel was presumed lost.

Recently, however, the fate of the vessel has come to light. Apparently, after drifting for some months, it ran aground on a small rocky islet near Ko Samet (off the Thai coast approximately 150 kilometers from Bangkok).

The ship was soon discovered by a band of pirates, who took over the vessel as their base of operations, using the supplies and military materiel on the vessel to terrorize the region's inhabitants and interfere with the Junta's sea communications in the area.

The group is to land on the islet and capture or destroy all pirate vessels there, with their crews (contract laborers with small boat handling experience are much in demand). A Thai naval officer will be sent along with the group to inspect the LST and determine if it can be recovered. If so, the group will be required to remain on the islet for a week or two while the fishing boat fetches a salvage team and a crew with LST experience. If the LST cannot be refloated, all recoverable materiel is to be removed, and the LST is to be blown up to prevent its use by other groups.

The Junta will pay \$200,000 upon completion of the mission, with a \$100 bonus for each prisoner taken and an additional \$50,000 if the LST is recovered intact. If the Thai naval officer is killed, the group forfeits half of its pay. The group must furnish its own weapons and ammunition.

APPROACH

The only real approach is by sea. Aircraft and fuel are too scarce and too valuable to be risked for a mission such as this. None of the Junta's remaining naval vessels are in shape to leave harbor. The Junta has made a deal with one of the Bangkok fishing clans to supply a small fishing boat large enough to carry the characters' party and a reasonable amount of equipment. This craft will land the characters on the islet, but will not do anything that would place the boat at risk.

For this reason, the characters will make the last kilometer or two of the journey using small rubber assault boats (provided by the Junta).

MAP DESCRIPTION

The map shows the islet (at the 8-meter tactical scale), the location of the LST, and suitable landing areas.

A floorplan of the LST is provided on pages 98 and 99.

REFEREEING THE SCENARIO

The players should be allowed to decide their own plan of attack after they receive as much of the following as the referee chooses to tell them. The islet is large enough for a small party to remain concealed for a day or two, and the characters may choose to put ashore a small recon party before the main attack.

The LST has three anti-aircraft positions which retain their original armament (one 20mm autocannon on a pintle mount per position). The remaining weaponry has been pulled and is fitted to whatever boats happen to be out on a raid at the time (meaning that the weapons are constantly at sea when they are not being transferred from one pirate boat to another).

Three pirate boats are using the islet as a base at the present, but only one boat is here at any given time, sheltered from wind and weather inside the LST. The LST was not designed to serve as long-term quarters for more than 10 crewmembers, but it was designed to transport hundreds of soldiers and four to eight vehicles and is thus fairly roomy inside. The main deck can shelter a fishing boat of the type the pirates use and usually does.

For all practical purposes, the LST can be treated as a building with a single large door opening into the sea. At low tide, the huge doors in the hull are in the water, and

the main vehicle deck of the LST is flooded to a depth of about a meter. At high tide, this goes up to two meters and allows the pirate boats to enter and leave (they are "beached" if inside at low tide). The pirates run rope ladders down the sides of the LST during the day, but they pull these up during the night and believe themselves reasonably safe from attack.

During the day, the pirates will be outside the LST and roaming all over the islet, drying fish, repairing gear, and preparing for their next voyage. At night, the pirates will have only three sentries on watch, all of them manning anti-aircraft positions on the LST. The remainder of the pirates will be sleeping, gambling, drinking, fighting, or otherwise amusing themselves.

The pirates have a number of slaves who have been taken on raids, who are kept locked in one of the holds of the LST when not performing their tedious and degrading duties.

Condition of the LST: The hull is intact, and the only reason the ship does not float out to sea again is that the storm surge drove it firmly into the mud and sand of the islet.

The crew left the engine idling when they deserted the vessel, and it has run completely out of fuel. The engine sustained some storm damage, but is repairable in six to eight hours given the proper tools. The naval expert will rule that the LST is salvageable and instruct the players to remain with it while he takes the fishing boat to fetch a salvage crew.

The weapons locker on the LST still contains 1800 rounds of 5.56mm N, 600 rounds of 20mm HE, and a dozen assorted grenades (frag, signal, smoke, etc).

NPCS

Sixteen pirates and 24 slaves are presently on the islet, a larger proportion of "base crew" than most pirate groups usually have, since the LST provides greater security than the normal fishing village. The 16 pirates include nine crew for the boat inside the LST and five others, including the present leader of the pirates.

The pirate leader, his four "staff," and the boat's captain are Veteran NPCs. The remaining pirates are Experienced NPCs. Thanks to the arms locker on the LST, every pirate is armed with an M16A2, an M1911A1 pistol, and four frag grenades.

The slaves (mostly women and children) are unarmed Novice NPCs.

The Pirates' Islet

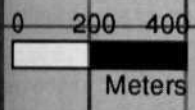
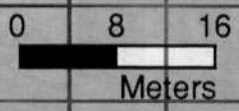
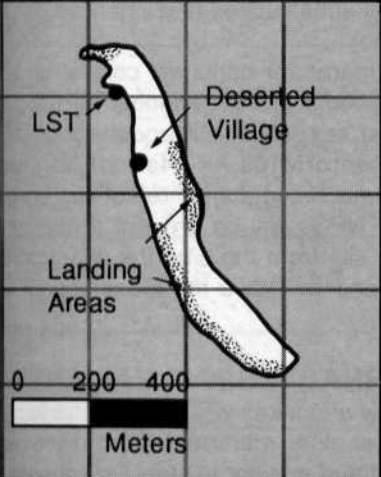
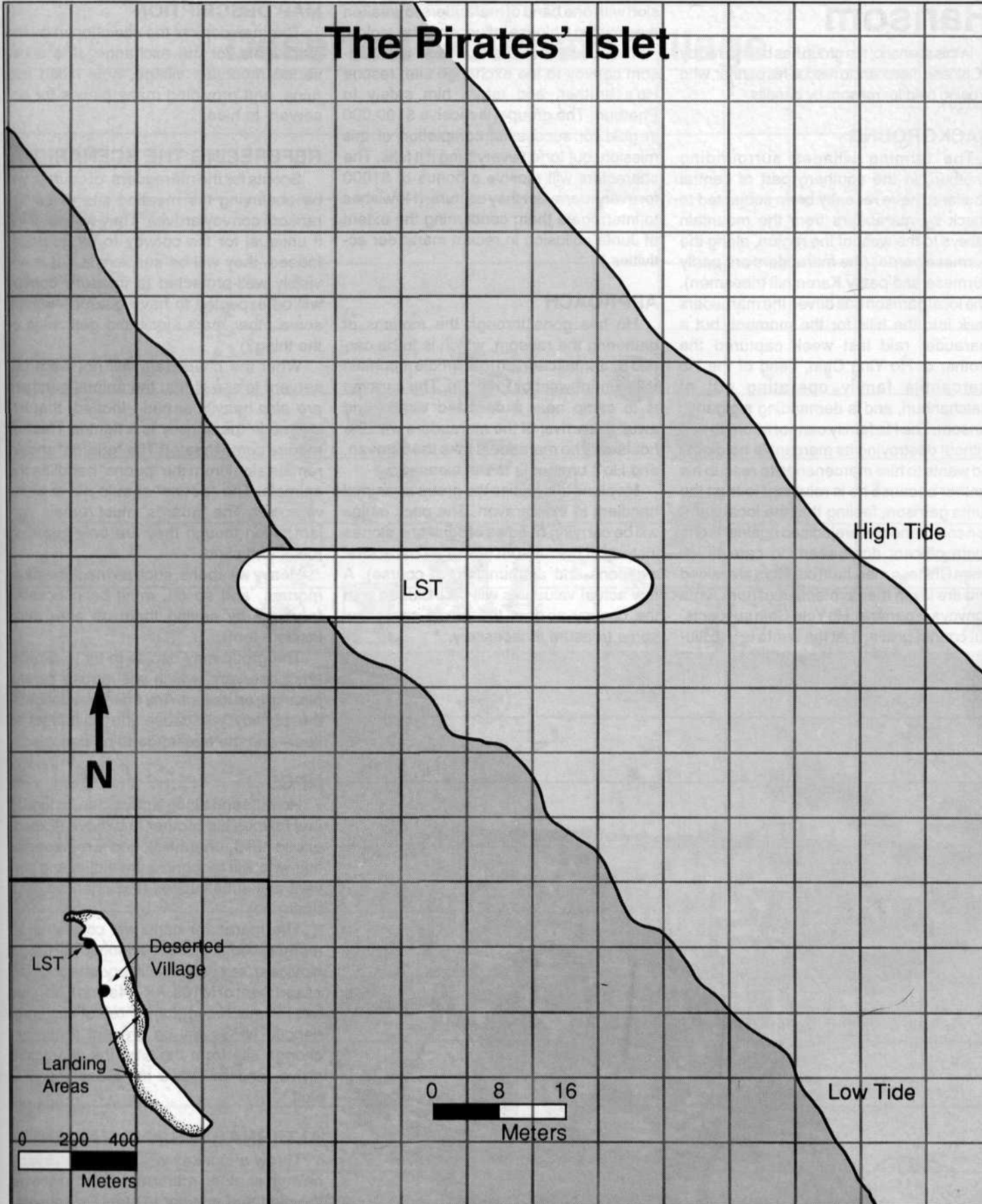

Ransom

In this scenario, the group has been hired by a Chinese merchant to rescue his partner, who is being held for ransom by bandits.

BACKGROUND

The farming villages surrounding Phetburi, in the southern part of central Thailand, have recently been subjected to attack by marauders from the mountain valleys to the west of the region, along the Burmese border (the marauders are partly Burmese and partly Karen hill tribesmen). The local garrison has driven the marauders back into the hills for the moment, but a marauder raid last week captured the brother of Ho Ying Chin, head of the Ho mercantile family operating out of Ratchanburi, and is demanding a gigantic ransom. The Ho family cannot afford to pay without destroying its mercantile holdings. Ho wants to hire mercenaries to rescue his brother because he is reluctant to trust the Junta garrison, feeling that the local garrison commander is prejudiced against them. Junta officers don't seem to care much when Chinese merchant convoys are raided and are lax in their protection of non-Junta convoys in general. Ho Ying Chin suspects, but cannot prove, that the Junta is in collu-

sion with one band of marauders to weaken the growing Chinese influence in the region.

The characters are to take a fake ransom convoy to the exchange site, rescue Ho's brother, and return him safely to Phetburi. The group will receive \$100,000 in gold for successful completion of this mission, but forfeit everything if it fails. The characters will receive a bonus of \$1000 foreverly marauder they capture. (Ho wishes to interrogate them concerning the extent of Junta collusion in recent marauder activities.)

APPROACH

Ho has gone through the motions of gathering the ransom, which is to be carried by a small caravan to a remote mountain valley northwest of Phetburi. The caravan is to camp near a deserted village and await the arrival of the marauders with the hostage. The marauders take the caravan, and Ho's brother is to be released.

Ho plans to disguise the group as animal handlers in the caravan. The pack mules will be carrying bundles of sand and stones instead of the ransom (and the characters' weapons and ammunition, of course). A few actual valuables will be included with the convoy so that the group can show some treasure if necessary.

MAP DESCRIPTION

The map depicts the site chosen by the marauders for the exchange. It is a deserted mountain village, now fallen into ruins, and providing many places for observers to hide.

REFEREEING THE SCENARIO

Scouts for the marauders, of course, will be observing the meeting site when the ransom convoy arrives. They will not think it unusual for the convoy to be guarded. Indeed, they will be suspicious if it is not visibly well-protected (a treasure convoy will be expected to have guards—what if some other marauder band gets wind of the thing?).

What the characters will not want observers to see is that the animal handlers are *also* heavily armed—indeed, that everyone in the convoy is a fighter. This will require some theater: The "guards" should remain aloof from the "peons" handling the animals. The "peons" should never show weapons. The "guards" must remain vigilant, even though they are only guarding rocks and sand.

Heavy weapons, such as machineguns, mortars, and so on, must be concealed (perhaps by setting them up after dark, inside a tent).

The group may decide to try to capture any observers, which will require careful planning on its part. Any offensive action by the convoy will cause the observers to flee—and the exchange to be canceled.

NPCS

Ho will send along a physician, to tend to any injuries his brother may have (Experienced NPC, unarmed), and a representative who will recognize the victim and prevent any substitutions (Experienced, also unarmed).

The marauder band will consist of 18 members total (six Experienced NPCs, 12 Novices), armed with military weapons (an assortment of M16s, AK-74s and FNs, plus two PK machineguns). Three of the Experienced NPCs will be present at the exchange site from the time the characters arrive, and will have the Observation: 8 skill.

ALTERNATIVES AND VARIANTS

Throw a monkey wrench into things by having another marauder band discover the plan and attempt to steal the ransom.



Deserted Mountain Village

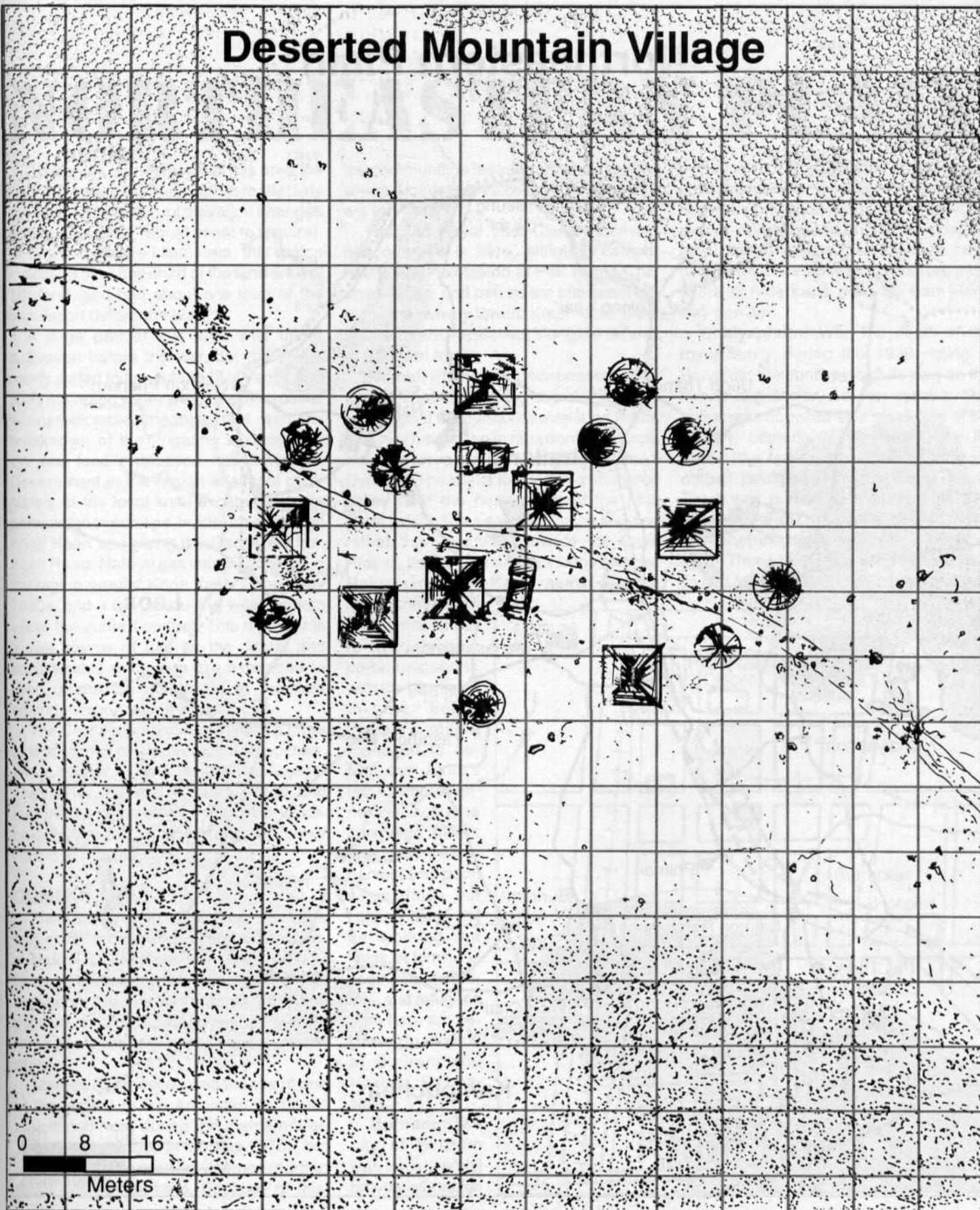

Northeastern Plain

KEY

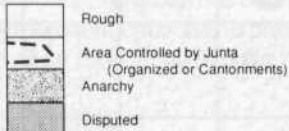

All other terrain is terrorized
* Independent

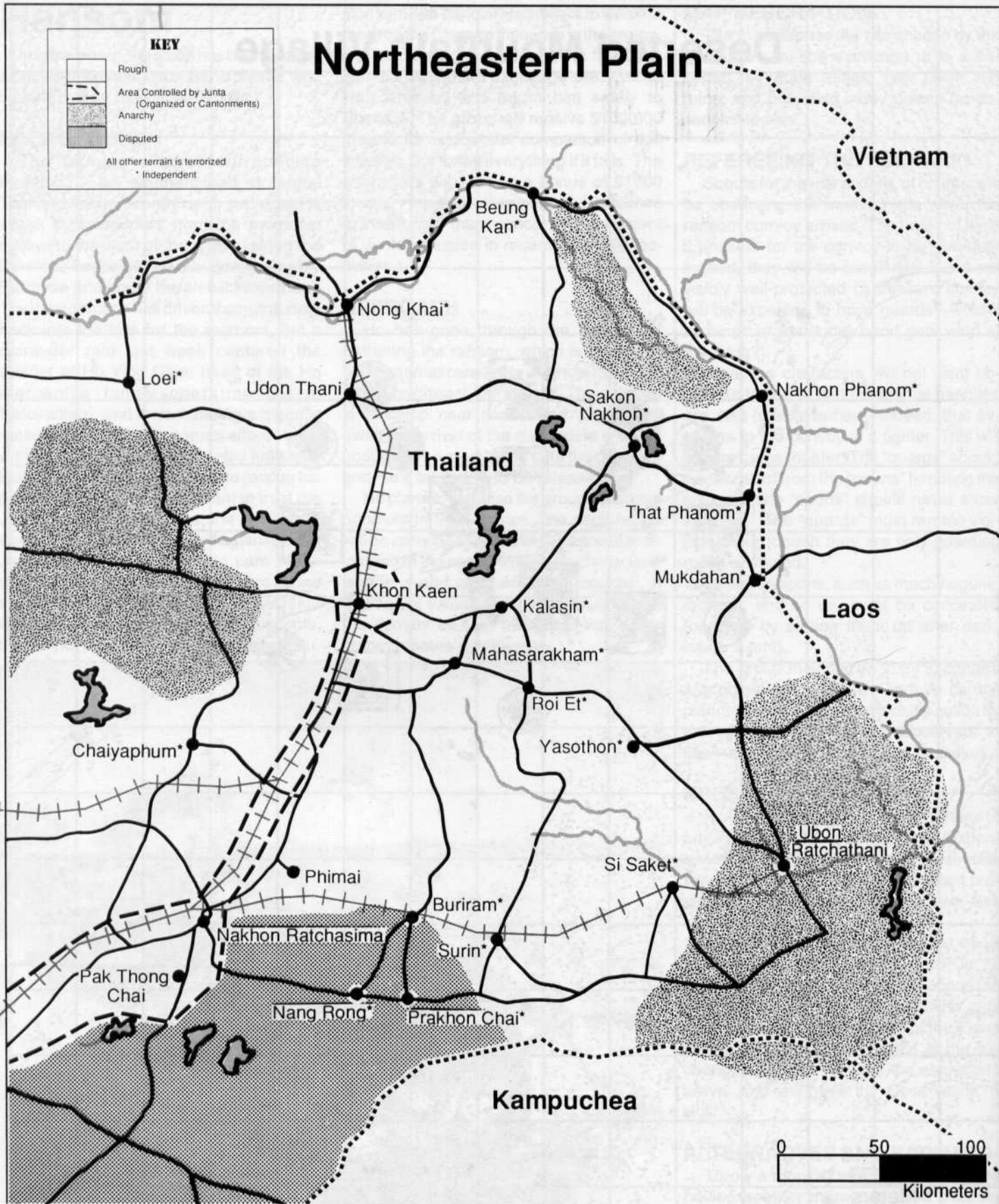

NORTHEASTERN PLAIN

Foreigners sometimes call this area the Khorat plateau, but the region is really fairly low-lying with no abrupt elevation changes (which a "plateau" would seem to require). At 171,000 square kilometers, this region makes up over one-third of the land area of Thailand, and had about one-third of the population before the war.

A large part of this area was under cultivation before the war, but the soil is poorly suited to agriculture (it is sandy and does not retain water well), and the rainfall is unpredictable, meaning that with the breakdown of the irrigation system after the war food production has fallen off. Government in the region is almost completely at the local level except for Junta garrison/communities in the area around Khon Kaen and along the Bangkok/Khon Kaen Road. Natural gas was discovered in the region around Khon Kaen in the early 1980s, and a few producing wells remain under the Junta's control. This represents a vital source of fuel for the Junta, and considerable resources are expended to keep production going and to maintain communication with the fields.

The Cardamom Mountains form a more or less natural boundary with Kampuchea, and a barrier to help keep out refugees. Their soil is poor and heavily forested, and they remain sparsely populated and forbidding. The few inhabitants are uniformly hostile to outsiders.

COMMUNITIES

The following is a description of the major cities and towns in central Thailand.

Nakhon Ratchasima: The city of Nakhon Ratchasima forms the easternmost contiguous garrison of the Junta. From this point on, the Junta patrols the railway only when a caravan to or from Khon Kaen is en route.

Nakhon Ratchasima was the site of one of the largest of the American air bases maintained here during the Vietnam War. The air base closed in the mid-1970s, but a number of American servicemen married locals and settled here. Because of this,

the community is less xenophobic (at least where Americans are concerned) than others in Thailand.

The 2nd Royal Thai Cavalry Division headquarters is here, although detachments are maintained at Pak Thong Chai and Sikhieu, and patrols are often sent out along the railway toward Khon Kaen. Cantonments are maintained along the railway to Saraburi also.

Phimai: Phimai is an independent community, controlled by a group of Thais who believe that the Junta assassinated Rama IX. They have been in rebellion ever since, claiming to represent the spirit of the Chakri Dynasty. The city is located in a sheltered valley near the headwaters of the Mun River (which flows eastward to the Mekong rather than westward toward the Chao Praya), and is near enough to the Nakhon Ratchasima/Khon Kaen railway that the

in the midst of a picturesque tourist area (it is surrounded by many old ruins and a very popular park containing the cone of an extinct volcano), and is now an independent community. Its main claim to fame nowadays is that its militia is built around a cadre of Americans from the Cam Ranh Bay garrison.

Chaiyaphum: With the death of the royal family during the 1998 rioting in Bangkok, the Junta placed its king on the throne and declared a new dynasty. This action was opposed by a small core of the military, primarily in the Royal Thai Air Force (the crown prince was an air force officer). Because of this, the Royal Thai Air Force was purged by the Junta in 1999. Hundreds of officers loyal to the old dynasty were shot and their families sold into bonded labor. Those lucky enough to escape were forced to flee from Junta control, and most

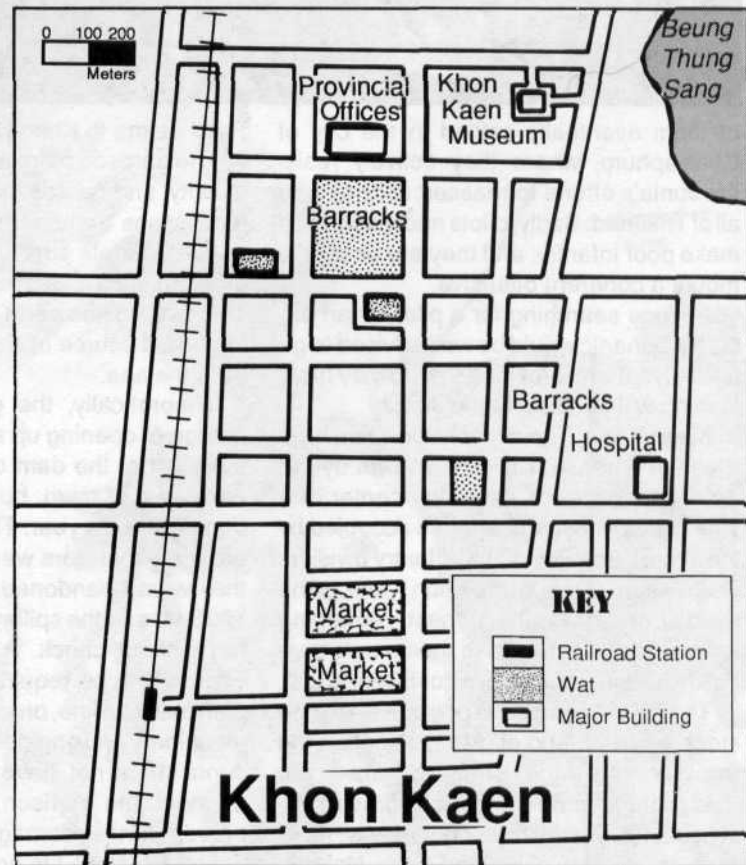



of them eventually settled in the city of Chaiyaphum, where they actively resist the Junta's efforts to reassert control over all of Thailand. Sadly, pilots and mechanics make poor infantry, and they are unable to mount a coherent offensive.

Anyone searching for a pilot, or an aircraft mechanic would be well advised to go to Chaiyaphum, provided the job they have in mind will not benefit the Junta.

Khon Kaen: The city of Khon Kaen is an island in a sense. Called Can-Can by the Americans, Khon Kaen is the center of a small number of cantonments occupied by the Junta's 2nd Royal Thai Infantry division. The reason for this is that Khon Kaen, in the middle of Thailand's richest remaining natural gas field, is vital to the Junta's control of the country, and a major military post.

The railroad no longer operates—rolling stock is scarce and efforts to maintain the track in the face of saboteurs from Chaiyaphum and Phimai have proven unsuccessful. The railroad right of way, however, is still the best road from Nakhon

Ratchasima to Khon Kaen.

The garrison patrols the railway south of the city, and guards the gas fields and the technicians that operate them, as well as the city and its surrounding villages. The garrison also oversees operation of the small salt mines north of town, a small but important source of a vital mineral this far from the sea.

Theoretically, the garrison is also in charge of opening up a nearby hydroelectric plant at the dam on the Phong River northwest of town, but nothing has been done in over a year. The dam itself holds, but the generators were burned out when they were abandoned during the panic of 1998-99 and the spillways were allowed to run without check. A major engineering effort would be required to get the power plant back on line, one which would require machinery and engineering talents that the Junta does not have available. For the moment, the garrison guards the dam to prevent further damage by looters.

Roi Et: Roi Et is an independent com-

munity in the midst of the Khorat "plateau" and is thus suffering greatly from the agricultural shortfall of the last two years.

Udon Thani: Udon (sometimes spelled Udon) Thani is another former Vietnamese American air base, and thus has its small cadre of American servicemen who chose to settle here rather than return home after the war.

Nong Khai: Nong Khai (and its surrounding villages) is an independent community on the Mekong River, and is fortunate in having 300 Laotian soldiers acting as a cadre for its militia of 850 fighters. The soldiers are a benevolent garrison, and the populace (mostly ethnic Laotians) is happy to have experienced protection from bandits. Because of this particularly well-equipped and trained militia, the community has managed to develop a prosperous river trade with other Mekong communities and make considerable income from tolls on river traffic.

A couple of kilometers outside of town is the monastery of Wat Khaek, founded in 1978 in tribute to Luang Pu (venerable grandfather) Bunleua Surirat, a famous mystic. Luang Pu accumulated a large following by preaching a fusion of Hindu and Buddhist beliefs. Local custom states that anyone drinking from the water at the monastery must leave all his possessions with the monks—violation of this custom will cause the locals to turn surly.

Loei: Loei (and the surrounding villages) is an independent community in the mountainous region which has the greatest temperature extremes in Thailand. Hot during the summer months, some of the mountain villages experience temperatures as low as 0°C during the cool season, making Loei the coldest spot in Thailand.

Chaing Khan: Another independent community on the Mekong, Chaing Khan is a collection point for mercantile traffic down the river, including a small quantity of drugs headed for points east. The community is ruled by a consortium of merchants, who have hired ex-Laotian soldiers for protection.

Nakhon Phanom: Nakhon Phanom, like Nong Khai, is an independent community garrisoned by a unit of ex-Laotian soldiers, making a living off of trade along the Mekong River.

That Phanom: That Phanom is largely run by ethnic Chinese, but the outlying villages are Laotian and Vietnamese. Like its neighbors to the north, That Phanom is

prospering from the resurgent river trade along the Mekong.

Ubong Ratchathank The remote city of Ubong Ratchathani is presently occupied by a force of 1100 Kampuchean renegades, some of them military deserters, some of them criminals. As Ubong Ratchathani was a major American air base during the Vietnam War, a number of the Americans serving here married locals and settled in the city. The militia contained many of these ex-servicemen, before it was massacred by the attacking Kampucheans.

ECONOMY

The northeast region was one of the first from which the Junta withdrew as conditions worsened during the war. The population surplus was made worse by an influx of refugees from the fighting in Kampuchea, and the breakdown of civil order meant that the carefully maintained system of catchments and irrigation canals fell into disrepair as well.

Remaining Trade: Most trade is local, with two major exceptions: the caravans running from Nakhon Ratchasima to Khon Kaen and the growing trade (in drugs, salvage, and rice) along the Mekong River and its tributaries.

Agriculture: The breakdown of the central irrigation system means that this region, formerly second in food production, is now barely able to maintain itself. Rice was and is the primary crop, but the growing season is now much more dependent upon rain than before the war. Local shortfalls were once made up from surpluses elsewhere, but this is no longer possible.

The main exception to this is along the Mekong River, where harvests are still adequate to supply local needs with a small surplus left for trade. This has made the river communities more prosperous than their inland counterparts.

The destruction of the electric grid in the region has had another adverse effect on the local diet. Before the war, electric rice cookers were so common that the locals soon forgot how to cook their meals any other way. An electric cooker puts out an even heat that cooks completely, without waste. Now that the locals are forced to cook over open fires once again, the uneven heat means that a larger proportion of the meal is over- or undercooked, and less nutritive. To keep the same level of nourishment, therefore, per capita rice consumption must increase at a time when

harvests are dwindling. This is a single, small example of how the complex synergistic effects of the war interact and make simple solutions impossible.

Natural Gas: At the same time Thailand began to exploit the undersea deposits of natural gas in the Gulf of Thailand, the smaller fields near the city of Khon Kaen were also opened to drilling. These fields now provide the Junta with a major source of fuel, but they cannot be fully exploited because of a lack of knowledgeable technicians and a dwindling supply of spare parts and tools needed to maintain the pumping machinery.

ENCOUNTER SPECIFICS

The area within 20 kilometers of the triangle formed by the cities of Nakhon Ratchasima, Sikhieu, and Pak Thong Chai and the railway leading from this triangle to Saraburi consists of Junta cantonments. The area within 30 kilometers of the city of Khon Kaen also consists of Junta cantonments. Other territory types are as indicated on the map on page 36.

All military units encountered inside cantonment territory will be Junta units.

Outside the cantonments, any military unit encountered will be a Junta unit (on a special mission) on a 1D6 roll of 1-3; otherwise, it will belong to the militia of the nearest community. Military encounters along the railway between Khon Kaen and Nakhon Ratchasima will be Junta patrols from the Khon Kaen or Nakhon Ratchasima garrisons, whichever is closest. Military encounters within 50 kilometers of Nong Khai, Nakhon Phanom, and That Phanom will be with Laotian soldiers from the militias of those communities.

Marauder encounters within 50 kilometers of the border with Kampuchea will be Kampuchean army deserters, and armed as such. Refugees within 50 kilometers of the Kampuchean border will be Vietnamese on a 1D6 roll of 1-2; otherwise, they will be Cambodians. Marauder and refugee encounters within 20 kilometers of the Laotian border will be with Laotian on a 1D6 roll of 1-2; otherwise, they are with Thais.





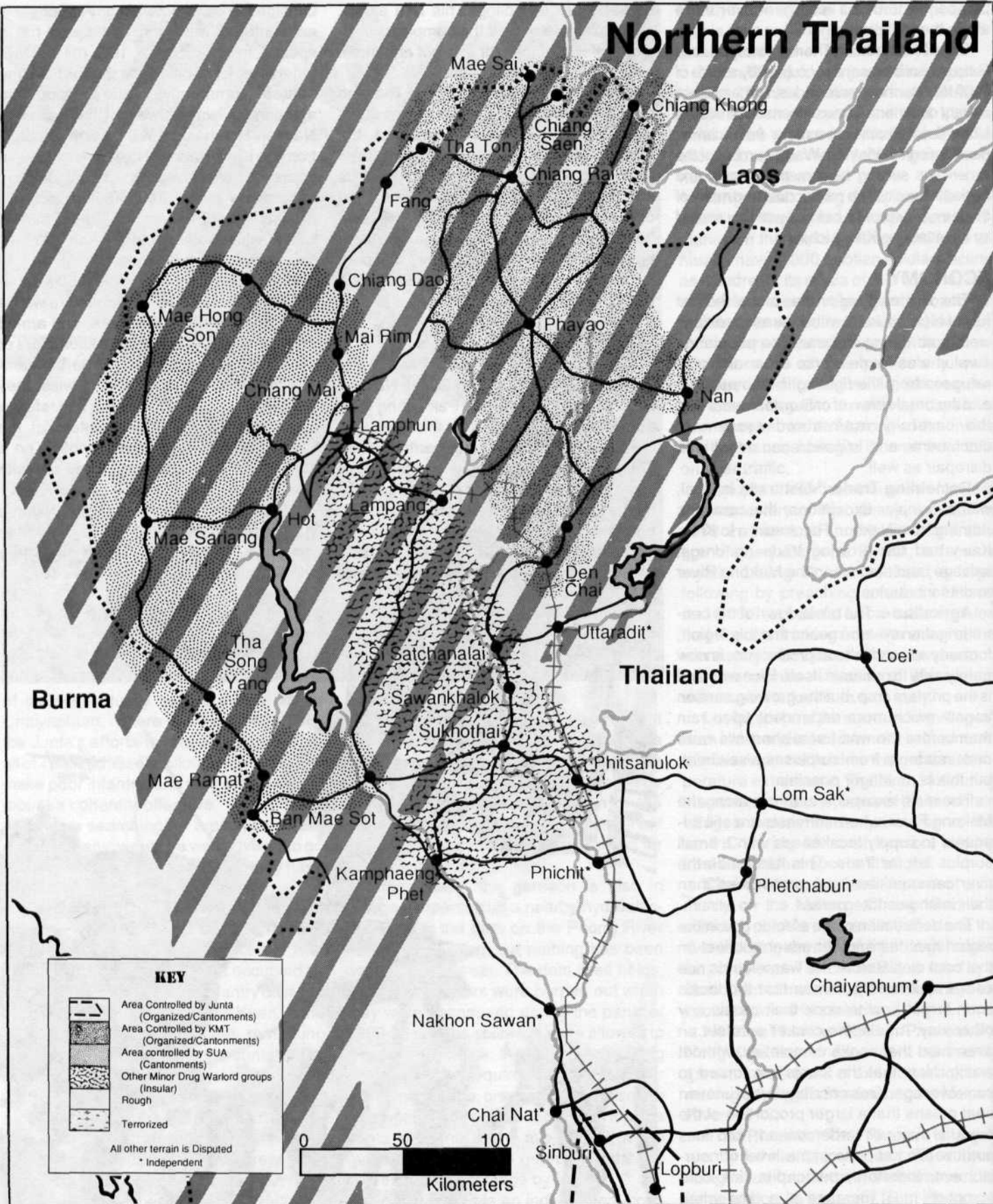

Merchant convoys along the Nakhon Ratchasima/Khon Kaen railway belong to the Junta. Those encountered elsewhere will be independents.



Northern Thailand



KEY

-  Area Controlled by Junta (Organized/Cantonments)
-  Area Controlled by KMT (Organized/Cantonments)
-  Area controlled by SUA (Cantonments)
-  Other Minor Drug Warlord groups (Insular)
-  Rough
-  Terrorized

All other terrain is Disputed
 * Independent

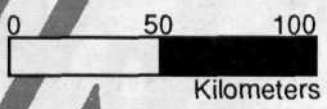

THE GOLDEN TRIANGLE

The first true Thai kingdoms arose in the mountainous northern part of the country, where the people have long been famed (in Thailand, anyway) for their relaxed, laid-back approach to life—or at least they were before the war.

The area of northern Thailand known as the Golden Triangle is that region where Laos, Burma, and Thailand meet. Opium has been grown for medicinal use in the south of China since the days of Kublai Khan. The nomadic hill tribes of south China grew it as a means of gathering hard currency to pay their taxes. After the Second World War and the Chinese Communist Revolution, many of these nomads fled to Thailand, where they settled in and continued growing the only crop they knew how to grow. The opium poppy is well-suited to the poor soil of the area, and will grow in places where very little else will.

Almost from the beginning, the Thai government (at the request of and with the assistance of the United States government) attempted to break up the opium trade, both militarily and by a crop substitution program (where the hill tribes were given incentives to grow crops other than opium poppies). The military raids temporarily disrupted small portions of the opium traffic by destroying a few fields, but the long-term effect was nil. The crop substitution program achieved some minor local successes, but the overall program was a failure.

With the Vietnam War, American GIs provided a market for heroin (an opium derivative), and cartels were formed to distribute the drug to markets beyond Southeast Asia. Many of these cartels were aided and abetted by the US Central Intelligence Agency, which used profits from drug runs to Vietnam and elsewhere to finance its covert activities (Congress can't cut such funding). After US involvement in that war wound down and the CIA withdrew, the drug trade persisted—the distribution cartels had acquired a life of their own thanks to the boost from that war.

Several of these "drug warlord" groups

persist in 2000, even though the world heroin market is not what it used to be. The war did more to disrupt heroin traffic out of the area than all previous efforts combined, but even a global thermonuclear Armageddon could not completely destroy the drug trade in the Golden Triangle.

DRUG WARLORDS

The Golden Triangle contains two major drug warlord groups (the KMT and the SUA) and a number of smaller ones that exist because it is not convenient for someone to wipe them out.

KMT: In 1948, the Chinese Communists under Mao Zedong finally prevailed over the Chinese Nationalists (the *Koumintang*, or KMT) under Chiang Kai-shek. The KMT 93rd Regiment, consisting largely of Yunnanese, fled China to Burma in 1949, where it soon became involved in the cultivation of opium and the manufacture and distribution of heroin. The soldiers of the 93rd and their families remained in Burma until the Burmese government finally expelled the bulk of them in 1961, forcing them into the Golden Triangle of Thailand. Their descendants remain there in the year 2000, largely unabsorbed into Thai society, and doing business at the old stand.

The KMT has about 2000 soldiers at its disposal, and has effectively taken control of the area along the northern border with Laos. The KMT has good relations with the populace (most of whom think of themselves as more Chinese than Thai anyway), and treats its bonded laborers much better than average for the region (which is still not saying much). The leadership has completely forgotten the original reason for the regiment's existence, since Chinese communism has effectively gone the way of the dodo and the passenger pigeon.

SUA: The Shan United Army was founded by a particularly interesting character, one Khun Sa (a.k.a. Chang Chi-fu and Sao Mong Khawn), a Shan/Chinese military leader/drug lord. With its chief stronghold in Chiang Mai, estimates put SUA strength at 1900 fighters, although

discipline has deteriorated since Khun Sa's day, and they can hardly be characterized as an army any longer.

Since Khun Sa passed on to glory in 1997, a sort of council of his lieutenants took over, and things have been deteriorating ever since. Individual bands will occasionally go on a rampage, kidnapping whole villages into slavery, stealing their crops, and burning everything they can't carry away.

THE DRUG TRADE

The warlord's soldiers do not usually grow opium themselves—slaves and drafts of labor from the cities take care of that on the plantations owned by the warlord directly. Soldiers collect tribute in the form of opium from the various hill tribe villages in the area as well. After the raw opium is harvested, the warlord's men will sometimes process it into heroin themselves (for easier transport). The warlord sells the resultant heroin to in the market at Sukhotai, sends it west into Burma, or east along the Mekong, whichever is most convenient for his location.

HILL TRIBES

In general, the hill tribes differ in language, details of dress, and specific village customs. Their agriculture is of the slash-and-burn variety, which means that a village will settle in a high valley, farm the local ground until such time as the soil is exhausted (which happens within a couple of years) and then move on. Their buildings are simple one- or two-room huts, their villages simple clusters around a common center where the village elders and their families live. Villages are usually led by a single headman, although actual governmental duties are minimal.

Animism: The main religion of the hill tribes is animism, the worship of nature spirits. Each natural object has its spirit, animists believe, and humans can get along only if they take care to treat these spirits well. The details of the animist religion, due to its very nature, vary from village to vil-

Kamphaeng Phet

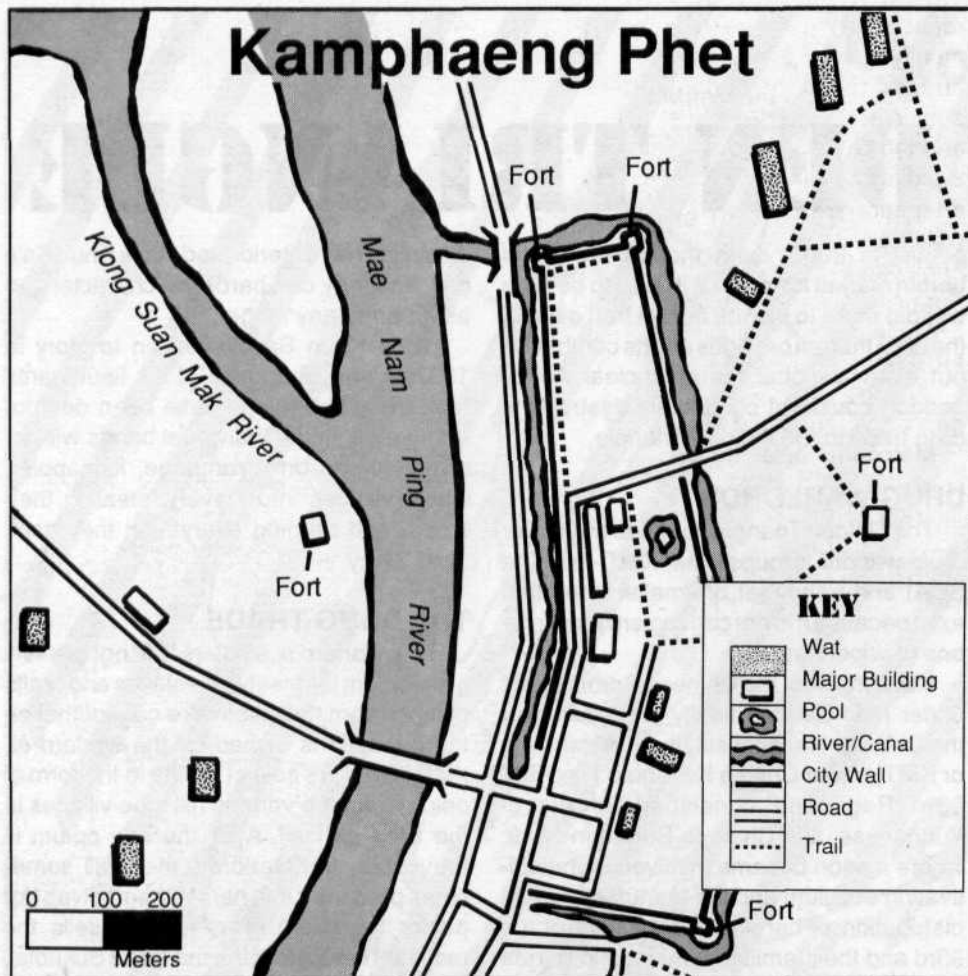

formed by Chiang Rai, Phayao, and Chiang Khong. They are sympathetic to the KMT and are allied with that group. The Lisu are also unique among the hill tribes in that no marriages are arranged by parents or shamans—spouses are freely chosen.

Mien: The Mien (known to the Thais as the Yao) are Chinese in origin, use Chinese ideographs for their written language, and are patrilineal and polygamous. A few villages are Taoist rather than animist, and almost all engage in some form of ancestor worship, which makes the recording of pedigrees and family trees a matter of considerable importance.

COMMUNITIES

The following is a description of the major cities and towns in northern Thailand.

Chaing Mai: The city of Chaing Mai is the headquarters of the Shan United Army (SUA). Even with its surrounding farming villages, it is not self-sufficient agriculturally, and depends upon trade with the south for food. The tin mines in the mountains nearby now go almost unused, and many serve as hiding places for marauders.

Chaing Mai was once the second largest city in Thailand, but the crop failures of the last few years (added to the civil disorder brought on by the global depression) have caused much of the population to flee. Further depopulation came about as the SUA sought to solve the food problem by taking excess population from the city to nearby farms as bonded labor.

Chiang Saen, Mae Sai, Nan: Communities in the Golden Triangle under the control of the KMT.

Lamphun: The villages around the city of Lamphun earn a living by trapping and training elephants for heavy lifting. Until recently, the community and its associated villages were under the control of the SUA, but the populace took advantage of the lack of real SUA leadership to throw out the local SUA commander and the thugs he called soldiers and raise a militia to keep them out.

The Lamphun militia captured four 75mm pack howitzers when the SUA was thrown out, and now is one of the few community defense forces with an artillery battery—and the only one using pack elephants.

Kamphaeng Phet: Kamphaeng Phet is another of the independent communities recently separated from SUA control. It is shifting its agriculture from poppy cultiva-

lage and even from person to person.

Akha: The Akha are of Tibetan ancestry, and are widespread throughout the region, having villages in Tibet, China, Burma, Thailand, and Laos. Like most hill tribes, they are animists, but they engage in ancestor worship as well. The Akha (known to the Thais as the *I-kaw*) grow corn, rice, and opium (for their own consumption and for trade).

Hmong: The Hmong are the second largest hill tribe group, and are especially numerous in the area around Chiang Mai. They are animists, practice polygamy and have a strict patrilineal kinship system (unlike most other tribes, which have no organized system of inheritance). The Hmong (known to the Thais as the *Meo*) are believed to be Chinese in origin, and may represent the earliest Chinese culture, driven into the hills by later, more organized groups.

Karen: The Karen are the most numerous hill tribe group, and came to Thailand to escape Burmese government persecution, beginning in the 1960s and con-

tinuing well into the 1990s. The Karen (known to the Thais as the *Kariang* or *Yang*) practice endogamous marriage, and have a highly organized matrilineal kinship system. Individual villages may be Buddhist, animist, or (rarely) Christian. Karen villages are concentrated in the area adjacent to the Burmese border both here and further south along the southern peninsula.

Lahu: The Lahu (known to the Thais as the *Musoe*) have their own form of animism with a single supreme spirit (known as *Geusha*). They are Tibetan in origin, and tend to live at lower altitudes than other hill tribes. Before the war, their intricately woven shoulder bags were highly prized by collectors of native art, and the tribe earned a considerable sum selling them. This market has collapsed recently.

Lisu: The Lisu (known to the Thais as the *Lisaw*) are unique among the hill tribes as they have a tribal council that functions as a government, with each village sending a representative. The Lisu are Tibetan in origin, and are concentrated in the triangle

tion over to food crops (primarily corn), but several hill tribe villages in the area still produce opium for sale in the market at Sukhothai. Once one of the outlying border fortresses of the Sukhothai kingdom, Kamphaeng Phet now uses the old fortifications for its own defense.

Phitsanulok: Phitsanulok is an independent community, and the growing success of the warlord of Sukhothai has brought relative prosperity to here as well. AS Phitsanulok sits astride the main roads both to Bangkok and east to the Mekong communities, merchant convoys from Sukhothai naturally pass through it, and the town has prospered from tolls.

Sukhothai: Sukhothai (and its sur-

rounding villages) is an independent community run by Mana Taptim, an ex-Thai army officer-turned warlord. Taptim acts as a middleman between the KMT, the SUA, and the Chinese and Japanese cartels in Bangkok. Every few months, there is a drug auction regulated by the local militia, which consists of soldiers from several armies, including US, Soviet, Chinese, Thai, Burmese, Vietnamese, and Kampuchean. Sukhothai is too valuable to destroy and too powerful to conquer, and Taptim counts on this to maintain his community's independence and well-being.

Merchants of all nationalities are welcomed, but soldiers are discouraged unless they are looking for work (the drug convoys

are always in search of guards).

Mae Hong Son, Mae Sarlang, Chalng Rai: Communities still under control of SUA warlords. They are occupied by 100-200 man garrisons of warlord soldiers, and count as terrorized territories.

ENCOUNTER SPECIFICS

Military encounters within the areas controlled by a drug cartel will be with that cartel's soldiers. Caravans will belong to the relevant cartel or to one of the mercantile/criminal conclaves from Bangkok. Primitive encounters are with a hill tribe of the referee's choice (since they are nomadic, there is some chance of encountering any of them throughout the area).



Science Project

This scenario is for **Merc: 2000**, although it could be adapted to **Twilight: 2000**. In it, the group is hired to destroy a major drug processing facility.

BACKGROUND

The Golden Dragon cartel (a.k.a. the KMT) has established a major opium processing factory on the Laotian side of the river north of Chiang Khong. Laotian authorities are too corrupt to be able to take action, and the Thai military is unwilling to attack the village because it is not in Thailand. The Thai military has no problem turning a blind eye to independent contractors, however. The mission is complicated by the fact that the factory is built in the middle of a village of Hmong, who are effectively being used as slave labor by the factory. An Arc Light mission is out of the question—the government has a bad

enough image in the Third World as it is.

The group is offered \$100,000 to destroy the processing factory without damaging the Hmong village. The patron will supply any equipment desired, deducting it from the final payment. Transportation will be provided by a private air transport firm.

APPROACH

Air transport will be provided for up to 12 people and up to one ton of equipment (no vehicles). Retrieval may be by helicopter, light plane, or skyhook at whatever location the characters specify.

MAP DESCRIPTION

The map shows the location of the lab, the village, and the surrounding terrain. An abandoned airstrip is located 15 kilometers southeast of the lab.

REFEREEING THE SCENARIO

This is a fairly straightforward raid sce-

nario, which the referee may proceed to dress up as desired.

NPCS

The village is inhabited by 200 Hmong, who serve as the factory's labor force, and a garrison of 64 warlord soldiers. The Hmong are mostly Novices, although a few of them are Experienced and one or two may even be Veteran. All are unarmed, but they all have some skill in fighting. The soldiers are armed with AK-74s, and have, in addition, 10 PK MGs, two KPV MGs, two AGS-17s, and an 82mm mortar.

ALTERNATIVES AND VARIANTS

The patron's information was wrong. There is a factory here, but it is producing chemical warfare agents for distribution to international terrorists. The Hmong are being used as slave laborers in its manufacture, and OSHA regulations are *not* being met.

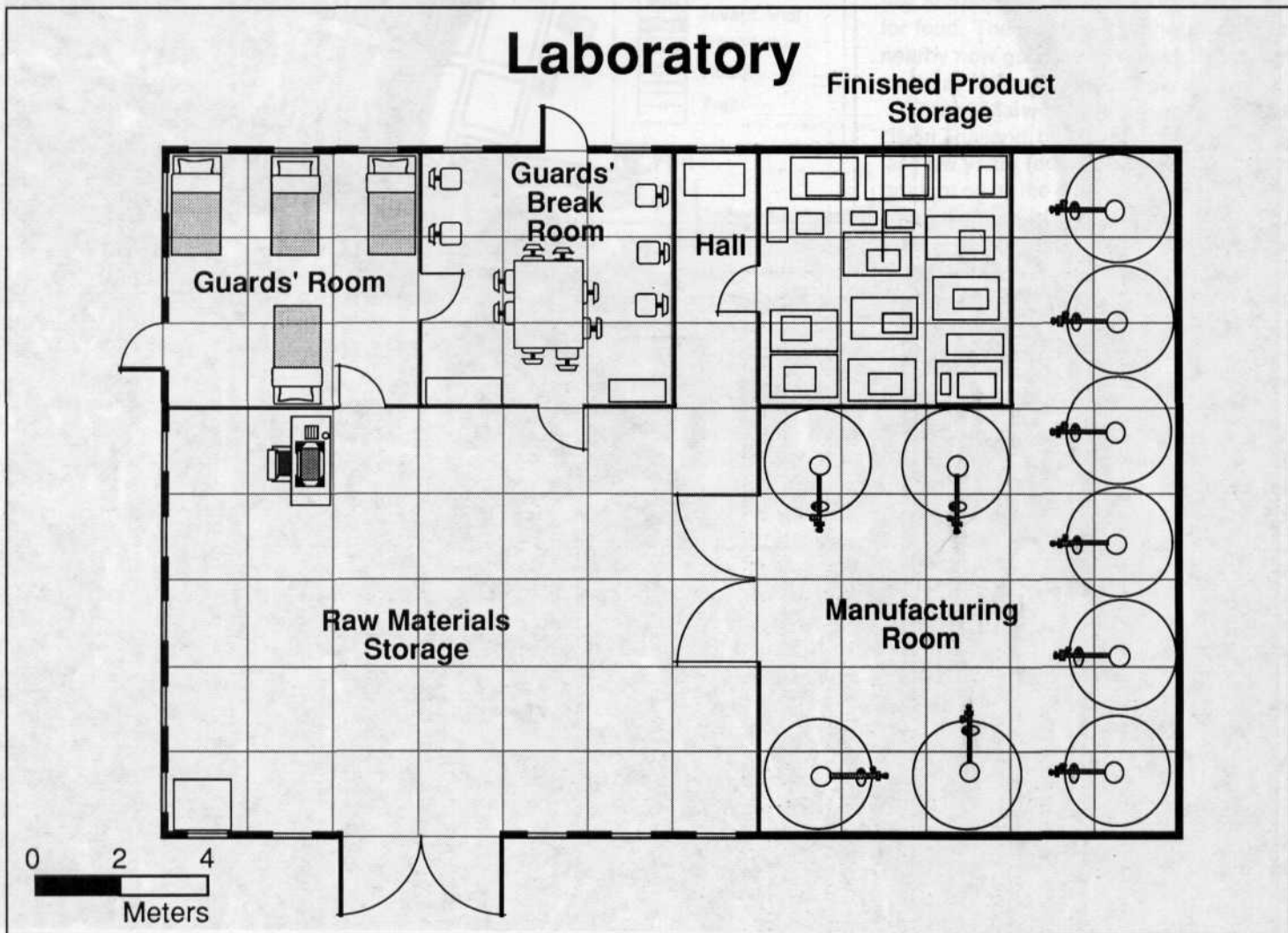

Lab, Village, and Surrounding Terrain

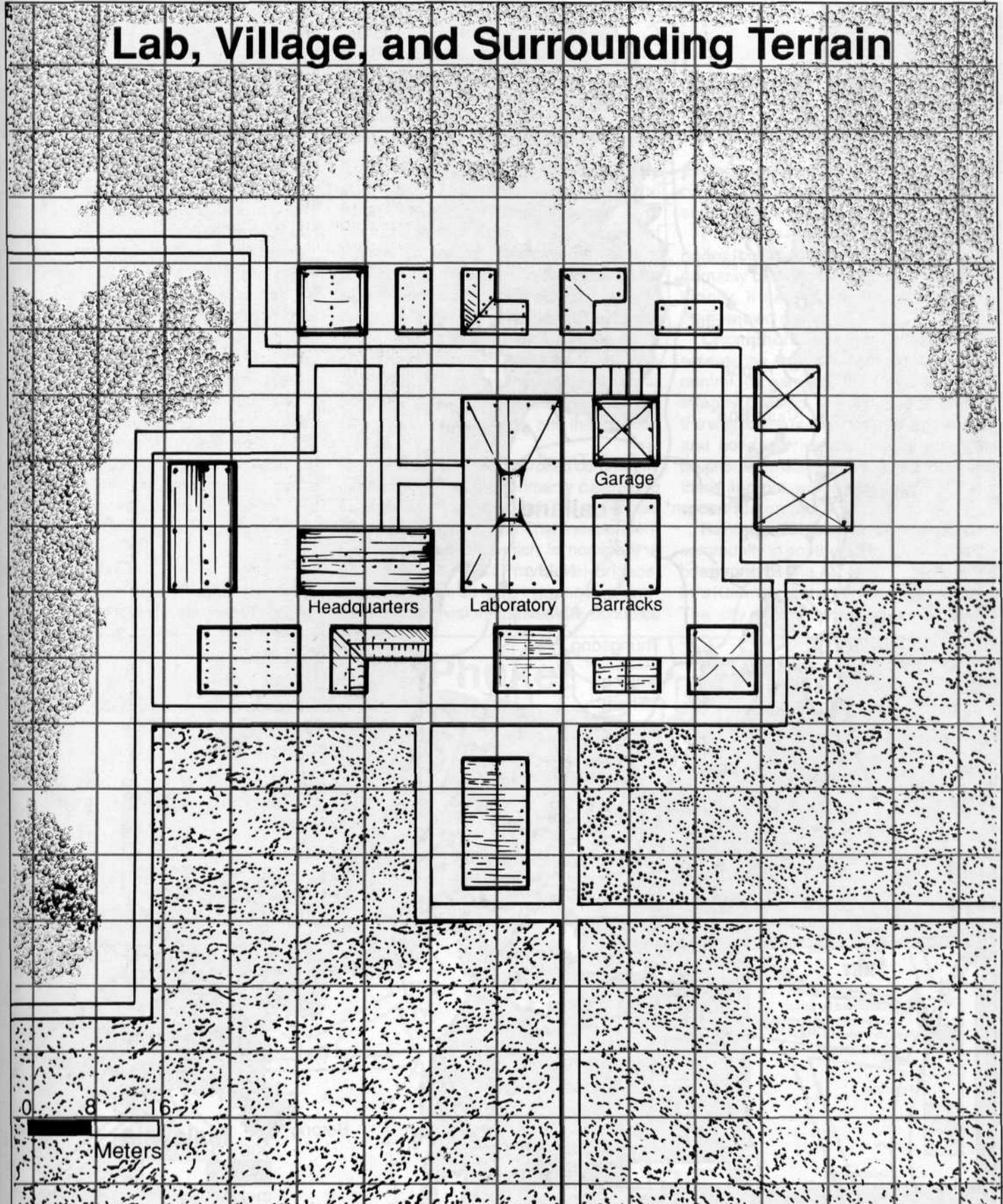

Southern Thailand

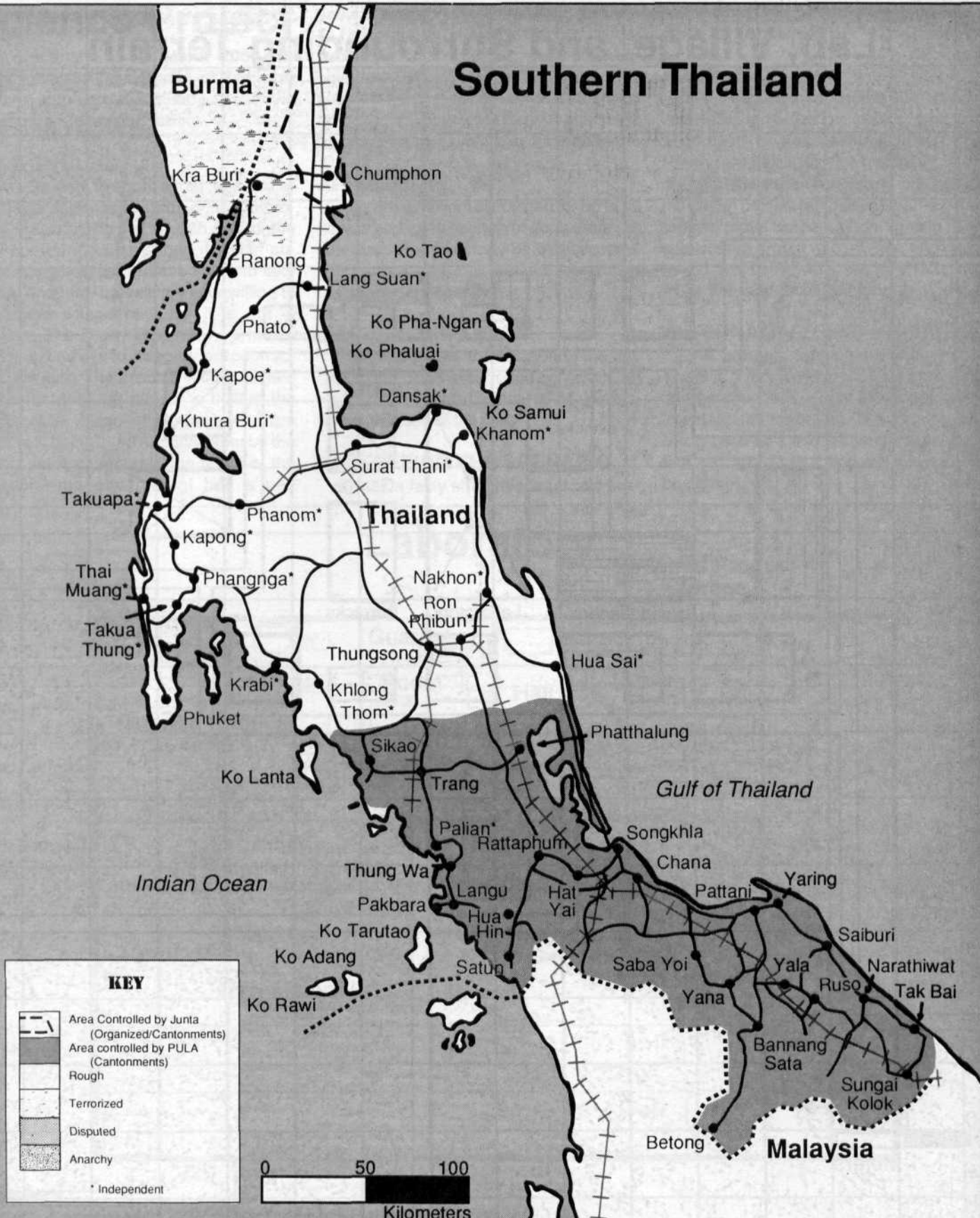

Burma

Kra Buri

Chumphon

Ranong

Ko Tao

Lang Suan*

Phato*

Ko Pha-Ngan

Ko Phaluai

Dansak*

Ko Samui

Khanom*

Kapoe*

Khura Buri*

Surat Thani*

Thailand

Takuapa*

Phanom*

Kapong*

Nakhon*

Ron Phibun*

Thai Muang*

Phangnga*

Thungsong

Hua Sai*

Takua Thung*

Krabi*

Khlong Thom*

Phuket

Phatthalung

Ko Lanta

Trang

Gulf of Thailand

Indian Ocean

Palian*

Rattaphum

Songkhla

Thung Wa

Chana

Pakbara

Langu

Hat Yai

Pattani

Yaring

Ko Tarutao

Hua Hin

Saiburi

Ko Adang

Satun

Saba Yoi







Yala

Narathiwat

Ruso

Tak Bai

KEY

-  Area Controlled by Junta (Organized/Cantonments)
-  Area controlled by PULA (Cantonments)
-  Rough
-  Terrorized
-  Disputed
-  Anarchy

* Independent

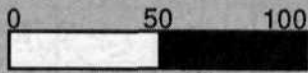

Malaysia

Betong

Bannang Sata

Sungai Kolok

SOUTHERN THAILAND

The mountainous peninsula that forms the southern portion of Thailand is sparsely settled and (despite heavy cutting of teak in the area) still more than 40% tropical rain forest or rubber trees. Rubber cultivation, tin mining and tourism were the prime economic assets of the region before the war. Now none of them remain at their former level. Tourism is nonexistent, and the need both for rubber and tin has fallen off considerably. The Junta maintains a few cantonments in the the peninsula, and is nominally in control, although much of the area is independent. In the south, this control is contested by various Malay independence groups. Many of the coastal villages serve as bases for the fishing/pirate boats of the Gulf of Thailand.

COMMUNITIES

The following is a description of the major cities and towns in southern Thailand.

Phetburi: A Junta-controlled community in southern Thailand, garrisoned by the Phetburi Provisional Brigade, consisting of the 1st and 2nd Royal Thai Independent Infantry Battalions. The caverns north of town provide a favorite shelter for marauder bands, and periodic raids are necessary to break them up before they can concentrate.

Recently, the commander of the garrison has reached an agreement with one band of marauders—they raid only caravans and warehouses associated with the Chinese merchant triads, and the garrison leaves them alone.

Hua Hin: A Junta-controlled community in southern Thailand, primarily catering to fishing villages in the vicinity. The city serves as a base for the Royal Thai Independent Cavalry Regiment, which is nominally a part of the Phetburi Provisional Brigade, but is actually *ade facto* independent command. The division commander occupies

the former royal summer residence on the beach, and leaves local matters up to his subordinates.

Prachuap Khiri Khan: A Junta-controlled community in southern Thailand, primarily catering to fishing villages in the vicinity. It has no regular garrison other than its own militia.

Chumphon: The city of Chumphon represents the southernmost extent of Junta control. Its garrison, the Royal Thai Light Infantry Division, is supposed to prepare the way for the reconquest of the peninsula, and conducts regular patrols down the peninsula to keep up a Junta presence there and prevent the formation of major opposition groups (PULO excluded).

Ranong: Ranong is an independent community in southern Thailand along the border with Burma. At present, it is controlled by a Karen despot and 1200 Karen fighters. The city presently serves as a rallying

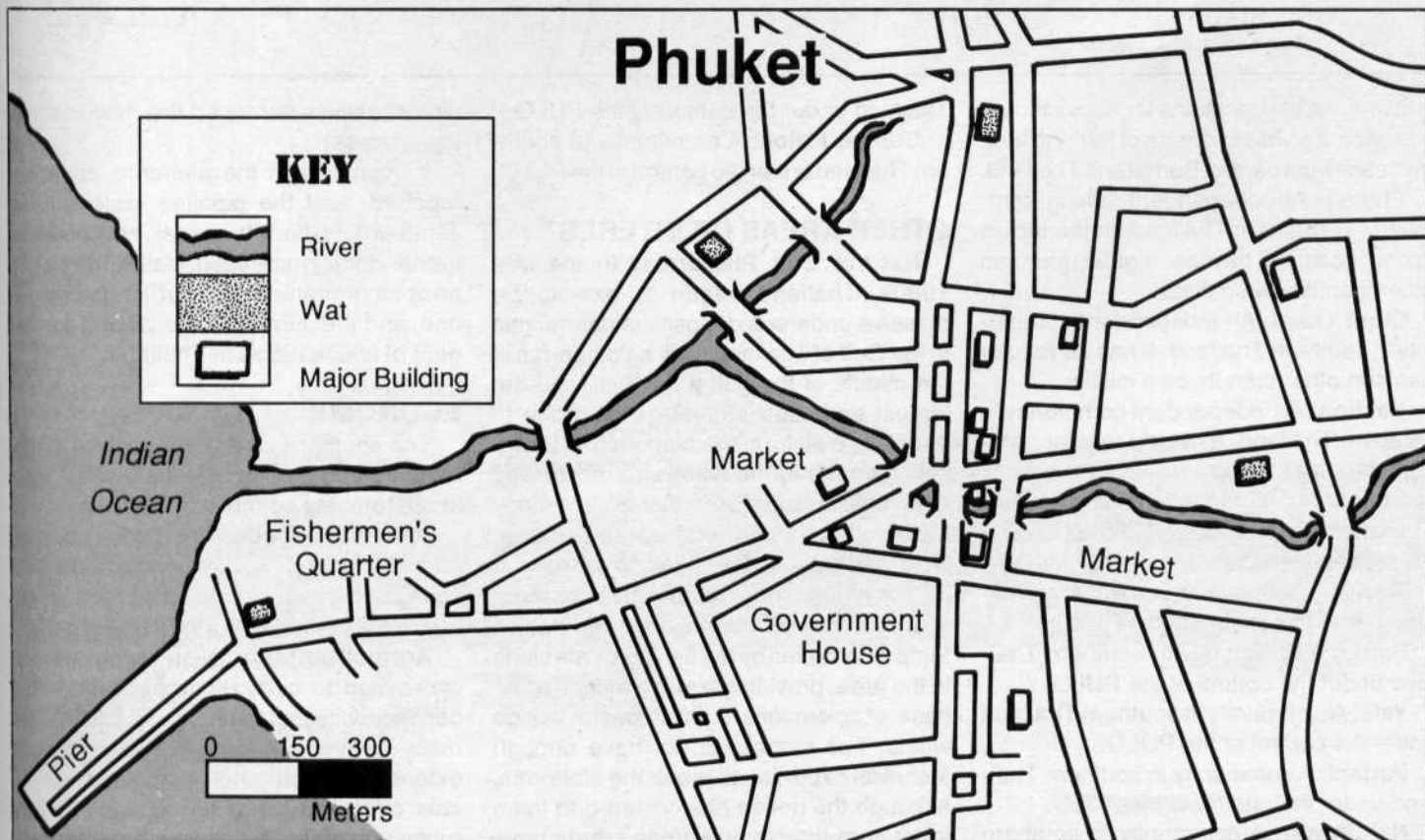

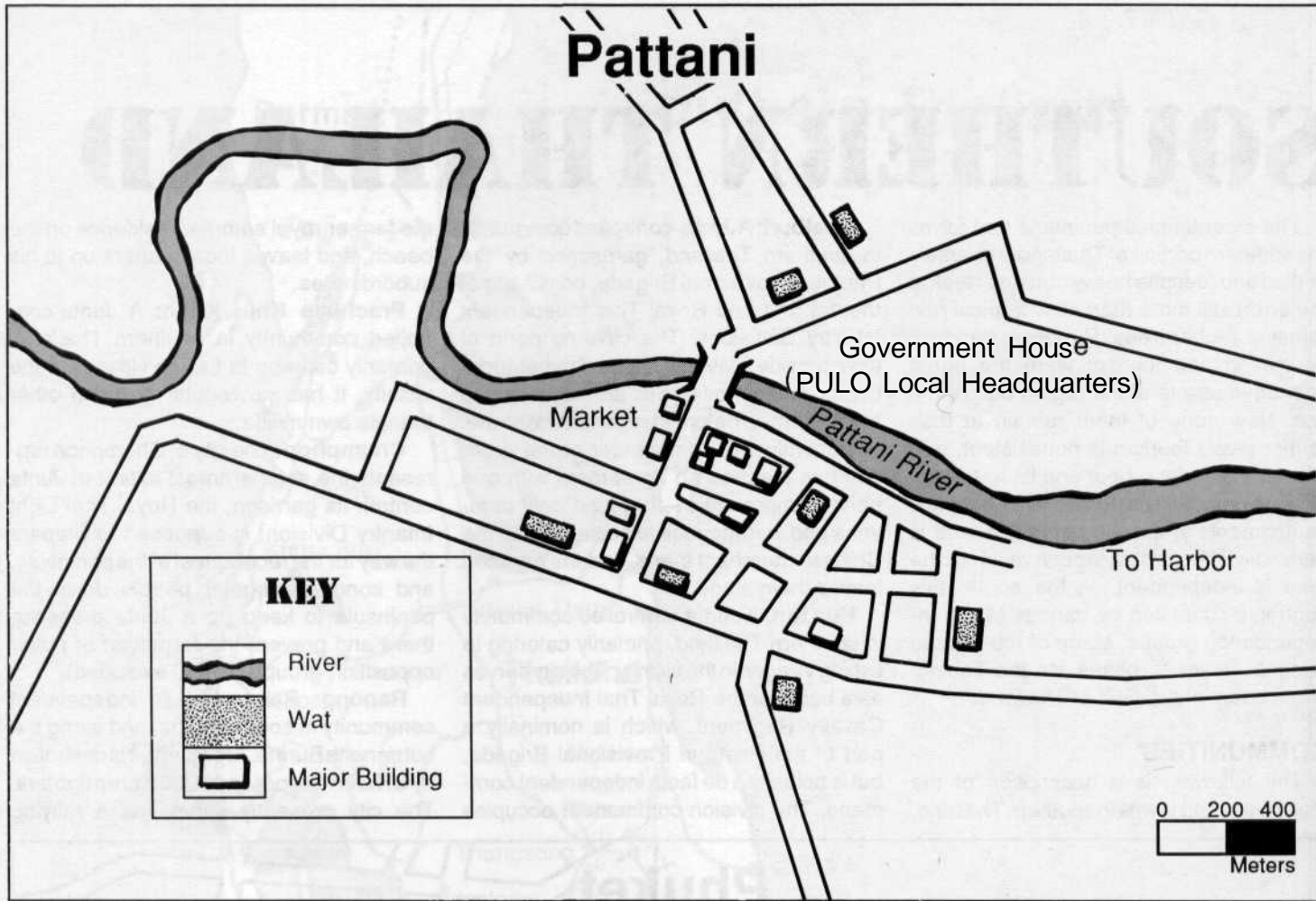

center/base of operations for Karen tribesmen, some of whom dream of forming their own state from parts of Burma and Thailand.

Phuket: An independent fishing community in southern Thailand on the Indian ocean coast. It has no regular garrison other than its own militia.

Surat Thank An independent community in southern Thailand. It has no regular garrison other than its own militia.

Nakhon: An independent community in southern Thailand. It has no regular garrison other than its own militia.

Songkhla: A community in southern Thailand under the control of the PULO.

Hat Yai: Headquarters of the PULO.

Trang: A community in southern Thailand under the control of the PULO.

Satun: A community in southern Thailand under the control of the PULO.

Yala: A community in southern Thailand under the control of the PULO.

Pattani: A community in southern Thailand under the control of the PULO.

Narathiwat: A community in southern

Thailand under the control of the PULO.

Sungai Kolok: A community in southern Thailand under the control of the PULO.

OTHER AREAS OF INTEREST

Natural Gas Platforms: In the late 1980s, Thailand began to exploit the massive undersea deposits of natural gas in the Gulf of Thailand. Drilling platforms in the middle of the gulf were built, and the largest undersea natural gas pipeline in Asia was built from the platforms to Bangkok. The platforms were shut down and abandoned when the war started, and many have suffered considerable damage from wind and waves. The pipeline closed for lack of natural gas to transport after this.

Some of the platforms are now used as temporary bases by the fishing/pirate clans in the area, providing a much more secure base of operations than a coastal village would. The pirates do not have enough technical expertise to repair the platforms, although the notion has occurred to them to try from time to time (their efforts have

almost always damaged the machinery in the process).

If even one of the platforms could be repaired, and the pipeline restored, the Junta would find its power and prestige tremendously increased. Natural gas is not an optimum vehicle fuel, but it is a workable one, and the Junta has the largest contingent of idle vehicles in Thailand.

ECONOMY

The southern peninsula was one of the most sparsely populated before the war, and it remains so today.

Remaining Trade: Trade in the region is primarily local. The Junta-controlled areas have a small export trade in tropical fruit and fish, mostly headed north to Bangkok.

Agriculture: The soil of this region is not well-suited to cultivation of cereal crops, but necessity has forced such activities on many communities. Before the war, the extensive tropical jungles provided teak for sale overseas (primarily to Japan). The rubber plantations are now mostly aban-

done, although a few are still operated by the Muslim Malays in the extreme south.

Coconut plantations are more economically viable. The meat and oil are much in demand, and the market for slaves to work the plantations is constant (since the work is grueling and "turnover" is high).

Fishing: The Gulf of Thailand, like most tropical waters, produces some fish, but not in massive quantities. Nevertheless, fish provide a source of much needed protein for the Thai diet, and provide the various sea people of the Gulf of Thailand with an income. Fishing also supports a number of villages on the Indian Ocean coast of the southern peninsula.

Small fishing boats (operated by ethnic Thai and other groups, such as the Moken) run in the coastal waters, and are pretty much immune from pirate attacks. The boats are small (they are the sampan or motorpan described on page 71), with family crews ranging from four to six in number, and the catches are too small to be of much interest to the pirates.

Deep-sea fishing boats (described on page 72) either belong to one of the informal fisher/pirate clans or are independents

(and risk attack from the clans if discovered). The larger boats of the various clans take fish from the gulf in economically significant quantities, meaning that each boat can pull in enough to feed its crew and have a surplus to sell. Fisher/pirates also charge tolls on merchant ships passing through the area, unless the latter are too well-armed or too fast to catch.

Minerals: The mining of tin was once the mainstay of many of the communities in the mountains that form the spine of Thailand's southern peninsula. Almost all of these mines are now closed, except for those inside Junta territory.

PATTANI UNITED LIBERATION ORGANIZATION (PULO)

In the 1980s and '90s, the ethnic differences between the primarily Buddhist Thais and the primarily Muslim Malays gave birth to an insurgent movement known as the Pattani United Liberation Organization. The name was a misnomer, since the various splinter groups sharing it (including communists until the early 1990s) were anything but united.

Never able to completely organize itself and fighting parts of itself more than the government, the PULO was never more than a minor irritation until the chaos of the war removed effective police control from the region. The primarily Muslim communities of south Thailand were galvanized into cooperation by chaos, and the PULO presented a convenient, areawide banner to flock to.

Each community runs itself, and sends a representative to an overall council, which oversees intercommunity conflicts, taxes merchants, and maintains a PULO "army" (mainly temporary drafts from local militias and a cadre of hired mercenaries) with the proceeds.

ENCOUNTER SPECIFICS

Military encounters in Junta-controlled territory will be with Junta forces from the nearest garrison. Military patrols in the PULO territory will be a unit of the PULO militia. Encounters in regions between these two may be with either force (on a long-range sweep), local militia, or mercenary soldiers on a mission of some kind. Reroll all merchant convoy encounters outside of PULO or Junta territory.



Cookin' With Gas...

In this scenario, the group must capture an offshore natural gas platform that has been taken over by pirates.

BACKGROUND

Although the underwater natural gas pipeline has long ceased to function, and pumping from the offshore platforms has ceased, the structures themselves are intact, although abandoned and (presently) inoperable. One of these platforms (Delta 747) has been taken over by a group of pirates who have begun to use it as a base of operations. The platform is a safe middle ground, far enough from shore to be safe from Junta attacks and not in any established fishing ground. Several of the pirate crews are using their boats to bring a few luxuries to the platform, and have begun to form their own version of Patpong Road in the middle of the sea. Some crews no

longer conduct raids on their own, but use the platform as a base to buy stolen goods from other pirates.

Naturally, the Junta is anxious to get control of this gold mine before one of the conclaves does: There is money to be made here, even if the wells cannot be reopened. The group has been hired to seize control of Delta 747, neutralizing the defenses until a garrison of Junta soldiers can arrive and take over.

APPROACH

The Junta has questioned pirates about the platform, and has learned a number of things. The operators of the platform are extremely well-organized and have an experienced security force. The platform has four or more weapons positions, including at least two 120mm mortars and an unknown number of KPV machineguns. The Junta feels that it will be extremely costly to assault the platform directly, and has decided to use a more subtle attack—the group. The group is to infiltrate the plat-

form, neutralize the weapons positions and the security guards, and await the arrival of a Junta garrison, which will follow within hours.

The group may attempt to pose as a pirate vessel (some have European crews these days) and board the platform by day, it may attempt to sneak aboard the platform at night, or it may try a combination of both (smuggling its weapons aboard undercover of darkness, for example).

The group will be paid \$120,000 upon success only.

MAP DESCRIPTION

The map depicts the platform and the placement of ships around it when the group arrives. Detailed plans of the platform are also shown on subsequent pages, but these will not become available to the player characters until they board the platform.

REFEREEING THE SCENARIO

The players will need to scout about the platform a bit, determine where the security forces concentrate, and devise a plan to take them out.

The pirates have formed a "police force" for Delta 747, and enforce a number of rules for its patrons, the most important being that all firearms must be surrendered to the management—no one is allowed aboard the platform with a firearm. Security forces are the only exception. If the characters hope to go unnoticed on the platform, they will need to smuggle their weapons aboard. Pistols and SMGs are concealable, anything larger is not.

In addition to patrolling the interior of the platform, the "police" maintain six weapons positions on the platform and a number of armed small boats (each with a PK MG) for investigation of suspicious customers.

NPCS

The platform is inhabited by almost 200 people, but only 24 of these are armed security guards on duty at any given moment. Eight of these are on roving patrol. The remainder crew mans the weapon emplacements (three KPV MGs, one AGS-17 AGL, and two 120mm mortars) covering the sea. The gun crews are Novices; the other guards are Experienced. All are armed with AK-74 or M16 assault rifles. The remaining inhabitants of the platform are Novices.

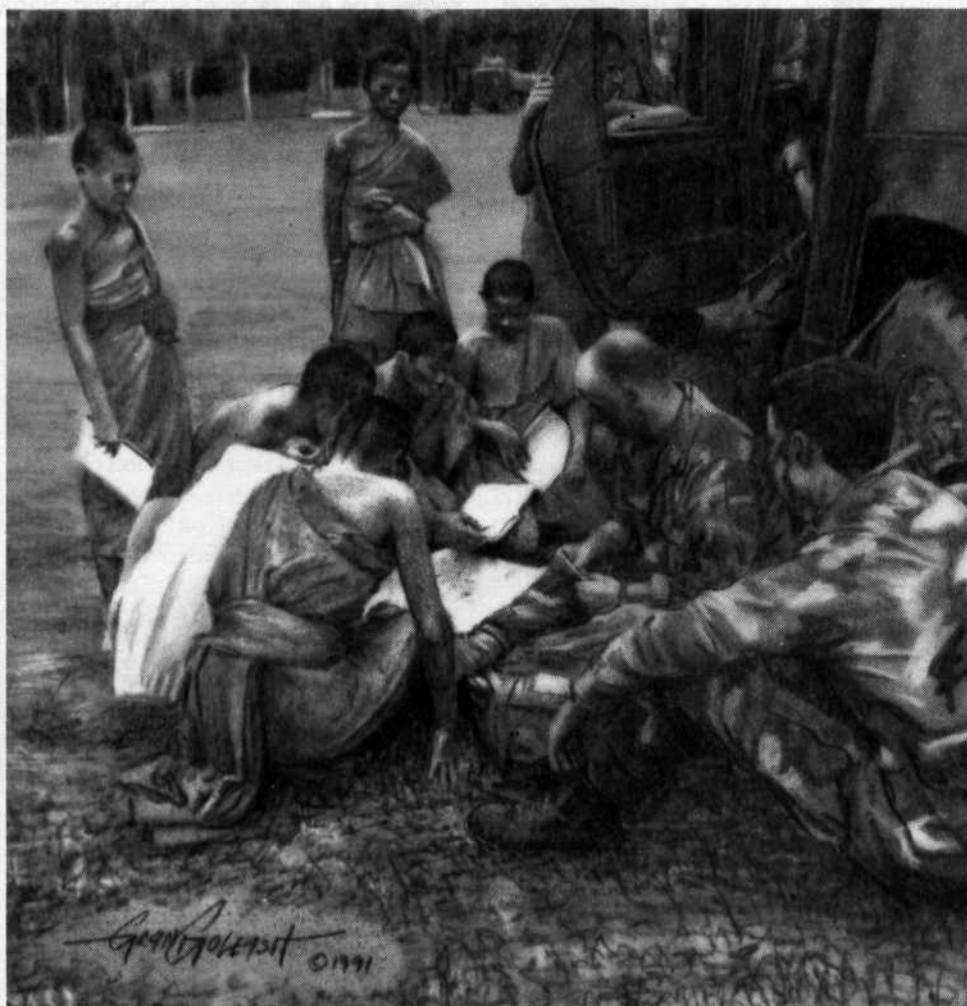

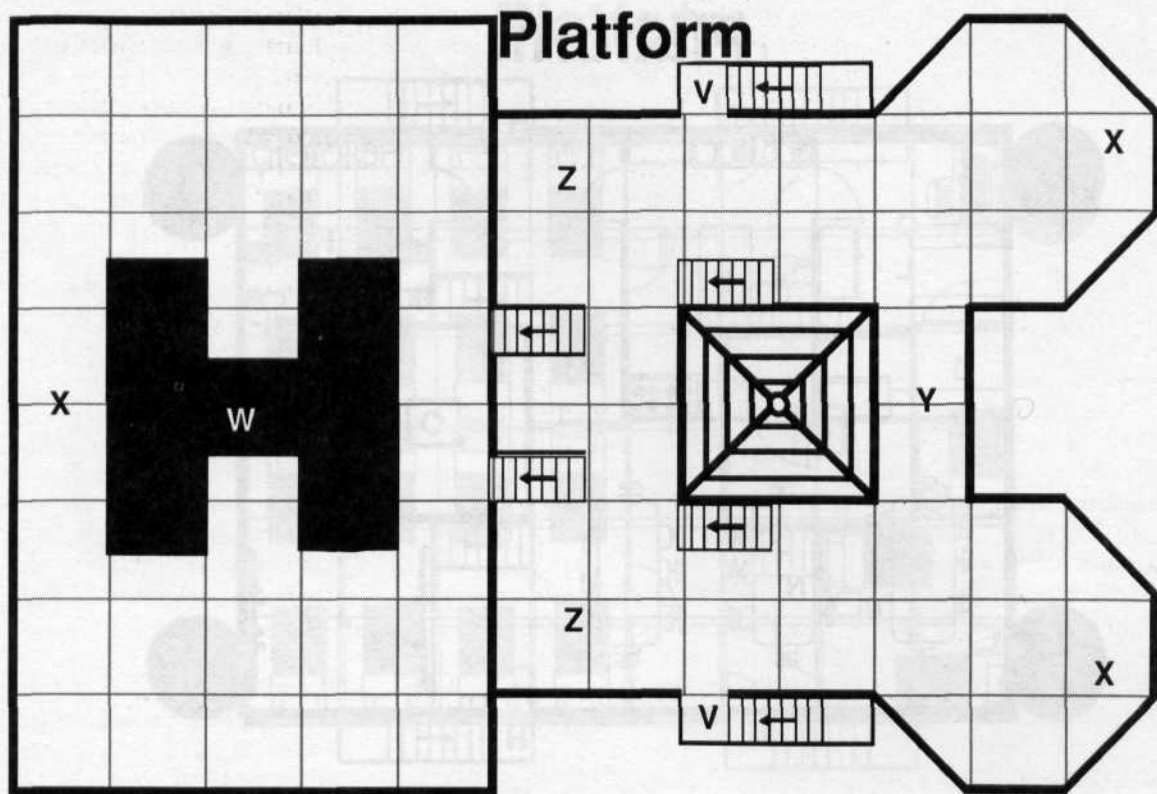

HELIPAD LEVEL

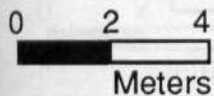
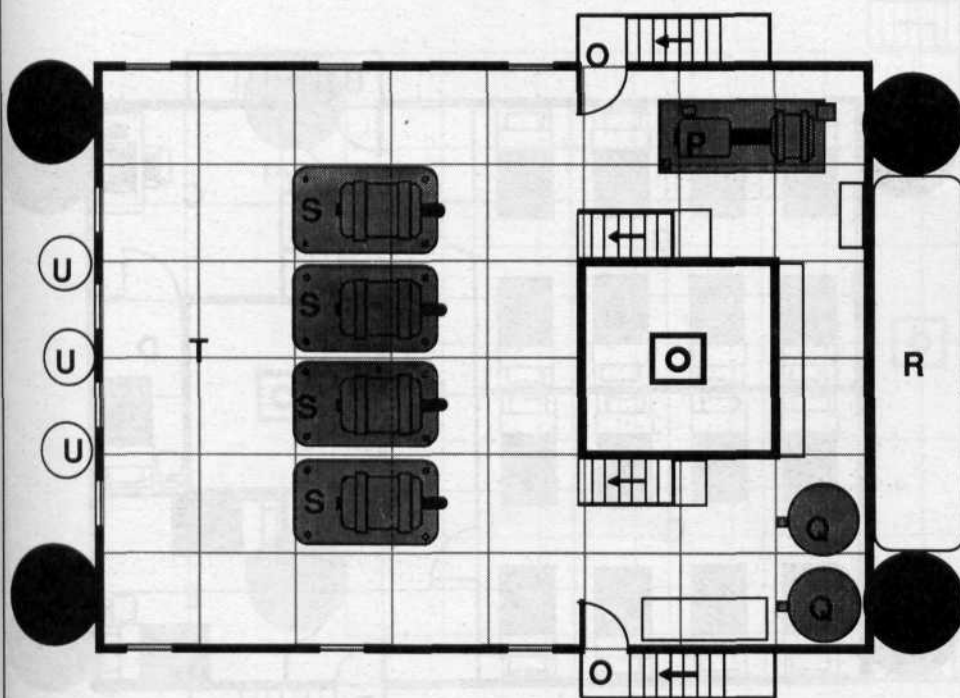

KEY

Machinery Level

- O Landing
- P Generator
- Q Desalinization Gear
- R Fresh Water Tank
- S Pumps
- T Machine Shop
- U Fuel Cylinders (for machinery)

Helipad Level

- V Landing
- W Helipad (now covered with jerry-rigged shelters)
- X KPV MG Position
- Y AGS-17 Position
- Z 120mm Mortar Position

Platform

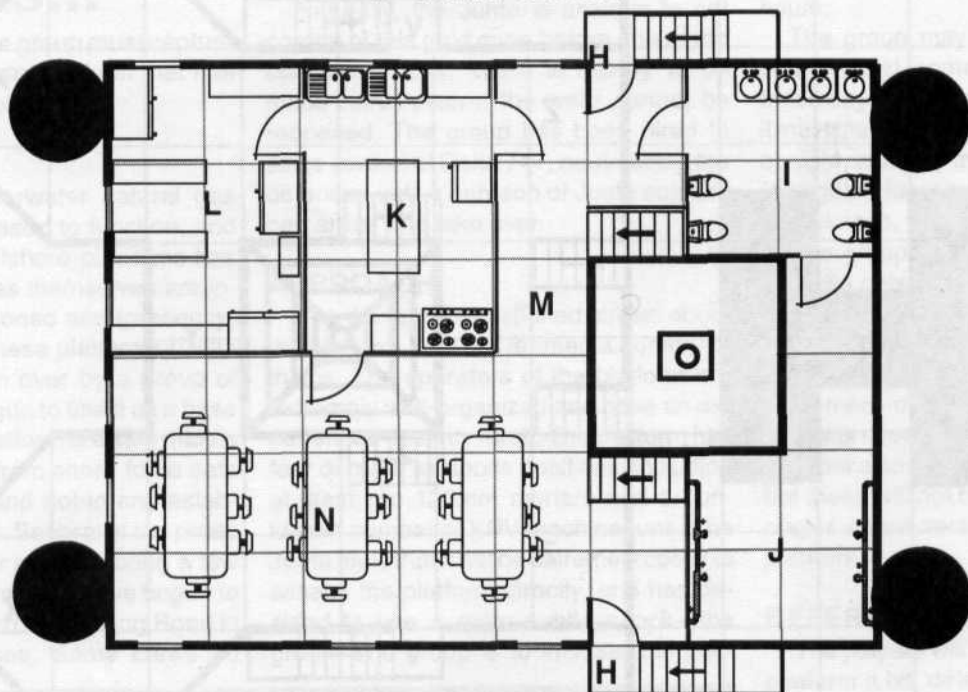

FACILITIES LEVEL

KEY

Pylon (Water) Level

A Landing

Quarters level 1 and 2

B Landing

C Office

D Officer's Quarters

E Semi-Private Quarters

F Hall

G Quarters

Facilities Level

H Landing

I Toilets

J Shower Room

K Kitchen

L Pantry

M Hall

N Wardroom/Lounge

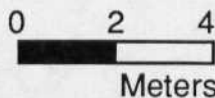
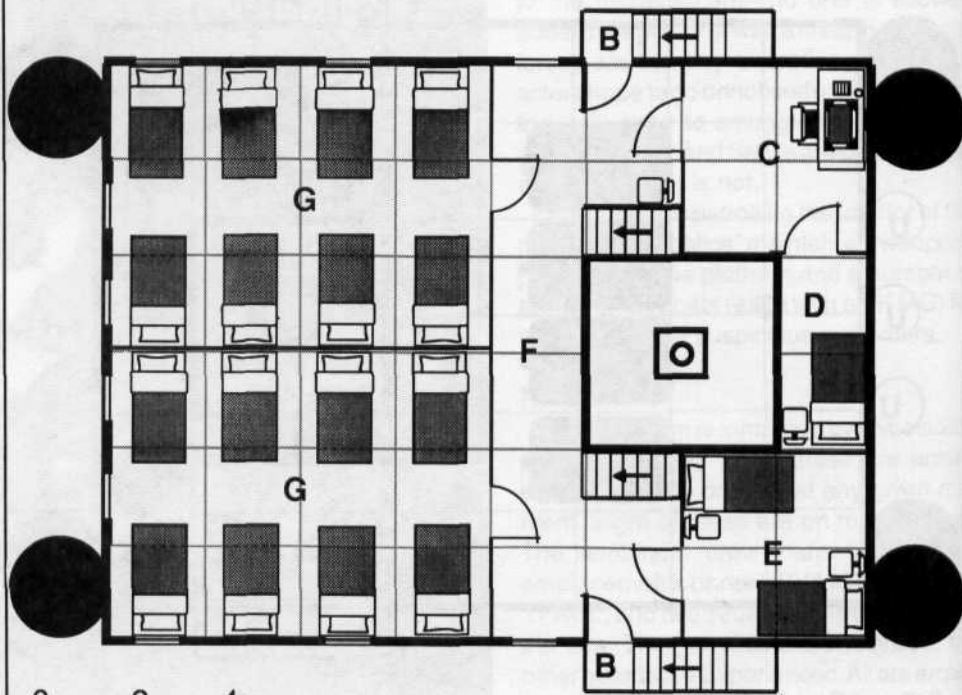

QUARTERS LEVEL 1

Platform

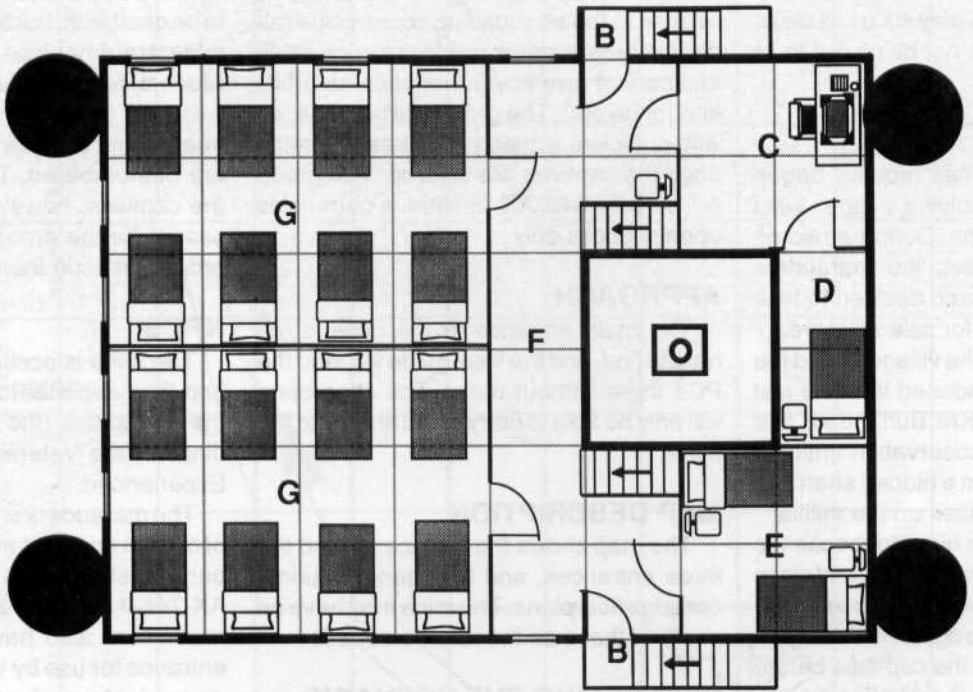

QUARTERS LEVEL 2

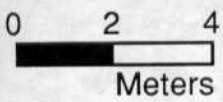
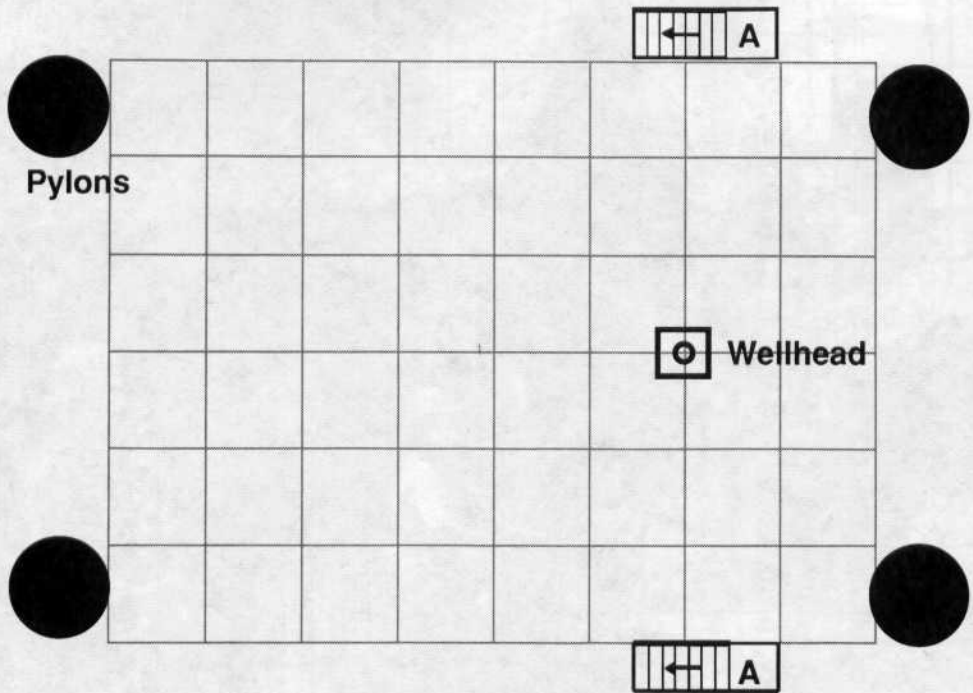

PYLON (WATER) LEVEL

Miner Problems

In this scenario, the players must clean out a tin mine which is not being put to its intended purpose.

BACKGROUND

A marauder group has recently begun regular raids on the outlying villages west of the city of Chumphon. During a raid on the village of Ban Paet, the marauders grew particularly bold and decided to take captives, presumably for sale as slaves.

A militia party from the village trailed the marauders to an abandoned tin mine just off the Chumphon/Kra Buri Road, and kept the mine under observation until the marauders sortied from a hidden shaft and inflicted severe casualties on the militia.

The group has been hired to rescue the captives, root out the marauders, and close the mine entrances so that it cannot be used for such a purpose again. The villagers are anxious to rescue the captives before the marauders carry them off, and the players' group represents the best military

force available.

By a great stroke of luck, one of the villagers used to work at the mine, and can provide a map showing the entrances in relation to the surrounding countryside (although he was never inside the mine itself, and cannot give any information about its interior layout). The group will be provided with sufficient explosives to seal the mine once the captives are cleared. The group will be paid \$40,000 in various currencies upon success only.

APPROACH

The main entrance to the mine is not hard to find, and the local guide will lead the PCs there without delay. The characters will only be able to carry small arms into the mine.

MAP DESCRIPTION

The map shows the surface around the three entrances, and four generic tunnel complex floorplans. The mine may have as many of these as the referee sees fit.

REFEREEING THE SCENARIO

Before beginning, the referee should

determine how many levels the mine has, and on what level the captives are being held. The marauders have placed a pair of sentries at each entrance, which will have to be dealt with, but the grounds outside the mine are otherwise unpatrolled. The marauders feel safe underground, and will withdraw to the mine when attacked, retreating out another exit if it appears they are outnumbered. They will not bring out the captives, however, and it will be necessary for the group to enter the mine in order to rescue them.

NPCS

The mine is occupied by 24 marauders and their dependents and captives. Six of the marauders (the leader and his subordinates) are Veterans; the remainder are Experienced.

The marauders are armed with a mixture of civilian and military firearms: six double-barreled shotguns, 11 bolt-action rifles, four AK-74s, two M16s and an Uzi SMG. The marauders also have a PK MG at each entrance for use by the sentries there. The dependents and captives are unarmed Novice NPCs.



Mine

Entrance

Parking Lot

Tailings Pile

Warehouse

Entrance

Main Building

0 8 16
Meters

Entrance

Creek

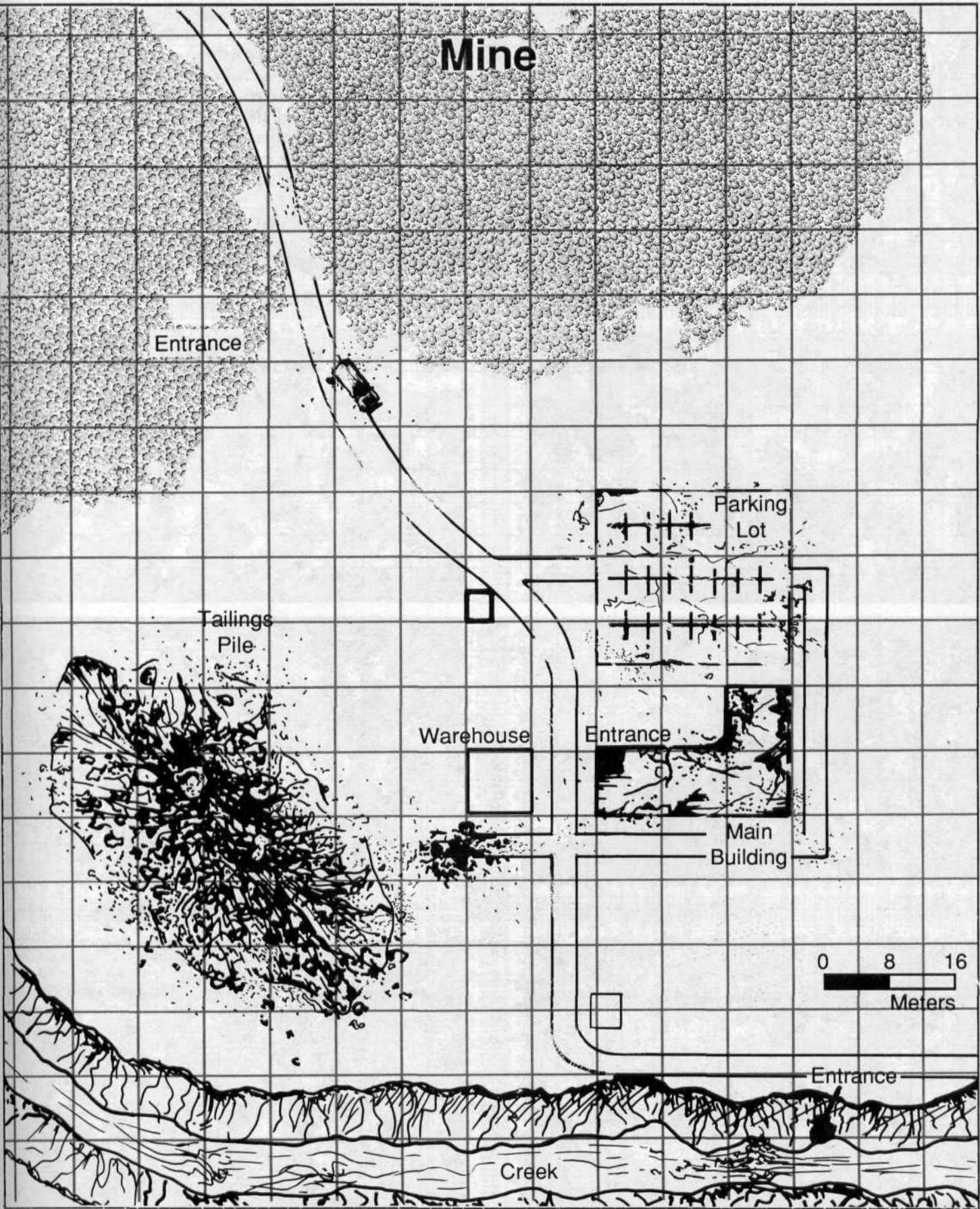

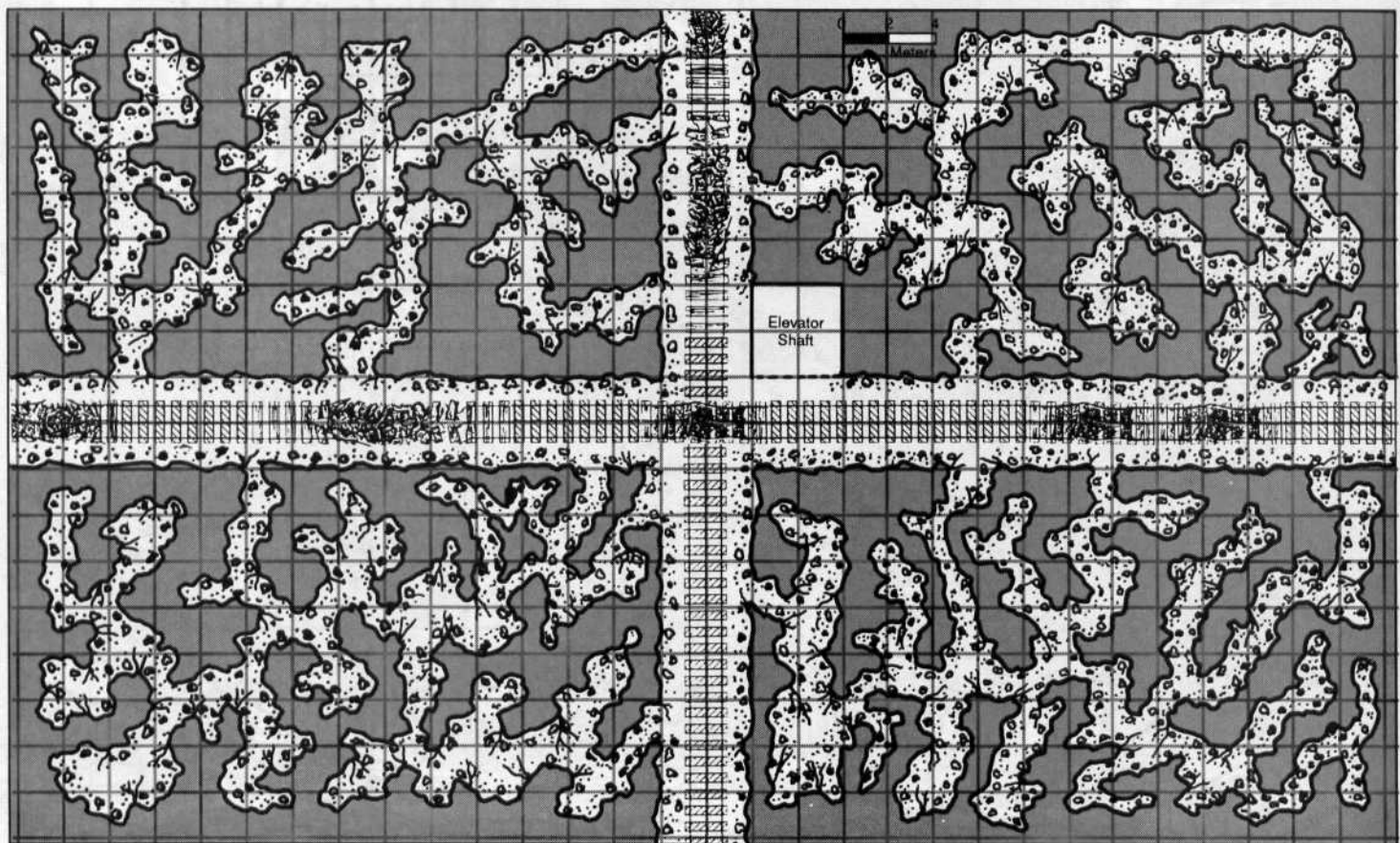
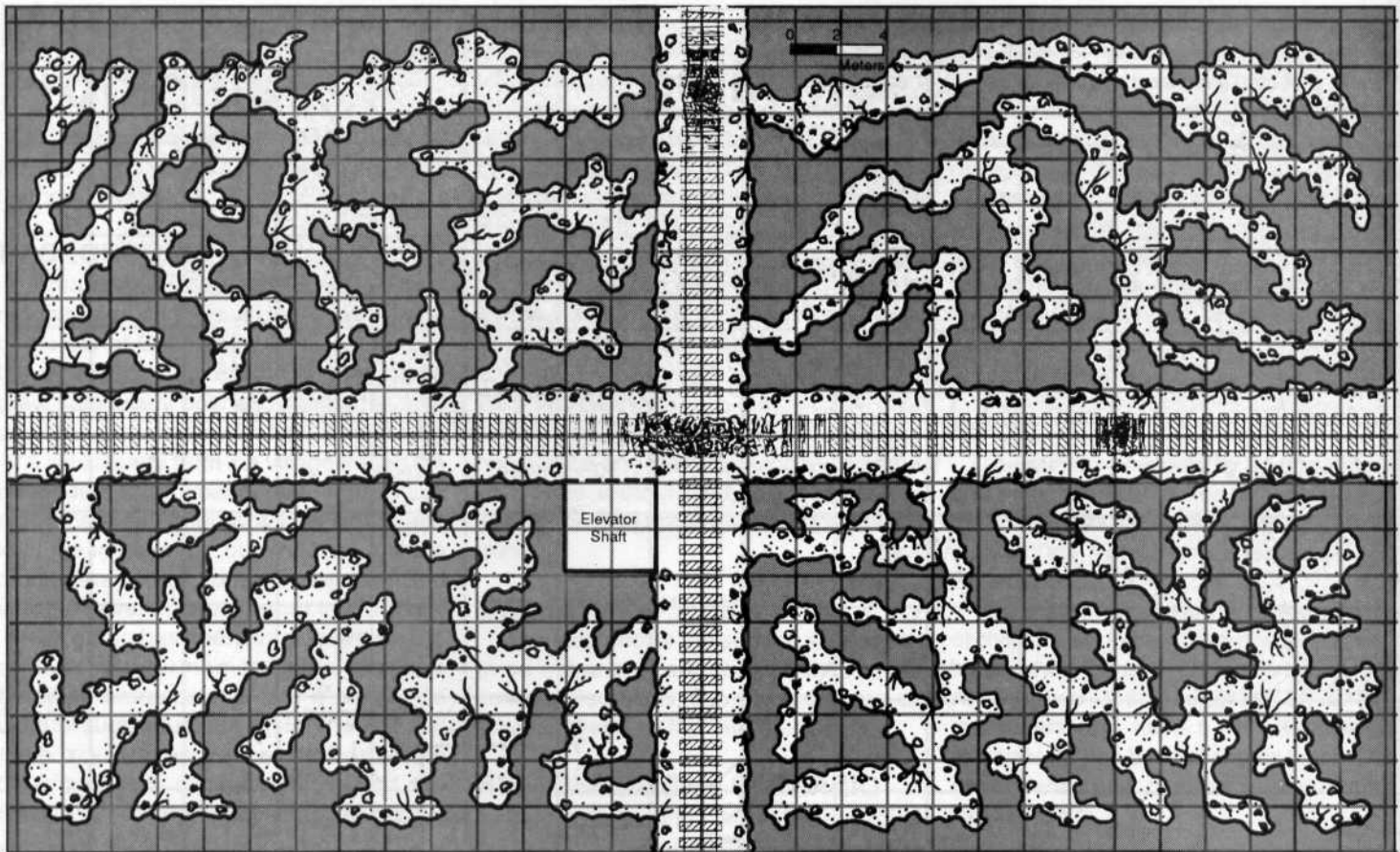

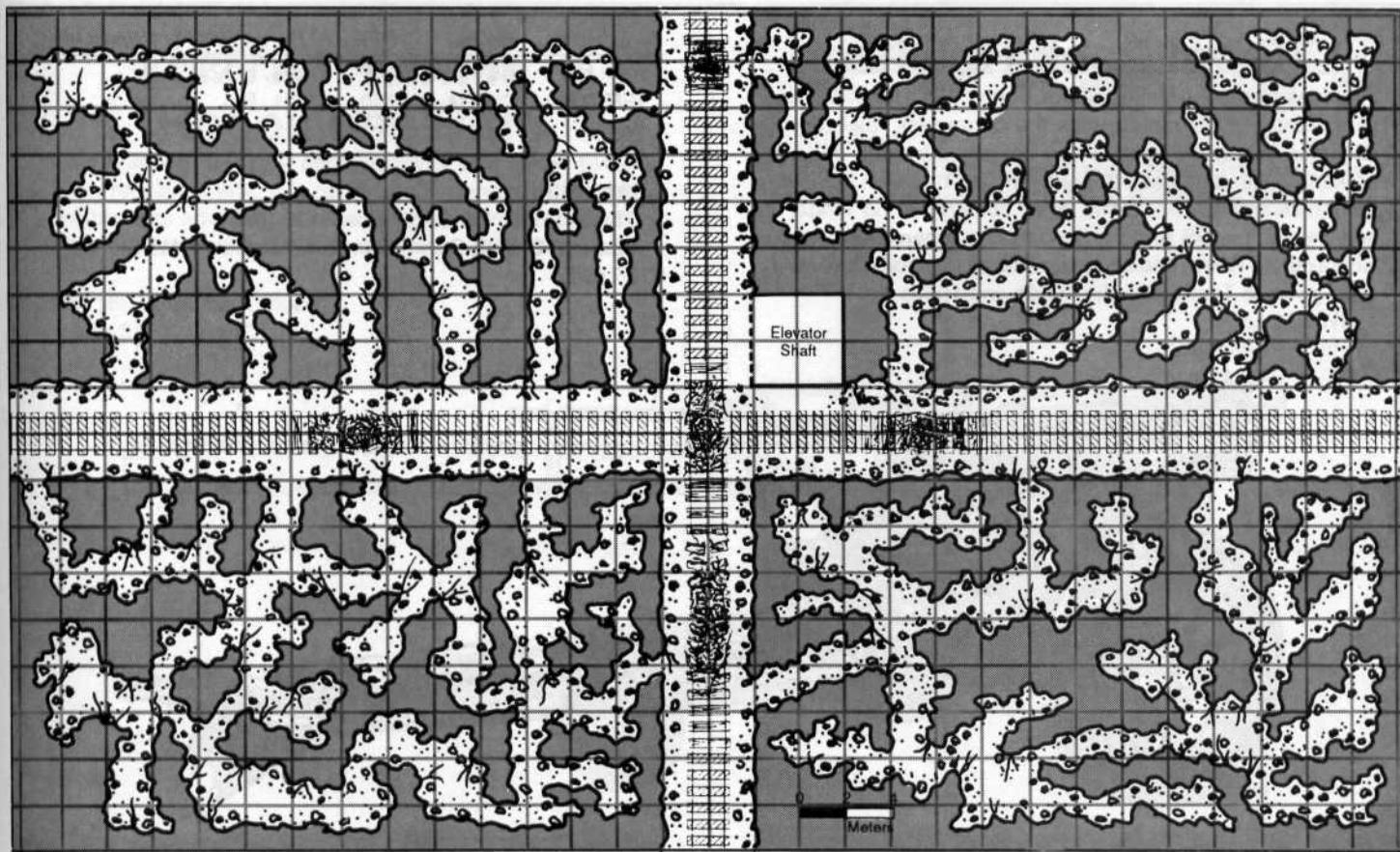
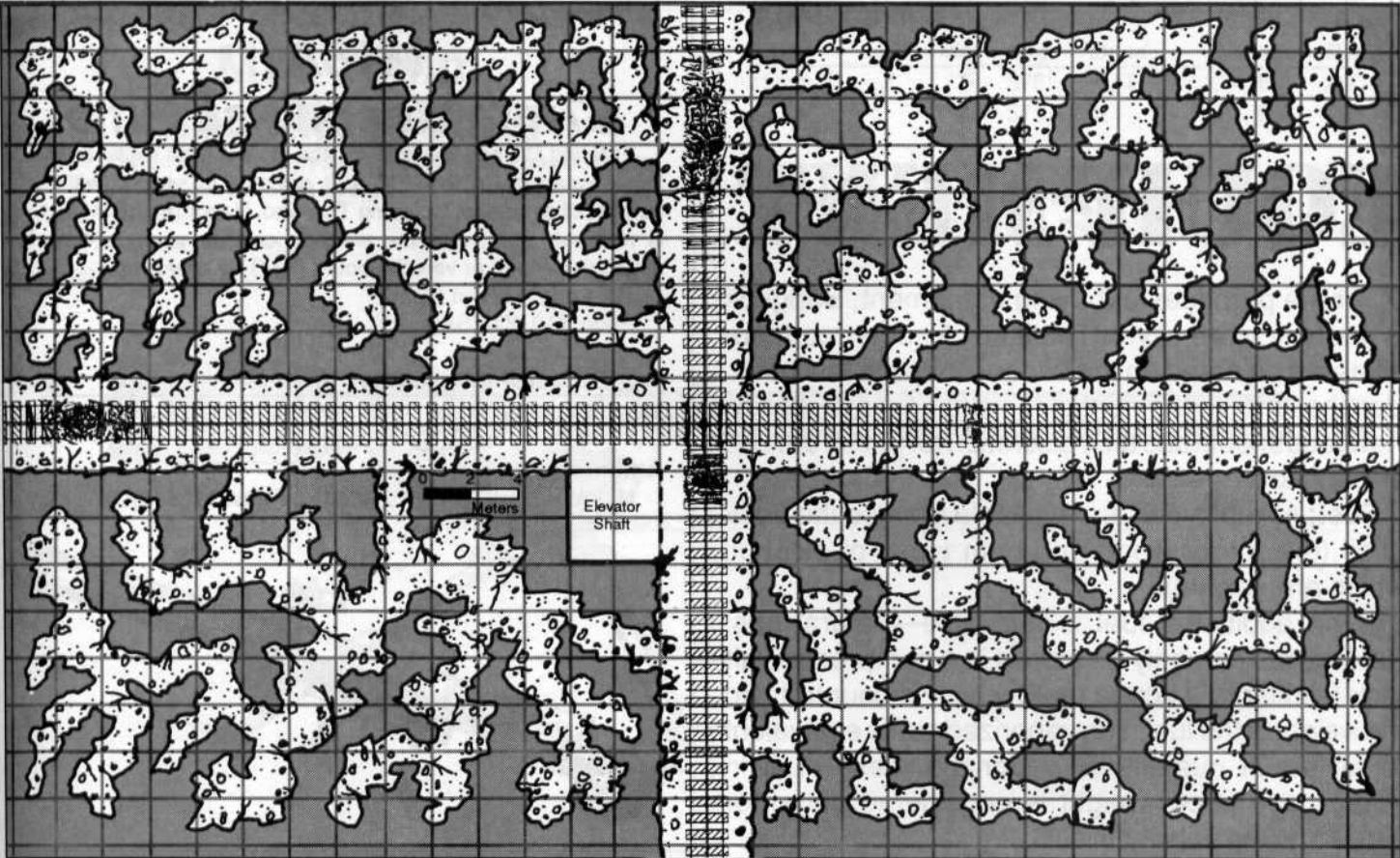

EQUIPMENT

For the purposes of buying equipment, Bangkok is the only large city in Thailand. All other communities are as noted on the various maps in this book. Use the letter to the right of the slash for availability. Referees should use their discretion for prices outside of Bangkok.

Fuel: All fuel types are available at twice the book price (except for wood and both types of alcohol, which are normal).

One additional fuel is available—natural gas. Natural gas can only be stored in a compressed air tank (similar to a scuba tank) which is counted into the weight of the fuel. The vaporized gas is equivalent to an equal quantity of vaporized diesel fuel in energy and price; weight is considered equal for simplicity. Availability is C/C.

75mm Pack Howitzer

Developed in the United States during WWII for parachute, light infantry, and mountain units, the 75mm pack howitzer was designed to save weight. It can be towed by one mule, or broken up into four loads (for pack mules) or seven loads (for human bearers). The 75mm pack howitzer is no longer in service with the US Army, but gigantic numbers were sent to China during WWII (and ended up sold all over Asia) and many were given to Thailand in the 1950s and 1960s.

Wt: 575 kg

Price: \$1250 (S/C)

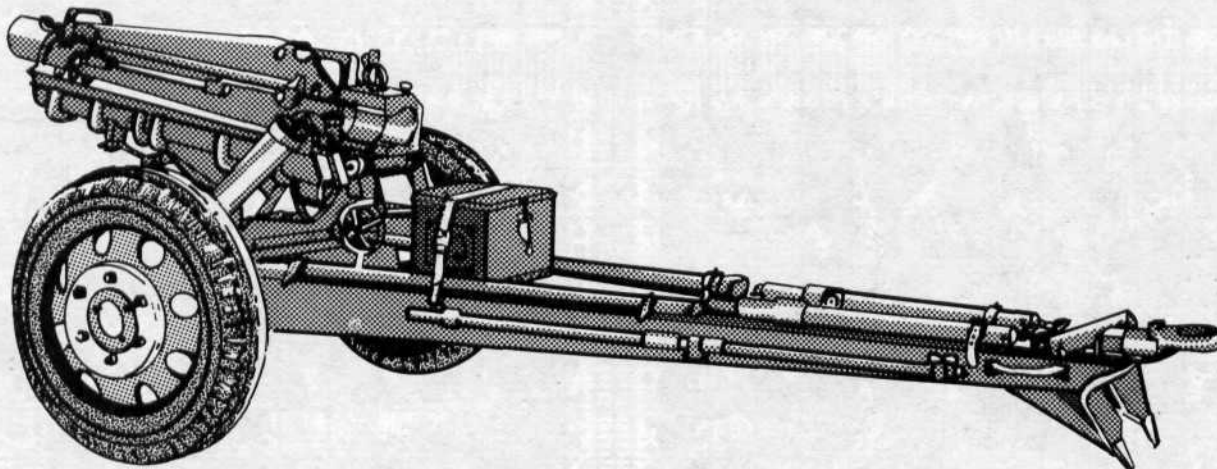

M18A1

57mm Recoilless Rifle

Entering US service in 1945, the M18A1 was replaced by larger weapons in the 1960s. It remains in service with a number of countries, including Thailand. Recoil on the M18A1 is relatively light, and the weapon can be shoulder-fired, although a tripod or vehicle mount (NMT) is preferred.

Wt: 11 kg (without tripod)

Price: \$10,000 (S/C)

Type	ROF	Mag	Rng	Round	Damage	Pen
57mm RL	1	(2)	300	HEAT	C:4, B:4	15C

Ammunition

M18A1 57mm RCL HE: *Wt:* 8 kg *Price:* \$125 (S/C)



Type	Round	DFR	Damage	Penetration
75mm P	HE	450	C:4, B:12	Nil
IFR: 9 km	CHEM	350	C:1, B:4	Nil

Rid: 1

Ammunition

75mm P HE: *Wt:* 8 kg *Price:* \$125 (S/C)

75mm P CHEM: Only HC smoke is available. *Wt:* 6kg *Price:* \$135 (S/C)

M20 75mm Recoilless Rifle

The M20 entered US Army service in 1945 and was obsolete by the 1970s. It can still be found in service with many nations, including Thailand.

Wt: 44 kg (without tripod)
Price: \$18,000 (R/S)

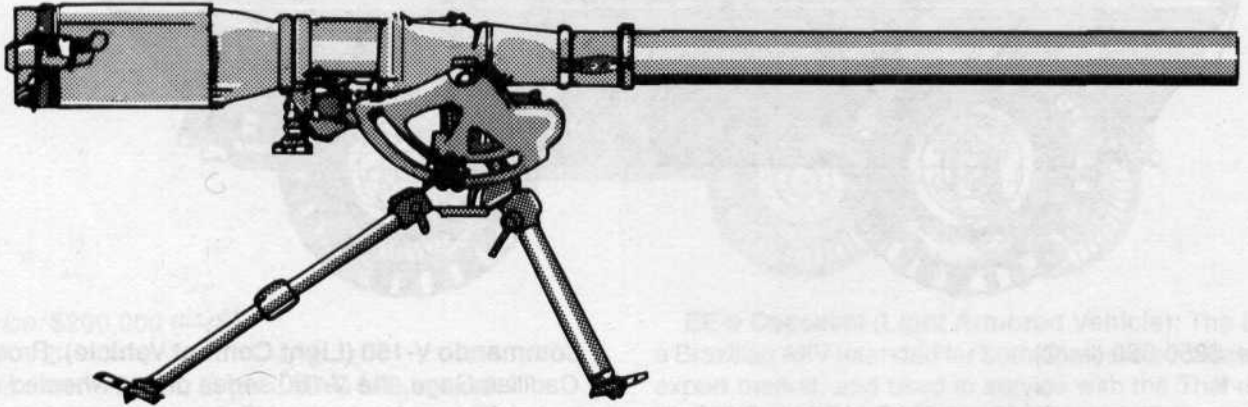

Type	ROF	Mag	Rng	Round	Damage	Pen
75mm RL	1	(2)	375	HEAT	C:4, B:4	20C
			375	HE	C:4, B:6	4C

Ammunition

75mm RCL HEAT: Wt: 10 kg Price: \$450 (R/S)

75mm RCL HE: Wt: 10 kg Price: \$350 (R/S)

M27A1 105mm Recoilless Rifle

This weapon is easily confused with the lighter M40A1 106mm recoilless rifle. It is no longer in service with the US Army, but was adopted by several other countries, including Thailand. It can be fired from a vehicle mount or from a tripod (NHT).

Wt: 165 kg (without tripod)
Price: \$15,000 (S/C)

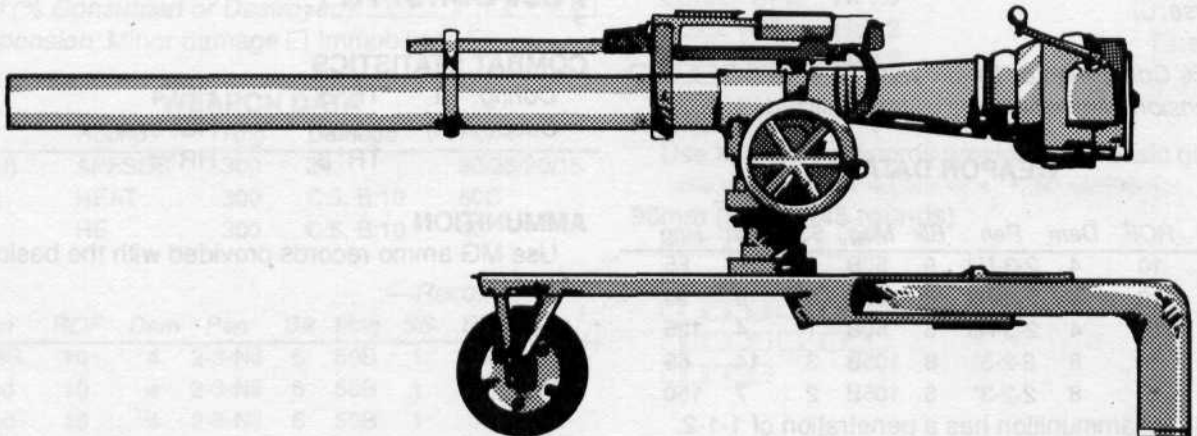

Type	ROF	Mag	Rng	Round	Damage	Pen
105mm RL	1	(2)	200	HEAT	C:6, B:8	40C

Ammunition

105mm RCL HEAT: The only round used in Thai service for the M27A1 recoilless rifle. IM: 16 kg Price: \$275 (S/C)

Commando V-150

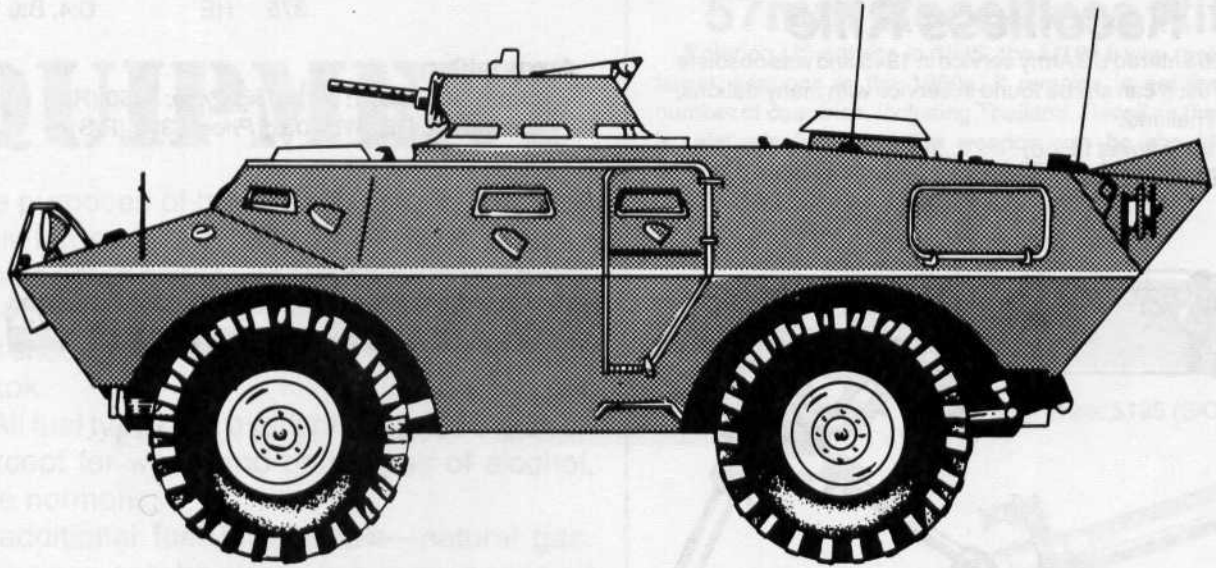

Price: \$250,000 (—/C)

RF: +1

Armament: Twin MAG MGs or MAG MG/M2HB MG

Ammo: 2000x7.62mm N or 1000x7.62mm N, 1260x.50

BMG

Fuel Type: D, A (some early export versions are G, A)

Load: 1.2 tons

Veh Wt: 10 tons

Crew: 3+9

Mnt: 6

Night Vision: Passive IR, headlights

Commando V-150 (Light Combat Vehicle): Produced by Cadillac Gage, the V-150 series of 4x4 wheeled APCs (adopted for service in the US Army) comes in several versions, the most common being an APC version, either with a machinegun turret as shown or with a pintle-mounted MAG MG. The 150 series is also available in mortar carrier (turret is removed and replaced with deck hatches), 20mm autocannon, and 90mm gun versions (using the low-pressure gun turret from the V-300). The vehicle is fully amphibious at one-fourth its cross-country speed. The vehicle has two side doors and an exit hatch on the rear deck. The Thai version is not NBC sealed.

Tr Move: 120/95

Com Move: 80/65

Fuel Cap: 300

Fuel Cons: 75

DAMAGE RECORD

Crewmembers: Commander Driver Gunner

Passengers: 1 2 3 4 5 6 7 8 9

Sight/Vision: Night vision equipment

Radio:

Machineguns: L R

Traverse:

Engine:

Fuel (% Consumed or Destroyed):

Suspension: Minor damage Immobilized

COMBAT STATISTICS

Config: Trt TF: 3 HF: 4

Susp: W(3) TS: 3 HS: 3

TR: 3 HR: 3

WEAPON DATA

—Recoil—

Weapon	ROF	Dam	Pen	Blk	Mag	SS	Brst	Rng
MAG MG	10	4	2-3-Nil	6	50B	1	9	65
bipod	10	4	2-3-Nil	6	50B	1	5	90
tripod	10	4	2-3-Nil	6	50B	1	4	125
M2HB	5	8	2-2-3*	8	105B	3	14	65
tripod	5	8	2-2-3*	8	105B	2	7	150

*.50 SLAP ammunition has a penetration of 1-1-2.

AMMUNITION

Use MG ammo records provided with the basic game.

FV101 Scorpion

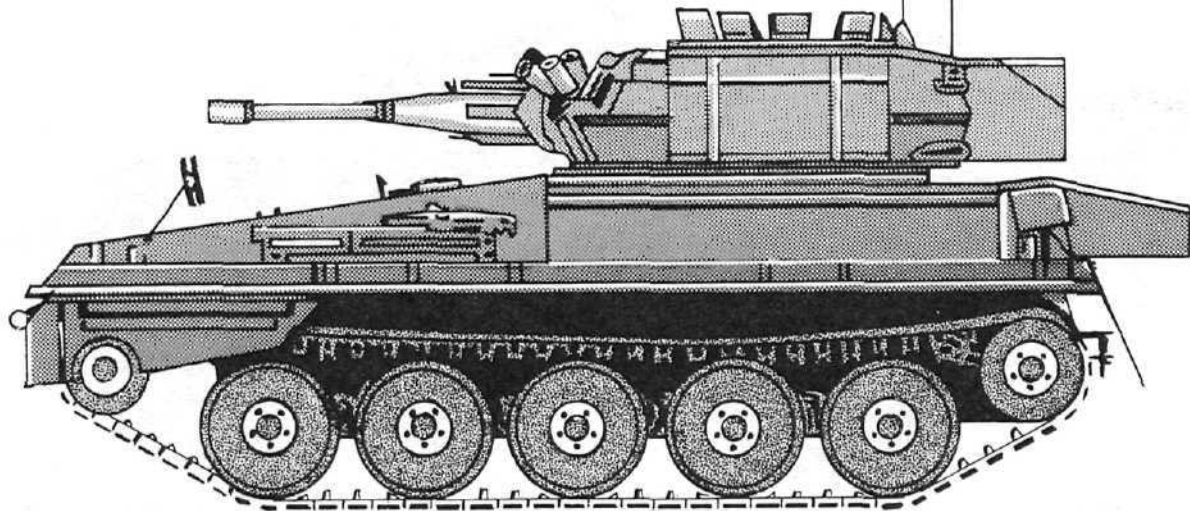

Price: \$350,000 (—R)

RF: +2

Armament: 76mm gun, MAG MG (coaxial)

Ammo: 40x76mm

Fuel Type: G, A

Load: 300 kg

Veh Wt: 8 tons

Crew: 3

Mnt: 7

Night Vision: Headlights

FV101 Scorpion (Light Combat Vehicle): The FV101 Scorpion is a British-built tracked reconnaissance vehicle, widely sold in the world export market. The model described below represents the export version in Thai service. The vehicle is of conventional layout, with a driver's hatch on the front hull deck, and commander's and gunner's hatches on the turret deck. The Thai version is not NBC sealed, but is amphibious (using a flotation screen) at one-fourth its cross-country speed.

Tr Move: 160/120

Com Move: 80/60

Fuel Cap: 423

Fuel Cons: 105

COMBAT STATISTICS

<i>Config:</i> Trt	TF: 6	HF: 8
<i>Susp:</i> T: 3	TS: 2	HS: 2
	TR: 2	HR: 2

AMMUNITION

Use MG ammo records provided with the basic game.

76mm Gun (40 rounds)

WEAPON DATA

Type	Round	Rng	Damage	Pen
76mm	AP	300	16	8/4/2
	HE	300	C:6, 8:12	-3C

—Recoil—

Weapon	ROF	Dam	Pen	81k	Mag	SS	Brst	Rng
MAG MG	10	4	2-3-Nil	6	50B	1	9	65
bipod	10	4	2-3-Nil	6	50B	1	5	90
tripod	10	4	2-3-Nil	6	50B	1	4	125

AAVP7A1

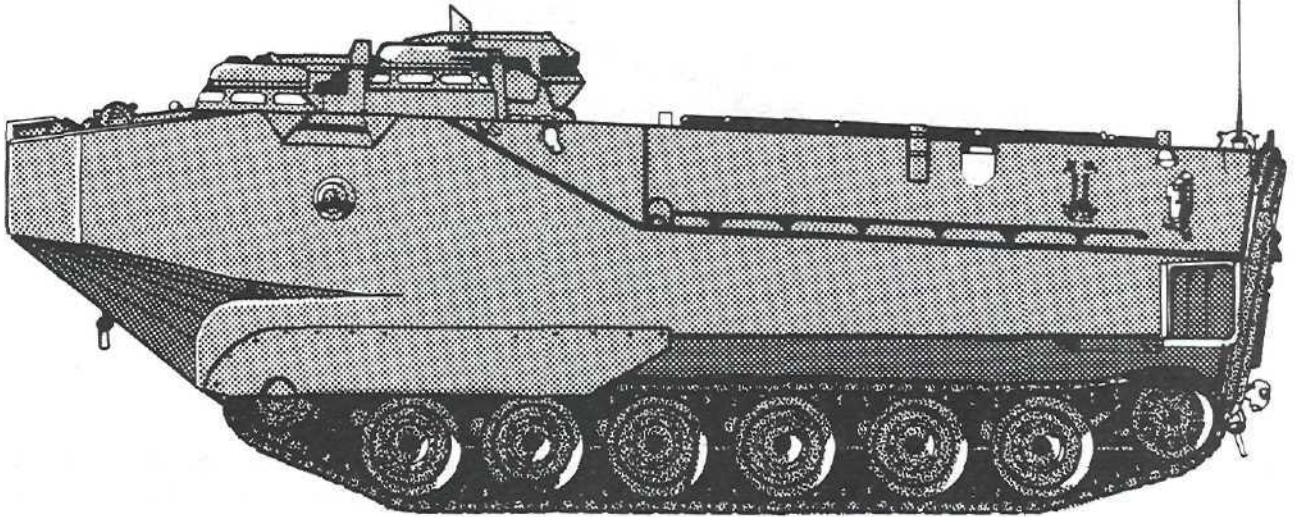

Price: \$80,000 (R/R)

RF: +2

Stabilization: Fair

Armament: 40mm AGL, M2HB MG

Ammo: 350x40mm, 175x.50BMG

Fuel Type: D, A

Load: 4 tons

Veh Wt: 18 tons

Creiv: 3+22

Mnf: 6

Night Vision: Headlights, passive IR

AAVP7A1 (Armored Personnel Carrier): The AAVP7A1 is an advanced version of the AAVP7 amphibious armored personnel carrier, and entered service in the early 1990s. A 40mm AGL and M2HB MG combination is mounted in a small cupola on the right front hull deck, and two smaller hatches for the driver and vehicle commander are located on the left front hull deck. The rear deck contains two large doors to allow personnel to disembark, and the rear has a ramp/door which can be lowered as well. The vehicle is fully amphibious, and all hatches and doors have waterproof seals.

Damage Record

Crewmembers: Commander Driver Gunner

Passengers: 1 2 3 4 5 6 7 8 9 10 11

12 13 14 15 16 17 18 19 20 21 22

Sight/Vision: Night vision equipment

Radio:

40mm AGL:

M2HB MG:

Engine:

Fuel (% Consumed or Destroyed):

Suspension: Minor damage Immobilized

Tr Mov: 120/70

Com Mov: 40/30

Fuel Cap: 360

Fuel Cons: 120

Combat Statistics

Config: Stnd HF: 11

Susp: T: 2 HS: 8

HR: 6

AMMUNITION

Use 40mm GL and M2HB ammo records provided with the basic rules.

WEAPON DATA

—Recoil—

Weapon	ROF	Dam	Pen	Blk	Mag	SS	Brst	Rng
M2HB	5	8	2-2-3*	8	105B	3	14	65
tripod	5	8	2-2-3*	8	105B	2	7	150

*.50 SLAP ammunition has a penetration of 1-1-2.

WEAPON DATA

Type	ROF	Mag	Rng	IFR	Rnd	Damage	Pen
40mm AGL	5	50B	200	3 km	HVHE	C:3, B:12	Nil
					HVHEDP	C:3, B:12	4C

M24 Chaffee

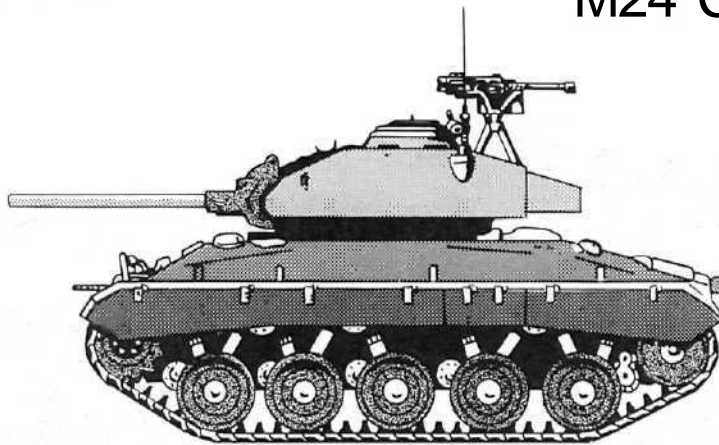

Price: \$350,000(—/R)

RF: +1

Armament: 75mm gun, MAG MG (bow casemate), MAG MG (coaxial), M2HB (C)

Ammo: 48x75mm

Fuel Type: G, D

Load: 400 kg

Veh Wt: 18.5 tons

Crew: 4

Mnt: 6

Night Vision: Headlights

M24 Chaffee (Light Combat Vehicle): A US-built WWII-era light AFV, now out of service in the US Army but still serving with many smaller armies, such as that of Thailand. The M24 is of conventional layout and is not NBC sealed.

Tr Move: 110/65

Com Move: 55/35

Fuel Cap: 416

Fuel Cons: 104

DAMAGE RECORD

Crewmembers: Commander Driver Gunner Loader

Sight/Vision: Gun sight Range finder Night vision equipment

Radio:

75mm Gun:

MAG MG (Coaxial):

MAG MG (Bow Casemate):

M2HB MG (C):

Traverse:

Engine:

Fuel (% Consumed or Destroyed):

Suspension: Minor damage Immobilized

COMBAT STATISTICS

Config: Trt TF: 10 HF: 10

Susp:T: 3 TS:4 HS: 4

TR: 4 HR:4

AMMUNITION

Use MG ammo records provided with the basic game.

75mm Gun (48 rounds)

WEAPON DATA

Type	Round	Rng	Damage	Pen
75mm	AP	300	16	8/4/2
	HE	300	C:6, B:12	-3C

—Recoil—

Weapon	ROF	Dam	Pen	Blk	Mag	SS	Brst	Rng
M2HB	5	8	2-2-3*	8	105B	3	14	65
tripod	5	8	2-2-3*	8	105B	2	7	150

*.50 SLAP ammunition has a penetration of 1-1-2.

M41

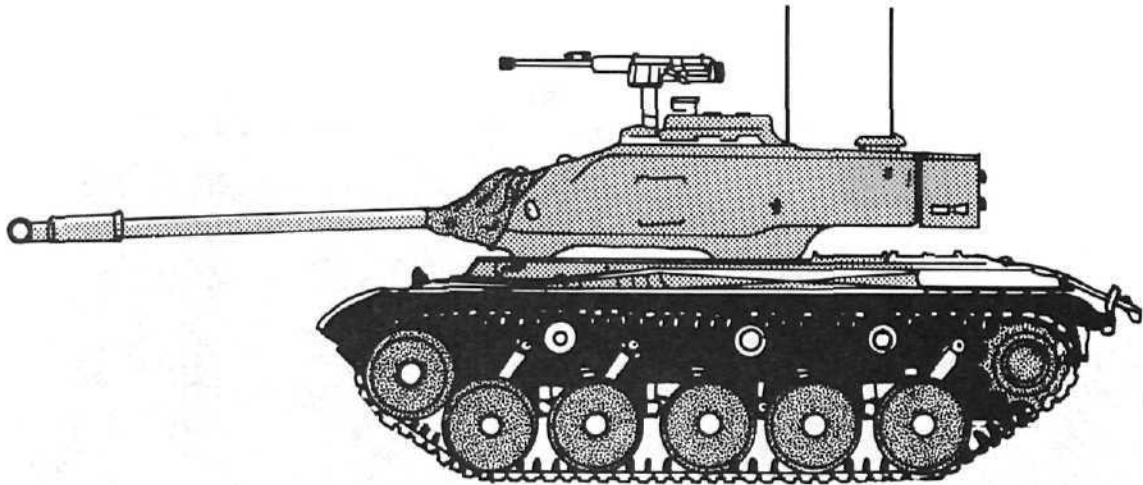

Price: \$500,000 {—/R}

RF: +2

Armament: 76mm gun, MAG MG (coaxial), M2HB (C)

Ammo: 65x76mm

Fuel Type: G, A (some models D, A)

Load: 400 kg

Veh Wt: 24 tons

Crew: 4

Mnt: 6

Night Vision: Headlights

DAMAGE RECORD

Crewmembers: Commander Driver Gunner
Loader

Sight/Vision: Gun sight Range finder Night vision
equipment

Radio:

76mm Gun:

M2HB MG (C):

MAG MG (Coaxial):

Traverse:

Engine:

Fuel (% Consumed or Destroyed):

Suspension: Minor damage Immobilized

WEAPON DATA

—Recoil—

Weapon	ROF	Dam	Pen	Blk	Mag	SS	Brst	Rng
MAG MG	10	4	2-3-Nil	6	50B	1	9	65
bipod	10	4	2-3-Nil	6	50B	1	5	90
tripod	10	4	2-3-Nil	6	50B	1	4	125
M2HB	5	8	2-2-3'	8	105B	3	14	65
tripod	5	8	2-2-3*	8	105B	2	7	150

* .50 SLAP ammunition has a penetration of 1-1-2.

M41 (Light Combat Vehicle): The M41 replaced the M24 Chaffee in US service in the 1950s, but was itself rendered obsolete by other vehicles. The M41 is still found in service with other countries, however. The M41 is of conventional layout for an AFV and is not NBC sealed. Some models have had their gasoline engines replaced with more economical diesel ones.

Tr Move: 140/110

Com Move: 70/45

Fuel Cap: 530

Fuel Cons: 135

COMBAT STATISTICS

Config: Trt TF: 12 HF: 12

Susp:T: 4 TS: 8 HS: 6

TR: 6 HR: 6

AMMUNITION

Use MG ammo records provided with the basic game.

75mm Gun (48 rounds)

WEAPON DATA

Type	Round	Rng	Damage	Pen
76mm	AP	300	16	8/4/2
	HVAP	300	16	12/6/3
	HE	300	C:6, B:12	-3C

Saracen

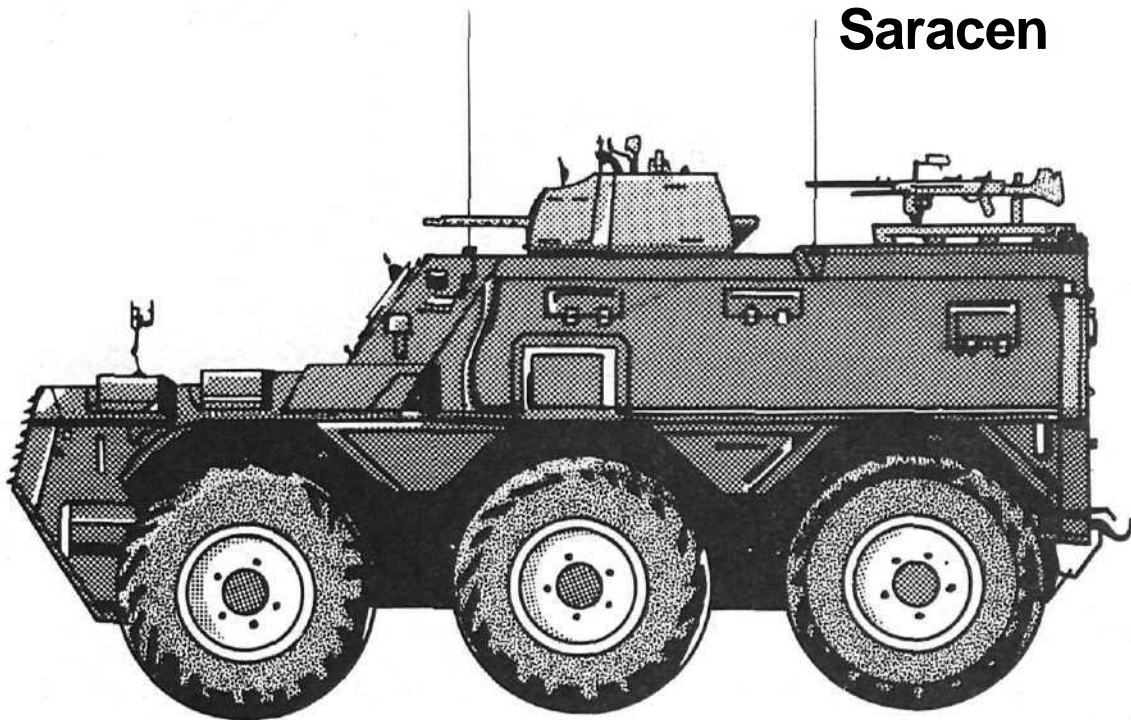

Price: \$200,000 (R/R)

Armament: MAG MG (turret) and MAG MG (P)

Ammo: As cargo

Fuel Type: G, A

Load: 1 ton

Veh LW: 10 tons

Crew: 2+10

Mnt: 7

Night Vision: Headlights

Saracen (Armored Personnel Carrier): The Saracen is a British-built light APC based on the Saladin armored car chassis and sharing many engine and drive train components with it. It left British service in the 1970s, but was exported in some numbers, and can still be found with the Thai Army.

Tr Move: 140/110

Com Move: 70/55

Fuel Cap: 200

Fuel Cons: 55

DAMAGE RECORD

Crewmembers: Commander/gunner Driver

Passengers: 1 2 3 4 5 6 7 8 9 10

Sight/Vision: Night vision equipment

Radio:

MAG MG (Turret):

MAG MG (P):

Traverse:

Engine:

Fuel (% Consumed or Destroyed):

Suspension: Minor damage Immobilized

COMBAT STATISTICS

Config: Trt HF: 4 TF:3

Susp: W: (4) HS: 2 TS:2

HR:2 TR: 2

AMMUNITION

Use MG ammo records provided with the basic game.

WEAPON DATA

—Recoil—

Weapon	ROF	Dam	Pen	Bik	Mag	SS	Brst	Rng
MAG MG	10	4	2-3-Nil	6	50B	1	9	65
bipod	10	4	2-3-Nil	6	50B	1	5	90
tripod	10	4	2-3-Nil	6	50B	1	4	125

Type 62

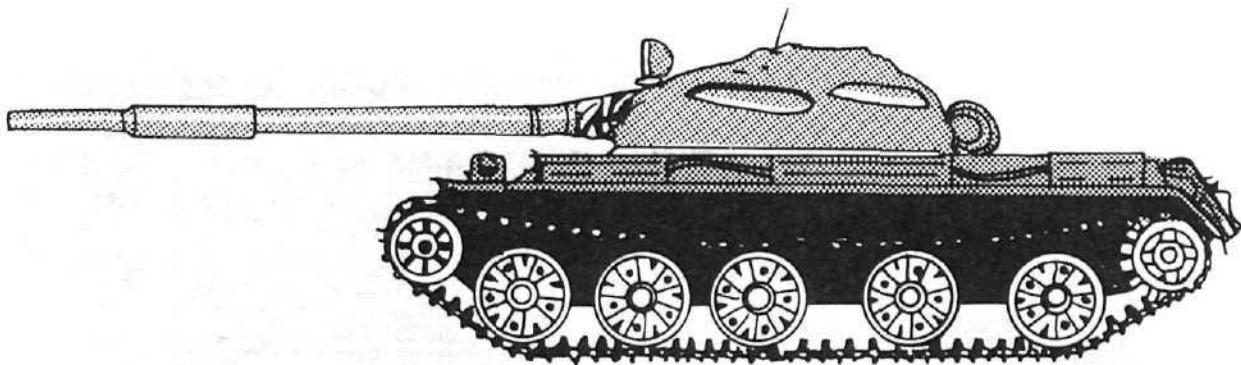

Price: \$950,000 {—/R}

RF: +1

Armament: 85mm gun, PK MG (coaxial)

Ammo: 36x85mm gun

Fuel Type: D, A

Load: 400 kg

Veh Wt: 18 tons

Crew: 4

Mnt: 6

Night Vision: Headlights

Type62 (Light Combat Vehicle): A Chinese-built tracked light tank, and a development of the Soviet PT-76 light recon tank. The Type 62 is of conventional layout, and armed with an 85mm gun and coaxial PK MG. An additional MG can be fitted to the commander's hatch in a cupola mount (C). Those purchased by Thailand had several mechanical flaws, including major problems with the turret elevation and traverse gears.

Tr Move: 100/80

Com Move: 50/40

Fuel Cap: 545

Fuel Cons: 135

DAMAGE RECORD

Crewmembers: Commander Driver Gunner

Loader

Sight/Vision: Gun sight Range finder Night vision equipment

Radio:

85mm Gun:

PK MG (Coaxial):

Traverse:

Engine:

Fuel (% Consumed or Destroyed):

Suspension: Minor damage Immobilized

COMBAT STATISTICS

Config:Trt TF:5 HF: 8

Susp:T: 3 TS: 3 HS: 3

TR: 3 HR:1

AMMUNITION

Use MG ammo record provided in the basic game.

WEAPON DATA

—Recoil—

Weapon	ROF	Dam	Pen	Blk	Mag	SS	Brst	Rng
PK	5	4	2-3-Nil	6	50B	2	5	65
bipod	5	4	2-3-Nil	6	50B	1	3	90
tripod	5	4	2-3-Nil	6	50B	1	2	125

85mm Gun (36 rounds)

WEAPON DATA

Type	Round	Rng	Damage	Pen
85mm	HVAP	300	20	30/20/10
Rld: 1	APHE	250	C:4, B:10	70C
	HE	250	C:3, B:8	20C

Sampan/Motorpan

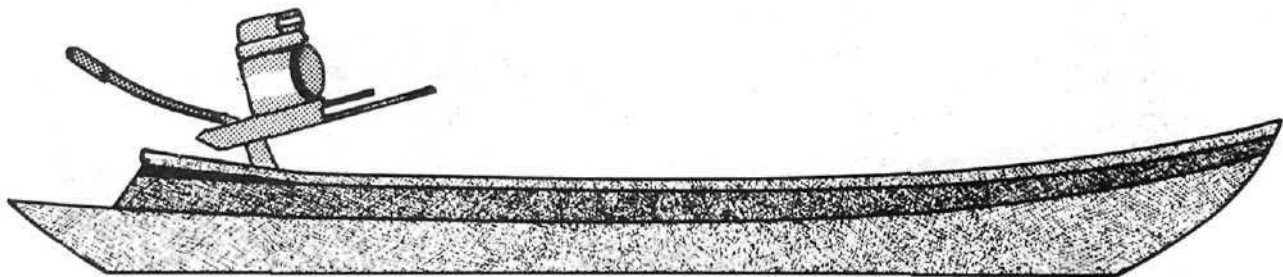

Price: \$100 (C/C)

Armament: None

Length: 1

Draft: 0.5 m

Speed: 1

Turn: 4

Acceleration: 1

Pumps: None

Night Vision: None

Load: 100 kg

Minimum/Optimum Crew: 2/4

Mnt: 1

Full Speed
Dead in Water
Sunk

A sampan is a traditional oriental shallow draft boat, propelled by paddles or oars. A motorpan is the same thing, fitted with a cheap motor, usually some kind of jury-rigged device adapted from another purpose.

Tr Move: 4/4

Config: Flush deck

Tonnage: 1

Hull Armor: 0

Waterline Armor: 0

Superstructure Armor: 0

Propulsion: Muscle power (sampan), small motor (motorpan)

Size: 1

Long-Tailed Boat

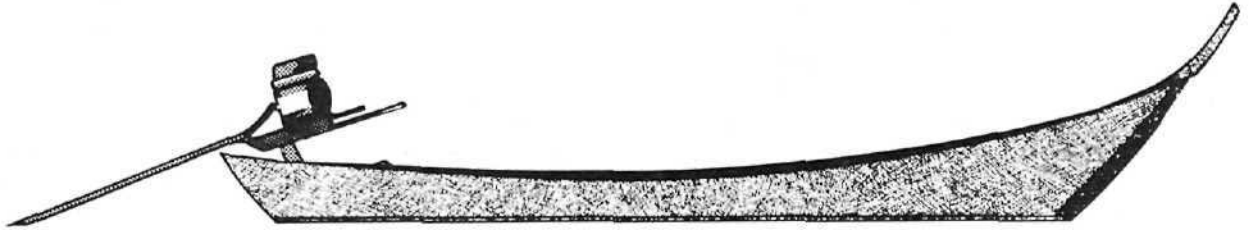

Price: \$100 fC/C)

Armament: None

Length: 1

Draft: 1 m

Speed: 1

Turn: 4

Acceleration: 1

Pumps: None

Night Vision: None

Load: 1 ton

Minimum/Optimum Crew: 1/2

Mnt: 1

Full Speed

Dead in Water

Sunk

This is a type of small boat peculiar to the rivers of Thailand, and consists of a small open-topped or partially decked boat fitted with an engine on a swivel mount for easy steering. The boat gets its name from the fact that the drive shaft is several feet long, and extends well back from the hull, giving the boat a "tail" of sorts.

Tr Move: 4/4

Config: Flush deck

Tonnage: 1

Hull Armor: 0

Waterline Armor: 0

Superstructure Armor: 0

Propulsion: Small motor

Size: 1

THAILAND AS A CAMPAIGN SETTING

Bangkok and Thailand as a whole offer many possible campaigns. We offer here one means of tying this book's adventures together and creating a continuing campaign setting. We have included some extra details in the summary presented below as a means of demonstrating how a couple of minor details can be utilized to link otherwise totally unconnected adventure scenarios.

SUMMARY

The characters arrive in Thailand (by whatever means the referee finds most reasonable). The initial stage of their stay is the best time to work in an encounter with the PULO in the south, and the referee may wish to land the group in the southern end of the Malay peninsula. No adventures are presented for the PULO, but the whole idea is to acquaint the group with the situation in Thailand by means of a series of minor encounters. It should be made obvious to the characters that there is little opportunity for lucrative employment with the PULO, and that they should seek their fortunes further north, in the city of Bangkok.

When the group travels north along the peninsula and enters Junta-controlled territory, it will probably come under some suspicion by the authorities for having come from PULO country. Partially to show their honest intentions and partially because the player characters are honorable human beings, they undertake the adventure described in *Miner Problems*. Following its successful conclusion, the group is no longer under a big cloud with the local army, and one of the rescued militia men (of Chinese ancestry) offers the PCs a letter of introduction to his third cousin, one Ho Ying Chin, who is a merchant of some importance further north. The group decides to seek Ho out and use the letter to help them secure employment as caravan guards or some such. As it happens, Ho

has need of their services.

Upon meeting Ho, the group is hired to carry out the events described in *Ransom*. Ho Ying Chin is very pleased to have his brother back, and introduces the player characters to a local officer of the Junta's forces who is in need of an elite strike force. The officer assigns them the mission described in *Viper's Nest*, which they carry out successfully, much to the surprise of the officer (he had figured this as a suicide mission and a way to get rid of a group of armed foreigners).

Impressed by the PCs' success, the officer reports the results to his superior in Bangkok, General Suwankiri. This estimable fellow sends word that he has need of the special talents of the group. The PCs are brought to Bangkok and the general hires them to carry out the mission described in *Smash-n-Grab*. In the course of this mission the characters receive their first information that there is a shadowy figure attempting to manipulate events in Bangkok from afar. Major Chamanan is not acting completely on his own, but rather is working for Pan Yu Sung (the plot thickens!). The characters can find this out themselves, either from conversations with the technician or from documents recovered from the townhouse. Whether they decide to tell General Suwankiri about their discovery is up to them. Whatever happens, there will not seem to be a great deal to be done with the information at the time.

Now that he has the gas technician and the ability to get the natural gas wells going again, General Suwankiri has a real reason to retake the natural gas platform off the southern coast. He sends the team down to carry out the mission described in *Cookin' With Gas*. The players carry this mission out, but upon returning to Bangkok, discover that General Suwankiri has been arrested and is being held by some other higher-ranking member of the Junta, who now has the technician. Although this

officer pays the PCs and thanks them for their assistance, he will not pay them as much as was promised and will say that he has no further need of their services.

Although the characters are now out of a job and out of favor with at least part of the Junta, on the basis of their reputation from the previous jobs they are contacted by the Technical Union and hired to carry out the job described in *Street of the Seven Brothers*. In the course of this adventure they discover that the Japanese-supported gang has been hired by Pan Yu Sung to harass the Technical Union. He is doing this because the union refuses to cooperate with him in sabotaging the Junta's reconstruction plans as a means of bringing discredit to the Junta and paving the way for his own takeover.

At this point the player characters should become very interested in learning much more about Pan Yu Sung and should have the connections to piece together what is happening. The referee should allow the PCs to discover the material presented in the biographical essay in this section, but should impart this information slowly, a piece at a time, from various contacts and sources.

In the course of the group's investigation, it will discover the location of one of Pan's main opium processing facilities. The referee should use the information in *Science Project* to run this raid, but modify the scenario so it can be used with **Twilight: 2000** (basically, the village is controlled by Pan Yu Sung instead of the **KMT**, and the chemical weapons are for his attack on the Junta and takeover of the country instead of for international terrorists).

After this raid is over, the PCs will have set back Pan Yu Sung's organization quite a bit, although they will not have broken it. Pan will now be their implacable enemy, but they will have a few friends as well. Where the campaign goes from here is up to the referee and the players.

Campaign Flowchart

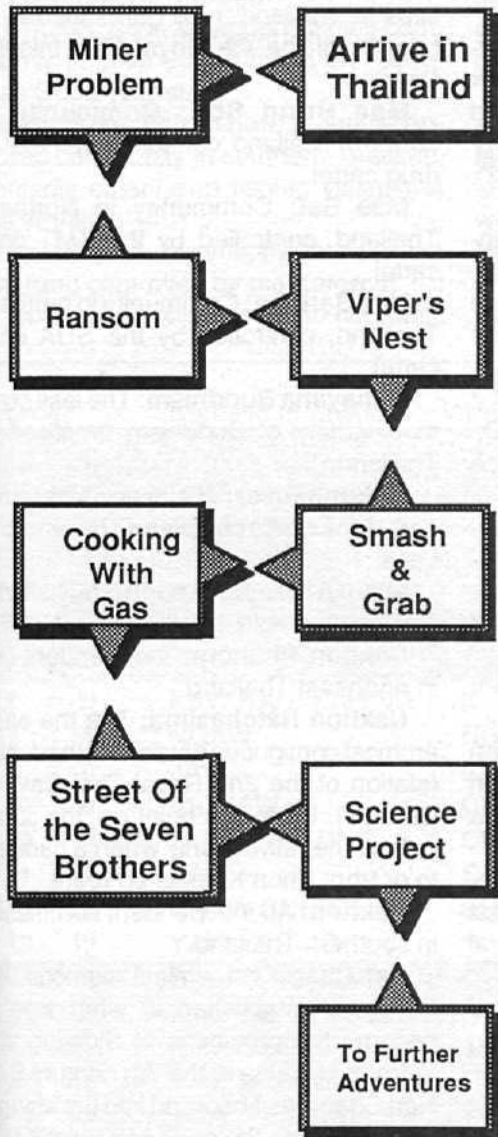

PAN YU SUNG

Technically a member of the Junta, Pan Yu Sung is actually one of its greatest enemies. Commander of the Nakhon Ratchasima garrison, Pan acquired his post through connections within the Junta and blackmail. His pose as an indolent but competent commander is a cover for his scheme to take over the country, expel the Europeans and establish a new Siamese empire, with himself as its ruler.

Early Life: Sung was born of mixed Thai-Chinese parents in 1952 or 1953 (even he isn't sure) in the seedy area along what was to become the infamous Patpong Road during the Vietnam War. Orphaned at an early age, Pan spent his formative years on the streets of Bangkok, where he lost anything resembling human compassion and acquired an extremely cynical view of the world and a near-insatiable hunger for wealth and the power that wealth can bring. As soon as he was old enough, Pan began working in the bars and brothels of Bangkok, eventually becoming leader of a small gang of toughs that specialized in robbing drunken GIs. During this period, Pan grew to hate foreigners (especially Americans) for their ostentatious displays of wealth—the wealth he seemed to be permanently denied. He also learned to cultivate his natural cunning and talents for dissimulation that were eventually to prove a greater factor in his success than his intelligence (which is just slightly above average). By the war's end, Pan had branched out into drug dealing and prostitution, and was a member of one of Bangkok's many gangs.

The Middle Years: Although he showed some leadership potential, Pan was an uninspired leader and rose slowly through the ranks of the criminal underworld. Because the military held much power in Thailand, even before the war, Pan sought to gain influence over it. The natural (and in some cases, unnatural) appetites of certain officers gave Pan the opportunity he needed. A willingness to break the law to provide for "special" customers brought Pan much business and gave him much ammunition for later blackmail. Within a few years, Pan's enterprises had begun to prosper as his competitors went out of business—or vanished. His connections with the drug dealers in the north were cemented by his ability to influence where and when military "anti-opium" sweeps would occur. His connections with the drug-smuggling syndicates gave him foreign contacts and influence.

The War: When the war broke out, Pan was not initially concerned. Later, however, as he began to realize the true effect of the war on Thailand and became aware of the planned coup by a clique of military officers, Pan saw an opportunity. Using his military connections, Pan became an integral part of the coup and of the resulting Junta coalition.

The Present: The present setup in Nakhon Ratchasima is a pose: Pan is pretending to be a fat, hedonistic warlord type, with few interests other than the acquisition and consumption of the trappings of the good life. In reality, Pan sits in the middle of a network of influence and blackmail, like a spider in a web.

At 48, Pan's physical health has begun to deteriorate, and he is increasingly in the market for exotic and expensive potions, charms, and spells to maintain his sagging muscles and flagging virility (even though he only half-believes in their efficacy). He is rumored to have recently traded 75 kilos of nearly pure heroin for less than a kilo of rhinoceros horn (an allegedly very powerful ingredient in many oriental potions).

Personality: Pan's main personality traits are:

- An extremely cynical view of the world, born of his early years in the slums of Bangkok.
- An almost pathological need to acquire and display (as ostentatiously as possible) possessions, including technological toys, antiques, beautiful women, and valuable art treasures (also originating in his early years).
- An equally strong desire for power and influence over his surroundings. Pan considers his surroundings, ultimately, to be Southeast Asia.
- A powerfully narcissistic, egomaniacal streak that often leads him to overconfidence. Pan never really trusts anyone and is constantly testing his closest associates to verify their loyalty.
- An unusually virulent and antisocial cruelty. In a society where torture and cruelty are commonplace, Pan is unusual in that he takes an almost perverse pleasure in doing such things. One of the secrets of his success was, and is, his willingness to murder those he believes represent a threat to him. (Unlike most other leaders in Thailand, Pan has no qualms about doing the killing personally, and often does.) His total lack of conscience or any feeling of remorse for any of his actions make him a textbook psychopath and a dangerous person under any conditions, let alone the chaotic free-for-all that characterizes Thailand in 2000.

GLOSSARY

Players and referees will not necessarily be familiar with all of the terms and place names used in this book. This section will help sort things out.

Akha: A hill tribe of northern Thailand, Tibetan in origin.

Animism: A term used to describe the worship of nature spirits in general. It does not represent a formal religious movement with accepted doctrine or ceremonies.

Ayuthaya: A city in central Thailand which served as the capital of the Ayuthaya Empire from 1376 to 1782. It now contains the largest single troop contingent outside of Bangkok itself.

Bant: The Thai unit of currency. For purposes of **Twilight: 2000**, consider it to equal one-twentieth of a US dollar. One baht contains 100 satang.

Ban: House or village.

Buriram: Independent city in northeast Thailand. Its militia is built around a cadre of Americans from the Cam Ranh Bay garrison.

Chaing Khan: Independent city in northeast Thailand.

Chaing Mai: Community in northern Thailand, headquarters of the SUA drug cartel.

Chaing Rai: Community in northern Thailand, headquarters of the KMT drug cartel.

Chaiyaphum: Independent city in northeast Thailand, center of regional resistance to the Junta.

Chanthaburi: Isolated enclave on the coast of east central Thailand.

Chedi: Monument to house a Buddha relic, a.k.a. pagoda, dagoba.

Chiang Saen: Community in northern Thailand controlled by the KMT drug cartel.

Chumphon: The southernmost extent of Junta control, garrisoned by the Royal Thai Light Infantry Division.

Devaraja: An Imperial title, meaning

God-king, used by the kings of the Ayuthaya Empire.

Dhammachakha: Buddhist wheel of law.

Dhammaraja: *Karma-king*, the title used by Thai kings before the Ayuthaya period.

Dvaravati: From the Sanskrit, meaning *place having gates*. A loose network of city-states in Southeast Asia, believed to have been primarily Mon or Mon-Khmer in ethnic makeup (see page 12).

Farang: European, foreigner.

Golden Triangle: A region of Southeast Asia where the borders of Thailand, Burma and Laos intersect. After the end of the Vietnam War, this region became one of the primary opium-producing areas in the world.

Hat Yai: Headquarters of the PULO.

Hmong: The second largest hill tribe group, Chinese in origin.

Hua Hin: A Junta-controlled community in southern Thailand, primarily catering to fishing villages in the vicinity.

Kachanaburi: Community in west central Thailand.

Kamphaeng Phet: Independent community in northern Thailand.

Karen: The most numerous hill tribe group, and of Burmese origin. Karen villages are concentrated in the area adjacent to the Burmese border.

Khon Kaen: An isolated Junta enclave in the natural gasfields of northeast Thailand, garrisoned by the 2nd Royal Thai Infantry Division.

KMT (Kuomintang): The second largest of the northern Thailand drug cartels.

Ko Chang: Island off the coast of east central Thailand.

Ko Samet: Island off the coast of east central Thailand.

Lahu: A hill tribe of northern Thailand, Tibetan in origin.

Lamphun: Independent community

in northern Thailand.

Lisu: A hill tribe of northern Thailand, Tibetan in origin.

Loei: Independent city in northeast Thailand.

Lopburi: One of the oldest inhabited sites in Thailand, now garrisoned by a brigade of the 4th Royal Thai Infantry Division.

Mae Hong Son: Community in northern Thailand, controlled by the SUA drug cartel.

Mae Sai: Community in Northern Thailand, controlled by the KMT drug cartel.

Mae Sariang: Community in northern Thailand, controlled by the SUA drug cartel.

Mahayana Buddhism: The less common variety of Buddhism practiced in Thailand.

Mekong River: The river which forms part of the border between Thailand and Laos.

Mien: A hill tribe of northern Thailand, Chinese in origin.

Nakhon Phanom: Independent city in northeast Thailand.

Nakhon Ratchasima: The the easternmost contiguous garrison of the Junta, (station of the 2nd Royal Thai Cavalry Division). From this point on, the Junta patrols the railway only when a caravan to or from Khon Kaen is en route.

Nakhon: An independent community in southern Thailand.

Nan Chao: First semiautonomous Thai kingdom, established in what was to become the provinces of Sichuan and Yunnan in China in the 7th century B.C. Nan Chao was absorbed into the Mongol Empire during the reign of Kublai Khan.

Nan: Community in Northern Thailand, controlled by the KMT drug cartel

Narathiwat: A community in southern Thailand under the control of the PULO.

Nong Khai: Independent city in

northeast Thailand.

Pattani United Liberation Organization (PULO): A Muslim/Malay independence group operating in southern Thailand.

Pattani: A community in southern Thailand under the control of the PULO.

Phetburi: A Junta-controlled community in southern Thailand.

Phimai: Independent city in northeast Thailand. The population is strongly anti-Junta.

Phitsanulok: Independent community in northern Thailand.

Phuket: An independent fishing community in southern Thailand on the Indian Ocean coast.

Prachuap Khiri Khan: A Junta-controlled community in southern Thailand, primarily catering to fishing villages in the vicinity.

Ranong: A community in southern Thailand controlled by the Karen.

Roi Et: Independent city in northeast

Thailand.

Samui Islands: A group of fishing villages in southern Thailand which have banded together for their common defense.

Satang: The smallest unit of currency in Thailand. One hundred satang make a baht.

Satun: A community in southern Thailand under the control of the PULO.

Songkhla: A community in southern Thailand under the control of the PULO.

Srivijaya Empire: A Malay empire centered on the island of Sumatra which dominated the Malay peninsula from the 8th through the 13th centuries A.D.

SUA (Shan United Army): The largest of the drug cartels in northern Thailand and Northern Burma.

Sukhothai: A city in northern Thailand which served as the capital of the Sukhothai Empire from 1238 to 1376. It is now an independent community which serves as a central clearinghouse for the

drug trade in the region.

SungaiKolok: A community in southern Thailand under the control of the PULO.

SuratThani: An independent community in southern Thailand.

That Phanom: Independent city in northeast Thailand.

Theravada Buddhism: The form of Buddhism most commonly practiced in Thailand, also called Sinhalese Buddhism.

Three Pagodas Pass: Main pass to Burma, now held by Karen tribesmen.

Trang: A community in southern Thailand under the control of the PULO.

UbonRatchathani: Independent city in northeast Thailand.

Udon Thani: Independent city in northeast Thailand.

Wat: In Thailand, a Buddhist temple/monastery.

Yala: A community in southern Thailand under the control of the PULO.

Order	Name in Phonetics	Equivalent Sound Initial	Final	Order	Name in Phonetics	Equivalent Sound Initial	Final		
1	ก	GAW	G	K	22	ต	(r)TAW (r)TOO!NG	T	T
2	ข	(r)KAW KAI!	K	K	23	ถ	TAW TAH!-HAHN	T	T
3	ค	(r)KAW KUAT	K	K	24	ด	TAW TOHING	T	T
		(obsolete)			25	น	NAW NOO	N	N
4	ก	KAW KWAI	K	K	26	บ	BAW	B	P
5	ก	KAW KOHIN	K	K	27	ป	BPAW	BP	P
		(obsolete)			28	ผ	(r)PAW	P	P
6	ก	KAW RAH!-KAHING	K	K	29	ฟ	(r)FAW	F	—
7	ง	NGAW	NG	NG	30	พ	PAW PAH!N	P	P
8	จ	JAW	J	T	31	ฟ	FAW	F	F
9	ช	(r)CHAW	CH	T	32	ภ	PAW SAH!M-PAOI!	P	P
10	ช	CHAW CHAHNG	CH	T	33	ม	MAW	M	M
11	ซ	SAW	S	T	34	ย	YAW YAH!K	Y	(vowel)
12	ฉ	CHAW CHUH	CH	T	35	ร	RAW REUA	R	N
13	ญ	YAW YEEING	Y	N	36	ล	LAW LEE!NG	L	N
14	ด	DAW CHAH!-DAH	D	T	37	ว	WAW	W	(vowel)
15	ด	DTAW BPAH!-DTAH!K	DT	T	38	ศ	(r)SAW (r)SAH-LAH	S	T
16	ด	(r)TAW (r)TAHN	T	T	39	ษ	(r)SAW REU-(r)SEE	S	T
17	ท	TAW MOH!N-TOH	T	T	40	ส	(r)SAW (r)SEUA	S	T
18	ด	TAW POO-TAO!	T	T	41	ห	(r)HAW	H	—
19	น	NAW NEHN	N	N	42	ฬ	LAW JOO!-LAH	L	N
20	ด	DAW DEHIK	D	T	43	อ	AW	AW	AW
21	ด	DTAW DTAO!	DT	T	44	ฮ	HAH	H	—

(r) indicates that the following syllable is spoken with a rising tone

Thai Alphabet

NPCs

DEVELOPED NPCS

The Junta officers described below are those with actual military commands, and with which

the characters may actually have to deal. There are other, more superior Junta officers, but they will probably never contact the PCs.



General Phra Duriyanga

The commanding officer of the Ayutha garrison and the virtual dictator of the city and surrounding countryside, General Phra Duriyanga is a former Thai gangster. Duriyanga took advantage of the crisis caused by the war to take control of Ayutha. Because of the city's important position, the Junta had to absorb him (it couldn't afford to have him as an enemy).

Duriyanga is 58, and a veteran of numerous gang wars, although he has no military experience. He sees the Junta as his best bet to stay in power, since he has a long-standing "professional" dislike for the Chinese and Japanese consortiums in Bangkok—they are his prewar rivals, after all—particularly Hua Derong and the Hua triad.

Level: Veteran

Skills: Small Arms (Pistol): 3, Interrogation: 3

Initiative: 4



General Nong Khai

Khai is an avid target shooter, gun collector, and a veteran of the Vietnam War, having served there with the Royal Thai Army Volunteer Force's 2nd Brigade from 1970 to 1972.

There, Khai acquired an intense dislike for US foreign policy in Asia, and a deep admiration for US military equipment (particularly the M48 tank).

A former commander of the Royal Thai Tank Division, Khai is now commander of the Southern Corps. General Nong Khai is probably the second most powerful officer in the Junta.

Level: Experienced

Skills: Interrogation: 3, Small Arms (Rifle): 3

Initiative: 3



General Pai Luang

Luang, at 68, is the oldest member of the ruling Junta, and was commander of the Thai Marines before the war. His support secured the Royal Thai naval facilities in Bangkok and other Thai ports, and ensured that navy officers disloyal to the Junta were dealt with swiftly.

Luang is in command of the Northern Corps, which is responsible for all Thai troops north of Bangkok. This nominally makes him General Duriyanga's superior, but in actual fact, the latter is effectively an independent command.

This last is a constant irritant to Luang, who would very much like to see Duriyanga done away with.

Level: Novice

Skills: Leadership: 4

Initiative: 1

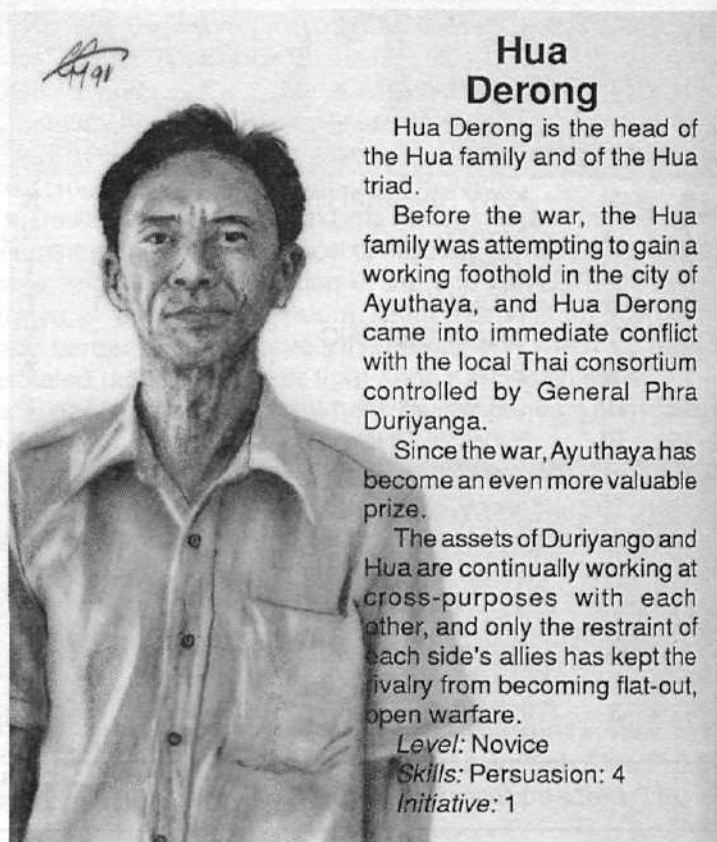

Hua Derong

Hua Derong is the head of the Hua family and of the Hua triad.

Before the war, the Hua family was attempting to gain a working foothold in the city of Ayuthaya, and Hua Derong came into immediate conflict with the local Thai consortium controlled by General Phra Duriyanga.

Since the war, Ayuthaya has become an even more valuable prize.

The assets of Duriyanga and Hua are continually working at cross-purposes with each other, and only the restraint of each side's allies has kept the rivalry from becoming flat-out, open warfare.

Level: Novice

Skills: Persuasion: 4

Initiative: 1

Zheng Desheng

Zheng Desheng is the head of the Zheng family and of the Zheng triad.

Desheng is fascinated by the Thai people, and has married a Thai woman, which makes him somewhat of an outcast among the remainder of the Chinese community.

The Zheng triad is the smallest of the Chinese merchant/criminal conclaves in Bangkok, and Desheng's irrational attachment to "barbarians" (as the local Chinese call all non-Chinese, regardless of their type or level of civilization) has not helped him to grow.

Level: Veteran

Skills: Persuasion: 3, Interrogation: 3

Initiative: 4



Yu Qiuli

Yu Qiuli is the head of the Yu family and the Phong triad. The Yu family is new in Bangkok, having come here in the early 1990s from Hong Kong. It married into the Phong family, and inherited the extensive Phong holdings in the Patpong Road neighborhood. Qiuli has deflected several attempts by other groups to take over the district, but has been unable to expand into other areas.

At heart an extremely moral man, Qiuli is personally disgusted by the businesses his family controls, but he is also realistic enough to know that he cannot abandon them without securing an alternate power base.

Level: Experienced

Skills: Leadership: 2, Persuasion: 3

Initiative: 3

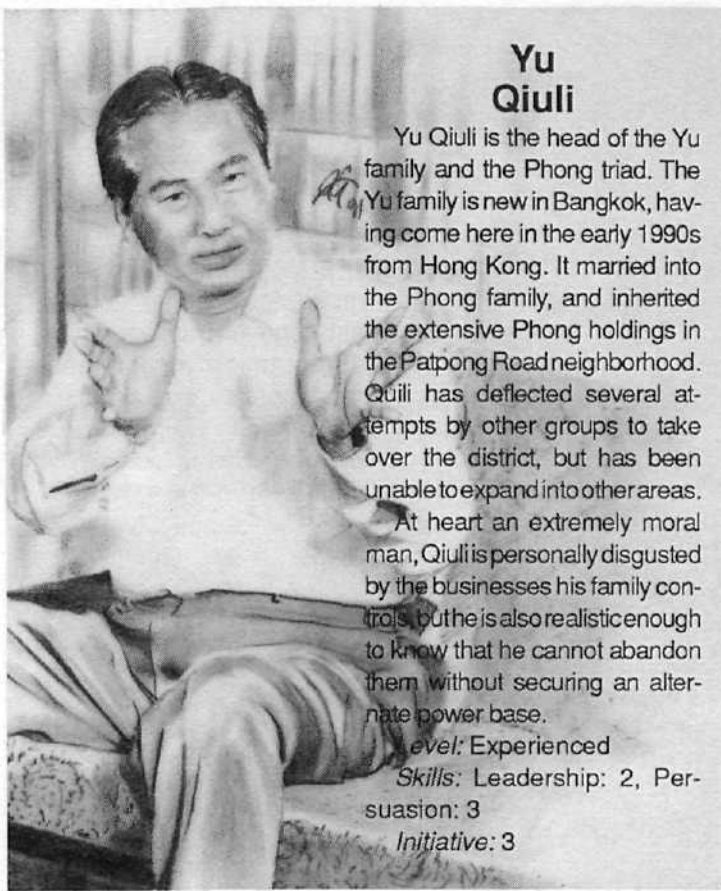

Li Dezhi

Li Dezhi is the head of the Li family and of the Li triad.

Dezhi is a fourth generation Thai citizen, but his family never intermarried with the locals (always taking its spouses from the ethnic Chinese community in Bangkok).

The Li triad would very much like to throw the Zhengs out of the business district of Bangkok.

This would, however, require an all-out war, which Li and his allies believe would probably weaken all parties so much that the Junta would easily be able to take over the whole city—something Li doesn't want.

Level: Novice

Skills: Leadership: 4

Initiative: 1

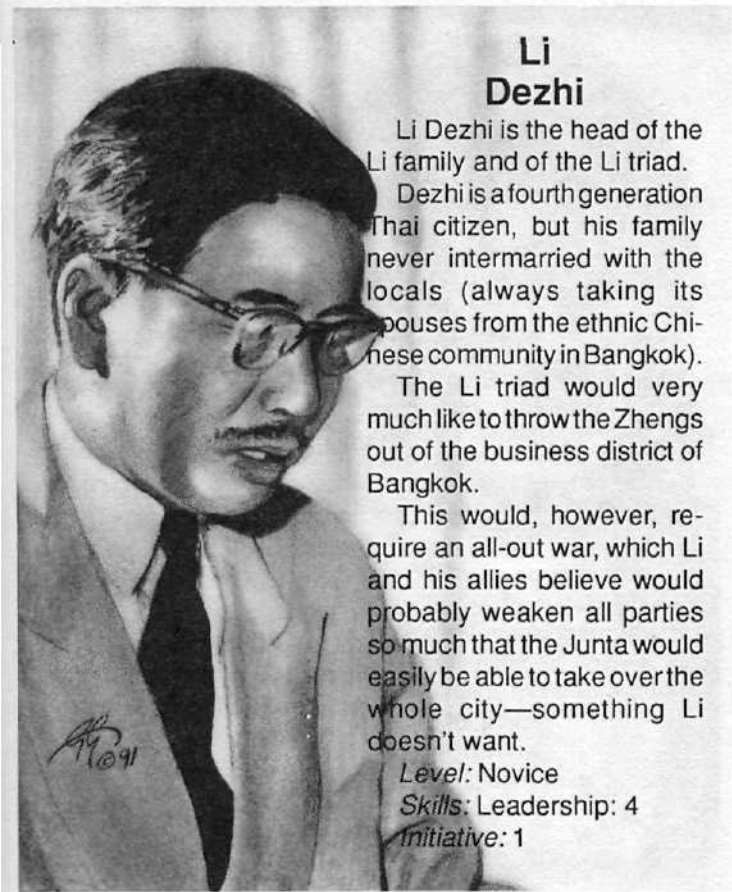

Yosuke Asukata

Yosuke Asukata is the head of the Asukata family and of the *Ni Tora* conclave, and at 34 is the youngest head of a yakuza.

Raised in the United States (his father thought he would be safer there than in Tokyo), young Yosuke acquired an US education and values grafted on to his love for his native land. After acquiring a law degree from UCLA, Yosuke was sent to Bangkok to start a branch of the Asukata family enterprise there. Since the war, he has not heard from either homeland.

Level: Experienced

Skills: Leadership: 4, Persuasion: 1

Initiative: 3

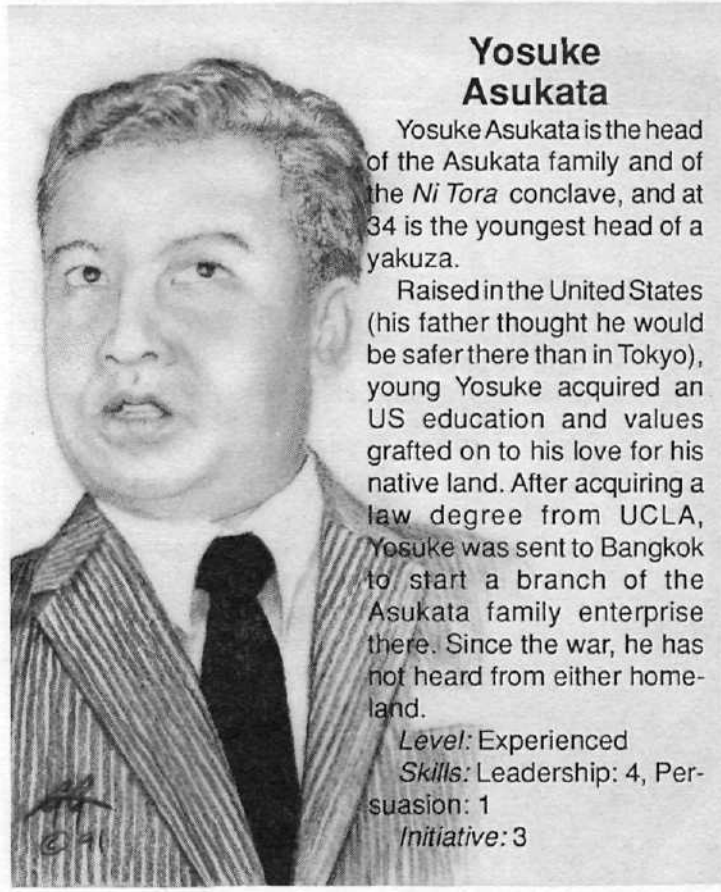

Hideki Sasaki

Hideki Sasaki is the calculating head of the Sasaki family and of the *Hana* conclave.

In his youth, Sasaki was a motorcross racing enthusiast, acquiring many trophies, a reputation in Japanese racing circles, and a number of scars. He was also quite popular with the ladies in his youth.

Sadly, his age (58) and his present position prevent him from engaging in such "unseemly" activities, although he occasionally indulges himself in bouts of reminiscence.

Level: Veteran

Skills: Persuasion: 4,
Leadership: 2, Motorcycle: 3
Initiative: 4

Chinese Merchant

"The world is not what it used to be, but one thing is the same: The family is our only protection, and we are the only protectors of our family. Much money can be made nowadays, even though trade is more dangerous, and we shall receive our share and more if we keep our wits about us and stay with the tried and true ways."

The Chinese merchant family is in business. Anything that is bad for business must be removed or suborned to one's side. Obstacles to free trade—bandits, government bureaucrats, etc.—must be eliminated or chased off. Bother-some competitors must be undercut. And this must be done as cost-efficiently as possible.

Level: Novice

Skills: Persuasion: 5
Initiative: 1

Tadashi Kono

Tadashi Kono is the head of the Kono family and of the *Juuku Rinjin* conclave.

The Kono family is a recent addition to the yakuza of Bangkok. The Konos arrived in July of 1997, having fled Singapore in the wake of a disastrous gang war.

The situation in Bangkok was still fluid enough to enable the Konos to join the *Juuku Rinjin* conclave (where they had relatives). Tadashi soon rose to a leadership position over the shoulders of the other families despite his relative youth (he is 48). His position is not too secure because of this, and an internal power struggle is always possible.

Level: Novice

Skills: Leadership: 5
Initiative: 1

Japanese Enforcer

"My grandfather told me that the Germans had a saying when they were our allies in the great Pacific War: 'My honor is loyalty.' He told me Germans are the only Europeans who come close to understanding the true meaning of loyalty. I have never met a German, but grandfathers are seldom wrong."

The Japanese enforcer isn't a ninja, a samurai, or anything else out of a cheap American martial arts movie. He is a thug who knows how to kill people several ways and has no qualms about doing so. His favorite method involves the Western martial arts weapon called the Uzi.

Level: Veteran

Skills: Small Arms: 4, Melee
Combat: 3
Initiative: 4

Thai Soldier

"We did not start the war—we were not involved. So why do we suffer so much from its effects?"

The average Thai soldier does not really understand world events. The whys and wherefores of the global economic collapse are beyond his understanding, even if he had the facts readily available.

All he knows for sure is that suddenly gasoline for his motorbike is beyond his reach, the supply of Western cassette tapes has absolutely dried up, and life seems to have gotten a good deal more violent, even though the communist insurgents vanished almost a decade ago.

Level: Veteran

Skills: Small Arms (Rifle): 3, Melee Combat (Unarmed): 2, Scrounging: 2

Initiative: 4

Thai Fishing Captain

Not much has changed. Life is one unending cycle: sail out, fish until the holds are full, sail back, sell the fish, buy what you need to repair the damage done by the voyage, and start again. Your sons are the crew. Your wife and daughters mend nets, cook, and help clean the catch. Everyone helps sell it when you're in port. But now there are fewer things to spend the money on.

The pirates have always been around—now there are just more of them, and most of the time you don't have much to interest them. The real danger is the storm that blows up on you without warning, now that there is no more weather radio, or the fight with the other boat over who has the right to cast where.

Level: Experienced

Skills: Small Boat Handling: 4, Fishing: 2

Initiative: 3

Thai Military Officer

"Frankly, when the old king died, I thought we were simply going to do without. But the people love the idea of a king so much. The splendor, the emotion, the traditions of monarchy all have their attractions. Someone has to start the planting season with the proper ceremony, after all."

A part of the middle echelon of the Junta, the military officer is genuinely interested in the well-being of his country. He tolerates the corruption he sees around him only as a necessary evil to keep things from falling apart completely—making sure that he gets his share, of course. No point in being more honest than is good for you.

Level: Novice

Skills: Leadership: 3, Small Arms (Pistol): 1

Initiative: 1

Hill Tribe Headman

"The world is different. Fewer outsiders come with their magical boxes: the boxes that make sounds, those that capture souls, and those that hold their clothes. I could never understand the talk they made, and it is good they no longer come, because their jabbering scared the game. It is also bad they no longer come, because they used to give us money and the shirts with the pictures of strange animals on them.

The soldiers no longer come and burn our poppies, and that is good, but the new men who come to buy the opium say the market is down, and no longer pay what they did. Sometimes the new men come not to buy our opium, but to steal our sons and daughters, and that is bad."

Level: Experienced

Skills: Foraging: 2, Tracking: 1, Outsteering: 1

Initiative: 3

A Merc's Thailand

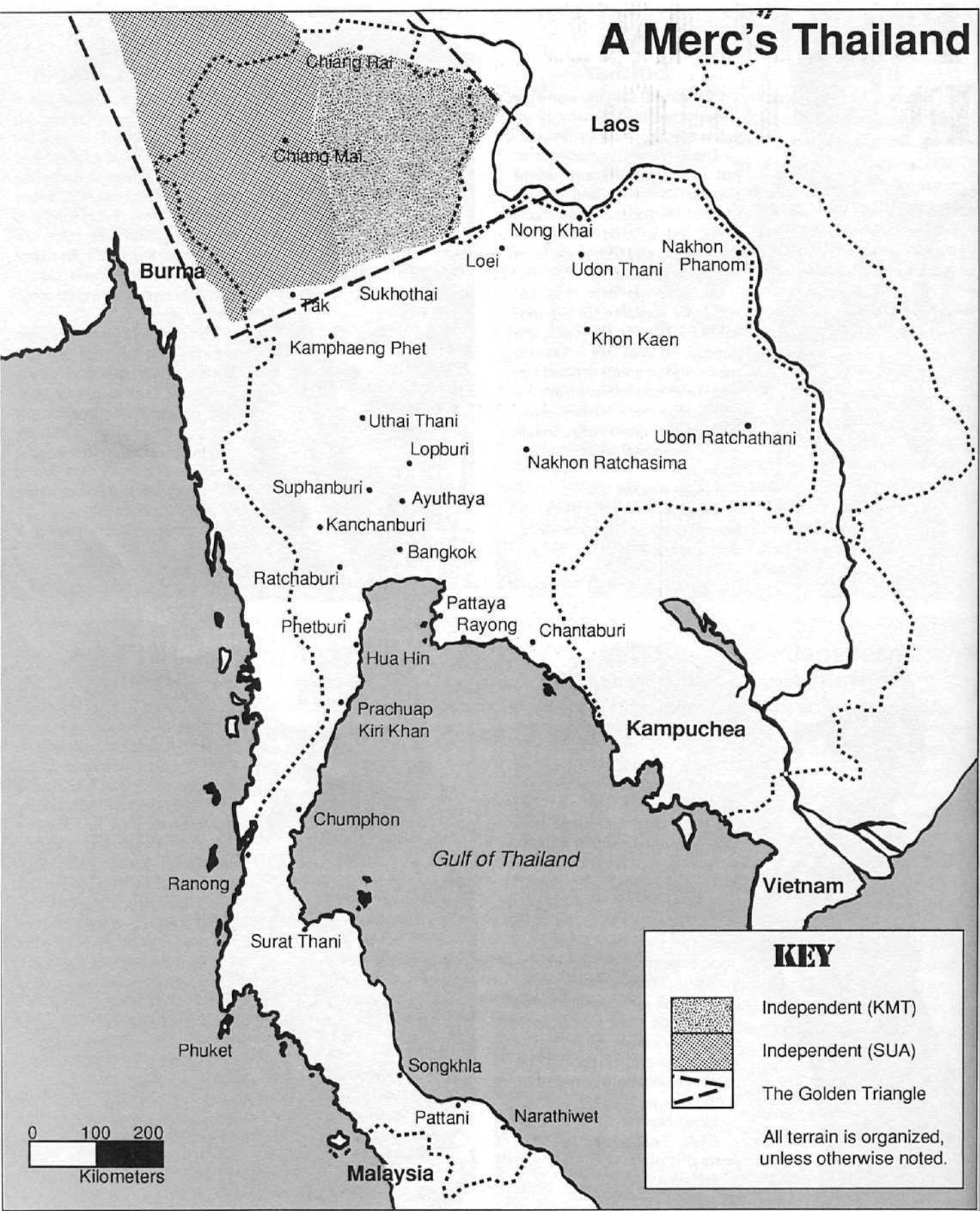

KEY



Independent (KMT)

Independent (SUA)

The Golden Triangle

All terrain is organized, unless otherwise noted.

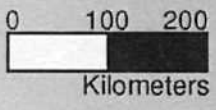

Malaysia

THAILAND IN MERC: 2000

One way to describe the difference between Bangkok in **Twilight: 2000** and in **Merc: 2000** is to say that in **Merc** the city buses still operate and there is still scheduled air service from Bangkok airport. But the differences are more complex than that.

BACKGROUND

The biggest difference in background is that the war did not occur, and the global dislocation of that event did not occur. Remember, however, that **Merc: 2000** postulates a breakdown in global trade and a recession, which means that stresses will still be placed on the Thai government.

WG postulate that the stresses to which the

world is subjected still bring about civil unrest in Thailand, and that these cause the death of the king and his family under mysterious circumstances (the question of whether the Junta had them assassinated or merely took advantage of an opportunity will be left unsettled). After this, a collection of military officers known as the Junta placed a new king on the throne, establishing a new dynasty (based on an old precedent not exercised since the 18th century). This choice of a king is not uncontested, and a short purge of certain branches of the military (primarily the air force) occurs as the Junta secures its power base. In the **Twilight** scenario, the air force was not reformed (lack of fuel prevents planes from flying in any case) and opposition to the Junta is centered in a number of independent communities outside of Junta-controlled territory. In **Merc's** Bangkok, the air force is reformed (although it is much smaller than before), using politically reliable officers.

Most government services are still available in Bangkok (electricity, sanitation, water, etc.), but a certain level of civic corruption exists in the Thailand of **Merc**, which is to say that bribery and corruption are still a way of life in Bangkok, although this is less true in the countryside.

COUNTRYSIDE

With the exception of the cities identified as being under the control of one of the drug warlord groups, all areas of Thailand are considered to be organized.

MERCHANT/CRIMINAL CARTELS

The situation in Thailand under the **Merc** future history still permits the existence of the merchant/criminal cartels (primarily Chinese and Japanese). The cartels do not control any portion of the government, but are equally powerful in many ways. Their operations are more subtle and more circumspect.

DRUG WARLORD GROUPS

The KMT and SUA are still the two main drug cartels, although there are others. The smaller ones come and go, forming, growing, and breaking up in no set pattern. The larger groups know no national boundaries, and are too powerful for local authorities to control.

KMT: This group is often referred to as the

Golden Dragon cartel, because of the symbol it uses to identify its shipments—a trademark of sorts. It is otherwise as described elsewhere in this book, and is the largest and most powerful of the drug cartels.

SUA: The Shan United Army does not have a single symbol, since it is in the process of coming apart at the seams. The organization is nothing more than a loose coalition of individual strongmen, each one based in a particular city and terrorizing the surrounding villages

HILL TRIBES

The various hill tribes are as described elsewhere in the text, but none of them are in control of any city in Thailand. Small parties of hill tribe hunters or foraging parties make excellent tools for the referee in need of a monkey wrench to throw into a scenario.

THE ECONOMY

Like most of the rest of the world in **Merc**, Thailand is in the midst of a severe recession, which has caused a disruption in the market for tin, rubber, and teak. Thailand remains a major rice exporter, and is self-sufficient in energy, even though several of the offshore natural gas platforms have been blown up by terrorists. Drugs remain a lucrative, although untaxed, export.

THE MILITARY

Thailand, like almost everywhere else in the world, has been forced to reduce the size of its military, especially the extremely expensive air and naval forces. The Thai Navy has been reduced to a few dozen coastal patrol craft, and a few larger vessels necessary for preservation of face (and little else).

ENCOUNTERS

Since most encounters in **Merc** are mandated encounters, referees will find little need for extensive encounter tables. The main purpose of random encounters in **Merc** is to bring unforeseen complications into the scenario, and these are best worked out in advance, rather than randomly generated. The referee should, however, use the existing tables (both in this book and in the basic rules) as a guide in formulating such encounters.

THAI NAVY—2000

- 3 frigates
- 1 minesweeper
- 24 river patrol craft
- 32 coastal patrol craft
- 5 LST
- 3 LSM
- 4 LCVP
- 24 aircraft of all types

THAI AIR FORCE—2000

- 2 fighter squadrons
- 4 COIN squadrons
- 3 transport squadrons
- 1 recce squadron
- 1 liaison squadron

THAI ARMY—2000

- 1 cavalry division
- 1 division
- 4 infantry divisions (2 at cadre strength)
- 2 mechanized infantry divisions
- 1 artillery division (cadre strength)
- 2 special forces divisions
- 11 engineer battalions (7 at cadre strength)
- 8 independent infantry battalions (4 at cadre strength)
- 3 airmobile assault companies
- 2 marine infantry regiments
- 1 marine amphibious assault battalion
- Various support and logistical units

THAI SETTINGS

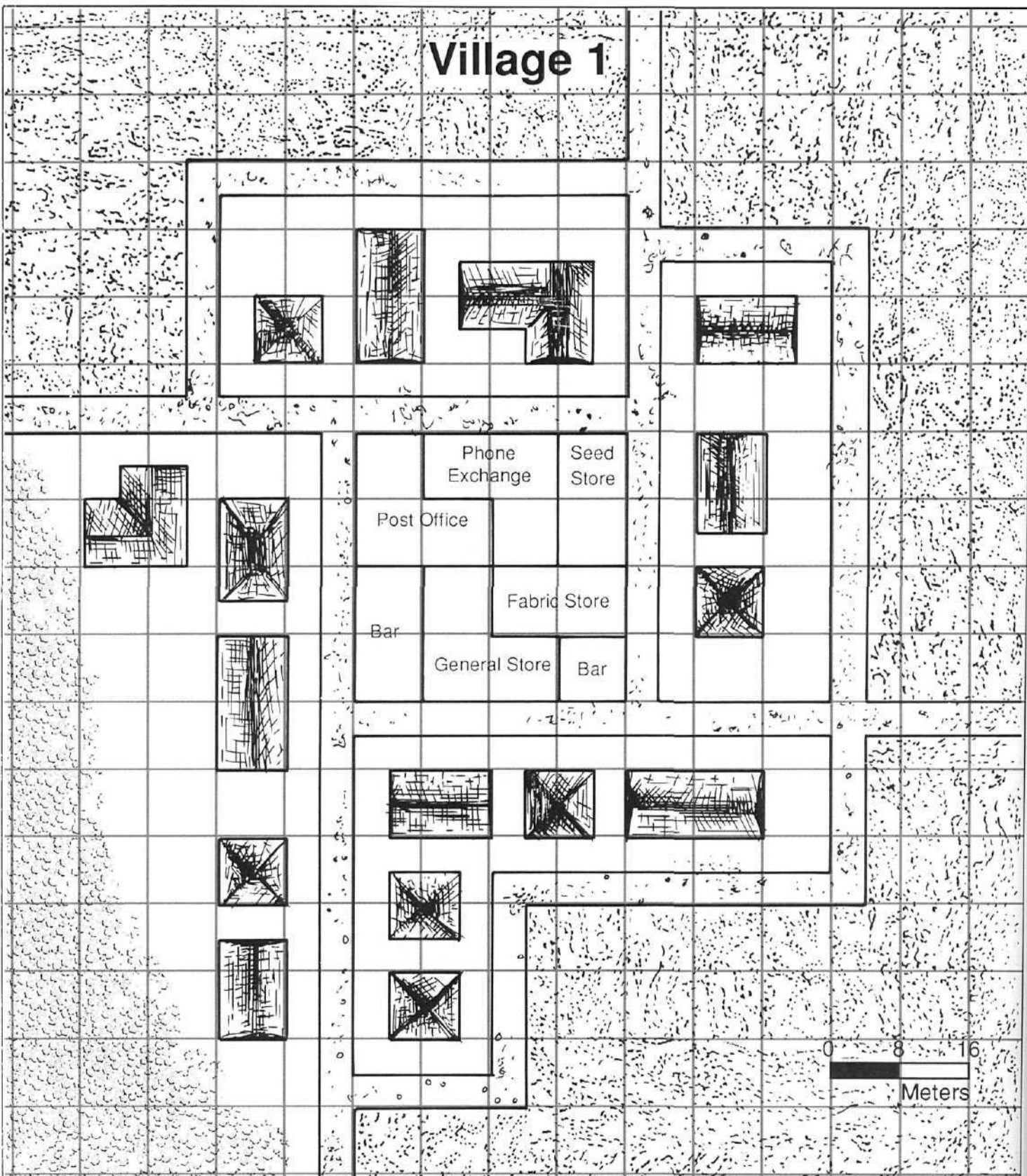

Village 2

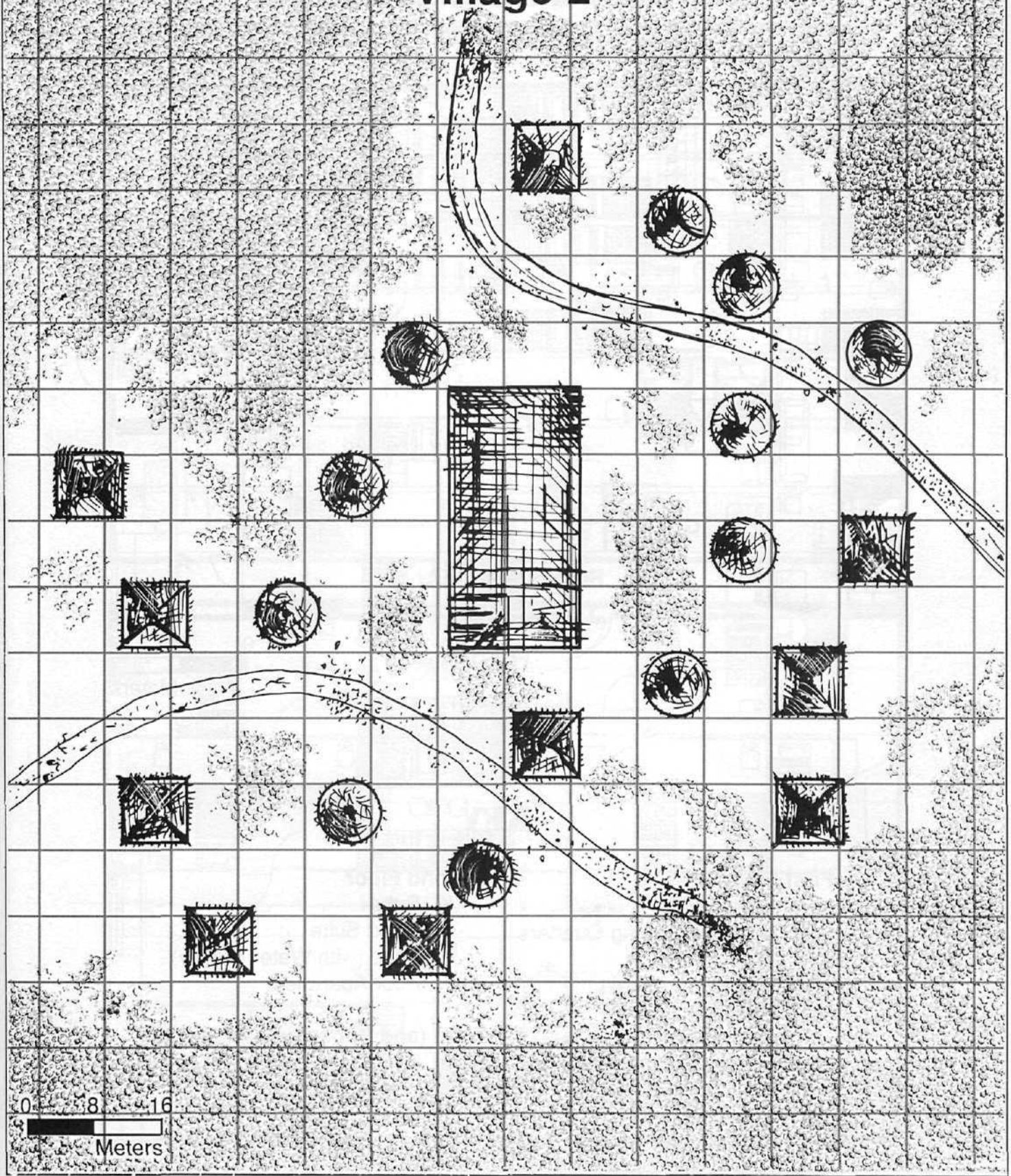

Generic Thai Buildings

Urban Apartment/Shop Complex

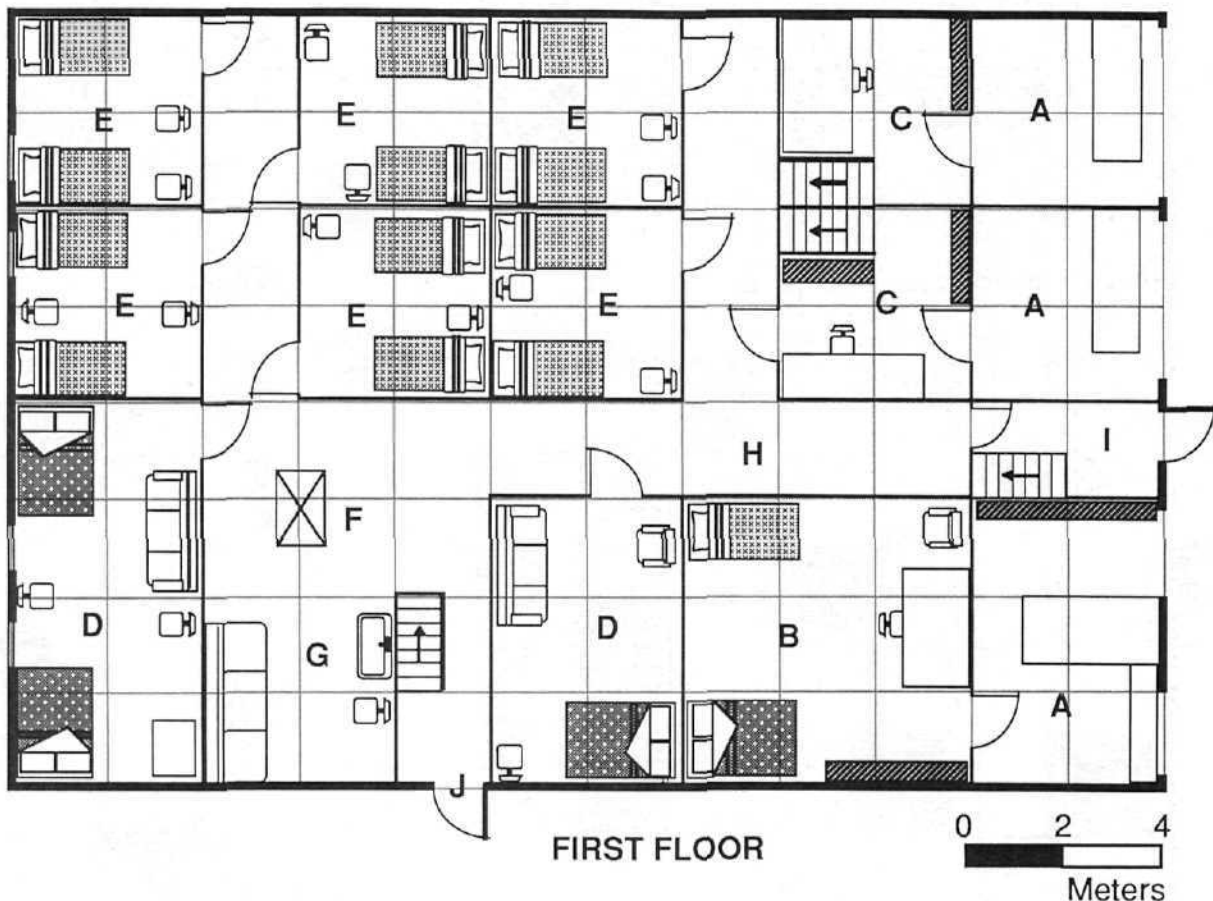

KEY

First Floor

- A Store Front
- B Workshop/Living Quarters
- C Workshop
- D Good Apartment
- E Poor Apartment
- F Spirit House
- G Building's Water Supply
- H Hall
- I Entrance
- J Door to Alley or other Building

Second Floor

- K Suite
- L Good Suite
- M Suite (with Water Supply)
- N Poor Apartment

Third (and Subsequent) Floors

- O Poor Apartment
- P Suite

Generic Thai Buildings

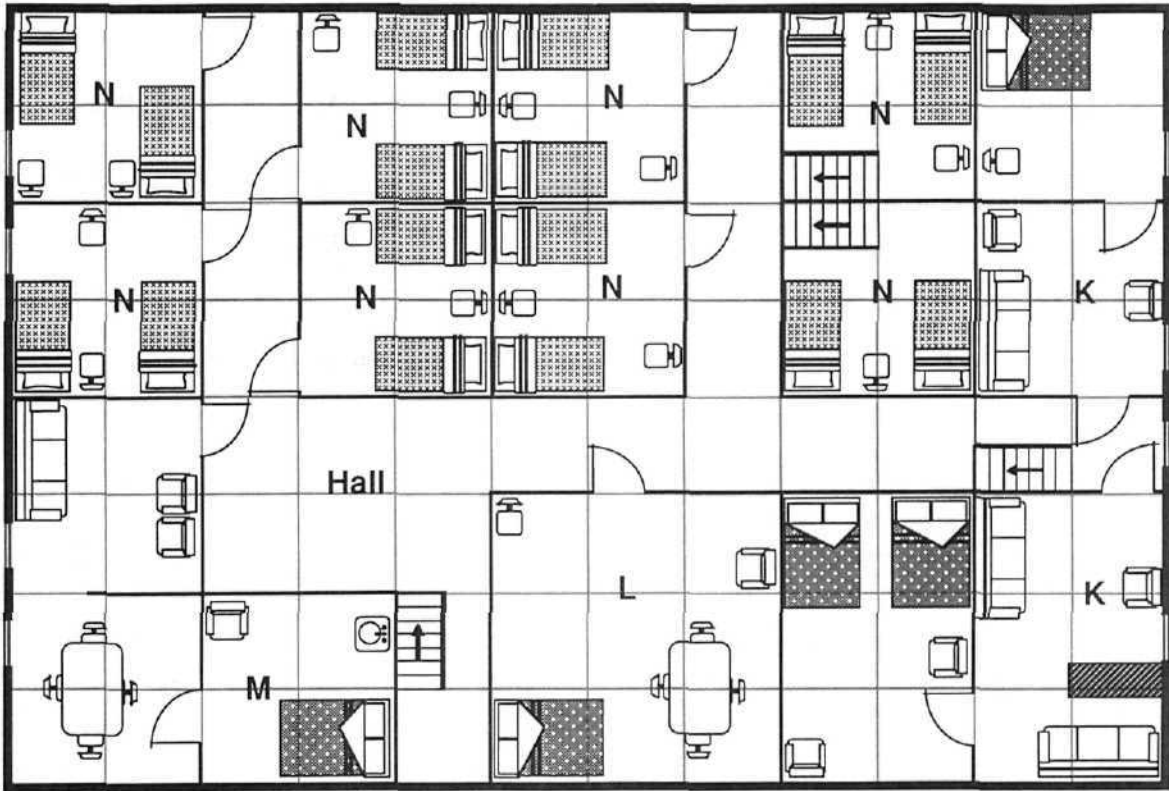
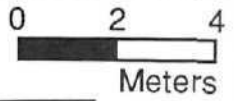

SECOND FLOOR

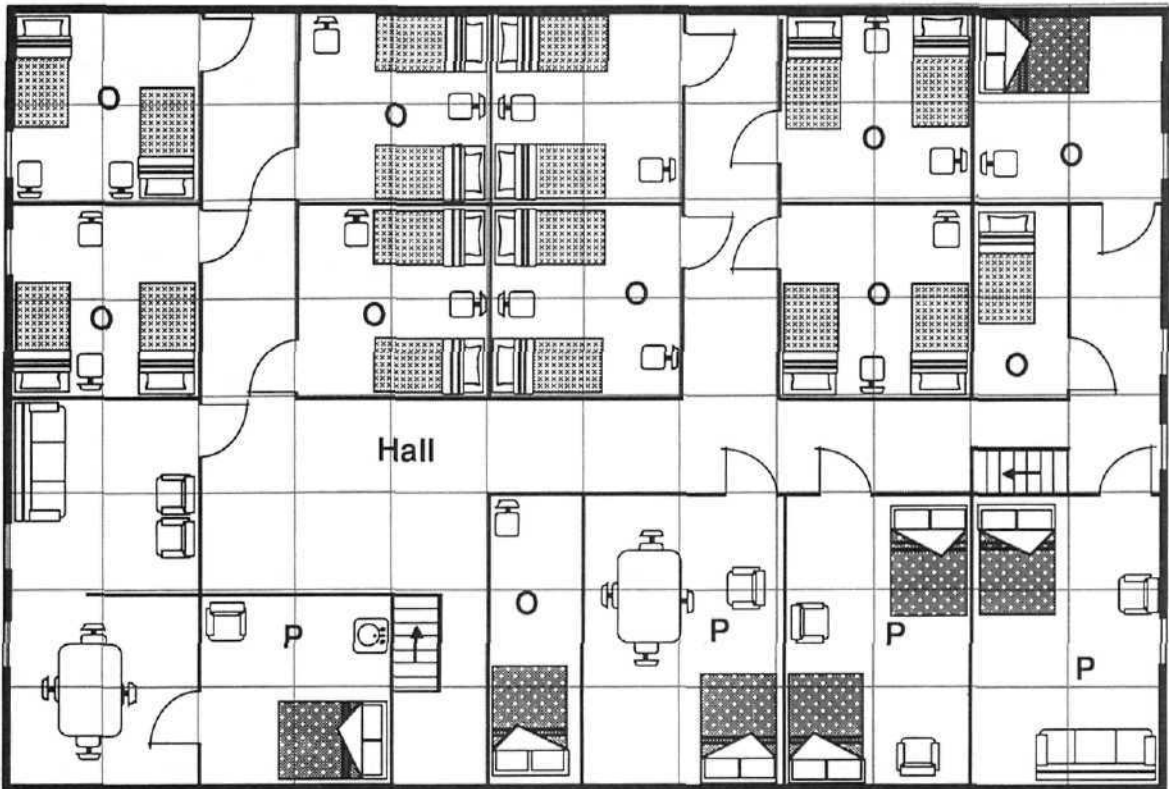

THIRD (AND SUBSEQUENT) FLOORS

Generic Thai Buildings

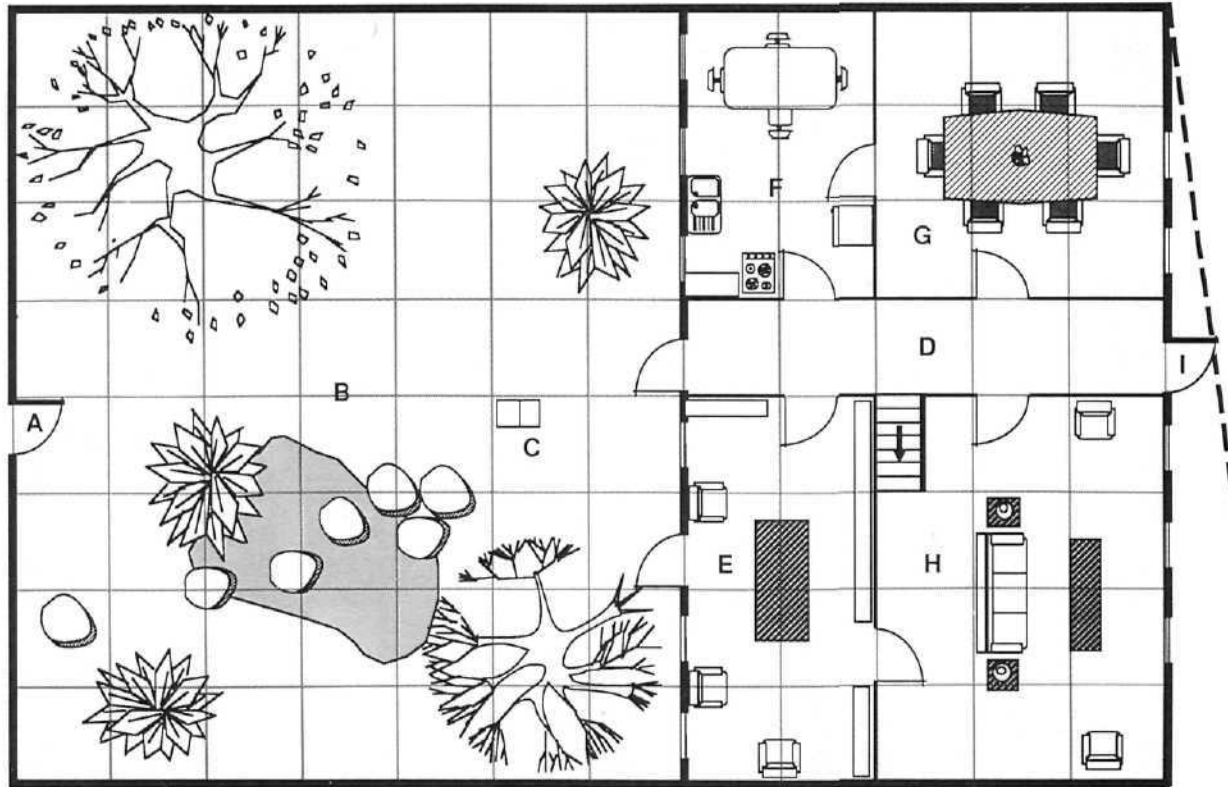

WEALTHY MERCHANT'S HOUSE
(Ground Floor)

KEY

Ground Floor

- A Rear Gate
- B Garden
- C Spirit House
- D Hall
- E Library
- F Kitchen
- G Dining Room
- H Sitting Room
- I Street Entrance

Upper Floor

- J Master Bath
- K Dressing Room
- L Closet
- M Master Bedroom
- N Hall
- O Servant's Room
- P Bedroom
- Q Bedroom
- R Bedroom
- S Bedroom

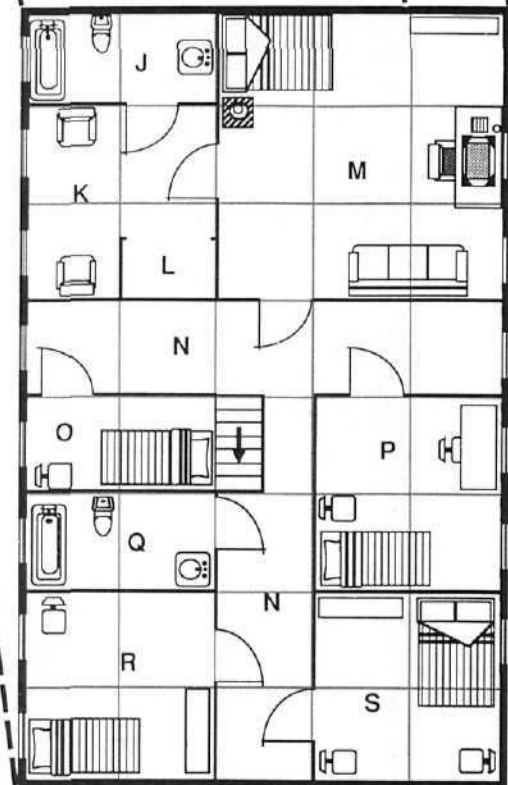
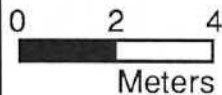

UPPER FLOOR

Generic Thai Buildings

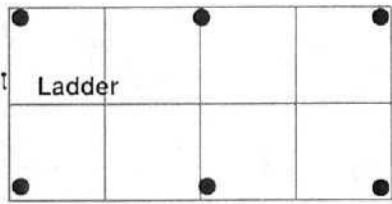

HILL TRIBE "STILT" HOUSE
(Ground Level)

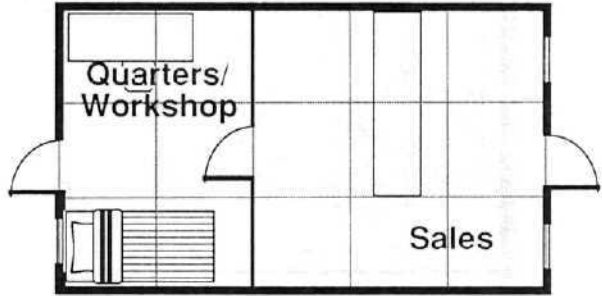

CRAFTSMAN'S SHOP

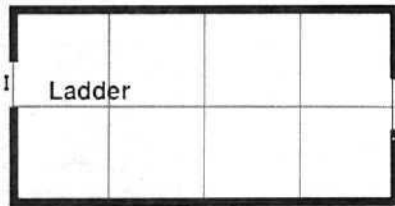

HILL TRIBE "STILT" HOUSE
(Living Level)

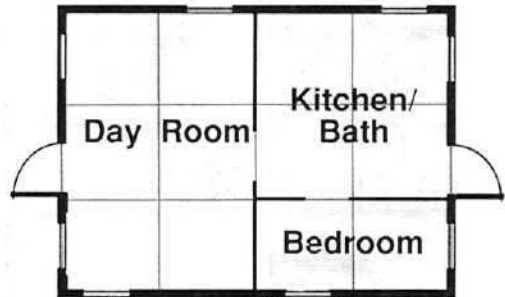

SMALL HOUSE

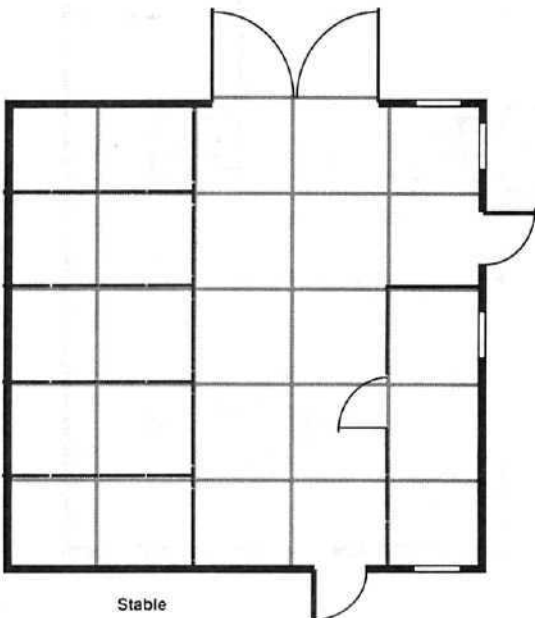

Stable

Shed/Hut

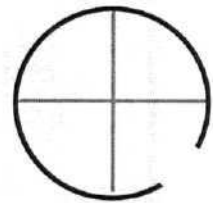

Round Hut

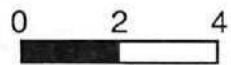

Meters

Thai Hotel

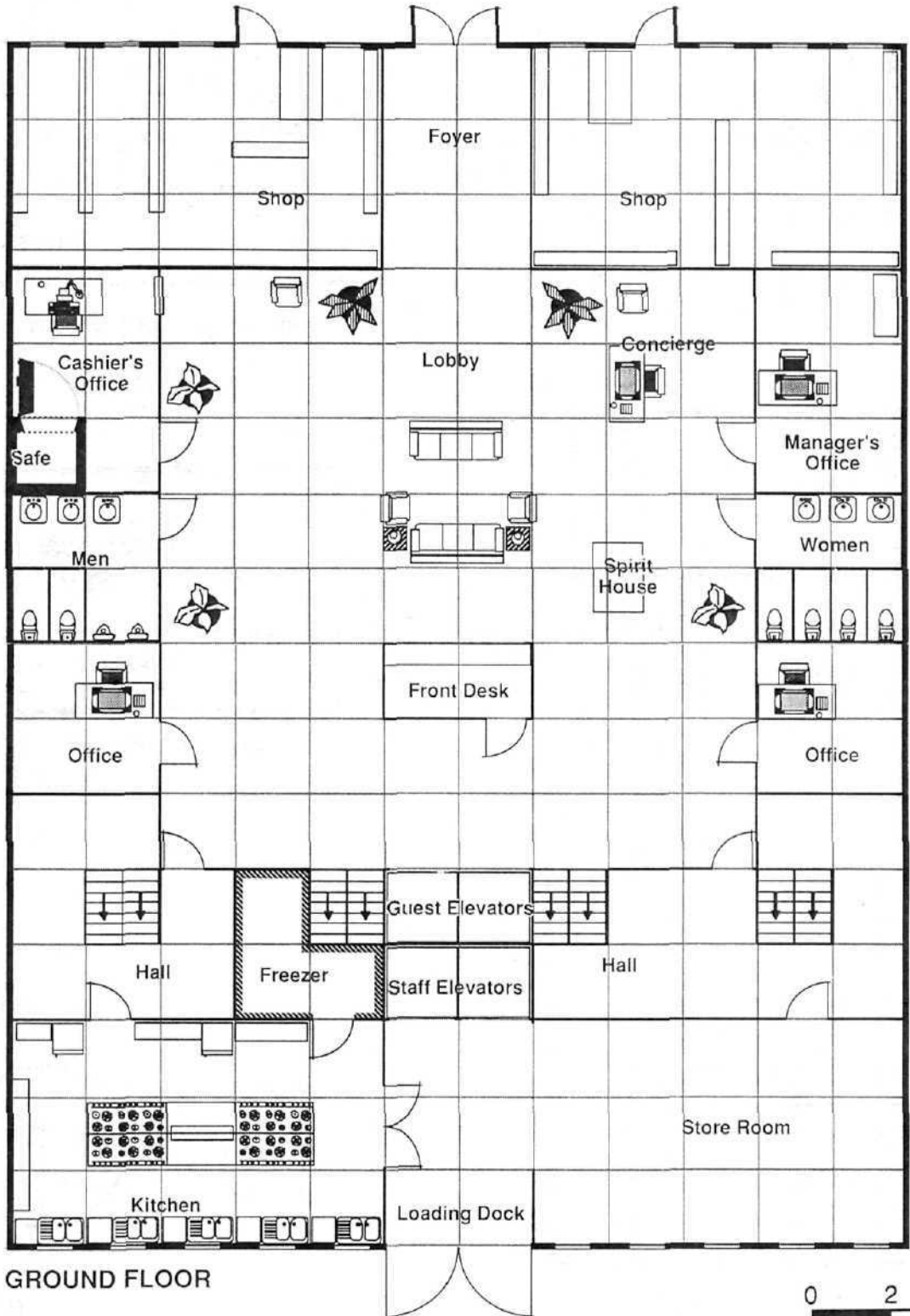

GROUND FLOOR

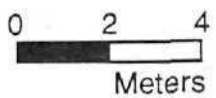

Thai Hotel

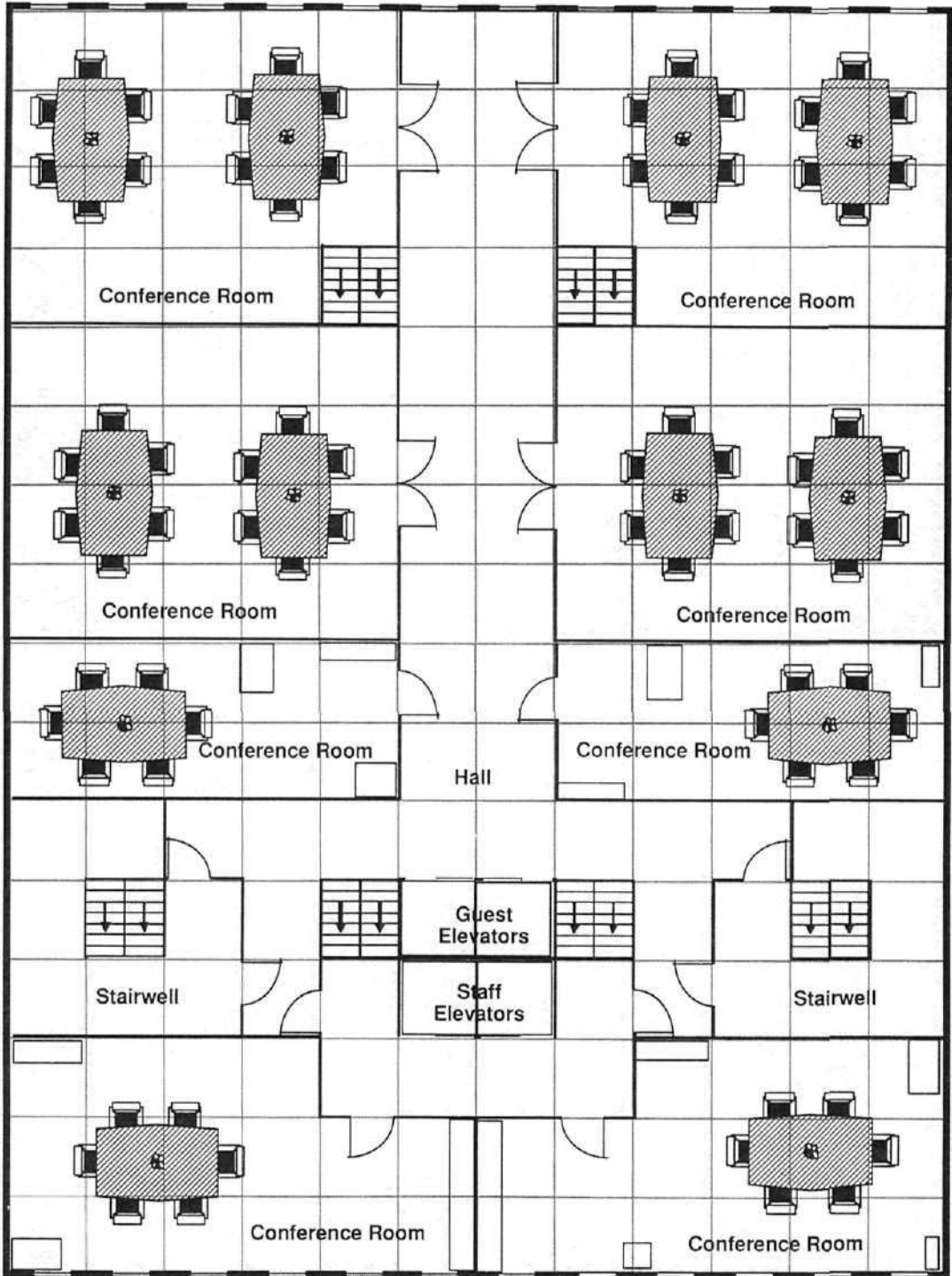

MEETING LEVEL

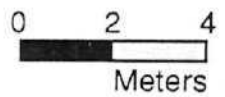

Thai Hotel

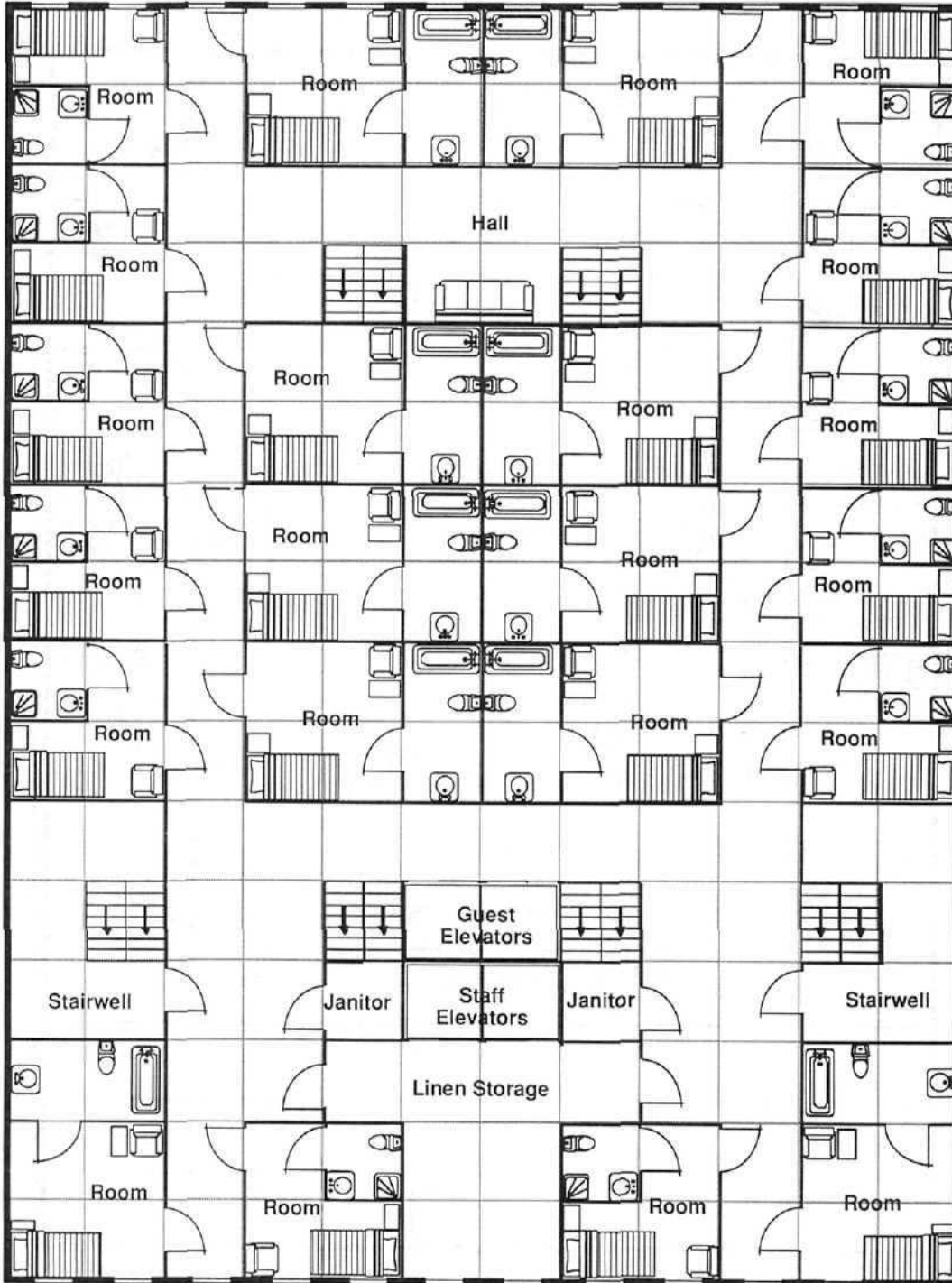

ACCOMMODATION LEVEL
(repeat as desired)

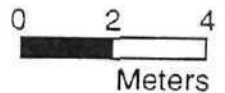

Thai Hotel

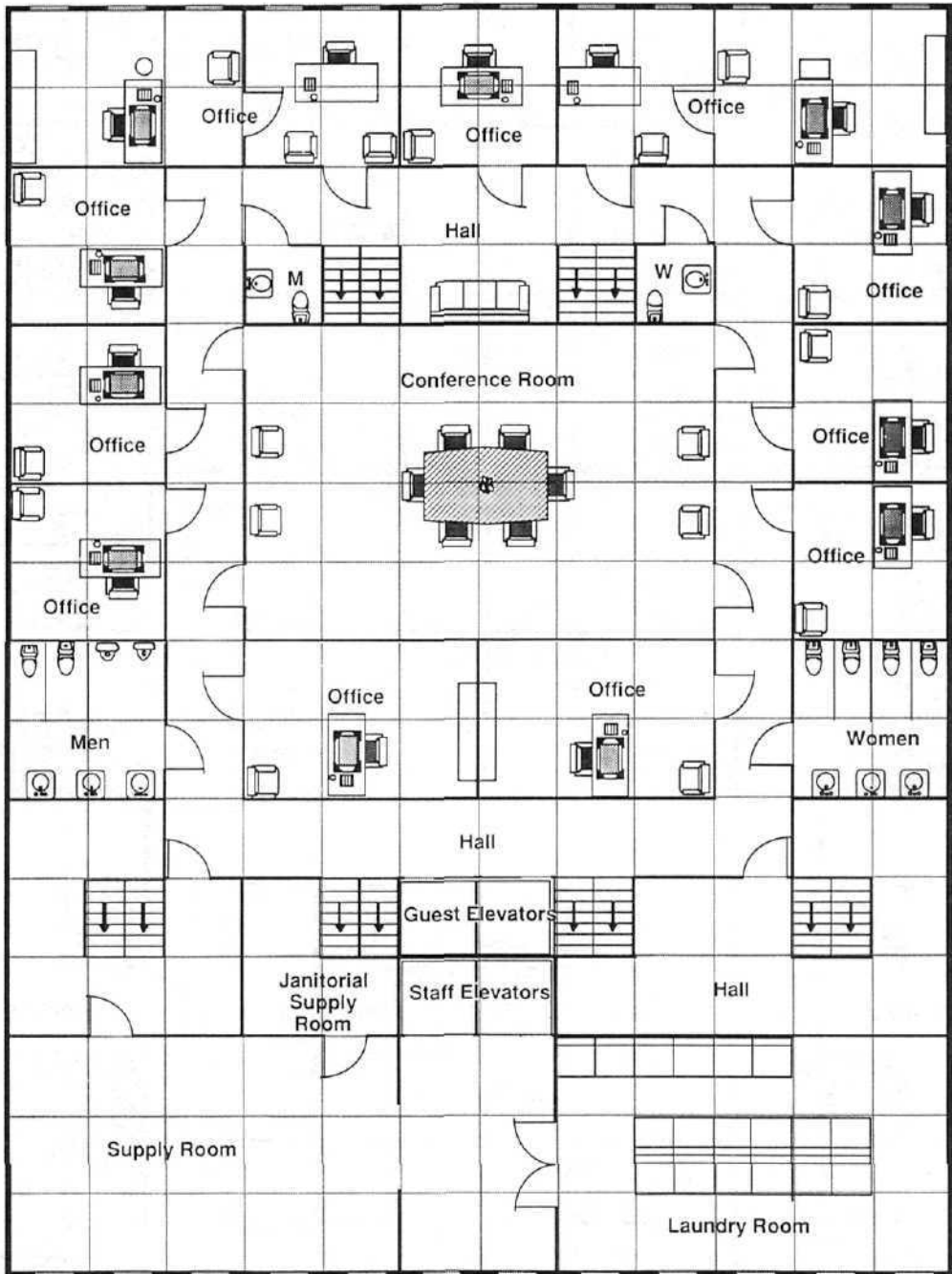

ADMINISTRATIVE LEVEL

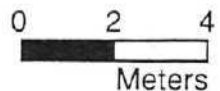

Thai Hotel

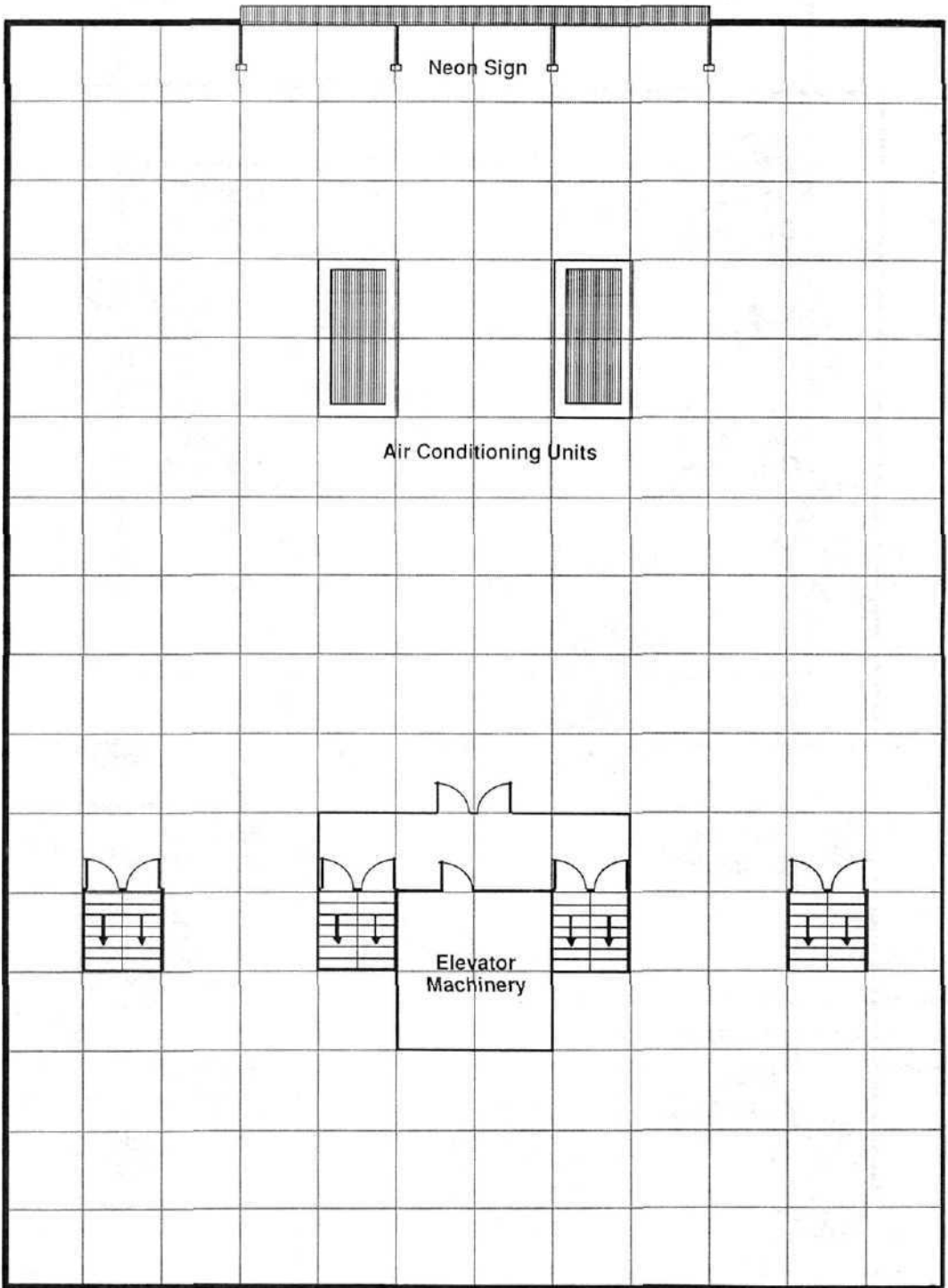

ROOF LEVEL

0 2 4
Meters

Thai Wat

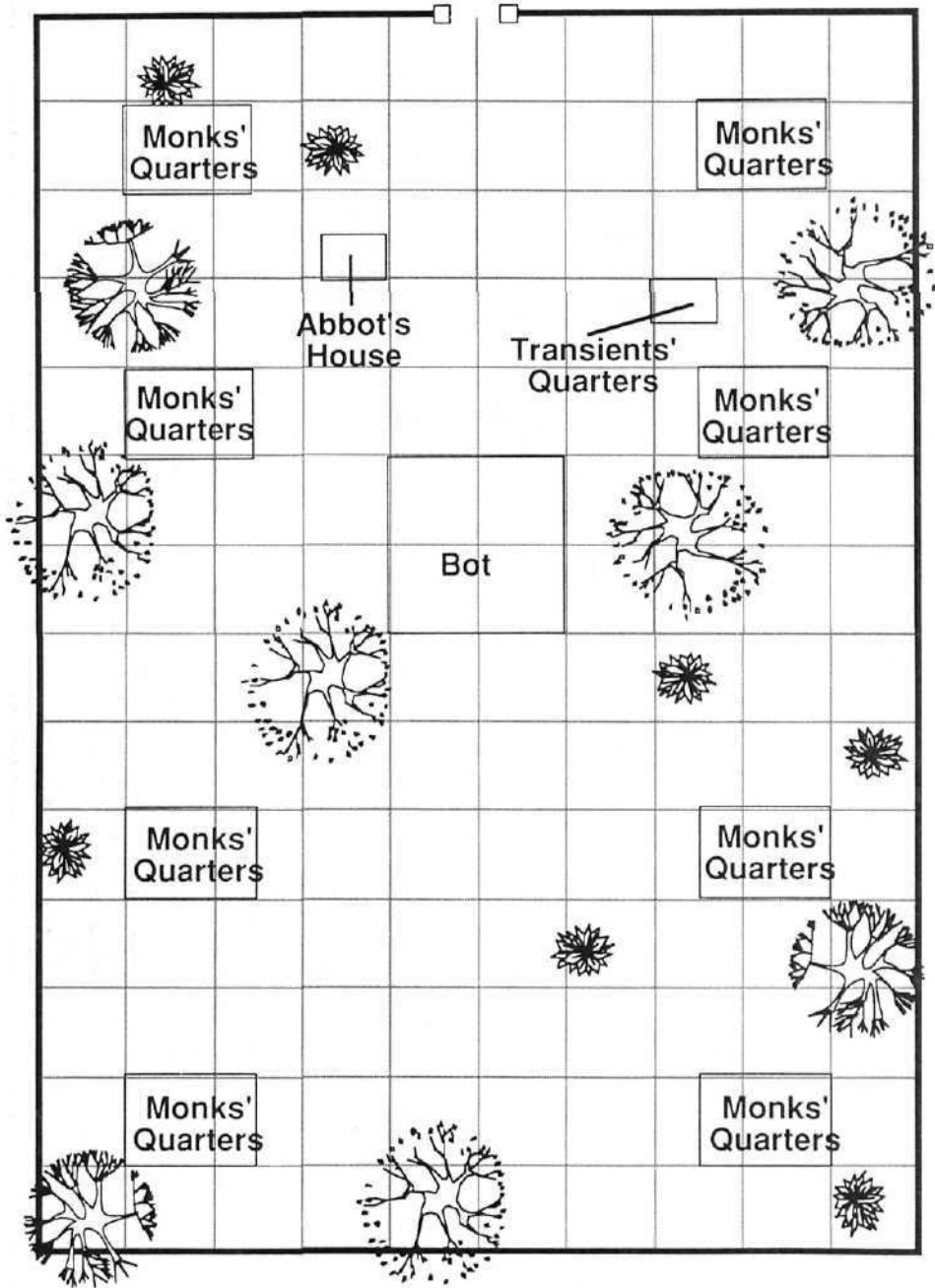

0 8 16
Meters

Thai Wat

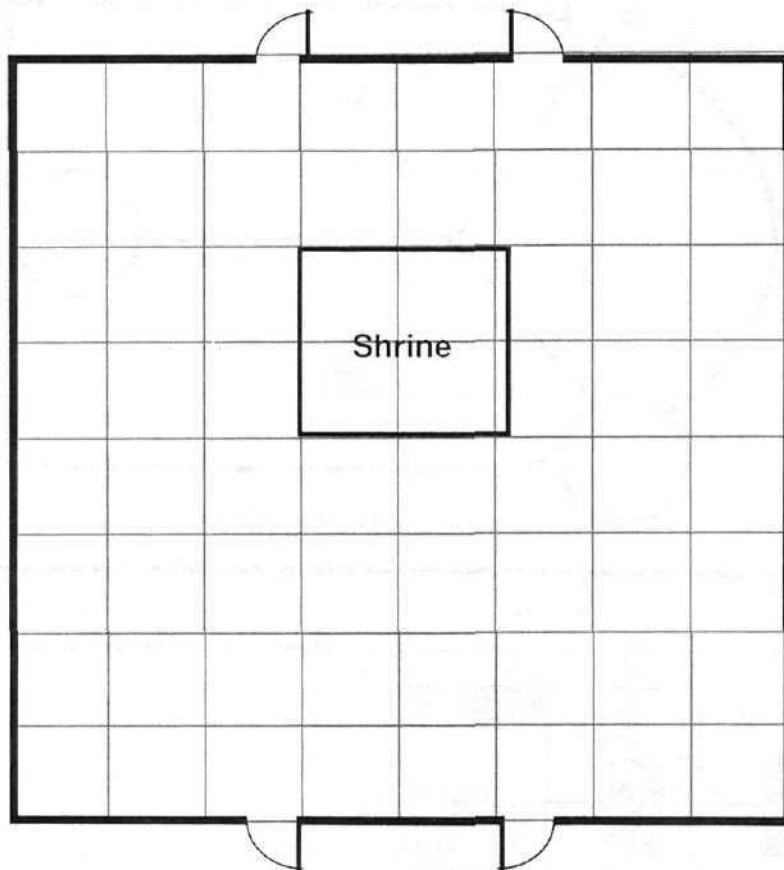

BOT
(Chapel)

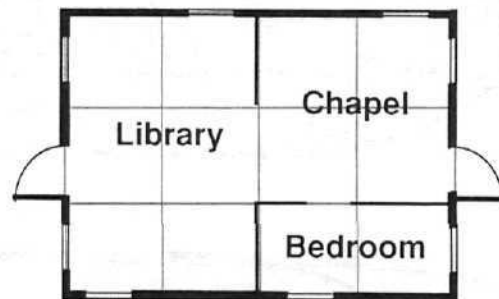

ABBOT'S HOUSE

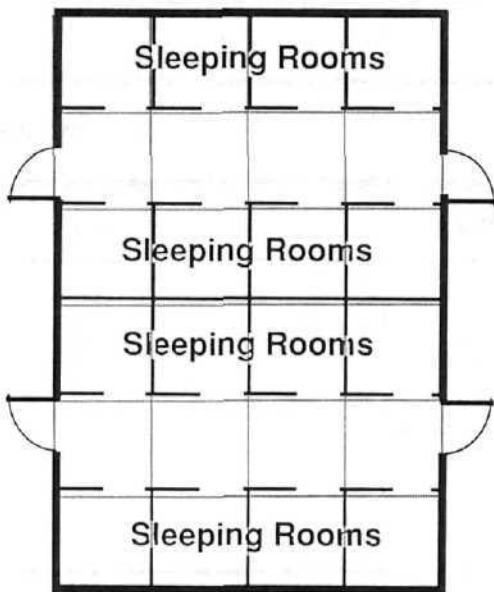

MONK'S QUARTERS

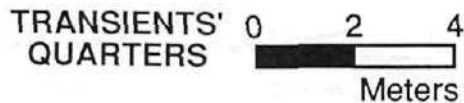

Thai LST

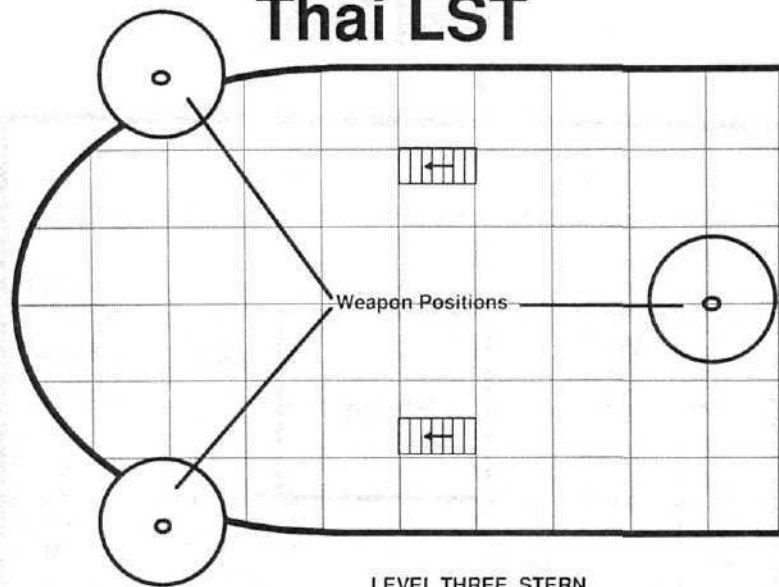

LEVEL THREE, STERN

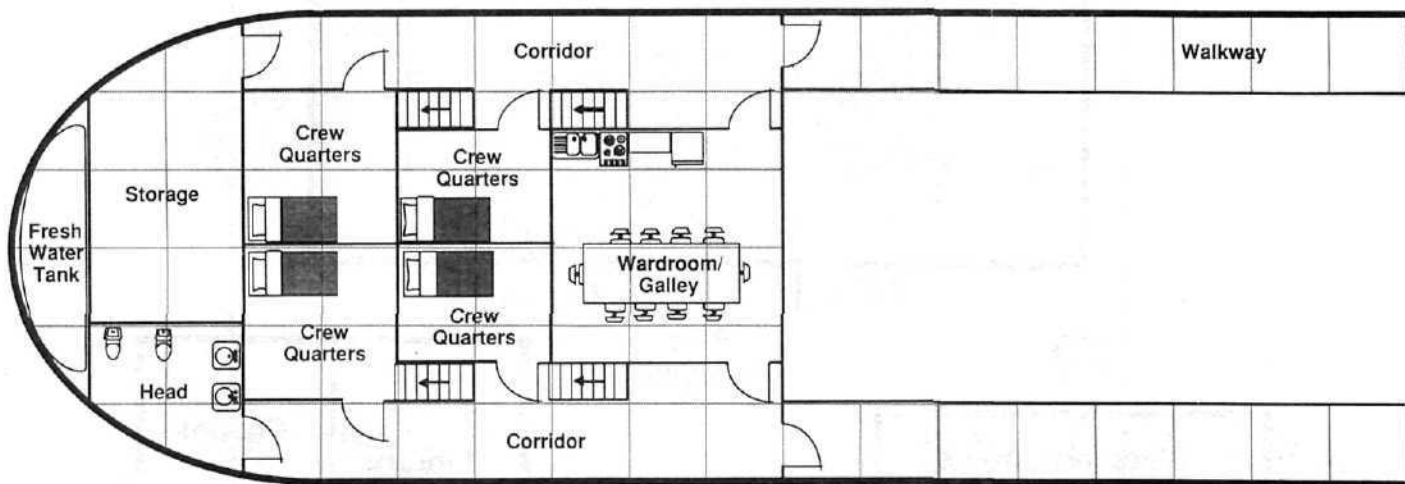

LEVEL TWO, STERN

LEVEL TWO, AMIDSHIPS

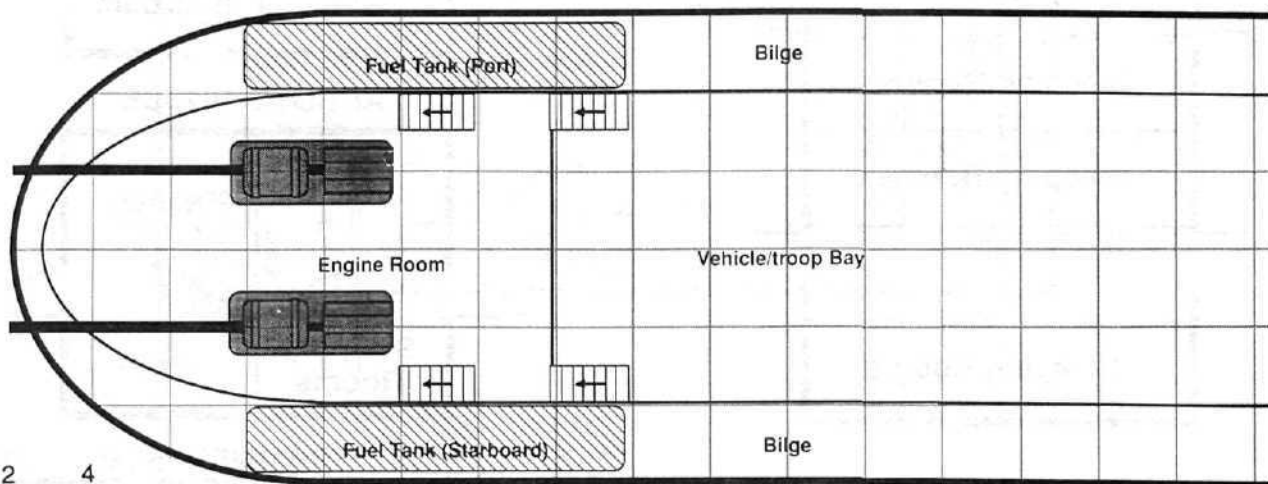

LEVEL ONE, STERN

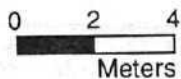

Thai LST

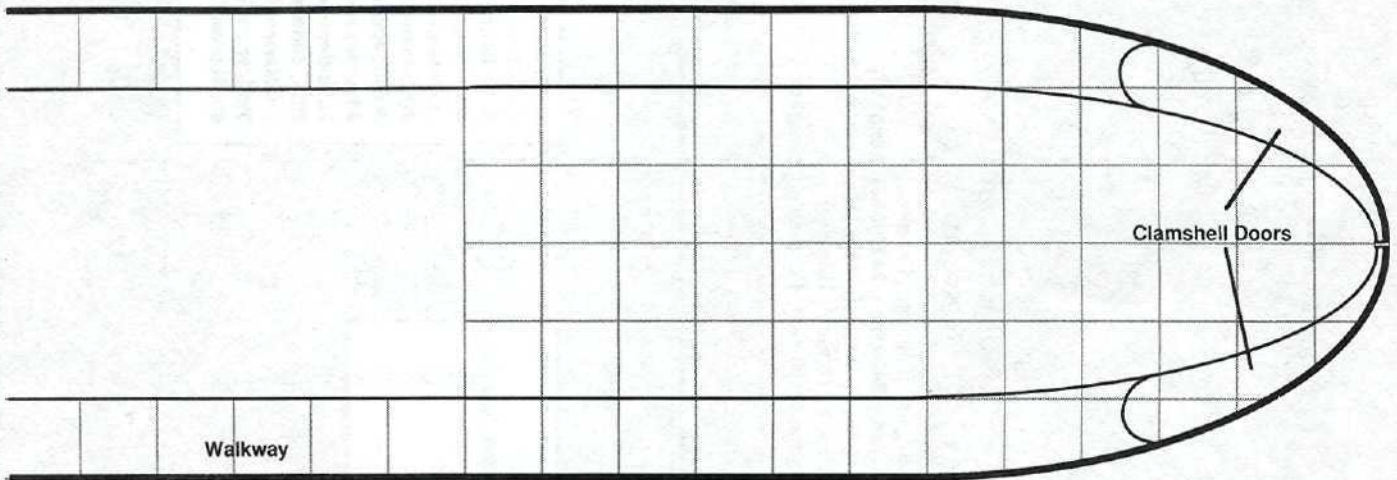

LEVEL TWO, BOW

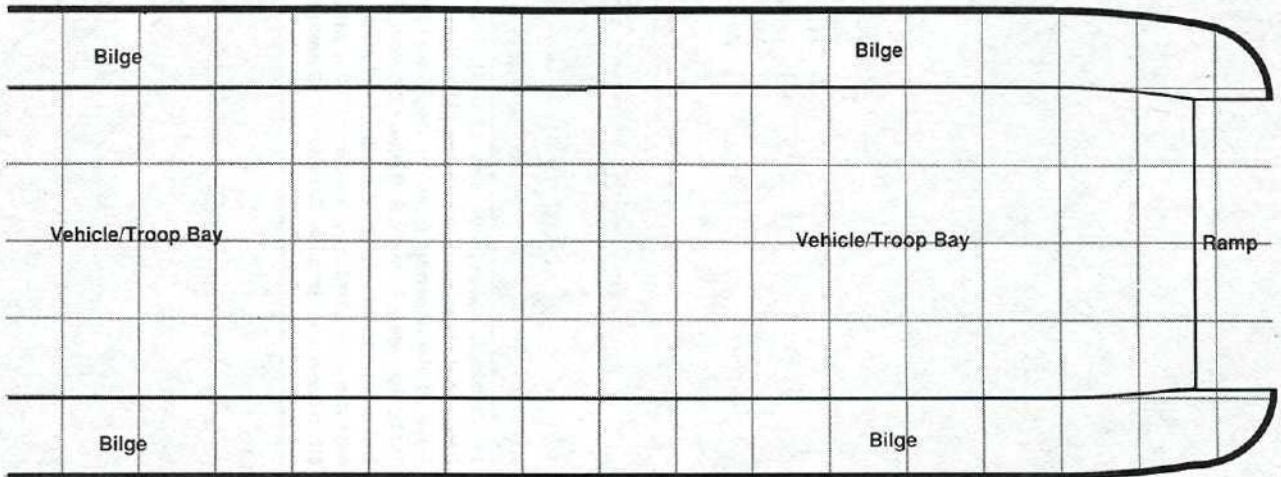

LEVEL ONE, AMIDSHIPS

LEVEL ONE, BOW

Thai Military Organizations

ROYAL THAI SUPREME HEADQUARTERS

(Bangkok)

Guard Infantry Brigade (800 men), Bangkok
1st Armored Division (2400 men, 24 M60A3), Bangkok
1st Mechanized Infantry Division (2300 Men, 12 M113, 12 V-150), Bangkok
1st Marine Regiment (360 men), Thonburi
Air Cavalry Regiment (400 men, 4 Cascavel), Bangkok

SOUTHERN CORPS (Rachaburi)

1st Cavalry Division (1800 men, 12 M24), Rachaburi
Royal Thai Light Infantry Division (2300 Men), Chumphon
Royal Thai Independent Cavalry Regiment (400 men, 3 M24), Hua Hin
1st Independent Infantry Battalion (320 men), Phetburi
2nd Independent Infantry Battalion (180 men), Phetburi
5th Independent Infantry Battalion (200 men), Cha Am
6th Independent Infantry Battalion (320 men), Cha Am

NORTHERN CORPS (Saraburi)

2nd Mechanized Infantry Division (2400 men, 24 M113), Khon Kaen
2nd Cavalry Division (1800 men, 12 Scorpion), Nakhon Ratchasima
3rd Infantry Division (2200 men, 8 M48A5), Ayuthaya
4th Infantry Division (2100 men, 8 M48A5), Lopburi
5th Infantry Division (2400 men, 8 M48A5), Ayuthaya
6th Infantry Division (2200 men, 8 M48A5), Singburi
3rd Independent Infantry Battalion (240 men), Singburi
4th Independent Infantry Battalion (230 men, 6 Saracens), Singburi
7th Independent Infantry Battalion (220 men), Suphanburi
6th Independent Infantry Battalion (200 men), Chantaburi
3rd Marine Regiment (280 men), Chantaburi
5th Marine Regiment (220 men), Pattaya
6th Marine Regiment (240 men), Rayong

Thai Military Organizations

Key

UNIT TYPE



Armor



Infantry



Mechanized Infantry



Cavalry



Armored Cavalry



Heliborne Cavalry



Marine Infantry



Infantry Heavy Weapons



Heliborne Heavy Weapons



Mortar



Artillery



Engineers



Military Police



Signal



Headquarters

UNIT SIZE

XX Division

X Brigade

III Regiment

II Battalion

I Company

●●● Platoon

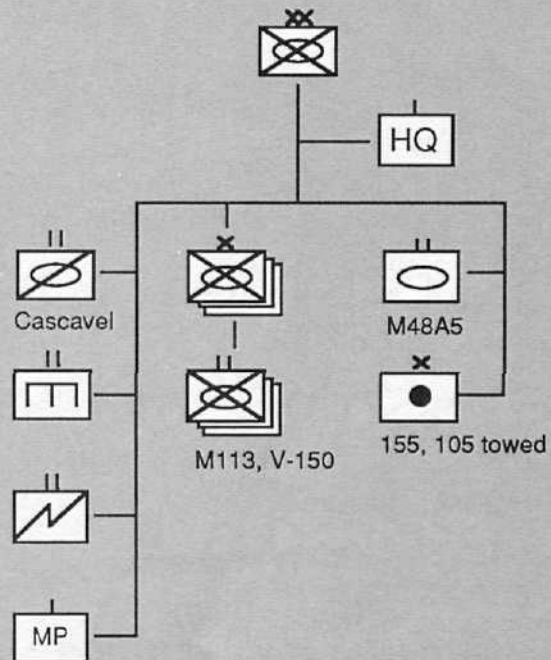

MECHANIZED INFANTRY DIVISION

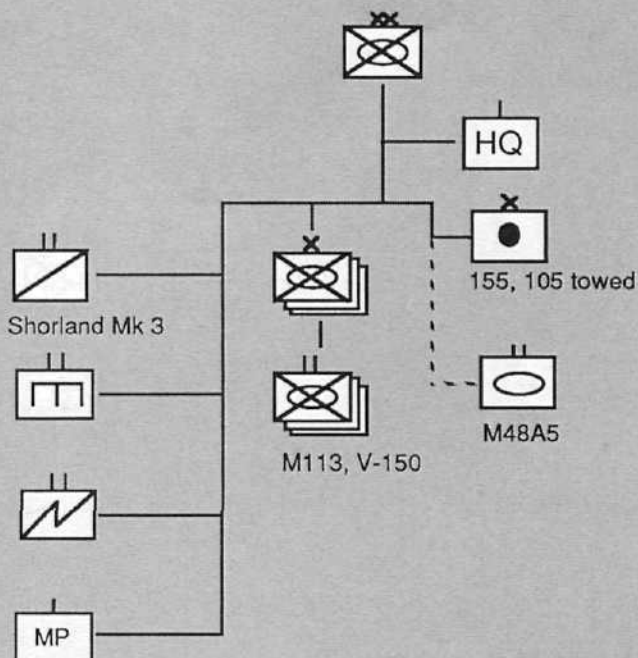

INFANTRY DIVISION

Thai Military Organizations

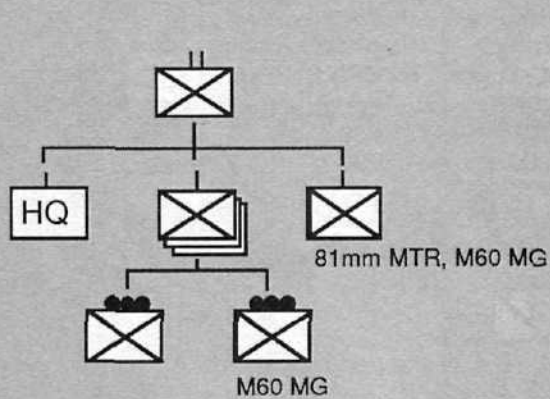

INDEPENDENT INFANTRY BATTALION

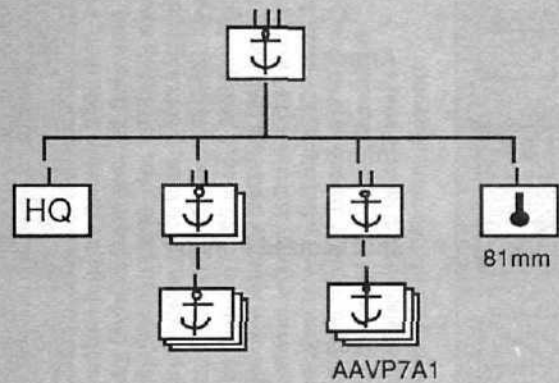

MARINE REGIMENT

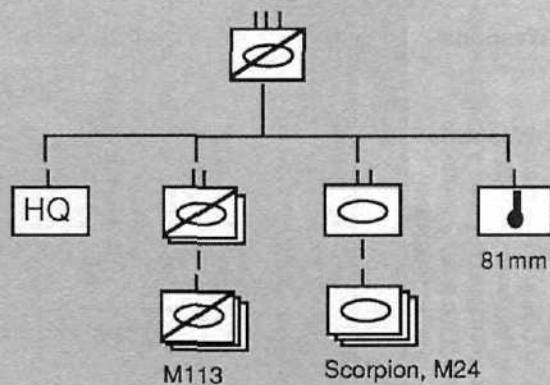

INDEPENDENT CAVALRY REGIMENT

Thai Military Organizations

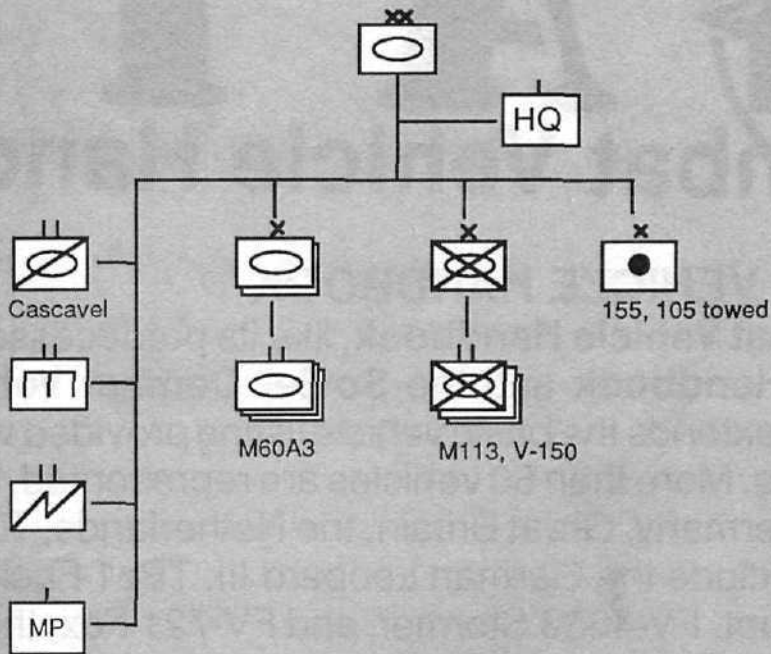

ARMORED DIVISION

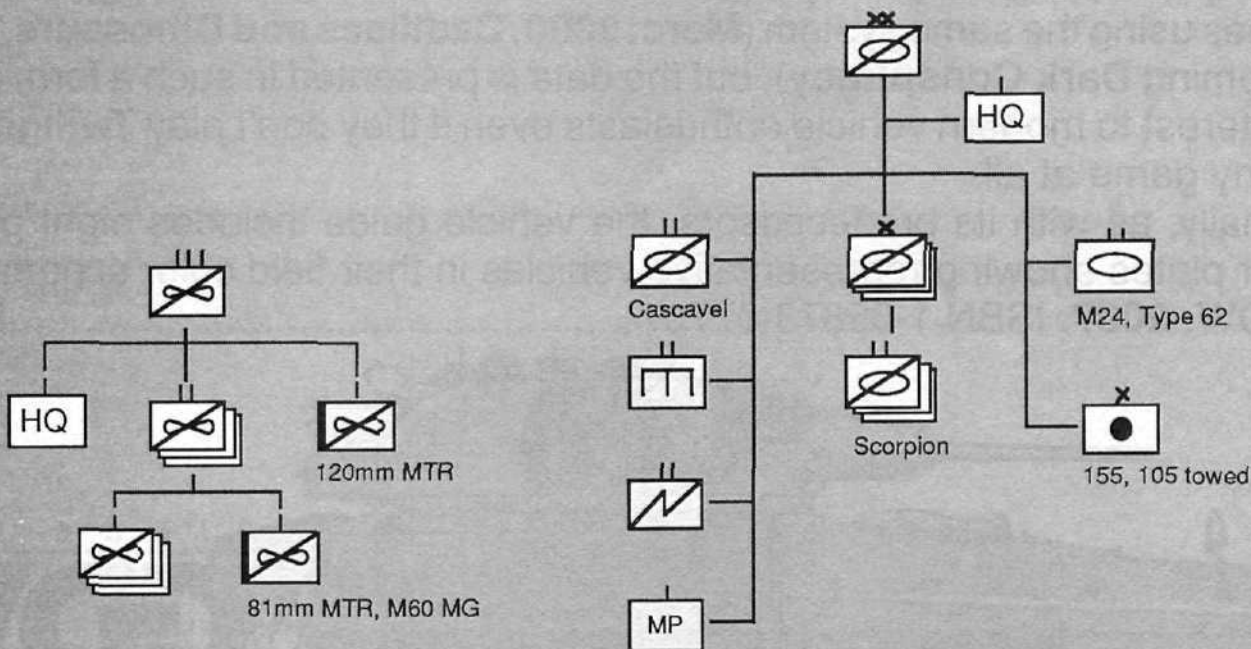

AIR CAVALRY REGIMENT

CAVALRY DIVISION

BANGKOK™

Cesspool of the Orient

For years, I'd heard about the white elephants of Thailand. You know the ones, right? They're considered so sacred that only the king can own them, and even he can't put them to work like normal elephants. They can't be killed...the only thing you can do with the suckers is feed 'em and breed 'em. I got to see a bunch finally. They aren't white, they're kind of a faded pinkish-brown. Some local told us that the word white doesn't refer to the color anyway, it just means the elephant is considered "auspiciously significant." I was disappointed.

What a place! In the dry season you can go fishing with a shovel, I haven't seen a single Siamese cat since we got here, and the second most popular spectator sport is fish fighting! Nothing in this place is what you expect it to be.

Bangkok is the first adventure/campaign sourcebook written especially for the revised **Twilight: 2000** game system. It presents players and referees with a totally new and different background against which to adventure: Thailand. **Bangkok** describes the geography, climate, peoples, and culture of Thailand, giving maps of the major cities, a rundown on the three main political factions, and complete organizational details of the various armies. From the opium warlords of the Golden Triangle to the "sea gypsies" of the Gulf of Thailand, from the primitive hill tribes of the northeast to the sophisticated mercantile/criminal syndicates of Bangkok itself, each region of the country is fully described. Each section also includes a short folio-type adventure set in that part of the country.

Further chapters provide adaptations to the slightly different milieu of **Merc: 2000**, enabling Bangkok to be used with campaigns for that system as well. In all, **Bangkok** will serve as a stepping stone to a whole new world of exotic adventures in the **Twilight: 2000/Merc: 2000** roleplaying universe.



2006 12.00



Made in U.S.A.
Printed in U.S.A.

ISBN 1-55878-074-2
Copyright©1991 GDW, Inc.
All rights reserved.

Twilight: 2000™ is a trademark of
GDW, Inc.



TWILIGHT: 2000™

GDW

GAMES

P.O. Box 1646
Bloomington, IL 61702-1646