

Soviet Vehicle Guide

Series Module

Twilight: 2000™



Game Designers' Workshop



Soviet Army Vehicle Guide

Contents

The Soviet Army	2
Order of Battle	2
Strategic Reserve	2
Western TVD	2
Northwestern TVD	3
Southwestern TVD	3
Southern TVD	3
Far Eastern TVD	3
Pacific TVD	4
Unit History and Current Status	4
Tank Divisions	4
Motorized Rifle Divisions	7
Airborne Units	19
Color Plates	21
Separate Regiments and Brigades	29
Organization	31
Authorized Levels of Weapons and Vehicles.....	31
Motorized Rifle Battalion (BTR)	31
Motorized Rifle Battalion (BMP)	31
Tank Battalion.....	31
Howitzer Battalion	31
Rocket Launcher Battalion.....	31
Antitank Battalion	31
Reconnaissance Battalion.....	32
Attack Helicopter Regiment	32
Airborne Battalion	32
Air Assault Brigade.....	32
Naval Infantry Regiment.....	32
Arctic Brigade	32
Subordinate Units - Soviet Regiments, Divisions	33
Equipment Descriptions	34
Unarmored Cargo Vehicles	34
Main Battle Tanks	34
Self-Propelled Artillery.....	34
Armored Personnel Carriers.....	35
Light Combat Vehicles.....	36
Engineer Vehicles and Hovercraft.....	36
Large Caliber Guns.....	37
Antiaircraft Missiles.....	37
Ammunition	37
Other Equipment.....	38
Hovercraft Rules.....	38
Soviet Fire Chart Data	39
Additions to Vehicle Damage	40
Unarmored Cargo Vehicles	40
Armored Personnel Carriers	40
Light Combat Vehicles	40
Main Battle Tanks	40
Self-Propelled Artillery.....	41
Engineering Vehicles and Hovercraft	41
Color Plate Notes	42
Glossary	48

Credits

Design and Development: Frank Frey and Brad Hay

Supplementary Design: Loren Wiseman

Art Direction: Barbie Pratt

Cover, Interior Illustrations and Color Plates: Steve Venters and Tim Bradstreet

Game Designers' Workshop

PO Box 1 646

Bloomington, IL 61702-1646

Copyright©1987 by Game Designers' Workshop. All Rights Reserved. ISBN 0-943580-33-1 *Twilight: 2000* is Game Designers' Workshop's trademark for its role-playing game of survival in a devastated world.



The Soviet Army

This chapter will provide players with an overview of the current position and approximate strength of the Soviet Army and Navy forces as of July 1, 2000. The order of battle provides an infrastructure of the Soviet command system. The divisional histories give a brief description of the major units of the Soviet Armed Forces. Referees are allowed considerable freedom in manipulating this data to suit the needs of their campaign.

All strengths given for manpower have been rounded to the nearest thousand. Tank strength is for main battle tanks only, and the numbers reflect the current best estimate. Most units have acquired an assortment of other vehicles including lighter armored vehicles, soft-skinned vehicles, civilian vehicles, and a variety of captured equipment.

Order of Battle

STRATEGIC CENTRAL REGION COMMAND

Strategic Reserve

Current Location: Ryazan, USSR

106th Guards Air Assault Division

7th Guards Air Assault Division

9th Soviet Army

4th Guards Tank Division

15th Guards Tank Division

2nd Guards Motorized Rifle Division

3rd Guards Motorized Rifle Division

WESTERN TVD (theatre of war)

Baltic Front

Current Location: Poland

22nd Soviet Cavalry Army

43rd Cavalry Division

96th Cavalry Division

89th Cavalry Division

Reserve Front

Current Location: Poland

4th Soviet Guards Tank Army

21st Motorized Rifle Division

20th Tank Division

124th Motorized Rifle Division

3rd Soviet Shock Army

127th Cavalry Division

129th Motorized Rifle Division

12th Guards Tank Division

1st Western Front

Current Location: Poland

1st Soviet Guards Tank Army

9th Guards Tank Division

11th Guards Tank Division

25th Tank Division

1st Tank Division

8th Soviet Guards Army

39th Guards Motorized Rifle Division

20th Guards Cavalry Division

131st Motorized Rifle Division

2nd Western Front

Current Location: Northeastern Germany

2nd Soviet Guards Army

21st Guards Motorized Rifle Division

103rd Motorized Rifle Division

117th Motorized Rifle Division

157th Motorized Rifle Division

20th Soviet Guards Army

132nd Cavalry Division

12th Guards Motorized Rifle Division

94th Cavalry Division

1st Southwestern Front

Current Location: Czechoslovakia

21st Soviet Army

1 02nd Guards Motorized Rifle Division
 135th Motorized Rifle Division
 108th Motorized Rifle Division

2nd Southwestern Front

Current Location: Austria
 8th Soviet Guards Tank Army
 5th Tank Division
 51st Tank Division
 16th Soviet Army
 106th Motorized Rifle Division
 35th Guards Motorized Rifle Division
 41st Soviet Army
 18th Guards Motorized Rifle Division
 122nd Motorized Rifle Division
 130th Motorized Rifle Division

1st Byelorussian Front

Current Location: Western Russia
 86th Air Assault Brigade
 7th Soviet Guards Tank Army
 3rd Guards Tank Division
 8th Guards Tank Division
 22nd Tank Division
 47th Tank Division
 9th Soviet Guards Tank Army
 1st Guards Motorized Rifle Division
 138th Motorized Rifle Division
 3rd Guards Motorized Rifle Division

NORTHWESTERN TVD

Red Banner Leningrad Front

Current Location: Leningrad
 76th Guards Air Assault Division
 27th Naval Infantry Regiment
 6th Soviet Army
 45th Guards Motorized Rifle Division
 77th Guards Motorized Rifle Division
 37th Motorized Rifle Division
 1 54th Motorized Rifle Division
 152nd Motorized Rifle Division
 18th Soviet Army
 64th Guards Motorized Rifle Division
 69th Motorized Rifle Division
 37th Motorized Rifle Division

Red Banner 3rd Baltic Front

Current Location: Latvia (near Riga)
 11th Soviet Guards Army
 140th Motorized Rifle Division
 107th Motorized Rifle Division
 40th Guards Motorized Rifle Division

SOUTHWESTERN TVD

Southern Front

Current Location: Central Yugoslavia
 112th Air Assault Brigade
 20th Soviet Army
 73rd Guards Motorized Rifle Division
 266th Motorized Rifle Division
 9th Motorized Rifle Division

Danube Front

Current Location: Romania
 32nd Air Assault Brigade
 38th Soviet Army

24th Motorized Rifle Division
 97th Motorized Rifle Division
 3rd Soviet Guards Tank Army
 14th Tank Division
 42nd Guards Tank Division
 13th Tank Division
 117th Guards Tank Division

1st Ukrainian Front

Current Location: Northern Ukraine
 14th Air Assault Brigade
 13th Soviet Army
 128th Motorized Rifle Division
 318th Guards Motorized Rifle Division
 70th Guards Motorized Rifle Division
 19th Soviet Army
 33rd Guards Motorized Rifle Division
 34th Tank Division
 286th Motorized Rifle Division
 92nd Motorized Rifle Division
 98th Guards Motorized Rifle Division

SOUTHERN TVD

Transcaucasus Front

Current Location: Northern Iran (near Tehran)
 104th Guards Air Assault Division
 212th Guards Air Assault Brigade
 7th Soviet Guards Army
 261st Motorized Rifle Division
 164th Motorized Rifle Division
 75th Motorized Rifle Division
 24th Guards Motorized Rifle Division
 627th Attack Helicopter Regiment
 4th Soviet Army
 31st Guards Motorized Rifle Regiment
 26th Motorized Rifle Division
 146th Motorized Rifle Division
 32nd Attack Helicopter Regiment
 45th Soviet Army
 147th Motorized Rifle Division
 19th Motorized Rifle Division
 10th Motorized Rifle Division
 45th Attack Helicopter Regiment
 1st Soviet Army
 346th Motorized Rifle Division
 150th Motorized Rifle Division
 8th Motorized Rifle Division
 11th Attack Helicopter Regiment
 40th Soviet Army
 66th Motorized Rifle Division
 360th Motorized Rifle Division
 1 5th Tank Division
 84th Motorized Rifle Division
 340th Attack Helicopter Regiment

FAR EASTERN TVD

1st Far Eastern Front

Current Location: Manchuria
 98th Air Assault Brigade
 50th Airmobile Brigade
 39th Soviet Army
 23rd Motorized Rifle Division
 100th Motorized Rifle Division

36th Soviet Army
 49th Tank Division
 6th Tank Division
 46th Motorized Rifle Division
 5th Soviet Army
 3rd Tank Division
 29th Motorized Rifle Division
 79th Motorized Rifle Division
 71st Motorized Rifle Division

2nd Far Eastern Front

Current Location: Mongolia

1 7th Soviet Army
 11th Tank Division
 34th Motorized Rifle Division
 56th Motorized Rifle Division
 91st Motorized Rifle Division

Yalu Front

Current Location: Korea

203rd Air Assault Brigade
 63rd Naval Infantry Regiment
 35th Soviet Army
 1 73rd Motorized Rifle Division
 194th Motorized Rifle Division
 38th Motorized Rifle Division

Siberian Front

Current Location: Siberia

2nd Soviet Army
 70th Motorized Rifle Division
 342nd Motorized Rifle Division
 78th Motorized Rifle Division
 31st Motorized Rifle Division
 1 5th Soviet Army
 118th Motorized Rifle Division
 102nd Motorized Rifle Division
 73rd Motorized Rifle Division
 116th Motorized Rifle Division

Aleutian Front

Current Location: Pacific Northwest and Alaska

6th Guards Air Assault Division
 1st Naval Infantry Brigade
 18th Hovercraft Transport Regiment
 11th Soviet Army
 7th Motorized Rifle Division
 147th Motorized Rifle Division
 113th Motorized Rifle Division
 1st Arctic Mechanized Brigade
 2nd Arctic Mechanized Brigade

PACIFIC TVD

1st Indochinese Front

Current Location: Vietnam

128th Air Assault Brigade
 28th Soviet Army
 50th Guards Motorized Rifle Division
 104th Motorized Rifle Division
 101st Guards Motorized Rifle Division

Unit History and Current Status

Tank Divisions

1ST TANK DIVISION

Originally a Category II (see note at the end of *Organization*) division from the Baltic MD, the 1st TD was brought up to nearly its full complement and sent to the Far East in 1995. In July 1997 the division was returned to Europe in response to the NATO threat in Poland.

Subordination: 1st Guards Tank Army

Current Location: West Central Poland

Manpower: 3000

Tanks: 9

2ND TANK DIVISION

A prewar Category II division stationed in southern East Germany, the 2nd fought well against the initial German invasion. The division has been heavily engaged throughout the war in Europe, and in early 1999 it stopped answering orders. The unit is believed to be operating as a marauder band at this time.

Subordination: None

Current Location: Near Bratislava?

Manpower: 2000

Tanks: 6

3RD GUARDS TANK DIVISION

A Category II division from the Byelorussian MD, the 3rd Guards TD was brought up to full strength in early 1995. The unit took part in the Soviet counteroffensive at Brest and the relief of Warsaw, after which it returned to Byelorussia. In April 2000 the division became involved in the Ukrainian revolt.

Subordination: 7th Guards Tank Army

Current Location: Mozyr, Byelorussia

Manpower: 3000

Tanks: 18

3RD TANK DIVISION

A Category I division from the Far East MD, the 3rd was engaged in the initial invasion of China where it was surrounded and nearly destroyed. Sent back to Khabarovsk for reinforcements, which never came, the division rejoined its command after the collapse of China.

Subordination: 5th Army

Current Location: Manchuria

Manpower: 500

Tanks: 2

4TH GUARDS TANK DIVISION

A Category II division from the Moscow Military District, the 4th was brought up to full strength in early 1997. Sent into action against the 3rd German Army in Silesia, the 4th GTD was encircled and nearly destroyed. The 4th GTD has been withdrawn to the Strategic Reserve.

Subordination: Strategic Central Command

Current Location: Near Kaluga

Manpower: 100

5TH TANK DIVISION

A prewar Category I division stationed in Hungary, the 5th Division has been active in the campaigns in Austria and

southern Germany. In 1999 the division absorbed the survivors of the 253rd MRD.

Subordination: 8th Guards Tank Army
Current Location: Vienna, Austria
Manpower: 4000
Tanks: 16

6TH TANK DIVISION

A Category I division from the Transbaikal MD, the 6th was a spearhead in the invasion of China and fought there until the collapse of the Chinese forces. It was sent to Manchuria in early 1998 where it has taken part in various anti-partisan activities.

Subordination: 36th Army
Current Location: Manchuria
Manpower: 4000
Tanks: 36

8TH GUARDS TANK DIVISION

A prewar Category I division from the Byelorussian MD, the 8th Guards TD fought at the Battle of Brest and aided in the relief of Warsaw. The division was sent to the Ukrainian border in early 2000.

Subordination: 7th Guards Tank Army
Current Location: Kalinkovichi, Byelorussia
Manpower: 3000

9TH GUARDS TANK DIVISION

A Category I division originally stationed in East Germany, the 9th Guards TD was withdrawn to bolster the Far Eastern Front. After war broke out in Europe, the unit was transferred back to the West in 1997 and has been engaged in several battles since returning to Poland.

Subordination: 1st Guards Tank Army
Current Location: West Central Poland
Manpower: 4000
Tanks: 24

9TH TANK DIVISION

A prewar Category I division stationed in Germany at the outbreak of hostilities there, the 9th has been involved in the fighting for Germany and Poland ever since. After the division HQ was destroyed in late 1999, the unit revolted and began operating independently from Soviet control. It is believed to be marauding in southern Poland.

Subordination: None
Current Location: Southern Poland?
Manpower: 1000
Tanks: 2

10TH GUARDS TANK DIVISION

A prewar Category I division stationed in East Germany, the 10th fought well throughout the campaigns in East Germany and Poland. In late 1999 the unit declared itself in favor of NATO and stopped fighting.

Subordination: None
Current Location: Warsaw Area
Manpower: 1000
Tanks: 6

11TH GUARDS TANK DIVISION

A Category I division stationed in East Germany, the 11th Guards TD was heavily engaged against the Bundeswehr and

their former East German allies at the start of the war in Europe. The division has performed well in the various central European campaigns throughout the conflict.

Subordination: 1st Guards Tank Army
Current Location: West Central Poland
Manpower: 500
Tanks: 3

11TH TANK DIVISION

A Category II division from Soviet forces in Mongolia, the 11th TD was involved in the initial invasion of China and continued fighting in the Far East throughout the campaign. After the collapse of China, the unit was withdrawn to Mongolia where it has fought sundry separatists and marauders.

Subordination: 1 7th Army
Current Location: Mongolia
Manpower: 1000
Tanks: 8

12TH GUARDS TANK DIVISION

A prewar Category I division in GSFG, the 12th Guards TD has been a part of the 3rd Shock Army for the entire war. The division has fought in every major campaign in the area and has suffered accordingly.

Subordination: 3rd Shock Army
Current Location: Central Poland
Manpower: 500
Tanks: 0

13TH TANK DIVISION

A Category II division from the Carpathian MD, the 13th TD was sent into action against Romanian forces in late summer of 1997. The division took part in the destruction of the Romanian forces north of Ploesti and has remained in the area fighting Romanian partisans.

Subordination: 3rd Guards Tank Army
Current Location: Central Romania
Manpower: 3000
Tanks: 12

14TH TANK DIVISION

A prewar Category II division from the Kiev MD, the 14th TD was brought up to nearly full strength by April 10, 1997, and sent to Romania as part of the 3rd Guards Tank Army. The division fought poorly in Romania and suffered heavy losses, particularly in vehicles. In July 2000 the division was converted to cavalry.

Subordination: 3rd Guards Tank Army
Current Location: Bucharest, Romania
Manpower: 1000
Tanks: 1

15TH GUARDS TANK ARMY

A Category II division from the Moscow MD, the 15th GTD was brought up to full strength and rushed into action in Silesia, where it performed well. After the front stabilized, the 15th GTD was withdrawn to its home station at Tula, where it is being held in reserve.

Subordination: 9th Soviet Army
Current Location: Tula
Manpower: 2000
Tanks: 16

15TH TANK DIVISION

A Category I division from Afghanistan, where it was involved against partisans, the 15th was provided as a stiffener for the 40th Army and sent into action in early 1997 in northeastern Iran. The division fought in Iran continually until early 2000 when it was withdrawn to try to put down the revolt in the Turkestan area.

Subordination: 40th Army

Current Location: Near Chardzhou, USSR

Manpower: 4000

Tanks: 8

18TH GUARDS TANK DIVISION

A Category II division from the Kiev MD, the 18th was mobilized and sent to China in early 1996 where it was heavily engaged. In the summer of 1997 the unit was returned to the West and sent into action in Bulgaria. It again took heavy losses and was withdrawn to Zhitomir to be rebuilt. In the summer of 1999 the unit stopped answering orders and is thought to have become a band of marauders.

Subordination: None

Current Location: Ukraine?

Manpower: 2000

Tanks: 2

20TH GUARDS TANK DIVISION

A Category II division from the Kiev MD, the 20th was mobilized around Odessa in the winter of 1996 and took part in the initial invasion of Romania. After the collapse of the Romanian forces in the fall of 1997, the unit was sent back to the Ukraine to be held in reserve. It joined with the 341st TD in declaring an independent Ukraine in mid-1999.

Subordination: None

Current Location: Vinnitsa?

Manpower: 4000

Tanks: 36

20TH TANK DIVISION

A prewar Category I division, the 20th fought well against the invasion of East Germany and has continued to give a good account of itself throughout the struggle in Europe. Withdrawn to the Ukraine in 1999 to become part of the 4th Guards Tank Army, the 20th TD reentered Poland in early 2000.

Subordination: 4th Guards Tank Army

Current Location: Central Poland

Manpower: 1000

Tanks: 0

22ND TANK DIVISION

A Category II division from the Byelorussia MD, the 22nd TD was upgraded to Category I on January 17, 1995. The unit took part in the Soviet counteroffensive, which resulted in the relief of Warsaw in the late summer of 1997 and cost the division nearly all of its vehicles.

Subordination: 7th Guards Tank Army

Current Location: Svetogorsk, Byelorussia

Manpower: 2000

25TH TANK DIVISION

A Category I division in East Germany at the start of the war, the 25th TD has fought in central Europe since the outbreak of

hostilities there.

Subordination: 1st Guards Tank Army

Current Location: West Central Poland

Manpower: 1000

Tanks: 4

27TH GUARDS TANK DIVISION

A Category II division from the Byelorussian MD, the 27th was mobilized to be sent to the Far East but was held up because of logistical problems. It was sent into Poland during the Soviet counteroffensive in 1997. After receiving orders to move to the south in late 1998, the unit revolted and is believed to have become a marauding unit operating in western Byelorussia.

Subordination: None

Current Location: Vicinity of Brest?

Manpower: 3000

Tanks: 24

27TH TANK DIVISION

A Category II division from the Kiev MD, the 27th was mobilized shortly after the war erupted with China and sent to the Far East. The division took part in several major actions before being returned to the west where it took part in the summer offensive in late June of 1998. After heavy losses the unit became rebellious, left its position near Debrecen, and marched towards Lvov. It has declared itself in favor of NATO.

Subordination: None

Current Location: Western Ukraine

Manpower: 4000

34TH TANK DIVISION

A Category II division from the Odessa MD, the 34th was sent to the Far East in early 1996 where it saw limited action. The unit was returned to European Russia in the summer of 1997 to form part of the 19th Army which took part in the campaign that drove the Turks from Bulgaria. In early 1999 the unit was withdrawn to the Zhitomir area because of increasing unrest there.

Subordination: 19th Army

Current Location: Zhitomir, USSR

Manpower: 4000

Tanks: 16

38TH TANK DIVISION

A Category I division stationed in northern East Germany, the 38th division was to have been sent to China, but the Bundeswehr put a halt to the order. After being engaged heavily throughout the campaigns of 1996-97, the unit stopped responding to Front HQ and is believed to have turned into marauders operating in northern Poland.

Subordination: None

Current Location: Northern Poland

Manpower: 3000

Tanks: 27

42ND GUARDS TANK DIVISION

A prewar Category II division from the Kiev MD, the 42nd Guards TD was mobilized at the outbreak of the war and held in reserve. The division was sent to the Danube Front in August 1997 to take part in the offensive in Romania and played a major part in the destruction of the Romanian forces in and around Bucharest.

Subordination: 3rd Guards Tank Army
Current Location: Ploesti, Romania
Manpower: 3000
Tanks: 27

47TH TANK DIVISION

A Category II division from the Byelorussian MD, the 47th Division was being held in reserve near Minsk when the city was destroyed by nuclear attack. Most of the division was also destroyed.

Subordination: 7th Guards Tank Army
Current Location: Slutsk, Byelorussia
Manpower: 300
Tanks: 2

49TH TANK DIVISION

A Category II division from the Transbaikal MD, the 49th Division fought through the entire campaign against China and is now involved against various partisan units in Manchuria.

Subordination: 36th Army
Current Location: Manchuria
Manpower: 2000

51ST TANK DIVISION

A prewar Category I division stationed in Czechoslovakia, the 51st was surrounded by NATO forces in the 1998 Summer Offensive. Although the division was able to break out, it lost all of its vehicles and has been operating as a cavalry unit since early 1999.

Subordination: 8th Guards Tank Army
Current Location: Wolkersdorf, Austria
Manpower: 4000

53RD TANK DIVISION

A Category II division from the Kiev MD, the 53rd TD was first sent into action against the NATO advance in Poland during the summer of 1997 where it suffered heavy losses. The division was being withdrawn towards Lvov when it was hit and destroyed by a nuclear strike.

76TH TANK DIVISION

A Category II division from the Siberian MD, the 76th Division was shipped to the Canadian coast in late 1997. During the drive on Seattle, the 76th was involved in costly fighting against Canadian and US forces. In 1998 the 76th retreated to Queen Charlotte Island and set up a warlord-style cantonment.

Subordination: None
Current Location: Coast of British Columbia
Manpower: 3000
Tanks: 6

87TH TANK DIVISION

A Category II division from the Kiev MD, the 87th was in the vicinity of Kiev when the city was destroyed by nuclear attack. The unit is presumed to have been destroyed.

93RD TANK DIVISION

The 93rd Division started the war as a Category I division from the Far East MD and was a spearhead in the invasion of China. During the Chinese counterattack, the 93rd was cut off and badly mauled, losing nearly all its vehicles. The surviving infantry were destroyed by Chinese militia.

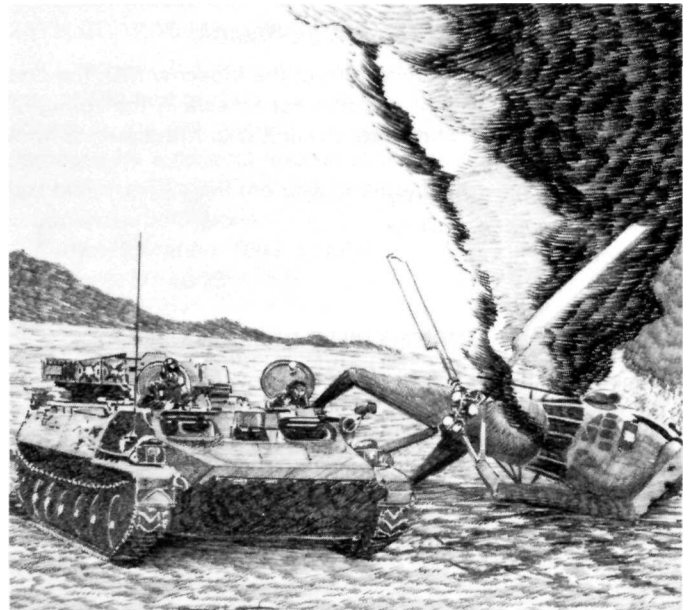

95TH TANK DIVISION

A prewar Category II division, the 95th was mobilized and sent into China at the start of the war. Surrounded by the Chinese counteroffensive later in 1995, it lost contact with the Front HQ and is presumed to have been annihilated.

117TH GUARDS TANK DIVISION

Originally a Category II division from the Carpathian MD, the 117th Division was hit by a tactical nuclear strike in the summer of 1997. The 117th Guards was then reorganized, equipped with horses, and sent to Romania where it fought partisans.

Subordination: 3rd Guards Tank Army
Current Location: Central Romania
Manpower: 400
Tanks: 2

341ST TANK DIVISION

A prewar Category II division from the Kiev MD, the 341st was not fully mobilized until the summer of 1997. The division was making its way to the Danube Front when it was hit by a tactical nuclear strike. The survivors refused to follow any further orders and have since joined one of the separatist movements in the Ukraine.

Subordination: None
Current Location: Vinnitsa?
Manpower: 600
Tanks: 2

Motorized Rifle Divisions

1ST GUARDS MOTORIZED RIFLE DIVISION

A Category II division from the Baltic MD, the 1st Guards was brought up to strength in March of 1996 and took part in the Soviet counteroffensive in Poland in the summer of 1997. The unit was shifted to the Ukrainian border in 1998.

Subordination: 9th Guards Army
Current Location: Vicinity of Pinsk, Byelorussia
Manpower: 3000
Tanks: 18

2ND GUARDS MOTORIZED RIFLE DIVISION

A prewar Category I division from the Moscow MD, the 2nd performed well in the bitter battle for Selesia in the spring of 1997. After the front stabilized, the unit was withdrawn to form a strategic reserve.

Subordination: 9th Army

Current Location: Kaluga

Manpower: 3000

Tanks: 15

3RD GUARDS MOTORIZED RIFLE DIVISION

A Category III division from the Moscow MD, the 3rd Guards was brought up to Category readiness in February 1997. The unit was heavily damaged by tactical nuclear strikes in late 1997 and was withdrawn to rebuild.

Subordination: 9th Army

Current Location: Near Tula

Manpower: 600

Tanks: 3

3RD MOTORIZED RIFLE DIVISION

A Category III division from the Baltic MD, the 3rd was activated in February of 1995. It was sent into the Battle of Wroclaw where it was heavily damaged in 1997. The division has seen little action since.

Subordination: 9th Guards Army

Current Location: Kobrin, Byelorussia

Manpower: 2000

Tanks: 10

4TH MOTORIZED RIFLE DIVISION

A Category III division from the Kiev MD, the 4th was raised in late 1997. The division saw limited action in occupation duty in Romania during 1998 and was ordered to the Ukraine in early 1999. The 4th revolted upon arrival in the Ukraine and has fought several actions since—against loyal forces and rebels.

Subordination: None

Current Location: Near Uman, Ukraine

Manpower: 2000

Tanks: 4

7TH MOTORIZED RIFLE DIVISION

A Category III division from the Kiev MD, the 7th was activated in late 1996 and received some training in Arctic warfare. The division participated in the invasion of Alaska and was the first unit to enter Anchorage. The 7th is now isolated with the rest of the 11th Army in and around Anchorage.

Subordination: 11th Army

Current Location: Anchorage, Alaska

Manpower: 3000

Tanks: 15

8TH MOTORIZED RIFLE DIVISION

A Category III division from the Turkestan MD, the 8th was raised and committed to Iran in mid-1997. The unit has seen some action, but is being held in reserve at the present. It is considered unreliable.

Subordination: 1st Army

Current Location: Yazd, Iran

Manpower: 4000

Tanks: 36

9TH MOTORIZED RIFLE DIVISION

A Category III division from the North Caucasus MD, the 9th has been involved in the Carpathian campaigns since early 1997. Heavy losses have forced the unit to convert to cavalry.

Subordination: 20th Army

Current Location: Mostar, Yugoslavia

Manpower: 1000

Tanks: 1

10TH MOTORIZED RIFLE DIVISION

A Category III from the Transcaucasus MD, the 10th has been involved in much of the fighting in Iran since its arrival in early 1997. The division is still active in the area.

Subordination: 45th Army

Current Location: Yazh, Iran

Manpower: 4000

Tanks: 4

12TH GUARDS MOTORIZED RIFLE DIVISION

A prewar Category I division stationed in East Germany, the 12th Guards has been a part of every campaign in Central Europe and is still active in Poland.

Subordination: 20th Guards Army

Current Location: Southern Poland

Manpower: 4000

Tanks: 32

14TH MOTORIZED RIFLE DIVISION

A Category III unit from the Far East MD, the 14th landed in the Alexander Archipelago in August of 1997 and captured Juneau. In December of 1998 the 14th suffered heavy losses when it was driven out of Juneau by the US X Corps. Isolated and deep in hostile territory, the division changed sides and declared itself as friendly to the US.

Subordination: None

Current Location: Near Juneau

Manpower: 200

18TH GUARDS MOTORIZED RIFLE DIVISION

A prewar Category I division stationed in Czechoslovakia, the 18th Guards has seen action in all of the campaigns in Austria and Germany, particularly distinguishing itself in the retreat from southern Germany in late summer 1998, when the 18th Guards fought a skillful delaying action, probably saving the entire front.

Subordination: 41st Army

Current Location: Klagenfurt, Austria

Manpower: 1000

Tanks: 6

19TH MOTORIZED RIFLE DIVISION

A Category III division from the North Caucasus MD, the 19th has been engaged in Iran almost from the moment of its arrival in the spring of 1997. The performance of the division has been a pleasant surprise for the Soviet high command.

Subordination: 45th Army

Current Location: Esfahan

Manpower: 4000

Tanks: 32

20TH GUARDS CAVALRY DIVISION

A prewar Category I division stationed in Grimma, East Germany, the 20th was surrounded by the Bundeswehr at the outbreak of the war. After escaping the encirclement, it was set upon by its former East German allies and badly damaged. The survivors were reformed as a cavalry division in 1998 and sent back to Poland.

Subordination: 8th Guards Army
Current Location: Central Poland
Manpower: 1000

21ST GUARDS MOTORIZED RIFLE DIVISION

A prewar Category I division stationed in Perleburg, East Germany, the 21st has fought valiantly in the campaigns in Germany and Poland where it has spent the entire war.

Subordination: 2nd Guards Army
Current Location: Southern Poland
Manpower: 1000
Tanks: 5

21ST MOTORIZED RIFLE DIVISION

A Category III division, the 21st was assigned to the Strategic Reserve after it was raised in late 1997. The unit saw some action in the Balkans in 1998 before being sent to Poland in early 2000.

Subordination: 4th Guards Tank Army
Current Location: Central Poland
Manpower: 3000
Tanks: 8

23RD MOTORIZED RIFLE DIVISION

A Category II division from the Siberian MD, the 23rd was raised to Category I status and was allocated to the Spring Offensive in China in 1996. The division fought well throughout the campaign and has remained in Manchuria since the collapse of China.

Subordination: 39th Army
Current Location: Near Tsitsihar, Manchuria
Manpower: 2000
Tanks: 6

24TH GUARDS MOTORIZED RIFLE DIVISION

A Category III division, the 24th Guards was raised and equipped in the North Caucasus MD. The division took part in the initial invasion of Iran and has been involved in the campaigns there ever since. In October 1997 the 24th was roughly handled during the US counteroffensive.

Subordination: 7th Guards Army
Current Location: Hasarad, Iran
Manpower: 400

24TH MOTORIZED RIFLE DIVISION

A Category III division from the Carpathian MD, the 24th was activated in early 1997. The division took part in the fighting in Romania in the summer of 1997 and has remained as an occupying force since the fall of Romania.

Subordination: 38th Army
Current Location: Sinaia, Romania
Manpower: 4000
Tanks: 36

26TH GUARDS MOTORIZED RIFLE DIVISION

A Category III division from the Baltic MD, the 26th Division was raised and outfitted in the fall of 1997. Most of the personnel in the unit were from Riga. When Riga was heavily damaged by a tactical nuclear strike, the division revolted. It has taken upon itself the task of defending what is left of Riga.

Subordination: None
Current Location: Riga, Latvia
Manpower: 4000
Tanks: 28

26TH MOTORIZED RIFLE DIVISION

A Category III division from the Transcaucasus MD, the 26th was activated and sent to Iran in late 1996. Spearheading the drive towards Esfahan in the Spring Offensive of 1997, the division proved quite capable in combat. In the summer of 1997 the 26th was caught by a US counterattack and suffered heavy losses. The division is still active in Iran.

Subordination: 4th Army
Current Location: Kermanshah
Manpower: 200

29TH GUARDS MOTORIZED DIVISION

A Category III division from the Kiev MD, the 29th Guards were activated in the spring of 1997 and sent into the campaign against Romania and Yugoslavia in late 1997. Throughout 1998 the division was busy fighting partisans and the resurgent Romanians. In late 1998 the Guards were ambushed in Transylvania and nearly destroyed. The unit stopped answering its higher command and is thought to have become marauders.

Subordination: None
Current Location: ?
Manpower: 300?

29TH MOTORIZED RIFLE DIVISION

A prewar Category I unit, the 29th was a part of the initial invasion of China in 1995. The unit fought in all of the major campaigns in China from 1995 to mid-1997 when it was overrun by a Chinese counterattack and suffered horrendous losses. After the collapse of China, the 29th stayed on to provide local security in Manchuria.

Subordination: 5th Army
Current Location: Manchuria
Manpower: 500
Tanks: 3

30TH GUARDS MOTORIZED RIFLE DIVISION

A Category I division stationed in East Germany, the 30th Division fought in southern Germany and Austria in 1997-98. In late 1998 the 30th Guards was ordered to engage the Italian Folgore division near Ljubljana, Yugoslavia, which had declared itself in favor of NATO. The 30th has since stopped answering signals from the Front HQ and is believed to be operating as marauders somewhere in northern Yugoslavia.

Subordination: None
Current Location: Northern Yugoslavia?
Manpower: 4000
Tanks: 28

31ST MOTORIZED RIFLE DIVISION

A prewar Category I division stationed in the Far East, the

31st fought in every major campaign in China. After the fall of China, the division was used in the occupation of Manchuria until mid-1998 when it was transferred to western Siberia. In late 1999 the division fought an intense battle with the 156th MRD which has set itself up as a warlord-style principality around Barnaul, Siberia.

Subordination: 2nd Army

Current Location: Western Siberia

Manpower: 3000

31ST GUARDS MOTORIZED RIFLE DIVISION

A Category III division from the Transcaucasus MD, the 31st was raised in mid-1996 and sent to Iran. In March, the 31st was involved in the Soviet Spring Offensive and since then has seen action in most of the fighting in Iran.

Subordination: 4th Army

Current Location: Western Iraq

Manpower: 1000

Tanks: 9

33RD GUARDS MOTORIZED RIFLE DIVISION

A Category II division from the Odessa MD, the 33rd Guards was sent to the Far East in mid-1996. The division was returned to Europe in the summer where it took part in the campaign to drive out the Turks from Bulgaria. As the division was being returned to the Ukraine, it came under heavy NATO air attack and suffered heavy losses.

Subordination: 19th Army

Current Location: Berdichev, Ukraine

Manpower: 600

Tanks: 3

34TH MOTORIZED RIFLE DIVISION

A prewar Category I unit stationed in the Transbaikalian MD, the 34th was in the initial invasion of China. When units on both sides of the 34th were cut off in late 1995, the division retreated in good order. The division fought well in the rest of the campaign against China, escaping with relatively few losses. After the fall of China, the division went to Mongolia to provide local security.

Subordination: 17th Army

Current Location: Mongolia

Manpower: 4000

Tanks: 36

35TH GUARDS MOTORIZED RIFLE DIVISION

A prewar Category I division stationed in Hungary, the 35th Guards was overrun and nearly destroyed by the US 5th Infantry Division in 1997. The unit was reinforced and took part in the Pact Offensive in southern Germany in 1998 where it again suffered heavy losses. At this time it is reported that the unit is considered unreliable.

Subordination: 16th Army

Current Location: Southern Austria

Manpower: 200

Tanks: 1

37TH MOTORIZED RIFLE DIVISION

A Category I division which was stationed in Leningrad before the war, the 37th was sent to the Far East shortly after the war with China broke out. After the defeat of China, the division was sent back to the Leningrad area, ostensibly as a reinforce-



ment, but probably because of its loyalty. The Leningrad area has been very mutinous as of July 2000.

Subordination: 18th Army

Current Location: Kirovsk, RSFSR

Manpower: 2000

Tanks: 10

38TH MOTORIZED RIFLE DIVISION

A Category III division from the Far East MD, the 38th was mobilized in early 1996 in order to make good the terrible losses in China. After seeing limited action in China, the division was withdrawn and sent to Korea in late 1997 where it engaged the US II Corps.

Subordination: 35th Army

Current Location: North Korea

Manpower: 2000

Tanks: 8

39TH GUARDS MOTORIZED RIFLE DIVISION

A prewar Category I division stationed in East Germany, the 39th has participated in every major campaign in Central Europe. In late 1998 the unit absorbed the remnants of the 47th Guards Motorized Rifle Division.

Subordination: 8th Guards Army

Current Location: Central Poland

Manpower: 3000

Tanks: 27

40TH GUARDS MOTORIZED RIFLE DIVISION

A Category III division from the Baltic MD, the 40th Guards was activated in December of 1996. After the division finally received its equipment and manpower complement, it was given the unusual order to contact and engage the 26th GMRD, which had revolted. The 40th caught up with the 26th near the ruins of Riga and was badly mauled in early 1999.

Subordination: 11th Guards Army

Current Location: Jelgava, Latvia

Manpower: 500

Tanks: 4

40TH MOTORIZED RIFLE DIVISION

A Mobilization Only division from the Baltic MD, the 40th

Division was activated in early 1998 and equipped as a cavalry division. The unit has been surprisingly loyal and has fought in several skirmishes against a group calling itself the Baltic Liberation Front.

Subordination: 11th Guards Army
Current Location: Ainaz, Latvia
Manpower: 500
Tanks: 4

41ST MOTORIZED RIFLE DIVISION

A Category III division from the Siberian MD, the 41st was activated in late 1996 and landed with the 14th MRD in Alaska in 1997. It took part in the capture of Juneau. Driven out of Juneau in December of 1998, the 41st joined with the 14th in changing its allegiance to NATO.

Subordination: None
Current Location: Near Juneau
Manpower: 4000
Tanks: 4

43RD CAVALRY DIVISION

A Category III division from the Volga MD, the 43rd was originally a motorized rifle division. During the campaign in Poland in the fall of 1997, the division was decimated. The surviving infantry went to Byelorussia where it was converted to horse cavalry in July 1998. The unit was sent to Poland in 2000.

Subordination: 22nd Cavalry Army
Current Location: Northern Poland
Manpower: 2000

45TH GUARDS MOTORIZED RIFLE DIVISION

A Category II division from the Leningrad MD, the 45th was virtually destroyed by advancing NATO forces in the Petsamo campaign. It has been withdrawn to the Leningrad area.

Subordination: 6th Army
Current Location: Vicinity of Leningrad
Manpower: 100

45TH MOTORIZED RIFLE DIVISION

A Category III division from the Leningrad MD, the 45th was hit hard by tactical nuclear strikes in the Kola Peninsula in 1997. The survivors were then battered further by the NATO offensive. The remnants were withdrawn to the Leningrad area.

Subordination: 6th Army
Current Location: Primorsk, RSFSR
Manpower: 300

46TH MOTORIZED RIFLE DIVISION

A Category III division from the Transbaikal MD, the 46th was mobilized in early 1997 and sent into the line in mid-summer of the same year. The unit fought well in limited action against the Chinese and is now serving as an occupation and anti-partisan force in Manchuria.

Subordination: 36th Army
Current Location: Harbin
Manpower: 3000
Tanks: 24

47TH GUARDS MOTORIZED RIFLE DIVISION

A Category II division from the Moscow MD, the 47th was upgraded and sent to the campaign in China in late 1995. During the Soviet Spring Offensive in 1996, the 47th Guards were

cut off and destroyed by a combination of regular Chinese forces and Chinese Peoples Militia. The survivors were incorporated into the 39th GMRD.

50TH GUARDS MOTORIZED RIFLE DIVISION

A Category III division from the Byelorussian MD, the 50th Guards was activated in late 1995. In mid-1996 the unit was sent to Vietnam in order to protect the naval facilities at Haiphong, and has been engaged against the Chinese and various other armed bands since.

Subordination: 28th Army
Current Location: Haiphong, Vietnam
Manpower: 2000
Tanks: 12

54TH GUARDS MOTORIZED RIFLE DIVISION

A Category I division stationed at Kandalasksha before the war, the 54th went into action in Norway in late 1996 in the attempt to relieve the Soviet Marines near Narvik. The division suffered heavy casualties and withdrew under its own initiative. The division has not responded since.

Subordination: None
Current Location: ?
Manpower: 100?

54TH MOTORIZED RIFLE DIVISION

A Category III division stationed in Afghanistan at the start of the war, the 54th was ordered to Iran in late 1997 to shore up the crumbling Soviet position. The division was hit by a tactical nuclear strike in early 1998 while in transit in northern Iran. The survivors withdrew with the 201st MRD and declared a free Turkestan Republic.

Subordination: None
Current Location: Bayram Ali, Turkmen SSR
Manpower: 200

56TH MOTORIZED RIFLE DIVISION

A prewar Category I division stationed in Mongolia, the 56th Division took heavy losses in the battles of late 1995 and early 1996. In early 1997 the division absorbed the men and equipment of the shattered 85th MRD, and later that year the 56th was posted to the 17th Army to provide security in Mongolia.

Subordination: 17th Army
Current Location: Mongolia
Manpower: 4000
Tanks: 32

62ND MOTORIZED RIFLE DIVISION

A Category III division from the Transbaikal MD, the 62nd was activated in late 1996. It landed on the coast of British Columbia in August of 1997 and took part in the drive on Seattle. The division was halted by US and Canadian forces and retreated to the coast in 1998. The 62nd is still apparently loyal, but isolated.

Subordination: ?
Current Location: British Columbia
Manpower: 3000?

64TH GUARDS MOTORIZED RIFLE DIVISION

A Category III division from the Leningrad MD, the 64th Guards was decimated during the campaign for the Kola peninsula. Since then, the Guards have had trouble with desertion and

famine.

Subordination: 18th Army

Current Location: Kirovsk, RSFSR

Manpower: 400

Tanks: 3

66TH GUARDS MOTORIZED RIFLE DIVISION

A Category III division from the Carpathian MD, the 66th was activated for action against Romania in the fall of 1997. Never reaching more than an oversized regiment, the 66th Guards saw only limited action in the campaign against Romania and the ensuing occupation. In late 1998 the division left its position in Romania and began marauding, making its way back toward the Ukraine.

Subordination: None

Current Location: ?

Manpower: 600?

Tanks: 4?

66TH MOTORIZED RIFLE DIVISION

A Category III division, the 66th was on duty in Afghanistan when it was called to form part of the 40th Army for the campaign against Iran. The division saw action in Iran against both US and Iranian forces.

Subordination: 40th Army

Current Location: Kerman, Iran

Manpower: 1000

Tanks: 4

68TH MOTORIZED RIFLE DIVISION

A Category II division that was stationed in Mongolia, the 68th was upgraded and took part in the initial invasion of China. The unit was cut off, but fought its way out in late 1995 suffering heavy losses. In the Spring Offensive of 1996, the 68th was again cut off, and this time it was destroyed.

69TH MOTORIZED RIFLE DIVISION

A Category III division from the Leningrad MD, the 69th was mobilized in early 1996 and sent to Norway. The 69th was heavily engaged by NATO forces there and was further reduced by airstrikes as it attempted to withdraw. The survivors have been withdrawn from combat.

Subordination: 18th Army

Current Location: Kirovsk, RSFSR

Manpower: 200

Tanks: 1

70TH GUARDS MOTORIZED RIFLE DIVISION

A Category II division from the Carpathian MD, the 70th was mobilized and sent to the Far East. The division was returned to European Russia in order to bolster the forces in Austria; however, as the unit was staging around Kiev, the city was destroyed by nuclear attack. Most of the 70th was destroyed.

Subordination: 13h Army

Current Location: Chortkov, Ukraine

Manpower: 100

70TH MOTORIZED RIFLE DIVISION

A Category III Division from the Far East MD, the 70th was mobilized and committed to the 1996 Spring Offensive in China. The division suffered heavy losses in the initial attacks and was withdrawn to Siberia.

Subordination: 2nd Army

Current Location: Vicinity of Tomsk

Manpower: 200

71ST MOTORIZED RIFLE DIVISION

A Category II division from the Far East MD, the 71st has fought with distinction in all the major campaigns in Manchuria. After the fall of China, the division was sent to the 5th Army, which is responsible for security from the warlords, Separatists, and other assorted troublemakers in Manchuria.

Subordination: 5th Army

Current Location: Manchuria

Manpower: 3000

Tanks: 15

72ND GUARDS MOTORIZED RIFLE DIVISION

A Category III division from the Kiev MD, the 72nd began mobilizing around Kramatorsk in late 1997. After numerous administrative blunders, the 72nd Guards was finally able to muster near full strength in mid-1998. However, the division promptly revolted and seized Kramatorsk, which it now holds as a "free city."

Subordination: None

Current Location: Kramatorsk, Ukraine

Manpower: 3000

Tanks: 18

73RD GUARDS MOTORIZED RIFLE DIVISION

A Category III division from the North Caucasus MD, the 73rd was activated in October of 1997 and has performed internal security functions. In late 1999 the unit was sent to Yugoslavia.

Subordination: 20th Army

Current Location: Sarajevo, Yugoslavia

Manpower: 4000

Tanks: 32

73RD MOTORIZED RIFLE DIVISION

A Category II division from the Far East, the 73rd was not committed to the fighting in China until the initial invasion bogged down. The division somehow escaped serious damage even though it saw much action. In mid-1997 the unit was withdrawn to form part of the 15th Army, which is currently fighting various armed bands in Siberia.

Subordination: 15th Army

Current Location: Eastern Siberia (Kansk?)

Manpower: 3000

Tanks: 12

75TH MOTORIZED RIFLE DIVISION

A Category III division from the Transcaucasus MD, the 75th Division was brought up to strength and sent into Iran as part of the initial invasion. The 75th has performed well in many engagements throughout the campaign in Iran.

Subordination: 7th Guards Army

Current Location: Mianeh, Iran

Manpower: 2000

Tanks: 18

77TH GUARDS MOTORIZED RIFLE DIVISION

A Category III division from the Leningrad MD, the 77th was activated in early 1997 to strengthen the battered 6th Army.

Subordination: 6th Army
Current Location: Sestroretsk, RSFSR
Manpower: 4000
Tanks: 36

77TH MOTORIZED RIFLE DIVISION

A Category III division from the Transcaucasus MD, the 77th was activated in mid-1998 and provided security for the northern portions of Iran and Iraq. In early 2000 the division revolted and is now calling itself the Transcaucasian Republican Army.

Subordination: None
Current Location: Yerevan, Armenian
Manpower: 4000
Tanks: 20

78TH MOTORIZED RIFLE DIVISION

A Category II division from the Far East MD, the 78th saw action in the Sinkiang area of China in 1996-97. After the collapse of China, the unit remained in occupation until mid-1998. It was then sent to Siberia where it has fought various warlords and other armed bands.

Subordination: 2nd Army
Current Location: Western Siberia (Asino?)
Manpower: 1000
Tanks: 3

79TH MOTORIZED RIFLE DIVISION

A Category II division from the Far East MD, the 79th was heavily engaged in the initial attack on China in 1995. In the Spring Offensive of 1996, the division was surrounded near Harbin but fought its way out. After the collapse of China in late 1997, the division was sent to join the 5th Army, which provides security in Manchuria.

Subordination: 5th Army
Current Location: Manchuria
Manpower: 3000
Tanks: 12

80TH MOTORIZED RIFLE DIVISION

A Category III division on duty in Afghanistan when the war broke out, the 80th remained in occupation in Afghanistan. In mid-1998, as the Turkestan and Central Asian MDs' became more and more unruly, the unit was sent to Ashkhabad. The 80th stopped answering its higher command in early 1999 and is now thought to be operating as a marauder band.

Subordination: None
Current Location: Ashkhabad, Turkmen, SSR
Manpower: 2000
Tanks: 6

84TH MOTORIZED RIFLE DIVISION

A Category III division from the Turkestan MD, the 84th Division was activated in late 1996 and sent to Iran where it has been involved against Iranian and US forces. The unit had its vehicles cannibalized in late 1997 to provide transport and armor to the spearhead units in the Soviet counterattack of mid-1998.

Subordination: 40th Army
Current Location: Jiroft, Iran
Manpower: 2000

85TH MOTORIZED RIFLE DIVISION

A Category II division from the Byelorussian MD, the 85th was upgraded and sent to China in 1995 where it was overrun and nearly destroyed by the Chinese counteroffensive later that year. The survivors were absorbed by the 56th MRD.

89TH CAVALRY DIVISION

A Category III division from the Ural MD, the 89th was supposed to be a motorized rifle division, but the shortage of equipment forced it to be raised as a horse cavalry division. After serving as a security force in Romania in 1998, the unit was sent to Poland.

Subordination: 22nd Cavalry Army
Current Location: Northern Poland
Manpower: 300

91ST MOTORIZED RIFLE DIVISION

A Category III division which had been in Mongolia before the war, the 91st was overrun and nearly destroyed in Northern China in mid-1996. In late 1996 the division was withdrawn to Mongolia where it later became part of the 17th Army.

Subordination: 1 7th Army
Current Location: Mongolia
Manpower: 200

92ND GUARDS MOTORIZED RIFLE DIVISION

A Category II division from the Odessa MD, the 92nd Division was mobilized and sent into action against Romania in 1996. The division became part of the 19th Army, which took part in driving the Turks from Bulgaria in late 1997. The 92nd Guards was then sent back to the Ukraine in mid-1999 in order to combat the local uprising there. The division was heavily damaged fighting the 20th Guards Tank Division after the 20th had revolted.

Subordination: 19th Army
Current Location: Berdichev, Ukraine
Manpower: 400
Tanks: 2

94TH CAVALRY DIVISION

A prewar Category I division stationed in Schwerin East Germany, the 94th has been heavily engaged throughout almost the entire war in Central Europe. By the spring of 1999 the division had been nearly destroyed, and it was withdrawn and rebuilt as a cavalry division. The 94th returned to Poland in late 1999.

Subordination: 20th Guards Army
Current Location: Southern Poland
Manpower: 1000

96TH CAVALRY DIVISION

A Category III division from the Volga MD, the 96th was raised to a Category II motorized rifle division in July of 1997 and took part in the Fall Campaigns in Poland. The division was converted to a cavalry division in 1998 and was sent to northern Poland in the summer of 2000.

Subordination: 22nd Cavalry Army
Current Location: Northern Poland
Manpower: 1400

97TH MOTORIZED RIFLE DIVISION

A Category III division from the Carpathian MD, the 97th was

activated in early 1997 and sent to take part in the Fall Offensive in Romania. The division suffered heavily in the initial drive on Bucharest. In early 1998 while on anti-partisan duty, the unit was ambushed by the resurgent Romanians and was withdrawn to Ploesti.

Subordination: 38th Army
Current Location: Ploesti
Manpower: 600
Tanks: 4

98TH GUARDS MOTORIZED RIFLE DIVISION

A Category III division from the Odessa MD, the 98th was activated in the spring of 1997 and sent to join the 19th Army in Thrace for the campaign against the Turks. In late 1998 the division was sent to the Ukraine in order to help still the unrest in that area. When full-scale revolt broke out in mid-1999, the 98th found themselves engaged against their former comrades.

Subordination: 19th Army
Current Location: Berdichev, Ukraine
Manpower: 4000
Tanks: 4

100TH MOTORIZED RIFLE DIVISION

A Category III division from the Siberian MD, the 100th Division was mobilized in late 1996 and was used as a reserve division for the 39th Army; consequently, the 100th saw little action in the war with China. Instead, it has been in limited action against marauders, bandits, and guerrillas.

Subordination: 39th Army
Current Location: Near Tsitsihar, Manchuria
Manpower: 2000
Tanks: 16

101ST GUARDS MOTORIZED RIFLE DIVISION

A Category I division stationed in Byelorussia before the war, the 101st Guards was sent to Vietnam at the start of the war with China in order to help the Vietnamese Army protect its northern borders. The unit fought a series of sharp engagements with the Chinese before the fall of China.

Subordination: 28th Army
Current Location: Hanoi, Vietnam
Manpower: 1000

101ST MOTORIZED RIFLE DIVISION

A Mobilization Only division raised in the Central Asian MD in mid-1996, the 101st was sent into western China in late 1996. The 101st suffered heavy losses in the campaigns in 1996-97. After the fall of China, the unit spent some time on occupation duty, and in late 1998 the division mutinied and turned to marauding.

Subordination: None
Current Location: Northwestern China
Manpower: 500
Tanks: 4

102ND GUARDS MOTORIZED RIFLE DIVISION

A prewar Category I division stationed in Hungary, the 102nd has taken part in both the '97 and '98 Soviet Offensives from southern Germany. In late 1999 the division benefited from a consolidation of men and equipment from burned-out and destroyed units.

Subordination: 21st Army

Current Location: Linz, Austria
Manpower: 4000
Tanks: 16

102ND MOTORIZED RIFLE DIVISION

A Mobilization Only division raised in Siberia, the 102nd was activated in mid-1996. After serving occupation duty in northern China, the division was withdrawn to help restore authority in eastern Siberia.

Subordination: 15th Army
Current Location: Eastern Siberia
Manpower: 3000
Tanks: 18

103RD MOTORIZED RIFLE DIVISION

A Mobilization Only division from the Carpathian MD, the 103rd was activated in the summer of 1998. A shortage of motor transport has made this a leg mobile division, but the unit does have some old and obsolete armor. The division was sent to Poland in early 2000.

Subordination: 2nd Guards Army
Current Location: Southern Poland
Manpower: 4000
Tanks: 28

104TH MOTORIZED RIFLE DIVISION

A Mobilization Only division raised in the Kiev MD in late 1996, the 104th was sent to Vietnam as a reinforcement after the units there became involved in fighting the Chinese.

Subordination: 28th Army
Current Location: Vietnam
Manpower: 3000
Tanks: 15

106TH MOTORIZED RIFLE DIVISION

A Mobilization Only rifle division from the Carpathian MD, the 106th was activated in early 1998 to perform anti-partisan duties and has been reasonably effective.

Subordination: 16th Army
Current Location: Graz, Austria
Manpower: 4000
Tanks: 24

107TH MOTORIZED RIFLE DIVISION

A Category III division from the Baltic MD, the 107th was activated in December of 1996. Because of shortages in nearly everything, the division was not ready for service until the summer of 1997. The unit has seen some action in the Baltic.

Subordination: 11th Guards Army
Current Location: Vicinity of Riga, Latvia
Manpower: 4000
Tanks: 36

108TH MOTORIZED RIFLE DIVISION

A Mobilization Only division from the Moscow MD, the 108th was not called until early 1999, by which time the shortages of men and equipment were appalling. Fortunately for the 108th, it has not seen combat.

Subordination: 21st Army
Current Location: Austria
Manpower: 3000
Tanks: 15

111TH MOTORIZED RIFLE DIVISION

A Mobilization Only division raised in the Transbaikal MD in mid-1997, the 111th was never greater than a regiment in strength. After numerous changes in orders, the 111th mutinied and is now raiding in the area around Irkutsk.

Subordination: None

Current Location: Irkutsk

Manpower: 3000

Tanks: 6

112TH MOTORIZED RIFLE DIVISION

A Mobilization Only division raised in the Siberian MD, the 112th was hastily committed to combat in north central China. After heavy losses, contact was lost with the division in late 1997. There is some indication that the unit is still active in the mountains of China.

Subordination: ?

Current Location: ?

Manpower: ?

113TH MOTORIZED RIFLE DIVISION

A Mobilization Only division raised in the Transbaikal MD, the 113th landed in Alaska in July 1997 and participated in the drive on Fairbanks. The unit retreated to Anchorage in the face of the US X Corps' assault in 1998.

Subordination: 11th Army

Current Location: Skwentna, Alaska

Manpower: 2000

Tanks: 4

114TH MOTORIZED RIFLE DIVISION

A Mobilization Only division raised in the Transbaikal MD, the 114th was landed with the 14th MRD and the 41st MRD in August of 1997. After being driven out of Juneau, the 114th marched north towards Whitehorse on its own initiative. The division has been terrorizing the area around Whitehorse since early 1999.

Subordination: None

Current Location: Whitehorse, Canada

Manpower: 1000

Tanks: 8

116TH MOTORIZED RIFLE DIVISION

A Category III division from the Far East MD, the 116th was activated in late 1995 and committed to the Spring Offensive of 1996 where it was nearly destroyed by a surprise Chinese counterattack. The division had been withdrawn to Siberia for rest when the Chinese collapsed. The 116th then came under control of the 15th Army.

Subordination: 15th Army

Current Location: Krasnoyarsk, Siberia

Manpower: 600

117TH MOTORIZED RIFLE DIVISION

A Mobilization Only division from the Kiev MD, the 117th was activated in the spring of 1999 as a security force for the Ukraine. Many of the division's personnel simply refused service and disappeared into the countryside.

Subordination: 2nd Guards Army

Current Location: Southern Poland

Manpower: 100

118TH MOTORIZED RIFLE DIVISION

A Category II division from the Far East MD, the 118th was brought up to strength and used in the initial invasion of China. As part of the drive towards Peking, the division was involved in intense combat in 1995. The 118th was part of the Spring Offensive of 1996 and was still near the Mongolian border when China collapsed. Withdrawn to eastern Siberia in late 1997, the unit now provides local security around Krasnoyarsk.

Subordination: 15th Army

Current Location: Krasnoyarsk, Siberia

Manpower: 2000

120TH MOTORIZED RIFLE DIVISION

A Mobilization Only division raised in the Far East MD, the 120th was activated in late 1996 and landed with the 76th TD in August 1997 in British Columbia. The 120th took part in the drive on Seattle in late 1997. Repulsed by US and Canadian troops, the 120th retreated and now occupies Queen Charlotte Island with the 76th TD.

Subordination: None

Current Location: Queen Charlotte Island

Manpower: 2000

Tanks: 6

122ND GUARDS MOTORIZED RIFLE DIVISION

A Mobilization Only division from the Carpathian MD, the 122nd Division was called up in April of 1998 and sent to southern Germany. Never at full strength, the division was badly mauled by the NATO counteroffensive of 1998.

Subordination: 41st Army

Current Location: Austria

Manpower: 1000

Tanks: 6

124TH MOTORIZED RIFLE DIVISION

A Mobilization Only division from the western Ukraine, the 124th was activated in late 1997 or early 1998. Only a small part of the division's men and equipment have ever assembled, and the unit has seen little action.

Subordination: 4th Guards Tank Army

Current Location: Central Poland

Manpower: 3000

Tanks: 6

125TH GUARDS MOTORIZED RIFLE DIVISION

A Category II division from the Baltic MD, the 125th Guards was brought up to strength and sent to Poland in July 1997 to try to stop the NATO offensive. The division fought well, but was overrun by German and US forces and destroyed in late 1997.

126TH GUARDS MOTORIZED RIFLE DIVISION

A Category III division from the Odessa MD, the 126th Guards was activated in January 1998 in order to conduct anti-partisan activities in the Balkans. Never reaching full strength, the unit refused to move as ordered and joined with several other units in declaring a free Ukraine in mid-1999.

Subordination: None

Current Location: Kotovsk, Ukraine

Manpower: 2000

Tanks: 4

127TH CAVALRY DIVISION

A Mobilization Only division from the Carpathian MD, the 127th was raised as a cavalry division due to a shortage of equipment in 1998. The unit was sent to Poland in 1999 where it has acted as security against NATO raiders.

Subordination: 3rd Shock Army

Current Location: Central Poland

Manpower: 2000

128TH MOTORIZED RIFLE DIVISION

A Category II division from the Carpathian MD, the 128th was mobilized and sent to the Far East in mid-1996. The division was returned to help stop the NATO offensive from southern Poland in the summer of 1998. It was hit by a tactical nuclear strike on the way to the front and nearly destroyed.

Subordination: 13th Army

Current Location: Ternopol, Ukraine

Manpower: 400

Tanks: 2

129TH MOTORIZED RIFLE DIVISION

A Mobilization Only division from the Moscow MD, the 129th Division was activated in 1997, but it was not until early 1998 that it had any equipment. The 129th was sent to Czechoslovakia in the fall of 1998 in response to a NATO offensive and was transferred to Poland in late 1999.

Subordination: 3rd Shock Army

Current Location: Central Poland

Manpower: 3000

Tanks: 5

130TH MOTORIZED RIFLE DIVISION

A Mobilization Only division from the North Caucasus MD, the 130th was activated in early 1998. It was virtually destroyed by tactical nuclear strikes in late 1998 on its way to Austria. The survivors have been organized as cavalry for anti-partisan duties.

Subordination: 41st Army

Current Location: Villach, Austria

Manpower: 400

Tanks: 1

131ST MOTORIZED RIFLE DIVISION

A Mobilization Only division from the Baltic MD, the 131st was activated in 1998. A shortage of vehicles forced the division to be primarily foot mobile with a ragtag collection of armored vehicles. The division has been sent to Poland.

Subordination: 8th Guards Army

Current Location: Central Poland

Manpower: 2000

Tanks: 16

132ND CAVALRY DIVISION

A Mobilization Only division from the Volga MD, the 132nd was activated in early 1999 as a cavalry division due to the lack of equipment. This suits the commander just fine; he is a Don Cossack. The unit has seen little action.

Subordination: 20th Guards Army

Current Location: Southern Poland

Manpower: 3000

133RD GUARDS MOTORIZED RIFLE DIVISION

A Category II division from the Carpathian MD, the 133rd Guards was upgraded and sent to China in late 1995. In the spring of 1996 the division was cut off and presumed destroyed.

134TH MOTORIZED RIFLE DIVISION

A Mobilization Only division raised in the Central Asian MD in late 1997, the 134th was to help provide local security. As to its loyalty, the 134th's was always questionable, and in late 1999 when Samarkand and Bukhara declared themselves independent Islamic cities, the 134th marched to join them.

Subordination: None

Current Location: Uzbek SSR

Manpower: 1000

Tanks: 9

135TH MOTORIZED RIFLE DIVISION

A Mobilization Only division from the Volga MD, the 135th was not activated until late 1997. The shortages of men and equipment have forced this unit to be converted to cavalry. The 135th has seen little action.

Subordination: 21st Army

Current Location: Austria

Manpower: 1000

Tanks: 3

137TH MOTORIZED RIFLE DIVISION

A Mobilization Only division from the Leningrad MD, the 137th was activated in January 1999. The division has been used mainly to combat marauders and assorted riffraff.

Subordination: 6th Army

Current Location: Svetogorsk, RSFSR

Manpower: 4000

138TH MOTORIZED RIFLE DIVISION

A Mobilization Only division from the Byelorussian MD, the 138th was activated in June 1998 as a garrison for Borisov. The 138th was assigned to the 9th Guards Army in 2000.

Subordination: 9th Guards Army

Current Location: Near Brest, Byelorussia

Manpower: 4000

Tanks: 20

139TH MOTORIZED RIFLE DIVISION

A Mobilization Only division raised in the Siberian MD in mid-1996, the 139th was sent into combat in Manchuria in late 1996. The division was poorly trained and equipped and was shattered almost immediately. A radio message in 1997 from the interior of China was the last contact with this unit.

Subordination: ?

Current Location: ?

Manpower: 300 (as of last contact)

Tanks: 1 (as of last contact)

141ST MOTORIZED RIFLE DIVISION

A Mobilization Only division raised in the Far East MD in mid-1996, the 141st was sent into action in Manchuria in the spring of 1997. Understrength and poorly equipped, the division was mauled by the Chinese in their last counteroffensive. As the division was marching back towards Vladivostok, it stopped answering orders—little is presently known of the unit.

Subordination: None
Current Location: ?
Manpower: 200?

145TH MOTORIZED RIFLE DIVISION

A Category II division from the Transcaucasus MD, the 145th was held in reserve for the forces in Iran. During the US counterattack in late 1997, the division was ordered forward. It was struck by a tactical nuclear warhead and nearly destroyed as it crossed the border in northern Iran. The survivors are responding only to their own officers.

Subordination: None
Current Location: Northern Iran?
Manpower: 300?

146TH GUARDS MOTORIZED RIFLE DIVISION

A Category II division from the Transbaikal MD, the 146th was upgraded and took part in the invasion of north central China. The division was heavily damaged by the Chinese counterattack in late 1995. When the division was separated from the main body of Soviet forces during its retreat, Chinese militia finished it off.

146TH MOTORIZED RIFLE DIVISION

A Mobilization Only division from the North Caucasus MD, the 146th was activated in late 1996 in preparation for action in Iran. The unit has served well in Iran considering the third-line nature of the unit and its equipment.

Subordination: 4th Army
Current Location: Khorramabad, Iran
Manpower: 2000
Tanks: 16

147TH GUARDS MOTORIZED RIFLE DIVISION

A Category III division from the Transcaucasus MD, the 147th was activated in late 1996 in preparation for the 1997 Spring Campaign in Iran. After achieving initial success in 1997, the division was cut off by the US counteroffensive (Operation Pegasus II) in the fall of 1997 and nearly annihilated. The 147th has been limited to security duties since.

Subordination: 45th Army
Current Location: Khunsar, Iran
Manpower: 100

147TH MOTORIZED RIFLE DIVISION

A Mobilization Only Division raised in the Siberian MD in mid-1996, the 147th Division landed in Alaska in July 1997 and took part in the capture of Fairbanks. The unit was driven out of Fairbanks by the US X Corps in March of 1998, and it retreated to the Anchorage area.

Subordination: 11th Army
Current Location: Tyonek, Alaska
Manpower: 3000
Tanks: 18

148TH MOTORIZED RIFLE DIVISION

A Mobilization Only division raised in the Far East MD in mid-1996, the 148th was sent into China in early 1997. The unit was cut off and lost contact with the main body of Soviet forces in the summer of 1997. The unit was thought to have been destroyed when the Soviets used nuclear weapons on a large scale in the fall of 1997; however, it has been reported

that a Soviet unit is fighting in the area where the 148th was last known to be.

Subordination: None
Current Location: Manchuria?
Manpower: 200?
Tanks: 1 ?

150TH MOTORIZED RIFLE DIVISION

A Mobilization Only division from the Turkestan MD, the 150th was activated in early 1997. The division never reached full strength, but was committed to the Soviet counteroffensive in Iran in the fall of 1997 where it performed creditably. It is still in action in Iran.

Subordination: 1st Army
Current Location: Kharanaq, Iran
Manpower: 1000
Tanks: 2

151ST MOTORIZED RIFLE DIVISION

The 151st is a Mobilization Only division raised in the Transbaikal MD in mid-1997. Many of the divisional personnel never showed up, and those who did took their weapons and promptly began raiding the countryside.

Subordination: None
Current Location: Central Yakut, ASSR
Manpower: 300?

152ND MOTORIZED RIFLE DIVISION

A Mobilization Only division from the Riga MD, the 152nd was activated in August of 1998 and attempted to put down the mutiny of the 154th. Many of the division's troops refused to fire on their comrades and promptly deserted. The loyal troops have been converted to cavalry.

Subordination: 6th Army
Current Location: Gatchina, RSFSR
Manpower: 2000
Tanks: 6

153RD MOTORIZED RIFLE DIVISION

A Mobilization Only division raised in the Far East MD in mid-1996, the 153rd Division was hastily sent into combat in Manchuria in early 1997. The division was nearly annihilated by Chinese mechanized forces in mid-1997. The division left its position in late 1998 and has not been heard from since.

Subordination: None
Current Location: ?
Manpower: 100?

154TH MOTORIZED RIFLE DIVISION

A Mobilization Only division from the Riga MD, the 154th was activated in July of 1998. From the start the division was in a state of mutiny, and most of the personnel deserted immediately. The loyal troops were formed into a cavalry unit.

Subordination: 6th Army
Current Location: Vyborg, RSFSR
Manpower: 100

155TH MOTORIZED RIFLE DIVISION

A Mobilization Only division raised in the Kiev MD, the 155th was in Bratislava on its way to Austria when the city was destroyed by a nuclear strike in late 1997.

156TH MOTORIZED RIFLE DIVISION

A Mobilization Only division raised in the Siberian MD in late 1996, the 156th was assigned to anti-partisan activities in western China. In late 1997 the division mutinied and marched back into Siberia. The 156th is now up around Barnaul as an independent unit and has been involved in several clashes with loyal Soviet troops.

Subordination: None

Current Location: Barnaul, Siberia

Manpower: 4000

Tanks: 32

157TH MOTORIZED RIFLE DIVISION

A Mobilization Only division from the Byelorussian MD, the 157th was activated in early 1998 to combat partisans and the resurgent Romanians. The division suffered a tactical nuclear strike on the way to Romania, and the survivors were sent to Poland.

Subordination: 2nd Guards Army

Current Location: Southern Poland

Manpower: 1000

Tanks: 7

159TH MOTORIZED RIFLE DIVISION

A Mobilization Only division raised in the Central Asian MD in late 1996 to take part in the war in China, the 159th Division's orders were changed when China fell. When the unit was ordered to Iran in late 1997, the division mutinied. At present it seems to be in support of the free city of Alma-Ata.

Subordination: None

Current Location: Alma-Ata

Manpower: 3000

Tanks: 27

160TH MOTORIZED RIFLE DIVISION

A Category I division stationed in the Far East MD, the 160th was a spearhead into Manchuria. By late 1995 all contact with the division had been lost, and the division is presumed to have been destroyed.

164TH MOTORIZED RIFLE DIVISION

A Category III division from the Transcaucasus MD, the 164th Division was with the initial invasion force committed against Iran in December 1996. The unit has been involved in the campaigns in Iran ever since.

Subordination: 7th Guards Army

Current Location: Miandowab, Iran

Manpower: 2000

Tanks: 12

173RD MOTORIZED RIFLE DIVISION

A Category II division from the Far East MD, the 173rd was committed against the Chinese in late 1995. After limited action in the 1996 and 1997 campaigns in China, the 173rd was sent into action against the US II Corps in Korea. The 173rd is still in contact with South Korean and US forces in Korea.

Subordination: 35th Army

Current Location: North Korea

Manpower: 1000

Tanks: 8

194TH MOTORIZED RIFLE DIVISION

A Category I division stationed in the Far East before the war, the 194th has taken part in every major campaign against China. After the collapse of China, the 194th was sent to Korea in late 1997 where it was mauled by US air strikes. In mid-1998 the division was again severely handled by US and ROK forces.

Subordination: 35th Army

Current Location: North Korea

Manpower: 200

Tanks: 1

201ST MOTORIZED RIFLE DIVISION

A Category III division in Afghanistan when the war started, the 201st was sent to northwestern Iran as an anti-partisan unit in early 1998. In 1999 the division revolted and marched into Turkmen SSR where it joined the 54th MRD in declaring a free Turkestan republic.

Subordination: None

Current Location: Bayram Ali, Turkmen SSR

Manpower: 2000

210TH MOTORIZED RIFLE DIVISION

A Category II division from the Transbaikai MD, the 210th was sent into combat against the Chinese counterattack in late 1995. After a courageous rearguard action in early 1996, the unit lost contact and is presumed to have been destroyed.

222ND MOTORIZED RIFLE DIVISION

A Category III division from the Baltic MD, the 222nd was activated in mid-1997 and was in Riga awaiting transport to the front when the city was destroyed by a nuclear strike in late 1997.

253RD MOTORIZED RIFLE DIVISION

A Mobilization Only division from the Far East MD, the 253rd was activated in late 1996 in response to the Chinese counter-attack. The division was never at full strength and was hastily committed, suffering heavy losses as a result. In late 1998 the survivors went to the 5th TD.

261ST MOTORIZED RIFLE DIVISION

A Category II division from the Transcaucasus MD, the 261st took part in the initial invasion of Iran in December of 1996 and was heavily damaged by the fanatical Pasdaran. Since then the unit has served mainly in a security role.

Subordination: 7th Guards Army

Current Location: Tabriz, Iran

Manpower: 400

Tanks: 3

266TH MOTORIZED RIFLE DIVISION

A Category III division from the North Caucasus MD, the 266th was involved in the Romanian campaign of late 1997. After the collapse of Romania, the unit was shifted to Yugoslavia where it has been active against various partisan bands.

Subordination: 20th Army

Current Location: Sarajevo, Yugoslavia

Manpower: 4000

Tanks: 8

280TH MOTORIZED RIFLE DIVISION

A Mobilization Only division raised in the Carpathian MD in mid-1997, the 280th was committed against the Romanians in the fall of 1997. The division was plagued by desertion during the winter of 1997/1998 and in the spring of 1998, the 280th was ambushed and destroyed by Romanian partisans.

286TH MOTORIZED RIFLE DIVISION

A Category II division from the Odessa MD, the 286th was mobilized and sent into action against Romania in late 1996. The division has fought in various Balkan actions with the 19th Army.

Subordination: 19th Army

Current Location: Near Zhitomir, Ukraine

Manpower: 1000

300TH MOTORIZED RIFLE DIVISION

A Category II division stationed in Mongolia before the war, the 300th was upgraded and sent into China with the spearhead forces. The division was surrounded in late 1995 and destroyed by Chinese armored forces.

318TH GUARDS MOTORIZED RIFLE DIVISION

A Category II division from the Carpathian MD, the 318th was brought up to strength in early 1996 in preparation for a move to China. The Romanian revolt caused the division to be committed to the Balkans instead. In late 1998 the unit was withdrawn to form the core of the 13th Army.

Subordination: 13th Army

Current Location: Ternopol, Ukraine

Manpower: 2000

321ST MOTORIZED RIFLE DIVISION

A Mobilization Only division raised in the Carpathian MD in early 1997, the 321st was hit by a nuclear strike on its way to Romania. The survivors were distributed among various units.

342ND MOTORIZED RIFLE DIVISION

A Category II division from the Far East MD, the 342nd fought in the entire campaign in China where it suffered heavy losses. The division was withdrawn from Manchuria to provide security and to help restore order in Western Siberia in early 1998.

Subordination: 2nd Army

Current Location: Western Siberia

Manpower: 200

346TH MOTORIZED RIFLE DIVISION

A prewar Category I division stationed in Afghanistan, the 346th was used to form the nucleus of the 1st Army and sent to Iran in August of 1997. During the Soviet counteroffensive in October, the division was heavily engaged against the marines at Bandar Abbas. In late October the 346th was caught in an air mobile ambush during Operation Pegasus II and largely destroyed.

Subordination: 1st Army

Current Location: Baft, Iran

Manpower: 200

360TH MOTORIZED RIFLE DIVISION

A Category III division on duty in Afghanistan along with the 66th MRD, the 360th helped form the 40th Army. The division

has seen only limited action.

Subordination: 40th Army

Current Location: Rafsanjan, Iran

Manpower: 3000

Tanks: 15

376TH GUARDS MOTORIZED RIFLE DIVISION

A Category III division from the Leningrad MD, the 376th Division was activated in early 1997 in response to the NATO threat in Finland. The 376th was rushed into action only partially equipped and was roughly handled in its first combat experience. By 1 998 the division was no longer answering to its command, and reports from the area identified the division as the same unit which had been seen marauding in the area.

Subordination: None

Current Location: The Finnish-RSFSR border?

Manpower: 2000

Tanks: 12

Airborne Units**6TH GUARDS AIR ASSAULT DIVISION**

A Category I division from the Far East MD, the 6th was used to secure river crossings for the 1996 offensive in China. The unit was then used to secure a bridgehead in Alaska in July of 1997 where it took heavy losses. The unit was cut off on the Seward peninsula in early 1998 and retreated in the summer of 1998 across the Bering Straits with what little transport it could find.

Subordination: Aleutian Front

Current Location: Chukotski Peninsula

Manpower: 3000

7TH GUARDS AIR ASSAULT DIVISION

A Category I division from the Baltic MD, the 7th AAD was used in Norway where it suffered heavy losses. The division then fought in the Kola peninsula in 1997 until it was withdrawn in June 1998.

Subordination: Strategic Central Command

Current Location: Ryazan

Manpower: 2000

14TH AIR ASSAULT BRIGADE

A prewar Category I unit, the 14th was used in the Far East where it suffered heavy losses. Sent back to the Ukraine, the brigade was reinforced and used in a ground combat role in Austria during the 1998 Soviet offensive. In late 1998 the unit was returned to the Ukraine where it is acting as a security force.

Subordination: Ukrainian Front

Current Location: Kirovograd, Ukraine

Manpower: 750

Tanks: 1

32ND AIR ASSAULT BRIGADE

A prewar Category I formation, the 32nd has seen action in several deep penetration raids in Austria and the Balkans. The proximity of the oilfields at Ploesti allow the unit to keep a few helicopters operational. The unit is used as a quick reaction force.

Subordination: Danube Front

Current Location: Bucharest, Romania

Manpower: 750

A NOTE ABOUT OUR SOURCES FOR THE SOVIET ARMY VEHICLE GUIDE

When the war finally ended, the state of information exchange was in an atrocious shape. The intervening years have done little to improve the situation, particularly in the areas that were a part of the Soviet Union when the war started. This, coupled with the destruction of many of the library systems of the world, has made the task of reconstructing the history of the war an extremely difficult task. We here at the university felt that the reader deserved to know how we obtained our information.

The Unit Histories were given for the year 2000 because, shortly thereafter, most units lost what little cohesion they still had and turned to survival in one form or another. The government of the Soviet Union had, for all practical purposes, ceased to exist. The Ukraine, the Baltic states, Siberia, the central Asian districts and the southern areas were all in various stages of revolt, and units from those districts felt more loyalty to their "homeland" than they did to a central government. What was left of the Soviet government was limited to what was roughly the Ural military district and the area around the ruins of Moscow and Tula.

Most of the information about the Soviet forces as of July 2000 has been obtained from official sources. We have the U.S. Army's last intelligence report on the strength and dispositions of the Soviet Army dated March 1, 2000. Also, we have a copy of the last known Soviet report about the state of that army received from the personal collection of Major-General I. M. Kotiev, who surrendered to the Germans in August of 2000. The last source is from the Japanese, who have travelled extensively in the areas that were once part of the Soviet Union, trying to establish trade with the various local governments. Of course, we have many private diaries, letters, orders and remembrances, but these are usually limited to information about a single division; and we have found that many times, the average soldier really did not *know* where he was.

The area that is still calling itself the Soviet Union still believes itself to be at war; thus, we have been able to obtain no information at all from it. Thus, what may someday prove to be a valuable resource is still closed to us. At any rate, the information presented here is the result of painstaking research and is as accurate as possible.

The information about the color plates was a little easier to obtain. During the early part of the war, both sides made propaganda films depicting the victorious sweep of their armies. Those films that have survived have been an extremely valuable source of information about the vehicles of the war. Newsmen of many countries also provided videotape footage, as did private individuals. Of course, training manuals and technical manuals have given us details of the weapons and their characteristics. And, as mentioned above, the wealth of personal papers, recollections and private photographs have provided much information about the vehicles of the war.

One of the major problems we had with the Soviet vehicles was identifying the ownership of vehicles at a level any lower than the division, and even that was sometimes difficult. The problem was that the Soviets did not put tactical markings on their vehicles the way that most armies do. We pointed out in the descriptions that the Soviet Army rarely put any markings on its vehicles. As the war progressed, some armies adopted a marking system, and we have been able to identify those

vehicles with a good deal of reliability. Some of the vehicles have only recently been identified because we have been able to establish a correspondence with some of the soldiers (mainly officers) who served with the Soviet Army during the war.

I hope this note conveys to the reader some sense of the immense problems facing us as we attempt to establish a comprehensive history of the war. Later historians will undoubtedly have access to much more information than is currently available to us; however, the job of sorting out the information must start somewhere, and we believe we have begun that task.



A1: T-72 of the 38th Motorized Division; Korea, early 1998.

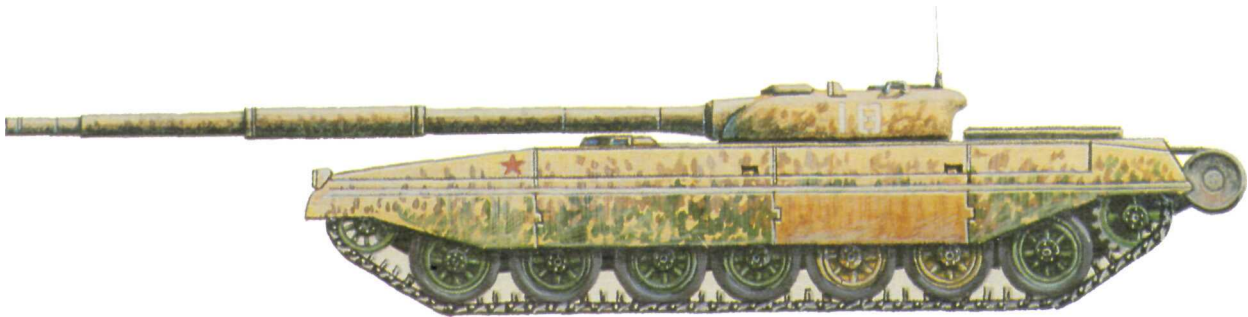

A2: T-90 of the 75th Motorized Rifle Division; Iran, 1998.

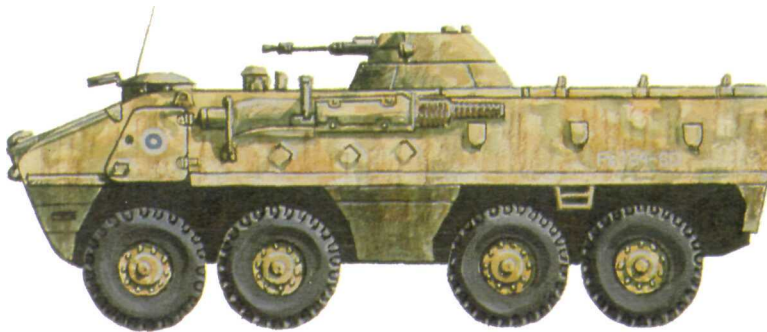

A3: OT-64 in Finnish service; Finland, 1997.



A4: T-86 of the 9th Guards Tank Division; Poland, 1999.

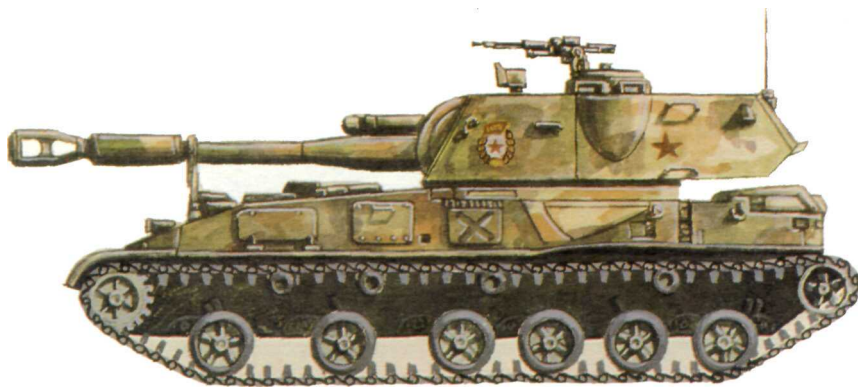

B1: An SAU-152 from the 11th Guards Tank Division; Poland, 1998.



B2: SAU-122 with the 37th Motorized Rifle Division; near Leningrad, 1998.

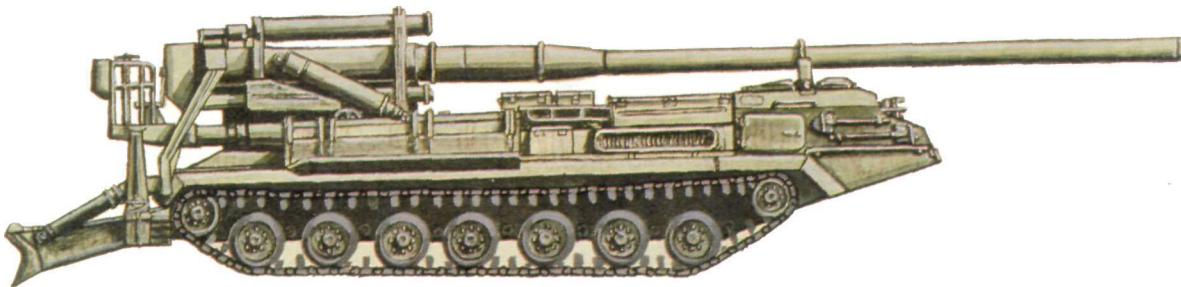

B3: SAU-203, the vehicles attachment has not been determined.



B4: Bm-27 rocket launcher from the artillery regiment of the 125th Guards Motorized Rifle Division; Poland, 1997.



C1: BRDM-2 with AT-5 launcher tubes from the 34th Motorized Rifle Division; Mongolia, 1998.

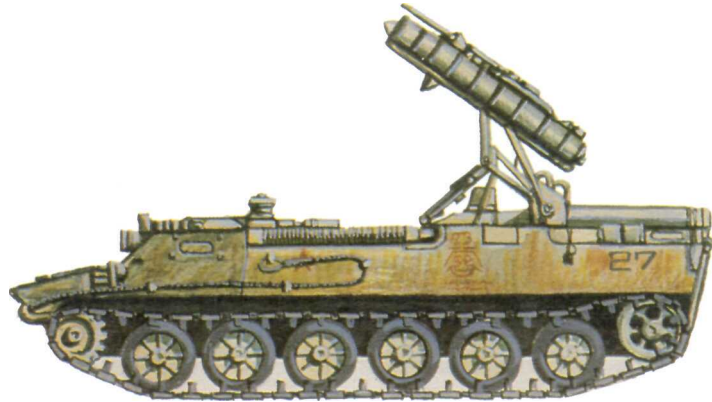

C2: SA-13 Air Defense Artillery vehicle from the 11th Tank Division; Mongolia, 1998.



C3: BRDM-3 from the 98th Guards Motorized Rifle Division; the Ukraine, 1999.

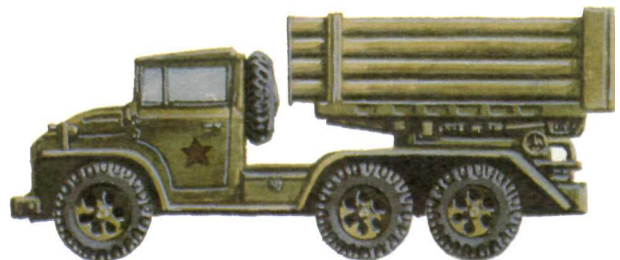

C4: Bm-14 rocket launcher, part of the 2nd Southwestern Front's artillery assets; Austria, 2000.

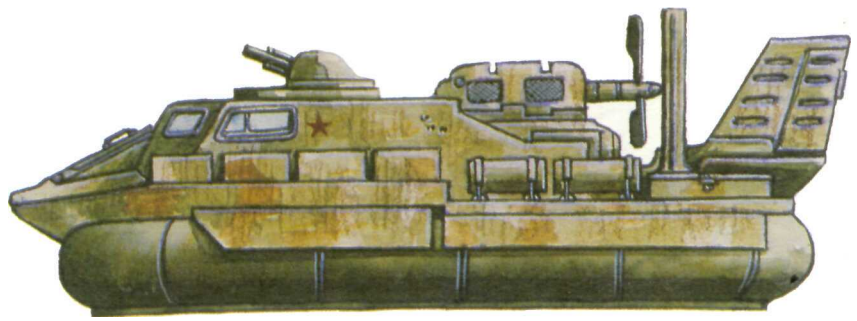

D1: KVP-92v from the 2nd Arctic Mechanized Brigade; Alaska, 1998.



D2: KVP-92 from the 1st Naval Infantry Brigade; Alaska, 1997.

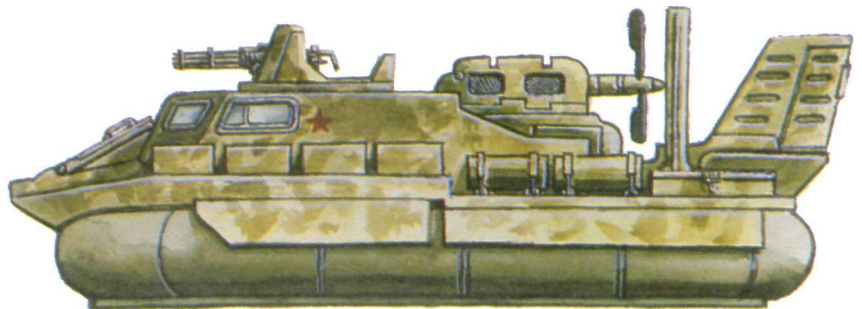

D3: KVP-92z from the 27th Naval Infantry Regiment; Leningrad, 1998.

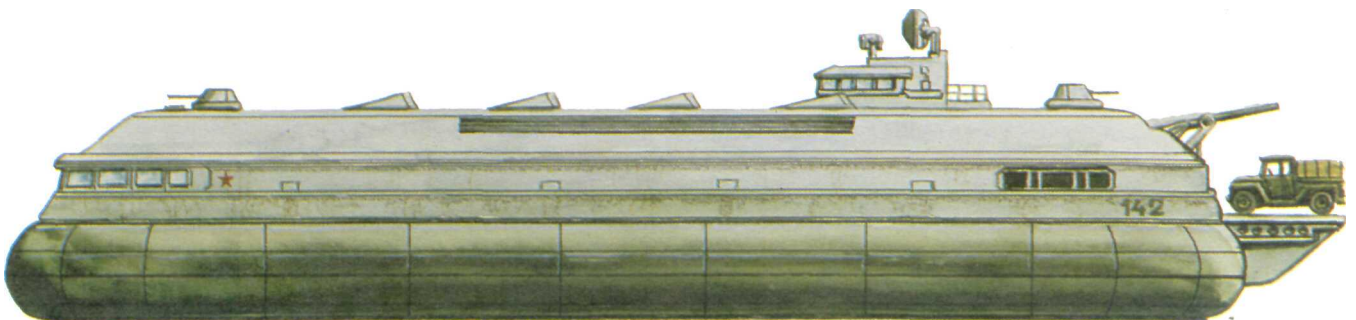

D4: KVP-121 of the 18th Hovercraft Transport Regiment; Alaska, 1997.



E1: T-55 from the 76th Tank Division; British Columbia, 1 998.



E2: OT-65 of the 24th Guards Motorized Infantry Division; Iran, 1998.



E3: MTLB from the 24th Guards Motorized Division; Iran, 1 998.

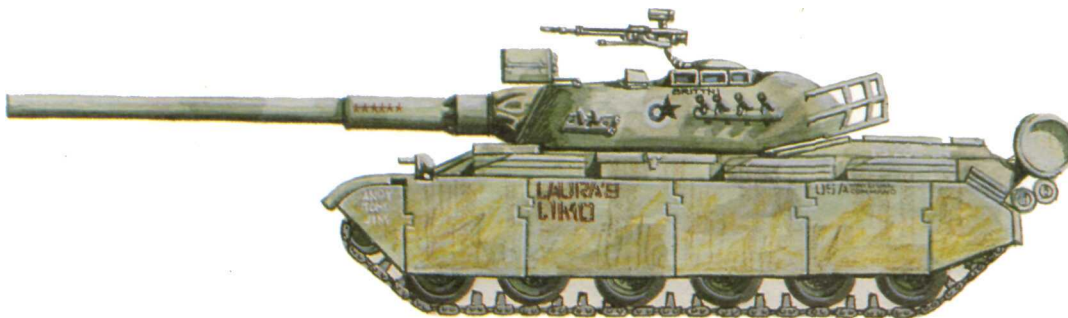

E4: M-81 of the US 6th Infantry Division; Germany, 1998.

F1: BRDM-2 with the 21st Guards Motorized Rifle Division; Poland, 1999.

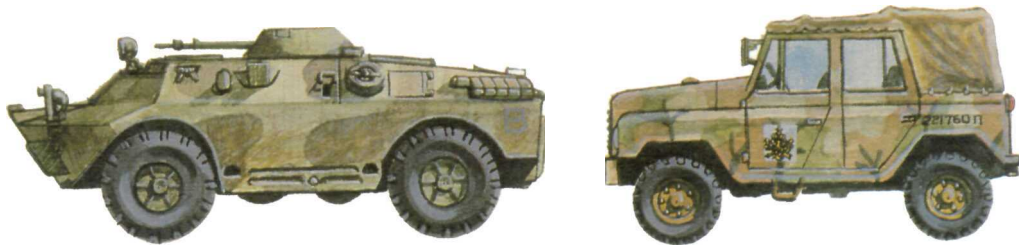

F2: UAZ 469 from the 41st Motorized Rifle Division; Alaska, 1999.

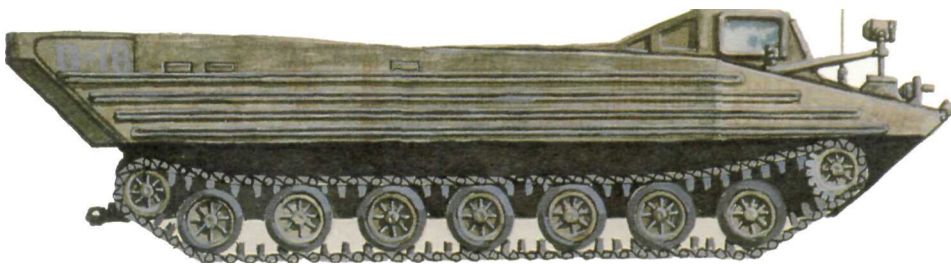

F3: PTS-M from the 24th Motorized Rifle Division; Romania, 1998.

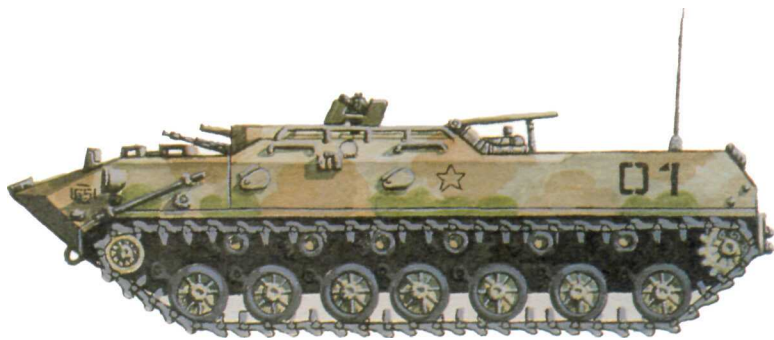

F4: BMD weapons carrier with the 104th Guards Air Assault Division; Iran, 1998.

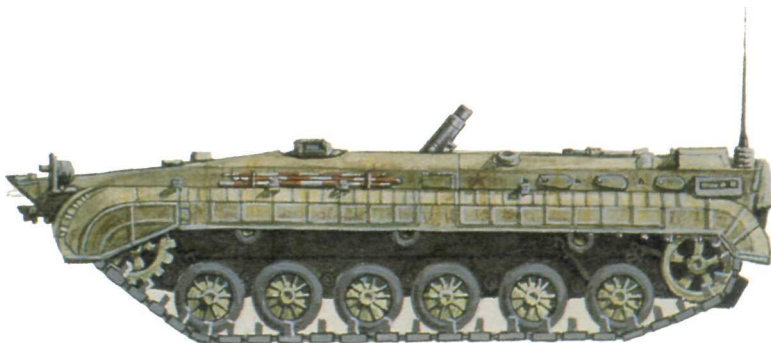

F5: BMP mortar carrier of the 50th Guards Motorized Rifle Division; Vietnam, 1997.



G1: BMP-A from the 19th Motorized Rifle Division; Iran, 1998.

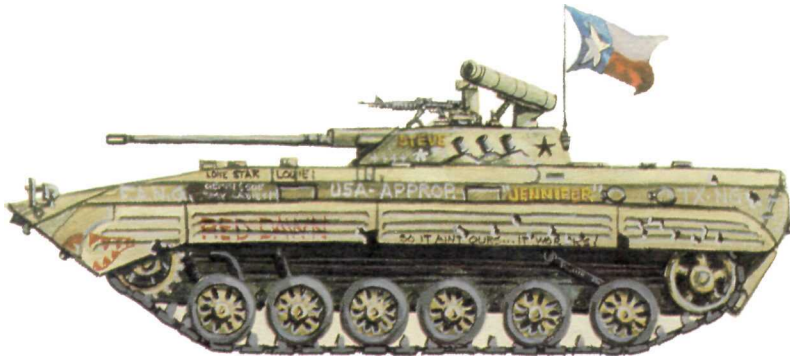

G2: BMP-C with the US 49th Armored Division; Texas, 1999.



G3: BMD-B from the 63rd Naval Infantry Regiment; Korea, 1998.

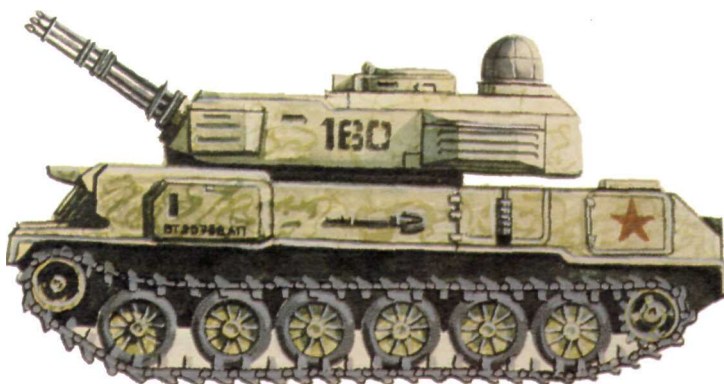

G4: ZSU-30-6 from the 1st Tank Division; Poland, 1998.

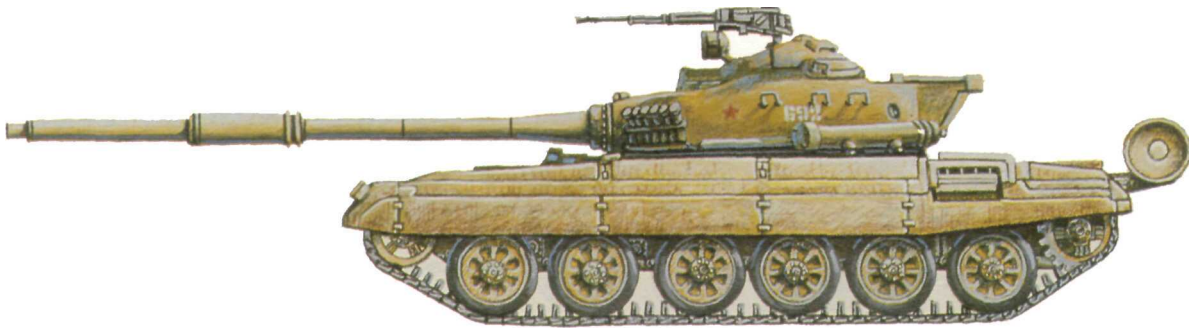

H1: T-74 of the 24th Guards Motorized Rifle Division; Iran, 1997.

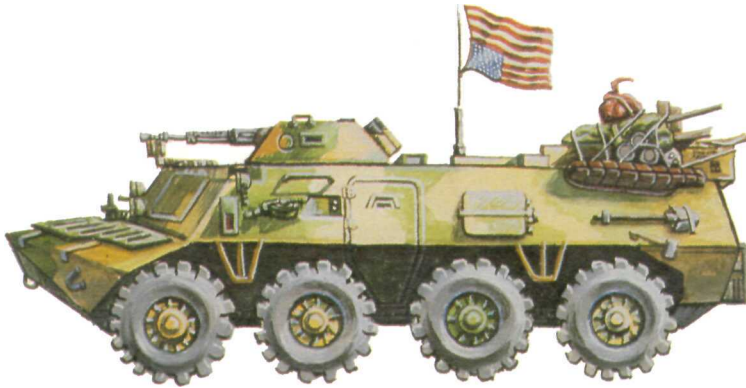

H2: BTR-80 from the 114th Motorized Rifle Division; Canada, 1999.

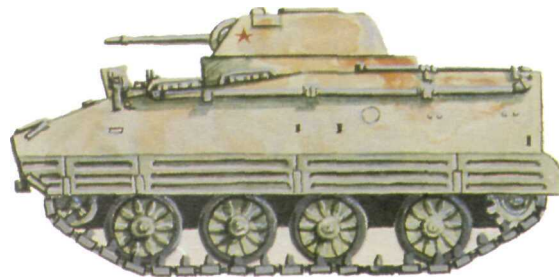

H3: TAB-90 of the 97th Motorized Rifle Division; Romania, 1998.

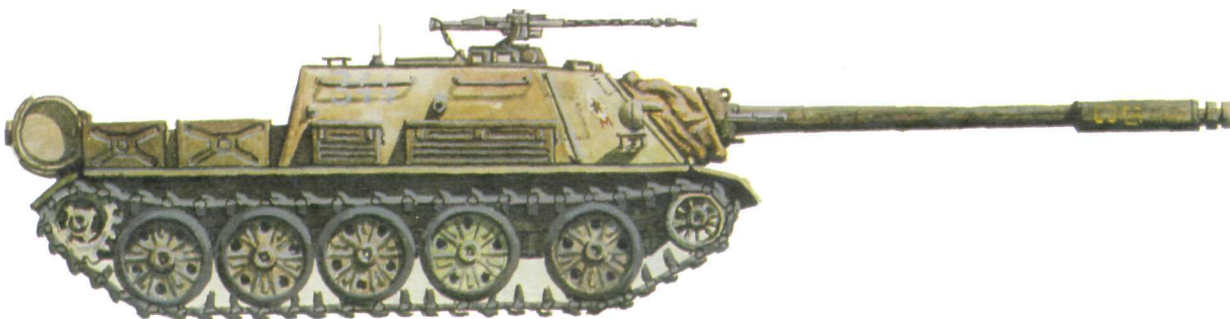

H4: SU-130 from the 23rd Motorized Rifle Division; Manchuria, 1996.

Aircraft: 2 Mi-28s, 3 Mi-27s

50TH AIRMOBILE BRIGADE

A prewar Category I unit attached to the Far East MD, the 50th was used in the initial invasion of China to block the escape route of several shattered Chinese divisions. In the battles of late 1996 the unit was used to attack the spearheads of the counterattacking Chinese divisions and was nearly destroyed.

Subordination: 1st Far Eastern Front

Current Location: Manchuria

Manpower: 200

76TH GUARDS AIR ASSAULT DIVISION

A prewar Category I division stationed in Leningrad, the 76th was involved in the battles for Norway and the Kola peninsula. The division was withdrawn to Leningrad in early 1998.

Subordination: Red Banner Leningrad Front

Current Location: Volkov

Manpower: 2000

86TH AIR ASSAULT BRIGADE

A prewar Category I division stationed in Byelorussia, the 86th has been used sparingly throughout the campaigns in Poland as deep penetration raiders.

Subordination: 1st Byelorussian Front

Current Location: Volkovysk, Byelorussian

Manpower: 600

98TH AIR ASSAULT BRIGADE

A prewar Category I formation, the 98th was used to secure bridges in Manchuria at the start of the war with China. The unit was severely mauled by Chinese militia after running short of fuel in late 1996 and was withdrawn. The 98th now serves as an HQ security force.

Subordination: 1st Far Eastern Front

Current Location: Manchuria

Manpower: 300

103RD GUARDS AIRBORNE DIVISION

A Category I division stationed in Afghanistan, the 103rd was sent to Iran in early 1997. The division was involved in the air assault during the spring of 1997. The 103rd landed at Bandar Abbas and was wiped out when Soviet mechanized forces failed to relieve the division.

104TH GUARDS AIR ASSAULT DIVISION

A prewar Category I division from the Transcaucasus MD, the 104th Guards were used in the 1997 Spring Offensive in Iran. Dropped at Bandar Khomeini, the unit became embroiled in savage fighting and had to withdraw. The battered 104th has been sent north to rest.

Subordination: Transcaucasus Front

Current Location: Mozzfarabad, Iran

Manpower: 1800

Tanks: 16

105TH GUARDS AIRBORNE DIVISION

A Category II division from the North Caucasus MD, the 105th was activated and took part in the Airborne assault in Iran in 1997. The 105th was dropped at Bushehr, and when the relief forces were delayed, the unit was destroyed in May of 1997.

106TH GUARDS AIR ASSAULT DIVISION

A Category I division stationed in Moscow, the 106th was used in the Far East at the start of the war. In August the unit fought against the NATO offensive in Poland. It was withdrawn to reserve status in mid-1998.

Subordination: Strategic Central Command

Current Location: Ryazan, USSR

Manpower: 2000

112TH AIR ASSAULT BRIGADE

A prewar Category I division, the 112th has been active in the Balkans since the outbreak of the war. With the fall of Romania, the oilfields at Ploesti have supplied the unit's helicopters with some fuel, thus making it a very formidable unit in the year 2000.

Subordination: Southern Front

Current Location: Beograd, Jugoslavia

Manpower: 700

Aircraft: 2 Mi-28s, 3 Mi-17s

128TH AIR ASSAULT BRIGADE

A Category I unit attached to the Central Asian MD, the 128th was sent to Vietnam as part of the force to protect the naval facilities in 1997. The 128th has seen little action, suffering mainly from lack of fuel and desertion.

Subordination: 1st Indochinese Front

Current Location: Hanoi, Vietnam

Manpower: 600

212TH AIR ASSAULT BRIGADE

A prewar Category II formation that was not brought up to strength, the 212th has seen little action in the Iranian Campaign because of its limited capabilities. It provides rear area security.

Subordination: Transcaucasus Front

Current Location: Tehran

Manpower: 800

203RD AIR ASSAULT BRIGADE

A Category I unit attached to the Far East MD, the 203rd went into action in Korea against US forces in late 1997. It suffered heavy losses to US airpower in early 1998 and has been in reserve ever since.

Subordination: Yalu Front

Current Location: North Korea

Manpower: 200

Separate Regiments and Brigades

1ST ARCTIC MECHANIZED BRIGADE

A hovercraftborne unit, the 1st Arctic was the spearhead in the invasion of Alaska. The unit took Fairbanks in late July and then turned south to Anchorage. The division was isolated with the rest of the 11th Army in the spring of 1998.

Subordination: 11th Army

Current Location: Anchorage, Alaska

Manpower: 600

2ND ARCTIC MECHANIZED BRIGADE

A hovercraftborne unit, the 2nd took part in the initial invasion of Alaska in 1997. After taking Fairbanks, the 2nd turned

south and headed in the general direction of Juneau. The US counterattack in the spring of 1998 forced the unit to return to the Anchorage area where it is trapped with the rest of the 11th Army.

Subordination: 11th Army

Current Location: Anchorage, Alaska

Manpower: 1000

1ST NAVAL INFANTRY BRIGADE

A Category I unit from Vladivostok, the 1st Naval saw little action until the invasion of Alaska in 1997. The unit was landed along the Cook Inlet in an effort to flank the defenders of Anchorage. The mission was partially successful. The defenders withdrew, but on the way out, they thrashed the brigade; the survivors retreated to Anchorage.

Subordination: Aleutian Front

Current Location: Near Anchorage

Manpower: 300

27TH NAVAL INFANTRY REGIMENT

Originally part of the Red Banner Northern Fleet, the 27th was heavily engaged in the invasion of Norway in 1996. The unit was cut off and had to fight its way overland to Finland. From there it was withdrawn to Leningrad in mid-1997.

Subordination: Red Banner Leningrad Front

Current Location: Kronstadt

Manpower: 600

Tanks: 4

30TH NAVAL INFANTRY REGIMENT

Part of the Red Banner Northern Fleet, the 30th landed in Norway in late 1996. The regiment was cut off and destroyed before it could be relieved.

63RD NAVAL INFANTRY REGIMENT

A prewar Category I unit stationed at Vladivostok, the 63rd saw little action in China, but was used as regular infantry against the US forces in Korea in late 1997.

Subordination: Yalu Front

Current Location: North Korea

Manpower: 800

Tanks: 2

11TH ATTACK HELICOPTER REGIMENT (see note)

Part of the initial invasion force of Iran with the 7th Guards Army, the 11th took heavy losses in the Soviet Summer Offensive of 1997. In mid-1998 the unit was transferred to the 1st Army.

Subordination: 1st Army

Current Location: Yazd, Iran

Manpower: 100

Helicopters: 2 Mi-17s

32ND ATTACK HELICOPTER REGIMENT

Originally involved in the fighting in China, the 32nd was in the Far East when China collapsed. The unit was sent to Iran in late 1997.

Subordination: 4th Army

Current Location: Kermanshah, Iran

Manpower: 150

Helicopters: 3 Mi-27s, 3 Mi-17s

45TH ATTACK HELICOPTER REGIMENT

The 45th represents a collection of the remnants of other helicopter regiments. Combat losses, lack of spare parts, and lack of fuel have all contributed to the inability of both sides to keep aircraft flying. The 45th has seen some action in Iran since being assembled in late 1997.

Subordination: 45th Army

Current Location: Qom, Iran

Manpower: 400

Helicopters: 4 Mi-27s, 3 Mi-17s, 3 Mi-28s

340TH ATTACK HELICOPTER REGIMENT

A collection of surviving helicopters from various other regiments, the 340th was assembled in early 1998 and has seen some action in Iran.

Subordination: 40th Army

Current Location: Kerman, Iran

Manpower: 200

Helicopters: 1 Mi-28, 2 Mi-27s

627TH ATTACK HELICOPTER REGIMENT

The 627th was sent to Iran in mid-1997 after shortages forced it to curtail operations elsewhere. The 627th has been used in Iran on several occasions to perform deep penetration raids.

Subordination: 7th Guards Army

Current Location: Tabriz, Iran

Manpower: 400

Helicopters: 2 Mi-27s, 6 Mi-17s, 4 Mi-28s

18TH HOVERCRAFT TRANSPORT REGIMENT

The only unit of its kind in existence, the 18th was composed of heavy KVP-121 hovercraft and was used to transport men and equipment during both the Korean campaign and the invasion of Alaska. Shortages of fuel have forced severe curtailment of the operation of the remaining hovercraft.

Subordination: Independent unit

Current Location: Kamchatka Peninsula

Manpower: 300

Hovercraft: 4 KVP-121s

DIVISION CUBA

Division Cuba was formed from several small Soviet units in Cuba in June of 1998 and was transported to Texas to support the Mexican invasion. Division Cuba has been involved in heavy fighting in Texas. By late 1999 both sides were exhausted and, although still in contact with the Americans, the division has not attempted any offensive action since. The division simply wants to go home.

Subordination: Autonomous

Current Location: San Antonio, Texas

Manpower: 3000

Tanks: 15

Note: Because of the destruction of most of the world's oil-producing and refining capabilities, the few places which can provide this need are still hotly contested. They are also a convenient place for the remaining operational aircraft. As a rule of thumb, wherever there is oil, you will find both sides still fighting and more of the machines of war still operating.

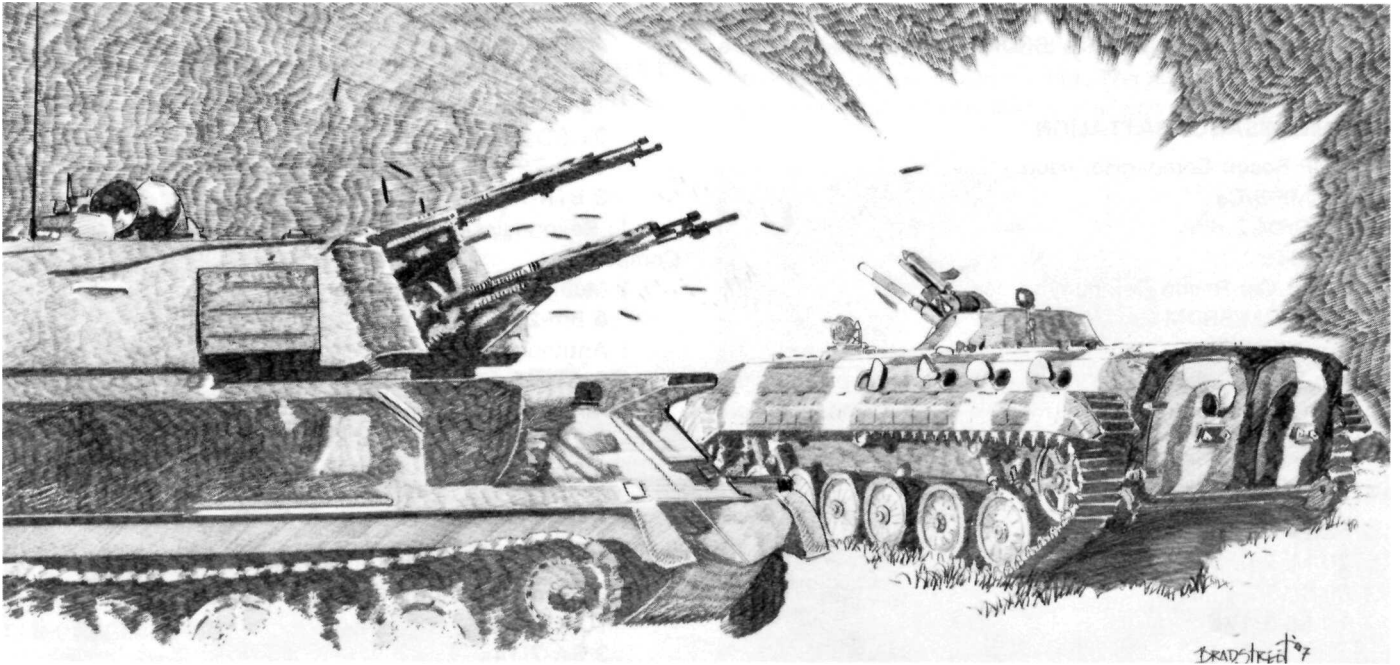

Organization

This chapter deals with the authorized strengths of the more common combat units of the Soviet Armed Forces. The basic units dealt with are battalion and regiment size. These levels are based on the Soviet Tables of Organization and Equipment (TO&E) established in 1992. Bear in mind that the strengths listed below reflect prewar levels and probably have little relation to the state of Soviet units in July 2000. However, these listings do provide a useful guide to players and referees as to the kinds of equipment one might find in a game or campaign. Remember, soldiers throughout history have 'liberated' equipment from various sources (other units, civilians, etc.) and any type of vehicle or weapon may be present in a Soviet unit in 2000.

The chart at the end of this chapter shows how the battalions are assembled into divisions. Not all the battalions in the divisional component chart are listed in the TO&E; many represent specialist formations which have long since ceased to function for one reason or another.

Authorized Levels of Weapons and Vehicles

MOTORIZED RIFLE BATTALION (BTR)

Battalion Headquarters:

1 BTR70PU

Mortar Battery:

6 120mm Mortars (towed)

Antitank platoon:

4 BTR-70/80s

4 ATGMs (Manpack AT-4)

4 RPG-16s

3 Motorized Rifle Companies, each:

11 BTR-70/80s

3 SA-7 or SA-14s

9 RPG-16s

MOTORIZED RIFLE BATTALION (BMP)

Battalion Headquarters:

1 BMP-C

Mortar Battery:

6 SO-120s (turret on BMP hull)

Antiaircraft Platoon:

3 BMP-Cs

9 SA-7s or SA-14s

3 Motorized Rifle Companies, each:

10 BMP-Cs

9 RPG-16S

TANK BATTALION

Battalion Headquarters:

1 MBT command tank

2 ACVs (BRDMS?)

2 RPG-16S

3 Tank Companies, each:

13 MBTs

HOWITZER BATTALION

3 Firing Batteries, each:

6 towed or self-propelled howitzers (3 per platoon)

Note: These battalions are equipped with 122mm and 152mm howitzers.

ROCKET LAUNCHER BATTALION

3 Firing Batteries, each:

6 BM-21 or BM-27 multiple rocket launchers (3 per platoon)

Note: The BM-21 fires a fin-stabilized 122mm rocket; the BM-27 fires a 220mm fin-stabilized rocket.

ANTITANK BATTALION

2 Antitank Gun Batteries, each:

6 100mm Rapira-1 antitank guns or 6 125mm Rapira-3 antitank guns

- 1 ATGM Battery:
- 9 ATGM launcher vehicles (BRDM-2) with AT-4s or AT-5s
- 9 RPG-16s

RECONNAISSANCE BATTALION

- 2 BMP Recon Companies, each:
 - 6 BMP-B/Cs
 - 2 BDRM-2 rkhs
 - 3 MBTs
- 1 Scout Car Recon Company:
 - 12 BRDM/BRDM-2S
 - 13 RPG-16s

Note: The BRDM-2 rkh is a vehicle specially equipped for dealing with the unique problems of the nuclear and chemical battlefield.

ATTACK HELICOPTER REGIMENT

- 2 Mi-24/28 Squadrons, each:
 - 20 Mi-24/28s
- 1 Mi-8/17 Squadron:
 - 10 Mi-8/17s

TRANSPORT HELICOPTER REGIMENT

- 2 Heavy-lift Squadrons, each:
 - 12 Mi-6/26s
- 2 Medium-lift Squadrons, each:
 - 16 Mi-8/17s

AIRBORNE BATTALION

- 3 Airborne Companies, each:
 - 10 BMDs
 - 9 RPG-16S
 - 3 SA-7/14s (antiaircraft missile squad)
 - 2 AGS-17s (weapons squad)

AIR ASSAULT BRIGADE

- Brigade HQ
- 2 Assault Battalions, each:
 - 3 Assault Companies (same as airborne companies above)
- 2 Parachute Battalions, each:
 - 3 Parachute Companies, each:
 - 9 RPG-16s
 - 3 SA-7/14S
 - 2 AGS-17s
- 1 Antitank Battery
 - 9 ATGM vehicles (BRDM-2 with AT-5)
- 1 Antiaircraft Battery:
 - 9 ZSU-30-6s
- 1 Artillery Battalion:
 - 2 Artillery Batteries, each:
 - 6 SO-120S

NAVAL INFANTRY REGIMENT

- 3 Naval Infantry Battalions, each:
- 3 Naval Infantry Companies, each:
 - 10 BTR-70/80s
 - 3 SA-7/14S
 - 9 RPG-16s
- 1 Mortar Platoon
 - 1 BTR-70/80
 - 3 BTR-70 with 82mm Vasileks

- 1 Antitank Platoon
- 2 BTR-70/80s
- 3 AT-4 Manpacks
- 1 Tank Battalion
 - 31 SO-120s
 - 10 T-72s
 - 3 BTR-70/80s
- 1 Reconnaissance Company (see Scout Car Recon Company)
 - 1 Multiple Rocket Launcher Battery
 - 6 Bm-21s
 - 1 Antitank Battery
 - 6 ATGM vehicles (BRDM-2 with AT-5)
 - 1 Air Defense Battery
 - 9 ZSU-30-6s
 - 9 SA-7/14s

ARCTIC BRIGADE

- 4 Hovercraft Infantry Battalions, each:
- 3 Hovercraft Infantry Companies, each:
 - 10 KVP-92s
 - 3 SA-7/14s
 - 9 RPG-16s
- 1 Mortar Battery
 - 6 KVP-92vs
- 1 Antiaircraft Battery
 - 6 KVP-92zs

Note: The Soviets divide their army into different degrees of readiness. The following is a brief description of that system.

A Category I division is at 75 percent to 110 percent of full strength and would certainly be brought up to full strength very quickly if there were a real threat of war. A Category II division is at 50 percent to 70 percent of its authorized manpower and at nearly full strength in equipment. These divisions can be ready for service quickly. Category III divisions are manned at only 10 percent to 30 percent of their authorized strength and have only 30 percent to 50 percent of their allotted equipment. Category III divisions may take up to three months to become combat ready. Mobilization Only divisions have no peacetime existence except for a cadre. The Mobilization Only units would take at least three months to be combat ready, and even then, they would be short of manpower and equipment. If the Soviets need these divisions, things have gone from worse to terrible.

Subordinate Units of Selected Soviet Regiments and Divisions

MOTORIZED RIFLE REGIMENT (BTR)

- 1 Regimental Headquarters
- 3 Motorized Rifle Battalions (in BTRs)
- 1 Tank Battalion
- 1 Antiaircraft Battery
- 1 Antitank Battery
- 1 Artillery Battery
- 1 Howitzer Battery (usually towed)
- 1 Reconnaissance Company

MOTORIZED RIFLE REGIMENT (BMP)

These regiments differ from the BTR mounted regiments in only two areas. The Motorized Rifle Regiments are mounted on BMPs, and the Howitzer Battery is usually self-propelled.

TANK REGIMENT

- 1 Regimental Headquarters
- 3 Tank Battalions
- 1 Self-propelled Howitzer Battalion
- 1 Motorized Rifle Battalion (BMP)
- 1 Antiaircraft Battery
- 1 Artillery Battery
- 1 Reconnaissance Company

ARTILLERY REGIMENT

- 1 Regimental Headquarters
- 2 Howitzer Battalions (towed)
- 1 Self-propelled Howitzer Battalion
- 1 Rocket Launcher Battalion

TANK DIVISION

- 1 Divisional Headquarters
- 3 Tank Regiments
- 1 Motorized Rifle Regiment (BMP)
- 1 SAM Regiment
- 1 Artillery Regiment
- 1 Reconnaissance Battalion
- 1 Helicopter Squadron

MOTORIZED RIFLE DIVISION

- 1 Divisional Headquarters
- 3 Motorized Rifle Regiments (A BTR division has 2 BTR Regiments and 1 BMP Regiment. A BMP division is the reverse.)
- 1 Tank Regiment
- 1 Artillery Regiment
- 1 SAM Regiment
- 1 Antitank Battalion
- 1 Reconnaissance Battalion
- 1 Helicopter Squadron

AIRBORNE DIVISION

- 1 Divisional Headquarters
- 3 Airborne Battalions
- 1 Artillery Regiment
- 1 SO-120 Battalion
- 1 Antiaircraft Battalion

Note: This is by no means a complete listing of the components that make up the various Soviet divisions. In fact, this is more of a generic buildup chart. The huge number of Soviet divisions prevented a division-by-division breakdown of subor-



ordinate formations. Many ancillary formations were left out in order to concentrate on the combat units.

You have probably already noted that the Soviets designate certain divisions as Guards. Historically, the designation Guards has been given to units that have performed well in combat. Since the Soviet Union had not been engaged in a general war before 1995, the title was mainly honorific in nature. The pre-1995 Guards units were no better and no worse than any other Soviet unit when the war began, with the possible exception of the Category I Guards stationed outside the Soviet Union's borders. Those units may have been a little better equipped than other units.

Equipment Descriptions

The following material supplements the VEHICLES section and other sections of the equipment list.

Unarmored Cargo Vehicles

Zil 135: An 8 x 8 heavy truck with fair cross-country performance, the Zil 135 is the carrier for the Bm-27 rocket launcher system. *Price:* \$25,000 (S/C) *TrMov:* 130/30 *Com Mov:* 40/15 *Fuel Cap:* 500 *Fuel Cons:* 85 *Fuel Type:* G, A *Load:* 12 tons *Veh Wt:* 10 tons *Mnt:* 4 *Crew:* 4

Ural 375: A 6 x 6 truck with good cross-country performance, the Ural 375 is the carrier for the Bm-21 rocket launcher system. *Price:* \$20,000 (C/C) *Tr Mov:* 160/40 *Com Mov:* 60/25 *Fuel Cap:* 480 *Fuel Cons:* 80 *Fuel Type:* G, A *Load:* 5 tons *Veh Wt:* 8 tons *Mnt:* 4 *Crew:* 3 + 24

UAZ 469: As per the description in the basic game equipment list. *Price:* \$8,000 (S/C) *TrMov:* 200/40 *Com Mov:* 70/25 *Fuel Cap:* 90 *Fuel Cons:* 30 *Fuel Type:* D, G, A *Load:* 1.25 tons *Veh Wt:* 2 tons *Mnt:* 2 *Crew:* 2 + 4

PTS-M: An unarmored, tracked, amphibious carrier, the PTS-M has a fully enclosed cab located at the extreme front of the vehicle. The cargo/passenger area is open-topped, and there is a rear ramp that drops down for loading cargo. *Price:* \$35,000 (R/S) *Tr Mov:* 80/50 *Com Mov:* 30/20 *Fuel Cap:* 500 *Fuel Cons:* 150 *Fuel Type:* D, A *Load:* 7 tons (land), 11 tons (water) *Veh Wt:* 15 tons *Mnt:* 4 *Crew:* 2

Main Battle Tanks

T-55: A Soviet-built tracked main battle tank. There is a driver's hatch on the left front deck, and a commander's hatch and a loader's hatch on the turret deck. The gunner uses the commander's hatch. A weapons mount (C) is located near the commander's hatch. *Price:* \$200,000 (R/S) *RF:* +15 *Armament:* 100mm gun, PK MG (C) *Ammo:* 43 x 100mm *TrMov:* 100/60 *Com Mov:* 35/20 *Fuel Cap:* 960 + 280 *Fuel Cons:* 240 *Fuel Type:* D, A *Load:* 500 kg *Veh Wt:* 36 tons *Mnt:* 35 *Crew:* 4

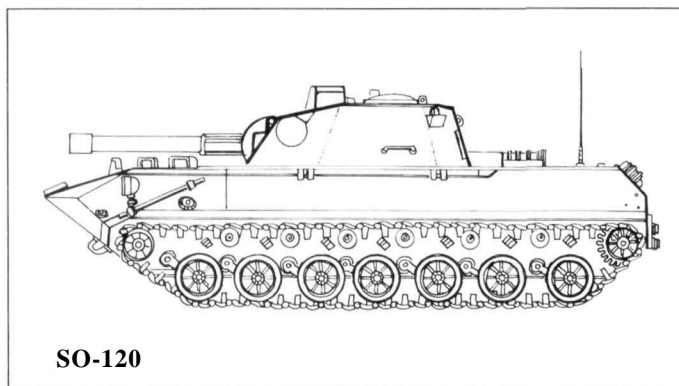

T-62: The T-62 is a tracked main battle tank. The driver has a hatch on the front deck, and the commander and the loader have hatches on the turret. There is a weapons mount (C) by the commander's hatch. *Price:* \$300,000 (R/S) *RF:* +30 *Armament:* 115mm gun, PK MG, DShK MG (C) *Ammo:* 40 x 115mm *Tr Mov:* 100/60 *Com Mov:* 35/20 *Fuel Cap:* 912 *Fuel Cons:* 380 *Fuel Type:* D, A *Load:* 500 kg *Veh Wt:* 36.5 tons *Mnt:* 40 *Crew:* 4

T-64: A tracked main battle tank. The T-64 has a driver's hatch in the center of the front deck, and commander's and gun-

ner's hatch on the turret deck. A weapons mount is located near the commander's hatch. *Price:* \$350,000 (R/S) *RF:* +30 *Armament:* 1 25mm gun, PK MG, DShK MG (C) *Ammo:* 40 x 125 *Tr Mov:* 120/70 *Com Mov:* 40/25 *Fuel Cap:* 960 + 400 *Fuel Cons:* 240 *Fuel Type:* D, A *Load:* 500 kg *Veh Wt:* 38 tons *Mnt:* 20 *Crew:* 3

T-80: Basically a T-64 incorporating better armor (notably in the turret and glacis area) and an improved power plant. The characteristics are the same as the T-64 except as follows: *Price:* \$400,000 *Mnt:* 18

T-72: As per the description in the basic game equipment list. *Price:* \$400,000 (R/R) *RF:* +30 *Armament:* 125mm gun, PK MG, DShK MG (C) *Ammo:* 40 x 125 *TrMov:* 120/70 *Com Mov:* 40/25 *Fuel Cap:* 960 + 400 *Fuel Cons:* 240 *Fuel Type:* D, A *Load:* 500 kg *Veh Wt:* 40 tons *Mnt:* 18 *Crew:* 3

T-74: Basically a T-72 with improvements in the armor; the layout and characteristics are the same except as follows: *Tr Mov:* 110/65 *Com Mov:* 35/20 *Veh Wt:* 41 tons

T-86: A tracked main battle tank, the T-86 has a chassis similar to that of the T-72. The turret is more angular, making it possible for the T-86 to incorporate composite armor. The hatch layout on the T-86 is the same as the T-72. (The T-86 is what was called the T-80 in the basic game equipment list.) *Price:* \$500,000 (R/R) *RF:* +30 *Armament:* 125mm gun, PK MG, DShK MG (C) *Ammo:* 40 x 125mm *Tr Mov:* 120/70 *Com Mov:* 40/25 *Fuel Cap:* 960 + 400 *Fuel Cons:* 240 *Fuel Type:* D, A *Load:* 500 kg *Veh Wt:* 40 tons *Mnt:* 18 *Crew:* 3

T-90: As per the description in the basic game equipment list. *Price:* \$600,000 (R/R) *RF:* +40 *Armament:* 125mm gun, PK MG, DShK MG (C) *Ammo:* 40 x 125 *TrMov:* 120/70 *Com Mov:* 40/30 *Fuel Cap:* 960 + 400 *Fuel Cons:* 240 *Fuel Type:* D, A *Load:* 500 kg *Veh Wt:* 40 tons *Mnt:* 16 *Crew:* 3

M-81: A Romanian-built tracked main battle tank. The chassis is similar to the T-55; however, the turret is larger, allowing room for the German-made 120mm gun. The gun is manually loaded. The M-81 is equipped with side skirts and has a driver's hatch on the front deck. The turret deck has two hatches, one for the commander and one for the gunner. The commander's hatch has a weapons mount. *Price:* \$350,000 *RF:* +25 *Armament:* 1 20mm gun, PK MG, DShK MG (C) *Ammo:* 40 x 120mm *Tr Mov:* 120/70 *Com Mov:* 40/30 *Fuel Cap:* 960 + 400 *Fuel Cons:* 260 *Fuel Type:* D, A *Load:* 500 kg *Veh Wt:* 39 tons *Mnt:* 18 *Crew:* 4

Self Propelled Artillery

SAU-152: As per description in the basic game equipment list. *Price:* \$250,000 (R/R) *RF:* +5 *Armament:* 152mm howitzer, DShK MG (C) *Ammo:* 30 x 1 52mm *Tr Mov:* 100/60 *Com Mov:* 35/25 *Fuel Cap:* 500 *Fuel Cons:* 80 *Fuel Type:* D, A *Load:* 800 kg *Veh Wt:* 28 tons *Mnt:* 10 *Crew:* 5

SAU-122: As per description in the basic game equipment list. *Price:* \$200,000 (R/R) *RF:* +5 *Armament:* 122mm howitzer, DShK MG (C) *Ammo:* 40 x 122mm *TrMov:* 1 20/70 *Com Mov:* 40/30 *Fuel Cap:* 550 *Fuel Cons:* 130 *Fuel Type:* D, A *Load:* 600 kg *Veh Wt:* 26 tons *Mnt:* 10 *Crew:* 4

SAU-203: A tracked, self-propelled gun, the SAU-203 has a fully enclosed armored cab for the crew. The gun is mounted at the rear of the vehicle and is not protected; it has a power-assisted loader. The crew gains access through two hatches on the front deck. *Price:* \$400,000 *Armament:* 203mm gun *Ammo:* 2 x 203mm *Tr Mov:* 80/45 *Com Mov:* 25/15 *Fuel Cap:* 500 *Fuel Cons:* 180 *Fuel Type:* D, A *Load:* 800 kg *Veh Wt:* 40 tons

Mnt: 14 *Crew:* 4

SU-130: The SU-130 is a tracked, turretless assault gun built on the chassis of the T-62A tank. There are hatches for the commander and driver on the top deck (the loader uses the commander's hatch). A weapons mount (C) is next to the commander's hatch. The SU-130 has no indirect fire capability. *Price:* \$250,000 (R/S) *RF:* +20 *Armament:* 130mm gun PK MG, DShK MG (C) *Ammo:* 30 x 130mm *Tr Mov:* 90/50 *Com Mov:* 30/1 5 *Fuel Cap:* 912 + 280 *Fuel Cons:* 380 *Fuel Type:* D, A *Load:* 700 kg *Veh Wt:* 39 tons *Mnt:* 35 *Crew:* 4

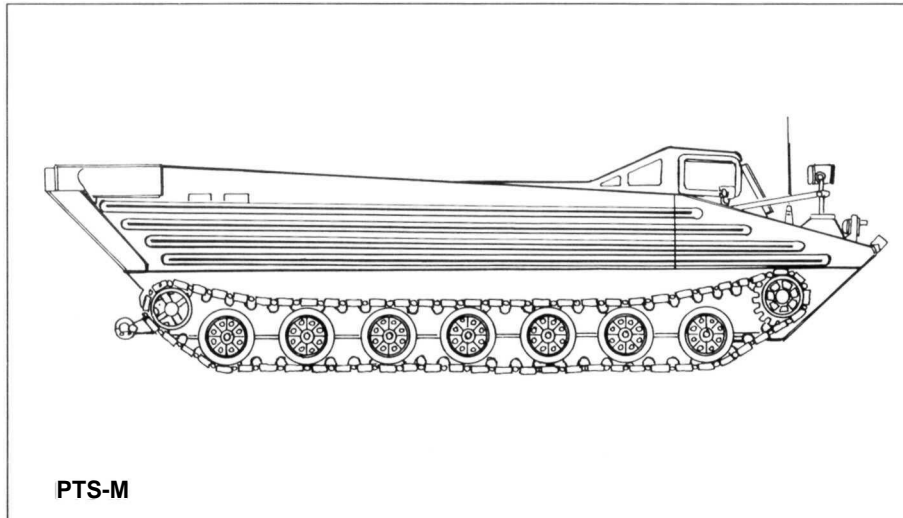

SA-13 ADA: The SA-13 ADA is a tracked, armored, surface-to-air missile system. It carries the SA-13 SAM on an MTLB chassis. The missiles are carried on the top of the vehicle in erectable launcher rails. Some versions have a radar link to an air defense radar. The layout is the same as the MTLB except for the hatches on the rear deck. *Price:* \$85,000 (R/R) *RF:* none *Armament:* PK MG, 4 SA-13 missiles *Ammo:* 8 SA-13 *Tr Mov:* 100/80 *Com Mov:* 35/30 *Fuel Cap:* 450 *Fuel Cons:* 125 *Fuel Type:* D, A *Load:* 2 tons *Veh Wt:* 11 tons *Mnt:* 9 *Crew:* 4

ZSU-30-6: As per the description in the basic game equipment list. *Price:* \$100,000 (R/R) *RF:* +5 *Armament:* 30mm gatling gun *Ammo:* 500 x 30mm *Tr Mov:* 90/55 *Com Mov:* 65/40 *Fuel Cap:* 250 *Fuel Cons:* 80 *Fuel Type:* D, A *Load:* 600 kg *Veh Wt:* 14 tons *Mnt:* 14 *Crew:* 4

Bm-21: A 40-tube rocket launcher usually mounted on a Ural 375 truck. *Reload Time:* 20 combat rounds *Price:* \$45,000 (S/S) *Ammo:* 122mm rockets *ROF:* 40 *Mag:* 60 *Mnt:* 1 *Crew:* 6

Bm-14: A 16-tube multiple rocket launcher, either mounted on a 2½-ton truck or towed. *Reload Time:* 18 combat rounds *Price:* \$25,000 (R/S) *Ammo:* 140mm rockets *ROF:* 16 *Mag:* 16 *Mnt:* 1 *Crew:* 7

Bm-27: A truck-mounted multiple rocket launcher, carried on the Zil 135 8x8 truck. *Reload Time:* 36 combat rounds *Price:* \$60,000 (R/R) *Ammo:* 220mm rockets *ROF:* 16 *Mag:* 16 *Mnt:* 1 *Crew:* 6

Armored Personnel Carriers

BTR-70: As per description in the basic game equipment list. *Price:* \$75,000 (S/C) *RF:* none *Armament:* PK MG, KVP MG *Ammo:* as cargo *Tr Mov:* 160/65 *Com Mov:* 55/25 *Fuel Cap:* 290 *Fuel Cons:* 80 *Fuel Type:* D, A *Load:* 2.5 tons *Veh Wt:* 10 *Mnt:* 6 *Crew:* 3 +14

BTR-80: Very similar in layout to the BTR-70, the BTR-80 has

a different power plant and the firing ports are obliquely angled to provide better forward fire capabilities. The BTR-80 also has small doors near the center of the hull for passenger egress. *Price:* \$85,000 (R/S) *RF:* none *Armament:* PK MG, KVP MG *Ammo:* as cargo *Tr Mov:* 160/65 *Com Mov:* 55/25 *Fuel Cap:* 290 *Fuel Cons:* 70 *Fuel Type:* D, A *Load:* 2.5 tons *Veh Wt:* 10 *Mnt:* 6 *Crew:* 3 +14

BMP-A: The first in the long line of Soviet BMP designs, the BMP-A has a driver's hatch and a commander's hatch on the front deck, and a gunner's hatch on top of the turret. The passenger area is accessible by two hatches on the rear deck and rear doors. There are four firing ports on either side of the passenger compartment. *Price:* \$140,000 (R/S) *RF:* +5 *Armament:* 73mm gun, PK MG *Ammo:* 40 x 73mm *Tr Mov:* 120/70 *Com Mov:* 40/30 *Fuel Cap:* 440 *Fuel Cons:* 110 *Fuel Type:* D, G, Avg, A *Load:* 1.5 tons *Veh Wt:* 13 tons *Mnt:* 12 *Crew:* 3 + 8

BMP-B: As per description in the basic game equipment list. *Price:* \$150,000 (R/S) *RF:* +5 *Armament:* 30mm autocannon, AT-5 launcher, PK MG *Ammo:* 200 x 30mm, 3 x AT-5 *Tr Mov:* 120/70 *Com Mov:* 40/30 *Fuel Cap:* 440 *Fuel Cons:* 110 *Fuel Type:* D, G, AvG, A *Load:* 1.5 tons *Veh Wt:* 12.5 tons *Mnt:* 12 *Crew:* 3 + 8

BMP-C: As per description in the basic game equipment list. *Price:* \$175,000 (R/S) *RF:* +15 *Armament:* 30mm autocannon, PK MG, AGS-17 GL, AT-5 launcher *Ammo:* 200 x 30mm, 3 x AT-5, 100 x 30mm grenades *Tr Mov:* 130/80 *Com Mov:* 45/30 *Fuel Cap:* 520 *Fuel Cons:* 130 *Fuel Type:* D, G, AvG, A *Load:* 1.5 tons *Veh Wt:* 13 tons *Mnt:* 12 *Crew:* 3 + 8

BMD-B: The BMD-B is a tracked, amphibious, infantry combat vehicle developed for the airborne forces. The vehicle includes a driver's hatch on the center front deck, and hatches for the commander and gunner on top of the turret. The combat vehicle's rear passenger compartment has large plate-like hatches for top armor protection, while the passenger compartment has two firing ports on either side. *Price:* \$100,000 (R/S) *RF:* +5 *Armament:* 30mm autocannon, PK MG *Ammo:* 200 x 30mm *Tr Mov:* 160/80 *Com Mov:* 60/30 *Fuel Cap:* 520 *Fuel Cons:* 130 *Fuel Type:* D, A *Load:* 1 ton *Veh Wt:* 9 tons *Mnt:* 12 *Crew:* 3 + 6

MTLB: The MTLB is a tracked, amphibious, multi-purpose vehicle that serves mainly as a prime mover for Soviet AT guns and howitzers. More recently, the multi-purpose vehicle has served as a platform for SAM missiles. The MTLB has a hatch on the left front deck for the driver and a hatch for the commander on the center deck. There are also two hatches on the rear deck and two rear doors for passenger usage. A firing port is in each rear door and on each side of the passenger compartment. *Price:* \$60,000 (R/S) *RF:* none *Armament:* PK MG *Ammo:* as cargo *Tr Mov:* 100/80 *Com Mov:* 35/30 *Fuel Cap:* 450 *Fuel Cons:* 125 *Fuel Type:* D, A *Load:* 2 tons *Veh Wt:* 11 tons *Mnt:* 8 *Crew:* 2 + 11

OT-64: As per the description in the basic game equipment list. *Price:* \$80,000 (S/C) *RF:* none *Armament:* KVP MG *Ammo:* as cargo *Tr Mov:* 180/70 *Com Mov:* 60/30 *Fuel Cap:* 290 *Fuel Cons:* 70 *Fuel Type:* D, A *Load:* 2 tons *Veh Wt:* 14 tons *Mnt:* 6 *Crew:* 3 + 15

Light Combat Vehicles

SO-120: A tracked, amphibious airborne assault vehicle, the SO-120 is based on the BMD-2 chassis and has a turret-mounted 120mm gun/mortar (2S9). There are hatches for the commander and gunner on the turret deck, and two hatches on the front deck for the other two crew members. *Price:* \$120,000 (R/R) *RF:* +15 *Armament:* 120mm gun/mortar *Ammo:* 50 x 120mm *Tr Mov:* 110/60 *Com Mov:* 40/30 *Fuel Cap:* 300 *Fuel Cons:* 125 *Fuel Type:* D, A *Load:* 500 kg *Veh Wt:* 9 tons *Mnt:* 16 *Crew:* 4

BRDM-2: A four-wheel armored scout car that has the retractable wheels like the BRDM-3, the BRDM-2 comes in several variants. The most common are a Spandrell (AT-5) launch platform and a turreted vehicle. There is a hatch for the driver and the commander on the front deck of all versions, and a hatch for the gunner on the turret deck for the turreted version. *Price:* \$45,000 (S/C) *RF:* +5 *Armament:* PK MG, KVP MG (turret version), 5 AT-5 launcher rails (AT-5 version), 4 SA-9/13 (SAM version) *Ammo:* as cargo, 10 AT-5 or 4 SA-9/13 *Tr Mov:* 200/60 *Com Mov:* 70/25 *Fuel Cap:* 290 *Fuel Cons:* 80 *Fuel Type:* G, AvG, A *Load:* 600 kg *Veh Wt:* 8 tons *Mnt:* 4 *Crew:* 4

BRDM-3: As per the description in the basic game equipment list, except the vehicle sometimes has a 23mm autocannon in place of the 30mm autocannon. *Price:* \$50,000 (S/C) *RF:* +5 *Armament:* 30mm or 23mm autocannon, PK MG *Ammo:* 100 x 30mm or 23mm *Tr Mov:* 200/60 *Com Mov:* 70/25 *Fuel Cap:* 290 *Fuel Cons:* 80 *Fuel Type:* G, AvG, A *Load:* 600 kg *Veh Wt:* 8 tons *Mnt:* 4 *Crew:* 4

OT-65: As per the description in the basic game equipment list. *Price:* \$45,000 (S/C) *RF:* +5 *Armament:* 23mm autocannon, PK MG *Ammo:* 150 x 23mm *Tr Mov:* 200/60 *Com Mov:* 70/25 *Fuel Cap:* 290 *Fuel Cons:* 80 *Fuel Type:* D, A *Load:* 700 kg *Veh Wt:* 8 tons *Mnt:* 4 *Crew:* 4

BT-76: A tracked, amphibious light tank designed to give mobile fire support to airborne and air assault units. The BT-76 replaced the PT-76 and the ASU-85 and was itself being replaced by the SO-120 when the war started. There is a driver's hatch in the center of the front deck, and hatches for the commander and gunner on the turret deck. A weapons mount (C) is by the commander's hatch. *Price:* \$70,000 (R/S) *RF:* +30 *Armament:* 76.2mm gun, PK MG, NSV MG (C) *Ammo:* 40 x 76.2mm *Tr Mov:* 160/80 *Com Mov:* 60/30 *Fuel Cap:* 300 *Fuel Cons:* 125 *Fuel Type:* G, A *Load:* 800 kg *Veh Wt:* 13.5 tons *Mnt:* 12 *Crew:* 3

BT-57: A variant of the BT-76 armed with a 57mm autocannon. Characteristics are the same except the following: *Price:* \$75,000 (R/S) *Armament:* 57mm autocannon, PK MG, NSV MG (C) *Ammo:* 60 x 57mm

BMD Weapons Carrier: The BMD is the same vehicle as the BMD-B but with the turret removed. Two AGS-17 grenade launchers are on either side of the space where the turret used to be, and two PK machinegun mounts have been fitted, one on the bow firing forward and another on the rear deck firing to the rear. The driver's hatch is still on the front deck, and the place where the turret was is now open-topped. *Price:* \$110,000 (R/S) *Armament:* 2 AGS-17s, 2PK MG *Ammo:* as cargo *Tr Mov:* 160/80 *Com Mov:* 60/30 *Fuel Cap:* 520 *Fuel Cons:* 130 *Fuel Type:* D, A *Load:* 1 ton *Veh Wt:* 8.5 tons *Mnt:* 11 *Crew:* 3 + 6

BMP Automortar: A turretless BMP with an 82mm Vasilyek mounted in the chassis in place of the turret. Characteristics are the same except for reduced passenger capabilities. *Price:* \$160,000 (R/R) *RF:* none *Armament:* 82mm mortar, PK MG *Ammo:* 40 x 82mm *Tr Mov:* 120/70 *Com Mov:* 40/30 *Fuel Cap:* 440 *Fuel Cons:* 110 *Fuel Type:* D, G, AvG, A *Load:* 1.5 tons *Veh Wt:* 11 tons *Mnt:* 10 *Crew:* 4

BMP-120: Another variant of the BMP, this one mounting the 2S9 120mm gun/mortar turret. Intended for close artillery support, this vehicle does not carry passengers. Instead, the rear area is for stowage of ammunition. *Price:* \$185,000 (R/R) *RF:* +10 *Armament:* 120mm gun/mortar, PK MG *Ammo:* 40 x 120mm *Tr Mov:* 120/70 *Com Mov:* 40/30 *Fuel Cap:* 440 *Fuel Cons:* 125 *Fuel Type:* D, G, AvG, A *Load:* 1.5 tons *Veh Wt:* 14 tons *Mnt:* 11 *Crew:* 3

TAB-90: A tracked, infantry combat vehicle designed and built in Romania, the TAB-90 has a turret-mounted 23mm autocannon. There is a driver's hatch on the front deck, and a hatch for the commander and the gunner on the top of the turret. A large hatch on the rear deck allows passenger entry. Two firing ports are on either side of the vehicle. *Price:* \$110,000 (R/S) *RF:* +5 *Armament:* 23mm autocannon *Ammo:* as cargo *Tr Mov:* 150/70 *Com Mov:* 50/25 *Fuel Cap:* 500 *Fuel Cons:* 125 *Fuel Type:* D, A *Load:* 1 ton *Veh Wt:* 10 tons *Mnt:* 12 *Crew:* 3 + 6

Engineer Vehicles and Hovercraft

MTU-20: A tracked cantilever-type bridging vehicle based on a T-55 chassis. The turret has been removed so the bridge span can lay flat on the deck area. The bridge can span 18 meters. *Price:* \$200,000 (R/R) *Tr Mov:* 100/60 *Com Mov:* 35/20 *Fuel Cap:* 960 *Fuel Cons:* 220 *Fuel Type:* D, A *Load:* 500 kg *Veh Wt:* 37 tons *Mnt:* 16 *Crew:* 2

KvP-92: An amphibious air cushion vehicle developed in the early 1990s for the Soviet Naval Infantry, the KvP-92 was found equally suitable for the Arctic brigades. There is a hatch on the front deck for the driver, hatches on the top deck for the commander and the gunner, a bow ramp, and a door on either side for the passengers. *Price:* \$300,000 (R/R) *RF:* +15 *Armament:* 30mm autocannon, AT-5 launcher *Ammo:* 200 x 30mm, 6 x AT-5 *Tr Mov:* 150 *Com Mov:* 55 *Fuel Cap:* 520 *Fuel Cons:* 240 *Fuel Type:* D, A *Load:* 1 ton *Veh Wt:* 11 tons *Mnt:* 24 *Crew:* 3 + 8

KvP-92v: The same vehicle as the KvP-92 except it carries the 82mm Vasilyek automortar. The statistics are the same ex-

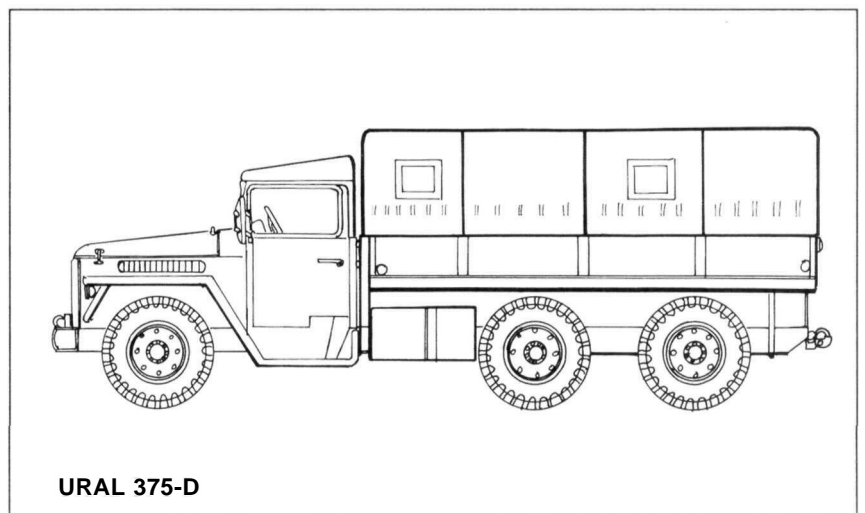

URAL 375-D

cept for the following: *RF: +5 Armament: 82mm automortar Ammo: 60 x 82mm Crew: 4*

KvP-92z: Again, the KvP-92z is another variant of the KvP-92, this time with a 30mm gatling gun like the one on the ZSU-30-6. The gun is mounted on a 360-degree rotating base plate. The statistics are the same except for the following: *RF: +5 Armament: 30mm gatling gun Ammo: 500 x 30mm Crew: 4*

KvP-121: A large air cushion vehicle used for transport, the KvP-121 has a large enclosed cargo space that is accessible through large front doors, which drop down to form ramps when loading. The crew is in a fully enclosed cab on the top of the vehicle. *Price: \$800,000 (R/R) TrMov: 120 Com Mov: 40 Fuel Cap: 50,000 Fuel Cons: 600 Fuel Type: D, A Load: 225 tons Veh Wt: 86 tons Mnt: 35 Crew: 8 + 1 50*

Large Caliber Guns

ZU-23-2: A towed, twin gun version of the 23mm autocannon, the ZU-23-2 can be mounted or towed on a 2.5 ton or larger vehicle. *Price: \$15,000 (S/C) RF: +5 Wt: 950 kg Mnt: 2 Crew: 4*

57mm Autocannon: A magazine-fed autocannon mounted in the BT-57 LAV, the 57mm autocannon is fed from a four-shot magazine. The data below applies to the towed version. *Price: \$40,000 (R/S) RF: +5 Wt: 4.5 tons Mnt: 4 Crew: 8*

73mm Gun: A large-caliber gun mounted on the BMP-A armored personnel carrier.

76.2mm D-56tm Gun: A large-caliber gun mounted on the BT-76 LAV, the BT-76 is equipped with an autoloader.

100mm D-10 Gun: A large-caliber gun mounted in the T-55 and used as a field antitank gun (the M1955). The M1955 has an armor class 15 gunshield providing protection against hostile fire from the front. *Price: (M1955) \$40,000 (R/S) Wt: (M1955) 3.3 tons RF: + 15 Mnt: 6 Crew: 8*

115mm U5TS Gun: A manually loaded gun mounted on the T-62 series of tanks.

120mm Automortar: A large-caliber, turret-mounted gun/mortar. The weapon is placed on the BMD and BMP chassis to provide heavy close artillery support.

130mm M1946 Gun: A manually loaded gun mounted on the SU-130 assault and the M1946 towed field piece, the M1946 has a gunshield of armor class 15, which provides protection against fire from the front of the gun.

203mm M1975 Gun: A large-caliber gun mounted on the SAU-203, the 203 has a power-assisted loader.

Anti-aircraft Missiles

SA-9: A four-rail launcher system usually mounted on an MTLB or a BRDM carrier.

SA-14: A four-rail launcher system mounted on MTLBs or BRDMs.

AMMUNITION

Rockets

220mm Rocket HE: *Wt: 300 kg Price: \$800 (R/R)*

220mm Rocket CHEM: *Wt: 300 kg Price: \$800 (R/R)*

140mm Rocket HE: *Wt: 240 kg per case of 8 rounds Price: \$2,800 per case (R/R)*

140mm Rocket CHEM: *Wt: 240 kg per case of 8 rounds Price: \$2,800 per case (R/R)*

122mm Rocket HE: *Wt: 250 kg per case of 4 rounds Price: \$1,400 per case (R/R)*

122mm Rocket CHEM: *Wt: 250 kg per case of 4 rounds Price: \$1,400 per case (R/R)*

Antiarmor Missiles

AT-8: A radio-guided missile with a HEAT warhead, the AT-8 is fired from the main gun of the T-64, T-80, T-86 and T-90 main battle tanks. The AT-8 can also be used against helicopters. *Wt: 30 kg Price: \$2,000 (R/S)*

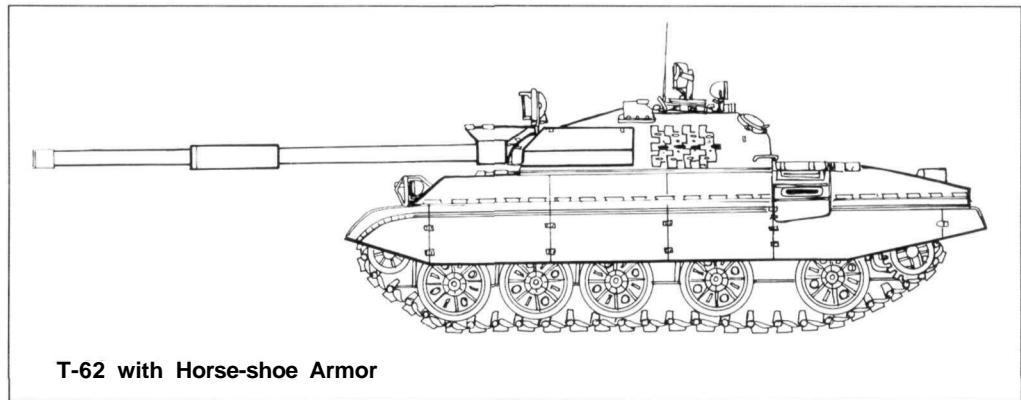

T-62 with Horse-shoe Armor

Anti-aircraft Missiles

SA-7: The SA-7 is a heat-seeking missile fired from a disposable gripstock launcher. Data includes launcher. *Wt: 10 kg Price: \$850 (R/S)*

SA-9: A heat-seeking missile with an HE warhead. *Wt: 55 kg Price: \$1,000 (R/R)*

SA-13: A heat-seeking missile with an HE warhead. *Wt: 50 kg Price: \$1,500 (R/R)*

SA-14: A heat-seeking missile fired from a gripstock launcher, the SA-14 has an HE warhead. Data includes launcher. *Wt: 10 kg Price: \$950 (R/S)*

Large Caliber Rounds

57mm HE: *Wt: 7 kg Price: \$100 (S/C)*

57mm APDS: *Wt: 8 kg Price: \$125 (R/S)*

57mm APHE: *Wt: 8 kg Price: \$150 (R/S)*

73mm HE: *Wt: 9 kg Price: \$150 (R/S)*

73mm HEAT: *Wt: 9 kg Price: \$175 (R/S)*

120mm HE: *Wt: 25 kg Price: \$450 (S/C)*

120mm HEAT: *Wt: 25 kg Price: \$500 (R/S)*

120mm CHEM: *Wt: 25 kg Price: \$500 (R/R)*

100mm HE: *Wt: 20 kg Price: \$400 (R/S)*

100mm APC: *Wt: 20 kg Price: \$400 (R/S)*

100mm HEAT: *Wt: 20 kg Price: \$450 (R/R)*

100mm APDS: *Wt: 22 kg Price: \$500 (R/R)*

115mm HE: *Wt: 25 kg Price: \$400 (R/S)*

115mm HEAT: *Wt: 25 kg Price: \$450 (R/R)*

115mm APDS: *Wt: 27 kg Price: \$500 (R/R)*

130mm HE: *Wt: 25 kg Price: \$550 (R/S)*

130mm HEAT: *Wt: 25 kg Price: \$600 (R/S)*

130mm APFSDS: *Wt: 25 kg Price: \$750 (R/R)*

130mm CHEM: *Wt: 25 kg Price: \$900 (R/R)*

203mm HE: *Wt: 50 kg Price: \$1,000 (R/R)*

Other Equipment

Horse-Shoe Armor: Simply a large cast block of steel attached to the turret of the T-55 and T-62 tanks, horse-shoe armor provides an additional 30 units of protection. Turret front hits have an 85-percent chance of hitting the horse-shoe armor. Any turret side hits have a 50-percent chance of hitting the horse-shoe armor. Not all T-55s or T62s will have this extra armor; it is up to the referee as to the frequency of its occurrence. Horse-shoe armor also decreases a vehicle's speed by 10 percent. *Wt:* 220 kg per unit *Price:* \$300 (R/S)

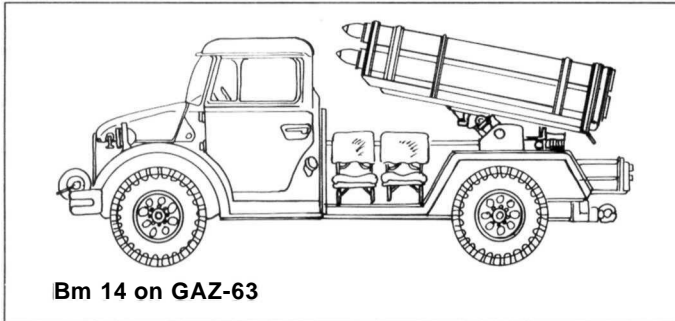

Bm 14 on GAZ-63

Reactive Armor: These are special explosive charges fastened to an AFV for additional armor protection. Reactive armor units explode when hit by a shell of 35mm or more. The outwardly directed explosion interferes with HEAT-type warheads. Reactive armor has little effect on kinetic energy penetrators. Reactive armor provides an additional 200 units of armor protection, or halves the value of the HEAT warhead, whichever is greater. Reactive armor can be installed on the turret front, back and sides, and also to the glacis if the AFV has the appropriate lugs. Installing the lugs takes one man-hour per lug and welding equipment.

A reactive unit covers 10 percent of an armor face and is destroyed when it is activated. The number of units hit times 10 is the percent chance of hitting a part of the face unprotected by reactive armor. *Wt:* 10 kg *Price:* \$5,000 (R/R)

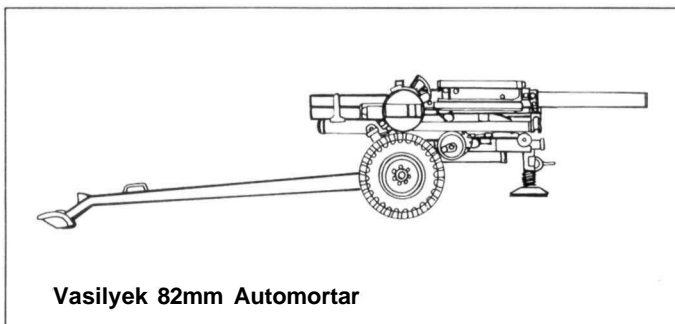

Vasilyek 82mm Automortar

Hovercraft: Because of their extremely low ground pressure, hovercraft can go places ordinary vehicles cannot. Hovercraft have less ground pressure than a human on foot and can go where a person would sink out of sight. They can traverse swamps and tundra that would bog a conventional vehicle, cross water as easily as land and cross any obstacle that is no higher than their air-cushion skirt. For game purposes, terrain has the following effect on travel movement: *Open:* N *Wood:* N *Swamp:* N *Hill:* N *Mountain:* N. They suffer no penalties for crossing water.

Hovercraft do have some limitations. They cannot cross steep terrain (such as ravines or gullies) or obstacles (such as boulders or fences) more than a meter or so tall. They can push small

trees and underbrush aside, but large, closely set trees will stop them. The referee should designate the presence of any such obstacles to hovercraft movement that may be present in a particular combat situation before the scenario begins.

Soviet Fire Chart Data

Grenade Launchers

Type	Rnd	Rng	Dam	Arm	KDR	Burst	IFR
AGS-17	HE	150	x8C	x10	2.5	5	1700
	ROF:5						
	Mag:30						

Rocket Launchers

Type	Rnd	Rng	Dam	Arm	KDR	Burst
RPG-16	HEAT	150	x25C	—	5	10
	ROF: 1					
	Mag:(2)					

Antitank Missiles

Type	ROF	Mag	Rng	Dam	Arm	KDR	Burst
AT-4	1	(3)	2000	x30C	—	5	10
AT-5	1	(2)	3500	x35C	—	5	10
AT-8	1	(2)	8000	x60C		10	15

Large Caliber Guns

Type	Rnd	Rng	Dam	Arm	KDR	Burst	IFR
23mm	API	250	x4	—	—	—	
	ROF:5		HE	250	x4C	x10	2.5 5
	Mag:33						
30mm	API	250	x6			—	
	ROF: 5		HE	250	x6C	x10	2.5 5
	Mag:33						
57mm S-60	APFSDS	500	x 17	1/2	—	—	—
	ROF:4		APHE	400	x8C	—	—
	Mag:4		HE	350	x16C	10	5 15
73mm	HE	250	x20C	1/2	x 10	5	—
	ROF:3		HEAT	250	15C	—	2 15
	Mag:1						
100mm D-10	HE	250	x30C	x15	10	20	21000
	ROF:1		HEAT	250	x15C	x 10	5 10 21000
	Mag:(2)		APHE	250	x7C	—	— 21000
			APC	300	x20		21000
115 U5TS	APFSDS	400	x25	—	—	—	—
	ROF: 1		HEAT	300	x20C	5	10 —
	Mag:(2)		HE	400	x30C	x 10	15 25
120mm G	HEAT	400	x30C	—	5	20	—
	ROF:1		APFSDS	550	x35	—	— —
	Mag:1		HE	500	x35C	x10	15 25
125mm	HE	400	x30C	x10	10	30	
	ROF: 1		HEAT	400	x30C	—	5 20
	Mag:(2)		APFSDS	500	x35	—	—
			APFSDSDU	500	x35	1/1	
130mm	HEAT	500	x30	—	5	25	—
	ROF: 1		HE	500	x35C	x10	15 30 27000
	Mag:(2)		APFSDS	550	x25	—	—
			CHEM	500	x2C	x10	20 27000
203mm	HE	—	x40	x5	40	60	30000
	ROF: 1						
	Mag:(3)						

Howitzers

Type	Rnd	Rng	Dam	Arm	KDR	Burst	IFR
122mm	HE	300	x30C	x10	10	30	15000
	ROF: 1		HEAT	300	x30C	5	20 15000
	Mag:1		WP	300	x15C	x10	— 35 15000
			CHEM	300	x2C	x10	— 15 15000
			ICM	—	x10C	x10	30 35 15000
			ILLUM	300			1500 15000
152mm	HE	300	x40C	x10	15	40	18500
	ROF: 1		HEAT	350	x10	—	5 10 18500
	Mag:(2)		WP	300	x15C	x10	— 45 18500
			CHEM	300	x2C	x10	— 25 18500
			ICM	—	x10C	x10	50 60 18500
			ILLUM	300			2000 18500
155mm	HE	350	x40C	x10	15	40	24000
	ROF: 1		HEAT	350	x35C	10	30 24000
	Mag:(2)		CHEM	350	x2C	x10	— 25 24000
			ILLUM				2000 24000

Mortars

Type	Rnd	Rng	Dam	Arm	KDR	Burst	IFR
82mm	HE	200	x25C	x10	5	30	3000
	ROF:5		HEDP	200	x25C	x2	2.5 15 3000
	Mag:5		WP	200	x15C	x10	— 20 3000
			ILLUM	200			1000 3000
120mm	HE	—	x35C	x10	10	45	5700
	ROF:1		WP	—	x15C	x10	— 40 5700
	Mag:1		ILLUM				— 1500 5700
			CHEM	—	x1C	x10	— 15 5700

Artillery Rockets

Type	Rnd	Rng	Dam	Arm	KDR	Burst	IFR
122mm Bm21	HE	—	x30C	x10	10	30	20000
	ROF: 40		CHEM	—	x2C	MO	— 15 20000
	Mag: (60)						
140mm Bm14	HE		x35C	x10	15	40	10600
	ROF: 16		CHEM	—	x2C	x10	— 15 10600
	Mag: (36)						
220mm Bm27	HE	—	x40C	x10	30	60	35000
	ROF: 16		CHEM	—	x2C	x10	— 30 35000
	Mag: (36)						

Antiaircraft Missiles

Type	Rof	Mag	Rng	Dam	Arm	KDR	Burst
SA-7	1		1/2	4000	x10C	x 10	— 5
SA-14	1		1/2	6000	x10C	x 10	— 5
SA-9	4		4	3000	x15	x5	— 5
SA-13	2		4	10000	x20	x5	2.5 15

Additions to the Vehicle Damage Location List

Unarmored Cargo Vehicles

ZIL-135

Per unarmored cargo listing, referee's charts.

URAL-375

Per unarmored cargo listing, referee's charts.

PTS-M

Per unarmored cargo listing, referee's charts, except the PTS-M is a tracked vehicle. The damage multiplier remains 10 but hits that would miss a wheeled vehicle will hit the PTS-M.

Armored Personnel Carriers

MTLB

R: LH(25),G(25),HB(10) G,C,A,P,S
L: LH(25),G(25),HB(10) D,C,E,F,P,S
L&C: TF,TB Miss
R: TF(15),TS(15),TB(15) W,G
F: HS(10) D,C,R,E
C: HS(10) E,F,S,P
B: (10) F,S,P
FD(10) D,C,R,E
TD(10) E,F,S,P
RD(10) F,S,P

BMD WEAPONS CARRIER

R: LH(30),G(40),HB(15) E,A,P,F
L: LH(30),G(40),HB(15) D,C,R,A,P,F
R: TF(0),TB(0) Miss
C: TF(40),TB(20) Miss
L: TF(0),TB(0) Miss
TS: (20) M,X,W,N,G
F: HS(15) D,C,R,E
C: HS(15) G,A,P,S
R: HS(15) P,F
FD (10) D,C,R,E
TD (10) M,X,W,N,G,A
BD (10) P,S,F

BMD B

R: LH(30),G(40),HB(15) E,A,P,F
L: LH(30),G(40),HB(15) D,C,R,A,P,F
R: TF(0),TB(0) Miss
C: TF(40),TB(20) M,X,W,N,G
L: TF(0),TB(0) Miss
TS: (20) M,X,W,N,G
F: HS(15) D,C,R,E
C: HS(15) G,A,P,S
R: HS(15) P,F
FD (10) D,C,R,E
TD (10) M,X,W,N,G,A
BD (10) P,S,F

BTR-80

R: LH(15),G(20),HB(20) C,S,P,E,F
L: LH(15),G(20),HB(20) D,R,S,P,E,F
R&L: TF,TB Miss
C: TS(20),TF(20),TB(20) X,W,G
F: HS(20) D,R,C
C: HS(20) P,G,S
B: HS(20) F,E
FD(15) D,C,R
TD(15) X,W,G
RD(15) P,F,S,E

Light Combat Vehicles

BRDM-2

R: LH(20),G(20),HB(15) C,R,P,S,E,F
L: LH(20),G(20),HB(15) D,G,S,E,F
R&L: TF(15),TB(15) W,G
C: TS(15),TF(15),TB(15) X,W,N,G
F: HS(15) D,C,R
C: (15) P,G,S
B: (15) F,E
FD(15) D,C,R
TD(15) X,W,N,G,P
BD(15) S,F,E

SO-120 (BMD CHASSIS)

R: LH(30),G(40),HB(15) E,A,P,F
L: LH(30),G(40),HB(15) D,C,R,A,P,F
R: TF(40),TB(20) W,N,G
C: TF(40),TB(20) M,X,W,N,G
L: TF(40),TB(20) W,N,G
TS(20) M,X,W,N,G
F: HS(15) D,C,R,E
C: HS(15) G,A,P,S
R: HS(15) P,F
FD(10) D,C,R,E
TD(10) M,X,W,N,G,A
BD(10) P,S,F

SO-120 (BMP CHASSIS)

R: LH(50),G(50),HB(20) E,A,P,F
L: LH(50),G(50),HB(20) D,C,R,A,P,F
R: TF(40),TB(20) W,N,G
C: TF(40),TB(20) M,X,W,N,G
L: TF(40),TB(20) W,N,G
TS(20) M,X,W,N,G
F: HS(15) D,C,R,E
C: HS(15) G,A,P,S
R: HS(15) P,F
FD(10) D,C,R,E
TD(10) M,X,W,N,G,A
BD(10) P,S,F

BMP AUTOMORTAR

R: LH(50),G(50),HB(20) E,A,P,F
L: LH(50),G(50),HB(20) D,C,R,A,P,F
R: TF, TB Miss
C: TF,TB Miss *
L: TF,TB Miss
TS (20) M,X,W,N,G
F: HS(15) D,C,R,E
C: HS(15) G,A,P,S
R: HS(15) P,F
FD (10) D,C,R,E
TD (10) M,X,W,N,G,A
BD (10) P,S,F

BT-76, BT-57

R: LH(40),G(60),HB(20) E,AP,F
L: LH(40),G(60),HB(20) D,C,R,A,P,F
R: TF,TB Miss
C: TF(60), TB(20) M,X,W,N,G
L: TF,TB Miss
TS: (20) M,X,W,N,G
F: HS(20) D,C,R,E
C: HS(20) G,A,S
R: HS(20) F,A
FD (10) D,C,R,E
TD (10) M,X,W,N,G,A
BD (10) S,F

TAB-90

R: LH(20),G(25),HB(20) C,S,P,E,F
L: LH(20),G(25),HB(20) D,R,S,P,E,F
R&L: TF(20),TB(20) X,W,G
C: TS(20),TF(20),TB(20) X,W,G
F: HS(20) D,R,C
C: HS(20) P,G,S
B: HS(20) F,E
FD(15) D,C,R
TD(15) X,W,G
RD(15) P,F,S,E

Main Battle Tanks

T-64

R: LH(120),G(350),HB(50) D,C,R,S,A,E,F
L: LH(120),G(350),HB(50) D,G,S,A,E,F
R: TF(250),TB-R(90) C,R
C: TF(250),TB(90) X,W,N,A
L: TF(250),TB(90) G
TS(90) L,C,G,W,A,X
F: HS(70) D,R
C: HS(70) L,G,S
B: (70) E,F
FD(20) D,R
TD(20) X,W,C,G,L,N,S,A
RD(20) F,E,A

T-80 (NEW)

R: LH(170),G(375),HB(50) D,C,R,S,A,E,F
 L: LH(170),G(375),HB(50) D,G,S,A,E,F
 R: TF(270),TB-R(90) C,R
 C: TF(270),TB(90) X,W,N,A
 L: TF(270),TB(90) G
 TS(95) G,W,N,C,X
 F: HS(75) D,R,A
 C: HS(75) G,A,S
 B: (75) F,E
 FD(20) D,A,R
 TD(20) X,W,N,C,G,L,S,A
 RD(20) F,E

T-74

R: LH(250),G(400),HB(50) D,C,R,S,A,E,F
 L: LH(250),G(400),HB(50) D,G,S,A,E,F
 R: TF(320),TB-R(100) C,R
 C: TF(320),TB(100) X,W,N,A
 L: TF(320),TB(100) G
 TS(120) G,W,N,A,C,X
 F: HS(80) D,R,A
 C: HS(80) G,A,S
 B: (80) F,E
 FD(25) D,A,R
 TD(25) X,W,N,C,G,L,S,A
 RD(25) F,E

M-81

R: LH(170),G(350),HB(50) D,R,G,E,F
 L: LH(170),G(350),HB(50) D,L,S,E,F
 R: TF(300),TB-R(85) G,C,A
 C: TF(300),TB(85) X,W,N,A
 L: TF(300),TB(85) L,A
 TS(85) L,C,G,W,A,X
 F: HS(60) D,R
 C: HS(60) L,G,S
 B: (60) E,F
 FD(20) D,R
 TD(20) X,W,C,G,L,N,S,A
 RD(20) F,E,A

T 62

R: LH(100),G(350),HB(50) D,R,G,E,F
 L: LH(100),G(350),HB(50) D,L,S,E,F
 R: TF(200),TB(80) G,C,A
 C: TF(200),TB(80) X,W,N,A
 L: TF(200),TB(80) L,A
 TS: (80) L,C,G,W,A,X
 F: HS(60) D,R
 C: HS(60) L,G,S
 R: HS(60) E,F
 FD (20) D,R
 TD (20) X,W,C,G,L,N,S,A
 BD (20) F,E,A

T-55

R: LH(100),G(300),HB(50) D,R,G,E,F
 L: LH(100),G(300),HB(50) D,L,S,E,F
 R: TF(170),TB(80) G,C,A
 C: TF(170),TB(80) X,W,N,A
 L: TF(170),TB(80) L,A
 TS: (80) L,C,G,W,A,X
 F: HS(60) D,R
 C: HS(60) L,G,S
 R: HS(60) E,F
 FD (20) D,R
 TD (20) X,W,C,G,L,N,S,A
 BD (20) F,E,A

Self Propelled Artillery**SU-130**

R: LH(125),G(400),HB(50) D,R,W,G,E,F
 L: LH(125),G(400),HB(50) D,R,W,L,A,E,F
 R: TF,TB Miss
 C: TF,TB Miss
 L: TF,TB Miss
 TS Miss
 F: HS(60) D,R,W
 C: HS(60) L,C,S
 R: HS(60) E,F
 FD (20) D,R
 TD (20) X,W,C,G,L,N,S,A
 BD (20) F,E,A

SA-13

R: LH(25),G(25),HB(10) G,C,A,P,S
 L: LH(25),G(25),HB(10) D,C,E,F,P,S
 L&C: TF(0),TB(0) W
 R: TF(15),TS(15),TB(15) G
 F: HS(10) D,C,R,E
 C: HS(10) E,F,S,P
 B: (10) F,S,P
 FD(10) D,C,R,E
 TD(10) E,F,S,P
 RD(10) F,S,P

SAU-203

R: LH(25),G(25),HB(10) C,S
 L: LH(25),G(25),HB(10) D,E,F
 L&C: TF,TB W
 R: TF(15),TS(15),TB(15) G
 F: HS(10) E,F
 C: HS(10) E,F,S,P
 B: (10) F,S,P
 FD(10) R,E
 TD(10) E,F,S,P
 RD(10) F,S,P

Engineering Vehicles & Hovercraft**MTU-20**

R: LH(100),G(300),HB(50) D,R,G,E,F
 L: LH(100),G(300),HB(50) D,L,S,E,F
 R: TF(0),TB-R(0) *
 C: TF(0),TB(0) *
 L: TF(0),TB(0) *
 TS(0) Miss
 F: HS(60) D,R
 C: HS(60) L,G,S
 B: (60) E,F
 FD(20) *(D,R)
 TD(20) *(X,W,C,G,L,N,S-
 ,A)
 RD(20) F,E,A

* Any turret or deck hits are taken in the bridge, which has a damage multiplier of x 50. If the bridge has been deployed, turret hits count as misses, and deck hits use parenthetical ratings.

KVP-92 (ALL VERSIONS)

R: LH(30),G(40),HB(0) A,P,E,F
 L: LH(30),G(40),HB(0) D,C,R,A,P,F,E
 R&L: TB,TF Miss
 C: TF(50),TB(20) M,W,N,A,L
 TS(40) M,W,N,A,X,L
 F: HS(20) D,R
 C: HS(20) C,G,A,P,S
 R: HS(20) E,F
 FD (10) D,R
 TD (10) M,W,N,C,G,L,P,S-
 ,A
 BD (20) F,E

Treat all turret hits on the KVP-92z as gun hits. Any gun hit destroys the weapon. The damage multiplier for a hovercraft suspension hit is x 20. A hovercraft counts as a tracked vehicle on the vehicle hit location chart.

KVP-121

Per unarmored cargo listing, referee's charts. Suspension hits are taken in the air cushion skirts (small arms fire has no effect on the KVP-121's suspension, since it takes an almost infinite number of hits to cause significant air leakage). Because of the size of the vehicle's cargo bay, the referee will need to bear in mind the exact arrangement of any vehicles or personnel carried by the KVP-121.

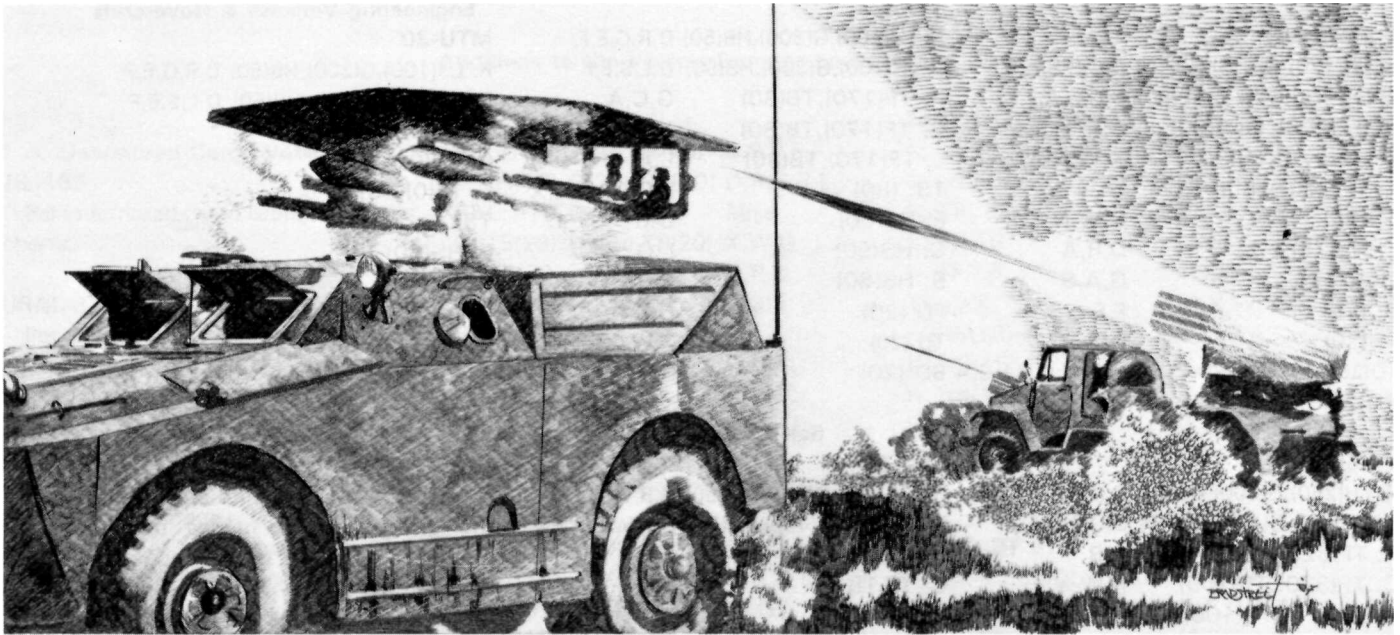

The Color Plate Notes

A1: *T-72 of the 38th Motorized Division; Korea, early 1998.*

Even though the T-72 series was over twenty years old when the war broke out, it was still a match for many of its opponents, particularly the Chinese and the minor participants in the war. T-72s were just being phased out of production in the late 1980s. Common Soviet practice after that time was to use T-72s as the one of the main battle tanks for the tank regiment of the motorized rifle divisions.

This vehicle has neither the searchlight (usually mounted to the right of the main gun) nor the smoke dischargers, which are standard equipment, and it is unclear as to whether these have been removed intentionally or as a result of battle damage. The overall appearance of the tank and the presence of the external fuel tank is a strong indicator that the vehicle has not taken extensive damage and that it is in good shape. The red star on the turret is a nonstandard marking that was applied by the crew.

This was a common practice as the war progressed and is thought to have been an expression of national pride. Since the marking was unofficial, no stencil was issued, and it tends to vary in size and quality depending on the care taken by a particular vehicle's crew.

A2: *T-30 of the 75th Motorized Rifle Division; Iran, 1998.*

The T-90 began production in the early 1990s and was issued to category I units in Germany and the Soviet Union. The T-90 incorporated the best of Soviet tank design to that point, including composite armor, very low profile and improved track-laying.

This vehicle was probably not part of the original issue of equipment to the 75th MRD. The commander of the 7th Guards Army, of which The 75th MRD was a part, probably "borrowed" it from another unit prior to the invasion of Iran. Note the brown-green camouflage pattern adopted by many tanks in Iran and the ubiquitous, crew-painted red star. Also, this tank has a number on the turret, a device which some Army commanders

adopted for vehicle identification, one of which was the commander of the 7th Guards Army. The last full skirt at the back of the vehicle and the two road wheels below the skirt have been replaced recently, indicating the vehicle was damaged and subsequently repaired. The skirt and wheels have not been repainted to match the rest of the camouflage pattern.

A3: *OT-64 in Finnish service; 1997, Finland.*

The OT-64 was developed by the Czech and Polish Armies and purchased by many armies, among which was the Finnish Army. This plate is taken from a vehicle which survived the war and was used by a Finnish lumber company for several years before being sold to a private collector. The vehicle is somewhat battle-worn and rusty, as is to be expected. The ID number at the rear of the vehicle has not helped to identify the parent unit of the vehicle. Also, the camouflage scheme is not a standard pattern for the Finnish area of operations, making the vehicle even harder to place, but the colors are authentic Finnish Army formulas.

A4: *T-86 of the 9th Guards Tank Division; Poland, 1999.*

The T-86 continued the Soviet tradition of evolutionary rather than revolutionary tank design. The late 1980s saw the Soviets wrestle with the problem of Chobham armor without finding a satisfactory solution. As a stopgap, the Soviets developed a composite armor, which they used as armor for the turret of the T-86. The angular turret mounted on the T-72 chassis proved to be an all too common and none too pleasant sight for US soldiers in Europe.

The photograph from which this plate was taken was acquired from a captured tanker of the 9th Guards TD in 1999. The vehicle has recently been given a summer camouflage scheme and still has its searchlight, smoke dischargers and external fuel tank, indicating it is in good repair. The lack of marking on the vehicle, other than the red star, is typical. The red star is a hand-painted marking done by many Soviet tankers soon after the war started.

B1: *An SAU-152 from the 11th Guards Tank Division; Poland, 1998.*

Along with the SAU-122, the SAU-152 has been the mainstay of the Soviet self-propelled artillery for many years. These two weapons provide for mobile, high-caliber fire that can be delivered very close to front lines while providing protection to the crews.

This vehicle is interesting not only because of the hand-rendered red star but also the Guards crest at the front of the turret. The Guards crest is also nonstandard and was probably done by the crew as a sign of unit pride. The 11th Guards were engaged against US forces for much of the war, and it seems likely that the habit of painting things on their tanks may have been picked up by Soviet tankers from their US counterparts, although the practice is not limited to the Americans (and was practised by some Soviet vehicle crews in WWII). Many Soviet vehicles that have slogans, pictures, etc. painted on them have been in action against US forces. The crest on this vehicle is well deserved. The 11th Guards fought well.

The camouflage pattern on this vehicle is a basic summer pattern for Europe and appears to be relatively fresh. The vehicle shows little battle damage, which is unusual since it has almost certainly seen much combat.

B2: *SAU-122 with the 37th Motorized Rifle Division; near Leningrad, 1998.*

This vehicle was part of the self-propelled howitzer battalion of the tank regiment of the 37th MRD. The identification number on the rear hull of the vehicle was put there after the vehicle returned from action in the Far East. Many Soviet Army commanders ordered some sort of markings placed on the vehicles in commands subordinate to them in areas where mutinies had broken out in order to help distinguish friendly vehicles from the mutineers. The picture this was taken from shows the vehicle against a snow background. The crew apparently has not had time to change its green camouflage pattern or no longer feels it is necessary.

B3: *SAU-203. The vehicle's attachment has not been determined.*

The SAU-203 went into production in the late 1980s to provide for long-range fire support. It was usually attached in battalion size with a Front's artillery assets. SAU-203s were never produced in great numbers, so they tended to be sent from Front

to Front as the need arose. This is not unusual with Soviet artillery assets at the Front level.

This vehicle is factory gray and has no identifying marks at all. Even the photograph from which this plate was taken gives no clues as to where the vehicle is located; the surrounding terrain is flat and featureless. The overall good condition of the vehicle and the lack of damage or rust seem to indicate the picture was taken early in the war somewhere in Europe, but this can only be conjecture. Note the large stabilizing spades and the power loading apparatus at the back of the vehicle. Many Soviet crews disabled the power loader when they discovered that the gun could be loaded faster manually. The power loader was an advantage only during long bombardments (it didn't get tired). Counterbattery fire makes long bombardments risky for artillery crews, so these tend to be rare in modern combat.

B4: *Bm-27 rocket launcher from the artillery regiment of the 125th Guards Motorized Rifle Division; Poland, 1997.*

The Bm-27 was introduced as a replacement for the Bm-21 rocket launcher in the late 1980s and was being used in about half the Soviet divisions when the war broke out. The Bm-27 fired a 220mm rocket and had very good range. Usually, there was one rocket launcher battalion in each artillery regiment and one artillery regiment per division.

The 125th Guards were overrun and destroyed in late 1997; the vehicle was captured at that time and photographed by the army technical section for study. The vehicle itself is done in a fall camouflage scheme and has the ubiquitous crew-painted red star on it. At the very rear of the vehicle is some sort of identification number, probably put there on the orders of the Army commander. This vehicle is secured and in standard travel mode. Note the circular objects just below the two doors behind the cab and at the extreme rear of the vehicle. These are stabilizing pads, which are extended to stabilize the vehicle before it is fired.

C1: *BRDM-2 with AT-5 launcher tubes from the 34th Motorized Rifle Division; Mongolia, 1998.*

The BRDM series began production in the early 1960s and was so successful that several versions were created. The version illustrated here gave marginal antitank capabilities to recon units. The BRDM series was produced in large numbers.

The vehicle shown here is with the 17th Army, as is the SA-13 pictured elsewhere, which explains why there is an identification number on the rear of the vehicle. This BRDM-2 has a hand-painted red star, which, as mentioned before, became popular with Soviet crewmen.

C2: *SA-13 Air Defense Artillery vehicle from the 11th Tank Division; Mongolia, 1998.*

The SA-13 was the replacement for the SA-9 vehicle and was issued to the anti-aircraft battery of many Soviet regiments. The SA-13 began production in the late 1980s and was still in production when the war started.

This plate is taken from a propaganda film produced while the 11th TD was on occupation duty in Manchuria in 1998 after

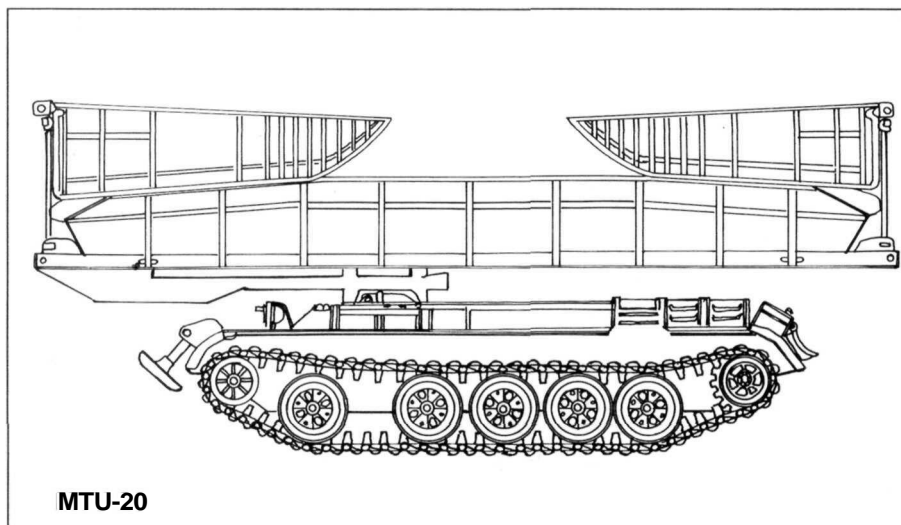

after the fall of China. The "27" on the rear of the vehicle was a vehicle identification number put there under orders from the commander of the 17th Army, which the 11th TD was subordinate to. As mentioned before, vehicle numbering was carried out by Army commanders and was not standard in the Soviet Army. The brown, rusty camouflage pattern was used extensively in northern China. The cartoon-like drawing on the side of the vehicle is very unusual for a Soviet vehicle. The smiling face and the mushroom cloud suggest that the vehicle and crew survived a sojourn on a nuclear battlefield with a certain amount of humor. The fact that the drawing is on the vehicle at all implies a lax discipline in the unit, maybe because of its isolation and the deteriorating local conditions.

C3: *BRDM-3 from the 98th Guards Motorized Rifle Division; the Ukraine, 1999.*

The vehicle pictured here is in a camouflage pattern that was used in the mountains of the Balkans. The 98th Guards had been active in the Balkans until late 1998, when they were hurriedly recalled to the Ukraine. The red star on the turret was probably added to the vehicle early in the war, but the number on the hull was not added until mid-1999, when the revolt in the Ukraine broke out. The commander of the 19th Army, which the 98th GMRD was subordinate to, had his forces number their vehicles to avoid confusion with the rebel vehicles.

The vehicle shown is in very good shape considering the late stage of the war. The 30mm autocannon in this vehicle was very effective against partisans and irregular forces who had little in the way of antitank weapons as the war went on.

C4: *Bm-14 rocket launcher, part of the 2nd Southwestern Front's artillery assets; Austria, 2000.*

This vehicle was part of a rocket launcher brigade of an artillery division attached to the 2nd Southwestern Front. Aside from the red star that the crew painted on the door, there are no distinguishing marks. Even the paint pattern is a standard color. The caption for the photographic source of this plate identifies it as part of 2nd Southwestern Front's artillery assets. This vehicle is in good shape, indicating that the maintenance has been kept up on it in spite of the fact that rockets have become very scarce.

D1: *KvP-92v from the 2nd Arctic Mechanized Brigade; Alaska, 1998.*

Another variant of the KvP series, this vehicle is armed with the 82mm automortar. The vehicle pictured here was found wrecked by US forces during the spring counterattack of 1998. The photograph this plate was obtained from was found inside the vehicle. The red star is visible on the passenger compartment, and directly behind the red star is evidence of battle damage, more of which was noted on the power plant (but is not visible in the photograph). Note the odd turret, which houses the automortar on the top of the vehicle. This weapon could only be fired when the vehicle was stationary, as it tended to destabilize the vehicle (usually by sending it skittering off from the recoil—the low ground-friction of hovercraft was a disadvantage in this situation).

D2: *KvP-92 from the 1st Naval Infantry Brigade; Alaska, 1997.*

The KvP series of hovercraft went into service in the early 1990s, and was used by the Soviet Naval Infantry and Arctic



Brigades. The vehicle pictured here has both the Naval Infantry flag and a vehicle identification mark, both of which became common on Soviet Naval Infantry vehicles. It is missing the red star, which was also a common addition to Soviet vehicles. Note the large exterior stowage containers and the extra fuel tanks directly above the side skirts, which were vital in operations far from supply centers. Another feature of hovercraft is the large power plant and fan assembly sitting amidships. The skirts on the vehicle are made of a material similar to Kevlar and have a self-sealing capability similar to that of a puncture-proof automobile tire. The light gray camouflage scheme was adopted by many vehicles operating on the coastline of Alaska.

D3: *KvP-92z from the 27th Naval Infantry Regiment; Leningrad, 1998.*

This vehicle is the air-defense version of the KvP series, mounting a 30mm gatling gun like that of the ZSU-30-6. This version proved to be nearly useless against aircraft, as it lacked decent target acquisition and control equipment. Also, when the vehicle was in motion, fire from the gun tended to send it in the opposite direction, like a puck in a game of air hockey.

The vehicle shown here lacks any markings other than the red star, which is unusual for Naval Infantry troops, who often painted the Naval Infantry flag on their vehicles. It is probable that this vehicle was not part of the original equipment of the 27th Naval Infantry.

D4: *KvP-121 of the 18th Hovercraft Transport Regiment; Alaska, 1997.*

This photograph was obtained from a civilian who videotaped the craft at Anchorage during the Soviet occupation of that city. The tape records the civilian's arrest by Soviet security officials, who were found in possession of the tape later. The ultimate fate of the camera operator is unknown, although Soviet practice in other occupied cities would indicate that he was simply incarcerated.

Few of these huge vehicles saw active service in Alaska. Most were stripped and abandoned when fuel became scarce. They could carry a company of men and their vehicles over the most inhospitable terrain imaginable because of its low ground pressure. Useful on land or water, they were the only means of transporting materiel over the tundra of the far north. Their

weakness was that they were easily spotted from the air.

This vehicle is shown loading its cargo through the huge bow loading ramp. The identification number is in the standard position for all KvP-121s. Again, someone has painted the red star on the rear of the vehicle. The bridge area on top of the vehicle has a large spotlight, several lookout posts, and an early warning radar in order to help it detect the approach of enemy aircraft. SA-14 crews were often assigned to ride in improvised positions on the dorsal surface of the cargo compartment to provide some protection against air attack.

E1: *T-55 from the 76th Tank Division; British Columbia, 1998.*

The vehicle shown here is from a unit that invaded Canada in 1997. After being defeated near Seattle, the 76th TD mutinied, seized Queen Charlotte Island and set itself up as warlord. The vehicle depicted here is taken from a home movie shot by one of the local inhabitants.

The vehicle has several odd markings on it, most notably the unusual kill markings on the barrel, the significance of which remains unexplained. The "DIE YANKIE" inscription indicates that the crew has little knowledge of the fine points of English spelling but leaves little doubt about their real enemy. Note the undetonated reactive armor blocks on the turret, indicating that the marauders have a few of these to spare. The red star on one of the blocks seems odd for a unit that has mutinied. It has been suggested that the unit is still communist in nature but not loyal the Soviet government.

E2: *OT-65 of the 24th Guards Motorized Infantry Division; Iran, 1998.*

The OT-65 was a Hungarian development used in place of the BRDM by many Pact armies. It proved to be very mobile and sturdy; when the Soviets invaded Iran, they scraped together as many OT-65s as possible because of their great mobility.

The vehicle pictured here was captured by the US 24th Infantry Division during Operation Pegasus II. The new owners wasted little time in naming the vehicle (note "OLGA" above the front wheel) and painting identification marks on the rear. The large "7" at the extreme rear was a Soviet mark (the 7th Guards Army followed the practice of numbering its vehicles in Iran) that has not been painted over. Oddly enough, the red star on the vehicle has also not been removed. The fact that both Soviet markings and US markings both exist on the vehicle suggests that the photograph was taken soon after the vehicle was captured. An alternative explanation is that the American crew simply did not care, although it would seem dangerous to be wandering about behind NATO lines in a captured enemy vehicle without taking steps to make it obvious

that the tank is now one of the "good guys."

E3: *MTLB from the 24th Guards Motorized Division; Iran, 1998.*

The MTLB became an all-purpose vehicle for the Soviet Army, serving as an artillery tractor, a weapons platform and an armored personnel carrier. In the late 1980s, the Soviet Army began producing them in much greater quantities.

The vehicle pictured here was abandoned by the 24th Guards as it was being pursued by the US 24th infantry. Note the vehicle numbering, which was used extensively in Iran by the Soviets. The "СССР" marking on the rear hull is very rare. The name "OLGA" is probably the American nickname for the vehicle....Soviet soldiers would have used the Cyrillic alphabet. This vehicle has a tow cable tied to the hull, which was reasonably common on a multipurpose vehicle such as this.

E4: *M-81 of the US 6th Infantry Division; Germany, 1998.*

The M-81 was a Romanian tank design that proved to be a very capable piece of equipment. Many armies purchased the tank, including the Finnish Army. The M-81 used the German-made 120mm gun, which was highly thought of by many tankers.

The vehicle shown here was captured by the US 6th Infantry Division during the fighting in Norway and northern Finland in 1997. The Finnish symbol is still visible on the turret. When the 6th was transferred to Germany in late 1997, they took the tank with them. This vehicle and its crew were the subject of a news item done in early 1998 by an American network news crew.

The names on the forward skirt ("Andy, Tom and Jim") are the names of the tank commander's children. The term "Laura's Limo" refers to the driver, Laura Matteson of Memphis, Tennessee. The six red stars on the barrel denote six enemy vehicles destroyed in combat. Another name has been painted on the turret, but the crew declined to comment upon it and became irritated when the matter was pursued. The crewmen indicate that they were impressed with the vehicle on all levels except for its cramped conditions. The film never aired, but is nevertheless a valuable resource for the historian interested in the morale and psychological state of American servicemen in Europe in the latter stages of the war.

Subsequent interviews with the surviving crewmembers after the war indicate that, much to their dismay, they were forced to abandon the vehicle in late 1999, due to a lack of spare parts.

F1: *BRDM-2 with the 21st Guards Motorized Rifle Division; Poland, 1999.*

This BRDM-2 was with the Reconnaissance Battalion of the 21st Guards. The photograph that this plate came from was obtained from a defector of the 21st GMRD in the fall of 1999. The vehicle is in a spring camouflage pattern and shows no other markings. The lack of markings is significant; it shows that the division is still a part of the Soviet Army and following the standard procedure of not using any identification symbols.

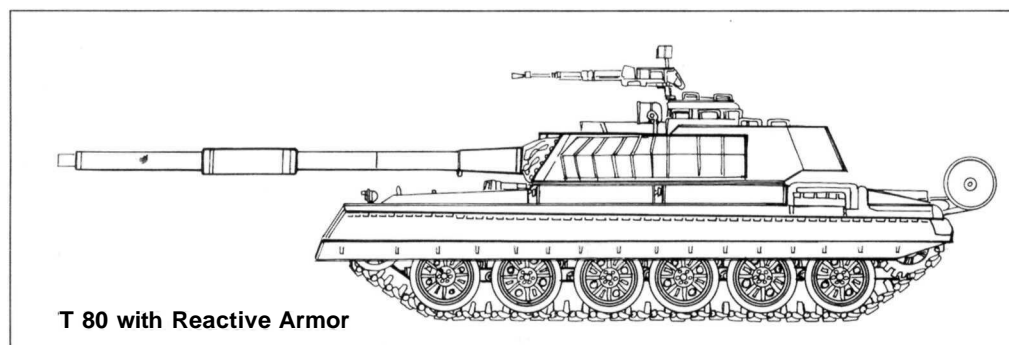

F2: *UAZ 469 from the 41st Motorized Rifle Division; Alaska, 1999.*

The 41st MRD was driven out of Juneau in 1998 and found itself isolated and surrounded by hostile forces. The commander, who was never in favor of the operation, contacted the US forces facing him and effected a change of sides.

The vehicle pictured here has a rendering of the Czar's crest on the door. Since the picture dates from after the division changed sides, it is hard to establish whether the crest was painted by the Soviet troops themselves or by US liaison personnel. The vehicle has an identification number above the rear fender, which was definitely done by the US forces, probably to integrate the vehicle into the overall command structure. The vehicle is now in a private collection in the city of Juneau.

F3: *PTS-M from the 24th Motorized Rifle Division; Romania, 1998.*

The PTS-M has proved to be a very useful vehicle. Used as an artillery tractor, a truck and amphibious transport, the PTS-M has excelled in all roles.

This plate is from a TASS film short subject, showing the commander of the 24th MRD inspecting newly arrived troops. The paint is standard factory color and is in good shape, indicating the vehicle has been well-cared for and has not yet seen action. This vehicle mounts a searchlight which was not on all PTS-Ms. Other than this, the vehicle is devoid of personality.

F4: *BMD weapons carrier with the 104th Guards Air Assault Division; Iran, 1998.*

The BMD was the main carrier for the airborne forces of the Soviet Army. A weapons carrier variant, the vehicle has several machinegun mounts, and the object sticking up where the turret should be is an AGS-17 grenade launcher. The vehicle has markings that became common in Iran, namely the vehicle ID number and the star. In this case, however, the star is only a black outline. Many other crew-painted red stars were outlined in black and then filled in red; for some reason, the crew of this vehicle never completed the star. Also the camouflage scheme is a nonstandard pattern.

F5: *BMP mortar carrier of the 50th Guards Motorized Rifle Division; Vietnam, 1997.*

These vehicles were to provide local fire support for motorized rifle battalions. They were highly thought of by the Soviet infantry, who never had enough of them. Shortly after the vehicle illustrated here arrived in Vietnam, it was photographed on the docks by a French news magazine. The vehicle has a typical green camouflage scheme overall and was probably adapted to local conditions soon after it arrived.

G1: *BMP-A from the 19th Motorized Rifle Division; Iran, 1998.*

The 19th was a Category III division and was equipped with stores from its assembly point. Many Category III divisions thus received older equipment. The BMP-A shown here is such a piece of equipment. The antitank missile on the launcher is an AT-3, which was almost completely phased out of service before the war started. The vehicle identification number on the side of the hull became common with the Soviet forces in Iran, as did the red star.

G2: *BMP-C with the US 49th Armored Division; Texas, 1999.*

This vehicle was captured from Division Cuba in mid-1999 and used by anti-Soviet partisans in the region around San An-



tonio for a few months, where it evidently acquired the nickname "Lone Star Louie" (This was the nickname of Luis Mateos, a Houston Astros pitcher famed for his fastballs.) The vehicle and its crew made their way north to Oklahoma, where they were incorporated into the 49th. The vehicle served with this division for a number of years and was eventually retired to Fort Sill, where it stood for decades in front of the Officers' Club. It was eventually restored and can now be seen on exhibit in the Museum of Texas History in Austin.

This plate shows the vehicle in late 1999, in service with the 49th. Typically, it is covered with soldierly graffiti. Two of the names seem to refer to girlfriends of the crew ("Gerri & Sue...My Ladies" and "Jennifer"). The slogan "so it aint ours...it works" is interesting and gives some insight into the feelings of the crew. Note the teeth painted on the front of the vehicle (for reasons unknown) and the slogan "RED DAWN," which refers to a movie of the early 1980s in which the US is invaded by the Soviets, and a group of American high school students resists them. (This film attained cult status in college cinemas in the middle 1990s.) The significance of the initials "F.A.N.G." has not been determined. The white crosses on the turret are memory marks, a typical means of honoring deceased crewmembers. The name "Steve" is prominently displayed on the turret and is believed to refer to the vehicle's commander. The flag of Texas is almost a requirement in any illustration of this vehicle....There is no evidence that it was ever flown in battle. (Of course, the crew consisted of Texans.) "USA APPROP." has no official meaning but was presumably added when the vehicle was made a part of the 49th. "TX.NG" would indicate Texas National Guard and, in this case, would note the presence in the crew of one or more former members of that organization.

It is not possible to determine what the vehicle's original camouflage pattern was, since so many have been laid over it. The vehicle shows much battle damage, particularly to the skirts and the passenger area.

G3: *BMD-B from the 63th Naval Infantry Regiment; Korea, 1998.*

The BMD series of light armored vehicles was developed for the Soviet airborne forces but was found to be a very useful vehicle for the Naval Infantry as well. The vehicle pictured here has the Naval Infantry flag painted on the side of the hull. This

was discouraged by higher commands but became a common practice of the Soviet Naval Infantry as the war went on. The vehicle identification numbers were nonstandard but have been noted on other vehicles from the 63rd Naval Infantry, leading one to believe that the regimental commander ordered the numbering. Of course, the red star quickly became a favorite of the Soviet crews.

The vehicle shown here has an AT-5 launcher, smoke dischargers and a spotlight on the front deck. Not all BMDs are equipped with such devices. The vehicle is a little the worse for wear, showing battle damage to the passenger compartment.

G4: *ZSU-30-6 from the 1st Tank Division; Poland, 1998.*

The ZSU-30-6 is a self-propelled antiaircraft gun mounting a six-barrel 30mm gatling gun. Many Soviet tank divisions had a battalion of self-propelled antiaircraft artillery with at least a battery of ZSU-30-6s. The main drawback was its lack of effective range.

The vehicle shown here has a target acquisition and tracking radar on it. (Note the dome at the rear of the turret.) Not all ZSU-30-6s were so equipped. Most ZSU-30-6s had automated and conventional gunsights on them. Note the large hatches for stowage, particularly the one on the rear hull. The red star here is the largest and most flamboyant example of this form of self-expression. The identification numbers are odd on this vehicle because the 1st Tank Division followed standard Soviet practice and did not use a vehicle numbering system. This vehicle has apparently been incorporated from another division without repainting, as was done in the later stages of the war (the time for such niceties was not always available).

H1: *T-74 of the 24th Guards Motorized Rifle Division; Iran, 1997.*

The T-74 series filled the need for a more heavily armored vehicle, while not drastically changing the production procedure, since it is based on the T-72 series. This vehicle has several variant additions, including the searchlight, smoke dischargers (mounted on the front of the turret) and an external fuel tank.

This vehicle was found in a salt marsh during the US counteroffensive in 1997 and was photographed by a news magazine. It was nearly out of fuel and had apparently been abandoned by its crew at the approach of American troops. The significance of the turret number is debated. Some commanders issued orders that the vehicles under their command be given identifying numbers, and the Commander of the 7th Guards Army seems to have been one of these. The vehicle is otherwise unremarkable in its external appearance.

H2: *BTR-80 from the 114th Motorized Rifle Division; Canada, 1999.*

The BTR series of armored vehicles began production in the early 1950s and continued right to the start of the war, with the BTR-80 being the latest model. The BTR series has many variants and was a very successful light armored vehicle.

The 114th turned marauder after being driven out of Juneau. The vehicle pictured here dates from that time. Notice the surplus possessions (some would say booty) strapped on the rear of the vehicle. The upside-down American flag is also an indication of the piratical nature of the crew of this vehicle. This vehicle has a smoke discharger on the back of the turret and a small spotlight on the front, neither of which were standard

on all BTR-80s.

H3: *TAB-90 of the 37th Motorized Rifle Division; Romania, 1998.*

The TAB-90 was a Romanian-designed and -built IFV. Used almost exclusively by the Romanian Army, a few were sold to the Hungarians and the Finns. The TAB-90 was the mainstay of the Romanian motorized infantry but was never held in very high regard because of a number of shortcomings. It was relatively slow, very cramped, and presented a high profile.

The vehicle pictured here was captured by the 97th MRD in late 1997 when Romania collapsed. The red star on the turret of this vehicle is probably to identify it as now operating under Soviet command since the Romanian partisans were also fairly well equipped with TAB-90s. The color scheme is common for mountainous areas.

H4: *SU-130 from the 23rd Motorized Rifle Division; Manchuria, 1996.*

The photograph of the the SU-130 from which this plate was taken was obtained from a soldier who had served in the 23rd earlier in the war. This plate shows the vehicle as it appeared shortly after the fall of China. The unusual marking on the front of the vehicle is believed to be some sort of tactical marking, but this has never been confirmed. Note the fuel cans and external fuel tank on the rear of the vehicle. Another interesting feature of this vehicle is that one of its road wheels has recently been replaced....This, coupled with the good overall appearance of the vehicle, indicates that it has recently undergone extensive maintenance.

Glossary

The following is a compilation of some of the major terms and abbreviations used in this work. The Russian names are provided for your interest.

AGS-17: Automatic grenade launcher (Automatichesky Granomat Stankovy).

AT-#: A NATO numbering system designating the progressive development of Soviet antitank missiles. The higher the number, the more recent the missile.

APDS: Armor piercing, discarding sabot.

APFSDS: Armor piercing, fin stabilized, discarding sabot.

APHE: Armor piercing, high explosive.

ATGM: Antitank guided missile.

BMD: Airborne combat vehicle (Bronevaya Maschina Desantnaya).

BMP: Armored vehicle, infantry (Bronevaya Maschina Piekhota).

BRDM: Armored reconnaissance vehicle (Bronevaya Rasvedyvateinaya Dosornaya Maschina).

BTR: Armored personnel carrier (Bronetransportir).

GAZ-#: A truck produced by the Gorkiy Motor Truck Plant. (Most trucks are identified by the plant they come from.)

GMRD: Guards Motorized Rifle Division.

GTD: Guards Tank Division.

HE: High explosive.

HEAT: High explosive, antitank.

ICM: Improved conventional munitions.

ILLUM: Illumination (flares).

MBT: Main battle tank.

MRD: Motorized Rifle Division.

RPG: Rocket antitank grenade launcher (Reaktivniy Protivotankovy Granatomet).

SA-#: A NATO numbering system for Soviet surface-to-air missiles. The higher the number, the more recent the missile.

SAM: Surface-to-air missile.

SAU: Self-propelled artillery mount (Samaochnaya Artilleriyskiy Ustenovka).

PK: A Soviet machinegun (Pulemyot Kalashnikov).

TD: Tank division.

T-#: A numbering system for Soviet main battle tanks.

TVD: Theater of military operations (Teatr Voennikh Deystiv).

Ural-#: A truck produced by the Ural Motor Vehicle Plant.

WP: White Phosphorus.

Zil-#: A truck from the Lihachev Motor Vehicle Plant.

ZSU: Self-propelled anti-aircraft mount (Zenitnaia Samokhodnaya Ustanovka).

Soviet Vehicle Guide

This is the perfect companion piece to the *U.S. Army Vehicle Guide*, detailing and illustrating a plethora of Soviet and Warsaw Pact equipment. The *Soviet Vehicle Guide* contains:

Details of the T-80 and T-90 main battle tanks, the BMP series of armored personnel carriers, the BT-76 Soviet light tank, the SO-120, an automatic 120mm turret-mounted mortar, the OT-65 light scout car, the SAU-203 self-propelled gun, the SA-13 ADA rocket launcher vehicle, and several hovercraft in the KVP series (including both transport and combat variants).

Additional information on the latest Soviet weapons and armor enhancements, such as the AT-8 and reactive armor (just now coming into service in western Europe). Many of these vehicles are illustrated in full color on eight pages of color plates, or in the black and white line drawings accompanying the descriptions. *Soviet Vehicle Guide* also includes the complete worldwide order of battle for all the Soviet divisions and several brigades and regiments as of July 2000, brief divisional histories, tables of organization and equipment from battalion to division for Soviet military units, and notes on the use of hovercraft in **Twilight: 2000**.

The *Soviet Vehicle Guide* presents referees and players of **Twilight: 2000** with a single authoritative source of information for the vehicles of World War III.

Design: Frank Frey and Brad Hay

Supplementary Design: Loren Wiseman

Art Director: Barbie Pratt

Cover, Interior Illustrations, and Color Plates: Steve Venters

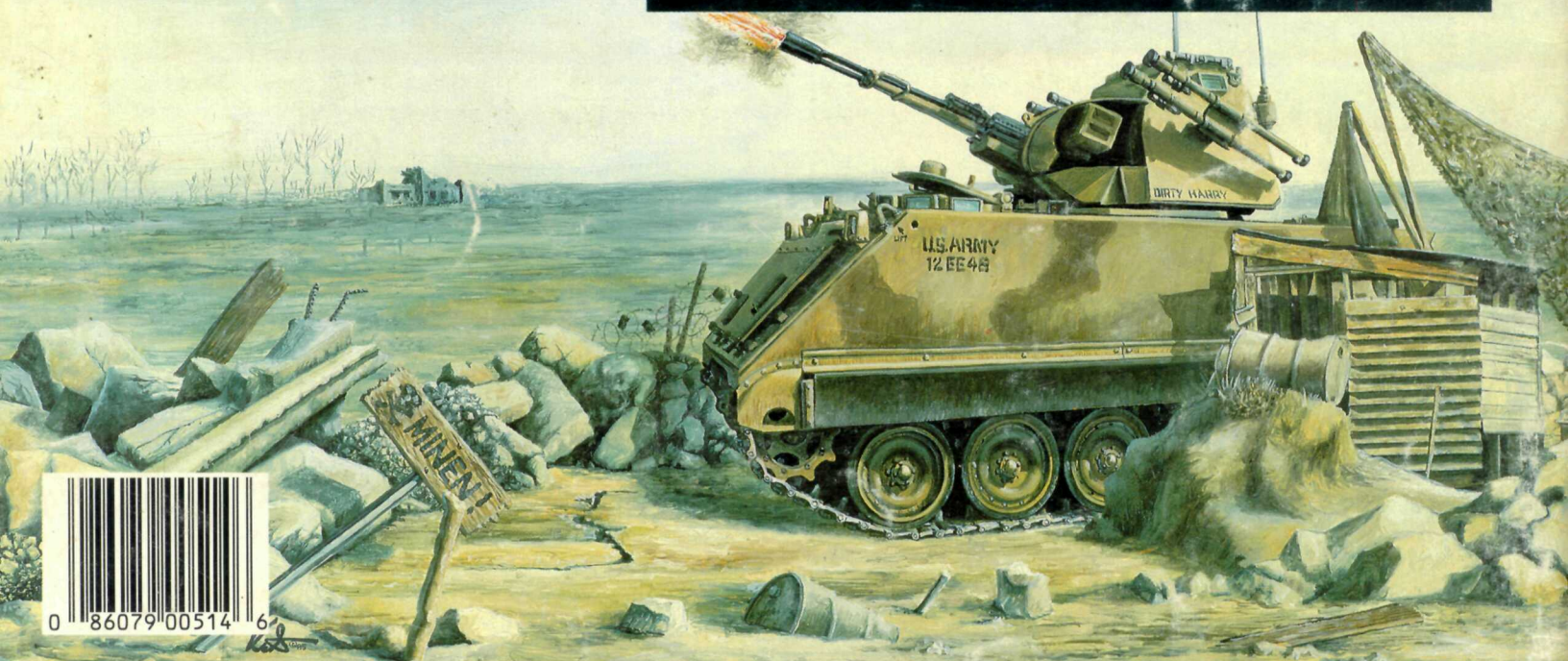

Twilight: 2000™

Series Module

Copyright © 1987 Game Designers' Workshop. All rights reserved.
Printed in the U.S.A. Made in the U.S.A. ISBN 0-943580-33-1



GDW Game Designers' Workshop
Since 1973

PO Box 1646, Bloomington, IL 61702-1646