

Small Arms Guide

Series Module

TWILIGHT: 2000™



GDW

TWILIGHT:2000™

Small Arms Guide

Contents

Small Arms Guide	2	Battle Rifles	32
Classifications.....	2	FN-FAL, H & K G3/HK 91,	
Abbreviations.....	2	M1 Garand, M14.....	32
The M16EZ	3	Beretta BM-59, SIG 510-4, SKS, FN-LAR.....	33
Black Powder Firearms	3	Sniper Rifles	34
Automatic Pistols	4	Barret Model 82, L42, M21, M40.....	34
AMT .380 Backup, AMT Hardballer, Astra Constable,		Parker-Hale C3, PSG1, SVD, Steyr SSG-69.....	35
Auto-Mag 44.....	4	Walther WA-2000N, Vz 54.....	36
Beretta Model 70S, Beretta Model 92S,		Sporting Rifles	37
Beretta Model 84, Beretta Model 951.....	5	Browning BBR, BSA CF-2, Colt Sauer Sporting Rifle,	
Browning Hi-Power, HP-35, Browning Hi-Power, HP-DA,		Colt Sauer Grand Alaskan.....	37
Browning BDA-380, Browning Buck Mark 22.....	6	Colt Sauer Grand African, Mauser Mark X,	
Charter Arms Explorer II, Colt Combat Commander,		Mauser Mark X Carbine, Remington Model 700.....	38
Colt Lightweight Commander, Colt M1911A1.....	7	Ruger Model 77, Sako Standard, Savage Model 110-C,	
Colt Government Model 380, Czech CZ-75,		Weatherby .460 Magnum Deluxe.....	39
Detonics D/A 9mm, Detonics Scoremaster.....	8	Winchester Model 70,	
Heckler & Koch HK-4, H & K P7 M8, H & K P7 M13,		Winchester Model 70 XTR Super.....	40
H & K P9S.....	9	Shotguns	41
H & K VP70Z, Glock 17A, IMI M91, IMI Desert Eagle..	10	Atchisson/Dae Woo Assault 12, Browning Auto-5M,	
Llama Large Frame Automatic, Llama Small		Franchi SPAS-12, High Standard M-10B/C.....	41
Frame Automatic, Luger P-08, MAB-P15.....	11	Ithaca Model 37, Mossberg 500, Mossberg M590,	
Makarov PM, Manhurin "Walther" Model PPK/S,		Manufrance RPS.....	42
Mauser M1896, Mauser HSc.....	12	Remington Model 870, Remington Model 1100,	
Metzger Arms Spectre 15, Ruger Mk II, Ruger P-85,		Savage Model 69-RKL, Winchester Stainless Police..	43
Tokarev.....	13	Winchester Defender, HK CAW.....	44
SIG/Sauer P 226, SIG/Sauer P 230, P-64,		Automatic Rifles	45
Smith & Wesson Model 439, 639, and 39.....	14	M1918A2 BAR, LSW, M249 SAW, RPK-74.....	45
S & W Model 459, 659, and 59, Walther PPK,		Machineguns	46
Walther P-38, Steyr GB-80.....	15	AAT-52, Bren M II, H & K HK21, MAG.....	46
Revolvers	16	MG3, M134, M60, Stoner Mk 23 Commando.....	47
Astra Model 357, Astra Model 44,		Japanese Type 62, PK, PKM, RPD.....	48
Charter Arms Bulldog 45, Colt Python.....	16	Czech Vz 59, DShK, KPV, M2HB.....	49
Llama Commanche, Llama Super Commanche,		M214.....	50
Ruger Security Six, Ruger Redhawk.....	17	Ammunition Listing	51
S & W Model 19 Combat Magnum, S & W Model 25,		Consolidated Fire Charts	52
S & W Model 27, S & W Model 28.....	18	Index	55
S & W Model 29, S & W Model 36 Chiefs' Special,			
S & W Model 38 Bodyguard, S & W Model 57.....	19		
Submachineguns	20		
AKR, Beretta PM-12, Colt CAR-15, Colt CAR-15A1.....	20		
H & K MP-5, H & K MP-5SD, H & K G11, HM-3.....	21		
MAC-10, M3A1, M-45 Swedish K, Madson M50.....	22		
MP-40, MPK, M231, PM-63.....	23		
PPSh-41, PPS-43, S & W M76, Sterling.....	24		
Sten Mk II, Thompson M1A1, Uzi, Mini Uzi.....	25		
Vz 24, Vz 61 Skorpcion.....	26		
Assault Rifles	27		
Australian Leader, AK-74, AKM, AKMR.....	27		
AR-7, AR-18, Beretta AR-70, CETME Model L.....	28		
FA-MAS, FN-CAL, Galil ARM, H & K HK 33A2/HK 93..	29		
IW, M1/M2 Carbine, M16, M16 EZ,			
Ruger Mini-14/AC-556.....	30		
SIG SG 540, SAR-80, Steyr AUG.....	31		

Credits

Design: Frank Frey and Loren K. Wiseman
Development: Loren K. Wiseman
Cover: Steve Venters



Copyright©1988 by GDW. PO Box 1646, Bloomington, IL 61702-1646. Printed in USA. Made in USA. All rights reserved. ISBN 0-943580-59-5. **Twilight: 2000** is GDW's trademark for its role-playing game of survival in a devastated world.

Small Arms Guide

This guidebook is designed to provide **Twilight: 2000** players and referees with a detailed look at what small arms are available and who's using them. Naturally, we could not include everything as there are simply too many weapons available for a comprehensive treatment. We tried to pick those weapons which would be of greatest interest, while at the same time trying to predict what the armies of the world will adopt in the 13 years between now and the year 2000. Prognostications of this sort are very uncertain. Some of the weapons we describe will never see service while others, now undreamt of, will be commonplace.

Likewise, the weapons in this sourcebook often come in calibers other than those listed. Referees who wish to represent these weapons should determine the appropriate characteristics for the particular caliber desired by comparing it with another weapon or by interpolation from the characteristics presented.

CLASSIFICATIONS

For the benefit of our readers who may be unfamiliar with the classifications used in this guide, we present short discussions of each.

Pistols: Firearms designed to be used with one hand, and usually without shoulder stocks. There is a certain mystique to handguns. In the military, they've always been a symbol of the officer corps. In civilian life, they represent power and protection to millions. Most handguns are fairly easy to conceal. They are one-handed weapons that allow the firer to use the other hand for other things.

In practical military terms, however, the handgun is virtually useless except for short-range defense or special uses. Vehicle and aircraft crews carry them because of their handiness. Special purpose squads (like antiterrorist units) and troops fighting in close combat environments such as buildings or dense woods also carry them, complementing the combat shotgun and the submachinegun.

In civilian life, police and government agencies use them as a standard weapon because of their portability and their ease of concealment. Private citizens use them for personal defense, hunting, and target shooting.

One important fact to note about revolvers is that the ones that are chambered for the .357 magnum round can also fire the .38 special round. Likewise, .44 magnum revolvers can fire the .44 special round. The reverse is not true for either revolver. Magnum cartridges are longer and more powerful and will seriously damage or destroy the lighter weapons—not to mention the firer.

Submachineguns: A submachine gun is a fully automatic fire weapon designed to fire a pistol or small rifle cartridge. It is usually shorter and more handy than a rifle, but larger than a pistol, and falls into a middle ground. The submachinegun (or SMG) had its origins in the trenches of World War I. It was an attempt to provide the individual soldier with hand-held automatic firepower. It proved to be a successful concept and was further refined during World War II. It became the favorite weapon of elite forces on both sides and was extensively used in commando operations. Vehicle crews were also issued SMGs.

Police departments began using the SMG after World War I. For a time, in fact, the SMG came to be more often identified

as a "police weapon" than a military one. More recently, the SMG has been replaced by the assault rifle for most uses, although SMGs continue to see service in many units.

Rifles: The modern assault rifle had its origins in World War II. It is a hybrid weapon designed to give the individual infantryman a weapon with a high volume of fire combined with a smaller or less powerful cartridge than that of a battle rifle. The assault rifle reflects the modern doctrine emphasis on mass firepower rather than individual marksmanship.

Battle rifles are larger, and designed to fire more powerful cartridges than assault rifles. Battle rifles tend to have slower rates of fire, and their ammunition is heavier, so a soldier can carry fewer rounds per unit weight.

Sniper rifles are specially manufactured for high accuracy, often having match grade barrels and firing higher quality ammunition than normal rifles of their caliber. They have telescopic sights, and often have other special equipment for low-light or night firing. Volume of fire is seldom a consideration, so many sniper rifles are bolt actions.

Sporting rifles are civilian hunting rifles, and tend to have better finishes (finer wood in the stocks, checkering and engraving, etc.) than military rifles.

Support Weapons: These are weapons used to provide supporting fire for a military unit, such as machineguns and automatic rifles. They are usually fired by soldiers specially trained in their use, although all soldiers of a given army usually know how to fire and load them.

ABBREVIATIONS

The abbreviations used on the tables in this book are the same as those used on the tables in the basic game, except for *Nation*. Nation refers to the country of design or primary manufacture. The countries involved are self explanatory, except that "Germany" refers to the preWWII *Reich*, whereas "West Germany" refers to the postWWII *Bundesrepublik*.



The M16 EZ

Early in 1999, the breakdown of civil order in the United States was evidenced by an increased demand by local civil authorities for small arms with more power and effectiveness than normally accepted police weapons such as revolvers and shotguns.

Initially, the two federal governments (Civgov and Milgov) responded with grants of small quantities of M16 rifles. As demand outstripped supply, it proved impossible to continue to supply the many local police departments and militias with new production M16 rifles.

Routine ordnance maintenance of small arms in the US Army inventory replaces barrels, bolts, and other small parts as they become worn out. Many of these parts are still serviceable, and can be used in weapons, but with a lower level of accuracy and safety. Rejected parts are normally sold for scrap metal in less critical times.

Milgov, anxious to provide small arms to local governments, decided to produce the M16 EZ kit for distribution to loyal civilian forces. It consisted of the following components:

- One M16 barrel, bolt, and bolt carrier combination.
- One set of basic trigger mechanism parts.
- Several pieces of steel tubing and flats.
- One set of plans and instructions for use in machining and assembly.

Local governments were expected to use local machine shop talent and supplies to manufacture auxiliary parts, stocks, and other components of the rifles. Using the plans provided, local forces arranged for the necessary parts to be manufactured, and the final weapons assembled. Civgov rapidly introduced a similar program for the local governments loyal to it.

Necessarily, M16 EZ rifles vary in their quality and appearance, depending on the ability of the local manufacturing process. Many weapons have carefully finished wood stocks produced by militiamen during the long winters of the war. Others sport improvements developed by the local machinists: special sling swivels, winter trigger guards, and precision sights (often unable to compensate for the poor rifle barrels of the weapons).

In use, the EZ model was inaccurate, unreliable, and often dangerous to the user. But it succeeded admirably because it fulfilled its purpose. It retained the basic silhouette of the M16 rifle and lent an air of authority to any force armed with it; the militia looked less rag-tag when it was not armed with deer rifles. It used standard military ammunition and magazines, which helped resupply situations. During the cold days of World War III, it was the rifle that the average citizen saw in the hands of the local militia; it represented a calming voice of authority in the midst of hard times.

Black Powder Firearms

After World War II, the hobby of shooting reproduction black powder weapons became very popular. The centennial of the Civil War and the bicentennial of the American Revolution and Declaration of Independence gave added impetus to the hobby, and black powder firearms proliferated. Many states legalized hunting using black powder firearms. Millions of these weapons were made using modern materials and manufacturing techniques before the beginning of the war in 1995. A few modern designs were manufactured, but most were faithful reproductions of their prototypes.

Each weapon is assumed to be accompanied by a mold suitable for casting the ammunition for it. Often, metal bullets can be recovered, melted and recast, and fired again. Many individuals consider the black powder weapon to be the optimum long-term survival gun, since its user can make ammunition from natural sources almost indefinitely.

Ammunition for black powder firearms consists of a metal bullet (usually lead, but any soft, low-melting-point metal or alloy can be used) and a quantity of black powder. Metal can be traded for or scrounged from practically any building (this is a task: AVG:SCR). Making black powder is ESY:CHM if materials are available; finding the proper materials is DIF:SCR. Each attempt at scrounging yields enough metal or materials to make 20 shots. The referee must decide what limits to place on scrounging a given location, bearing in mind that only a limited amount of basic chemical material is likely to be available in a given location. Referees who wish to go into more detail may look up the chemical components of gunpowder in any encyclopedia and determine the likelihood of such mineral deposits in the area of player character operations. For simplicity, referees should assume that a player has caps or flints sufficient for ignition of each round (although referees may require players to search out and prepare these as well if desired).

Specific Weapons: Because of the plethora of models and designs, only broad categories will be given here, and it will not be possible to illustrate them. Any good encyclopedia will provide illustrations. We consider only muzzleloading weapons here, since cartridge arms are too complex for a short essay.

For purposes of **Twilight: 2000**, there are three categories of black powder firearms: revolver, shotgun, and rifle. Each is given a place on the Consolidated Fire Chart on page 52. We make no distinction between cap-and-ball and flintlock, but referees who wish to do so may formulate a rule for the differing probabilities of misfire for each type.

Their descriptions are as follows:

Revolver: We divide black powder revolvers into two classes: large (around .44 caliber) and small (around .36 caliber).

Rifle: This is the approximate equivalent of a Kentucky Long rifle or Hawken rifle, between .36 and .45 caliber.

Shotgun: This is a double-barreled shotgun, approximately 12 gauge.

AUTOMATIC PISTOLS (½W, ½T)

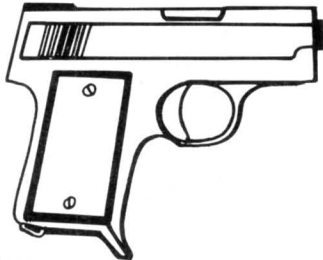

AMT .380 Backup

Type	ROF	Mag	Rng	DAM	ARM
.380 ACP	2	2	10	1	×4

AMT .380 Backup: A small, lightweight pistol designed to be carried concealed as a backup weapon. Not much good for anything but short-range combat.

Nation: United States
Ammunition: .380 ACP
Weight: .476 kg
Magazine: 2
Price: \$230 (R/S)



Astra Constable

Type	ROF	Mag	Rng	DAM	ARM
.380 ACP	2	2	10	1	×4

Astra Constable: A small automatic pistol designed to be carried by urban police units.

Nation: Spain
Ammunition: .380 ACP
Weight: .728 kg
Magazine: 2
Price: \$400 (R/S)



AMT Hardballer

Type	ROF	Mag	Rng	DAM	ARM
.45 ACP	2	2	10	2	×3

AMT Hardballer: A stainless steel version of the standard US Army .45 Automatic. The Hardballer is an exceptionally well-made weapon. A special long-barreled version called the "Longslide" was the pistol that Arnold Schwarzenegger carried in the movie *The Terminator*.

Nation: United States
Ammunition: .45 ACP
Weight: 1 kg
Magazine: 2
Price: \$550 (S/S)



Auto-Mag 44

Type	ROF	Mag	Rng	DAM	ARM
.44 Auto-Mag	2	2	18	1	×2

Auto-Mag 44: A large caliber automatic pistol, made famous by Clint Eastwood in the *Dirty Harry* films. It fires a specially designed .44 automatic magnum cartridge and has very powerful recoil. It and its ammunition are extremely rare, and referees should exercise care in allowing players to have this weapon. For this reason, the weapon and its ammunition have not been assigned an availability rating.

Nation: United States
Ammunition: .44 Auto-Mag
Weight: 1.66 kg
Magazine: 2
Price: \$4000 (—/—)

AUTOMATIC PISTOLS (½W, ½T)

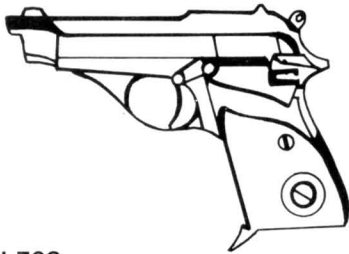

Beretta Model 70S

Type	ROF	Mag	Rng	DAM	ARM
.22 LR	3	3	15	0	×4

Beretta Model 70S: Originally designed as a “plinking” pistol, the Model 70S has found its niche as an assassin’s weapon. When used with a silencer/suppressor, the .22 LR caliber is virtually noiseless. The only drawback is that the weapon is effective only at close range.

- Nation:* Italy
- Ammunition:* .22 LR
- Weight:* .5 kg
- Magazine:* 3
- Price:* \$300 (R/S)



Beretta Model 84

Type	ROF	Mag	Rng	DAM	ARM
.380 ACP	2	4	10	1	×4

Beretta Model 84: A smaller version of the 92S. The Model 84 fires the .380 ACP cartridge and is designed primarily for police and private use.

- Nation:* Italy
- Ammunition:* .380 ACP
- Weight:* .62 kg
- Magazine:* 4
- Price:* \$535 (R/S)



Beretta Model 92S

Type	ROF	Mag	Rng	DAM	ARM
9mmP	2	5	15	1	×3

Beretta Model 92S: A double-action, modern pistol that was selected to replace the Colt M1911A1 as the standard sidearm of the US Army. Although designed in Italy, the 92S was produced in the US as a way of ensuring its steady supply.

- Nation:* United States and Italy
- Ammunition:* 9mmP
- Weight:* .95 kg
- Magazine:* 5
- Price:* \$545 (C/S)

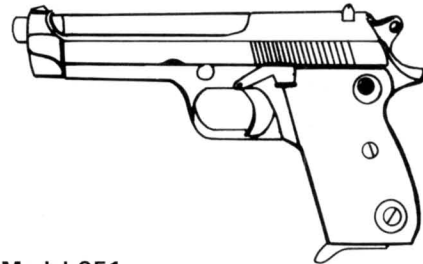

Beretta Model 951

Type	ROF	Mag	Rng	DAM	ARM
9mmP	2	3	15	1	×3

Beretta Model 951: The predecessor to the 92S/84 series of handguns, the M951 was designed for shooting ease and accuracy. Also known as the Beretta “Brigadier,” the M951 was the standard sidearm of the Israeli military until its replacement in 1991 by the IMI M91.

- Nation:* Italy and Israel
- Ammunition:* 9mmP
- Weight:* .87 kg
- Magazine:* 3
- Price:* \$500 (R/S)

AUTOMATIC PISTOLS (½W, ½T)

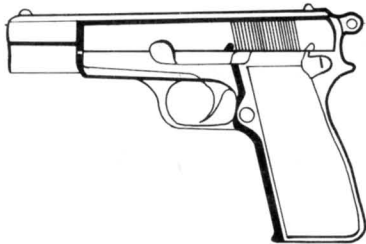
**Browning Hi-Power, HP-35**

Type	ROF	Mag	Rng	DAM	ARM
9mmP	2	4	15	1	×3

Browning Hi-Power, HP-35: One of the first commercially successful, high magazine capacity automatic pistols, the HP-35 was the last automatic pistol designed by the legendary John M. Browning. The pistol was put into production after his death, with the first ones coming off the assembly lines in the mid-1930s. The HP-35 can be found in various nations' arsenals. Its reliability and production quality set the standards by which most modern automatic pistols are judged, and the HP-35 can still hold its own among all but the most advanced designs.

Nation: Belgium and Canada

Ammunition: 9mmP

Weight: .9 kg

Magazine: 4

Price: \$535 (C/S)

**Browning BDA-380**

Type	ROF	Mag	Rng	DAM	ARM
.380 ACP	2	4	10	1	×4

Browning BDA-380: Like the Beretta Model 84, the BDA-380 is a smaller version of a larger pistol—in this case the HP-DA. It was designed primarily for police and civilian use.

Nation: Belgium

Ammunition: .380 ACP

Weight: .64 kg

Magazine: 4

Price: \$350 (C/R)

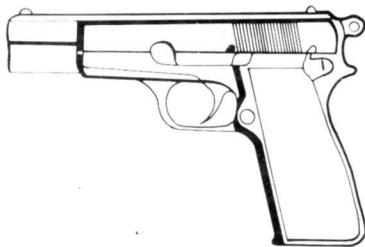
**Browning Hi-Power, HP-DA**

Type	ROF	Mag	Rng	DAM	ARM
9mmP	2	5	15	1	×3

Browning Hi-Power, HP-DA: A modernized and upgraded version of the classic HP-35, the HP-DA (Double-Action) carries the fine tradition of Browning automatic pistols.

Nation: Belgium

Ammunition: 9mmP

Weight: .9 kg

Magazine: 5

Price: \$500 (C/R)

**Browning Buck Mark 22**

Type	ROF	Mag	Rng	DAM	ARM
.22 LR	3	3	15	0	×4

Browning Buck Mark 22: A high quality sporting pistol, the Mark 22 is sturdily built and designed for outdoor use.

Nation: United States and Belgium

Ammunition: .22LR

Weight: .896 kg

Magazine: 3

Price: \$300 (C/S)

AUTOMATIC PISTOLS (1/2W, 1/2T)

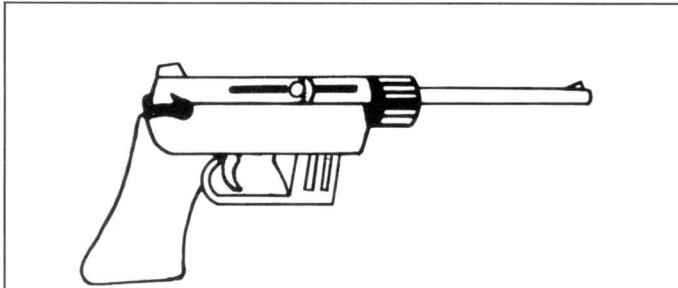

Charter Arms Explorer II

Type	ROF	Mag	Rng	DAM	ARM
.22 LR	3	2	15	0	×4

Charter Arms Explorer II: An American sporting pistol, the Explorer is unique in that the magazine feed is in front of the trigger guard. An extra magazine is carried in the grip and the barrels are interchangeable. Designed primarily for the survival market.

Nation: United States
Ammunition: .22 LR
Weight: .56 kg
Magazine: 3
Price: \$110 (R/R)

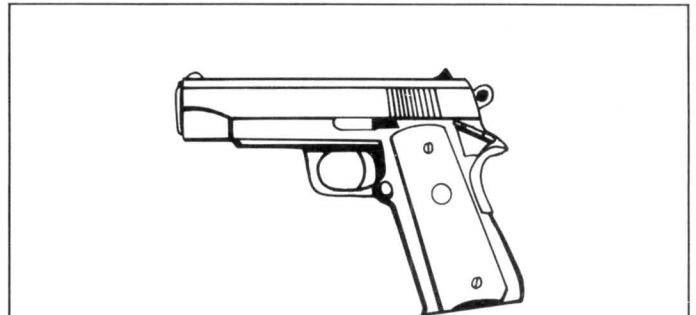

Colt Lightweight Commander

Type	ROF	Mag	Rng	DAM	ARM
.45 ACP	2	2	10	2	×3

Colt Lightweight Commander: Identical to the Combat Commander except for an aluminum frame.

Nation: United States
Ammunition: .45 ACP
Weight: .75 kg
Magazine: 2
Price: \$550 (C/S).

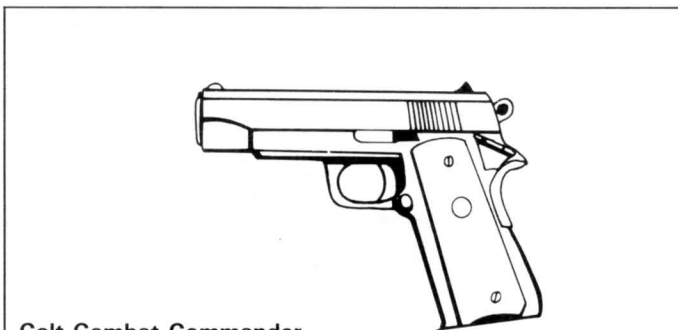

Colt Combat Commander

Type	ROF	Mag	Rng	DAM	ARM
.45 ACP	2	2	10	2	×3

Colt Combat Commander: Considered by many to be the definitive version of the M1911A1, the Combat Commander is a slightly shorter version of that classic handgun. It is often carried by US Army officers in place of the 1911A1.

Nation: United States
Ammunition: .45 ACP
Weight: 1 kg
Magazine: 2
Price: \$550 (C/S)

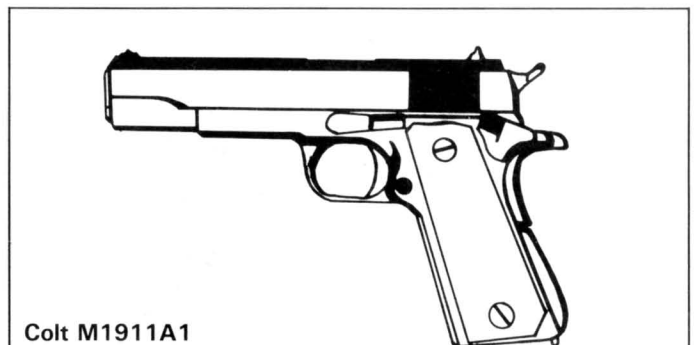

Colt M1911A1

Type	ROF	Mag	Rng	DAM	ARM
.45 ACP	2	2	10	2	×3

Colt M1911A1: Originally designed by John Browning, the M1911A1 was adopted by the US military in 1921. It was supposed to be replaced in the late 1980s by the Beretta 92S, but many continue to soldier on. The M1911A1 is a rugged design that has withstood the test of time (many consider it to be the finest handgun ever designed).

Nation: United States
Ammunition: .45 ACP
Weight: 1.1 kg
Magazine: 2
Price: \$650 (C/S)

AUTOMATIC PISTOLS (½W, ½T)



Colt Government Model 380

Type	ROF	Mag	Rng	DAM	ARM
.380 ACP	2	3	10	1	×4

Colt Government Model 380: Based on the M1911A1 design, the Model 380 fires the smaller .380 ACP round. It is designed for the civilian and police market.

Nation: United States
Ammunition: .380 ACP
Weight: 1 kg
Magazine: 2
Price: \$375 (S/R)



Detonics D/A 9mm

Type	ROF	Mag	Rng	DAM	ARM
9mmP	2	2	15	1	×3

Detonics D/A 9mm: An American design, the Detonics Super Combat is intended to be used as a backup or holdout gun. The 9mm Parabellum cartridge is used since it has much more punch than the .380 ACP.

Nation: United States
Ammunition: 9mmP
Weight: .616 kg
Magazine: 2
Price: \$465 (R/—).



Czech CZ-75

Type	ROF	Mag	Rng	DAM	ARM
9mmP	2	5	15	1	×3

Czech CZ-75: An upgrade of earlier Czechoslovakian pistols, the CZ-75 was designed with the Western market in mind. It was much sought after, although it was difficult to obtain in the United States.

Nation: Czechoslovakia
Ammunition: 9mmP
Weight: .9 kg
Magazine: 5
Price: \$550 (S/C)



Detonics Scoremaster

Type	ROF	Mag	Rng	DAM	ARM
.45 ACP	2	2	10	2	×3

Detonics Scoremaster: A heavy pistol designed primarily for target shooting.

Nation: United States,
Ammunition: .45 ACP
Weight: 1.15 kg
Magazine: 2
Price: \$1000 (R/—)

AUTOMATIC PISTOLS (1/2W, 1/2T)



Heckler & Koch HK-4

Type	ROF	Mag	Rng	DAM	ARM
.380 ACP	2	2	10	1	× 4
.32 ACP	2	2	8	1	× 4
.25 ACP	3	2	16	0	× 4
.22 LR	3	3	15	0	× 4

H & K HK-4: A small automatic pistol manufactured and sold with four interchangeable barrels (and magazines), enabling the same weapon to be quickly and easily converted from one caliber to another. The HK-4 was the official sidearm of the German border police until the late 1970s, and was popular with survivalists and weapon fanciers.

Nation: West Germany

Ammunition: .380 ACP/.32 ACP/.25 ACP/.22 LR

Weight: .3 kg

Magazine: 2 (3 for .22 LR)

Price: \$600 (C/S)



H & K P7 M13

Type	ROF	Mag	Rng	DAM	ARM
9mmP	2	4	15	1	× 3

H & K P7 M13: Identical to the P7 M8 except for increased magazine capacity.

Nation: West Germany

Ammunition: 9mmP

Weight: .95 kg

Magazine: 4

Price: \$675 (C/S)



H & K P7 M8

Type	ROF	Mag	Rng	DAM	ARM
9mmP	2	2	15	1	× 3

H & K P7 M8: A West German handgun which has a squeeze-cocking mechanism and can be drawn, cocked, and fired with one motion. It cannot fire if dropped or bumped.

Nation: West Germany

Ammunition: 9mmP

Weight: .83 kg

Magazine: 2

Price: \$600 (C/S)

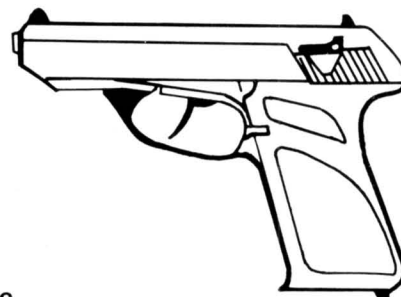

H & K P9S

Type	ROF	Mag	Rng	DAM	ARM
9mmP	2	3	15	1	× 3

H & K P9S: A double-action automatic pistol made in West Germany, with the same roller-locking feature as the H & K G3 assault rifle series. A cocking lever makes it safe to carry.

Nation: West Germany

Ammunition: 9mmP

Weight: .88 kg

Magazine: 3

Price: \$700 (C/S).

AUTOMATIC PISTOLS (½W, ½T)

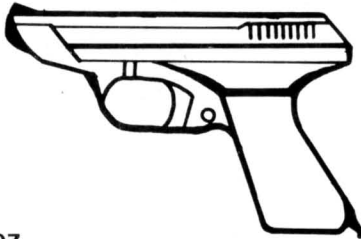
**H & K VP70Z**

Type	ROF	Mag	Rng	DAM	ARM
9mmP	2	6	15	1	×3

H & K VP70Z: This high-magazine-capacity, West German pistol replaced the Walther PPK as the service weapon of the British Secret Service (MI-6) and the Security Service (MI-5). It has been used by the West German Anti-Terrorist Group, GSG-9, favored for its light weight and large magazine capacity. It was designed for automatic fire using a detachable stock.

Nation: West Germany

Ammunition: 9mmP

Weight: .78 kg

Magazine: 6

Price: \$800 (S/R)

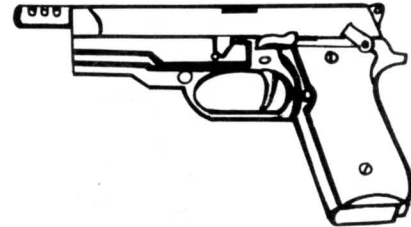
**IMI M91**

Type	ROF	Mag	Rng	DAM	ARM
9mmP	2	6	15	1	×3

IMI M91: Designed and built by Israeli Military Industries (IMI), the M91 is based on the popular Desert Eagle handgun series. In 1991, the M91 became the standard issue sidearm for the Israeli military. It has proven itself to be a rugged and reliable weapon.

Nation: Israel and South Africa

Ammunition: 9mmP

Weight: 1 kg

Magazine: 6

Price: \$850 (S/R)

**Glock 17A**

Type	ROF	Mag	Rng	DAM	ARM
9mmP	2	6	15	1	×3

Glock 17A: A modern, high magazine capacity pistol, the Austrian Glock became the standard issue sidearm of the Austrian military. Most of the component parts are made from high-tech carbon fiber plastics, making it difficult to detect. This weapon sparked controversy when it was introduced, but the whole question has become moot.

Nation: Austria

Ammunition: 9mmP

Weight: .65 kg

Magazine: 6

Price: \$900 (S/S)

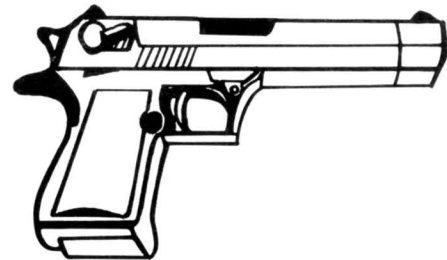
**IMI Desert Eagle**

Type	ROF	Mag	Rng	DAM	ARM
.357 mag	1	3	18	2	×3
.44 mag	1	2	20	2	×2

IMI Desert Eagle: Designed and built in Israel, it is the only commercial automatic pistol that fires the .357 magnum cartridge. Another version fires the .44 magnum cartridge. Their short length makes them an exception to general rules on .38 special/.357 magnum interchangeability.

Nation: Israel

Ammunition: .357 magnum, .44 magnum

Weight: 1.75 kg

Magazine: 3 (.357 magnum), 2 (.44 magnum)

Price: \$2500/\$3000 (R/—).

AUTOMATIC PISTOLS (1/2W, 1/2T)



Llama Large Frame Automatic

Type	ROF	Mag	Rng	DAM	ARM
.45 ACP	2	2	10	2	×3
.9mmP	2	5	15	1	×3

Llama Large Frame Automatic: A heavy-duty, automatic pistol, the Llama Large Frame comes in either .45 ACP or 9mmP. It is nearly identical in appearance to the Colt M1911A1, the most striking difference being the barrel rib.

Nation: Spain

Ammunition: .45 ACP or 9mmP

Weight: 1.12 kg

Magazine: 4 (9mmP) or 2 (.45 ACP)

Price: \$335 (S/R)

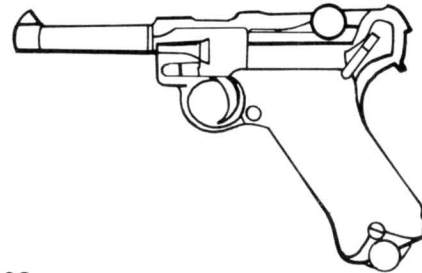

Luger P-08

Type	ROF	Mag	Rng	DAM	ARM
9mmP	2	2	15	1	×3

Luger P-08: Unique among handguns, the Luger is one of the most famous and easily recognizable automatic pistols in the world. Because of its distinctive toggle action and close parts tolerance, it is easy to jam simply from dirt getting into the weapon. Most Lugers are now owned by collectors, but because millions are in circulation, they must be included here.

Nation: Germany

Ammunition: 9mmP

Weight: .87 kg

Magazine: 2

Price: \$1100 (R/R)



Llama Small Frame Automatic

Type	ROF	Mag	Rng	DAM	ARM
.380 ACP	2	2	10	1	×4
.22 LR	3	3	15	0	×4

Llama Small Frame Automatic: As the name suggests, it is a smaller, lighter version of the Large Frame Automatic. Because of its similarity to the Colt M1911A1 in both appearance and operation, the Llama Small Frame has become extremely popular with NATO vehicle and aircraft crews.

Nation: Spain

Ammunition: .380 ACP or .22 LR

Weight: .644 kg

Magazine: 2 (.380 ACP) or 3 (.22 LR)

Price: \$260 (S/R)



MAB-P15

Type	ROF	Mag	Rng	DAM	ARM
9mmP	2	5	15	1	×3

MAB-P15: The standard issue sidearm of the French military, the P15 has a simple action, high magazine capacity and is ruggedly built. It is considered one of the best French handguns designed.

Nation: France

Ammunition: 9mmP

Weight: 1.09 kg

Magazine: 5

Price: \$550 (C/S)

AUTOMATIC PISTOLS (1/2W, 1/2T)



Makarov PM

Type	ROF	Mag	Rng	DAM	ARM
9mmM	2	3	15	1	×4

Makarov PM: The Makarov is the standard issue sidearm for the Soviet Union and in common use with other Warsaw Pact nations.

- Nation:* USSR
- Ammunition:* 9mmM
- Weight:* .5 kg
- Magazine:* 3
- Price:* \$150 (S/V)

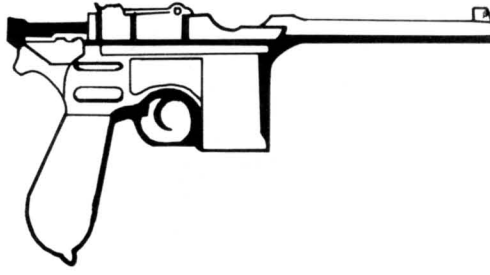

Mauser M1896

Type	ROF	Mag	Rng	DAM	ARM
.32 ACP	2	3l	11	1	×4

Mauser M1896: Known as the "Broomhandle" Mauser, the M1896 was the first successful automatic pistol design. It was used by many countries and originally manufactured in Germany. By the late 1980s, it had become a collector's item. The M1896 has an integral magazine which is fed by a 10-round stripper clip.

- Nation:* Germany
- Ammunition:* .32 ACP
- Weight:* 1.13 kg
- Magazine:* 3l
- Price:* \$1000 (R/R)



Manhurin "Walther" Model PPK/S

Type	ROF	Mag	Rng	DAM	ARM
.22 LR	3	2	15	0	×4
.32 ACP	2	2	9	1	×4
.380 ACP	2	2	10	1	×4

Manhurin "Walther" Model PPK/S: Although originally designed and manufactured in Germany, since 1952 the PPK/S has been manufactured in France. It comes in three calibers: .22 LR, .32 ACP, and .380 ACP. It is one of the weapons favored by the DGSE (French Military Intelligence).

- Nation:* France
- Ammunition:* .22 LR, .32 ACP, .380 ACP
- Weight:* .64 kg
- Magazine:* 2
- Price:* \$435 (S/S)

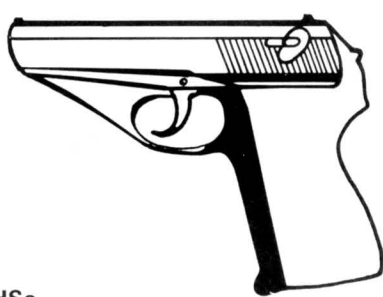

Mauser HSc

Type	ROF	Mag	Rng	DAM	ARM
9mmP	2	2	10	1	×4

Mauser HSc: A small pistol carried by the German Luftwaffe and Kriegsmarine during World War II. Like the M1896, the HSc is a collector's item, but is somewhat more scarce.

- Nation:* Germany
- Ammunition:* .380 ACP
- Weight:* .6 kg
- Magazine:* 2
- Price:* \$1200 (R/R)

AUTOMATIC PISTOLS (½W, ½T)

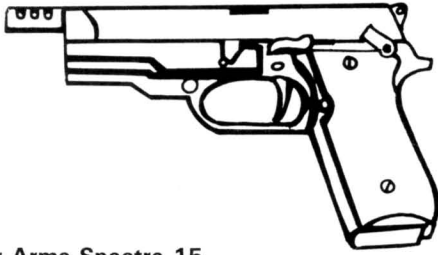

Metzger Arms Spectre 15

Type	ROF	Mag	Rng	DAM	ARM
9mmP	2	5	15	1	×3

Metzger Arms Spectre 15: The American-made answer to the Glock 17, the Spectre 15 was designed for covert operations. It is made from carbon fiber and high impact plastics. The barrel protrudes slightly from the end of the pistol, making it easy to fit with a suppressor.

Nation: United States
Ammunition: 9mmP
Weight: .55 kg
Magazine: 5
Price: \$1000 (R/—)



Ruger P-85

Type	ROF	Mag	Rng	DAM	ARM
9mmP	2	5	15	1	×3

Ruger P-85: In the late 1980s, politics and congressional pork barrelling had served to drastically slow down U.S. military procurement of the Beretta 92S. Several thousand P-85's were purchased as a stopgap measure by the US Navy and Marine Corps. They proved to be excellent service pistols and by the time America entered the war, the Navy and Marines had over 10,000 P-85 pistols in their inventory.

Nation: United States
Ammunition: 9mmP
Weight: .85 kg
Magazine: 5
Price: \$500 (C/S)



Ruger Mk II

Type	ROF	Mag	Rng	DAM	ARM
.22 LR	3	3	15	0	×4

Ruger Mk II: An American-made small caliber pistol, the Ruger Mk II has a reputation for reliability. It is distributed worldwide.

Nation: United States
Ammunition: .22 LR
Weight: 1 kg
Magazine: 3
Price: \$225 (C/S)

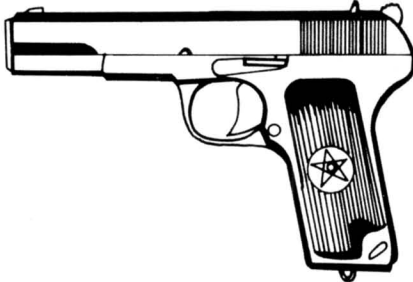

Tokarev

Type	ROF	Mag	Rng	DAM	ARM
7.62T	2	3	10	1	×4

Tokarev: The Tokarev was the standard issue sidearm for the Soviet Union in WWII and is still in service with that army, as well as in the armies of other Warsaw Pact nations. It is notable for its similarity to the American .45 caliber service automatic, and for its lack of a safety catch.

Nation: USSR
Ammunition: 7.62mmT
Weight: .5 kg
Magazine: 3
Price: \$100 (R/C)

AUTOMATIC PISTOLS (½W, ½T)



SIG/Sauer P 226

Type	ROF	Mag	Rng	DAM	ARM
9mmP	2	2	15	1	×3

SIG/Sauer P 226: A high quality Swiss-made handgun, the P 226 was a serious contender for the U.S. Army's standard sidearm. Even though it lost out in that competition, the P 226 became popular with a number of police and law enforcement agencies worldwide.

Nation: Switzerland
Ammunition: 9mmP
Weight: .84 kg
Magazine: 5
Price: \$585 (S/R)

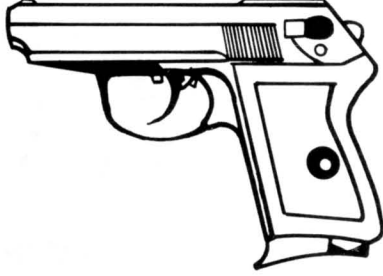

P-64

Type	ROF	Mag	Rng	DAM	ARM
9mmM	2	3	15	1	×4

P-64: The standard-issue sidearm of the Polish military, the P-64 fires the Soviet 9mm Makarov round. It is a reliable pistol, and is much sought by soldiers of the Warsaw Pact in 2000.

Nation: Poland
Ammunition: 9mmM
Weight: .636 kg
Magazine: 2
Price: \$450 (S/C)



SIG/Sauer P 230

Type	ROF	Mag	Rng	DAM	ARM
9mmP	2	2	10	1	×4

SIG/Sauer P 230: A lightweight, easily concealable automatic pistol, the P 230 has found its way into a number of European police arsenals. It is also carried by some Luftwaffe flight crews.

Nation: Switzerland
Ammunition: .380 ACP
Weight: .45 kg
Magazine: 2
Price: \$400 (S/R)

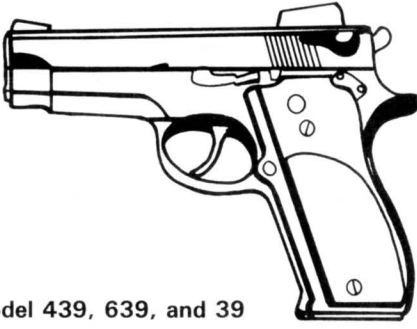

S & W Model 439, 639, and 39

Type	ROF	Mag	Rng	DAM	ARM
9mmP	2	3	15	1	×3

S & W Model 439, 639, and 39: An automatic pistol from a company far more famous for its revolvers (S & W). The Model 639 is identical except for a stainless steel finish. The Model 39 is an earlier version and is identical for game purposes.

Nation: United States
Ammunition: 9mmP
Weight: .82 kg
Magazine: 3
Price: \$485 (C/R)

AUTOMATIC PISTOLS (½W, ½T)



S & W Model 459, 659, and 59

Type	ROF	Mag	Rng	DAM	ARM
9mmP	2	5	15	1	×3

S & W Model 459, 659, and 59: The Model 459 is a double-action pistol with an alloy frame. It was designed as a possible replacement for the M1911A1 but lost out in the competition. The Model 659 is identical except for a stainless steel finish. The Model 59 is an earlier variant, which is identical for game purposes.

- Nation:* United States
- Ammunition:* 9mmP
- Weight:* .85 kg
- Magazine:* 5
- Price:* \$485 (C/R)



Walther P-38

Type	ROF	Mag	Rng	DAM	ARM
9mmP	2	3	15	1	×3

Walther P-38: The standard issue sidearm of the German Army in WW II, the P-38 was designed as a simpler, more rugged replacement for the Luger. It can still be found in many armies throughout the world.

- Nation:* Germany
- Ammunition:* 9mmP
- Weight:* .772 kg
- Magazine:* 3
- Price:* \$750 (R/R)



Walther PPK

Type	ROF	Mag	Rng	DAM	ARM
.32 ACP	2	2	10	1	×4

Walther PPK: A small automatic pistol best known as the preferred sidearm of fictional spy James Bond. In reality, it was used by the British Secret Service until it was replaced in the mid-1970s by the H & K VP-70z.

- Nation:* Germany
- Ammunition:* .32 ACP
- Weight:* .65 kg
- Magazine:* 2
- Price:* \$500 (S/R)

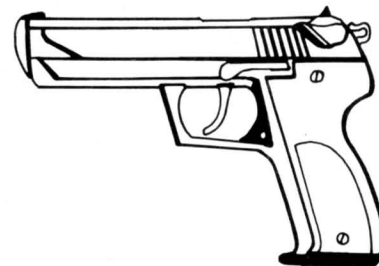

Steyr GB-80

Type	ROF	Mag	Rng	DAM	ARM
9mmP	2	6	15	1	×3

Steyr GB-80: A double-action, high magazine capacity automatic pistol, the GB-80 was adopted as the standard sidearm of the Australian military. It is a highly efficient combat weapon.

- Nation:* Austria and Australia
- Ammunition:* 9mmP
- Weight:* .88 kg
- Magazine:* 6
- Price:* \$750 (S/R)

REVOLVERS (½W, ½T)

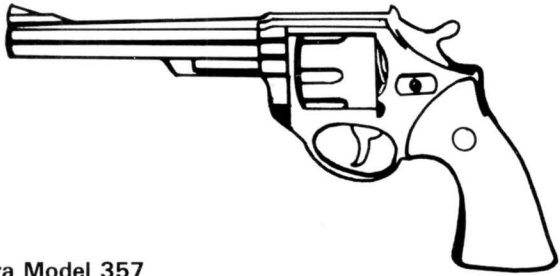

Astra Model 357

Type	ROF	Mag	Rng	DAM	ARM
.357 mag	1	2	18	2	×3

Astra Model 357: A Spanish-made revolver that enjoys some popularity in the US, the weapon is reliable and was fairly inexpensive before the war.

- Nation:* Spain
- Ammunition:* .357 magnum
- Weight:* 1.12 kg
- Magazine:* 2l
- Price:* \$285 (R/—)



Charter Arms Bulldog 45

Type	ROF	Mag	Rng	DAM	ARM
.45 ACP	2	2	10	2	×3

Charter Arms Bulldog 45: A lightweight but powerful backup pistol favored by many police officers. Originally, the weapon was made in .44 special. However, the version listed here was made for the US Air Force in .45 ACP as an emergency issue to Air Force Reserve Combat Security Squadrons.

- Nation:* United States
- Ammunition:* .45 ACP
- Weight:* .56 kg
- Magazine:* 2l
- Price:* \$265 (C/R)

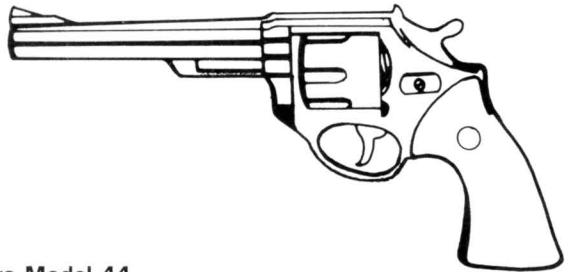

Astra Model 44

Type	ROF	Mag	Rng	DAM	ARM
.44 mag	1	2	20	2	×2

Astra Model 44: A larger version of the Model 357, it has the same features and advantages as the Model 357.

- Nation:* Spain
- Ammunition:* .44 magnum
- Weight:* 1.23 kg
- Magazine:* 2l
- Price:* \$350 (R/l)

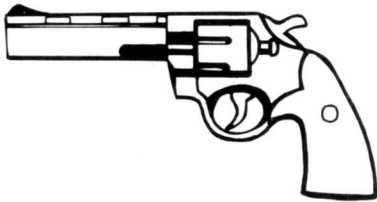

Colt Python

Type	ROF	Mag	Rng	DAM	ARM
.357 mag	1	2	18	2	×3

Colt Python: A top quality high-powered revolver in common use throughout the United States. A rib running down the top of the barrel gives the Python its distinctive look. Although not an "official" service weapon, many have found their way into the hands of US military personnel around the world.

- Nation:* United States
- Ammunition:* .357 magnum
- Weight:* 1.06 kg
- Magazine:* 2l
- Price:* \$750 (R/—)

REVOLVERS (½W, ½T)



Llama Commanche

Type	ROF	Mag	Rng	DAM	ARM
.357 mag	1	2	18	2	×3

Llama Commanche: A Spanish-made revolver that is quite popular in the US. The Commanche compares quite favorably with many US made revolvers.

- Nation:* Spain
- Ammunition:* .357 magnum
- Weight:* .86 kg
- Magazine:* 2l
- Price:* \$325 (S/R)



Ruger Security Six

Type	ROF	Mag	Rng	DAM	ARM
.357 mag	1	2	18	2	×3

Ruger Security Six: A .357 magnum revolver from the firm that is famous for them, the Security Six is a double-action revolver with an integral sighting rib and ejector rod housing.

- Nation:* United States
- Ammunition:* .357 magnum
- Weight:* .924 kg
- Magazine:* 2l
- Price:* \$350 (R/—)

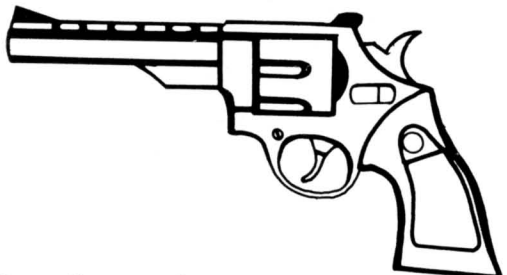

Llama Super Commanche

Type	ROF	Mag	Rng	DAM	ARM
.44 mag	1	2	20	2	×2

Llama Super Commanche: A heavier version of the Commanche that fires the powerful .44 magnum cartridge. The gun features an eccentric cam safety that makes it impossible for the hammer to contact the firing pin unless the trigger is fully depressed.

- Nation:* Spain
- Ammunition:* .44 magnum
- Weight:* 1.4 kg
- Magazine:* 2l
- Price:* \$535 (R/—)

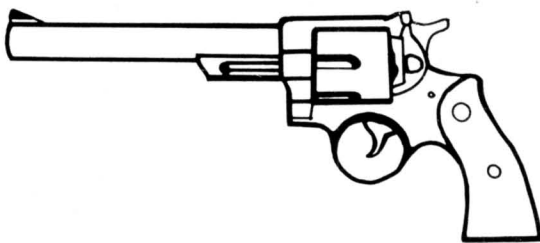

Ruger Redhawk

Type	ROF	Mag	Rng	DAM	ARM
.357 mag	1	2	18	2	×3
.44 mag	1	2	20	2	×2

Ruger Redhawk: A large, powerful handgun with a well-deserved reputation for accuracy and ruggedness. Some models of the Redhawk come with rings for mounting a telescopic sight.

- Nation:* United States
- Ammunition:* .357 magnum or .44 magnum
- Weight:* 1.47 kg
- Magazine:* 2l
- Price:* \$450 (R/l)

REVOLVERS (½W, ½T)

**S & W Model 19 Combat Magnum**

Type	ROF	Mag	Rng	DAM	ARM
.357 mag	1	2	18	2	×3

S & W Model 19 Combat Magnum: Originally designed and produced in the mid-1950s, the Model 19 was meant for law enforcement personnel. It is built on the light S & W K frame. Many can be found in the hands of both military and civilian police officers.

Nation: United States

Ammunition: .357 magnum

Weight: 1 kg

Magazine: 2l

Price: \$350 (R/—)

**S & W Model 27**

Type	ROF	Mag	Rng	DAM	ARM
.357 mag	1	2	18	2	×3

S & W Model 27: Designed and built in 1935, the Model 27 was the first pistol designed to use the .357 magnum cartridge. General George S. Patton carried an ivory-handled model (*not* pearl-handled, as is commonly held). The pistol is very heavily and sturdily built, making for an accurate and comfortable weapon.

Nation: United States

Ammunition: .357 magnum

Weight: 1.25 kg

Magazine: 2l

Price: \$450 (R/—)

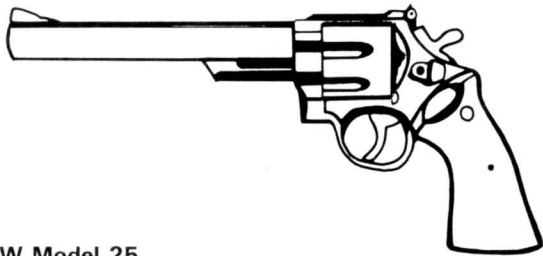
**S & W Model 25**

Type	ROF	Mag	Rng	DAM	ARM
.45 LC	2	2	10	2	×3

S & W Model 25: Chambered for the .45 LC cartridge, this revolver is less common than the other S & W models and thus more expensive. For decades, this weapon was a favorite among American "Wild West" aficionados (it fired the same cartridge as the Colt 1876 revolver... "the gun that won the west"), and it also acquired quite a reputation among Central and South American drug smugglers and other criminals.

Nation: United States

Ammunition: .45 LC

Weight: 1 kg

Magazine: 2l

Price: \$450 (R/—)

**S & W Model 28**

Type	ROF	Mag	Rng	DAM	ARM
.357 mag	1	2	18	2	×3

S & W Model 28: Nicknamed "Highway Patrolman," this revolver is a staple in many police forces throughout the United States.

Nation: United States

Ammunition: .357 magnum

Weight: 1.25 kg

Magazine: 2l

Price: \$450 (R/—)

REVOLVERS (½W, ½T)



S & W Model 29

Type	ROF	Mag	Rng	DAM	ARM
.44 mag	1	2	20	2	×2

S & W Model 29: What Sean Connery’s portrayal of James Bond did for the Walther PPK, Clint Eastwood’s portrayal of Inspector Harry Callahan did for this large powerful handgun. Designed to fire the .44 magnum cartridge, the Model 29 is built on the same frame as the Model 27 and looks like it could bring down a buffalo.

Nation: United States
Ammunition: .44 magnum
Weight: 1.35 kg
Magazine: 2l
Price: \$1250 (R/—)



S & W Model 38 Bodyguard

Type	ROF	Mag	Rng	DAM	ARM
.38 spec	1	2	15	1	×3

S & W Model 38 Bodyguard: An aluminum-frame revolver that features a fully shrouded hammer. The Model 38 was specifically designed to be carried concealed (the covered hammer does not catch on clothing and makes for a faster, smoother draw). The short barrel and light frame make accuracy difficult at any range over 5 meters.

Nation: United States
Ammunition: .38 special
Weight: .39 kg
Magazine: 2l
Price: \$375 (R/l)



S & W Model 36 Chiefs’ Special

Type	ROF	Mag	Rng	DAM	ARM
.38 spec	1	2	15	1	×3

S & W Model 36 Chiefs’ Special: A short-barreled .38 special revolver that is often carried by plainclothes law enforcement officers. Because of its design, the weapon is easy to conceal and the .38 Special round gives it a good, solid punch.

Nation: United States
Ammunition: .38 special
Weight: .6 kg
Magazine: 2l
Price: 315 (S/R)



S & W Model 57

Type	ROF	Mag	Rng	DAM	ARM
.41 mag	1	2	14	1	×3

S & W Model 57: This is a rare weapon in a rare caliber (.41 magnum).

Nation: United States
Ammunition: .41 magnum
Weight: 1 kg
Magazine: 2l
Price: \$350 (R/—)

SUBMACHINEGUNS (W, T)

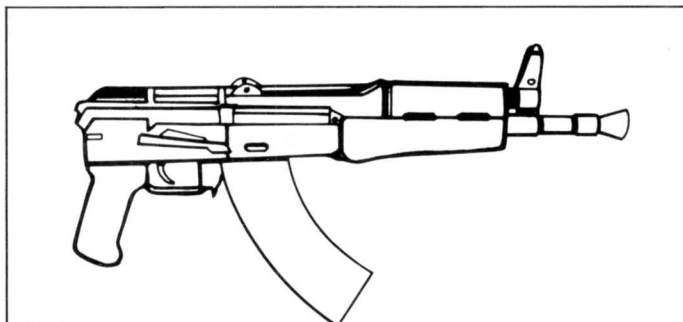

AKR

Type	ROF	Mag	Rng	DAM	ARM
5.45 B	4	10	30	2	×2

AKR: The AKR is the standard Eastern bloc submachinegun (except in the Czech army). The AKR (also known as the AKSU) is merely a cut-down version of the AK-74. Although a bit heavy for a submachinegun, it has good accuracy and stopping power.

- Nation: USSR
- Ammunition: 5.45B
- Weight: 4 kg
- Magazine: 10
- Price: \$300 (S/C)

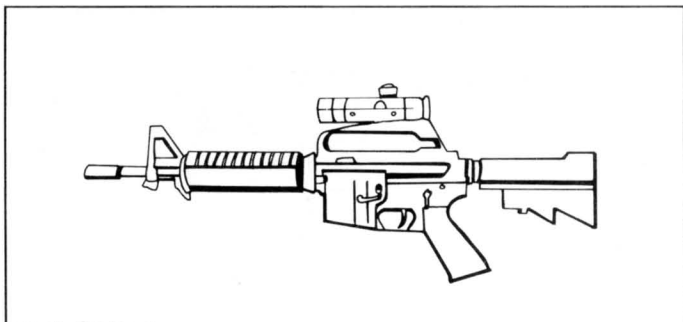

Colt CAR-15

Type	ROF	Mag	Rng	DAM	ARM
5.56 N	4	10	30	1	—

Colt CAR-15: A submachinegun version of the M16 originally designed for aircrews. It is more accurate than the M231. The CAR-15 cannot be fitted with the M203 grenade launcher, but can fire rifle grenades.

- Nation: United States
- Ammunition: 5.56 N
- Weight: 2.75 kg
- Magazine: 10
- Price: \$750 (S/R)

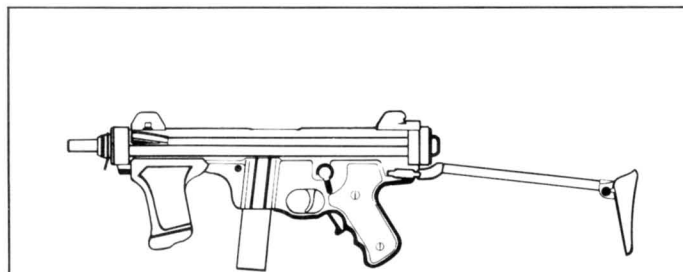

Beretta PM-12

Type	ROF	Mag	Rng	DAM	ARM
9mmP	2	13	15	1	×3

Beretta PM-12: The standard issue SMG of the Italian police and military, the PM-12 is a well crafted, well balanced weapon. It features a front and rear pistol grip, folding stock, and grip safety. The PM-12 was one of the contestants in the US Army's Combat Vehicle Crewman Individual Weapon competition in 1991. Although it wasn't chosen, the PM-12 found a number of buyers in various US police departments.

- Nation: Italy
- Ammunition: 9mmP
- Weight: 3 kg
- Magazine: 13
- Price: \$550 (R/S)

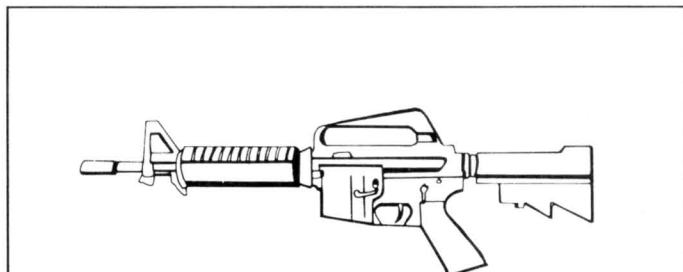

Colt CAR-15A1

Type	ROF	Mag	Rng	DAM	ARM
9mmP	2	5	30	1	×3

Colt CAR-15A1: Identical to the CAR-15 except that it used 9mmP ammunition. Although never adopted by the US military in any large quantities, the CAR-15A1 was used in Europe, mainly by local police forces. A semiautomatic version was also manufactured.

- Nation: United States
- Ammunition: 9mmP
- Weight: 2.75 kg
- Magazine: 10
- Price: \$950 (R/—)

SUBMACHINEGUNS (W, T)

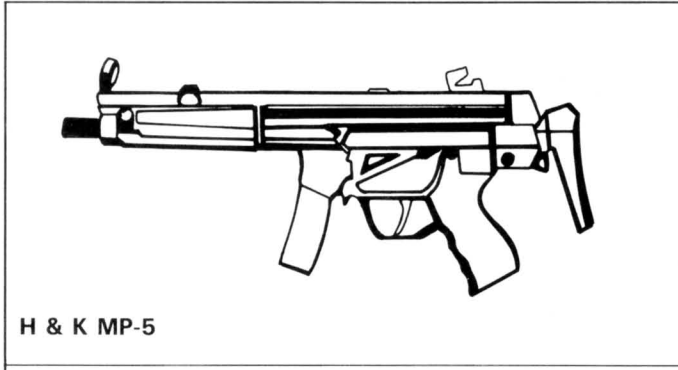

H & K MP-5

Type	ROF	Mag	Rng	DAM	ARM
9mmP	3	10	15	1	×3

H & K MP-5: The standard SMG of the West German territorial troops and police. A 5.56 N firing port weapon, the HK-54 is similar in overall appearance, but has a different magazine and barrel.

- Nation:* West Germany
- Ammunition:* 9mmP (MP-5), 5.56 N (HK-54)
- Weight:* 3 kg (MP-5), 3.05 kg (HK-54)
- Magazine:* 10 (MP-5), 13 (HK-54)
- Price:* \$400 (C/S) (MP-5), \$650 (R/—) (HK-54)

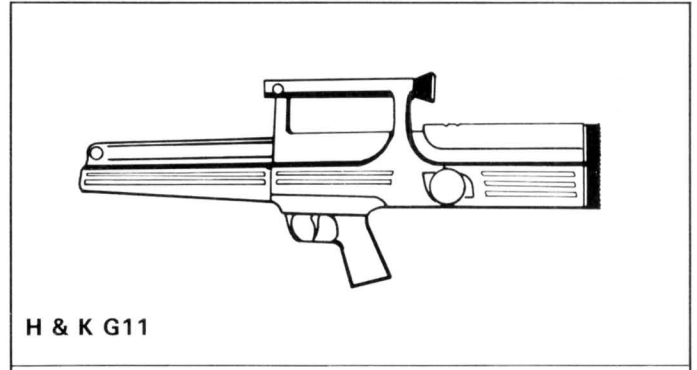

H & K G11

Type	ROF	Mag	Rng	DAM	ARM
4.7mm	5	32	40	2	×½

H & K G11: A weapon of radical design and great effectiveness, the G11 replaced the G3 as the standard assault rifle and the Uzi as the standard submachinegun of the West German Army. Its unique nature is fully described in the basic game.

Currently, although the weapon is fairly common, ammunition for it is increasingly rare, and most German soldiers have equipped themselves with obsolete weapons.

- Nation:* West Germany
- Ammunition:* 4.7mm caseless
- Weight:* 4 kg
- Magazine:* 32
- Price:* \$400 (S/R)

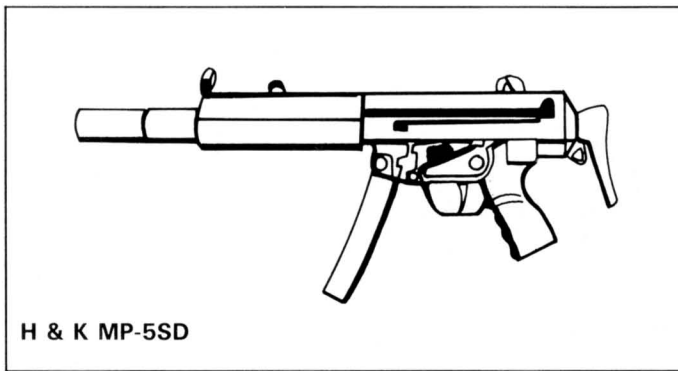

H & K MP-5SD

Type	ROF	Mag	Rng	DAM	ARM
9mmP	3	10	15	1	×3

H & K MP-5SD: A variant of the MP-5 fitted with an integral suppressor. Any attempt to spot a character using this weapon gets an automatic –40 percent to their RCN roll.

- Nation:* West Germany
- Ammunition:* 9mmP
- Weight:* 3 kg
- Magazine:* 10
- Price:* \$1000 (S/R)

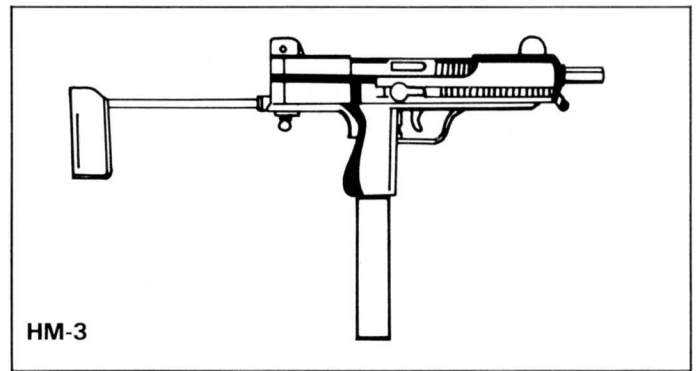

HM-3

Type	ROF	Mag	Rng	DAM	ARM
9mmP	3	11	30	1	×3

HM-3: A light SMG manufactured in Mexico by the Mendoza Arms Company. The HM-3 has the magazine in the grip like the Uzi. It has a folding metal stock. When the stock is folded forward, its rear section is used as a handgrip. The weapon is found only in Mexico and in the continental U.S.

- Nation:* Mexico
- Ammunition:* 9mm P
- Weight:* 3 kg
- Magazine:* 11
- Price:* \$750 (C/S)

SUBMACHINEGUNS (W, T)

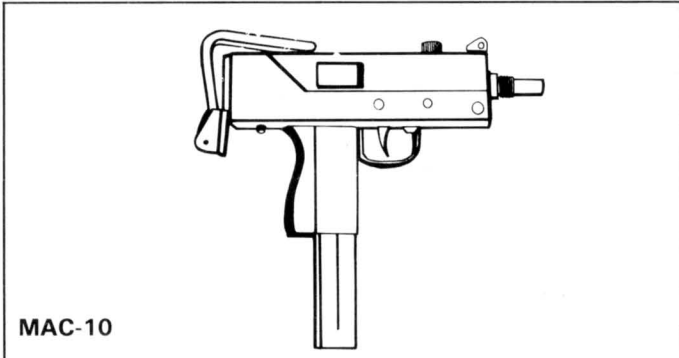

MAC-10

Type	ROF	Mag	Rng	DAM	ARM
9mmP	11	11	15	1	×3

MAC-10: A very small submachinegun designed for clandestine operations and used (although never officially adopted) by various arms of the U.S. military. The MAC-10 (also known as the M-10 or the Ingram) is available with a suppressor which reduces the sound of firing. Characters attempting to spot an M-10 fired using the suppressor get -20 percent to their RCN roll. The suppressor weighs .5 kg and costs \$200.

- Nation:* United States
- Ammunition:* 9mmP
- Weight:* 3.5 kg
- Magazine:* 11
- Price:* \$350 (C/S)

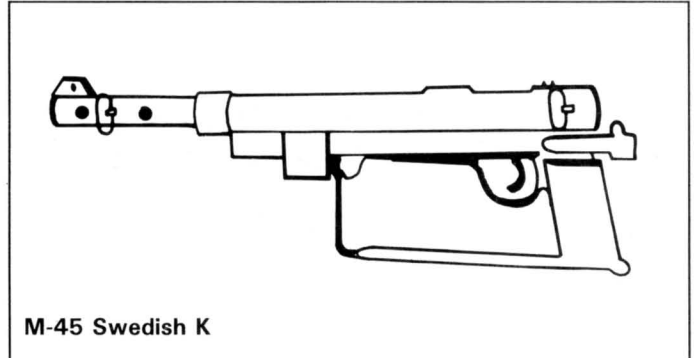

M-45 Swedish K

Type	ROF	Mag	Rng	DAM	ARM
9mmP	3	12	30	1	×3

M-45 Swedish K: A Swedish built SMG that was widely sold throughout the world. It is highly favored by mercenaries and others desiring a weapon from a neutral, nonaggressive country (for political reasons).

- Nation:* Sweden
- Ammunition:* 9mmP
- Weight:* 3.43 kg
- Magazine:* 12, 16
- Price:* \$400 (C/S)

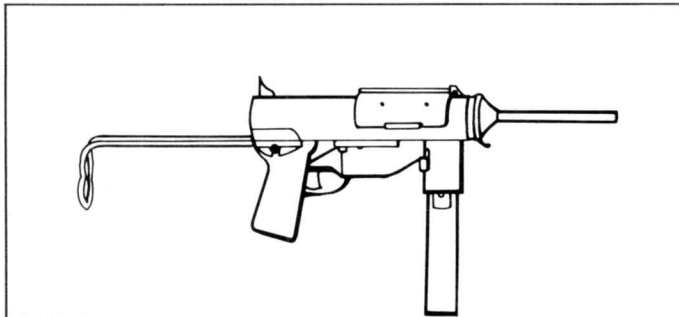

M3A1

Type	ROF	Mag	Rng	DAM	ARM
.45 ACP	3	10	10	2	×3

M3A1: Known as the "Grease Gun" because of its resemblance to an automotive servicing tool, the M3A1 was a cheap, easily manufactured and fairly reliable WWII vintage American SMG. It was used primarily by vehicle crews (usually in tanks) until well into the 1990s.

- Nation:* United States
- Ammunition:* .45 ACP
- Weight:* 3.47 kg
- Magazine:* 10
- Price:* \$350 (C/S)

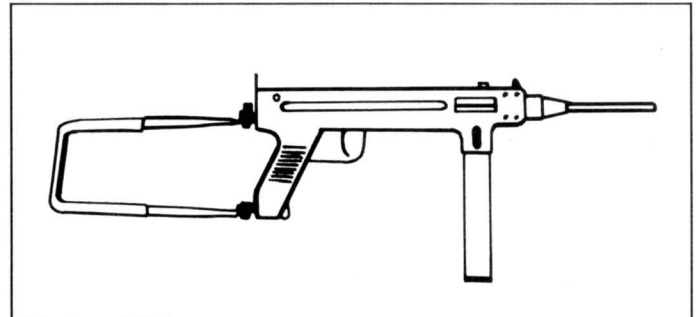

Madson M50

Type	ROF	Mag	Rng	DAM	ARM
9mmP	3	11	30	1	×3

Madson M50: A Danish SMG that has sold well in Latin America. The M50 has a magazine grip safety that prevents the weapon from being fired with one hand.

- Nation:* Denmark
- Ammunition:* 9mmP
- Weight:* 3.15 kg
- Magazine:* 11
- Price:* \$450 (C/S)

SUBMACHINEGUNS (W, T)

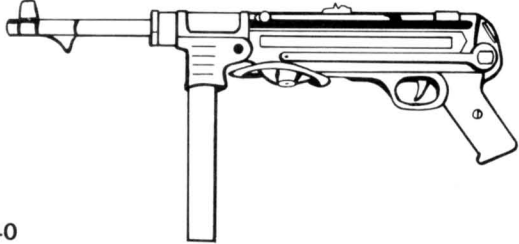

MP-40

Type	ROF	Mag	Rng	DAM	ARM
9mmP	3	11	30	1	×3

MP-40: Also called the *Schmeisser*, the MP-40 is one of the world's most famous submachineguns. Developed for the *Wehrmacht* during WWII, the MP-40 was the prototype for the majority of modern SMG designs and remained in service with many armies well into the 1970s. By 2000 it was obsolete, but could still be found in the arsenals of many police forces and Third World armies. It is considered to be the first of the modern submachineguns.

Nation: Germany
Ammunition: 9mmP
Weight: 4.03 kg
Magazine: 11
Price: \$1200 (R/R)

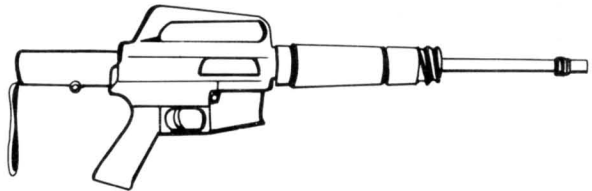

M231

Type	ROF	Mag	Rng	DAM	ARM
5.56 N	5	10	20	1	—

M231: The standard firing port weapon on the M2 Bradley AFV, this weapon is a satisfactory vehicle weapon for suppressive fire, but a mediocre submachinegun. Nevertheless, with large numbers of Bradleys no longer operational it was inevitable that the M231 would be dismantled and used in large numbers.

Nation: United States
Ammunition: 5.56 N
Weight: 4 kg
Magazine: 10
Price: \$300 (V/C)

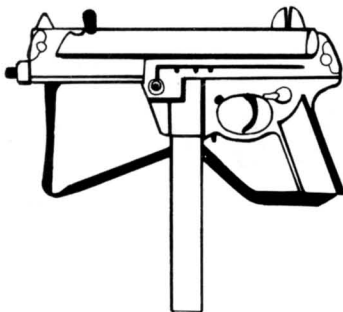

MPK

Type	ROF	Mag	Rng	DAM	ARM
9mmP	3	10	30	1	×3

MPK: Manufactured by the Walther company, the MPK is a conventional SMG design with a folding stock. It is used by a number of police and internal security organizations worldwide, and is fairly common.

Nation: West Germany
Ammunition: 9mmP
Weight: 2.75 kg
Magazine: 10
Price: \$400 (C/C)



PM-63

Type	ROF	Mag	Rng	DAM	ARM
9mmM	3	3	20	1	×4

PM-63: A relatively small (33.3 cm) SMG, the PM-63 is often carried by Polish AFV crews and airborne forces. The weapon has a folding metal stock which can double as a handgrip and a progressive trigger. The PM-63 is often carried in a hip holster.

Nation: Poland
Ammunition: 9mmM
Weight: 1.55 kg
Magazine: 5, 18, and 13
Price: \$350 (R/S)

SUBMACHINEGUNS (W, T)

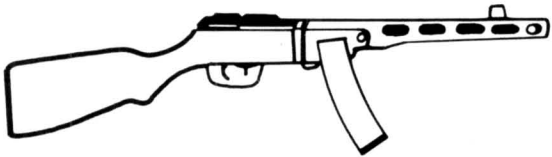

PPSh-41

Type	ROF	Mag	Rng	DAM	ARM
7.62mm T	3	12/27	10	1	×4

PPSh-41: A WWII vintage Soviet SMG, the PPSH-41 has also seen action in Korea and Vietnam. It uses a high capacity drum magazine that gives the weapon a very distinctive appearance, and caused it to be nicknamed "Stalin's Banjo." This weapon is no longer in Soviet service but can be found in many Third World arsenals.

- Nation:* USSR
- Ammunition:* 7.62mmT
- Weight:* 3.5 kg
- Magazine:* 12 box, 27 drum
- Price:* \$750 (—/R)

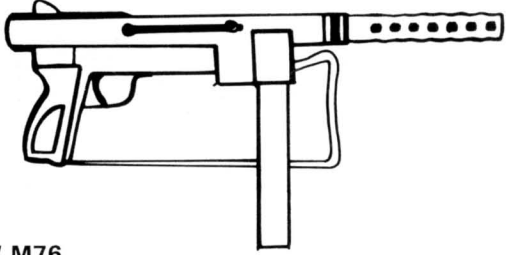

S & W M76

Type	ROF	Mag	Rng	DAM	ARM
9mmP	3	12	30	1	×3

S & W M76: The S & W M76 follows the conventional SMG pattern, and at one time was considered for use by the U.S. military. The M76 was first manufactured in the middle and late 1960s, with production ceasing for a time and resuming in the late 1980s. The weapon was very popular with police and security agencies.

- Nation:* United States
- Ammunition:* 9mmP
- Weight:* 3.28 kg
- Magazine:* 12
- Price:* \$800 (S/—)

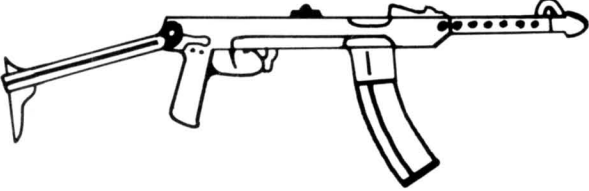

PPS-43

Type	ROF	Mag	Rng	DAM	ARM
7.62mm T	3	12	10	1	×4

PPS-43: Another WWII vintage Soviet SMG, the PPS-43 has a folding stock and can use the same box magazine as the PPSH-41 (but not the drum). This weapon is no longer in Soviet service, but can be found in many Third World arsenals.

- Nation:* USSR
- Ammunition:* 7.62mmT
- Weight:* 3.36 kg
- Magazine:* 12
- Price:* \$700 (—/S)



Sterling

Type	ROF	Mag	Rng	DAM	ARM
9mmP	3	11	30	1	×3

Sterling: The standard military submachinegun of the British Army, the Sterling has also found its way into general use.

- Nation:* United Kingdom
- Ammunition:* 9mmP
- Weight:* 3 kg
- Magazine:* 11
- Price:* \$600 (C/S)

SUBMACHINEGUNS (W, T)

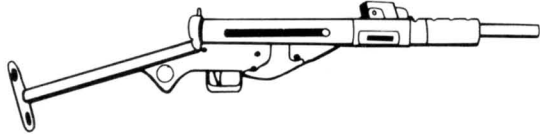

Sten Mk II

Type	ROF	Mag	Rng	DAM	ARM
9mmP	3	11	30	1	×3

Sten Mk II: A WWI vintage British submachinegun made from metal stampings for ease of production. It was the standard SMG for British and Canadian forces. The British manufactured and distributed thousands of Sten guns to underground forces opposing the Axis during WWII, and the weapon was in service with some Third World armies well into the 1990s.

- Nation:* United Kingdom
- Ammunition:* 9mmP
- Weight:* 2.8 kg
- Magazine:* 11
- Price:* \$200 (C/S)

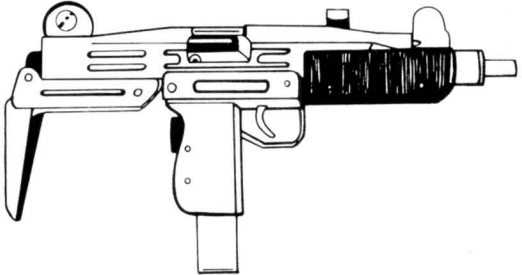

Uzi

Type	ROF	Mag	Rng	DAM	ARM
9mmP	4	11	30	1	×3

Uzi: The Israeli made Uzi is a common SMG worldwide. Once the standard submachinegun of the West German army, it is now returning to service as ammunition for the G11 becomes scarce. The Uzi is commonly used by police and other government agencies, such as the United States Secret Service and the Federal Marshal Service.

- Nation:* Israel
- Ammunition:* 9mmP
- Weight:* 4 kg
- Magazine:* 11
- Price:* \$500 (V/C)



Thompson M1A1

Type	ROF	Mag	Rng	DAM	ARM
.45 ACP	2	10/16	12	2	×3

Thompson M1A1: The last version of the venerable "Tommygun." Too late for action in WWI, it was used by American gangsters in the 1920s and '30s. It was obsolete by WWII but was still used. Later variants could use only a 10-shot box magazine. Referees should double the price for versions that also accept the 16-shot drum and allow only one drum.

- Nation:* United States
- Ammunition:* .45 ACP
- Weight:* 4.9 kg
- Magazine:* 10 box, 16 drum
- Price:* \$1000 (S/-)

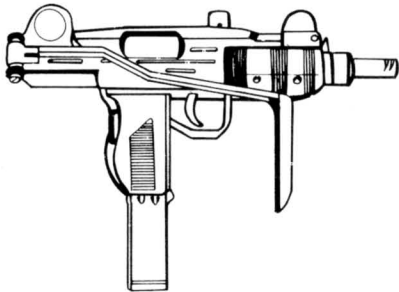

Mini Uzi

Type	ROF	Mag	Rng	DAM	ARM
9mmP	5	11	20	1	×3

Mini Uzi: A smaller version of the Uzi, using the same magazines and many of the same components. It is favored by vehicle crews because of its small size.

- Nation:* Israel, United States
- Ammunition:* 9mmP
- Weight:* 3 kg
- Magazine:* 11
- Price:* \$600 (C/S)

SUBMACHINEGUNS (W, T)

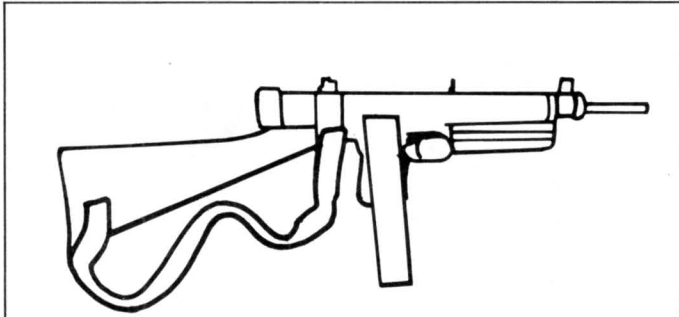

Vz 24

Type	ROF	Mag	Rng	DAM	ARM
7.62 T	4	11	25	1	×4

Vz 24: The standard Czech submachinegun, mostly found with militia and internal security forces.

- Nation:* Czechoslovakia
- Ammunition:* 7.62mm T
- Weight:* 4 kg
- Magazine:* 11
- Price:* \$300 (R/S)

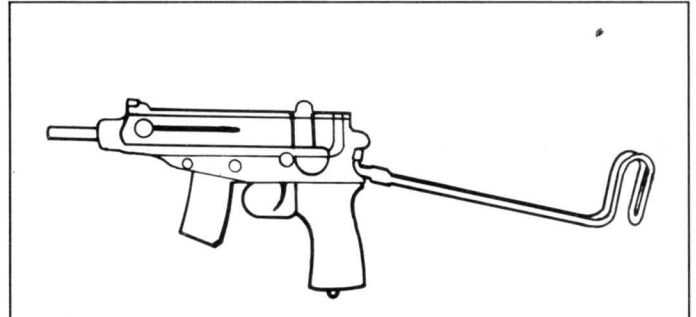

Vz 61 Skorpion

Type	ROF	Mag	Rng	DAM	ARM
.32 ACP	4	7	10	0	×4

Vz 61 Skorpion: Commonly referred to as a machine pistol, the Skorpion is small enough to be carried in a shoulder holster. Its short range and underpowered ammunition make it of limited combat value, but its ease of concealment has made it very popular with Warsaw Pact covert agents.

- Nation:* Czechoslovakia
- Ammunition:* .32 ACP
- Weight:* 2 kg
- Magazine:* 7
- Price:* \$250 (R/S)

ASSAULT RIFLES (W, ½T)

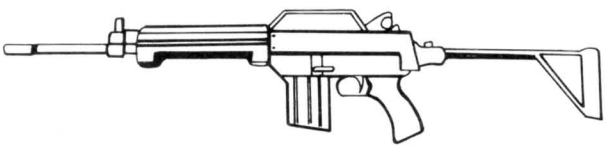

Australian Leader

Type	ROF	Mag	Rng	DAM	ARM
5.56 N	4	10	50	2	—

Australian Leader: An Australian rifle which sold moderately well in the American civilian semiautomatic rifle market in the last decades of the 20th century.

Nation: Australia
Ammunition: 5.56 N
Weight: 3.15 kg
Magazine: 10
Price: \$800 (R/—)



AKM

Type	ROF	Mag	Rng	DAM	ARM
7.62 S	3	10	40	4	× 2

AKM: The modern version of the ubiquitous AK-47, perhaps the most widely used military small arm in the world, and a very popular one despite its underpowered and unstable cartridge. Replaced in frontline service by the AKM, many AKMs were rechambered to fire 5.45 B ammunition, and thus true AKMs are mostly found with militia units.

Nation: USSR
Ammunition: 7.62 S
Weight: 4 kg
Magazine: 10
Price: \$300 (C/V)



AK-74

Type	ROF	Mag	Rng	DAM	ARM
5.45 B	3	10	40	2	× 2

AK-74: The standard combat rifle of Warsaw Pact forces in the 1990s.

Nation: USSR
Ammunition: 5.45 B
Weight: 4 kg
Magazine: 10
Price: \$300 (C/C)

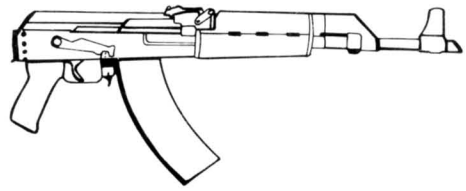

AKMR

Type	ROF	Mag	Rng	DAM	ARM
5.45 B	3	10	35	2	× 2

AKMR: An AKM rechambered to fire 5.45 B ammunition, the AKMR is widely used in Eastern Bloc nations alongside the AK-74.

Nation: USSR
Ammunition: 5.45 B
Weight: 4
Magazine: 10
Price: \$300 (C/V)

ASSAULT RIFLES (w. 1/2T)

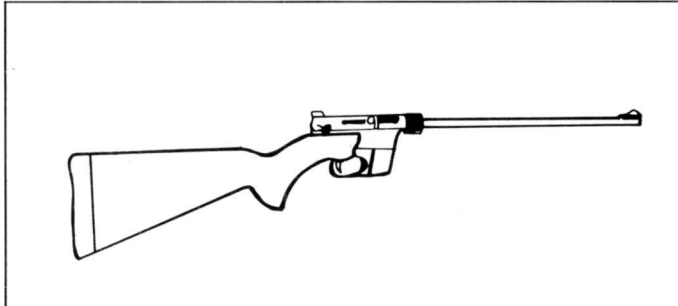

AR-7

Type	ROF	Mag	Rng	DAM	ARM
.22 LR	3	2	14	0	×4

AR-7: The AR-7 is more a survival rifle than a true assault rifle. Its component parts can be stored in the hollow stock. The AR-7 is lightweight, compact, and bouyant. Designed by the USAF and issued to aircrews as survival weapons (for hunting small game rather than for personal defense), the AR-7 is popular with campers, hikers, hunters, and other outdoor types.

- Nation:* United States
- Ammunition:* .22 LR
- Weight:* 1.13 kg
- Magazine:* 2
- Price:* \$200 (C/S)



Beretta AR-70

Type	ROF	Mag	Rng	DAM	ARM
5.56 N	4	10	50	2	—

Beretta AR-70: The standard issue rifle of the Italian military, the AR-70 replaced the BM-59. Like many other Italian-made weapons, it was widely sold on the world arms market and is commonly available.

- Nation:* Italy
- Ammunition:* 5.56 N
- Weight:* 3.41 kg
- Magazine:* 10
- Price:* \$500 (S/S)

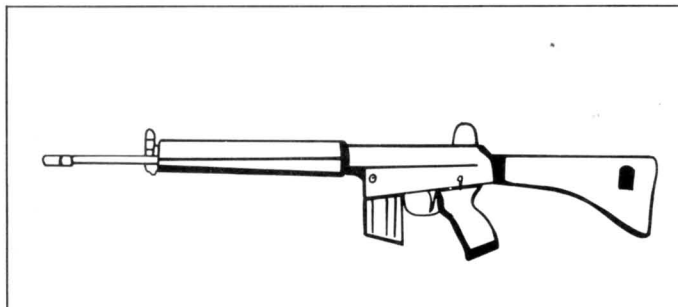

AR-18

Type	ROF	Mag	Rng	DAM	ARM
5.56 N	4	10	50	2	—

AR-18: Designed as a replacement for the M16, the AR-18 was rejected by the US Army and was sold on the international arms market. By the outbreak of the Sino-Soviet war, the Chinese military had purchased thousands of them, labeling them Type 96. A semiautomatic version known as the AR-180 was sold on the civilian market.

- Nation:* United States
- Ammunition:* 5.56 N
- Weight:* 3.17 kg
- Magazine:* 6, 10, 13
- Price:* \$450 (S/—)

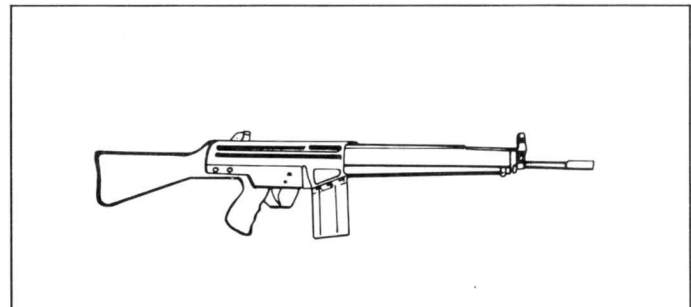

CETME Model L

Type	ROF	Mag	Rng	DAM	ARM
5.56 N	4	10	50	2	—

CETME Model L: The standard issue weapon of the Spanish military, the CETME is an evolutionary design based on the earlier Model 58. It is a sturdy, lightweight weapon for fighting in rugged areas. It had some foreign sales, especially in Latin America.

- Nation:* Spain
- Ammunition:* 5.56 N
- Weight:* 3.6 kg
- Magazine:* 10
- Price:* \$550 (S/R)

ASSAULT RIFLES (W, 1/2T)

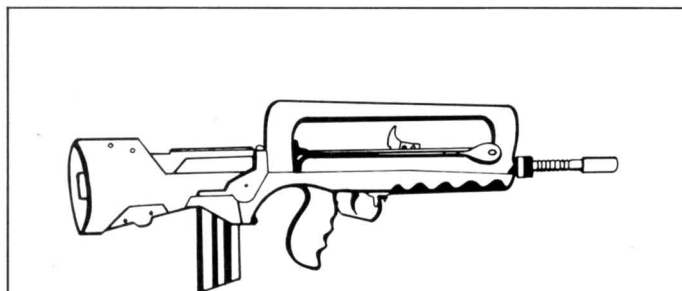

FA-MAS

Type	ROF	Mag	Rng	DAM	ARM
5.56 N	4	8	50	2	—

FA-MAS: The standard French combat rifle, replacing the earlier MAS 49/56. The FA-MAS is a "bullpup" configuration weapon, like the IW and G11, and is very rare outside of French service.

- Nation: France
- Ammunition: 5.56 N
- Weight: 4 kg
- Magazine: 8
- Price: \$500 (R/—)

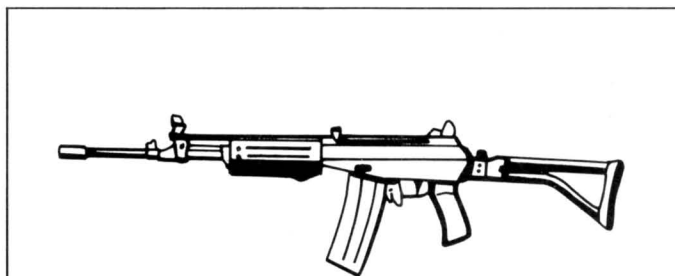

Galil ARM

Type	ROF	Mag	Rng	DAM	ARM
5.56 N	4	12	50	2	—

Galil ARM: The standard rifle of the Israeli military, exported in large numbers since the 1970s. It fires rifle grenades, can be fitted with the M203 grenade launcher, and has an integral bipod. A short barrelled version (the Galil SAR) weighs 3.5 kg, but is otherwise identical.

- Nation: Israel
- Ammunition: 5.56 N
- Weight: 4 kg
- Magazine: 12, 16
- Price: \$600 (S/S)

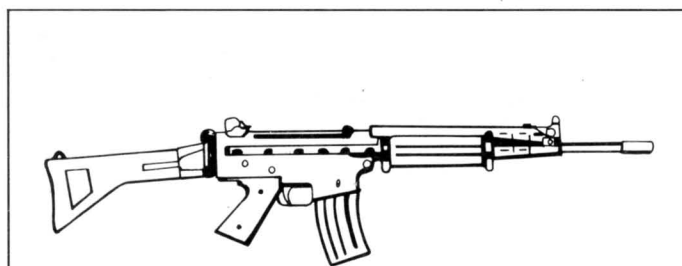

FN-CAL

Type	ROF	Mag	Rng	DAM	ARM
5.56 N	4	10	50	2	—

FN-CAL: The "little brother" to the FN-FAL, the CAL was meant as a replacement for it. The weapon enjoyed some sales on the international arms market, specifically in the Middle East and Africa. Many found their way into various NATO units during the war.

- Nation: Belgium
- Ammunition: 5.56 N
- Weight: 3 kg
- Magazine: 6, 10
- Price: \$525 (C/S)

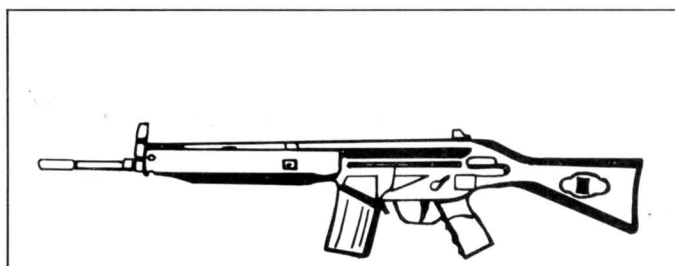

H & K HK 33A2/HK 93

Type	ROF	Mag	Rng	DAM	ARM
5.56 N	4	13	50	2	—

H & K HK 33A2/HK 93: A German-made assault rifle, the HK 33A2 is a smaller version of the famous G3. The HK 33A2 was issued to many of the Bundeswehr Territorial units and the West German Grenzschutztruppen (Border Guards). Several thousand were sold to the Iranians in 1993. A semiautomatic version called the HK 93 was also sold worldwide.

- Nation: West Germany
- Ammunition: 5.56 N
- Weight: 3.65 kg
- Magazine: 13
- Price: \$500 (C/S)

ASSAULT RIFLES (w, ½T)

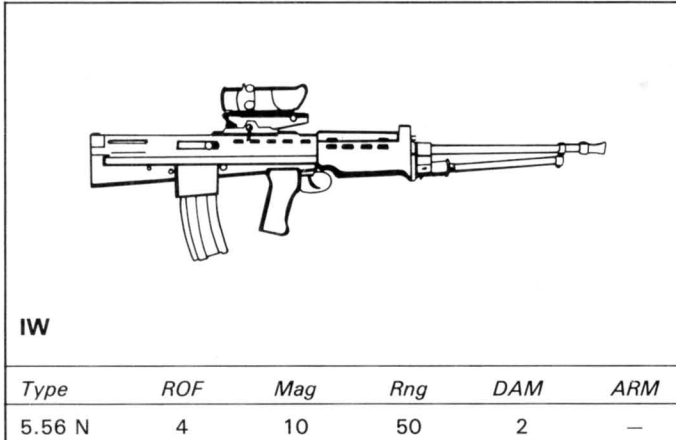

IW: The standard British combat rifle, replacing the FAL in the middle 1980s. Like the G11, the IW is a "bullpup" configuration rifle. The IW is rare outside of British service.

Nation: United Kingdom

Ammunition: 5.56 N

Weight: 4 kg

Magazine: 10

Price: \$500 (S/R)

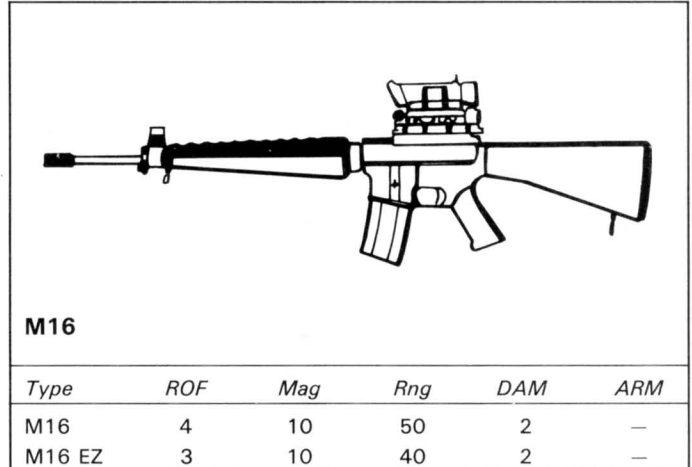

M16: The standard combat rifle of US and Canadian armies, the M16 is widely used. The M16 EZ is dealt with on page 3. The availability rating of the EZ model is (C/—); the AR-15's is (V/—). The price of the EZ model is \$250.

Nation: United States, Canada, Korea, and others

Ammunition: 5.56 N

Weight: 3 kg

Magazine: 10

Price: \$400 (V/C)

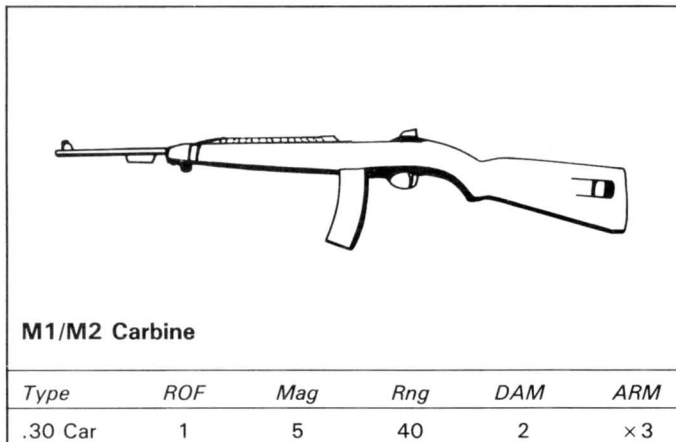

M1/M2 Carbine: A .30 caliber weapon developed in the middle 1940s to give officers and vehicle crewmen a more portable weapon than the M1 Garand. The M2 is the fully automatic version of the M1. The M3 has a mount for a sniper scope but does not differ in game terms. Many entered the surplus market, with the semiautomatic version becoming a popular hunting weapon (thousands were distributed by the department of defense).

Nation: United States

Ammunition: .30

Weight: 2.5 kg

Magazine: 5

Price: \$500 (R/—)

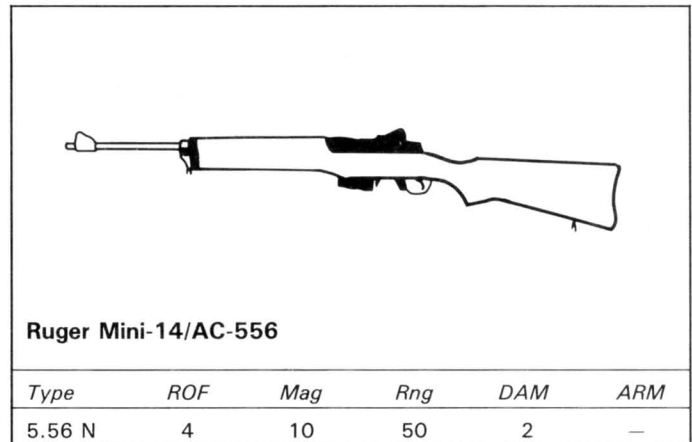

Ruger Mini-14/AC-556: A weapon made popular in the 1980s by television, the Mini-14 and its full auto variant, the AC-556, enjoyed sales at home and abroad. It has the configuration of the M14 and has many accessories, including a folding steel stock. It is preferred by many survivalist groups. The availability code is for the continental U.S.; overseas it would be (S/R).

Nation: United States,

Ammunition: 5.56 N

Weight: 2.9 kg

Magazine: 6 or 10

Price: \$500 (C/S).

ASSAULT RIFLES (W, 1/2T)



SIG SG 540

Type	ROF	Mag	Rng	DAM	ARM
5.56 N	4	10	50	2	—

SIG SG 540: A Swiss-designed assault rifle that is manufactured in Switzerland and in France by Manhurin. The SG 540 is a modern weapon that is in the inventories of various armies throughout the world including the French. Accessories include a folding stock and an integral grenade launcher.

Nation: Switzerland, France

Ammunition: 5.56 N

Weight: 3.55 kg

Magazine: 7 or 10

Price: \$600 (C/S)

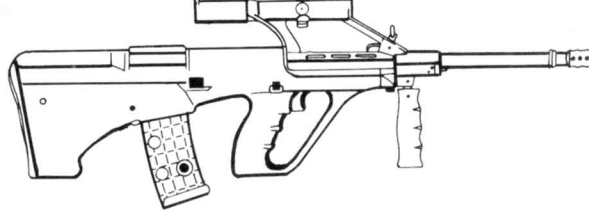

Steyr AUG

Type	ROF	Mag	Rng	DAM	ARM
5.56 N	4	10	50	2	—

Steyr AUG: The standard issue assault rifle of the Austrian and Australian military, the AUG has sometimes been referred to as the "Star Wars Rifle" because of its futuristic look. The weapon uses a "bullpup" configuration and aluminum and plastic materials to hold down weight. The magazine is made of transparent plastic which allows the shooter to visually keep track of the rounds expended. The AUG was also adopted by the Australian Army.

Nation: Austria, Australia

Ammunition: 5.56 N

Weight: 2.8 kg

Magazine: 10

Price: \$800 (S/R)



SAR-80

Type	ROF	Mag	Rng	DAM	ARM
5.56 N	4	10	50	2	—

SAR-80: Designed and built by Chartered Industries of Singapore, the SAR-80 was an easily produced assault rifle. It is the standard issue weapon of the Singapore military. The weapon did well on the international arms market in the early 1990s. It is a rugged, reliable, simple to use, and, most importantly, it came from a "nonaggressive" Third World country.

Nation: Singapore

Ammunition: 5.56 N

Weight: 3.7 kg

Magazine: 10

Price: \$600 (C/S)

BATTLE RIFLES (½W, ½T)

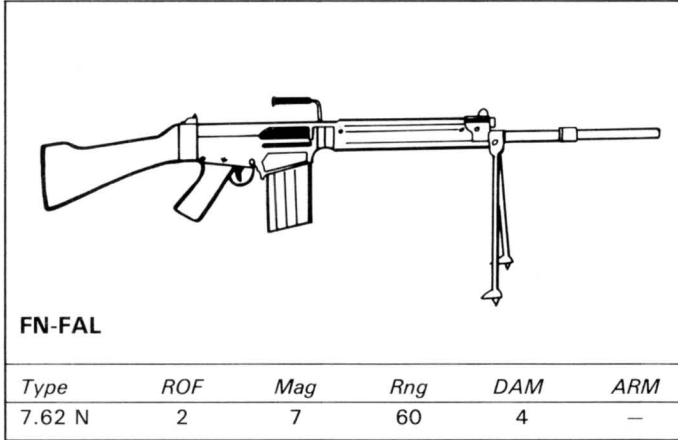

FN-FAL: This rifle is the Belgian rifle adapted as the standard rifle of the British Army (in its LAR variant) until its replacement by the IW and is in service with many other armies throughout the world. Since the outbreak of the war, numerous FALs have been picked up by military units, particularly those nostalgic for the heavier 7.62 N cartridge.

Nation: Belgium
Ammunition: 7.62 N
Weight: 5 kg
Magazine: 7
Price: \$600 (S/R)

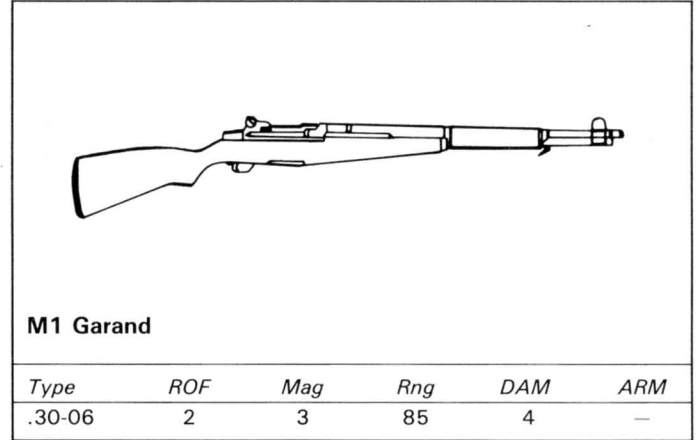

M1 Garand: The standard-issue US military rifle from WWII until 1956, the M1 was the first semiautomatic rifle adopted by any country as its standard weapon. It is fed from a three-shot block clip inserted in the top. The action remains open to aid in reloading. The M1 cannot fire semiautomatically if the ammo is not loaded with the clip, and only a full clip can be inserted. A conversion kit allows it to be converted to 7.62 NATO.

Nation: United States
Ammunition: 30-06, 7.62 N
Weight: 4.3 kg
Magazine: 3
Price: \$600 (R/—)

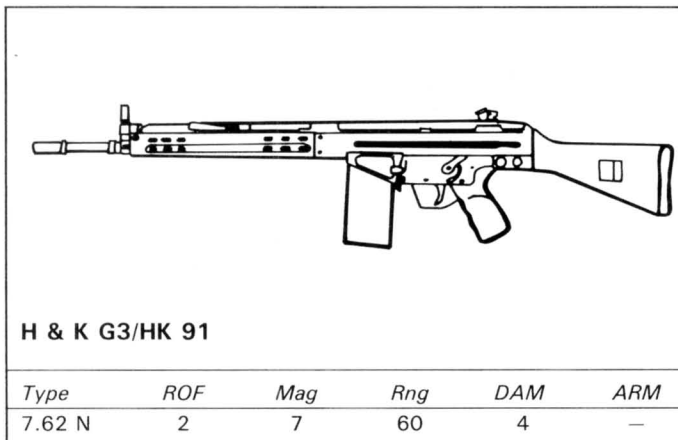

H & K G3/HK 91: The H & K G3 was the service rifle of the West German army until the 1980s and was sold worldwide. It went into reserve armories to equip territorial and internal security troops, and is used by West German units. A semi-automatic civilian version, the HK 91, differs in external details.

Nation: West Germany
Ammunition: 7.62 N
Weight: 5 kg
Magazine: 7
Price: \$500 (C/R)

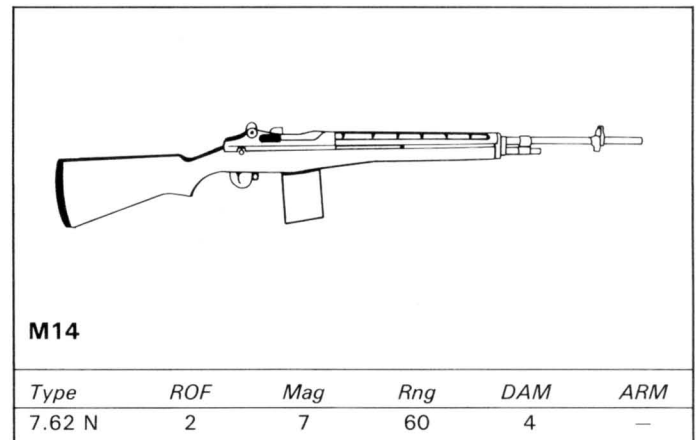

M14: The M14 was the last U.S. Army rifle to use a large caliber round. The M14 is fed from a seven-shot box magazine. Many sold on the civilian market wound up in the hands of paramilitary survivalist groups. The sniper version is the M21.

Nation: United States
Ammunition: 7.62 N
Weight: 4.12 kg
Magazine: 7
Price: \$400 (S/R)

BATTLE RIFLES (1/2W, 1/2T)

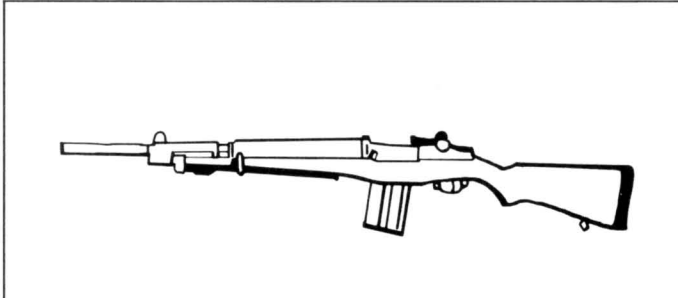

Beretta BM-59

Type	ROF	Mag	Rng	DAM	ARM
7.62 N	2	7	60	4	—

Beretta BM-59: The standard issue Italian Army rifle until it was replaced by the AR-70, the BM-59 was essentially an M1 Garand rechambered for 7.62 NATO ammo. Its features include selective fire capability and a seven-shot box magazine. Interestingly enough, a number of them were manufactured in the US from spare parts in a semiautomatic version designed for the civilian market.

- Nation:* Italy and United States
- Ammunition:* 7.62 N
- Weight:* 4.6 kg
- Magazine:* 7
- Price:* \$550 (R/R)

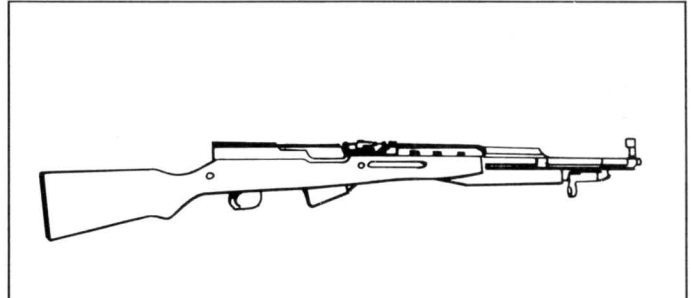

SKS

Type	ROF	Mag	Rng	DAM	ARM
7.62 S	2	3	40	4	× 2

SKS: A Soviet made semiautomatic rifle adopted in 1945, the SKS was the first weapon to use the 7.62 S round. The weapon uses an integral clip which is fed from a three-shot stripper clip. The weapon comes with an integral spike bayonet. The SKS is now generally found in the hands of local militia.

- Nation:* USSR
- Ammunition:* 7.62 S
- Weight:* 3.85 kg
- Magazine:* 3 shot stripper clip
- Price:* \$350 (R/S)

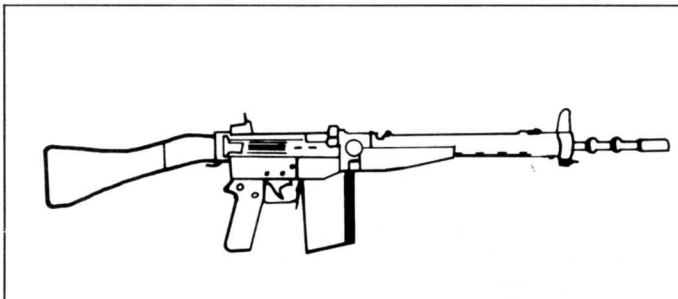

SIG 510-4

Type	ROF	Mag	Rng	DAM	ARM
7.62 N	2	7	60	4	—

SIG 510-4: One of the finest made military rifles in the world, the Swiss SIG 510-4 enjoys a reputation as a highly accurate weapon. It was the standard battle rifle of the Swiss Army until it was replaced by more modern types. The 510-4 is also used by several South American countries.

- Nation:* Switzerland
- Ammunition:* 7.62 N
- Weight:* 4.36 kg
- Magazine:* 7
- Price:* \$850 (R/—)

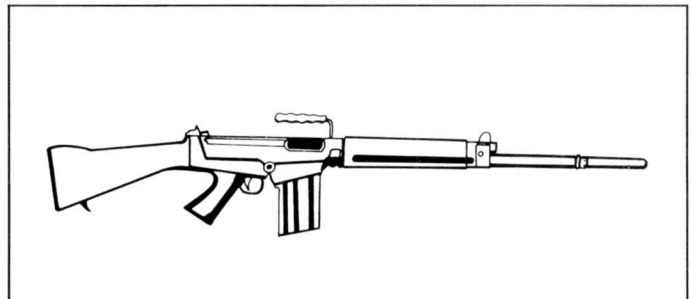

FN-LAR

Type	ROF	Mag	Rng	DAM	ARM
7.62 N	2	7	60	4	—

FN-LAR: The British Commonwealth version of the FN-FAL battle rifle, replaced in British service by the IW, but still found in service with armed forces worldwide. The magazines are not interchangeable with the FN-FAL. Many LARs are in service with the Indian armed forces (Indian Army LARs are slightly different, and their parts are not interchangeable with other versions).

- Nation:* United Kingdom
- Ammunition:* 7.62 N
- Weight:* 3.9 kg
- Magazine:* 7
- Price:* \$600 (C/R)

SNIPER RIFLES (1/2W)

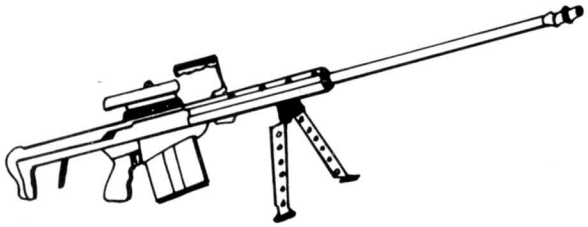

Barret Model 82

Type	ROF	Mag	Rng	DAM	ARM
.50 BMG	2	4	150	6	—
.50 SLAP	2	4	150	6	× 1/2

Barret Model 82: The largest caliber sniper rifle currently in service, the Barrett Model 82 is a semiautomatic, magazine-fed weapon chambered for the same ammunition as the M2HB machinegun.

- Nation:* United States
- Ammunition:* .50 BMG or .50 SLAP
- Weight:* 15 kg
- Magazine:* 4
- Price:* \$2000 (R/—)

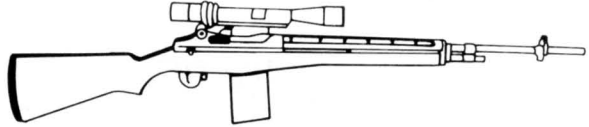

M21

Type	ROF	Mag	Rng	DAM	ARM
7.62 N	3	7	60	4	—

M21: The sniper variant of the M14 battle rifle, in use with the U.S. Army. It is fitted with a match grade barrel and a telescopic sight.

- Nation:* United States
- Ammunition:* 7.62 N
- Weight:* 5 kg
- Magazine:* 7
- Price:* \$400 (S/R)

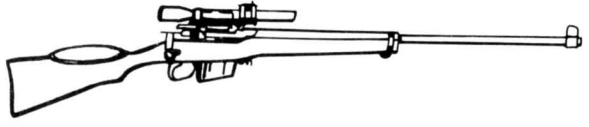

L42

Type	ROF	Mag	Rng	DAM	ARM
7.62 N	1	3	75	4	—

L42: The standard sniper rifle of the British Army and a progressive development of the SMLE (Short Magazine Lee-Enfield, the British service rifle of WWII), rechambered to fire more modern ammunition and fitted with a telescopic sight.

- Nation:* United Kingdom
- Ammunition:* 7.62 N
- Weight:* 4 kg
- Magazine:* 3
- Price:* \$400 (R/R)

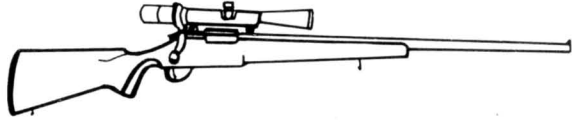

M40

Type	ROF	Mag	Rng	DAM	ARM
7.62 N	1	2	75	4	—

M40: The standard U.S. Marine Corps sniper rifle, the M40 is a civilian Remington Model 700 bolt action rifle fitted with a telescopic sight.

- Nation:* United States
- Ammunition:* 7.62 N
- Weight:* 3 kg
- Magazine:* 21
- Price:* \$700 (R/R)

SNIPER RIFLES (1/2W)

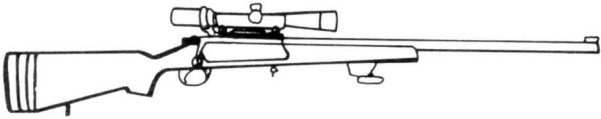

Parker-Hale C3

Type	ROF	Mag	Rng	DAM	ARM
7.62 N	1	1	75	4	—

Parker-Hale C3: The standard Canadian sniper rifle is a well made civilian hunting rifle adapted to military use and fitted with a telescopic sight.

- Nation:* Canada
- Ammunition:* 7.62 N
- Weight:* 4 kg
- Magazine:* 11
- Price:* \$400 (R/R)

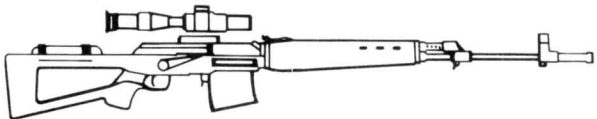

SVD

Type	ROF	Mag	Rng	DAM	ARM
7.62 L	2	3	70	4	—

SVD: The standard sniper weapon of the Warsaw Pact (except in Czech service), a semiautomatic, clip-fed rifle with a telescopic sight.

- Nation:* USSR
- Ammunition:* 7.62 L
- Weight:* 4 kg
- Magazine:* 3
- Price:* \$500 (R/S)



PSG1

Type	ROF	Mag	Rng	DAM	ARM
7.62 N	2	7	70	4	—

PSG1: The standard West German sniper rifle, a development of the H&K G3 battle rifle, with a match grade barrel, special trigger and stock modifications, and a telescopic sight. The weapon has excellent accuracy, but is considered too heavy compared to other sniper rifles.

- Nation:* West Germany
- Ammunition:* 7.62 N
- Weight:* 8 kg
- Magazine:* 7
- Price:* \$600 (R/R)



Steyr SSG-69

Type	ROF	Mag	Rng	DAM	ARM
7.62 N	1	3	75	4	—

Steyr SSG-69: An Austrian made bolt action sniper rifle, the SSG-69 is made especially for sniping duties. It uses a three-shot box magazine. It is issued to Austrian counter-terrorist units.

- Nation:* Austria
- Ammunition:* 7.62N
- Weight:* 4.37 kg
- Magazine:* 3
- Price:* \$1000 (R/R)

SNIPER RIFLES (1/2W)

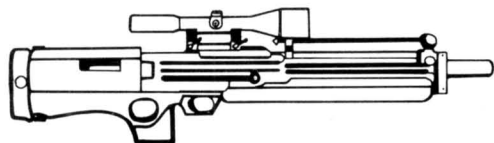
**Walther WA-2000N**

Type	ROF	Mag	Rng	DAM	ARM
.300 WM	2	2	62	4	—

Walther WA-2000N: An upgraded version of the famous WA-2000 sniper rifle, the WA-2000N is a "bullpup" configuration semiautomatic weapon. It has a built-in combination frame/case that protects the barrel and provides a mount for various sighting systems (IR, starlight scopes, and so on). The WA-2000N is the standard sniper rifle of GSG-9, the West German antiterrorist organization.

Nation: West Germany

Ammunition: .300 Win magnum

Weight: 7.8 kg (w/scope)

Magazine: 2

Price: \$2000 (R/—)

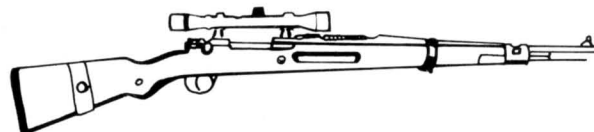
**Vz 54**

Type	ROF	Mag	Rng	DAM	ARM
8mm M	1	2	65	4	—

Vz 54: The standard Czech sniper rifle is a progressive development of the German Mauser bolt action series (which was the *Wehrmacht's* service rifle in WWII), fitted with a telescopic sight.

Nation: Czechoslovakia

Ammunition: 8mm M

Weight: 4.5 kg

Magazine: 2

Price: \$300 (R/R)

SPORTING RIFLES (½W)



Browning BBR

Type	ROF	Mag	Rng	DAM	ARM
.30-06	1	11	85	4	—

Browning BBR: A high quality, bolt action hunting rifle made in the United States. The BBR features a floating barrel and is drilled and tapped for a scope sight.

Nation: United States
Ammunition: .30-06
Weight: 3.6 kg
Magazine: 11
Price: \$500 (R/—)

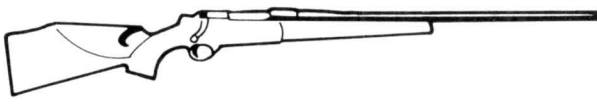

Colt Sauer Sporting Rifle

Type	ROF	Mag	Rng	DAM	ARM
.300 WM	1	1	60	4	—

Colt Sauer Sporting Rifle: A collaborative venture between Colt Firearms of America and SIG-Sauer of Switzerland. The result is a smooth shooting bolt action rifle of high quality. The weapon is tapped for sights.

Nation: United States and Switzerland
Ammunition: .300 WM
Weight: 3.65 kg
Magazine: 1
Price: \$1300 (R/—)

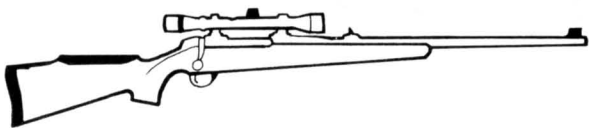

BSA CF-2

Type	ROF	Mag	Rng	DAM	ARM
7.62 N	1	11	70	4	—
.30-06	1	11	75	4	—

BSA CF-2: A British-made, bolt action hunting rifle. The CF-2 is representative of the British small arms industry. It features an extended forestock.

Nation: United Kingdom
Ammunition: 7.62N, .30-06
Weight: 3.5 kg
Magazine: 11
Price: \$750 (R/—)

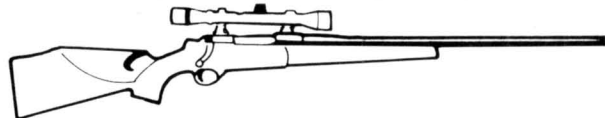

Colt Sauer Grand Alaskan

Type	ROF	Mag	Rng	DAM	ARM
.375 mag	1	11	80	4	—

Colt Sauer Grand Alaskan: A heavy, bolt action rifle designed for the powerful .375 H & H Magnum cartridge. Designed for large game, this rifle was mostly used in Alaska and the western United States.

Nation: United States and Switzerland
Ammunition: .375 H & H magnum
Weight: 3.8 kg
Magazine: 11
Price: \$1300 (R/—)

SPORTING RIFLES (1/2W)

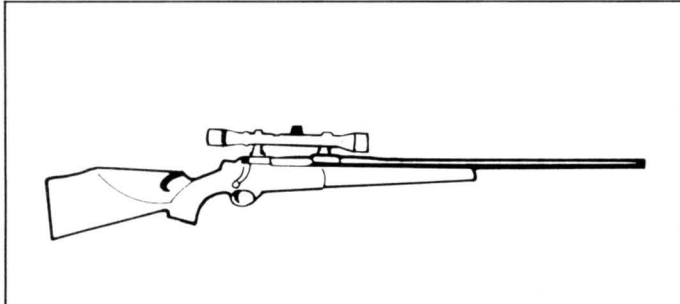

Colt Sauer Grand African

Type	ROF	Mag	Rng	DAM	ARM
.458 WBM	1	11	60	4	× 1/2

Colt Sauer Grand African: Same as the Grand Alaskan except that it fires .458 Winchester belted magnum cartridge. This is one of the largest cartridges still commonly available, and can bring down the largest of game (and some light armored vehicles!).

Nation: United States and Switzerland
Ammunition: .458 WBM
Weight: 3.8 kg
Magazine: 11
Price: \$1500 (R/—)

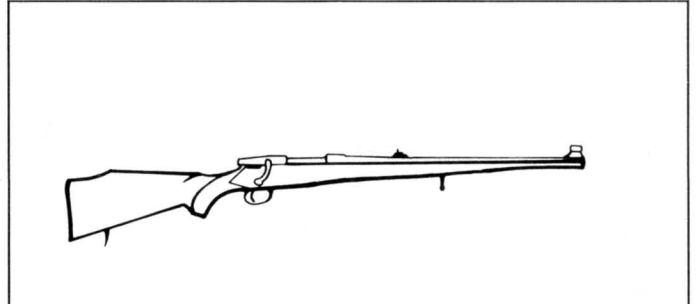

Mauser Mark X Carbine

Type	ROF	Mag	Rng	DAM	ARM
7.62 N	1	21	60	4	—

Mauser Mark X Carbine: A reduced version of the Mark X. The carbine features butterknife bolt handle, double set triggers, straight stock, and European style fore-end muzzle cap.

Nation: West Germany
Ammunition: 7.62 N
Weight: 3.4 kg
Magazine: 21
Price: \$550 (S/R).

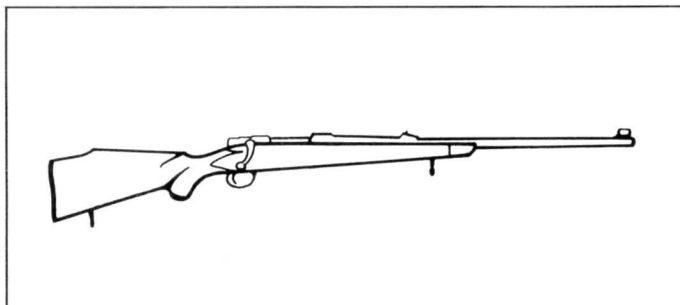

Mauser Mark X

Type	ROF	Mag	Rng	DAM	ARM
.30-06	1	11	75	4	—
7.62 N	1	11	60	5	× 1/2

Mauser Mark X: A German bolt action hunting rifle with an excellent reputation.

Nation: West Germany
Ammunition: 7.62 N, .30-06
Weight: 3.8 kg
Magazine: 21 (11 in magnums)
Price: \$1200 (R/—).

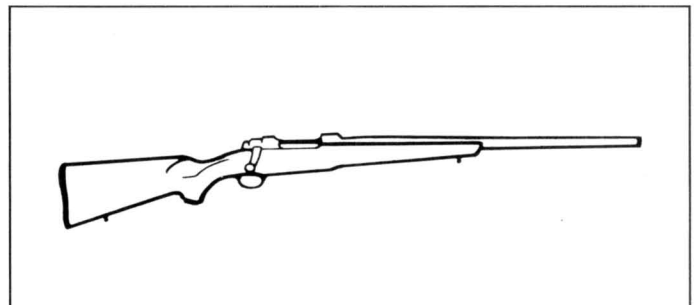

Remington Model 700

Type	ROF	Mag	Rng	DAM	ARM
7.62 N	1	21	75	4	—
.30-06	1	21	75	4	—
.375 mag	1	21	80	4	—

Remington Model 700: The civilian version of the M40 sniper rifle, the Model 700 was sold worldwide. It is considered a "workhorse" hunting rifle and has seen use from Alaska to South Africa.

Nation: United States
Ammunition: 7.62 N, .30-06, 375 H & H Mag
Weight: 3.5 kg
Magazine: 21
Price: \$750 (C/S)

SPORTING RIFLES (1/2W)



Ruger Model 77

Type	ROF	Mag	Rng	DAM	ARM
5.56 N	1	11	60	2	—
7.62 N	1	11	75	4	—

Ruger Model 77: A heavy bolt action American-made hunting rifle. The Model 77 is not as well known as many other rifles but nevertheless it is still a solid piece of work.

Nation: United States
Ammunition: 5.56 N, 7.62 N
Weight: 4 kg
Magazine: 11
Price: \$500 (S/R)

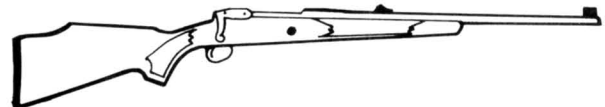

Savage Model 110-C

Type	ROF	Mag	Rng	DAM	ARM
.30-06	1	1	75	4	—
.300 WM	1	1	60	4	—

Savage Model 110-C: An American-made bolt action rifle. It features a floating barrel with Monte Carlo cheekpiece. There is also a left-handed version available.

Nation: United States
Ammunition: .30-06, .300 WM
Weight: 3.5 kg
Magazine: 1
Price: \$350 (S/R)



Sako Standard

Type	ROF	Mag	Rng	DAM	ARM
5.56 N	1	11	60	2	—
7.62 N	1	11	75	4	—
.30-06	1	11	75	4	—

Sako Standard: A Finnish-made bolt action hunting rifle with an international reputation for quality and accuracy. A Sako rifle was a much sought after "war trophy" by the Nato forces fighting in Finland. It features an adjustable trigger and sight mountings.

Nation: Finland
Ammunition: 5.56 N, 7.62 N, .30-06
Weight: 3.6 kg
Magazine: 11
Price: \$775 (S/R)

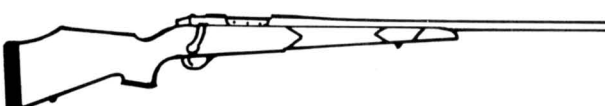

Weatherby .460 Magnum Deluxe

Type	ROF	Mag	Rng	DAM	ARM
.460 Mag	1	11	65	5	× 1/2

Weatherby .460 Magnum Deluxe: The most powerful big game rifle in the world, the .460 is a heavy bolt action rifle designed to bring down the largest game animals (rhinoceros, cape buffalo, light helicopters, etc.). The rifle itself is very hard to find, and its ammunition even harder.

Nation: USA
Ammunition: .460 WbyMag
Weight: 4.8 kg
Magazine: 11
Price: \$1200 (R/—)

SPORTING RIFLES (½W)

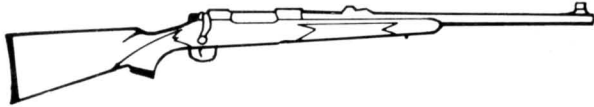
**Winchester Model 70**

Type	ROF	Mag	Rng	DAM	ARM
.30-06	1	11	75	4	—
7.62 N	1	11	75	4	—
.300 WM	1	11	60	4	—

Winchester Model 70: Another internationally popular American-made bolt action rifle. The model 70 is considered a classic among sportsmen and can be found the world over.

Nation: United States

Ammunition: .30-06, 7.62 N, .300 WM

Weight: 3.65 kg

Magazine: 21

Price: \$700 (S/R)

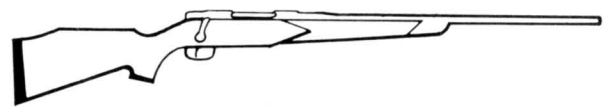
**Winchester 70 XTR Super Express Magnum**

Type	ROF	Mag	Rng	DAM	ARM
.458 Mag	1	11	60	4	× ½

Winchester Model 70 XTR Super Express Magnum: The top-of-the-line heavy bolt action hunting rifle.

Nation: United States

Ammunition: .458 WBM

Weight: 3.85 kg

Magazine: 11

Price: \$800

SHOTGUNS (1/2W)

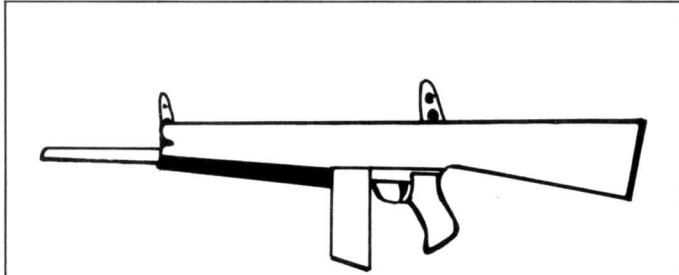

Atchisson/Dae Woo Assault 12

Type	ROF	Mag	Rng	DAM	ARM
12 gauge	5	20/6	40	4	×4

Atchisson/Dae Woo Assault 12: A devastating close-in weapon, the Assault 12 was designed in the US and manufactured in South Korea. It is surprisingly light, using a 20-round drum or a seven-round box magazine. The weapon was popular with arms collectors, but never saw large-scale military service because of competition from better-marketed designs.

- Nation:* South Korea/United States
- Ammunition:* 12 gauge
- Weight:* 4.5 kg
- Magazine:* 20-round drum or 10-round box
- Price:* \$1200 (R/—)

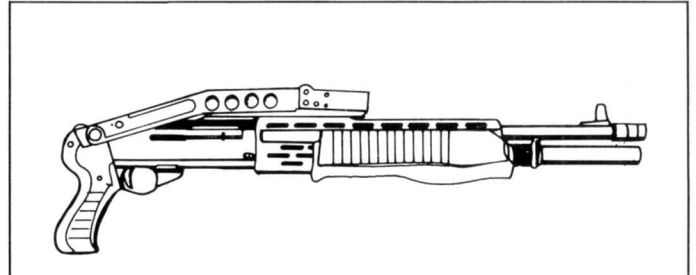

Franchi SPAS-12

Type	ROF	Mag	Rng	DAM	ARM
12 gauge	4	8	40	4	×4

Franchi SPAS-12: The initials stand for Sporting Purpose Automatic Shotgun, but SPAS-12 is a military weapon. With a folding stock and buttplate, it can be fired one-handed. It can easily be switched to manual pump. Built in Italy and America, it was issued to US Army MPs in Europe and the Persian Gulf.

- Nation:* United States and Italy
- Ammunition:* 12 gauge
- Weight:* 4.3 kg
- Magazine:* 8
- Price:* \$900 (S/R).

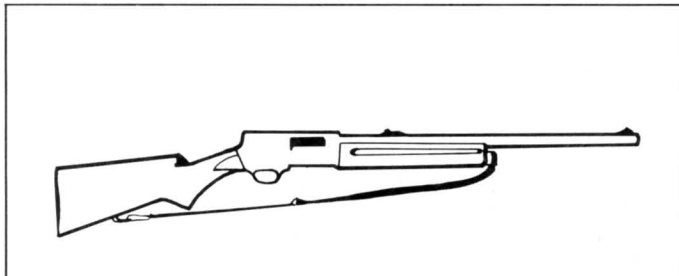

Browning Auto-5M

Type	ROF	Mag	Rng	DAM	ARM
12 gauge	4	5	40	4	×4

Browning Auto-5M: A well-made European autoloading shotgun, the 5M is a recoil operating weapon, and because of this, it needs to be well braced when firing. Otherwise the mechanism may not get enough recoil energy to function.

- Nation:* Belgium
- Ammunition:* 12 gauge
- Weight:* 3.75 kg
- Magazine:* 5
- Price:* \$650 (S/R).

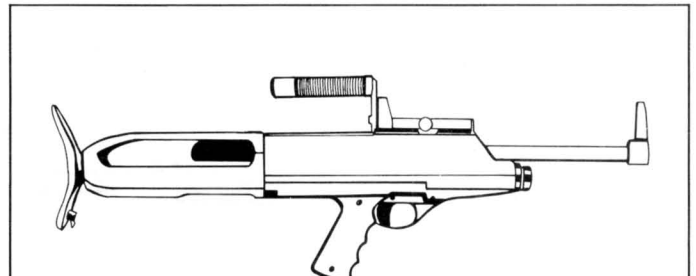

High Standard M-10B/C

Type	ROF	Mag	Rng	DAM	ARM
12 gauge	4	7	40	4	×4

High Standard M-10B/C: A bullpup configuration, gas operated, semiautomatic shotgun manufactured in the United States. Features include a folding handle with removable flashlight, folding sights, a cocking lever on both sides, a pistol grip, and a yoke for firing one-handed. Intended for military and law-enforcement use, it was never manufactured in large numbers and was a collectors' item by the 1970s.

- Nation:* United States
- Ammunition:* 12 gauge
- Weight:* 3.9 kg
- Magazine:* 7
- Price:* \$950 (R/—)

SHOTGUNS (½W)

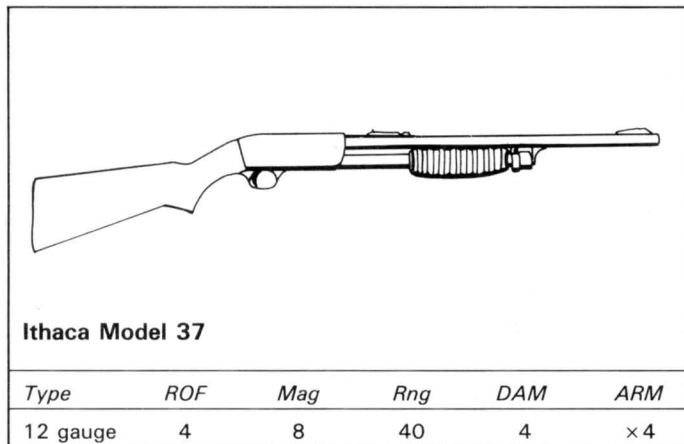

Ithaca Model 37: An American-made pump shotgun that can be customized using a number of different accessories. The Model 37 has good magazine capacity and is widely distributed in both police and civilian markets.

Nation: United States
Ammunition: 12 gauge
Weight: 3 kg
Magazine: 8
Price: \$450 (C/S)

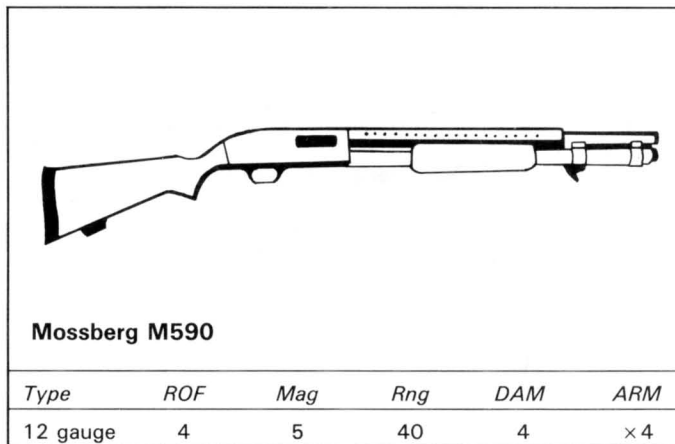

Mossberg M590: An American-made semiautomatic shotgun intended for military and police enforcement service.

Nation: United States
Ammunition: 12 gauge
Weight: 3.15 kg
Magazine: 5
Price: \$350 (C/—)

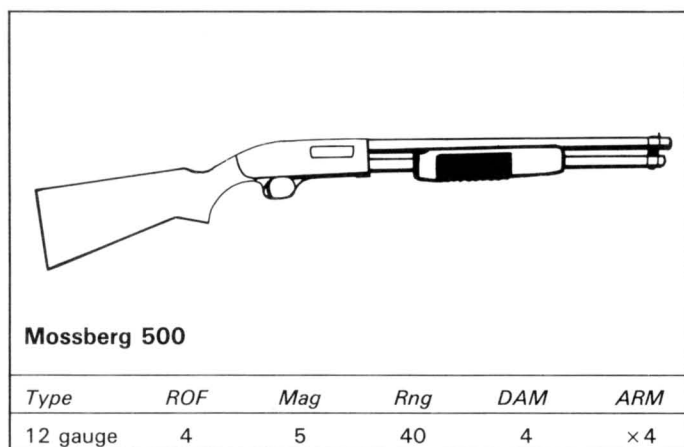

Mossberg 500: An American-made semiautomatic shotgun.
Nation: United States
Ammunition: 12 gauge
Weight: 3.15 kg
Magazine: 5
Price: \$350 (C/—)

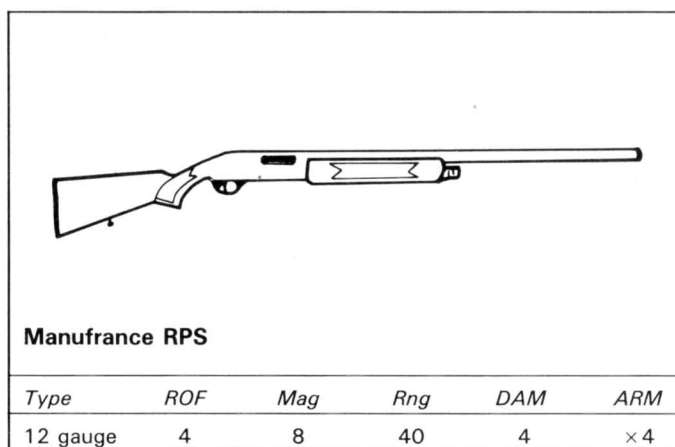

Manufrance RPS: The only European country that has shown any continued interest in combat shotguns has been France (the example of the HK CAW is a singular exception). The RPS can be considered typical of the quality of French combat shotguns. It is a straightforward design that follows a standard layout. The RPS is issued to select French military and police units.

Nation: France
Ammunition: 12 gauge
Weight: 2.78 kg
Magazine: 8
Price: \$500 (C/S)

SHOTGUNS (1/2W)

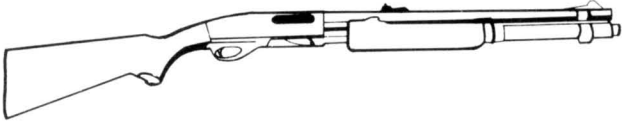

Remington Model 870P

Type	ROF	Mag	Rng	DAM	ARM
12 gauge	4	7	40	4	× 4

Remington Model 870P: Originally developed in the early 1950s, the 870P (P for police...there are a number of civilian variations) has been a standard of police work since then. The 870P can have a top folding metal stock, extended tubular magazine, and sling swivels. It is a very popular weapon with civilians (there are a number of hunting and skeet versions) as well as with law enforcement personnel.

- Nation:* United States
- Ammunition:* 12 gauge
- Weight:* 3.4 kg
- Magazine:* 7
- Price:* \$575 (C/S)



Savage Model 69-RKL

Type	ROF	Mag	Rng	DAM	ARM
12 gauge	4	7	40	4	× 4

Savage Model 69-RKL: An inexpensive American-made pump action shotgun. The Model 69 is a standard design and can be considered representative of its kind. While not a particularly outstanding weapon, it is a serviceable one.

- Nation:* United States
- Ammunition:* 12 gauge
- Weight:* 2.95 kg
- Magazine:* 7
- Price:* \$200 (C/S)



Remington Model 1100

Type	ROF	Mag	Rng	DAM	ARM
12 gauge	4	7	40	4	× 4

Remington Model 1100: An auto-loading shotgun, the 1100 was originally designed for hunting and trap shooting. The recoil spring is located in the stock of the weapon.

- Nation:* United States
- Ammunition:* 12 gauge
- Weight:* 3.4 kg
- Magazine:* 7
- Price:* \$400 (S/R).

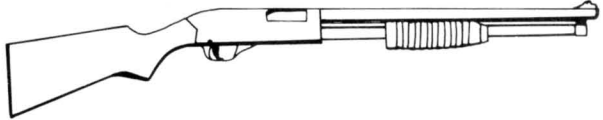

Winchester Stainless Police

Type	ROF	Mag	Rng	DAM	ARM
12 gauge	4	7	40	4	× 4

Winchester Stainless Police: A pump action shotgun, this model is finished in brushed stainless steel. A similar weapon is the standard issue shotgun of the US Navy, Marines, and Coast Guard. It has a full stock and has seen extensive police and military use.

- Nation:* United States
- Ammunition:* 12 gauge
- Weight:* 3.18 kg
- Magazine:* 7
- Price:* \$375 (C/S)

SHOTGUNS (1/2W)

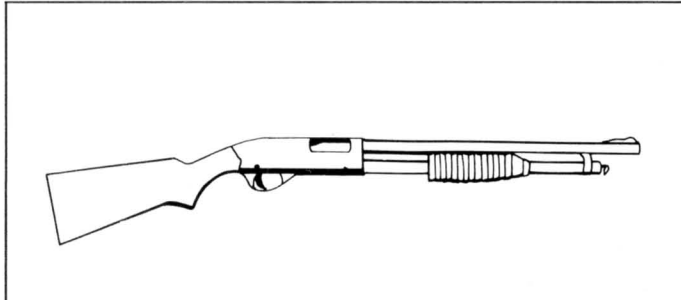

Winchester Defender

Type	ROF	Mag	Rng	DAM	ARM
12 gauge	4	7	40	4	×4

Winchester Defender: A pump action shotgun designed specifically for police work.

Nation: United States

Ammunition: 12 gauge

Weight: 2.5 kg

Magazine: 8

Price: \$450 (C/S)

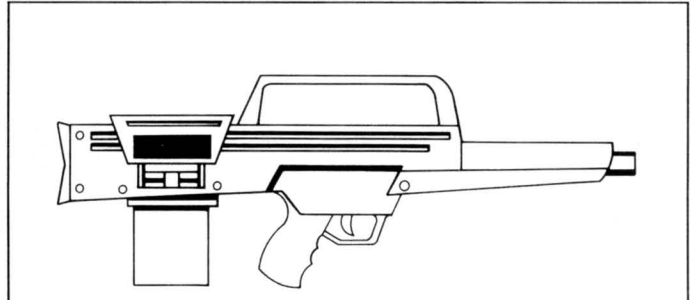

H & K CAW

Type	ROF	Mag	Rng	DAM	ARM
12 gauge	10	10	40	4	×4

H & K CAW: The standard combat shotgun of the U.S. and German Armies, the H & K CAW (Combat Assault Weapon) is a "bullpup" configuration weapon, like the G11.

Nation: Germany, United States

Ammunition: 12 gauge

Weight: 4 kg

Magazine: 10

Price: \$800 (C/R)

Automatic Rifles (1/2W)

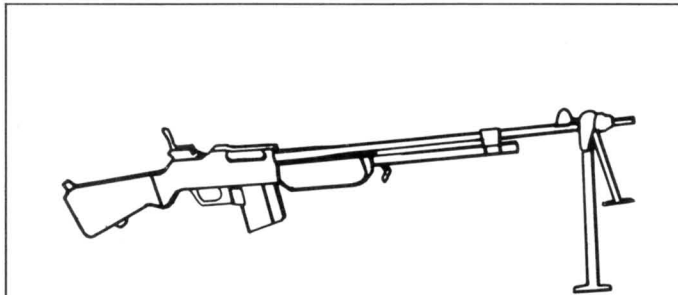

M1918A2 BAR

Type	ROF	Mag	Rng	DAM	ARM
.30-06	2	7	60	4	—

M1918A2 BAR (Browning Automatic Rifle): Originally developed for trench warfare in World War I, the BAR became the standard squad automatic weapon until the introduction of the M14. The weapon uses a seven-shot box magazine. Although it is extremely accurate, its low ammo capacity limits its utility. It is now obsolete, but continues to see service in the armies of many Third World countries.

- Nation:* United States
- Ammunition:* .30-06
- Weight:* 8.8 kg
- Magazine:* 7
- Price:* \$950 (R/—)

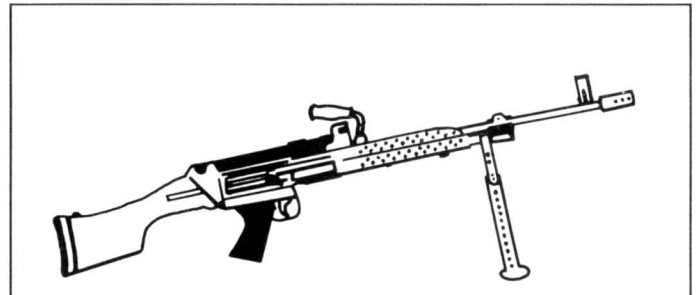

M249 SAW

Type	ROF	Mag	Rng	DAM	ARM
5.56 N	5	10/50	50/75	2	—

M249 SAW: The M249 Squad Automatic Weapon (SAW) is the standard U.S. light automatic support weapon. It can accept either the standard 10-shot magazine of the M16 series or a 50-shot belt. It is equipped with a bipod.

- Nation:* United States
- Ammunition:* 5.56 N
- Weight:* 7 kg
- Magazine:* 10, 50 belt
- Price:* \$1500 (S/R)

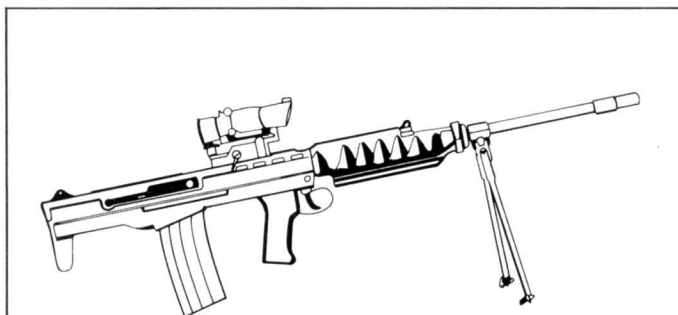

LSW

Type	ROF	Mag	Rng	DAM	ARM
5.56 N	4	10	50/75	2	—

LSW: The heavy-barrel support version of the IW, the LSW (Light Support Weapon) has a bipod and uses the same magazines as the IW.

- Nation:* United Kingdom
- Ammunition:* 5.56 N
- Weight:* 4.5 kg
- Magazine:* 10
- Price:* \$1500 (R/R)

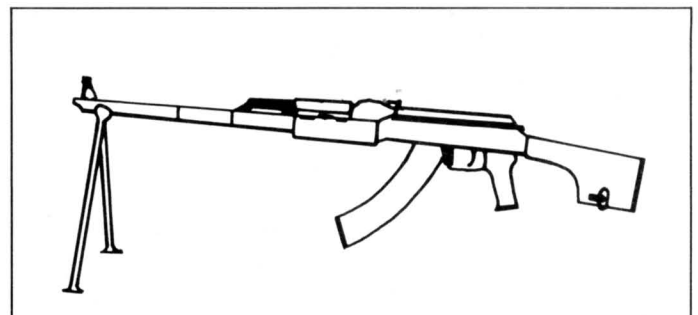

RPK-74

Type	ROF	Mag	Rng	DAM	ARM
5.45 B	4	10/13	40/60	2	×2

RPK-74: The standard Warsaw Pact light automatic support weapon, the RPK-74 can accept either the same magazine as the AK-74 or an oversized 13-shot magazine.

- Nation:* USSR
- Ammunition:* 5.45 B
- Weight:* 4.5 kg
- Magazine:* 10, 13
- Price:* \$1000 (S/C)

MACHINEGUNS

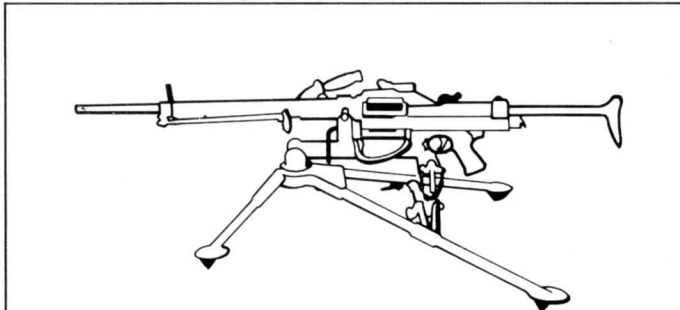

AAT-52

Type	ROF	Mag	Rng	DAM	ARM
7.5mm	4	33	90/120	4	—

AAT-52: The standard machinegun of the French armed forces, the AAT-52 is equipped with a bipod and be fired from a tripod (NLT). It accepts 33-shot belts of 7.5mm MAS ammunition. The blowback extraction tends to rip cartridges in half, leaving a ring of brass in the chamber. French troops grease their cartridge cases, but troops unfamiliar with the weapon, especially once the weapon's ready supply of ammunition has been fired, have a 10-percent chance of jamming the weapon each combat turn it is fired. A jam requires a full combat turn to clear.

Nation: France
Ammunition: 7.5mm MAS
Weight: 11 kg
Magazine: 33 belt
Price: \$400 (R/R)

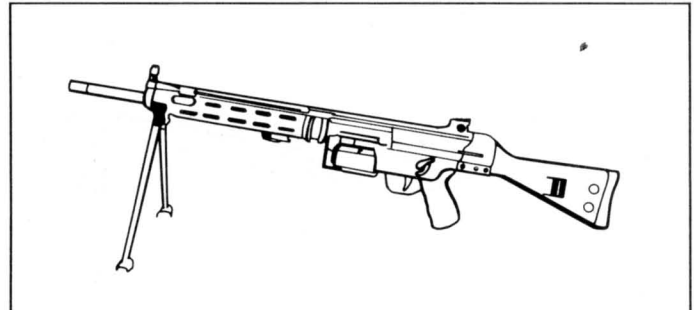

H & K HK21

Type	ROF	Mag	Rng	DAM	ARM
7.62 N	4	33	90/120	4	—

H & K HK21: A West German machinegun considered by some to be the best of its kind. It is equipped with a bipod, but can also be fired from a tripod (NLT). It can accept a 33-shot belt, a 23-shot drum, or the same 10-shot magazine as the G3.

Nation: West Germany
Ammunition: 7.62 N
Weight: 8 kg
Magazine: 10, 23 drum, 33 belt
Price: \$2500 (S/R)

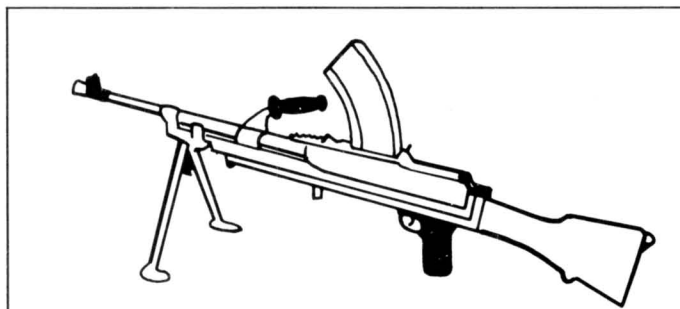

Bren Mk II

Type	ROF	Mag	Rng	DAM	ARM
7.62 N	4	33	90/120	4	—

Bren Mk II: Developed from a Czech design, the Bren was the standard issue British Army LMG. The weapon uses either a box or drum magazine and has an integral bipod and carrying handle.

Nation: England
Ammunition: 7.62N
Weight: 10.5 kg
Magazine: 10 shot box or 33 shot drum
Price: \$850 (S/R)

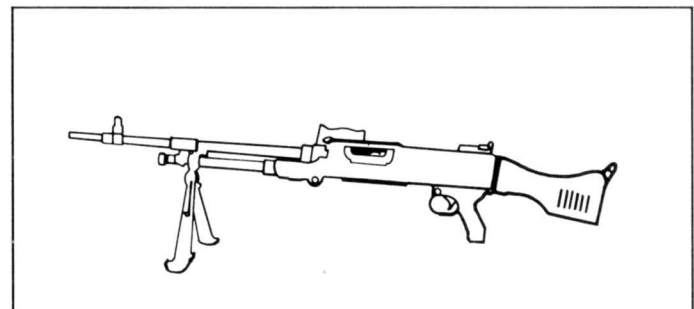

MAG

Type	ROF	Mag	Rng	DAM	ARM
7.62 N	4	33	90/120	4	—

MAG: The Belgian MAG is the standard general purpose machinegun of the British Army. It is equipped with a bipod and can also be fired from a tripod (NMT). It accepts 33-shot belts.

Nation: United Kingdom
Ammunition: 7.62 N
Weight: 12 kg
Magazine: 33 belt
Price: \$1500 (S/R)

MACHINEGUNS

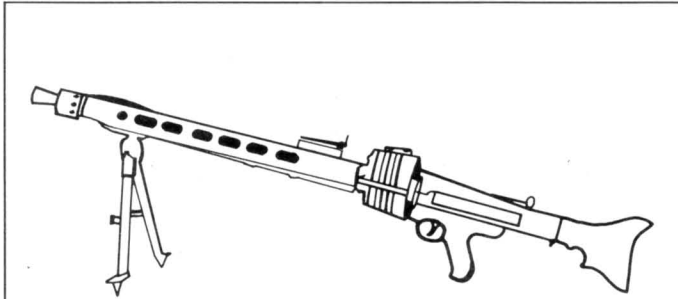

MG3

Type	ROF	Mag	Rng	DAM	ARM
7.62 N	4	33	90/120	4	—

MG3: A West German bipod mount machinegun, developed from the WWII MG42. It accepts 33-shot belts, and can be fired from a tripod (NMT).

- Nation:* West Germany
- Ammunition:* 7.62 N
- Weight:* 12 kg
- Magazine:* 33 belt
- Price:* \$1500 (S/R)

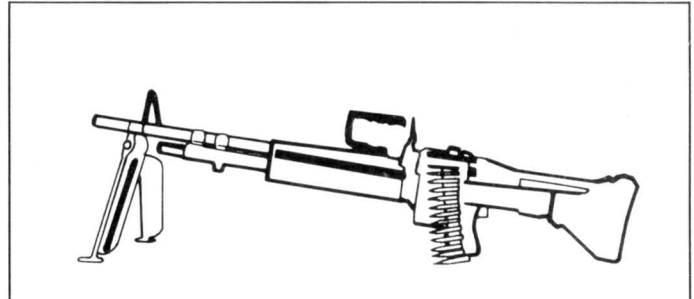

M60

Type	ROF	Mag	Rng	DAM	ARM
7.62 N	4	33	90/120	4	—

M60: The standard general purpose machinegun of the U.S. Army. It is equipped with with a bipod, and can be fired from a tripod mount (NLT). There is a lighter (8 kg) version called the M60E3 in service with the U.S. Marines.

- Nation:* United States
- Ammunition:* 7.62 N
- Weight:* 10 kg
- Magazine:* 33 belt
- Price:* \$1500 (S/R)

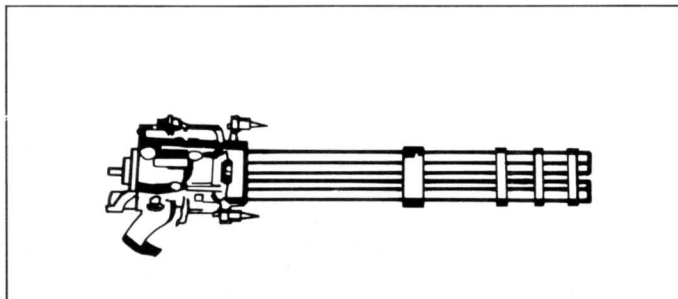

M134

Type	ROF	Mag	Rng	DAM	ARM
7.62 N	20	500	90/120	4	—

M134: A six-barreled gatling-type minigun chambered for the 7.62 N cartridge. Originally designed for use on helicopters, the M134 can also be mounted on a tripod (NHT). It accepts special 500-shot belts.

- Nation:* United States
- Ammunition:* 7.62 N
- Weight:* 15.9 kg
- Magazine:* 500 belt
- Price:* \$3000 (R/—)

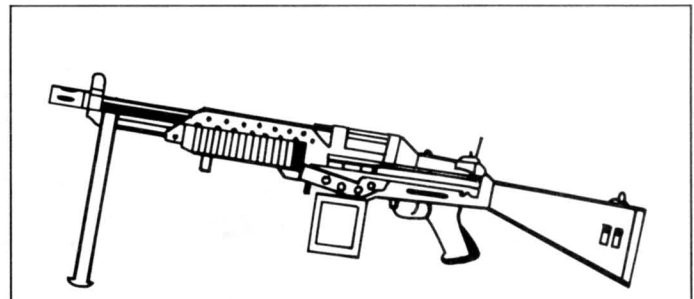

Stoner Mk 23 Commando

Type	ROF	Mag	Rng	DAM	ARM
5.56 N	4	33	70/100	3	—

Stoner Mk 23 Commando: Designed as part of the Stoner 63 System, it was a candidate for the U.S. SAW (squad automatic weapon) in the late 1960s. Called the XM207 by the army and the Mk 23 Commando by the navy, it saw limited action in Vietnam with SEAL teams, where it acquired a reputation for poor performance in adverse conditions. The system was never adopted by the U.S. Army but was manufactured by a number of countries on a limited basis. Some examples still exist.

- Nation:* United States, West Germany, Holland
- Ammunition:* 5.56 N
- Weight:* 4.5 kg
- Magazine:* 33 belt
- Price:* \$2500 (R/—)

MACHINEGUNS

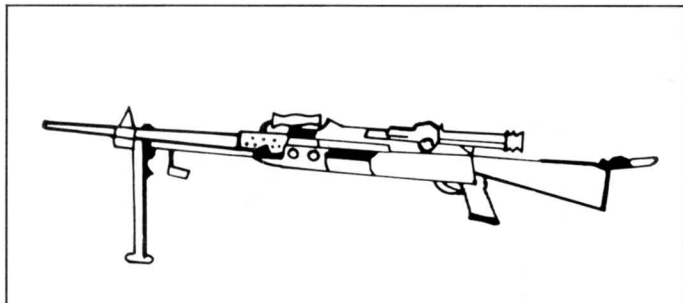

Japanese Type 62

Type	ROF	Mag	Rng	DAM	ARM
7.62 N	4	33	90/120	4	—

Japanese Type 62: The Type 62 is a Japanese general purpose bipod mount machinegun, chambered for the 7.62 N cartridge. It accepts 33-shot belts and can also be fired from a tripod mount (NLT).

Nation: Japan
Ammunition: 7.62 N
Weight: 10.7 kg
Magazine: 33 belt
Price: \$2000 (R/—)

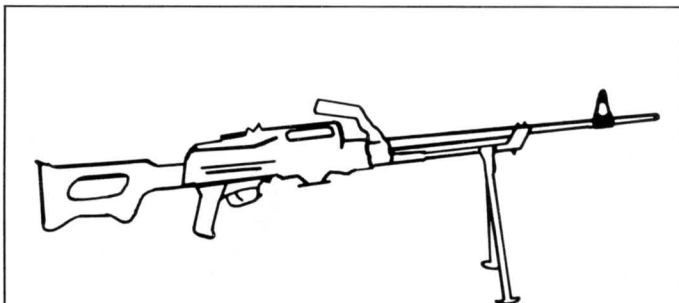

PKM

Type	ROF	Mag	Rng	DAM	ARM
7.62 L	5	33	90/120	4	—

PKM: An improved version of the PK medium machinegun.

Nation: USSR
Ammunition: 7.62 L
Weight: 9.4 kg
Magazine: 33 belt
Price: \$2200 (—/R)

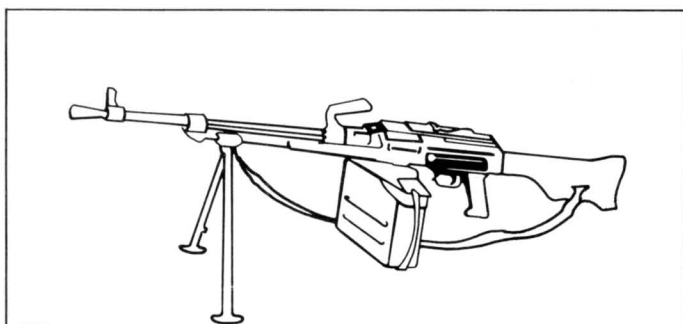

PK

Type	ROF	Mag	Rng	DAM	ARM
7.62 L	5	33	90/120	4	—

PK: The standard Warsaw pact medium machinegun, usually found mounted on a vehicle. It is equipped with a bipod, and can also be fired from a tripod (PLT). It accepts 33-shot belts.

Nation: USSR
Ammunition: 7.62 L
Weight: 10 kg
Magazine: 33 belt
Price: \$2000 (R/S)

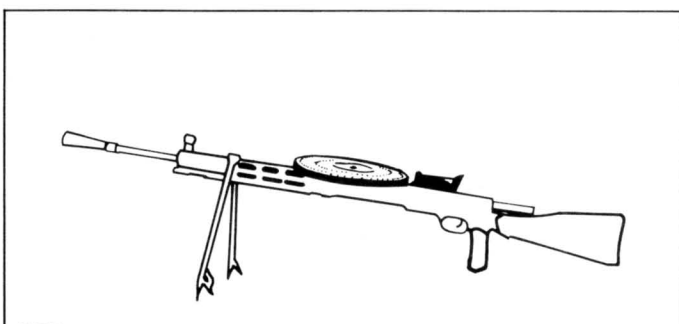

RPD

Type	ROF	Mag	Rng	DAM	ARM
7.62 S	4	10	60/90	4	× 2

RPD: The standard Soviet LMG until the adoption of the RPK. The RPD uses the same ammo as the AKM. The weapon is fed from a drum container. The RPD is often found in Category III and Mobilization Divisions as well as various guerilla and terrorist groups. It has an integral bipod and some models have a carrying handle.

Nation: USSR
Ammunition: 7.62 S
Weight: 6.6 kg
Magazine: 33 shot drum
Price: \$575 (R/S)

MACHINEGUNS

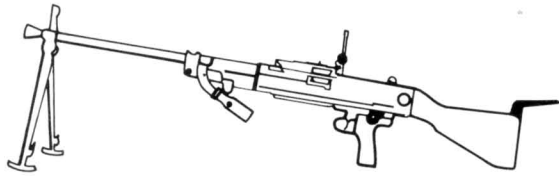

Czech Vz 59

Type	ROF	Mag	Rng	DAM	ARM
7.62 L	3	17	90/120	4	—

Czech Vz 59: The standard medium machinegun of the Czech Army, a local design which is equipped with a bipod and can also be fired from a tripod (PLT). It accepts 33-shot belts.

- Nation: Czech
- Ammunition: 7.62 L
- Weight: 9 kg
- Magazine: 33 belt
- Price: \$1500 (R/R)

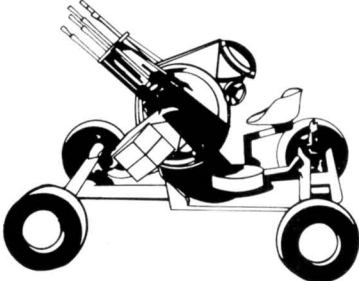

KPV

Type	ROF	Mag	Rng	DAM	ARM
14.7 B	3	17	180	7	—

KPV: The KPV is the largest caliber conventional machinegun in service, and is virtually a small cannon. It fires a round originally developed for the Soviet RTRS-41 antitank rifle in WWII, and is found mounted only on vehicles. It accepts 17-shot belts.

- Nation: USSR
- Ammunition: 14.7 B
- Weight: 50 kg
- Magazine: 17 belt
- Price: \$3000 (S/C)

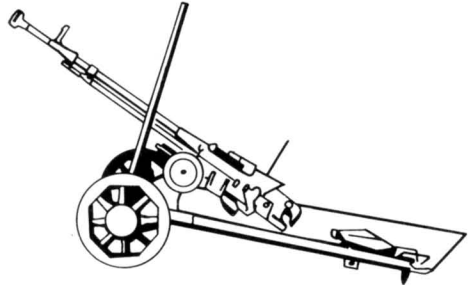

DShK

Type	ROF	Mag	Rng	DAM	ARM
12.7 B	3	17	160	6	—

DShK: The standard heavy machinegun in use by the Warsaw Pact. It is usually used on a vehicle mount, but can also be used on a wheeled carriage (PHC) which is treated as a tripod mount. It accepts 17-shot belts.

- Nation: USSR
- Ammunition: 12.7 B
- Weight: 40 kg
- Magazine: 17 belt
- Price: \$2000 (C/V)

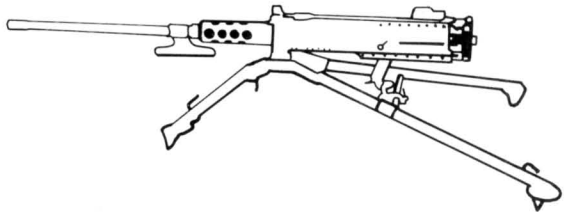

M2HB

Type	ROF	Mag	Rng	DAM	ARM
.50(BMG)	3	35	160	6	—
.50(SLAP)	3	35	160	6	× ½

M2HB: The M2 Heavy Barrel is the standard heavy machinegun of every western european army. It accepts 35-shot belts, and may only be fired from a tripod (NHT) or from a vehicle mount.

- Nation: United States and others
- Ammunition: .50 BMG, .50 SLAP
- Weight: 42 kg
- Magazine: 35 belt
- Price: \$1600 (V/C)

MACHINEGUNS

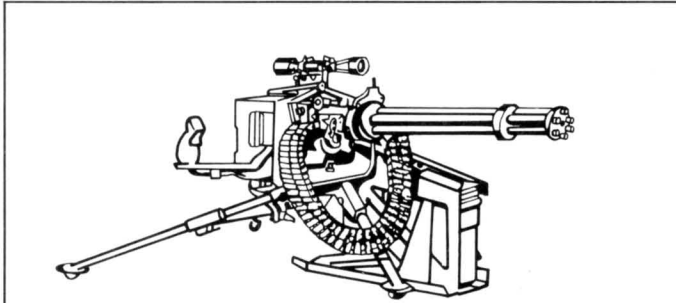
**M214**

<i>Type</i>	<i>ROF</i>	<i>Mag</i>	<i>Rng</i>	<i>DAM</i>	<i>ARM</i>
5.56 N	30	333	100	2	—

M214: The M214 is a six-barreled gatling gun, fed by a 335-shot drum. It may be fired only from a tripod (NHT) or from a vehicle mount.

Nation: United States

Ammunition: 5.56 N

Weight: 20 kg

Magazine: 335 drum

Price: \$10,000 (R/R)

Ammunition Listing

Every entry below lists the weight in kilograms, price in dollars, and availability. The last is given in the form *availability in the Western bloc/availability in the East*. The following abbreviations are used for availability: V=very common, C=common, S=scarce, and R=rare.

Ammunition = type of ammunition used; *Magazine* = number of shots per magazine ('I' means that the magazine is internal and not detachable; if *Magazine* is missing, the weapon has no magazine).

Magazines and ammunition must be purchased separately, and are not counted into weight or price.

Weights per magazine include weight of magazine. Magazines are purchased separately and cost \$1 per shot of capacity, except the 335-shot drum for 5.56 N.

CONSOLIDATED AMMUNITION LISTING

4.7 CIs (4.7 × 21mm Caseless): *Weight:* 10 kg per case of 600, 1 kg per 32-shot magazine, *Price:* \$1300 per case (S/R).

5.45 B (5.45 × 39mm Bloc): *Weight:* 10 kg per case of 280, 0.5 kg per 10-shot magazine, 0.6 kg per 13-shot magazine, *Price:* \$100 per case (C/V).

5.56 N (5.56 × 45mm NATO): *Weight:* 10 kg per case of 280 or 250 belted, 0.5 kg per 10-shot magazine, 2 kg per 50-shot belt, 15 kg per 335-shot drum, *Price:* \$100 per case, \$200 per drum (magazine included) (V/C).

.22 LR (5.7 × 17mmR Long Rifle): *Weight:* 20 kg per case of 1,600, 0.1 kg per 3-shot magazine, *Price:* \$225 per case (C/S).

.25 ACP (6.3 × 15.7mm) *Weight:* 21 kg per case of 1,600, 0.1 kg per 2-shot magazine, 0.1 kg per 3-shot magazine, *Price:* \$250 per case (S/—).

7.5 MAS (7.5 × 53.6mm MAS): *Weight:* 15 kg per case of 200, 3 kg per 33-shot belt, *Price:* \$30 per case (R/R).

7.62 T (7.62 × 25mm Tokarev): *Weight:* 35 kg per case of 840, 11-shot magazine, *Price:* \$250 per case (R/S).

7.62 S (7.62 × 39mm Short): *Weight:* 10 kg per case of 220, 1 kg per 10-shot magazine, *Price:* \$80 per case (S/C).

.30 (7.62 × 42mm M1 Carbine): *Weight:* 3 kgs per case of 150, 50 loose shots per kg, *Price:* \$70 (S/R).

.30-30 (7.62 × 51mmR): *Weight:* 20 kg per case of 300, 15 loose shots per kg, *Price:* \$170 per case (C/S).

.300 WM (7.62 × 66mm Winchester Magnum): *Weight:* 1 kg per ten shots, not available in case lots, *Price:* \$12 per kg (R/—).

7.62 N (7.62 × 51mm NATO): *Weight:* 15 kg per case of 200, .75 kg per 7-shot magazine, 3 kg per 33-shot belt, *Price:* \$65 per case (C/S).

7.62 L (7.62 × 54mmR Long): *Weight:* 15 kg per case of 200 or 165 belted, 0.3 kg per 3-shot magazine, 3 kg per 33-shot belt, *Price:* \$70 per case (S/C).

.30-06 (7.62 × 63mm): *Weight:* 15 kg per case of 150, 35 loose shots per kg, *Price:* \$80 per case (S/R).

.32 ACP (7.65 × 17mmSR): *Weight:* 20 kg per case of 800, 0.4 kg per 7-shot magazine, *Price:* \$150 per case (S/S).

8mm M (7.92 × 57mm Mauser): *Weight:* 10 kg per case of 100, 0.2 kg per 2-shot magazine, *Price:* \$30 per case (S/S).

.380 ACP (9 × 17mm): *Weight:* 15 kg per case of 480, 0.1 kg per 3-shot magazine, *Price:* \$125 per case (C/S).

9mm M (9 × 18mm Makarov): *Weight:* 15 kg per case of 480, 0.1 kg per 3-shot magazine, *Price:* \$200 per case (S/C).

9mm P (9 × 19mm Parabellum): *Weight:* 15 kg per case of

480, 0.2 kg per 5-shot, 0.5 kg per 10-shot, 0.6 kg per 11-shot magazine, *Price:* \$225 per case (V/C).

.38 Special (9 × 29mmR): *Weight:* 15 kg per case of 300 (20 loose shots per kg), *Price:* \$175 per case (S/R).

.357 Magnum (9 × 33mmR): *Weight:* 20 kg per case of 300, (15 loose shots per kg), *Price:* \$500 per case (R/—).

.375 H & H Magnum (9.5 × 73mm Holland & Holland magnum): *Weight:* 1 kg per 10 loose shots, not available in case lots, *Price:* \$110 per kg (R/—).

.41 Magnum (10.4 × 31.8mmR): *Weight:* 20 kg per case of 300, (15 loose shots per kg), *Price:* \$500 per case (S/R).

.44 Auto-Mag (10.89 × 32.9mm): *Weight:* 1 kg per 5 shots, not available in case lots. The referee must determine individual availability, since these cartridges are extremely rare. *Price:* \$20 kg (—/—).

.44 magnum (11.2 × 32.8mmR): *Weight:* 20 kg per case of 300, (15 loose shots per kg), *Price:* \$550 per case (R/—).

.44 special (11.2 × 29.5mmR): *Weight:* 20 kg per case of 300, (15 loose shots per kg), *Price:* \$525 per case (R/—).

.45 ACP (11.43 × 23mm): *Weight:* 20 kg per case of 300, .3 kg per 2-shot magazine, *Price:* \$63 per case (S/R).

.45 LC (11.43 × 32.8mmR Long Colt): *Weight:* 20 kg per case of 300, *Price:* \$100 per case (S/—).

.458 WBM (11.63 × 63.5mm Winchester belted magnum): *Weight:* 1 kg per 4 shots, not available in case lots, *Price:* \$25 per kg (R/—).

.460 WM (11.63 × 74mm Weatherby magnum): *Weight:* 1 kg per 4 shots, not available in case lots, *Price:* \$30 per kg (R/—).

12.7 B (12.7 × 83mmR Bloc): *Weight:* 25 kg per case of 34 belted, 11 kg per 17-shot belt, *Price:* \$35 per case (S/C).

.50 BMG (12.7 × 99mm): *Weight:* 15 kg per case of 35, belted, 13 kg per 35-shot belt, *Price:* \$35 per case (C/S).

.50 SLAP (12.7 × 99mm Saboted Light Armor Piercing): *Weight:* 15 kg per case of 35, belted, 13 kg per 35-shot belt, *Price:* \$60 per case (S/R).

14.5 B (14.5 × 114mm Bloc): *Weight:* 30 kg per case of 33, belted, 25 kg per 33-shot belt, *Price:* \$30 per case (S/C).

12 Gauge (12 Gauge All-brass): *Weight:* 15 kg per case of 240, 1 kg per 10-shot magazine, (15 loose shots per kg), *Price:* \$100 per case (C/C).

Consolidated Fire Charts

Automatic Pistols: ½W, ½T

Type	ROF	Mag	Rng	Dam	Arm
AMT Backup	2	2	10	1	×4
AMT Hardballer	2	2	10	2	×3
Constable	2	2	10	1	×4
Auto-Mag 44	2	2	18	1	×2
M 70S	3	3	15	0	×4
M 92S	2	5	15	1	×3
M 84	2	4	10	1	×4
M 951	2	3	15	1	×3
HP-35	2	4	15	1	×3
HP-DA	2	5	15	1	×3
BDA-380	2	4	10	1	×4
Mk 22	3	3	15	0	×4
Explorer II	3	2	15	0	×4
C Commander	2	2	10	2	×3
L Commander	2	2	10	2	×3
M1911A1	2	2	10	2	×3
Colt Gov M 380	2	3	10	1	×4
CZ-75	2	5	15	1	×3
Detonics D/A 9mm	2	2	15	1	×3
Scoremaster	2	2	10	2	×3
HK-4 (.380 ACP)	2	2	10	1	×4
HK-4 (.32 ACP)	2	2	8	1	×4
HK-4 (.25 ACP)	3	2	16	0	×4
HK-4 (.22 LR)	3	3	15	0	×4
P7 M8	2	2	15	1	×3
P7 M13	2	4	15	1	×3
P9S	2	3	15	1	×3
VP70Z	2	6	15	1	×3
Glock 17A	2	6	15	1	×3
IMI M91	2	6	15	1	×3
IMI D Eagle (.357 mag)	1	3	18	2	×3
IMI D Eagle (.44 mag)	1	2	20	2	×2
L Lg Auto (.45 ACP)	2	2	10	2	×3
L Lg Auto (.9mmP)	2	5	15	1	×3
L Sm Auto (.380 ACP)	2	2	10	1	×4
L Sm Auto (.22 LR)	3	3	15	0	×4
Luger	2	2	15	1	×3
MAB-P15	2	5	15	1	×3
Makarov PM	2	3	15	1	×4
Man PPK/S (.22 LR)	3	2	15	0	×4
Man PPK/S (.32 ACP)	2	2	9	1	×4
Man PPK/S (.380 ACP)	2	2	10	1	×4
M1896	2	31	11	1	×4
HSc	2	2	10	1	×4
Spectre 15	2	5	15	1	×3
Mk II	3	3	15	0	×4
P-85	2	5	15	1	×3
Tokarev	2	3	10	1	×4
P 226	2	2	15	1	×3
P 230	2	2	10	1	×4
P-64	2	3	15	1	×4
S & W M 439	2	3	15	1	×3
S & W M 459	2	5	15	1	×3
PPK	2	2	10	1	×4
P-38	2	3	15	1	×3
GB-80	2	6	15	1	×3

Revolvers: ½W, ½T

Type	ROF	Mag	Rng	Dam	Arm
Large BP Rev	1	2††	12	2	×4
Small BP Rev	1	2††	8	2	×4
Astra M 357	1	2*	18	2	×3
Astra M 44	1	2*	20	2	×2
Bulldog 45	2	2*	10	2	×3
Python	1	2*	18	2	×3
Commanche	1	2*	18	2	×3
S Commanche	1	2*	20	2	×2
S Six	1	2*	18	2	×3
Redhawk	1	2*	18	2	×3
Redhawk	1	2*	20	2	×2
S & W M 19	1	2*	18	2	×3
S & W M 25	2	2*	10	2	×3
S & W M 27	1	2*	18	2	×3
S & W M 28	1	2*	18	2	×3
S & W M 29	1	2*	20	2	×2
S & W M 36	1	2*	15	1	×3
S & W M 38	1	2*	15	1	×3
S & W M 57	1	2*	14	1	×3

Submachineguns: W, T

Type	ROF	Mag	Rng	Dam	Arm
AKR	4	10	30	2	×2
PM-12	2	13	15	1	×3
CAR-15	4	10	30	1	—
CAR-15A1	2	5	30	1	×3
MP-5, MP-5SD	3	10	15	1	×3
HK-54	5	10	20	1	—
G11	5	32	40	2	×½
HM-3	3	11	30	1	×3
MAC-10	11	11	15	1	×3
MAC-11	10	10	15	2	×3
M3A1	3	10	10	2	×3
M-45	3	12	30	1	×3
M50	3	11	30	1	×3
MP-40	3	11	30	1	×3
MPK	3	10	30	1	×3
M231	5	10	20	1	—
PM-63	3	3	20	1	×4
PPSh-41	3	12/27	10	1	×4
PPS-43	3	12	10	1	×4
S & W M76	3	12	30	1	×3
Sterling	3	11	30	1	×3
Sten	3	11	30	1	×3
Th M1A1	2	10/16	12	2	×3
Uzi	4	11	30	1	×3
Mini-Uzi	5	11	20	1	×3
Vz 24	4	11	25	1	×4
Vz 61	4	7	10	0	×4

Assault Rifles: W, ½T

Type	ROF	Mag	Rng	Dam	Arm
Leader	4	10	50	2	—
AK-74	3	10	40	2	×2
AKM	3	10	40	4	×2
AKMR	3	10	35	2	×2
AR-7	3	2	14	0	×4
AR-18	4	10	50	2	—
AR-70	4	10	50	2	—
CETME L	4	10	50	2	—

FA-MAS	4	8	50	2	—	Sako (7.62 N)	1	11	75	4	—
FN-CAL	4	10	50	2	—	Sako (.30-06)	1	11	75	4	—
Galil ARM	4	12	50	2	—	M 110-C (.30-06)	1	1	75	4	—
HK 33A2/HK 93	4	13	50	2	—	M 110-C (.300 WM)	1	1	60	4	—
IW	4	10	50	2	—	W'by .460	1	11	65	5	× 1/2
M1/M2 Car	1	5	40	2	× 3	Win M 70 (.30-06)	1	11	75	4	—
M16	4	10	50	2	—	Win M 70 (7.62 N)	1	11	75	4	—
M16 EZ	3	10	40	2	—	Win M 70 (.300 WM)	1	11	60	4	—
Mini-14	4	10	50	2	—	Win M 70 XTR S	1	11	80	4	—
SG 540	4	10	50	2	—	Win M 70 XTR S	1	11	60	4	× 1/2
SAR-80	4	10	50	2	—						
AUG	4	10	50	2	—						

Battle Rifles: 1/2W, 1/2T

Type	ROF	Mag	Rng	Dam	Arm
FN-FAL	2	7	60	4	—
G3/HK 91	2	7	60	4	—
M1 Gar	2	3	85	4	—
M1 Gar	2	7	60	4	—
M14	2	7	60	4	—
BM-59	2	7	60	4	—
SIG 510-4	2	7	60	4	—
SKS	2	3	40	4	× 2
FN-LAR	2	7	60	4	—

Sniper Rifles: 1/2W

Type	ROF	Mag	Rng	Dam	Arm
Barret M 82 .50 (BMG)	2	4	150	6	—
Barret M 82 .50	2	4	150	6	× 1/2
L42	1	3	75	4	—
M21	3	7	60	4	—
M40	1	2*	75	4	—
Parker-Hale C3	1	1	75	4	—
PSG1	2	7	70	4	—
SVD	2	3	70	4	—
SSG-69	1	3	75	4	—
WA-2000N	2	2	62	4	—
Vz 54	1	2	65	4	—

Sporting Rifles: 1/2W

Type	ROF	Mag	Rng	Dam	Arm
BP Rifle	1	(4)	40	3	× 4
.30-30 LA	1	3*	60	3	× 3
.30-06 BA	1	2*	85	4	—
.22 BA	1	1	55	0	× 4
.22 SA	1	3*	50	0	× 4
BBR	1	11	85	4	—
BSA CF-2	1	11	70	4	—
BSA CF-2	1	11	75	4	—
C/S (.30-06)	1	1	75	4	—
C/S (.300 WM)	1	1	60	4	—
C/S Grand Alaskan	1	11	80	4	—
C/S Grand African	1	11	60	4	× 1/2
Mauser Mk X	1	11	75	4	—
Mauser Mk X	1	11	60	5	× 1/2
Mauser Mk X Car	1	21*	60	4	—
Rem M 700 (7.62 N)	1	21*	75	4	—
Rem M 700 (.30-06)	1	21*	75	4	—
Rem M 700 (.375mag)	1	21*	80	4	—
Ruger M 77 (5.56 N)	1	11	60	2	—
Ruger M 77 (7.62 N)	1	11	75	4	—
Sako (5.56 N)	1	11	60	2	—

Shotguns: 1/2W

Type	ROF	Mag	Rng	Dam	Arm
Double Barrel	2	2	40	4	× 4
BP Double	2	2††	30	4	× 4
Pump	4	8**	40	4	× 4
A/DW Assault 12	5	20/6	40	4	—
Auto-5M	4	5**	40	4	× 4
SPAS-12	4	8**	40	4	× 4
M-10B/C	4	7	40	4	× 4
Ithaca M 37	4	8**	40	4	× 4
M'berg 500	4	5**	40	4	× 4
M'berg M590	4	5**	40	4	× 4
M'france RPS	4	8**	40	4	× 4
Rem M 870P	4	7**	40	4	× 4
Rem M 1100	4	7**	40	4	× 4
M 69-RKL	4	7**	40	4	× 4
Win Stainless Police	4	7**	40	4	× 4
Win Defender	4	7**	40	4	× 4
HK CAW	10	10	40	4	× 4

Automatic Rifles: 1/2W

Type	ROF	Mag	Rng	Dam	Arm
M1918A2 BAR	2	7	60	4	—
LSW	4	10	50/75	2	—
M249	5	10/50	50/75	2	—
RPK-74	4	10/13	40/60	2	× 2

Machineguns

Type	ROF	Mag	Rng	Dam	Arm
AAT-52	4	33	90/120	4	—
Bren Mk II	4	33	90/120	4	—
HK21	4	33	90/120	4	—
MAG	4	33	90/120	4	—
MG3	4	33	90/120	4	—
M134	20	500	90/120	4	—
M60	4	33	90/120	4	—
Mk 23	4	33	70/100	3	—
Type 62	4	33	90/120	4	—
PK	5	33	90/120	4	—
PKM	5	33	90/120	4	—
RPD	4	10	60/90	4	× 2
Vz 59	3	17†	90/120	4	—
DShK	3	17†	160	6	—
KPV	3	17†	180	7	—
M2HB .50 (BMG)	3	35†	160	6	—
M2HB .50 (SLAP)	3	35†	160	6	× 1/2
M214	30	333†	100	2	—

Notes: ROF=rate of fire. Magazine=number of shots per magazine; if the magazine number is in parentheses, then the weapon has a single-shot magazine which takes the indicated

number of combat rounds to reload. *Rng* = close range, automatic rifles and machineguns have two different ranges; for automatic rifles, the first is used if firing while held, the second is used if firing from a bipod; for machineguns, the first is used if firing from a bipod, the second if firing from a tripod or vehicle mount. *Dam* = damage number, *Arm* = armor multiplier.

* Magazine is not detachable; only one shot may be reloaded per combat round.

** Only three shots may be reloaded per combat round.

† The weapon can only be used from tripod or vehicle mounts.

†† Magazine not detachable: only one shot may be reloaded per two combat rounds

‡ One shot may be reloaded per two combat rounds; the weapon may be fired while being reloaded.

Index

For the convenience of players and referees searching for a specific firearm, we present the following index.

.380 Backup (AMT).....	4	Hi-Power, HP-35 (Browning).....	6
.460 Magnum Deluxe (Weatherby).....	39	Hi-Power, HP-DA (Browning).....	6
510-4 (SIG).....	33	HK-4 (Heckler & Koch).....	9
AAT-52.....	46	HK 21 (H & K).....	46
AK-74.....	27	HK 33A2 (H & K).....	29
AKM.....	27	HK 91 (H & K).....	32
AKMR.....	27	HK 93 (H & K).....	29
AKR.....	20	HK CAW (H & K).....	44
AR-7.....	28	HM-3.....	21
AR-18.....	28	HSc (Mauser).....	12
AR-70 (Beretta).....	28	IW.....	30
Atchisson Assault 12 (Dae Woo).....	41	Japanese Type 62.....	48
AUG (Steyr).....	31	KPV.....	49
Auto-Mag 44.....	4	L42.....	34
Auto-5M (Browning).....	41	Large Frame Automatic (Llama).....	11
BBR (Browning).....	37	Leader.....	27
BDA-380 (Browning).....	6	Lightweight Commander (Colt).....	7
BM-59 (Beretta).....	33	LSW.....	45
Bren Mk II.....	46	Luger P-08.....	11
Buck Mark 22 (Browning).....	6	M1 Garand.....	32
Bulldog 45 (Charter Arms).....	16	M1/M2 Carbine.....	30
C3 (Parker-Hale).....	35	M2HB.....	49
CAR-15 (Colt).....	20	M3A1.....	22
CAR-15A1 (Colt).....	20	M-10B/C (High Standard).....	41
CF-2 (BSA).....	37	M14.....	32
Combat Assault Weapon (H & K).....	44	M16.....	30
Combat Commander (Colt).....	7	M16 EZ.....	30
Commanche (Llama).....	17	M21.....	34
Constable (Astra).....	4	M40.....	34
CZ-75 (Czech).....	8	M-45 Swedish K.....	22
D/A 9mm (Detonics).....	8	M50 (Madson).....	22
Defender (Winchester).....	44	M60.....	47
Desert Eagle (IMI).....	10	M76 (S & W).....	24
DShK.....	49	M91 (IMI).....	10
Explorer II (Charter Arms).....	7	M134.....	47
FA-MAS.....	29	M214.....	50
FN-CAL.....	29	M231.....	23
FN-FAL.....	32	M249 SAW.....	45
FN-LAR.....	33	M500 (Mossberg).....	42
G3 (H & K).....	32	M590 (Mossberg).....	42
G11 (H & K).....	21	M1896 (Mauser).....	12
Galil ARM.....	29	M1911A1 (Colt).....	7
GB-80 (Steyr).....	15	M1918A2 BAR.....	45
Glock 17A.....	10	MAB-P15.....	11
Government Model 380 (Colt).....	8	MAC-10.....	22
Grand African (Colt Sauer).....	38	MAG.....	46
Grand Alaskan (Colt Sauer).....	37	Makarov PM.....	12
Hardballer (AMT).....	4	Mark X (Mauser).....	38
		Mark X Carbine (Mauser).....	38
		MG3.....	47
		Mini Uzi.....	25
		Mini-14/AC-556 (Ruger).....	30
		Mk II (Ruger).....	13
		Model 19 Combat Magnum (S & W).....	18
		Model 25 (S & W).....	18
		Model 27 (S & W).....	18
		Model 28 (S & W).....	18

Model 29 (S & W).....19
 Model 36 Chiefs' Special (S & W).....19
 Model 37 (Ithaca).....42
 Model 38 Bodyguard (S & W).....19
 Model 44 (Astra).....16
 Model 57 (S & W).....19
 Model 69-RKL (Savage).....43
 Model 70 (Winchester).....40
 Model 70 XTR Super (Winchester).....40
 Model 70S (Beretta).....5
 Model 77 (Ruger).....39
 Model 82 (Barret).....34
 Model 84 (Beretta).....5
 Model 92S (Beretta).....5
 Model 110-C (Savage).....39
 Model 357 (Astra).....16
 Model 439, 639, 39 (S & W).....14
 Model 459, 659, 59 (S & W).....15
 Model 700 (Remington).....38
 Model 870 (Remington).....43
 Model 951 (Beretta).....5
 Model 1100 (Remington).....43
 Model L (CETME).....28
 Model PPK/S (Manhurin).....12
 MP-5 (H & K).....21
 MP-5SD (H & K).....21
 MP-40.....23
 MPK.....23

P7 M8 (Heckler & Koch).....9
 P7 M13 (Heckler & Koch).....9
 P9S (Heckler & Koch).....9
 P-38 (Walther).....15
 P-64.....14
 P-85 (Ruger).....13
 P 226 (SIG/Sauer).....14
 P 230 (SIG/Sauer).....14
 PK.....48
 PKM.....48
 PM-12 (Beretta).....20
 PM-63.....23
 PPK (Walther).....15
 PPS-43.....24
 PPSH-41.....24
 PSG1.....35
 Python (Colt).....16

Redhawk (Ruger).....17
 RPD.....48
 RPK-74.....45
 RPS (Manufrance).....42

SAR-80.....31
 Scoremaster (Detonics).....8
 Security Six (Ruger).....17
 SG 540 (SIG).....31
 SKS.....33
 Small Frame Automatic (Llama).....11
 SPAS-12 (Franchi).....41
 Spectre 15 (Metzger Arms).....13
 Sporting Rifle (Colt Sauer).....37
 SSG-69 (Steyr).....35

Stainless Police (Winchester).....43
 Standard (Sako).....39
 Sten Mk II.....25
 Sterling.....24
 Stoner Mk 23 Commando.....47
 Super Commanche (Llama).....17
 SVD.....35
 Swedish K (M-45).....22

Thompson M1A1.....25
 Tokarev.....13

Uzi.....25

VP70Z (Heckler & Koch).....10
 Vz 24.....26
 Vz 54.....36
 Vz 59.....49
 Vz 61 Skorpion.....26

WA-2000N (Walther).....36

Credits

Design: Frank Frey and Loren K. Wiseman
Development: Loren K. Wiseman
Additional Material: Marc W. Miller
Cover: Steve Venters
Interior Illustrations: Marty Gerwick and Rob Reed
Art Director: Barbie Pratt
Graphic Design and Production: Lauretta Oblinger, Dana Reischauer, and James R. Kuntz
Text Manager: Michelle Sturgeon
Typesetting: Michelle Sturgeon and Kelly Walsh
Text Processing: Tim Ryan, Carol Etter, Julia Martin, and Elysabeth Dzik

Small Arms Guide

The *Small Arms Guide* is a sourcebook for **Twilight: 2000** which contains a consolidated listing of every personal firearm in the basic game; as well as additional material of interest to both players and referees.

In response to player requests, the single entry for the generic pistols (such as the 9mmP Auto) of the basic rules has now been expanded to include every major handgun type in use by the year 2000 and encompasses the full sweep of technological change, ranging from the German Luger and "Broomhandle" Mauser pistols of the early 1900s to the advanced materials and technology of the Austrian Glock 17. Also described are weapons not yet in service or just entering service (such as the Ruger P85), and hypothetical extensions of current firearms technology.

Increased coverage of both military and civilian rifles is also presented in the *Small Arms Guide*. Submachinegun coverage now includes all major types, from the Tommygun of the 1920s to the most modern suppressed designs, such as the H&K MP5 and Ingram MAC-10.

Each weapon entry contains an illustration of that particular firearm, a few short descriptive remarks, and full details for the incorporation of the weapon into the game.

The *Small Arms Guide* expands the ammunition covered in **Twilight: 2000**, including the ever-popular .375 and .44 magnum rounds.

The guide also includes a consolidated price and equipment listing for all weapon and ammunition types covered in **Twilight: 2000**. Special essays in the *Small Arms Guide* cover topics such as reproduction black-powder firearms and the special low-tech auto-rifle, the M16EZ.

The *Small Arms Guide* is a valuable resource for both players and referees of **Twilight: 2000**, and for anyone who has an interest in modern firearms.

Design: Frank Frey and Loren K. Wiseman

Development: Loren K. Wiseman

Twilight: 2000

Series Module

