

TWILIGHT: 2000™ 2nd Edition

MERC: 2000

Loren K. Wiseman



GDW
GAMES

MIERC: 2000

Loren K. Wiseman

SINCE 1973



P.O. Box 1646
Bloomington, IL 61702-1646

CREDITS

Design: Loren K. Wiseman

Art Direction: Amy Doubet

Cover Art: Bob Larken

Interior Art: Tim Bradstreet and Grant Goleash

Graphic Design and Production: Kirk Wescom

Cover Design: Steve Bryant

Text Manager: Michelle Sturgeon

Text Processing: Julia Martin and Elizabeth Meier

Merc: 2000

Copyright©1990 GDW, Inc.

Made in USA. Printed in USA. All rights reserved.

ISBN 1-55878-072-6.

Merc: 2000 is GDW's trademark for its roleplaying game of modern soldiers of fortune.

Twilight: 2000 is GDW's trademark for its roleplaying game of World War III.

S I N C E 1 9 7 3



P.O. Box 1646
Bloomington, IL 61702-1646

TABLE OF CONTENTS

Introduction	4	Panhard VCR.....	38	Central Asia Map.....	64
Chronology	6	RAM V-1.....	39	Indian Subcontinent and Indian Ocean.....	64
1989.....	6	RBV Mk1.....	40	Indian Subcontinent Map.....	65
1990.....	6	TAM/TH-301.....	41	East Asia.....	66
1991.....	7	Truck, 1-Ton.....	42	East Asia Map.....	66
1992.....	7	Type 62.....	43	Southeast Asia.....	67
1993.....	8	VBC-90.....	44	Southeast Asia Map.....	67
1994.....	8	Vickers Valiant.....	45	Africa.....	68
1995.....	9	The Referee	46	Northern Africa Map.....	68
1996.....	9	Scenarios.....	46	Southern Africa Map.....	69
1997.....	10	Teams.....	46	Time, Travel and Encounters	70
1998.....	10	Patrons.....	46	Encounters.....	70
1999.....	10	Mission Generation.....	46	Group Encounters.....	70
2000.....	11	Opposition.....	48	Animals.....	71
State of the World: 1 July 2000.....	11	Retrieval.....	48	Item Encounters and Settlements.....	71
Character Generation	12	Rewards.....	48	Generic Locales.....	71
Overview.....	12	Lifestyle.....	48	Perimeter Checkpoint Map.....	71
Contacts.....	12	Travel and Transportation.....	48	Underground Bunker Map.....	72
Welcome to the Life.....	12	Air Travel.....	49	Weapon Pits Map.....	72
Rads.....	12	Overland Travel.....	49	Officers' Quarters Map.....	73
Equipment.....	12	Water Travel.....	49	Headquarters Building Map.....	74
New Military Occupation.....	13	Campaigns.....	49	Barracks Map.....	75
Mercenary Terms and Expressions.....	13	Stock NPCs.....	50	Mansion Map.....	76
Equipment List	14	Local Recruit NPC.....	50	Sheds, Huts andhovels Diagram.....	78
Explosives.....	14	Maniac NPC.....	50	Prison Camp Map.....	80
Body Armor.....	14	Company Man NPC.....	50	Remote Estate Map.....	82
Electronics.....	14	Freedom Fighter/Terrorist NPC.....	50	New Combat Rules	84
Signal Gear.....	15	Ice Man NPC.....	51	Parachute Deviation Diagram.....	84
Miscellaneous Equipment.....	16	Quiet One NPC.....	51	Commands Diagram.....	84
New Ammunition.....	18	Enthusiastic Newbie NPC.....	51	Parachute Landings.....	84
40mm Stun Grenade Chart.....	18	Loudmouth NPC.....	51	Silence/Noise.....	84
Weapon Cards.....	19	Patrons	52	Sleeping Garrisons.....	84
S&W Model 0 (Mk-22).....	19	Meeting Patrons.....	52	Guard Dogs.....	85
Stun Gun.....	19	Organizations.....	52	Weather (Optional).....	85
Tranquillizer Gun.....	19	The World of 2000	54	Critical Hit/Quick Kill (New Rule).....	85
Vehicle Cards.....	20	World Space Programs.....	54	Noise Chart.....	85
Commando Scout.....	20	US Armed Forces.....	54	The Opposition	86
Commando V-150.....	21	Crime.....	55	USSR.....	86
Commando V-300 TUA.....	22	The Hiring Hall	56	United States.....	86
Commando V-300 CS.....	23	North America.....	56	France.....	87
Commando V-300 APC.....	24	North America Map.....	58	United Kingdom.....	87
EE-3 Jararaca.....	25	The Pacific.....	56	China.....	87
EE-9 Cascavel.....	26	The Pacific Map.....	57	Industrial Security Forces.....	87
EE-11 Urutu.....	27	Central America.....	57	Border Patrols/Paramilitary Police Forces.....	87
Ferret.....	28	Central America and the Caribbean Map.....	56	Criminal Cartels.....	87
HWK II.....	29	South America.....	58	Elite Forces.....	87
LWB Land Rover.....	30	South America Map.....	59	Sample Missions.....	88
M20.....	31	Europe.....	60	Sample Campaigns.....	100
M24Chaffee.....	32	Western Europe Map.....	60	Price List	108
M41.....	33	Eastern Europe Map.....	61	Appendix	115
OTO-Melara 6614.....	34	Middle East/Near East.....	62	Tactical Grid (Blank).....	115
OTO-Melara 6616.....	35	Near East Map.....	62	Air Distances Chart.....	116
Panhard AML.....	36	Middle East Map.....	63	Designer's Notes	118
Panhard M3.....	37	Central Asia.....	64	Index to Merc: 2000	119

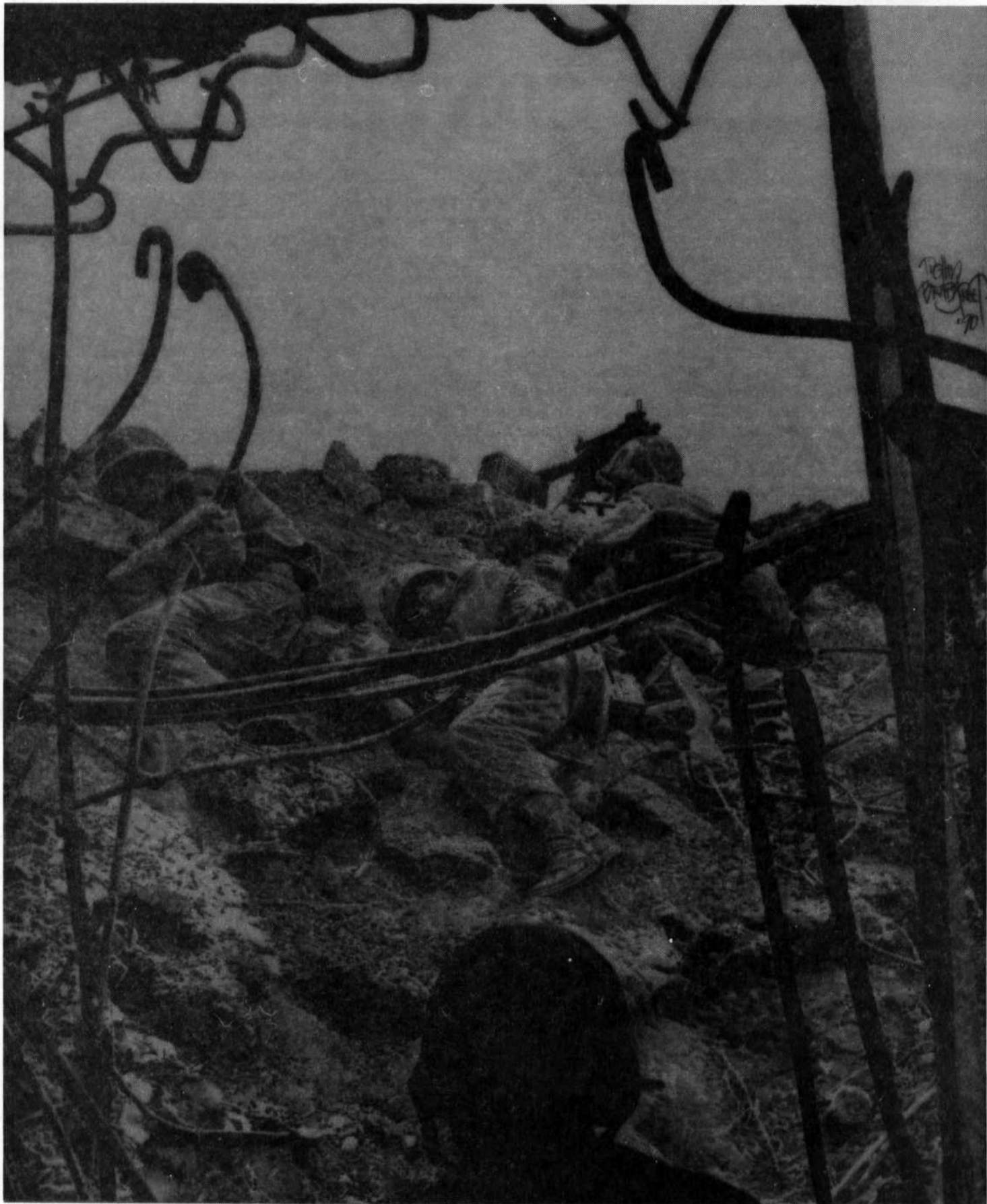

MERC: 2000

It's the jazz. We do it for the jazz.

B. A. Baracus

For as long as there have been wars, there have been mercenaries. At one time, a mercenary was a soldier who fought for pay (as opposed to his conscripted counterpart, who often received nothing other than food and whatever he could loot). Indeed, the word *soldier* itself comes from the word *solidus*, a type of Byzantine coin.

Later, as the notion of salaries for soldiers became more common, the term *mercenary* came to be applied to a soldier who had no fixed allegiance to a particular side. The Fabian maneuvering and procrastinations of the *condottiere* during the Italian renaissance gave mercenaries a bad name, which was reinforced by the writings of the Italian statesman and author, Niccolò Machiavelli.

Until that time, it was often mercenaries who were the most valuable troops, as demonstrated by the famed Balearic slingers and Cretan archers, the Varangian Guardsmen of the Byzantine Empire, and the Swiss (probably the most famous mercenaries in the world, since they still serve as the bodyguard to the Pope).

Mercenary acquired a connotation of incipient disloyalty, of the willingness to sell-out to the highest bidder in the midst of a conflict.

For whatever reason, with the rise of the nation-states in the 17th and 18th centuries, use of mercenaries dropped in favor of national standing armies, but did not vanish altogether. The British hired Hessians for service in the American Revolution, while the Americans had to make do with individuals (like Major General F. A. von Steuben of Prussia).

Mercenaries from France, England, and Germany served in the Greek War of Independence in the 19th century (calling themselves *Philhellenes*, or "lovers of Greece,"

this group included Lord Byron, the English poet). Americans served in the Abraham Lincoln Brigade in the Spanish Civil War. American pilots served with the French in WWI (the famed Lafayette Escadrille), and with the RAF in WWII (in both cases before American entry into those wars). After WWII, a large number of Germans entered service in the French Foreign Legion, fighting in Algeria and Indochina.

Whenever a war ends, some excess soldiers, for whatever reason, choose to continue to follow a profession at arms. Some simply do not fit into civilian life. Some have nothing to go back to. Some are a little in love with death or addicted to danger, and stock car racing seems to pale by comparison to war. Loyal only to their leaders, and with no stake in the final outcome (except their lives), men like Xenophon's hoplites, Hawkwood's White Company, and their modern emulators continue to fight (and to die) for someone else's cause.

Four things greater than all things are,
Women and horses and power and war.

Rudyard Kipling

Merc: 2000 is an alternate background and world situation for use with **Twilight: 2000**, GDW's roleplaying game of survival in a devastated world. The world represented by **Merc: 2000** is a different one from that in **Twilight**, mainly in that a nuclear holocaust did not destroy civilization.

It is not a happy world, however.

The world of **Merc: 2000** is a world of graphic contrasts. In some places, life is peaceful, productive, and quiet. In others, it is nasty, brutish, and short.

The gap between the haves and the have-nots has widened to a gulf, with the rich nations of the world struggling to keep their standard of living and the poor ones

struggling to stay intact and alive.

The major divisions of the world since 1945 have broken down. The division into the Eastern Bloc, the Western Bloc, and the nonaligned or Third World countries is no longer valid. The NATO alliance is gone, as is the Warsaw Pact, the OAS, and the EEC. Multinational corporations have taken over much of the economic coordination that was the venue of organizations such as the World Bank and OPEC. The one major economic activity that has not yet been taken over by the corporations is that of mercenary.

In the absence of the global cops to keep things calm, every simmering border dispute, every ethnic complaint, every historical economic or political grudge (real or created) might boil over into war. As it happened, the reductions in force taking place in the world's armies due to the economic crisis have dumped large numbers of fighters onto the world job market at about the same time.

The question of whether excess soldiers bring about war or war causes surplus soldiers is one historians will debate for decades.

It is evident enough for most, however, that the world has avoided a great war at the cost of having to fight a hundred little ones.

Merc: 2000 is a game of daring night raids on enemy camps, audacious hostage rescues, and tense industrial sabotage missions in exotic foreign locales—ranging from the mountains of Borneo to the suburbs of Chicago.

Using GDW's award-winning **Twilight: 2000** rules as a base, **Merc: 2000** enables players and referees to conduct adventures in this world of almost perpetual, low-key conflict.

Merc: 2000 includes a new chronology of the events of the decade between 1990 and 2000, new rules, new equipment, new vehicles, new weapons, and a new career path (counterterrorist). **Merc: 2000** contains ready-to-play scenarios and suggestions for scenario creation and campaign organization.

Everything is fully compatible with the **Twilight: 2000** rules system, and characters can even be used interchangeably if desired.

All warfare is deception.

Sun Tzu

CHRONOLOGY

What follows is a rough outline of major world events from 1989 to 2000, concentrating on those felt to be of the greatest interest.

1989

The year the Cold War ends. Across Europe, communist governments topple in response to pro-democracy demonstrations or, in the case of Romania, armed insurrection. Voting with their feet, East German citizens flood to the west. In Poland, German ethnic organizations form in response to West Germany's policy of accepting as a German citizen anyone who can prove himself of Germanic descent (it is rumored that membership in ethnic clubs is good enough).

The Soviet Union's new policy of encouraging political pluralism in Europe makes the end of bureaucratic communism certain. Mao Tse-tung's forgotten maxim, "Let 10,000 flowers bloom," becomes reality as dozens of new parties spring into being. The only European communist governments which survive the revolution of 1989 are those outside the Warsaw Pact—Yugoslavia and Albania. The Berlin wall is torn down in spots, and German reunification is spoken of openly: The question is no longer "if," but rather, "when?"

Riots in the Soviet republic of Azerbaijan (over alleged repression of Armenians) require intervention by Soviet troops. The republic remains a powder keg for months.

Elsewhere, the Chinese political reform movement is brutally crushed by government military forces. An attempted coup against President Aquino of the Philippines is foiled (with the help of American air cover), and the republic of Panama is invaded by the US to remove the government of Manuel Noriega.

The American economy began to show signs of slowing several years ago, despite the best efforts of the Reagan administration. Some portions remain strong, but excessive government spending is beginning to take a toll.

1990

In a major upset for political pundits in the US, a coalition of opposition parties headed by Violetta Chomoro defeats Daniel Ortega's bid for reelection in Nicaragua. Despite some early problems, Chomoro's government finally settles into a period of relative stability.

In Europe, the long-awaited (and long-

feared, in some circles) unification of Germany is finally accomplished, although not as smoothly as some people thought.

The four-power conferences (representing the US, UK, USSR, and France) that recognize the inevitable unification of Germany also guarantee Poland's territorial integrity. As a part of the agreement, NATO and Warsaw Pact troops will maintain a presence in the newly unified republic (the only way some European nations will agree to the deed). Few outside Germany note the distinction between the word unification (which to Germans means unity of the post-WWII *Bundesrepublik Deutschland* and the *Deutsche Demokratische Republik*) and reunification (which to Germans means reacquisition of the prewar territories—including parts of modern Poland). It is a distinction of tremendous significance.

Unification of the currencies occurs in July, almost without incident, producing a curious anomaly. Soviet forces in Germany received part of their wages in Ostmarks (the East German currency). When the Ostmark ceased to exist, the Soviets continued to be paid by the East German government, but in West German Marks—a hard and easily spendable currency. Duty in Germany suddenly became a highly valuable perk in the Soviet Army (amusingly enough, this was about the same time that members of some groups refused to enlist unless it was specified that they would not have to serve outside their own republic).

Once the principle of unification is agreed upon and all external hindrances are dealt with, internal problems surface. The East German government demands a constitutional reformation of the east into its constituent states, which will then vote for entry into the new *Bundesrepublik*—thus giving East German politicians a constituency to run for. East German business heavily resents the concept of sudden, unhindered competition with western businesses—as one observer put it, "Everyone figures they'll be driven out of business, and end up either unemployed or working for fat West Germans who will move in and take over everything at bargain basement prices."

West German economic officials resent all the investment capital required to bring the east up to western standards of living. Western workers resent the prospect of hordes of laborers used to starvation wages entering

the job market. As for politics, the same observer notes "The ruling party wants to do reunification now to claim it as a success in the next elections. The opposition wants to put it off for awhile, since the east's economy is obviously going to collapse and cause a small recession in the west as well. Then they can run as the only ones capable of putting everything back together again."

Nonetheless, unification is a done deal in October, and the newly united *Bundesrepublik* opts for continued membership in NATO, but at a greatly reduced level of commitment. It renounces any territorial claims outside its post-WWII boundaries, but asserts its interest in the welfare of ethnic Germans living outside of Germany. Membership in German ethnic organizations in western Poland grows, particularly in Silesia, where the floundering efforts of the new (and noncommunist) Polish government to convert from a controlled to a free economy result in only partial success.

Elsewhere in Europe, increasing demands for reform in Albania are met by measures that are described as unbelievably brutal by the few outside observers present. An Australian magazine camera crew captures scenes of a massacre of rioting farmers outside Shkodër, which are later denounced as "computer-enhanced fabrications" by the Albanian government.

Spring elections in the Soviet republics of Byelorussia, the Ukraine, and the RSFSR dissolve some of Gorbachev's problems and create others. The election of Boris Yeltsin to the position of president of the RSFSR (the USSR's largest component republic) brings Gorbachev's greatest critic into a major position of power.

Before, during, and after these elections, ethnic unrest simmers in Azerbaijan and spreads to the minority republics of Tajikistan, Georgia, and Kazakhstan, mostly in the form of ethnic demonstrations and occasional riots. Gorbachev's demand that local armed forces disarm is largely ignored, and low-level armed violence spreads throughout the Moslem parts of the Caucasus and Central Asia, although Armenia remains strangely quiet. Most of this fails to come to the attention of the rest of the world, which is distracted by events in Germany and in the Middle East.

By the end of the year, Soviet troops begin to withdraw from Czechoslovakia, but the governments of Poland and Hungary (concerned over the specter of a unified Germany) request continued Soviet troop presence. The Soviet military begins to reorganize along defensive lines, with greater attention to internal security.

In the US, exposés of massive financial losses in the savings and loan industry as a result of federal deregulation policies begin to

undermine popular confidence in the administration, especially its lower level officials.

In the Middle East, tensions increase between Iraq and Kuwait throughout June and July, culminating in the Iraqi invasion of Kuwait on 2 August. American land and naval forces, in conjunction with those of several other nations, speed to the area, and the UN (in a remarkably swift debate) votes to censure Iraq and declares a blockade of Iraqi products. This causes an immediate rise in oil prices, and the oil market is skittish for the next few months. The blockade is not complete at first, but by mid-September is tightly in place. In spite of these measures, Saddam Hussein refuses to yield to diplomatic overtures, and the stage is set for the Second Persian Gulf War (1990-1991).

In the Caribbean, the Soviets announce that they can no longer subsidize the inefficient Cuban economy and that all aid will be halted within a year.

In North Korea, increasing numbers of Koreans take to the streets with demands for Soviet-style reform and German-style reunification with the south. The government reacts with token reform measures which promise much but achieve little. Finally, in November, the member nations of the Warsaw Pact formally dissolve that organization.

1991

With the rise in oil prices that attends events in the Middle East, many oil-rich, but heavily indebted, countries decide to invest in expensive drilling equipment with an eye towards increased production. Mexico, Venezuela, Indonesia, and others submerge themselves deeper in debt (many were already on the brink of insolvency) in hopes of cashing in on the oil revenues inherent in continuing oil market unrest. A brief (but significant) expansion in the American oil industry temporarily rejuvenates the economies of the oil belt states in the United States. A shaky stock market keeps most Americans from feeling the benefits of this rejuvenation, however.

Ethnic and religious violence in the Central Asian republics of the Soviet Union escalates, and the Soviet Union increases its troop withdrawal schedule in order to use the forces inside its own borders.

Having reunified, Germany now turns its attentions to bringing the eastern portion of the country up to the standard of living of the West. The Bundeswehr is radically reduced in size, and by year's end, Germany places increasing pressure on NATO to reduce troops in proportion to the Soviet withdrawal. Germany also pledges to station troops only in the western part of its territory in return for a complete Soviet troop pullout from eastern Germany.

Hungary protests that the Romanian government is withholding medical relief of the AIDS epidemic (a legacy of the Ceausescu regime's deranged medical policies) from Magyar (ethnic Hungarian) sections of Transylvania; Bucharest denies the charge. French medical investigators accuse the Romanian government of concealing the severity of the AIDS infestation in rural areas, but find no evidence of ethnic prejudice. "It's not a matter of bigotry," remarks a young French medical student returning from a six-month stay in Romania. "It is purely incompetence."

A wave of Slavic nationalism in Bulgaria prompts anti-Turkish riots. Many ethnic Turks are killed, resulting in increased friction with Turkey. German ethnic groups demonstrate in Pomerania and Silesia, protesting their alleged mistreatment by the Polish government.

Americans continue to be scandalized at the extent of Japanese and South Korean ownership of property (even though it is still only a small portion of total foreign ownership) and at the increasing wave of urban violence caused by the explosion of crank (smokable methamphetamine) into the heavily populated urban centers of the East and Midwest. The increase in antisocial, extremely violent psychotic episodes in crank users turn the inner cities of the American "Rust Belt" into war zones. Accusations of a racial motivation for the current inner city conditions appear increasingly in minority publications and speeches.

The Second Persian Gulf War ends with the defeat of the Iraqi Army in a costly ground campaign. Saddam Hussein is removed, and a more moderate leader takes over. Kuwait is returned to its former rulers. The economy of both countries is wrecked by the war, and both begin massive pumping to generate revenue. The effect on oil prices is an immediate and long-term drop. Most of the allies withdraw their forces, but the XVIIIth US Corps (consisting of the 24th Mechanized Infantry, 1st Cavalry, and 7th Marine Expeditionary Brigade) remains in the region.

As the oil market bottoms out, oil-producing countries begin to default on their loans to international banks. Because of this and increasing stress brought on by a recessionary spiral in the US and European economies, these banks begin to fail, one by one.

With the cut-off of Soviet funding, Cuba begins to withdraw troops from their foreign stations in nations like Angola. Cutbacks in military forces produce a pool of experienced fighters who have little prospect for employment at home—a potentially dangerous situation in the best of economies.

North and South Korea finally achieve a reunification, and the last of the fragmented nations of the Cold War become one government again.

1992

In March, NATO and German foreign ministers agree to the Rhineland Compromise, providing for token NATO forces to remain in the Rhineland for a period of five years. This force will consist of one British division, one French division, two US divisions, and a brigade each from Belgium and the Netherlands. NATO's presence in Europe is reduced to five corps (one each British, French, and Benelux, two American) in three armies (US 7th, British Rhine, and French 1st). As a result of this reduced commitment, both the US and Great Britain begin slight reductions in force for economic reasons.

A civil war in Albania results in the fall of the communist government and its replacement with a caretaker military regime (which some call a junta). Albanian nationalists demonstrate throughout southern Yugoslavia, while Croatian and Slovenian nationalists demonstrate in other parts of the country. The Yugoslavian government response is careful and low-key, but firm.

Because the German economy is the only thing holding the EEC's head above water, at the request of the German government, the European parliament puts the universal European currency and other similar economic reform proposals on temporary hold. "Europe '92" is stillborn, to the relief of conservatives in Britain and the United States.

After early successes in holding down the Central Asian unrest, the Soviets suffer several major setbacks and lose control of large parts of Central Asia. Gorbachev accuses Iran of supplying arms to rebels in Central Asia and Caucasus. Bloody fighting continues, with Islamic fundamentalist insurgents growing in strength. Late in the year, some Western observers begin to use the term "civil war" in referring to the Central Asian unrest.

In the Philippines, President Aquino is reelected by a narrow margin. In the United States, President Bush is reelected to a second term.

The danger of the imminent collapse of the international banking system is finally driven home when the IMF announces that without major financial assistance it will go bankrupt. A financial package put together by Japan, the United States, and Germany temporarily staves off disaster, but the global economy is still entering a recessionary spiral, forcing many governments to take belt-tightening measures. The first of these is a reduction of British overseas military commitments, particularly in Cyprus and Belize.

In Cuba, Fidel Castro dies and is replaced by Pablo Quinonez Belloso. Socialism in Cuba (in a process of change since the cutoff of Soviet funds the year before) ceases to exist in its old form.

1993

In his inaugural address, President Bush sets the twin national priorities of rebuilding America's deteriorating infrastructure and "breaking the double grip of crank and crime that have made the nation's largest cities all but uninhabitable." Reductions in the defense budget made possible by the reduced American military presence in Europe are to fund a national reconstruction program and support large increases in law enforcement and antidrug education.

None of these measures have any real effect. (By year's end, the DEA will announce a 250% increase in drug seizures, both from smuggling and domestic crank factories. This will represent only 4% of the total estimated illegal drug consumption for the year.)

Bush is more successful on the international scene, using international events to distract attention from domestic problems in time-honored fashion. By year's end, he negotiates a withdrawal of Turkish troops from Cyprus and a reunification of the island republic, for which he will receive a Nobel Prize nomination.

Fighting in Central Asia continues for most of the year, but the Soviet military gradually begins to gain the upper hand and regains control of most of the cities of the region. A guerrilla war continues in the countryside, and many veterans of the fighting in Afghanistan a decade before find themselves fighting a very similar campaign. As casualties mount, civilian pressure to end the war grows, until finally, in November of 1993, Mikhail Gorbachev is forced out of office.

The glue that held the fragile coalition together begins to soften, then suddenly dissolves completely. Boris Yeltsin (Gorbachev's chief critic and president of the RSFSR) proposes a loose economic association between the various republics, with the Russian Republic included but not predominant (although it does retain control of the ICBMs). Local autonomy becomes the new motto of the new coalition, and Yeltsin becomes the most powerful man in a much-weakened USSR. Troops are withdrawn from the Central Asian republics, and they are allowed to go their own way. Within months, all but the republics of Turkmenistan, Uzbekistan, and Kirghizia elected to remain loosely associated with the USSR. The republics of Azerbaijan and Armenia remain at loggerheads over their mutual border and continue to dream of union with ethnics outside their own borders (in Turkey and Iran), but neither republic is in any condition to mount a full-fledged war.

In China, underground pro-democracy organizations, with encouragement and financial aid from relatives in other countries, begin demonstrating in many of China's larger cities. While these demonstrations remain relatively peaceful for awhile, they soon erupt into violence, forcing military intervention. Better prepared than the

students of 1989, the pro-democracy factions of the northeast hold out for months before the military manages to restore order.

Elsewhere, things settle down more quickly. Some regional military commanders, increasingly mistrustful of the ability of the local government to maintain order, begin taking matters into their own hands, seizing direct control of local government and imprisoning government officials.

Within a year, most of China is effectively ruled by military commanders, modern versions of China's traditional warlords. Central government effectively ceases to exist, and the Soviet Union's border problems vanish as the border lords conclude separate agreements with the new Soviet Union. Those in the strongest positions are the ones who have possession of ICBMs.

The British declare that the treaty requiring them to leave Hong Kong is now voided, but economic pressures force the withdrawal of the non-Asian parts of the garrison. The Gurkha units in Hong Kong are turned over to local government control. Training cadres of British troops begin forming a local defense force.

By the end of the year, low-key demonstrations by Albanians, Macedonians, and other ethnic groups continue in Yugoslavia, some becoming more violent. The Yugoslavian government accuses the Albanian junta of supplying weapons to dissident Albanians within the Yugoslavian provinces of Kosovo and Macedonia. The Albanians deny the charges but admit that Albanians might be entering Yugoslavia without government sanction.

1994

In Romania, antigovernment demonstrations by Magyars (ethnic Hungarians) in several Transylvanian cities are suppressed by Romanian riot control police, with some loss of life. The Hungarian government again protests the mistreatment of these people at the hands of what the Magyars claim is an increasingly genocidal government.

On 14 June, Romanian police shoot and kill a man crossing the border to the Romanian town of Satu Mare, and the Hungarian government suspends diplomatic relations. The Romanians claim he was a smuggler, bringing arms to antigovernment forces. Three days later, Hungarian army spies or Romanian government provocateurs (depending on which side you believe) blow up a Romanian railway station in Cluj.

The Romanians conduct mass arrests of Magyars throughout Romania. Police sweeps are met with armed resistance. Romanian troops move north, and Hungary declares war.

Sweeping off the Hungarian Plain, the T-72s of the Hungarian Army drive towards

Cluj in the north and Arad/Timisoara in the south. The Hungarian 1st Combined Arms Corps (with three tank brigades and two motor rifle brigades, and supported by an assault helicopter regiment), overruns and destroys the Romanian 11th Motorized Rifle Division at Oradea and barrels up the Crisul Repede River Valley towards Cluj, where it encounters the Romanian 6th Tank Division. In the south, parachutists of the 37th Parachute Battalion isolate Timisoara, and the Romanian 18th Motor Rifle Division is surrounded and destroyed by the Hungarian 3rd Combined Arms Corps. The Magyars of Transylvania greet the Hungarian forces as liberators.

By July, the Romanian 3rd Army has halted the Hungarian offensive in the Carpathians, and it launches a counteroffensive on 3 August. The attack is initially successful, but Romanian reinforcements moving through the passes in the Carpathians are delayed by Magyar partisans, and the counteroffensive slows, then halts. Under diplomatic pressure to end the war, both governments agree to a ceasefire.

Armistice talks begin in Geneva with Hungarian forces occupying just over a quarter of Romania, roughly the area west of a line from Resita to Hunedoara to Alba Iulia to Cluj to Satu Mare.

After several years of intensive investment in the eastern third of the country, Germany is finally showing signs of emerging as a world-class economic superpower. Eastern Germany has been successfully integrated with the West—with infrastructure, education, and services comparable (if not yet equal) to those standards in the rest of the country. As Europe shows signs of increasing political and economic instability, Germany begins quietly increasing its force structure. In January of 1994, the six understrength divisions which had been maintained as a token army are brought up to full strength, and each is given a new "territorial" brigade stationed in eastern Germany. Germany is still technically within its agreement not to station active troop units in eastern Germany since territorials are not active components.

Researchers in France and the United States begin testing a vaccine which shows every sign of being effective against the Human Immunodeficiency Virus (the causative agent in AIDS). Pressured by several special interest groups, researchers soon yield to demands for an accelerated testing program, and the United States Food & Drug Administration (FDA) waives animal tests in favor of immediate large-scale human experimentation.

The Bush administration refuses to fund

these tests completely, claiming that it cannot do so without placing an onerous additional burden on the American taxpayer.

Small-scale testing begins, with waiting lists that grow astronomically. The experiments prove successful, but it will be years before pharmaceutical firms can gear up to produce the vaccine in sufficient quantities to deal with the domestic demand in the developed countries, let alone the massive outbreaks of the disease in Third World countries (those hardest hit—and least able to afford help). The countries of central Africa, in particular, are facing complete collapse of their respective health care systems under an avalanche of AIDS victims. Adding to the problem, many health care professionals decide to leave the region out of fear for their own lives.

Uganda is effectively in civil disorder, the central government having almost completely broken down. Rwanda, Burundi, Tanzania, Kenya, and Zambia are in danger of going the same route, although in Kenya the situation is less critical than elsewhere due to an influx of British medical aid.

After five years of relative quiet, differences between the Sinhalese majority and the Tamil minority (about a fifth of the population) in Sri Lanka again boil over into civil war in December, shortly after it was announced that the scheduled elections were to be indefinitely suspended.

The United States establishes diplomatic relations with the Cuban government of Presidente Quinonez Belloso, over the objections of a number of expatriate Cubans in the US, who want a completely new government.

1995

The Hungarian/Romanian armistice talks conclude in Geneva, with neither side completely satisfied. Hungary is forced to give up the occupied territories, but is able to force reparations from the Romanian government (in the form of payments to Magyars in Romania) and to provide legal guarantees for the civil rights of ethnic Hungarians. Non-Magyar military and police units may not enter any district with a majority population of Magyars, and Hungarian-language schools must be established in all districts with a significant Magyar population.

In response to increasing regional instability (primarily the situation in Romania), Germany declares its agreement on size and location of armed forces "obsolete in relation to the current European situation." The six eastern territorial brigades are immediately expanded to weak divisions, while the original six divisions are expanded to nine (the additional troops being provided by mobilization of

reserve units from the western part of the country). Poland protests and begins bringing several divisions in western Poland to higher states of readiness.

In October, United Nations peacekeeping forces are sent to Sri Lanka to intervene in the civil war there. Canadian, Danish, and Swedish contingents are among those sent, many of them units that had just been rotated out of Cyprus with the settlement there.

Cuban soldiers begin appearing on the international mercenary market, with no political or social agenda evident. Because of their skills, they are soon sought after for counter-revolutionary forces throughout South and Central America.

1996

Several days of anti-Turkish rioting in Bulgaria are touched off when a Bulgarian national, arrested for attempting to assassinate the president of the Turkish republic, dies in custody. Despite Turkish protestations that his death was from natural causes, the incident soon assumes crisis proportions, and Bulgarians move over the border. Turkish response is massive, and Bulgaria is quickly defeated. Turkish forces occupy Bulgaria and begin setting up a new (and pro-Turkish) government.

Flushed with a new and virulent nationalism, Turkish Cypriots begin anti-Greek riots. The Cypriot Army moves to restore order, and reports of atrocities are received in Ankara. In response, the Turkish Army invades Cyprus and quickly occupies most of the island. Greece first sends military units to Cyprus to resist the Turks, then declares war on Turkey and attacks the Turkish forces in Thrace. Both sides carefully avoid the British sovereign areas at Akrotiri and Larnaca, but British diplomats threaten military intervention if hostilities do not cease. This—combined with Greek successes in Thrace, a growing Armenian insurgency, and a Bulgarian revolt—forces an armistice.

In Yugoslavia, anti-Albanian rioting by the Serbian minority in the province of Kosovo turns into a civil war when an Albanian crowd hangs a local Serbian criminal. When the provincial government proves unable to take action, Serbian "defense militias" move into Kosovo from neighboring provinces, and Yugoslavia explodes into civil war.

The Yugoslavian government disintegrates, and the country breaks into six sections: Slovenia, Serbia, Croatia, Bosnia/Herzegovina (also called Dalmatia), Macedonia, and Kosovo. The Albanian junta immediately recognizes the independence of Kosovo and sends in troops (provoking a reaction by the

Serbian minority). Macedonia requests help from the Greek government, which is granted in the form of military advisers, weapons, and materiel. Serbia is divided among those who seek to reunify Yugoslavia (in a minority) and those who feel that Serbia is best shed of its troublesome neighbors. The army breaks up along ethnic lines, and the Yugoslavian melting pot breaks up into its component parts.

In the United States, widespread perceptions of a lack of effective Republican leadership on the drug front, and an inability to deal with the oil-driven recession, lead to the election of John Tanner (a Democrat from California) as president. Tanner's vice president, Deanna Pemberton (former representative from Ohio), is the first woman to hold such a high elected office.

In July the *Sendero Luminoso* (Shining Path), Maoist guerrillas, make a bid for control of Peru. They do not succeed in overthrowing the government, but they do succeed in wresting about half of the country from central control.

Other South and Central American countries experience varying degrees of political instability. Chile and Argentina fight a short war over a long-disputed border. The Argentines win, but at a cost of continued low-scale guerrilla war with Chile.

In Bolivia, economic problems related to the general worldwide recession cause widespread dissatisfaction with the elected government, and a coalition of military officers attempts a coup in late September. The attempt fails, but Bolivian President Guillermo Gonzalez Lora initiates a purge of the disloyal officer corps, which does not put him in good standing with the rest of the army. By December, a second military coup expels Lora and installs General Leonidas Escobar Moscoso as head of government. Moscoso is the first to make extensive use of post-Castro Cuban mercenaries, but he will not be the last.

In Canada, the Meach Lake Accords to the constitution were approved in 1990 by a controversial compromise. This proved to be only a temporary solution to the problem of the Quebecois. A resurgence of French-Canadian nationalism begins late in the year and is matched by demands from other Canadian minorities (primarily Indians), including a group in Manitoba which demands Winnipeg street signs in Ukrainian as well as English and French (pointing out that there are more native speakers of Ukrainian than of French in Manitoba).

Troops in Germany under the Rhineland compromise begin their scheduled withdrawal, and this process is largely completed by February of 1997.

1997

In his inaugural address, US President Tanner promises a sweeping reform of the budget and a shift in national priorities. "We must put our own house in order," he says, "and revitalize our own economy, before we can consider extensive foreign assistance programs." Critics label this the "Ostrich Address," accusing Tanner of burying his head in the sand.

The US military is reduced, the deepest cuts coming from the navy (which is forced to mothball all of its *Nimitz*-class carriers and the associated task force component ships), but the other services are severely reduced as well. The XVIIIth US Corps is withdrawn from Kuwait, and large numbers of American ex-soldiers enter the job market. Unemployment soars in the United States.

In March, another round of pro-German demonstrations breaks out in Poland; they are again violently suppressed. This time, however, small groups of demonstrators fight back with military small arms. Polish Army units move in, and soon Pomerania and Silesia appear to be in the grips of a civil war.

Poland charges that many of the rebels are German right-wing nationalists who have crossed the border with the collaboration of the German Army. Berlin denies any involvement with rioters but admits that German nationals have crossed into Poland, and German military units move closer to the border to step up security. The Polish government protests and also begins moving more units into the area.

War erupts in April—a Polish border guard patrol intercepts German nationals (members of a right-wing proreunification group) smuggling arms across the Neisse River north of Görlitz. Gunfire is exchanged, and the Polish border guards call for help, which arrives in the form of an airmobile reaction force. In the confusion, a party of Polish airmobile infantry accidentally sets down in Germany and exchanges fire with German troops arriving to investigate. The commanding general of the Polish 4th Motorized Rifle Division (stationed along the river south of Frankfurt-an-Oder), hearing Polish radio transmissions, believes the firefight is taking place east of the river, in Polish territory (where the airmobile troops think they are). Believing a German invasion underway, the general orders his division across the river at Gubin, Swiecko, and Frankfurt.

By morning, both sides are denouncing each other for starting the war, and German troops are pouring into Poland along a wide front. The first day is a cakewalk for the Germans as Leopards and *Marders* bypass

the Polish border positions and sweep across Pomerania and Silesia. Within two days, however, Polish resistance stiffens, and the offensive stalls as it approaches Warsaw.

Seven days after the war starts, Czechoslovakia enters on the Polish side and turns the tide against the Germans, capturing Dresden and Meissen (after heavy fighting). A joint US-Soviet delegation manages to persuade both sides to cease hostilities. Both sides agree to a return to prewar borders, and a UN peacekeeping force takes up duties in July. This is to be the last effective intervention by the UN in an international conflict, largely due to lack of funds as the United States reduces its annual contribution.

In Asia, India and Pakistan drift into war through an escalating spiral of border incidents, mobilization, and major armed clashes over possession of Kashmir. Outright war begins in October, and by year's end the Indian Army is slowly advancing across the length of the front, despite fierce resistance.

The collapse of world oil prices has sent Indonesia into a severe economic crisis. A coup by a group of generals overthrows the elected government, but conditions continue to worsen. Piracy, once almost wiped out, begins again in the Sulu Sea.

1998

A number of factors conspire to end the Indo-Pakistani war of 1997. Dissident Sikhs in the Indian military revolt, charging that they are sent into combat more than other units in an attempt to destroy the flower of their male youth. This, coupled with a threatened invasion by the Tibetan warlord of Lhasa and deteriorating economic conditions, forces the Indians to settle the war with Pakistan. India annexes the region of Pakistan bordering on Kashmir, a region bordered by a line running from the historic Khyber Pass to the city of Lahore, and including Peshawar and Rawalpindi. Indian troops will be entangled against Kashmiri guerrillas for years to come.

Pakistan is not without its own problems, however. Baluchi tribesmen in the south of Pakistan and in neighboring Iran take advantage of the chaos introduced by the war to declare their independence. In Iran, the revolt is quickly put down, but Pakistani forces, weakened by the war, are unable to exercise any control over the region. Although not recognized by any major nation, Baluchistan (at least the portion inside Pakistan) is a de facto independent country.

In Europe, after years of increasing disquiet, ETA (*Euskadi to Azkatasuna*—Basque Nation and Liberty) the Basque separatist organization, begins active civil war in north-

ern Spain. Spanish response is swift, but less than totally effective, and while active resistance lasts only 18 months, sporadic bursts of fighting continue to flare up from time to time.

In Africa, the former French colony of Burkina Faso, fortified with Libyan armaments, instructors, and several cadres of the Muslim African Legion, renews its decades-old border conflict with its neighbor, Mali. The armed forces of Mali, mostly in the north dealing with the ever-present Polisario insurgents (also supplied by Libya), were overwhelmed initially, but soon manage a counterattack. The situation soon settles into a continuing low-level war, with occasional offensives that soon stall.

In the Pacific, the Indonesian military government invades Papua New Guinea in what outside observers label a desperate attempt to distract the populace's attention from the nation's economic problems by military adventurism. Australia (the defender of Papua New Guinea by treaty) sends troops in response. The forces are only part Australian since no nation maintains a large standing army any more. Australians and New Zealanders form perhaps 20% of the force, and about half is hired mercenary soldiers from India. The remainder are Chinese, Soviet, and a small number of other nationalities. This army is the first of many forces to be primarily mercenary.

The UN announces that the situation in Sri Lanka is stabilizing and orders peacekeeping forces withdrawn. The reality of the situation is that the UN can no longer afford to support military intervention and its other programs. Indeed, the other programs of the UN are on shaky financial ground as well.

1999

In Europe, the economic strain of the war with Germany finally proves too much for the Czechoslovakian economy, and the nation's industries begin to collapse in the ever-widening global recession. The gulf between the Czechs of the industrialized west (Bohemia and Moravia) and the Slovaks of the less industrialized (and less economically depressed) east strains the central government to the breaking point. Finally, Slovak nationalists, fed up with supporting a dying economy, secede and declare their independence, and a civil war is soon in full swing. The army splits along national lines, but more ends up in the hands of the Czechs than the Slovaks. To even the balance, Slovakia hires Polish veterans to fill out its forces, and the second major use of mercenary armed force begins.

Baluchis continue to raid Iran from Pakistan, prompting Iranian military forces to make forays into Pakistan for the purpose of breaking up Baluchi raider assembly areas. Soviet veterans will play an increasing role in this war

as it heats up from raiding to full-scale conflict.

In the Amazonian rain forests, an unprecedented coalition of Indian groups begins an escalating antigovernment campaign.

In southern China, the forces of General Ch'en Mien-wu, warlord of Yunnan, advance down the Gam River Valley into Vietnam, with the intention of acquiring the city of Hanoi and the port of Haiphong. The invading Chinese forces are stopped at Viet Tri and slowly pushed back up the valley to a point just north of the town of Tuyen Quang.

Troops under Australian command in Indonesia defeat the local forces on Java and Sumatra, and secure a surrender of all Indonesian forces. The Australians install a sympathetic government, which invites them to stay and help administer the country.

Using arms and military expertise acquired during the Central Asian wars, the Armenian areas in Turkey begin an active anti-Turkish insurgency. Fed arms and supplies from the quasiautonomous Armenian Republic in the old Soviet Union, the mountain guerrillas tie down large numbers of Turkish forces and strain a Turkish economy still reeling from the Bulgarian and Cypriot affairs of three years before.

Oppressed ethnic groups in Iran and Iraq seem to take inspiration from the Armenians and Baluchis. By the end of the year, the Kurds in Iraq and Iran, and the Azerbaijanis in Iran had risen in active rebellion, many of them hiring as mercenaries soldiers who had fought against them only a few years before.

In Africa, oppression of the predominantly Catholic Ibo tribe by other ethnic groups in Nigeria (mostly the Muslim Hausas) had exploded into civil war three decades before, and the underlying conflict resurfaced in the 1990s. The Nigerian government does well initially, but an influx of mercenary forces (primarily German veterans) hired by unspecified sources stem the tide. The Biafrans declare their independence on 14 October and manage to seize the area east of the Niger and south of the Benue rivers, a region which includes most of Nigeria's active oilfields and (even more important) Port Harcourt, through which supplies can be landed. Nigerian forces are unable to enforce a blockade of the port, and several offensives intended to take the city fail. Cubans begin showing up in increasing numbers on the Nigerian side late in the year.

2000

A coup in the Pacific island nation of Tonga overthrows the monarchy of King Taufa'ahau Tupou V. Foreign mercenaries led by a local noble, Tu'ipelehake Pa'anga, help in the coup. Pa'anga is installed as president and commander-in-chief. Tonga is a member of the British Commonwealth, but the British have yet to take action

other than to denounce the takeover in parliament and give the deposed king sanctuary.

In the Philippines, a military coalition opposed to the government of President Aquino attempts to seize power. It is unable to secure the help of the air force and is soon forced to retreat from Luzon to the lesser islands, although it manages to maintain a small enclave on the large island of Mindanao.

After laying low for almost a year, a number of anti-Australian secret societies (including Moluccan rebels, Sulu Sea pirates, and anti-European minorities) manage to secure the help of a cadre of mercenaries and revolt against the Australian-backed government of Indonesia. The rebels quickly secure most of the island of Sumatra and the bulk of the Moluccan group, as well as small enclaves on Sumatra and Borneo.

In Africa, Zaire makes a grab for the oil-rich Cabinda enclave of Angola, starting a war between the two nations. Angola is unable to prevent the annexation of Cabinda, but begins a series of escalating border raids inland hoping to keep the Zairan Army occupied while it gathers its own forces.

STATE OF THE WORLD: 1 JULY 2000

North America: Canada and the United States face severe economic difficulties. Some ethnic and racial violence continues in both Canada and the US, to a slightly greater extent in the latter. In the US, some inner cities are effectively war zones, created by feuding drug/criminal cartels. Rural areas do not completely escape either, and America is violent at a level not seen since the 1920s. The American government believes at least some Libyan-backed terrorist activity is beginning to occur.

Central America and the Caribbean: Mexico is relatively quiet as the world goes, but still has internal civil strife brought about by its loan defaults and the collapse of the Pemex oil consortium. Guatemala and Belize are still at war, and an active mercenary market exists, albeit at a low level. Anti-government insurgencies exist in practically every country, but the most active are the *Falange* *Deno* of the Dominican Republic, the *Ejercito Revolution Popular* of El Salvador, and the *Cinchoneros* of Honduras.

South America: The Colombian and Panamanian governments face a major threat from an alliance of criminal organizations, largely engaged in the drug trade.

Peru is in the midst of retaking the territories lost to the *Sendero Luminoso* guerrillas, using primarily Cuban and Russian mercenaries. Brazil has a growing problem in the Amazon river basin. Argentina occupies a portion of Chile, and faces hostile guerrilla

actions there. Bolivia is experiencing increasing resistance to the military dictatorship currently in control. Venezuela has recently survived a coup attempt and is ruled by an increasingly autocratic military regime. Paraguay, Ecuador and Uruguay are relatively stable, but minor antigovernment movements exist in practically every country.

Europe: Most of Europe is in a reasonably peaceful condition, although economic distress is everywhere. The Romanians have defaulted on their reparation payments to Hungary, and a tense situation is developing. The Polish/German border is relatively quiet. The Libyan government is financing a low-key (but growing) terrorist campaign in numerous countries, primarily France, Germany, and Great Britain.

Northern Ireland is still in the midst of "the troubles" since it remains one of the few places the British have not switched over to mercenaries. The Turkish/Bulgarian border situation is tense but stable. Cyprus is once again split between Greek- and Turkish-backed factions, and a low-level civil war continues. Spain faces an increasing insurgency in the Basque portions of the country, although the Catalans have remained quiet. The Scandinavian countries are free of internal minority strife, but occasional disturbances attributed to Libyan troublemaking occur.

Africa: The Mali/Burkina Faso War, the Second Nigerian Civil War, and the Cabinda War continue. Morocco and Mali continue to face Polisario insurgencies. The countries of Central Africa are in severe civil disorder due to the recession and the devastation of AIDS. The black/white coalition government of South Africa continues to experience antigovernment violence. Libyan-backed insurgents continue to trouble Chad. Minor antigovernment coalitions exist in Mozambique, Sudan, Somalia, Liberia, Gabon, and Cameroon.

Asia: Vietnam is still troubled by minor bodies of Yunnanese troops that hold out in the northern portion of the country. Pakistan and Iran face Baluchi independence forces. Minor Islamic fundamentalist violence continues in Central Asia. Lebanon is divided along much the same lines as during the last decade. Israel is an armed camp, facing the continued hostility of the Palestinians from within and a continuing (but slightly diminished) threat from most of its neighbors. Israeli forces still make occasional forays into Lebanon.

The Pacific: The civil wars in Indonesia and the Philippines continue. The Tongan coup was successful, but the situation there is far from stable. A Japanese border dispute with the Soviets over Sakhalin and the Kurile Islands has yet to result in military action. Other Pacific countries are stable but suffer from the global recession.

CHARACTER GENERATION

Merc: 2000 uses the standard **Twilight: 2000** character generation system presented on pages 16 to 51 of the basic game rules book to create mercenary characters. A few minor differences will be explained in this section. Terms used in both **Twilight** and **Merc** are defined in the former, and players and referees will need to be familiar with **Twilight** before attempting to play **Merc**.

OVERVIEW

The primary difference between **Twilight** and **Merc** is that in the latter a global war did not break out in 1996. Instead, each character may have experienced one or more smaller wars (or not, depending on nationality) as a preliminary to a career as a professional soldier or merc. Players may end the character generation sequence at the end of any term and begin their merc career. Characters need not have been in the military to become mercenaries, although it will be helpful.

The rule sections in **Twilight** headed Die-Rolling Conventions, Military Careers, Rank, Arm of Service, Secondary Activities, Reserves, Obtaining Skills, Languages, Additional Notes on Skills, Initiative, and Age also apply to **Merc**. Other rules have changed somewhat, and this section discusses those differences.

CONTACTS

Contacts are acquired in the same way as in the basic game, but have a slightly different meaning. Instead of the contact representing a prewar occupation, it represents a current one. Any contact can lead to jobs, but contacts can prove directly useful to a merc. Need details of the power system in Alma Ata? Get in touch with your old pal at Georgetown University. Need a short biography of a drug kingpin? Try your pal who's now with the *Washington Post*. Need a double who's a dead ringer for the dictator of Parador? Doesn't your old buddy the actor—the guy who's starving doing dinner theater in Arizona—look a little like....

WELCOME TO THE LIFE

Merc is about close combat. What happens in between missions should not be dwelt upon in any great detail. Any background embellishments that the players choose to add (wife, kids, mortgage, etc.) are nice, but players and referees alike should keep in mind what the ultimate purpose is.

Groups who wish their characters to have between-mission lives may do so, and may even have those lives impinge on missions (after all, what better mission motivator can there be but "They got my *kid!*"), but we will provide no detailed rules for this.

Only one aspect of the between-mission life of the characters will be dealt with: lifestyle. Lifestyle is important in determining the type of job offers a character receives, and will be discussed more fully beginning on page 48.

RADS

Nuclear weapons have not been used in any of the wars in **Merc**, so players and referees should ignore the provisions of these rules.

EQUIPMENT

Characters in **Merc** do not automatically start the game with any items of equipment or with vehicles. Military characters are allowed their basic bad minus weapon(s). Everything else must be purchased.

Buying Equipment: Unlike in **Twilight**, characters in **Merc** can actually purchase equipment, but some types (particularly weapons) will be hard to come by. High-priced or extremely rare items may be provided by a patron (in which case the contract will specify penalties for loss or damage of such equipment).

Prices: Prices in **Merc** are radically different from in **Twilight**. The prices in **Twilight** were set on the basis of the value the item had in the world situation of the game, with considerations as to an item's relative availability. In **Merc**, current market prices apply in most cases. A new price list has been provided (pages 108-114) including both the new items of equipment discussed in this book and the old ones from the basic game, with proper adjustments made.

The availability code on the price entry now means without/with proper contacts, since some items are difficult to find without help (most governments take a dim view of private citizens—and mercs are just that—owning tanks, surface-to-air missiles, mortars, and the like). The same Equipment Availability Table (from **Twilight** page 224) may be used, but the referee should exercise reasonable judgment in applying its results: Obviously, T-72 tanks are not going to be available in every major city.

Contacts: The type of contact needed for purchase of a particular type of equipment varies.

The contact types and their relevant equipment types are discussed below. Some types of contact are not particularly useful in obtaining equipment (entertainment, for example, or journalist), and have been omitted. Contacts have certain requirements that must be met in order to remain on good terms. Buying tanks using a British government contact and then using them contrary to British interests will destroy any good relations between the contact and the character. Some referee discretion should be exercised here: Obviously, nobody will care about innocuous items like skis or radbs. Here's a short rundown on what the various types of contact can provide help with:

Business: Business contacts can help locate civilian weapons and explosives, body armor, specialized electronic equipment, military vehicles except IFVs and AFVs, and any forged document. Equipment cannot be used contrary to the contact's interests (defined by the referee), and equipment may be of any nationality.

Criminal: Criminal contacts can help locate civilian weapons and explosives, body armor, military small arms, forged documents, backpick tools, any civilian vehicle and any military unarmed cargo vehicle. There are no restrictions on use, and equipment may be of any nationality.

Government: Government contacts can help locate military weapons and explosives, body armor, military vehicles of all types, and specialized electronic equipment, providing that these items will not be used against the contact's government. Equipment may be of any nationality.

Intelligence Community: Intelligence community contacts can help locate military weapons and explosives, body armor, military vehicles of all types, and specialized electronic equipment, providing that these items will not be used against the best interests of the contact's agency. Equipment may be of any nationality.

Law Enforcement: Law enforcement contacts can help locate civilian weapons, body armor, backpick tools, gas masks and incapacitating chemicals, and specialized electronic equipment, provided that the items are to be used outside the contact's jurisdiction. Equipment may be of any nationality.

Medical: Medical contacts can help locate medical supplies. There are no restrictions on use.

Military: Military contacts can help locate mili-

tary small arms, body armor, specialized electronic equipment, and explosives, provided that they will be used outside of the contact's country. The equipment is limited to the nationality of the contact.

Specialist: The precise equipment provided by specialist contacts will depend on their specialty. Some will have none, engineers will help with explosives, and so on. Any restrictions are a matter for the referee's judgement.

Wealthy: Wealthy contacts can help locate civilian weapons and explosives, body armor, military small arms, forged documents, lockpick tools, any civilian vehicle and any military unarmed cargo vehicle. There are no restrictions on use, and equipment may be of any nationality.

As a rule of thumb, the more valuable and/or dangerous an item, the tougher it should be to get.

Money: Characters begin the game with money in the usual way, representing what the characters have managed to save in their various prewar careers. The amount of money received for each career differs, however.

NEW MILITARY OCCUPATION

The following additional career is available.

Counterterrorist, Enlisted and Officer

Entry: At least one term in special forces, Marine force recon or Navy SEAL.

First Term Skills:

- Small Arms: 2
- Parachute: 1
- Melee Combat: 1

Subsequent Term Skills: A total of four levels from any one or a combination of the

following:

- 1 • Small Arms
- 2 • Melee Combat
- 3 • Heavy Weapons
- Thrown Weapon
- 5 • Observation
- Stealth
- 7 • Lockpick
- 8 • Disguise
- 9 • Instruction
- 10 • Parachute
- 11 • Language
- 12 • Medical
- Interrogation
- Leadership

Contacts: Two per term, military or intelligence community. Roll 1D10 for 7+ for the contact to be foreign.

Special: None.

Mercenary Terms and Expressions

These are in addition to the list of military terms and expressions provided in the basic game.

Artichoke Suit: A nickname applied to the brown and green "woodland" BDU.

BDU: Battle dress utility. The current issue "fighting suit" of the United States Army.

Black Bag Job: A mission requiring a stealthy arrival and departure, leaving no trace of the team's presence. This term usually refers to industrial espionage operations rather than combat missions.

Buy the Farm: To die in action, also abbreviated to "buy it."

Camies: Camouflaged clothing.

Chocolate Chip Suit: A nickname applied to the tan and dark brown "desert" BDU.

Crease: To wound, as in, "We only creased him, and it just made him mad."

Flash-Bang: A stun grenade, especially one designed to temporarily blind as well as incapacitate. Also called "crash-bangs."

Grease: To kill or to die, as in, "Anything you do can get you greased, including doing nothing."

Hush Puppy: A nickname applied to the US Navy Mk-22 silenced pistol. This 9mm Parabellum weapon is specially built by the firm of Smith & Wesson (which calls it the S&W Model 0). The nickname comes from the original purpose of the weapon, which was to silence guard dogs.

Job: A mission.

Le Baroud: A French phrase translating roughly as 'the last stand' or 'the good fight,' used idiomatically to mean the mercenary way of life. Its equivalent in English is 'the life.'

LZ: Landing zone for a parachute drop or helicopter insertion. A "hot LZ" is one that is close to action, in which soldiers can expect little or no time to unpack gear (meaning they must drop with weapons at the ready). A "cool LZ" is one where no enemy action is expected.

Meat: Hostage or other person to be rescued or picked up. Also called 'the package,' 'the freight,' 'the goods,' and 'the cargo.'

Merc: A mercenary. By 2000, the term "soldier of fortune" is used only by news anchors and adventure novelists.

Mike Force: Originally used in Vietnam to denote special forces-trained reserve mobile strike force units, the term is now used to indicate any reserve or relief force.

New Shoe: Applied to mercs who have not been on at least one mission with their present team.

Newbie: An inexperienced soldier.

No Comebacks: Without a trace. A job completed with no comebacks is one completed without the patron's connection to the job being revealed.

Tackline: A useless or incompetent person, used originally by US Navy SEALs. A tackline, in naval parlance, is a piece of rope between two signal flags, or (more informally) "a tackline is six feet of nothing."

Tiger Stripes: A type of camouflage pattern, characterized by sharp irregular horizontal stripes across a light background. Very popular in many Third World "elite" units,

SOF: Soldier of fortune. A poetic name for a mercenary. In 2000, it is used only in novels, in newscasts and by wannabees.

Strikers: Local troops trained for penetration missions or as mobile reserve forces. They are usually better quality troops than run-of-the-mill garrison units. Originally used in conjunction with special forces-trained native mobile reserve (mike force) units in Vietnam.

Ticket: Mission or specific assignment. Used only in novels and in the press.

Tweep: Slang pronunciation of TWEPE, an acronym for 'terminate with extreme prejudice,' meaning to assassinate. Originating with the CIA in the 1960s, by 2000 the term is used only in novels and movies.

Wannabee: An aspiring merc, usually (but not always) without the talent.

Wet Job: An assassination. The name comes from an old KGB euphemism, 'to wet the ground (with blood).'

Wet Jump: A parachute landing or helicopter insertion into water.

Wet Landing: See wet jump.

Willie Peter: White phosphorus, either in a grenade or in other ordnance. The name comes from the letters WP used as an identifying mark on such weapons.

EQUIPMENT LIST

The merc trade has its own special tools. Here are representative examples of items not dealt with in **Twilight**.

EXPLOSIVES

The following are additional explosives.

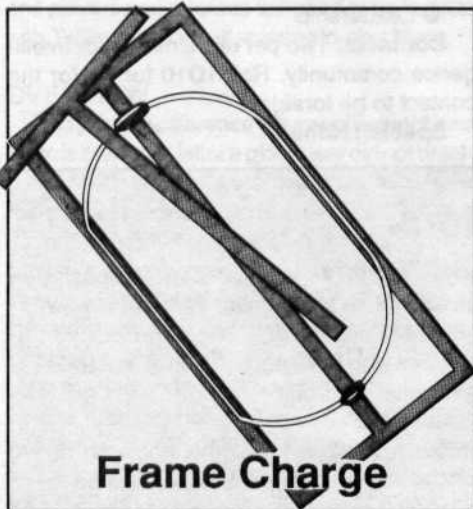

Frame Charge: A prepared explosive charge used to blow in locked windows or doors, even those equipped with bars or metal plate up to two centimeters thick. It requires two phases (10 seconds) to em place (using prefitted double-sided tape or an integral wooden brace), and can be command or remotely detonated, or rigged with a timer. The charge can also be used to blow holes in walls, provided they are not too thick. The frame charge has a penetration value of 2, but automatically counts as tamped and has only a concussion value of 1 due to the shape and composition of the charge.

Wt: 2 kg.

Price: \$100 (—/R).

Primercord: A rope-like plastic explosive used in various demolition jobs. Primercord can be wrapped around conduits or small girders to sever them or taped to a wall (in a circle) to blow an entry hole. It can also be used to link other explosive charges together for almost instantaneous detonation (it will detonate other explosives by itself, without need for a blasting cap). Primercord itself requires a blasting cap. Primercord has a DP value of 3 per meter

Wt: 0.5 kg per meter.

Price: \$15 per meter (—/C).

BODY ARMOR

The following is additional body armor.

Close Assault Armor: Improved, but bulky, body armor incorporating additional layers of Kevlar and metal/ceramicplate inserts. It protects chest and abdomen with an armor factor of 2. Because of this armor's bulk, wearers may not move faster than a trot, and all tasks become one level more difficult.

Wt: 6kg.

Price: \$1200 (—/S).

ELECTRONICS

The following are additional electronic devices.

Portable Satellite Downlink Subsystem:

An antenna system permitting radio communication via geosynchronous satellite with practically any location in the world when linked into a proper radio in place of the normal antenna. It requires five minutes to erect and align, and two minutes to completely dismantle.

Wt: 4kg.

Price: \$12,000 (R/S).

Portable Facsimile Machine: Connected to a radio, this enables recon photos, situation maps and other reports to be sent and received by units in the field.

Wt: 6kg.

Price: \$1800 (C/C).

Scrambler/Descrambler: Used with a telephone or voice radio unit, this scrambles conversation to seemingly random noise at the transmitter and back to conversation at the receiver. A sophisticated computer analysis can descramble a particular conversation within hours and, once the scramble pattern is known, can be used to program a scrambler with a similar pattern.

Wt: 1 kg.

Price: \$2000 (R/S).

Frequency-Hopping Radio: This radio resists jamming and interception by shifting among several preset frequencies at preset intervals. Unless a listener knows the frequencies and intervals, he cannot remain locked onto the signal. All sets in a system must be synchronized in order to communicate.

Wt: 10 kg.

Price: \$800 (R/S).

Individual Tactical Radio: A small radio

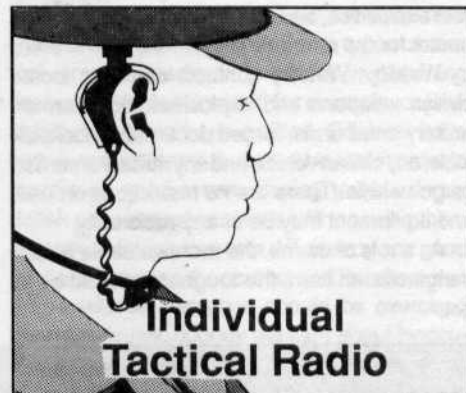

of limited range (one kilometer) designed to be used by small groups who require precise coordination and hands-free operation.

The radio consists of a voice activated throat mike (strapped in place over the larynx), a headset with bone-conduction earphones, and a battery case (usually carried in a shirt pocket). This radio is hands-free and allows the wearer to hear more-or-less normally when in use. The set also incorporates a manual "beeper" button, enabling Morse signals to be sent if the sender does not want to speak. These are relatively sophisticated radios and are more expensive than the normal walkie-talkie.

Wt: 0.5 kg.

Price: \$550 (S/R).

Transponder: Special radio transmitter designed to broadcast a specific signal at a specific frequency to provide a homing beacon for pickup aircraft, radiation homing missiles, etc. The device has a one-kilometer range without an antenna, which extends to 10 kilometers with an antenna. Its internal battery will power the broadcast for 18 hours and can be started with an internal timing circuit up to 72 hours after emplacement.

Wt: 1 kg.

Price: \$1800 (S/C).

Radio Direction Finder: A specialized radio receiver designed to determine the specific direction a particular radio broadcast is coming from. These are useful for a variety of tasks. Getting a directional fix using one of these is a task (Easy: Electronics) and requires one minute (provided that the signal stays on the air that long). The result is a compass bearing, not a distance. Two or three such RDF units, spaced far apart, can

get two or more bearings for triangulation of a broadcast source.

Wt:2kg.

Price: \$1500 (C/C).

Directional Microphone: Also called a "shotgun mike," this device permits the user to electronically "eavesdrop" on normal conversations at ranges of up to 500 meters. It functions off an internal battery, and requires 30 seconds to set up and tune.

Wt:5kg.

Price: \$3000 (C/C).

SIGNAL GEAR

The following is additional signal gear.

Signal Flare: A hand-launched pyrotechnic signal available in various colors (white, red, green, yellow, or violet), designed primarily for use at night (when colored smoke is harder to see). Each flare is launched skyward (using an internal propelling charge) and drifts to the ground on a small parachute. The flare burns for one turn (30 seconds) and can be seen from 1500 meters at night (500 meters during the day). By disabling the propelling charge before ignition, the flare can be placed on the ground if desired. It is hot enough to serve as a source of ignition.

Wt:0.2kg.

Price: \$25 (C/V).

Colored Smoke Grenade: This grenade produces a dense cloud of colored smoke without the high heat characteristic of WP grenades (although it is still hot enough to ignite easily combustible substances like dry grass, so care is needed in its use). The color of the cloud depends on the chemical contents (red, green, yellow, or violet are available) and is indicated by a colored band around the outside of the grenade. The smoke is of the same size and duration as that of an HC smoke cloud, described on page 201 of the **Twilight: 2000** rules. Smoke cannot be seen at night unless illuminated.

Wt: 0.5 kg.

Price: \$30 (R/S).

Illuminating Grenade: This grenade produces a bright light (equivalent to full daylight within the burst radius). It produces enough heat to be a source of ignition and should be used with care. Illumination grenades have the same characteristics as chemical grenades (described in the **Twilight** basic rules).

Wt:0.5kg.

Price: \$25 (—/S).

Shotgun Flare: These are designed for use in 12-gauge shotguns and can only be launched (they cannot be ignited and laid on the ground). They are otherwise identical to signal flares. They are in civilian use as distress signals for sportsmen.

Wt.0.1 kg.

Price: \$5 (R/S).

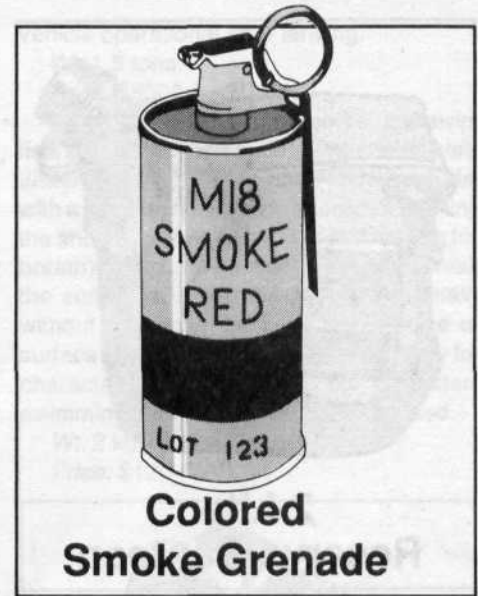
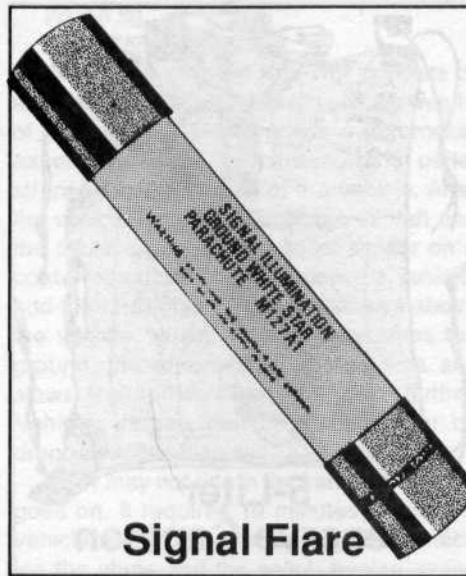



**2-Liter
Reserve Canteen**



**5-Liter
Reserve Canteen**

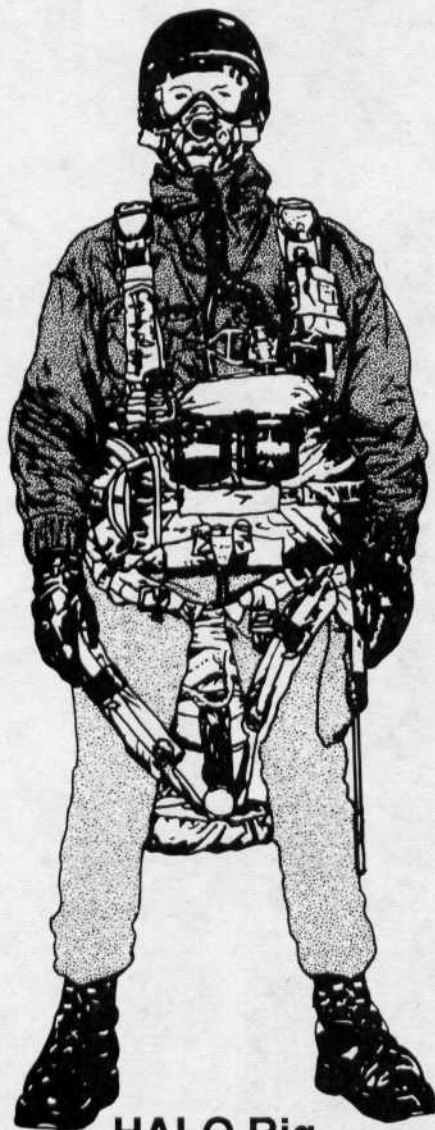

HALO Rig



Assault Suit

MISCELLANEOUS EQUIPMENT

The following is miscellaneous gear.

1-liter Canteen: Self explanatory. Canteens are not intended to serve as a soldier's only water supply, but they are just that for soldiers on special missions of the type described in **Merc: 2000**. Because of this, characters may wish to carry two or more.

Wt: 1 kg (loaded).

Price: \$10 (V/V).

2-liter Reserve Canteen: This is a large-capacity reserve water supply, attached to the outside of a field pack or slung on a strap.

Wt: 2 kg (loaded).

Price: \$25 (V/V).

5-liter Reserve Canteen: This is a larger reserve water supply, usually carried inside a field pack or slung on a strap.

Wt: 5 kg (loaded).

Price: \$30 (V/V).

HALO Rig: HALO stands for high-altitude, low-opening, and refers to a particular style of parachute drop. The parachutist leaves the plane at a great height (usually over 25,000 feet—high enough to require oxygen gear) and free-falls to a level below radar and visual observation height before opening. The HALO rig consists of a standard parachute, oxygen tank, face mask, insulated overgarment (it gets cold up that high) and altimeter.

Wt: 14kg.

Price: \$3500 (—/S).

Assault Suit: Special assault equipment intended for use on drug lab raids, hostage rescues, and other similar situations. The suit consists of a set of black fatigues, gloves, a Kevlar helmet (with integral individual tactical radio, a throat mike and bone conduction earphones), a gas mask, tactical web gear, and boots. Body armor and personal weapons must be purchased separately. Luminescent markings (such as "POLICE" or "DEA") are usually stenciled on the back for quick identification of friend or foe during dimly-lit firefights.

Wt: 8kg.

Price: \$1100 (—/S).

Skyhook (Ground Unit): A specialized ground/air pickup rig for extraction by aircraft when ground conditions do not permit a landing, which was originally designed for military and civilian air/sea rescue units. The ground unit consists of a personnel harness (very similar to a parachute harness), a coil of cable, and an inflatable helium balloon large enough to carry the cable several hundred feet into the air. The unit can be used for either personnel or cargo. Skyhook requires a specially modified multiengine aircraft, usually provided by the patron (few merc groups can afford to maintain them). Skyhook aircraft

will be detailed in a future handbook due to space constraints.

Using Skyhook: The passenger dons the harness, inflates the balloon (upon arrival of the pickup aircraft), and prepares himself for the shock of pickup. A specially modified cargo aircraft snares the balloon/cable with a specially fitted V-shaped "blimp-catcher" on its nose, and reels in the passenger until the passenger is close enough to a specially installed cargo door on the bottom of the aircraft. The aircrew snares the passenger/cargo, hauls him/it aboard the plane, and prepares for another pickup if necessary.

The shock involved is no more severe than an opening parachute, provided that the pickup aircraft does not fly too fast. The process is dangerous, but no more so than a parachute jump if done properly.

The pickup plane must fly straight and level a few hundred feet off the ground. The whole operation needs suitable terrain (no nearby obstructions) and reasonable privacy. The blimp can be equipped with IR/white light strobes (activated at the last moment) for a night pickup. The weather must be reasonably clear, with no excessive wind conditions. Skyhook can also be used at sea. A skyhook ground unit may not be reused.

Wt: 18kg.

Price: \$800 (—/R).

Silencer/Suppressor: A kit of parts which, when fitted to a firearm, reduces the sound of the discharge. Nothing can completely eliminate the sound of a weapon firing. There is always some sound, even from the best of silenced/suppressed weapons (if it's only the clack of the action and the click of the hammer falling). Weight and price below do not include the weapon. Price includes the cost of a gunsmith's modification. For all practical purposes, revolvers cannot be silenced.

Wt: 0.5 kg pistol, 1 kg SMG/rifle.

Price: \$1000(S/C).

Parachute: A device which allows a character to leap from a perfectly good aircraft and probably reach the ground intact. Includes main canopy, reserve canopy, and all necessary harnesses. If recovered, the parachute can be repacked and reused. A character may carry up to four times his normal load during a parachute drop (note, however, that he may not be able to carry it far on the ground).

Wt: 5kg.

Price: \$450 (C/C).

Paraglider (Steerable Parachute): A special form of parachute permitting the passenger to direct his descent more than is possible with a normal parachute. If recovered, the paraglider can be repacked and reused.

Wt: 16kg.

Price: \$650 (C/C).

Vehicle Parachute Kit: This consists of several parachutes (depending on the weight of the vehicle to be dropped), a retro rocket assembly, and a shock-absorbing pallet strapped to the bottom of the vehicle. After the vehicle is dropped from the aircraft and the chute deployed, a contact sensor on a cord drops three meters below the vehicle, and the retrorocket package deploys above the vehicle. When the sensor touches the ground, the retrorocket package fires and slows the vehicle's descent even further. Vehicles larger than 15 tons cannot be dropped in this fashion.

Crew may not ride in the vehicle while this goes on. It requires 10 minutes to make a vehicle operational after landing: disconnecting the chute and the pallet, freeing everything that had to be tied down for airtransport, screwing down everything that was jarred loose during the landing, and—last but not least—a quick inspection, which is not something to have to do in a hot LZ.

Wt: 1 ton.

Price: \$12,000 (—/R).

Vehicle Low-Altitude Extraction Kit: This consists of a drogue parachute and a shock-absorbing pallet strapped to the bottom of the vehicle. The aircraft must have a rear cargo ramp to utilize this kit. The aircraft flies at extremely low altitude (three to five meters) at minimum speed and deploys the drogue chute out the back. The drogue chute opens; the vehicle is yanked out of the aircraft; and the pallet absorbs most of the shock of landing. Vehicles larger than 25 tons cannot be dropped in this fashion.

Crew may not ride in the vehicle while this goes on. It requires 10 minutes to make a

vehicle operational after landing.

Wt: 1.5 tons.

Price: \$8000 (—/R).

Snorkel Gear: A mask, snorkel, and swim fins, permitting a character to swim completely underwater for periods of up to 30 seconds, with a minimum of surface interaction (pulling the snorkel below the surface and holding his breath). The character need only gently break the surface and can then breathe normally without making great amounts of noise or surface ripples. Spotting is done normally for characters on the surface, but characters swimming underwater cannot be spotted.

Wt: 2 kg.

Price: \$120 (V/V).

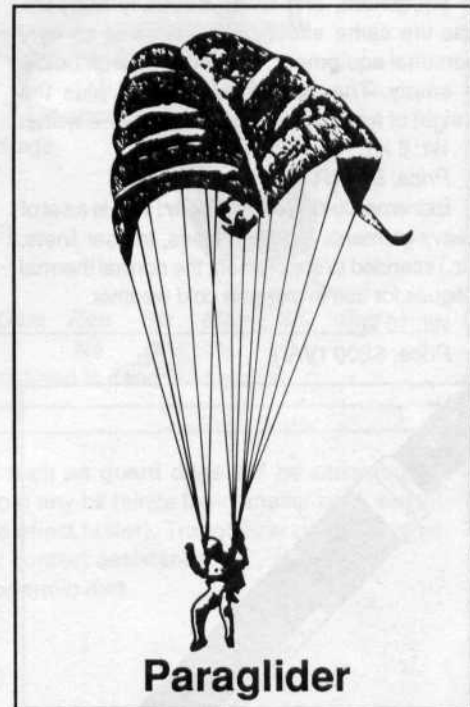

Paraglider

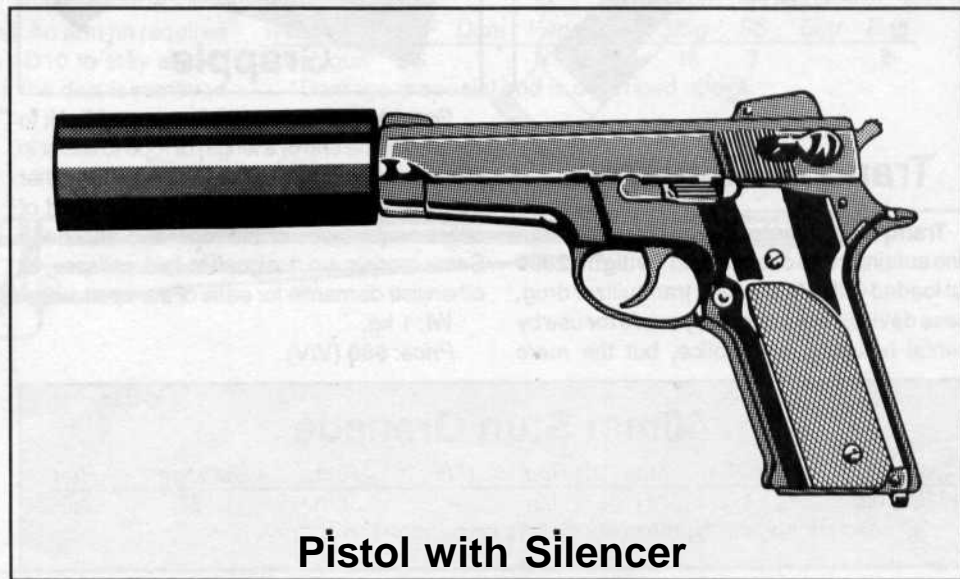

Pistol with Silencer

Underwater Carrier: A sealed container to transport weapons, ammunition and equipment underwater. This cylindrical containers 1.5 meters long and about 0.4 meter in diameter. It opens like a clamshell for ease of access, and contains several straps and lashing rings to secure gear inside. When sealed, the container will protect its contents from water damage. By inflating or deflating several internal flotation/ballast bladders, its buoyancy can be adjusted to enable it to float, sink, or be neutral (preferable for hauling gear long distances underwater). Pulling a lever will inflate several emergency bladders, making the banded container capable of supporting the weight of an average person as well.

The container can carry up to 50 kilograms of equipment, and when neutrally buoyant, has the same effect on a swimmer as light personal equipment. The weight given below is empty. The carrier weighs this plus the weight of any contents when out of the water.

Wt: 6 kg.

Price: \$85 (R/S).

Extreme Cold Weather Gear: This is a set of heavy garments (parka, mittens, trouser liners, etc.) intended to supplement the normal thermal fatigues for use in extreme cold weather.

Wt: 10 kg.

Price: \$200 (V/V).

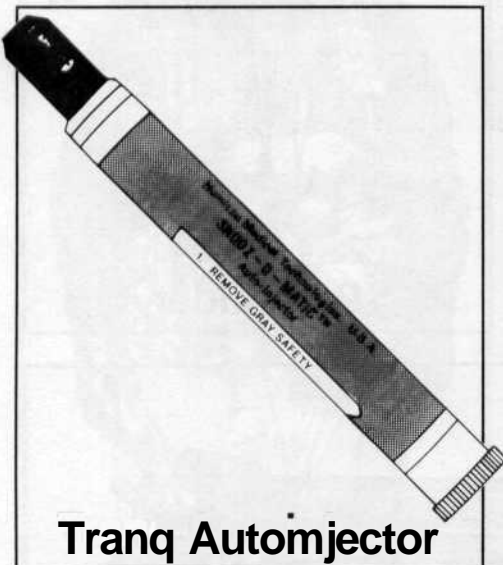

Tranq Autoinjector

Tranq Autoinjectors: Similar to the atropine autoinjectors described in **Twilight: 2000** but loaded with a fast-acting tranquilizer drug, these devices were originally made for use by mental hospitals and police, but the mere

trade soon adopted them. When applying one to an unresisting target (one surprised or subdued by unarmed combat), the user may choose the body part the injector is used on. Resisting targets must be subdued using unarmed combat before the injector can be applied.

As with tranq darts, a hit in any part of the body will be effective eventually, but some areas give faster results than others. Head hits result in instant unconsciousness. Chest and abdomen hits result in unconsciousness after 1 D6+2 phases (five to 15 seconds). An arm hit requires the target roll his Constitution or less on 1D10 to stay awake each phase. The drug will take effect even if the injector is removed immediately. Tranq autoinjectors also affect dogs in the same way as tranq darts.

Wt: 0.1 kg per set of three.

Price: \$75 per set of three (—/S).

Rope: This is milspec 11 mm climbing and rappelling line.

Wt: 5 kg per coil.

Price: \$100 per 50m coil (V/V).

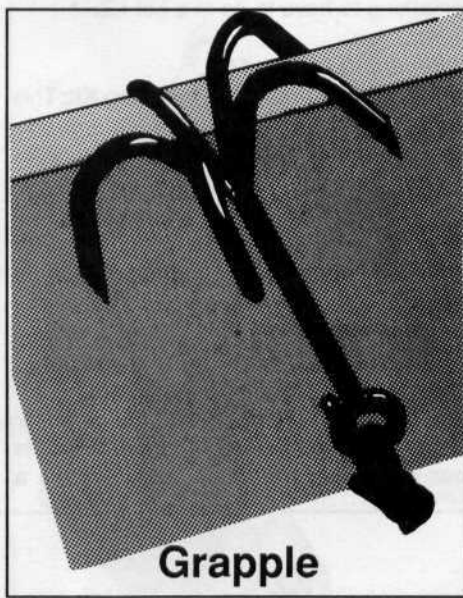

Grapple

Grapple: This is a multiple-pronged hook to be used at the end of a length of rope to assist in climbing walls, etc. It can be thrown as any other object, but counts as two kilograms instead of only one (because of the rope also attached). Some models are designed to fold, collapse, or otherwise dismantle for ease of transport.

Wt: 1 kg.

Price: \$60 (V/V).

NEW AMMUNITION

40mm Stun Grenade: This grenade can be fired from any single-shot launcher (it is too long for the Mk19). The grenade fires a nylon 'bean-bag' that fans out after firing to spread its impact over a wide area. The grenade is designed to incapacitate without doing permanent damage and has no explosive filler (and no concussion or fragmentation damage). Because of the grenade's design, all damage inflicted is blunt trauma, even if the target is Unarmored. The grenade can only be used in direct fire. See chart below.

Wt: 0.3 kg, 20 kg per case of 44.

Price: \$20 each, \$800 per case (—/S).

40mm Grapple Grenade: This grenade can be fired from any single-shot launcher (cannot be used in the Mk19) and propels a grappling hook and an attached rope up to 50 meters straight up. The grapple must be inserted separately into the front of the launcher.

Wt: 0.3 kg, 20 kg per case of 36.

Price: \$20 each, \$800 per case (—/S).

Flash-Bang or Crash-Bang Grenade: An enhanced concussion grenade designed to make a very loud noise and a bright flash in order to temporarily incapacitate its target. In addition to the normal concussion effects (described in the basic game) all characters within eight meters must make a D10 roll against their Constitution to avoid the other effects of the grenade, subtracting 1 from the die roll for each square (two meters) they are from the burst point. Failure means that the characters are incapacitated (flash-blinded, temporarily deafened, and disoriented) for 24 phases (2 minutes). Success means that the character is incapacitated for only one phase (five seconds).

Wt: 0.5 kg, 7 kg per case of 10.

Price: \$15, \$120 per case, (-/C).

15mm Dart/Cartridge: This is a hypodermic dart and compressed gas cartridge designed for use with the tranquilizer gun mentioned on page 19. The darts come prefilled with a tranquilizer compound. They must be fired from the gun in order to take effect. These cartridges count as medical equipment for contact assistance.

Wt: 0.1 kg (including dart, drug, and CO₂ cartridge).

Price: \$45 (including dart, drug, and CO₂ cartridge) (—/S).

9mm Subsonic: Specially made, low-velocity, 9mm ammunition designed for use in silenced pistols.

Wt: 0.6 kg per box of 50.

Price: \$45 per box (—/S).

Stun Dart Package: This includes a prebanded 15mm hypodermic dart and a CO₂ cartridge for propelling it from a tranquilizer gun. It counts as police equipment for contact assistance.

Wt: 1 kg per case of 10.

Price: \$50 (—/R).

40mm Stun Grenade

Type	ROF	Mag	Rng	IFR	Rnd	Damage	Pen
M203, etc.	1	1i	10	—	Stun	C:5*	Nil

*Contact damage only; the grenade has no burst radius.

S&W Model 0 (Mk-22)

The "Hush Puppy" is a silenced, 9mm, semiautomatic pistol specially manufactured for the US Navy (which calls it the Mk-22) by Smith & Wesson (which calls it the Model 0). Made of stainless steel (to resist saltwater-induced corrosion), it is fitted with an integral silencer and slide lock. When fired with the slide locked (to prevent the clank of the recoiling slide) using subsonic 9mm P ammunition, the only sound is the hammer dropping. The Mk-22 is thus a silenced weapon, rather than a suppressed one. With the slide locked, it can only be fired once, then the slide must be manually worked to eject the spent round and recock. The pistol comes with a special holster designed to hold the weapon with silencer affixed (included in the cost).

Ammo: 9mm P subsonic

Wt: 1.5 kg

Mag: 8 box

Price: \$900 (—/R)

Weapon	ROF	Dam	Pen	Blk	Mag	—Recoil—		
						SS	Brst	Rng
Mk-22	SA	1	Nil	1	8	3	—	8

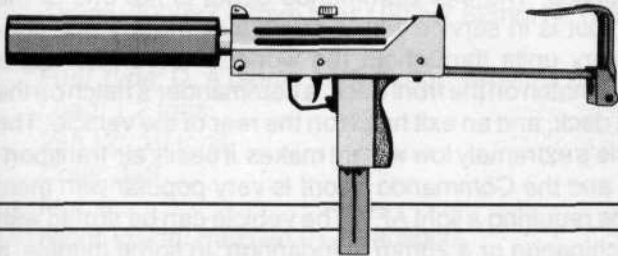

Stun Gun

A pistol-sized weapon used to stun rather than kill, the stun gun fires two small darts and two lengths of light wire into the target, then administers a mild electric shock. It doesn't always succeed in stunning the victim. With a successful hit anywhere on the target, that character immediately loses two Initiative levels and must roll versus his Constitution to stay conscious. Failure means the target loses consciousness for six phases (30 seconds). Reloading the stun gun consists of removing the expended dart package and loading a new one. The dart package contains a charged battery, darts, three meters of fine wire and a compressed gas cylinder to propel the darts.



Ammo: Dart package

Wt: 0.5 kg

Mag: 1i

Price: \$600 (R/S)

Weapon	ROF	Dam	Pen	Blk	Mag	—Recoil—		
						SS	Brst	Rng
Stun gun	SS	*	Nil	1	1i	1	—	1

'Damage is special and is described above.

Tranquilizer Gun

A specially made weapon designed to fire hypodermic darts containing a tranquilizer or other drug by means of compressed CO₂ cartridges. These were designed originally for administering drugs to dangerous animals, but the mere industry soon adopted them for its own purposes.

A hit in any part of the body will be effective eventually, but some areas give faster results than others. Head hits result in instant unconsciousness. Chest and abdomen hits result in unconsciousness after 1D6+2 phases (five to 15 seconds). An arm hit requires the target to roll his Constitution or less on 1D10 to stay awake each phase. The drug will take effect even if the dart is removed

immediately. Animals such as guard dogs will be rendered instantly unconscious from any hit (since their smaller body weight allows the drug to take effect faster). Tranquilizer guns count as medical equipment for contact assistance.

Ammo: 15mm hypodermic dart

Wt: 3 kg

Mag: 1i

Pr/ce: \$1200 (—/R)

Weapon	ROF	Dam	Pen	Blk	Mag	—Recoil—		
						SS	Brst	Rng
Tranq gun	SS	*	Nil	1	1i	3	—	8

'Damage is special and is described above.

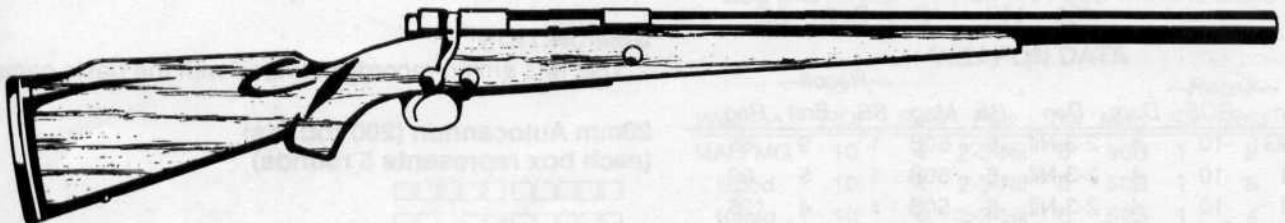

Commando Scout

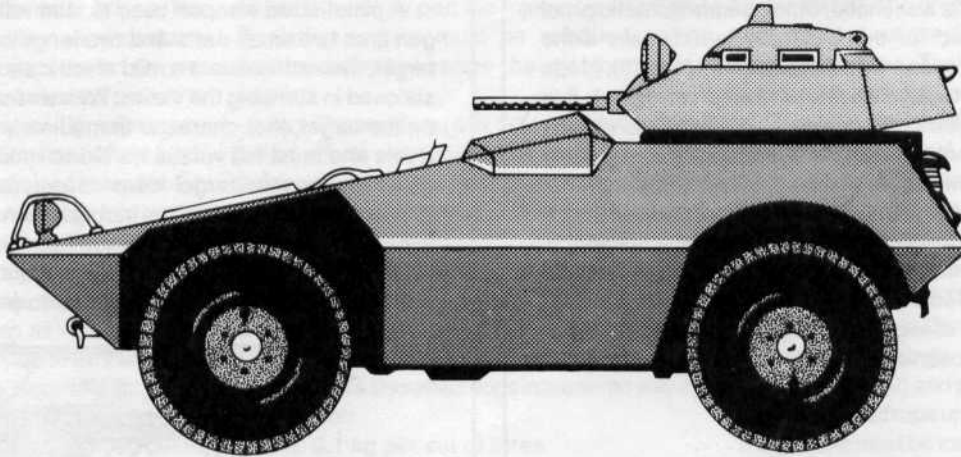

Price: \$40,000 (—/C)

RF: +3

Armament: MAG MG (coaxial), M2HB MG or 20mm autocannon

Ammo: 1260x.50 BMG or 200x20mm

Fuel Type: D, A

Load: 200 kg

Veh Wt: 6.5 tons

Crew: 2

Mnt: 7

Night Vision: Headlights

DAMAGE RECORD

Crewmembers: Commander/gunner Driver

Sight/Vision: Gun sight Range finder Night vision equipment

Radio:

20mm Autocannon or M2HB:

MAG MG (Coaxial):

Traverse:

Engine:

Fuel (% Consumed or Destroyed):

Suspension: Minor damage Immobilized

WEAPON DATA

Weapon	ROF	Mag	Rng	Ammo	Damage	Pen
20mm	60	100B	450	API	10	3/-2/-5
			450	HE	C: 1,B: 2	-8C

—Recoil—

Weapon	ROF	Dam	Pen	Blk	Mag	SS	Brst	Rng
MAG MG	10	4	2-3-Nil	6	50B	1	9	65
bipod	10	4	2-3-Nil	6	50B	1	5	90
tripod	10	4	2-3-Nil	6	50B	1	4	125
M2HB MG	5	8	2-2-3*	8	105B	3	14	65
tripod	5	8	2-2-3*	8	105B	2	7	150

*.50 SLAP ammunition has a penetration of 1-1-2.

Commando Scout (Light Combat Vehicle): The American firm of Cadillac Gage manufactures a number of vehicles for export, some of which have been picked up for US service. The 4x4 Commando Scout is not one of the latter, but is in service with a number of military and constabulary units throughout the world. The vehicle has a driver's hatch on the front deck, a commander's hatch on the turret deck, and an exit hatch on the rear of the vehicle. The vehicle's extremely low weight makes it easily air-transportable, and the Commando Scout is very popular with mere groups requiring a light AFV. The vehicle can be armed with a machinegun or a 20mm autocannon. In some models, a single remotely fired TOW II ATGM launcher is also mounted on the turret, or a 40mm autogrenade launcher such as the Mk19 may be fitted in place of the main armament.

Tr Mov: 180/120

Com Mov: 80/65

Fuel Cap: 208

Fuel Cons: 52

COMBAT STATISTICS

Config: Trt	TF:4	HF: 4
Susp: W(2)	TS:3	HS:3
	TR:3	HR:3

AMMUNITION

Use MG ammo records provided with the basic game.

20mm Autocannon (200 rounds)
(each box represents 5 rounds)

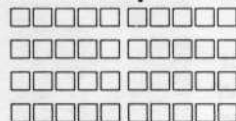

Commando V-150

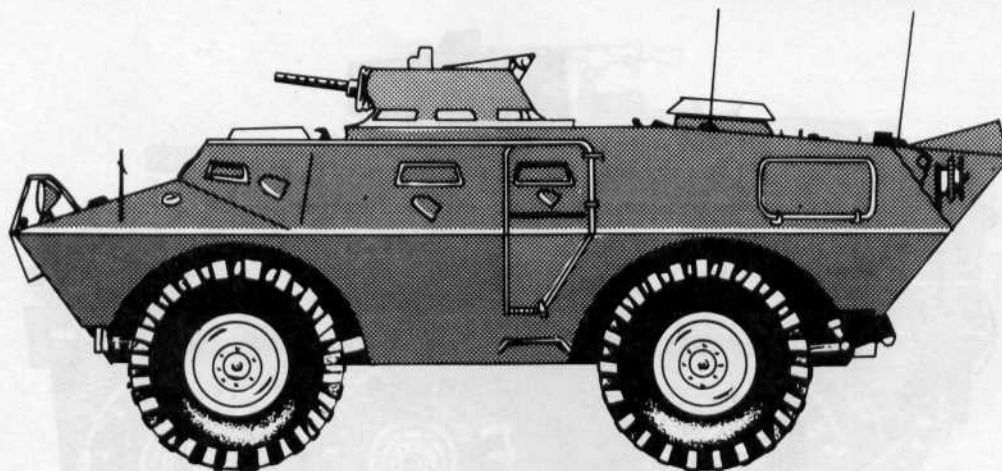

Price: \$250,000 (—/C)

RF: +1

Armament: Twin MAG MGs or MAG MG/M2HB MG

Ammo: 2000x7.62mm N or 1000x7.62mm N, 1260x.50

BMG

Fuel Type: D, A (some early export versions are G, A)

Load: 1.2 tons

Veh Wt: 10 tons

Crew: 3+9

Mnt: 6

Night Vision: Passive IR, headlights

Commando V-150 (Light Combat Vehicle): Produced by Cadillac Gage, the V-150 series of 4x4 wheeled APCs (adopted for service in the US Army) comes in several versions, the most common being an APC version, either with a machinegun turret as shown or with a pintle-mounted MAG MG. The 150 series is also available in mortar carrier (turret is removed and replaced with deck hatches), 20mm autocannon, and 90mm gun versions (using the low-pressure gun turret from the V-300). The vehicle is fully amphibious at one-fourth its cross-country speed. The vehicle has two side doors, and an exit hatch on the rear deck.

DAMAGE RECORD

Crewmembers: Commander Driver Gunner

Passengers: 1 2 3 4 5 6 7 8 9

Sight/Vision: Night vision equipment

Radio:

Machineguns: L R

Traverse:

Engine:

Fuel (% Consumed or Destroyed):

Suspension: Minor damage Immobilized

Tr Mov: 120/95

Com Mov: 80/65

Fuel Cap: 300

Fuel Cons: 75

COMBAT STATISTICS

Config: Trt TF:3 HF:4

Susp: W(3) TS:3 HS:3

TR:3 HR:3

AMMUNITION

Use MG ammo records provided with the basic game.

WEAPON DATA

—Recoil—

Weapon	ROF	Dam	Pen	Blk	Mag	SS	Brst	Rng
MAG MG	10	4	2-3-Nil	6	50B	1	9	65
bipod	10	4	2-3-Nil	6	50B	1	5	90
tripod	10	4	2-3-Nil	6	50B	1	4	125
M2HB MG	5	8	2-2-3*	8	105B	3	14	65
tripod	5	8	2-2-3*	8	105B	2	7	150

*.50 SLAP ammunition has; a penetration Of 1-1-2.

Commando V-300 TUA

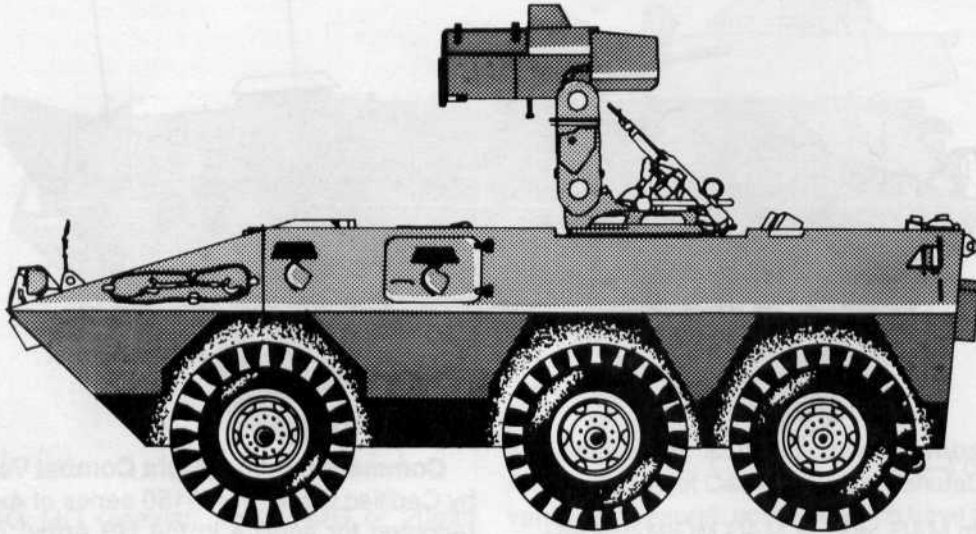

Price: \$350,000 {—/S}

RF: +2

Armament: Twin TOW ATGM launcher

Capacity: 10xTOW ATGM

Fuel Type: D, A

Load: 400 kg

Wt: 12 tons

Crew: 4

Mnt: 6

Mg/Ws/on: Passive IR, headlights

DAMAGE RECORD

Crewmembers: Commander Driver Gunner Loader

Sight/Vision: Gun sight Range finder Night vision equipment

Radio:

TOW ATGM Launcher:

Traverse:

Engine:

Commando V-300 TUA (Light Combat Vehicle): The V-300 series is a 6x6 wheeled armored vehicle manufactured by Cadillac Gage, but was not adopted by the US Army. The antitank TUA (TOW under armor) version is one of two TOW versions; the other has a single TOW launcher on a nonturreted pintle mount. The V-300 is fully amphibious at one-quarter its cross-country speed. The vehicle has two side doors and a rear exit ramp, plus a commander's hatch in the middle of the top deck fitted.

Tr Mov: 120/95

Com Mov: 80/65

Fuel Cap: 284

Fuel Cons: 71

COMBAT STATISTICS

Config: Trt TF: 6

HF: 6

Susp: W(3) TS: 4

HS: 4

TR: 4

HR: 3

AMMUNITION

TOW (10 missiles)

□□□□□□□□□□

WEAPON DATA

Type	Rid	Rng	Damage	Pen
TOW II	2	3500	C:12, B:12	160C
TOW IIC	2	3500	C:12, B:12	160C

Commando V-300 CS

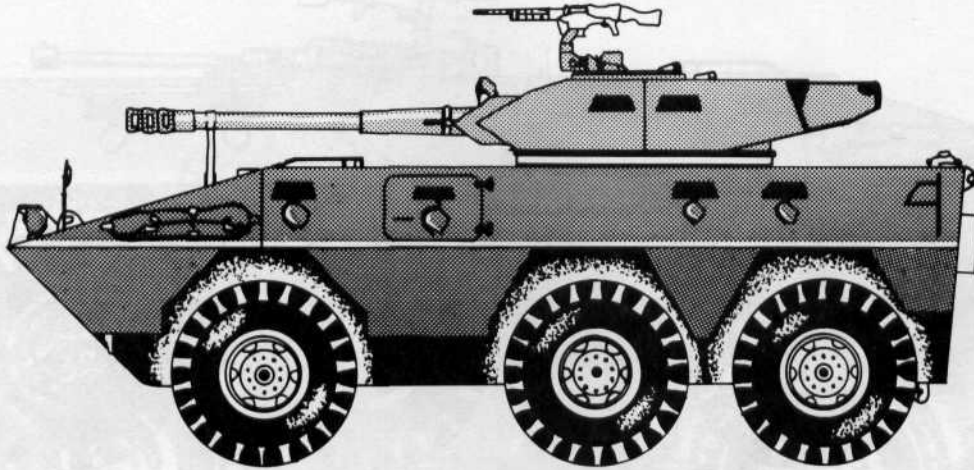

Price: \$350,000 (—/S)

RF: +2

Armament: 90mm gun, MAG MG coaxial, M2HB MG or MAG MG (C)

Ammo: 44x90mm gun

Fuel Type: D, A

Load: 400 kg

Veh Wt: 12 tons

Crew: 4

Mnt: 6

Night Vision: Passive IR, headlights

DAMAGE RECORD

Crewmembers: Commander Driver Gunner Loader

Sight/Vision: Gun sight Range finder Night vision equipment

Radio:

MAG MG (Coaxial):

MG (C):

90mm Gun:

Traverse:

Engine:

Fuel (% Consumed or Destroyed):

Suspension: Minor damage Immobilized

WEAPON DATA

—Recoil—

Weapon	ROF	Dam	Pen	Blk	Mag	SS	Brst	Rng
MAG MG	10	4	2-3-Nil	6	50B	1	9	65
bipod	10	4	2-3-Nil	6	50B	1	5	90
tripod	10	4	2-3-Nil	6	50B	1	4	125
M2HB MG	5	8	2-2-3*	8	105B	3	14	65
tripod	5	8	2-2-3*	8	105B	2	7	150

*.50 SLAP ammunition has a penetration of 1-1-2.

Commando V-300 CS (Light Combat Vehicle): The V-300 series is a 6x6 wheeled armored vehicle manufactured by Cadillac Gage, but it was not adopted by the US Army. The CS (combat support) version with a 90mm gun is shown. The V-300 is fully amphibious at one-quarter its cross-country speed. The vehicle has two side doors and a rear exit ramp, plus a commander's hatch atop the turret.

Tr Mov: 120/95

Com Mov: 80/65

Fuel Cap: 284

Fuel Cons: 71

COMBAT STATISTICS

Config: Trt	TF: 6	HF: 6
Susp: W(3)	TS: 4	HS: 4
	TR: 4	HR: 3

AMMUNITION

Use MG ammo records provided in the basic game.

90mm Gun (44 rounds)

WEAPON DATA

Type	Round	Rng	Damage	Pen
90mm	APDS-T	350	24	30/25/20/15
Rid: 1	HEAT	350	C:5, B:10	60C

Commando V-300 APC

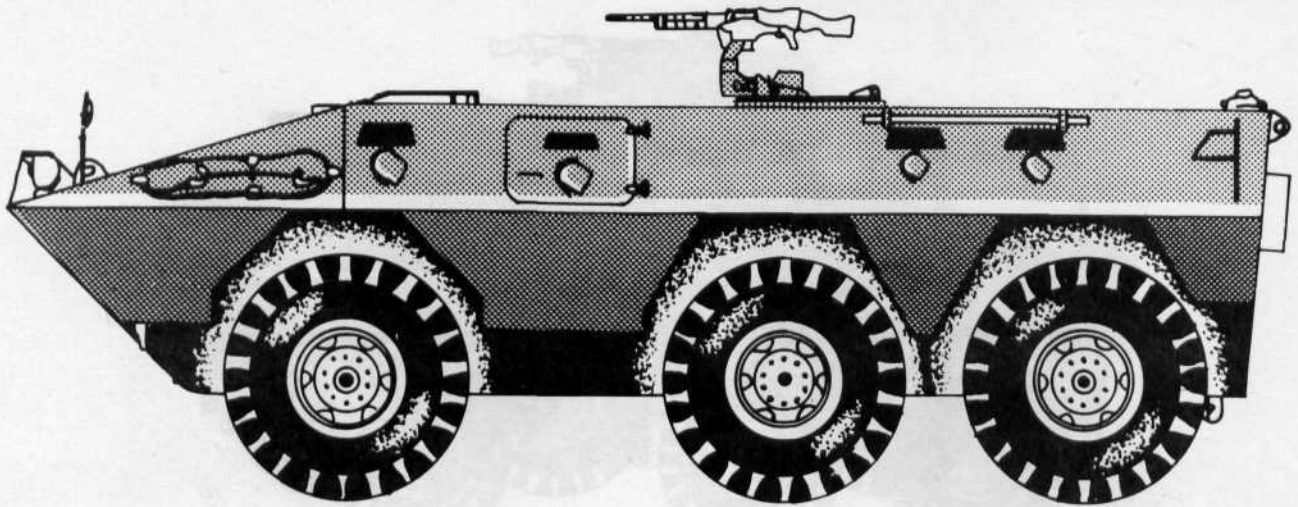

Price: \$350,000 (—/S)

RF:+2

Armament: M2HB MG or MAG MG

Ammo: 1260x.50 BMG or 1200x7.62mm N

Fuel Type: D, A

Load: 1.2 tons

Veh Wt: 12 tons

Crew: 2+10 (turreted versions 3+9)

Mnt: 6

Night Vision: Passive IR, headlights

DAMAGE RECORD

Crewmembers (Unturreted): Commander/gunner Driver

Crewmembers (Turreted): Commander Driver Gunner

Passengers (Unturreted): 1 2 3 4 5 6 7

8 9 10

Passengers (Turreted): 1 2 3 4 5 6 7 8

9

Sight/Vision: Night vision equipment

Radio:

MG:

Traverse (Turreted Versions Only):

Engine:

Fuel (% Consumed or Destroyed):

Suspension: Minor damage Immobilized

Commando V-300 APC (Armored Personnel Carrier): The APC version (illustrated) is normally fitted with a pintle-mounted MAG or M2HB MG, a light power turret incorporating twin machineguns (either MAG or an M2HB/MAG combo) or a 25mm autocannon (same as on the M2 Bradley series). Other armaments include a 40mm GL turret (same as that on the AAVP7A), an air defense version with a turret-mounted 20mm autocannon, and an open-topped 82mm mortar version. The V-300 APC is fully amphibious at one-quarter its cross-country speed.

Tr Mov: 120/95

Com Mov: 80/65

Fuel Cap: 284

Fuel Cons: 71

COMBAT STATISTICS

Config: Trt TF: 6 HF: 6

Susp: W(3) TS: 4 HS: 4

TR: 4 HR: 3

AMMUNITION

Use MG ammo records provided in the basic game.

WEAPON DATA

Weapon	ROF	Dam	Pen	Blk	Mag	—Recoil—		
						SS	Brst	Rng
MAG MG	10	4	2-3-Nil	6	50B	1	9	65
bipod	10	4	2-3-Nil	6	50B	1	5	90
tripod	10	4	2-3-Nil	6	50B	1	4	125
M2HB MG	5	8	2-2-3*	8	105B	3	14	65
tripod	5	8	2-2-3*	8	105B	2	7	150

*.50 SLAP ammunition has a penetration of 1-1-2.

EE-3 Jararaca

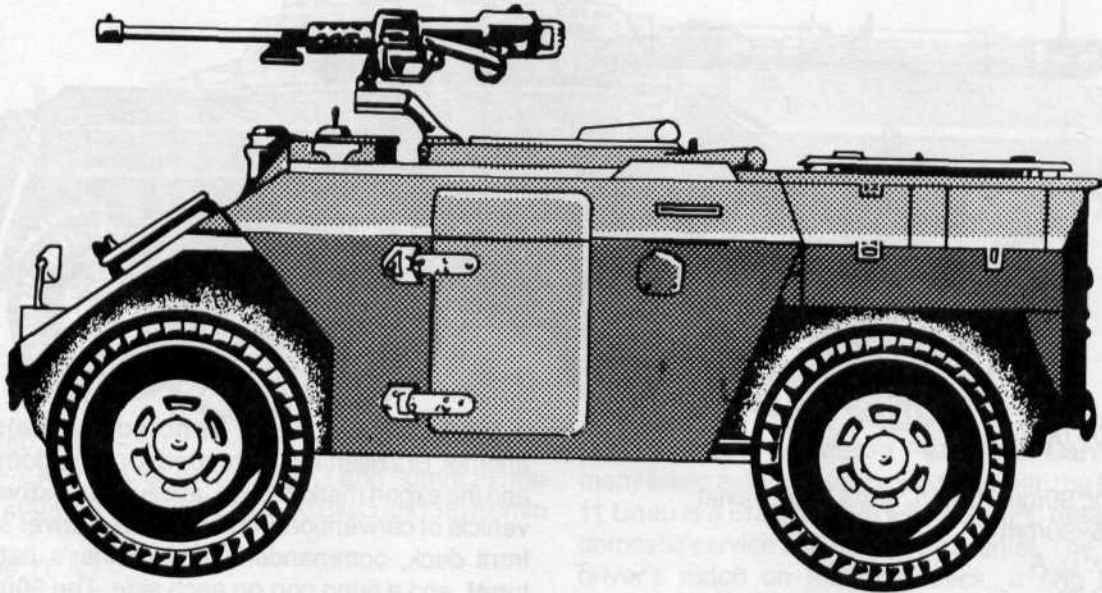

Price: \$200,000 (—/S)

RF:+1

Armament: M2HB MG (C)

Ammo: 1260x.50 BMG

Fuel Type: D, A

Load: 300 kg

Veh Wt: 5.5 tons

Crew: 3

Mnt: 6

Night Vision: Passive IR, headlights

DAMAGE RECORD

Crewmembers: Commander Driver Gunner

Sight/Vision: Night vision equipment

Radio:

M2HB MG (C):

Engine:

Fuel (% Consumed or Destroyed):

Suspension: Minor damage Immobilized

EE-3 Jararaca (Light Armored Vehicle): The Jararaca is a Brazilian 4x4 recon vehicle in service with a number of armies worldwide. The vehicle comes with a ring mount (NHT equivalent) to which an M2HB MG is usually fitted at the front deck hatch (C). The vehicle has two side doors and a rear deck hatch for crew access. Variant armaments include a 20mm autocannon, a 60mm gun/mortar, and a Milan ATGM launcher.

Tr Mov: 180/120

Com Mov: 90/50

Fuel Cap: 135

Fuel Cons: 35

COMBAT STATISTICS

Config: Trt TF: 4 HF: 4

Susp: W(3) TS: 3 HS: 3

TR: 3 HR: 2

AMMUNITION

Use MG ammo records provided in the basic game.

WEAPON DATA

Weapon	ROF	Dam	Pen	Blk	Mag	—Recoil—		
						SS	Brst	Rng
M2HB MG	5	8	2-2-3*	8	105B	3	14	65
tripod	5	8	2-2-3*	8	105B	2	7	150

*.50 SLAP ammunition has a penetration of 1-1-2.

EE-9 Cascavel

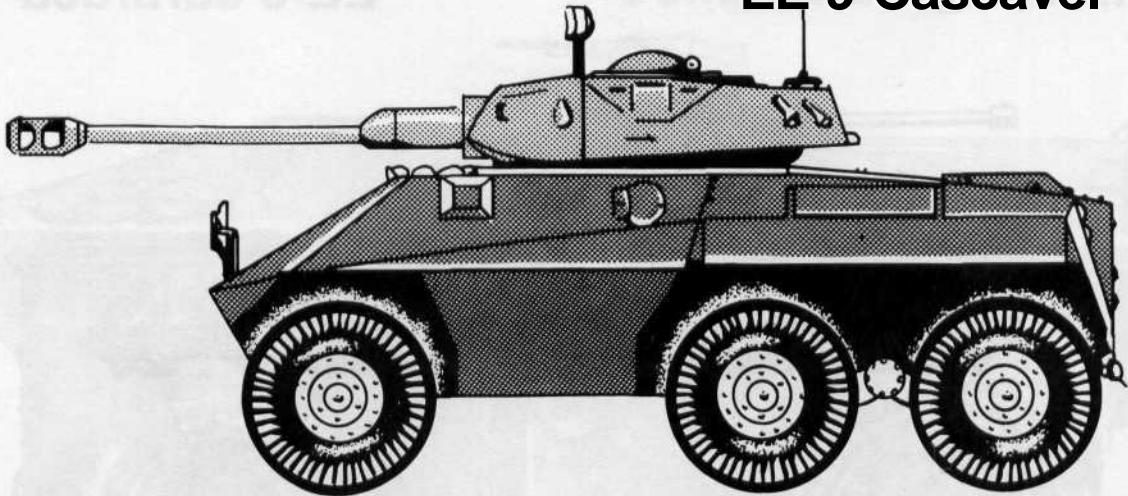

Price: \$200,000 (—/S)

RF: +2

Armament: 90mm (f) gun, MAG MG coaxial

Ammo: 45x90mm (f)

Fuel Type: D, A

Load: 300 kg

Veh Wt: 12 tons

Crew: 3

Mnt: 6

Night Vision: Passive IR, headlights

EE-9 Cascavel (Light Armored Vehicle): The EE-9 is another Brazilian AFV intended for both domestic service and the export market. The Cascavel is a 6x6 wheeled recon vehicle of conventional layout. It has a driver's hatch on the front deck, commander's and gunner's hatches on the turret, and a firing port on each side. The 90mm gun turret has a coaxial MAG MG, and a mount (NMT equivalent) at the commander's hatch (C) for an optional second MAG MG.

DAMAGE RECORD

Crewmembers: Commander Driver Gunner/loader

Sight/Vision: Gun sight Range finder Night vision equipment

Radio:

90mm (f) Gun:

MAG MG (Coaxial):

Traverse:

Engine:

Fuel (% Consumed or Destroyed):

Suspension: Minor damage Immobilized

Tr Mov; 160/120

Com Mov: 80/60

Fuel Cap: 360

Fuel Cons: 90

COMBAT STATISTICS

Config: Trt TF:2 HF:3

Susp: W(3) TS:2 HS:2

TR:2 HR:2

AMMUNITION

Use MG ammo records provided with basic game.

WEAPON DATA

—Recoil—

Weapon	ROF	Dam	Pen	Blk	Mag	SS	Brst	Rng
MAG MG	10	4	2-3-Nil	6	50B	1	9	65
bipod	10	4	2-3-Nil	6	50B	1	5	90
tripod	10	4	2-3-Nil	6	50B	1	4	125

90mm (f) Gun (45 rounds)

WEAPON DATA

Type	Round	Rng	Damage	Pen
90mm (f)	APFSDS	300	24	30/25/20/15
Rid:1	HEAT	300	C:5, B:10	60C
	HE	300	C:5, B:10	4C

EE-11 Uruti

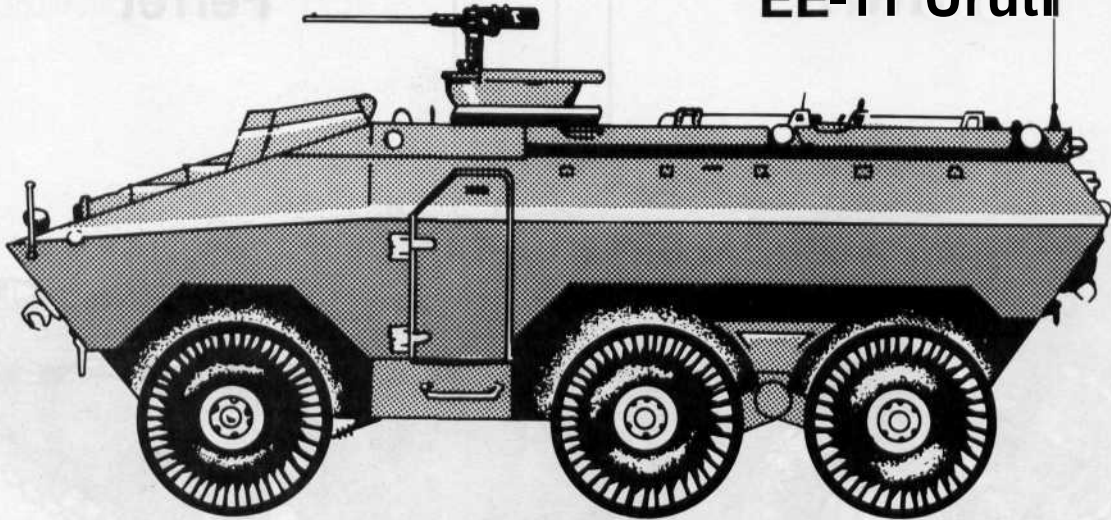

Price: \$180,000 (—/R)

Armament: M2HB MG, or M2HB MG and 60mm mortar

Ammo: 1260x .50 BMG or 1260x .50 BMG and 36x60mm mortar

Fuel Type: D, A

Load: 1.4 ton

Veh Wt: 13 tons

Crew: 3+11 (mortar versions 4)

Mnt:6

Night Vision: Passive IR, headlights

DAMAGE RECORD

Crewmembers (APC): Commander Driver Gunner/loader

Crewmembers (Mortar): Commander Driver Gunner Loader

Passengers (APC): 1 2 3 4 5 6 7 8 9 10 11

Sight/Vision: Night vision equipment

Radio:

M2HB MG:

60mm Mtr (Mortar):

Engine:

Fuel (% Consumed or Destroyed):

Suspension: Minor damage Immobilized

WEAPON DATA

Weapon	ROF	Dam	Pen	Blk	Mag	—Recoil—		
						SS	Brst	Rng
M2HB MG	5	8	2-2-3*	8	105B	3	14	65
tripod	5	8	2-2-3*	8	105B	2	7	150

*.50 SLAP ammunition has a penetration Of 1-1-2.

EE-11 Urutu (Armored Personnel Carrier): Sharing many basic automotive components with the EE-9, the EE-11 Urutu is a Brazilian 6x6 wheeled APC designed for both domestic service and the export market. The vehicle has a driver's hatch on the front deck, a ring mount (NHT equivalent) at the commander's hatch in the center deck, and a hatch in the rear deck for crew access. Some versions are armed with a 60mm mortar, and a few are fitted with the same 90mm turret as the EE-9. The EE-11 is fully amphibious at one-quarter its cross-country speed.

Tr Mov: 160/120

Com Mov: 80/60

Fuel Cap: 380

Fuel Cons: 95

COMBAT STATISTICS

Config: S/n6 HF: 6

Susp: W(3) HS:4

HR:3

AMMUNITION

Use MG ammo records provided with the basic game.

60mm Mortar (36 rounds)

WEAPON DATA

Type	Round	Damage	Pen
60mm	HE	C: 5, B: 20	Nil
IFR: 4km	WP	C: 2, B: 12	Nil
	ILLUM	B: 400	Nil

LWB Land Rover

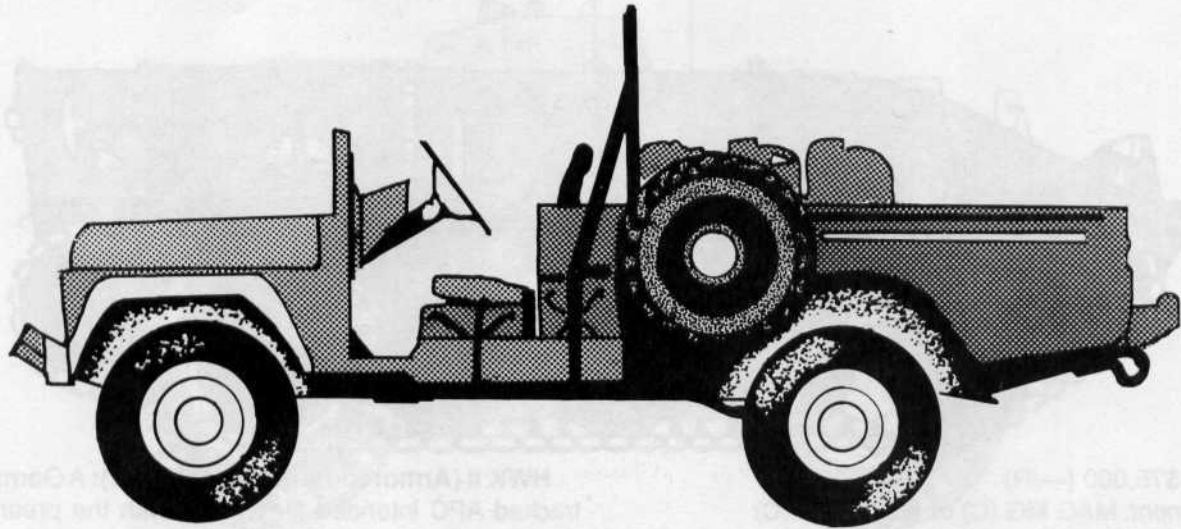

Price: \$18,000 (V/V)
Fuel Type: G, A
Load: 0.75 ton
Veh Wt: 2.5 tons
Crew: 1+3
Mnt: 4
Night Vision: Headlights

DAMAGE RECORD

Crewmembers: Driver
Passengers: 1 2 3
Sight/Vision: Night vision equipment
Radio:
Weapon (If Any):
Engine:
Fuel (% Consumed or Destroyed):
Suspension: Minor damage Immobilized

LWB Land Rover (Unarmored Cargo Vehicle): The British-built, 4x4 Long Wheelbase Land Rover is one of the most commonly seen vehicles in the Third World. Rovers are in service with many armies, police forces, and paramilitary forces throughout the world, as well as in civilian use. Civilian versions are sometimes converted to military use by a field-expedient weapon mount, added armor (sheet metal or sandbags in improvised frames) and (sometimes) a coat of paint. The vehicle is not NBC sealed.

***Tr Mov:* 180/45**

***Com Mov:* 60/35**

***Fuel Cap:* 90**

***Fuel Cons:* 30**

COMBAT STATISTICS

Config: Stnd HF: 1
Susp: W(1) HS: 1
HR: 1

M20

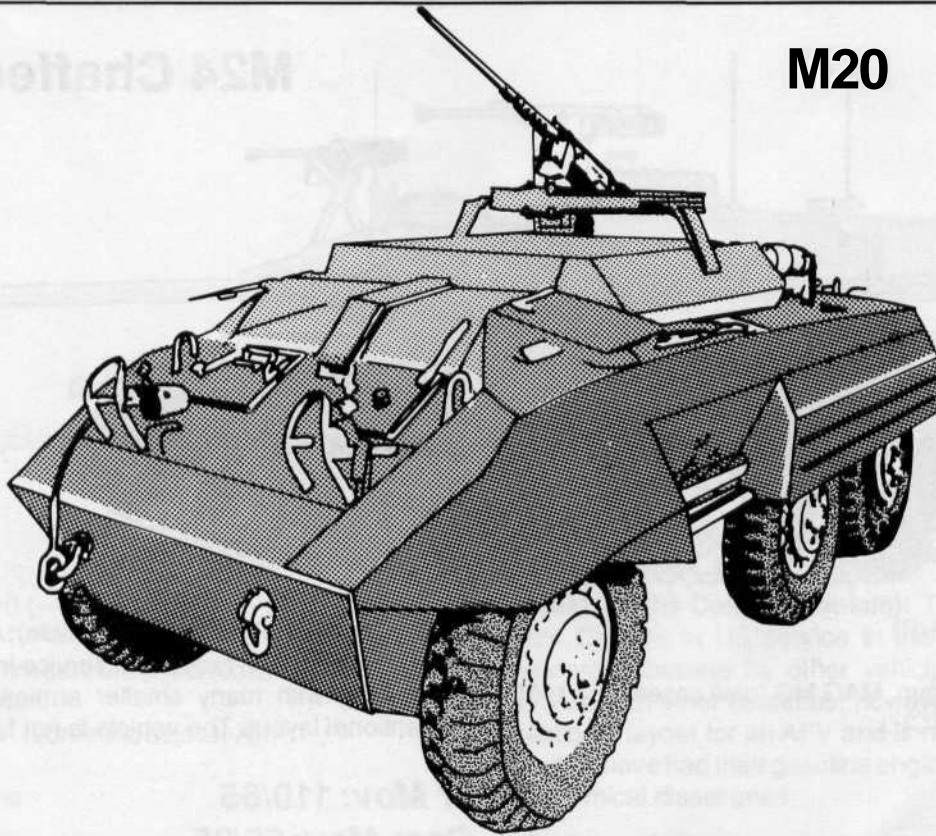

Price: \$125,000 (—/R)

Armament: M2HB ring-mounted MG

Ammo: 1260x.50 BMG

Fuel Type: G, A

Load: 300 kg

Veh Wt: 8 tons

Crew: 3

Mnt: 3

Night Vision: Headlights

M20 (Light Combat Vehicle): The M20 is an unturreted version of the WWII M8 Greyhound 6x6 reconnaissance vehicle, still used by a number of foreign countries. Its armor is inferior compared to other vehicles, but it is cheap and mechanically reliable. The vehicle is not NBC sealed.

Tr Mov: 180/120

Com Mov: 90/60

Fuel Cap: 212

Fuel Cons: 75

DAMAGE RECORD

Crewmembers: Driver Gunner Commander

Sight/Vision: Night vision equipment

Radio:

M2HB MG:

Engine:

Fuel (% Consumed or Destroyed):

Suspension: Minor damage Immobilized

COMBAT STATISTICS

Config: Std HF: 2

Susp: W(3) HS: 1

HR: 1

AMMUNITION

Use MG ammo records provided with the basic game.

WEAPON DATA

Weapon	ROF	Dam	Pen	Blk	Mag	—Recoil—		
						SS	Brst	Rng
M2HBMG	5	8	2-2-3*	8	105B	3	14	65
tripod	5	8	2-2-3*	8	105B	2	7	150

*.50 SLAP ammunition has a penetration of 1-1-2.

M24 Chaffee

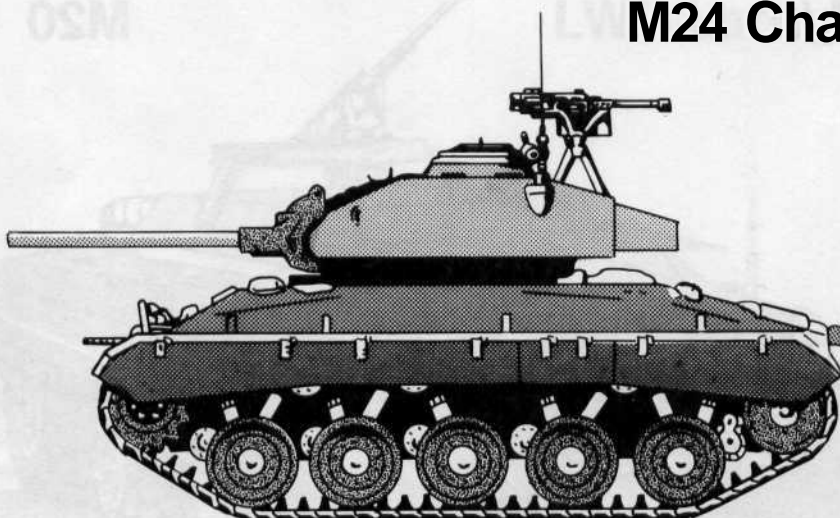

Price: \$350,000 (—/R)

RF: +1

Armament: 75mm gun, MAG MG (bow casemate), MAG (coaxial), M2HB MG (C)

Ammo: 48x75mm

Fuel Type: G, D

Load: 400 kg

VehWt: 18.5 tons

Crew: 4

Mnt: 6

Alt/g7f Vision: Headlights

M24 Chaffee (Light Combat Vehicle): An American-built, WWII-era, light AFV, now out of service in the US Army but still serving with many smaller armies. The M24 is of conventional layout. The vehicle is not NBC sealed.

Tr Mov: 110/65

Com Mov: 55/35

Fuel Cap: 416

Fuel Cons: 104

DAMAGE RECORD

Crewmembers: Commander Driver Gunner Loader

Sight/Vision: Gun sight Range finder Night vision equipment

Radio:

75mm Gun:

MAG MG:

MAG MG (Coaxial):

M2HB (C):

Traverse:

Engine:

Fuel (% Consumed or Destroyed):

Suspension: Minor damage Immobilized

COMBAT STATISTICS

Config: Trt TF: 10 HF: 10

Susp: T: 3 TS: 4 HS: 4

TR: 4 HR: 4

AMMUNITION

Use MG ammo records provided with the basic game.

75mm Gun (48 rounds)

WEAPON DATA

Weapon	ROF	Damt	Pen	Blk	Mag	—Recoil—		
						SS	Brst	Rng
MAG MG	10	4	2-3-Nil	6	50B	1	9	65
bipod	10	4	2-3-Nil	6	50B	1	5	90
tripod	10	4	2-3-Nil	6	50B	1	4	125
M2HB MG	5	8	2-2-3*	8	105B	3	14	65
tripod	5	8	2-2-3*	8	105B	2	7	150

*.50 SLAP ammunition has; a penetration of 1-1-2.

WEAPON DATA

Type	Round	Rng	Damage	Pen
75mm	AP	300	16	8/4/2
	HE	300	C:6, B: 12	-3C

OTO-Melara6614

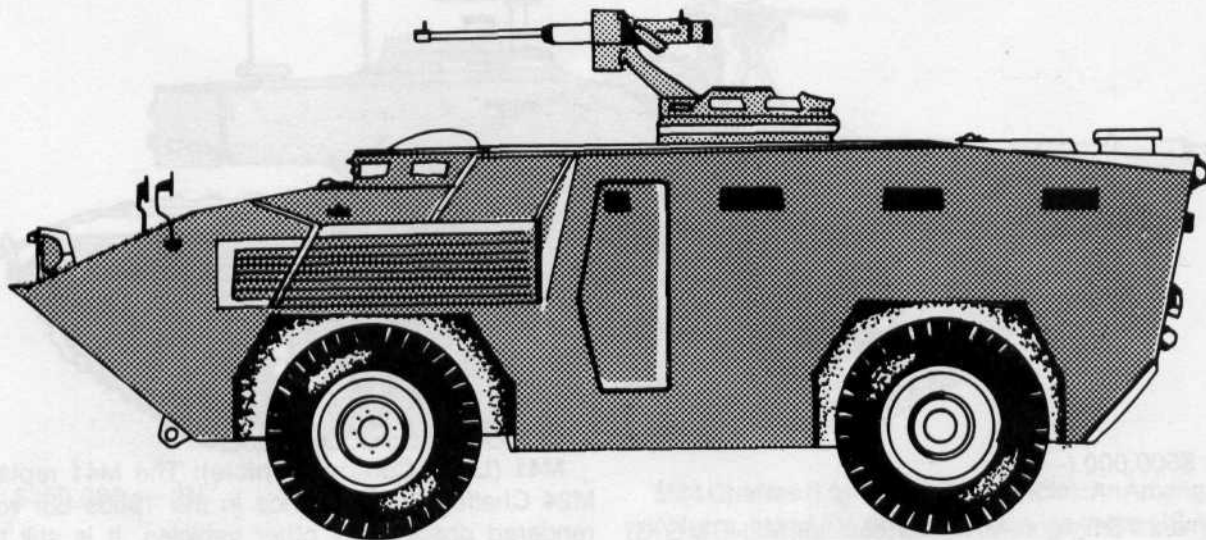

Price: \$75,000 (—/S)

Armament: MAG MG (C) or M2HB MG (C)

Ammo: 1200x7.62mm N or 1260x.50 BMG

Fuel Type: D, A

Load: 1.1 tons

Veh Wt: 8.5 tons

Crew: 1+10

Mnt: 4

Night Vision: Headlights

DAMAGE RECORD

Crewmembers: Driver

Passengers: 1 2 3 4 5 6 7 8 9 10

Sight/Vision: Night vision equipment

Radio:

MG (C):

Engine:

Fuel (% Consumed or Destroyed):

Suspension: Minor damage Immobilized

OTO-Melara 6614 (Armored Personnel Carrier): The OTO-Melara 6614 is an Italian-built, 4x4 APC used by the Italian Army and sold to foreign armies as well. It has a driver's hatch on the front deck, a cupola-mounted MG on the center deck, a door on each side, and a ramp in the rear for departure of passengers. One of the passengers serves as gunner.

Tr Mov: 180/120

Com Mov: 90/60

Fuel Cap: 142

Fuel Cons: 45

COMBAT STATISTICS

Config: Stnd HF: 3

Susp: W(3) HS: 2

HR: 2

AMMUNITION

Use MG ammo records provided with the basic game.

WEAPON DATA

Weapon	ROF	Dari,	Pen	Blk	Mag	—Recoil—		
						SS	Brst	Rng
MAG MG	10	4	2-3-Nil	6	50B	1	9	65
bipod	10	4	2-3-Nil	6	50B	1	5	90
tripod	10	4	2-3-Nil	6	50B	1	4	125
M2HB MG	5	8	2-2-3*	8	105B	3	14	65
tripod	5	8	2-2-3*	8	105B	2	7	150

*.50 SLAP ammunition has a penetration of 1-1-2.

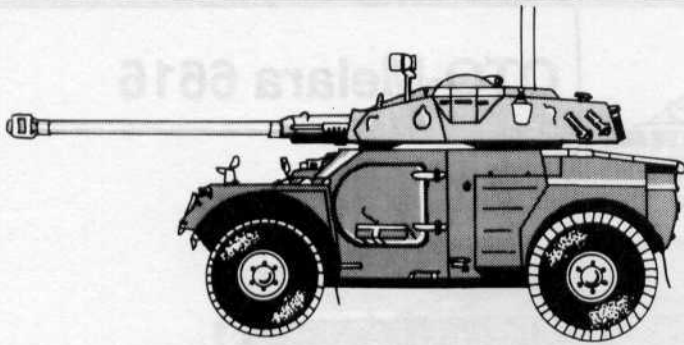

Panhard AML

Panhard AML(Light Combat Vehicle): Manufactured by the French firm of Panhard, the 4x4 Panhard AML comes in two types: the AML-90 armed with a French 90mm gun (the version illustrated), and the AML-60/20 with a 20mm autocannon and 60mm gun/mortar. Both versions have a door on each side, and a hatch on top of the turret for the commander and gunner.

Price: \$85,000 (—/C)

RF: +2

Armament:

AML-60/20: 20mm autocannon, MAG MG (C), 60mm gun/mortar

AML-90:90mm (f) gun, MAG MG (coaxial), MAG MG (C)

Ammo:

AML-60/20: 400x20mm, 36x60mm

AML-90: 24x90mm

Fuel Type: G, A

Load: AML-60/20, 300 kg; AML-90, 400 kg

Veh Wt: 5.5 tons

Crew:AML-60/20, 3; AML-90, 4

Mnt: 6

Night Vision: Passive IR, headlights

DAMAGE RECORD

Crewmembers (AML-60/20): Commander Driver
Gunner/Loader

Crewmembers (AML-90):CommanderDriverGunner
 Loader

Sight/Vision: Gun sight Range finder Night vision
equipment

Radio:

20mm Autocannon (AML-60/20):

60mm Gun/Mortar (AML-60/20):

MAG MG (C) (Both):

90mm (f) Gun (AML-90):

MAG MG (Coaxial) (AML-90):

Traverse:

Engine:

Fuel (% Consumed or Destroyed):

Suspension: Minor damage Immobilized

WEAPON DATA

Weapon	ROF	Mag	Rng	Ammo	Damage	Pen
20mm	60	100B	450	API	10	3/-2/-5
			450	HE	C:1,B:2	-8C

Weapon	ROF	Dam	Pen	Blk	Mag	—Recoil—		
						SS	Brst	Rng
MAG MG	10	4	2-3-Nil	6	50B	1	9	65
bipod	10	4	2-3-Nil	6	50B	1	5	90
tripod	10	4	2-3-Nil	6	50B	1	4	125

Tr Mov: 180/130

Com Mov: 90/65

Fuel Cap: 380

Fuel Cons: 95

COMBAT STATISTICS

Config: Trt TF: 4 HF: 3

Susp: W(2) TS: 3 HS:3

TR::2 HR:2

AMMUNITION

Use MG ammo records provided with the basic game.

90mm Gun (AML-90) (24 rounds)

60mm Gun/Mortar (AML-60/20) (36 rounds)

20mm Autocannon (AML-60/20) (400 rounds) (each box represents 5 rounds)

WEAPON DATA

Type	Round	Rng	Damage	Pen
90mm (f)	APFSDS	300	24	30/25/20/15
Rid: 1	HEAT	300	C:5, B: 10	60C
	HE	300	C:5, B: 10	4C

Type	Round	Damage	Pen
60mm gun/mortar	HE	C: 5, B: 20	Nil
IFR: 4 km	WP	C: 2, B: 12	Nil

TAM/TH-301

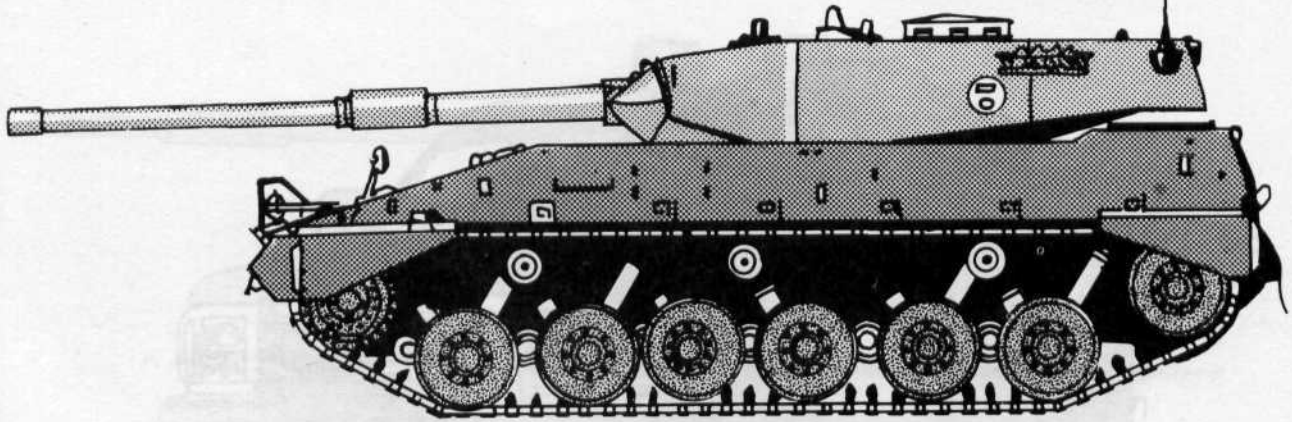

Price: \$750,000 (—/S)

RF: +3

Armament: 105mm gun, MAG MG coaxial, M2HB MG (C)

Ammo: 50x105mm

Fuel Type: D, A

Load: 400 kg

Veh Wt: 30.5 tons

Crew: 4

Mnt: 8

Night Vision: Passive IR, headlights

TAM/TH-301 (Light Combat Vehicle): A German-built light tank designed for the Argentinean Army and sold in the export market by the German firm of Thyssen-Henschel as the TH-301. The TAM (*Tanque Argentino Mediado* or Argentine medium tank) is armed with a 105mm gun and is of conventional layout. It is NBC sealed.

Tr Mov: 130/110

Com Mov: 60/40

Fuel Cap: 650

Fuel Cons: 150

DAMAGE RECORD

Crewmembers: Commander Driver Gunner Loader

Sight/Vision: Gun sight Range finder Night vision equipment

Radio:

105mm Gun:

MAG MG (Coaxial):

M2HB MG (C):

Traverse:

Engine:

Fuel (% Consumed or Destroyed):

Suspension: Minor damage Immobilized

COMBAT STATISTICS

Config: Trt TF: 35 HF: 35

Susp: T: 3 TS: 20 HS: 25

TR: 20 HR: 15

AMMUNITION

Use MG ammo records provided with the basic game.

105mm Gun (50 rounds)

WEAPON DATA

Type	Round	Rng	Damage	Pen
105mm	APFSDS	500	26	80/70/60/40
Rid:1	APFSDSDU	500	26	100/90/80/60
	HEAT	400	C:6, B:12	80C
	WP	400	C:3, B:20	Nil

WEAPON DATA

Weapon	ROF	Dam	Pen	Blk	Mag	—Recoil—		
						SS	Brst	Rng
MAG MG	10	4	2-3-Nil	6	50B	1	9	65
bipod	10	4	2-3-Nil	6	50B	1	5	90
tripod	10	4	2-3-Nil	6	50B	1	4	125
M2HB	5	8	2-2-3*	8	105B	3	14	65
tripod	5	8	2-2-3*	8	105B	2	7	150

*.50 SLAP ammunition has; a penetration Of 1-1-2.

Truck, 1-Ton

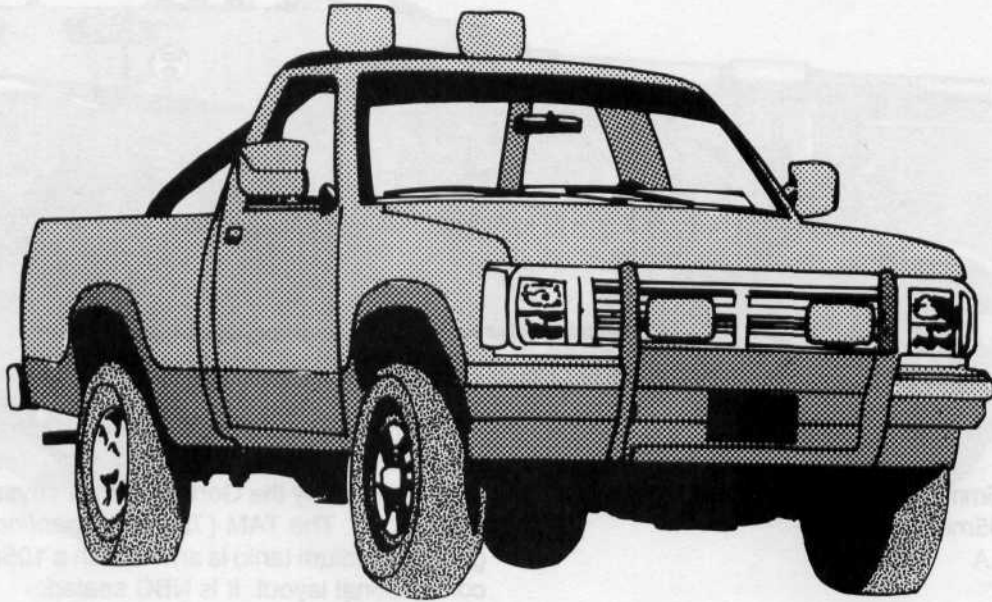

Price: \$20,000 (C/C)

Fuel Type: D, A

Load: 1 ton

Veh Wt: 2 tons

Crew: 2+6

Mnt: 4

Mgftf Vision: Headlights

Truck, 1-Ton (Unarmored Cargo): This vehicle is representative of a number of vehicles commonly available in less settled portions of the globe, usually serving mining or industrial interests. A weapon is not normally fitted, but a field-expedient pintle mount could be installed if necessary. Two-way radios are not always fitted either.

DAMAGE RECORD

Crewmembers: Commander/co-driver Driver

Passengers: 1 2 3 4 5 6

Sight/Vision: Night vision equipment

Radio (If Any):

Weapon (If Any):

Engine:

Fuel (% Consumed or Destroyed):

Suspension: Minor damage Immobilized

***Tr Mov:* 180/35**

***Com Mov:* 45/8**

***Fuel Cap:* 120**

***Fuel Cons:* 35**

COMBAT STATISTICS

Config: Std HF: 2

Susp: W(2) HS: 2

HR: 2

Type 62

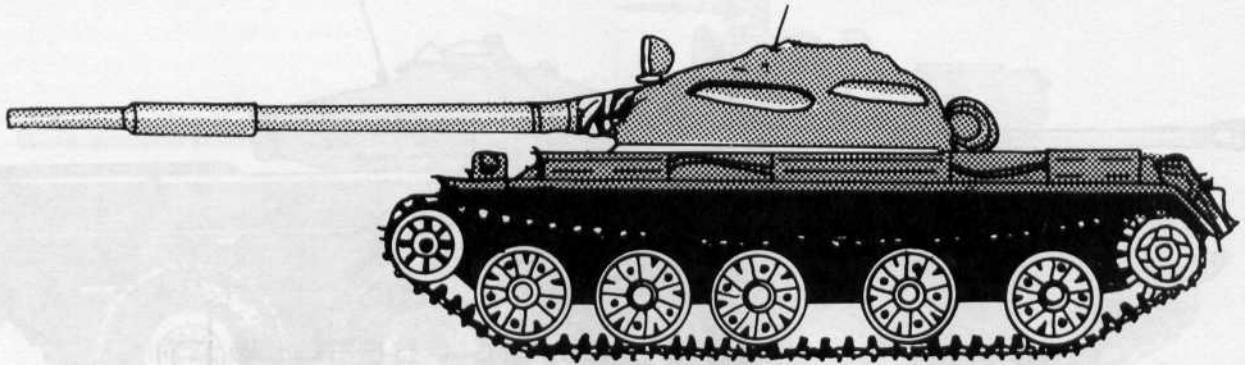

Price: \$950,000 (—/R)

RF: +1

Armament: 85mm gun, PK MG (coaxial)

Ammo: 36x85mm gun

Fuel Type: D, A

Load: 400 kg

Veh IW: 18 tons

Crew: 4

Mnf: 6

Night Vision: Headlights

Type 62 (Light Combat Vehicle): A Chinese-built tracked light tank, a development of the Soviet PT-76 light recon tank. The Type 62 is of conventional layout and is armed with an 85mm gun and coaxial PK MG. An additional MG can be fitted to the commander's hatch in a cupola mount (C).

7r Mov; 100/80

Com Mov: 50/40

Fuel Cap: 545

Fuel Cons: 135

DAMAGE RECORD

Crewmembers: Commander Driver Gunner Loader

Sight/Vision: Gun sight Range finder Night vision equipment

Radio:

85mm Gun:

PK MG (Coaxial):

Traverse:

Engine:

Fuel (% Consumed or Destroyed):

Suspension: Minor damage Immobilized

COMBAT STATISTICS

Config: in TF: 5 HF: 8

Susp: T: 3 TS: 3 HS: 3

TR: 3 HR: 1

AMMUNITION

Use MG ammo record provided in the basic game.

85mm Gun (36 rounds)

DDDDD DDDDD

nnnDnnnnnn

●●●●●●●●●●●●●●●●

●●●●●●

WEAPON DATA

—Recoil—

Weapon	ROF	Dam	Pen	Blk	Mag	SS	Brst	Rng
PK MG	5	4	2-3-Nil	6	50B	2	5	65
bipod	5	4	2-3-Nil	6	50B	1	3	90
tripod	5	4	2-3-Nil	6	50B	1	2	125

WEAPON DATA

Type	Round	Rng	Damage	Pen
85mm	HVAP	300	20	30/20/10
Rid: 1	APHE	250	C:4, B:10	70C
	HE	250	C:3, B:8	20C

VBC-90

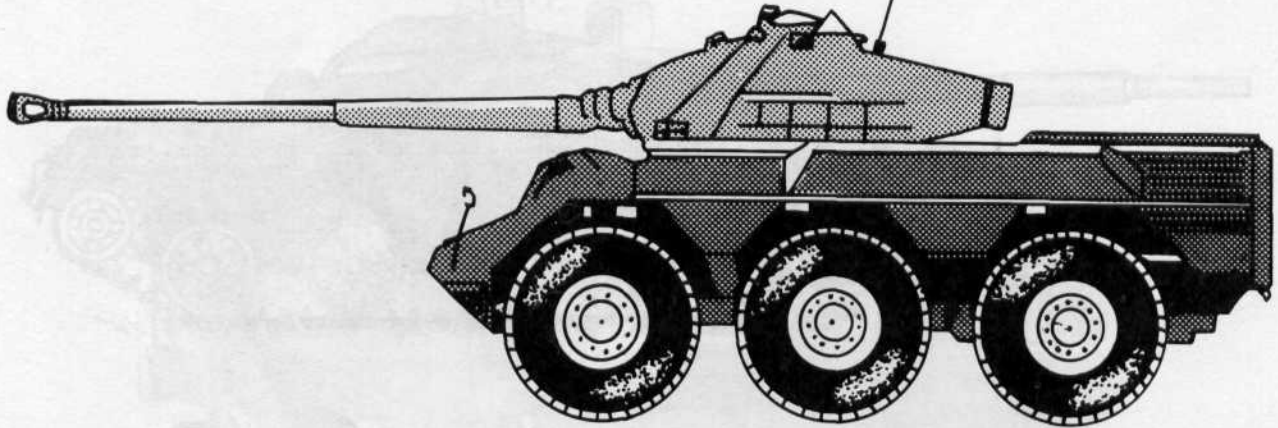

Price: \$750,000 (R/S)

RF: +4

Armament: 90mm gun (f), MAG MG (coaxial), MAG MG (C)

Ammo: 45x90mm (f)

Fuel Type: D, A

Load: 300 kg

Veh Wt: 12 tons

Crew: 4

Mnt: 8

Night Vision: Active/passive IR

VBC-90 (Light Combat Vehicle): The VBC-90 is a French-built, 6x6, armored car, intended both for domestic use and for the export market. It features a driver's hatch on the front deck, and commander and gunner's hatches on the turret deck. It has an extremely high road speed, but suffers in cross-country performance due to its size. The vehicle is armed with a 90mm French-built gun which differs slightly from the 90mm low-pressure guns used by other vehicles in this book.

DAMAGE RECORD

Crew members: Commander Driver Gunner Loader

Sight/Vision: Gun sight Range finder Night vision equipment

Radio: 13

90mm Gun (f):

MAG MG (Coaxial):

MAG MG (C):

Traverse:

Engine:

Fuel (% Consumed or Destroyed):

Suspension: Minor damage Immobilized

Tr Mov: 180/120

Com Mov: 90/70

Fuel Cap: 360

Fuel Cons: 90

COMBAT STATISTICS

Config: Trt TF: 8 HF: 8

Susp: W(3) TS: 8 HS: 6

TR: 4 HR: 4

AMMUNITION

Use MG ammo records provided with basic game.

90mm Gun (f) (45 rounds)

WEAPON DATA

Weapon	ROF	Dam	Pen	Blk	Mag	—Recolt—		
						SS	Brst	Rng
MAG MG	10	4	2-3-Null	6	50B	1	9	65
bipod	10	4	2-3-Null	6	50B	1	5	90
tripod	10	4	2-3-Null	6	50B	1	4	125

WEAPON DATA

Type	Round	Rng	Damage	Pen
90mm (f)	APFSDS	300	24	30/25/20/15
Rid: 1	HEAT	300	C:5, B: 10	60C
	HE	300	C:5, B:10	4C

THE REFEREE

Almost all of the material discussed in the Referee chapter of **Twilight: 2000** has some application in **Merc: 2000**. Naturally, the characters' overall goals will differ, and rewards and experience are somewhat changed (as discussed below). First, however, a short discussion of a real time saver.

Referee Common Sense: At certain points in a scenario, a referee can speed things up tremendously by applying common sense, either in situations where no rules exist or where the outcome is not really at issue. As an example of the first situation, say a character wishes to disable a truck so it cannot be used by the enemy. No one is there to interfere, and the character has several minutes to accomplish his task. No rules covers disabling vehicles, and no task has been defined, but the task to be accomplished is relatively easy, can be done by anyone and can be accomplished in several ways (a frag grenade under the gas tank, a thermite grenade on the engine block, cutting the engine wiring, smashing the distributor, etc.). In situations such as this, the referee should simply ask how the character proposes to do it, make a snap judgment, and get on with the game.

As an example of the second situation, where the outcome is not really an issue, a player with high melee skills has surprised a sentry and wishes to knock him cold. Running the situation according to the melee rules would take more time than the situation is worth. In a case such as this, the referee should declare the sentry knocked unconscious (or overpowered, or whatever) and get on with more interesting parts of the game, saving valuable referee time and energy for the more exciting stuff.

SCENARIOS

This section will discuss how to administer a scenario and will touch briefly on campaigns.

There's eight of us. Two four-person fireteams, each with an SAW gunner, a grenadier with an M203 blooper underslung on an M16, a sniper and a team leader. We like eight 'cause we fit into most aircraft and we don't have to "liberate" more than one or two vehicles when things get hairy. We all know each others' moves, and we all work together well. We're a team.

Teams

The group of characters in a scenario is called a team. Teams may consist of any reasonable number of both PCs and NPCs. A team may be a permanent grouping of characters hired all at once or a temporary assemblage hand-picked for a specific job. A team may carry out a specific mission by itself, or may be asked to act as a cadre or command staff for a larger force of NPCs (although this last will be harder for the referee to administer).

Size: Mission requirements may set a maximum size for a team (perhaps the patron can only get proper documents for a limited number), or the number may be reasonably open. For small information-gathering missions, two to five characters are about right—any more and they will begin getting in each other's way. Small raids or hostage rescues will take six to eight characters. Large battles are really beyond the scope of the game, so teams of 20 or more characters will soon prove unmanageable.

Composition: Each team needs a leader. Committees don't do well in firefights. The composition of the rest of the team will be dictated partly by the characters available and partly by the mission at hand. A team needs members with a proper skill balance to accomplish a particular mission. Combat skills will be required of almost every mission, but vehicle skills, mechanical skills, Mountaineering, Swimming, Computer, and (last but not least) Medical skill are often called for. How the team is organized is up to the players, for good or ill. Previous military rank is not important unless the players make it so.

Equipment: The equipment taken along will depend on what the team must accomplish. The requirements of a hostage rescue are considerably different from an industrial espionage mission, for example. Teams travelling in vehicles will be able to take along a greater quantity of equipment, but those forced to parachute in and helicopter out will have certain limitations on their gear, especially if they are to pick up passengers along the way and space on the bus home is limited.

Each member of a team will have to coordinate what equipment (and supplies—mustn't forget food) he takes along with the others. No point in everyone bringing an M60

machinegun, and someone needs to bring ammunition for the 60mm mortar. Equipment should be chosen after considering the type of mission, available transport space, any emergencies that may arise, and other significant details. For short missions, characters may want to dispense with food, but medical supplies are likely to be vital (first aid kits, at least).

Characters should be allowed to bring whatever they want (and can afford), but referees should not hesitate to implement the rules about overloading and fatigue. Vehicles will cause special problems, which will be discussed later.

Selling Equipment: Characters who acquire surplus equipment may wish to sell it on the international arms market to add to their profits. Used military equipment can be sold for one-third the listed purchase price if it is fully functional (otherwise, you sell it as scrap metal for two or three cents on the dollar).

Patrons

For lack of a better term, we have chosen to use the term patron to represent the person or group who hires the players. Patrons will be discussed in more detail later, in their own section of this book.

Mission Generation

To help referees in putting together missions, we have included a number of sample ones in this book (starting on page 88), as well as a couple of small campaigns (page 100). After looking these over, referees will have a better idea of how to put their own together. Mission ideas can be drawn from movies, books, games, and numerous other sources. A mission consists of three basic things: what the team has to do, who opposes them, and how much they will get paid. A mission should be interesting, challenging, and lucrative for the team. It should be neither a deathtrap nor a cakewalk, and should not hand out giant rewards for minor actions.

Premission Preparations: Each scenario will require a greater or lesser amount of planning on the part of the players. For simplicity's sake, **Merc: 2000** assumes that the patron will take care of the boring details of the mission: getting the team and its equipment to the departure point, handling the various customs inspections and government officials encountered along the way, arranging for retrieval, and so on. The players should get to do the exciting part of the preparation: working out the assault plan, finding good places for an ambush, and so on.

The referee's job is much larger. He must

not only figure out an interesting mission, he must put together the opposing forces (and run them during the scenario), decide on the lay of the land (so he can either obtain a map or make one up), throw in a few surprises to keep it all interesting, and figure out how much it's all worth.

Briefing: Here's the part where the patron pulls down a blackboard and starts lecturing. The briefing must contain everything the patron reveals to the characters that is of importance to their mission. This includes what the team members are to accomplish, where they need to go to do it, and how much they can take along to do it with. It will include maps, intelligence information on the expected opposition, background details important to the mission, and so on.

Insertion Phase: The active part of the scenario begins with the insertion phase. After that, the characters are on their own and call their own shots, for good or ill. Insertion can be accomplished by anyone of a wide variety of methods, including parachutedrops, paddling ashore in rubberboats from a submarine or surface vessel, light plane landings, helicopter landings, ground transport overland, and so on. The precise method chosen may be stated as part of the contract with the patron or may be left up to the team's discretion. The characteristics and potential problems of each major type are discussed below:

Parachute Drops: These include HALO drops (high altitude, low opening), water drops (parachute landings in water), night drops, and normal daytime drops. Vehicles and supplies can also be dropped, but they must be specially prepared.

Waterborne: In simple waterborne insertions, a small boat beaches and the team disembarks. In more complex insertions, a submarine may drop the team off in rubber boats or as scuba-equipped swimmers. Team members can also be dropped into water more than three meters deep from a slow, low-flying aircraft, or they may leave from a specially equipped submarine. Vehicles and bulk supplies are more difficult to land from waterborne transport.

Airborne: In this form of insertion, the team members are carried to their landing zone by a light aircraft or helicopter. Fixed-wing aircraft must land to disembark the team and equipment and thus need a large, relatively flat area suitable as a landingfield. Helicopter insertions need only land if significant equipment is to be unloaded. Otherwise, the team can rappel down from the helicopter on ropes.

Vehicles and supplies can be dropped from slow, low-flying, fixed-wing cargo aircraft under certain conditions if they are properly prepared.

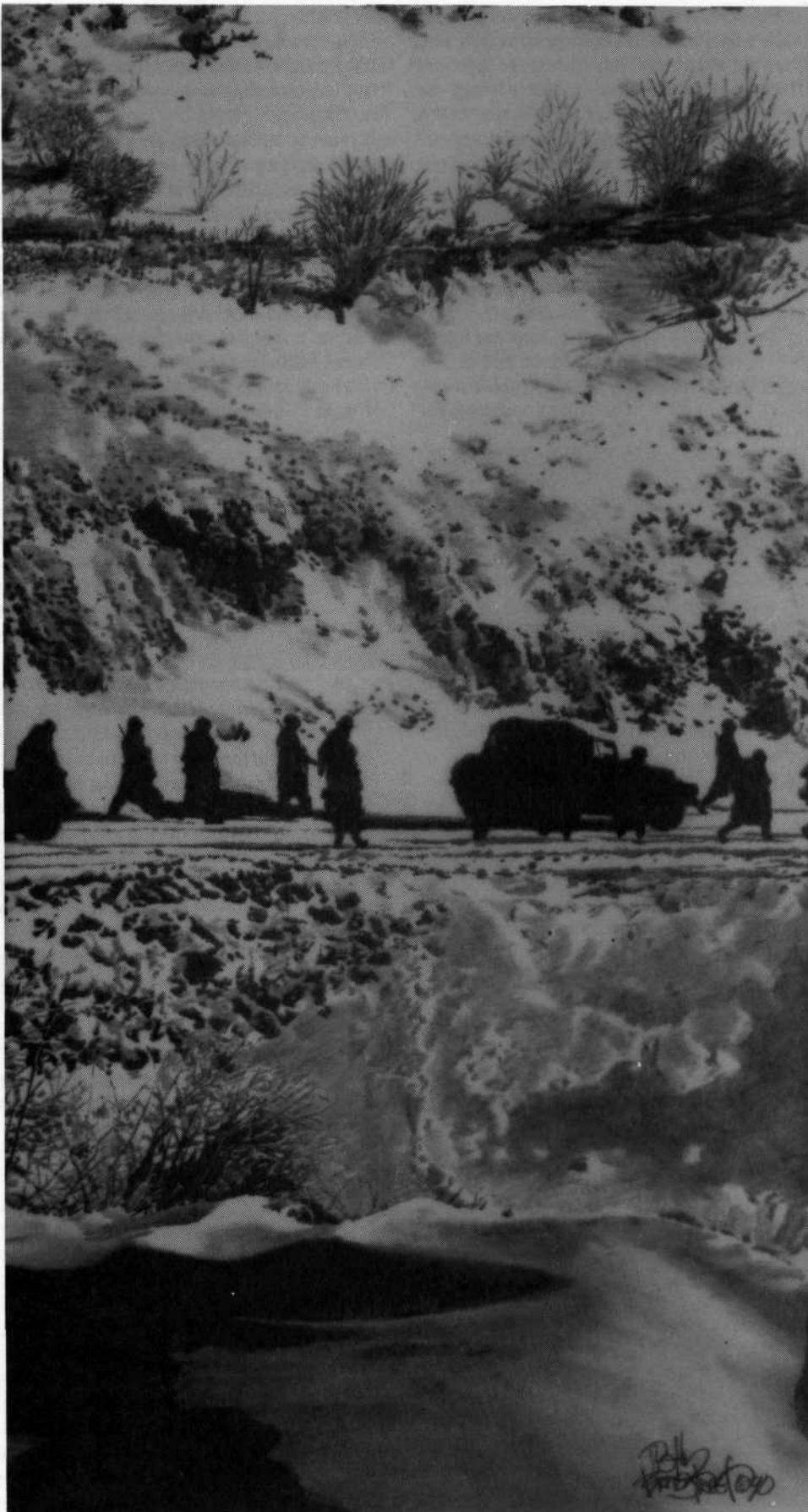

Mission Resolution: The scenario should state what the team is to accomplish and (sometimes) set restrictions on other actions. These should be readily summarized as simple statements (i.e., "Kill the leader of the insurgents and destroy his headquarters." "Locate General Diaz and his family, and get them out alive." "Take over the television station intact, and hold it until the team from the propaganda section arrives." "Destroy the chemical weapons factory before it can be completed, killing no civilians in the process.").

The scenario is over when the characters have accomplished their mission and gotten safely home, when they decide to give up and leave, or when it has become impossible for them to complete their mission.

Opposition

Enemy forces will vary from a handful of criminal thugs to highly trained elite military forces. We have included some sample tables of organization and equipment, but the world's military forces are too diverse to be easily summed up by a few examples. In any case, most units that have been in action cease to resemble their official tables of organization and equipment. Considerable latitude is allowed referees in this regard, and the opposing force can be (indeed, must be) varied to suit the abilities and equipment of the team. Adjusting the opposition is one of the most effective means of play balance available to the referee.

An interesting possibility is the use of detailed NPCs as opposition, either as part of a campaign or in an occasional scenario. A continuing nemesis to deal with can add spice to an otherwise dull scenario.

Retrieval

Arrangements to get the team out again are usually concluded in advance. There are basically two types of retrievals: *prearranged* and *standby*. In prearranged retrievals (the most common) the team members have a schedule they must meet. They must be at a certain place at a certain time, or they "miss the bus." In standby retrievals, the characters send a prearranged signal giving their location (a radio broadcast, a certain color of flare, a signal lamp flashed out to sea from a selected point along the shore), and settle in to wait until their ride home arrives.

The scenario may dictate one or more landing zones, or the players may be allowed to choose them.

Of course, situations may arise where the team must arrange for its own transportation. This can be an adventure in itself.

Rewards

The characters are not running a charitable institution and expect to receive payment for their efforts on the patron's behalf. Also, characters learn from experience, and this must be reflected in game terms as well.

Skill Points: These are as discussed in the Referee section of **Twilight** on page 133, and are awarded and used in the same way.

Money: Some players may be interested in the details of payment. Referees can use their imagination: deposits to numbered bank accounts, bearer bonds, gold bars, escrow accounts under assumed names, stock certificates—the list is endless. It is also pretty much irrelevant to the action. The characters get paid in something negotiable, and for convenience sake we call it dollars.

The base payment rate is \$1000 per team member paid in advance, plus \$300 per team member per day (or fraction thereof) and \$1000 per surviving team member paid upon completion. Completion money and per diems are not paid for failures, but the characters retain their advance money—they did try, after all. Penalties are imposed for loss of patron-supplied equipment unless such loss was vital to the accomplishment of the mission (referee's judgment). Likewise, a patron may agree to supply weapons, ammunition, or other gear (for the team to keep) but deduct the price from the final payment. Modifications to this payment rate are possible: The characters may have sufficient renown to demand more money, the inherent dangers of the mission may dictate a higher rate, or the characters may decide to work *pro bono* (for free). In some cases, individual scenarios will not net the players money since they may be on a monthly or annual salary (in cases where the characters are serving as an on-call strike team or whatever).

Renown: After a number of successful missions, mers will begin to accumulate renown points. Renown points represent fame in the mercenary community (more importantly, they represent fame among patrons). Renown, along with lifestyle, helps determine the nature of the job offers a mere receives.

At the conclusion of a mission where the success requirements were met, the referee should award a renown point to each surviving member of the team. Each member then keeps a running total of points earned. At the conclusion of missions that fail to meet their requirements, one or more renown points should be subtracted from each team member's total (the number subtracted is up to the referee—team leaders should lose more than grunts). Failure can cost a character more than several successes will gain back.

In some cases, however, the referee may choose to reward heroic or extremely moral actions with extra renown points, even in situations where the mission's requirements weren't met (rescuing a corrupt generalissimo's family from a kangaroo court, but leaving him to face the music is a good example).

The use of renown in meeting patrons and raising the base pay rate is discussed in the Patrons section of **Merc**, starting on page 52.

LIFESTYLE

Everyone has a lifestyle: the place they live, the food they eat, the clothes they wear, the people they associate with during periods of leisure. Lifestyle is determined by money. Characters may freely choose how much of their income to devote to maintaining their lifestyle. The lifestyle of a merc will have a great effect on the type of people he meets, and this will affect the type of job offers he gets. Millionaire industrialists don't trust the life of their most valued employee to some guys they meet buying snow cones at a convenience store.

To determine the lifestyle rating, divide the dollar amount spent per month by 1000, rounding down (but never dropping below 1). The resulting number (expressed as a Roman numeral) is the character's lifestyle rating. The use of the lifestyle rating is discussed in the Patrons section.

TRAVEL AND TRANSPORTATION

Usually, the patron will handle this sort of thing, but here are some guidelines for the referee if the players want to take care of things themselves.

Because of the deteriorating economic condition of much of the world, scheduled air travel has become more expensive. Travel to nonproblem areas presents no particular difficulties except the usual ones associated with international travel (passports, visas, etc.). Getting to a trouble spot, however, is more—ah—trouble.

Also, getting an M1 tank from Patterson New Jersey to Java (or wherever) is an expensive and time-consuming process, which is why there are almost no mercenary armored units (those few which exist have long-term contracts and usually use locally supplied vehicles). The smaller the vehicle, the easier it is to ship. Vehicles small enough to ship by air are very popular.

Customs: Each time a mere crosses an international border, consideration must be given to how the local authorities will react. A great deal will depend on immediate circumstances and what the character is trying to get across the border.

Characters crossing at normal points of entry with no contraband will encounter no particular problems. Vehicles and bulk equipment will need bills of lading and similar papers, but again, these will normally present no problems. Military hardware, ammunition, and military vehicles need special documentation, called an end user certificate, specifying where the item is going (this document does not always reflect reality—you can't put "counterrevolutionary forces in a neighboring country" as a destination and hope not to attract attention). The cost of various documents is listed on page 108. The rules for passing a forged document are described in **Twilight: 2000**.

Illegal Entry: Smuggling and bribery are options for getting contraband into a country, especially into the area where they are to be put to their final use. It is best to game out these sequences.

Air Travel

Air travel has the advantage of speed, for which users pay a price. Any good atlas will show major air routes, and practically every map shows airports. Air travel rates vary tremendously depending on a great number of factors. For simplicity, refer to the Air Rates Table and see below.

Air Rates; *Distance* is the distance to be travelled, in air miles, from airport to airport.

Cost is the price for passengers per person, or the cost per ton for shipping bulk goods or vehicles.

Time is the amount of time taken by the flight and includes loading, air time, minor delays, and unloading. Freight over 10 tons adds another D6 hours to represent increased loading/unloading time.

Charter flights double these rates (but not the time taken)'.
'

Vehicles over 12 tons triple these rates (this represents the difficulty in finding aircraft large enough to carry the vehicles). Transporting large vehicles by air is prohibitively expensive, and most private patrons refuse to do it. Governments and the extremely wealthy are another matter, of course.

A chart showing distance between major world cities has been provided on page 116, for use by referees in determining cost and travel time.

Overland Travel

Overland trucks and railroads offer considerable price advantages for bulk cargo and can handle vehicles of any size. Of course, there is a time penalty, and they cannot cross oceans. Any good atlas will show roads and rail lines, and the referee can take the dis-

tances from this source. Truck and rail rates vary tremendously, and are even more complicated than airline rates. For simplicity, refer to the Overland Rates section below.

Overland Rates: *Cost:* \$125 per 1000 km
Time: 8 hrs per 1000 km.

Cost is the price for passengers per person (and assumed to be rail travel only) or the cost per ton for shipping bulk goods or vehicles.

Time is the amount of time taken by the trip and includes loading, travel time, minor delays, and unloading. Freight over 30 tons adds another D6 hours to represent increased loading/unloading time .

Charters double these rates (but not the time taken).

Water Travel

The cheapest way to transport heavy vehicles or bulk cargo long distances is by water, but it is also the slowest. Refer to the Water Rates section below.

Water Rates: *People:* \$75 per 1000 km
Freight: \$50 per 1000 km
Time: 1 day per 1000 km.

People is the price for passengers, per person.

Freight is the cost per ton for shipping bulk goods or vehicles.

Time is the amount of time taken by the trip and includes loading, travel time, minor delays, and unloading.

Charters double these rates (but not the time taken).

CAMPAIGNS

Campaigns consist of a series of scenarios. Two short sample campaigns are included in this book, to serve as examples to help referees devise their own. One type of campaign sets up a background and then proceeds into a number of linked scenarios, each one following

the other in chronological sequence. Another type of campaign is less strict and simply uses the background as a loose framework into which a number of adventures are fitted. In the first type of campaign, the separate scenarios proceed like the interconnected subplots of a movie, whereas in the second type, the scenarios proceed like the episodes in a TV series (same characters, same general situation, but little connection between this week's show and last week's).

The first type of campaign is more interesting for the players, but the second type is easier on the referee and more suited to groups that meet on a regular basis or that play other games in-between **Merc: 2000** sessions.

Air Rates

<i>Distance</i>	<i>Cost</i>	<i>Time</i>
Under 800 km	\$450	2+1D6+3 hours
800-2400 km	\$650	8+1D6+2 hours
2400-10,000 km	\$1200	12+1D6 hours
10,000-20,000 km	\$1500	24+1D6 hours



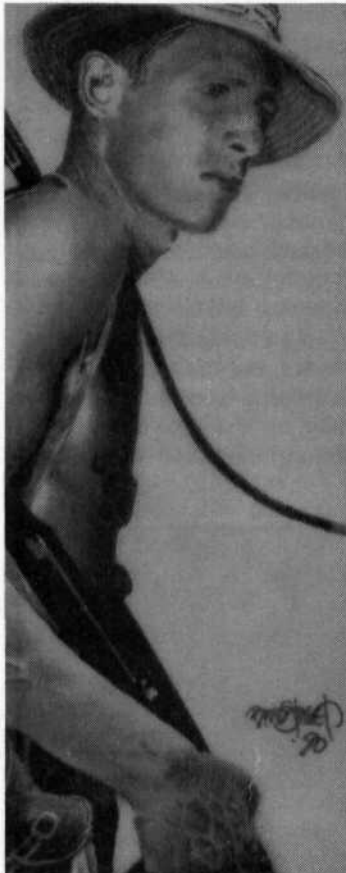

Local Recruit

The local recruit is someone the player characters' team has bumped into along the line and felt like taking along.

He may be a local soldier, a local civilian guide hired to lead the team somewhere, a noncombatant the team has encountered along the way, or even a soldier from the other side who has decided to join the group.

The local recruit is not a bad soldier, and his knowledge of the countryside is excellent, especially if he is serving in his old stomping grounds. He can be expected to know the lay of the land and provide insight into good ambush and camp sites.

Level: Experienced

Skills: Melee: 2, Small Arms (Rifle): 4, Foraging: 4

Initiative: 4

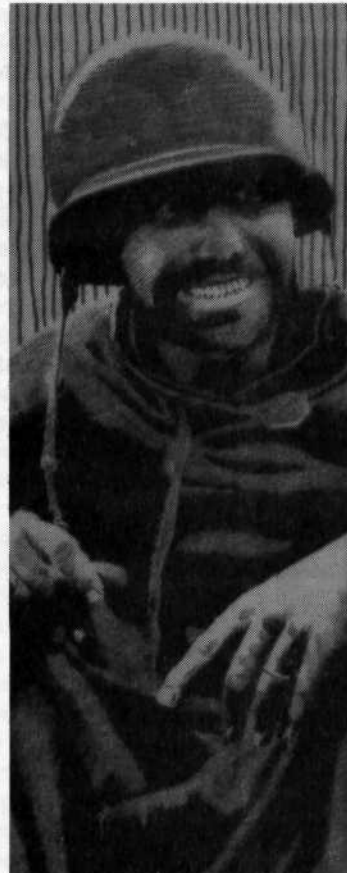

Maniac

Most of the time, the maniac is a actually quite a credit to the team—capable and intelligent.

Most of the time.

Sometimes, however, the maniac just doesn't seem to care whether he (or the rest of the team, for that matter) lives or dies.

In the middle of a firefight, something inside him will snap, and he'll go completely berserk.

At the end of it all, if he is still alive (and fortune seems to favor the deranged), he will seek solitude and sit for awhile, vibrating like a violin string.

Then, after a few minutes, he will return to normal.

Level: Veteran

Skills: Melee: 4, Small Arms (Rifle): 6, Small Arms (Pistol): 2

Initiative: 4



Company Man

The company man is sent along by the patron to make sure you complete the mission as contracted. He is excited to be doing something other than sitting behind a desk and fancies himself quite a man of action. He's been through an expensive combat pistol course, has a match barrel M21 rifle (with a custom stock, reconfigured set-trigger, and unbelievably expensive telescopic sight), a customized .45 long slide, and 100 kilos of camping gear (about 20 kilos more than he can carry), all in a matching tiger-striped camo pattern.

Of course—you have to get him back alive. He's the patron's brother-in-law.

Level: Novice

Skills: Computer: 3, Small Arms (Pistol): 4, Chemistry: 1

Initiative: 1



Freedom Fighter/Terrorist

Depending on which side you are on, this nonplayer character is either a hero fighting for a just cause or a murdering swine out to destroy civilization.

Driven by a fiery anger fueled by the memory of what the enemy did to someone he loved deeply, the freedom fighter (or terrorist, if you are his enemy) is impossible to deal with on anything approaching a rational level.

His emotions are too fierce, the memory of past atrocities too strong.

In some ways, he is the worst possible ally.

In some ways, he is the best.

Level: Veteran

Skills: Melee: 4, Small Arms (Rifle): 4, Foraging: 6

Initiative: 4



Ice Man

The Ice man kills with the calm precision of a machine. He shows no emotion, no regrets, and absolutely no hesitation. Rifle, pistol, mortar, machinegun, knife, garrote, truncheon, or blasting machine—it makes no difference to him how he does it. Remote demolition charges are fine by him, but he is just as undisturbed to do the job up close and personal.

Nobody really knows much about his background or how he got his nickname. He could have picked it up because he has ice water in his veins—he could have acquired it because he puts people "on ice" so well. Nobody has had the courage to ask him.

Level: Elite

Sk//s: Melee:6, SmallArms (Rifle): 6, Heavy Weapons: 4

Initiative: 5



Quiet One

The quiet one doesn't talk much about her past. She doesn't talk much at all, just sits stropping a combat knife on a thick leather wristband she wears, responding to questions with monosyllables, if at all.

Tormented by some vague, shadowy monster from her past (perhaps represented by the faint purplish scar tissues barely visible on her left cheek), she sleeps fitfully, spends a lot of time staring blankly into space, and in general is not good company. She is average in almost every respect—height, weight, hair color. But she fights like nothing human.

Level: Veteran

Skills: Small Arms (Rifle): 2, Melee Combat: 8, Thrown Weapon: 4

Initiative: 4

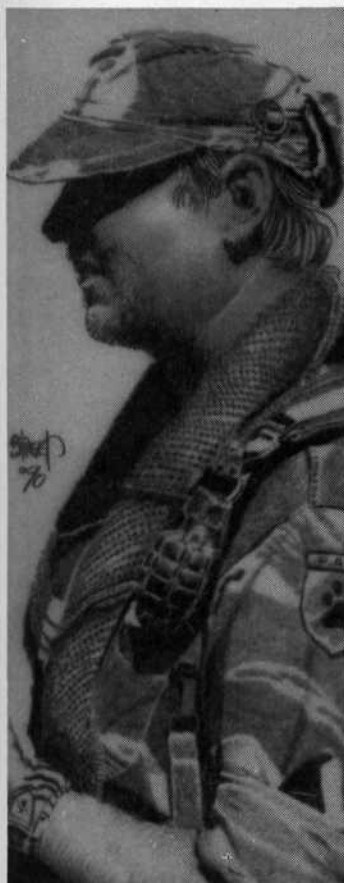

Enthusiastic Newbie

We all start somewhere, and we all looked like this once. "Shavetail," "newbie," "newfish," "fresh meat," or "rookie," the enthusiastic newbie talks a good fight, but his greatest secret (one he carries written all over him) is that he has never seen action and is afraid of how he will perform.

Will he earn the respect of his fellow mercs? Will he make a complete fool of himself? Will he get killed? Or (worst of all) will he get someone else killed?

Although he has the potential to become a good soldier, for now he is short on experience and long on zeal. Some think this makes him more dangerous than sweaty dynamite.

Level: Novice

Sfc/7/s: SmallArms (Rifle): 4, Melee: 2

Initiative: 3



Loudmouth

"Say, did I ever tell you about the time that Dutch and me.... What? You've heard it? Oh. Well, then, how about the time I...."

The loudmouth is a competent soldier, but during the lengthy periods of inactivity that characterize any military or paramilitary operation, he like to talk.

And talk.

And talk.

This can sometimes drive his compatriots to distraction. They may even long for action—anyaction—just so they can escape this soldier's incessant chatter and off-color jokes (all told with perfectly awful timing).

Level: Veteran

Sk//s: Melee:3, SmallArms (Rifle): 4, Foraging: 2, Thrown Weapon: 2

Initiative: 4

PATRONS

Most of the people that they don't know squat about the life. They think it's some kind of campout, only with gunfire. The best kinds of patrons are ex-mercs, because they know exactly what you need to do a particular job (or at least they have a clue, which is better than nothing). We had a guy one time, back in '98, that I wanted to invite along with us—and if you knew how I feel about suits, you'd know what a compliment that really is.

For lack of a better word, we have chosen to use the term *patron* to represent the person or group that hires the players. The patron will usually supply intelligence data, special weapons, special equipment, transportation, any special documents necessary, additional personnel, and so on. The patron sets the goals for the mission, decides when these have been met, and issues payment accordingly. Patrons (or their representatives) may accompany the team, but normally do not.

Patrons may be thought of as a special form of contact. Like contacts, the same patron may be used over and over (perhaps eventually almost becoming a detailed NPC as described on page 142 of **Twilight: 2000**), or discarded after one or two appearances. Their main use is to provide a framework for mercenary job-hunting and to put some restrictions on what the players can do. They also make the game a little more sophisticated and add a layer of verisimilitude.

Success will make patrons like the team and give them other jobs or provide links with other patrons. Failure will have the opposite effect.

MEETING PATRONS

Sometimes mercs seek patrons; sometimes patrons seek mercs. Lifestyle, contacts, and renown determine what kind of patron the players find, or what kind finds them. Patrons are classified in levels, like lifestyles.

These are defined as:

Patron Level I: Local business types, local police and government agencies, local security companies and so on. Patrons at this level pay half the going rate (unless the scenario specifies a different arrangement).

Patron Level II: National business types, national police and government agencies,

small museums, and lower-level government officials in foreign countries.

Patron Level III: The medium to high range of government officials, large museums, representatives of international businesses, and the governments of small foreign countries.

Patron Level IV: Wealthy private individuals, high government officials (British foreign secretary, US secretary of state, and so on).

Patron Level V: Eccentric multibillionaires, chief executives of large multinational corporations, and heads of state.

The level of a character's lifestyle represents the highest level of patron he can expect to contact or be contacted by. Characters normally encounter patrons at the same level (or lower) as their lifestyle. Lifestyle I allows you to meet level I patrons, etc. Contacts and renown can increase this level.

Using Contacts: Contacts serve to allow mercs seeking work to find higher-level patrons than their lifestyle would ordinarily permit. When the contact is created, the referee must work out what level of patrons the contact will have association with. Most contacts will have links to patrons of levels II, III, and (rarely) IV. For these, roll 1D6-2 (converting the result to a Roman numeral). For wealthy contacts, subtract only 1. A result of 0 or less means that the contact has no useful patron links (but may still be of value in other ways, of course).

Not all types of contacts can provide a link to a patron, but patrons met through contacts can be of any level, no matter how high.

Using Renown: Renown, like contacts, allows the character to come into contact with higher level patrons than allowed ordinarily. It also allows characters to negotiate for larger financial rewards.

Patrons: Divide the team's average renown rating by 2 (rounded to the nearest whole number). If the result is greater than the level of patron the highest lifestyle of the group members ordinarily allows them to contact, the team has managed to attract a patron one level higher than normal. Only one higher level of patron can be gained in this way.

Money/Only patrons of level III and higher will agree to pay more based on renown (lower ones can't afford it). Use the average renown of the characters (rounded to the

nearest whole number) as a D10 roll for success. If they make it, the characters can double the base salary for that job. The group members can roll as many times as they like but may only roll again if they are successful. If they fail, all salary increases are cancelled, and the team cannot roll again.

Meeting Patrons Example

Suppose the team consists of four members, two with lifestyle I, one with lifestyle II, and one with lifestyle III. One of the group has a foreign government contact, which a die roll determines has a link with a level IV patron. The average renown of the group is 3.25.

Purely on lifestyle, the group can be contacted by patrons of level III or less. The group's renown is not yet enough to allow this to increase. However, the foreign government contact allows the team to meet a level IV patron.

ORGANIZATIONS

This section contains a few brief sketches of a number of worldwide organizations which may serve as sources of patrons for the team. The choice of which of these organizations to use is completely up to the referee.

CIA: This is the American Central Intelligence Agency. In 2000, it is underfunded and understaffed, but still active. The CIA is the American organization primarily responsible for antiterrorist actions outside of the borders of the United States, as well as what little foreign espionage the US still undertakes.

DIA: The United States Defense Intelligence Agency in 2000 is an information-gathering branch of the US Department of Defense. The DIA is primarily responsible for threat assessments of foreign military equipment and capabilities.

DEA: This group is the Drug Enforcement Authority of the US Bureau of Narcotics. It is responsible for antidrug raids in the US. The DEA often hires mercenary groups for foreign operations.

NSA: The US National Security Agency gathers electronic intelligence through intercepts of all sorts of electronic communications media, including radio, television, telephone, telegraph, and many others. The agency does not hire many mercenaries and usually works through several layers of intermediaries when it does.

NSC: The US National Security Council is a consulting body to the American president. Legally, this group is purely advisory.

DoS, DoD: The US Departments of State and of Defense occasionally hire mercenaries, but working for them is not common. Antiterrorist activities are handled by a multi-

service force known as Special Operations Group Delta (Delta Force for short).

KGB: The KGB (*Komitet Gosudarstvennoy Bezopasnosti* Committee for State Security) is the Soviet covert operations/espionage organization. By 2000, the KGB's worldwide operations are considerably reduced from previous decades. Like the American CIA, it is smaller, leaner, and less active, but still around and very competent. The GRU (*Glavnoye Razvedyvatel'noye Upravleniye* or Chief Intelligence Directorate of the General Staff), the Soviet military espionage/sabotage organization is much less active than it once was, primarily due to lack of funding.

Special Branch: Special Branch is the oldest of the British security organizations, and as a part of Scotland Yard, is directly responsible to the British home secretary. Special Branch does not hire mercenaries, but mercs on missions to the United Kingdom will run up against it if their missions are contrary to the best interests of the British

government.

MI-5: MI-5 (Military Intelligence-5) is a British organization also responsible to the home secretary. Its duties parallel those of Special Branch, but MI-5 occasionally hires mercs to assist in its activities.

MI-6: Military Intelligence-6 is responsible for active overseas operations conducted by the British foreign secretary. It occasionally hires mercenaries, usually working through intermediaries. Antiterrorist activities are handled by elite units of the British armed forces (SAS, SBS, Royal Marine Commandoes, etc.)

SDECE: The SDECE (*Service de Documentation Exterieur et de Contre-Espionnage* or Foreign Intelligence and Counterespionage Service) is the French foreign intelligence organization. The SDECE prefers to work with units of the French Foreign Legion whenever possible, but is not beyond hiring mercenary groups on occasion, especially where the French government does not wish to become formally involved.

Counterespionage operations inside France are handled by the DST (*Defense et Surveillance du Territoire*).

Mossad: The Israeli Mossad (*Mossad Letafkiddim Meyouchadim* or Secret Intelligence Service) prefers to use its own operatives, distrusting mercenaries. It may be encountered when the team's mission is counter to Israeli interests. Counterespionage is handled by Shin Beth (*Sherut Bitachon Klatt* or Counterespionage and Internal Security). Counterterrorist operations are handled by Mossad and special elite units of the Israeli Army.

BND: The BND (*Bundesnachrichtendienst* or Federal Intelligence Service) is the German intelligence service. Counterespionage and counterterrorist operations are handled by GSG-9 (*Grenzeschutzgruppe-9*).

UB: The Polish intelligence service.

AVH: The Hungarian intelligence service.

DIE: The Romanian intelligence service, in low esteem from 1989 to 1993, but reformed when things started to fall apart in Europe.

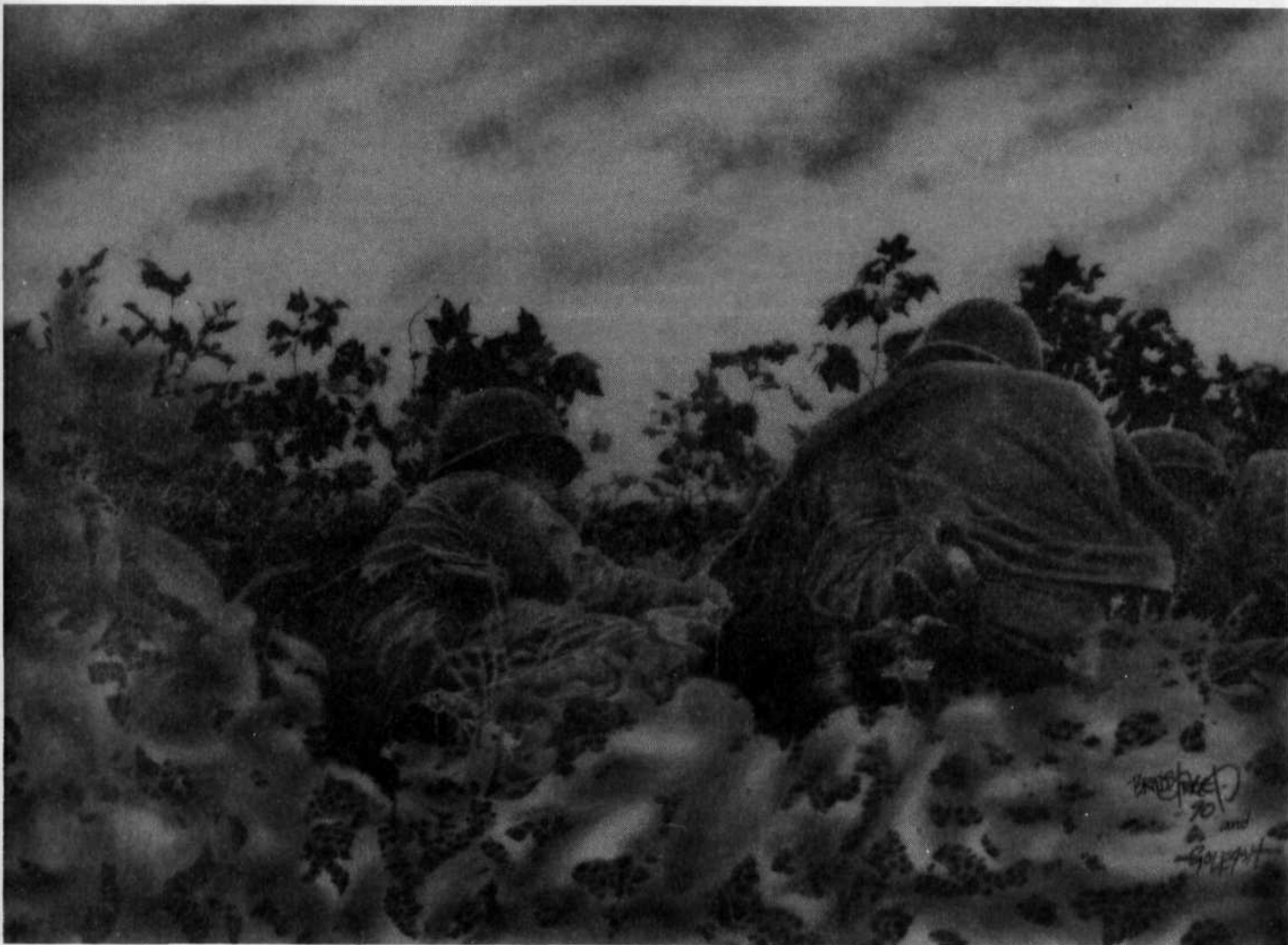

THE WORLD OF 2000

The present world situation is an unexpected one. Most people anticipated that the last decade of the 20th century was to be "the end of history" (as one writer put it), a period of peace and of little or no historical interest whatsoever. By the second half of 1990, it was obvious to some that the coming decade was not going to be fun.

Another idea formulated in the late 1980s proved more accurate. This hypothesis stated that the bipolar East/West, US/USSR conflict was soon to fall apart and the two primarily military superpowers (the United States and the Soviet Union) would be replaced by five primarily economic powers (the US, the USSR, Japan, China, and a European community dominated by Germany). Further, the

hypothesis stated that none of these new economic powers would be able to be "global policemen" (enforcers of international order), positions filled by the US and USSR since 1945.

As outlined in more detail on pages 6 through 11 of this book, the world of 2000 is in the midst of a kind of international lawlessness, where each nation (including the major economic powers) is unwilling or unable to project military power beyond its own borders. All of this has radically changed the political-economical landscape. In the absence of the global cops to keep things calm, ethnic groups that had once been independent (or dreamed of it, at least) sought to assume their "proper place." Old territorial claims were

dusted off; old grudges, old hatreds, and old rivalries smoldered and burst into flame. Nuclear war was looking less and less likely, but a new kind of conflict came into being: the brushfire war.

A brushfire war is a little holocaust of limited duration and small global effect (although it is devastating to those involved). During previous years, such wars were discouraged (although not totally prevented) when they did not mesh with one of the bipolar powers' plans. (The conflict between Hungary and Romania, for example, is centuries old, but was kept in check by the Soviets since it would have wasted resources needed elsewhere. With the safety valve of the Soviets removed, events took their own course.)

World Space Programs

United States: The US effort in space was largely abandoned by President Tanner in 1998. All deep space research programs and the Bush administration Mars and moon colony programs were canceled. Shuttle launches of commercial and weather satellites continued on a reduced schedule (the shuttle *Atlantis* was mothballed). The partially finished Bush administration space station project was canceled by the Tanner administration but was purchased by an international business consortium in January 2000 (using a number of California science-fiction writers as its public spokesmen). Nothing has been done as of July 2000.

Soviet Union: The Soviets abandoned all space programs in 1995, but since the Soviets had done nothing in space since 1991, this merely served to formalize an existing condition.

China: China abandoned all space programs in 1994, with the breakup of that nation's central government

Others: Japan and the European Space Agency continue occasional launches, mostly telecommunications and meteorological satellites. Their deep space scientific research programs have been severely cut back, but some are still taking place. Brazil abandoned satellite launches in 1996.

US Armed Forces

The armed forces of the United States were downsized under President Bush after the conclusion of the Iraq/Kuwait crisis of 1990, and further cutbacks were made out of political and economic necessity under President Tanner. The programs of the Strategic Defense Initiative were largely canceled under President Tanner.

The current US armed forces stand as follows:

Army: In 2000, the army consists of four heavy mechanized divisions (all based in the US), two light divisions (one in Hawaii, one in Alaska), one airborne division, one air assault division, and one mountain division.

Six national guard divisions and three reconstitutable divisions (nicknamed "freeze-dried" divisions) are maintained at cadre strength, with the plan of bringing them up to strength from reserves in a crisis.

Air Force: The US Air Force now consists of 16 tactical fighter wings and a small number of transport and specialty units. Strate-

gic bomber and missile wings have been reduced to eight and six respectively. With the B-52 bomber approaching the end of its useful service life, a major debate in the US Congress now rages over whether to replace the B-52 with a newer model or do away with strategic nuclear bombers altogether.

Navy: With the threat of the Soviet Union gone for more than a decade, the US Navy became almost a pure defensive force and suffered the most severe cutbacks of the US armed forces. Many of the huge carrier task forces and all battleship task forces were mothballed. The navy maintains an Atlantic fleet (based on the east coast of the US), a Pacific fleet (based in Hawaii), and a number of smaller task forces. A strategic missile submarine fleet is retained but is much smaller than in previous years.

Marines: The US Marine Corps in 2000 consists of four active and three reserve brigades, plus attached air assets. Small contingents are maintained with each fleet and at US embassies throughout the world.

The Iraq/Kuwait crisis of 1990 was one of the last where concerted international military action was undertaken. The recession that had begun to hit the United States and Japan was worsened by the erratic oil market, and the world economy proved unable to take the strain.

The major divisions of the world since 1945 have completely broken down. The division into the Eastern Bloc, the Western Bloc, and the nonaligned or Third World countries is no longer valid. The NATO alli-

ance is gone, as is the Warsaw Pact, the OAS, and the EEC.

Multinational corporations have taken over much of the economic coordination that was the venue of organizations such as the World Bank and OPEC. These corporations have become, in a way, landless nation-states. The one major economic activity that has not yet been taken over by the corporations is that of the mercenary—the life is still largely pursued by independent contractors or small groups.

CRIME

In the absence of effective government controls, a number of areas of the world have been taken over by a new form of international corporation: the international criminal cartel. These new cartels make the criminal groups of earlier in the century seem small, disorganized, and ineffective by comparison. Taking a leaf from the book of international corporations, these new criminal cartels are organized, financed, and operated almost identically to the multinational corporations.



THE HIRING HALL

A Job-Hunters' Guide to World Hot Spots

The four major hiring centers for mercenaries in 2000 are Singapore, Tunis, Istanbul, and Havana. Singapore is the largest of these, and has been labeled the "mercenary capital of the world" by some observers. Singapore covers Asia, Tunis covers Africa, Istanbul covers the Arab world and east Africa, and Havana covers the Western hemisphere, primarily Central and South America.

Other minor centers of mere hiring are London, Geneva, and Miami.

NORTH AMERICA

While it is reported that a number of terrorist organizations are operating in North America, no solid evidence of such activities has been made public. Both Canada and the United States have disgruntled socioethnic groups which could form insurgencies given sufficient provocation, but again, no such activities have been reported.

Canada: In Canada, Quebec is the prime source of strife, but this is presently low-key compared to previous years. There has been

occasional armed violence on Indian reservations, but this is also less than in recent years. Some criminal violence has spread across the border from the US, but all in all, Canada is relatively quiet.

United States: Crime is the problem most on the minds of America's citizens, and most place the blame squarely at the feet of the federal and state governments (although the reasons vary). Kidnapping, industrial sabotage, and drug/gang-related violence are on the increase. In the US, some inner cities are effectively war zones, created by feuding drug/criminal cartels. Rural areas do not completely escape either, and America is violent at a level not seen since the 1920s. Firearms sales are up, vigilantism is growing, and there is an increasing tendency to hire private security firms (as mere groups are euphemistically called in the US) to fill in where the police fail.

THE PACIFIC

The Pacific islands are underpopulated and (with some exceptions) economically

deprived. Occasional attempts have been made to exploit the isolation of these island countries by mercenary bands, most notably the recent coup in Tonga.

A few underfunded and ill-supported local insurgencies exist, and local governments often make use of mercenaries as security forces or training cadres for their conventional armed forces.

Tonga: The Tongan coup was successful, leaving an 800-man mercenary force in charge of the country. But the situation is far from stable, and anything could happen.

Indonesia: Indonesia is in the grip of a continuing civil war pitting mercenary forces of the Australian-backed government against several groups of local insurgents. Both sides are hiring.

Philippines: The civil war in the Philippines continues. Both sides are hiring.

Japan: A Japanese border dispute with Soviets over Sakhalin and the Kurile islands has yet to result in military action, but could do so any time.

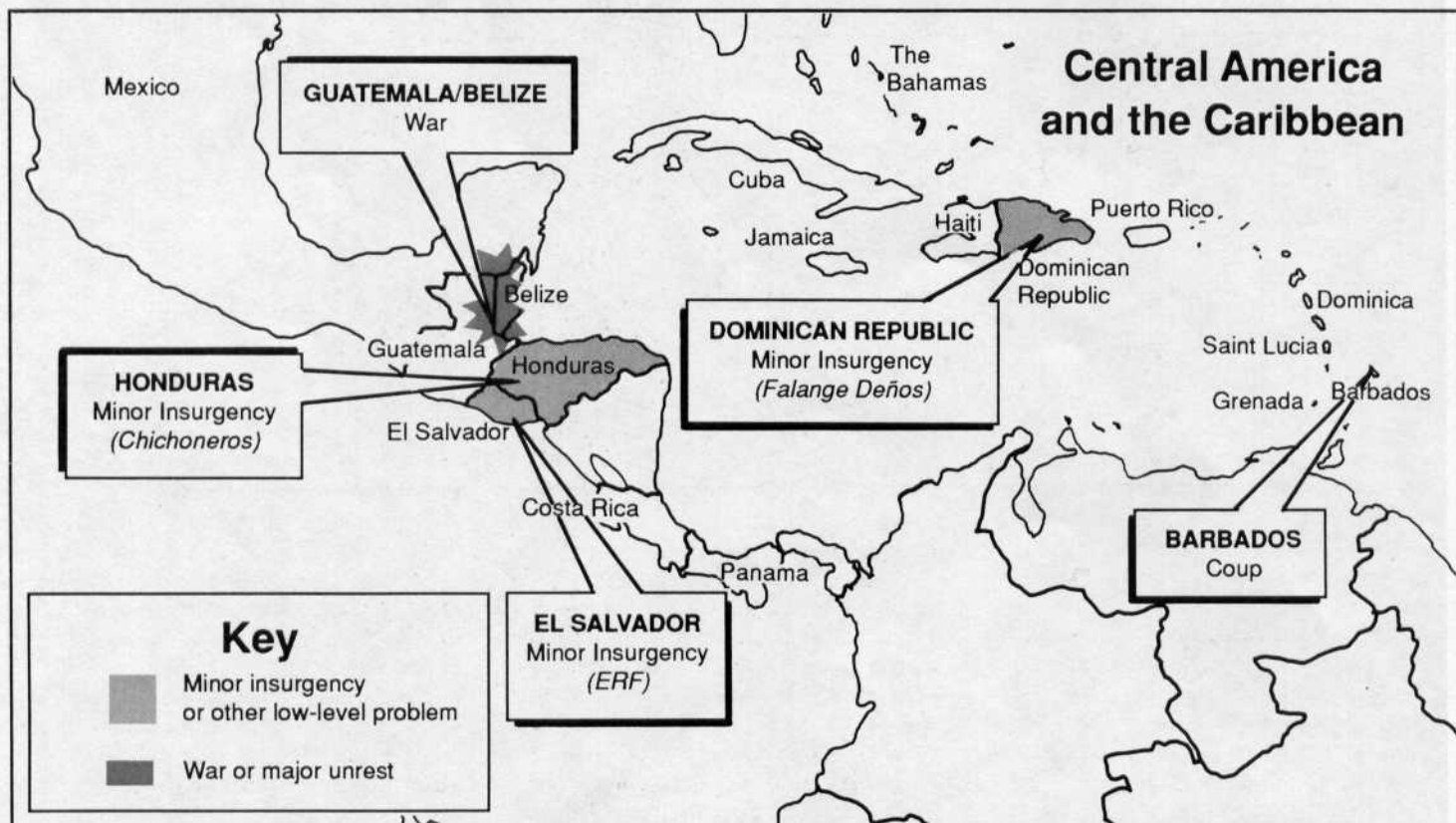

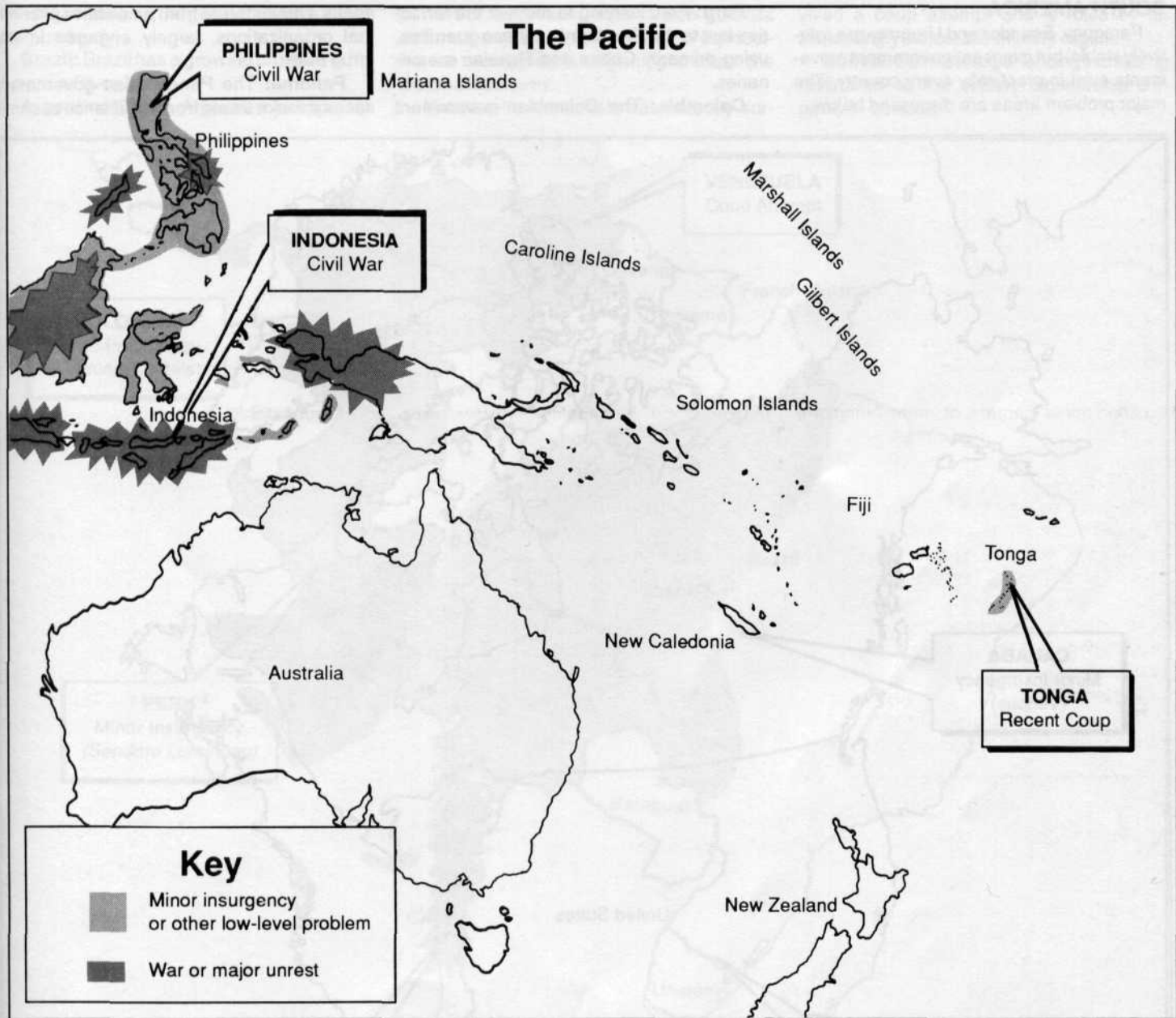

CENTRAL AMERICA

With the reduction of US and Soviet diplomatic presence in the region, the situation in Central America has become "more fluid." Antigovernment insurgencies exist in practically every country, but the most active are dealt with below.

As a side note, American mercenaries are not always welcome in South and Central America.

Mexico: Mexico is relatively quiet as the world goes, but still has internal civil strife brought about by its loan defaults and the world economic crisis.

Guatemala/Belize: Guatemala and Belize are still at war, and an active mere market exists in both countries.

El Salvador: The government is hiring mercenaries for action against a minor insurgency conducted by a group called the *Ejercito Revolution Popular*, an old-style socialist revolutionary coalition.

Cuba: With aid from the Soviet Union cut off, Cuba found itself in an economically precarious position, which it tried to solve in several ways, one of which was to become a supplier of mercenary troops. Cuban troops are experienced, trustworthy, and relatively apolitical (nowadays).

Honduras: The government is hiring mercenaries for action against a minor insurgency conducted by a group called the *Cinchoneros*.

Panama: When the canal was turned over

to the Panamanians, American military presence in the region was severely reduced, and the economic situation forced even more cutbacks. The Panamanian Army seeks mercenaries as cadre for its elite forces and as part of the presidential guard.

Dominican Republic: The government is hiring mercenaries for action against a minor insurgency conducted by a group called the *Falange Deño*, a conservative coalition with some sympathy among lower-level Dominican military officers.

Barbados: A recent coup ousted the democratically elected government of Prime Minister Calvin Forsythe, dissolving the senate and house of assembly and declaring martial law.

SOUTH AMERICA

Paraguay, Ecuador and Uruguay are relatively stable, but minor antigovernment movements exist in practically every country. The major problem areas are discussed below.

Peru: Peru is trying to recover the territories lost to the *Sendero Luminoso* guerrillas, using primarily Cuban and Russian mercenaries.

Colombia: The Colombian government

faces a major threat from an alliance of criminal organizations, largely engaged in the drug trade.

Panama: The Panamanian government faces a major threat from an alliance of crimi-

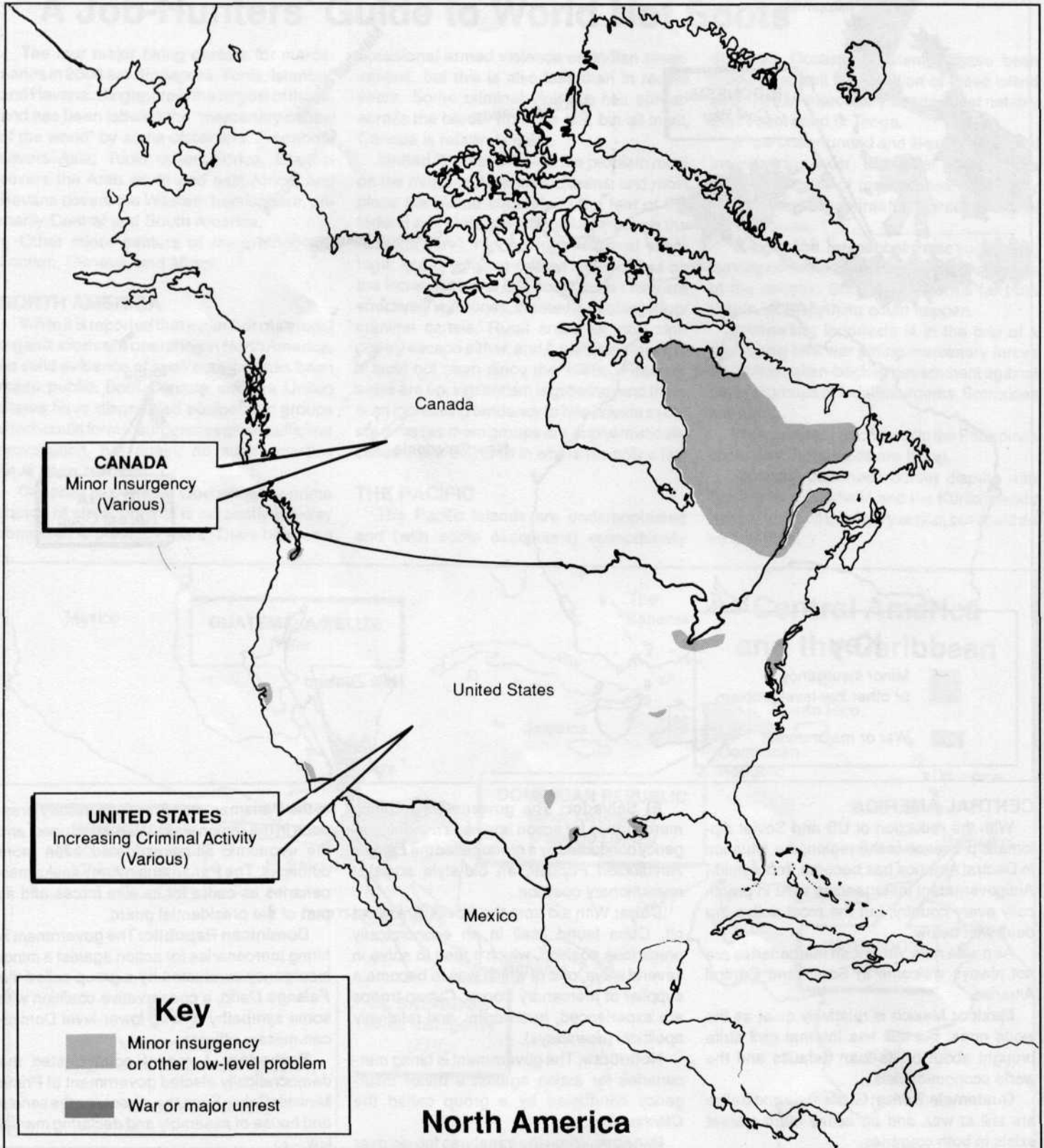

nal organizations, largely engaged in the drug trade.

Brazil: Brazil has agrowing problem in the Amazon River basin.

Argentina/Chile: Argentina occupies a

portion of Chile and faces hostile guerrilla actions there. The financial strain of conducting the occupation is beginning to affect the national economy.

Venezuela: Venezuela has recently sur-

vived a coup attempt and is ruled by an increasingly autocratic military regime.

Bolivia: Bolivia is experiencing increasing resistance to the military dictatorship currently in control.

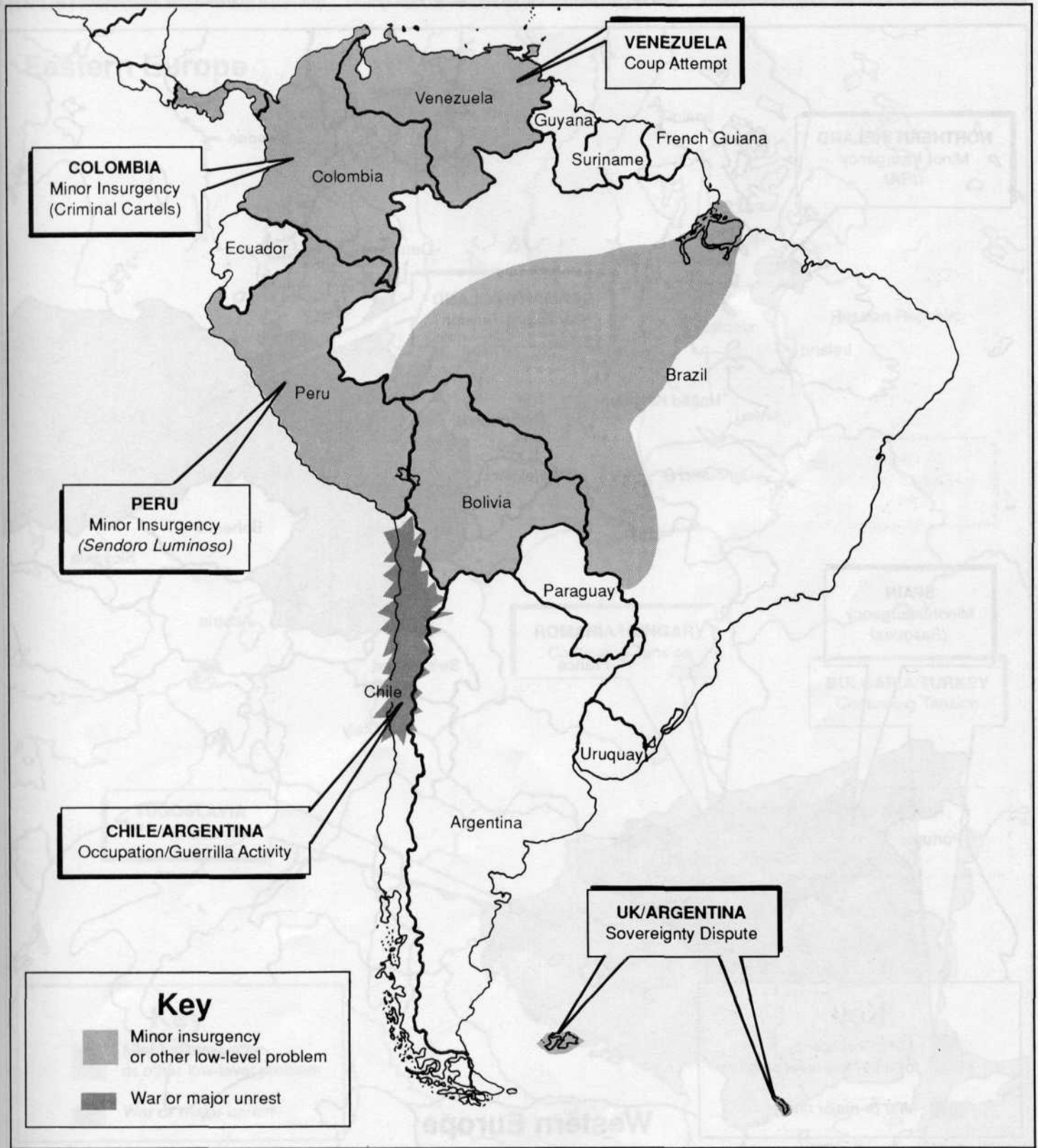

EUROPE

Most of Europe is reasonably peaceful, although economic distress is everywhere. The Libyan government is financing a low-key (but growing) terrorist campaign in numerous countries, primarily France, Germany, and Great Britain.

Germany/Poland: Reductions in forces in the early 1990s put many German mercs on the market, but many of these returned to German service at the time of the Polish crisis and remain there. German mercenaries are still fairly common in South American coun-

tries, in Africa, and in China. At present, the Polish/German border is relatively quiet.

Hungary/Romania: The Romanians have defaulted on their reparation payments to Hungary, and a tense situation is developing, but open warfare has not yet broken out.

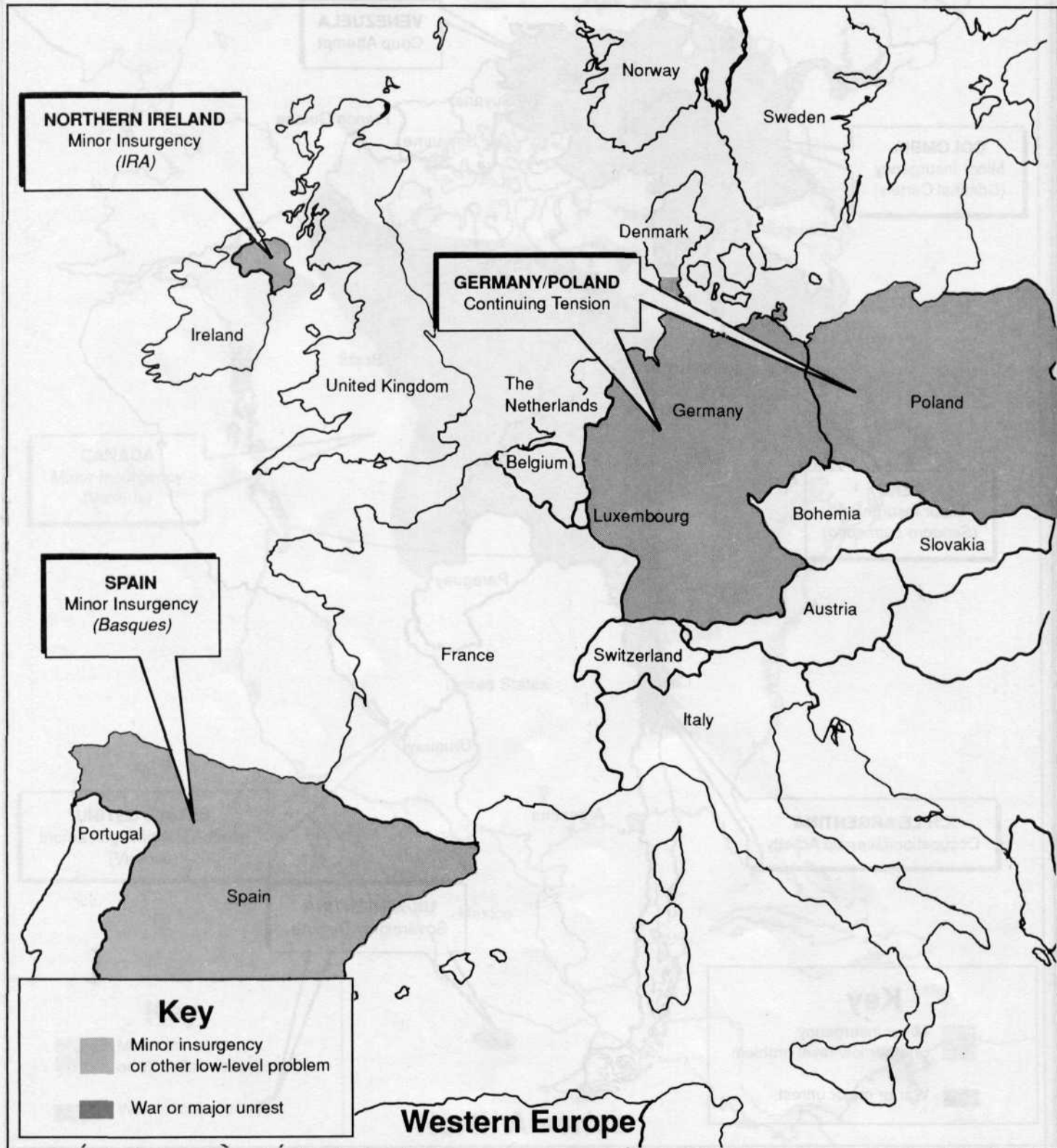

Ireland: Northern Ireland is still in the midst of "the troubles," and it remains one of the few places the British have not switched over to mercenaries.

Greece: Greece retains some forces in Cyprus in support for the Greek Cypriots and

some in Macedonia to protect the Greeks there. Many of these troops are Soviet and American mercenaries.

Turkey/Bulgaria: The Turkish/Bulgarian border situation is tense but stable.

Spain: Spain faces an increasing insur-

gency in the Basque portions of the country, although the Catalans have remained quiet.

Scandinavia, et al.: The Scandinavian countries are free of internal minority strife, but disturbances attributed to Libyan troublemaking occur from time to time.

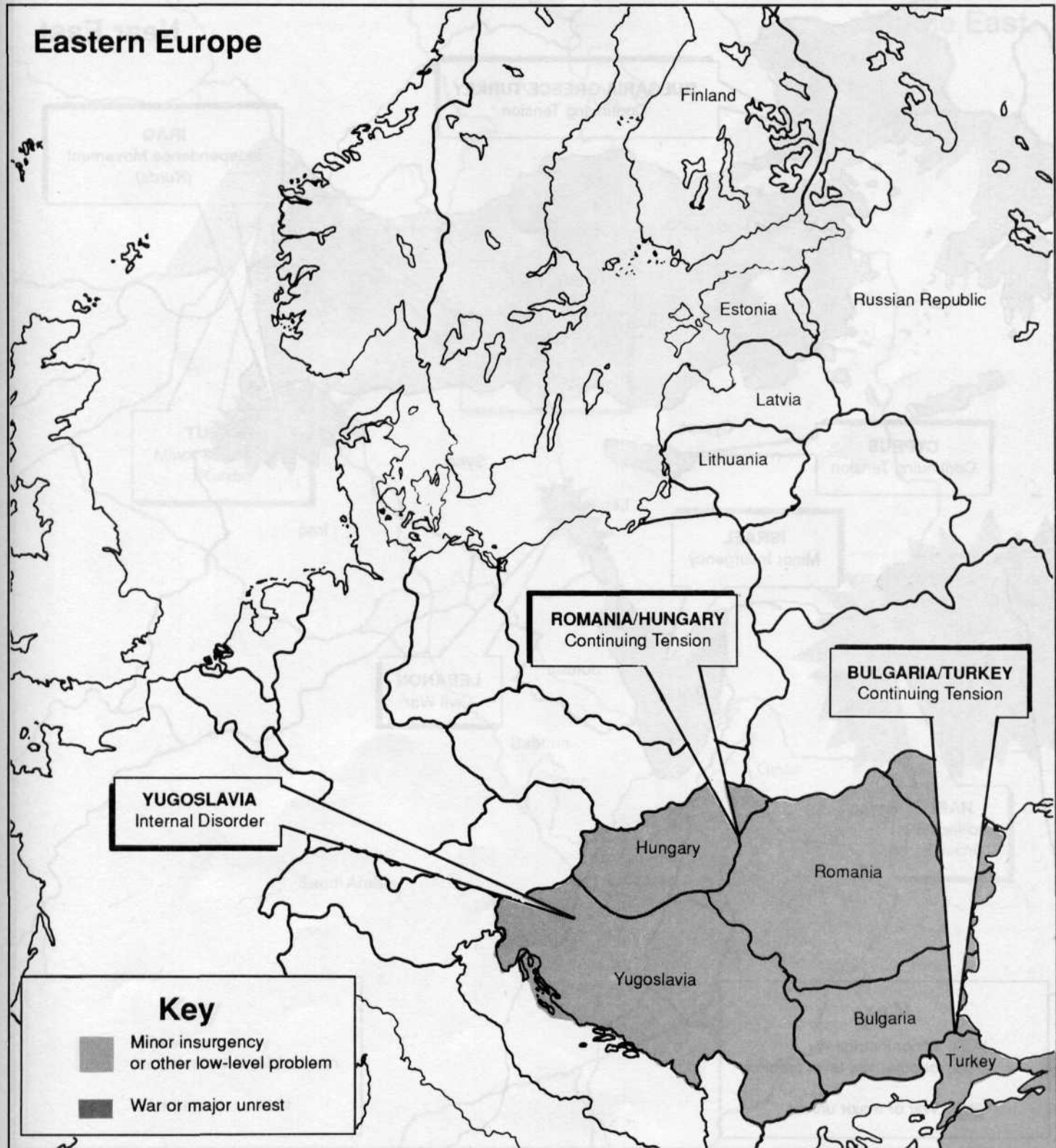

MIDDLE EAST/NEAR EAST

Turkey/Cyprus: Cyprus is once again split between Greek-backed and Turkish-backed factions, and a low-level civil war continues.

Lebanon: After a relatively quiet period

from 1992 to 1996, things have begun to heat up again. The main groups still remain: a number of Christian militias (some of them Israeli-supported and often fighting themselves as much as everyone else), several

anti-Israeli factions (primarily Palestinian), and a number of Islamic militias (again, often fighting each other as often as they do their nominal opposition). The area is ripe for criminal groups and terrorists as well.

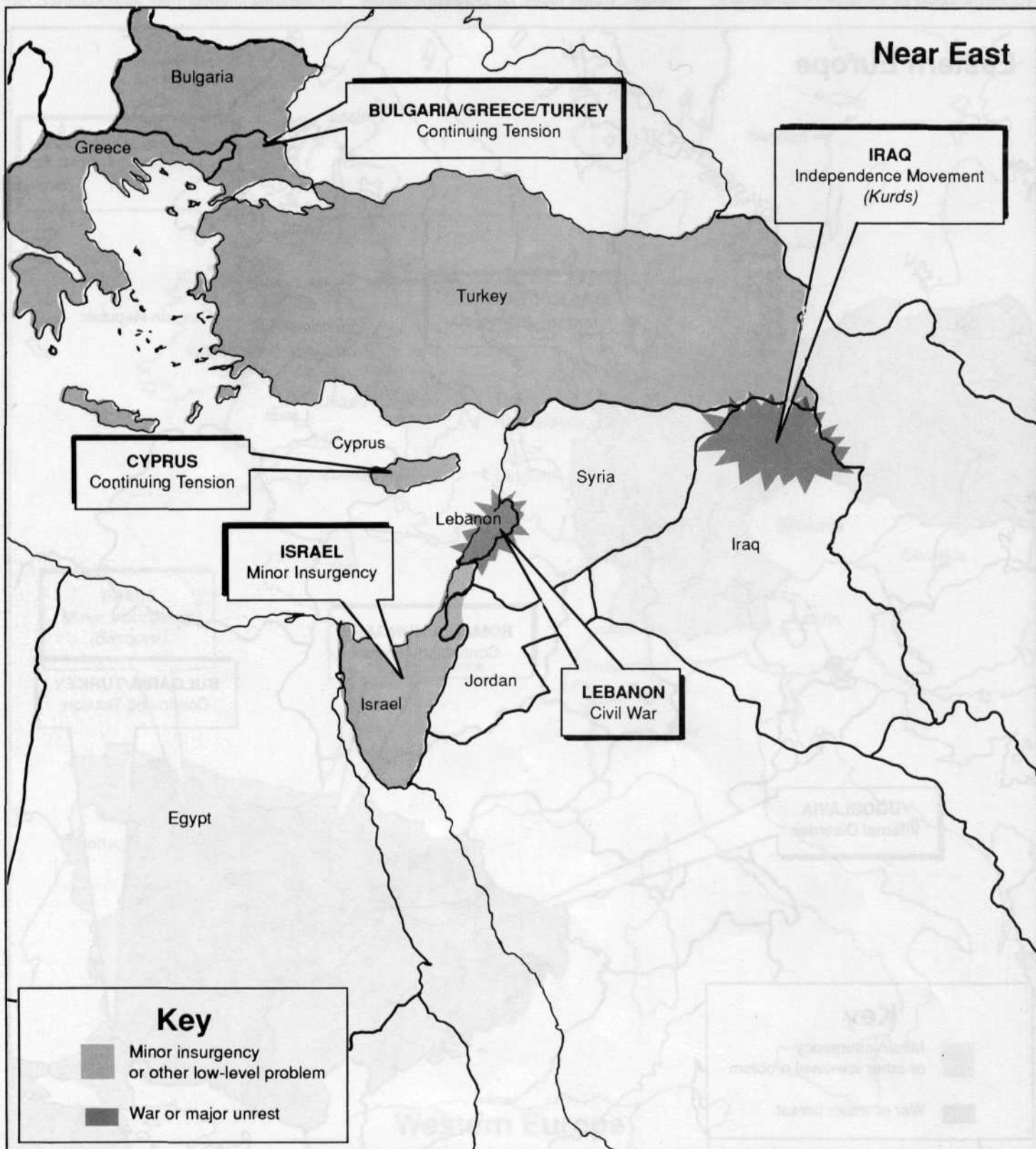

Iran: The major military threat faced by the Iranians is the continued insurgency by the Baluchis, aided by their countrymen in the Baluchi portion of Pakistan. This low-level guerrilla war has recently begun to heat up as

the Baluchis hire foreign soldiers to train their fighters in modern combat.

Iraq: By the time Iraq had recovered from the Kuwait crisis of 1990, the Kurds (aided by unknown foreign powers) rose in active re-

bellion. Iraqi treatment of the Kurds during the Iran/Iraq war of the 1980s was barbaric (Kurdish civilians were the subject of chemical attacks) which instilled in them a tremendous desire for revenge.

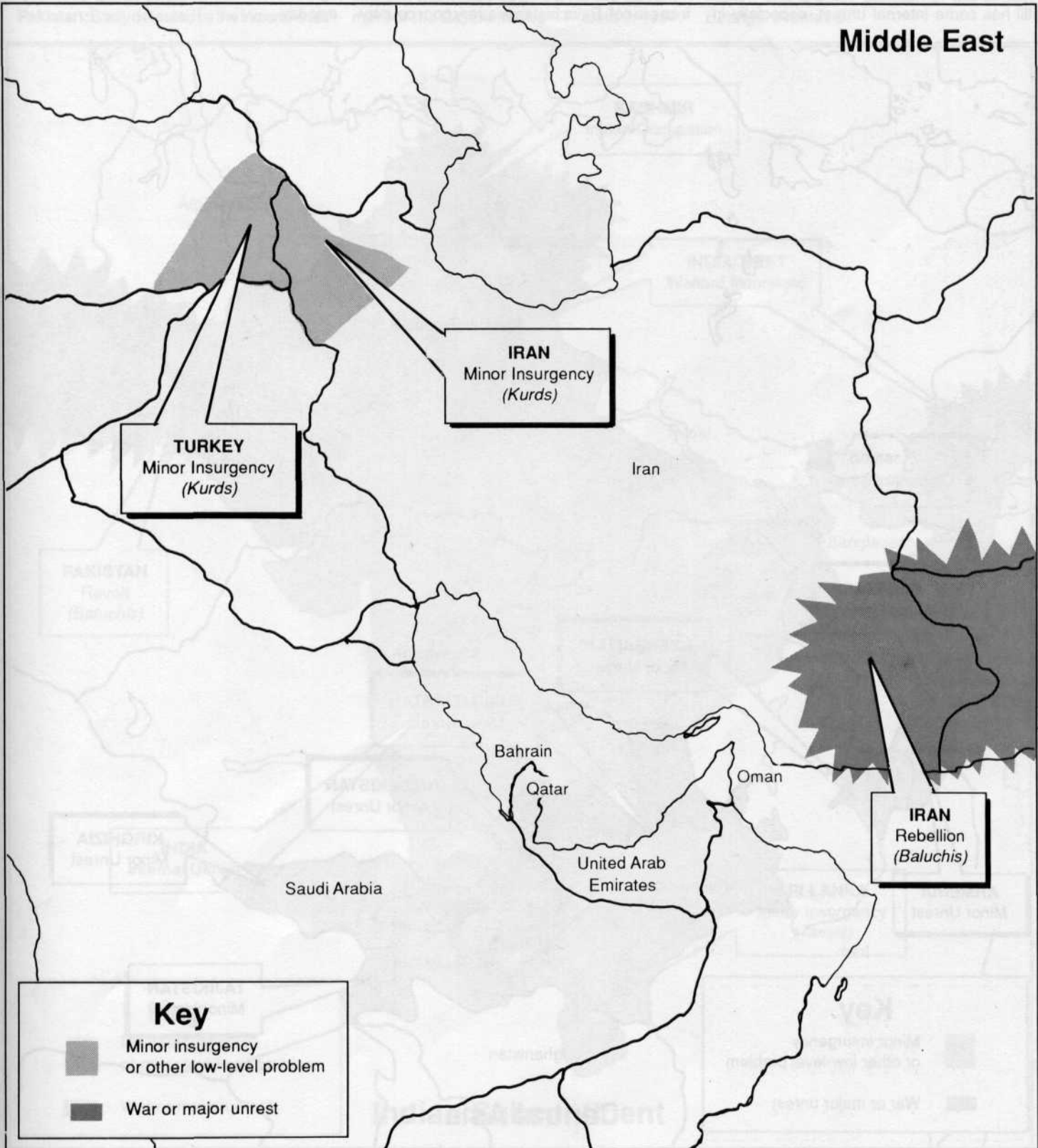

CENTRAL ASIA

USSR: For all practical purposes, the Soviet Union has ceased to exist as the superstate it once was. Now more closely resembling the 13 American colonies under the Articles of Confederation, the Soviet Union still has some internal unrest, especially in

Armenia, Georgia, and the Islamic republics.

INDIAN SUBCONTINENT AND INDIAN OCEAN

Baluchistan: The Baluchi areas of Pakistan are effectively independent, but those in Iran are not. Baluchistan is a very poor country

and is unable to pay much, but is still seeking mercenaries to train its forces and help in liberating the other part of the country.

Sri Lanka: With the withdrawal of UN forces, the situation in Sri Lanka has begun to heat up again and could explode suddenly into violence any day.

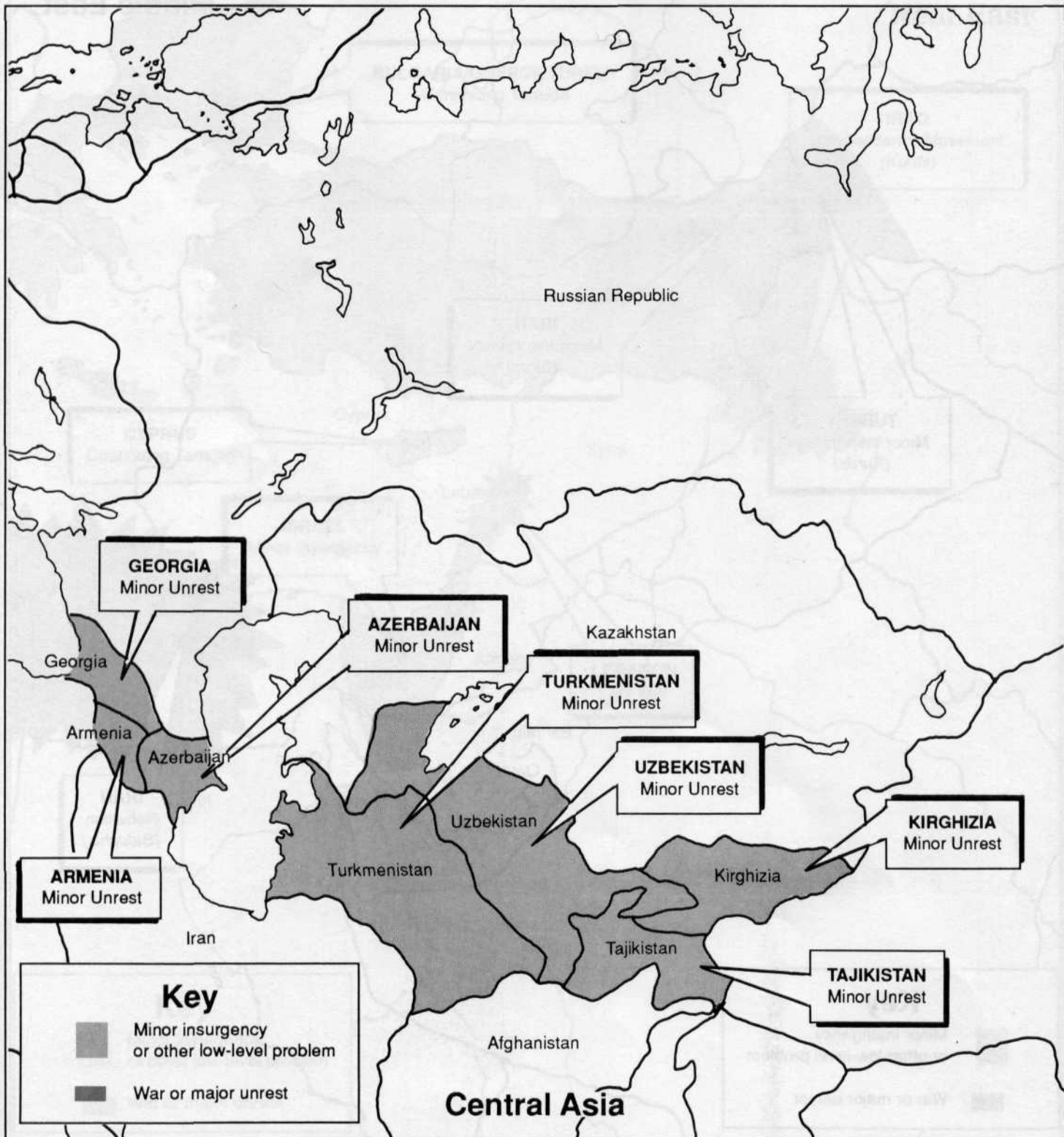

India: India is plagued by internal economic problems caused by too many people and too few resources, as well as revolts in Kashmir and other areas. Border conflicts with the Chinese and Tibetan warlords also help to keep things tense.

Pakistan: Badly defeated by the Indians in the

recent war, the Baluchi insurgency keeps the Pakistani military (or what's left of it) occupied.

Seychelles: Perhaps inspired by Mike Hoare's attempt in 1981, a group of mercs (reputedly in the pay of a Latin American drug kingpin) attempted to take over the government of the Seychelles from France in 1997.

Swift action by the French Foreign Legion foiled the coup, which had no local support to begin with and (in hindsight, at least) was doomed to failure. Nominally apart of France, the islands' defense is still technically a French matter, and a small garrison of the *Ldgion Étrangère* remains.

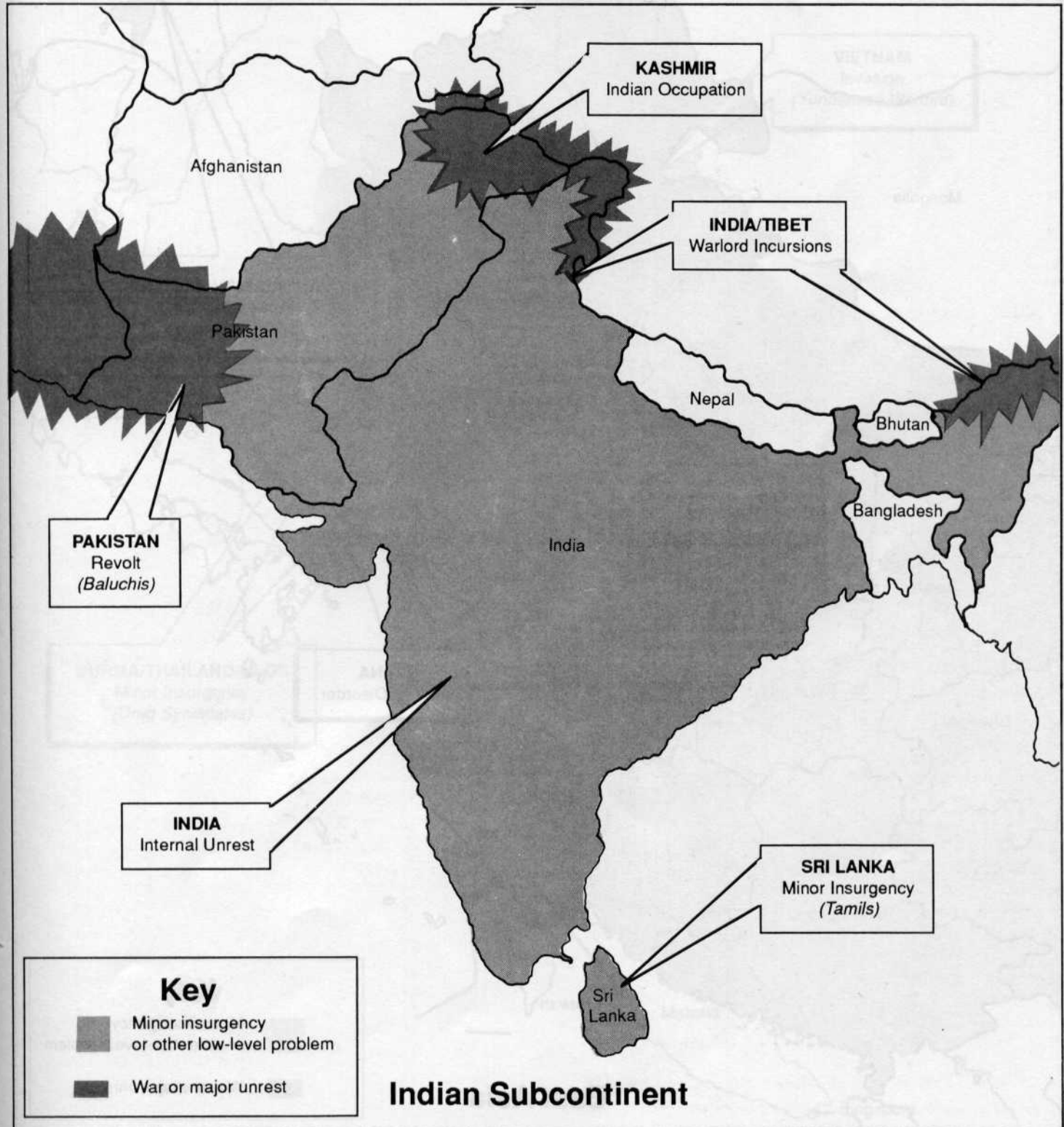

EAST ASIA

China: There is no longer a central government in China, but the warlords (major and minor) are constantly searching for mer-

to act as cadres and to perform special missions. The map shows the rough divisions of the country and areas of conflict.

Hong Kong: Hong Kong took advantage

of Chinese disorder to declare itself a free and independent city, like Singapore. The city is nominally a part of the British Commonwealth, but is pretty much on its own militarily.

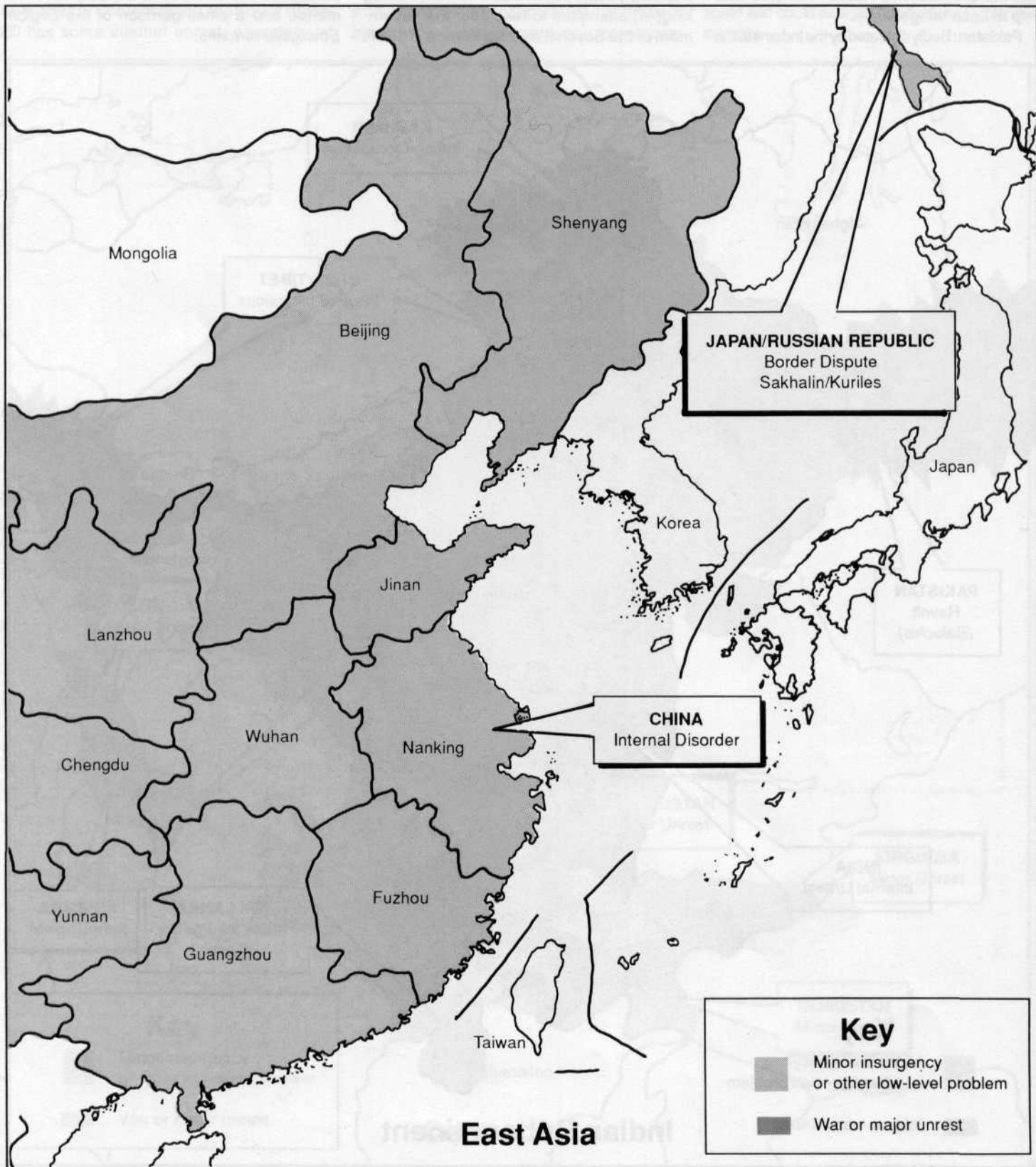

Mercenaries are in quite heavy demand, both for local defense and because the city is a clearing house for mercs seeking work inside of China.

SOUTHEAST ASIA

Vietnam: Vietnam is still troubled by minor bodies of Yunnanese troops that hold out in the northern portion of the country.

Thailand/Burma: Both are subject to a continuing insurgency by drug cartels in the interior regions. Neither can do much about the situation without assistance, and little is forthcoming.

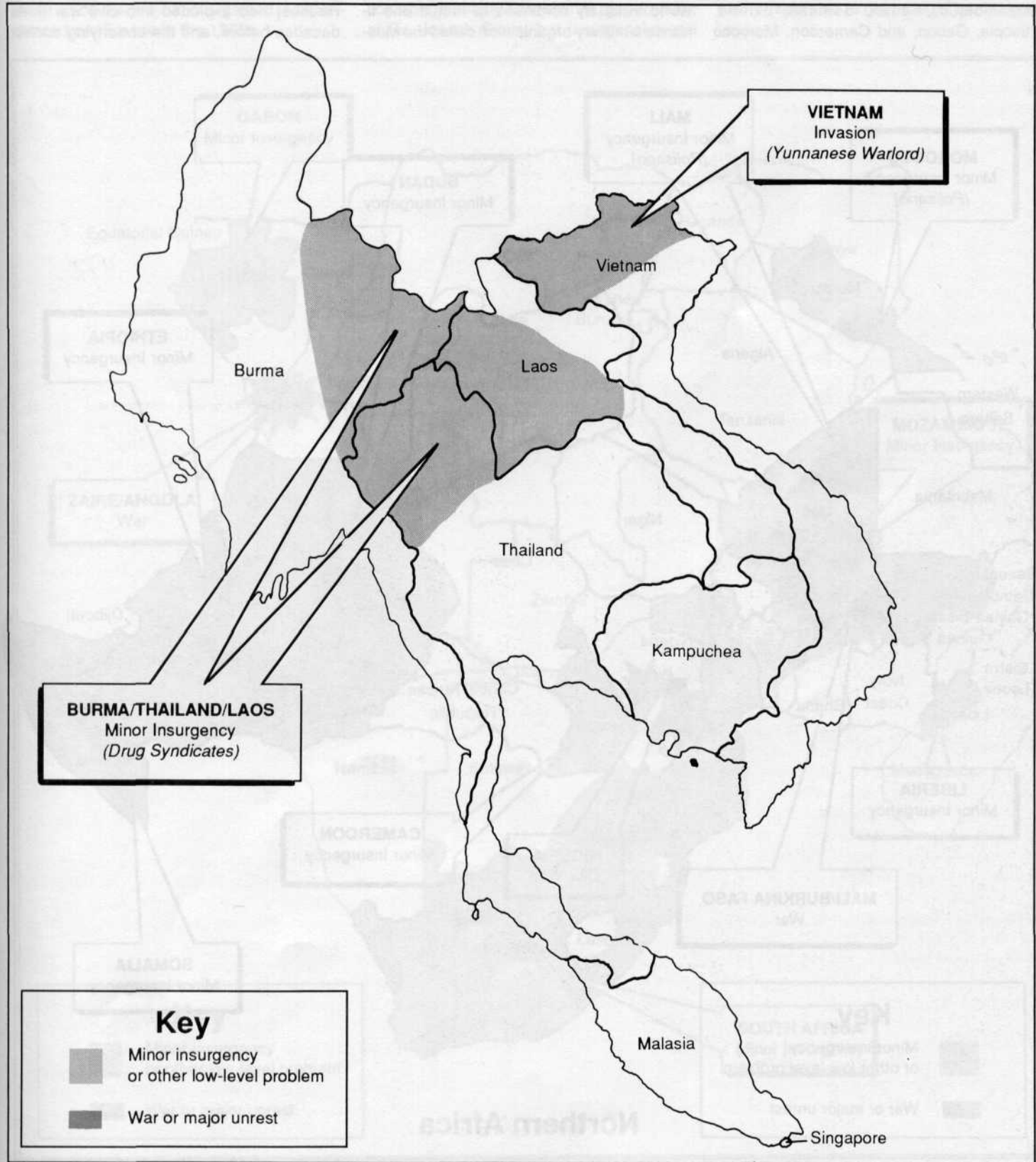

AFRICA

The countries of Central Africa are in severe civil disorder. Libyan-backed insurgents continue to trouble Chad.

Minor antigovernment coalitions exist in Mozambique, Sudan, Somalia, Liberia, Ethiopia, Gabon, and Cameroon. Morocco

and Mali continue to face Polisario insurgencies.

Libya: Muamar Khadafy remains in charge of Libya and is devoted to spreading his political philosophy throughout Africa and the world. Khadafy continues to recruit and finance a military organization called the Mus-

lim Legion of Africa. The legion serves mostly in Africa, but occasionally pops up elsewhere.

Nigeria/Biafra: Oppression of the predominantly Catholic Ibo tribe by other ethnic groups in Nigeria (mostly the largely Muslim Hausas) had exploded into civil war three decades before, and the underlying conflict

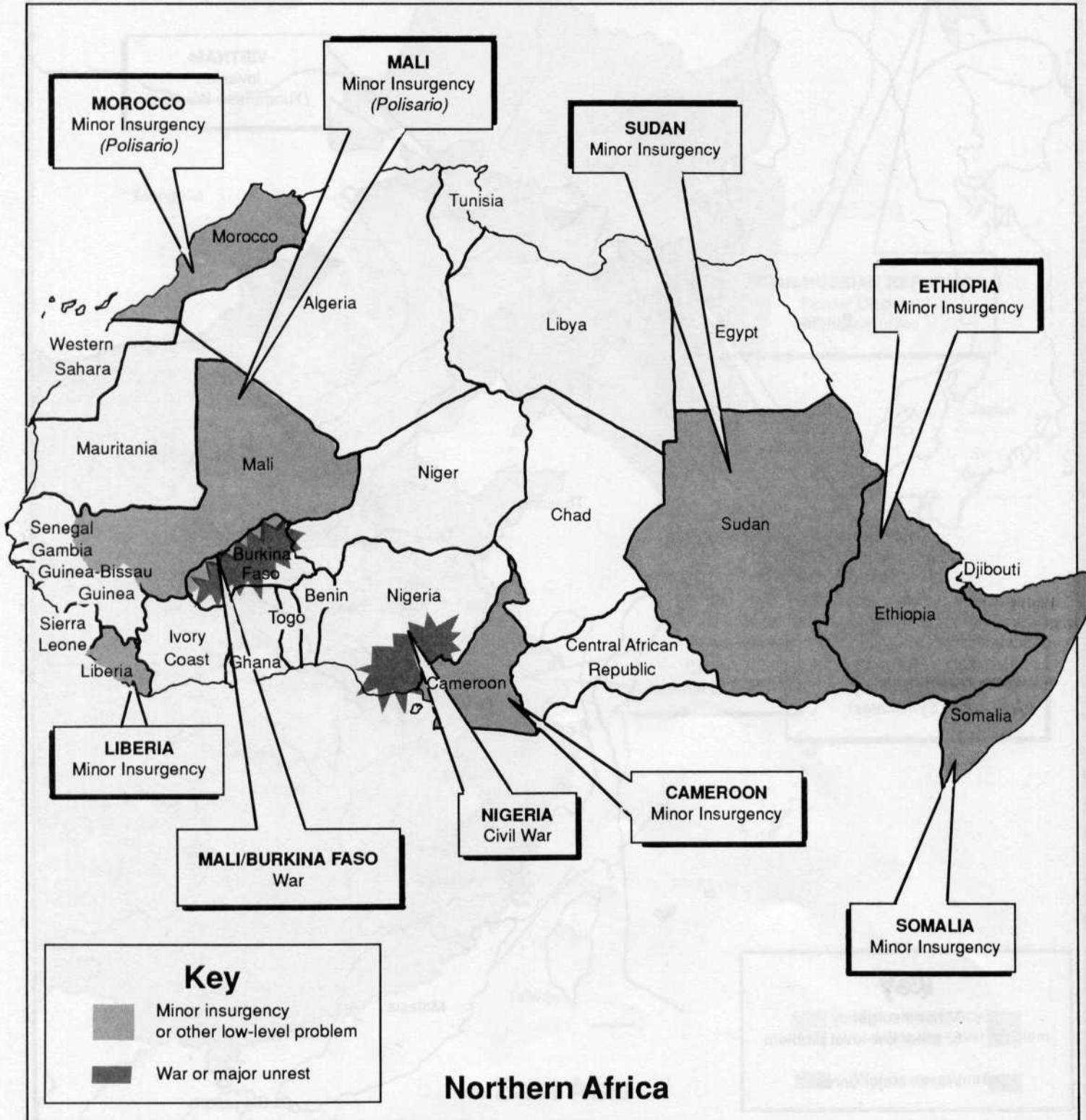

resurfaced in the 1990s. The action has stalemated, and both sides seek mercs.

Mali/Burkina Faso: The long-standing border dispute between these two western African nations has flared up and cooled down since the two nations gained independence from France in the 1960s.

In 1998, it erupted into full-scale war and continues to the present. Burkina Faso has support from Libya.

Republic of South Africa: The Republic of South Africa is relatively stable under the coalition (primarily Xhosa/white) government of Dr. Joseph Slovo, but insurgencies still

remain (primarily among the Zulus, but among other black and conservative white groups as well).

Angola/Zaire: The war over the annexation of the Cabinda Enclave continues with neither side able to gain a significant advantage.

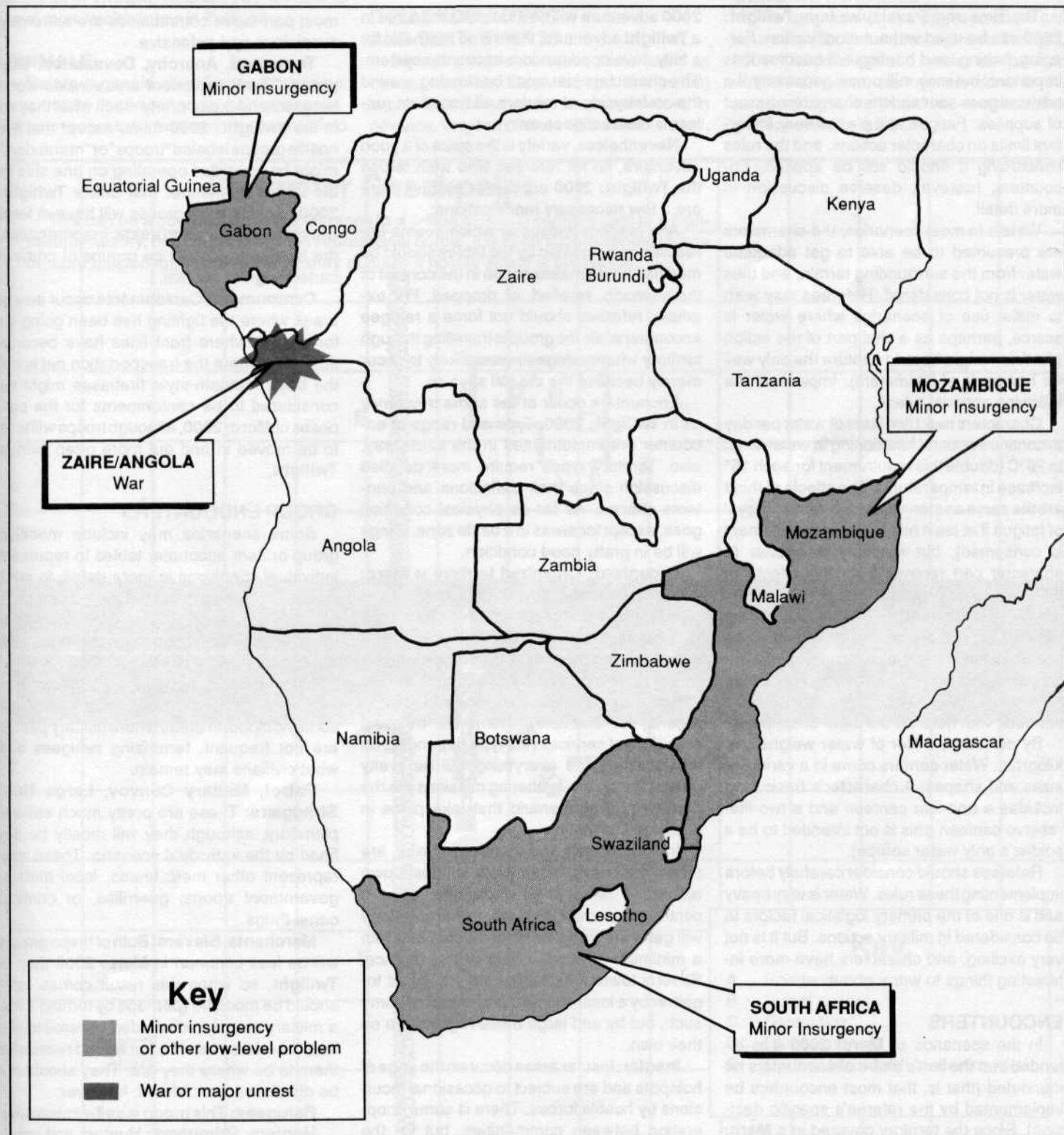

TIME, TRAVEL AND ENCOUNTERS

The Time and Travel rules from **Twilight: 2000** can be used without modification. Foraging, fishing, and hunting will become less important, but may still prove necessary if a retrieval goes sour and the characters run out of supplies. Fatigue still places very important limits on character actions, and the rules concerning it should still be applied. Encounters, however, deserve discussion in more detail.

Water: In most scenarios, the characters are presumed to be able to get adequate water from the surrounding terrain, and thus water is not considered. Referees may wish to make use of scenarios where water is scarce, perhaps as a vital part of the action (the team might have to capture the only well for hundreds of kilometers). Implement the following optional rules:

Characters need two liters of water per day to continue optimal functioning in weather up to 20°C (double this requirement for each 15° increase in temperature). The effects of thirst are the same as starvation (subtract one level of fatigue if at least half the daily requirement is consumed), but recovery is quicker (a character can recover from the effects of thirst in one day by consuming 110% of the normal requirement). Death occurs more rapidly also: A character on half water rations will die within a week, one on no water within a few days. Animal water requirements are much larger than those for humans, but are not dealt with here for the sake of simplicity.

By definition, a liter of water weighs one kilogram. Water carriers come in a variety of sizes and shapes. A character's basic load includes a one-liter canteen and a two-liter reserve canteen (this is not intended to be a soldier's only water source).

Referees should consider carefully before implementing these rules. Water is very heavy and is one of the primary logistical factors to be considered in military actions. But it is not very exciting, and characters have more interesting things to worry about.

ENCOUNTERS

In the scenarios of **Merc: 2000** it is intended that the lion's share of encounters be mandated (that is, that most encounters be implemented by the referee's specific decision). Since the territory covered in a **Merc:**

2000 adventure will be much less than that in a **Twilight** adventure, there is no real need for a fully developed random encounter system. The characters just won't be running around the countryside at random all that often (unless a retrieval goes awry).

Nevertheless, variety is the spice of a good adventure, so for referees who wish to use the **Twilight: 2000** encounter system, here are a few necessary modifications:

Any random encounter which seems unrealistic as mandated by the tables should be modified until it makes sense in the context of the scenario, rerolled, or dropped. For example, referees should not force a refugee encounter while the group is travelling through territory where refugees are unlikely to occur merely because the die roll says so.

Encounters occur at the same frequency as in **Twilight: 2000**. Type and range of encounter are implemented in the same way, also. Territory types require more detailed discussion since their definitions and contents change. As far as physical condition goes, except for areas in a battle zone, things will be in pretty good condition.

Organized: Organized territory in **Merc: 2000** is still under government control and represents the predominant terrain type throughout the world. Conditions will vary depending on the nation (the definition of a "major road in good repair" in central Indiana will be very different from those in Central Algeria, for example). There will be local government services (the type depending on the locality), and everything will be pretty quiet. Information-gathering missions are the primary sort of scenario that take place in organized territory.

Independent: Independent areas are those that have fallen back on their own resources rather than depending upon a central government. Everything that gets done will get done using local resources, and with a minimum of outside help or interference. Several towns or villages may be linked together by a local cooperative council or some such, but by and large these regions are on their own.

Insular: Insular areas occur on the edge of hotspots and are subject to occasional incursions by hostile forces. There is some cooperation between communities, but for the

most part these communities are extremely suspicious and defensive.

Terrorized, Anarchy, Devastated, Disputed: These represent areas inside world hotspots and mean pretty much what they do in the **Twilight: 2000** rules, except that the hostile groups labeled "troops" or "marauders" might be guerrillas operating on one side or the other. Remember that unlike **Twilight: 2000**, most fighting groups will have at least a nominal allegiance to a side. In some cases, the hostile bands will be groups of criminal cartel thugs or the like.

Cantonment: Cantonments occur only in areas where the fighting has been going on for awhile, where front lines have become fluid, and where the transportation net is not the best. Vietnam-style firebases might be considered to be cantonments for the purposes of **Merc: 2000**, although troops will tend to be moved in and out more often than in **Twilight**.

GROUP ENCOUNTERS

Some scenarios may include modified group or item encounter tables to represent individual conditions in more detail. In most cases, the scenario will define the composition and equipment of any groups encountered. The group encounter descriptions will change somewhat in **Merc: 2000**:

Marauders: Marauders are groups of ex-soldiers or civilians turned bandit. They infest some hotspots in areas where military patrols are not frequent, terrorizing refugees and what civilians may remain.

Patrol, Military Convoy, Large Unit, Stragglers: These are pretty much self-explanatory, although they will mostly be defined by the individual scenario. These may represent other mere teams, local militias, government troops, guerrillas, or criminal cartel thugs.

Merchants, Slavers: Both of these groups will be less common in **Merc: 2000** than in **Twilight**, so when this result comes up it should be modified (perhaps by turning it into a military convoy), discarded or rerolled unless the referee can think of a good reason for them to be where they are. They should not be dismissed out-of-hand, however.

Refugees: This group is self-explanatory.
Hunters, Primitives: Hunters and primi-

tives will be less common in hotspots, but if the characters are making a cross-country impromptu escape, they could be encountered randomly. These groups now represent indigenous inhabitants of a less-developed territory rather than their **Twilight** definitions.

Smugglers: Smugglers are pretty much the same as in *Twilight*, although they will tend to have more vehicles than in *Twilight*.

ANIMALS

Referees should allow for random animal encounters in all scenarios. Animal encounters can serve to throw a monkey wrench into

the best-laid attack plans. Suppose a herd of wild pigs decides to move across the perimeter just as your group is moving into attack position? What if the team decides to choose a rice paddy full of water buffalo for an LZ? What if a tiger wanders into your carefully laid-out ambush?

ITEM ENCOUNTERS AND SETTLEMENTS

As with group encounters, items (such as camps, hospitals, supply dumps, and so on) should be marked on the map and defined in advance. Very few of these will be encountered,

and the characters will know about some of them (or they should, anyway) from the mission briefing. The same holds true of villages, towns, and other communities. Settlement size, attitude, government type, and soon are better dictated by the referee than determined at random.

GENERIC LOCALES

The diagrams on the pages to come can be used to supplement those given in *Twilight: 2000*. The buildings and locales can be used with either game, as they are done to the standard eight-meter and two-meter combat grid specified in the game.

Perimeter Checkpoint

This can be a guardhouse at the entrance to a prison or prison camp, a gate to a high-security factory, or a checkpoint at an international border. It may be supplemented by one or more machinegun bunkers or infantry dugouts if hostile action is suspected.

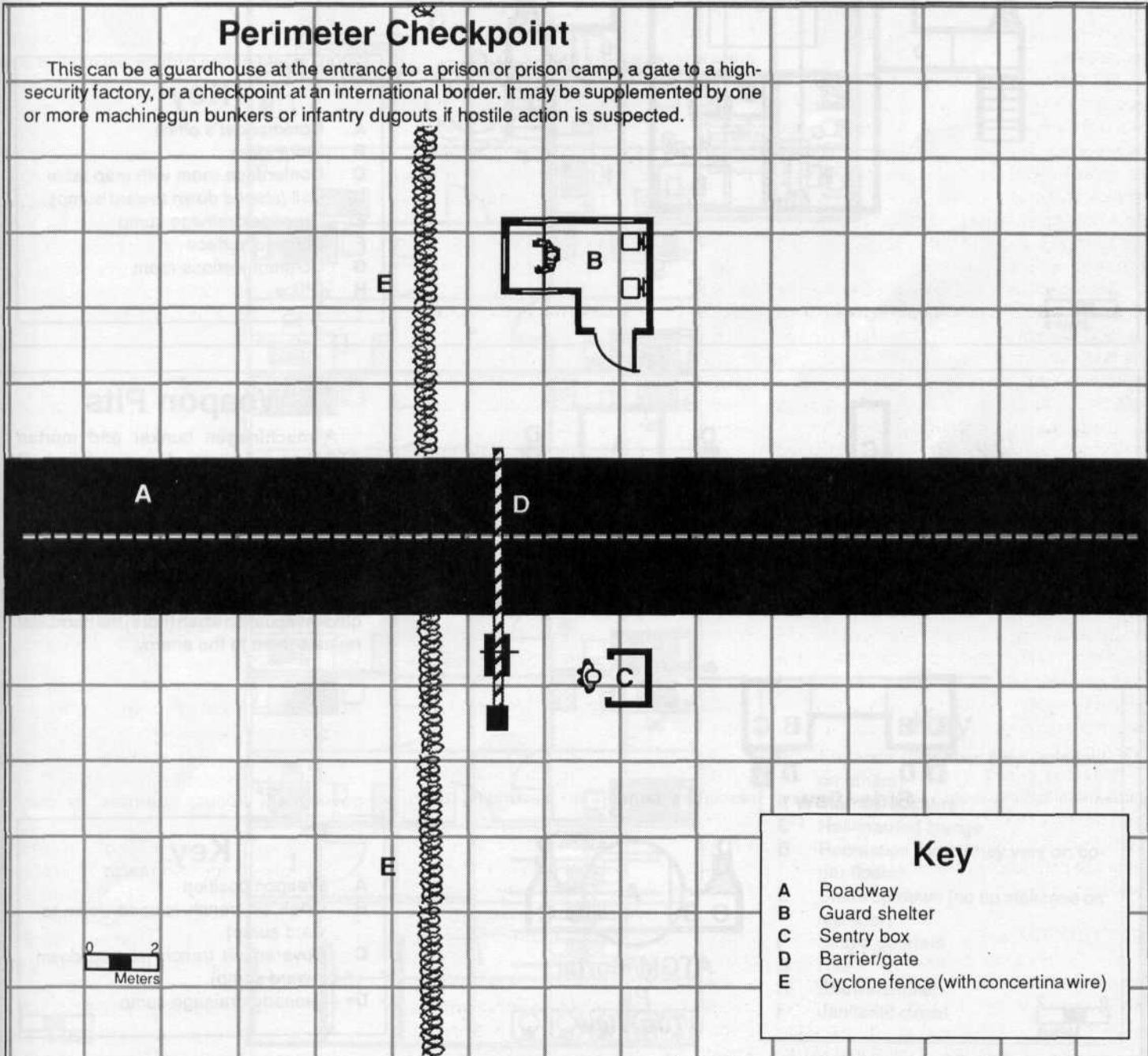

Key	
A	Roadway
B	Guard shelter
C	Sentry box
D	Barrier/gate
E	Cyclone fence (with concertina wire)

Underground Command Bunker

The layout of these command posts varies, but some general features are common to all. Their purpose is to serve as a headquarters for a unit or installation, providing some protection from artillery bombardment and small arms fire.

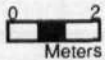
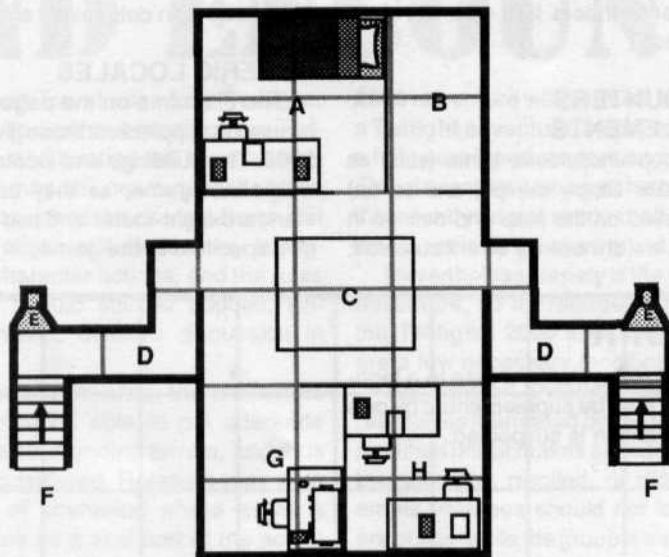

Key

- A Commander's office
- B Store room
- C Conference room with map table
- D Hall (sloped down toward sump)
- E Grenade/drainage sump
- F Stairs to surface
- G Communications room
- H Office

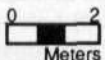
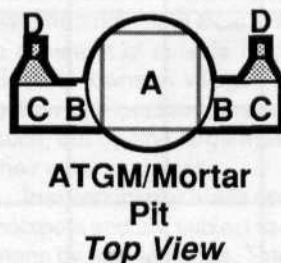
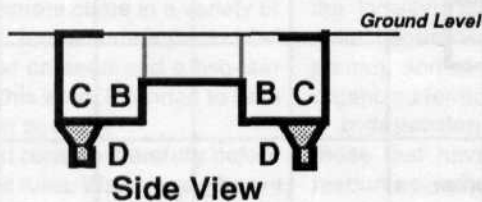
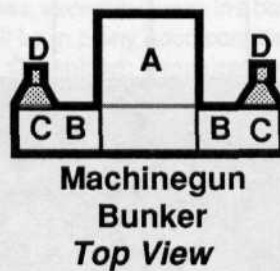
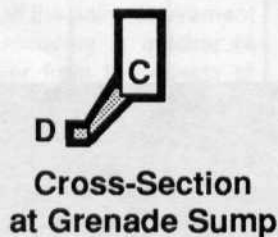

Weapon Pits

A machinegun bunker and mortar/ATGM pit are shown. Many variations of these exist, some with overhead cover, some without (mortars, of course cannot have overhead cover). Those designed for recoilless weapons or rocket launcher systems have open backs to allow the exhaust gas to disperse and to allow for quick evacuation when (not if) the backblast reveals them to the enemy.

Key

- A Weapon position
- B Open slit trench (sloped down toward sump)
- C Covered slit trench (sloped down toward sump)
- D Grenade/drainage sump

Officers' Quarters

These buildings house higher-level officers (but probably not the commander) on relatively secure installations. A few somewhat larger rooms are reserved for married officers.

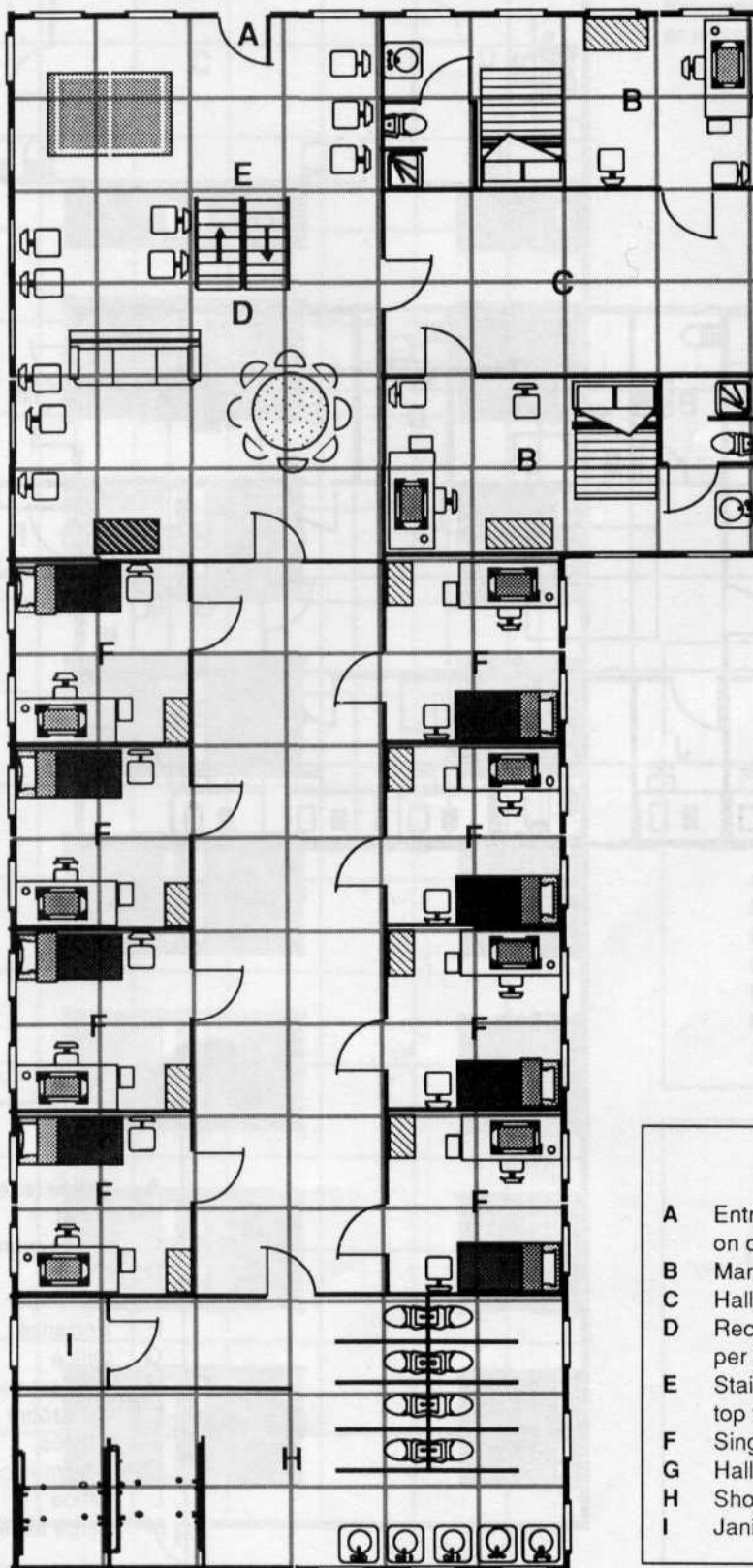

0 2
Meters

Key

- A Entrance (first floor only—window on others)
- B Married quarters
- C Hall/married lounge
- D Recreation room (may vary on upper floors)
- E Stairs up/down (no up staircase on top floor)
- F Single quarters
- G Hall
- H Showers/toilet
- I Janitorial closet

Headquarters Building

These serve the same purpose as the underground command bunker described on page 72, but are for installations not expecting to be brought under direct attack, such as rear area camps and prison camps.

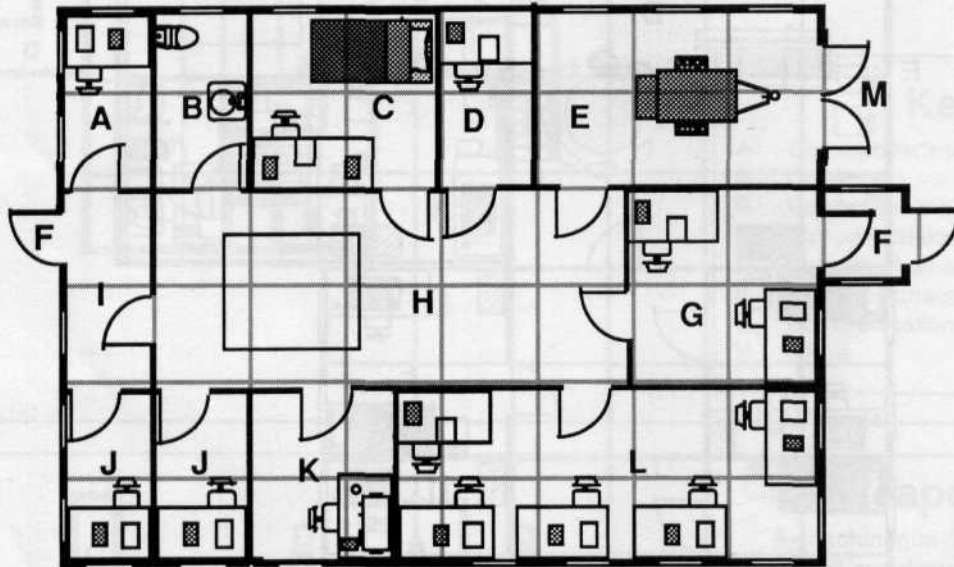

Key

- A Office (executive officer)
- B Toilet
- C Office (commander)
- D Office
- E Generator room
- F Entrance
- G Office
- H Conference room with map table
- I Mud room
- J Offices
- K Communications room
- L Office
- M Large access doors

0 2
Meters

Barracks

These buildings serve to house masses of soldiers or prisoners. Conditions vary. Key provided differs depending on prison or military use.

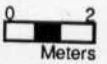
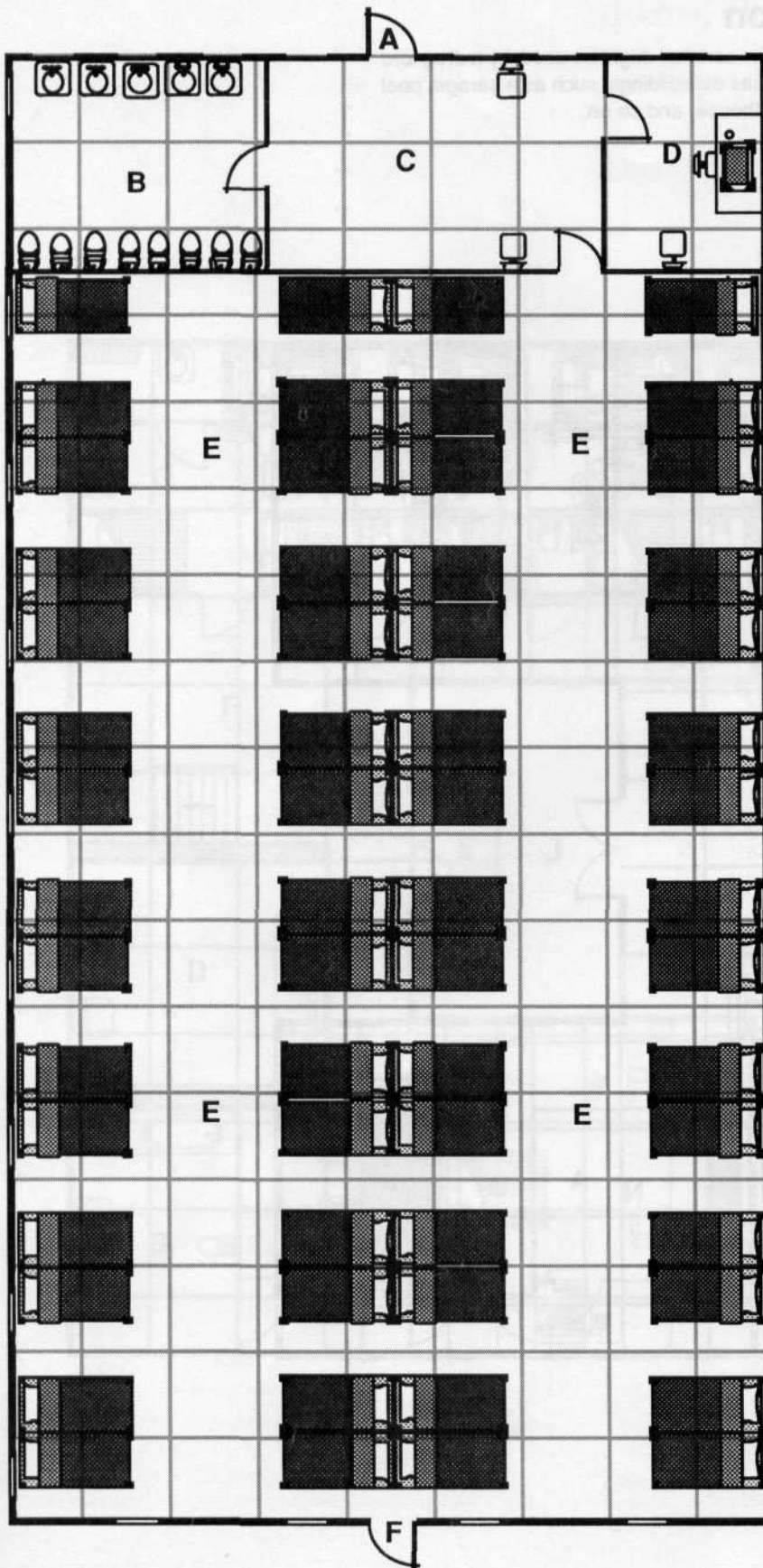

Key (Prison Use)

- A Main door
- B Toilets
- C Guard room
- D Interrogation room
- E Bunks
- F Secondary door

Key (Military Use)

- A Main door
- B Toilets
- C Mud room
- D NCO's office
- E Bunks
- F Secondary door

Mansion

This building represents a luxury dwelling, of the sort that might be used by a drug lord or deranged despot. It does not include the requisite outbuildings, such as a garage, pool house, guest house(s), servants' quarters, guardhouse, and so on.

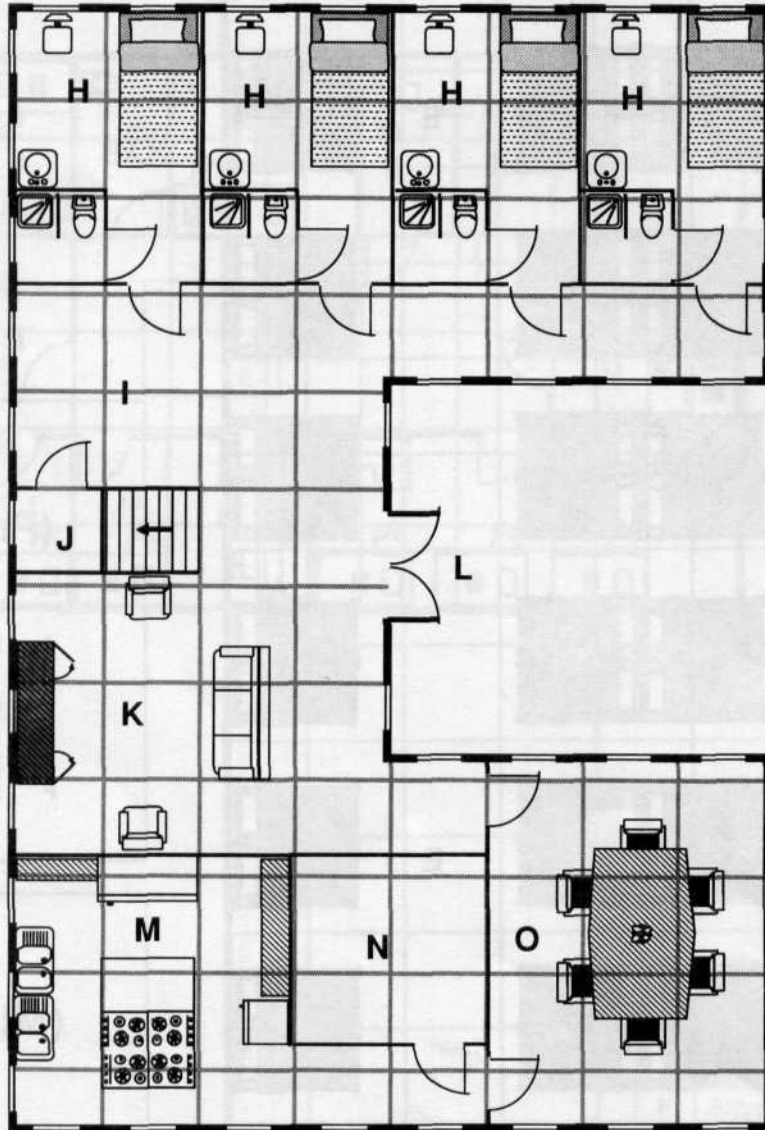

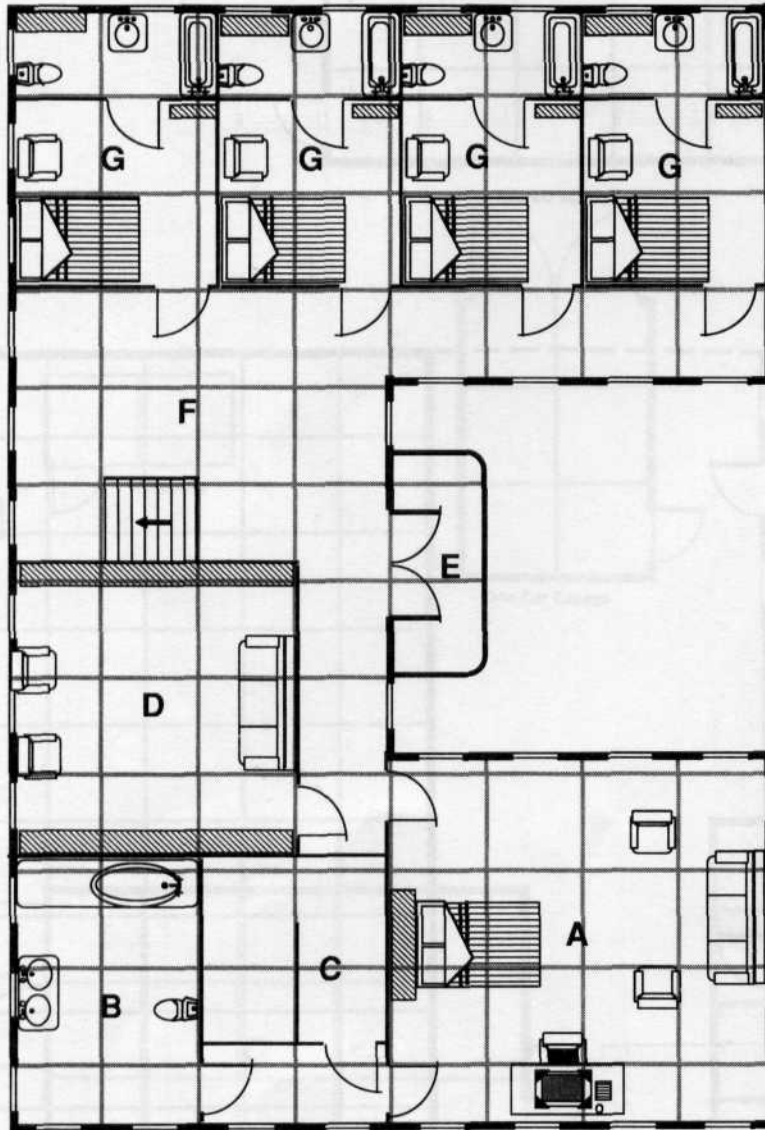

Key

Second Floor

- A Master bedroom
- B Master bath
- C Master closet and dressing room
- D Library
- E Balcony
- F Hall
- G Guest rooms

First Floor

- H Servants' quarters
- I Hall
- J Hall closet
- K Solarium
- L Entry
- M Kitchen
- N Pantry
- O Dining room

Sheds, Huts andhovels

This is a collection of fairly typical small buildings for assorted uses: rural farmhouses, factory or estate outbuildings, etc.

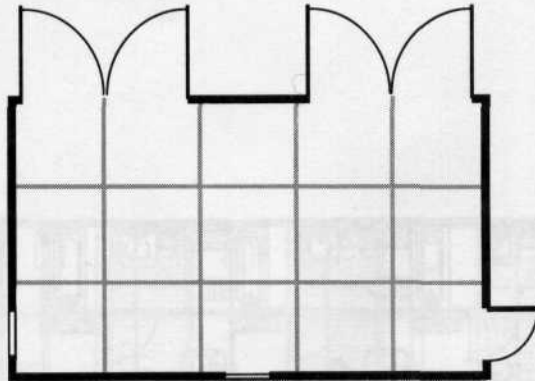

Two-Car Garage

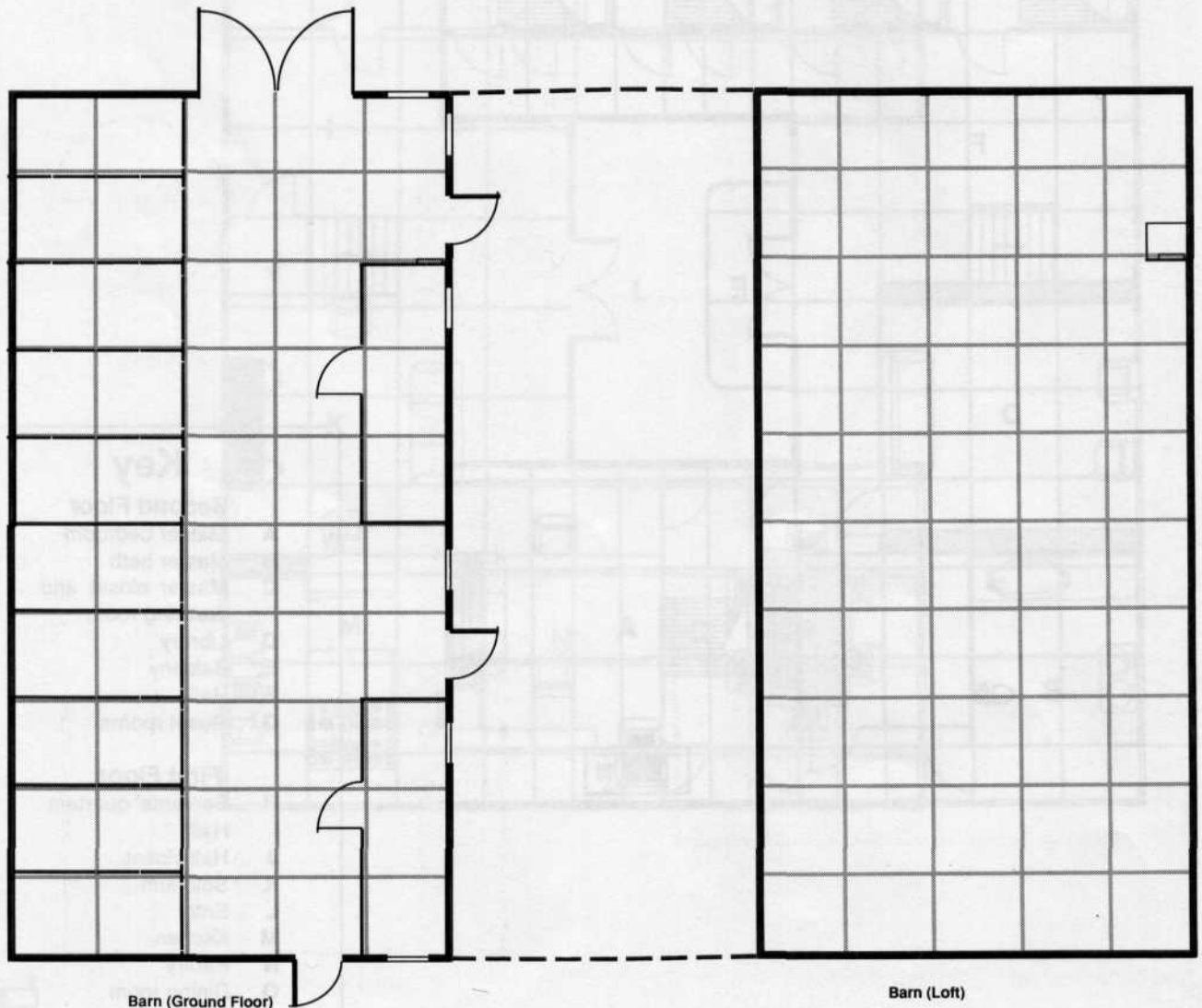

Barn (Ground Floor)

Barn (Loft)

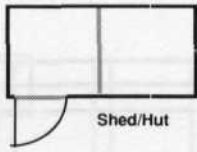

Shed/Hut

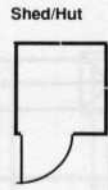

Shed/Hut

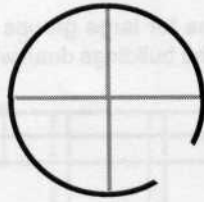

Round Hut

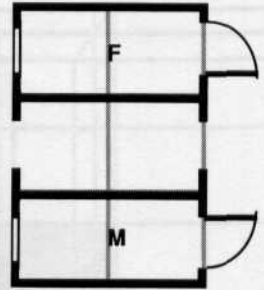

Pool/Beach House

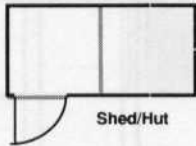

Shed/Hut

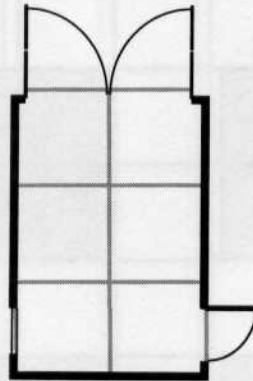

One-Car Garage

Shed/Hut

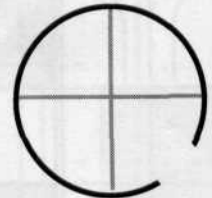

Round Hut

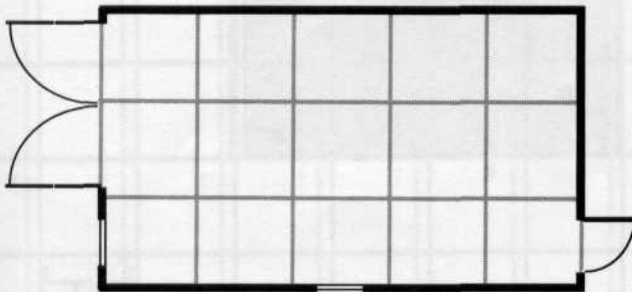

Vehicle Repair Shed

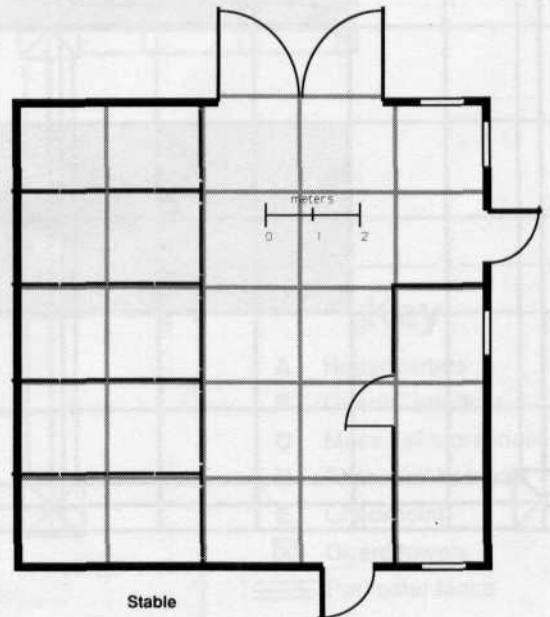

Stable

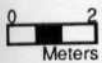

Prison Camp

This can represent a camp for prisoners of war, a holding area for large groups of hostages, or a "prison farm"-type civilian prison. It is composed of the buildings dealt with elsewhere in this section.

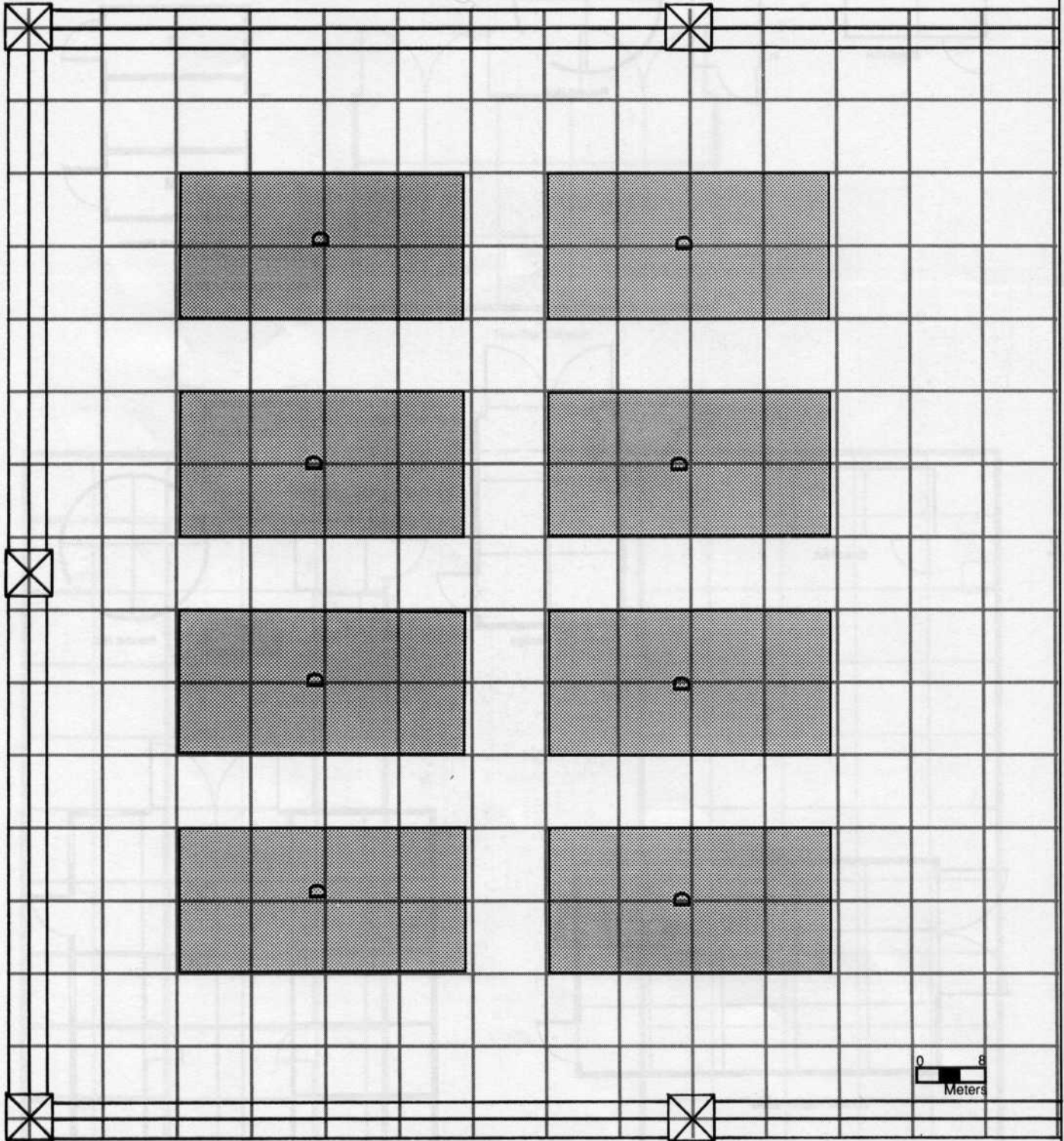

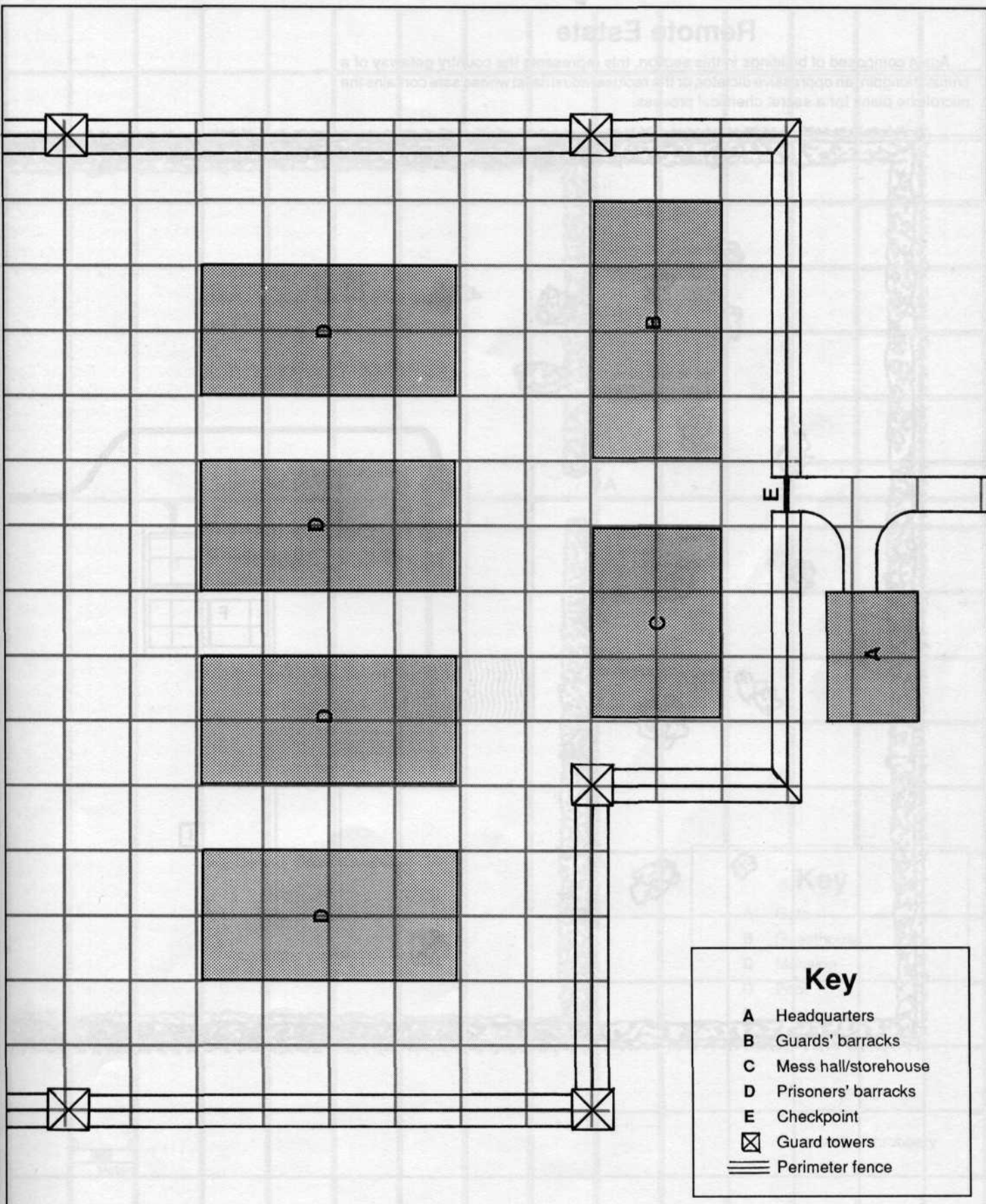

Key

- A Headquarters
- B Guards' barracks
- C Mess hall/storehouse
- D Prisoners' barracks
- E Checkpoint
- ☒ Guard towers
- ≡≡≡ Perimeter fence

Remote Estate

Again composed of buildings in this section, this represents the country getaway of a criminal kingpin, an oppressive dictator, or the recluse industrialist whose safe contains the microfiche plans for a secret chemical process.

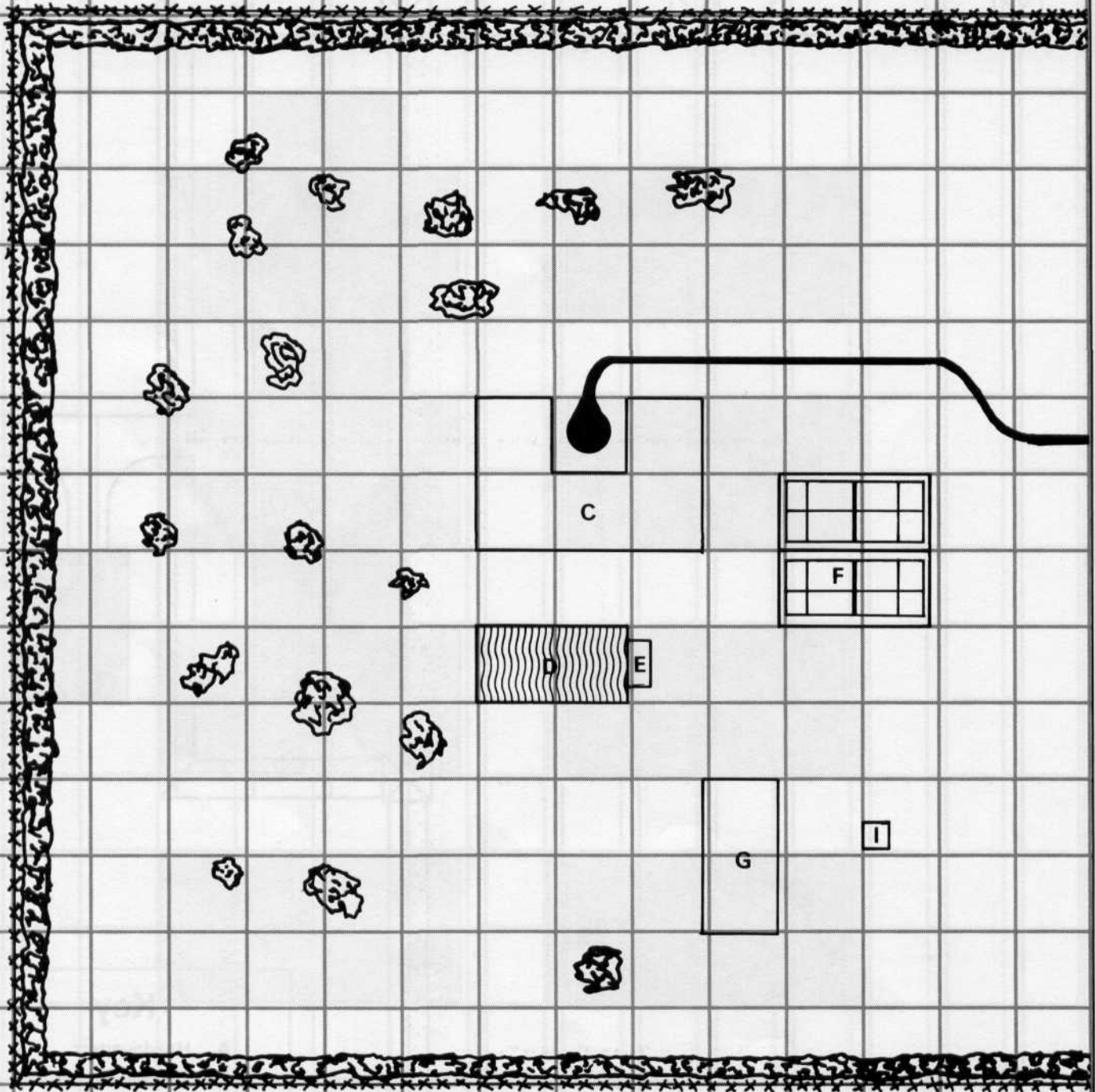

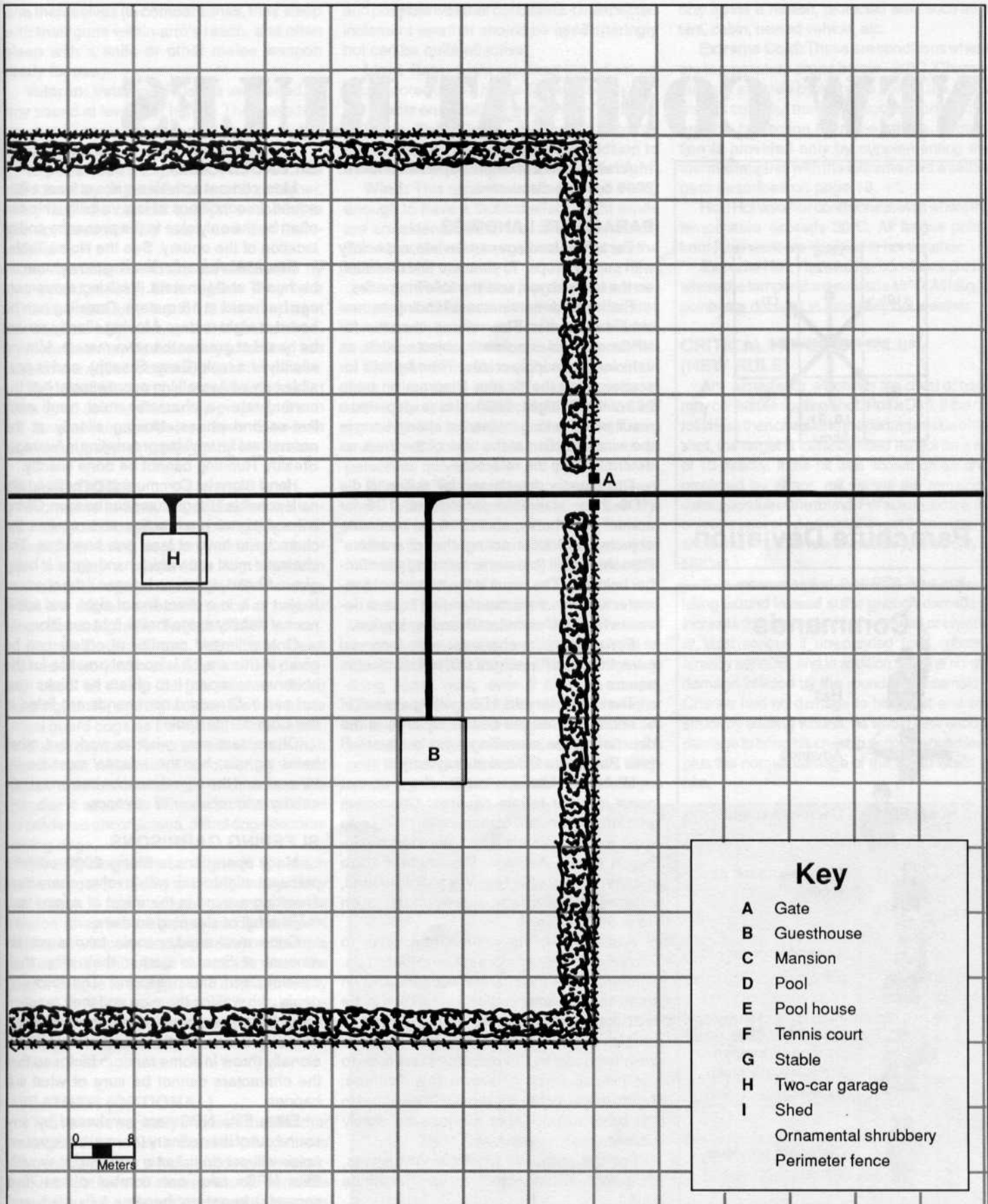

Key

- A Gate
- B Guesthouse
- C Mansion
- D Pool
- E Pool house
- F Tennis court
- G Stable
- H Two-car garage
- I Shed
- Ornamental shrubbery
- Perimeter fence

0 6
Meters

NEW COMBAT RULES

A few aspects of combat specific to **Merc: 2000** deserve discussion.

PARACHUTE LANDINGS

Parachute landings can deviate, especially with supply drops. To simulate this deviation on the tactical grid, use the following rules.

Each player nominates a landing square for his character. The referee chooses for NPCs and for inanimate objects such as vehicles and supply crates. Then he rolls for scatter using the Scatter Diagram on page 252 of the **Twilight: 2000** rules (except that a result of a 7 is long instead of short). Long is the wind direction at the time of the drop, as determined by the referee.

Distance is determined by rolling a die (1D6+2 for steerable parachutes, 1D6 for normal parachutes, and 1D10 for inanimate objects) and subtracting the characters' Parachute skill (but never reducing the number below 1). The result is the number of two-meter squares the actual landing square deviates from the nominated landing square.

For example, a character with a normal parachute and Parachute skill of 3 nominates square A.

The character rolls 1D6, getting a result of 5, and thus deviates $5-3=2$ squares in the direction of the prevailing wind to square B (see Parachute Deviation diagram).

Mishaps: Mishaps on landings do not occur in clear terrain squares. Characters who land in a square containing anything else must roll to avoid a mishap. Avoiding a mishap is a task, Average: Parachute. Failure means the character receives a slight wound, catastrophic failure a serious wound (location up to the referee).

Alternatively, the referee may wish to implement a mishap more suited to the terrain. If, for example, the character comes down in trees, the character could be entangled in the branches several meters off the ground. A character coming down in water could be weighed down by the parachute and have to cut himself loose or drown (roll Average: Agility to get loose; Swimming is as noted in the basic rules). Other mishaps will surely occur to creative referees.

For the purposes of avoiding mishaps, consider inanimate objects to have Parachute skill 1.

SILENCE/NOISE

Most combat activities make at least a little sound. In conditions of low visibility, this can often be the only clue to the presence and/or location of the enemy. See the Noise Table.

Silent Movement: Running movement can be heard at 24 meters. Walking movement can be heard at 16 meters. Crawling can be heard at eight meters. Moving silently cannot be heard at greater than two meters. Moving silently is a task (Easy: Stealth), and is possible only while walking or crawling at half the normal rate—a character must reroll each five-second phase. Moving silently at the normal rate for walking or crawling is Average: Stealth. Running cannot be done silently.

Hand Signals: Communication by hand signal is possible if the gestures can be seen. Giving a hand signal is an action and requires the character to have at least one hand free. The character must state which hand signal is being given. A hand signal can be seen if the observer is alert to it, in a direct line of sight, and within normal visibility range for the light condition.

Only a limited number of orders can be given in this way. It is normal practice for the observer to repeat it to others he thinks may not see it. Standard commands are listed in the Commands Table.

Characters may wish to work out other hand signals, but the referee must be informed, and the signal must be known to both sender and receiver in advance.

SLEEPING GARRISONS

Many operations in **Merc: 2000** will take place at night and will involve characters sneaking around in the midst of camps and the like full of sleeping soldiers.

Once awakened, people take a certain amount of time to gather their wits, their clothing, and their weapons. The following deals with waking them up and their reaction time. Referees should apply their common sense to such situations and should occasionally throw in some random factor so that the characters cannot be sure of what will happen.

Elite: Elite NPCs are awakened by any sound out of the ordinary (normal background noise will not do it, but a creaking stair will). Elite NPCs take one combat phase (five seconds) to get up, become fully alert, and

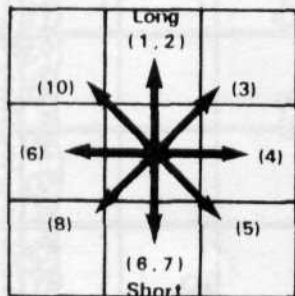

Parachute Deviation

Commands

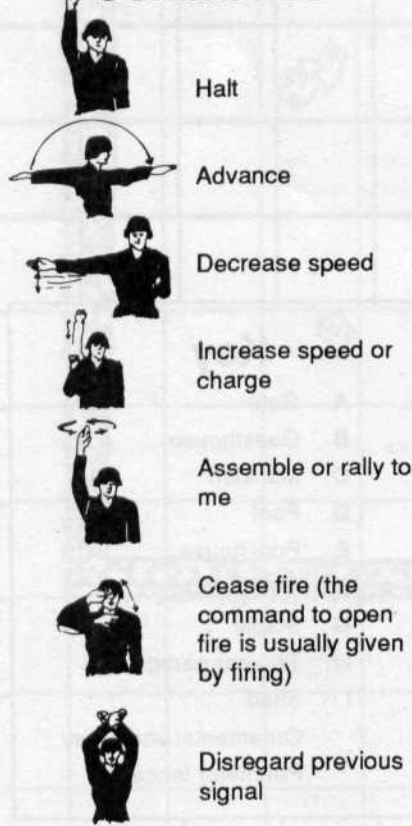

arm themselves (in combat zones, they sleep with their guns within arm's reach, and often sleep with a knife or other melee weapon ready for use).

Veteran: Veteran NPCs are awakened by any sound at level II or higher. They take two combat phases (10 seconds) to get up, become fully alert, and arm themselves.

Experienced: Experienced NPCs are awakened by any sound at level II or higher. They take one combat turn (30 seconds) to get up, become fully alert, and arm themselves.

Novice: Novice NPCs are awakened by any sound at level III or higher. They take 1D6+2 combat turns (upto 1.5 minutes) to get up, become fully alert, and arm themselves.

More time may be necessary to form up into fireteams or squads, but this is upto the referee.

Vehicles: Many vehicles take time to start from dead cold and warm up properly. It can be several minutes before even Elite tank crews can get their tanks ready for service.

GUARD DOGS

From time to time, the characters will encounter guard dogs, either patrol dogs with handlers or roving dogs on their own. A handler is simply a person the dog has been trained to recognize and obey. Guard dogs have the same combat statistics as regular dogs as noted in the **Twilight: 2000** rules.

Patrol Dogs: These dogs have been trained to work with a handler and are primarily used as living burglar alarms. Their hearing, smell, and night vision are very acute (treat guard dogs as if they had Observation: 10), and they can detect intruders better than people can. When with a handler, they will not attack unless commanded to or unless the handler is attacked. When a handler is killed or rendered unconscious, patrol dogs become roving dogs.

Roving Dogs: These dogs will approach any stranger (to them) and bark loudly. They will attack if the stranger makes a hostile motion (they are trained to recognize guns and other weapons as dangerous) or attempts to flee. They will cease the attack when the target ceases to struggle and displays empty hands, at which point they will move back a couple of meters and resume growling and barking. This will continue until a handler arrives.

WEATHER (OPTIONAL)

The referee normally chooses the weather condition of a particular situation, much in the same way that he simple chooses the background light level. Referees should consult a good atlas for seasonal temperature ranges

and possible weather conditions. Unexpected inclement weather should be used sparingly but can be quite effective.

Light Rain: Light rain has the effect on sound noted on the Noise Table, in addition to the effects on visibility mentioned in **Twilight**.

Heavy Rain: Heavy rain has the effect on sound noted on the Noise Table, in addition to the effects on visibility mentioned in **Twilight**.

Wind: This represents wind speed heavy enough to have a tactical effect. Light winds are considered within the range of normal. Wind has the effect on sound noted on the Noise Table.

Snow: This condition represents a normal snowfall with little or no wind. Snowfall has the effect on sound noted on the Noise Table, in addition to the effects on visibility mentioned in **Twilight**. Snowfall cannot occur in conditions other than cold (it seldom snows in extremely cold weather, although snow will remain on the ground in such weather). Deep snow (more than a few inches) halves all personnel movement.

Blizzard: This condition represents a heavy snow with high winds. A blizzard has the effect on sound noted on the Noise Table, in addition to the effects on visibility mentioned in **Twilight**. It cannot occur in conditions other than extremely cold.

Cold: These are conditions where the temperature is about 0°C or below. Characters in cold weather without protective clothing (thermal fatigues) accumulate fatigue points as if they were doing heavy work, even if they are at rest. Characters losing consciousness in cold weather continue to accumulate fatigue until all attributes affected by fatigue are reduced to 1, at which point they are considered frozen to death. Characters can recover from cold-induced fatigue

only inside a heated, protected area such as a tent, cabin, heated vehicle, etc.

Extreme Cold: These are conditions where the temperature drops below -20°C. Characters are affected by extreme cold in the same way as cold, but thermal fatigues alone do not provide protection from the effects. Protection is provided only by supplementing the thermal fatigues with the extreme cold weather gear described on page 18.

Hot: Hot weather conditions prevail where the temperature exceeds 30°C. All fatigue points from hard work are doubled in hot weather.

Extreme Hot: Hot weather conditions prevail where the temperature exceeds 45°C. All fatigue points are doubled in extremely hot weather.

CRITICAL HIT/QUICK KILL (NEW RULE)

Any *aimed shot* which hits the chest or head may constitute a killing shot. Roll a D10. If the die roll is less than or equal to the damage value of the shot, the target is instantly killed except on a roll of 10 exactly. If the hit was scored on an area protected by armor, roll versus the remaining damage value of the round. For automatic fire, roll only once per phase (regardless of the number of shots that hit). This rule should be applied only to NPCs.

It is recommended that PCs who suffer a killing wound instead suffer enough damage to increase the wound level of the head or chest to at least serious if unwounded (and critical if already serious), and in addition take the normal damage inflicted by the round. For example, if Charles had no damage to his chest and was struck by a killing wound, he would take enough damage to bring his chest to serious wound level plus the normal damage of the round which hit him.

Noise

Sound	Level	Clear	Maximum
I	Whispers	1	5
II	Normal voice, silenced weapon	10	20
III	Shouts, suppressed weapon	40	80
IV	Small arms fire, vehicles	500	1000
V	Heavy weapons fire, light planes	1000	2000
VI	Explosions, jets	1500	3000

On the table above, *clear* represents the distance at which the sound can be heard clearly. At this range, the direction from which the sound originated can be discerned.

Maximum is the maximum distance at which the sound can be heard—direction can be determined only within a 90° arc (left, right, forward or rear quadrants).

Modifiers: *Higher levels* quarter levels below them. *Rain* or *snow* on the ground reduces these distances by one-third. *Woods*, a *built-up area*, or *brush* reduces these distances by one-fourth. *Heavy rain* or *wind* halves these distances.

THE OPPOSITION

Troop organizations for individual nationalities will vary, but they follow some general patterns. In general, the armed forces of smaller countries tend to follow those of larger nations—the US, the USSR, the UK, and France. The US and USSR, in particular, were prone to supply and train a country's armed forces. Former colonies tend to follow the patterns set down by their mother country if the parting was amicable (the French had a number of these, to pick one example). Some nations seemed to specialize in training armies in a certain region (the UK trained many armies in the Middle East and eastern Africa, for instance).

Military organizations are notoriously variable. Few units match their official table of organization and equipment (TO&E) exactly. Illness, injury, accident and combat all take their toll, and most units are always short a few soldiers and sometimes one or two vital pieces of equipment.

Larger organizations are dealt with in the various vehicle guides issued for **Twilight: 2000** (the **American Combat Vehicle Handbook**, the **Soviet Combat Vehicle Handbook**, etc.)

Vehicle Crew: Crewmembers of tanks, armored cars, and recon vehicles tend to be armed with pistols or SMGs, although some will be armed with rifles (either regular assault rifles or folding-stock versions).

Communal Equipment: Every soldier in the squad is usually called upon to carry one or two belts of ammunition for the machinegun (if present), which are given to the machinegunners as needed. If a mortar or ATGM launcher is present and no transport is provided, soldiers may have to carry one or two rounds for these as well.

When the squad takes up a position, the soldiers drop the ammo off near the weapon(s), picking it up again if they have to move out.

Heavy Weapons: Mortars, heavy machineguns, autocannons, and ATGM launchers tend to be clustered into specialized groupings, usually attached at the battalion or company level (meaning that a battalion will have an integral weapons company, or a company an integral weapons platoon). In combat, these weapons may be split up and attached at a lower echelon. An infantry platoon

might have one or two ATGM launchers (and crews) assigned to them on a more or less permanent basis. This varies tremendously from nation to nation, and even within armies.

Referees can justify just about any arrangement that will make a good scenario, regardless of what the official organization is. Crewmembers for such weapons are usually armed with the appropriate assault rifle for their nationality, but some have pistols or SMGs.

USSR

For much of the last half of the 20th century, the Soviets exported weapons and advisors to many Third World nations and to others as well. Nations using USSR-style organizations are Poland, Czech, Slovakia, Hungary, Romania, the various Soviet republics, the various Yugoslav splinters, Albania, Cuba, and many nations in Africa and Central and South America.

Soviet-Style Rifle Squad

- 1 squad leader (assault rifle or SMG)
- 2 machinegunners (light MG)
- 2 asst. machinegunners (assault rifle)
- 1 RPG gunner (RPG)
- 1 asst. RPG gunner (assault rifle)
- 1 rifleman (assault rifle)

In Vehicle:

- 1 APC driver (pistol or SMG)
- 1 APC gunner (pistol or SMG)

The vehicle driver and gunner seldom dismount.

Additional riflemen may be added or substituted for the RPG gunner and one of the machinegunners. One or two riflemen may have a rifle-mounted GL.

Some nations often substitute trucks for APCs or do not have internal transport at all. In the latter case, the driver and gunner are replaced with ordinary riflemen.

Soviet-Style Rifle Platoon

- 1 platoon leader (assault rifle or SMG)
- 1 sniper (sniper rifle)
- + 3 rifle squads

Soviet-Style Tank Platoon

This consists of three tanks (four in motor-

ized rifle units), one of which is commanded by the platoon leader. Recon platoons are organized in a similar fashion.

UNITED STATES

From 1945 until the late 1990s, the United States armed and equipped a number of allies, providing weapons and advisors. Nations using US-style organizations are the Philippines, Panama, Korea, and many nations in Asia, Central America and South America.

US-Style Rifle Squad

- 1 squad leader (M16)
- Fire Team Alpha:*
 - 1 team leader (M16)
 - 1 rifleman (M16)
 - 1 SAW gunner (SAW)
 - 1 grenadier (M16/M203 GL)
- Fire Team Bravo:*
 - 1 team leader (M16)
 - 1 dragon gunner (Dragon, M16)
 - 1 SAW gunner (SAW)
 - 1 grenadier (M16/M203GL)
- In Vehicle:*
 - 1 driver (M16)
 - 1 gunner (M16)

The vehicle driver and gunner seldom dismount, even though they are nominally members of one of the fireteams. Riflemen may be added or deleted to adapt to the capacity of the APCs available.

Nonmechanized squads may have a three-man M60 MG team attached as needed. Mechanized squads have an M60 MG but no designated gunners (these are chosen as the need arises). Some nations substitute trucks for APCs or do not have internal transport at all. In the latter case, the driver and gunner are replaced with ordinary riflemen.

US-Style Rifle Platoon

- 1 platoon leader (M16)
- 1 assistant platoon leader (M16)
- +3 rifle squads

US-Style Tank Platoon

This consists of three to five tanks (depending on the nation), one of which is commanded by the platoon leader. Recon platoons are organized in a similar fashion.

FRANCE

Nations using French-style organizations are the many ex-French colonies in Africa and elsewhere such as Chad, Djibouti, and Mali.

French-Style Infantry Squad

- 1 squad leader (FA-MAS)
- 1 sharpshooter (FR-F1)
- 2 riflemen (FA-MAS)
- 1 LRAC gunner (LRAC, FA-MAS)
- 1 assistant LRAC gunner (FA-MAS)
- 1 AA-52 gunner (AA-52, FA-MAS)
- 1 assistant AA-52 gunner (FA-MAS)
- In Vehicle:*
- 1 driver (FA-MAS)
- 1 gunner (FA-MAS)

The vehicle driver and gunner seldom dismount. Riflemen may be added or deleted to adapt to the capacity of the APCs available. In some units, the sharpshooter may be replaced with a regular rifleman, and other weapons may be substituted as available. Riflemen may be added or subtracted to adapt the squad to the available APCs.

Some nations substitute trucks for APCs or do not have internal transport at all. In the latter case, the driver and gunner are replaced with ordinary riflemen.

French-Style Infantry Platoon

- 1 officer (PA-15)
- 2 Milan gunners (Milan launcher, FA-MAS)
- 2 assistant Milan gunners (FA-MAS)
- 2 riflemen (FA-MAS)
- +3 infantry squads

French-Style Tank Platoon

This consists of four light tanks or three heavy tanks, one of which is commanded by the platoon leader. Recon platoons are organized in a similar fashion.

UNITED KINGDOM

Nations using British-style organizations are primarily ex-British colonies throughout the world, such as Hong Kong, Kenya, South Africa, and Belize.

British-Style Rifle Section

- 1 section leader (IW)
- 1 machinegunner (GPMG/MAG MG)
- 1 MAW gunner (Carl Gustav)
- 5 riflemen (IW)
- In Vehicle:*
- 1 driver (IW)

British-Style Rifle Platoon

- 1 platoon leader
- 6 LSW gunners (LSW)*

- 1 light mortarman
- 2 assistant mortarman
- +3 rifle sections
- *LSW gunners are usually split up among the sections.

British-Style Tank Troop (Platoon Equivalent)

This consists of three heavy tanks, one of which is commanded by the platoon leader. Recon platoons have four to eight vehicles.

CHINA

Asiatic insurgent groups, a few Chinese-sponsored governments (such as Kampuchea), and the Chinese warlord armies use these organizations.

Chinese-Style Rifle Squad

- 1 squad leader (AK-74)
- 1 RPG gunner (RPG)
- 1 LMG gunner (PK MG)
- 9 riflemen (AK-74)
- In Vehicle:*
- 1 driver (AK-74)
- 1 gunner (AK-74)

The vehicle driver and gunner seldom dismount.

Riflemen may be added or deleted to adapt to the capacity of the APCs available. In some units, the sharpshooter may be replaced with a regular rifleman, and other weapons may be substituted as available. Riflemen may be added or subtracted to adapt the squad to the available APCs.

Some nations substitute trucks for APCs or do not have internal transport at all. In the latter case, the driver and gunner are replaced with ordinary riflemen.

Chinese-Style Rifle Platoon

- 1 platoon leader
- 1 assistant platoon leader
- +3 rifle squads

Chinese-Style Tank Platoon

This consists of three light or two heavy tanks, one of which is commanded by the platoon leader.

Recon platoons consist of three APCs and 10 motorcycles.

INDUSTRIAL SECURITY FORCES

Most security guards are not trained in small group tactics, and groups of them show little cohesion.

Armed security guards usually carry either pistols or shotguns (rarely SMGs or assault rifles).

Some companies are beginning to train

special paramilitary units for defense of remote installations or facilities in high-risk areas (the phrase "private security force" is a commonly used euphemism for "mercenary" in the United States).

These teams of industrial security forces tend to operate in four-man to eight-man teams armed with submachineguns or assault rifles plus pistols, and built around one or two sharpshooters who are armed with sniper rifles.

BORDER PATROLS/ PARAMILITARY POLICE FORCES

Border security forces may be lightly armed (and thus resemble police or park rangers) or heavily armed (and thus resemble soldiers). Lightly armed border patrols are armed with pistols and/or shotguns, and rarely even SMGs. Heavily armed border patrols are armed similarly to paramilitary forces. Up until 1995, American border patrols were lightly armed.

Paramilitary police forces tend to be organized like their military counterparts, but are not equipped as well as the full military. They tend to have bolt-action or semiautomatic rifles, shotguns, and very few machineguns. Where they have grenade launchers or hand grenades, these are mostly stun or incapacitating gas types. The Spanish *Guardia Civil* is a good example of one paramilitary police force.

CRIMINAL CARTELS

Criminal cartels tend to employ armed forces in groups of six to 12 fighters under a single team leader. These will be armed with a polyglot collection of military and paramilitary weapons.

Some cartels are beginning to make use of mercenary units and mercenary training cadres, and a few cartel units now make use of the US-type or Soviet-type squad organizations (nonmechanized). But they do not have the training or discipline of full-time soldiers—yet.

Rumors of cartel armored units have also been circulating. None have been encountered as of 1 July 2000.

ELITE FORCES

Elite forces are discussed on page 157 of the Twilight: 2000 rules. Many of the world's armies still maintain elite forces for special operations. Both the organization and equipment of these groups usually varies from mission to mission and is largely a matter of individual choice.

The referee can justify just about anything in the hands of an elite group.

Dragon's Lair

This is a fairly typical "snatch" scenario. The patron (level IV) is a government official, fairly high up in the USDEA.

MISSION BRIEFING

A rare opportunity to cripple the leadership of the Asiatic heroin-smuggling operation known as the Golden Dragon Cartel has arisen. For two days, the six controlling members of the cartel will be conducting their annual meeting at one of the cartel's remote mountain bases in northern Burma. In a tremendous stroke of luck, the DEA's human intelligence sources have identified which site is to be used and managed to determine the exact date.

The team is to capture the six cartel officials and remove them from the country alive, neutralizing as much of the cartel's other assets as possible in the process. The team is offered twice the base rate.

The patron will supply air transport and HALO gear for up to 12 team members and will arrange for one RH-53 helicopter at a pickup point. The patron will provide weapons, ammunition, and any other equipment desired, but it will be deducted from the team members' pay. They must leave within two days.

APPROACH

Team members are to be inserted by HALO parachute drop into LZ Alpha approximately one kilometer away from the target at 0225 hours. They will then make their way overland at the fastest possible speed to the enemy encampment, where they will secure all escape routes and penetrate the facility. Meteorological data indicates that the moon will set at 0258, giving the team lighting condition 3 until that time, condition 1 thereafter. The ground is not suitable for vehicular traffic, and the only road to the encampment is heavily patrolled.

RETRIEVAL

One RH-53 Super Stallion helicopter will arrive at LZ Omega at 1000, where it will hover until two green smoke grenades are set off (one at each end of the LZ). It will then land, pick up the party, and move out. If the green smoke is not spotted by 1010, the helicopter will leave.

MAP DESCRIPTION

The map has been prepared from photos taken during a recent recon overflight of the area and is accurate as of 72 hours ago. Infrared imaging during the overflight revealed several concealed emplacements at the edge of the clearing which had not shown up in previous (normal light) photographs. In addition, the photographs indicate a newly emplaced linear system around the edge of the clearing which may be a fence of some kind. Major points of interest are as follows:

LZ Alpha: This is a clearing just over one kilometer from the carters base. Agents of the DEA will cause an "accidental" fire in the trees the day before, sufficient to clear the LZ of major obstacles.

LZ Omega: This is the pickup point, a small field about five kilometers from the base camp.

Bunker: This is a newly dug installation, housing a DShK MG and two soldiers. The bunker also contains electronic equipment to monitor the newly installed perimeter motion detectors, but these are not yet hooked up. When the system is connected and fully operational, telephones will link each bunker with the headquarters building, and an additional soldier will be assigned to monitor the detection instruments.

Barracks: This building contains 40 sleeping soldiers and the other members of the base, except the six cartel officials. It has a couple of TV rooms, a game room, and other recreational facilities.

House: This is a former plantation manager's house which now houses the cartel executives and their staff.

Headquarters Building: A central command post for the military aspect of the base.

Processing Lab: This building contains the heroin processing lab and its associated supplies and equipment.

Machinery Building: This houses the base generator and water pumping machinery. Underground fuel tanks nearby contain diesel fuel for the generator and gasoline for the base vehicles.

Warehouses: These buildings contain the processed heroin awaiting shipment.

Vehicle Repair Shed: This building contains tools and a nonfunctional Land Rover with its parts strewn about.

Helipad: Now empty. An underground tank contains a bit of aviation gasoline.

REFEREEING THE SCENARIO

The unknown emplacements shown in the infrared photographs are newly dug bunker positions, housing the control centers for a series of electronic motion detectors. These motion detectors have been emplaced, but the wires which will connect them have not been hooked up yet, only strung out along the ground. These wires are patrolled by sentries at random intervals.

The characters obviously cannot storm the camp and remove the executives by force.

Opposing Forces: The base is normally garrisoned by 84 cartel employees, all of them armed. Of these, 60 are soldiers, only 20 of which are on duty at any given moment: eight divided among the four bunkers (two Veteran NPCs in each, armed with two AK-74s and a DShK MG), eight on sentry patrol (four Veteran and four Novice, armed with AK-74s), and four in the headquarters building (two Veterans and two Experienced, armed with two AK-74s, one RPK-74, and an Uzi SMG). One AK-74 in four has an attached BG-1 grenade launcher. Each soldier has a pair of fragmentation grenades. The camp has four 5/4-ton civilian trucks, two Landrovers, and a civilian car. When the whole garrison is called out, it will be armed in a similar fashion. The remainder of the normal base garrison (mainly lab workers) are Novices and are armed with PM Makarov pistols.

NPCS

The six cartel executives (and their assistants and body guards) have taken over the main house at the base and are living in it. The six executives are Novices and are unarmed. Each executive has two assistants, also Novices and unarmed. Each executive also has two bodyguards, both Experienced and armed with Uzi SMGs and HP-35 pistols. Four of the bodyguards are awake at any given time, patrolling the house and the grounds outside.

The sentries along the perimeter wire are the only random encounter in this scenario. Any player inside a square containing the wire will encounter a sentry on a 1D10 roll of 2 or less. Determine surprise as usual.

Golden Dragon Cartel Mountain Base

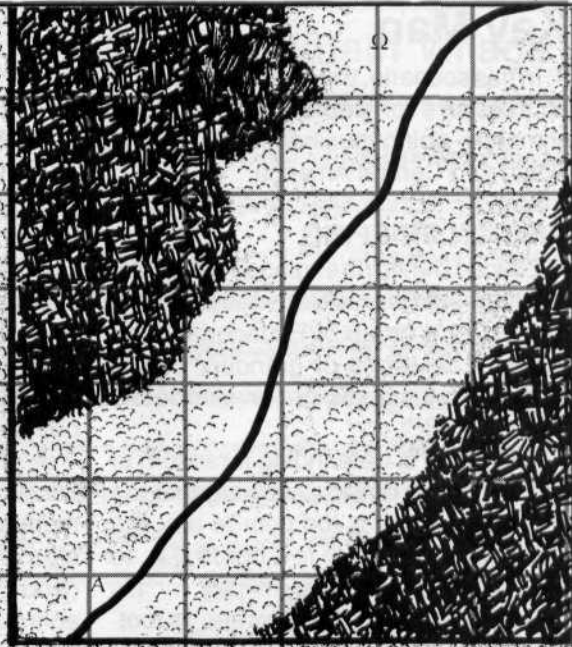
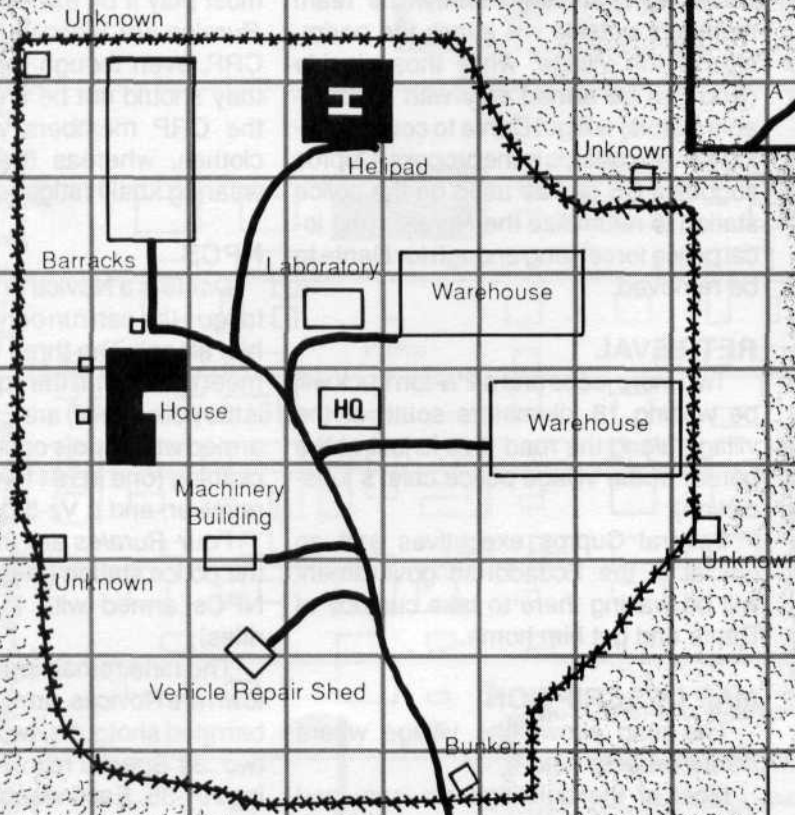

Key

- x----- Perimeter fence
- Road
- Jungle
- ~~~~~ Rough terrain
- LZ-A Landing zone alpha (A)
- LZ- Ω Landing zone omega (Ω)
- |— 8-meter squares

Key Man

In this scenario, the patron (level III) is an executive for Cupros S.A., a mining company doing business primarily in South and Central America.

MISSION BRIEFING

Edward Dante, an engineering trouble-shooter from Cupros S.A., has been kidnapped by a group of Ecuadorian bandits with delusions of grandeur calling themselves the *Coalición Revolucionario Popular (CRP)*.

The group is demanding a ransom of several million dollars, knowing that the engineer's family is too poor to pay, but counting on his value to Cupros S.A. to persuade the company to pay for his return. Angered at what they see as foot-dragging by the Ecuadorian government and unwilling to pay so much for Dante's return, Cupros S.A. is taking action on its own.

Cupros S.A. has arranged for the team and its equipment to be transported to a company installation near the remote mountain village where the exchange is to take place. The head of the local police is a confederate of the CRP and hopes to share in the loot once the exchange is made, which will complicate things. For political reasons, Ecuadorian officials are unable to take action while Dante is within the village, but once Dante is removed from the village's jurisdiction, he can safely be turned over to Ecuadorian officials.

The team must locate Dante, free him, and get him out of the local jurisdiction with minimal violence.

The team may defend itself if fired upon by CRP members, but confrontation with the local police must be avoided at all costs.

The plan as outlined by the CRP is that three Cupros representatives enter the village to meet in the town square with Dante and three CRP members. The money will remain outside of town with Cupros' security party. The Cupros people will verify that the hostage is really Dante, and is alive and well. One CRP member will then leave the village to count the money accompanied by one Cupros representative. When the CRP member re-

turns to the village with the money, Dante and the other two will be allowed to leave.

APPROACH

Cupros wants three members of the team to take the place of its representatives in the village, driving in on a jeep. Cupros proposes to helicopter the remainder of the team into the forest several kilometers north of the village the day before the exchange and have the team work its way to the village without being seen.

At the point where the CRP member leaves to count the money, the team members outside will attack the perimeter of the village, while those inside (who can be armed only with concealable pistols) will get Dante to cover, dealing with any guards in the process. Cupros suggests CS gas be used on the police station to neutralize the *Rurales* (the local police force) long enough for Dante to be removed.

RETRIEVAL

Two more jeeps and a 2¹/₂-ton truck will be waiting 18 kilometers south of the village along the road (this is just at the border of the village police chief's jurisdiction).

Several Cupros executives and an official of the Ecuadorian government will be waiting there to take custody of Dante and get him home.

MAP DESCRIPTION

The map shows the village where Dante is being held.

Most of the buildings are one- and two-room shanties with cowering villagers in them (the ones that haven't left town already).

Police Station/Jail/Village Hall: Most of the buildings in town are of wood, galvanized metal, or adobe, but this one is made of concrete blocks. It contains six jail cells, an office, two storerooms, and a large room where legal events (trials, inquests, etc.) take place. The second floor consists of a single large room, sleeping quarters for the *Rurales*.

Two jeeps are parked in back of the building.

Village Square: This is where the town

pump is located. Village market days and large public meetings are held here. This is where the exchange will take place.

Stores: The square is faced on three sides by several mercantile establishments (a couple of small stores, several *pulquerias*, and the telephone/telegraph/post office).

All of these are closed up (except one of the *pulquerias*). All of these buildings are large, one- or two-room adobe or wooden affairs.

REFEREEING THE SCENARIO

Once the attack begins, the players must play it by ear. Remember that the *Rurales* are technically not part of the CRP, even though their chief is. Thus, they should not be fired on. In general, the CRP members will be in civilian clothes, whereas the *Rurales* will be wearing khaki fatigues.

NPCS

Dante is a Novice in a state of extreme fatigue (he can run only if someone helps him along). The three CRP leaders who meet the team in the square (one of them is the police chief) are Experienced NPCs, armed with pistols concealed under their clothing (one M1911A1, one .38 Special revolver, and a Vz-52).

Four *Rurales* are in their quarters in the police station (they are Experienced NPCs armed with Mauser bolt-action rifles).

The nine remaining CRP members in town are Novices, armed with four double-barreled shotguns, two bolt-action rifles, two .38 Special revolvers and a Browning HP-35. Each weapon has 10 rounds of its own ammunition, except for the weapons of the *Rurales*, who have 60 rounds each.

ALTERNATIVES AND VARIANTS

An interesting situation arises if the referee has a stray shot hit the gas tank on the jeep, resulting in the team's jeep running out of gas about eight kilometers down the road.

Alternatively, the referee can have the fuel ignite (if no one is within range) and explode with a spectacular fireball, leaving the team to get Dante out of town by some other means.

Mountain Village

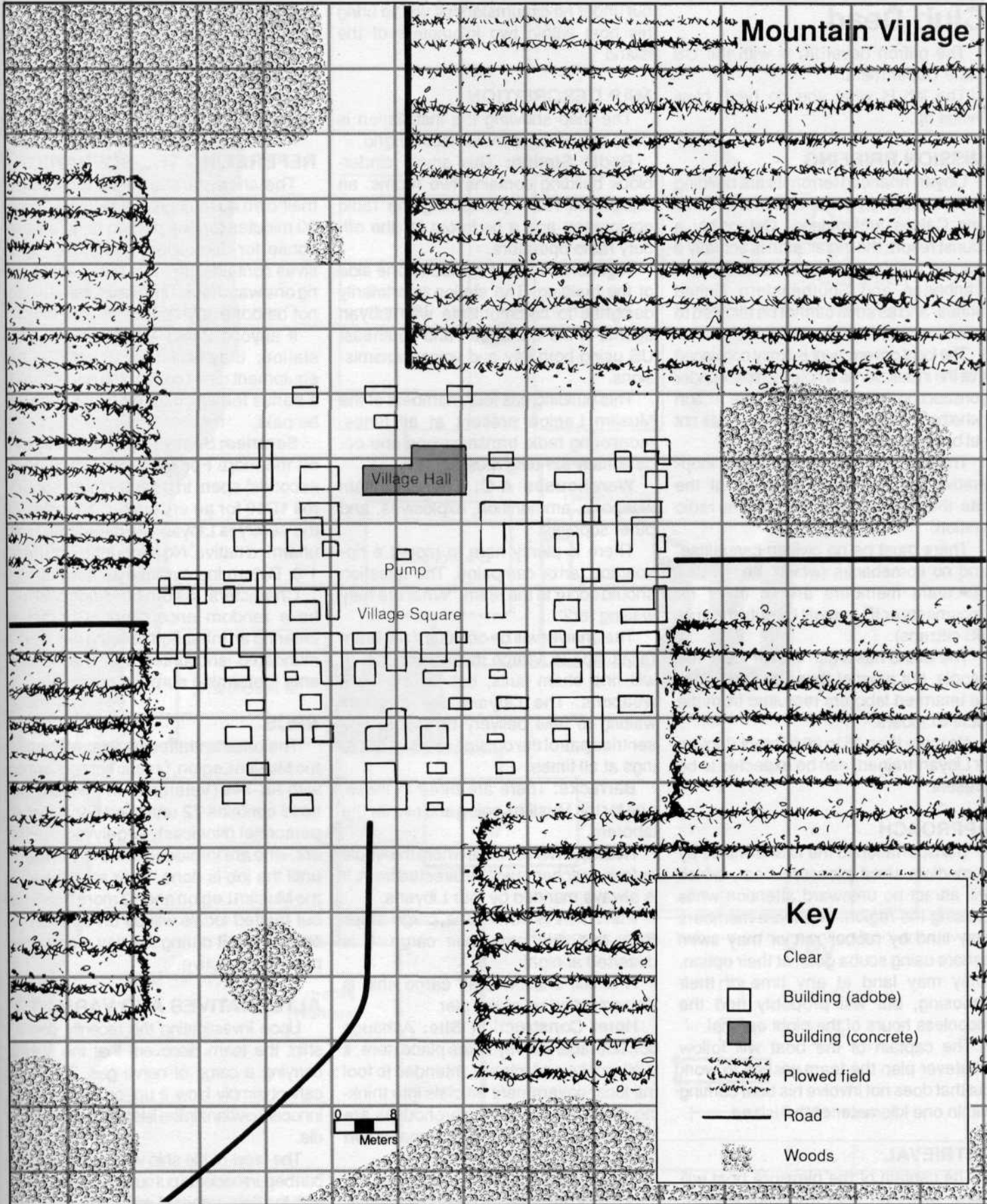

Club Dead

The patron (level III) is with the US State Department.

The job is what you do best: blow things up.

MISSION BRIEFING

Libyan-financed terrorists are building a base on a remote island in the Turks and Caicos archipelago. Ostensibly a tourist resort, the installation is actually a staging area for terrorist attacks in the Caribbean and Southeastern United States, and as such cannot be allowed to reach completion.

The local government is firmly convinced that the installation is a hotel complex under construction and refuses to take action (whether this is due to Libyan bribes has not yet been determined).

The team is to destroy or render inoperative the munitions secreted at the site, the pier/dock facilities, and the radio station.

There must be no civilian casualties, and no comebacks (which means that the team members are to carry no documents or ID that will identify them as US citizens).

The island has a garrison of 75 to 100 people, but most of these are known to be unarmed laborers recruited from the local islanders.

No more than 15 to 20 fighters (Libyan or Libyan-trained) can be expected to be present.

APPROACH

Transportation to the island will be by a medium-sized pleasure boat, which will attract no untoward attention while cruising the region. The team members may land by rubber raft or may swim ashore using scuba gear, at their option. They may land at any time of their choosing, but will probably find the moonless hours of the night optimal.

The captain of the boat will follow whatever plan the team wishes to work out that does not involve his boat coming within one kilometer of the island.

RETRIEVAL

The captain of the pleasure boat will follow whatever plan the team wishes,

but under no circumstances will he bring his boat within two kilometers of the island.

MAP DESCRIPTION

The map showing the installation is done on the eight-meter tactical grid.

Radio Station: This small, cinder-block building contains two rooms: an equipment room (containing the radio equipment) and a bedroom for the off-duty radio operators.

A generator sits in a shed to one side of the building. The station is primarily designed to communicate with Libyan agents in the Caribbean and southeast US using both key and voice transmissions.

This building has four members of the Muslim Legion present at all times, monitoring radio transmissions and occasionally sending messages.

Warehouses A-C: These contain weapons, ammunition, explosives, and other supplies.

There is plenty here to mount a rip-snorting terror campaign. The question should occur to the team: "What are they waiting for?"

The answer will be obvious if the team takes time to search the warehouse. It will find chem suits, but no chemical weapons. The Libyans are obviously waiting to take delivery on these. The sentries patrol the outside of these buildings at all times.

Barracks: There are three of these, one for the Muslim Legion and two for the laborers.

Headquarters: This is where the whole nefarious scheme will be directed from. It is always manned by four Libyans.

Pier: This is where the cargo ships dock and discharge their cargo. It is deserted at night.

A small, shallow draft cargo ship is presently tied up at the pier.

Hotel Construction Site: Although considerable activity takes place here, it is all smoke and mirrors, intended to fool the local government officials into thinking that at the pier and warehouses are for the construction of a large resort complex.

In actuality, all construction that will take place has already been completed.

It is deserted at night and is not even patrolled by sentries.

Helipad: This is empty at the moment, but a shelter and fuel tank (containing aviation gasoline) are both present. It is deserted at night.

REFEREEING THE SCENARIO

The characters are free to work out their own assault plan. It will take about 30 minutes for one person to rig a warehouse for demolition, using the explosives contained in them (two people can rig one warehouse in 15 minutes—it cannot be done any faster).

If anyone thinks to search the radio station, they will find a safe in the equipment room containing code books, a bonus for which an extra \$20,000 will be paid.

Sentries: Sentry routes are indicated on the map. For each combat turn (30 seconds) spent in a sentry route square, roll 1D10 for an encounter: 10 indicates the sentry is Libyan; 7+ means he is an unarmed native. No encounter occurs on 1-6. Determine surprise as normal.

Characters inside buildings will not have random encounters. Characters entering an inhabited building will have a mandated encounter with the inhabitants (determine surprise normally).

NPCS

The base is staffed by 24 members of the Muslim Legion, fanatic fighters armed with AK-74s (Veterans). In addition, the base contains 72 unarmed construction personnel (Novices), largely local workers, who are forbidden to leave the island until the job is done. Four sentries from the Muslim Legion and 12 more unarmed but trusted locals will be on duty at any one time, but during the day many more people are active.

ALTERNATIVES AND VARIANTS

Upon investigating the recently docked ship, the team discovers that the ship is carrying a cargo of nerve gas. The team cannot simply blow it up, or thousands of innocent civilians in the islands downwind will die.

The crew of the ship will be present and can be persuaded to put out to sea if presented with the right caliber of argument.

Island Base

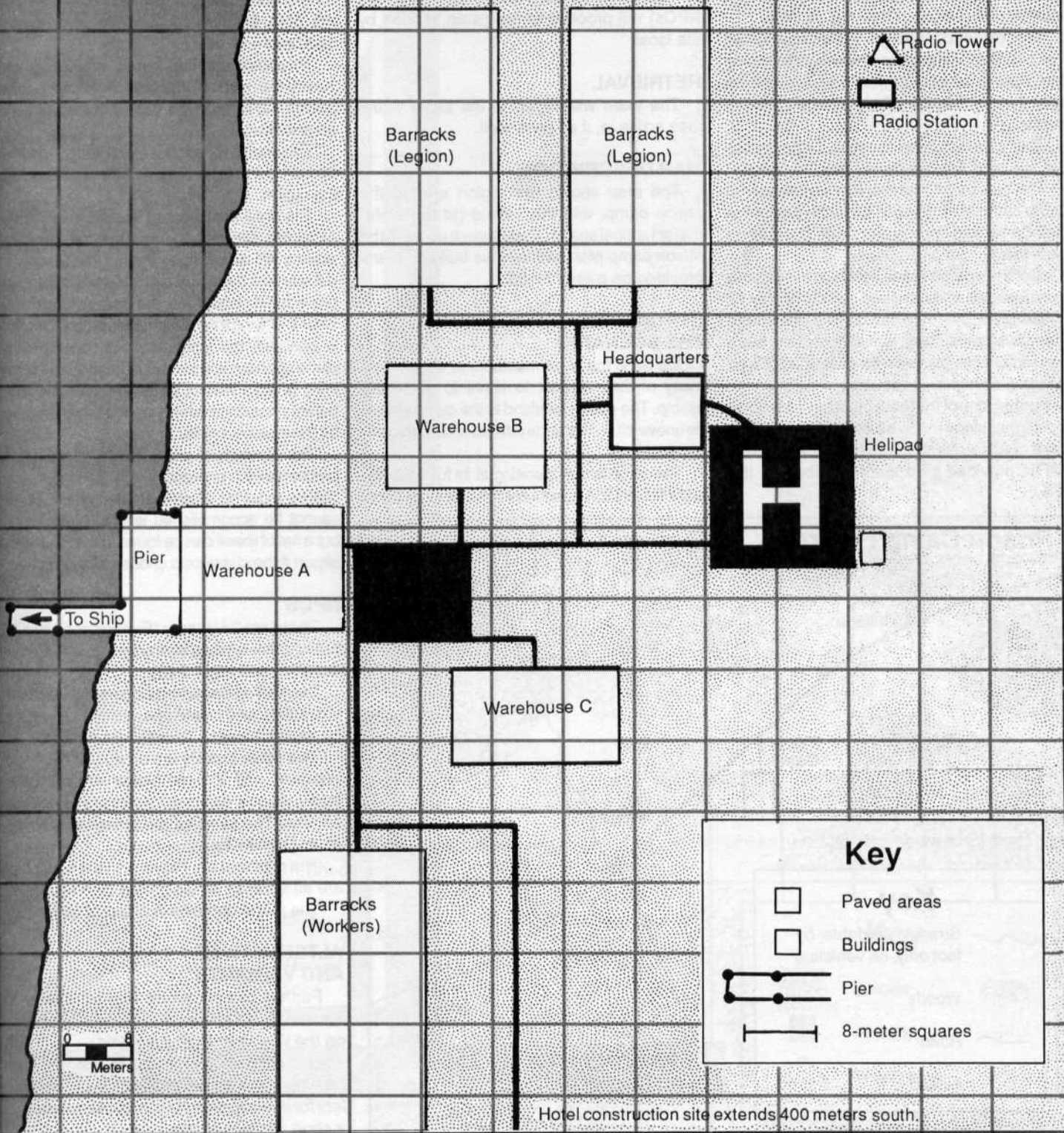

△ Radio Tower
□ Radio Station

Barracks
(Legion)

Barracks
(Legion)

Headquarters

Warehouse B

Helipad

Pier

Warehouse A

← To Ship

Warehouse C

Barracks
(Workers)

Key

□ Paved areas

□ Buildings

—●— Pier

—|— 8-meter squares

0 8
Meters

Hotel construction site extends 400 meters south.

Breakout

This scenario is a prison break.
The patron (level III) is with the DEA.

MISSION BRIEFING

The Columbian federal police have arrested five operatives of the DEA. The police are holding the operatives in a work farm located in a remote part of the country.

The evidence against these operatives has been fabricated; nonetheless, the agency has reason to believe that the five will be killed before the judicial process can release them.

The team is to enter the work camp, locate the five, and remove them from the camp.

The guards and administrative personnel at the camp are known to be in the pay of the Cali Cartel and can be dealt with however is necessary.

Since the cargo plane by which the team is to be inserted and retrieved can carry only 12 passengers, the team can consist of no more than seven personnel, unless two of the team can replace the pilot and co-pilot. Pilot (Fixed Wing): 5 or higher is required to do so.

Further, one of the team must have Medical: 4 or higher since the five captives are likely to need medical attention (an NPC with this skill will be provided if no team member fits the bill).

APPROACH

The team members will be flown in by a small cargo plane, landing shortly before sundown at a little-used airstrip 12 kilometers from the camp, where they will be met by a local who knows which building the five DEA agents are held in.

The plane will be parked and the team (minus the crew for the aircraft, if they are NPCs) will proceed to the camp, guided by the local.

RETRIEVAL

The team will depart in the same plane they arrive in, if all goes well.

MAP DESCRIPTION

The map shows the region around the prison camp, and the airfield (at the eight-meter tactical scale). This adventure uses the prison camp plan and various building plans provided on pages 71 -83.

REFEREEING THE SCENARIO

It is up to the team members to decide how many of their number to leave to guard the airstrip. The march overland to the camp should be uneventful (unless the referee wishes to complicate things).

The camp is not operating at its full capacity, and the five DEA agents are the only inhabitants

of their barracks block.

The members of the team should arrive at the camp during the last vestiges of twilight, just before the searchlights in the guard towers are turned on.

At this time, sentries are beginning to walk the perimeter wire, but they do so from inside the camp, as they are looking for attempts to cut through the wire entanglements from the inside, not from the outside. Sentries pass a given section of wire every 10 minutes.

To complicate the team's mission, shortly before the team returns from the camp, another aircraft will land on the airstrip, forced down by engine trouble.

This aircraft will contain a pilot and two couriers for a drug-smuggling gang which operates out of the region.

The crew members of this plane will not be expecting the strip to be inhabited, and their actions will depend on whether the team left a detachment there to guard the plane. If the cargo plane is left unguarded, the drug smugglers will steal it, leaving their aircraft in its place. If the strip is guarded, the smugglers will see the cargo plane upon landing and will be alerted that something is afoot (two of them will leave the plane before it has completely stopped moving and run for the nearest shelter).

The smugglers' plane has a minor engine problem which prevents it from taking off again unless repaired (Average: Mechanic). Repair cannot be accomplished without aircraft tools, but a set of these can be found in the shed at the airport if the characters choose to search.

NPCS

There are 24 guards (Experienced NPCs), half of them on duty at any one time (basically day shift and night shift).

Each tower contains two guards—one with binoculars and one to operate the searchlight (at night) or watch unaided (in daylight).

Two other guards are on duty in the headquarters, and the remainder are on sentry patrol. All guards in the towers are armed with AK-74s. The sentries are armed with PPSH-41 or Uzi SMGs.

The pilot and the couriers in the light plane are all Veteran NPCs armed with M177s.

The plane contains nothing of interest.

ALTERNATIVES AND VARIANTS

Further complications can be added by throwing in an encounter with a jungle animal on the way to or from the camp.

One or more of the prisoners could have recently been taken to the camp headquarters for interrogation, which would necessitate a short unplanned trip.

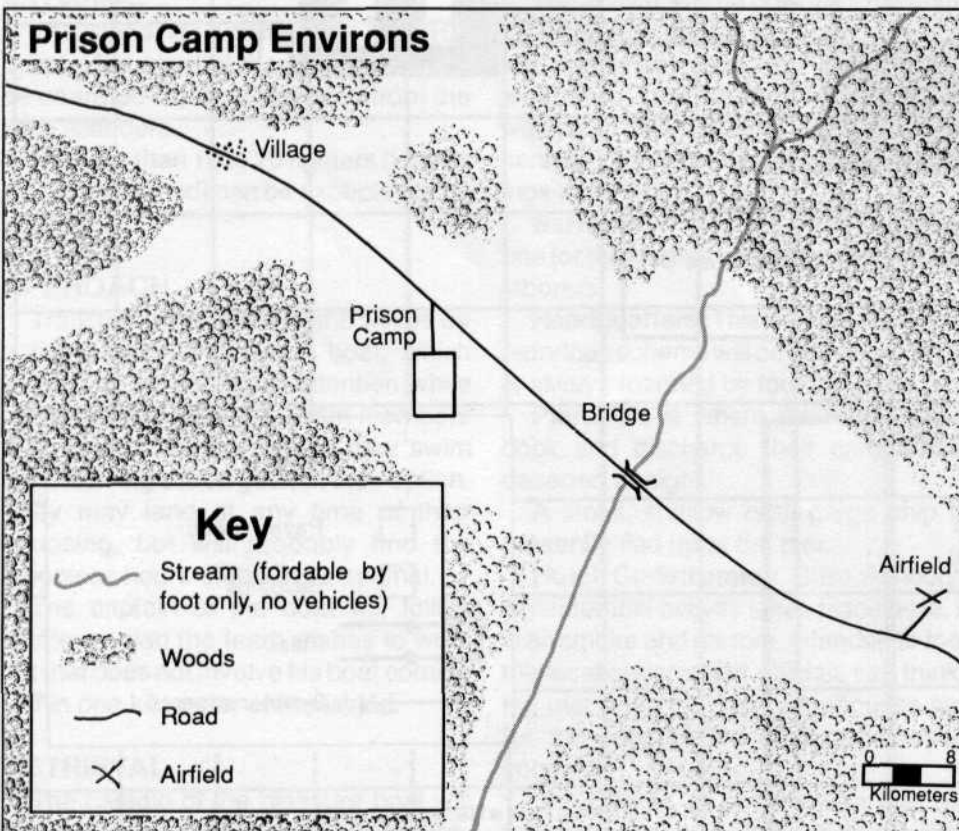

Airfield

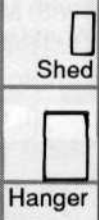
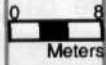
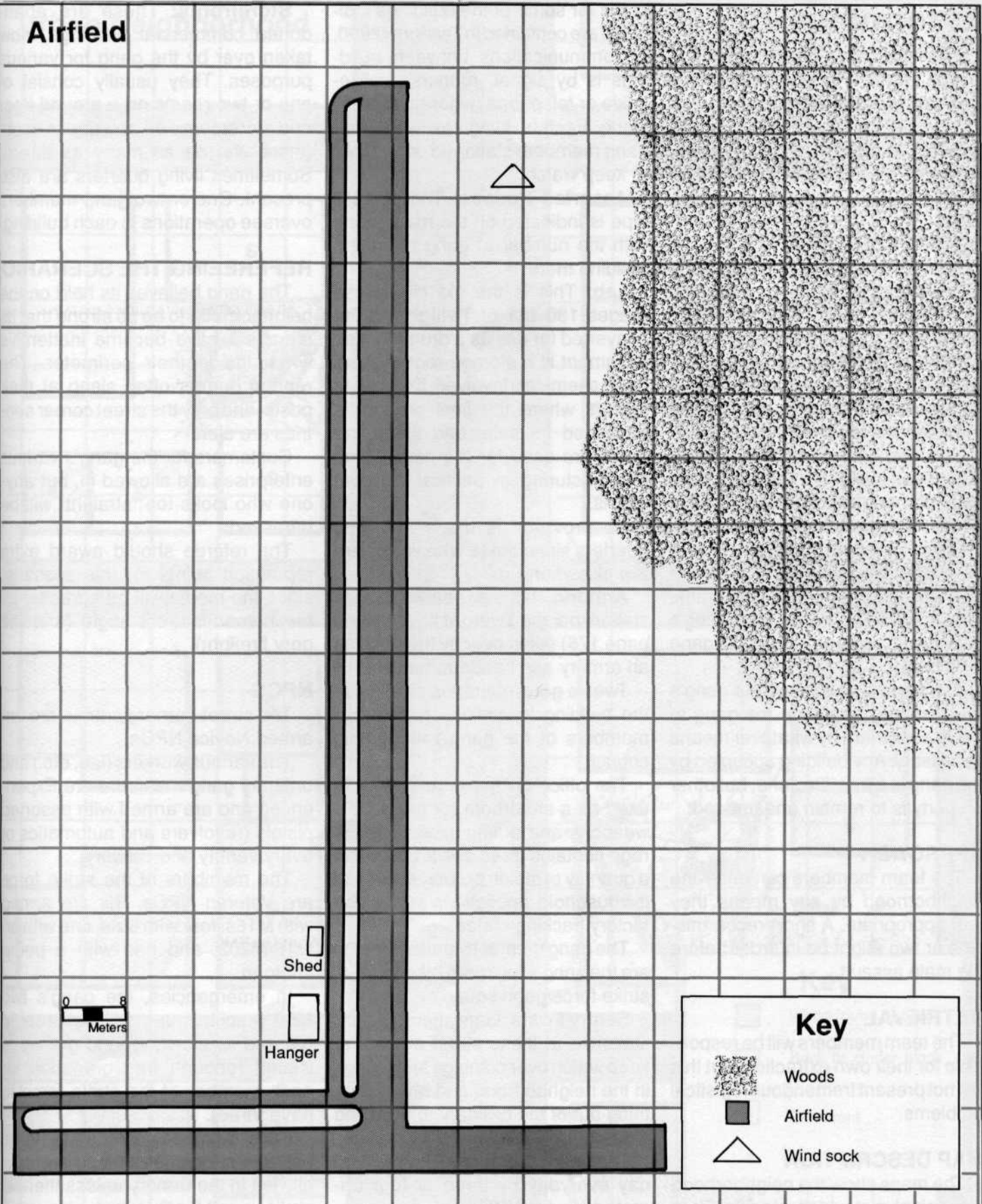

Key	
	Woods
	Airfield
	Wind sock

Exterminators

This mission is a little different. The patron (level 1) is a member of a neighborhood that is being taken over by a small-time criminal gang, driving honest citizens out.

Payment will be at half the standard rate.

MISSION BRIEFING

A small-time gang with delusions of grandeur has taken up residence in a formerly peaceful urban neighborhood, terrorizing it with a campaign of drive-by shootings and seemingly random vandalism calculated to drive honest citizens away and permit the gang to take over.

The local authorities are evidently powerless, and the actions of a neighborhood watch group have resulted in several deaths.

Gang members have taken over several houses in the area, using one as a lab for the manufacture of crank. Other buildings house the gang's armory and serve as "dorms" for gang members.

The team is to destroy the gang's drug lab and persuade the gang to move elsewhere by whatever means necessary. Any building occupied by the gang is a free-fire zone, but other property is to remain undamaged.

APPROACH

The team members can enter the neighborhood by any means they feel appropriate. A short recon mission or two might be in order before the main assault.

RETRIEVAL

The team members will be responsible for their own extraction, but this will not present tremendous logistical problems.

MAP DESCRIPTION

The maps show the neighborhood at the eight-meter tactical scale. Floor

plans for some of the buildings indicated are contained in **Twilight: 2000**.

Communications between buildings is by signal, runners, walkie-talkie or telephone (where these still work). Each building has two armed gang members stationed on the roof to keep watch.

Assorted Houses: The specific type is indicated on the map, along with the number of gang members residing there.

Lab: This is the old city house (pages 180-181 of **Twilight: 2000**) converted for use as a drug lab. The basement is a storage room for the basic chemicals involved; the ground floor is where the final product is packaged for sale; and the upper floors are used for the actual drug manufacturing in several different rooms.

No provision is made for living quarters since those who work here live elsewhere.

Armory: This is an abandoned fire station (per the **Twilight** floor plan on page 176) taken over by the gang as an armory and headquarters.

Twelve gang members now live in the building in addition to the four members of the gang's leadership council.

The office on the ground floor is used as a storeroom for the gang's weapons and ammunition. The garage contains three civilian cars and a quantity of stolen property, much of it household appliances still in the factory packing crates.

The gang members stationed here are the gang's "warriors," the reserve strike force/goon squad.

Sentry Posts: Gang members are stationed at these street corners to keep watch over comings and goings in the neighborhood and report anything out of the ordinary to the gang leaders.

These locations are manned all day everyday by three or four unarmed Novice NPCs.

Storefronts: These are abandoned commercial buildings, now taken over by the gang for various purposes. They usually consist of one or two rooms on a ground floor and storerooms on any upper floors (there can be as many as three). Sometimes living quarters are also present. One or two gang members oversee operations in each building.

REFEREEING THE SCENARIO

The gang believes its hold on the neighborhood to be so strong that its members have become inattentive when inside their perimeter. The rooftop guards often sleep at their posts, and only the street corner sentries are alert.

Customers for the gang's various enterprises are allowed in, but anyone who looks too "straight" will be harassed.

The referee should award extra reputation points for this scenario, since the media will be attracted by the human-interest angle (and the gory firefight).

NPCS

The street-corner sentries are unarmed Novice NPCs.

The various workers (lab, etc.) and ordinary gang members are Experienced and are armed with assorted pistols (revolvers and automatics of every variety and caliber).

The members of the strike force are Veteran NPCs. Six are armed with M16s, four with Uzis, one with an M16/M203, and one with a pump shotgun.



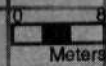
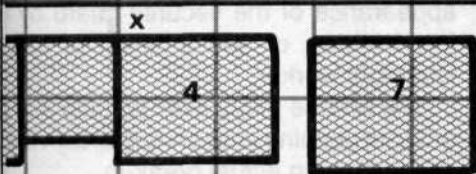
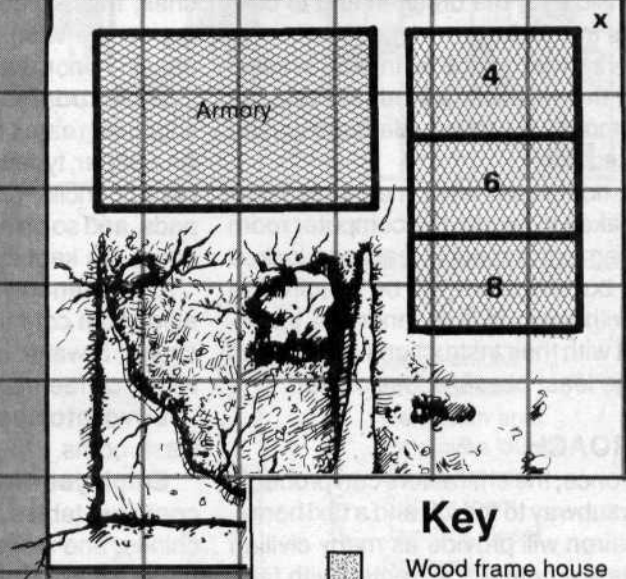
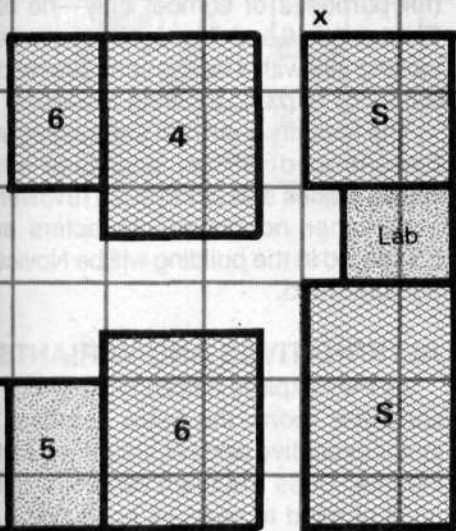
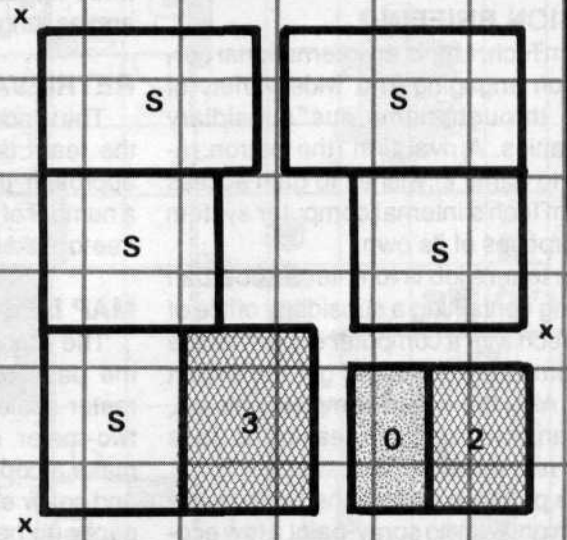
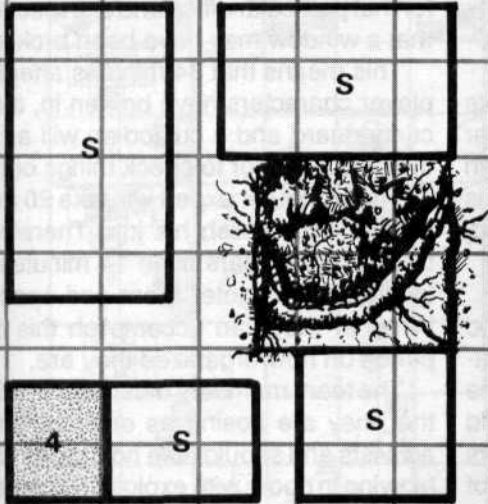
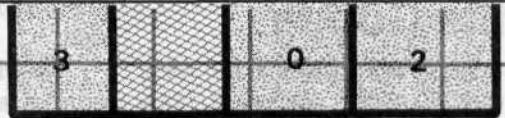

In emergencies, the gang's two M60 machineguns will be brought out and its store of hand grenades issued (enough frag grenades for each member of the strike force to have three).

Each member of the strike force has a gas mask, but these are usually left in the armory unless there is obvious call for them to be issued.

Urban Neighborhood



Key

-  Wood frame house
-  Brick or cinder block house
-  Storefront
-  Sentry post

Get the Goods

This scenario takes place in the wilds of suburban Chicago and is a fairly straightforward industrial espionage caper. The patron (level II) is a partner in a fair-sized law firm, representing an even bigger fish.

MISSION BRIEFING

RamTech, Ltd. is an international corporation engaging in a wide variety of fields through numerous subsidiary companies. A rival firm (the patron refuses to name it) wishes to gain access to RamTech's internal computer system for purposes of its own.

The team's job is to enter a suburban building containing a subsidiary office of RamTech with a computer expert, locate the computer room, and get the expert into it. After the expert completes his job, the team is to exit again, leaving no trace of the real mission.

The patron suggests the team members might want to spray-paint a few eco-guerrilla slogans on the walls and splash red paint around to give the impression that a group of environmental activists is responsible for the break-in and to conceal its true nature.

It is vital that no one be injured or killed during this mission, although a reasonable amount of property damage can be tolerated.

It is not known what measures have been taken to secure the computer room (the team can expect at least one locked door), but the team will be required to deal with them in a manner not inconsistent with their instructions (swiftly and with the least possible loss of life).

APPROACH

For once, the characters can probably take a subway to the job and a taxi home. The patron will provide as many civilian cars as are needed, all rented with fake IDs and untraceable so they can be abandoned if necessary. The team members may make other arrangements if they wish.

A couple of well placed bribes have ensured that a window-washing platform on the side of the building will be lowered to a position where the team can gain

access to it at 2100 hours the night of the raid.

This will enable the team to bypass the normal entrances (with their security guards) and travel directly to the 22nd floor, where the offices of RamTech, Ltd. are located. The platform can carry up to 1000 kilograms at once, and it will take three minutes to rise to the 22nd floor and as long to go down again.

RETRIEVAL

The window-washing platform will take the team down again. As noted under approach, the team will be provided with a number of untraceable rental cars but is free to make other arrangements if desired.

MAP DESCRIPTION

The maps show the grounds around the base of the building at the eight-meter scale, and the 22nd floor at the two-meter scale. The referee should make a copy of this map for the players and cover each room with a small slip of paper (to be removed as the characters enter that room).

Offices: Each of these is pretty much like the others: desk, padded leather chair, mass-produced landscape painting on the wall) and so on. They differ only in minor details.

Storerooms: These contain office supplies: reams of copier paper, rolls of FAX paper, typewriter ribbons, cartons of pens, pencils, plastic paper clips, legal pads, and so on ad infinitum. Their Dutch doors are kept locked.

Conference Room: This large, paneled room contains a conference table, chairs, a water cooler and a sideboard with a coffee maker.

Laboratories: These are typical washrooms.

Employee Break Room: This room contains tables, chairs, vending machines, and a small kitchenette.

Computer Room: This room contains several computer terminals, each one locked. Access to this room is by an electronic keypad lock rather than a normal key lock. Opening this lock requires two successive Average: Electronics rolls. Only one roll may be attempted per minute.

Janitorial Closet: This contains

cleaning supplies and the floor's vacuum cleaner. It is kept locked.

REFEREEING THE SCENARIO

On arriving at the 22nd floor, the PCs will need to break a window in order to get into the building. No alarms will go off, but the computerized air conditioning system will soon notice the added load for that particular office and alert security that a window may have been broken.

This means that 34 minutes after the player characters have broken in, a security guard and a custodian will arrive on the 22nd floor to check things out.

The computer expert will take 20 minutes to accomplish his job. Therefore, the team members have 14 minutes to locate the computer room and open it. Whether they can accomplish this depends on how organized they are.

The team members must bear in mind that they are posing as environmental activists and should take no actions (like blowing in doors with explosive charges) that will contradict this.

NPCS

The computer expert is a Novice NPC (for purposes of combat only—he has Electronics: 6 and Computer: 9), a nerdy looking guy with a laptop computer and a tendency to panic in tense situations.

The security guards in the building are Experienced NPCs, equipped with walkie-talkies and .38 Special revolvers.

All other nonplayer characters encountered in the building will be Novices and unarmed.

ALTERNATIVES AND VARIANTS

As they explore offices looking for the computer room, the team surprises a junior executive and his secretary working late. Does the team have the presence of mind to pose as ecological activists, tie them up, and carry on the mission, or will they panic?

It the team members are having too easy a time of it, move up the scheduled appearance of the security guard by a few minutes, or add a janitor or other late-night worker.

The referee might even want to add a group of genuine environmental activists, conducting an actual break-in.

RamTech Subsidiary Office, 22nd Floor

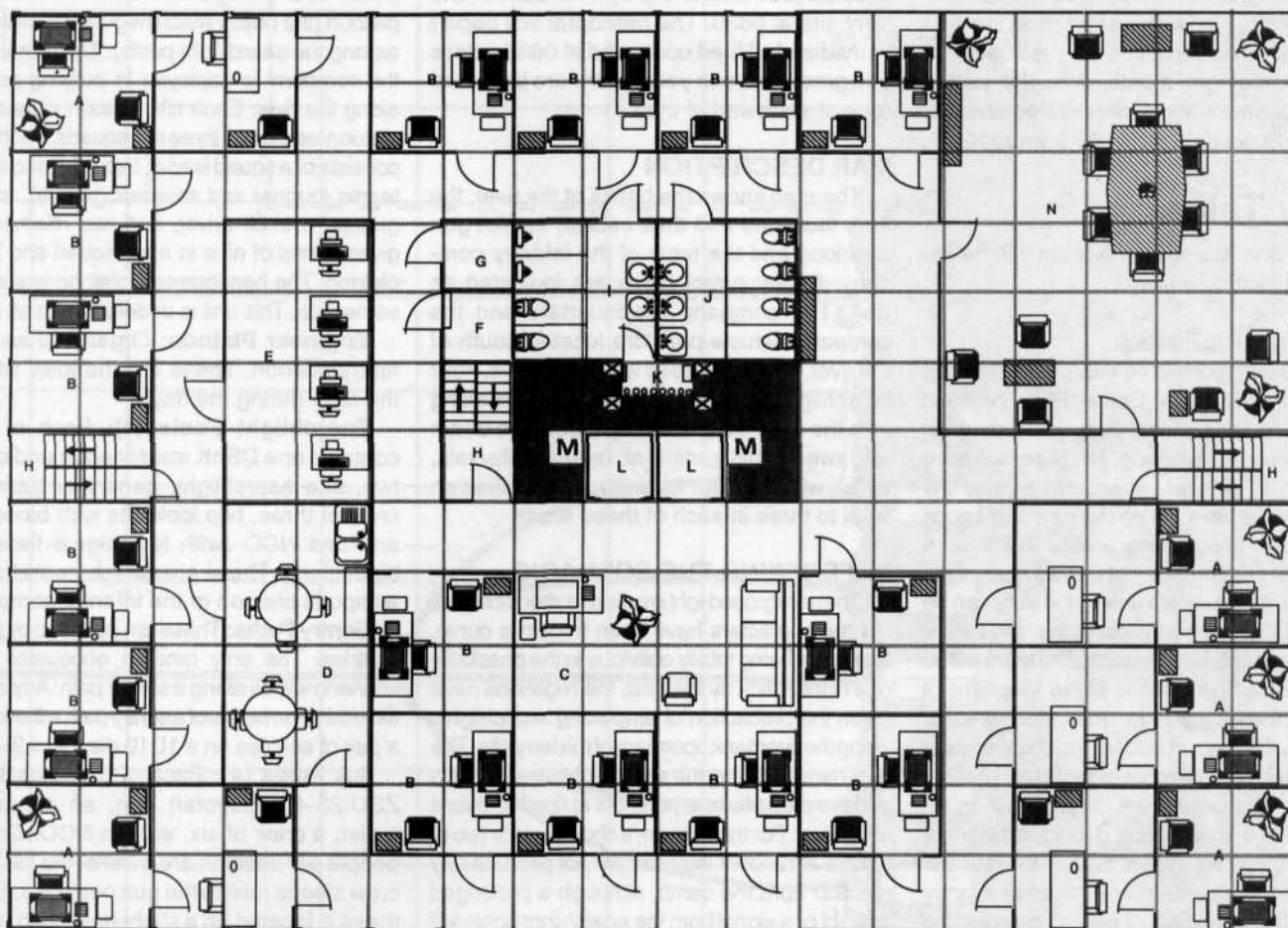

0 2
Meters

Key

- A** Large offices
- B** Small offices
- C** Reception area
- D** Employee lounge
- E** Computer room
- F** Supply room
- G** Janitor's closet
- H** Stairwell
- I** Men's lavatory
- J** Women's lavatory
- K** Utility access room
- L** Elevator
- M** Elevator counterweight channel
- N** Meeting/conference room

Biafran Civil War

In this first sample campaign, the PCs have been approached by an old contact (or a friend of one) to serve as a special strike force for the Biafran Army. The contract is for three months, renewable as often as the PCs care to remain in service. Salary is \$3000 per team member per month, with the patron supplying ammunition and special equipment, and the team supplying its own weapons.

Ferry Tales

In this first scenario, the team will be assigned to destroy a ferry.

MISSION BRIEFING

A Nigerian mechanized infantry brigade has managed to cross the Benue River between Makurdi and Ibi, and has deployed a pontoon ferry to support the crossing. The Nigerians have been able to achieve air superiority over the bridgehead, at least during the day, and troops and vehicles are pouring across the river. A counterattack is planned, but the high command is doubtful of its success unless the ferry can be destroyed. The team is to destroy the ferry before the Biafran counterattack starts. The team will be provided with a demolitions kit, 10 kilograms of plastic explosive, a 5/25 km manpack/vehicular radio, signal flares as needed, three underwater carriers, and snorkeling gear for up to 12 team members. Scuba gear will be provided on request, but the cost will be deducted from the payment. Other equipment is up to the referee.

The ferry is guarded by a Nigerian infantry company, reinforced with a platoon of tanks and two batteries of towed ZSU-23-4 anti-aircraft guns. The remainder of a Nigerian mech infantry battalion (one tank company and another infantry company, plus headquarters and heavy weapons) is picketed less than 10 kilometers away. The team must get in quickly and quietly, mine the ferries, and get out again.

APPROACH

Transport can be provided in the form of one Westland Puma helicopter (capacity up to 24 passengers). The team will be dropped into the river 12 kilometers upstream of the ferry at 2145 hours (just after moonset) and will need to make its way down it to the ferry. The river flows at two kph, and the team can be expected to arrive at the bridge no later than 0400. The bridge must be destroyed by 0430, when the Biafran counterattack will begin.

RETRIEVAL

Retrieval will also be by helicopter. If the team manages to destroy or neutralize the

guns, upon receipt of a radioed code word the Puma will approach and pick up the team on the north bank of the river in a position concealed from hostile fire to the south. Otherwise, the Puma will proceed to a prearranged position four kilometers downstream of the ferry site at 0630. The helicopter will depart immediately if fired upon, and at 0635 unless one green and one yellow flare are launched (one at each end of the LZ).

MAP DESCRIPTION

The map shows the banks of the river, the ferry locations and their cables, the AA gun positions and the tents of the infantry company. Sentry patrol paths are indicated as well. The company headquarters and the company vehicle park are located south of the river, inside a barbed wire enclosure. Four searchlight/MG posts are also indicated, along with the area illuminated by them. The beam will sweep this radius at regular intervals, which will raise the background illumination level to three in each of these areas.

REFEREEING THE SCENARIO

The background light level is one after moonset, but the characters have been thrown a curve. Instead of being totally oblivious to the possibility of a night attack by the river, the Nigerians have taken the precaution of emplacing searchlights along the riverbank upstream of the ferry site. The Nigerians manning the searchlights are nervous and are prone to take potshots at floating debris in the river. For this reason, a short burst or two of gunfire at random intervals will not provoke any reaction from the camp, although a prolonged firefight or a signal from the searchlight posts will (also, a searchlight that goes out for any length of time will attract attention). The searchlight posts are not provided with communication sensors or signaling gear except for a few signal flares at each.

There are five ferries at the site. Each ferry consists of three pontoons and two motorboats to push it across. Cables secure each ferry and keep it on course. Explosives with a DP value of 2 will be required to destroy a pontoon or motorboat, or to cut a cable in one place.

It will require five minutes after being alerted for the camp to awaken and organize itself. It will require another five minutes for the tank crews to start their vehicles.

NPCS

All Nigerian infantry are armed with AK-74s, except for light machinegunners, with PK machineguns, and RPG gunners, with RPG-7s. Officers are armed with PM Makarov pistols. Tank crewmembers have Uzis. All infantry are Experienced; the tankers are Novices.

Tank Platoon: The tank platoon contains two T-55 tanks, one officer, and 11 enlisted men. This is understrength.

Infantry Company: The infantry company consists of a headquarters platoon, two rifle platoons, and a detachment from the weapons platoon (the heavy machineguns are distributed among the searchlight posts). The remainder of the company is deployed in outlying positions along the river. Each rifle platoon consists of a platoon leader and three rifle squads. Each squad consists of a squad leader, two light machinegun teams (gunner and assistant gunner), an RPG gunner, a truck driver, and two riflemen. This gives a total of nine in each squad and 28 in a platoon. The headquarters platoon is about the same size. This unit is understrength as well.

Engineer Platoon: Organized as an infantry platoon. These are the folks who run the ferry during the day.

Searchlight Posts (4): Each of these contains one DShK machinegun and crew of two, one searchlight, generator trailer and crew of three, two lookouts with binoculars, and one NCO (with four signal flares and binoculars). These are detachments from the weapons platoon of the infantry company.

Sentry Paths: These are patrolled by pairs of sentries. The only random encounter in this scenario will be along a sentry path: Any character within five meters of a sentry path will encounter a pair of sentries on a 1D10 die roll of 9+.

AA Posts (4): Each of these contains a ZSU-23-4 anti-aircraft gun, an ammunition trailer, a crew of six, and an NCO. Only two people per position are awake; the rest of the crew sleeps next to the gun positions. Each of these is located on a slight rise—two north of the river, two south of it.

ALTERNATIVES AND VARIANTS



If the characters are too sure of themselves, add a team of four to eight opposing mercenaries: Experienced NPCs with night vision binoculars and AK-74s, one of them with a sniper rifle and starlight scope.

To add a touch of reality, the referee may wish to work out call signs and code words for use in radio communications. For example, names should be assigned to the team (Ferret), the ferry site (Chicago), the Puma helicopter (Weasel), the ferry site LZ (O'hare), and the downriver LZ (LeGuardia). In addition, code words should be assigned for announcing the destruction of the ferry (Apple Pie), the destruction of both the ferry and the AA guns (Pumpkin Pie), and any other message the players want to work out in advance. The team leader would be "Ferret-1" or "Ferret leader," and other members of the team would be "Ferret-2," "Ferret-3," and so on.

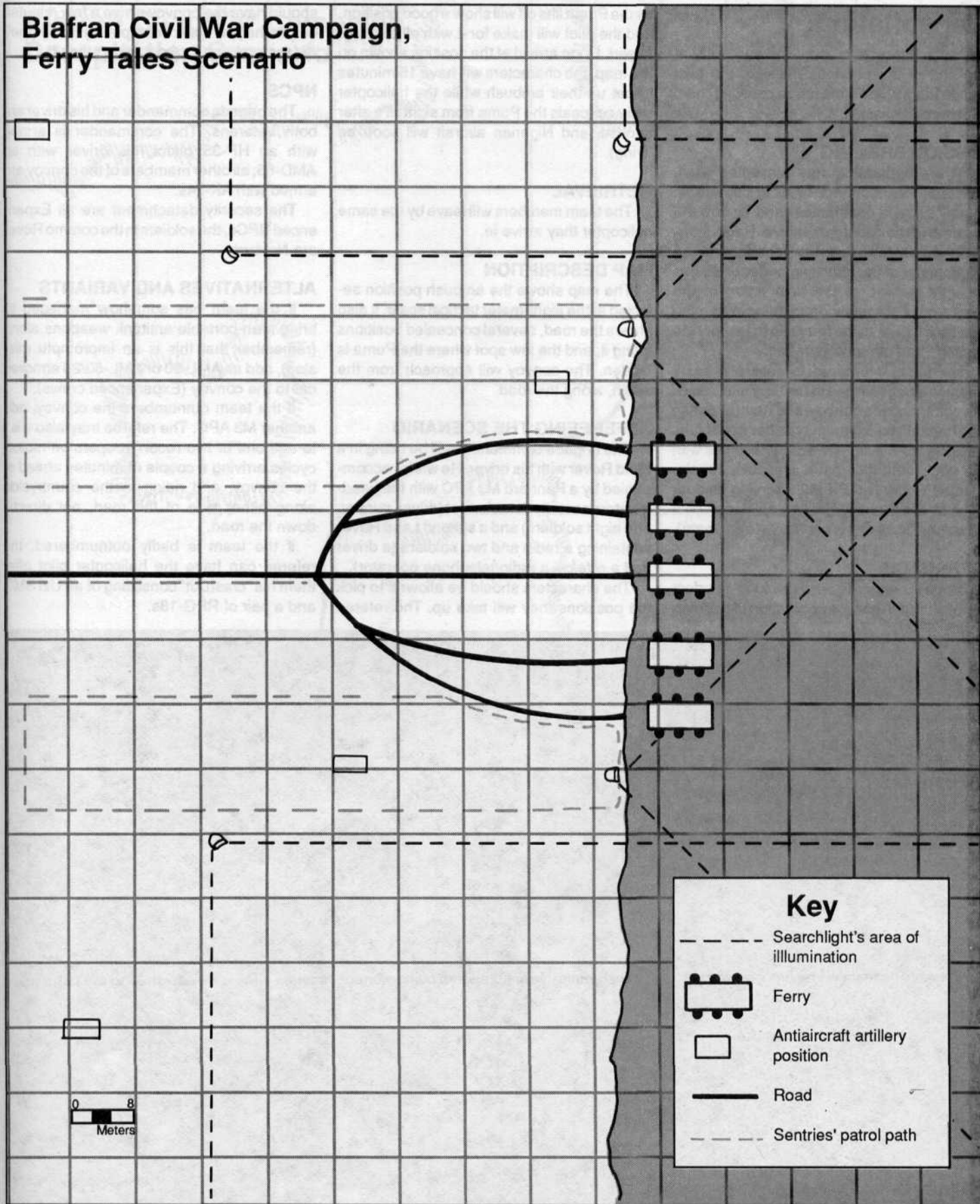
Biafran Civil War Campaign, Ferry Tales Scenario



Key

- Searchlight's area of illumination
-  Ferry
-  Anti-aircraft artillery position
-  Road
- Sentries' patrol path

0 8
Meters

Decapitation

As the characters board the helicopter at the end of the previous mission, the pilot hands them a radio message ordering them to a second mission.

MISSION BRIEFING

A rare opportunity has presented itself. The team has a chance to kill or capture an enemy brigade commander and ensure the success of the counteroffensive. Radio intercepts have revealed the location of the commander of the attacking brigade. He has recently learned of the destruction of the ferry, and is presently proceeding with minimal escort back to the ferry site to inspect the damage and oversee its repair.

The team is ordered to set up a hasty ambush along the road to the ferry site, attack the commander's convoy, and neutralize him and his staff, taking them prisoner if possible. The players will have to accomplish this with the equipment they have available, supplemented by the two PK MGs serving as door guns on the Puma (which the helicopter pilot has offered to dismount and give to the team).

APPROACH

There is no time to waste picking a perfect ambush site. A hasty examination of the map

as the Puma lifts off will show a good position, and the pilot will make for it with all possible speed. Upon arrival at the position shown on the map, the characters will have 15 minutes to set up their ambush while the helicopter crew conceals the Puma from sight (it's after sunrise, and Nigerian aircraft will soon be flying).

RETRIEVAL

The team members will leave by the same helicopter they arrive in.

MAP DESCRIPTION

The map shows the ambush position selected at the eight-metertactical scale. It also shows the road, several concealed positions along it, and the low spot where the Puma is hidden. The convoy will approach from the south, along the road.

REFEREEING THE SCENARIO

The brigade commander will be riding in a Land Rover with his driver. He will be accompanied by a Panhard M3 APC with the headquarters security detachment (driver, gunner, and eight soldiers) and a second Land Rover containing a radio and two soldiers (a driver and a *rateb*—a radio/telephone operator).

The characters should be allowed to pick the positions they will take up. The referee

should have the convoy arrive a few minutes before the players are completely ready (they *did* remember a lookout, didn't they?).

NPCS

The brigade commander and his driver are both Veterans. The commander is armed with an HP-35 pistol, his driver with an AMD-65; all other members of the convoy are armed with AK-74s.

The security detachment are all Experienced NPCs, the soldiers in the commo Rover are Novices.

ALTERNATIVES AND VARIANTS

If the team has somehow managed to bring man-portable antitank weapons along (remember that this is an impromptu mission), add an AML-90 or AML-60/20 armored car to the convoy (Experienced crews).

If the team outnumbers the convoy, add another M3 APC. The referee may also wish to add one or two recon troopers on motorcycles arriving a couple of minutes ahead of the convoy, and riding in the countryside along either side of the road, not directly down the road.

If the team is badly outnumbered, the referee can have the helicopter pilot offer them his "crash kit" consisting of an Uzi SMG and a pair of RPG-18s.

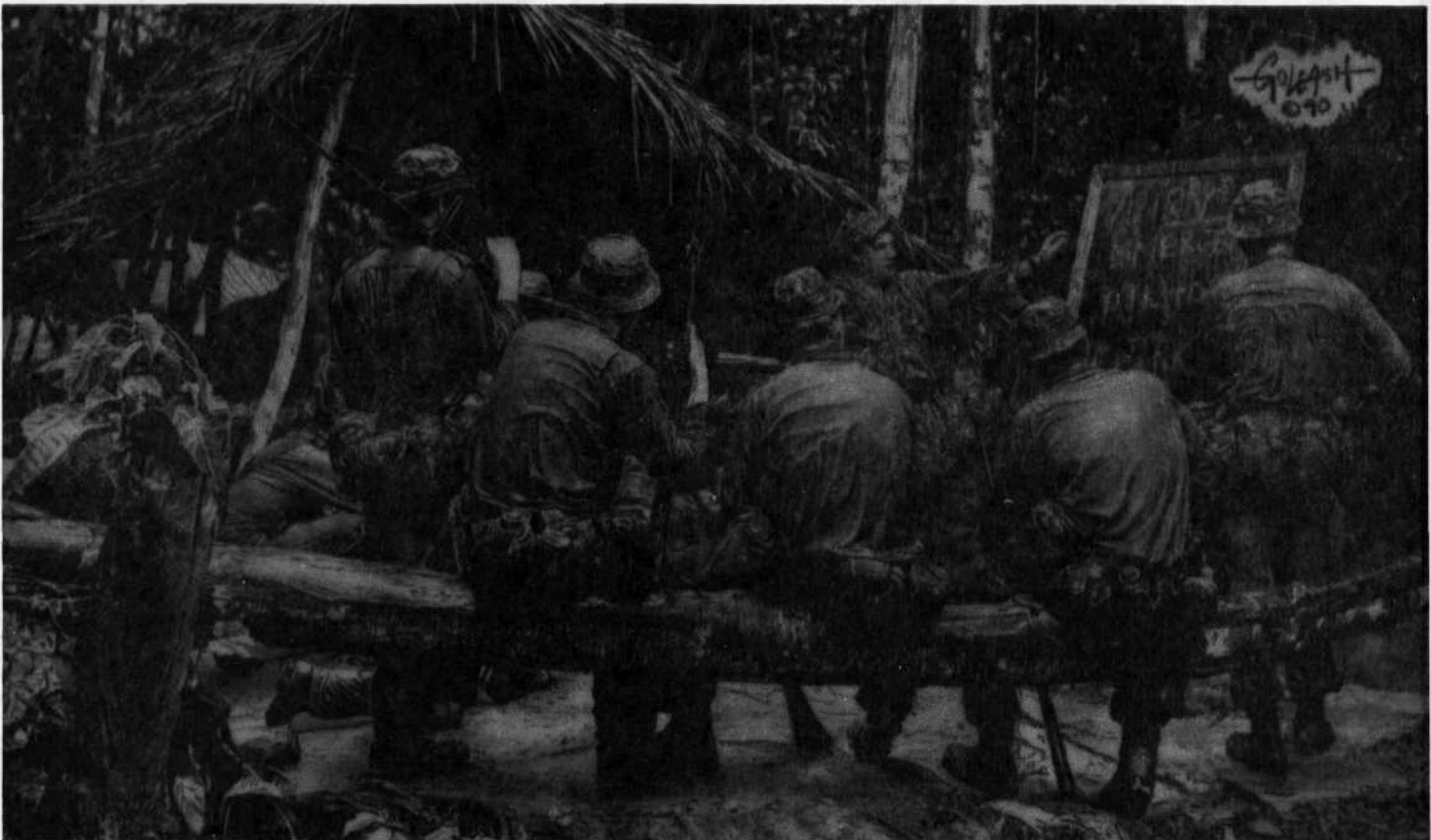

Biafran Civil War Campaign, Decapitation Scenario

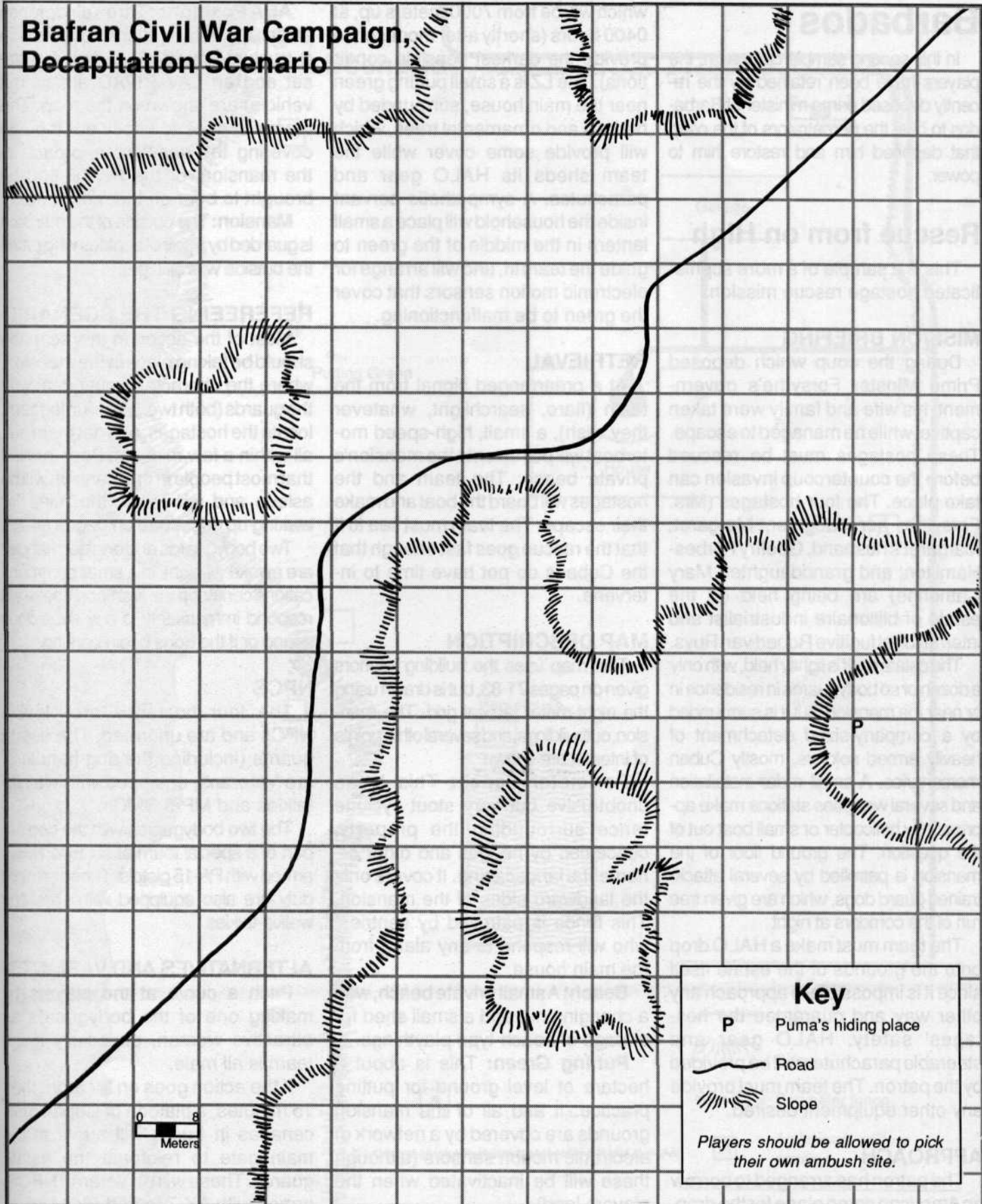

0 8
Meters

Key

P Puma's hiding place

— Road

▨ Slope

Players should be allowed to pick their own ambush site.

Barbados

In this second sample campaign, the players have been retained by the recently deposed prime minister of Barbados to oust the perpetrators of the coup that deposed him and restore him to power.

Rescue from on High

This is a sample of a more sophisticated hostage rescue mission.

MISSION BRIEFING

During the coup which deposed Prime Minister Forsythe's government, his wife and family were taken captive, while he managed to escape. These hostages must be rescued before the countercoup invasion can take place. The four hostages (Mrs. Forsythe; her daughter, Margaret; Margaret's husband, Geoffry Forbes-Hamilton; and granddaughter, Mary Catherine) are being held on the estate of billionaire industrialist and international fugitive Robert van Ruys.

The estate itself is lightly held, with only a dozen or so bodyguards in residence in or near the mansion, but it is surrounded by a company-sized detachment of heavily armed soldiers, mostly Cuban mercenaries. A small radar installation and several weapons stations make approach by helicopter or small boat out of the question. The ground floor of the mansion is patrolled by several attack-trained guard dogs, which are given free run of the corridors at night.

The team must make a HALO drop onto the grounds of the estate itself since it is impossible to approach any other way and guarantee the hostages' safety. HALO gear and steerable parachutes will be provided by the patron. The team must provide any other equipment desired.

APPROACH

The patron has arranged to borrow an American cargo plane for the drop,

which will be from 7000 meters up, at 0400 hours (shortly after moonset, to provide the darkest possible conditions). The LZ is a small putting green near the main house, surrounded by hedges and ornamental trees, which will provide some cover while the team sheds its HALO gear and parachutes. A sympathetic servant inside the household will place a small lantern in the middle of the green to guide the team in, and will arrange for electronic motion sensors that cover the green to be malfunctioning.

RETRIEVAL

At a prearranged signal from the team (flare, searchlight, whatever they wish), a small, high-speed motorboat will pull up onto the mansion's private beach. The team and the hostages will board the boat and make their escape. The team must see to it that the rescue goes fast enough that the Cubans do not have time to intervene.

MAP DESCRIPTION

This map uses the building interiors given on pages 71-83, but is drawn using the eight-meter tactical grid. The mansion, outxjibings, and several other points of interest are shown.

Perimeter Fence: This is an unobtrusive but very stout cyclone fence surrounding the property, concealed by hedges and other ornamental landscaping. It covers only the landward sides of the mansion. This fence is patrolled by sentries, who will respond to any alarm from the main house.

Beach: A small private beach, with a changing hut and a small shed for storage of beach-type playthings.

Putting Green: This is about a hectare of level ground for putting practice. It and all of the mansion grounds are covered by a network of electronic motion sensors (although these will be inactivated when the players land).

ADA Positions: Three airdefense artillery positions (each equipped with a truck-mounted air defense radar set and an LAV PIVAD anti-aircraft vehicle) are shown on the map. The team will need to knock out the one covering the seaward approach to the mansion, or the PIVAD can be brought to bear on the motorboat.

Mansion: The outside of the mansion is guarded by a pair of sentries who patrol the outside wall all night.

REFEREEING THE SCENARIO

Most of the action in this scenario should be taking place in the mansion, where the characters must deal with the guards (both two- and four-legged), locate the hostages, and get them out, all within a few minutes. Bear in mind that most people in the mansion will be asleep and will follow the rules for waking up described on pages 84-85.

Two bodyguards and one dog handler are awake all night in a small communications center on the first floor. These will respond immediately to any suspicious sound or if the dogs begin barking.

NPCS

The four hostages are Novice NPCs and are unarmed. The estate guards (including the dog handlers) are Veterans, equipped with walkie-talkies and MP-5 SMGs.

The two bodyguards with the dog are part of a special team of six Elite NPCs armed with PA-15 pistols. Those on night duty are also equipped with Uzis and walkie-talkies.

ALTERNATIVES AND VARIANTS

Pitch a curve at the players by making one of the bodyguards an attractive woman, especially if the team is all male.

If the action goes on for more than 15 minutes, a platoon of Cuban mercenaries in trucks will arrive at the main gate to reinforce the estate guards. These will be Veteran NPCs, armed with AK-74s and PK MGs.

Barbados Campaign, Rescue from on High Scenario

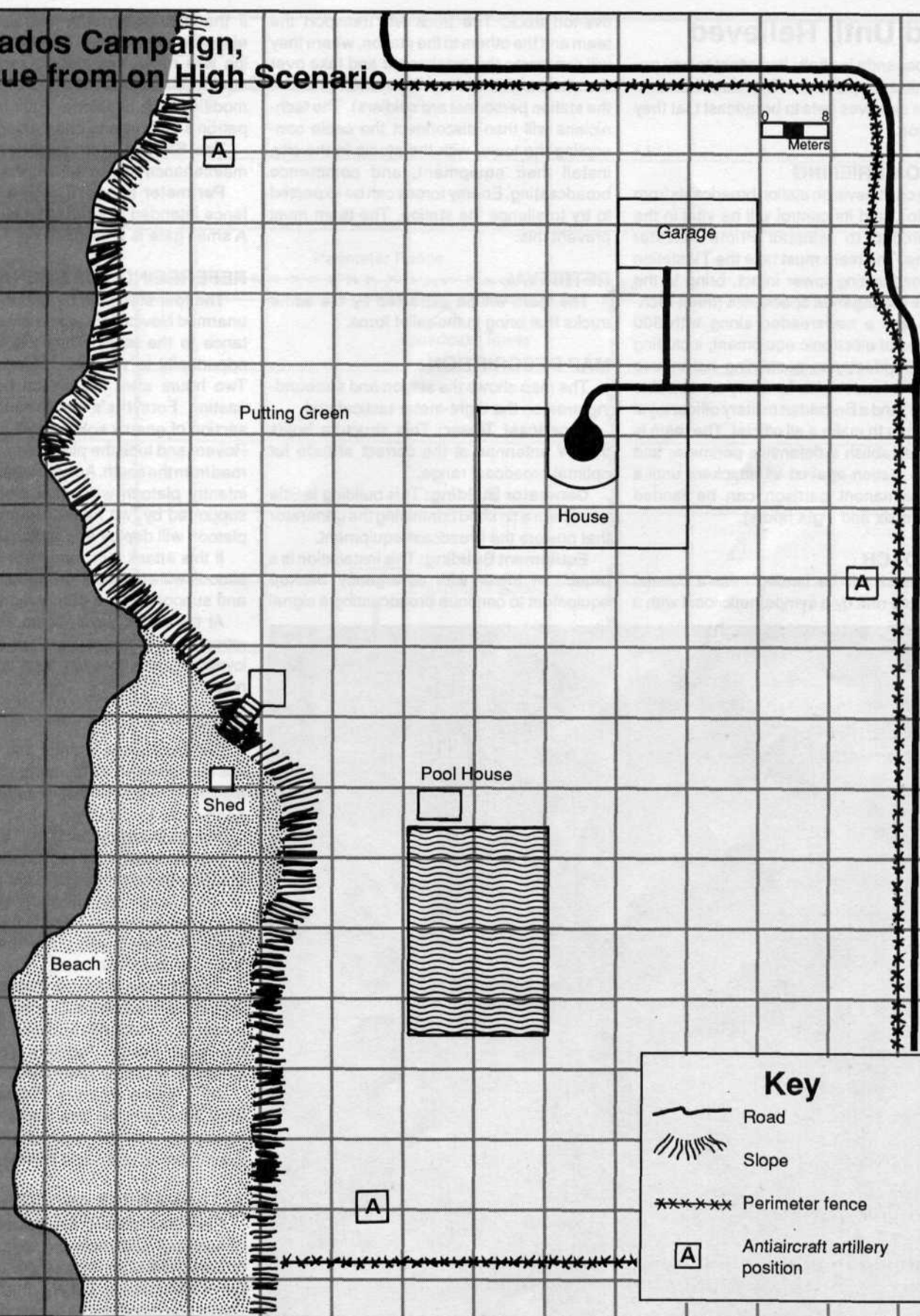

0 8
Meters

Garage

Putting Green

House

A





Shed

Pool House

Beach

A

Key

-  Road
-  Slope
-  Perimeter fence
-  Anti-aircraft artillery position

Hold Until Relieved

Propaganda is vitally important to any political/military operation. The side that controls the airwaves gets to broadcast that they have won.

MISSION BRIEFING

Only one television station broadcasts from Barbados, and its control will be vital in the counter coup to reinstall Prime Minister Forsythe. The team must take the TV station and broadcasting tower intact, bring in the patron's propaganda specialists (three technicians and a newsreader, along with 800 kilograms of electronic equipment, including about 60 videotapes containing harangues and political statements for every conceivable situation) and a Barbadian military officer loyal to Forsythe to make it all official. The team is then to establish a defensive perimeter and hold the station against all attackers until a more permanent garrison can be landed (between six and eight hours).

APPROACH

The team will be landed near a coastal village and met by a sympathetic local with a

five-ton truck. The truck will transport the team and the others to the station, where they will overcome the gatekeeper and take over the station with minimal bloodshed (none of the station personnel are soldiers). The technicians will then disconnect the cable connecting the tower with the studio in the city, install their equipment, and commence broadcasting. Enemy forces can be expected to try to silence the station. The team must prevent this.

RETRIEVAL

The team will be extracted by the same trucks that bring in the relief force.

MAP DESCRIPTION

The map shows the station and surrounding area on the eight-meter tactical grid.

Broadcast Tower: This structure holds the TV antennae at the correct altitude for optimal broadcast range.

Generator Building: This building is little more than a tin shed containing the generator that powers the broadcast equipment.

Equipment Building: This installation is a broadcast tower with emergency backup equipment to continue broadcasting a signal

if the connection with the studio (located elsewhere) is broken. The equipment building was never intended to serve as a fully equipped broadcast studio. It will have to be modified with additional equipment that the patron's technicians bring along with them

Tool Shed: A tin structure holding grounds maintenance equipment for the installation.

Perimeter Fence: This is a light cyclone fence intended to keep out casual intruders. A small gate is shown.

REFEREEING THE SCENARIO

The four staff members at the station are unarmed Novice NPCs and will offer no resistance to the team. They will take the first opportunity to run away if left unattended. Two hours after the station begins broadcasting Forsythe's propaganda, a recon section of enemy soldiers will arrive in Land Rovers and look the place over, securing the road from the south. An hour later, a truckborne infantry platoon will arrive along this road, supported by two Ferret armored cars. This platoon will deploy and attack the station.

If this attack fails, one hour later another platoon will arrive, this one mounted in M113s and supported by a 60mm mortar team.

At the end of seven hours, the enemy will retreat, due to the approach of a company of loyalist infantry from the main landings to the north.

NPCS

The truckborne infantry and recon troops are Novices; the APC-mounted infantry and the Ferret crew are Experienced. All are organized as British-style units.

Recon Infantry Section: This consists of a section leader, a Carl Gustav gunner, a MAG machinegunner, and six riflemen (two of which serve as vehicle drivers). The section is carried in two Land Rovers, and each soldier is armed with an FN-LAR (including weapons Crewmembers).

Truckborne Infantry Platoon: This consists of a platoon leader, an assistant platoon leader, and three rifle sections (organized as the recon section, above). The platoon is carried in unarmed American 2 V_2 -ton trucks.

APC-Borne Infantry Platoon: This platoon is organized the same way as the truckborne platoon, but has a 60mm mortar team (carried in a Land Rover).

ALTERNATIVES AND VARIANTS

Fine-tune the scenario by adjusting the number of attackers and improving their equipment to provide a challenge for the characters. Tanks are out of the question, but an armored car with a 20mm gun or larger can be introduced.



Barbados Campaign, Hold Until Relieved Scenario

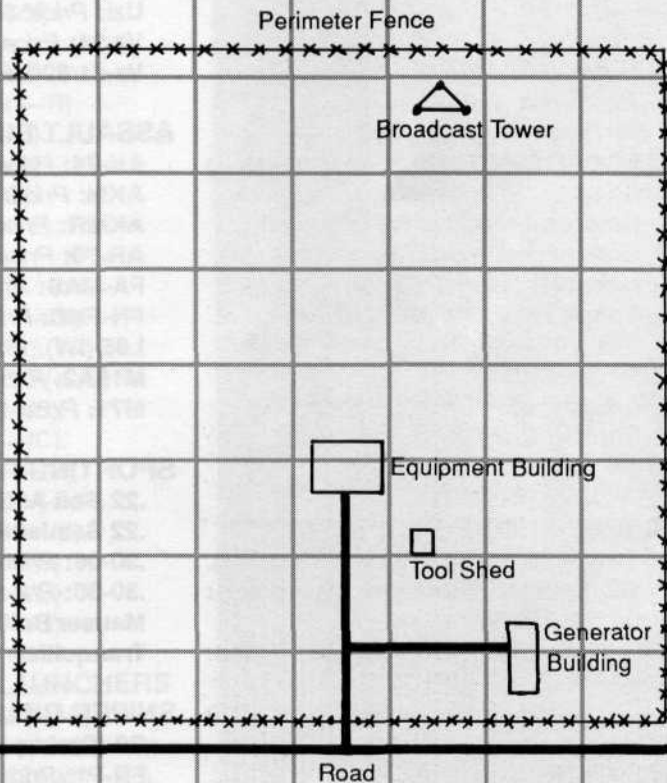

0 8
Meters

PRICE LIST

Prices and the meaning of the availability code in **Merc: 2000** are radically different from **Twilight** since prices in **Twilight** were determined by a different set of criteria. The availability code is still in two parts. The code to the left of the slash now means availability without contacts; the code to the right of the slash now means availability with contacts (how contacts work into it is explained on pages 12-13). The abbreviations are the same (V: Very common C: Common S; Scarce R: Rare and —: Unavailable). Weight remains the same in both games.

This listing is for the referee and players when purchasing equipment. Items are grouped by broad categories (melee weapons, bows, etc.).

We have included most items listed in **Twilight** but some were left out because they have no real application in **Merc: 2000**. No prices for alcohol fuels are included, for example, since the situations where the characters will buy them are almost nonexistent.

Conversion: Unfortunately, there are no easy guidelines for conversion of prices from **Merc** to **Twilight** or back. **Merc** prices can be arrived at simply by using present-day prices where they can be found or extrapolating from similar items listed in this book.

Converting **Merc** prices to **Twilight** and vice versa requires a referee judgment on the relative value of the item to the situation represented in the game, and a decision on how easy the item is to make, how much demand there will be for it, and other economic considerations. Judging from the lack of questions we have received on this matter over the years **Twilight: 2000** has been in print, few referees really have any problems in doing this sort of thing.

DOCUMENTS

Note that these are all for forged documents. Genuine documents can be obtained through the normal channels for such things and usually involve only nominal fees.

Forged Passport, Identity Papers, Etc.: Price: \$1500 (—/S).

Forged Bill of Lading or Similar: Price: \$1000 (—/A).

Forged End User Certificate: Price: \$5000 (—/R).

Other Forged Document: Price: \$1500 (—/S).

MELEE WEAPONS

Axe: Price: \$50 (V/V).

Bayonet: Price: \$45 (V/V).

Club: Price: Usually free for the taking (V/V).

Hatchet: Price: \$15 (V/V).

Knife: Price: \$45 (V/V).

Machete: Price: \$75 (V/V).

Spear: Price: \$45 (VA).

BOWS

Crossbow: Price: \$550 (C/C).

Hunting Bow: Price: \$450 (C/C).

REVOLVERS AND SINGLE-SHOT PISTOLS

.38 Special (Revolver): Price: \$220 (V/V).

.38 Special Snubnose (Revolver): Price: \$250 (VA).

.44 Magnum (Revolver): Price: \$450 (C/C).

.357 Magnum (Revolver): Price: \$300 (V/V).

Black Powder Pistol: Price: \$120 (C/C).

Stun Gun: Price: \$600 (R/S).

AUTOMATIC PISTOLS

.22 (Automatic): Price: \$180 (C/C).

.380 (Automatic): Price: \$250 (C/C).

HP-35: Price: \$475 (C/C).

M9 (M92S): Price: \$540 (C/C).

M1911A1: Price: \$275 (C/C).

M1933 Tokarev: Price: \$350 (—/C).

P-64: Price: \$400 (—/S).

P7M13: Price: \$450 (S/C).

PA-15: Price: \$450 (S/C).

PM Makarov: Price: \$400 (—/C).

Vz-52: Price: \$400 (—/S).

S&W Model 0 (Mk-22): Price: \$900 (—/R).

BATTLE RIFLES

FN-FAL (L1A1): Price: \$750 (—/C).

G3: Price: \$760 (—/C).

SUBMACHINEGUNS

AKR: Price: \$400 (—/C).

AMD-65: Price: \$450 (—/S).

G11: Price: \$800 (—/S).

L2A3 Sterling: Price: \$500 (—/A).

M3A1: Price: \$500 (—/C).

M12: Price: \$650 (—/A).

M177: Price: \$700 (—/A).

M231: Price: \$700 (—/S).

MAT-49: Price: \$650 (—/C).

MP-5: Price: \$500 (—/A).

PPSh-41: Price: \$600 (—/A).

Uzi: Price: \$500 (—/A).

Vz-24: Price: \$750 (—/R).

Vz-61/62 Skorpion: Price: \$800 (—/R).

ASSAULT RIFLES

AK-74: Price: \$500 (—/A).

AKM: Price: \$500 (—/C).

AKMR: Price: \$550 (—/C).

AR-70: Price: \$650 (—/S).

FA-MAS: Price: \$750 (—/S).

FN-FNC: Price: \$700 (—/A).

L85 (IW): Price: \$750 (—/R).

M16A2: Price: \$650 (—/A).

M71: Price: \$700 (—/S).

SPORTING RIFLES

.22 Bolt Action: Price: \$120 (VA).

.22 Semiauto: Price: \$180 (VA).

.30-06: Price: \$320 (C/C).

.30-30: Price: \$300 (C/C).

Mauser Bolt Action: Price: \$320 (C/C).

Tranquilizer Gun: Price: \$1200 (—/R).

SNIPER RIFLES

C3 (Parker-Hale): Price: \$1200 (C/C).

FR-F1: Price: \$1250 (—/R).

L42: Price: \$1200 (C/C).

M21: Price: \$1200 (C/C).

M40: Price: \$1100 (C/C).

PSG1: Price: \$1250 (—/C).

SVD: Price: \$1100 (—/S).

Vz-54: Price: \$950 (C/C).

SHOTGUNS

Double: Price: \$120 (VA).

H&K Combat Assault Weapon: Price: \$750 (—/S).

Pump: Price: \$350 (VA).

Semiautomatic: Price: \$450 (C/C).

AUTOMATIC RIFLES

L86A1 LSW: Price: \$850 (—/S).

M249: Price: \$750 (—/C).

RPK-74: Price: \$700 (—/C).

RPK: Price: \$675 (—/C).

MACHINEGUNS

AAT-52: Price: \$1800 (—/R).

L7A2 GPMG (MAG): Price: \$1700 (—A).
M60: Price: \$1800 (—A).
M214: Price: \$7500 (—/R).
MG3: Price: \$1800 (—/C).
PK: Price: \$1600 (—A).
Vz-59: Price: \$2000 (—/S).

HEAVY MACHINEGUNS

DShK: Price: \$4200 (—/C).
KPV: Price: \$4500 (—/S).
M2HB: Price: \$3500 (—A).

GRENADE LAUNCHERS

AGS-17: Price: \$1750 (—/R).
BG-15: Price: \$400 (—/S).
HK-69: Price: \$460 (—/C).
M203: Price: \$450 (—/C).
Mk-19: Price: \$1800 (—/S).

ROCKET LAUNCHERS

Armbrust: Price: \$250 (—A).
AT4W: Price: \$250 (—A).
Carl Gustav: Price: \$250 (—/C).
Folgore: Price: \$750 (—/S).
LAW 80: Price: \$250 (—/C).
LRAC F1: Price: \$650 (—/S).
M12 SMAW: Price: \$650 (—/C).
M72 LAW: Price: \$260 (—A).
RPG-16: Price: \$450 (—/C).
RPG-18: Price: \$550 (—/C).
RPG-75: Price: \$300 (—/S).

ANTITANK MISSILE LAUNCHERS

ADATS: Price: \$75,000 (—/S).
AT-3 "Sagger": Price: \$5500 (—/C).
AT-4 "Spigot": Price: \$7000 (—/C).
AT-5 "Spandrel": Price: \$8500 (—/S).
AT-7 "Saxhorn": Price: \$9000 (—/S).
Dragon PIP: Price: \$9000 (—/C).
HOT: Price: \$45,000 (—/C).
MILAN II: Price: \$60,000 (—/C).
Swingfire: Price: \$55,000 (—/S).
Tank Breaker: Price: \$75,000 (—/S).
TOW II: Price: \$60,000 (—/C).

LARGE-CALIBER GUNS AND HOWITZERS

122mm D-30 Howitzer: Price: \$85,000
(—/R).
125mm Gun (Rapira-3): Price: \$45,000
MR).

MORTARS

60mm: Price: \$6500 (—A).
81mm: Price: \$8000 (—A).
82mm Vasilek: Price: \$12,000 (—/S).
4.2": Price: \$10,000 (—/S).
120mm: Price: \$15,000 (—/S).





TRIPODS

NHT (NATO Heavy Tripod): Price: \$800 (-/C).

NMT (NATO Medium Tripod): Price: \$650 (-/C).

NLT (NATO Light Tripod): Price: \$500 (-/C).

PHC (Pact Heavy Carriage): Price: \$550 (-/Ft).

PMT (Pact Medium Tripod): Price: \$450 (-/C).

PLT (Pact Light Tripod): Price: \$375 (-/S).

AMMUNITION

Magazines are purchased separately and cost \$1 per round of capacity, except the 1000-round drum for 5.56mm N, which costs \$800.

SMALL ARMS AND MACHINEGUNS

Arrow/Crossbow Bolt: Price: \$36 per 24 (C/C).

Stun Dart Package: Price: \$50 (-/R).

4.7mm CIs (4.7x21 mm Caseless): Price: \$1300 per case (-/S).

5.45mm B (5.45x39mm Bloc): Price: \$170 per case (S/C).

5.56mm N (5.56x45mm NATO): Price: \$160 per case (C/C).

.22LR (5.7x17mmR Long Rifle): Price: \$110 per case (V/V).

7.5mm MAS (7.5x54mm MAS): Price: \$80 per case (R/S).

7.62mm T (7.62x25mm Tokarev): Price: \$375 per case (R/S).

7.62mm S (7.62x39mm Short): Price: \$80 per case (R/S).

.30-30 (7.62x51 mmR): Price: \$130 per case (V/V).

7.62mm N (7.62x51 mm NATO): Price: \$75 per case (C/V).

7.62mm L (7.62x54mmR Long): Price: \$80 per case (C/V).

.30-06 (7.62x63mm): Price: \$95 per case (C/C).

.32 ACP (7.65x17mmSR): Price: \$240 per case (V/V).

8mm M (7.92x57mm Mauser): Price: \$45 per case (C/C).

.380 ACP (9x17mm): Price: \$240 per case (V/V).

9mm M (9x18mm Makarov): Price: \$200 per case (C/C).

9mm P (9x19mm Parabellum): Price: \$195 per case (V/V).

9mm Subsonic: Price: \$45 per box (-/S).

.38 Special (9x29mmR): Price: \$90 per case (V/V).

.357 Magnum (9x33mmR): Price: \$100 per case (V/V).

.44 Magnum (11.2x32.8mmR): Price: \$120 per case (V/V).

.45 ACP(11.43x23mm): Priced 0 per case (VA).

12.7mm B (12.7x83mmR Bloc): Price: \$80 per case (—/S).

.50 BMG (12.7x99mm Browning Machinegun): Price: \$75 per case (S/V).

.50 SLAP (12.7x99mm Saboted Light Armor Piercing): Price: \$85 per case (S/V).

14.5mm B (14.5x114mm Bloc): Price: \$110 per case (—/S).

15mm Dart/Cartridge: Price: \$45 (including dart, drug, and CO₂ cartridge) (—/S).

12 Gauge(12-Gauge All-Brass): Price: \$110 per case (V/V).

HAND GRENADES

Antitank: Price: \$24 each, \$325 per case (—/C).

Chemical: P/7ce; \$18 each, \$250 per case for smoke, double prices for irritant (smoke, C/S; irritant, S/R).

Concussion: Price: \$8 each, \$120 per case (—/A).

Flash-Bang or Crash-Bang Grenade: Price: \$15, \$120 per case (—/C).

Fragmentation: Price: \$10 each, \$150 per case (—/A).

Thermite: Price: \$18 each, \$250 per case (S/C).

WP (White Phosphorus): Price: \$12 each, \$170 per case (—/C).

GRENADE LAUNCHER ROUNDS

30mm HE: Price: \$2 each, \$50 per drum (—/C).

40mm HE: Price: \$3 each, \$200 per case (—/A).

40mm HEDP: Price: \$4 each, \$250 per case (—/C).

40mm CHEM: Price: \$3 each, \$120 per case, (—/S).

40mm ILLUM: Price: \$2 each, \$75 per case (—/C).

40mm HVHE: Price: \$5 each, \$220 per case (—/S).

40mm HVHEDP: Price: \$6 each, \$275 per case (—/S).

40mm Stun: Price: \$20 each, \$800 per case (—/S).

40mm Grapple: Price: \$20 each, \$800 per case (—/S).

ROCKETS

Folgore HEAT: Price: \$24 (—/S).

58.3mm HEAT: Price: \$32 each, \$80 per case (—/S).

82mm SMAWHE: Price: \$35 each, \$180 per case (—/S).

82mm SMAW HEAT: Price: \$35 each, \$180 per case (—/S).

84mm HEAT: Price: \$32 (—/S).

89mm HEAT: Price: \$40 (—/S).

RIFLE GRENADES

HEAT: Price: \$8 each, \$65 per case (—/C).

WP: Price: \$14 each, \$100 per case (—/C).

140mm RAW (Rifle Assault Weapon) HE: Price: \$36 each (—/R).

140mm RAW (Rifle Assault Weapon) HEAT: Price: \$48 each (—/R).

ANTITANK MISSILES

152mm HEAT (Tank Breaker): Price: \$9000 each (—/R).

152mm HEAT (TOW II): Price: \$6500 (—/C).

152mm HEAT (TOW II-C): Price: \$7500 (—/S).

AT-3 "Sagger": Price: \$4500 (—/C).

AT-4 "Spigot": Price: \$5000 (—/C).

AT-5 "Spandrel": Price: \$8500 (—/S).

AT-7 "Saxhorn": Price: \$9200 (—/R).

AT-8 "Songster": Price: \$12,000 (—/R).

MILAN II: Price: \$8000 (—/C).

MILAN II-T: Price: \$9000 (—/S).

HOT: Price: \$5500 (—/C).

Swingfire: Price: \$5500 (—/S).

127mm HEAT (DRAGON PIP): Price: \$3000 (—/C).

ADATS: Price: \$3500 (—/S).

AUTOCANNON ROUNDS

23mm API: Price: \$36 per case (—/S).

23mm HE: Price: \$36 per case (—/S).

25mm API: Price: \$38 per case (—/S).

25mm HE: Price: \$40 per case (—/S).

25mm APDU: Price: \$55 per case (—/R).

30mm API: Price: \$45 per case (—/S).

30mm HE: Price: \$45 per case (—/S).

40mm HE: Price: \$50 per case (—/C).

75mm HE: Price: \$65 each (—/S).

75mm WP: Price: \$68 each (—/R).

75mm APFSDS: Price: \$82 each (—/R).

LARGE-CALIBER ROUNDS

105mm HEAT: Price: \$115 (—/C).

105mm APFSDS: Price: \$120 (—/C).

105mm APDU: Price: \$130 (—/S).

105mm WP: Price: \$130 (—/R).

120mm HEAT: Price: \$120 (—/C).

120mm APFSDS: Price: \$125 (—/C).

120mm APDU: Price: \$135 (—/S).

120mm WP: Price: \$135 (—/R).

125mm HE: Price: \$130 (—/C).

125mm HEAT: Price: \$140 (—/C).

125mm APFSDS: Price: \$150 (—/S).

125mm APDU: Price: \$175 (—/R).

125mm Powder Charge: Price: \$40 (—/C).

HOWITZER ROUNDS

122mm HE: Price: \$135 (—/S).

122mm HEAT: Price: \$140 (—/S).

122mm ICM: Price: \$200 (—/R).

122mm WP: Price: \$160 (—/R).

122mm CHEM: Price: \$160 (—/R).

122mm ILLUM: Price: \$150 (—/S).

122mm Powder Charge: Price: \$40 (—/S).

152mm HE: Price: \$150 (—/S).

152mm HEAT: Price: \$180 (—/S).

152mm ICM: Price: \$300 (—/R).

152mm WP: Price: \$200 (—/R).

152mm CHEM: Price: \$200 (—/R).

152mm ILLUM: Price: \$190 (—/R).

152mm Powder Charge: Price: \$60 (—/S).

155mm HE: Price: \$140 (—/C).

155mm HEAT: Price: \$175 (—/C).

155mm ICM-DP: Price: \$280 (—/S).

155mm WP: Price: \$190 (—/R).

155mm CHEM: Price: \$190 (—/R).

155mm ILLUM: Price: \$170 (—/S).

155mm FASCAM: Price: \$300 (—/R).

155mm Powder Charge: Price: \$55 (—/C).

MORTAR ROUNDS

60mm HE: Price: \$72 per case (—/C).

60mm WP: Price: \$75 per case (—/S).

60mm ILLUM: Price: \$75 per case (—/VS).

81mm HE: Price: \$36 per case (—/C).

81mm WP: Price: \$48 per case (—/S).

81mm ILLUM: Price: \$45 (—/S).

82mm HE: Price: \$60 per clip (—/S).

82mm HEDP: Price: \$65 per clip (—/R).

82mm WP: Price: \$75 per case (—/R).

82mm ILLUM: Price: \$70 per case (—/R).

4.2" HE: Price: \$48 per case (—/S).

4.2" ICM-DP: Price: \$60 per case (—/R).

4.2" WP: Price: \$55 per case (—/S).

4.2" CHEM: Price: \$55 per case (—/R).

4.2" ILLUM: Price: \$55 per case (—/S).

120mm HE: Price: \$72 per case (—/S).

120mm WP: Price: \$80 per case (—/S).

120mm CHEM: Price: \$85 per case (—/R).

120mm ILLUM: Price: \$85 per case (—/S).

EXPLOSIVES

Frame Charge: Price: \$100 (—/R).

Primercord: Price: \$15 per meter (—/C).

Dynamite Stick: Price: \$8 per quarter-kilogram stick, \$600 per case of 100 sticks (S/V).

Engineer Demolitions Kit: Price: \$500 (R/C).

Mine, Antipersonnel: Pr/ce: \$110, \$375 per case (—/C).

Mine, Antitank: Price: \$650, \$1100 per case (—/S).

Mine, Directional: Price: \$240, \$1200 per case (—/C).

Plastic Explosive: Price: \$35 per one-kilogram block, \$600 per case of 20 blocks (-/C).

GENERATORS

1.5 Kilowatt: Price: \$450 (C/C).

5 Kilowatt: Price: \$750 (C/C).

10 Kilowatt: Pr/ce: \$1100 (S/S).

60 Kilowatt: Pr/ce: \$1600 (S/S).

100 Kilowatt: Pr/ce: \$14,000 (S/S).

500 Kilowatt: Pr/ce: \$25,000 (R/R).

HEATERS AND COOLERS

Field Cooker, Military: Pr/ce: \$25 (C/C).

Portable Heater: Price: \$75 (C/C).

HAND TOOLS

Aircraft Tools: Pr/ce: \$1100 (S/S).

Arc Welder: Pr/ce: \$850 (C/C).

Basic Tool Kit: Pr/ce: \$250 (V/V).

Construction Tools: Pr/ce: \$400 (V/V).

Electrical Repair: Price: \$275 (V/V).

Electronic Repair: Pr/ce: \$350 (V/V).

Excavating Tools: Price: \$250 (V/V).

Heavy Ordnance Tools: Price: \$2400 (-/S).

Lockpick Tools: Price: \$50 (—/C).

Portable Machine Shop: Pr/ce: \$12,000 (S/S).

Power Hand Tools: Pr/ce: \$1200 (V/V).

Small Arms Tools: Price: \$750 (S/C).

Tracked Vehicle Tools: Price: \$2200 (-/S).

Wheeled Vehicle Tools: Pr/ce: \$800 (V/V).

RADIOS AND COMMUNICATIONS GEAR

2km Hand: Price: \$250 (V/V).

5/25km Manpack/Vehicular: Pr/ce: \$800 (C/C).

5/25km Secure: Pr/ce: \$1100 (S/C).

50km Secure Vehicle: Pr/ce: \$1450 (S/C).

Directional Microphone: Price: \$3000 (C/C).

Frequency Hopping Radio: Pr/ce: \$800 (R/S).

Individual Tactical Radio: Price: \$550 (S/R).

Portable Facsimile Machine: Pr/ce: \$1800 (C/C).

Portable Satellite Downlink Subsystem: Price: \$12,000 (R/S).

Radio Direction Finder: Price: \$1500 (C/C).

Scrambler/Descrambler: Pr/ce: \$2000 (R/S).

Transponder: Pr/ce: \$1800 (S/C).

RANGEFINDERS

Portable Coincidence RF: Pr/ce: \$7000 (-/S).

Portable Laser RF: Pr/ce: \$15,000 (—/S).

Reticle Gunsight: Pr/ce: \$7500 (—/S).

Vehicle Coincidence RF: Pr/ce: \$25,000 (—/S).

Vehicle Laser RF with Ballistic Computer: Price: \$45,000 (—/R).

Vehicle Laser RF: Pr/ce: \$30,000 (—/R).

VISION DEVICES

4x Binoculars: Price: \$75 (V/V).

25x Image Intensifier: Price: \$750 (R/S).

IR Goggles: Pr/ce: \$850 (R/C).

IR Spotlight: Price: \$5000 (R/C).

Starlight Scope: Price: \$1250 (R/S).

Telescopic Rifle Sight: Price: \$750 (C/C).

Thermal Sight: Price: \$1250 (—/S).

White Light Spotlight: Price: \$225 (V/V).

RADARS

Artillery Counterbattery: Pr/ce: \$45,000 (—/S).

Ground Surveillance: Pr/ce: \$30,000 (-/S).

Mortar Counterbattery: Pr/ce: \$56,000 (-/S).

LASER

DESIGNATORS

Man Portable: Price: \$15,000 (—/R).

Vehicle Mounted: Pr/ce: \$18,000 (—/S).

NBC EQUIPMENT

Chemical Defense Suit: Pr/ce: \$975 (-/C).

Chemical Sniffer: Price: \$750 (—/S).

Gas Mask: Pr/ce: \$110 (S/V).

Geiger Counter: Price: \$250 (S/C).

M256 Chemical Detector Kit: Price: \$24 (—/C).

Optical Chemical Sensor: Pr/ce: \$850 (-/R).

Steam Decontamination Trailer: Price: \$14,000 (—/R).

MEDICAL SUPPLIES

Anesthetic, Local (100 Units): Pr/ce: \$45 (—/N).

Anesthetic, Total (100 Units): Price: \$75 (—/V).

Antibiotic (100 Units) +, -, & ± Varieties: Price: Liquid, \$25; oral, \$30 (—/W).

Antifever (100 Units): Pr/ce: \$10 (—/V).

Atropine (100 Units): Price: \$25 (—/C).

Atropine (Autoinjector): Pr/ce: \$75 per kit of 10 HC).

Blood, Whole (1 Unit): Pr/ce: \$45 (—/C).

Pain-Reliever, Mild (100 Units): Price: \$40 (—/N).

Personal Medical Kit: Pr/ce: \$25 (S/V).

Plasma (1 Unit): Price: \$40 (—/C).

Sedative, Mild (100 Units): Price: \$30 (-/C).

Sedative, Strong (100 Units): Price: \$45 (—/C).

Surgical Instruments: Price: \$350 (—/C).

BODY ARMOR

Close Assault Vest: Pr/ce: \$1200 (—/S).

Flak Jacket: Price: \$450 (R/C).

Kevlar (Ballistic Nylon) Helmet: Price: \$150 (C/C).

Kevlar (Ballistic Nylon) Vest: Price: \$350 (R/C).

Steel Helmet: Price: \$120 (V/V).

PERSONAL GEAR

1-liter Canteen: Price: \$10 (V/V).

2-liter Reserve Canteen: Price: \$25 (V/V).

5-liter Reserve Canteen: Price: \$30 (V/V).

Assault Suit: Pr/ce: \$1100 (—/S).

Basic Load: Free upon creation of character (except for weapons).

Combat Webbing: Price: \$30 (V/V).

Extreme Cold Weather Gear: Price: \$200 (V/V).

Fatigues: Pr/ce: \$80 (V/V).

Flashlight: Pr/ce: \$10 (V/V).

HALO Rig: Pr/ce: \$3500 (—/S).

Pack: Pr/ce: \$30 (V/V).

Parka: Pr/ce: \$80 (V/V).

Shelter Half: Pr/ce: \$45 (V/V).

Sleeping Bag: Price: \$85 (V/V).

Snorkel Gear: Pr/ce: \$120 (V/V).

Thermal Fatigues: Price: \$100 (V/V).

OTHER EQUIPMENT

20-Liter Jerrycan: Price: \$20 (V/V).

Air Compressor: Pr/ce: \$280 (V/V).

Air Tank, Aqualung: Price:\$110 (C/C).
Aqualung: Price:\$300 (C/C).
Food, Domestic: Price:\$3 per kg (VA).
Food, MRE or Equivalent: Price:%5 per kg (VA).
Food, Wild: Price:\$1 per kg (VA).
Grapple: Price: \$60 (VA).
Grenade, Colored Smoke: Price: \$30 (R/S).
Grenade, Illuminating: Price: \$25 (—/S).
Horse Tack: Price: \$300 (C/C).
Pack Saddle: Price: \$200 (C/C).
Parachute: Price: \$450 (C/C).
Paraglider (Steerable Parachute): Price: \$650 (C/C).
Rebreather Recharge Kit: Price: \$120 (S/S).
Rebreather: Price: \$375 (S/S).
Rope: Price: \$100 per 50m coil (VA).
Shotgun Flare: Price: \$5 (R/S).
Signal Flare: Price: \$25 (C/V).
Silencer/Suppressor: Price: \$1000 (S/C).
Skis, Cross-Country: Price: \$450 (VA).
Skyhook (Ground Unit): Price: \$800 (—/R).
Tent, 4-man: Price: \$120 (VA).
Tent, 10-man: Price: \$375 (C/C).
Tranq Autoinjectors: Price: \$75 per set of three (—/S).
Underwater Carrier: Price: \$85 (R/S).
Vehicle Low-Altitude Extraction Kit: Price: \$8000 (—/R).
Vehicle Parachute Kit: Price: \$12,000 (—/R).

FUEL

Avgas: Price: \$.50 per liter (C/C).
Gasoline: Price: \$.50 per liter (VA).
Diesel: Price: \$.40 per liter (C/C).

UNARMORED CARGO VEHICLES

1-ton Cargo Trailer: Price: \$1100 (VA).
1000-Liter (1-Ton) Tank Trailer: Price: \$1200 (S/C).
5000-liter (5-ton) Tank Truck: Price: \$20,000 (S/C).
10,000-Liter (10-Ton) Tank Truck: Price: \$30,000 (S/S).
Bicycle: Price: \$250 (VA).
Civilian Car: Price: \$14,000 (VA).
FAV: Price: \$15,000 (R/S).
GAZ-46 MAV: Price: \$12,000 (—/S).
HMMWV (Hum-Vee): Price: \$18,000 (—/C).
HMMWV Fire Support Vehicle: Price: \$24,000 (—/R).
LWB Land Rover: Price: \$11,000 (VA).
M151 V4-Ton Truck "Jeep": Price:

\$9500 (VA).
M548 6-Ton Cargo Carrier: Price: \$28,000 (—/S).
M648 10-Ton Cargo Carrier: Price: \$32,000 (—/S).
M973 Carrier, Tracked, 1 1/2-Ton SUSV: Price: \$28,000 (R/S).
M992 FAASV: Price: \$30,000 (—/R).
Motorcycle: Price: \$2200 (VA).
PTS-M: Price: \$18,000 (—/R).
Truck, Cargo, 3/4-Ton: Price: \$11,000 (C/C).
Truck, 1-Ton: Price: \$20,000 (C/C).
Truck, Cargo, 1-A-Ton: Price: \$12,000 (VA).
Truck, Cargo, 2 1/2-Ton: Price: \$18,000 (C/C).
Truck, Cargo, 5-Ton: Price: \$22,000 (C/C).
Truck, Cargo, 8-Ton: Price: \$35,000 (C/C).
UAZ-469: Price: \$8500 (—/S).

INFANTRY FIGHTING VEHICLES

AIFV: Price: \$275,000 (—/S).
AMX-10P: Price: \$225,000 (—/S).
BMP-1: Price: \$110,000 (—/C).
BMP-2: Price: \$125,000 (—/S).
BMP-3: Price: \$150,000 (—/R).
BVP-1: Price: \$115,000 (—/R).
BVP-2: Price: \$130,000 (—/R).
FV-510 Warrior (MCV-80): Price: \$220,000 (—/S).
M-80: Price: \$140,000 (—/S).
M2 Bradley: Price: \$1,100,000 (—/C).
M2A2 Bradley II: Price: \$1,250,000 (—/S).
M2A3 Bradley: Price: \$1,500,000 (—/R).
M113: Price: \$150,000 (—/C).
M113A3 ACCV: Price: \$160,000 (—/S).
M115A1 ACCV: Price: \$200,000 (—/R).
Marder: Price: \$280,000 (—/S).

ARMORED

PERSONNEL CARRIERS

BTR-50P: Price: \$55,000 (—/S).
BTR-60: Price: \$95,000 (—/C).
BTR-70: Price: \$100,000 (—/S).
BTR-80: Price: \$110,000 (—/R).
BTR-152: Price: \$90,000 (—/S).
Commando V-300 APC: Price: \$350,000 (—/S).
EE-11 Urutu: Price: \$180,000 (—/R).
HWK II: Price: \$75,000 (S/R).
M60-P: Price: \$80,000 (—/S).
MT-LB: Price: \$90,000 (—/S).
OT-62: Price: \$55,000 (—/R).
OT-64: Price: \$65,000 (—/R).

OTO-Melara 6614: Price: \$75,000 (—/S).
Panhard M3: Price: \$50,000 (R/C).
Panhard VCR: Price: \$75,000 (R/S).
RAM V-1: Price: \$45,000 (S/C).
RBV Mk1: Price: \$45,000 (S/C).
TAB-72: Price: \$100,000 (—/R).
TAB-77: Price: \$110,000 (—/R).
TAB-90: Price: \$120,000 (—/R).
Type 531: Price: \$65,000 (—/R).

LIGHT COMBAT VEHICLES

AAVP7A1: Price: \$275,000 (—/S).
BA-64: Price: \$20,000 (—/R).
BMD-1: Price: \$250,000 (—/S).
BMD-2: Price: \$400,000 (—/R).
BRDM-1: Price: \$200,000 (—/R).
BRDM-2: Price: \$250,000 (—/S).
BRDM-3: Price: \$250,000 (—/S).
BRDM-4: Price: \$275,000 (—/S).
Commando Scout: Price: \$60,000 (—/C).
Commando V-150: Price: \$250,000 (—/C).
Commando V-300 CS: Price: \$350,000 (MS).
Commando V-300 TUA: Price: \$350,000 (—/S).
EE-3 Jararaca: Price: \$200,000 (—/S).
EE-9 Cascavel: Price: \$200,000 (—/S).
Ferret: Price: \$95,000 (—/S).
FUG-70/OT-65/OT-65A: Price: \$180,000 (—/S).
LAV-25: Price: \$225,000 (—/S).
LAV-75: Price: \$500,000 (—/S).
M3 Bradley: Price: \$950,000 (—/R).
M3A1: Price: \$20,000 (—/R).
M8: Price: \$35,000 (—/R).
M18 Mortar Carrier: Price: \$1,100,000 (—/R).
M20: Price: \$125,000 (—/R).
M22 Laser Generator Vehicle: Price: \$1,200,000 (—/R).
M24 Chaffee: Price: \$350,000 (—/R).
M41: Price: \$500,000 (—/R).
M106 Mortar Carrier: Price: \$160,000 (MS).
M551 Sheridan: Price: \$850,000 (—/S).
M577A1: Price: \$190,000 (—/S).
M750 AC (Commando V-350): Price: \$375,000 (—/R).
OT-65: Price: \$225,000 (—/R).
OTO-Melara 6616: Price: \$85,000 (MS).
Panhard AML: Price: \$85,000 (—/C).
Peacekeeper Armored Car: Price: \$65,000 (R/R).
PT-76: Price: \$225,000 (—/R).

SO-120: Price: \$300,000 (—/R).
TAM/TH-301: Price: \$750,000 (—/S).
Type 62: Price: \$950,000 (—/R).
VBC-90: Price: \$750,000 (R/S).

ENGINEERING VEHICLES

M1 AVLB: Price: \$4,100,000 (—/R).
M5AbramsARV: Price: \$3,950,000 (—/R).
M60 AVLB: Price: \$1,200,000 (—/S).
M88A1 ARV: Price: \$850,000 (—/S).
M728 CEV: Price: \$1,100,000 (—/R).

MAIN BATTLE TANKS

C-1 "Ariete": Price: \$4,000,000 (—/R).
Cadillac Gage Stingray: Price: \$1,400,000 (—/S).
EPC "LeClerc": Price: \$4,000,000 (—/R).
FV-4030/4 Challenger: Price: \$4,200,000 (—/R).
Leopard I: Price: \$1,700,000 (—/C).
Leopard II: Price: \$3,500,000 (—/S).
M-47: Price: \$900,000 (—/R).
M-77: Price: \$1,000,000 (—/R).
M-81: Price: \$1,100,000 (—/R).

M-84: Price: \$1,500,000 (—/R).
M1: Price: \$3,750,000 (—/S).
M1A1: Price: \$4,300,000 (—/S).
M1A2: Price: \$4,900,000 (—/R).
M4A3E8: Price: \$750,000 (—/R).
M48A3 Patton: Price: \$1,000,000 (—/S).
M48A5: Price: \$800,000 (—/S).
M60A3/A4: Price: \$1,200,000 (—/C).
T-34/85: Price: \$800,000 (—/R).
T-54/T-55: Price: \$950,000 (—/C).
T-62: Price: \$1,000,000 (—/C).
T-64: Price: \$1,100,000 (—/S).
T-72/T-74: Price: \$1,500,000 (—/C).
T-80: Price: \$3,800,000 (—/R).
T-90: Price: \$4,000,000 (—/R).
Vickers Valiant: Price: \$1,700,000 (—/VS).

SELF-PROPELLED ARTILLERY

ASU-85: Price: \$110,000 (—/S).
Bm-14: Price: \$25,000 (—/S).
Bm-21: Price: \$45,000 (—/S).
Bm-27: Price: \$40,000 (—/S).
LAV-PIVAD: Price: \$500,000 (—/R).
M-77 Dana: Price: \$650,000 (—/R).

M7 Priest: Price: \$45,000 (—/R).
M17 LAVAA: Price: \$250,000 (—/S).
M21LADA Laser ADA Vehicle: Price: \$3,500,000 (—/R).
M42 Duster: Price: \$250,000 (—/S).
M48 Chaparral: Price: \$450,000 (—/S).
M107 SPA: Price: \$110,000 (—/R).
M109A2: Price: \$950,000 (—/S).
M110A2 SPA: Price: \$110,000 (—/R).
M691 Diana: Price: \$850,000 (—/R).
M741A6 PIVAD: Price: \$750,000 (—/S).
M901 ITV: Price: \$250,000 (—/S).
M917 ADATS: Price: \$350,000 (—/R).
M948 LARS: Price: \$200,000 (—/S).
M975A3 Roland II: Price: \$750,000 (—/S).
M990 ADA: Price: \$750,000 (—/R).
M993 MLRS: Price: \$750,000 (—/R).
MPGS-90: Price: \$600,000 (—/S).
SO-122: Price: \$250,000 (—/S).
SO-152: Price: \$300,000 (—/S).
SO-203: Price: \$500,000 (—/R).
SU-130: Price: \$600,000 (—/R).
XM12 Laser ADA: Price: \$7,500,000 (—/R).
ZSU-23-4: Price: \$450,000 (—/S).
ZSU-30-2: Price: \$650,000 (—/R).

HOVERCRAFT

M5 RACV: Price: \$1,750,000 (—/R).
XM22: Price: \$2,250,000 (—/R).
XM23: Price: \$2,250,000 (—/R).
KvP-92: Price: \$950,000 (—/S).
KvP-92z: Price: \$1,200,000 (—/R).
KvP-121: Price: \$3,500,000 (—/R).

ANIMALS

Camel: Price: \$3000 (R/S).
Dog, Guard: Price: \$1200 (V/V).
Elephant: Price: \$8000 (R/S).
Horse (Broken): Price: \$2500 (V/V).
Horse: Price: \$2000 (V/V).
Mule: Price: \$1750 (C/C).
Ox: Price: \$800 (R/R).

BOATS

Very Small Open Boat: Price: \$1000 (C/C).
Raft, Inflatable, 500 kg Capacity (Very Small Open Boat): Price: \$350 (C/C).
Raft, Inflatable, 1000 kg Capacity (Very Small Open Boat): Price: \$650 (C/C).
Small Motorboat: Price: \$14,000 (C/C).
Small Sailing Boat: Price: \$10,000 (C/C).
Medium Motorboat: Price: \$35,000 (C/C).
PBR: Price: \$100,000 (—/R).
River Tug: Price: \$950,000 (S/S).
Barge: Price: \$750,000 (S/S).
Torpedo Boat: Price: \$2,100,000 (—/R).



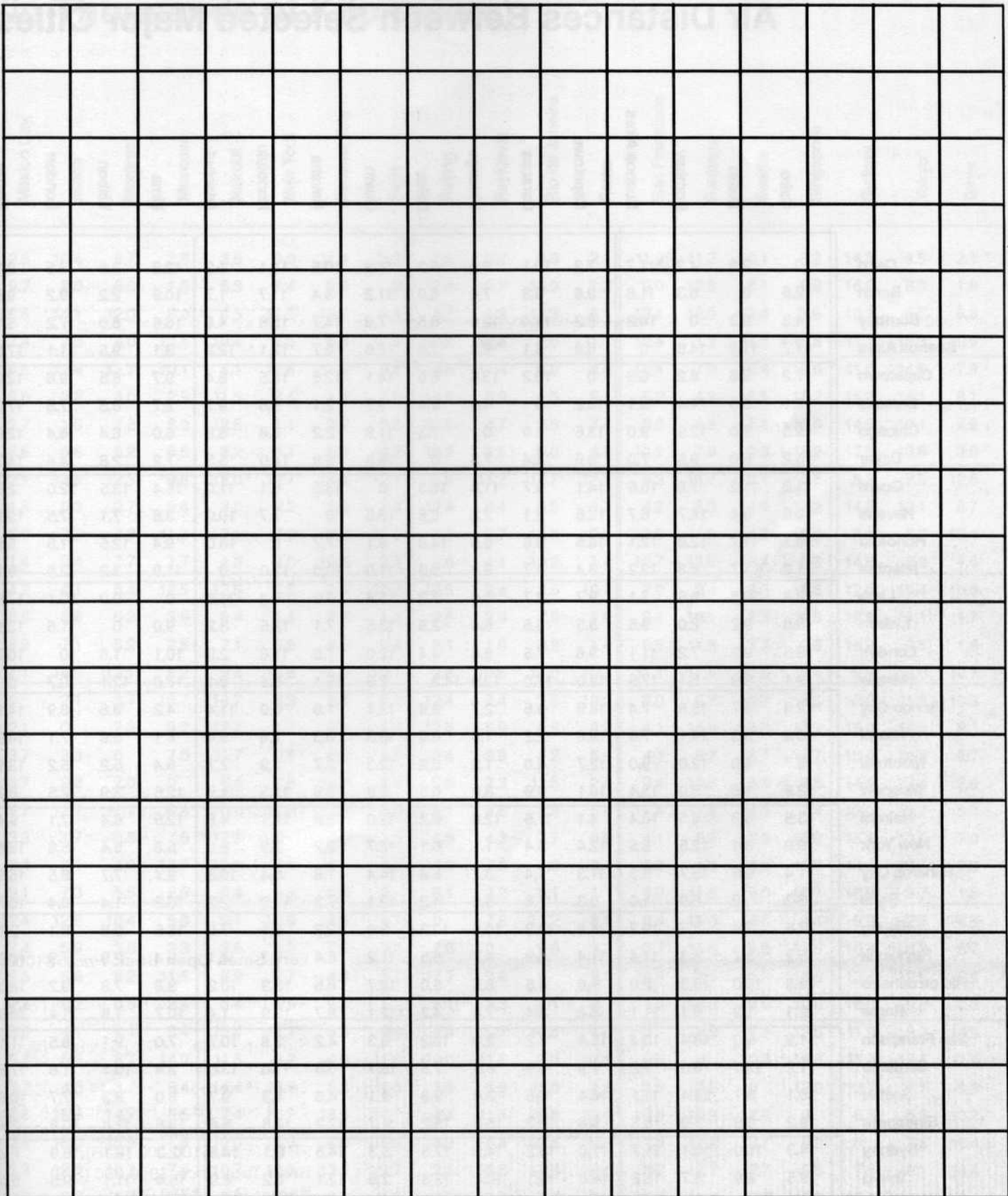

Air Distances Between Selected Major Cities

	Cairo	Berlin	Bombay	Buenos Aires	Capetown	Caracas	Chicago	Dakar	Guam	Havana	Honolulu	Istanbul	Lima	Lisbon	London	Manila
Cairo	0	2.8	4.3	11.7	7.2	10.1	9.8	5.2	11.3	10.8	14.1	1.2	12.2	3.8	3.5	9.1
Berlin	2.8	0	6.3	11.8	9.6	8.3	7.0	5.0	11.2	8.4	11.7	1.7	10.8	2.2	9.2	9.8
Bombay	4.3	6.3	0	14.8	8.2	14.4	12.9	9.5	7.6	14.7	12.8	4.8	16.6	8.0	7.2	5.1
Buenos Aires	11.7	11.8	14.8	0	6.8	5.1	9.0	7.0	16.6	6.7	12.1	12.2	3.1	9.5	11.1	17.8
Capetown	7.2	9.6	8.2	6.8	0	10.2	13.6	6.6	14.1	12.5	18.5	8.4	9.7	8.5	9.6	12.0
Caracas	10.1	8.3	14.4	5.1	10.2	0	4.0	5.4	9.7	2.1	9.6	9.7	2.7	6.5	7.5	17.0
Chicago	9.8	7.0	12.9	9.0	13.6	4.0	0	7.3	11.8	2.2	6.8	8.8	6.0	6.4	6.4	12.9
Dakar	5.2	5.0	9.5	7.0	6.6	5.4	7.3	0	16.3	6.8	14.0	5.3	7.2	2.8	4.4	14.3
Guam	11.3	11.2	7.6	16.6	14.1	9.7	11.8	16.3	0	13.5	6.1	11.0	15.4	13.5	12.0	2.6
Havana	10.8	8.4	14.7	6.7	12.5	2.1	2.2	6.8	13.5	0	7.7	10.0	3.8	7.1	7.5	15.1
Honolulu	14.1	11.7	12.8	12.1	18.5	9.6	6.8	14.0	6.1	7.7	0	13.0	9.4	12.5	11.6	8.5
Istanbul	1.2	1.7	4.8	12.2	8.4	9.7	8.8	5.3	11.0	10.0	13.0	0	11.9	3.2	2.5	9.1
Lima	12.2	10.8	16.6	3.1	9.7	2.7	6.0	7.2	15.4	3.9	9.4	11.9	0	9.0	10.1	17.8
Lisbon	3.8	2.2	8.0	9.5	8.5	6.5	6.4	2.8	13.5	7.1	12.5	3.2	9.0	0	1.6	12.1
London	3.5	9.2	7.2	11.1	9.6	7.5	6.4	4.4	12.0	7.5	11.6	2.5	10.1	1.6	0	10.7
Manila	9.1	9.8	5.1	17.8	12.0	17.0	12.9	14.3	2.6	15.1	8.5	9.1	17.8	12.1	10.7	0
Mexico City	12.3	9.7	15.6	7.4	14.6	3.6	2.7	8.6	12.1	1.8	6.0	11.4	4.2	8.6	8.9	14.1
Miami	10.4	8.0	14.1	7.0	12.6	2.2	1.9	6.6	13.5	0.3	7.8	9.4	4.1	6.6	7.1	14.9
Montreal	8.7	6.0	12.0	9.0	12.7	4.0	1.2	6.2	12.3	2.7	7.9	7.7	6.4	5.2	5.2	13.1
Moscow	2.9	1.6	5.0	13.4	10.1	9.9	8.0	6.5	9.8	9.6	11.3	1.7	12.5	3.9	2.5	8.2
Nairobi	3.5	6.3	4.5	10.4	4.1	11.5	12.8	6.2	12.0	3.0	17.1	4.8	12.5	6.4	7.1	9.4
New York	9.0	6.4	12.5	8.5	12.4	3.4	1.1	6.1	12.7	2.2	7.9	8.0	5.8	5.4	5.6	13.6
Panama City	11.4	9.5	15.7	5.3	11.3	1.4	3.7	6.8	14.4	1.6	8.4	10.8	2.4	7.7	8.5	16.5
Paris	3.2	.9	6.9	11.0	9.3	7.6	6.6	4.2	12.1	7.8	12.0	2.2	10.2	1.4	0.4	10.7
Beijing	7.5	7.4	4.7	19.2	4.8	14.3	10.5	12.2	3.8	12.8	8.1	7.0	16.5	9.6	8.1	2.8
Reykjavik	5.2	2.7	8.3	11.4	11.4	6.9	4.7	5.5	11.2	6.4	9.7	4.1	9.4	2.9	1.9	10.6
Rio de Janeiro	9.8	10.0	13.3	2.0	6.0	4.5	8.5	5.0	18.7	6.5	13.3	10.2	3.8	7.8	9.2	18.0
Rome	2.1	1.2	6.1	11.1	8.4	8.4	7.4	4.2	11.2	8.7	12.9	1.4	10.7	1.8	1.4	10.3
San Francisco	11.9	9.0	13.4	10.4	16.4	6.2	3.0	10.2	9.3	4.2	3.8	10.7	7.0	9.1	8.5	11.1
Santiago	11.2	12.5	16.0	1.2	7.9	4.9	8.5	7.8	15.7	6.3	11.0	13.0	2.4	10.1	11.6	17.5
Seattle	10.1	8.1	12.4	11.1	16.4	6.5	2.8	9.8	9.1	4.6	4.3	9.7	8.0	8.3	7.7	10.6
Singapore	8.2	9.9	3.9	15.8	9.6	18.2	15.0	13.2	4.7	17.2	10.8	8.6	18.6	11.8	10.8	2.4
Sydney	14.3	16.0	10.1	11.7	11.0	15.2	14.9	17.5	5.3	14.6	8.1	14.8	12.8	18.1	16.9	6.3
Tokyo	9.5	8.9	6.7	18.3	14.6	14.1	10.1	13.8	2.5	12.1	6.2	8.9	15.4	11.1	9.5	3.0
Tunis	2.1	1.8	6.3	10.6	7.9	8.1	7.9	3.6	12.6	8.7	13.4	1.6	10.5	1.7	1.8	10.7

(in Thousands of Kilometers)

Mexico City	Miami	Montreal	Moscow	Nairobi	New York	Panama City	Paris	Beijing	Reykjavik	Rio de Janeiro	Rome	San Francisco	Santiago	Seattle	Singapore	Sydney	Tokyo	Tunis
12.3	10.4	8.7	2.9	3.5	9.0	11.4	3.2	7.5	5.2	9.8	2.1	11.9	11.2	10.1	8.2	14.3	9.5	2.1
9.7	8.0	6.0	1.6	6.3	6.4	9.5	.9	7.4	2.7	10.0	1.2	9.0	12.5	8.1	9.9	16.0	8.9	1.8
15.6	14.1	12.0	5.0	4.5	12.5	15.7	6.9	4.7	8.3	13.3	6.1	13.4	16.0	12.4	3.9	10.1	6.7	6.3
7.4	7.0	9.0	13.4	10.4	8.5	5.3	11.0	19.2	11.4	2.0	11.1	10.4	1.2	11.1	15.8	11.7	18.3	10.6
14.6	12.6	12.7	10.1	4.1	12.4	11.3	9.3	4.8	11.4	6.0	8.4	16.4	7.9	16.4	9.6	11.0	14.6	7.9
3.6	2.2	4.0	9.9	11.5	3.4	1.4	7.6	14.3	6.9	4.5	8.4	6.2	4.9	6.5	18.2	15.2	14.1	8.1
2.7	1.9	1.2	8.0	12.8	1.1	3.7	6.6	10.5	4.7	8.5	7.4	3.0	8.5	2.8	15.0	14.9	10.1	7.9
8.6	6.6	6.2	6.5	6.2	6.1	6.8	4.2	12.2	5.5	5.0	4.2	10.2	7.8	9.8	13.2	17.5	13.8	3.6
12.1	13.5	12.3	9.8	12.0	12.7	14.4	12.1	3.8	11.2	18.7	12.1	9.3	15.7	9.1	4.7	5.3	2.5	12.6
1.8	0.3	2.7	9.6	3.0	2.2	1.6	7.8	12.8	6.4	6.5	8.7	4.2	6.3	4.6	17.2	14.6	12.1	8.7
6.0	7.8	7.9	11.3	17.1	7.9	8.4	12.0	8.1	9.7	13.3	12.9	3.8	11.0	4.3	10.8	8.1	6.2	13.4
11.4	9.4	7.7	1.7	4.8	8.0	10.8	2.2	7.0	4.1	10.2	1.4	10.7	13.0	9.7	8.6	14.8	8.9	1.6
4.2	4.1	6.4	12.5	12.5	5.8	2.4	10.2	16.5	9.4	3.8	10.7	7.0	2.4	8.0	18.6	12.8	15.4	10.5
8.6	6.6	5.2	3.9	6.4	5.4	7.7	1.4	9.6	2.9	7.8	1.8	9.1	10.1	8.3	11.8	18.1	11.1	1.7
8.9	7.1	5.2	2.5	7.1	5.6	8.5	0.4	8.1	1.9	9.2	1.4	8.5	11.6	7.7	10.8	16.9	9.5	1.8
14.1	14.9	13.1	8.2	9.4	13.6	16.5	10.7	2.8	10.6	18.0	10.3	11.1	17.5	10.6	2.4	6.3	3.0	10.7
0	2.1	3.7	10.7	14.7	3.3	2.4	9.1	12.4	7.4	7.6	10.2	3.0	6.7	3.7	16.5	12.9	11.3	10.3
2.1	0	2.3	9.2	12.7	1.7	2.1	7.3	12.5	5.9	6.6	8.2	4.1	16.9	4.5	16.9	15.0	12.0	8.3
3.7	2.3	0	7.0	11.7	0.5	4.0	5.5	10.4	3.8	8.2	6.5	4.1	8.7	3.7	14.7	15.9	10.3	6.7
10.7	9.2	7.0	0	6.4	7.5	10.7	2.5	5.8	3.3	11.5	2.4	9.4	14.0	8.4	8.5	14.4	7.4	2.9
14.7	12.7	11.7	6.4	0	12.3	12.9	6.4	9.1	8.6	8.9	5.4	15.4	11.5	14.4	7.4	12.0	10.7	5.0
3.3	1.7	0.5	7.5	12.3	0	3.5	5.8	10.9	4.2	7.7	6.9	4.1	8.2	3.9	15.2	15.9	10.8	7.0
2.4	2.1	4.0	10.7	12.9	3.5	0	8.6	14.3	7.5	4.9	9.4	5.3	4.8	5.8	18.6	14.0	13.5	9.3
9.1	7.3	5.5	2.5	6.4	5.8	8.6	0	8.1	2.2	9.1	1.1	8.9	11.6	8.0	10.7	16.9	9.7	1.5
12.4	12.5	10.4	5.8	9.1	10.9	14.3	8.1	0	7.8	17.2	8.1	9.4	19.0	8.6	4.4	8.9	2.1	8.5
7.4	5.9	3.8	3.3	8.6	4.2	7.5	2.2	7.8	0	9.8	3.3	6.7	11.6	5.8	11.5	16.4	8.8	3.7
7.6	6.6	8.2	11.5	8.9	7.7	4.9	9.1	17.2	9.8	0	9.1	10.5	2.9	11.0	15.6	13.4	18.5	8.6
10.2	8.2	6.5	2.4	5.4	6.9	9.4	1.1	8.1	3.3	9.1	0	1.0	12.0	9.0	10.0	16.0	9.8	0.6
3.0	4.1	4.1	9.4	15.4	4.1	5.3	8.9	9.4	6.7	10.5	1.0	0	9.5	1.1	13.5	11.9	8.2	10.3
6.7	6.6	8.7	14.0	11.5	8.2	4.8	11.6	19.0	11.6	2.9	12.0	9.5	0	10.3	16.3	11.3	17.1	11.4
3.7	4.5	3.7	8.4	14.4	3.9	5.8	8.0	8.6	5.8	11.0	9.0	1.1	10.3	0	12.9	13.7	7.7	9.3
16.5	16.9	14.7	8.5	7.4	15.2	18.6	10.7	4.4	11.5	15.6	10.0	13.5	16.3	12.9	0	6.3	5.3	10.2
12.9	15.0	15.9	14.4	12.0	15.9	4.0	16.9	8.9	16.4	13.4	16.0	11.9	11.3	13.7	6.3	0	7.8	16.4
11.3	12.0	10.3	7.4	10.7	10.8	13.5	9.7	2.1	8.8	18.5	9.8	8.2	17.1	7.7	5.3	7.8	0	10.4
10.3	8.3	6.7	2.9	5.0	7.0	9.3	1.5	8.5	3.7	8.6	0.6	10.3	11.4	9.3	10.2	16.4	10.4	0

DESIGNER'S NOTES

The first question to be answered is, "Why **Merc: 2000?**" Simply put, we did it because our customers wanted it. Many of our customers wanted to game out a situation that was a little less depressing than **Twilight**, where they could engage in commando raids, hostage rescues, and other "adventure novel" type stuff and then go home to civilization after it was all over. A good many wanted a way to work aircraft into their battles, and the situation in **Twilight** simply did not allow that in any great numbers. A number of our customers have been doing something like **Merc** for years: They take the system and use it to game out present-day small unit actions, where, as one put it "The PCs have plenty of gas, plenty of ammo, and they don't have to worry where their next meal is coming from." Games dealing with mercenary-type adventures have proven popular in the past (as our own product **Mercenary** proved in the late 1970s). It struck us that we could work some simple modifications to the **Twilight** background and give our customers a whole new world in which to adventure.

The design of **Merc** was easy in some ways and difficult in others. Easy because I had no major rules systems to design. Since **Merc** was intended to be a supplemental background for **Twilight** (an alternate future, as it were), I had none of the major headaches that attend designing a game from the ground up. Difficult because I had to create a new chronology that would seem as reasonable as **Twilight's**, reflect the changes since 1989, and still get us to the world politico-economic situation we wanted by the year 2000. I originally intended to keep as close as possible to the new chronology in the **Twilight** revision, but it rapidly became obvious that this was not going to work. Those taking notes will discover that the two chronologies depart from each other fairly quickly.

Reality intervened as the product was finalized, and I revised the 1990-1991 events several times to reflect the changing world situation. I wrote three versions of the outcome of events in the Persian Gulf and picked the one that seemed most likely at press time. If things go the way they always have, some earthshaking event will occur the day after **Merc** goes to press, ruining all my careful projections.

I chose to include industrial espionage

missions (in addition to the usual commando raid, hostage rescue, and so on) in order to provide referees with additional options for varied missions.

RULES

Early on, I made the decision to keep the fatigue rules and the requirements for food and rest. Despite player wishes to the contrary, their characters are not above such things and are subject to human limitations. I think players will be pleased with the one of the challenges that **Merc** presents: how to achieve a specific mission when all you have is what your team members can carry on their backs. Even though scenarios last only a few days at most, fatigue and food are vital considerations. In war, victory often goes to the side that is the least exhausted.

I chose not to include detailed rules on what happens to the characters between missions, although some treatment of specifics was necessary. How a mere gets his job is left a little up in the air, although I have given some general guidelines. The rules on medical treatment and healing from **Twilight** will handle wound recovery very nicely.

Character Generation: The main changes to character generation were in the acquisition of equipment and the means by which careers are ended. Since there was no longer a nuclear war to form the last term, there was no clear-cut place to end character generation. Players simply choose when they think their character is ready.

Encounters: The mechanics of encounters remain the same. A few remarks needed to be made with regard to the different sorts of encounters occurring in **Merc**. Most **Merc** encounters are mandated because of the differing nature of the adventure scenarios. Since teams don't traverse great expanses of territory, there is less need for encounter tables. Also, since there was no global holocaust, the specifics of the terrain type descriptions needed to be changed.

Referee: Referees of **Merc** need different advice from those running **Twilight**, although much of the advice in the latter also applies to the former. **Merc** will tend to be more episodic than **Twilight**, and I feel that referees will find **Merc** easier to run from this standpoint. Because of the increased emphasis on tactical actions, how-

ever, referees will need more maps of the locations where the action takes place. Maps at 1:1,000,000, 1:100,000, and 1:50,000 scales will prove invaluable, but represent more of an investment in a specific locale than many RPGs have required in the past. Referees should remember that one hilly area looks much like another, and you can use the same map (with some name changes) in many different actions.

The sample adventures I included were written to inspire referees as well as give something to play immediately. They are deliberately made simple because of their prototype nature. Referees can (indeed, should) make their scenarios more interesting by including such possibilities as patron double crosses, traitors, bad intelligence data, and the thousand other examples of Murphy's Law that are bound to occur in these sorts of situations.

Combat: The combat rules of **Twilight** needed no modification for **Merc**. It was necessary to add a few rules, however. To deal with silencers, for example, one must have rules about the sound made by unsilenced weapons. I added weather conditions and expanded on parachute drops because these things seemed to be required. I did not add rules for air-to-ground fire support or air-to-air combat, however. These will appear (along with statistics for helicopters and transport aircraft) in the upcoming **Aviation Handbook**, suitable for use with both **Twilight** and **Merc**. The **Twilight** combat rules contain almost everything the referee will need.

Equipment: Price and availability of equipment are radically different between the two games. Equipment in **Twilight** was priced according to its value in the world situation of that game, which differs tremendously from the world situation of **Merc**. Referees will need to exercise a little common sense and try to keep the collection of gear in the team's hands from growing too large (perhaps by billing the characters for warehouse fees if they accumulate too much stuff).

CONCLUSION

Merc has a completely different flavor than **Twilight**. The concentration on tactical combat and mission planning presents players and referees with a whole new collection of situations and a set of problems very different from those in **Twilight**. It is a much simpler game in some respects: The characters don't have to worry where their next meal is coming from, and they needn't pay excessive attention to their ammunition consumption. They don't have to consider how their actions will affect the future of civilization in the area where they are fighting, and they don't have to worry much about politics or economics (unless they want to).

INDEX TO MERC: 2000

40mm Stun Grenade Chart.....	18	Europe.....	60	Parachute Landings.....	84
1989.....	6	Explosives.....	14	Patrons.....	46, 52
1990.....	6	Ferret.....	28	Perimeter Checkpoint Map.....	71
1991.....	7	France.....	87	Price List.....	108
1992.....	7	Freedom Fighter/Terrorist NPC.....	50	Prison Camp Map.....	80
1993.....	8	Generic Locales.....	71	Quiet One NPC.....	51
1994.....	8	Group Encounters.....	70	Rads.....	12
1995.....	9	Guard Dogs.....	85	RAM V-1.....	39
1996.....	9	Headquarters Building Map.....	74	RBV Mk1.....	40
1997.....	10	Hiring Hall.....	56	Referee.....	46
1998.....	10	HWK II.....	29	Remote Estate Map.....	82
1999.....	10	Ice Man NPC.....	51	Retrieval.....	48
2000.....	11	Indian Subcontinent and Indian Ocean.....	64	Rewards.....	48
Africa.....	68	Indian Subcontinent Map.....	65	S&W Model 0 (Mk-22).....	19
Air Distances Chart.....	116	Industrial Security Forces.....	87	Sample Campaigns.....	100
Air Rates Table.....	49	Introduction.....	4	Sample Missions.....	88
Air Travel.....	49	Item Encounters and Settlements.....	71	Scenarios.....	46
Animals.....	71	Lifestyle.....	48	Sheds, Huts and Hovels Diagram.....	78
Barracks Map.....	75	Local Recruit NPC.....	50	Signal Gear.....	15
Body Armor.....	14	Loudmouth NPC.....	51	Silence/Noise.....	84
Border Patrols/Paramilitary Police Forces ..	87	LWB Land Rover.....	30	Sleeping Garrisons.....	84
Campaigns.....	49	M20.....	31	South America.....	58
Central America.....	57	M24 Chaffee.....	32	South America Map.....	59
Central America and the Caribbean Map ..	56	M41.....	33	Southeast Asia.....	67
Central Asia.....	64	Maniac NPC.....	50	Southeast Asia Map.....	67
Central Asia Map.....	64	Mansion Map.....	76	Southern Africa Map.....	69
Character Generation.....	12	Meeting Patrons.....	52	State of the World: 1 July 2000.....	11
China.....	87	Mercenary Terms and Expressions.....	13	Stock NPCs.....	50
Chronology.....	6	Middle East Map.....	63	Stun Gun.....	19
Commando Scout.....	20	Middle East/Near East.....	62	Tactical Grid (Blank).....	115
Commando V-150.....	21	Miscellaneous Equipment.....	16	TAM/TH-301.....	41
Commando V-300 APC.....	24	Mission Generation.....	46	Teams.....	46
Commando V-300 CS.....	23	Near East Map.....	62	Time, Travel and Encounters.....	70
Commando V-300 TUA.....	22	New Ammunition.....	18	Tranquilizer Gun.....	19
Commands Diagram.....	84	New Combat Rules.....	84	Travel and Transportation.....	48
Company Man NPC.....	50	New Military Occupation.....	13	Truck, 1-Ton.....	42
Contacts.....	12	Noise Chart.....	85	Type 62.....	43
Crime.....	55	North America.....	56	Underground Bunker Map.....	72
Criminal Cartels.....	87	North America Map.....	58	United Kingdom.....	87
Critical Hit/Quick Kill (New Rule).....	85	Northern Africa Map.....	68	United States.....	86
Designer's Notes.....	118	Officers' Quarters Map.....	73	US Armed Forces.....	54
East Asia.....	66	Opposition.....	48, 86	USSR.....	86
East Asia Map.....	66	Organizations.....	52	VBC-90.....	44
Eastern Europe Map.....	61	OTO-Melara 6614.....	34	Vehicle Cards.....	20
EE-3 Jararaca.....	25	OTO-Melara 6616.....	35	Vickers Valiant.....	45
EE-9 Cascavel.....	26	Overland Travel.....	49	Water Travel.....	49
EE-11 Urutu.....	27	Overview of Character Generation.....	12	Weapon Cards.....	19
Electronics.....	14	Pacific.....	56	Weapon Pits Map.....	72
Elite Forces.....	87	Pacific Map.....	57	Weather (Optional).....	85
Encounters.....	70	Panhard AML.....	36	Welcome to the Life.....	12
Enthusiastic Newbie NPC.....	51	Panhard M3.....	37	Western Europe Map.....	60
Equipment.....	12	Panhard VCR.....	38	World of 2000.....	54
Equipment List.....	14	Parachute Deviation Diagram.....	84	World Space Programs.....	54

MERC: 2000

Bandits calling themselves freedom fighters have kidnapped an oil company engineer. They want four million in ransom, and the guy's relatives are poor as churchmice. The goons figure the engineer is so valuable the oil company will pay to get him back, but they're wrong on two counts.

The company's only paying one million.
And they're paying it to us.

Merc: 2000 is a game of daring night raids on enemy camps, audacious hostage rescues, and tense industrial sabotage missions in exotic foreign locales. It is an alternate world situation for use with **Twilight: 2000**, GDW's roleplaying game of survival in a devastated world. In **Merc: 2000**, the world did not blow itself up. The old bi-polar superpower conflict is gone, replaced by a multipower competition. What armies remain are kept purely for internal security at reduced levels. When a war becomes necessary, a country (or company) will hire independent contractors—mercenaries—to conduct it.

Using the **Twilight: 2000** rules as a base, **Merc: 2000** enables players and referees to recreate modern close combat in a number of environments. **Merc: 2000** includes a new chronology of the events of the decade between 1990 and 2000, plus new rules, equipment, vehicles, weapons, and career path (counterterrorist). It also contains five ready-to-play scenarios and suggestions for scenario creation and campaign organization. Everything is fully compatible with the **Twilight: 2000** rules system, and characters can be used interchangeably.



2005 16.00



Made in U.S.A.
Printed in U.S.A.

ISBN 1-55878-072-6
Copyright©1990 GDW, Inc.
All rights reserved.

Twilight: 2000™ is a trademark of
GDW, Inc.



You **must** have **Twilight: 2000**
to play **Merc: 2000**.

TWILIGHT: 2000™

SINCE 1973

GDW
GAMES

P.O. Box 1646
Bloomington, IL 61702-1646