

EQUIPMENT LIST

Every entry lists weight in kilograms, price in dollars, and availability. The last is given in the form of availability in the West/availability in the East. East and West refer to respective parts of Europe. North America and Japan are considered West. The interior of the Soviet Union and all of Northern China are East. Everything else is the third world; Use the least common of the two availabilities.

V: Very common C: Common S: Scarce R: Rare —: Unavailable except at referee's discretion.

Some entries contain additional information. Some items are covered in data cards. These are intended to be photocopied and rearranged, enabling each player and referee to assemble weapon arrays to suit individual situations. Players and referees have permission to photocopy these data cards for personal use.

FIREARMS

Most of these entries represent weapons not covered by data cards.

Autocannon

Most autocannons are an integral part of a vehicle. Prices and availability are given only for those which are available separately.

20mm Autocannon: An automatic cannon mounted on the AMX-10P and on old versions of the Marder.

23mm Autocannon: A belt-fed automatic cannon mounted on the OT-65. It accepts 100-round belts. It may be fired only from the vehicle mount.

25mm Autocannon: A belt-fed automatic cannon mounted on the M2-2 and LAV-25. The weapon may have two belts, with two different types of ammunition loaded simultaneously, and may fire from either belt. Neither the 25mm autocannon nor the gunner's machinegun may fire while either belt is being reloaded. The weapon accepts 100-round belts.

30mm Autocannon: A belt-fed automatic cannon mounted on the BMP-B, BMP-C, and BRDM-3. The weapon accepts 100-round belts. A two-barrel Gatling gun version of the 30mm is used on the ZSU-30-2. Its rate of fire (5) is the number of times each gun can fire per combat round. Thus, if the vehicle fires five times, a total of 10 rounds could be fired.

30mm Rarden: A 30mm automatic can-

non used on the British Warrior MCV-80 and other British vehicles.

75mm Autocannon: A hopper-fed automatic cannon mounted on the LAV-75. The gun has a 108-round carousel in the bottom of the vehicle hull. If additional rounds are carried in the vehicle, the carousel may be reloaded while the gun is firing, but only one shell may be placed in the carousel per combat round.

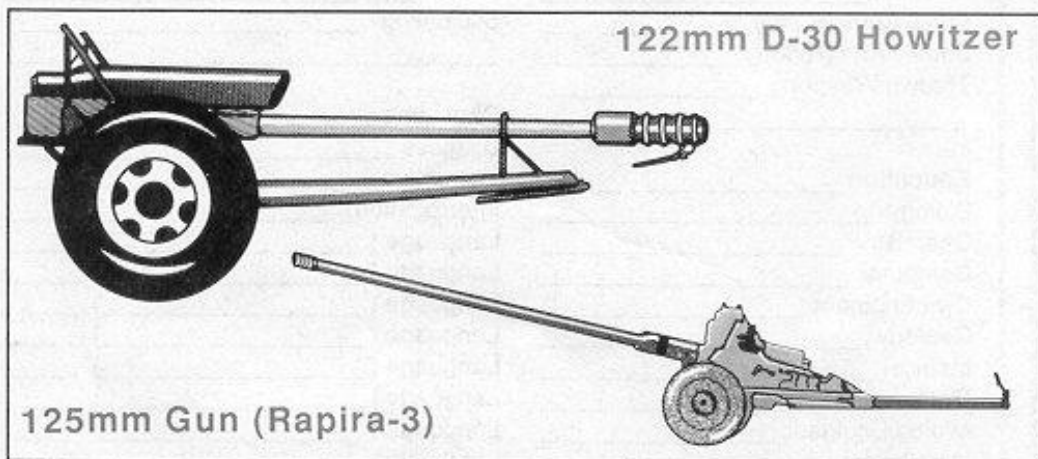

Large-Caliber Guns

105mm Gun: A manually loaded, large-caliber gun mounted on the M1 tank.

120mm Gun: A large-caliber gun mounted on the M1A1 and M1A2 tanks. On the M1A1 it is manually loaded; on the M1A2 it is equipped with an autoloader.

120mm Rifled Gun: The L11A5 rifled gun mounted on the Challenger and other British tanks.

125mm Gun (Rapira-3): A large-caliber gun mounted on the T-72, T-80, and T-90 tanks and the Rapira-3 towed antitank gun. All three tanks are equipped with autoloaders.

On the Rapira-3, the gun is manually loaded. On the T-72 and T-80, the gun automatically goes to maximum elevation while the autoloader is working, so the gunner may not aim during loading.

On the T-90 and the Rapira-3, the gunner may aim during loading.

The Rapira-3 has an armor value 2 gun shield which provides cover for the gunner and loader if fired at from the front. The Rapira-3 takes eight combat turns to set up.

Wt (Rapira-3): 3.5 tons.

Price (Rapira-3): \$50,000 (R/S).

Howitzers

122mm: The howitzer mounted on the SAU-122 self-propelled howitzer and D-30 towed howitzer.

It is manually loaded. The D-30 howitzer has an armor value 2 gun shield which provides cover for the gunner (but not the loader) if fired at from the front.

The D-30 howitzer takes 12 combat turns to set up.

Wt (D-30): 3 tons.

Price (D-30): \$50,000 (S/C).

152mm: The howitzer mounted on the SAU-152 self-propelled howitzer. It is manually loaded.

155mm: The howitzer mounted on the M109A2 self-propelled howitzer. It is manually loaded.

Tripods

With the exception of the AT-4, a tripod for a weapon must be purchased separately.

NLT (NATO Light Tripod): Accepts M60 and MG3.

Wt: 7 kg.

Price: \$200 (C/S).

NMT (NATO Medium Tripod): Accepts MAG.

Wt: 10 kg.

Price: \$200 (S/R).

NHT (NATO Heavy Tripod): Accepts M214, M2HB, Mk-19.

Wt: 22 kg.

Price: \$350 (C/S).

PLT (Pact Light Tripod): Accepts PK, Vz-59.

Wt: 10 kg.

Price: \$250 (S/C).

PMT (Pact Medium Tripod): Accepts AGS-17.

Wt: 12 kg.

Price: \$300 (S/C).

PHC (Pact Heavy Carriage): Accepts DShK.

Wt: 100 kg.

Price: \$1000 (R/S).

SMALL ARMS AMMUNITION

Weights per magazine include weight of magazine (which is negligible in most cases) and ammunition.

Magazines are purchased separately and cost \$1 per three rounds of capacity, except the 1000-round drum for 5.56mm N ammunition, which costs \$200.

Small Arms & Machineguns

Longbow Arrow:

Wt: 3 kg per 24.

Price: \$50 per 24 (C/C).

Crossbow Bolt:

Wt: 3 kg per 24.

Price: \$30 per 24 (C/C).

Loose Black Powder and Ball: These are most commonly premeasured and wrapped in paper in ready-to-use units.

Wt: 1 kg per 40.

Price: \$25 per 40 (C/C).

4.7mm CIs (4.7x21mm Caseless):

Wt: 10 kg per case of 1800, 1 kg per 50-round magazine.

Price: \$1300 per case (S/R).

5.45mm B (5.45x39mm Bloc):

Wt: 10 kg per case of 840, 0.5 kg per 30-round magazine, 0.6 kg per 40-round magazine.

Price: \$100 per case (C/V).

5.56mm N (5.56x45mm NATO):

Wt: 10 kg per case of 840 or 4 belts, 0.5 kg per 30-round magazine, 2 kg per 200-round belt, 15 kg per 1000-round drum.

Price: \$100 per case, \$200 per empty drum (V/C).

.22 LR (5.7x17mmR Long Rifle):

Wt: 20 kg per case of 5000, 0.1 kg per 7-round magazine.

Price: \$225 per case (C/S).

7.5mm MAS (7.5x54mm MAS):

Wt: 15 kg per case of four belts, 2 kg per 50-round belt.

Price: \$30 per case (R/R).

7.62mm T (7.62x25mm Tokarev):

Wt: 35 kg per case of 2500, 0.2 kg per 8-round magazine, 0.6 kg per 32-round magazine.

Price: \$250 per case (R/S).

7.62mm S (7.62x39mm Short):

Wt: 10 kg per case of 600, 1 kg per 30-round magazine.

Price: \$80 per case (S/C).

.30-30 (7.62x51mmR):

Wt: 20 kg per case of 1000, 5 loose rounds per kilogram.

Price: \$170 per case (C/S).

7.62mm N (7.62x51mm NATO):

Wt: 15 kg per case of 600, 0.75 kg per 20-round magazine, 1.5 kg per 50-round belt, 3 kg per 100-round belt.

Price: \$65 per case (C/S).

7.62mm L (7.62x54mmR Long):

Wt: 15 kg per case of 600, 0.3 kg per 10-round magazine, 3 kg per 100-round belt.

Price: \$70 per case (S/C).

.30-06 (7.62x63mm):

Wt: 15 kg per case of 500, 35 loose rounds per kilogram.

Price: \$80 per case (S/R).

.32 ACP (7.65x17mmSR):

Wt: 20 kg per case of 2000, 0.1 kg per 10-round magazine, 0.2 kg per 20-round magazine.

Price: \$150 per case (S/S).

8mm M (7.92x57mm Mauser):

Wt: 10 kg per case of 300, 30 rounds per kilogram.

Price: \$30 per case (S/S).

.380 ACP (9x17mm):

Wt: 15 kg per case of 1500, 0.1 kg per 7-round magazine.

Price: \$125 per case (C/S).

9mm M (9x18mm Makarov):

Wt: 15 kg per case of 1500, 0.1 kg per 8-round magazine.

Price: \$200 per case (S/C).

9mm P (9x19mm Parabellum):

Wt: 15 kg per case of 1500, 0.1 kg per 8-round magazine, 0.2 kg per 13- and 15-round magazine, 0.3 kg per 25- and 30-round magazine, 0.4 kg per 32- and 34-round magazine.

Price: \$225 per case (V/C).

.38 Special (9x29mmR):

Wt: 15 kg per case of 1000.

Price: \$175 per case (S/R).

.357 Magnum (9x33mmR):

Wt: 18 kg per case of 1000.

Price: \$500 per case (R/—).

.44 Magnum (11.2x32.8mmR):

Wt: 20 kg per case of 1000.

Price: \$550 per case (R/—).

.45 ACP (11.43x23mm):

Wt: 20 kg per case of 1000, .03 kg per 7-round magazine.

Price: \$63 per case (S/R).

12.7mm B (12.7x83mmR Bloc):

Wt: 25 kg per case of 2 belts, 11 kg per 50-round belt.

Price: \$35 per case (S/C).

.50 BMG (12.7x99mm Browning Machinegun):

Wt: 15 kg per case of 1 belt, 13 kg per 105-round belt.

Price: \$35 per case (C/S).

.50 SLAP (12.7x99mm Saboted Light Armor Piercing):

Wt: 15 kg per case of 1 belt, 13 kg per 105-round belt.

Price: \$60 per case (S/R).

14.5mm B (14.5x114mm Bloc):

Wt: 30 kg per case of 1 belt, 25 kg per 100-round belt.

Price: \$30 per case (S/C).

12 Gauge (12 Gauge All-Brass):

Wt: 15 kg per case of 240, 1 kg per 10-round magazine, (15 loose rounds per kilogram).

Price: \$100 per case (C/C).

.50 BMG

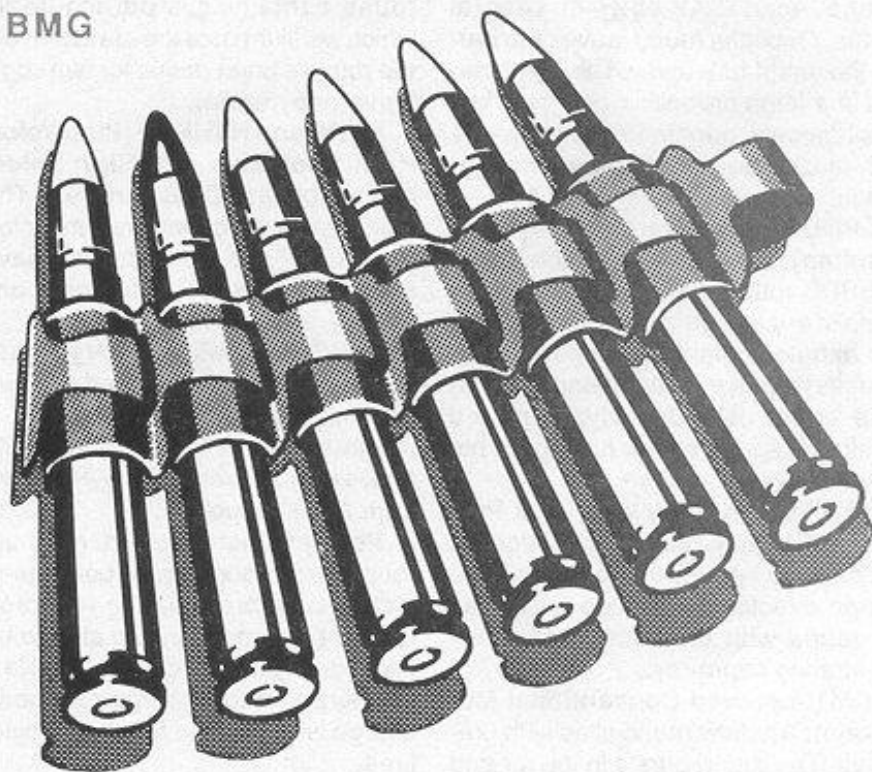

Types of Rounds

Large-caliber gun, autocannon, and grenade rounds come in several types, explained below. Each weapon can fire one or more of these types.

API (Armor Piercing Incendiary): A nearly solid round containing a small amount of incendiary material in the base. Primarily used against armored vehicles.

HE (High Explosive): A high explosive round is a hollow casing containing an explosive compound. Set to detonate on impact or at a selected altitude, it is useful against infantry and some larger targets. It is the least expensive (and thus most common) indirect fire round used.

HEAT (High Explosive Antitank): A hollow shell filled with explosive compound. An inverted cone in the nose of the shell directs the explosive force forward into a high-energy jet of superheated gas and molten metal, reducing the effectiveness of the round against soft targets, but vastly increasing it against armor.

APFSDS (Armor Piercing Fin Stabilized Discarding Sabot): The round consists of a subcaliber finned penetrator (usually made of tungsten) surrounded by a full-bore aluminum sabot (pronounced *SAY-bow*) in several pieces. Once the round leaves the barrel, the sabot falls away. The combination of a large propelling charge and a small diameter penetrator results in very high muzzle velocity and armor penetration.

APDU (Armor Piercing Depleted Uranium): Essentially the same as an APFSDS round, but with a penetrator made of depleted uranium. The density and hardness of the DU penetrator increases the ability of the round to penetrate armor considerably. Depleted uranium is spent reactor fuel and is not dangerously radioactive.

HEDP (High Explosive Dual Purpose): A hollow round containing an explosive compound filler with a shaped charge director in the nose to provide the round with an enhanced armor-penetrating capability.

ICM (Improved Conventional Munitions): A hollow round filled with grenades. The round bursts in the air and

scatters grenades over a large area. It is very effective against infantry.

ICM-DP (Improved Conventional Munitions, Dual Purpose): Similar to ICM, the ICM-DP round contains shaped-charge grenades which have an improved effectiveness against armored targets—provided they achieve a direct hit.

WP (White Phosphorus): A hollow round filled with white phosphorus. Upon detonation, it scatters burning white phosphorus throughout its burst radius. WP rounds also generate thick white smoke.

CHEM (Chemical): A hollow shell which, upon landing, burns and releases a gas or smoke. The most common chemical is hexachloroethane (HC) smoke, and all prices given later are based on that round. Rounds may also be filled with irritant gas (double price), blood agent poisonous gas (triple price) or nerve gas (quadruple price). In all cases, the chemical cloud will cover an area the width of the given burst area and four times as long as the burst area. The cloud will originate at the impact point of the round and stretch downwind.

ILLUM (Illumination): A hollow round containing a parachute flare which will illuminate the area defined by the round's burst radius for two combat turns (one minute).

HVHE and HVHEDP (High Velocity High Explosive and High Velocity High Explosive Dual Purpose): These high-explosive rounds are similar to HE and HEDP rounds, but they have a greater muzzle velocity and, consequently, an increased range.

FASCAM (Field Artillery Scatterable Mines): A hollow round containing antitank and antipersonnel mines. The round bursts in the air and scatters mines over an area 100 meters in radius from the burst point.

Powder Charges: Most guns use a round which consists of both the projectile and a brass casing with propellant. The 125mm gun and all howitzers fire a round consisting of a projectile and a separate powder charge. One powder charge is consumed for each projectile fired.

Hand Grenades

Fragmentation: The grenade, upon exploding, scatters metal fragments throughout its burst radius.

Wt: 0.5 kg, 30 kg per case of 30.

Price: \$4 each, \$100 per case (C/C).

Chemical: Same as a chemical round for large-caliber guns. Two types are available: HC smoke and irritant gas.

Wt: 0.5 kg, 16 kg per case of 16.

Price: \$3 each, \$40 per case for smoke, double prices for irritant (smoke, C/S; irritant, S/R).

Antitank: The grenade is designed to explode on impact. It contains a shaped charge and is stabilized by fins so that the grenade flies with the shaped charge pointing forward.

Wt: 1 kg, 25 kg per case of 15.

Price: \$10 each, \$120 per case (R/S).

Concussion: The grenade consists of explosive filler in a cardboard or plastic container. Upon explosion it will knock people down, but causes no lethal fragmentation.

Wt: 0.5 kg, 20 kg per case of 20.

Price: \$4 each, \$70 per case (C/S).

Thermite: The grenade has little blast or fragmentation, but it burns with intense heat.

Wt: 1 kg, 20 kg per case of 16.

Price: \$10 each, \$140 per case (S/R).

WP (White Phosphorus): The grenade scatters incendiary fragments throughout its burst radius and burns with intense heat.

Wt: 1 kg, 20 kg per case of 16.

Price: \$20 each, \$280 per case (S/S).

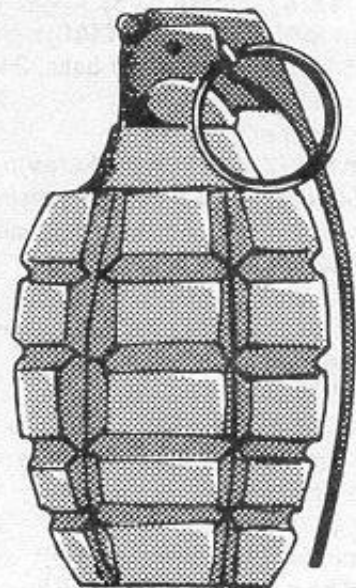

Fragmentation Grenade

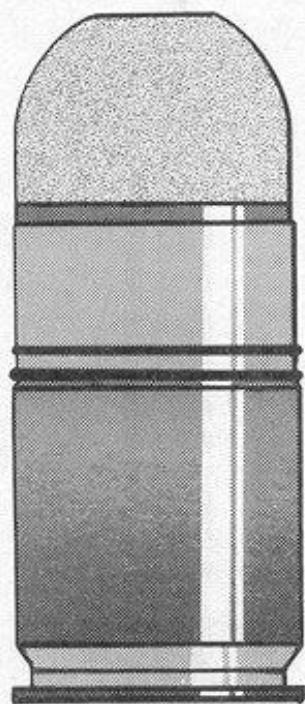

40mm HEDP

Rockets

Folgore HEAT: Used in the Folgore launcher.

Wt: 5 kg.

Price: \$120 (C/S).

58.3mm HEAT: Fired from the RPG-16 rocket launcher.

Wt: 3 kg, 10 kg per case of 3.

Price: \$50 each, \$125 per case (R/S).

82mm SMAW HE: Fired from the M12 SMAW.

Wt: 0.2 kg, 7 kg per case of 6.

Price: \$75 each, \$350 per case (S/—).

82mm SMAW HEAT: Fired from the M12 SMAW.

Wt: 0.2 kg, 7 kg per case of 6.

Price: \$75 each, \$350 per case (S/—).

84mm HEAT: Used in the Carl Gustav.

Wt: 3 kg.

Price: \$120 (C/S).

89mm HEAT: Used in the LRAC F1.

Wt: 2 kg.

Price: \$175 (R/—).

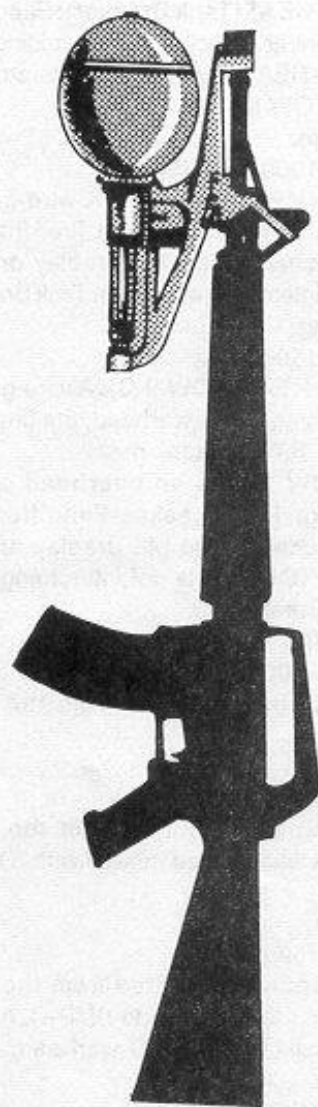

140mm RAW

Grenade Launcher Rounds

30mm HE: Fired from the AGS-17 auto-grenade launcher.

Wt: 0.35 kg, 10 kg per 29-round drum.

Price: \$3 each, \$75 per drum (R/C).

40mm HE: Fired from the M203, HK-69, or Mk-19 grenade launcher.

Wt: 0.3 kg, 25 kg per case of 72.

Price: \$4 each, \$200 per case (C/S).

40mm HEDP: Fired from the M203, HK-69, or Mk-19.

Wt: 0.3 kg, 25 kg per case of 72.

Price: \$5 each, \$250 per case (S/R).

40mm CHEM: Irritant gas only. Fired from the HK-69, M203, or Mk-19.

Wt: 0.3 kg, 25 kg per case of 44.

Price: \$4 each, \$150 per case, (S/R).

40mm ILLUM: Fired from the HK-69, M203, or Mk-19.

Wt: 0.2 kg, 20 kg per case of 44.

Price: \$6 each, \$225 per case (S/R).

40mm HVHE: Fired only from the Mk-19 grenade launcher, the round is a standard HE round with a larger propelling charge for greater range.

Wt: 0.4 kg, 20 kg per 50-round belt, 25 kg per case of 50, belted.

Price: \$6 each, \$250 per case (S/R).

40mm HVHEDP: Fired only from the Mk-19 grenade launcher, this is a standard HEDP round with a larger propelling charge.

Wt: 0.4 kg, 20 kg per 50-round case, 25 kg per case of 50 belted.

Price: \$10 each, \$400 per case (S/R).

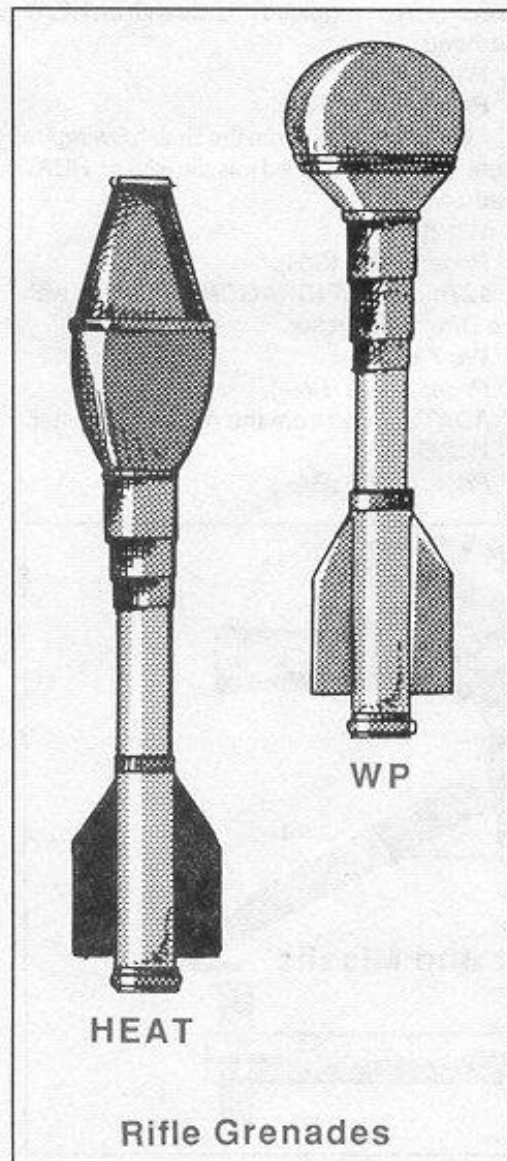

HEAT

WP

Rifle Grenades

Rifle Grenades

These weapons are fired using Heavy Weapons skill.

HEAT: Fired from any battle rifle or assault rifle.

Wt: 0.7 kg, 20 kg per 10-round case.

Price: \$12, \$100 per case (S/R).

WP: Fired from any battle rifle or assault rifle.

Wt: 0.7 kg, 20 kg per case of 10.

Price: \$25 each, \$200 per case (S/R).

140mm RAW (Rifle Assault Weapon) HE: A rocket-propelled grenade which can be fired from any assault rifle which fires 5.56mm N ammunition.

Wt: 3 kg.

Price: \$50 each (S/R).

140mm RAW (Rifle Assault Weapon) HEAT: As above, but with a HEAT warhead

Wt: 3 kg.

Price: \$100 each (S/R).

Antitank Missiles

These are fired using Heavy Weapons skill.

152mm HEAT (Tank Breaker): Fired from a Tank Breaker launcher. A self-guiding missile with an HEAT warhead. Not interchangeable with TOW II.

Wt: 18 kg.

Price: \$1000 each (S/R).

152mm HEAT (TOW II): A wire-guided missile with an HEAT warhead, fired from the TOW launcher on the M2 Bradley or on a tripod. Not interchangeable with Tank Breaker.

Wt: 28 kg.

Price: \$1500 (S/R).

152mm HEAT (TOW II-C): A wire-guided missile with an HEAT warhead, the final version of the TOW antitank missile.

The TOW II-C is an overhead attack weapon like Tank Breaker. Fired from the TOW launcher on the M2 Bradley or on a tripod, the TOW II-C is not interchangeable with Tank Breaker.

Wt: 31 kg.

Price: \$2100 (R/—).

AT-3 "Sagger": Fired from the AT-3 launcher.

Wt: 11 kg.

Price: \$1200 (R/S).

AT-4 "Spigot": Fired from the AT-4 launcher. A wire-guided missile with a HEAT warhead.

Wt: 7 kg.

Price: \$750 (R/S).

AT-5 "Spandrel": Fired from the AT-5 launcher on the BMP-B and BMP-C. A wire-guided missile with a HEAT warhead.

Wt: 8 kg.

Price: \$1200 (R/S).

AT-7 "Saxhorn": Fired from the AT-7 Saxhorn launcher.

Wt: 7 kg.

Price: \$1200 (—/R).

AT-8 "Songster": Dissatisfied with the long-range performance of tank gun range finders, the Soviets developed the AT-8 "Songster" to fire from the tank's guntube. Each AT-8 comes in two parts (propellant and warhead) and must be hand loaded by the gunner. This takes one complete combat turn. Each AT-8 missile carried displaces one conventional cannon round.

Wt: 50 kg.

Price: \$2000 (S/C).

MILAN II: Fired from the MILAN II launcher. A wire-guided missile with an HEAT warhead.

Wt: 7 kg.

Price: \$3000 (C/S).

MILAN II-T: Fired from the MILAN II launcher. A wire-guided, top-attack missile like Tank Breaker.

Wt: 8 kg.

Price: \$4500 (C/S).

HOT: Fired from the Euromissile HOT launcher. A wire-guided missile with an HEAT warhead.

Wt: 20 kg.

Price: \$5500 (S/R).

Swingfire: Fired from the British Swingfire launcher. A wire-guided missile with an HEAT warhead.

Wt: 20 kg.

Price: \$3000 (S/R).

127mm HEAT (DRAGON PIP): Used with the Dragon launcher.

Wt: 7 kg.

Price: \$1200 (R/—).

ADATS: Fired from the ADATS launcher.

Wt: 35 kg.

Price: \$3500 (R/—).

Dragon PIP

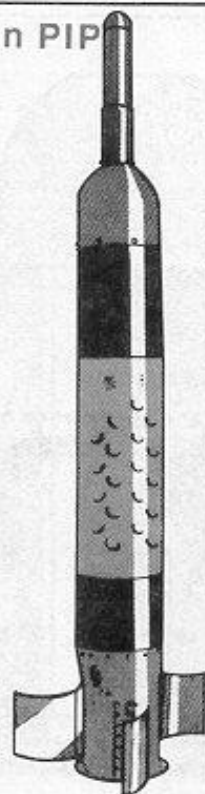

Autocannon Rounds

These are fired using Heavy Weapons skill.

23mm API:

Wt: 100 kg per case of 33, belted.

Price: \$500 per case (S/C).

23mm HE:

Wt: 100 kg per case of 33, belted.

Price: \$500 per case (S/C).

25mm API:

Wt: 100 kg per case of 33, belted.

Price: \$650 per case (C/S).

25mm HE:

Wt: 100 kg per case of 33, belted.

Price: \$650 per case (C/S).

25mm APDU:

Wt: 100 kg per case of 33, belted.

Price: \$2500 per case (S/R).

30mm API:

Wt: 25 kg per case of 33, belted.

Price: \$750 per case (S/C).

30mm HE:

Wt: 25 kg per case of 33, belted.

Price: \$750 per case (S/C).

40mm HE:

Wt: 50 kg per case of 64.

Price: \$6000 per case (C/S).

75mm HE:

Wt: 10 kg.

Price: \$250 each (C/S).

75mm WP:

Wt: 10 kg.

Price: \$500 each (R/R).

75mm APFSDS:

Wt: 10 kg.

Price: \$600 each (S/R).

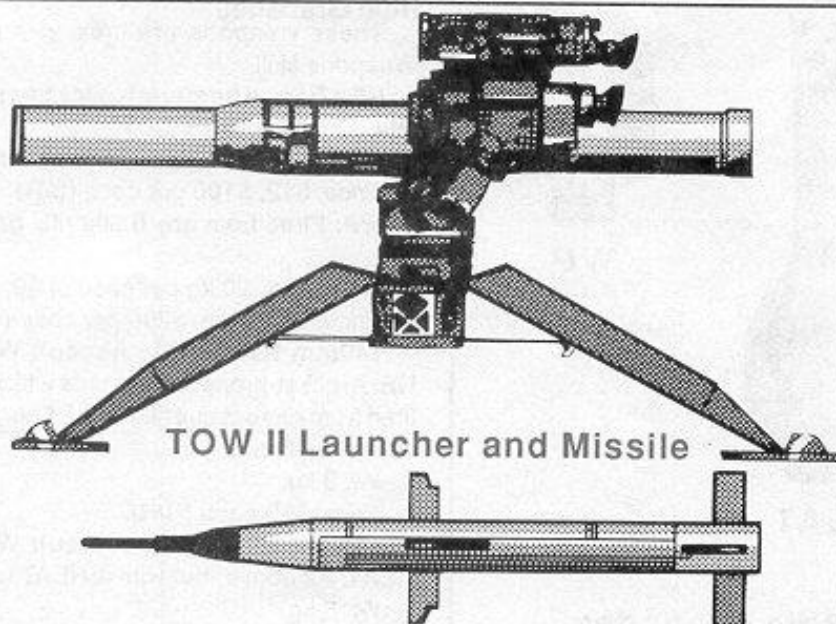

TOW II Launcher and Missile

Large-Caliber Rounds

105mm HEAT:

Wt: 25 kg.

Price: \$600 (C/S).

105mm APFSDS:

Wt: 25 kg.

Price: \$600 (S/R).

105mm APDU:

Wt: 25 kg.

Price: \$1000 (R/R).

105mm WP:

Wt: 25 kg.

Price: \$1000 (R/R).

120mm HEAT:

Wt: 50 kg.

Price: \$800 (C/S).

120mm APFSDS:

Wt: 50 kg.

Price: \$800 (S/R).

120mm APDU:

Wt: 50 kg.

Price: \$1500 (R/R).

120mm WP:

Wt: 50 kg.

Price: \$1000 (R/R).

125mm HE:

Wt: 40 kg.

Price: \$800 (S/C).

125mm HEAT

Wt: 40 kg.

Price: \$800 (R/S).

125mm APFSDS

Wt: 40 kg.

Price: \$800 (S/R).

125mm APDU:

Wt: 40 kg.

Price: \$1500 (R/R).

125mm Powder Charge:

Wt: 25 kg.

Price: \$80 (S/C).

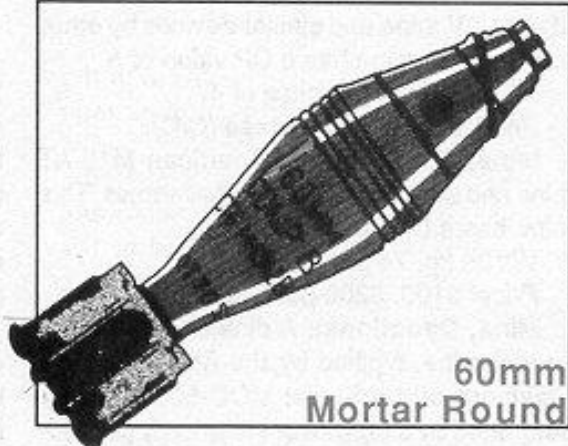

60mm
Mortar Round

Howitzer Rounds

122mm HE:

Wt: 25 kg Price: \$350 (S/C).

122mm HEAT:

Wt: 25 kg Price: \$500 (R/S).

122mm ICM:

Wt: 25 kg Price: \$2000 (R/R).

122mm WP:

Wt: 25 kg Price: \$700 (R/S).

122mm CHEM:

Wt: 25 kg Price: \$350 (R/S).

122mm ILLUM:

Wt: 25 kg Price: \$350 (R/R).

122mm Powder Charge:

Wt: 10 kg Price: \$40 (C/V).

152mm HE:

Wt: 50 kg Price: \$500 (S/C).

152mm HEAT:

Wt: 50 kg Price: \$750 (R/S).

152mm ICM:

Wt: 50 kg Price: \$3000 (R/R).

152mm WP:

Wt: 50 kg Price: \$1000 (R/S).

152mm CHEM:

Wt: 50 kg Price: \$500 (R/S).

152mm ILLUM:

Wt: 50 kg Price: \$500 (R/R).

152mm Powder Charge:

Wt: 25 kg Price: \$60 (C/V).

155mm HE:

Wt: 50 kg Price: \$500 (C/S).

155mm HEAT:

Wt: 50 kg Price: \$750 (C/S).

155mm ICM-DP:

Wt: 50 kg Price: \$3000 (R/R).

155mm WP:

Wt: 50 kg Price: \$1000 (S/R).

155mm CHEM:

Wt: 50 kg Price: \$500 (S/R).

155mm ILLUM:

Wt: 50 kg Price: \$500 (S/R).

155mm FASCAM:

Wt: 50 kg Price: \$5000 (R/R).

155mm Powder Charge:

Wt: 25 kg Price: \$60 (V/C).

Mortar Rounds

60mm HE:

Wt: 25 kg per case of 12.

Price: \$300 per case (C/S).

60mm WP:

Wt: 25 kg per case of 12.

Price: \$600 per case (S/R).

60mm ILLUM:

Wt: 25 kg per case of 12.

Price: \$300 per case (S/R).

81mm HE:

Wt: 25 kg case of 3.

Price: \$150 per case (C/S).

81mm WP:

Wt: 25 kg case of 3.

Price: \$300 per case (S/R).

81mm ILLUM:

Wt: 25 kg per case of 3.

Price: \$150 per case (S/R).

82mm HE:

Wt: 50 kg per 5-round clip.

Price: \$300 per clip (S/C).

82mm HEDP:

Wt: 50 kg per 5-round clip.

Price: \$600 per clip (R/S).

82mm WP:

Wt: 25 kg per case of 3.

Price: \$300 per case (R/S).

82mm ILLUM:

Wt: 25 kg per case of 3.

Price: \$150 per case (R/S).

4.2" HE:

Wt: 35 kg per case of 2.

Price: \$200 per case (C/S).

4.2" ICM-DP:

Wt: 35 kg per case of 2.

Price: \$2000 per case (R/R).

4.2" WP:

Wt: 35 kg per case of 2.

Price: \$400 per case (S/R).

4.2" CHEM:

Wt: 35 kg per case of 2.

Price: \$200 per case (S/R).

4.2" ILLUM:

Wt: 35 kg per case of 2.

Price: \$200 per case (S/R).

120mm HE:

Wt: 50 kg per case of 2.

Price: \$200 per case (V/V).

120mm WP:

Wt: 50 kg per case of 2.

Price: \$400 per case (S/S).

120mm CHEM:

Wt: 50 kg per case of 2.

Price: \$250 per case (S/S).

120mm ILLUM:

Wt: 50 kg per case of 2.

Price: \$200 per case (S/R).

Assorted Tank Gun Rounds

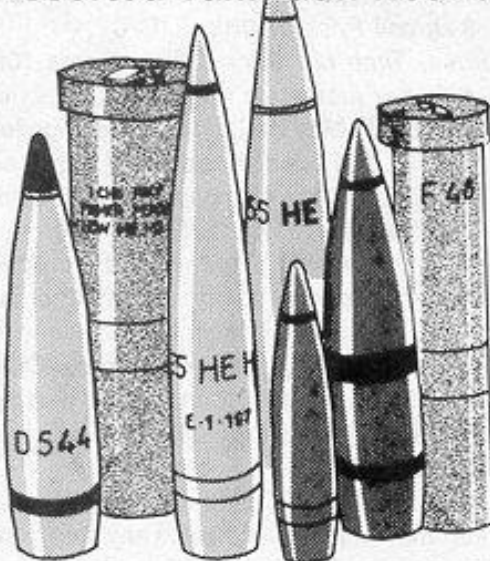

EXPLOSIVES

Explosives are described as follows.

Dynamite Stick: The most common explosive used by civil engineers for demolitions, it is relatively easy to manufacture and is coming into more common military use. A quarter-kilogram stick has a DP value of 1.

Wt: 30 kg per case.

Price: \$10 per quarter-kilogram stick, \$750 per case of 100 sticks (C/C).

Plastic Explosive: Plastic explosive can be molded to desired shapes and will adhere to desired surfaces. It will not explode if burned, and can only be detonated by another explosion, usually provided by a blasting cap. A one-kilogram block has a DP value of 6.

Wt: 30 kg per case.

Price: \$30 per 1 kg block, \$650 per case of 20 blocks (S/R).

Mine, Antipersonnel: The American

M16A1 AP mine and similar devices by other armies. This mine has a DP value of 6.

Wt: 20 kg, 84 per case of 4.

Price: \$50, \$200 per case (C/C).

Mine, Antitank: The American M19 AT mine and similar devices by other armies. This mine has a DP value of 18.

Wt: 35 kg, 74 per case of 2.

Price: \$100, \$200 per case (S/S).

Mine, Directional: A directional antipersonnel mine, typified by the American M18 Claymore or the Soviet MOC-50. It can be detonated by a tripwire or electrically (all necessary items are included with the mine and are disposable). The mine comes packaged in a canvas carrying case containing all items needed to emplace it. Special rules for its damage are discussed on page 202. This mine has a DP value of 4.

Wt: 2 kg, 12 per case of 6.

Price: \$250, \$800 per case (S/R).

Engineer Demolitions Kit: This kit contains an assortment of items to enable a character to rig explosive charges and fuse them for detonation. Weight and price are given for individual items as well as for the kit as a whole. Items without weight, etc., are not available separately. The explosives must be purchased separately.

A single charge uses up one blasting cap, and whatever fuse, detonators, and so on that the character chooses to use. Wire, tools, and the blasting machine can be recovered after a blast, but all other items are used up. Quantities in a kit are noted in parentheses.

Tools (1 Set): Pliers, knife, tape, cap crimper, and other items needed to prepare explosive charges. *Wt:* 4 kg *Price:* \$50 (C/C).

Cap, Blasting, Electric (50): At least one is required to set off a charge. *Wt:* Negligible *Price:* \$2 each (C/C).

Cap, Blasting, Nonelectric (50): At least one is required to set off a charge. *Wt:* Negligible *Price:* \$2 (C/C).

Wire, Electrical (2x100m Spools): For use with electrical blasting caps. Any length can be fastened to up to 10 caps. Not normally reused. *Wt:* 5 kg/spool *Price:* \$50 (V/V).

Wire, Trip (1x500m Spool): A thin wire used in booby traps and the like. Tripwires can be of any reasonable length, but it makes no sense to have them longer than the blast radius of the explosive. *Wt:* 2 kg/spool *Price:* \$10/spool (V/V).

Blasting Machine (1): A hand-cranked electrical igniter which can fire up to 10 caps electrically. The machine generates current by muscular motion and never needs recharging or battery changes. *Wt:* 0.5 kg *Price:* \$50 (C/C).

Fuse, Instant (2x100 m coils): Burns 5900 meters per second; for use with nonelectric blasting caps. May be ignited by any igniter or by flame, and it can be combined with itself (to set off more than one cap) or with time fuse. *Wt:* 3 kg/coil *Price:* \$100/coil (C/C).

Fuse, Time (2x100m Coils): Burns 100 seconds per meter; for use with nonelectric blasting caps. May be ignited by any igniter or by flame, and it can be combined with itself (to set off more than one cap) or with instant fuse. *Wt:* 3 kg/coil *Price:* \$75/coil (V/V).

Igniter, Fuse, M60 (50): A weatherproof pull igniter, which can be used to light either instant or time fuse. This igniter can be used in simple (pull-only tripwire) booby traps. Only one tripwire per igniter. It can be fixed directly to a nonelectric blasting cap. *Wt:* Negligible *Price:* \$3 (C/C).

Timer, M2A1 (5): This detonator has a digital timer which can be set to any time from 30 seconds to 48 hours, in 30-second incre-

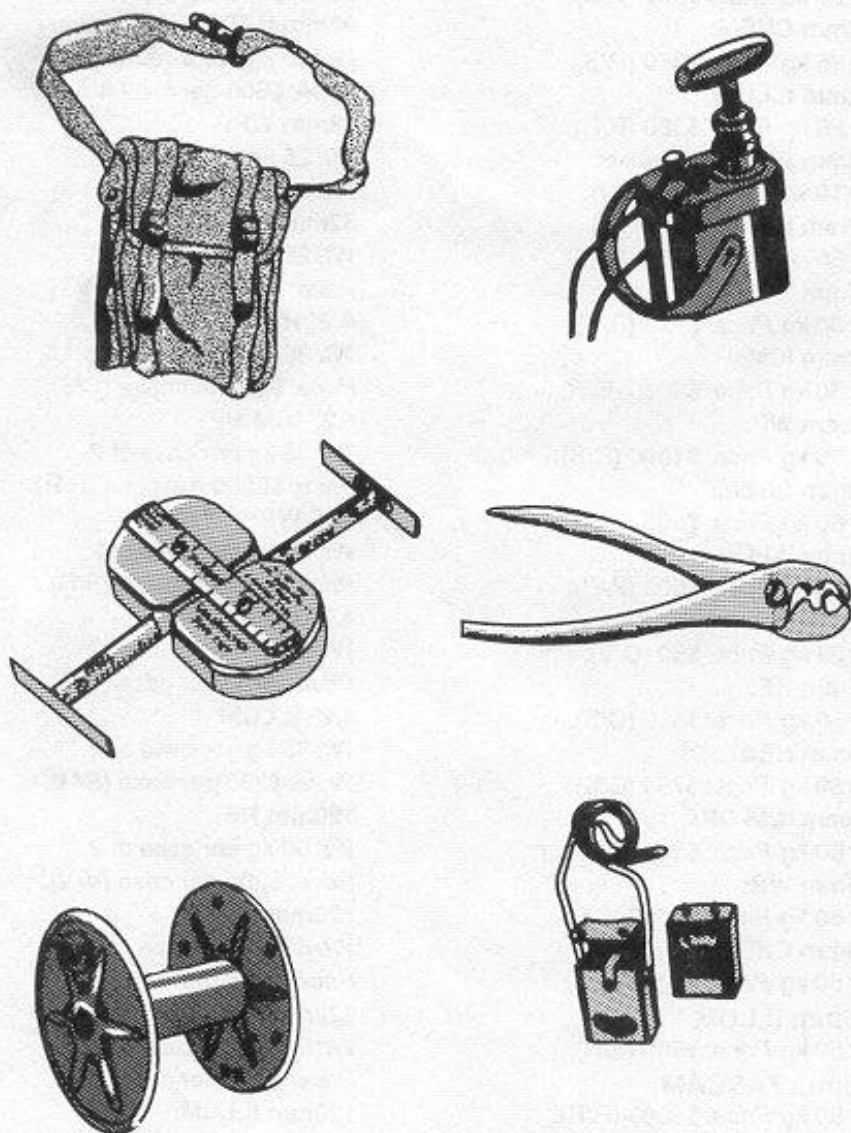

Engineer Demolitions Kit

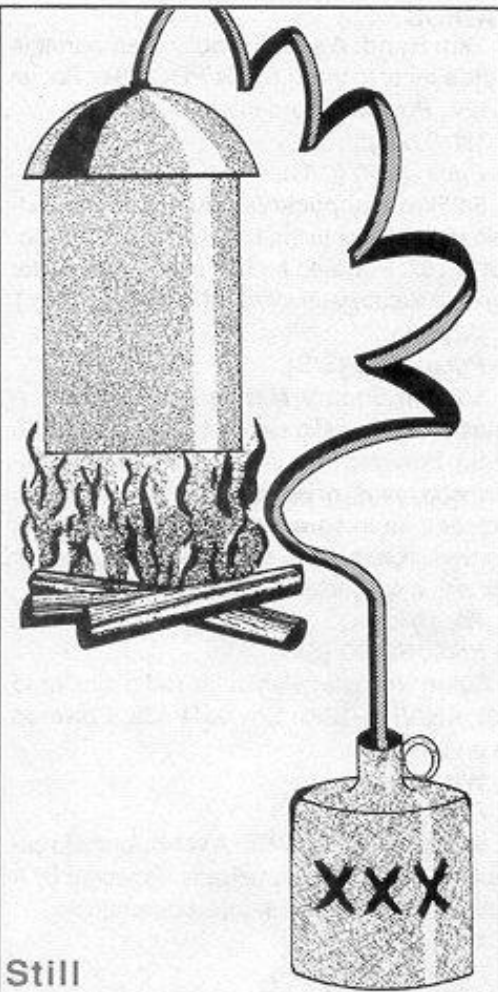

Still

GENERATORS

- 1.5 Kilowatt:**
Fuel Consumption: 2 liters per period.
Wt: 50 kg.
Price: \$200 (C/C).
- 5 Kilowatt:**
Fuel Consumption: 5 liters per period.
Wt: 150 kg.
Price: \$700 (C/C).
- 10 Kilowatt:**
Fuel Consumption: 7 liters per period.
Wt: 250 kg.
Price: \$1200 (S/S).
- 60 Kilowatt:**
Fuel Consumption: 40 liters per period.
Wt: 600 kg.
Price: \$8000 (S/S).
- 100 Kilowatt:**
Fuel Consumption: 55 liters per period.
Wt: 1000 kg.
Price: \$15,000 (R/R).
- 500 Kilowatt:**
Fuel Consumption: 170 liters per period.
Wt: 2500 kg.
Price: \$50,000 (R/R).

Notes on Generators and Electrical Equipment: A variety of electrical devices are available, but they require electricity in order to function.

The Equipment List included in *Twilight: 2000* 2nd edition gives the power consumption, in kilowatts, of each electrical equipment item.

Those pieces of equipment which are listed as vehicle powered may only function when they are in the vehicle or when they are hooked to a generator. Other types of electrical equipment which only have a power consumption listed may only function when they are hooked to a generator.

A generator can power equipment as long as the total power consumption of equipment which is connected to the generator is less than or equal to the generator's output. (A 60-kilowatt generator has an output of 60 kilowatts.)

A generator consumes fuel at the rate noted above.

Some equipment listed is powered by internal batteries. Internal batteries will work for one day before they require recharging. For a battery to be recharged, it must be hooked to a generator for one period before it can again be used.

The generator must be operating when used to recharge, but no power consumption is charged against its capacity due to recharging (as the power consumption of battery-operated items in the game is insignificant when compared to even the smallest generator's output).

HEATERS AND COOLERS

Freezer, Small: A one-cubic-foot freezer suitable for preserving food or medical supplies. It can be powered either by a vehicle battery or a generator.

- Power Consumption:* 0.12 kw.
- Wt:* 20 kg.
- Price:* \$100 (S/S).

Freezer, Large: A 14-cubic-foot freezer. It can only be powered by a generator.

- Power Consumption:* 1.4 kw.
- Wt:* 175 kg.
- Price:* \$1000 (S/S).

Portable Heater: Suitable for one average-sized room.

- Power Consumption:* 4.75 kw.
- Wt:* 3 kg.
- Price:* \$200 (C/C).

150-Liter Water Heater:
Power Consumption: 175 kw.
Wt: 180 kg.

Price: \$1500 (C/C).

Refrigerator, Small: Suitable for preserving small quantities of food or medical supplies. It can be powered by a vehicle or a generator.

- Power Consumption:* 0.1 kw.
- Wt:* 20 kg.
- Price:* \$100 (C/C).

Refrigerator, Large: 14 cubic feet.
Power Consumption: 1.3 kw.
Wt: 150 kg.

Price: \$1000 (S/S).

Field Cooker, Military:
Fuel Consumption: 8 liters/period.
Wt: 250 kg.

Price: \$1000 (C/C).

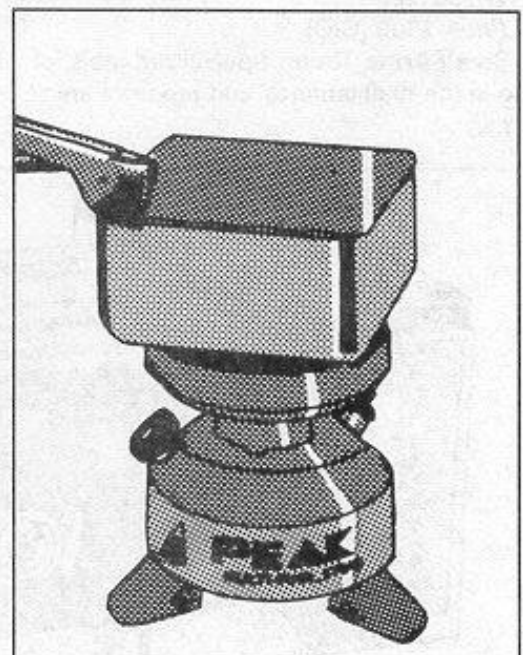

Field Cooker

ments. It will fire up to 10 electrical caps. Once set and sealed, it is waterproof, but it cannot be set underwater. *Wt:* 0.25 kg *Price:* \$20 (S/S).

Igniter, M4A1 (5): A pull/release detonator, used for sophisticated booby traps. It will detonate either when pressure is placed on a tripwire or released from the tripwire (if a wire is cut, for example). Up to three tripwires may be attached. *Wt:* Negligible *Price:* \$10 (R/R).

Full Kit: All of the above, packed in a wooden chest for transport. *Wt:* 30 kg *Price:* \$750 (C/C).

STILLS

Small: Uses 30 kilograms of organic material per day and produces five liters of alcohol per day.

- Wt:* 700 kg.
- Price:* \$500 (V/V).

Medium: Uses 80 kilograms of organic material per day and produces 35 liters of fuel per day.

- Wt:* 2000 kg.
- Price:* \$2500 (V/V).

Large: Uses three tons of organic material per day and produces 2400 liters of alcohol per day.

- Wt:* 83 tons.
- Price:* \$200,000 (C/C).

HAND TOOLS

Basic Tool Kit: Small hand tools which are suitable for a variety of purposes. These may include wrenches, pliers, screwdrivers, and so on.

Wt: 5 kg.

Price: \$200 (V/V).

Power Hand Tools: A selection of power tools including a chainsaw, 9" rotary saw, drill, and other electrical tools.

Power consumption listed is for the whole set.

Power Consumption: 4 kw.

Wt: 35 kg.

Price: \$500 (C/C).

Wheeled Vehicle Tools: Specialized tools for repair and maintenance of wheeled vehicles.

These vehicle tools include spark plug wrenches, torque wrenches, a grease gun, and so on.

Wt: 10 kg.

Price: \$500 (C/C).

Tracked Vehicle Tools: As above, but for tracked vehicles.

Wt: 15 kg.

Price: \$1000 (S/S).

Aircraft Tools: As above, but for aircraft.

Wt: 22 kg.

Price: \$2000 (R/R).

Excavating Tools: Picks, shovels, mattocks, and so on.

Wt: 20 kg.

Price: \$300 (V/V).

Construction Tools: Hammers, saws, squares, hatchets, chisels, and other wood-working tools.

Wt: 30 kg.

Price: \$500 (C/C).

Small Arms Tools: Specialized tools for use in the maintenance and repair of small arms.

These tools are not suitable for the purpose of the construction of weapons from scratch, however.

Wt: 5 kg.

Price: \$200 (S/S).

Heavy Ordnance Tools: As above, but for heavy ordnance.

Wt: 25 kg.

Price: \$750 (S/S).

Electrical Repair: Specialized tools for work on electrical appliances, wiring, and non-solid state equipment.

Wt: 3 kg.

Price: \$500 (C/C).

Electronic Repair: As above, but for work on solid state electrical devices such as radios, radar sets, etc.

Wt: 3 kg.

Price: \$1000 (S/S).

Arc Welder: Operates off of an integral generator, which cannot be modified for other use.

Fuel Consumption: 40 liters per period.

Wt: 75 kg.

Price: \$500 (S/S).

Portable Machine Shop: A trailer containing powered machine tools, including a bench grinder, horizontal and vertical boring machines, a milling machine, metalworking and woodworking lathes, and numerous other machine tools. Exact components and uses are left to the discretion of the referee. It can be towed by any truck except a 1/4-ton.

Power Consumption: 60 kw.

Wt: 1.75 tons.

Price: \$75,000 (R/R).

Lockpick Tools: Picks, torsion wrenches, shims, a stethoscope, and other equipment to open all types of locks.

Wt: 0.5 kg.

Price: \$20 (V/V).

RADIOS

2km Hand: A small, readily man-portable radio similar to the U.S. AN/PRC-68 or Soviet R-126. Powered from internal batteries.

Wt: 0.5 kg.

Price: \$250 (C/C).

5/25km Manpack/Vehicular: Small, portable radio similar to the U.S. AN/PRC-77 or Soviet R-107. Powered from internal batteries (for five-kilometer range) or a vehicle (25-kilometer range).

Wt: 5 kg.

Price: \$500 (S/S).

5/25km Secure Manpack/Vehicular: A small, portable radio similar to the AN/PRC-70 (U.S.). Powered from internal batteries (for five-kilometer range) or vehicle (25-kilometer range). Includes an integral scrambler/descrambler (conversations can only be understood by another unit with a scrambler/descrambler).

Wt: 10 kg.

Price: \$2000 (S/S).

50km Vehicle: Vehicular radio similar to U.S. AN/VRC-12 or Soviet R-409. Powered by a vehicle.

Wt: 15 kg.

Price: \$1500 (S/S).

50km Secure Vehicle: A vehicular radio capable of scrambled broadcasts. Powered by a vehicle, with integral scrambler/descrambler.

Wt: 15 kg.

Price: \$6000 (R/R).

RANGE FINDERS

Portable Laser RF: Powered from internal batteries. Reads out distance to a designated object.

Wt: 0.2 kg.

Price: \$1000 (R/R).

Vehicle Laser RF: Vehicle powered. Reads out distance to a designated object.

Wt: 5 kg.

Price: \$1500 (S/S).

Portable Coincidence RF: Powered from internal batteries. Reads out distance to a designated object.

Wt: 1 kg.

Price: \$500 (S/S).

Vehicle Coincidence RF: Powered from internal batteries. Reads out distance to a designated object.

Wt: 3 kg.

Price: \$700 (C/C).

Vehicle Laser RF with Ballistic Computer: Vehicular powered. Feeds target correction data directly into on-board targeting computer.

Wt: 5 kg.

Price: \$10,000 (S/S).

Reticule Gunsight: An old-style, non-electrical range finder.

Wt: 5 kg.

Price: \$10,000 (R/R).

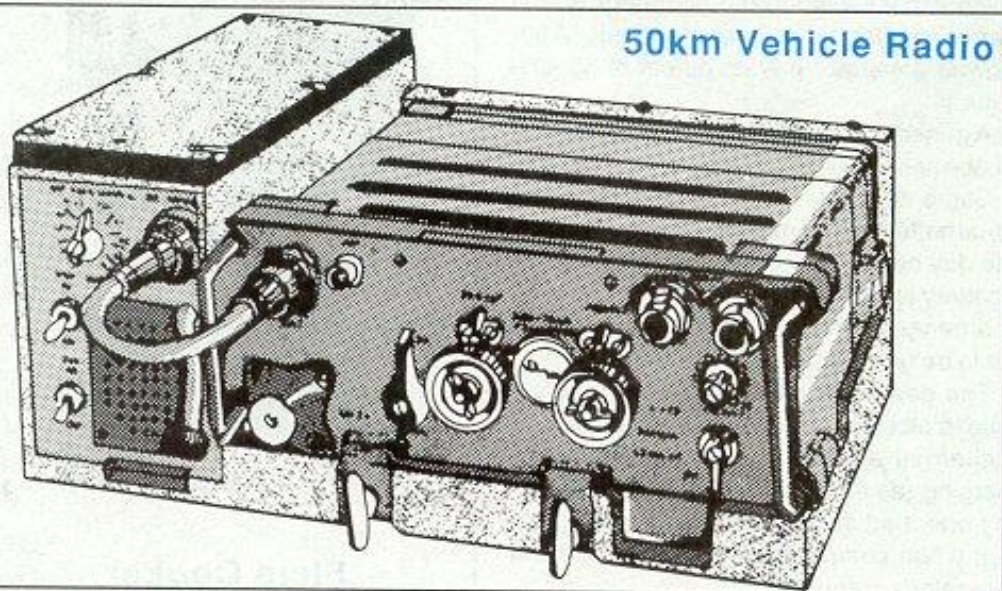

50km Vehicle Radio

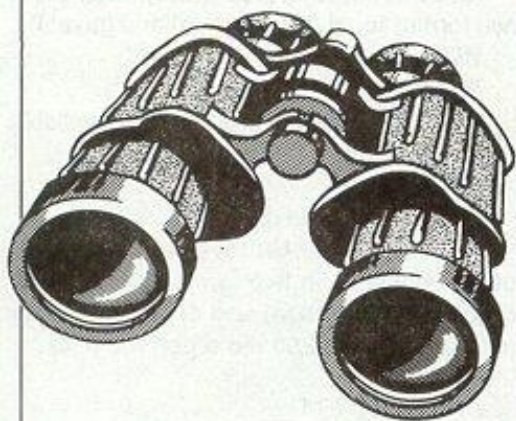

Binoculars



MOPP Suit (Armor Crew)

Ground Surveillance Radar



NBC EQUIPMENT

Chemical Sniffer: Detects and identifies the varieties of chemical agents in common use. It is reusable and is constantly in operation if power is supplied. Powered by internal batteries.

Wt: 2 kg.

Price: \$500 (C/C).

M256 Chemical Detector Kit: Detects and identifies the varieties of chemical agents in common use. The kit is usable only once and must then be disposed of.

Wt: Negligible.

Price: \$20 (S/R).

Optical Chemical Sensor: Detects and identifies the varieties of chemical agents in common use. It is reusable and is constantly in operation if power is supplied. Powered by internal batteries.

Wt: 2 kg.

Price: \$2000 (S/R).

Geiger Counter: Detects nuclear radiation. Powered by internal batteries.

Wt: 0.5 kg.

Price: \$500 (C/C).

Gas Mask: The U.S. M17, M17A1 and similar models issued by other nations.

Wt: 1 kg.

Price: \$150 (V/V).

Steam Decontamination Trailer: Operates from integral 60-kilowatt generator (requires fuel as on page 59). Removes radioactive particles and traces of chemical agents from the outside of vehicles. It will not make a radioactive object safe—it just rinses off fallout and the like.

Wt: 1 ton.

Price: \$5000 (S/C).

Chemical Defense Suit: This is the U.S. Army MOPP suit or similar items issued by other armies.

Wt: 8 kg.

Price: \$1000 (S/C).

VISION DEVICES

4x Binoculars: Allows the user to see longer distances than normal.

Wt: 0.5 kg.

Price: \$100 (V/V).

25x Image Intensifier: Allows the user to see in very little light. Powered from internal batteries. These act as binoculars also.

Wt: 1 kg.

Price: \$2500 (S/S).

Telescopic Rifle Sight: May be attached to any rifle (Average: Gunsmith). If a scope is mounted, add 15 to the printed range figure for the rifle *when conducting aimed shots*. In addition, aimed shots at extreme range are conducted as if at long range for purposes of hit determination. Scopes have no effect on quick shots.

Wt: 0.5 kg.

Price: \$500 (V/V).

Starlight Scope: Powered from internal batteries. May be attached to a rifle if desired (Easy: Gunsmith), making direct fire possible at night, but it is not telescopic and does not improve the chance to hit.

Wt: 2 kg.

Price: \$1000 (R/R).

IR Goggles: Powered from internal batteries. Allows the user to see at night.

Wt: 0.5 kg.

Price: \$250 (C/C).

IR Spotlight: Powered by a vehicle. IR goggles must be used to see by this light.

Wt: 3 kg.

Price: \$150 (C/C).

White Light Spotlight: Powered by a vehicle.

Wt: 5 kg.

Price: \$100 (V/V).

Thermal Sight: Powered from internal batteries.

Wt: 1 kg.

Price: \$5000 (R/R).

RADARS

Ground Surveillance: Vehicle powered through a 100-meter cable to permit limited tactical mobility.

Wt: 7 kg.

Price: \$40,000 (S/R).

Mortar Counterbattery: Vehicle powered through a 100-meter cable to permit limited tactical mobility.

Wt: 7 kg.

Price: \$100,000 (S/R).

Artillery Counterbattery: Vehicle powered through a 100-meter cable to permit limited tactical mobility.

Wt: 7 kg.

Price: \$200,000 (R/R).

LASER DESIGNATORS

Man Portable: Powered from internal batteries.

Wt: 3 kg.

Price: \$1000 (S/R).

Vehicle Mounted: Vehicle powered.

Wt: 5 kg.

Price: \$2000 (S/R).

BODY ARMOR

Kevlar (Ballistic Nylon) Vest: This type of body armor is intended to provide protection from fragments, not to protect against direct hits from small arms.

Wt: 4 kg.

Price: \$800 (C/S).

Flak Jacket: This type of body armor is intended to provide protection from fragments, not direct hits from small arms.

Wt: 8 kg.

Price: \$400 (C/C).

Kevlar (Ballistic Nylon) Helmet: This is intended to provide protection from fragments, not direct hits from small arms.

Wt: 0.5 kg.

Price: \$100 (C/S).

Steel Helmet: This is intended to provide protection from fragments, not direct hits from small arms.

Wt: 1 kg.

Price: \$50 (C/C).

MEDICAL SUPPLIES

Anesthetic, Total (100 Units): Available in two forms: liquid (for injection) and gaseous.

Wt: 0.1 kg.

Price: \$1000 (R/R).

Anesthetic, Local (100 Units): Available only in liquid form (for injection)

Wt: 0.5 kg.

Price: \$1000 (R/R).

Antibiotic (100 Units) +, -, and ± Varieties: Available in two forms: liquid (which requires refrigeration) and oral (which does not). Oral costs \$250 more per 100 units.

Wt: 0.2 kg.

Price: \$500 (R/R).

Antifever (100 Units):

Wt: 0.5 kg.

Price: \$500 (R/R).

Atropine (100 Units): Liquid form.

Wt: 0.2 kg.

Price: \$500 (R/R).

Atropine (Autoinjector): Premeasured, automatic injectors, which can be operated by nonmedical personnel. One dose, disposable.

Wt: 0.5 kg per kit of 10.

Price: \$75 (R/R).

Pain-Reliever, Mild (100 Units): Oral (pill) form only.

Wt: 0.5 kg.

Price: \$500 (R/R).

Sedative, Mild (100 Units): Oral form only.

Wt: 0.5 kg.

Price: \$500 (R/R).

Sedative, Strong (100 Units): Liquid (for injection) form only.

Wt: 0.5 kg.

Price: \$500 (R/R).

Blood, Whole (1 Unit):

Wt: 0.5 kg.

Price: \$25 (S/S).

Plasma (1 Unit):

Wt: 0.5 kg.

Price: \$10 (S/S).

Surgical Instruments: Scalpels, forceps, hemostats, clamps, and other tools for major surgery.

Wt: 5 kg.

Price: \$2500 (R/R).

Personal Medical Kit: An individual soldier's first aid kit. Includes bandages, one unit of ± antibiotic, and other first aid materials. This kit is used up in one first aid operation.

Wt: 0.2 kg.

Price: \$100 (C/C).

Doctor's Medical Kit: Medical equipment and drugs. Includes 10 units of each drug type, plus bandages and tools for minor surgery.

Wt: 5 kg.

Price: \$1000 (S/S).

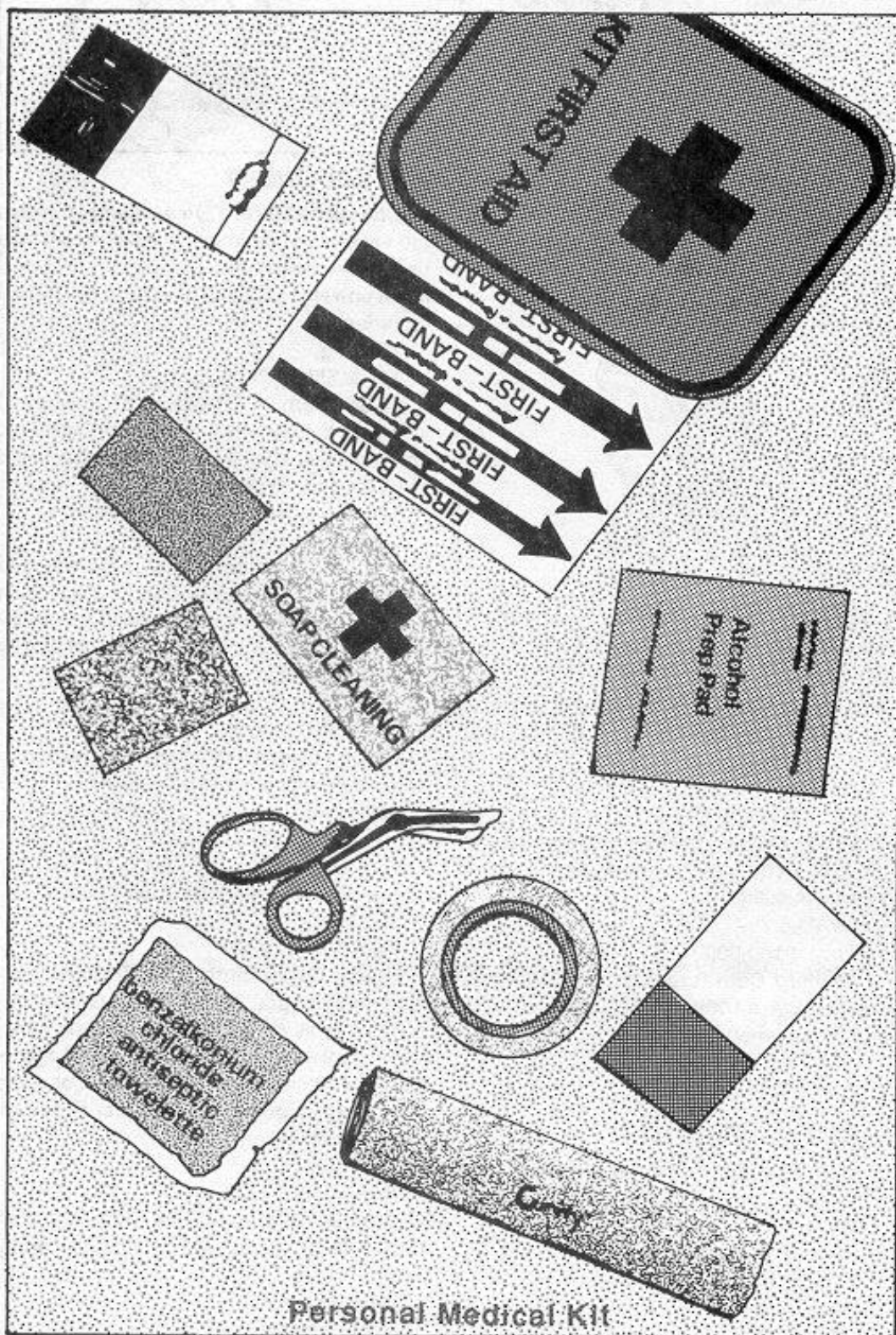

Personal Medical Kit

OTHER EQUIPMENT

20-Liter Jerrycan: For fuel and other liquids.

Wt: 1 kg (empty).

Price: \$25 (V/V).

Four-Man Tent:

Wt: 12 kg.

Price: \$100 (C/C).

10-Man Tent:

Wt: 35 kg.

Price: \$250 (S/S).

Horse Tack: Saddle, bridle, straps, stirrups, saddle blanket, and so on.

Wt: 10 kg.

Price: \$50 (C/C).

Pack Saddle: A saddle especially designed for cargo.

Wt: 5 kg (empty).

Price: \$40 (C/C).

Aqualung: Two compressed air tanks, fins, mask and regulator. One tank contains enough air for 30 minutes underwater. Up to two may be connected to a single regulator for use.

Wt: 12 kg.

Price: \$300 (C/C).

Air Tank, Aqualung: For use with above. Can be refilled when empty in five minutes with a compressor.

Wt: 5 kg.

Price: \$100 (C/C).

Rebreather: A device which absorbs carbon dioxide from exhaled air and bleeds pure oxygen into it. One oxygen tank is used at a time with it, and it contains enough for 30 minutes underwater. Fins and a mask are included.

Wt: 10 kg.

Price: \$400 (R/R).

Rebreather Recharge Kit: For use with the rebreather. This kit includes a can of carbon dioxide absorbent and a small tank of pure oxygen (enough to recharge a rebreather for 30 minutes underwater).

Wt: 5 kg.

Price: \$100 (R/R).

Air Compressor: For filling aqualung tanks, tires, rafts, and other items needing compressed air.

Fuel Consumption: 2 liters per period.

Wt: 45 kg.

Price: \$200 (R/R).

Skis, Cross-Country: Includes poles, skis, boots, and binders.

Wt: 8 kg.

Price: \$250 (C/C).

Raft, Inflatable: Inflates using an air compressor in two minutes, or using hand-pump in 10 minutes. Capacity is 1000 kilograms.

Wt: 30 kg.

Price: \$500 (C/C).

PERSONAL GEAR

Basic Load: Each soldier receives one of these as a basic equipment issue. It consists of a set of fatigues, a steel helmet, a pack, a shelter half, a gas mask, and one set of combat webbing.

Weapons include one bayonet, one personal weapon and six magazines, six frag grenades, two smoke grenades, and 180 additional rounds of ammunition for the personal weapon. Officers and vehicle crewmen also receive a sidearm and three full magazines for it. Additional items must be purchased. Personal weapons are as indicated on the Personal Weapons Table under the particular army.

American quartermasters are somewhat more generous compared to those of other armies. In addition to the above, the basic load includes a sleeping bag, flashlight, personal medical kit, thermal fatigues, and a kevlar vest. In addition, the helmet is kevlar instead of steel.

Wt: 12 kg (15 kg for U.S.).

Fatigues: These include boots, socks, undergarments, gloves, poncho, and so on. These are in a camouflage pattern and contain numerous pockets for storage of incidental gear.

Wt: 4 kg.

Price: \$50 (V/V).

Pack: A pack is capable of carrying up to 30 kilograms of equipment. Weight given is empty.

Wt: 2 kg.

Price: \$20 (V/V).

Flashlight: Powered by internal batteries.

Wt: 0.2 kg.

Price: \$20 (C/C).

Combat Webbing: This is a load-bearing harness with various pouches, packets, and attachment points to allow efficient transport of weapons, equipment and supplies. In the U.S., it is also called ALICE gear.

Wt: 2 kg.

Price: \$10 (V/V).

Shelter Half: A rubberized canvas sheet which can be combined with another to form a two-person tent or used by itself as a one-person tarp. Tent pegs, cord, and everything else needed to erect it are included.

Wt: 1 kg.

Price: \$25 (C/C).

Sleeping Bag:

Wt: 4 kg.

Price: \$50 (C/C).

Thermal Fatigues: Includes boots, socks, etc.

Wt: 6 kg.

Price: \$100 (S/S).

Parka: Includes overboots, socks, etc.

Wt: 3 kg.

Price: \$150 (C/C).



Poncho, Boots, and Sleeping Bag

Scan courtesy of Deathwind