

TRILEMMA ADVENTURES

48 Isometric Fantasy Maps
Michael Prescott



CREDITS

MICHAEL PRESCOTT

Illustrations
www.trilemma.com

JEFF BROWN GRAPHICS

www.jeffbrowngraphics.com
Cover (Tannòch Rest-of-Kings)

ABOUT THE MAPS

Thank you for purchasing this map book! The maps inside were created over a five-year period as part of the **Trilemma Adventures** series of one- and two-page dungeons.

Back in 2014, after many years of character-focused roleplaying campaigns, my local gaming group dipped back to dungeon crawling. We were playtesting the game that would eventually become Thor Olavsrud's *Torchbearer*. I suddenly found myself in need of a supply of dungeons that we could use, so I blew the dust off my sketchbooks and got to work.

It was the combination of the One-Page Dungeon Contest, and Dyson Logos'

inspirational Patreon campaign that gave me the push to bring the dungeons up to a polished level. I started a [Patreon campaign](#) of my own, and began producing monthly one- and two-page dungeons.

With the generous support of my Patrons, the "Trilemma Adventures" series grew each month, culminating in the **Trilemma Adventures Compendium Vol. I**, published in 2019.

This map pack contains all of the black-and-white adventure location maps from that compendium.

Most of my gaming is theater-of-the-mind; I don't normally play on battle maps. Nevertheless,

I'm fascinated by the power of an evocative map, like a fractalline invitation to find whatever secrets are lurking in every nook and cranny. I can stare at maps for hours, thinking about what it's like to actually be there, to hear the sounds and smell the smells of it.

Whether you're using these maps to show your players mid-game, stocking to create adventures of your own design, or just share that same thrill of seeing imaginary places come to life, I hope you enjoy them.

—Michael Prescott

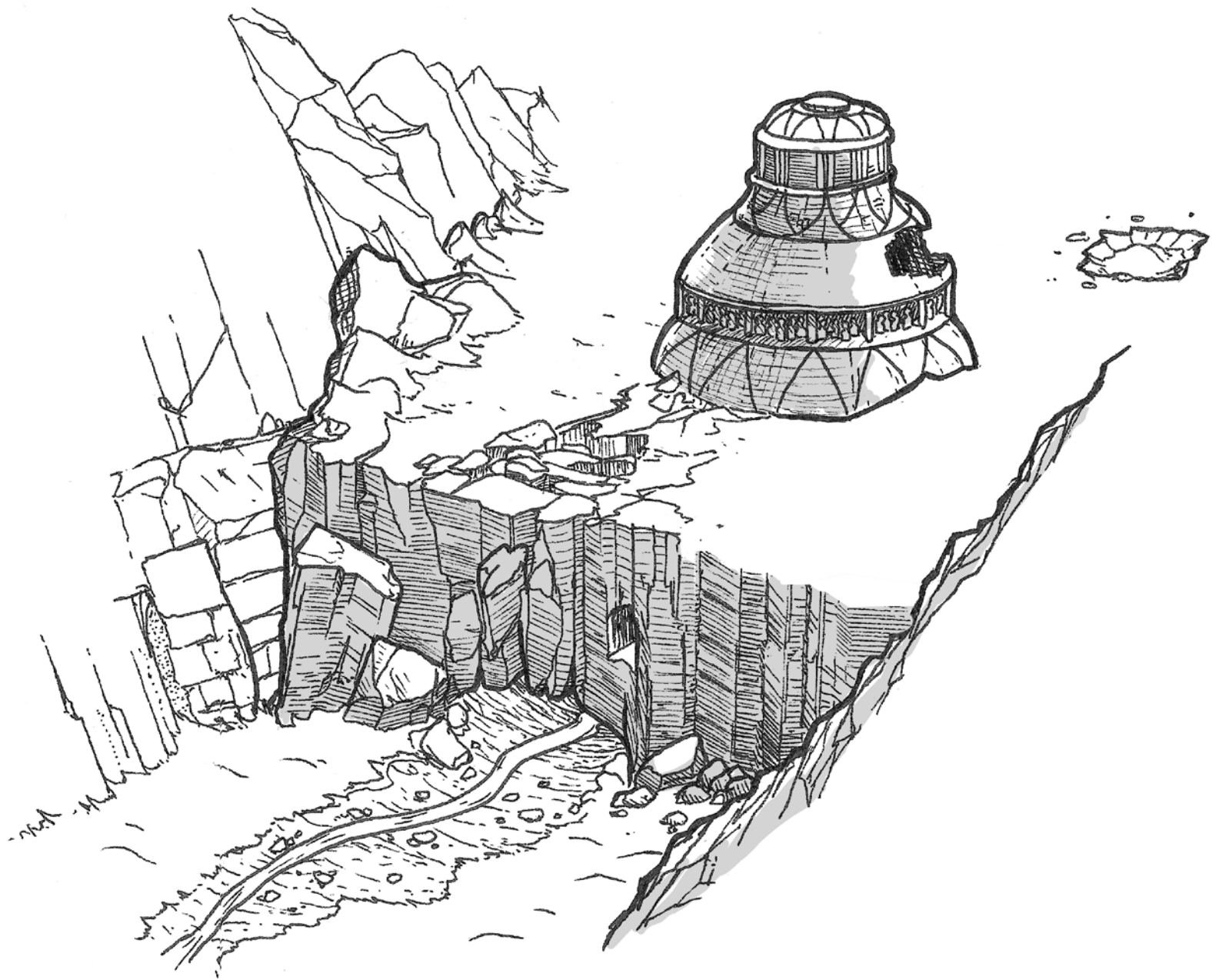

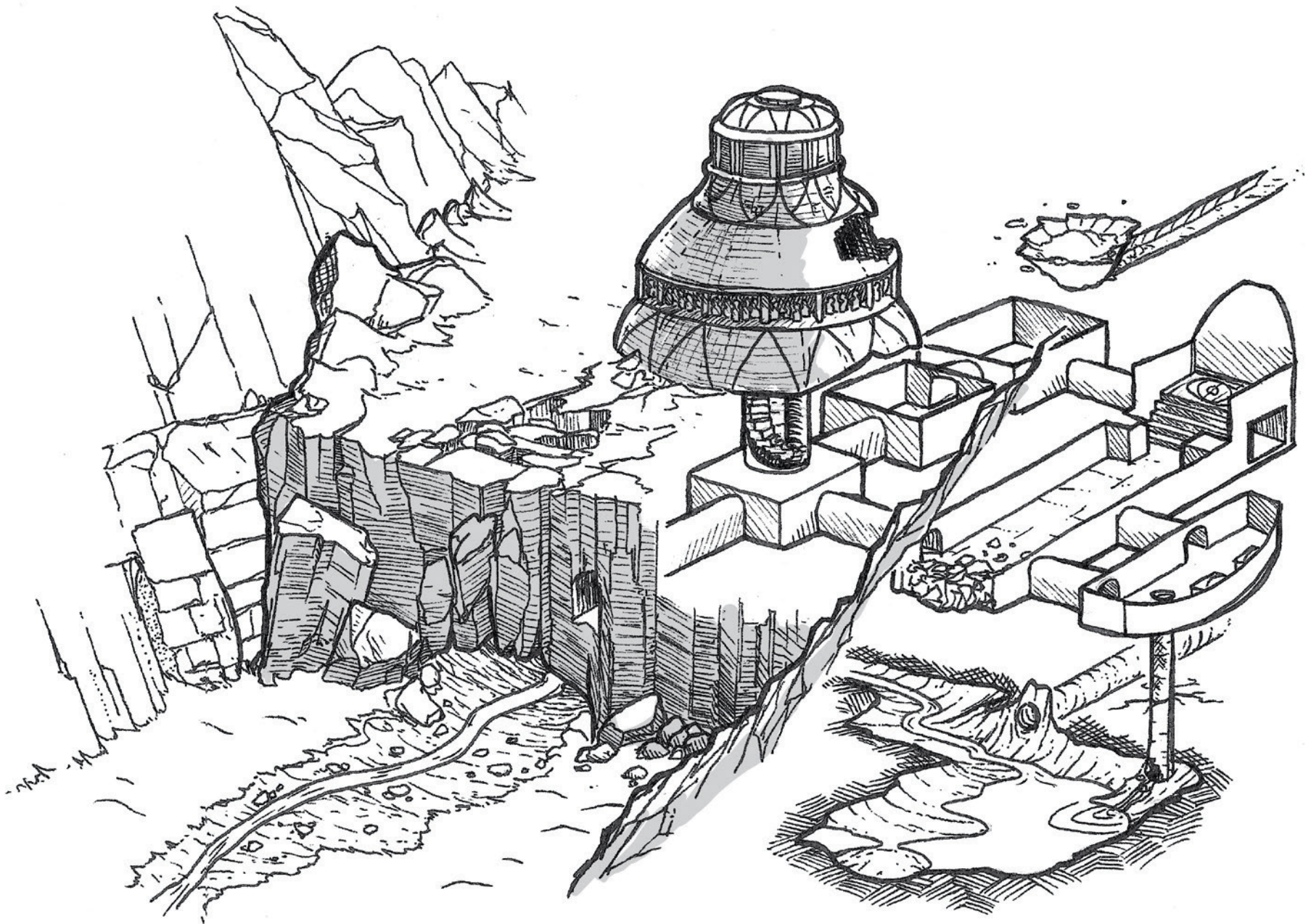



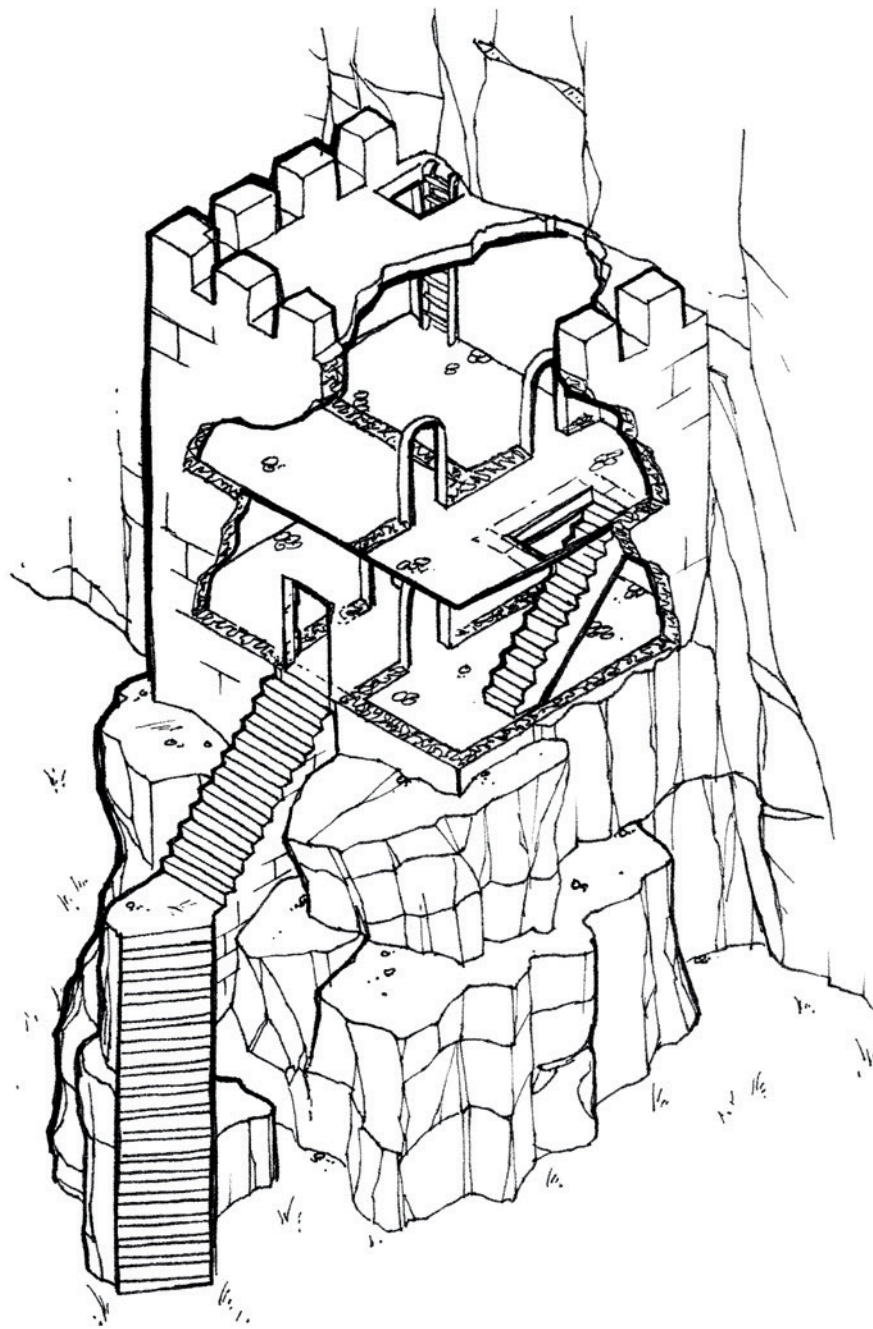

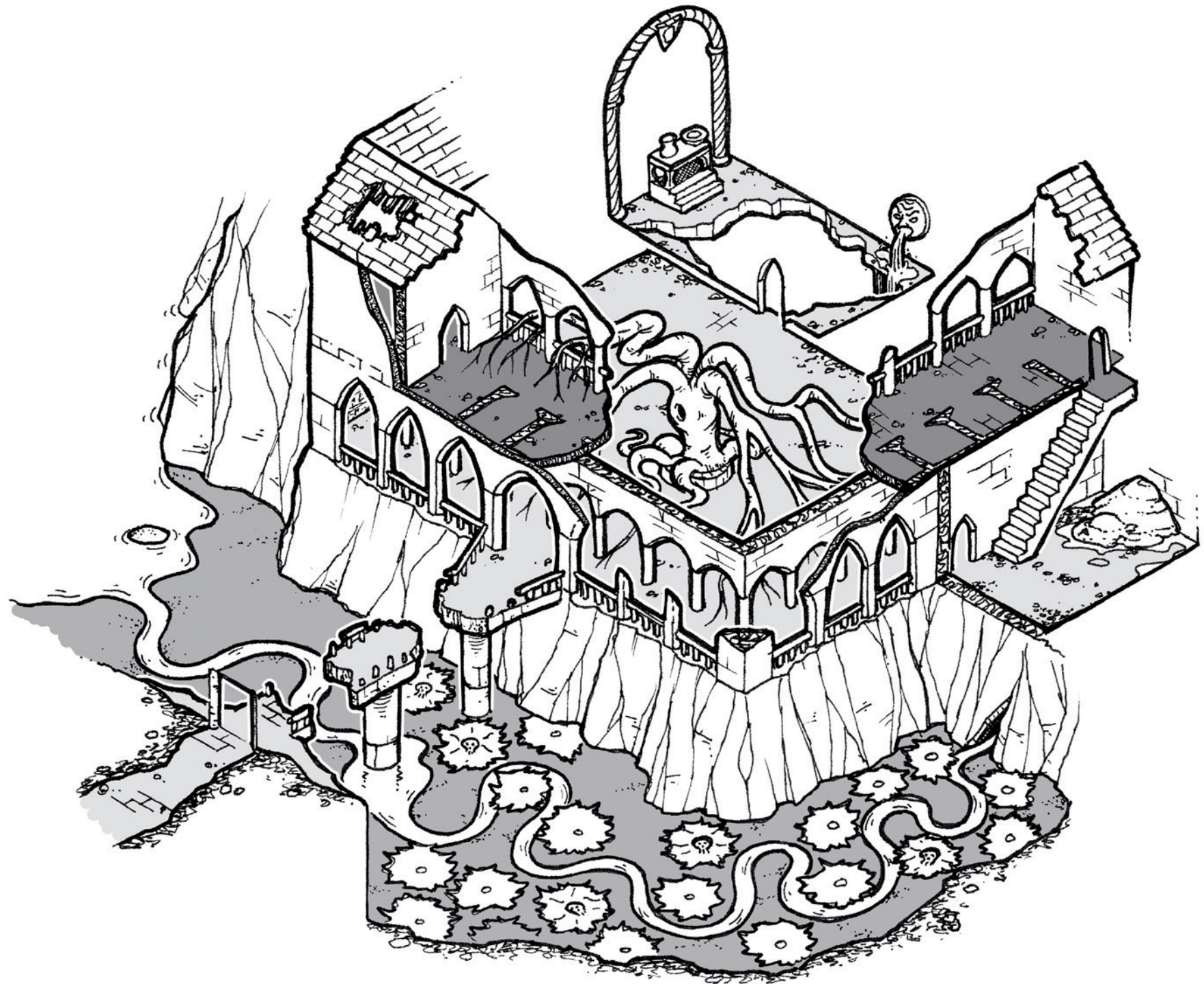



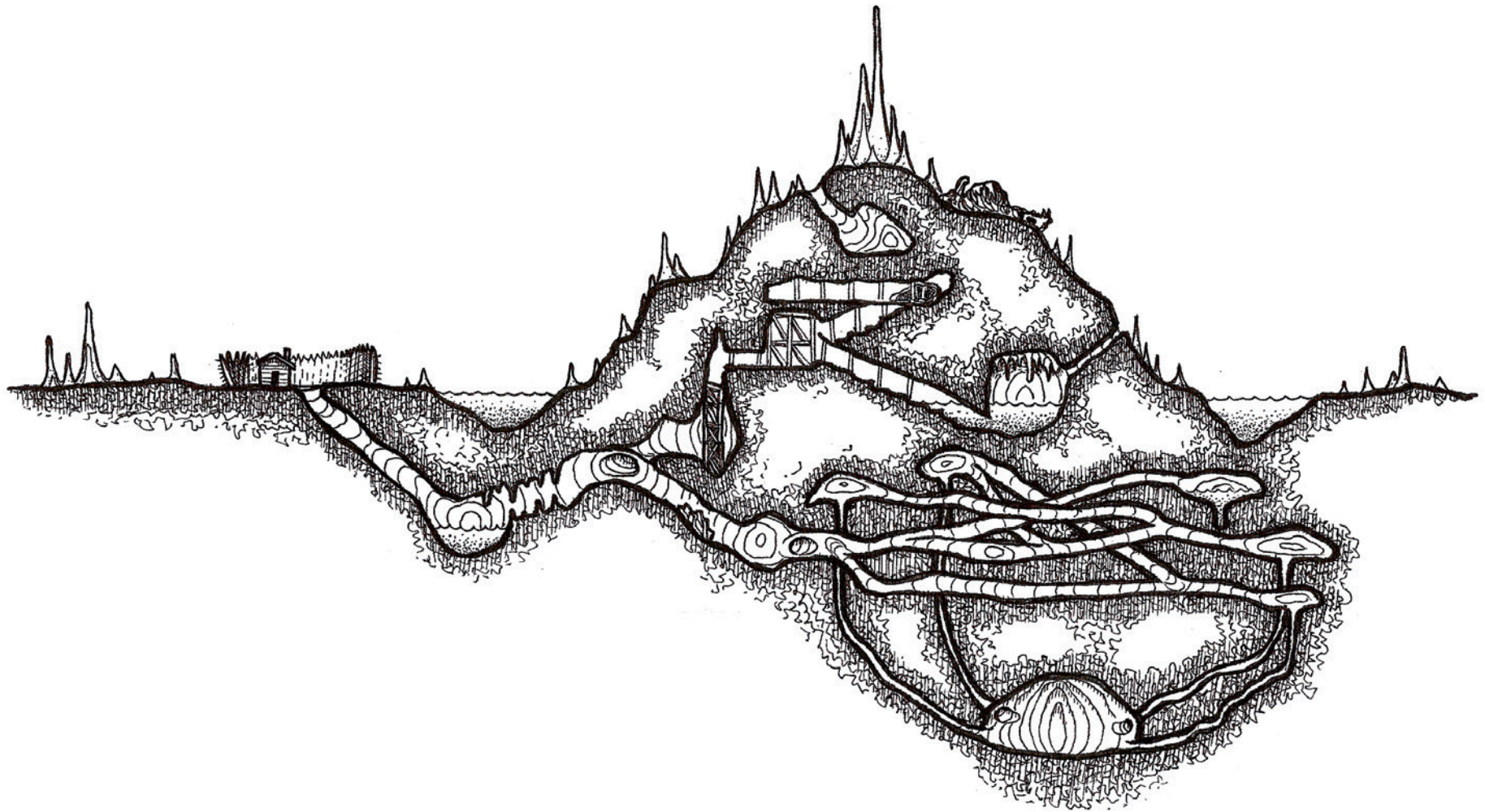

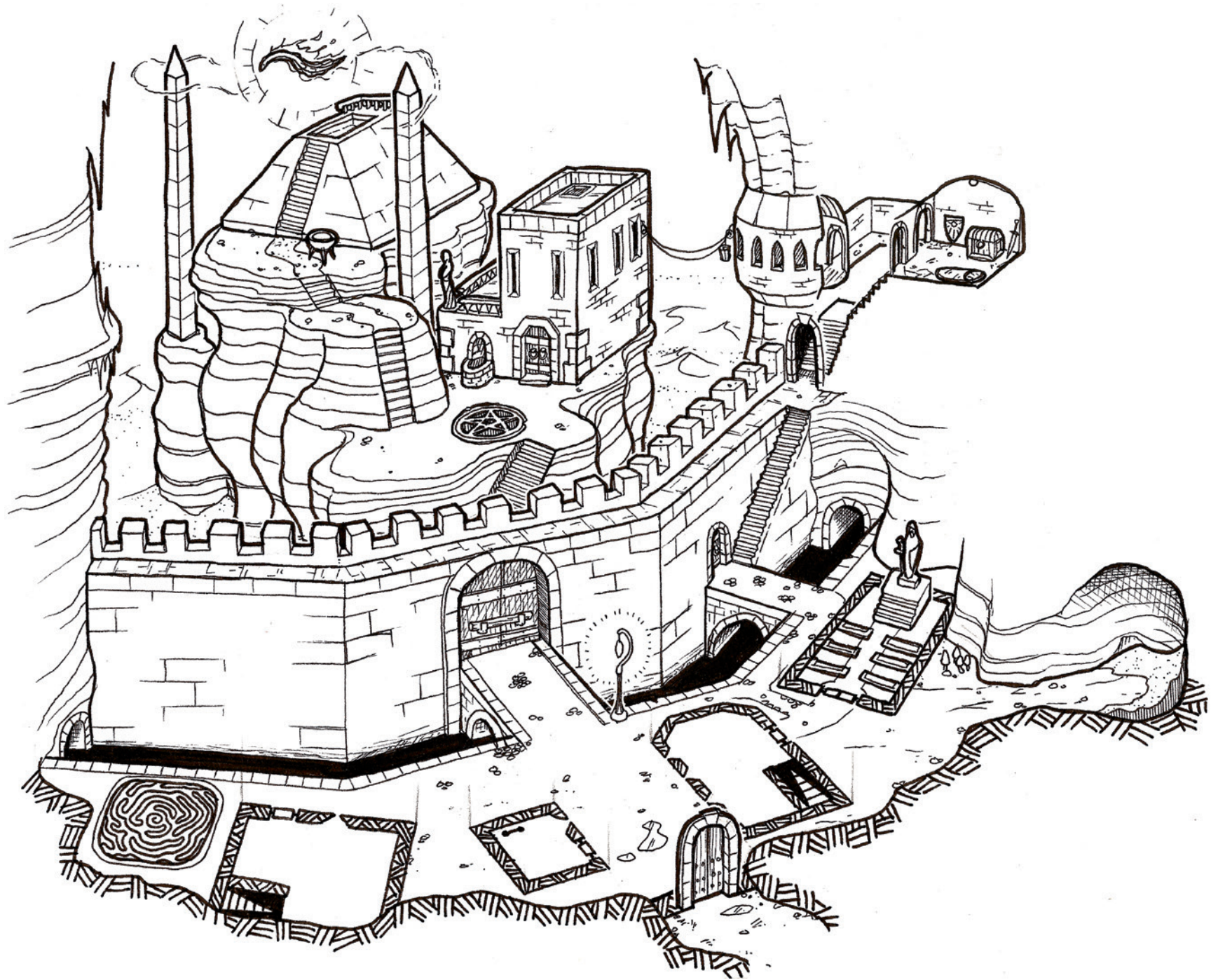





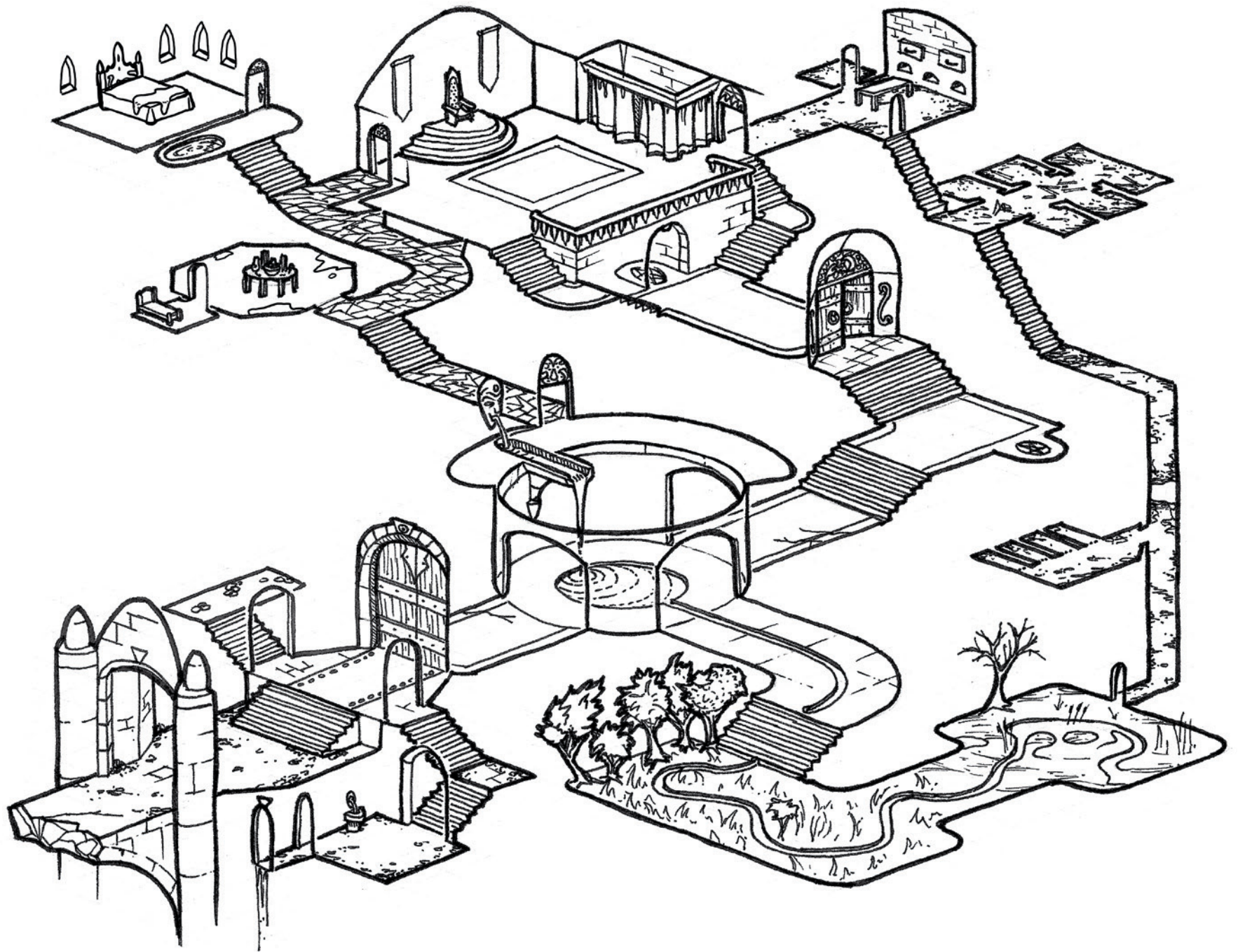

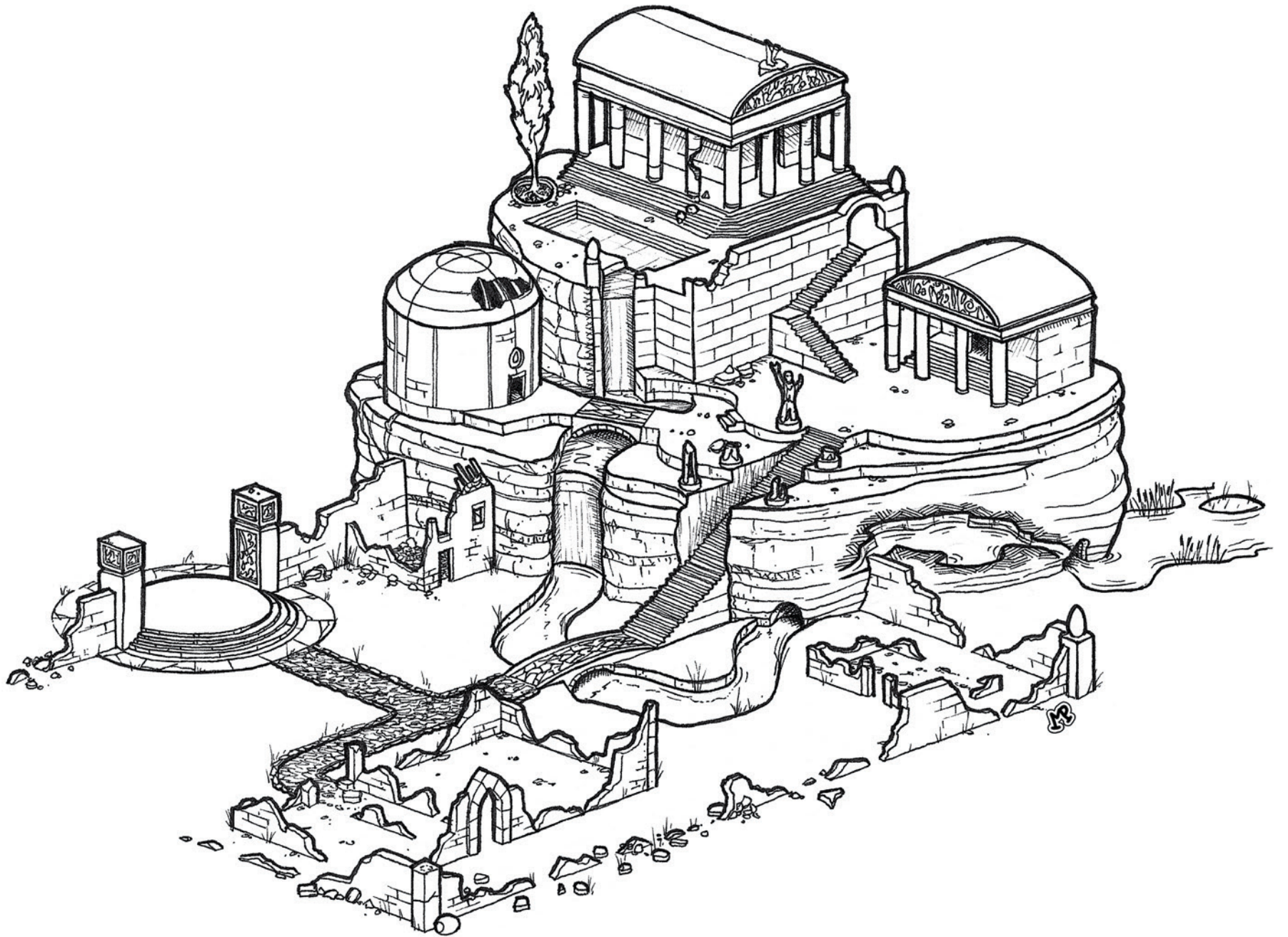

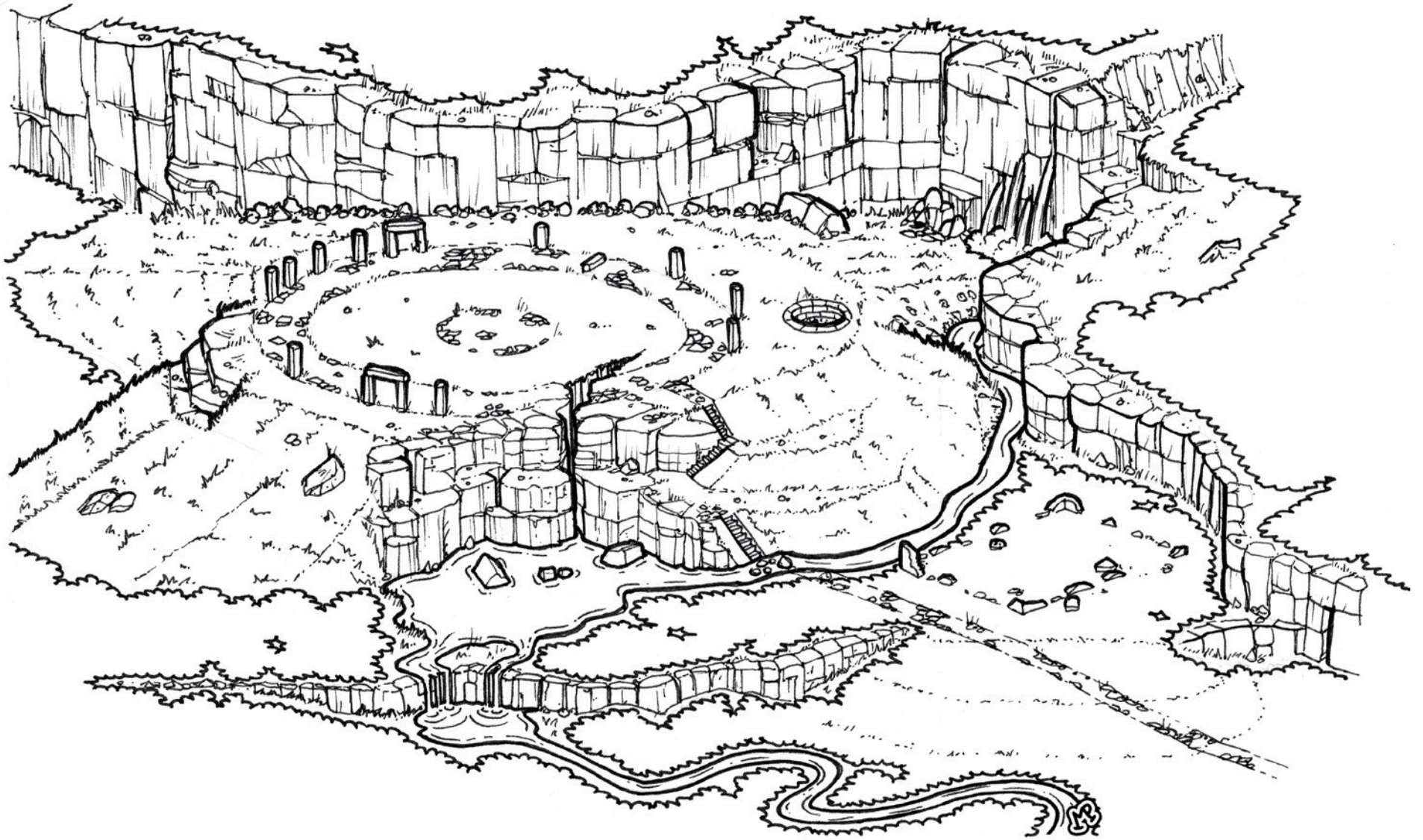

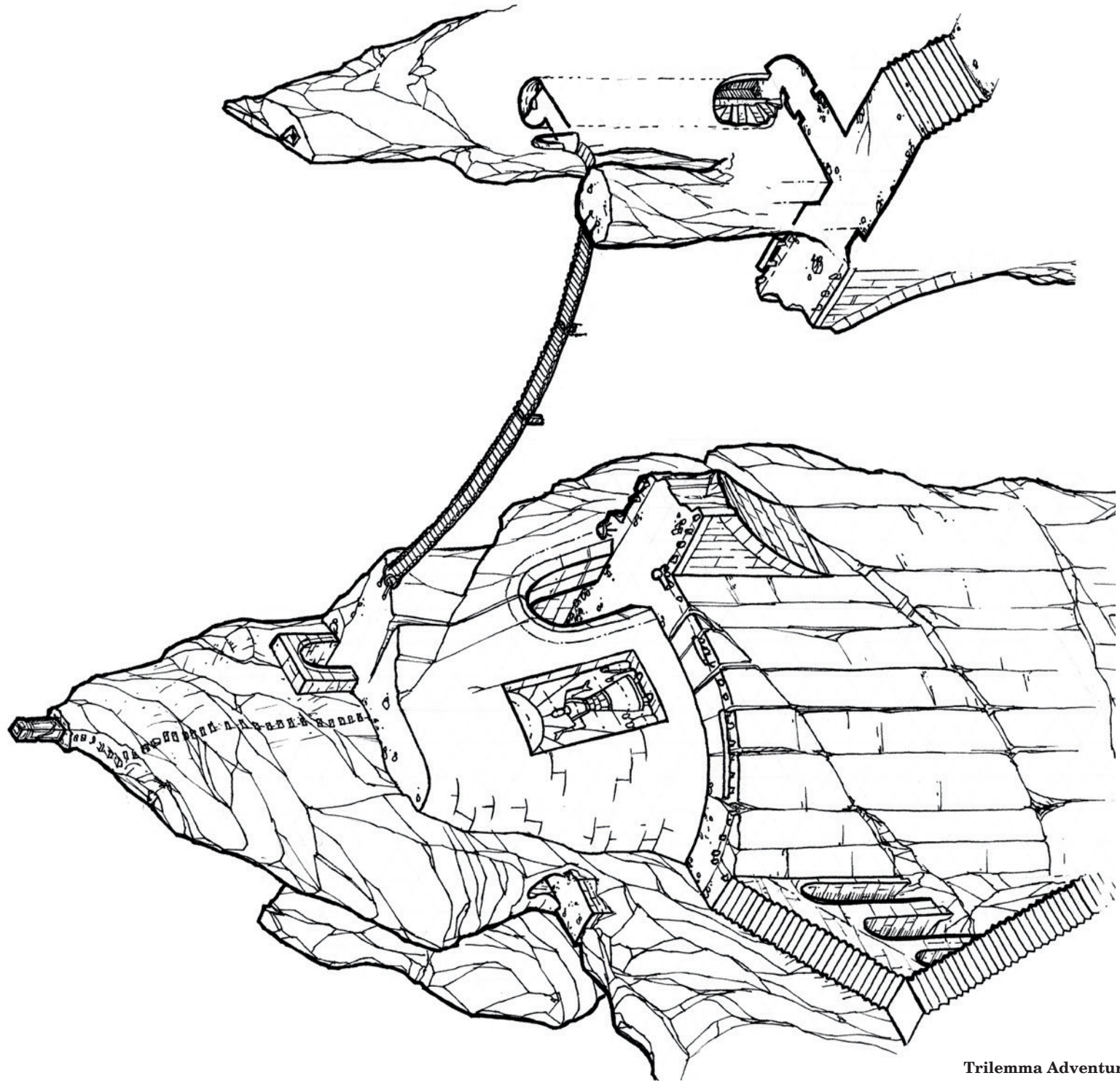

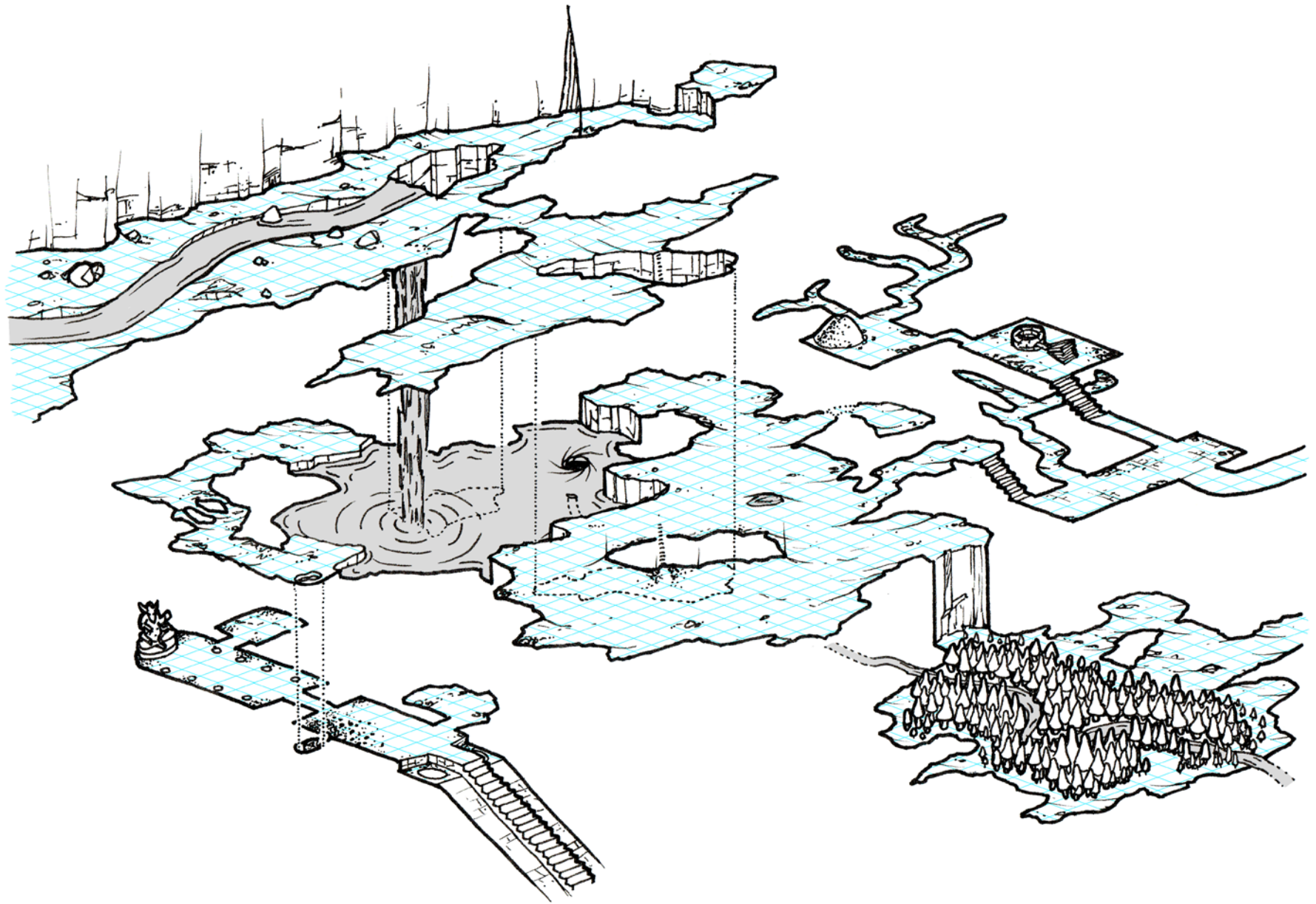

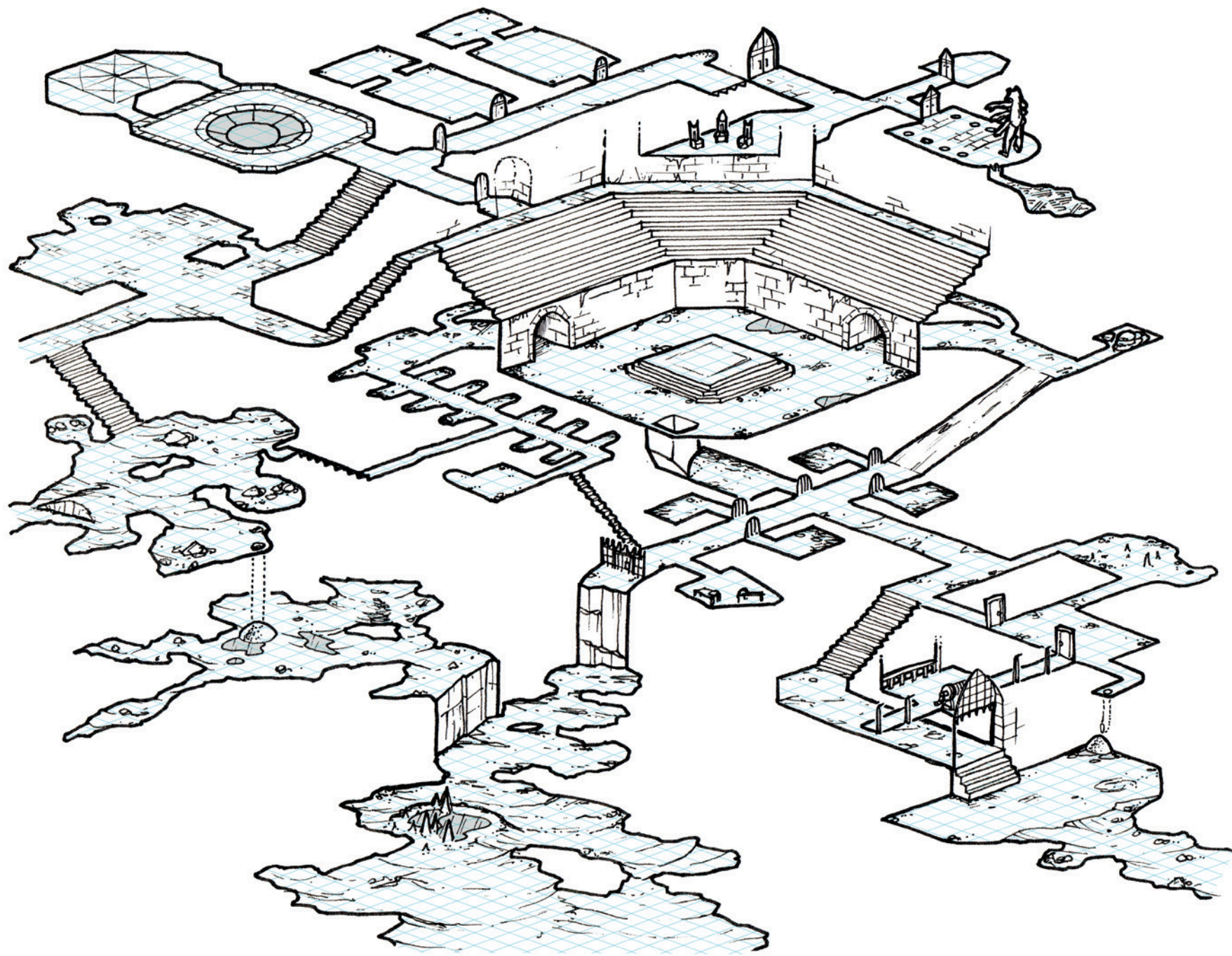

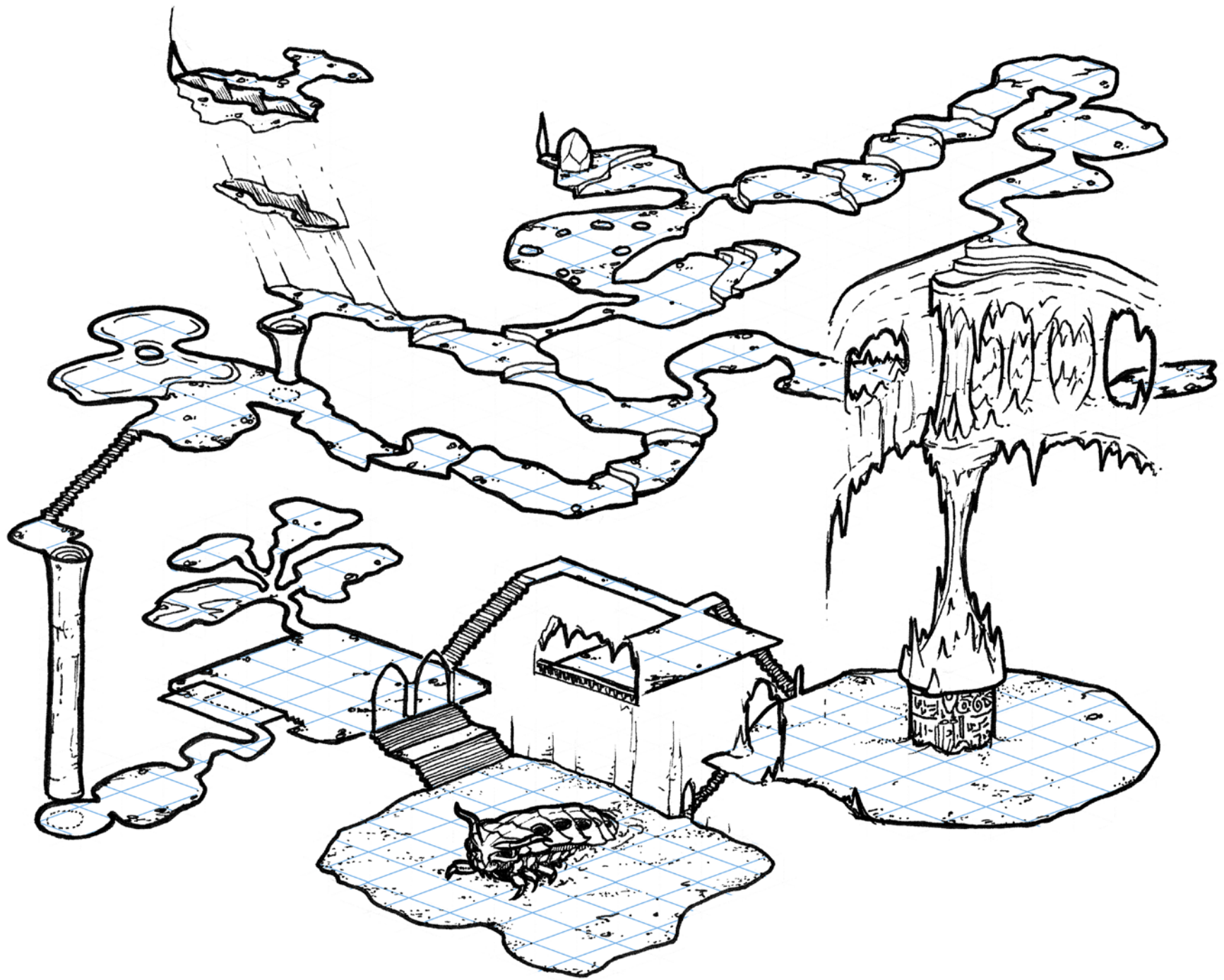

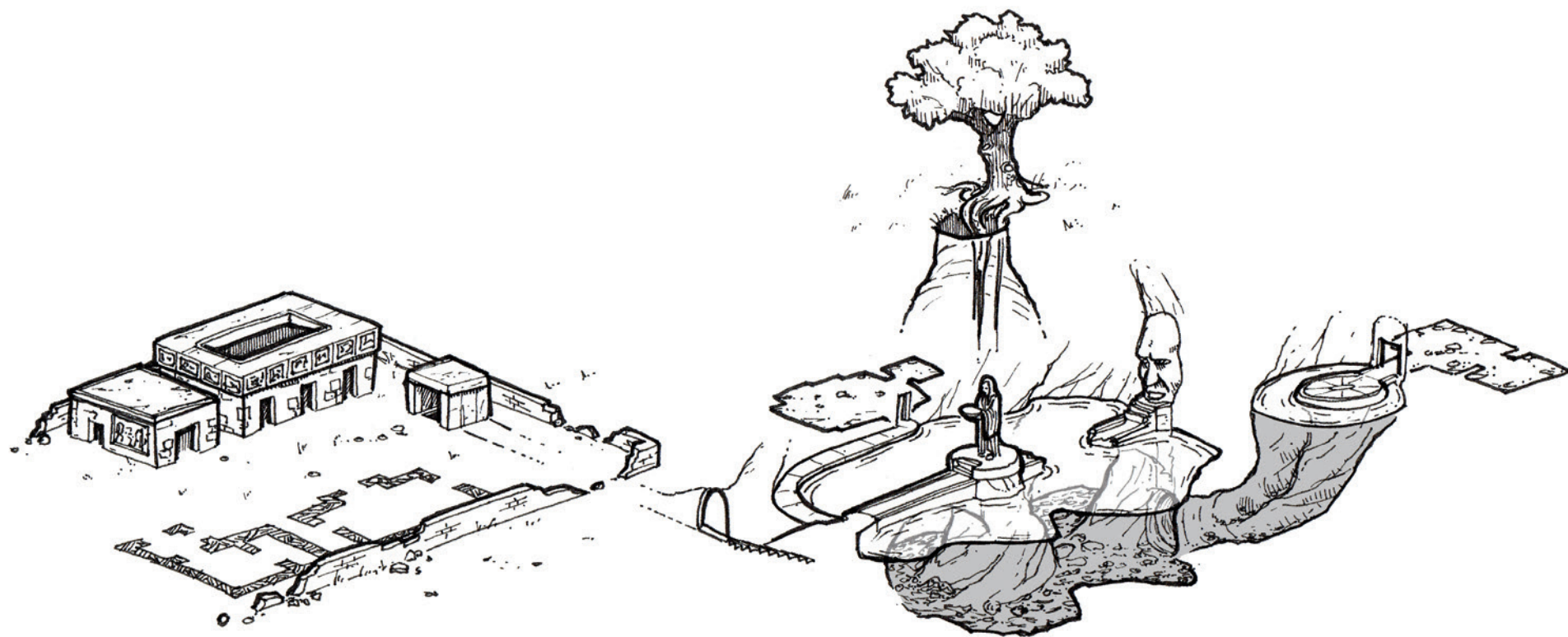

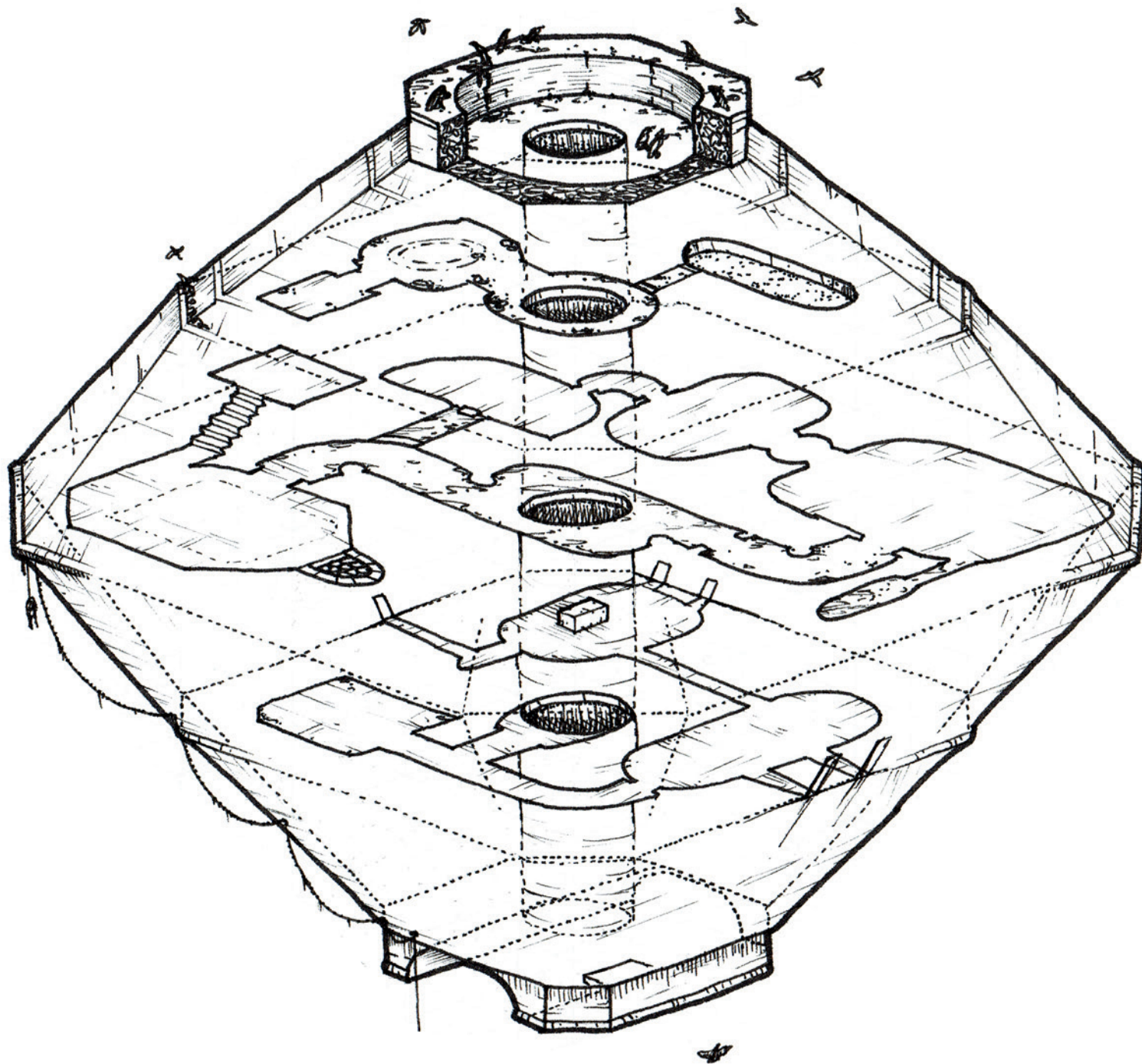

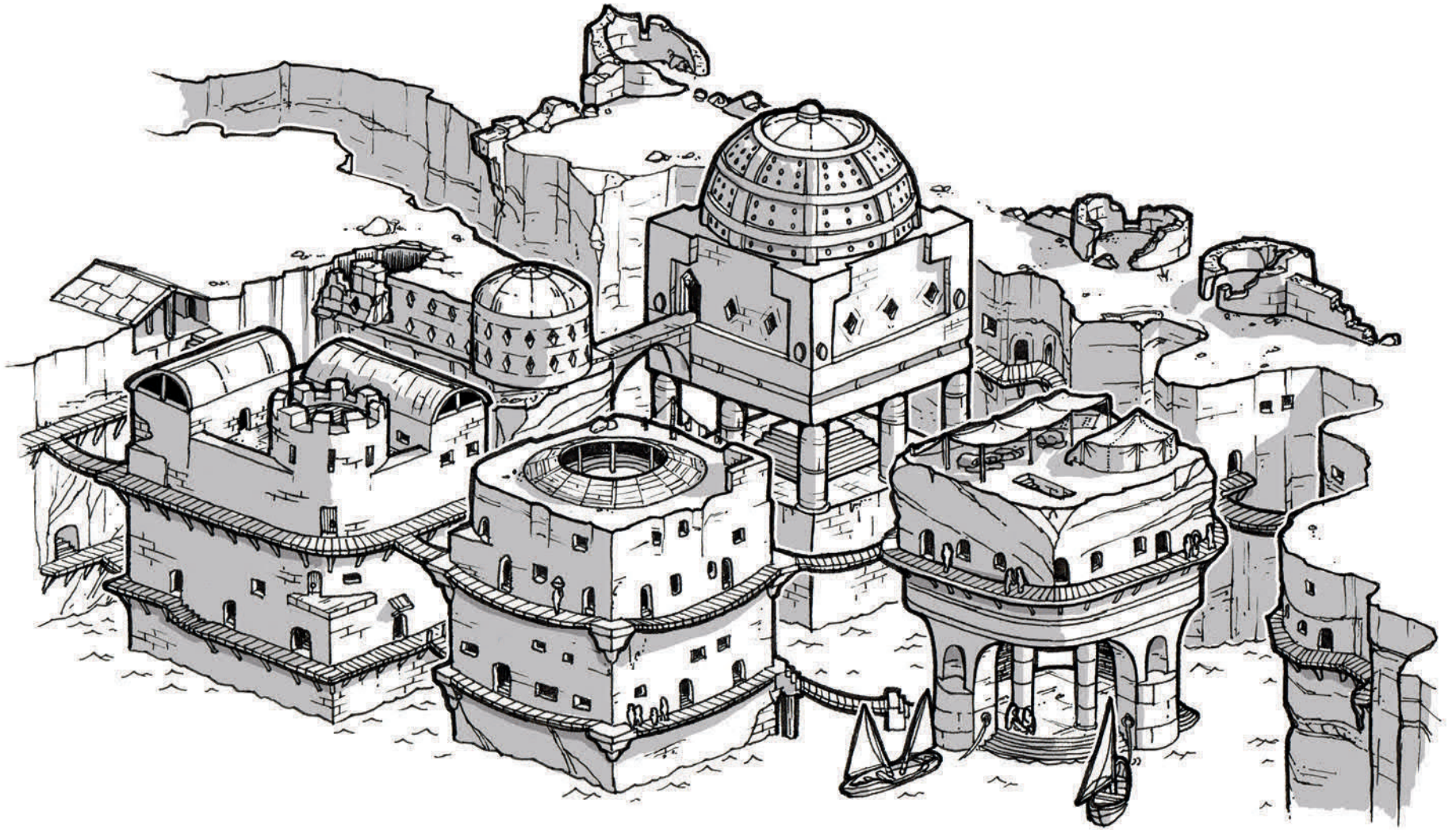

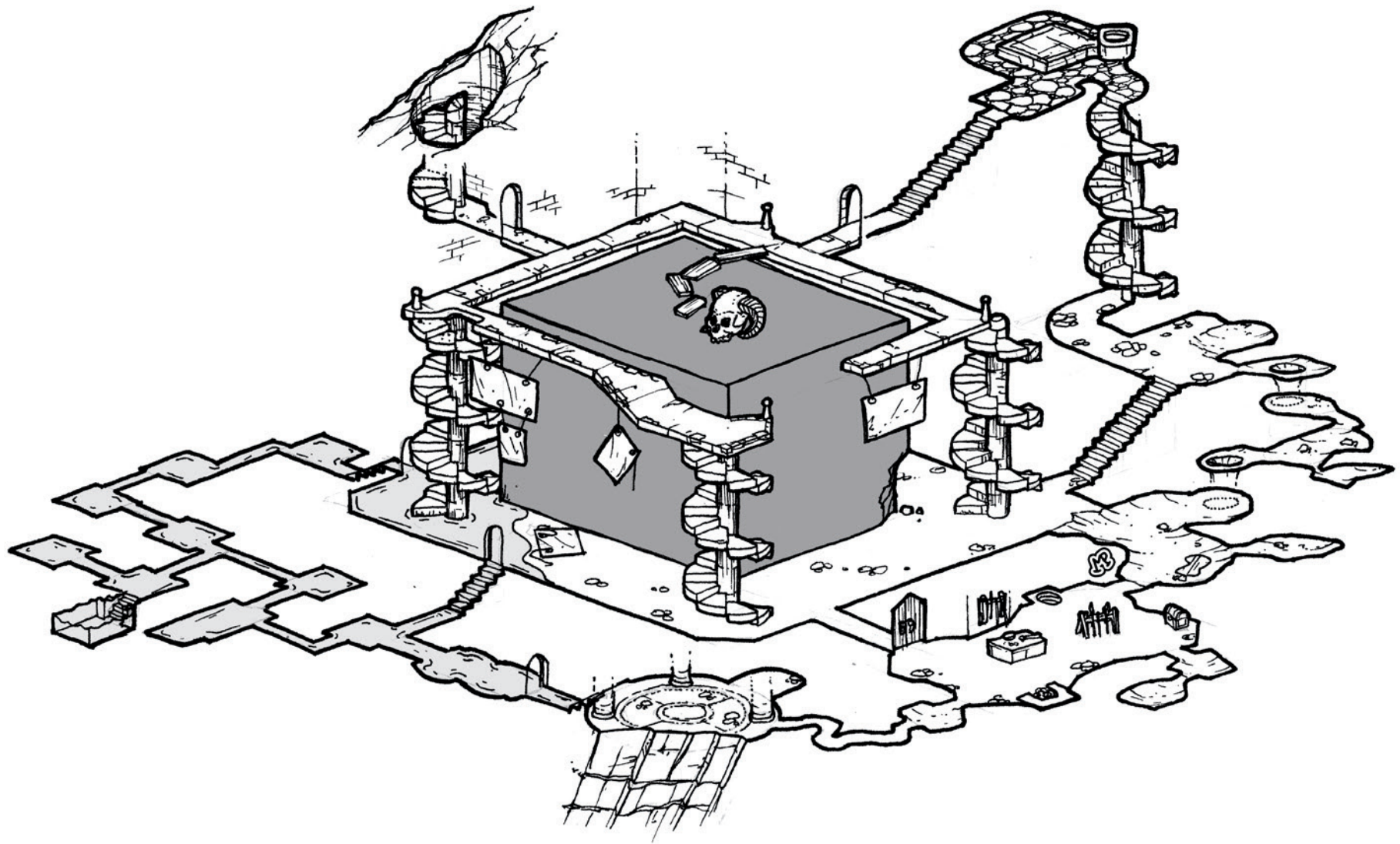

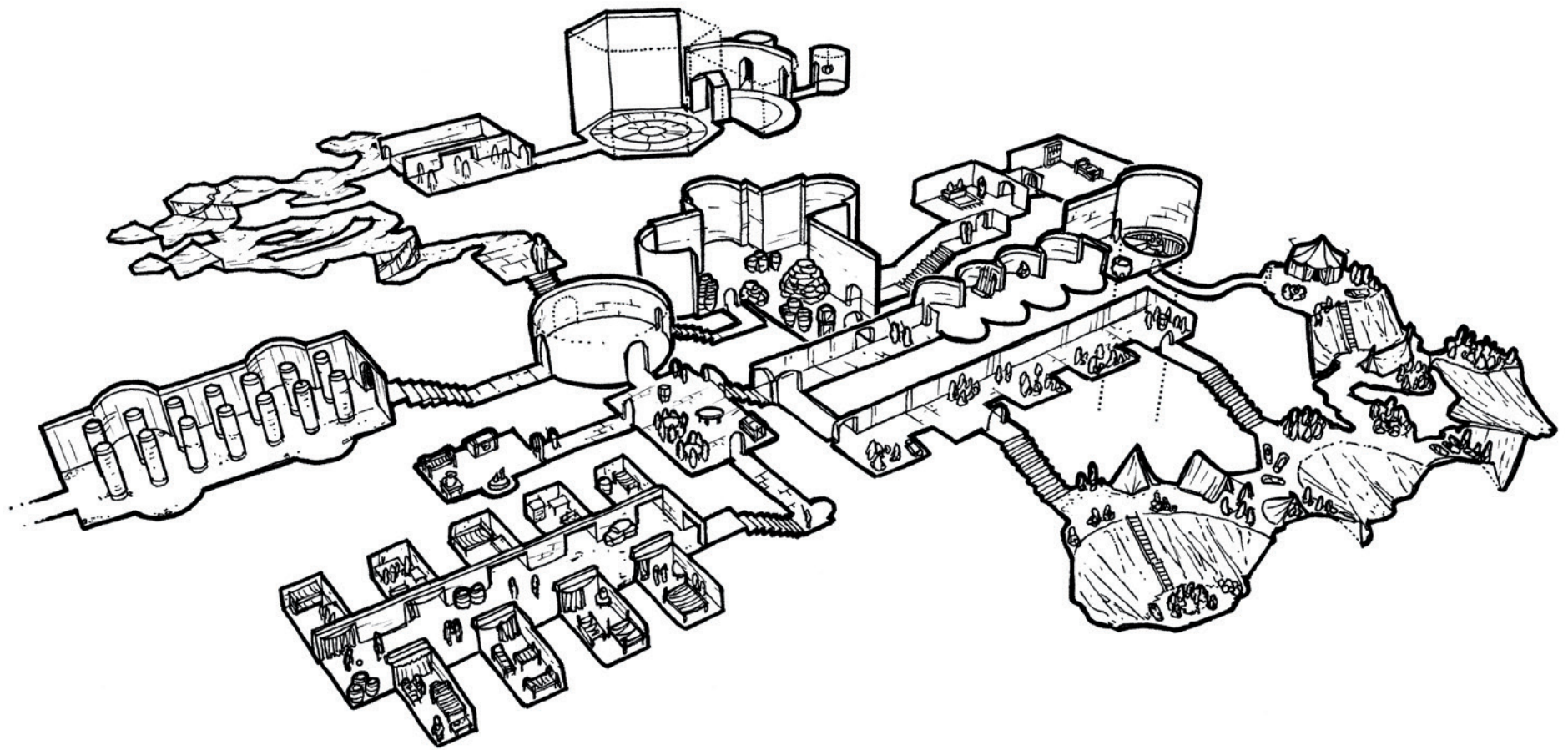



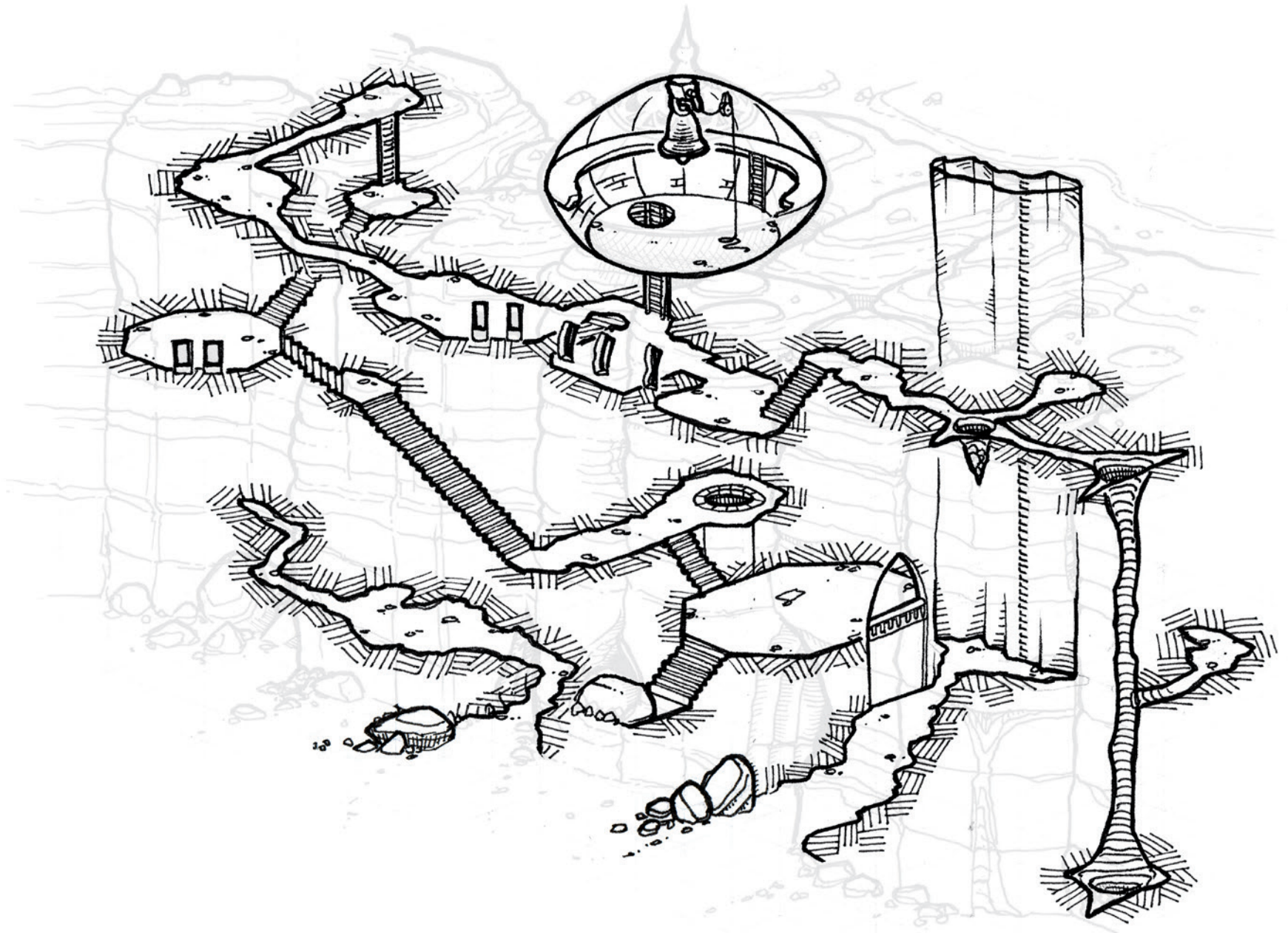

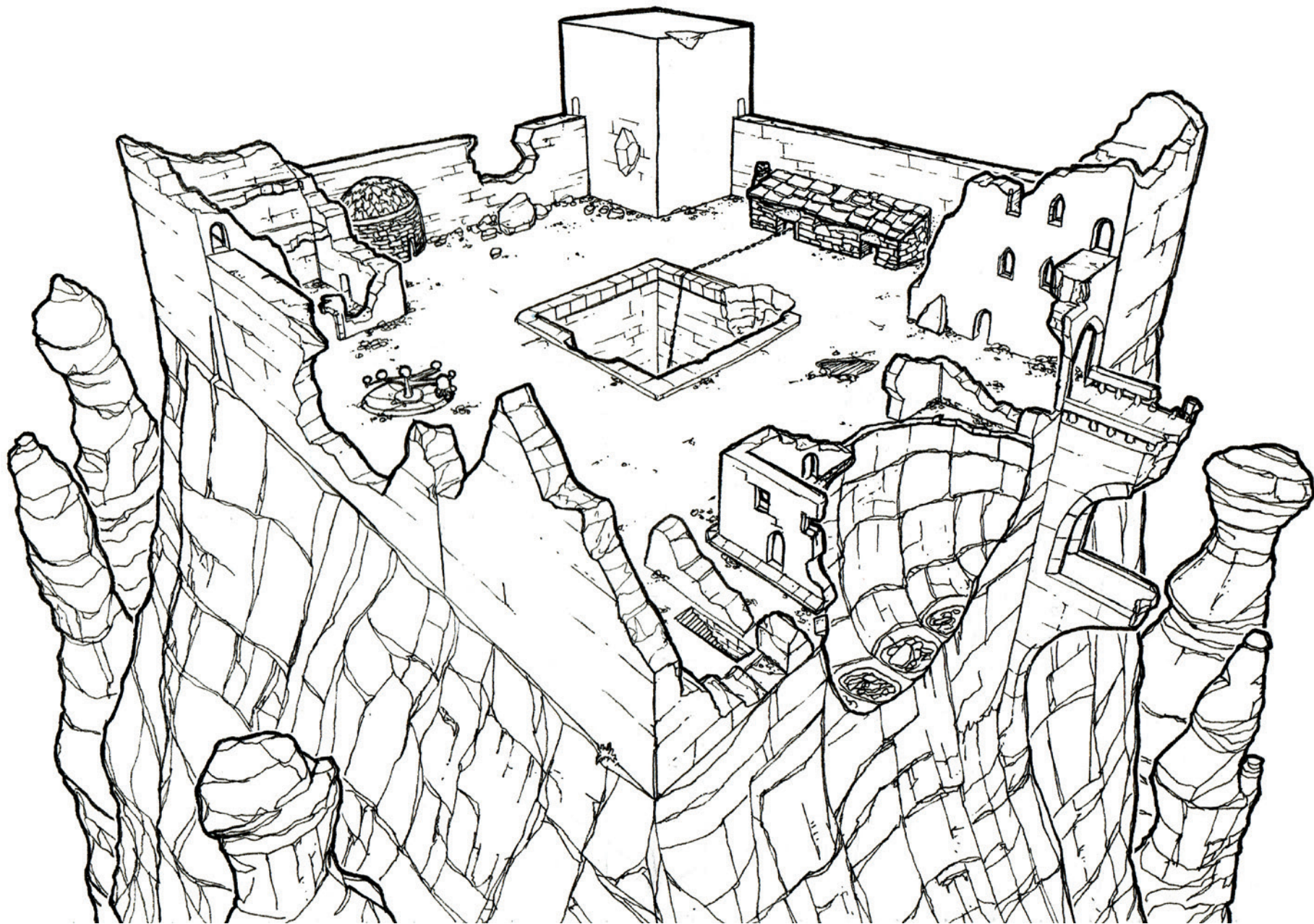



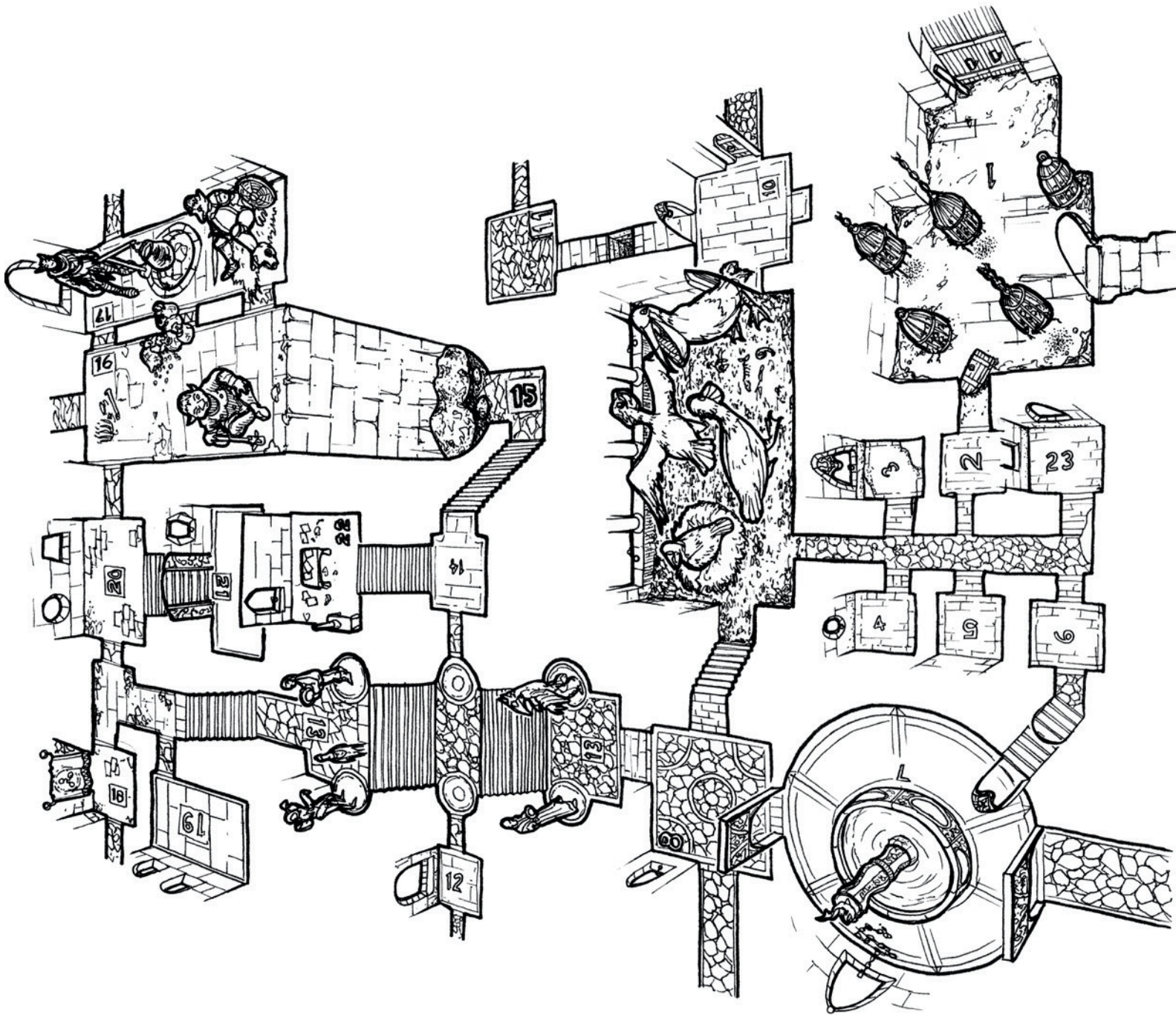

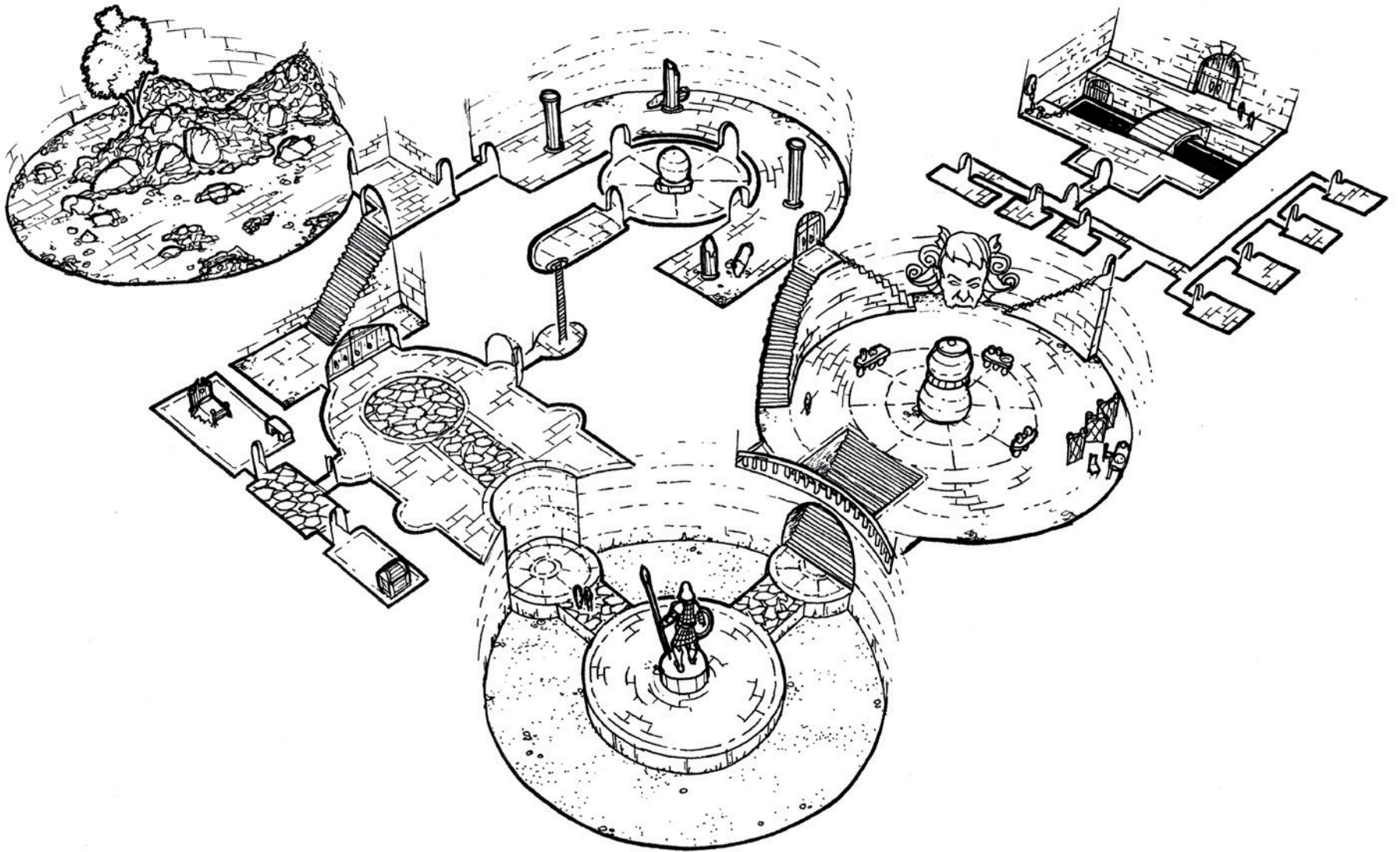

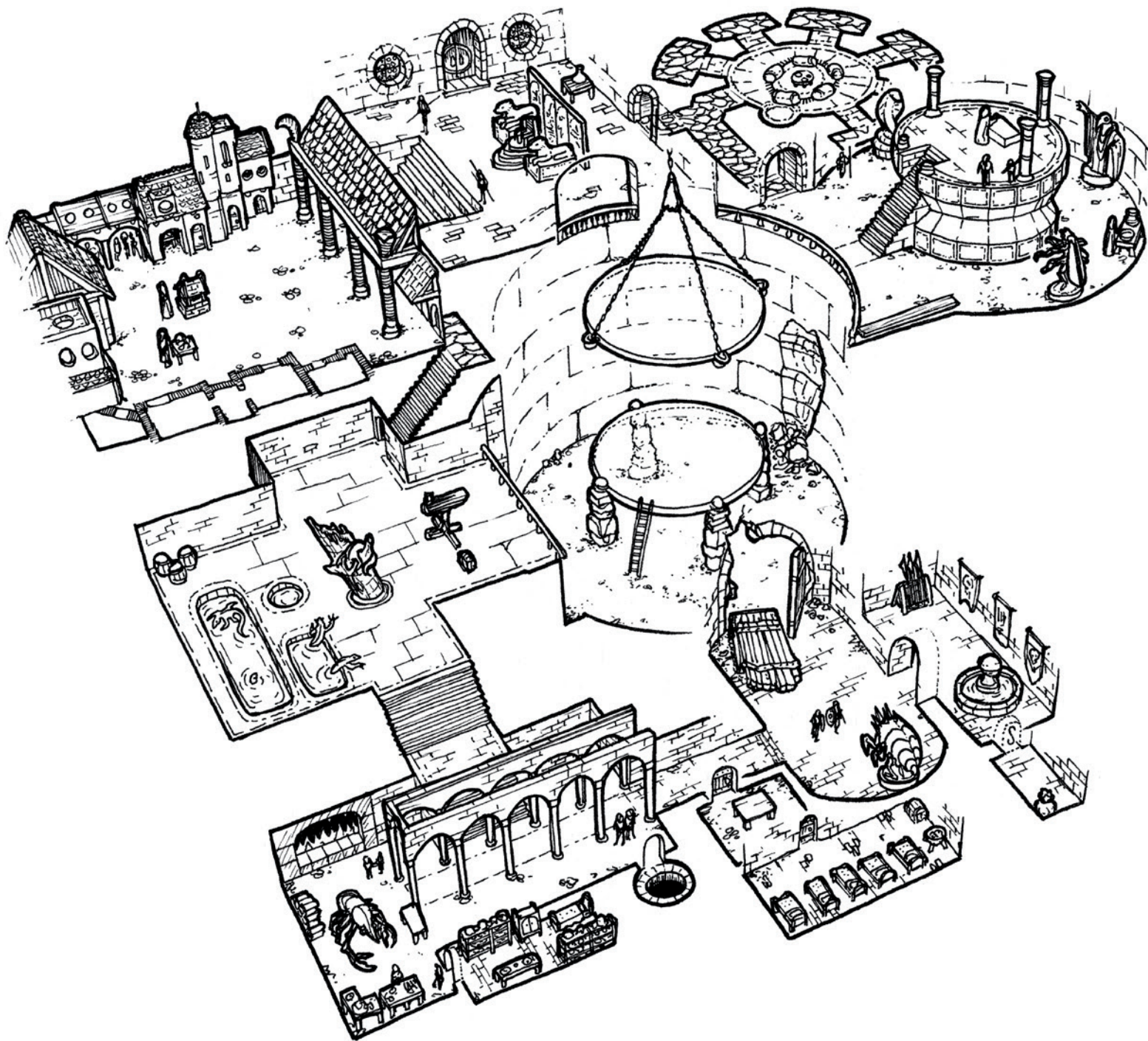

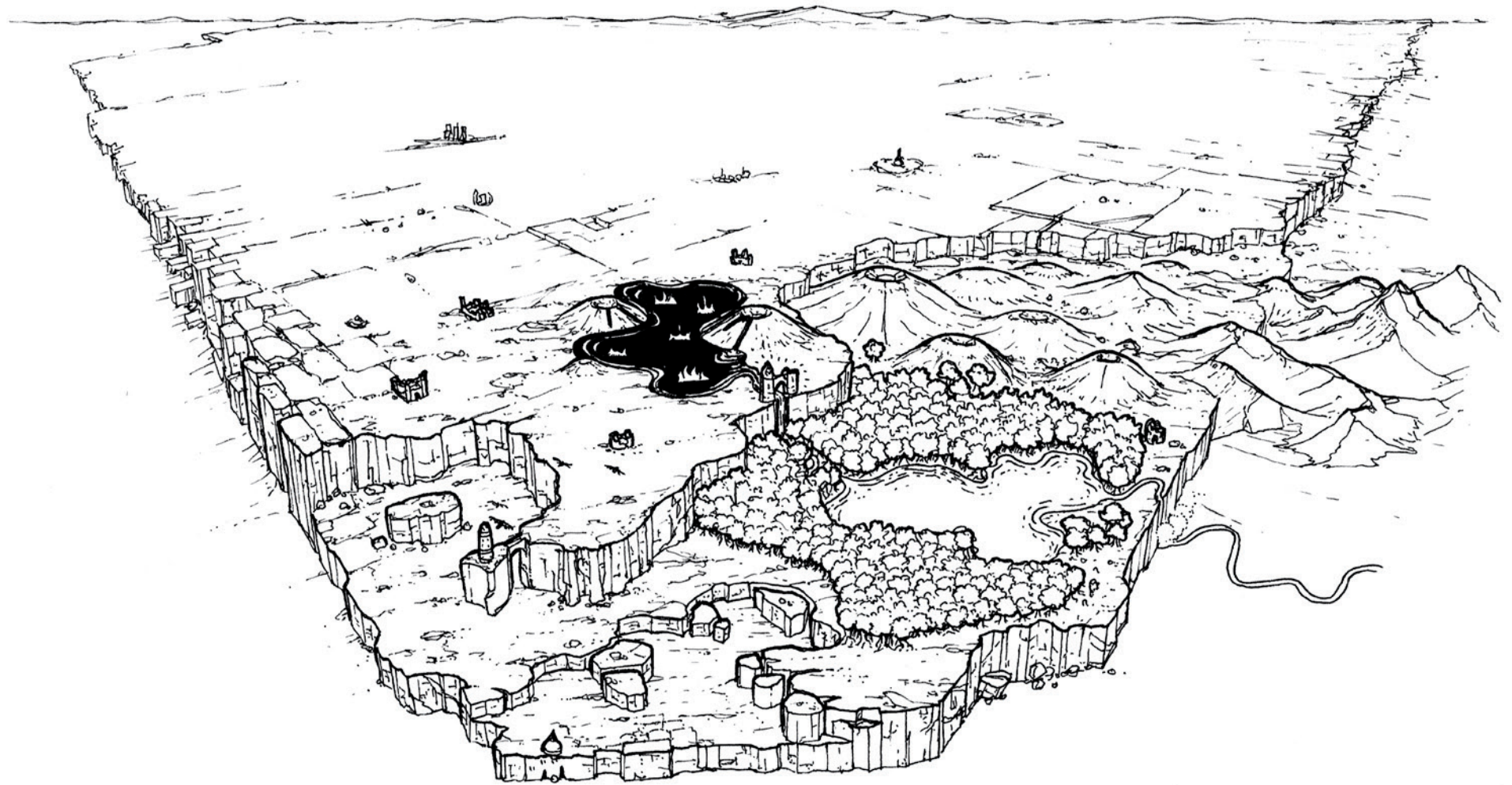

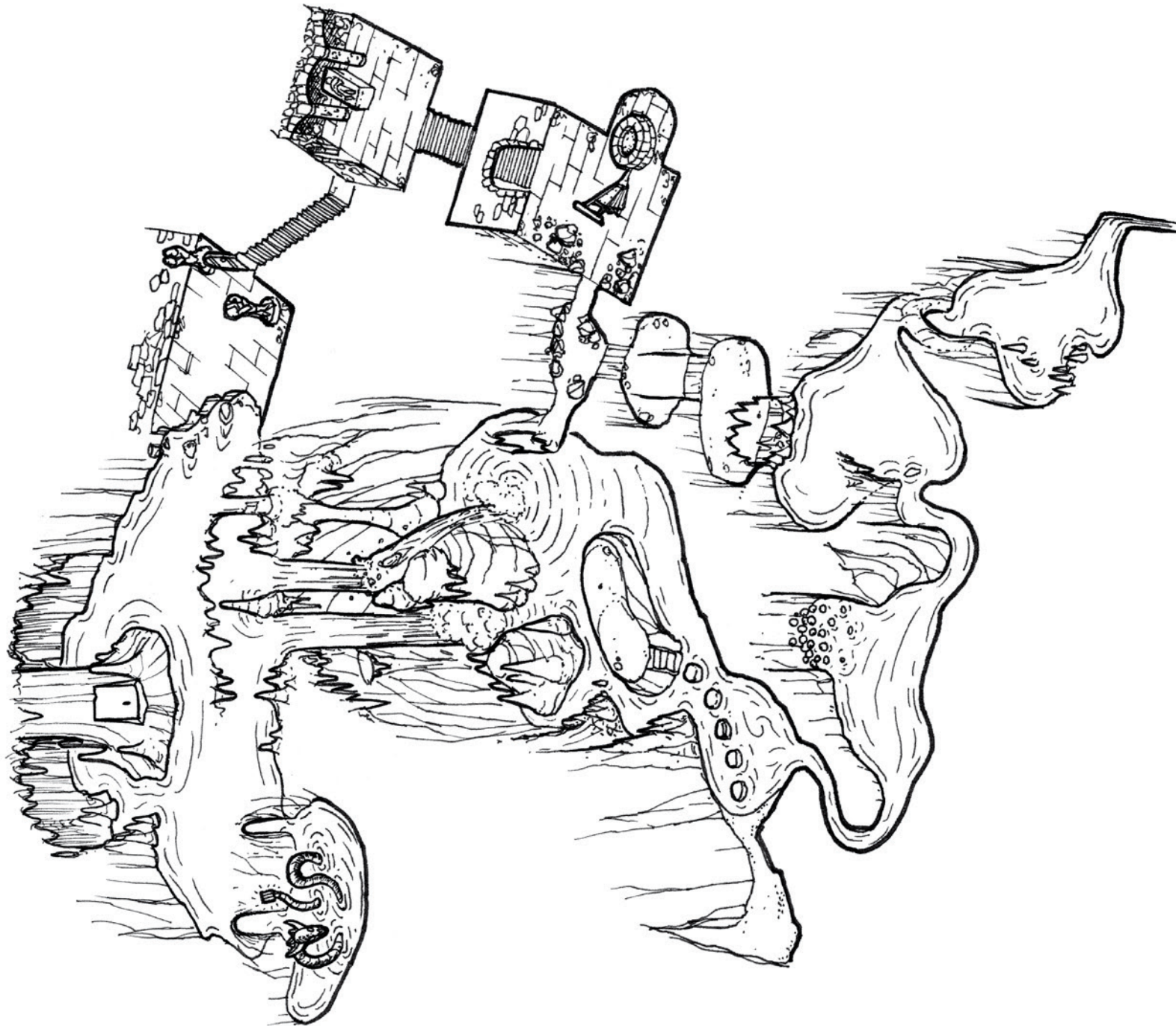

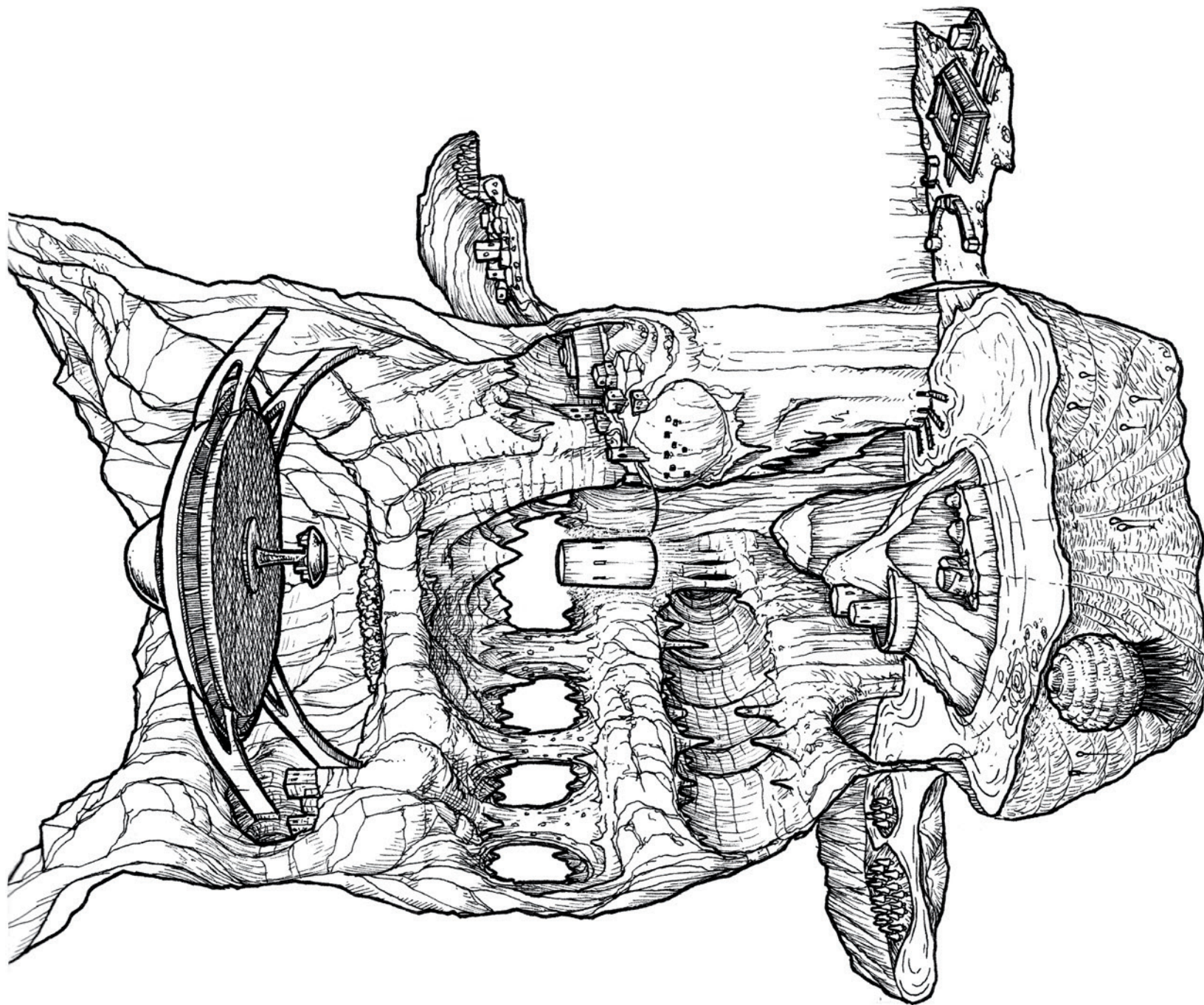

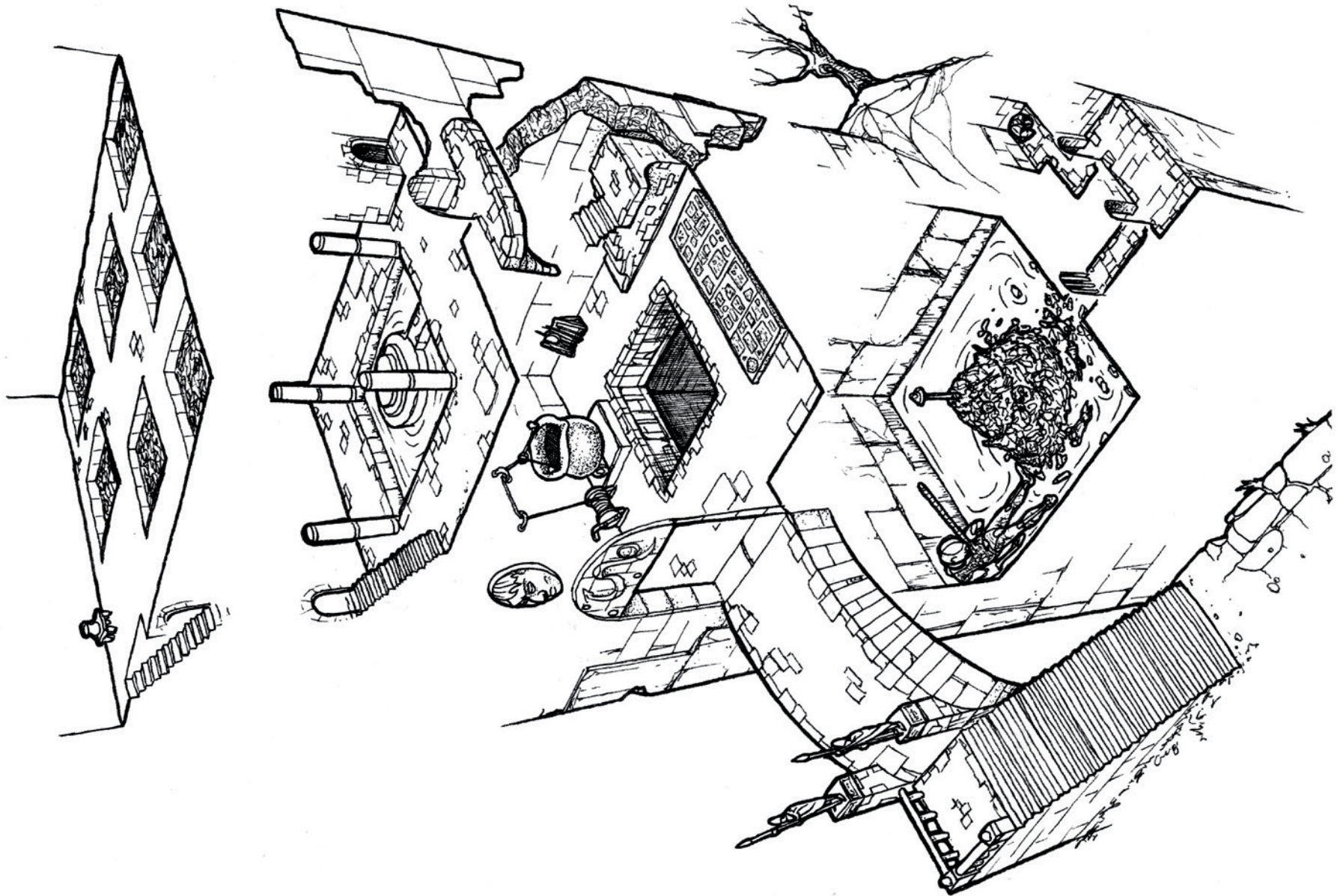

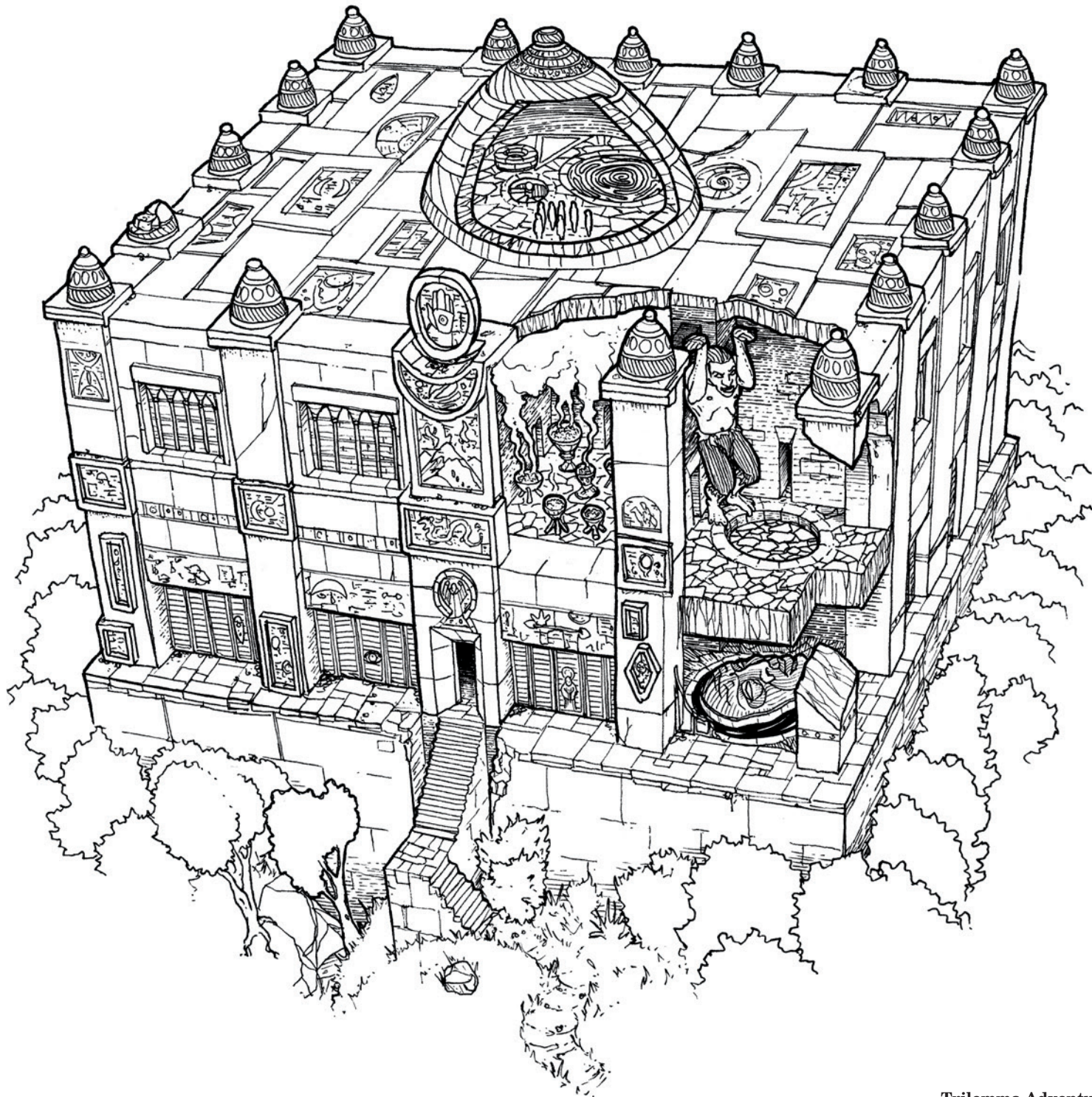

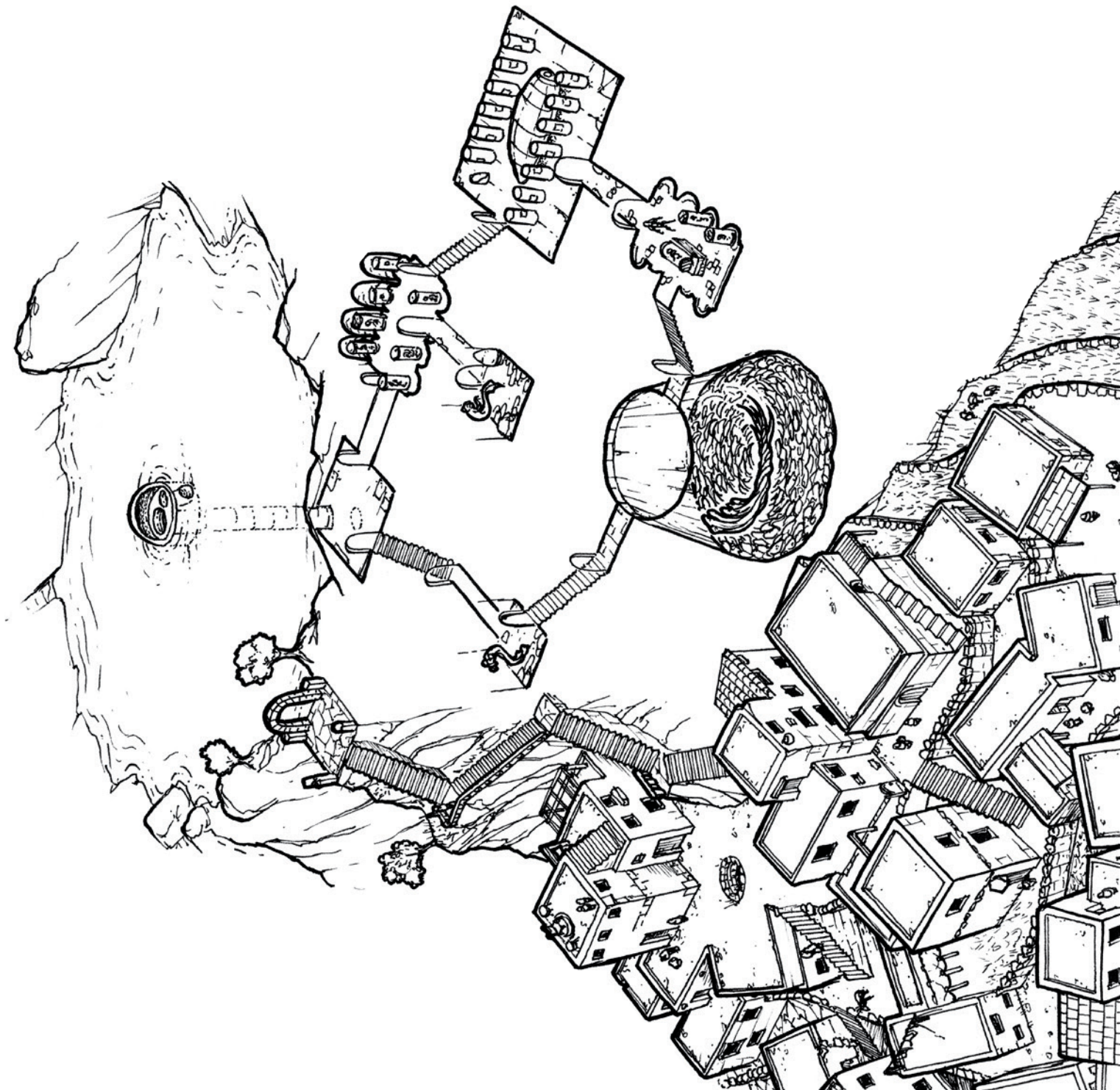

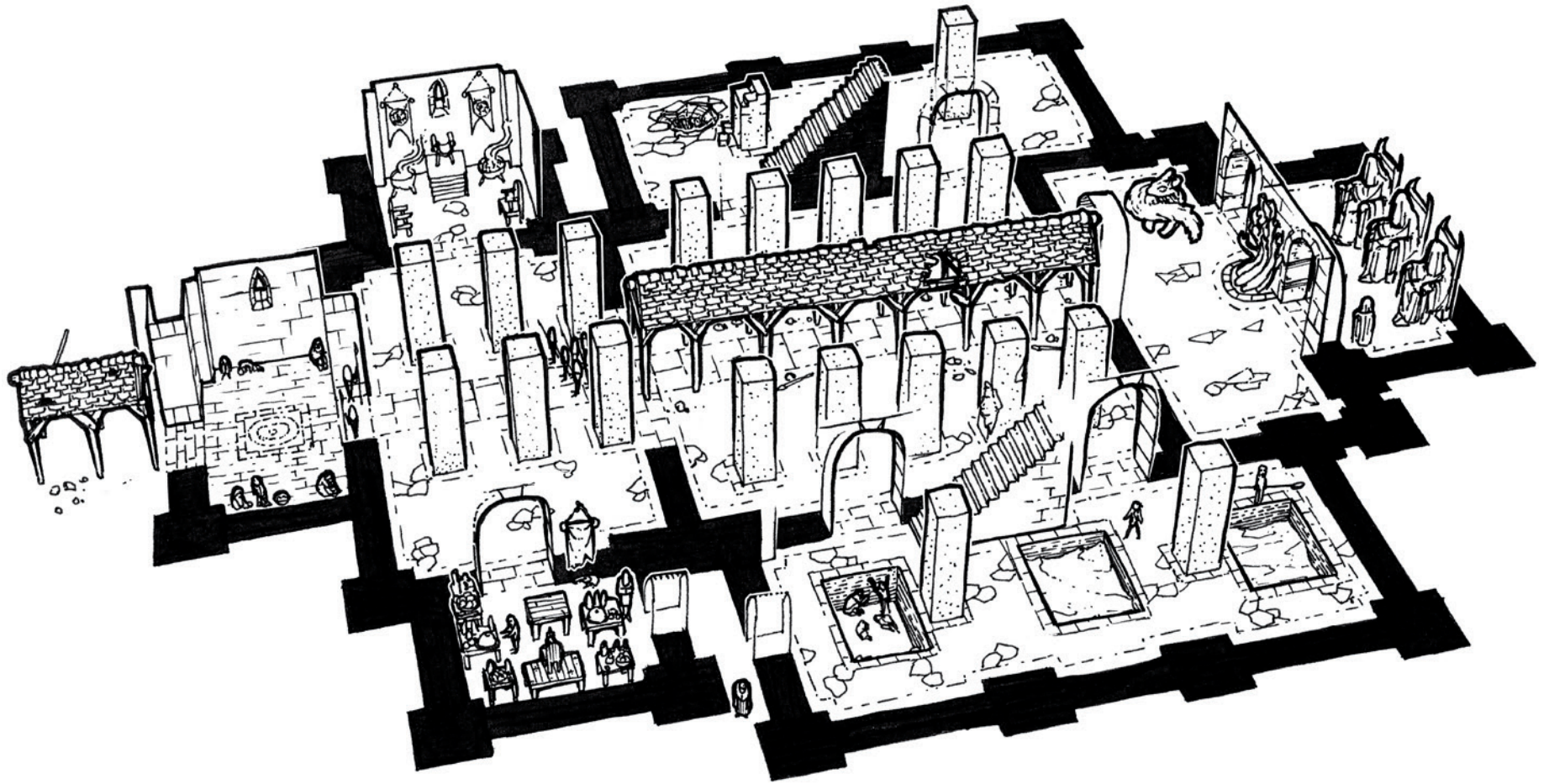



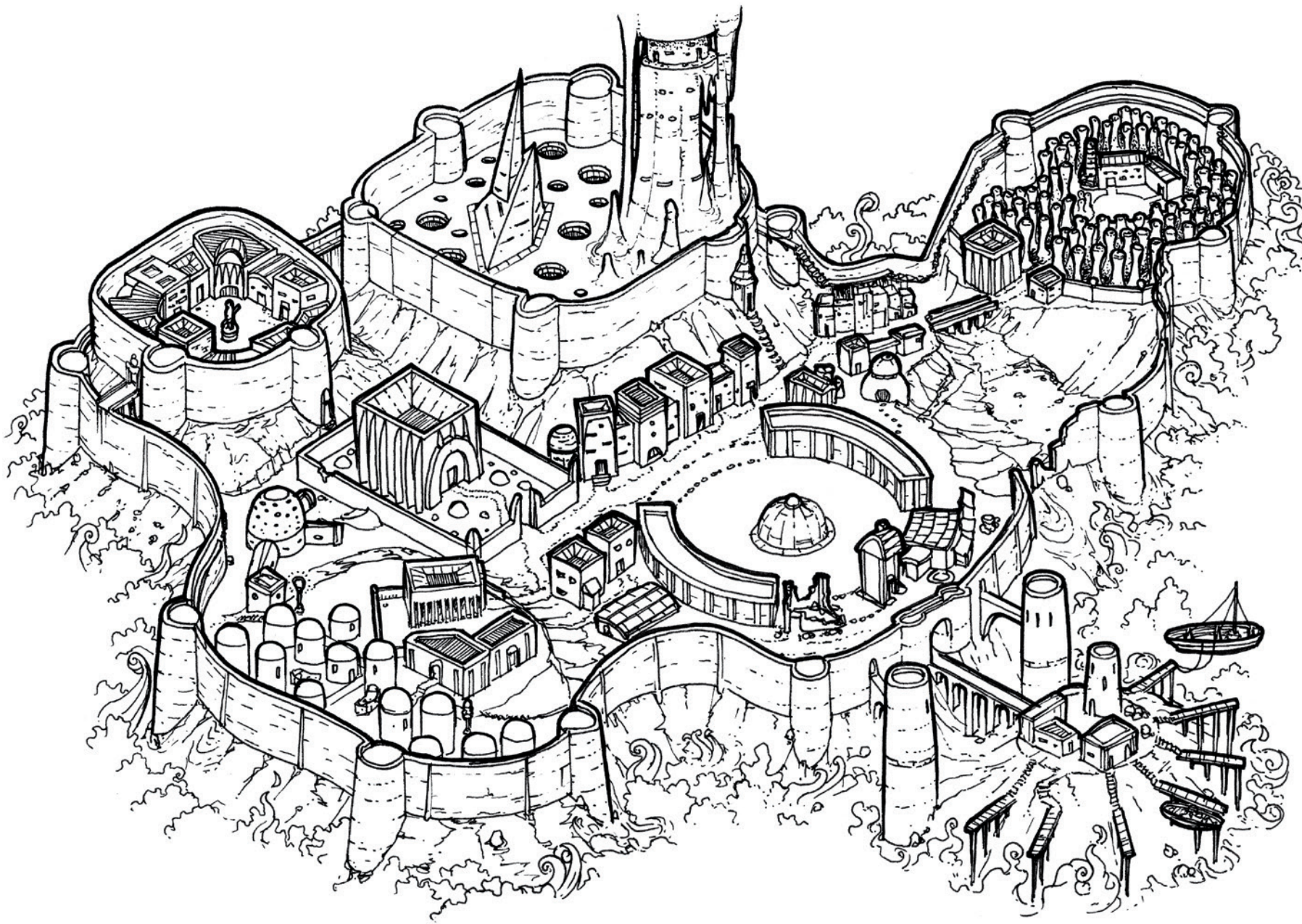

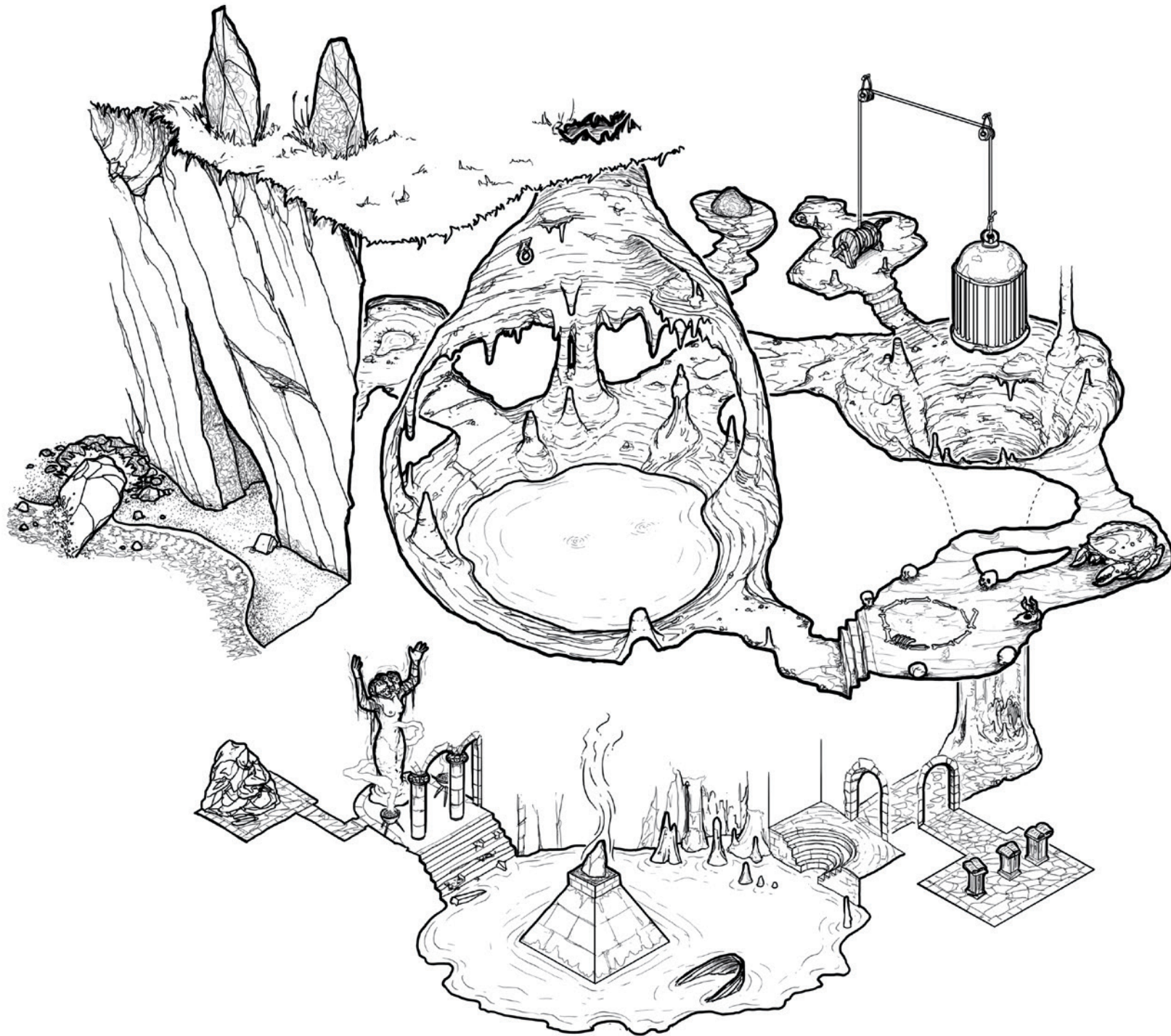







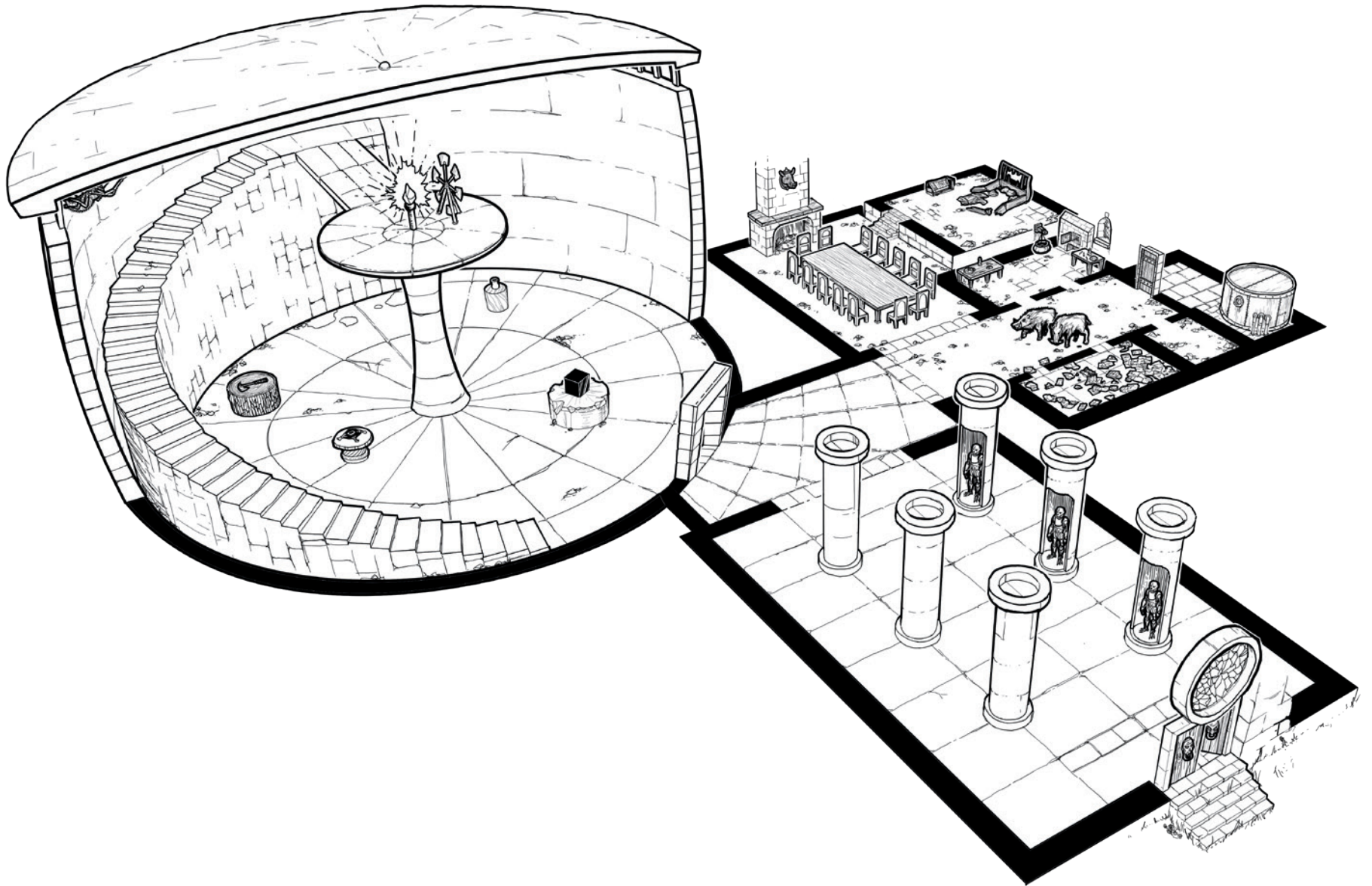

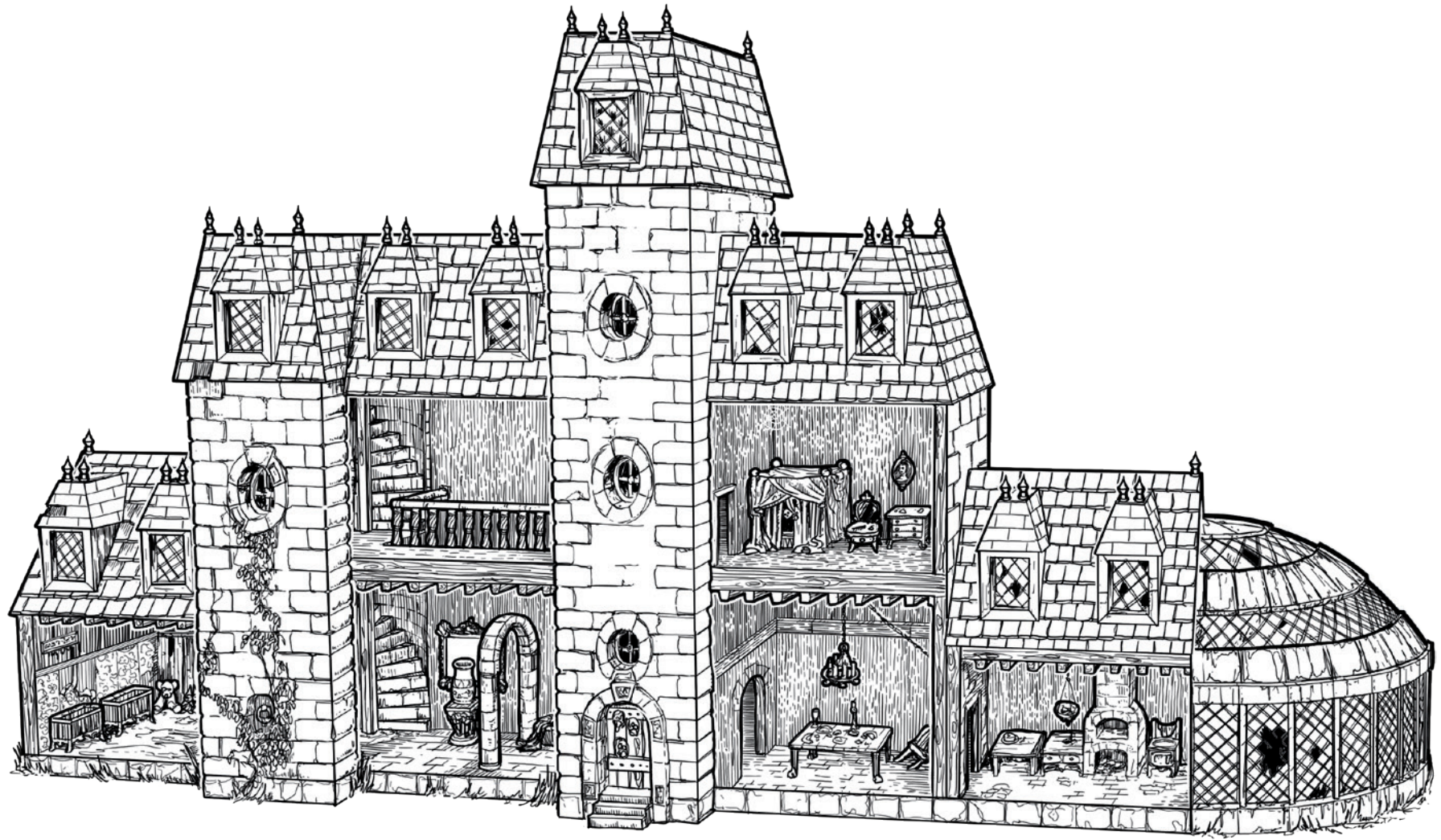

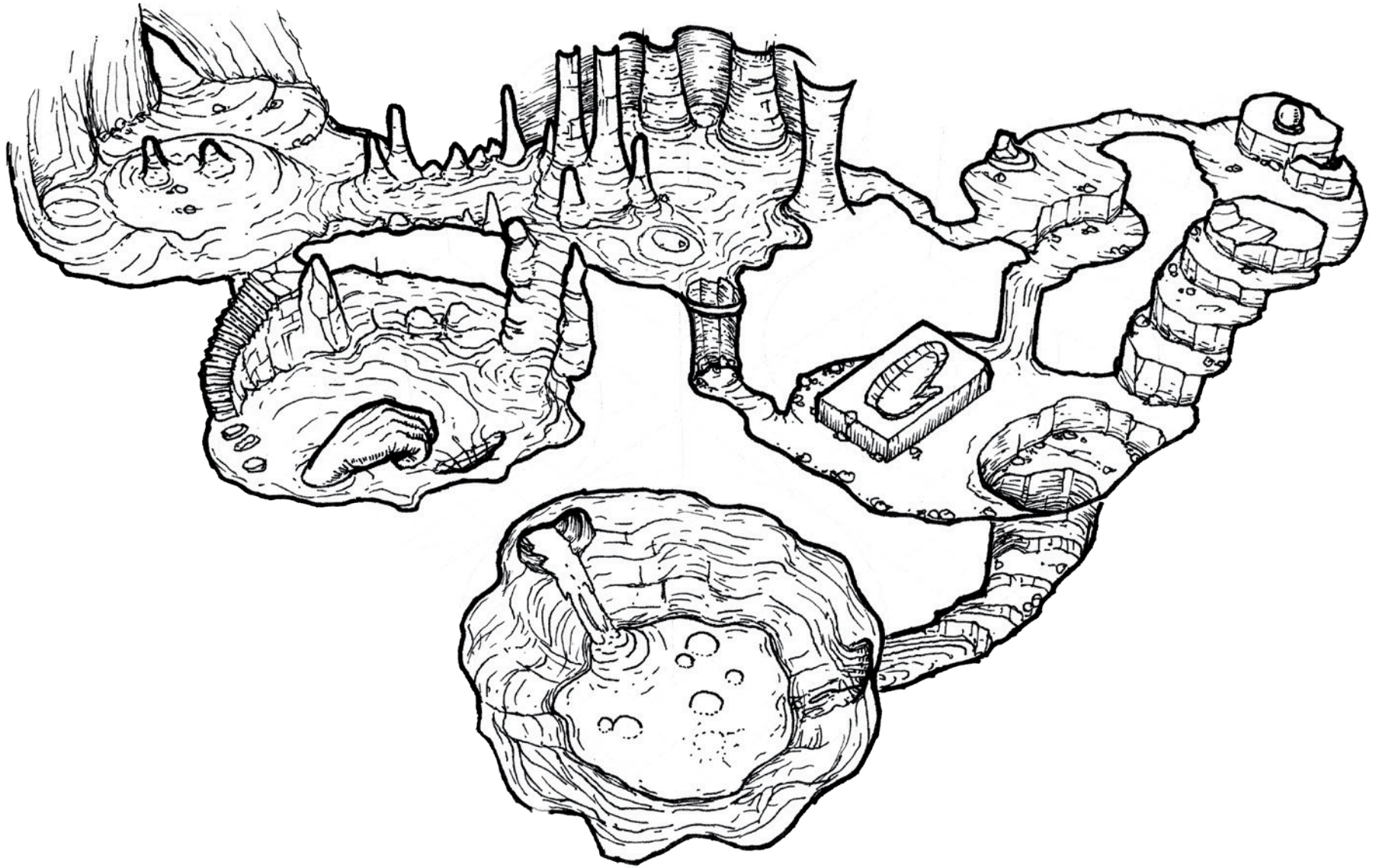

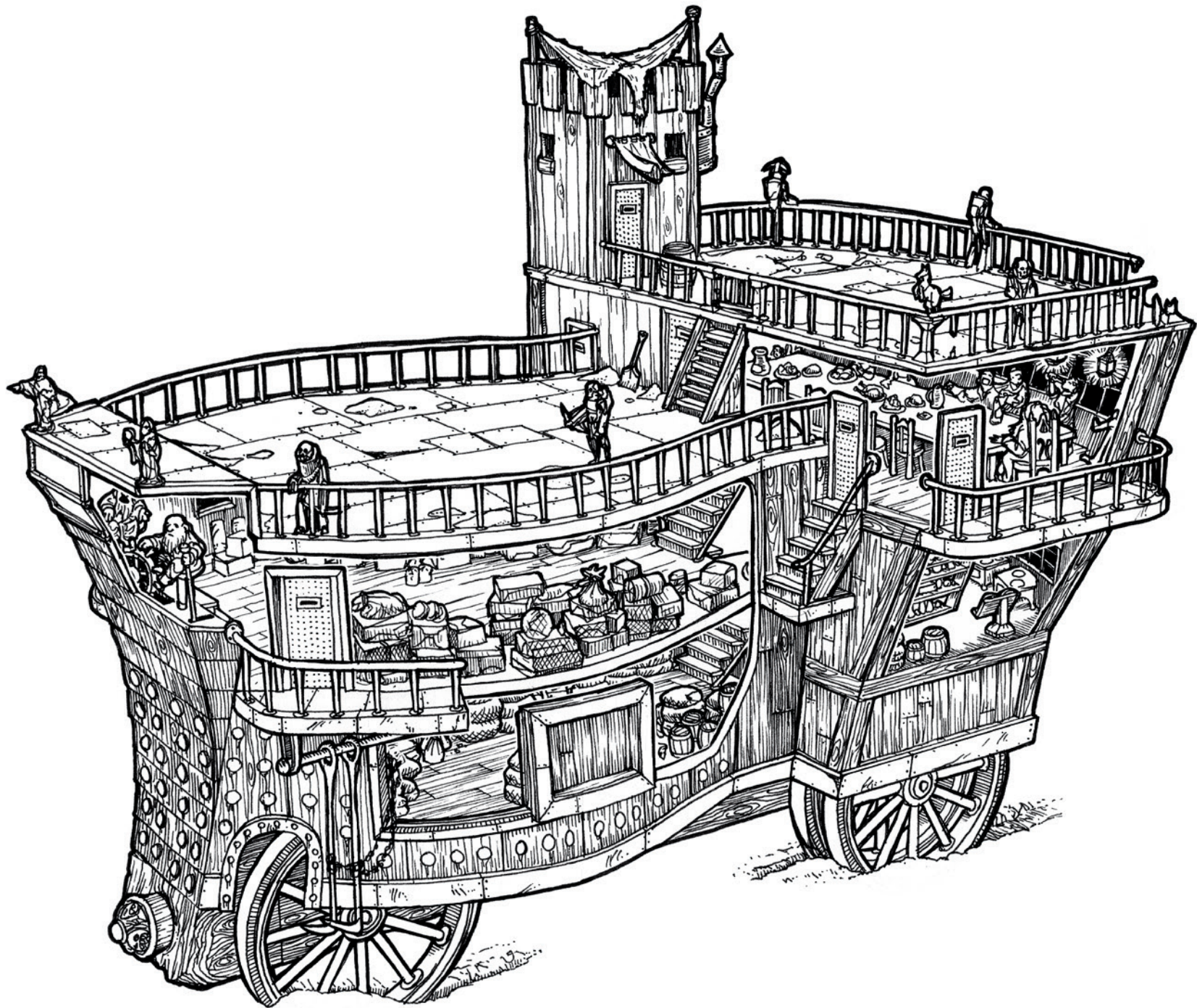

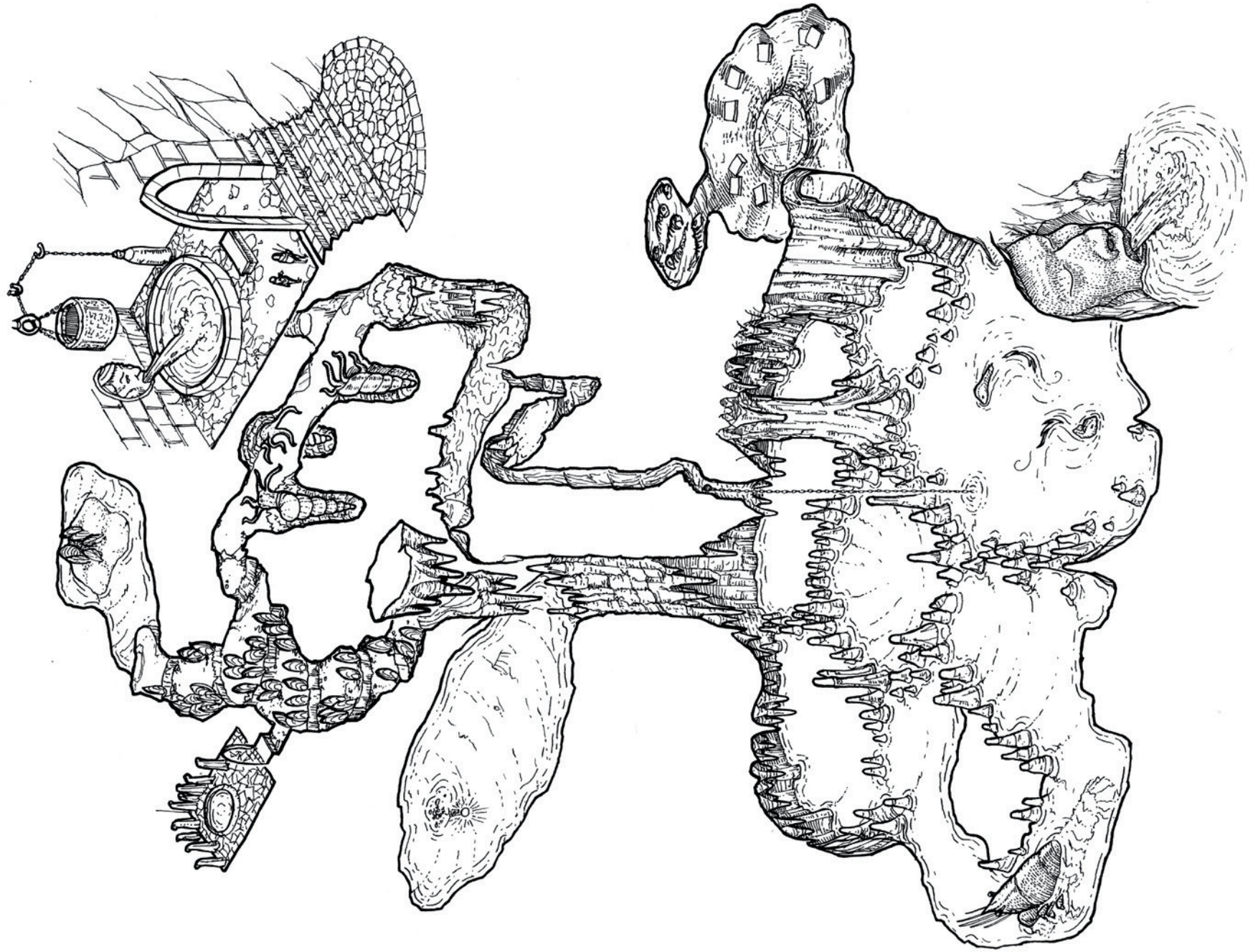

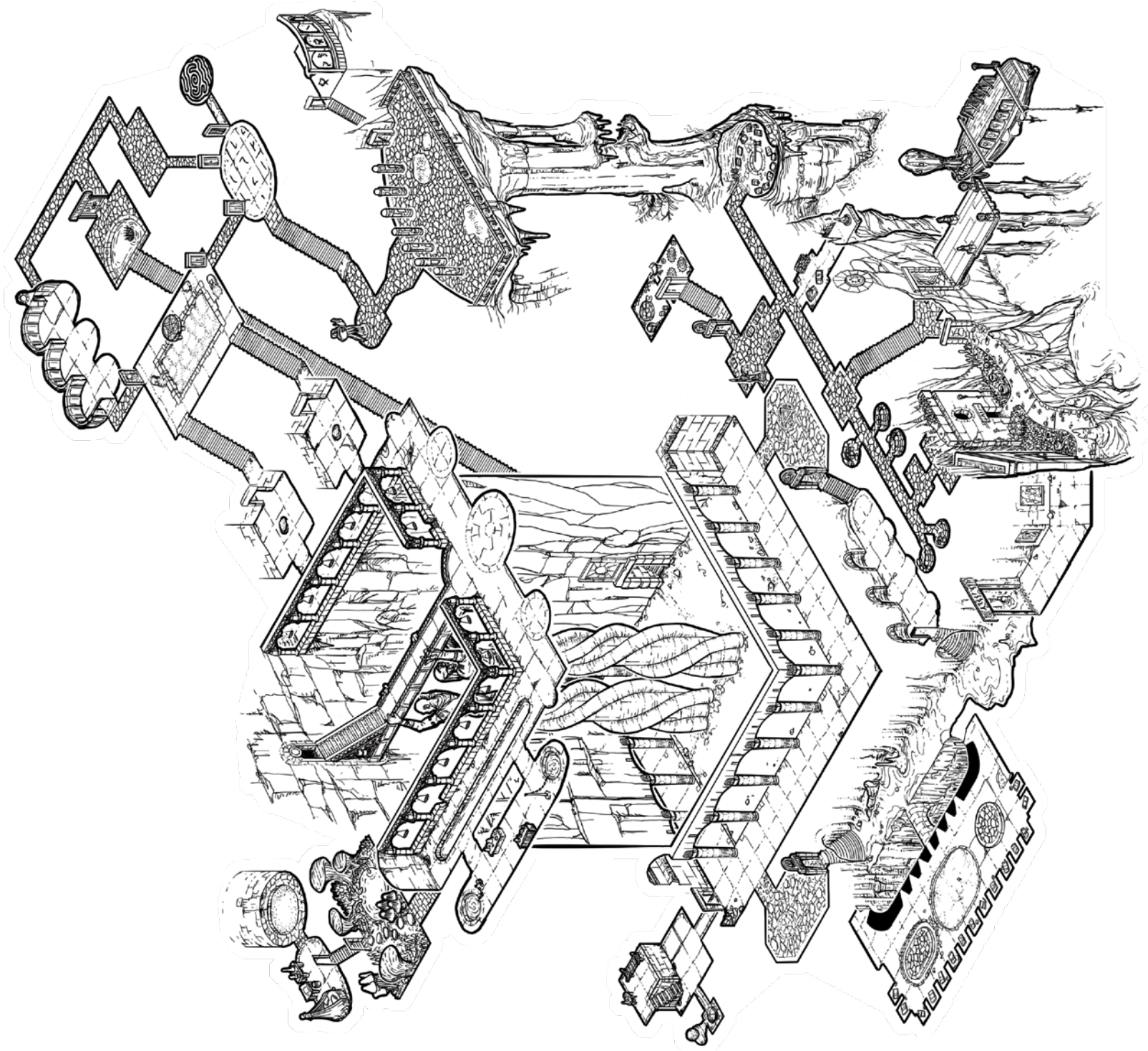

This map pack collects 48 isometric and perspective maps from the award-winning **Trilemma Adventures** series. Inside you'll find dungeons, natural caverns, dusty crypts, underworld cities, ruined towers, secret shrines, and more! Each map is presented as a full-page illustration, ready for you to print. Hook your players with tantalizing maps of fantasy locations, stock them with fiendish challenges of your own design, or use them as inspiration for your own locations.

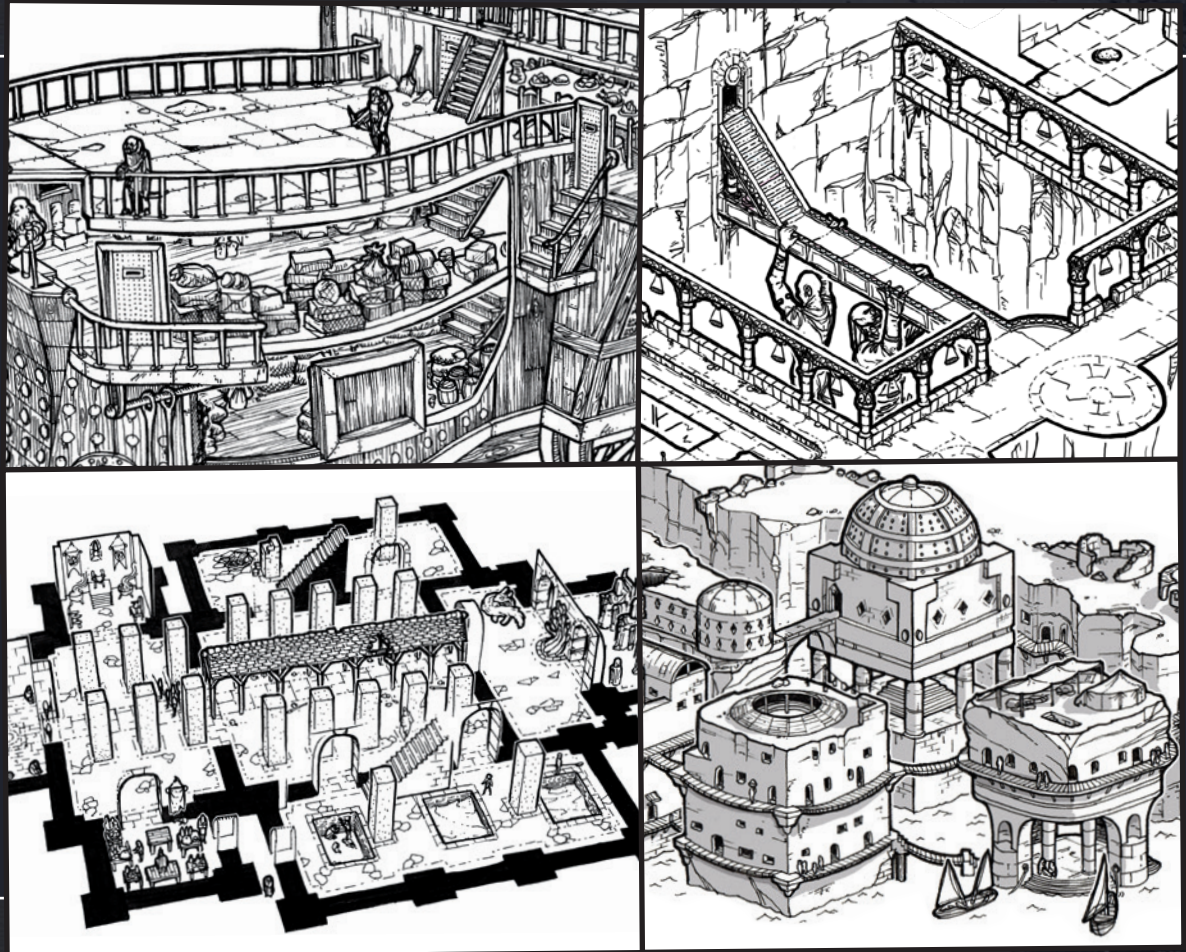

TRILEMMA
ADVENTURES

<http://trilemma.com>