

Loren K. Wiseman

GROUND Vehicle Guide

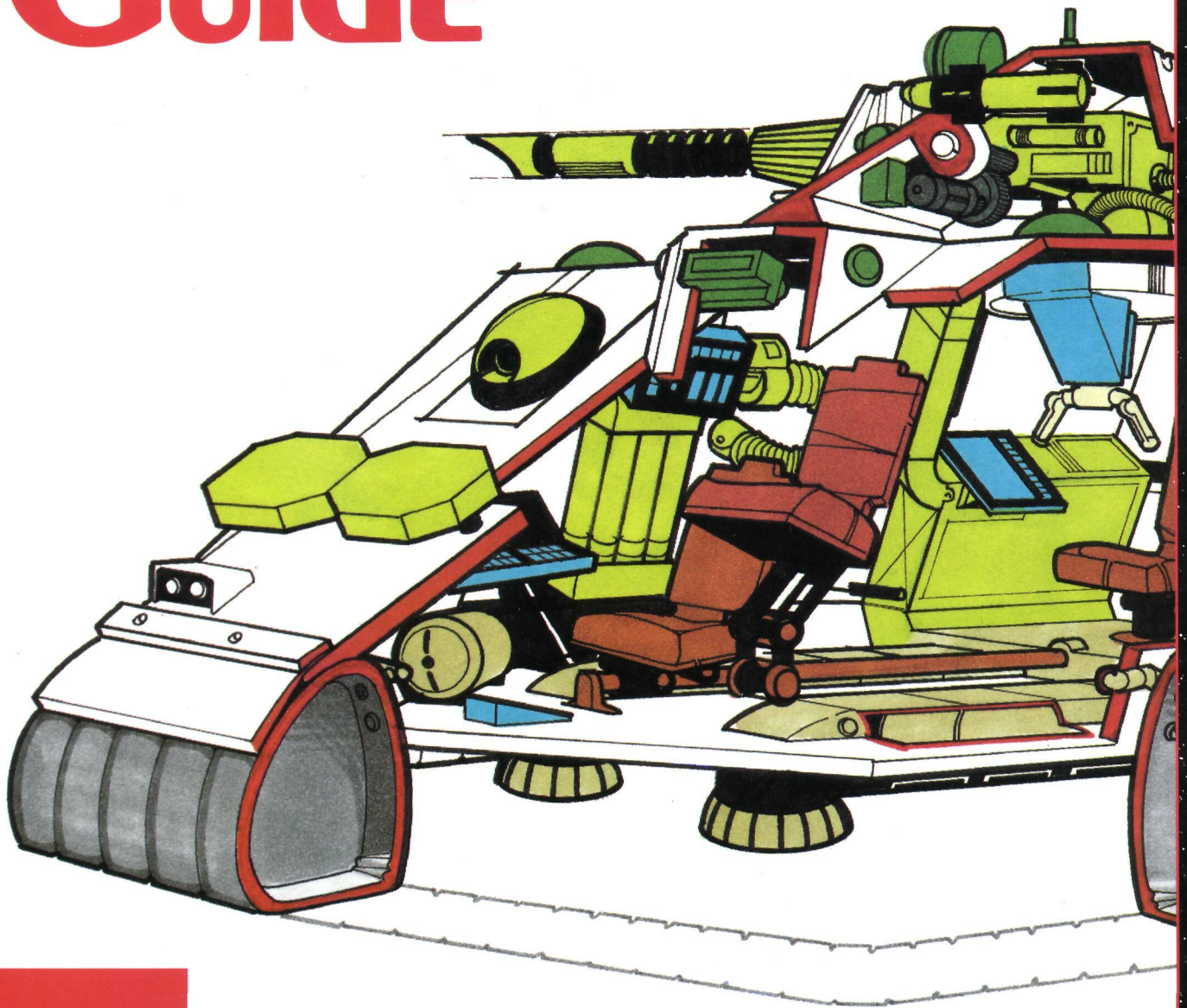

Vehicles Designed for Unearthly Terrain

GROUND VEHICLE Guide

Vehicles Designed for Unearthly Terrain

Loren K. Wiseman

2300AD

Since 1973



The *Ground Vehicle Guide* is an informational resource booklet designed to add variety and excitement to **2300 AD** campaigns and adventures.

Design and Development.....Loren K. Wiseman
Additional Design and Assistance.....Lester W. Smith,
Frank Chadwick
Cover Art.....David Deitrick
Interior Art.....Karl Martin,
Tim Bradstreet
Color Plates.....David Deitrick,
A. C. Farley
Art Director.....Lauretta Oblinger
Graphic Design and Production.....Barbie Pratt,
Dana Reischauer,
James R. Kuntz,
Kelly Walsh
Text Manager.....Michelle Sturgeon
Typesetting.....Tim Ryan,
Julia Martin,
Michelle Sturgeon
Text Processing.....Karen Lumb,
Michelle Anderson,
David Moll

Karl Martin's illustrations dedicated to the memory of Bruce Macurdy, Ph.D.

Copyright© 1988 GDW. All Rights Reserved. Printed in USA. Made in USA. ISBN 0-943580-99-4

2300 AD™ is GDW's trademark for its science-fiction role-playing game set in the 24th century.



PO Box 1646, Bloomington, IL 61702-1646 USA

TABLE OF CONTENTS

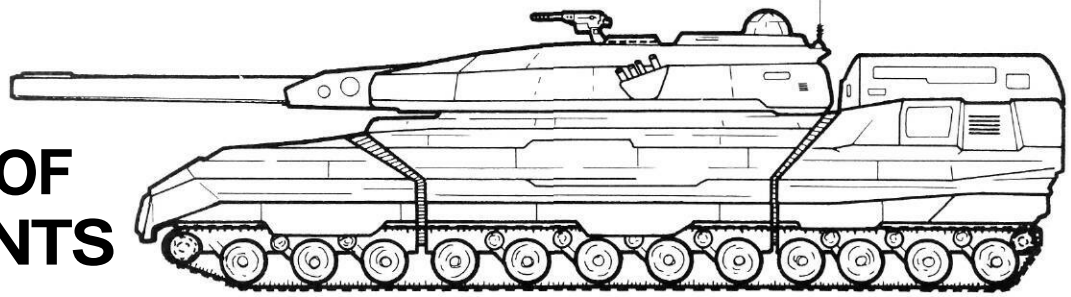

Introduction.....	4
Henderson Industries Explorer.....	5
Bridgeport Swift Songbird.....	6
Houston Motors Rangestar 8.....	7
Heavy Truck.....	8
Improvised APC.....	9
Maurice-Fenderman M-312.....	10
Bridgeport Swift Raven.....	11
Tiranefabrik Lk-250.....	12
Matsu Snow-Demon.....	13
Railroads.....	14
Metzger Aerosport.....	16
Vannoccio 420-X.....	17
American M9 Hovertank.....	18
American M24A3 Hover APC.....	20
American Hover APC Variants.....	22
Australian Kangaroo IV APC.....	24
Manchurian Type 27 Heavy Ground Tank.....	26
German LkPz-IX Hovertank.....	28
German GfPzTr-XIII.....	30
German LkPz-VIII.....	32
German BgLkPz-VIII.....	34
German LkRw-12 MRL.....	35
French AC-8 Hovertank.....	36
French AC-12 Hovertank.....	38
French ABR-76 Wheeled Armored Car.....	40
French CC-21 Main Battle Tank.....	42
French Bessieres Hover APC.....	44
Kafer "Cockroach Car" APC.....	46
Kafer "Deathsled" Hovertank.....	48
Kafer "Crawler II" APC.....	50
Kafer "Floater" Hover APC.....	52
Kafer "Behemoth" Main Battle Tank.....	54
Vehicle Accessories.....	56
Color Patches & Emblems.....	58
Color Cutaway: AC-12.....	59
Color Cutaway: GfPzTr-XIII.....	60
Color Cutaway: LkPz-IX.....	61
Color: M24A3.....	62
Color: M9.....	63
Color Cutaway: Kangaroo IV.....	64

Introduction

LOCAL VARIANTS

For almost all of the vehicles listed in this booklet, there exist locally manufactured variations. A colony world may not have the industrial capacity to manufacture a complete vehicle from the ground up, but they can often turn out variations on a vehicle purchased off-world.

Any of the vehicles described herein can have alternate weapon packages, sensor suites, or additional equipment, either manufactured locally or imported and then installed locally. For example, the basic Bessieres hover APC is often converted to other purposes by the installation of anti-vehicle missiles, mortars, or other heavy support weapons.

Mercenary units will often have heavily customized vehicles (sometimes modified by their own personnel). Casualties and varying sources of supply often result in a hodgepodge of vehicles, very few of them straight from the factory.

Vehicles play an important role in the **2300 AD** universe, and while the basic game contains a nice selection, there is not enough room to include detailed information on more than a few basic types. What we have chosen to do instead is to present these same basic types in a little more detail, giving some variants of each, and taking a look at the interiors of a few of the more important ones. Because of this, we had to limit discussion to some of the more interesting ground vehicles.

AVAILABILITY

Specific availability for a given vehicle is discussed in the game statistics included with that vehicle's description. Front-line, state-of-the-art military equipment will always be more expensive and harder to find than older, obsolete vehicles. This is especially true of large, expensive vehicles like tanks and APCs. Groups with the financial backing of a government or a major organization will not be as concerned with this (the ARI will provide a survey team it is sponsoring with several Explorer ATVs, for instance). Re-known will be of considerable help to players in situations such as these. A character who has led several exploratory expeditions, for example, will have more leverage in buying first-class vehicles than a relatively unknown character trying to get his first assignment.

In general, the more complex the vehicle or the more expensive, the more restricted its availability. Most of the complicated, state-of-the-art military vehicles, for example, are manufactured only on Terra or Tirane, and are hard to come by in the average frontier general store.

In some cases, a vehicle is marked "not generally available" or something similar. This does not mean the vehicle cannot be obtained, just that it is not available through ordinary channels. Exactly how the players go about obtaining a vehicle such as this is a matter for an individual referee's judgment. The gyrations involved in getting a "dream" vehicle will vary, depending upon which vehicle the characters have set their sights on. Buying state-of-the-art hovertanks for a mercenary unit is usually just a matter of knowing the right government officials (renown will help here, also), and plowing through hillocks of red tape. Getting a Kafer vehicle, on the other hand, will involve taking one away from its present owners (a different problem entirely). Sometimes, just getting the vehicles a group wants will usually provide several hours of good adventuring.

PRICE

Price is noted in the statistics for each individual vehicle. This is an average for a purchase of a single vehicle, usually new unless otherwise noted, not including delivery charges (the cost of freighting a hovertank to Aurore, for example, is significant). Discounts can be allowed for used vehicles (with the possibility of mechanical trouble rising in proportion to the decrease in price) or for vehicles purchased in bulk (a discount of up to 10 percent can be allowed on any purchase of more than five vehicles at once, at the referee's discretion).

CUSTOMIZING

There are very few players in existence who don't want to modify a stock vehicle to suit their character's individual needs. The specific type modification involved depends upon the imagination of the players and their characters' wealth and circumstances, so it is not possible to give any hard and fast rules. The referee should look at what the players want to do, and make a determination of where the customizing can be done, what it will take, and how much it will cost. The more complicated a modification, the more expensive it will be and the less likely the characters can do it themselves. A simple modification, such as welding on a machinegun mount, can probably be accomplished by the characters (assuming they have the materials, the skills, and the tools). More complex operations may involve going to a machine shop, or back to the manufacturer, depending on what must be done. It may be that what the players want can only be done on one of the core worlds.

Henderson Industries Explorer

(Multinational)

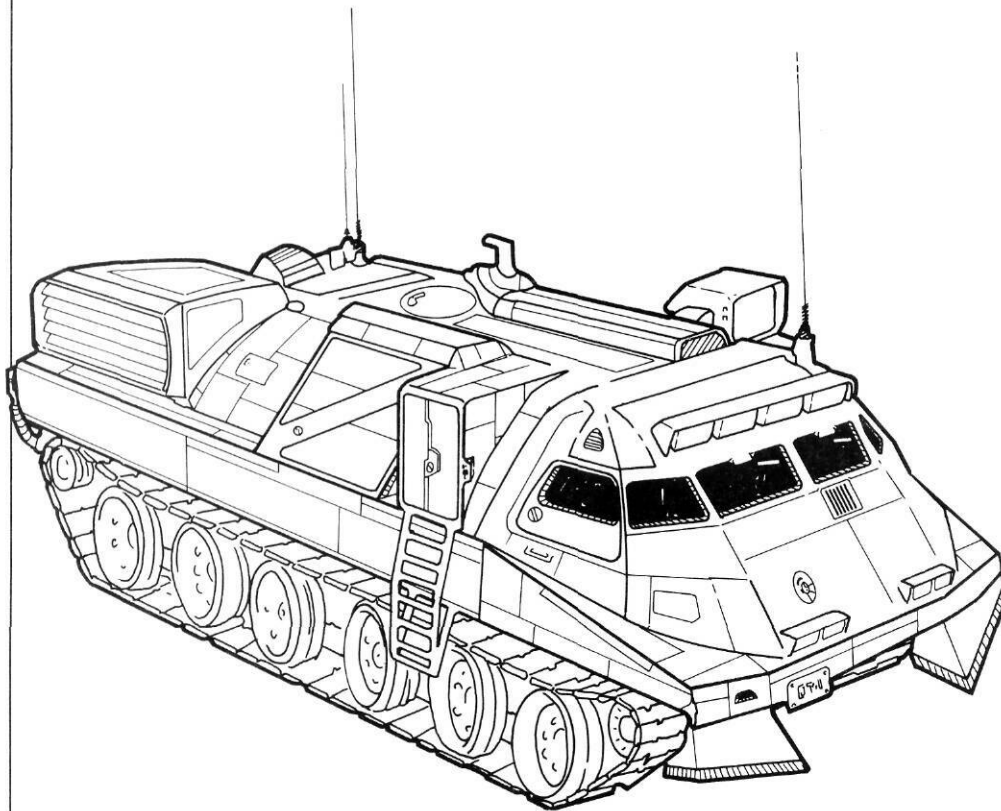

1 meter

Tracked ATV

Type: *Tracked all-terrain vehicle* Crew: *Driver* Weight: *3000 kg* Armor: *Suspension: / All Faces: 7* Signature: *8* Evasion: *0* Sensor Range: *None* Cargo: *8 passengers and 3000 kg* Max Speed: *700 kph* Cruising Speed: *50 kph* Combat Movement: *200 m* Off-Road Mobility: *Full* Power Plant: *0.2 MW hydrogen fuel cell* Fuel Capacity: *192 kg H₂* Fuel Consumption: *6 kg/hr* Endurance: *32 hr* Price: *Lv20,000, without any specialized instrumentation or supplies.*

EQUIPMENT

The main equipment will be tailored to the specific mission at hand. A mineralogical survey vehicle, for example, will have an assay lab, storage for rock and mineral samples, tools for gathering these samples, and so on. A vehicle carrying out botanical studies will need completely different laboratory facilities and equipment. A planetographic survey vehicle would not need extensive specimen storage space, but would need a large quantity of surveying instruments and computer equipment for recording findings. The equipment inside a vehicle can easily out-price the vehicle itself.

HENDERSON INDUSTRIES EXPLORER

The vehicle shown is the Henderson Industries Explorer, and is typical of several different models of ATV intended for exploratory survey parties and other information-gathering expeditions. The various makes and models differ in certain particulars but are quite similar overall. The Explorer can double as living quarters in hostile environments and can negotiate most types of terrain. Interior quarters are spartan and somewhat restricted, and many expeditions consist of several such vehicles, purposely under crewed, in order to allow more space for supplies, specimens, and crew comfort. Where conditions permit, many crewmembers prefer to bring tents or other portable shelters, and sleep outside the vehicle.

The basic model comes equipped with water purification and re-circulation apparatus, lavatory and laundry facilities, and a limited galley, but most of the space inside is devoted to instrumentation and laboratory facilities. Exact equipment varies tremendously from expedition to expedition, but an extensive (albeit specialized) library is almost a necessity, regardless of the other equipment.

Type: *Utility hovercraft*
 Crew: *Driver* Weight: *W00 kg* Armor: *Plenum: 0.3* All
 Faces: *7* Signature: */* Evasion: *9* Cargo: *6 passengers*
 and *W00 kg* Max Speed: *240 kph* Cruising Speed:
200 kph Combat Movement: *500 m* Off-Road Mo-
 bility: *Full* Power Plant: *0.25*
MW hydrogen fuel cell Fuel Capacity: *700 kg H₂*
 Fuel Consumption: *8 kg/hr* En-
 durance: *72 hr* Price:
Lv20,000.

Bridgeport Swift Songbird

(Multinational)

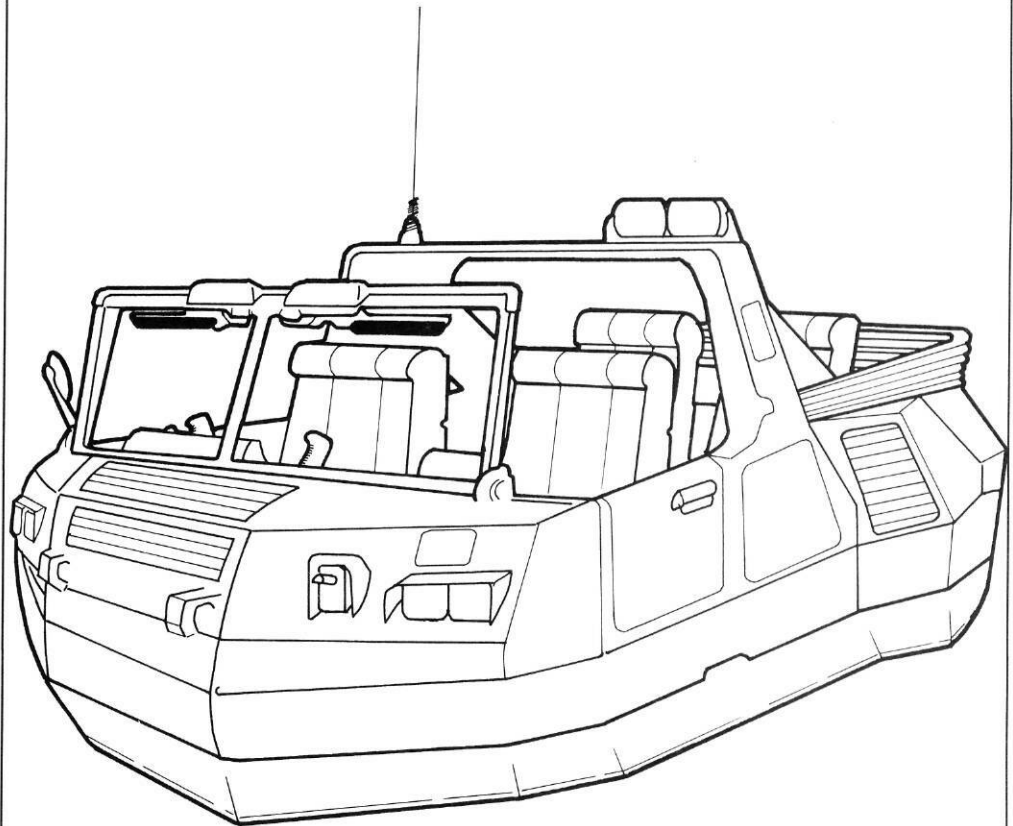

1 meter

Utility Hovercraft

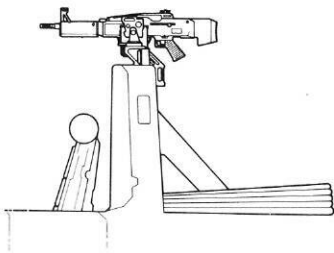

Detail of Warbird,
 showing weapon mount

BRIDGEPORT SWIFT SONGBIRD

This model is typical of a number of models of light hovercraft in civilian and military use. It has exceptional performance over both water and most types of land terrain, although its performance in dense woods is limited to established roads and paths; performance in heavily broken ground is nil. A wide variety of options and additional equipment are available, making it possible for the user to customize the model to suit individual requirements and specifications. Adaptation packages are available to fit out a Songbird for extremely hot, cold, wet, or arid environments. Since hovercraft don't work in vacuum environments, there is no vacuum package, but equipment can be installed to convert the Songbird for non-standard atmospheres (including non-breathable ones).

Military Models: The military version of the Songbird, called the Warbird, comes with a small winch in the back hull, a pintle mount on the overhead crossbar, a less comfortable interior, and a dull, gray-green, factory paint job. Individual camouflage schemes can be ordered from the factory for Warbirds purchased in lots of 12 or more.

Houston Motors Rangestar 8

(Multinational)

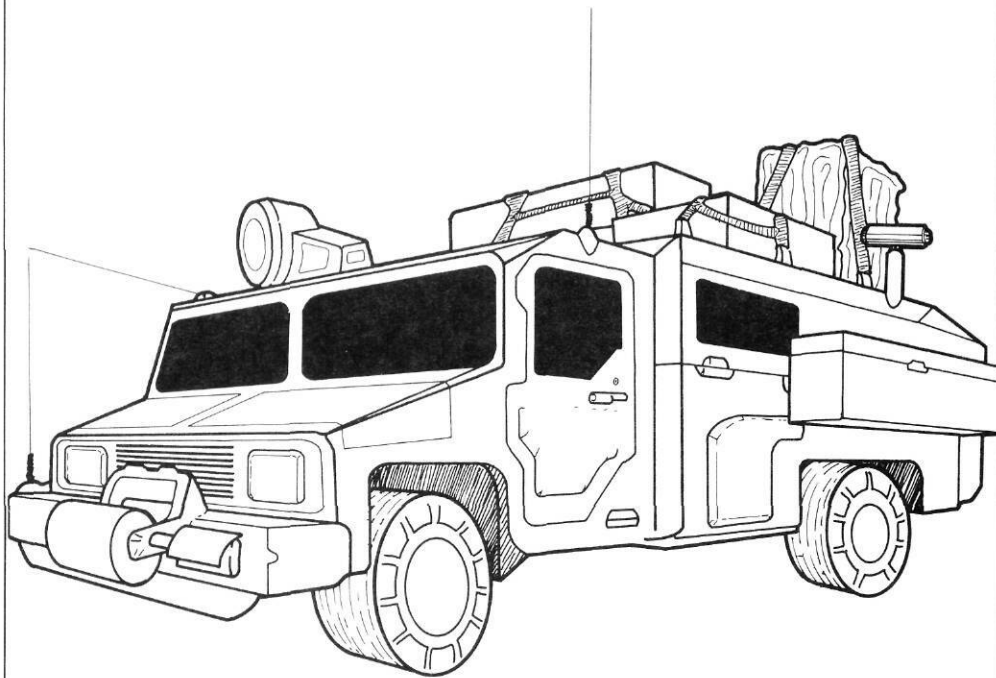

Cross-country Light Truck

Type: *Cross-country light truck* Crew: *Driver* Weight: *800 kg* Armor: *Suspension: 0.3 All Faces: 0.4* Signature: *2 Evasion: 2 Cargo: 5 passengers and 300 kg cargo* Max Speed: *140 kph* Cruising Speed: *700 kph* Combat Movement: *300 m* Off-Road Mobility: *Halved* Power Plant: *0.1 MW hydrogen fuel cell* Fuel Capacity: *48 kg H₂* Fuel Consumption: *3 kg/hr* Endurance: *76 hr* Price: *Lv3000*.

HOUSTON MOTORS RANGESTAR 8

This vehicle is representative of that class of vehicles (called rangetrucks) designed to carry passengers and light cargo off-road. Away from the developed areas of most colonies, hovercraft are often too expensive for everyday use, but vast distances still need to be crossed in the course of everyday living. The vehicle comes with a high wheelbase for obstacle clearance, an extra-rugged engine, a winch for towing the vehicle out of sticky situations, and run-flat tires.

Variants: Rangetrucks have to be one of the most heavily personalized vehicle types in existence. It is sometimes difficult to recognize the various brands and models, since most manufacturers strive for a great degree of interchangeability of parts. Among the more common modifications carried out on rangetrucks are added fuel tanks, storage racks for extra food and water, a large tool box, an auxiliary generator for powering farm equipment, and inflatable flotation gear for crossing large streams and rivers (the vehicle can ford water up to .75 meters deep without modification). Desert, arctic and jungle packages are available, as well as a vacuum operations package to permit the vehicle to operate in the absence of air (or the absence of oxygen).

Type: *Wheeled cargo truck* Crew: *Driver* Weight: *4000 kg* Armor: *Suspension: 0.3 All Faces: 0.4* Signature: *6* Evasion: *0* Cargo: *2 passengers and 10,000 kg* Max Speed: *130 kph* Cruising Speed: *700 kph* Combat Movement: *250 m* Off-Road Mobility: *Halved* Power Plant: *0.13 MW hydrogen fuel cell* Fuel Capacity: *96 kg H₂* Fuel Consumption: *4 kg/hr* Endurance: *24 hr* Price: *Lv10,000*.

Heavy Truck (Generic)

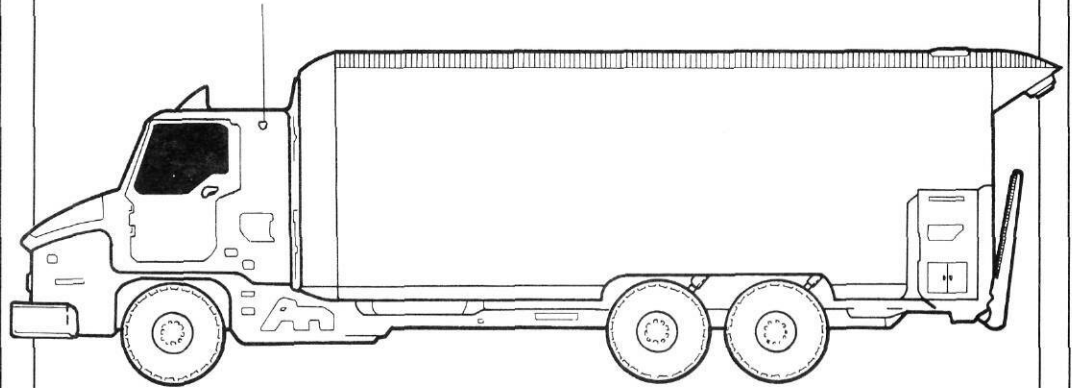

1 meter

Wheeled Cargo Truck

HEAVY TRUCK

This is a specialized cargo hauler for use on frontier worlds. Although designed to have better cross-country mobility than the late 20th century "18 wheelers," trucks of this sort are still not up to ATV or ACV performance levels. There are dozens of models which differ only in minor details. Where the terrain is not too rugged, these vehicles can operate very economically. Except for railroads, they are the cheapest method of hauling bulk cargoes and are often the lifeline of many rural communities in the less well-developed regions of many colony worlds.

Variants: Some versions are equipped with refrigeration equipment and extensive insulation, and are used solely for the transport of perishable materials, such as food. Most, however, are intended for general (and less perishable) cargo, and have simple metal- or fiberglass-composition cargo boxes. Fuel transport trucks are usually identical externally but carry internal compartments for the storage of catalytically absorbed hydrogen. Fuel transports are usually capable of carrying 90 percent of their cargo capacity as fuel, the rest being taken up with the catalyst and transferal equipment, such as hoses, pumps, and the like.

Improved APC

(Multinational)

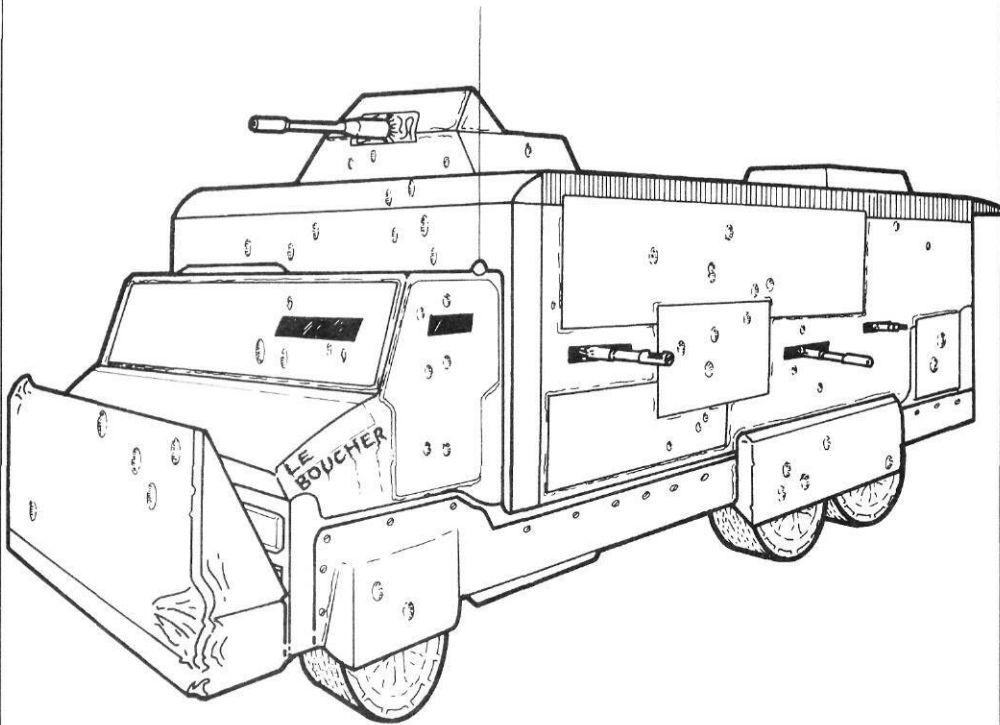

Improved Wheeled APC

Type: *Improved Wheeled APC*
Crew: *Driver* Weight: *6000 kg* Armor: *Suspension: 0.3 All Faces: 3* Armament: *7.5mm machinegun* Signature: *6* Evasion: *0* Cargo: *12 passengers and 1200 kg cargo* Max Speed: *700 kph* Cruising Speed: *80 kph* Combat Movement: *780 m* Off-Road Mobility: *Halved* Power Plant: *0.13 MW hydrogen fuel cell* Fuel Capacity: *96 kg H₂* Fuel Consumption: *5 kg/hr* Endurance: *79 hr* Price: *Field modification, base truck is Lv 10,000. plus Lv2000 to Lv4000 for extra armor plating, weapons, and chassis reinforcing.*

IMPROVED APC

This vehicle is typical of the many varieties of field-expedient armored personnel *earner* put together by local militias and guerrilla forces. Armament, armor protection, cargo and passenger capacity, and operational radius vary from vehicle to vehicle—each is essentially a separate design.

Armor usually consists of metal plates, but occasionally scrap ceramic or carbon monofilament structural members will be used. Metal is more plentiful on less well-developed worlds, such as Aurore. Where available, ballistic cloth will also be used.

Beginning with whatever vehicle is at hand, local artisans reinforce the frame, apply armor to the outside, cut firing slits, and add simple seats to the interior for the passengers. Often, a mount for a machinegun or AGL will be added, either to the cab or to the upper hull. Tires are seldom armored, although the suspension and drive train may receive some protection (armor values can vary from 2-4 for all faces, suspension from 0.2 to 0.7).

Cargo capacity is reduced by the extra weight, and passenger comfort is not a primary consideration; thus, these vehicles are hot, uncomfortable, and uniformly despised by their passengers.

Type: *Combination wheeled/air cushion utility vehicle* Crew: *Driver* Weight: *800 kg* Armor: *Suspension/Plenum: 0.2 All Faces: 0.4* Signature: *2* Evasion: *7* Cargo: *4 passengers and 1000 kg cargo* Max Speed: *100 kph* Cruising Speed: *75 kph* Combat Movement: *280 m* Off-Road Mobility: *Halved (wheels, full in ACV mode)* Power Plant: *0.06 MW hydrogen fuel cell* Fuel Capacity: *32 kg H₂* Fuel Consumption: *2 kg/hr (wheeled), 4 kg/hr (ACV)* Endurance: *16 hr (wheeled), 8 hr (ACV)* Price: *Lv2500.*

Maurice-Fenderman M-312

(Multinational)

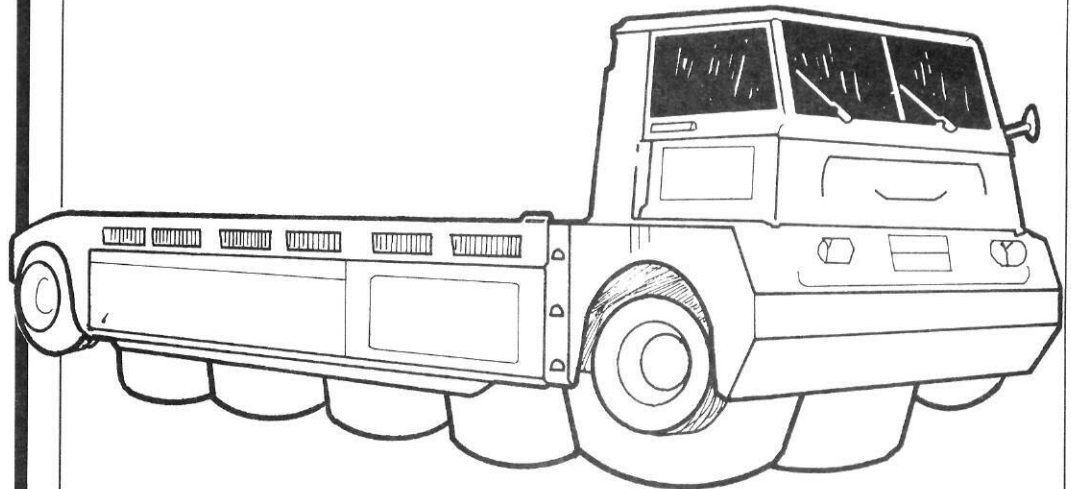

Utility Wheeled/ACV

MAURICE-FENDERMAN M312

This is a combination wheeled/air cushion all-terrain vehicle intended for agricultural/general utility use on frontier worlds. It was designed to provide the frontier colony farmstead with a multipurpose utility vehicle which can be used for a wide variety of agricultural tasks, such as plowing, cultivating, planting, and general hauling, as well as serving as a portable power source for electrical equipment. Its most unusual feature is its double suspension system, capable of shifting from wheeled to multiple-plenum air cushion suspension. As an ACV, fuel consumption is higher, but it can cross an almost infinite variety of terrain types with ease. Unlike most hovercraft, however, the M-312 still uses its wheels for forward propulsion and is therefore somewhat more fuel efficient than is normal for an ACV. The M-312 has the additional advantage, for an agricultural machine, of being able to pass over very young plants with only minimal damage.

A number of colonial militias have converted the M312 and similar machines into improvised armored personnel carriers, in a manner similar to that described on page 9.

Brigeport Swift Raven

(Multinational)

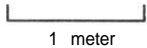
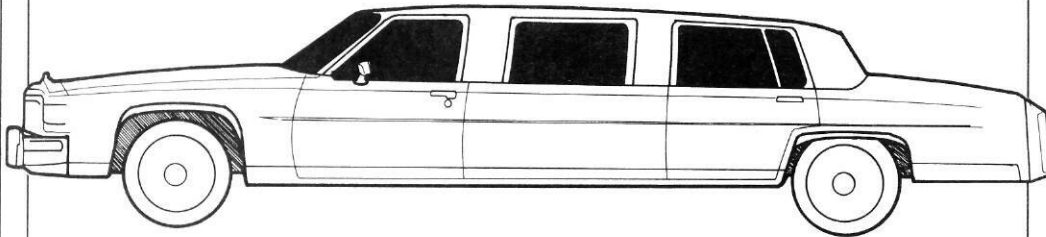

Wheeled Ground Luxury Car

Type: *Wheeled ground luxury car* Crew: *Driver* Weight: *800 kg* Armor: *Suspension: 0.2 All Faces: 0.4* Signature: *2* Evasion: *1* Cargo: *6 passengers and 200 kg of cargo* Max Speed: *120 kph* Cruising Speed: *700 kph* Combat Movement: *300 m* Off-Road Mobility: *Quartered* Power Plant: *0.06 MW hydrogen fuel cell* Fuel Capacity: *32 kg H₂* Fuel Consumption: *2 kg/hr* Endurance: *76 hr* Price: *Lv15,000 for the basic vehicle, without special equipment or armor.*

BRIDGEPORT SWIFT RAVEN

Manufactured by the makers of the ubiquitous Songbird light ACV, the Raven is a typical luxury ground car, used mostly to provide transportation for business executives, politicians, and those among the wealthy who prefer ground travel. It is usually a hydrogen-burner, although some eccentric individuals import petroleum fuels as a symbol of their elevated status.

The interior is usually individually outfitted to suit each purchaser, and often incorporates genuine leather seats, fully-equipped entertainment centers, portable refreshment centers, and other luxurious appointments installed in the passenger compartment. Machines used by business executives often have extensive communications equipment.

Political figures and anyone who might be a target for assassination usually avail themselves of armored models which are custom-built to order at the factory, and usually incorporate ballistic cloth/ceramic armor, bulletproof glass, a specially reinforced suspension with run-flat tires, and a sealed, gas-proof interior (to prevent attackers from using a chemical gas cloud to disable the driver). A more powerful engine and larger fuel tank are installed to retain the same performance.

SPECIAL ARMOR

For an additional Lv5000, the factory will install the armored package described in the main text. This changes the following ratings: Armor: *Suspension: 7 All Faces: 4* Power Plant: *0.07 MW hydrogen fuel cell* Fuel Capacity: *40 kg H₂* Fuel Consumption: *2.5 kg/hr.*

Type: *Heavy cargo ACV*
Crew: *Driver, commander, 10 cargo handlers*
Weight: *286,000 kg (loaded)*
Armor: *Plenum: 2 All Faces: 6*
Signature: *7 Evasion: 0*
Sensor Range: *20 km*
Cargo: *500 passengers or 250 tons of cargo*
Max Speed: *120 kph*
Cruising Speed: *90 kph*
Combat Movement: *175 m*
Off-Road Mobility: *Full*
Power Plant: *2x5 MW MHD turbines*
Fuel Capacity: *4840 kg H₂*
Fuel Consumption: *220 kg/hr*
Endurance: *22 hr*
Price: *Lv2,880,000.*

Tiranefabrik Lk-250

(Multinational)

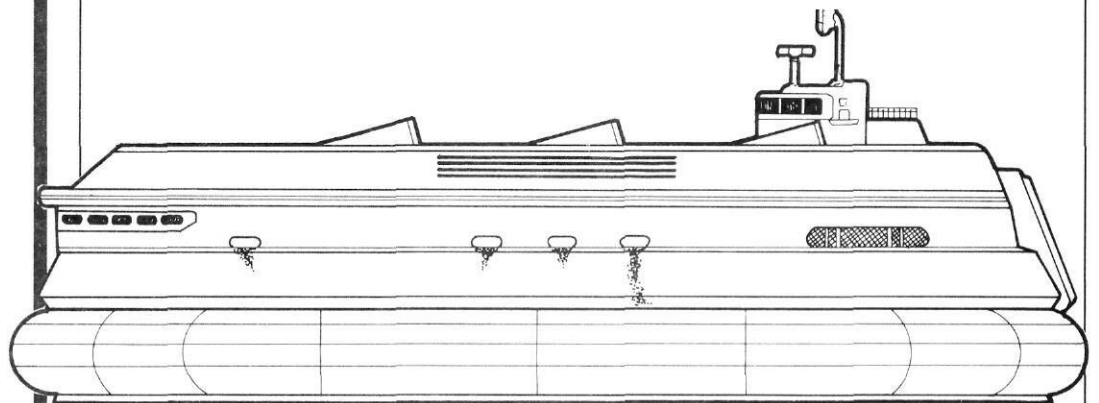

□
1 meter

Heavy Hovercraft

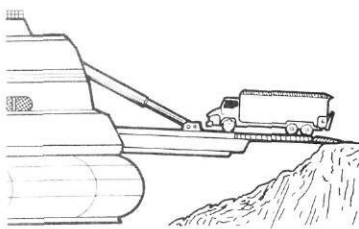

Detail of bow, showing loading ramp extended

TIRANEFABRIK LK-250

The Tiranefabrik Lk-250 is a large-capacity cargo ACV designed for bulk transport on worlds where the road net is poor or nonexistent. The large loading door in the front of the vehicle can be lowered to form a telescoping ramp, which enables the vehicle to be loaded without deflating the skirts, an advantage in many types of terrain. Other models of large cargo hovercraft are built as RORO-types (roll-on, roll-off), meaning that they have ramps at both ends. ROROs are commonly seen as ferries, since vehicles can drive on and drive off without backing up.

The Lk-250 is fitted with normal communications and radar anti-collision gear, along with either an inertial and/or a satellite navigation system as desired. The Lk-250's cavernous interior can be fitted to carry passengers (at a cost of .5 ton of cargo space per person) in combination with cargo; most models found on frontier worlds are designed for combination service (a few even have provisions for carrying livestock).

Military versions usually incorporate one or more weapon turrets, ECM equipment, and air defense weapons of some kind. These vehicles are seldom seen in the front lines, however.

Matsu Snow-Demon

(Multinational)

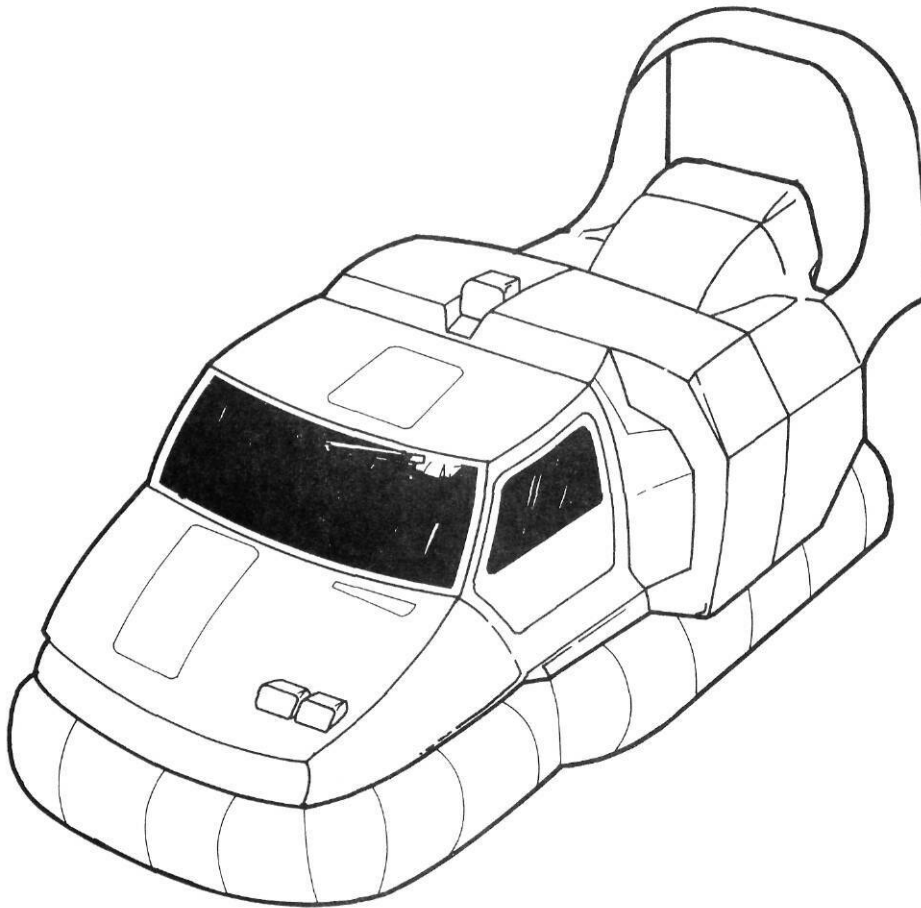

Light Arctic Vehicle

SNOW-GLIDER

Type: *Light arctic vehicle*
Crew: *Driver* Weight: *800 kg* Armor: *Suspension: 0.2*
All Faces: *.5* Signature: *4*
Evasion: *0* Cargo: *1 passenger and 100 kg* Max Speed: *180 kph* Cruising Speed: *120 kph* Combat Movement: *700m* Off-Road Mobility: *Full* Power Plant: *0.02 MW* Fuel Capacity: *20 kg H₂* Fuel Consumption: *2 kg/hr* Endurance: *10 hr* Price: *Lv3500*.

SNOW-DEMON

Type: *Light arctic ACV*
Crew: *Driver* Weight: *800 kg* Armor: *Plenum: .2* All Faces: *0.5* Signature: *4* Evasion: *0* Cargo: *7 passenger and 100 kg* Max Speed: *200 kph* Cruising Speed: *750 kph* Combat Movement: *740 m* Off-Road Mobility: *Full* Power Plant: *0.02 MW Hydrogen fuel cell* Fuel Capacity: *20 kg H₂* Fuel Consumption: *2 kg/hr* Endurance: *70 hr* Price: *Lv4000*.

MATSU SNOW-DEMON

Snowskimmers like the Matsu Snow-Demon are intended for use primarily in conditions of heavy snow or ice cover, or where the terrain is otherwise suited to its use. Because of its enclosed cabin, however, the vehicle is especially suited for high-speed movement in extremely cold conditions. As civilian recreational vehicles, and as military reconnaissance and communication vehicles, the Snow-Demon and its ilk are commonly encountered on any world with suitable terrain for its use. The Snow-Demon has no jump-jet mode, and cannot cross linear obstacles such as ditches and fences.

A ski-mounted variation, the Snow-Glider, is slightly less expensive, but has the disadvantage of being unable to cross streams and other water barriers. The vacuum equipment package can be fitted to both the Snow-Demon and the Snow-Glider, but its use is limited to worlds with non-breathable atmospheres, since both depend on a propeller blade for forward thrust.

Both the Snow-Demon and the Snow-Glider come with old weather passenger compartments as standard equipment, with special door seals, insulation, and a large-capacity heater.

SUSPENSIONS

Conventional Railroad: Railroads are an efficient means of moving large quantities of cargo and passengers by land. Each car of the train rides on solid wheels which in turn ride on solid tracks. This allows for very high pressure loadings (much higher than for vehicles which ride on open ground) and permits transport of bulk cargoes with very high energy efficiency and subsequent low cost-per-kilometer averages. Average speed in open country is 200 kph.

Airfilm Train: Airfilm trains also ride on hard rails, but interact by means of a thin, high-pressure airfilm instead of wheels. This allows even higher pressure loadings with very little friction, and permits higher speeds at the same energy expenditure. Average speed in open country is 500 kph.

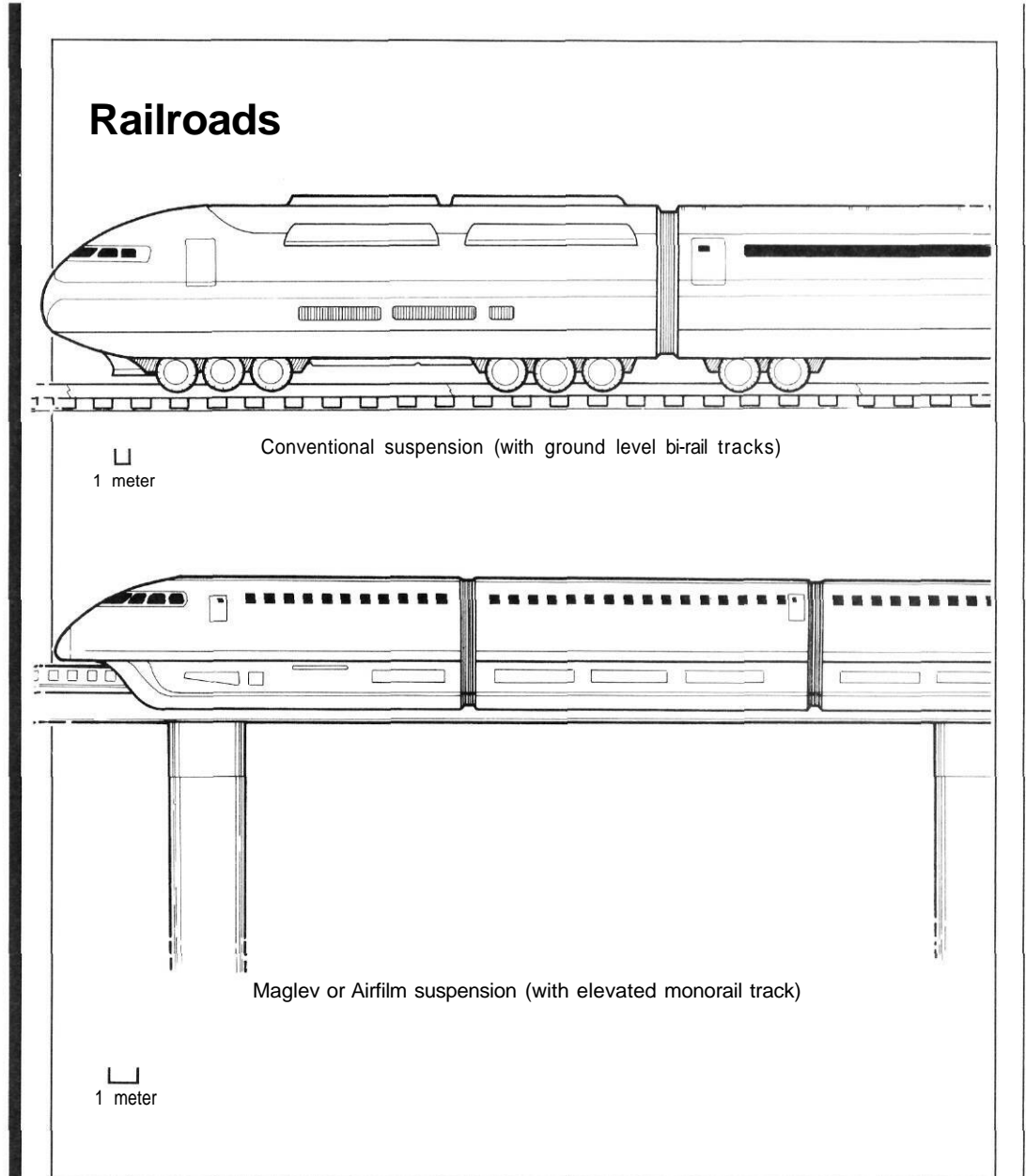

RAILROADS

There are three basic suspensions for railroad trains: conventional, airfilm, and maglev. These are discussed in the sidebars on this page and the facing page.

Trains are the most efficient means of transporting bulk cargo along standardized routes. Very little energy is required to keep a train moving once it has started (just enough to overcome the slowing effects of air resistance and friction). The largest trains may require several engines to start with, but once moving, they can often be throttled back and still maintain high speed.

The systems for running a railroad are centuries old, and the only modern changes have been with the introduction of the computer. Modern electronics have almost eliminated train crews (although a few personnel are still need in case of emergency). Passenger trains require stewards, cooks, conductors, and so on. Freight trains often have no more than one or two crewmembers.

Some trains are specially designed for runs through hostile environments: The Niebelungen trans-hotside railroad in the Neubayern system is a good example. These incorporate extra safety gear and have several back-up systems in case of accident.

MAGLEV SUSPENSION

Cross Section

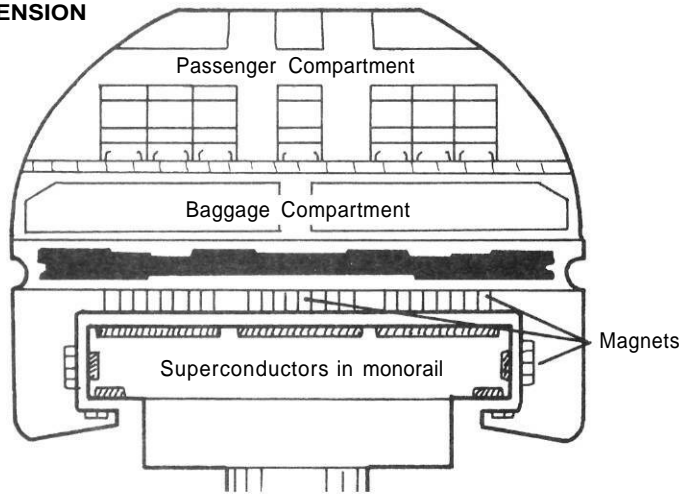

The electromagnetic field in the magnets induces an opposing field in the superconductors, and the two repel each other, lifting the train off of the rail, and producing a near-frictionless bearing.

Maglev Lines: On vacuum worlds, it is unfeasible to support a train on a film of air. Instead, a strong magnetic field is generated around the rail along which the train travels. Speeds for maglev trains are equivalent to those of airfilm trains.

Any of these systems can use either a twin rail or monorail system, although maglev and airfilm trains tend to use monorails. The monorail is more efficient from an engineering standpoint, but the twin rail system requires less sophisticated technology to construct and is, therefore, more common in less well-developed areas.

TRAIN MAKE-UP

As a rule of thumb, there is one engine per 10-15 cars, and usually all of them are together at the front of the train. On worlds which have enough traffic to warrant it, there are separate passenger and freight trains. The exact car mix will vary depending on the length of the run, as well as the cargo which is to be transported. Long haul trains will often include a single special crew car to be used by the train crew. The larger engines, on the other hand, contain a small compartment with bunks and facilities for a relief crewmember, and this serves for all but the longest of the freight runs.

ENGINES

Engines carry one- to two-MW MHD turbines, fuel for 48 to 72 hours continuous operation, and a control/monitoring center for the train's crew (usually one or two people). Closed circuit television monitors on each car allow continuous inspection of the train during operation, and a communications center keeps the train in continuous contact with a central dispatching center. Engines are designed to allow free movement between each other and passenger cars; this does not apply to freight cars, however.

CARS

As has been the case for centuries, almost all railroads have standardized cars. While these may be externally similar, they differ radically in internal details. Railroad cars can be divided into two broad categories: passenger cars and freight cars.

Passenger Cars: These are specifically designed to carry people (or sentient beings) in speed and comfort. There are several basic types, all of which are externally similar. All passenger cars share some characteristics, such as air conditioning, emergency exits, baggage space, internal power supplies, and so on. Some modern passenger cars often do not have windows, as these interfere with smooth airflow—passengers can watch video views of the countryside if they wish. Cars are usually powered by internal fuel cells, and are essentially little self-contained ecosystems, able to exist on their own for one or more days. All passenger cars are designed to permit free movement from one car to another.

Freight Cars: These are basically a streamlining envelope with an appropriate undercarriage added, designed to take a standard 50-ton cargo container. Specialized internal arrangements are taken care of inside the containers (for liquids, bulk dry goods such as grain, gasses such as propane, and so on). Some of the more primitive worlds have cars built to different standards, but they are similar in overall details to the cars discussed above.

Type: *Ultralight ACV*
 Crew: Driver Weight: 800 kg
 Armor: Plenum: 0.01 All Faces: 0.01 (driver and passenger unprotected)
 Signature: 2 Evasion: 2 Cargo: 200 kg cargo, or 1 passenger and 80 kg
 Max Speed: 120 kph Cruising Speed: 700 kph
 Combat Movement: 375 m Off-Road Mobility: Full
 Power Plant: 0.04 MW hydrogen fuel cell
 Fuel Capacity: 12 kg H₂ civilian, 32 kg H₂ military
 Fuel Consumption: 7 kg/hr
 Endurance: 12 (32) hr Price: Lv5000 for the civilian model. The 2296 procurement price for the militarized version of the Metzger Aerosport was Lv7500 (including armament).

RETROGRADE 30MM ACL

Occasionally, military models of the hovercycle are fitted with a rearward-firing 30mm autogrenade launcher. These usually carry two internal magazines of 12 grenades each (concealment and fragmentation are the most common choices), with a selector switch to enable either type to be fired at will. No targeting is possible, the tubes are fitted to fire at an angle of 20 degree on either side in order to provide covering fire when the vehicle is pursued. The 30mm grenades are described in the **2300 AD** rules. Type: 30mm grenade launcher
 Ammunition: Any 30mm propelled grenade
 Magazine: 2x12-round internal hoppers
 ROF: 2 Aimed Fire
 Range: 500 m DP Value: Dependent on grenade used.

Metzger Aerosport

(Multinational)

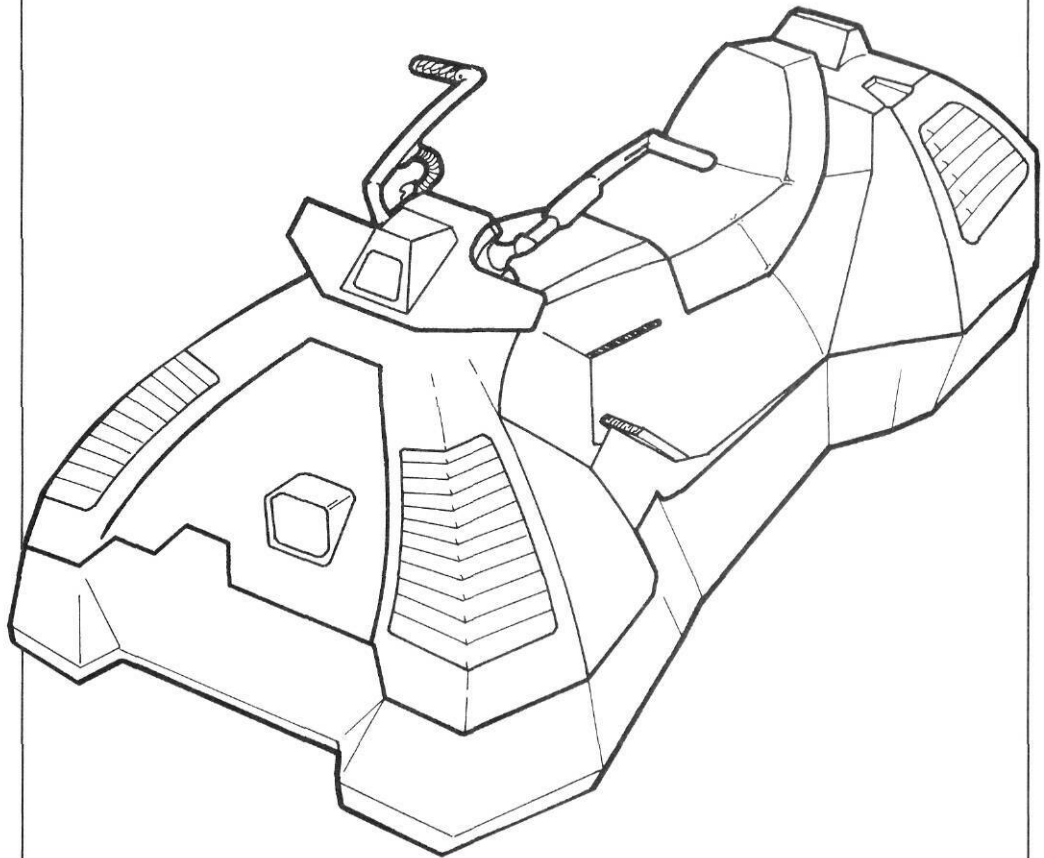

Ultralight ACV

METZGER AEROSPORT

Manufactured by Metzger, SA of Terra and Tirane (Alpha Centauri system), the Aerosport is a light, one to two person hovercraft intended to be put to the same uses as an off-road motorcycle: recreation, military reconnaissance, cross-country racing, and so on. The machine is primarily valued because of its ability to cross a wide variety of terrain types. The hovercycle is small enough to be able to weave between the large trees in a dense forest (although it cannot force its way through dense underbrush like heavier air cushion vehicles can), but it does no better in extremely broken terrain than other ACVs. The hovercycle is more likely to be upset by wave action, and cannot travel across extremely choppy water (larger ACVs have no trouble with this).

Military versions are seldom armed, although some are fitted with rearward-firing grenade launchers to assist in eluding pursuers, and they are usually painted in a drab-colored camouflage scheme. Military hovercycles (unlike civilian models) are capable of jump-jet mode at 10 times the normal fuel consumption, and are usually fitted with two 10-kilogram auxiliary fuel tanks, communications gear, and a 30mm AGL in place of the passenger.

Vannoccio 420-X

(Multinational)

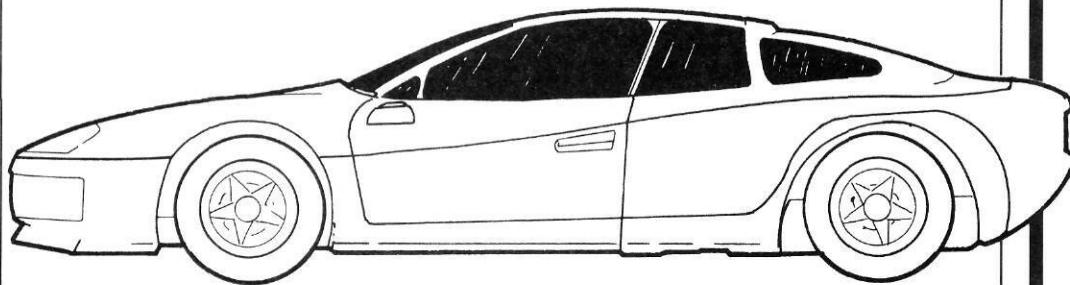

1 meter

Wheeled, High-Performance Automobile

Type: *Wheeled, high-performance automobile*
Crew: *Driver* Weight: *775 kg* Armor: *Suspension: 0.2*
All Faces: *0.4* Signature: *2*
Evasion: *1* Cargo: *1 passenger and 20 kg cargo* Max Speed: *250 kph* Cruising Speed: *180 kph* Combat Movement: *420 m* Off-Road Mobility: *One-eighth value* Power Plant: *0.08 MW hydrogen fuel cell* Fuel Capacity: *30 kg H₂* Fuel Consumption: *3 kg/hr* Endurance: *10 hr* Price: *Lv5000.*

VANNOCCIO 420-X

The Vannoccio 420-X represents a typical high-performance automobile, and continues a centuries-old tradition of gratifying the "need for speed" in a sizable portion of humanity. Such types of vehicles are usually hydrogen-burners, although certain esoteric high-performance enthusiasts make use of specially-blended exotic fuels incorporating highly dangerous petroleum/nitro mixtures.

Sports cars such as the 420-X are designed to fit into a specific environment (a solid highway in good condition). As specialized designs, they do not function well outside the narrow confines of their specialty. The 420-X's road speed is tough to match (by wheeled vehicles in any case), but its cross-country speed is abysmal. The vehicle's suspension is simply not designed by any means for cross-country travel. Fuel economy is not a major consideration in vehicles of this type—including the 420-X—either. Space is provided for only two people (driver and passenger), and provision for cargo is nil (the trunk is only large enough for a small suitcase and little else).

Type: *Hovertank* Crew: *Driver, gunner, commander*
 Weight: 7500 kg Armor: Plenum: 2 All Faces: 7 Ar-
 mament: 7cm *mass driver gun in turret* Aimed Fire
 Range: 7900 m Range Finder: +4 ROF: 5 Rounds
 Carried: 12+0 DP: 80, *M3A3 machinegun coaxial
 with main weapon, and M80 7.5mm machinegun at com-
 mander's hatch* Signature: 4 Evasion: 7 Sensor Range:
 10km Cargo: 500 kg Max Speed: 220 kph Cruising
 Speed: 200 kph Combat Movement: 460 m Off-Road
 Mobility: Full Power Plant: 0.5 MW MHD Turbine Fuel
 Capacity: 286 kg H₂ Fuel Consumption: 13 kg/hr En-
 durance: 22 hr Price: *American Army procurement price
 for 2297 was Lv480,000.*

**M80
 LIGHT MACHINEGUN**

Type: 7.5mm *conventional machinegun* Country: *America* Weight (empty): 7 kg Length: 110 cm Action: *Single shot or bursts* Am-
 munition: 7.5x35mm *fixed cartridge ball* Muzzle velocity: 960 mps Magazine: *150-round disposable cas-
 sette* Magazine Weight: 2 kg ROF: 5 Aimed Fire Range: 800 meters (*WOO on mount*) Area Fire Burst: 20 (*AFV=2*) Area Fire Range: 600 meters (*780 meters on mount*) DP Value: 0.7 Price: Lv880 (*Lv2 for cassette of 100 rounds*).

M9
 (American)

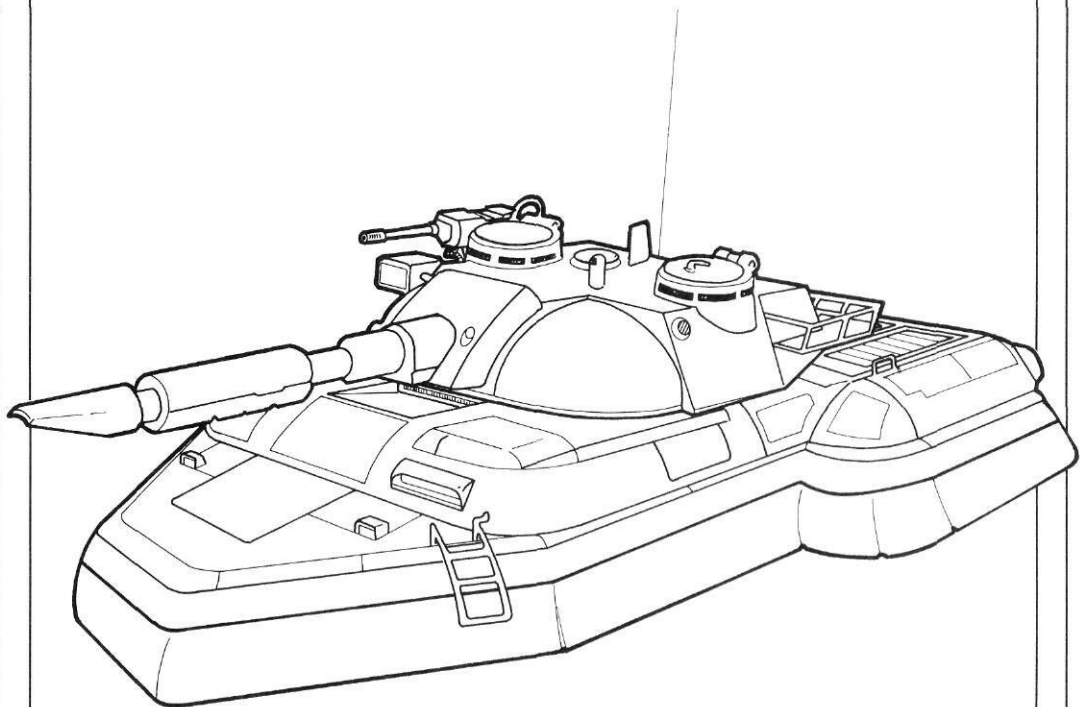

Hovertank

M9

The American M9 hovertank is a good solid design, and well up to the standards set by the French AC-12 and the German LkPz-VIII, although it is just now beginning to show its age. American forces have not been involved in a major war in decades, but the force exchange policy (where small American units "trade places" with units in foreign armies) has enabled the American military (especially weapon designs, vehicles, and tactics) to benefit from combat experience.

The M9 does not use a remote turret like the AC-12 or LkPz-IX, as the designers seemed to prefer a more conservative "tank-like" silhouette. American designers also seem to prefer external missile racks to internal.

Many M9s have been fitted with the M2 Tethered Reconnaissance Drone and external launchers for anti-vehicle missiles equivalent to the Guiscard Manta-1, or anti-aircraft missiles such as the Guiscard Aero-27 or the *Ohu*.

Hundeman Industries Whisperdrone: In 2291, Hundeman Industries of Portland, Oregon contracted with the American government to produce a limited number of specially designed

HUNDEMAN INDUSTRIES WHISPERDRONE

This is a tethered reconnaissance drone, described more fully in the main text. The complete package includes the drone, 100 meters of tether, a high-pressure air pump (powered off the vehicle's power plant), and the associated controls and other electronics. An infantry version (M3 Tethered Reconnaissance Drone, Infantry-Portable) has just hit the market, and is available in limited quantities. It includes its own power supply and comes with carrying straps to enable one person to carry the unit. Weight: 20 kg (M2), 40 kg (M3) Signature: -2 Price: Both models are available in limited quantities on the open market for Lv8000.



M9 turret with external launch racks

M3A3 MACHINEGUN

Type: 12mm conventional machinegun Country: America Weight (empty): 24 kg Length: 740 cm Action: Single shot or bursts Ammunition: 12x95mm fixed cartridge ball Muzzle velocity: 950 mps Magazine: 100-round disposable cassette Magazine Weight: 7 kg ROF: 5 Aimed Fire Range: 100 meters Area Fire Burst: 75 (AFV= 1.5) Area Fire Range: 780 meters DP Value: 3 Price: Lv 950 (Lv4 for cassette of 100 rounds).

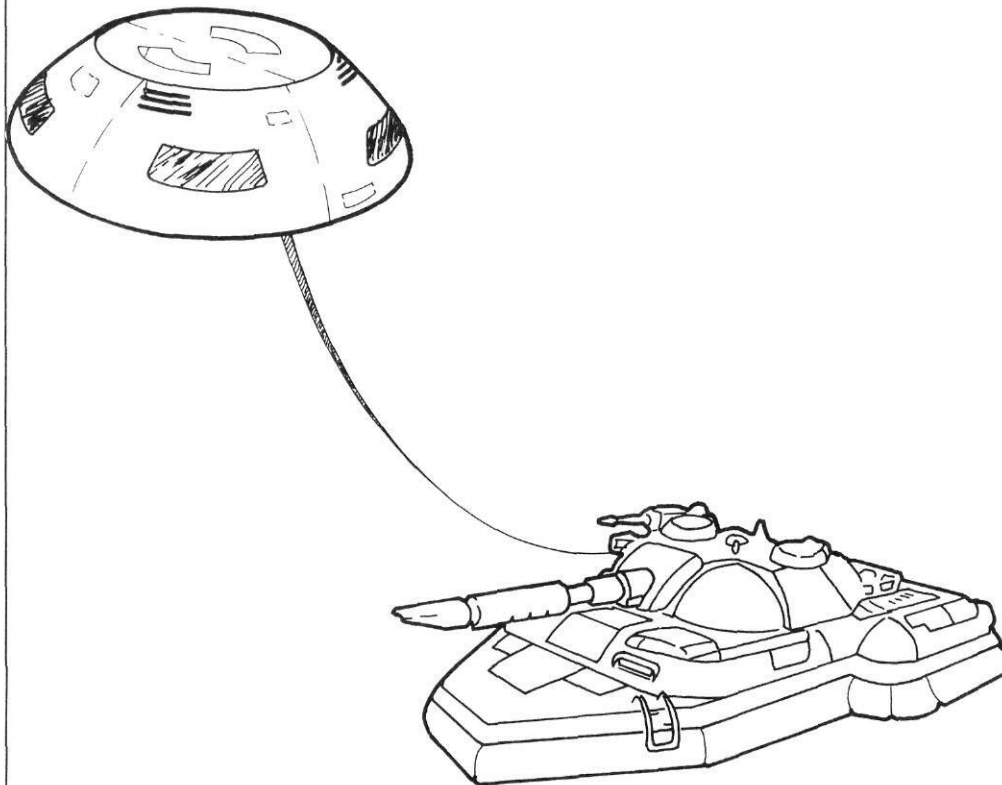

M9 with Whisperdrone

tethered reconnaissance drones for experimental use by American forces, and initial reception was so favorable that the government ordered the purchase of 9000 units three years later for retrofitting to its tanks and APCs (the vehicle-mounted unit is called the M2 Tethered Reconnaissance Drone in American service). The unit consists of a saucer-shaped disc with video/IR/UV sensors and a laser designator/rangefinder, connected to a vehicle by a fiber-optic datalink/power tether. The drone is lifted by high-speed hoverfans, which are powered by compressed air pumped through the combination air hose/lightguide datalink. The one-centimeter hose/lightguide is too small to register on most sensors at any distance, and the datalink does not require a line-of-sight connection between the drone and the master vehicle. The length of the hose (100 meters) is a limitation on the operational radius of the vehicle, but it is sufficient for most purposes. The drone is virtually noiseless (hence the name) and is very difficult to pick up on standard sensors because of the materials used in its construction, its small size, and its slim design.

Vehicles using the drone can take up a completely concealed position and still observe enemy movements, locate targets for popup fire, or serve as a target designator for laser-guided munitions.

Type: *Hover AFV-APC*
 Crew: *Driver, gunner, commander* Weight: *3200 kg*
 Armor: *Plenum: 2 All Faces: 6* Armament: *M707 plasma gun in remote mount* Aimed Fire Range: *1600 m* Range Finder: *+ / ROF: 5* Rounds Carried: *30* DP: *As tamped explosion (EP= 15); 1 Striker anti-vehicle missile launcher in remote turret with 5 internal reloads* Signature: *4* Evasion: *7* Sensor Range: *10 km* Cargo: *10 passengers and 100 kg* Max Speed: *220 kph* Cruising Speed: *200 kph* Combat Movement: *460 m* Off-Road Mobility: *Full* Power Plant: *0.6 MW MHD turbine* Fuel Capacity: *288 kg H₂* Fuel Consumption: *16 kg/hr* Endurance: *18 hr* Price: *The procurement price is Lv40,000 exclusive of armament.*

M24A3

(American)

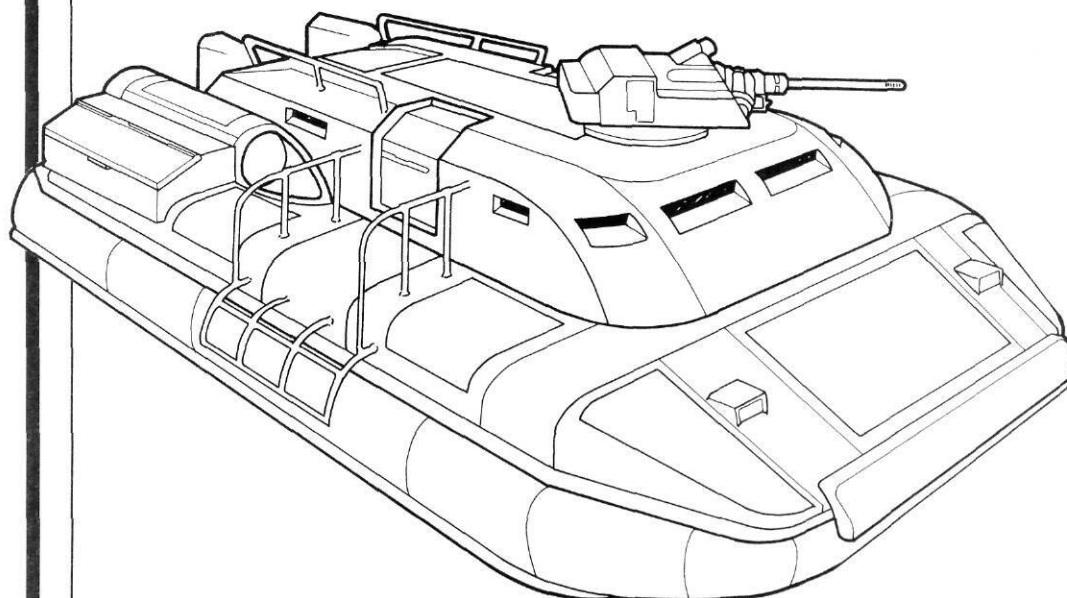

1 meter

Hover APC

STRIKER MISSILE

Type: *Vehicle-mounted anti-vehicle missile* Nation: *America* Launcher Weight: *90 kg* Missile Weight: *30 kg* Range: *72,000 m* Guidance: *Automatic following gunner lock-on* Homing Value: *17* Attack Angle: *Overhead* Damage: *EP=35* Launcher Price: *Lv3000* Missile Price: *Lv4000.*

M24A3

In common use with the armed forces of America and its armaments' customers, the M24A3 APC is a good solid machine, and its chassis is the basis of a good many American vehicles. The variants of the M24 series will be covered in some detail, as an example of what is available for it and for other similar vehicles.

The M24A3 retains two firing ports for passenger small arms (unlike more modern designs) and carries its main air intakes up front, an uncommon practice. The most unusual point about the M24A3 is the presence of handrails by the departure doors. Vehicle crews throughout the American Army usually remove these in the field (reinstalling them only for inspections), since it is commonly believed that they make the vehicle easier to detect by ground radar and other sensors. Although the American quartermaster corps maintains that this belief is untrue because of the EMR absorbent paint which is used on all vehicles, American soldiers still persist in the practice.

Variants: The major variants of the M24A3 hover APC are more fully detailed on pages 22-23,

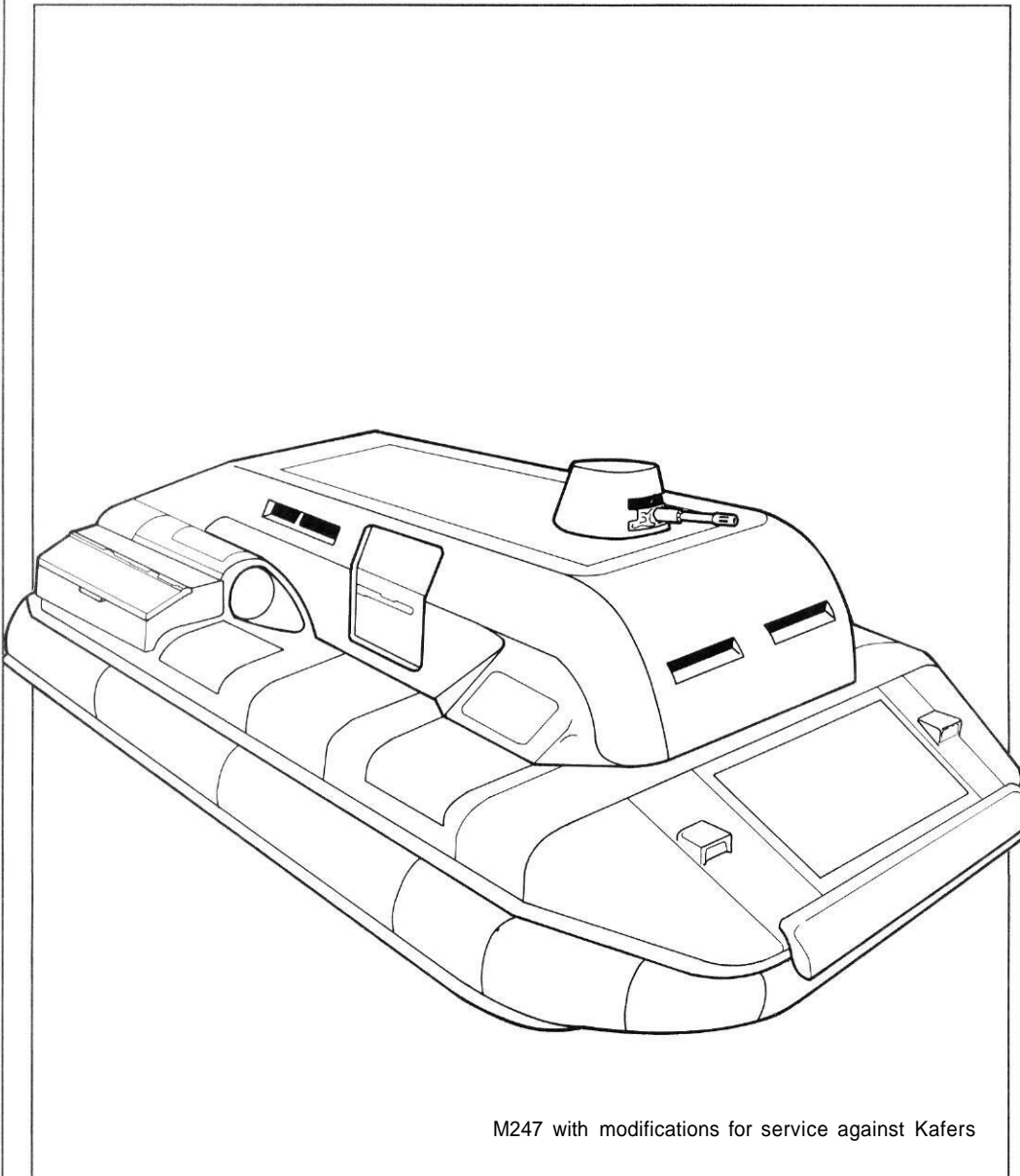

but here is a comprehensive list:

M247, Vehicle, Air Cushion, Casualty Evacuation: This is an ambulance version, capable of carrying five stretchers or 10 sitting wounded, and including one automed.

M241, Vehicle, Air Cushion, Communications: This is a specially equipped communications and communications security (ECM) vehicle.

M243, Vehicle, Air Cushion, Tactical Operations Center: This vehicle is specially equipped for command and control purposes.

M248, Vehicle, Air Cushion, Mobile Medical Unit: This vehicle contains six automed units, as well as other medical equipment, and is intended for use by brigade-level units and higher.

M386, Vehicle, Air Cushion, Multiple Rocket Launcher, 120mm: An SPA vehicle equipped with two eight-barrel box launchers for 120mm rockets.

M760, Vehicle, Air Cushion, Armored Utility: A cargo and general utility vehicle, intended for front-line support of troops in action, and therefore armed and armored.

Other variations on the basic chassis have been produced, but those above are the main lines.

M760

Type: *Hover cargo vehicle*
 Crew: *Driver* Weight: *3900 kg* Armor: *Plenum: 2* All Faces: *4* Signature: *4* Evasion: *7* Cargo: *2000 kg* Max Speed: *220 kph* Cruising Speed: *200 kph* Combat Movement: *460 m* Off-Road Mobility: *Full* Power Plant: *0.6 MW MHD turbine* Fuel Capacity: *306 kg H₂* Fuel Consumption: *17kg/hr* Endurance: *18 hr* Price: *Not generally available on the open market. The average procurement price is Lv38,000.*

M386

Type: *Hover artillery platform* Crew: *Driver, commander, gunner* Weight: *3900 kg* Armor: *Plenum: 2* All Faces: *6* Armament: *2 8-round box launchers for 12cm rockets on top rear hull* Aimed Fire Range: *30,000 m* ROF: *4* Guidance: *Automatic, after gunner lock-on, laser-homing, or free flight* Warhead: *APHE* DP: *As tamped explosion (EP=30)* Homing Value: *14* Warhead: *WASP* Burst Radius: *500 m* DP: *5* Warhead: *Obscuration* DP: *as explosion (EP=4), but no fragmentation. Creates a thick obscuration cloud which blocks thermal and visual images for 4 min. The cloud is 100 m long and 20 m high.* Signature: *4* Evasion: *7* Sensor Range: *70 km* Cargo: *200 kg* Max Speed: *220 kph* Cruising Speed: *200 kph* Combat Movement: *460 m* Off-Road Mobility: *Full* Power Plant: *0.6 MW MHD turbine* Fuel Capacity: *306 kg H₂* Fuel Consumption: *7 7kg/hr* Endurance: *18 hr* Price: *The procurement price is Lv42,000.*

Type: *Hover support APC*
Crew: *Driver, commander*
Weight: *3900 kg* Armor:
Plenum: *2* All Faces: *6* Ar-
mament: *Various (or none)*
Signature: *4* Evasion: *7* Sen-
sor Range: *10 km* Cargo:
70 passengers and 800 kg
Max Speed: *220 kph* Cruis-
ing Speed: *200 kph* Combat
Movement: *460 m* Off-Road
Mobility: *Full* Power Plant:
0.6 MW MHD turbine Fuel
Capacity: *306 kg H₂* Fuel
Consumption: *17 kg/hr* En-
durance: *18 hr* Price: *Not*
generally available on the
open market. The aver-
age procurement price
varies from Lv40,000 to
Lv50,000, depending on
specific equipment.

Hover APC Variants

(American)

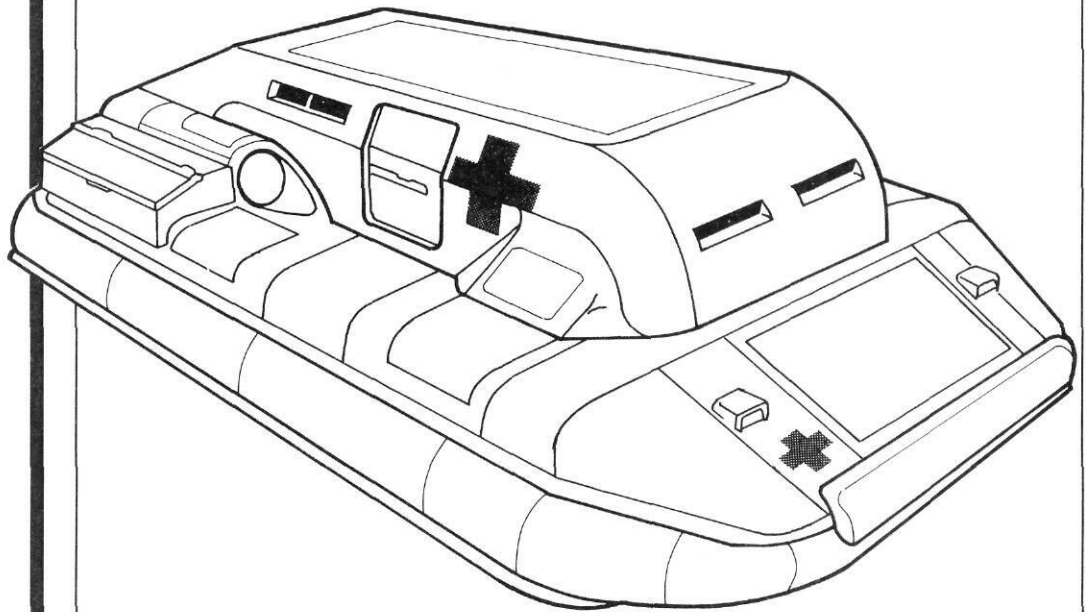

1 meter

Standard M247

M241

The M241 "Vehicle, Air Cushion, Communications" is a specially equipped communications and communications security (ECM) vehicle. Externally, it is identical to the M243, but it differs in its internal components. The M241 is equipped to continue battlefield communications, to intercept and decode enemy message traffic, and to ensure the security of friendly messages.

M243

The M243 "Vehicle, Air Cushion, Tactical Operations Center" is specially equipped with extra computers and/or military analysis computer chips, tactical map displays, and communications equipment for command and control purposes. Depending upon the specific mission requirements, the M243 can be equipped as a tactical operations command center, an administrative and logistical planning vehicle, or an intelligence analysis center. One or more of these vehicles will be found at company-level headquarters and higher command and administrative units.

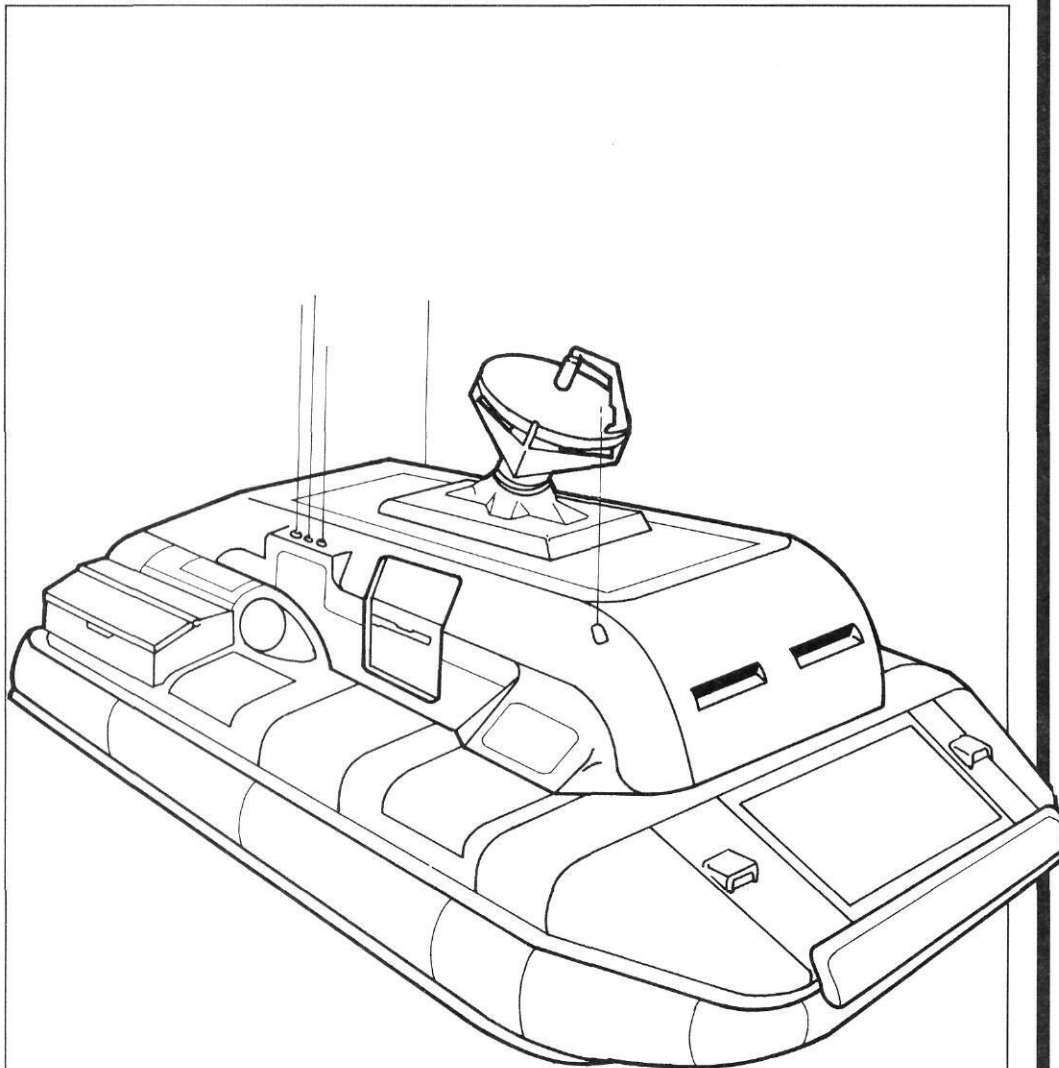

M247/M248

Type: *Hover Medical Vehicle*
 Crew: *Driver, two medical technicians (M247), Driver, physician/surgeon, two medical technicians (M248)*
 Weight: *3900 kg* Armor: *Plenum: 2 All Faces: 6*
 Armament: *When armed, various machineguns. AGLs, or light plasma guns in field-expedient mounts are installed* Signature: *4* Evasion: *7* Sensor Range: *10 km*
 Cargo: *1 automed unit and 5 stretcher cases or 10 sitting wounded (M247). 6 automed units and 200 kgs (M248)* Max Speed: *220 kph* Cruising Speed: *200 kph* Combat Movement: *460 m* Off-Road Mobility: *Full Power Plant: 0.6 MW MHD turbine* Fuel Capacity: *306 kg H₂* Fuel Consumption: *17 kg/hr* Endurance: *18 hr* Price: *Not generally available on the open market. The average procurement price is Lv44,000 (M247). Lv50,000 (M248).*

M248

The M248 "Vehicle, Air Cushion, Mobile Medical Unit" contains six automed units, as well as other medical equipment and supplies for treating and diagnosing the wounded, and is intended for use by brigade-level medical units and higher. It retains the normal armor, but is not armed, in keeping with its non-combatant status. The M247 is externally identical as it comes from the factory, but internally it has only one automed unit; the remaining space is allocated to seated wounded or stretcher cases not requiring automed treatment. If casualty victims can be stabilized and given medical treatment within the so-called "golden hour," their prospects for recovery are fairly good. Just about anything short of major brain damage can be healed if proper medical treatment is begun soon enough.

In combat with the Kafers, medical vehicles are often armed and the distinctive (and easily spotted) red cross markings painted over with a camouflage pattern, since the Kafers have no qualms about firing on medical vehicles. Likewise, stretcher bearers and medical personnel in action against the Kafers are usually armed as well.

Type: *Hover APC* Crew: *Driver, gunner, commander*
 Weight: 4000 kg Armor: Plenum: 2 All Faces: 10 Ar-
 mament: 2 *DunArmCo Mini-12 Machineguns* in ball
 mounts, one on either side of the forward hull; *CLP-1A*
Plasma gun in remote turret.
 Aimed Fire Range: 1600 m Range Finder: +1 ROF: 5
 Rounds Carried: 30 DP: As *tamped explosion (EP = 15)*;
 25mm conventional auto-cannon in remote turret on
 top of main turret. Signature: 5 Evasion: 6 Sensor Range:
 10 km Cargo: 6 passengers and 2000 kg Max Speed:
 200 kph Cruising Speed: 180 kph Combat Move-
 ment: 420 m Off-Road Mobility: Full Power Plant:
 0.5 MW hydrogen fuel cell Fuel Capacity: 270 kg H₂
 Fuel Consumption: 15 kg/hr Endurance: 18 hr
 Price: Average open market price for Kangaroo IVs with
 only twin machineguns and a 25mm autocannon mount-
 ed is Lv45,000. Average open market price of a
 CLP-1A is Lv9500. The CLP-1A fires 41 x 77mm
 175 MW photonic core plaser cells from a 10-round
 hopper. Each 10-round disposable clip weighs 38 kg
 and costs Lv500.

Kangaroo IV

(Australian)

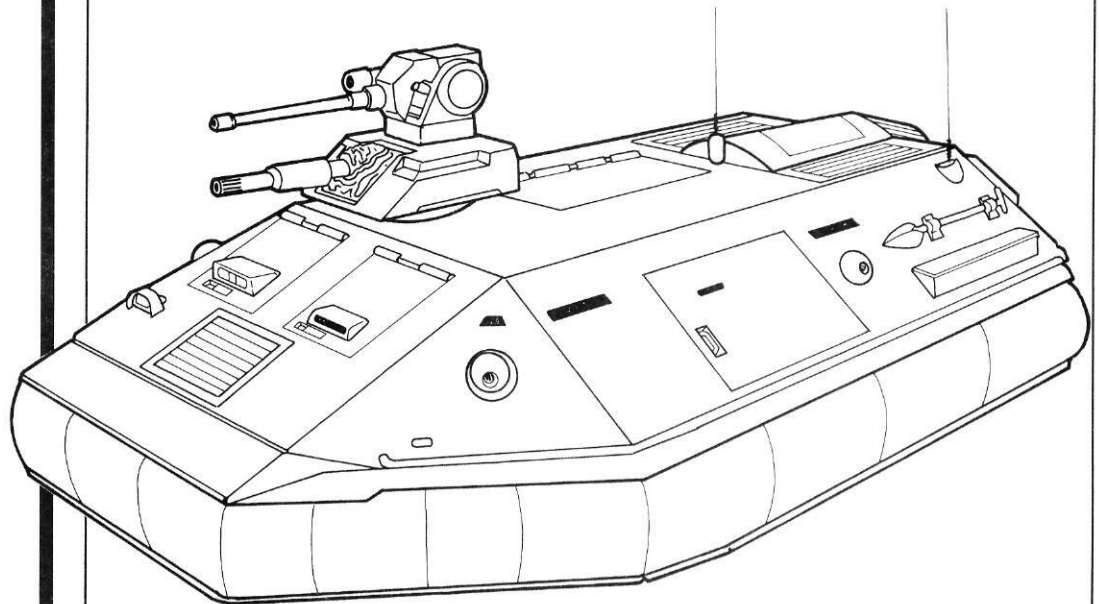

Hover APC

KANGAROO IV

The Kangaroo IV (nicknamed the 'Roo) is an obsolete but still serviceable military ACV-APC based on an older Bavarian design. Originally produced to meet an Australian army specification issued in 2264, the Kangaroo IV has been replaced in Australian service by more modern types and is now widely exported as surplus. Many local militia forces and mercenary units are equipped with versions of the Kangaroo IV (some of them so heavily reworked as to be barely recognizable).

The version shown above is the APC variant armed with the French CLP-1A, as used on *Aurore* by the forces of *Tanstaaf* (most notably of late by the various "Ramrod" RRTs (Rapid Response Teams)). Dozens of variants have been constructed on the basic chassis by various purchasers, including anti-armor, communications, command, medevac, air defense, cargo, and close support MRL artillery variants.

Variations: The most common variant of the 'Roo is the version armed with the CLP-1A plasma gun, which is in use with 16 national armies, seven colonial armed forces, and (at last

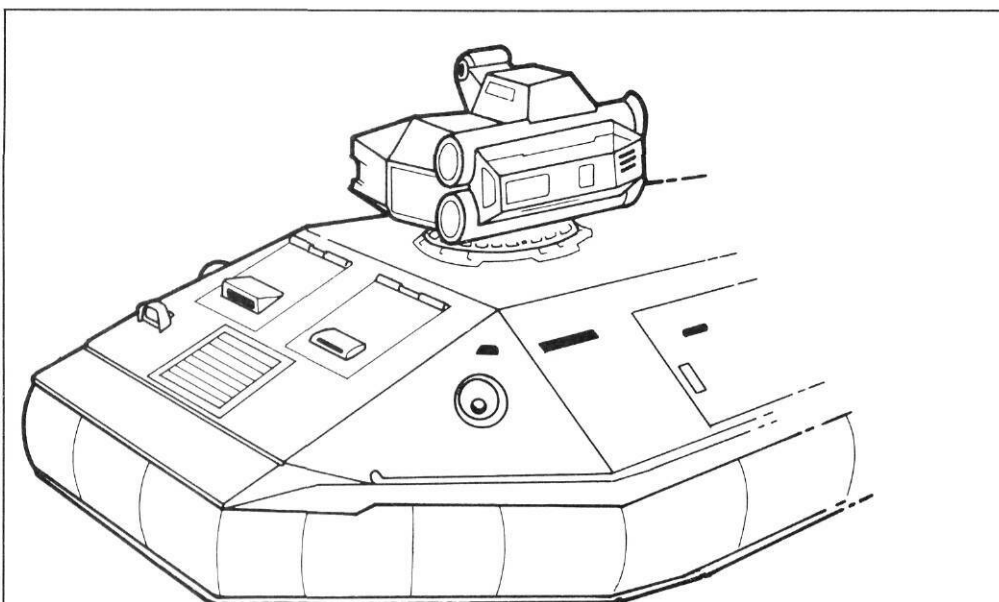

Kangaroo IV-DS

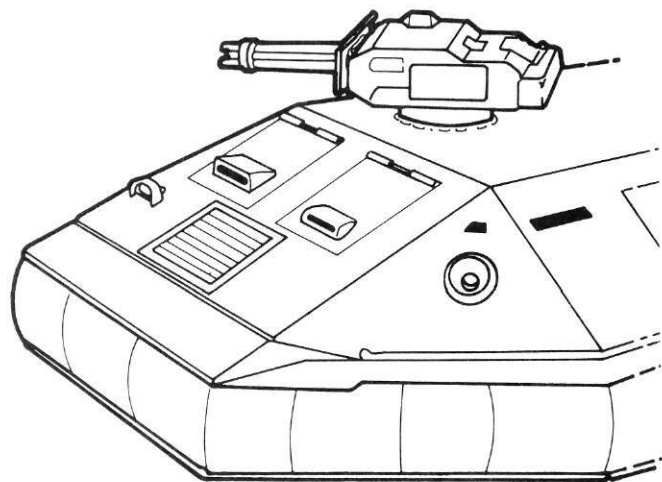

Kangaroo IV-AD

**MK-8
TRIPLE PLASMA GUN**

Type: 40 MW three-barreled plasma gun Action: Automatic Ammunition: 30x90 40 MW photonic core plasma cell Ammunition Weight: 1 kg Magazine: 600 rounds in disposable drum magazine, three drums carried in vehicle hull as reloads (manual reloading necessary) ROF: 3 Aimed Fire Range: 2000 meters DP Value: As tamped explosion (EP = 6).

count) four independent mercenary units.

Kangaroo IV-AD (Air Defense): This air defense version was produced in limited numbers for the Australian military and for export, but it proved to be so popular that several manufacturers make a nice living doing 'Roo conversions. Equipped with the Australian Mark-8 triple-barreled plasma gun in a remote turret, the vehicle is an excellent antipersonnel vehicle, as well as a good anti-aircraft system. Most mercenary users, depending on their employers for anti-aircraft protection, purchase these vehicles without the sophisticated (and costly) radars, intending them solely for antipersonnel use.

Kangaroo IV-DS (Direct Support): Produced by the Belgian firm of Aerotech SA, this direct support version of the 'Roo is sold mainly to colonial armed forces and mercenary units looking for fast-moving close support or anti-vehicle artillery. The vehicle is identical to the ordinary 'Roo except for the remote turret, which has been replaced by one containing two launchers for the obsolete Aero-12 missiles and sighting and range-finding equipment (other weapons are the same). Eight reloads are carried internally, as well as machinery for automatic reloading (not shown).

Type: *Tracked main battle tank* Crew: *Driver, gunner, second gunner, commander* Weight: *27,000 kg* Armor: *Suspension: 8 Front: 250 Overhead: 100 Other Faces: 60* Armament: *1 Model 8 120mm MD gun in elevating turret Aimed Fire Range: 5000 m Range Finder: +3 ROF: 1 Rounds Carried: 60 DP: WO; 2 Model 3 plasma gun, 1 coaxial with main gun and 1 in forward hull ball mount Aimed Fire Range: 1600 m Range Finder: + 1 ROF: 5 Rounds Carried: 150 DP: As tamped explosion (EP= 15); 1 12mm machinegun in plasma gun ball mount; 1 7.5mm machinegun in pintle mount at commander's cupola; 10 Guiscard Aero-12 missiles and 4 Guiscard Martel missiles in box launcher on the rear deck, no reloads carried* Signature: *10* Evasion: *0* Sensor Range: *20 km* Cargo: *500 kg* Max Speed: *100 kph* Cruising Speed: *60 kph* Combat Movement: *220 m* Off-Road Mobility: *Full* Power Plant: *2 MW MHD turbine* Fuel Capacity: *900 kg H₂* Fuel Consumption: *45 kg/hr* Endurance: *20 hr* Price: *Current market price is Lv819,640, including the main gun but no missiles.*

Type 27

(Manchurian)

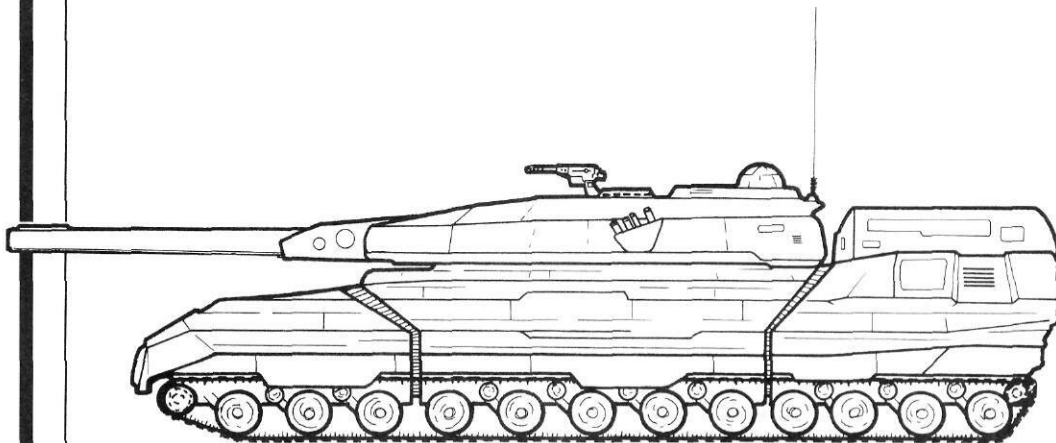

Main Battle Tank

TYPE 27

The Manchurian Type 27 is an older model AFV dating from the 2260s, and the design is finally beginning to show its age as one century ends and another begins. The major distinguishing feature of the Manchurian Type 27 is the unique elevating turret (which is sometimes called a "jack-turret"), which enables the vehicle to fire its main armament from the protection and concealment of a completely hull-down position. The entire turret and turret basket lifts up out of the central hull segment as a single assembly, and the unit can be rotated while in this position. The main gun's firing angle is adjusted in a conventional manner inside the turret assembly.

The commander and the first gunner sit in the turret and rise up with it. The turret's profile and special EMR absorbent coating provide ample concealment until the main gun opens fire, at which point sonic disruptions often reveal the vehicle. After one or more shots (the number depends upon the tactical situation), the turret is retracted to avoid return fire. The vehicle can then fire its missiles (usually using another unit to locate and designate a target with its RF/TD

TUNGHU MISSILE

Type: *Obsolete multipurpose 12cm rocket* Nation: *Manchuria* Aimed Fire Range: *20,000 m* ROF: *4* Guidance: *Automatic, after gunner lock-on, or free flight* Warhead: *APHE DP: As tamped explosion (EP = 30)* Homing Value: *10.*

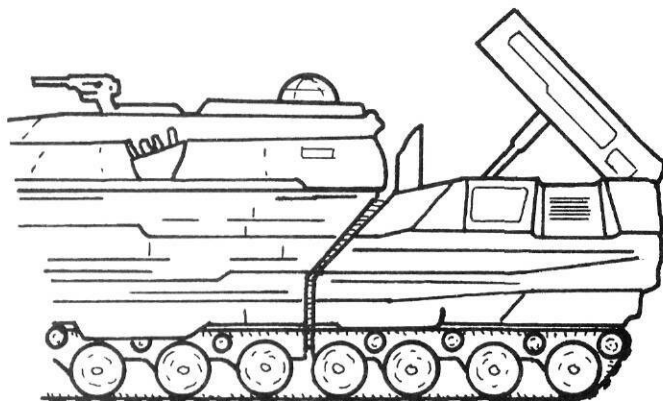

Type 27, Missile launcher in firing position

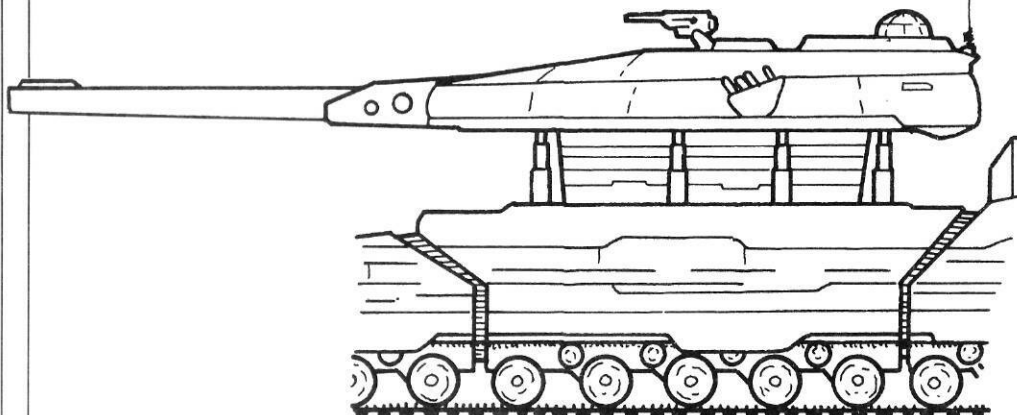

Type 27, turret elevated

laser), or move to another firing position. Alternatively, the tank can elect not to reveal its position by firing, and remain concealed, using its RF/TD (Range Finder/Target Designator) laser to paint a target for another vehicle's missiles (or for its own).

In order to reduce the load on the turret-lift hydraulics, and to reduce the overall profile of the turret, the Manchurian designers chose to install a missile launcher on the vehicle's rear deck instead of on the turret or internally. When lowered, the launcher slides into position behind a protective plate which keeps foreign matter away from the missiles.

Years ago, the Manchurians chose to amortize the costs of designing and gearing up for manufacture of the Type 27 by aggressively marketing it to every conceivable buyer. For this reason, the Type 27 is the most common vehicle in the "show units" of large ground tanks, which many armies maintain for prestige purposes. At Lv819,640, the Type 27 is very competitive with the CC-21.

Variants: Because of the size and specialized nature of the Type 27, there are not many variations on the basic vehicle: The Manchurians found no need for anything else.

Type: *Hovertank* Crew: *Command driver, gunner*
 Weight: *10,000 kg* Armor: *Plenum: 25 Front: 90 All Other Faces: 60* Armament: *7cm mass driver gun in remote overhead mount (Aimed Fire Range: 2000 m Range-finder: +3 ROF: 5 Rounds Carried: 700 DP: 90), 5.5mm machinegun in remote overhead mount (coaxial with main gun), 2 Luchs missile launchers with 10 missiles carried internally* Signature: *3* Evasion: *8* Sensor Range: *12 km (+2)* Cargo: *500 kg* Max Speed: *220 kph* Cruising Speed: *200 kph* Combat Movement: *460 m* Off-Road Mobility: *Full* Power Plant: *2 MW MHD turbine* Fuel Capacity: *275 kg H₂* Fuel Consumption: *45 kg/hr* Endurance: *6 hr* Price: *Not generally available on the open market. 2298 procurement cost was 398,300 talers each (approximately Lv300,000).*

LkPz-IX (German)

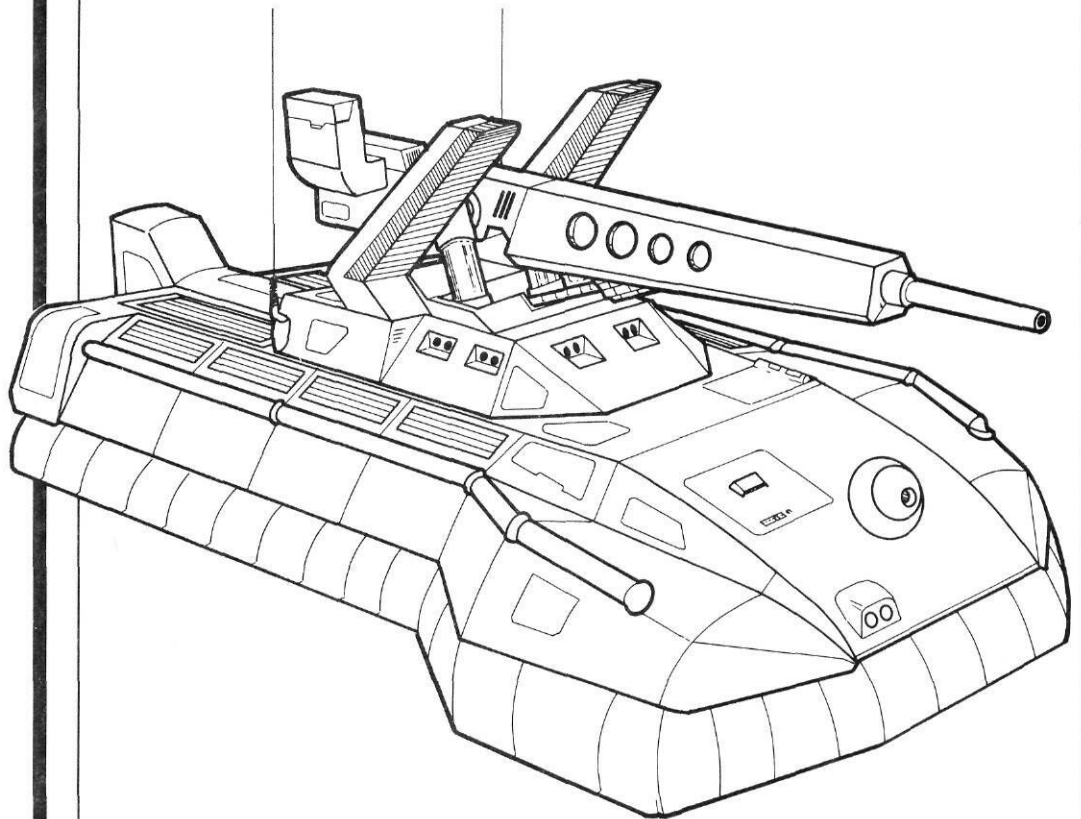

Hovertank

LKPZ-IX

Hovercraft (*Luftkissen*) are generally referred to in German service as "Lukis." The LkPz-IX Luki is the most recent version in service with the German Army. A vehicle this sophisticated is rarely encountered on the frontier except in a very hot situation. Like most combat hovercraft, it possesses a limited jump-jet capability, which uses 10 minutes of endurance for every minute of flight. Speed is quartered in jump mode.

The vehicle's extremely low hull and the unique shape of its turret give a distinctive silhouette, but the vehicle's EMR absorbent paint and its extensive ECM make it one of the more survivable vehicles on the modern battlefield. This feature, combined with a good weapon and a high speed, make it one of, if not *the*, finest hovertank presently in service.

History: The Luki IX made its debut in the War of German Reunification and proved a rude surprise to French commanders. Although its armor protection is inferior to the AC-12, and its complement of missiles less extensive, the Luki IX's gun is about equal to the French tank. However, the main difference is that the vehicle's higher speed enables it to be used in rapid,

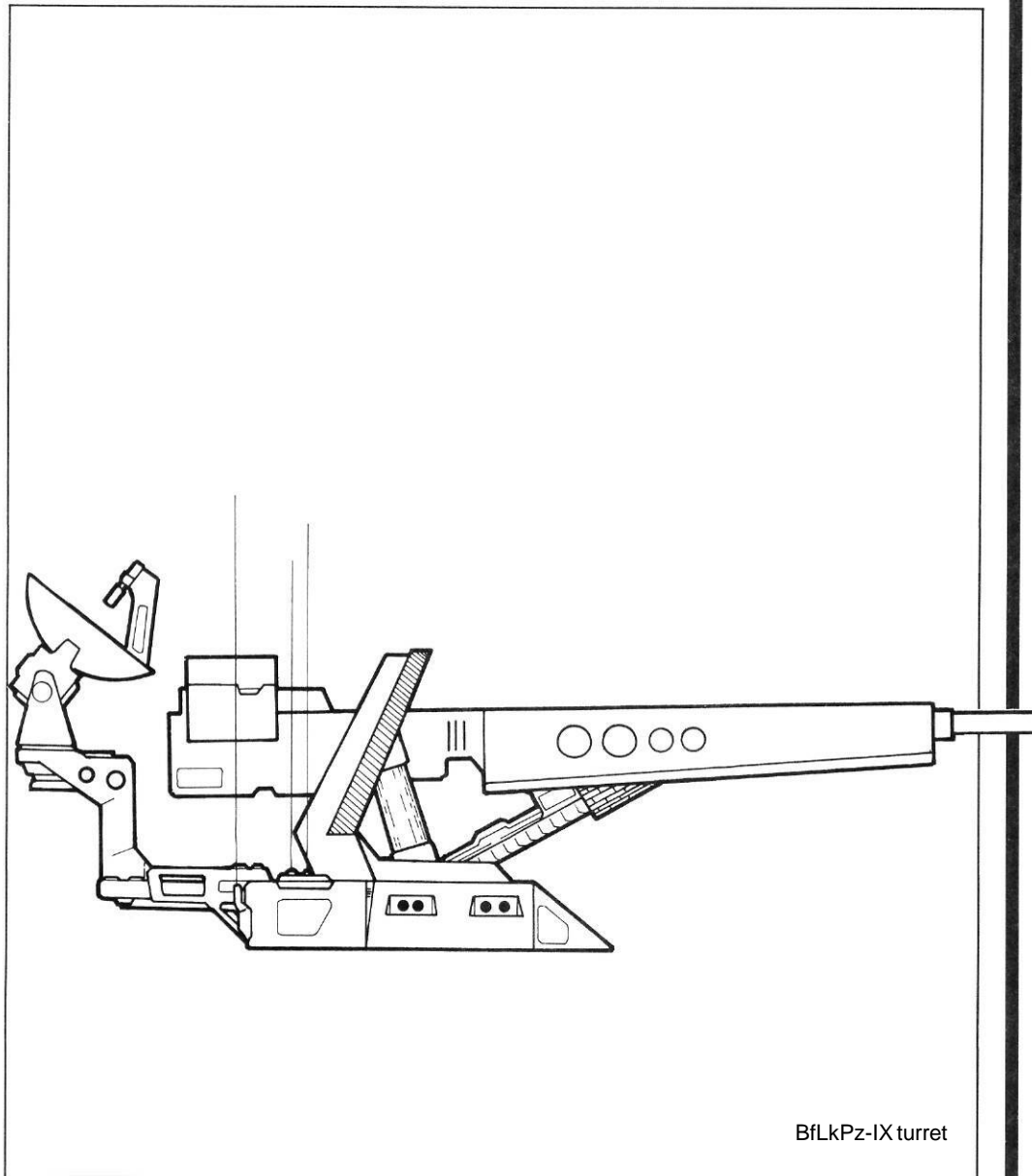

AVAILABILITY

The LkPz-IX is not that much more expensive than other hovertanks, but demand has kept it somewhat hard to get. Players will undoubtedly want to buy several. Referees should remember that the players are bidding against governments in the contest to obtain LkPz-IXs, and require a major effort on the part of the players. Reknown, political influence, and other factors should play a part in the quest for supertanks. Remember that what people acquire too easily they value too little.

VARIATIONS

The Luki IX has not been in service for very long, and the German Army has hundreds of surplus Luki VIII hulls to use as a basis for any support vehicles it needs (see pages 34-35). Therefore, there has been no need for the Germans to develop many variations in the basic Luki IX design. Aside from the command version (the LkPz-IX Befehlspanzer, recognizable by its added satellite up-link dish), the only major modifications to the basic design have been the installation of different guns by armies wishing to standardize ammunition. The most common guns used in these refittings are the American 7cm MD gun (from the M9 hovertank) and the French 6.5cm MD gun (used on the AC-12).

deep-penetration missions after mech infantry units make the initial breakthrough.

Luki IXs are in service with the armies of Australia, Azania, the newly independent Flanders, and several other armies. As part of the German contribution to the defense of the French Arm, several units of Luki IXs have been dispatched to various worlds (of which *Kampfgruppe Reiner* on Aurore is the most well-known. Because of its scarcity, the vehicle is not often found in mercenary units, although many commanders would give their eye-teeth to have even one.

A one-on-one slugout between the Luki IX and the French AC-12 (the Luki's closest competitor for best hovertank) has never occurred, and there is considerable discussion concerning which tank is superior. Discussions on the two tanks generally boil down to the old "speed versus firepower" argument that dates back to the year one. In one way, the arguments are nothing more than comparing apples and oranges, but the defenders of the Luki IX point out that the Germans won the war, and that has to count for something. In any case, neither the Luki IX nor the AC-12 are available in great numbers on the open market, and mercenary units and the smaller colonial forces who want hovertanks generally have to settle for second best.

Type: *Battle suit assault squad carrier* Crew: *Driver, gunner, commander* Weight *5000 kg* Armor: *Plenum: 2* Front Overhead: *20* Other Faces: *70* Armament: *Jaschonek Fabricant A-7 vehicle plasma gun in a front-mounted remote turret* Aimed Fire Range: *1600m* Range Finder: *+ 1* ROF: *5* Rounds Carried: *30* DP: *As tamped explosion (EP= 15)* and a *coaxial 7.5mm MG91 machinegun in a front-mounted remote turret; and rear-mounted remote turret containing a GW-120 30mm AGL and a single Luchs missile* Signature: *5* Evasion: *6* Sensor Range: *10 km* Cargo: *11 passengers and 400 kg* Max Speed: *200 kph* Cruising Speed: *180 kph* Combat Movement: *420 m* Off-Road Mobility: *Full* Power Plant: */ MW MHD turbine* Fuel Capacity: *264 kg H₂* Fuel Consumption: *22 kg/hr* Endurance: *12 hr* Price: *Not generally available on the open market. The German government's 2298 procurement cost was 380,300 talers each (approximately Lv285,000).*

GfPzTr-XIII (German)

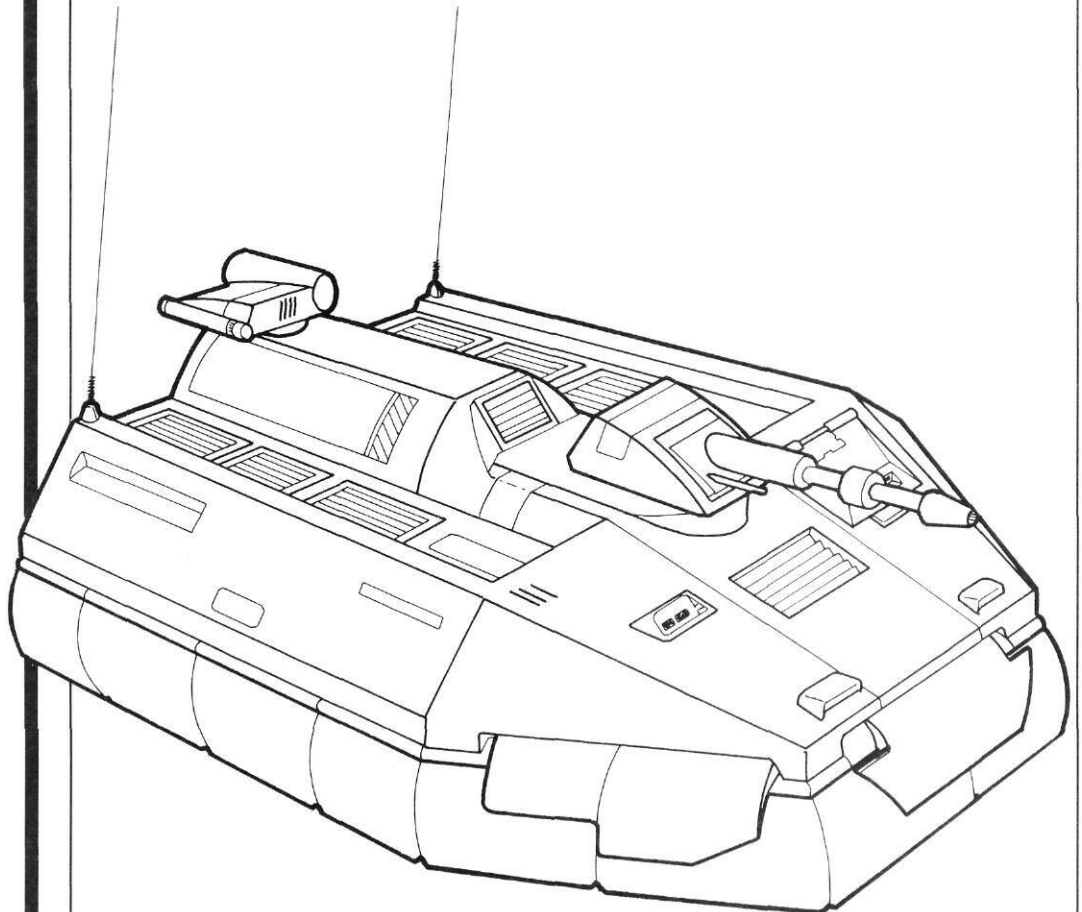

Hover APC

GFPZTR-XIII

The *Gefectspanzertrager-XIII* is a German-built APC designed to provide transport and support to an assault squad of eight infantry equipped with battlesuits (*Gefectspanzertruppen*). Soldiers drop through hatches into the plenum chamber (landing in a crouch), and the vehicle moves on over them. The battlesuits provide sufficient protection for the soldiers when the skirts pass over them, and the soldiers then leap up and move out. A poetically-minded soldier noted the resemblance to the ancient Greek myth of soldiers springing from soil sown with dragon's teeth: the GfPzTr-XIII is nicknamed *Drachen* (dragon) by the soldiers who ride in it, who have also come to call themselves *Drachenzahntruppen* (dragon-tooth soldiers).

The GfPzTr-XIII was developed out of the experience of Bavarian military officers during the Central Asian War, when it was determined that a new form of assault troops were needed to overwhelm strongpoints before their defenders had time to react. After the war, a number of experiments were begun, but progress was delayed and the War of German Reunification broke out before the design could be perfected. When the Bavarian military became the German mili-

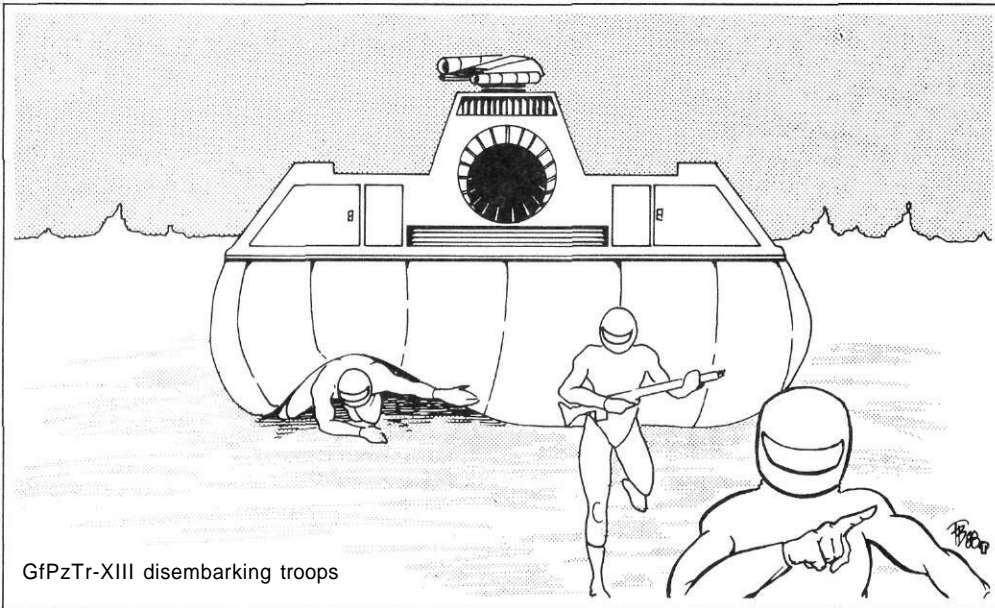

GfPzTr-XIII disembarking troops

tary, work was resumed. The GfPzTr-XIII and the associated equipment and tactics (*Sturmtaktik*) are the result.

Like most modern hover APCs, the GfPzTr-XIII is capable of limited jump-jet leaps for flying over difficult terrain (at a cost of 10 minutes of duration time for each minute spent in jump mode). Speed is quartered while in jump mode. Going to jump mode while deploying soldiers will result in serious injury, even with the battlesuits.

Sturmtaktik: Battlesuits provide excellent protection, but are not powered and are fatiguing to wear, hence the need for a transport vehicle of some sort. Normal APCs can be used, but the need for a lightning-quick assault on a strongpoint meant that some more rapid means of unloading the troopers without unduly exhausting them was needed. Experiments showed that battlesuit infantry could be safely run over by hovercraft and remain ready for instant action (unprotected infantry tend to take a half a minute or so to recover, but they too suffer no permanent ill effects). During a *Sturmtaktik* assault, the APCs drive to the site and open fire, halting for a few seconds to drop their troops, and then moving on. The troopers, often dropped in the middle of the objective, rapidly overwhelm the defenses using the vehicles for covering fire. Close communication and good fire discipline are required. To help with identification, panels in a bright and highly visible color (changed for each assault) are affixed to each trooper (at the shoulder, elbow, and knee). The assault troops and their supporting vehicles simply fire at anyone who is not wearing the right color panel (camouflage is not a consideration in a *Sturmtaktik* assault). Battlesuit troops used in conventional fashion omit the color panels. *Sturmtaktik* assaults require rapid support by conventional infantry, since the *Drachenzahntruppen* tire quickly, and need to be relieved as quickly as possible. Twelve minutes has been shown to be the period of peak fighting efficiency for battlesuit troopers.

GfPzTr-XIIIs and their associated battlesuit troops are usually used to spearhead assaults. They are targeted on command centers, logistical hubs, or weak points in a defensive line. Battlesuit assaults are quickly supported by more conventional mechanized infantry forces. Mobile forces are sent through these holes punched in the enemy lines to penetrate the enemy rear area, and to enable the attackers to maintain the pace of the offensive and achieve greater operational leverage. During this phase, the battlesuit troops are allowed to rest and recover. They are then used to attack vital targets in the rear area, keeping the enemy confused, and prohibiting them from coalescing around any new defensive line.

Kafers: In action against the Kafers, the application of these tactics has produced excellent results. A surprise assault by the heavily armed and armored *Drachenzahntruppen* can usually overwhelm an objective before the Kafers can react sufficiently to raise their intelligence levels.

MG91 LIGHT MACHINEGUN

Type: 7.5mm conventional machinegun Country: America Weight (empty): 7 kg Length: 110 cm Action: Single shot or bursts Ammunition: 7.5 x 35mm fixed cartridge ball Muzzle velocity: 960 mps Magazine: 150-round disposable cassette Magazine Weight: 2 kg ROF: 5 Aimed Fire Range: 800 m (WOO on mount) Area Fire Burst: 20 (AFV=2) Area Fire Range: 600 m (780 meters on mount) DP Value: 0.7 Price: Lv880 (Lv2 for cassette of 100 rounds).

GW-120AGL

Type: 30mm vehicle-mounted automatic grenade launcher Ammunition: Any 30mm propelled grenade Magazine: 2x 40-round internal hoppers (gunner can select from either magazine at will) ROF: 2 Aimed Fire Range: 500 m DP Value: Dependent on grenade used.

Type: *Hover tank* Crew: *Driver, gunner, commander*
Weight: 6500 kg Armor: Plenum: 2 All Faces: 6 Armament: 6cm mass driver gun in turret Aimed Fire Range: 1800 m Range Finder: +3 ROF: 5 Rounds Carried: 720 DP: 80 5.5mm machinegun coaxial to main gun, 5.5mm machinegun on pintle mount at commander's position Signature: 4 Evasion: 7 Sensor Range: 70 km Cargo: 500 kg Max Speed: 220 kph Cruising Speed: 200 kph Combat Movement: 460 m Off-Road Mobility: Full Power Plant: 0.5 MW hydrogen fuel cell Fuel Capacity: 270 kg H₂ Fuel Consumption: 75 kg/hr Endurance: 18 hrs Price: *The vehicle is now obsolete, and large numbers came on the surplus market after the end of the War of German Reunification. Average price (including armament) was 400,000 talers each (approximately Lv300,000).*

LkPz-VIII

(German)

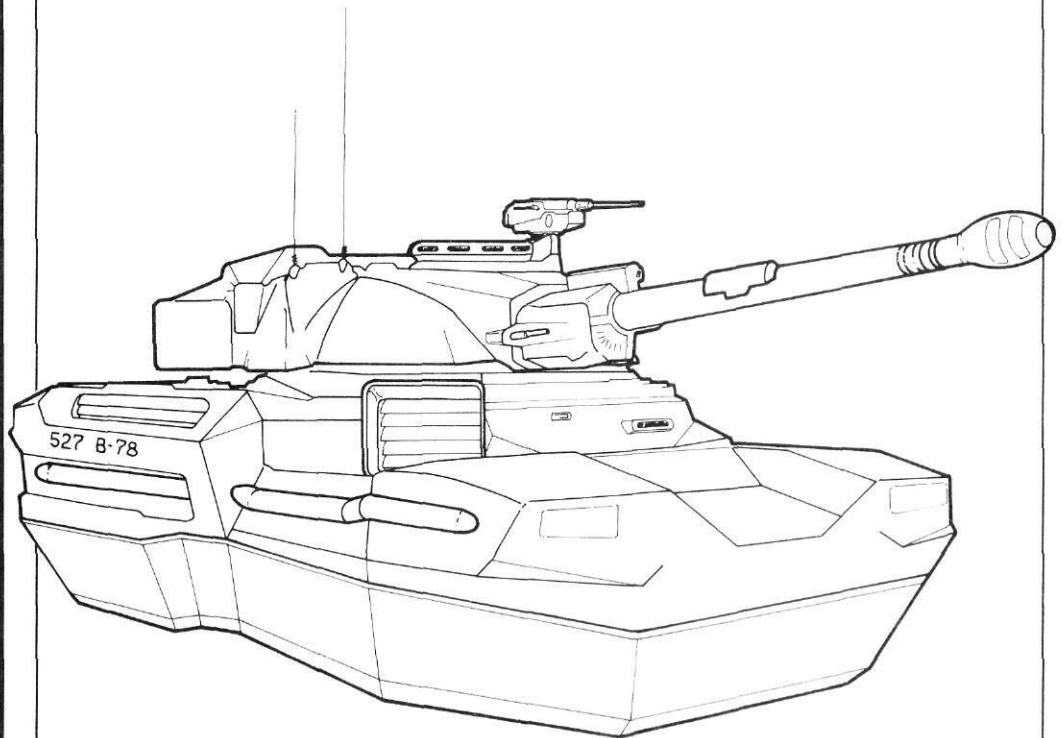

1 meter

Hovertank

LKPZ-VIII

During the War of German Reunification, the LkPz-VIII was already considered a second class vehicle, outclassed by the French AC-12, the American M9, and the Germans' own LkPz-IX. Because Luki IXs could not be produced in sufficient numbers to re-equip all of the German armored and mechanized formations, however, the Luki VIII saw service against the French with a number of frontline German units.

After the war, the German Army re-equipped its armored forces, and even though a large number of Luki VIII chassis were refitted for other duties (such as the LkRw-1 2 referred to below), and 600 were sold to the United Arab Republic in late 2299, a large number are available on the arms market as a less expensive (and slightly inferior) alternative to the French AC-12 or American M9.

The LkPz-VIII has only limited jump capability, and can lift itself only two meters into the air at a cost of 1 5 minutes of fuel for each minute spent in jump mode. This is useful for crossing linear obstacles such as fences and creeks, but is not very good for crossing cliffs and the like. Its

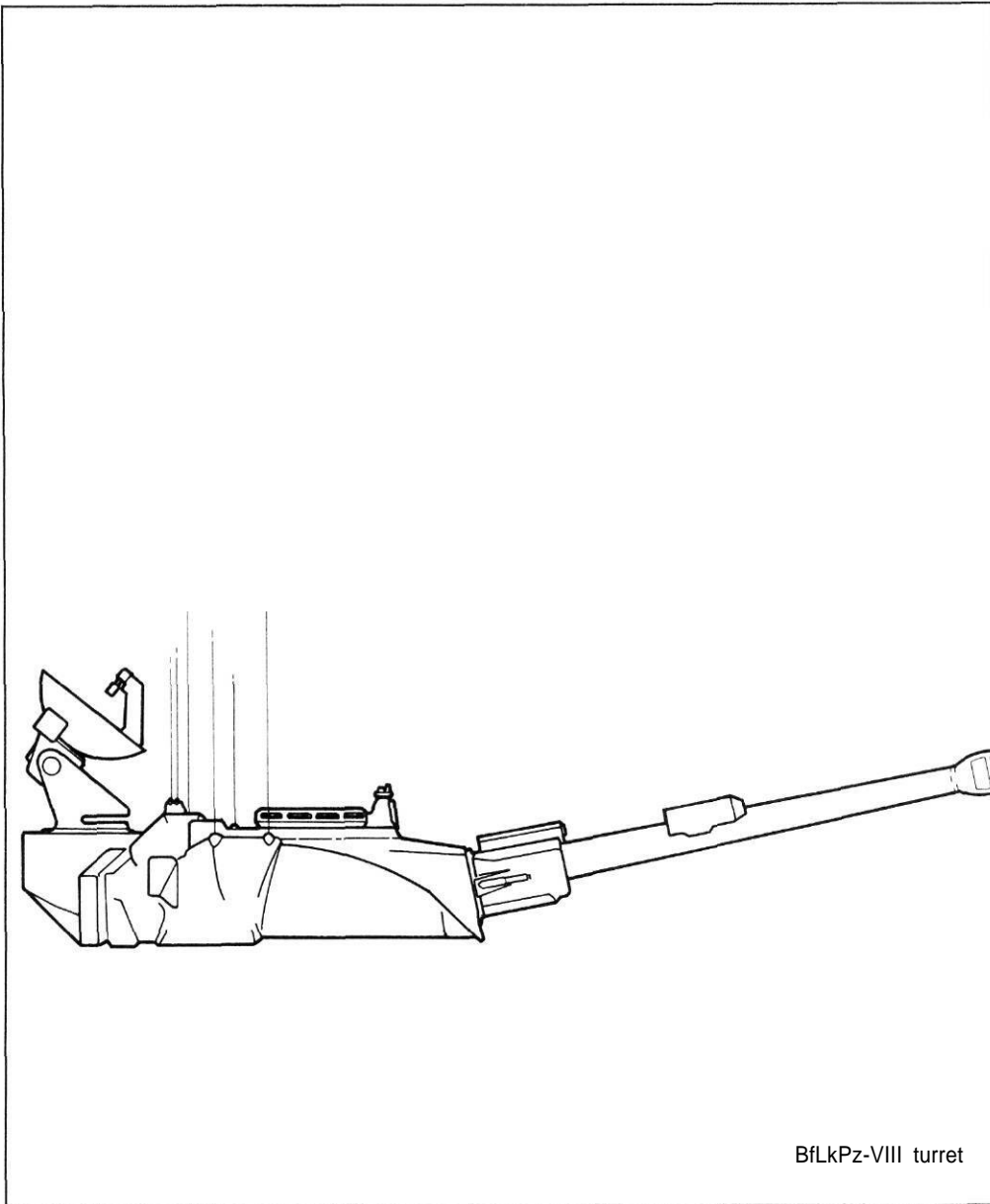

OHU

Type: *Vehicle-mounted air defense missile* Nation: Germany Launcher Weight: 90 kg Missile Weight: 100 kg Range: 200 km (*flight time to maximum range is 3 mm.*) Guidance: *Automatic following gunner lock-on* Homing Value: 29 Attack Angle: *Direct DP: As tamped explosion (EP= 10)* Launcher Price: Lv3000 Missile Price: Lv20,000.

6cm gun is only slightly inferior to the 7cm model in the Luki IX, however.

Variants: The main variations to the basic Luki VIII chassis are the different gun systems fitted by some armies. A nation, wishing to standardize its ammunition, may replace the 6cm MD gun with another model of similar size. Some vehicles have been fitted with plasma guns or other weapons. As an experiment, Mexico installed an internal anti-vehicle missile launcher in seven Luki Vllls, replacing the main gun. A few users have fitted an external *Ohu* missile launcher (two missiles, no reloads carried) to each side of the turret in addition to the basic weapon.

Of course, the secondary armaments vary greatly as well (machineguns, antipersonnel mines, etc.).

Availability: As hundreds of these vehicles have flooded the surplus market since the War of German Reunification, the vehicle is second only to the AC-8 in terms of popularity with colonial armored forces and independent mercenary units. Small quantities of surplus LkPz-Vlls in good condition can be purchased from a variety of independent weapons dealers (like most national governments, Germany refuses to deal with buyers who want fewer than 50-100 vehicles).

Type: *Hover Armored Recovery Vehicle* Crew: *Driver, commander, 3 hover technicians* Weight: *4000 kg* Armor: *Plenum: 2 All Faces: 4* Special Equipment: *High capacity crane fitted to upper rear hull, tow cables, hoses and fittings* Signature: *4* Evasion: *7* Cargo: *500 kg* Max Speed: *220 kph* Cruising Speed: *200 kph (80 with vehicle in tow)* Combat Movement: *460 m* Off-Road Mobility: *Full* Power Plant: *0.5 MW hydrogen fuel cell* Fuel Capacity: *270 kg H₂* Fuel Consumption: *15 kg/hr* Endurance: *18 hrs* Price: *Not generally available on the open market; 2298 procurement price was 305,000 talers each (Lv228,750). This price was for a full factory refit of a bare-bones LkPz-VIII chassis undertaken for the German Army.*

BgLkPz-VIII

(German)

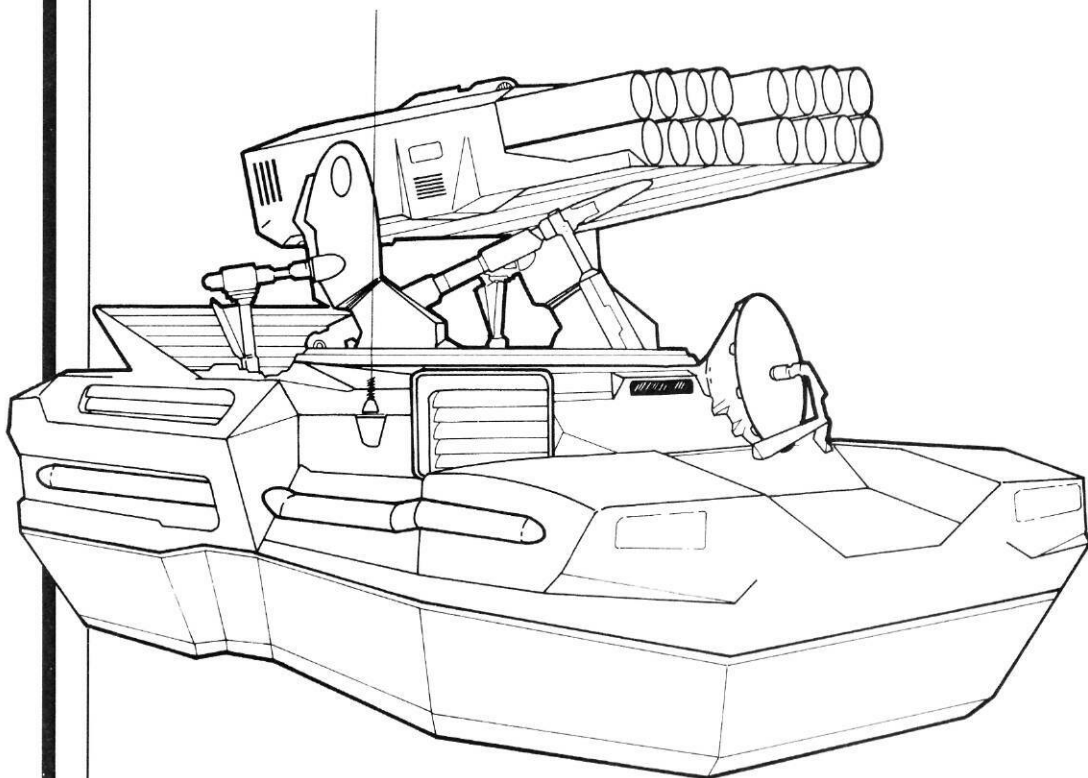

1 meter

Hover ARV

BGLKPZ-VIII

The Bergeluftkissenpanzer-VIII is an armored recovery vehicle on a Luki VIII chassis. Like all ARVs, the BgLkPz-VIII is not intended to act as a mobile workshop, but is designed to get the damaged vehicle away from the combat zone and to a rear area repair shop quickly.

The crane is capable of lifting 24 tons when the vehicle is grounded (skirts deflated and leveling struts deployed), and is used for repair and replacement of engines or turrets on damaged vehicles. In towing a damaged vehicle, hoses are run from the ARV's large blowers to the damaged vehicle (any damaged skirts are replaced by temporary ones), and air is pumped into the plenum chamber (it is not necessary to tow a damaged vehicle with intact skirts and a functional engine—these can make it to the repair site on their own). The vehicle can then be towed in an ordinary fashion. Wheeled vehicles are simply hooked to the ARV by conventional tow cables.

When towing, neither the ARV nor the towed vehicle are capable of jet-assisted jumps, and a relatively level path is required. Without a tow, the vehicle is capable of "leaping" the normal obstacles for a Luki VIII.

LkRw-12 MRL

(German)

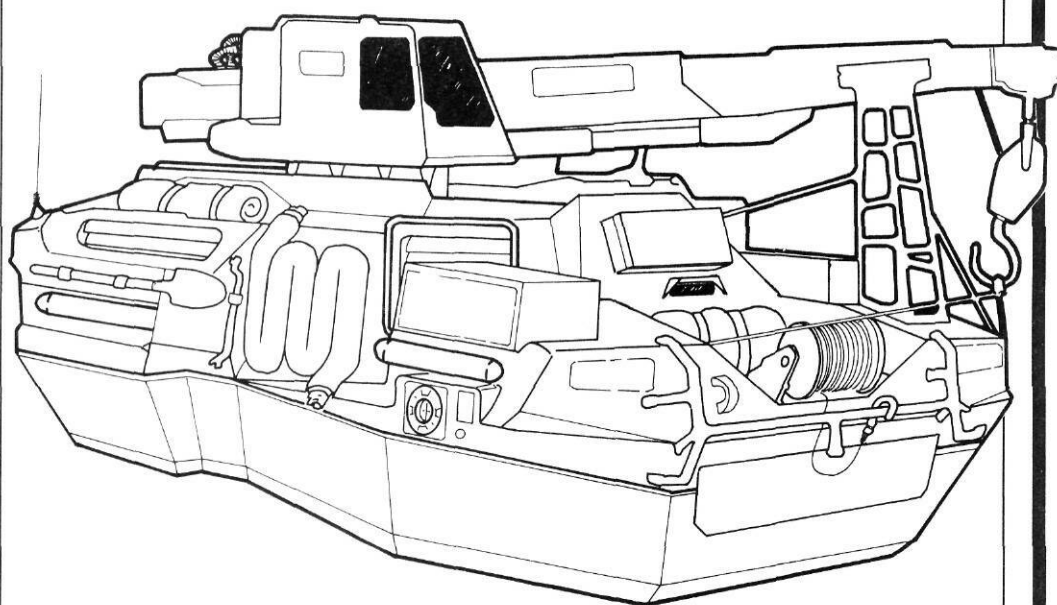

Hover Artillery Platform

LKRW-12

Another variant on the basic Luki VIII chassis, the LkRw-12 is a hover platform for 12cm artillery rockets. It combines good mobility and long-range firepower with moderate armored protection. The two banks of rockets each contain a mix of APHE, WASP, and Obscuration warheads. All rockets can be fired in free-flight or laser-homing mode. The rockets are low-flying flat-trajectory projectiles, which make it nearly impossible to locate the firing platform by electronic sensing devices before the vehicle has moved on.

Commonly deployed in batteries of one to three vehicles, a battery's fire will usually be dedicated to the support of a specific fighting unit. Each battery will have a headquarters vehicle and a number of forward observer teams attached to the supported organization (sometimes in their own vehicles, sometimes in the supported unit's vehicles). Ideally, one vehicle of a battery is always in a position to fire while the others are moving into new positions after having fired.

Few colonial or mercenary forces require firepower of this magnitude, although large numbers of LkRw-12s and many similar weapons are in service against the Kafers in the French Arm.

Type: *Hover artillery platform*
Crew: *Driver, gunner, commander*
Weight: 3300 kg
Armor: Plenum: 2 All Faces: 6
Armament: 2 8-round box launchers for 12cm rockets on top rear hull
Aimed Fire Range: 30,000 m
ROF: 4
Guidance: *Automatic, after gunner lock-on, laser-homing, or free flight*
Warhead: *APHE*
DP: *as tamped explosion (EP=30)*
Homing Value: 74
Warhead: *WASP*
Burst Radius: 500 m
DP: 5
Warhead: *Obscuration*
DP: *As explosion (EP=4), but no fragmentation. Creates a thick obscuration cloud which blocks thermal and visual images for 4 mm. The cloud is 700 m long and 20 m high*
Signature: 4
Evasion: 7
Sensor Range: 70 km
Cargo: 500 kg
Max Speed: 220 kph
Cruising Speed: 200 kph
Combat Movement: 460 m
Off-Road Mobility: *Full*
Power Plant: 0.5 MW hydrogen fuel cell
Fuel Capacity: 270 kg H₂
Fuel Consumption: 75 kg/hr
Endurance: 18 hrs
Price: *Not generally available on the open market: 2299 procurement price was 265,520 talers each (approximately Lv200,000), exclusive of armament. This price was for a full factory refit of a bare-bones LkPz-VIII chassis undertaken for the German Army.*

Type: *Obsolete French hovertank* Crew: *Driver, gunner, commander* Weight: *8000 kg* Armor: *Plenum: 5* Front Overhead: *80* Other Faces: *30* Armament: *8cm mass driver gun in hull sponson (Aimed Fire Range: 2000m Range Finder: +2 ROF: 4 Rounds Carried: 60 DP: 80), 25mm autocannon in remote turret, 7.5mm machinegun in remote turret, 1 Guiscard Aero-12 missile launcher in remote turret, with 8 missiles carried internally* Signature: *6* Evasion: *6* Sensor Range: *12 km (+ 1)* Cargo: *500 kg* Max Speed: *270 kph* Cruising Speed: *200 kph* Combat Movement: *460 m* Off-Road Mobility: *Full* Power Plant: *1.6MW MHD turbine* Fuel Capacity: *240 kg H₂* Fuel Consumption: *40 kg/hr* Endurance: *6 hr* Price: *Not available.*

AC-8 (French)

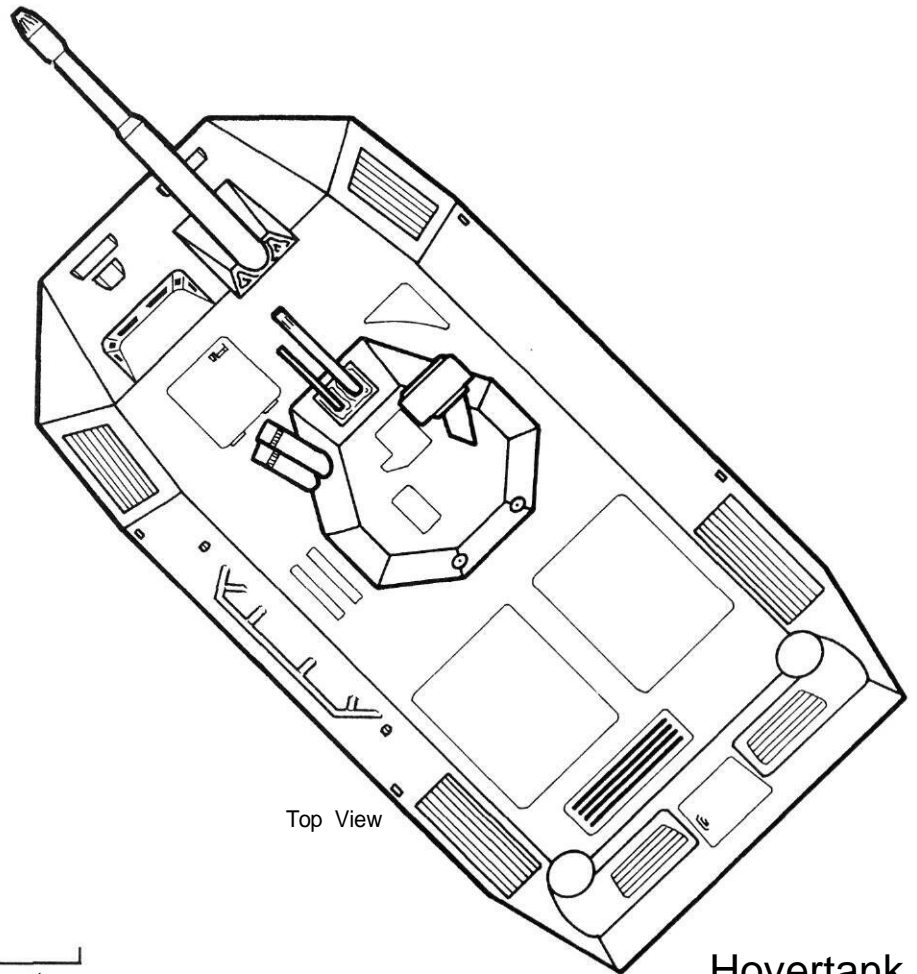

AC-8 (AERO CHAR, 8 TONS)

The AC-8 is representative of many similar tanks of Central Asian War vintage, most of which are no longer in service with front-line units. Mismanaged overproduction at the end of the war, coupled with bloc obsolescence, has caused the AC-8 to be widely exported, and it is still used by some French colonial troops.

The vehicle uses vectored-thrust jets which give it a limited jump-jet capability, enabling it to negotiate cliffs and similar obstructions. Each minute in jump-jet mode uses 10 minutes of fuel, and speed is quartered. Its 8cm gun and missile complement give it a respectable punch, and its speed is almost up to that of the best modern hovertanks. However, units equipped with AC-8s still made up a sizable proportion of French armored strength at the start of the War of German Reunification, and they were to be overmatched by their opposition.

The main problems with the AC-8 are: the high silhouette necessitated by the sponson gun location (which makes it tougher to assume hull-down firing positions), and its poor endurance (the result of an excessively fuel-hungry engine). Export versions have a simplified electronic

AVAILABILITY

The last recorded transfer of AC-8s was in the fall of 2299. A total of 56 vehicles, with armament and spares, were sold to the government of Chile for Lv200,000 each. Independent weapons contractors (of the sort which a nongovernmental buyer might seek out), sell small numbers (less than half a dozen) of AC-8s for between Lv300,000 and Lv500,000.

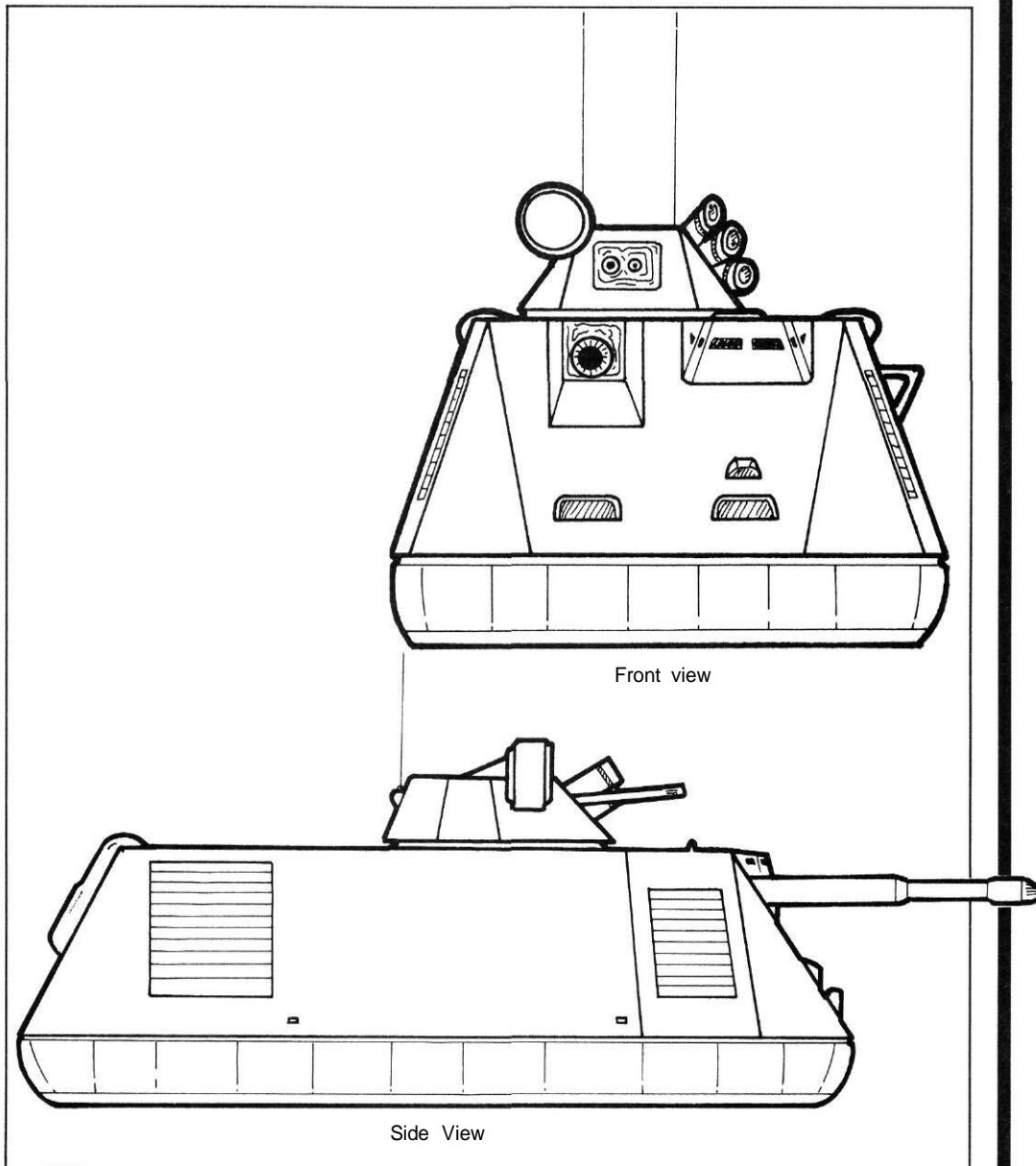

counter-measures suite, and their sensors are somewhat behind state-of-the-art as well. Despite these drawbacks, the AC-8 was a good vehicle in its day and is still capable of holding its own. As one expert observed, "The AC-8 was 15 years ahead of its time—it's just 30 years old now."

With the unavailability of the top-line AC-12 and LkPz-IX hovertanks, older vehicles such as the AC-8 are the most common hovertank encountered on frontier worlds, either with local governmental forces or with mercenary units.

Variants: The AC-8 is one of a number of vehicles (like the Australian Kangaroo IV and the German LkPz-VIII) that have achieved a high level of popularity on the open market. Because of this, it is often used as a basic chassis for a bewildering variety of short-run variants and conversions by various colonial forces and independent mercenary companies. The simplest (and most numerous) variants are those which have been fitted with different main guns as part of an army-wide ammunition standardization program. The AC-8's main gun may be supplemented by the addition of externally-mounted air defense or anti-vehicle missile launchers, or these launchers may replace the main turret entirely. Several armies have produced 12cm MRL versions.

Type: *Hovertank* Crew: *Driver, gunner, commander*
 Weight: 12,000 kg Armor: Plenum: 20 Front and Overhead: 100 Other Faces: 40 Armament: 1 6.5cm mass driver gun in remote overhead mount Aimed Fire Range: 2000 m Range Finder: +3 ROF: 6 Rounds Carried: 130 DP: 100; 7.5mm machinegun coaxial with main gun; 25mm autocannon on telescoping sensor pod; 1 Manta-1 missile launcher with 4 missiles carried internally; 1 Martel missile launcher carried on either side of the remote turret, no reloads carried Signature: 4 Evasion: 6 Sensor Range: 12 km (+2) Cargo: 500 kg Max Speed: 200 kph Cruising Speed: 180 kph Combat Movement: 413 m Off-Road Mobility: Full Power Plant: 2.4 MW MHD turbine Fuel Capacity: 385 kg H₂ Fuel Consumption: 55 kg/hr Endurance: 7 hr Price: Current French Army procurement price is Lv497,842 each.

AC-12 (French)

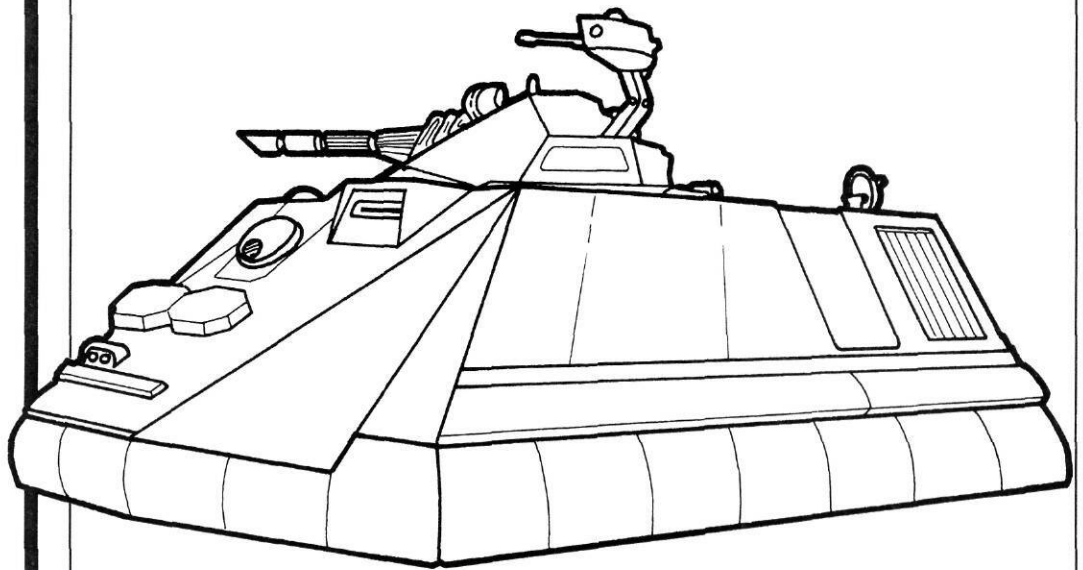

Hovertank

AC-12 (AERO CHAR, 12-TON)

The AC-12 enjoyed its combat debut during the War of German Reunification and racked up impressive kill ratios against German Mark VIII Lukis whenever it met them on relatively even terms.

History: Development began on the AC-12 shortly after the Central Asian War. In the years following that war, a replacement for the aging AC-8 was sought. Using the same basic chassis design, the vehicle was up-gunned and up-armored, and production began on what was to be an interim version, the AC-10 (see sidebar).

Both the AC-12 and AC-10 incorporated the "schnorkel" remote firing platform, incorporating a 25mm autocannon and a laser range finder/target designator. The schnorkel could be used to peek over terrain while the tank remained concealed from view. The vehicle could then execute a pop-up firing maneuver, engage the target with its 25mm cannon, or vector a laser-guided missile (either one of its own or from another source) to the target.

Baptism of Fire: About a third of the front-line armor units of the French Army had been re-

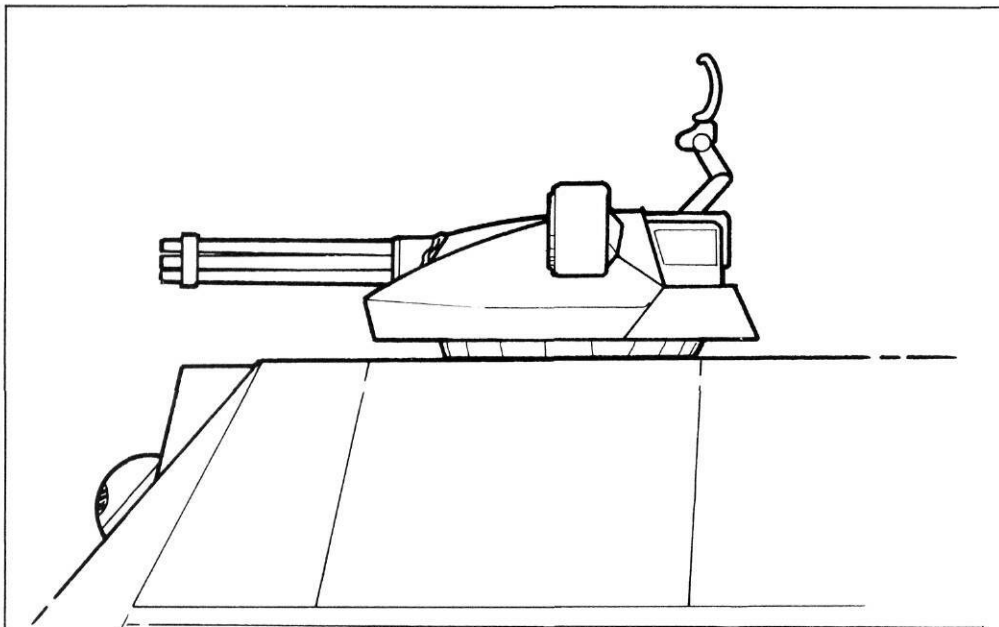

AC-12, General Support variant

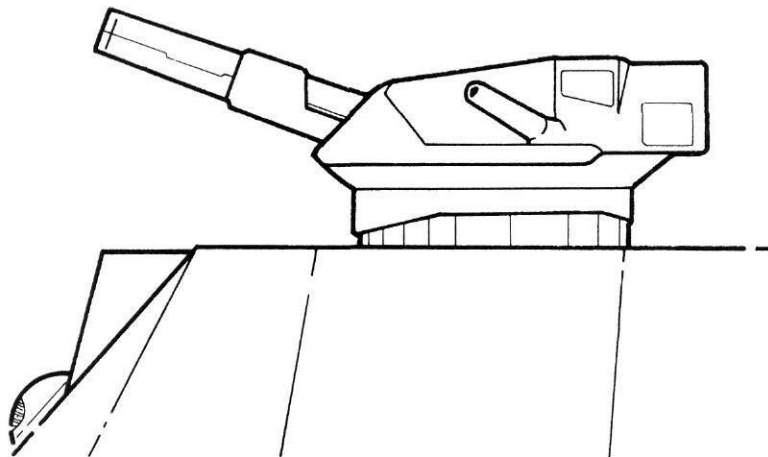

AC-12, Air Defense variant

AC-10

An interim version between the AC-8 and the AC-12, the AC-10, proved inadequate (it was underpowered and slow), and they are no longer in production. A few French units and some colonial armored units are still equipped with them, but the vehicle is gradually being replaced and is not available on the open market. The AC-10 is identical to the AC-12 except for the following: Max Speed: 140 kph
Cruising Speed: 120 kph
Combat Movement: 280 m
Off-Road Mobility: Full
Power Plant: 1.6 MW MHD turbine
Fuel Consumption: 35 kg/hr
Endurance: 11 hr.

VARIANTS

Factory versions of the AC-12 include a command version (with additional command and communications equipment, and a satellite/lite uplink in addition to the normal tight-beam communications dish), and a support vehicle (with an MRL launching rack in place of the remote turret). Numerous field-expedient weapon packages and sensor suites have been retrofitted by some colonial armies partly equipped with AC-12s (in the interests of army-wide weapon uniformity).

equipped with AC-12s by 2292, but many of these were in service elsewhere than on Earth. Of the armor units facing the new Germany, only about 10 percent were equipped with the new AC-12s. This was adequate for the first few months of the war, since Germany was hesitant to open a major offensive on Earth. Within a few months, however, it was apparent that France would never surrender until a knockout blow could be delivered, and a major offensive was undertaken to capture Paris. The French Army suffered a major defeat at the hands of the new German *Sturmtaktik* but managed to stop the offensive at the River Somme by herculean efforts. This was enough to bring down the government, and France was forced to sue for peace.

The AC-12's adherents maintain that the tank's superior armor protection and powerful main armament make it one of, if not the best, hovertanks currently in service. It was out-manuevered by the Germans, they claim, never outfought. The tank is definitely superior to the LkPz-VIII, which it defeated on several occasions during the war. There has never been a fair one-on-one matchup between AC-12s and LkPz-IXs, and expert opinion is divided as to which would win. Nevertheless, AC-12s are much desired, and demand still exceeds supply.

Some models are fitted with an additional 7.5mm machinegun on a pintle mount at the commander's station, usable against airborne vehicles or ground troops.

Type: 8-wheel armored car
Crew: Driver, gunner, commander
Weight: 2500 kg
Armor: Suspension: 0.3
Front: 8 All Other Faces: 4
Armament: 1xCLP-1A plasma gun in remote turret
Aimed Fire Range: 1600 m
Range Finder: +1 ROF: 5
Rounds Carried: 30 DP: As tamped explosion (EP= 15); 1 coaxial 7.5mm machinegun
Signature: 2 Evasion: 2
Sensor Range: 15 km (+2)
Cargo: 250 kg Max Speed: 140 kph
Cruising Speed: 100 kph
Combat Movement: 300 m
Off-Road Mobility: Halved
Power Plant: 0.2 MW hydrogen fuel cell
Fuel Capacity: 100 kg H₂
Fuel Consumption: 6 kg/hr
Endurance: 16 hr
Price: Lv35,000.

ABR-76

(French)

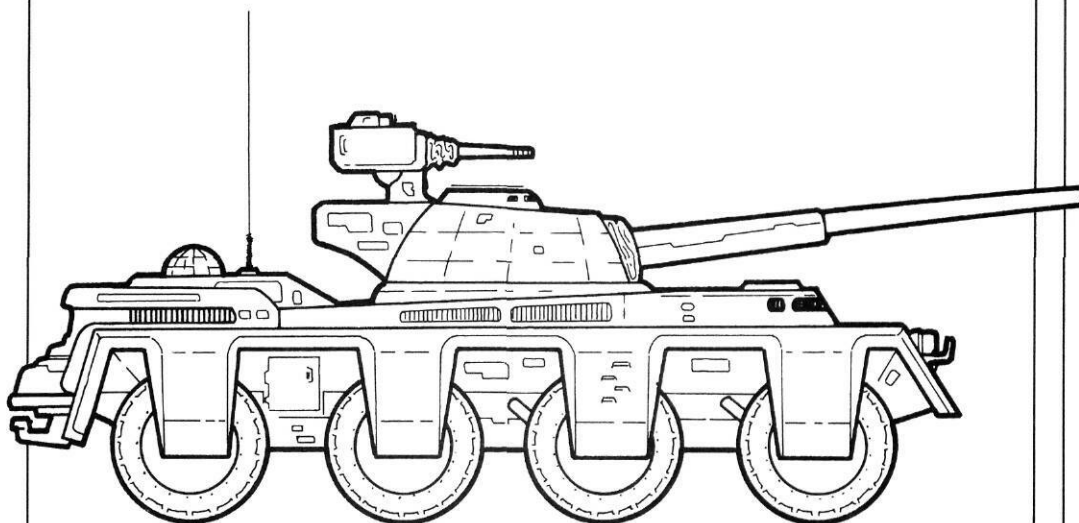

Side View

Wheeled Armored Car

ABR-76 Armored Car (*Auto-Blindes de Reconnaissance*)

The ABR-76 is a handy little wheeled AFV which combines good cross-country mobility in most terrain with respectable firepower and light armored protection. Its excellent sensor suite further suits it to light wheeled recon and patrol missions.

This series of vehicles was originally intended solely for the export market, but hundreds were sent directly from the factories to the front lines during the War of German Reunification, where the vehicle proved itself fully capable of survival in all but the most hazardous environments. (It is not a tank, however, and should not be used as one.)

It is currently readily available, and is in service with numerous colonial armed forces and militias. The chassis is a rugged little workhorse and has been the subject of numerous modifications, both by the manufacturer and by colonial factories.

ABR-76M: The mortar variant of the ABR-76 was designed to produce an inexpensive support vehicle for export to colonial forces. The chassis is identical to the standard ABR-76, but the turret (and its attendant training machinery) is not installed, and a larger hole is cut into the

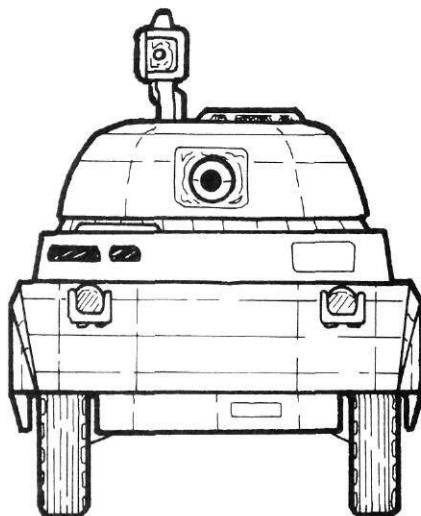

Front view

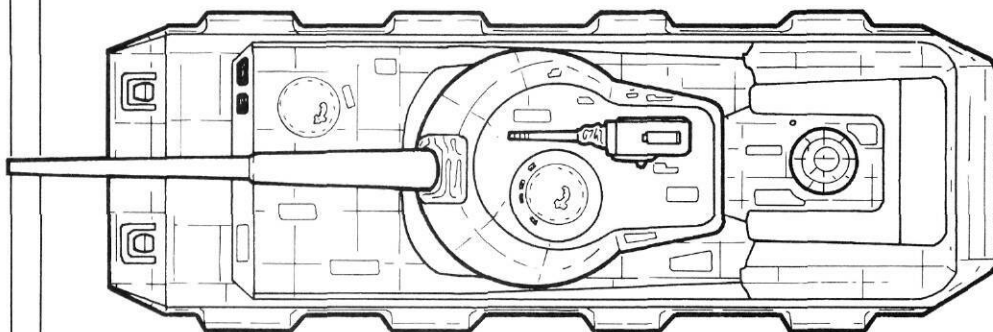

Top View

**SCHNEIDER
105MM MORTAR**

Type: 105mm clip-fed mortar Nation: France Tube Weight: 750 kg Range: 5000 m Tube Price: Lv3400.

**105MM
HIGH EXPLOSIVE
MORTAR ROUND**

Weight: 38 kg per 3-round clip DP: As explosion (EP=7) Price: Lv300 per clip of 3.

**105MM
OBSCURATION
MORTAR ROUND**

Weight: 38 kg per 3-round clip DP: As explosion (EP = 4), but no fragmentation. Creates a thick obscuration cloud which blocks thermal and visual images for 4 minutes. The cloud is 600 meters long and 10 meters high. Price: Lv300 per dip of 3.

**105MM
FLECHETTE
MORTAR ROUND**

Weight: 38 kg per 3-round clip DP: As explosion (EP=9) Price: Lv300 per clip of 3.

upper deck. The mortar compartment is then fitted: ammo storage racks, sights, communications gear, and the mortar itself. Speed and handling characteristics are not affected, and the vehicle is quite capable of keeping up with all but the most mobile of colonial formations. The vehicle comes from the factory fitted with a Schneider 105mm clip-fed mortar, but local variations are legion. The vehicle carries 12 3-round clips for the mortar, and usually has a single pintle mount 7.5mm machinegun. Mortar vehicles must be very fast, since advanced counter-battery radars can locate the firing vehicle after one round (such radars are rare in colonial forces, however).

Typical Anti-armor Variant: This vehicle is a local variant produced by Aerotech SA at their factory on Tirane, from French-manufactured vehicles sold as surplus. The main weapon, its power pack, and its fire control equipment have been removed from the basic vehicle and replaced with four Guiscard Aero-12 anti-armor missiles and a Texas-built R-700 fire control system. Reloading is accomplished manually (the vehicle carries a total of 12 missiles, counting those in the tubes initially).

Type: *Tracked main battle tank*
 Crew: *Driver, gunner, second gunner, commander*
 Weight: *21,000 kg* Armor:
 Suspension: *8* Front: *250*
 Overhead: *100* Other Faces:
60 Armament: *1 Mark 17 high energy pulse laser in remote turret* Aimed Fire Range: *4000 m* Range Finder: *+3* ROF: *1* Rounds Carried: *Unlimited (runs off vehicle power plant)* DP: *100* Limitations: *May not fire in the same turn that the vehicle moved; 25mm autocannon in remote turret coaxial with main gun; 3 CLP-1A plasma guns, 1 in each of three ball mounts (one on front and one on each side of the chassis)* Aimed Fire Range: *7600 m* Range Finder: *+ 1* ROF: *5* Rounds Carried: *750 (50 per mount); 3 7.5mm machineguns (one in each plasma gun ball turret, mounted coaxially); 1 launcher for Guiscard Aero-12 missiles on chassis top with 10 reloads carried internally; quad launcher for Guiscard Martel missiles on remote turret. No reloads*
 Signature: *10* Evasion: *0*
 Sensor Range: *20 km (+3)*
 Cargo: *500 kg* Max Speed: *100 kph* Cruising Speed: *50 kph* Combat Movement: *200 m* Off-Road Mobility: *Full* Power Plant: *2 MW MHD turbine* Fuel Capacity: *900 kg H₂* Fuel Consumption: *45 kg/hr* Endurance: *20 hr* Price: *Current French Army procurement price is Lv919,640 each.*

CC-21 (French)

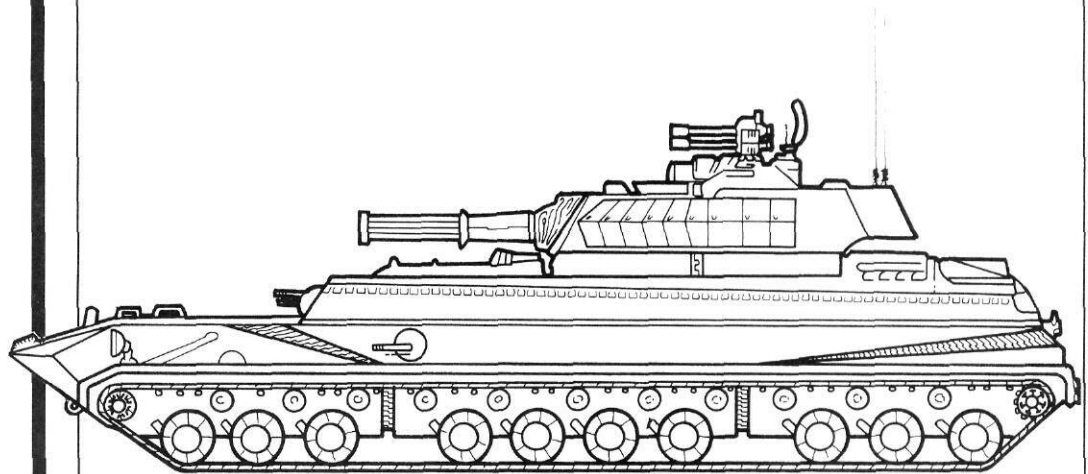

Main Battle Tank

CC-21 (CHAR DE COMBAT, 21-TON)

Heavy ground tanks are rare in frontier forces, and are much more common on the core worlds, where mobility is less important than firepower. The heavy protection and long-range firepower of a track-laying tank, however, is often handy, albeit expensive to procure and maintain. Smaller armed forces often keep a "show" unit of these vehicles just for the prestige involved.

The CC-21 lineage ultimately goes back to the heavy tanks of the mid- to late-1900s (the period between WWII and WWIII), but its development descends from the *earlier* CC-17 and CC-24 designs of the late 22nd century. The CC-21 saw its combat debut in the Central Asian War of 2282-2287, but it was not to see action in large numbers because of the immense distances involved and the fact that its large fuel consumption made it a logistical problem. Nevertheless, the tanks served with distinction during the Battle of Wu-Lu-Mu-Ch'i and during the Relief of Alma-Ata. The vehicle's armor proved almost impossible to penetrate with the weapons available to the Manchurians, but the tanks were especially vulnerable to air attacks, and field expedient air defense measures were undertaken (after the war, the Aero-12 missile rack was made part of

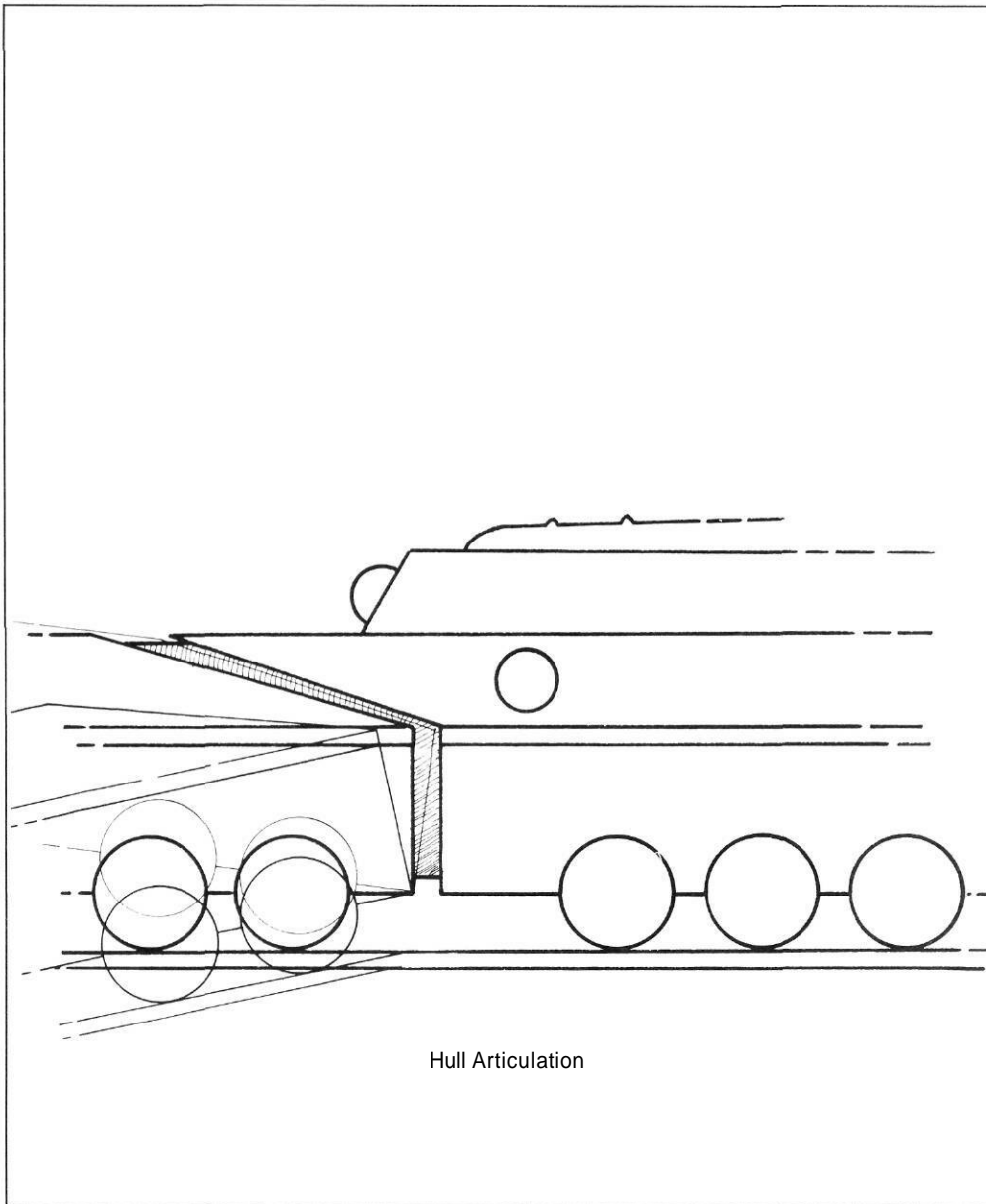

Hull Articulation

ARTICULATED HULL

Vehicles similar to the CC-21, because of their extreme length, have difficulty traversing terrain without bottoming out on a hilltop or jamming themselves between two slopes. For this reason, the hull of extremely large vehicles, such as the French CC-21 and the Manchurian Type 27, are articulated (or hinged) in two places to permit maximum traction despite the terrain. A generalized diagram of this articulation (minus the sliding, overlapping armor plating for clarity) is shown to the left.

The track drive for a tank of this sort is more complex than that of a conventional tracked vehicle, but early experiments with three separate tracks (one for each section) proved that a single track loop was easier to maintain, and was actually less prone to mechanical failure (provided it was properly designed and maintained).

the vehicle's standard equipment). Notwithstanding these changes, the tanks always seemed to be in the wrong place at the wrong time, and defeat was narrowly avoided by timely intervention by the Japanese. At the end of the war, attempts were made to upgrade the power plant of the CC-21 to 2.5 or 3 megawatts in order to increase the tank's speed, but endurance and range suffered, and the plans were shelved.

In the War of German Reunification, distances were not as great as those in Asia, and the CC-21 gave a better account of itself when it was engaged. The qualitative superiority of several French weapon systems during this war has never been questioned—the defeat at the hands of a reunified Germany was due to other factors.

The CC-21 is more expensive to buy and maintain than smaller vehicles, and most armies cannot afford large numbers of them. France is the only nation to deploy the CC-21 in battalion-strength units or larger.

Despite its age, the CC-21's powerful gun combined with its heavy armor protection make it a formidable opponent in a one-on-one encounter.

Type: *Hover APC* Crew: *Driver, gunner, commander*
 Weight: *3000 kg* Armor: *Plenum: 2 All Faces: 6*
 Armament: *1 Guiscard Aero-12 missile launcher with 6 missiles carried internally; 1 25mm autocannon; 1 5.5mm machinegun (all carried in a single overhead unmanned turret)* Signature: *4* Evasion: *7* Sensor Range: *10 km*
 Cargo: *8 passengers and 2000 kg* Max Speed: *220 kph* Cruising Speed: *200 kph* Combat Movement: *460 m* Off-Road Mobility: *Full* Power Plant: *0.5 MW hydrogen fuel cell* Fuel Capacity: *270 kg H₂* Fuel Consumption: *15 kg/hr* Endurance: *18 hr* Price: *Not generally available outside of military channels. The average open market price is around L v40,000, exclusive of armament.*

AVCI-3 Bessieres

(French)

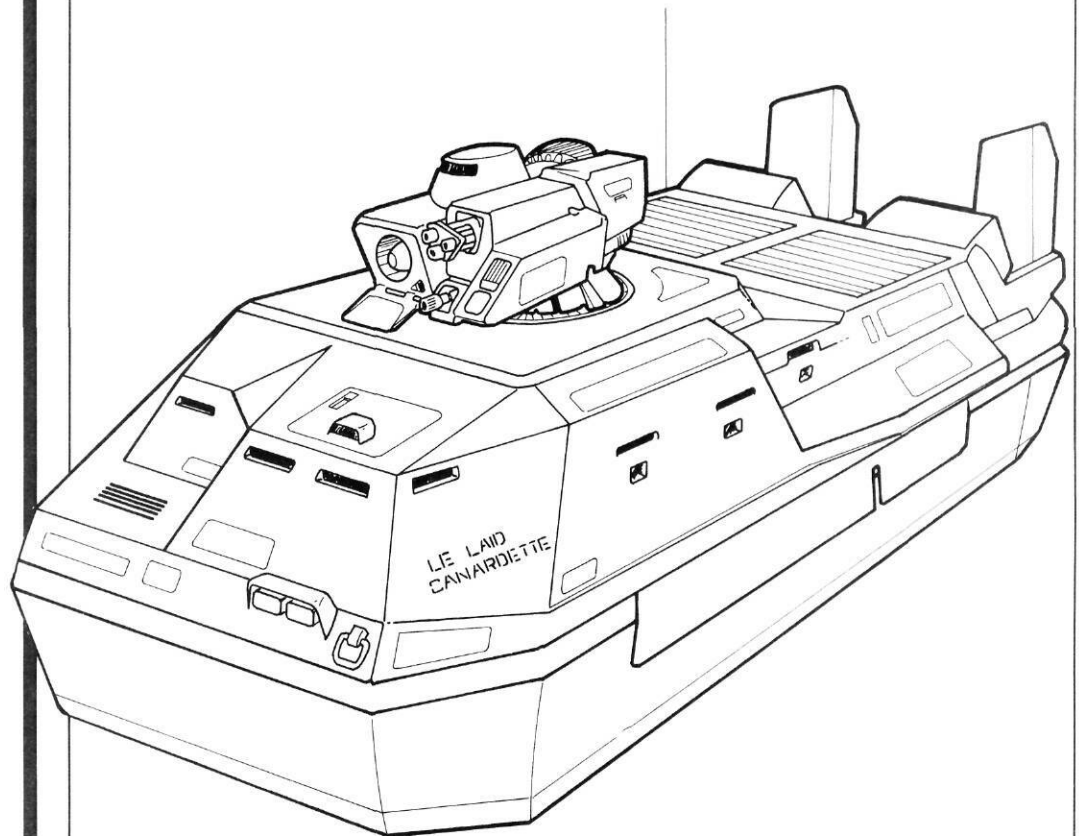

Hover APC

AVCI-3 (AERO VEHICULE COMBAT D'INFANTERIE, 3-TON)

The French AVCI-3 (commonly called the Bessieres) is the typical ACV armored personnel carrier the players will encounter on frontier worlds. Its basic design has been copied many times by many nations, and twins and near-twins of the Bessieres are still in service with many armies, both on Earth and in the other known worlds, although it has begun to be replaced in front-line units by more advanced types.

The Bessieres, like all modern military air cushion vehicles, is capable of short "hops" using high performance vectored thrusters. These give the vehicle a limited jump-jet capability, enabling it to negotiate cliffs and similar obstructions. Each minute in jump-jet mode uses 10 minutes of fuel, and speed is quartered.

Variants: Two typical factory variants (from the many produced) are the VALR-12 MRL vehicle, and the VBE electronic counter-measures and communications security vehicle. As with most APCs, however, the Bessieres have been the subject of innumerable conversions and short-run, local modifications.

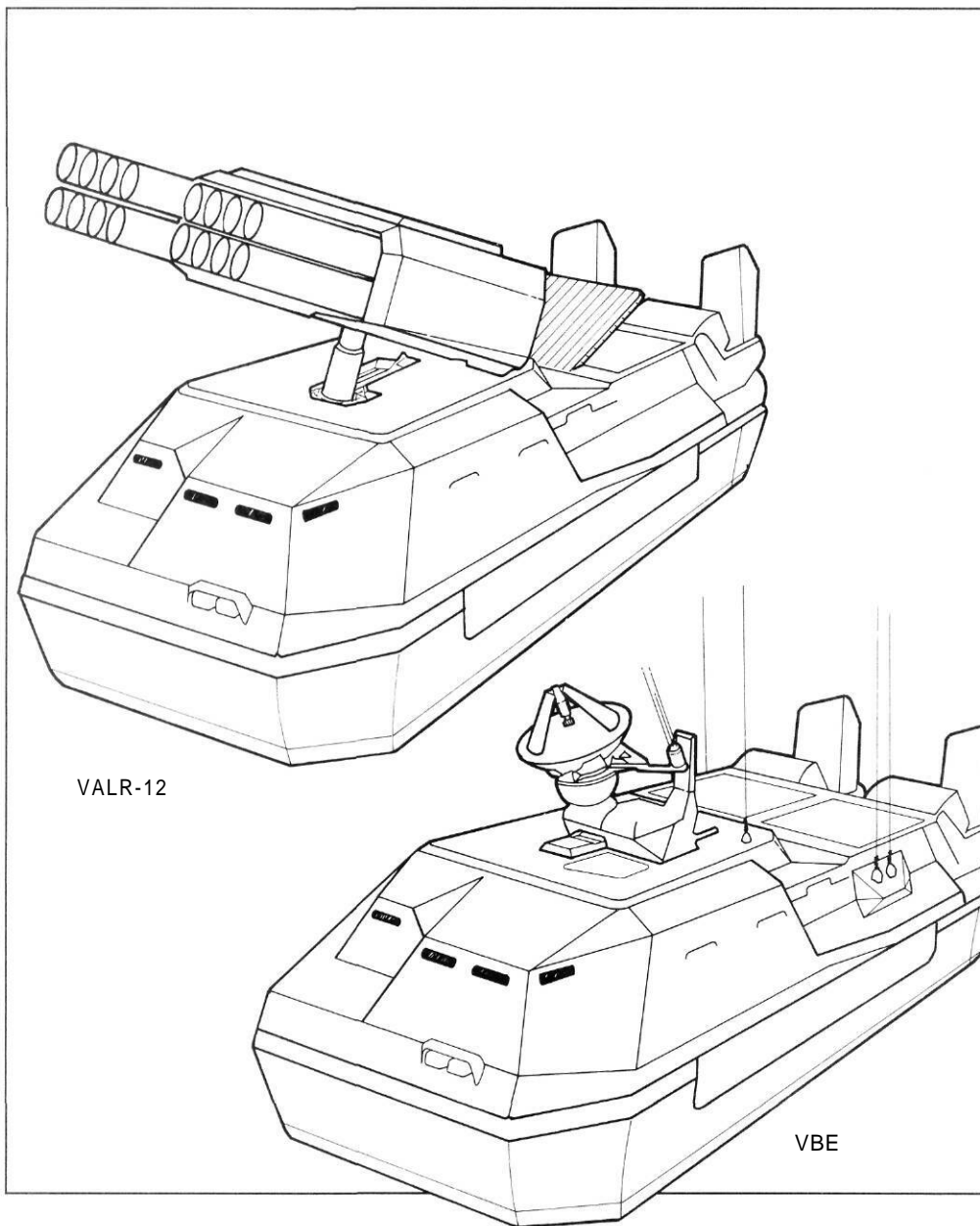

VALR-12

VBE

VALR-12

This vehicle is identical to the basic Bessieres in all but the following characteristics: Armament: 2 8-round box launchers for 12cm rockets on top rear hull Aimed Fire Range: 30,000 m ROF: 4 Guidance: Automatic, after gunner lock-on, laser-homing, or free flight Warhead: APHE DP: As tamped explosion (EP=30) Homing Value: 14 Warhead: WASP Burst Radius: 500 m DP: 5 Warhead: Obscuration DP: As explosion (EP=4), but no fragmentation. Creates a thick obscuration cloud which blocks thermal and visual images for 4 min. The cloud is 100 m long and 20 m high.

VALR-12 (Vehicule Autopropulse Lance-Roquettes, 12 cm): This vehicle is identical to the standard Bessieres, except for the armament, which has been replaced by two eight-tube, box launchers for 12cm rockets. Note the protective shield behind the launchers—this is a commonly installed field modification to deflect hot rocket exhaust gasses from the plenum intake vents. The Bessieres was not originally designed with this function in mind, and the hot exhaust gasses from multiple firings would rapidly erode the vehicle's skirts if they were not deflected and allowed to cool a bit before being sucked into the plenum chamber.

VBE (Vehicule Blinde Electronique): The VBE is designed to insure secure battlefield communications by making use of the most advanced tight-beam communications technology. It is equipped with broad-frequency radio intercept and jamming equipment, and sophisticated encrypting and decrypting electronics. The satellite up-link dish enables the vehicle (and the unit to which it is assigned) to stay in communication with higher and lower echelons (as well as spacecraft), despite most local atmospheric conditions and all but the most advanced jamming and signal disruption attempts.

Type: *Tracked All-terrain Personnel Carrier* Crew: *Driver* Weight: *5400 kg* Armor: *Suspension: 1* All faces: *2* Armament: *"Blaster II" plasma gun* Signature: *8* Evasion: *0* Sensor Range: *6 km* Cargo: *15 passengers and 2200 kg* Max Speed: *90 kph* Cruising Speed: *50 kph* Combat Movement: *180 meters* Off-road Mobility: *Full* Power Plant: *Hydrogen fuel cell, approximately 0.2 MW* Fuel Capacity: *240 kg* Fuel Consumption: *8 kg/hr* Endurance: *30 hours* Price: *Unavailable.*

"Cockroach Car"

(Kafer)

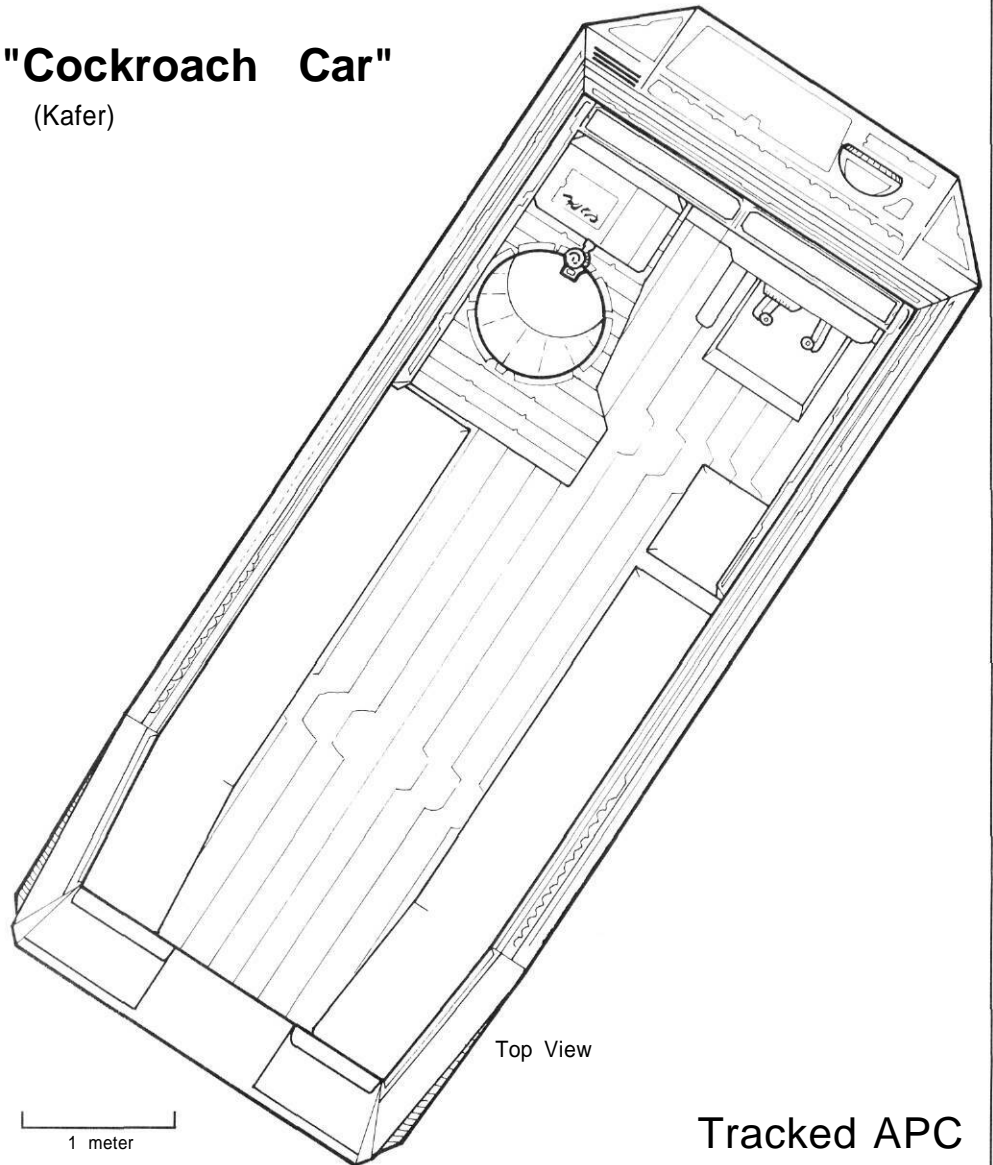

SHAH CH*KUSH ("COCKROACH CAR")

A general purpose, open-topped, tracked APC not encountered by humans on Aurore, but found in service with Kafer units landing on other worlds. This vehicle is representative of a slightly different "parallel evolution" in vehicle design. The vehicle is designed to the same basic job as the previously encountered "Bugbus," but differs from the latter in several particulars.

A mounting ring to the left of the driver frequently supports a Kafer Blaster II plasma gun or similar weapon. This seems not to be a permanent part of the vehicle's equipment, as it is dismounted when the troops are dismounted, leaving the vehicle defenseless (this is the opposite of what is evidently standard practice with the "Bugbus," which retains its weapon after disembarking troops).

The interior of the vehicle is not depicted clearly in this drawing, because no good *reference* photograph exists and no intact example has been captured. Internal storage arrangements are extremely primitive by human standards, and seating seems to consist of a pair of plank-like benches running down each side of the compartment. The seats seem to be removable, in order

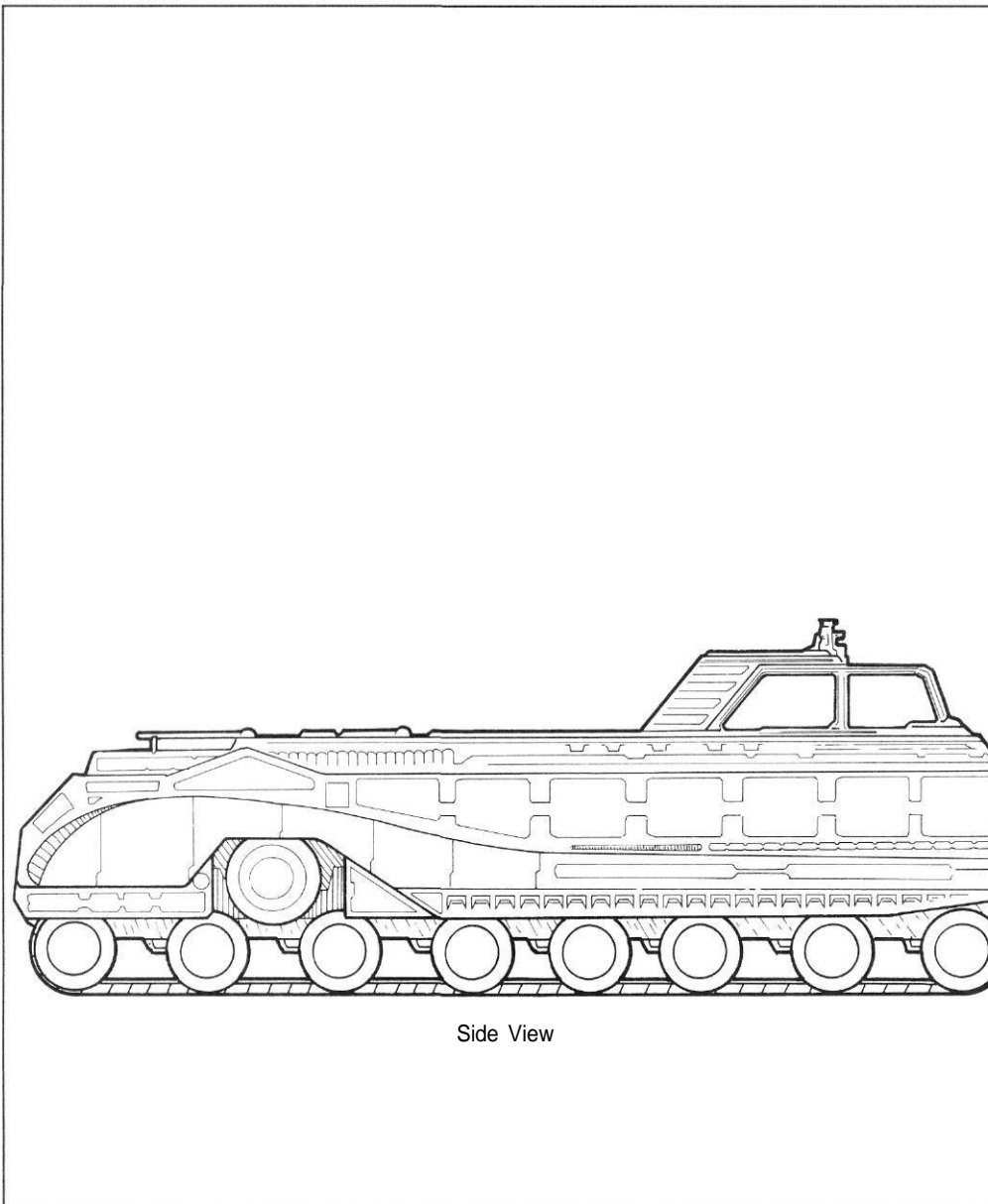

Side View

KAFER "BLASTER II" PLASMA GUN

Type: 35 MW vehicle-mounted plasma gun Action: Single shot Ammunition: Charged cells, 13.3x25.3mm, similar to Terran photonic core plasma cells, but more compact Ammunition Weight: .2 kg Magazine: 120 cells in detachable cartridge magazine Aimed Fire Range: 1800 m DP Value: As tamped explosion (EP = 4).

to quickly and easily convert the vehicle into a cargo carrier. No access doors are provided, however, and loading heavy objects into such a carrier must be a chore even for creatures as large as Kafers.

After action reports indicate that some "Cockroach Cars" are used to carry "Snapfire" anti-vehicle missiles. Several of the missiles are reported to have been fastened to the outside and command detonated from the inside, turning the APC into a primitive anti-armor vehicle. Whether this is a field expedient (a transport vehicle converted on the spur of the moment) or a purpose-built variant is not known at this time.

The "Cockroach Car" seems to be a relatively new addition to the Kafer arsenal, and was first encountered during the battles for Kimanjano (along with a number of other Kafer vehicles and items of equipment). This may be the result of increased military research and development efforts by the Kafer leader known as "Triumphant Destiny," or it may indicate that other Kafer leaders, with different resources and different equipment designs, may have recently joined the Kafer offensive against humanity.

KAFER "BEAMER" PLASMA GUN

Type: 40 MW vehicle-mounted plasma gun Action: Single shot Ammunition: Charged cells, 13.3x28.3mm, similar to Terran photonic core plasma cells, but more compact Ammunition Weight: .2 kg Magazine: 100 cells in detachable cartridge magazine Aimed Fire Range: 2000 m DP Value: As tamped explosion (EP = 5).

Type: *Hovertank* Crew: *Commander, gunner, driver, kibitzer* Weight: 23,000 kg Armor: Plenum: 35 Front: 120 All Other Faces: 40 Armament: 10.13cm *mass driver gun in turret* Aimed Fire Range: 2000 m Range-finder: + 1 ROF: 3 Rounds Carried: 62 DP: 110. *Twin anti-vehicle missile launcher mounted externally on turret side. Missiles appear to be roughly equivalent to French Manta-1. No reloads carried. One 40MW plasma gun carried in commander's cupola along with one 22.2mm autocannon (roughly similar in performance to Type 12 autocannon) and one 12.1 mm machinegun (similar in performance to the Type 12 autocannon) and one 12.1 mm machinegun (similar to DunArmCo Mini-12)* Signature: 8 Evasion: 4 Sensor Range: 8 km Cargo: 1000 kg Max Speed: 170 kph Cruising Speed: 140 kph Combat Movement: 320 m Off-road Mobility: Full Power Plant: 3 MW MHD turbine Fuel Capacity: 700 kg Fuel Consumption: 100 kg/hr Endurance: 7 hr.

"Deathsled"

(Kafer)

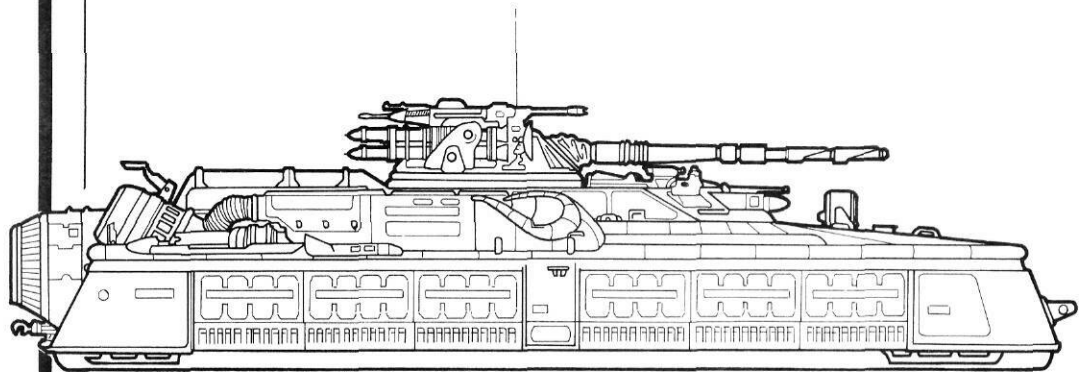

1 meter

Hovertank

"DEATHSLED"

Called *Shah uch*k* by the Kafers, the "Deathsled" is a large, extremely heavily armed and armored hovercraft. It does not have jump-jet capability beyond a height of about two meters, barely enough to provide a reasonable obstacle-crossing capability, but totally inadequate for crossing large ravines, chasms, cliffs and the like.

So far, the "Deathsled" is the only Kafer hovertank encountered by humans. In some respects, it is primitive compared to human designs, but in other ways, it is superior. Its armor protection is heavier than any human hovertank, and comes close to the armor protection enjoyed by the French CC-21 and similar human large track-laying tanks (indeed, it is actually *heavier* than the CC-21!). Its main gun is larger than most human hovertanks. On the down side, its missile complement is definitely inferior to the human state-of-the-art. The "Deathsled" is grossly underpowered for a vehicle its size, and thus is very slow, especially compared to the AC-12 or LkPz-IX. Its lack of jump-jet capability means that it can easily be out-maneuvered both tactically and operationally by human hovertank units.

Design Peculiarities: The "Deathsled" incorporates a number of features which are not completely understood. The plenum skirts are so heavily armored as to be almost totally inflexible, unlike the sliding, overlapping armor of most human designs. This means that all but the most minor obstacles cause large leaks of air from the beneath the skirts, further taxing the vehicle's already-short endurance. In addition, under certain environmental conditions, the outgassing can cause dust clouds which are almost as large as those created by a human hovertank in jump-jet mode, making the vehicle even easier to spot.

Another peculiarity of the "Deathsled" is its turret layout. The turret is constructed so that the missile launchers face to the rear. However, the turret is often seen with the gun traversed to the rear and resting in a travel lock, which brings the missile launchers to bear forward. Likewise, the commander's rotating cupola is mounted with a "Beamer" facing in one direction and an autocannon and machinegun in the other. The design rationale for these decisions is unclear.

Towing arrangements for the "Deathsled" look as if they were added as an afterthought, and some observers conclude that the vehicle was completely designed and in production before the notion of towing came up. No specialized recovery vehicles have been observed, but each "Deathsled" comes with what appears to be a towing hook in the middle of the rear face and a towing loop evidently designed to fit it affixed to the front of the vehicle. However, it is obvious from looking at it that the large exhaust vents would be almost totally blocked when the hook of one vehicle and the loop of another are fastened together, reducing the towed speed severely. A length of cable would solve this problem, but only a few "Deathsleds" have been seen with cables, and these seem to have been installed as a field modification by individual vehicle commanders. Reports from *Aurore* indicate that most damaged "Deathsleds" are indeed towed at a speed of only 10 to 20 kilometers per hour. Each "Deathsled" does come with a hose/nozzle arrangement, so that a towing vehicle can be hooked up to inflate the skirts of a towed vehicle, and thus vehicles with damaged power plants can be pulled off the battlefield. Using one power plant for two tanks reduces the speed considerably, however, and neither vehicle can jump during the process. Perhaps the *Kafers* see no need to tow damaged vehicles at high speed since their power plants are not built for that purpose in the first place.

Variations: Individual *Kafer* leaders modify their vehicles as much as their human counterparts, and in some respects even more so. A particularly inspired leader might order field modifications to his vehicles to take advantage of a tactical situation (the "Snapfire" vehicle converted from the "Cockroach Car" is a good example). In one case on *Aurore*, *Kafers* were known to have used human plasma guns to replace a battle-damaged "Beamers."

No examples of uniquely designed specialty vehicles (command, communications, ECM, medical, transport, self-propelled artillery, or support vehicles) of any sort are known. All of these functions seem to be served by modifications to a few basic existing vehicles—it is unknown whether these modifications take place at the factory or at lower echelon workshops.

Battle reports mention individual examples of "Deathsleds" equipped with anti-aircraft missile-launching racks, anti-personnel mines, MRL launchers (one example used a captured French 12cm launcher welded to a "Deathsled" turret in a manner reminiscent of the WWII Sherman Calliope, but *Kafers* are known to use 18.5cm MRLs as well), and dozens of other improvisations.

Kibitzer: The "Deathsled" carries a crewmember initially identified as the "kibitzer" in military journals. The precise function of this crewmember remains a mystery to humans, but (as was revealed in the **Kafer Sourcebook**) the actual function is that of chief mechanic (although an equally good title would be crew chief). The average *Kafer* can be cross-trained to perform some simple maintenance functions, but the more complicated nature of the "Deathsled's" equipment necessitates the allocation of a crew position dedicated to important maintenance tasks.

The referee can determine exactly how (and if) the player characters discover this minor bit of information. If desired, it can be allowed to remain a mystery.

The illustration of the "Deathsled" shows the large number of intricate details on its surface, far more than any human designer would place on a similar vehicle. The individual functions of these surface features are not known with any degree of certainty, and it is more than likely that some of them have a use entirely alien to human thought patterns. The large quantity of "junk" on the outside of the "Deathsled" does not seem to have made the vehicle any easier to detect with sensors than its size would normally indicate, which suggests that these surface features may have been specially treated in some manner to absorb sensor emissions and reduce echoes.

KAFER "BUG-BOMB" 18.5CM ROCKETS

Kafer rockets are packed in a combination carrying case/launch-rack. Multiple bundles of these rockets can be fastened to a firing vehicle (which can vary depending on circumstances). They have also been known to be emplaced by infantry units and fired by remote control. Human patrols sometimes come across one or more such rockets braced against a rock or similar object, presumably placed there in preparation for an attack. Since they are laser-homing, they need only be pointed in the general direction of a target and can be directed from another location after firing. Only one caliber has been discovered so far, but others may exist. Type: 18.5cm Rocket Aimed Fire Range: 30,000m Weight of Rocket: 120 kg plus 10 kg for case/launch-rack ROF: 4 Guidance: Laser-homing, or free flight Warhead: APHE DP: As tamped explosion (EP=40) Homing Value: 74 Warhead: WASP Burst Radius: 500 m DP: 6.

Type: Tracked all-terrain personnel carrier Crew: Driver Weight: 4800 kg Armor: Suspension: 2 All Faces: 2. 1 Armament: "Beamer" or "Blaster" plasma gun in remote turret Signature: 8 Evasion: 0 Sensor Range: 12 km Cargo: 12 passengers and 1000 kg Max Speed: 80 kph Cruising Speed: 40 kph Combat Movement: 160 meters Off-road Mobility: Full Power Plant: Hydrogen fuel cell, approximately 0.2 MW Fuel Capacity: 204 kg Fuel Consumption: 6 kg/hr Endurance: 34 hours.

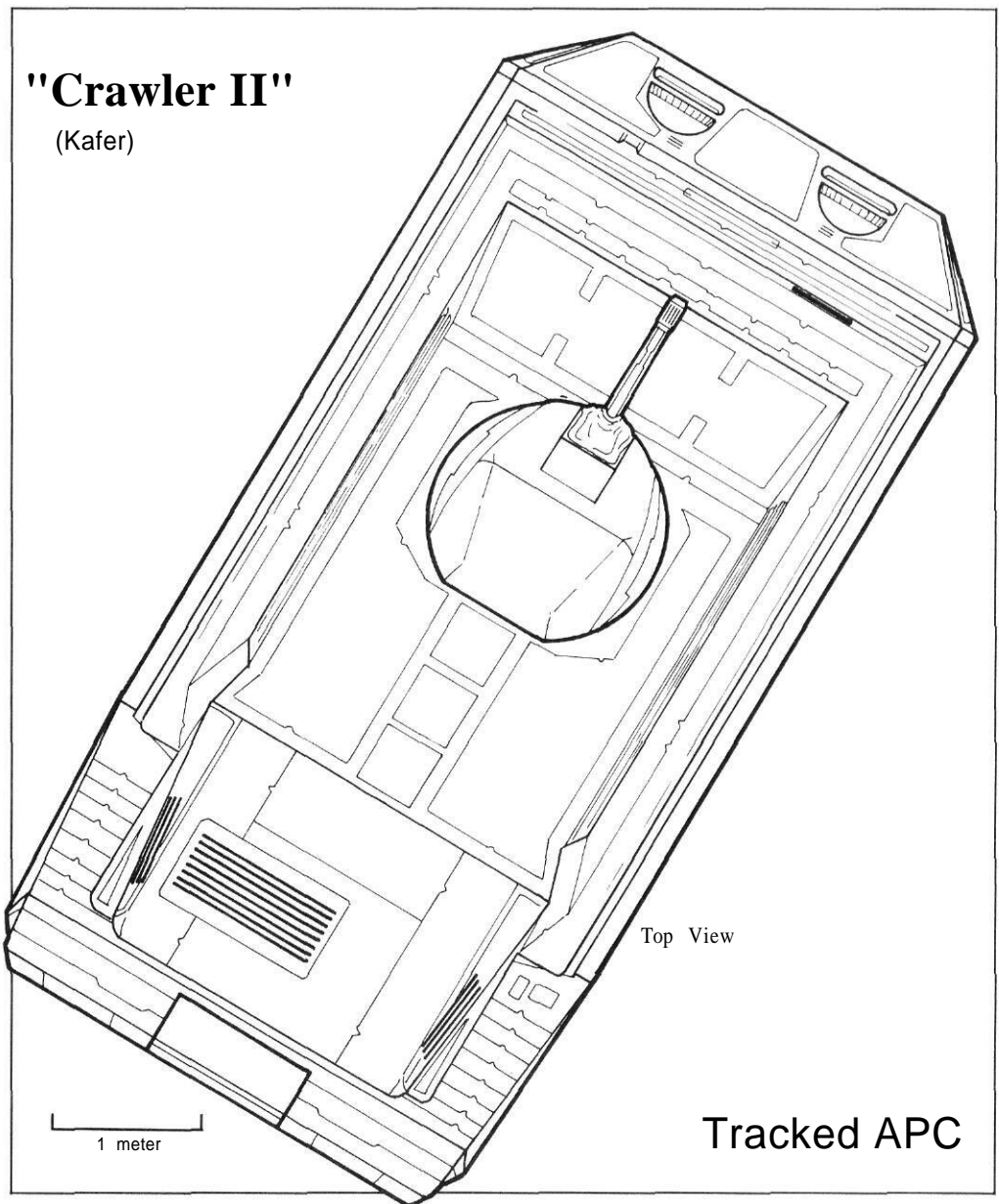

"CRAWLER II"

The "Crawler II" (called the *Shah shu'ch* * by Kafers) is a general purpose, enclosed, tracked APC, very similar to the original "Crawler" (first encountered on Aurore) in general function, but not in overall appearance. It differs in several particulars, the main one being its better armor protection. Like its predecessor, the "Crawler II" is equipped with a turret-mounted weapon, usually either the "Beamer" or (less often) the "Blaster II" plasma gun.

Mysteries: Detailed information on the "Crawler II" is sparse, and several aspects of its design remain ill-understood. First of all, the vehicle is without a doubt employed as an APC, that is, it carries infantry into combat more rapidly than they could walk, and provides them with limited protection from fragments and small arms fire. The problem is, how do the Kafers exit the vehicle? There is a small hatch on the back of the vehicle, but the placement of the air intake grill and what are evidently the exhaust ports (judging from their respective thermal emissions) would seem to indicate that this is an engine access panel. There do not seem to be any other hatches, doors, or other means of ingress/egress on the vehicle. Photographs show a number of

**KAFER
"TRI-BEAMER"
PLASMA GUN**

*Called Gh'eh uch * by the Kafers, the "Tri-beamer" (or "triple beamer") is three high-energy plasma guns fitted to a rotating mount for gatling-type, high-speed fire. The weapon is mounted on heavy vehicles, or on a quad-pod or heavy mount. Type: 28 MW vehicle-mounted or static defense plasma gun Action: Three single shots, together or in rapid sequence Ammunition: Charged cells, 9.8x21.2mm, similar to Terran photonic core plasma cells, but more compact Ammunition Weight: 0.15 kg Magazine: 120 cells in detachable cartridge magazine Aimed Fire Range: 1500 m DP Value: As tamped explosion (EP = 4).*

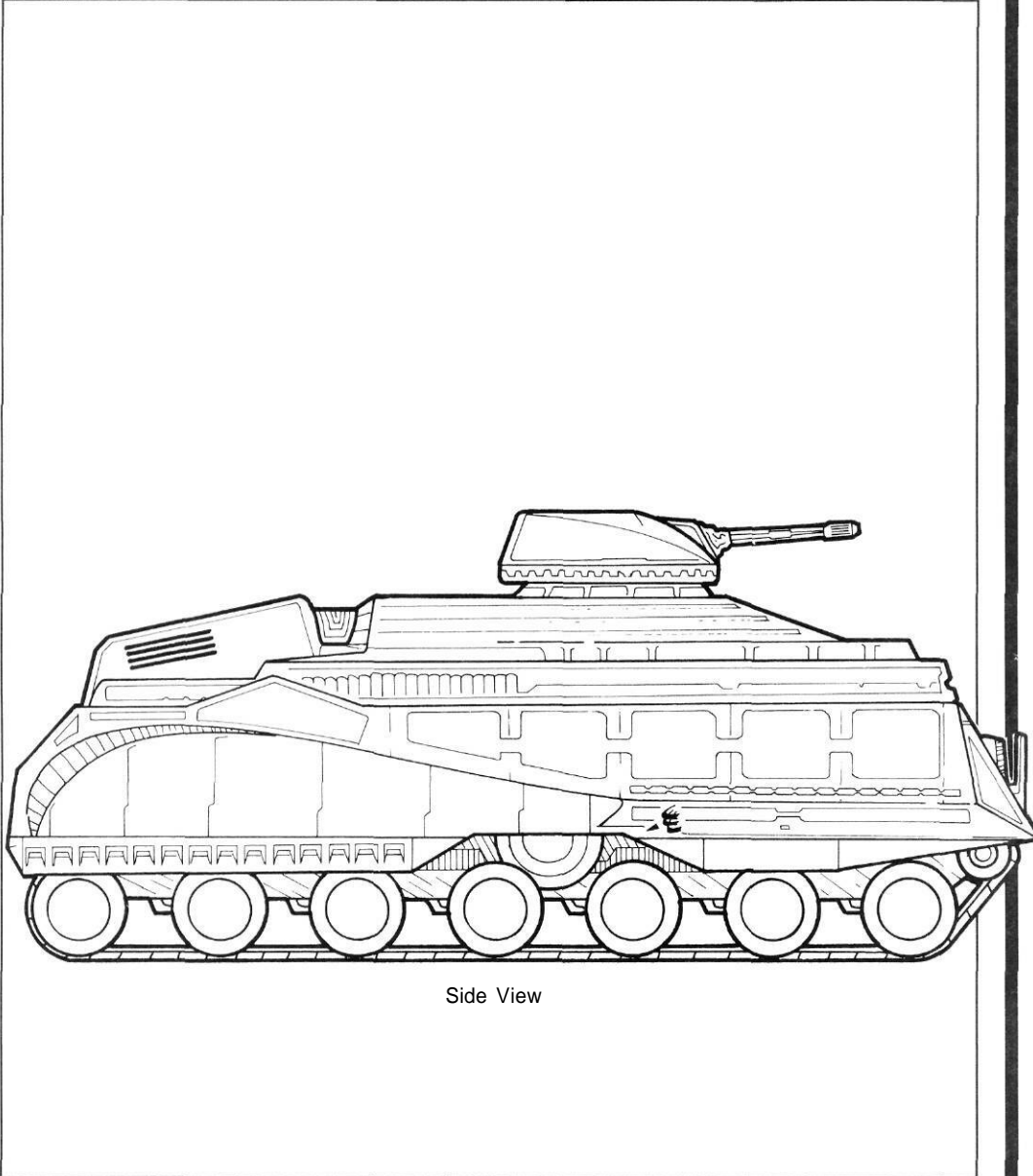

Side View

peculiar patterns at various locations on the hull, but none of these look like troop exit doors. The two rectangular patterns on the top of the hull in front of the turret seem to be hatches for the driver and gunner.

Speculation has run rampant, as it always does in the absence of facts. Some observers believe the front portion of the hull (containing what seem to be the headlights) hinges downward to form an exit ramp. Others (albeit the minority) believe that the whole top of the vehicle (turret and all) is lifted up hydraulically. One group has speculated that the Kafer designer decided (for whatever reason) to vent engine heat through a grill in the rear exit door, despite the detrimental effects this would have on the vehicle's IR signature. The best guess, however, is that the pair of semi-rectangular "things" behind the turret are fitted with inboard hinges and swing up. This would limit turret traverse during disembarkation of troops, but this may not be the flaw some critics think it is.

Another question: What is the circular object located in the center of the tracks? It may be the drive sprocket for the tracks, but this is not completely certain.

Type: *Kafer Hover APC*
Crew: *Driver, gunner*
Weight: *8000 kg* Armor:
Plenum: *7* All Faces: *4* Ar-
mament: *Unknown, possibly*
"Beamer" plasma gun in in-
ternal sponson mount, and
some type of internally
launched missile similar to
the Manta-1 Signature: *5*
Evasion: *6* Sensor Range: *8*
km Cargo: *12 passengers*
and 1000 kg Max Speed:
200 kph Cruising Speed:
180 kph Combat Move-
ment: *420 m* Off-Road
Mobility: *Full* Power Plant: *7*
MW MHD turbine Fuel
Capacity: *200 kg H₂* Fuel
Consumption: *20 kg/hr* En-
durance: *10 hr* Price:
Unavailable.

"Floater"

(Kafer)

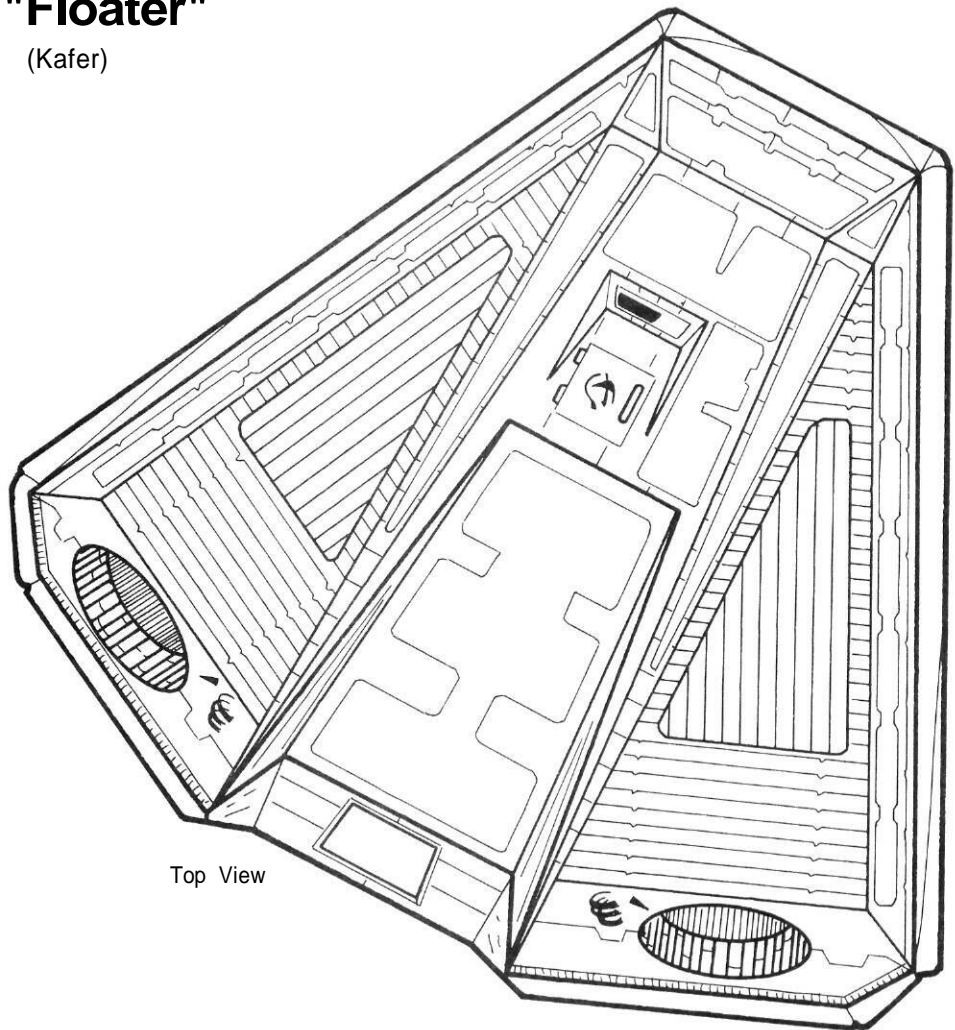

1 meter

Hover APC

"FLOATER"

This air cushion vehicle has been labeled the "Floater" by human observers, and it is generally agreed that it is an APC. If so, it is the first hover APC to be identified in Kafer service. As with all newly sighted Kafer vehicles, detailed information is not available, and many of the specifics must be deduced from surveillance drone photographs and sensor readouts, after-action reports and the testimony of battlefield observers. Thermal emissions indicate an MHD turbine power plant of approximately 1 MW in size, which is powerful enough to give the APC a limited jump-jet capacity equivalent to that in the most advanced human APCs (speed is presumably quartered while in jump mode, and fuel consumption is 10 times higher).

The vehicle is undoubtedly designed primarily for use as an APC. In several battles, infantry are reported to have emerged from the vehicle through the large door in the back (which is hinged at the front and lifts upwards).

A minority view holds that the "Floater" is primarily used as a scouting and reconnaissance vehicle. Supporters of this notion point to the fact that no more than two vehicles have ever been

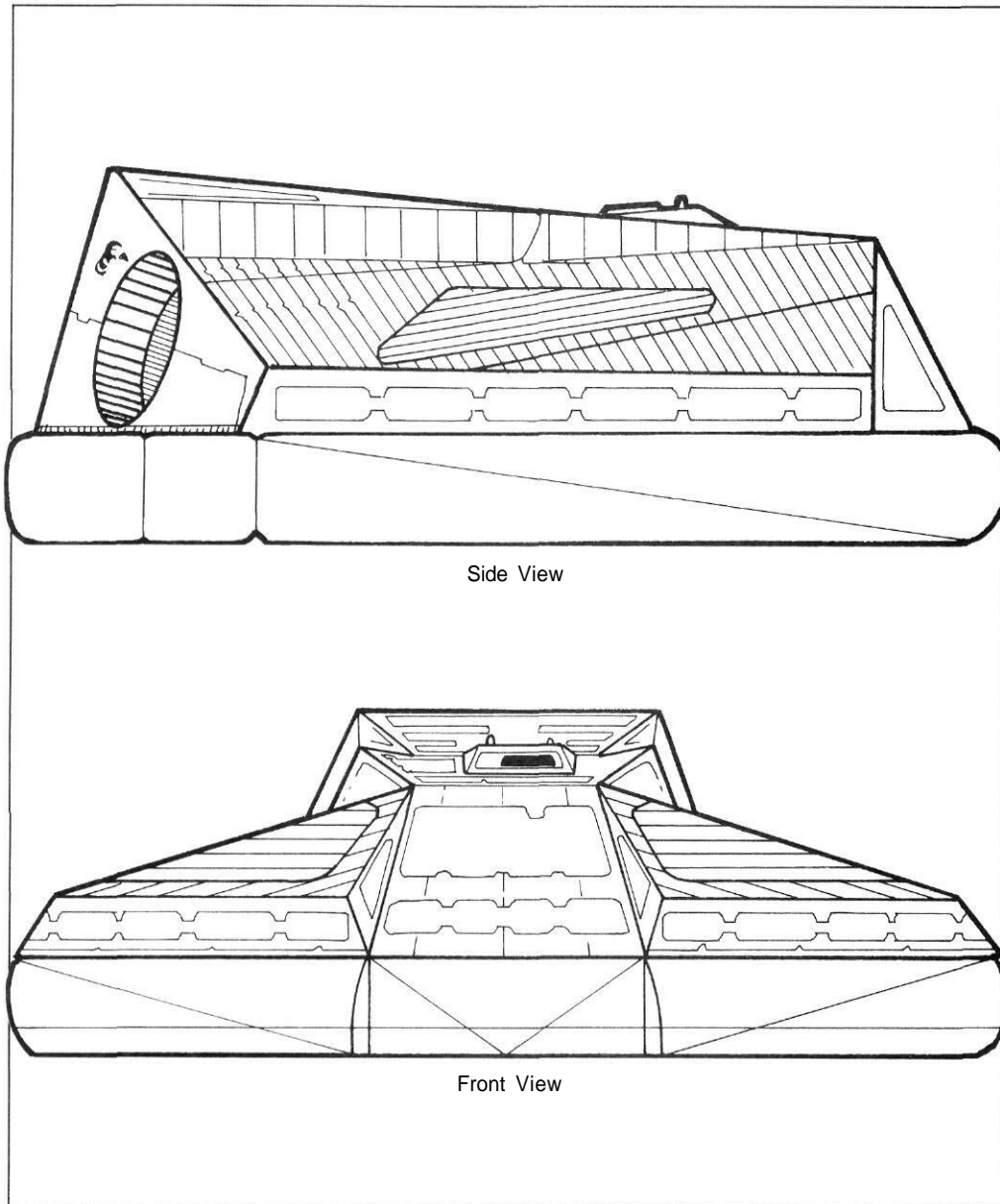

KAFER UNKNOWN MISSILE

Type: *Kafer anti-vehicle missile* Launcher Weight: *122kg* Missile Weight: *21.5 kg* Range: *7800 m* Guidance: *Automatic Homing* Value: *14* Attack Angle: *Evidently selectable* Damage: *EP=38.*

encountered at a time, and that the vehicles are often found operating deep behind the front lines. More battle reports are needed before a definitive answer to this question can be brought to light.

Armament: What is the "Floater" armed with? This is a question of considerable interest to human military intelligence personnel, and one for which there is little hard evidence. A survivor of the first combat encounter with "Floaters" (during the Kafer invasion of Kimanjano) reports that the vehicle "fired a large anti-vehicle missile of unknown type, which severely damaged our AC-8 and forced us to abandon the vehicle." Units engaging "Floaters" also report coming under plasma gun fire, but it is not known whether this is integral to the vehicle, or was part of the equipment carried by the accompanying infantry. Inherent military probability indicates that some form of close-in infantry suppression/support weapon must be carried by an APC.

Variants: No major variations in the basic "Floater" have yet been encountered. This may indicate that it is a new vehicle, or that it is a vehicle in service with one of the Kafer leaders other than "Triumphant Destiny" and has only recently been used in the war.

Type: *Kafer Tracked Main Battle Tank* Crew: *Driver, gunner, second gunner, kibitzer, commander* Weight: *43,000 kg* Armor: *Suspension: 8 Front: 260 Overhead: 100 Other Faces: 50* Armament: *1 high energy pulse laser in turret mount* Aimed Fire Range: *6000 m* Range Finder: *+3* ROF: *1* Rounds Carried: *Unlimited (runs off vehicle power plant)* DP: *120* Limitations: *May not fire in the same turn the vehicle moved; "Beamer" plasma gun coaxial with main gun; 4 "Beamer" plasma guns in antipersonnel sponson mounts, one on each side (front, back, left and right) 1 launcher for anti-armor missiles mounted in the rear turret overhang, with 10 reloads carried internally; single launcher for unknown anti-aircraft missile in hull rear with 6 internal reloads.* Signature: *16* Evasion: *0* Sensor Range: *18 km* Cargo: *10 passengers and 500 kg* Max Speed: *80 kph* Cruising Speed: *40 kph* Combat Movement: *1800 m* Off-Road Mobility: *Full* Power Plant: *3 MW MHD turbine* Fuel Capacity: *1200 kg H₂* Fuel Consumption: *60 kg/hr* Endurance: *20 hr* Price: *Unavailable.*

"Behemoth"

(Kafer)

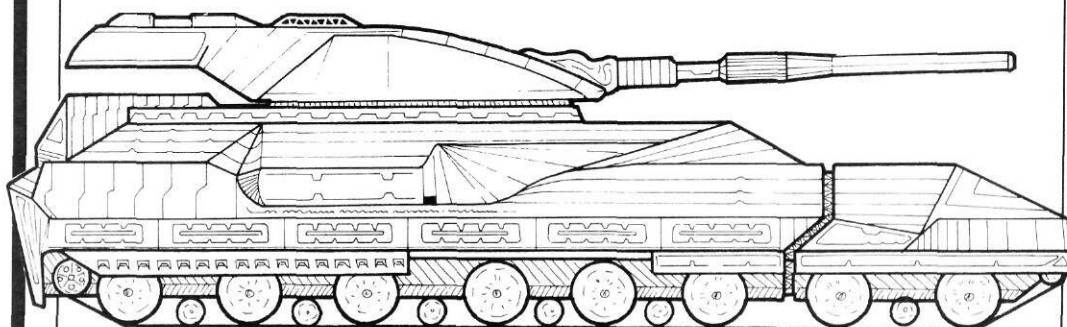

Main Battle Tank

"BEHEMOTH"

The Kafer "Behemoth" came as a tremendous shock to humans when it was first encountered on Kimanjano (this world was also the location of the first encounters with the Kafer hover APC called the "Floater"). Large, heavily armored, and armed with the most powerful laser carried by any AFV anywhere, the vehicle was dubbed "Behemoth" (after the biblical monster from the book of Job). Its Kafer name is unknown at this time.

The "Behemoth" has a long, articulated chassis similar to the CC-21, presumably for the same reason (to improve terrain crossing characteristics), and comparisons between the two are inevitable. The "Behemoth" is over twice the size of the CC-21, and is better armored from the front face, although the flanks are about the same. It carries almost as many missiles, and its main armament has a greater range. The biggest difference is that the "Behemoth" carries infantry, whereas the CC-21 does not.

The only example of the "Behemoth" in human hands was taken by American marines during the battles on Kimanjano, and was severely damaged in the process. (It had to be abandoned in

the retreat from Kimanjano, so the videotapes and the engineer's report made during that time are the only available information remaining.) From this single example, we know somewhat more about the interior arrangements of the vehicle than we do for the other Kafer vehicles encountered for the first time on Kimanjano, although several questions remain.

Layout: The layout of the "Behemoth" is fairly unique and deserves some discussion. The engine and fuel are contained in the forward segment, sealed off from the crew compartment except for the drive train (which on a tank like the "Behemoth" must be quite extensive). The chassis aft from the turret basket is the passenger compartment, large enough to hold 10 Kafers in full combat gear (although none of the vehicles on Kimanjano seemed to be carrying troops). The suspension is unique in that it has two sets of bogie wheels: the outer bogies (diameter: 1.45 meters) and the inner bogies (diameter: 0.95 meter). The first, fourth, and seventh of the outer bogies are powered, which is why the drive train is more extensive and complex than on any other Kafer vehicle. Human engineers believe that the inner bogies are necessitated by the extreme width of the vehicle's tracks. All bogies, both inner and outer, are independently articulated, and the vehicle is surprisingly agile for something its size.

Crew: The vehicle commander and the two gunners occupy seats in the turret. The driver and an additional crewmember (labeled the kibitzer—see page 49 for a discussion of this position) occupy seats in the hull. The passenger compartment for the "Behemoth's" contingent of troops opens out to the rear through a conventional exit door/ramp (hinged at the bottom).

One of the first units to encounter these giants in combat was the Elite Texas Rifles. During the action that was later to be labeled "The Battle of Armstrong's Mountain," Captain Robert Eugene Armstrong, commander of the 4th Independent Rifle Company, Republic of Texas, achieved the dubious distinction of commanding the first unit of humans to face "Behemoths." Armstrong's command held a key defensive point against a large enemy concentration while a larger force of American marines surrounded and destroyed them. Captain Armstrong's command was attacked by a pair of "Behemoths" during the battle, and managed to delay them long enough for air support to arrive and deal with the gargantuan tanks. Only 33 men (including Armstrong) survived the battle, most of them killed in the two-hour action with the "Behemoths." Armstrong, in an interview given after the action, states:

When we encountered them, we had been in action for about three days straight, and we were all more than a little groggy. I sensed them, somehow, before I heard them or saw them. I think I must have subliminally picked up some kind of subsonic ground vibration, because for a minute or two beforehand we all felt a foreboding—a sense of impending doom. Sergeant Carter, my company sergeant major, was the first to actually see them. I was working with the map box, trying to adjust the resolution, when I looked up. There was an odd look on his face, something I had never seen before—Carter was not a man that was easily shocked—and I remember wondering what, after all this time, there could be that could affect him like that. I turned to look in the direction he was facing, and I saw them too. I never saw anything that big that wasn't a building. I thought for a moment that I was hallucinating from exhaustion and lack of food, and I shook my head to clear it. Both of them were still there, about a quarter klick off and moving towards our position.

I looked back at Carter. He had the look of a man who had given up all hope of getting out alive. After a couple of seconds, he shrugged and said, "I think if we smash enough of their eggs, they'll become extinct eventually."

Fortunately for Armstrong, the two vehicles his unit encountered were not carrying their allotted contingents of infantry (having evidently disgorged them to attack another strongpoint earlier in the day, and not recovered them for some reason). Armstrong's unit called for air support, and held out long enough for it to arrive. The French fighters that responded managed to destroy one vehicle and damage the second severely enough for it to be captured the next day after ground reinforcements arrived.

Human forces had possession of the vehicle for only a little over one local day, during which time it was subjected to an intense examination by engineering officers. The whole operation was videotaped, and numerous instruments and pieces of equipment were removed for later study. The full report left Kimanjano on the last ship to leave the world, but this vessel was not large enough to carry the "Behemoth," and it would have been difficult to convince the ship's passengers (a troop of Foreign Legionnaires) to give up their places in favor of a wrecked tank.

REFEREE'S NOTE

The "Behemoth" described on these pages is so large that it is difficult to transport in large numbers. The two encountered on Kimanjano were part of a contingent of six landed on that world during the initial invasion. Referees should bear this factor in mind when creating encounters between humans and "Behemoths."

AVAILABILITY

The items discussed on these two pages are available for installation on just about any colony world. As players get further away from a starport, however, esoteric products should become more and more scarce, and increase in price. A backwoods general store, for instance, could hardly be expected to stock missile pods for hover-tanks, but might have a winch suitable for installation on a rangetruck and could probably find a local worker to install it (for a price).

Vehicle Accessories

A wide variety of optional add-ons are available for most vehicles. There are so many that is impossible to even list them all in the limited space available here (most are quite mundane anyway). Referees should consult a present day automotive accessories catalog, and convert the dollar price directly to livres. They should be readily available unless they are out of the ordinary. We can, however, deal with a few samples, particularly one marketed by the Pentapods.

FLOTATION PODS

These are inflatable airtight bladders which fasten onto the sides of a vehicle and render it buoyant enough to float. The pods are inflated by means of a small compressor powered by the vehicle's engine. These kits are intended to help vehicles cross rivers, and are not meant to make a truck into an ocean-going vessel. Most kits come with vanes which are fitted to the vehicle's rear wheels, allowing a speed of 3 kph during fording. Players may have to rig up field expedient methods to cross rivers with strong currents. Type: Vehicular Fording Adapter *Weight:* 80 kg *Price:* Lv250.

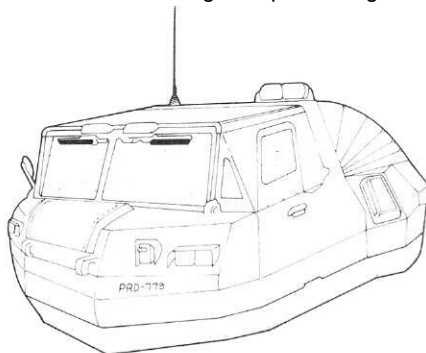
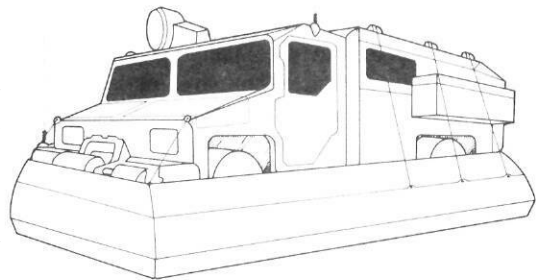

VACUUM OPERATIONS PACKAGE

This is a set of seals, plates, and other equipment intended to enable a vehicle to operate in the absence of air (or at least the absence of atmospheric oxygen. Usually, such kits can be ordered from the same factory that manufactured a particular vehicle, and consist of materials to render the passenger, engine, and baggage compartments airtight, oxygen for the engine and to replenish the passengers' atmosphere, carbon dioxide scrubbers, and condensers for the exhaust (in the case of hydrogen-burning MHD turbines and fuel cells alike, the exhaust is water vapor, which does not present disposal problems). For any given vehicle, the cost is 8 percent of the purchase price, and the weight 5 percent of the vehicle weight. They can often be installed when the vehicle is purchased. No provision is made for an airlock, and opening or breaking a seal will cause loss of interior pressure in vacuum or contamination of the interior air with outside gasses otherwise. Kits for vehicles larger than 20 tons include simple airlock fittings.

Packages of this sort are available for hovercraft, but are intended for use in non-breathable atmospheres only.

ARCTIC PACKAGE

Seals, insulation, and an extra-large capacity heating unit to equip vehicles for use in conditions of extreme cold, but where the atmosphere is still breathable. Most enclosed vehicles can operate in temperatures down to -15 degrees C without overwhelming their integral heating units. A similar package, weighing and costing the same, will enable a vehicle to operate in temperatures up to 140 degrees C. Type: Extreme Cold Adapter Kit *Weight:* 80-120 kg *Price:* Lv300 (depending on vehicle).

AUXILIARY FUEL TANKS

In remote locations, far from civilization, survival often depends directly on the fuel capacity of a vehicle. Vehicles which are intended to operate on their own for long periods of time must often carry more than a normal amount of fuel. Auxiliary fuel tanks can be fitted to almost any vehicle, either at the factory or by a local workshop. Such tanks extend the endurance of a vehicle at the expense of cargo capacity, but they do not otherwise affect the performance of a vehicle.

POWER WINCH

Winches of this sort are used to haul a vehicle out of some place where it has become stuck, to help a vehicle up a grade too steep for it to climb without help, or for other light- to medium-weight pulling and lifting tasks. Using a convenient tree limb, for instance, one vehicle can lift the engine out of another (a vehicle can't lift its own engine since the winch needs it for power). Some vehicles (such as range trucks) come with winches as standard equipment, but they can be installed on almost anything by a local workshop. Vehicles are usually equipped with a winch capable of lifting their full weight (but this is seldom necessary). A vehicle winch usually comes with 50 meters of cable, a couple of towing hooks, and two ground anchors (designed to screw into the ground, to provide a fastening point in the absence of a convenient stump, tree, or large rock). A couple of pulleys and some rope round out the package. *Type:* Vehicle Winch *Weight:* 1 kg per 250kg capacity *Price:* Lv5 per kg weight of winch

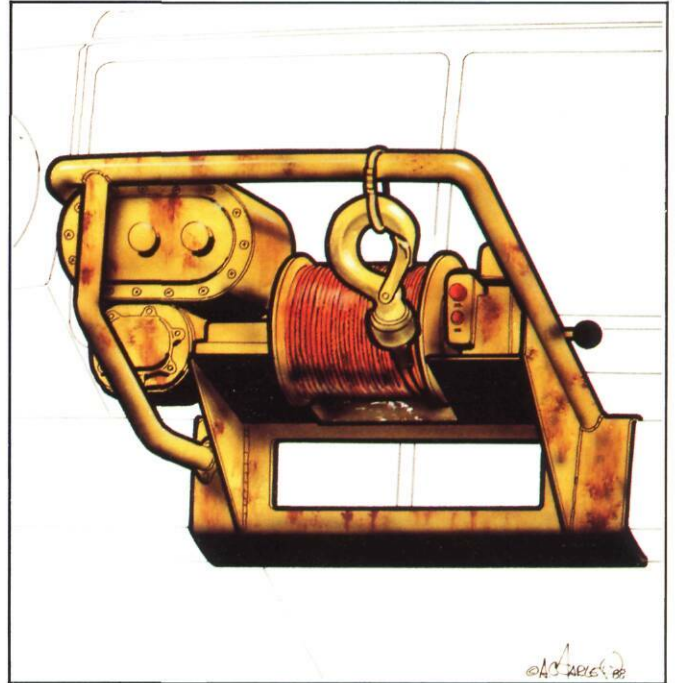
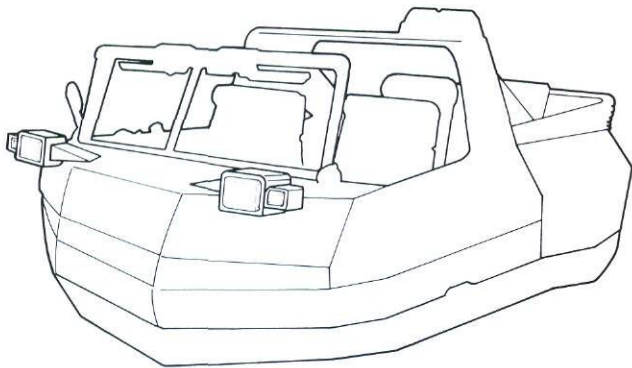

INFRARED/UV LIGHTS

It is often desirable to be able to see without using lights in the spectra visible to humans. These lights are affixed to the front of the vehicle and come with special viewing glasses to enable the driver to see by their light. They can often be factory-installed, in which case the vehicle glass can often be configured to act as the viewing glasses mentioned above. *Type:* Special Spectra Lights *Weight:* 10-20 kg (depending on vehicle) *Price:* Lv250-400 (depending on vehicle)

PENTAPOD AIR FILTER

This is a living air filter, now being marketed experimentally in many locations for use in desert areas and other regions where the atmosphere is filled with particulates capable of damaging an engine. The animal has no musculature except a number of clinging structures designed to hold it in place, and depends on engine suction to draw air through it. The filter's body is mostly a large chamber lined with cilia and mucous membranes which trap particulate matter and convey it to the creature's digestive sac. Here, any organic matter is extracted and digested, and leftovers are sealed in a small membrane-covered package. These packages, in the form of small, black, glistening ovoids, are dropped to the ground. The filter is capable of surviving the heat of most engines, but it cannot operate in temperatures below -5°C . It cannot function in vacuum conditions (but there is no need for an air filter in a vacuum anyway).

Maintenance is simple—the filter does not need food or water except in the most arid and lifeless environments, and the owner does not need to replace anything, ever. *Type:* Pentapod Products Automotive Air Filter *Weight:* 3 kg *Price:* Lv75

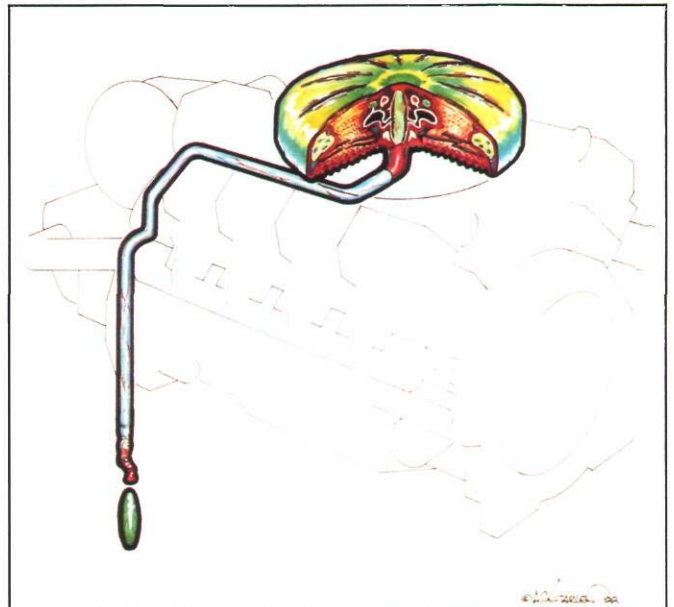



OFFICIAL UNIT PATCH, 1ST BDE, AMERICAN MARINES

The full-color version of this patch is presently authorized for wear on Class A uniforms. A subdued version (black thread on OD green) is authorized for battle dress.



VEHICLE MARKING, 2/1 BDE, AMERICAN MARINES

This unofficial "fender art" reflects the orbital assault mission of this unit. The unit had a special run of "peel-n-stick" decals manufactured for them, and they paste these on every accessible surface wherever they are stationed.



UNOFFICIAL PATCH, KG REINER, AURORE

A privately procured unit patch worn by members of *Kampfgruppe Reiner* in service on Aurore. The unit's commander, Gerhart Reiner, was nicknamed "Reineke Fuchs" (Renyard the Fox), by his soldiers.



UNIT PATCH, TANSTAAFL FREE LEGION, AURORE

This patch is the most common of a number of privately procured uniform distinctions among the soldiers of the TFL.

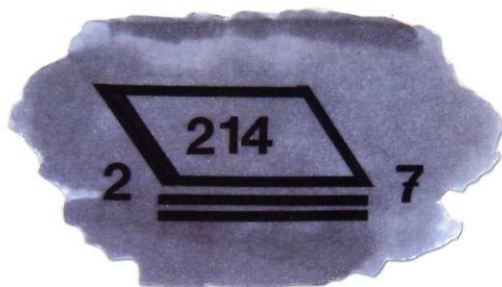

GERMAN TACTICAL MARKING, KG REINER, AURORE

The marking is part of a complicated German tactical marking code: The parallelogram with the heavy left bar indicates an armored company; the lines beneath it indicate an ACV. The numbers show the vehicle is from the 2nd Zug, 7th Kompanie of the 214th LkPz Abteilung, which supplied units to *Kampfgruppe Reiner*.

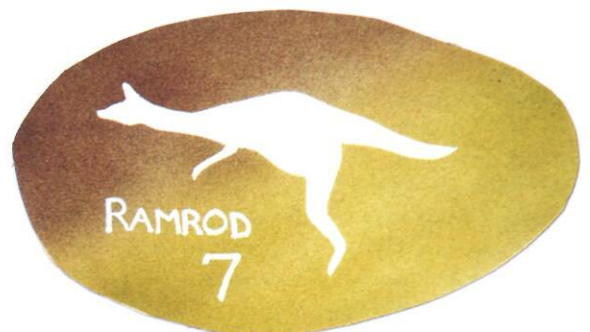

VEHICLE MARKING, RRT-7, TANSTAAFL, AURORE

The white kangaroo comes from the fact that the Rapid Response Teams (nicknamed "Ramrods") are equipped with Australian surplus Kangaroo-IV APCs (nicknamed 'Roos').

AC-12

Nationality: French

Armament: 6.5cm MD, 7.5mm MG, 25mm AC, Manta-1 and Martel missiles

Crew: 3

In Service With: French Metro and Colonial Forces, Texas, Brazil and others

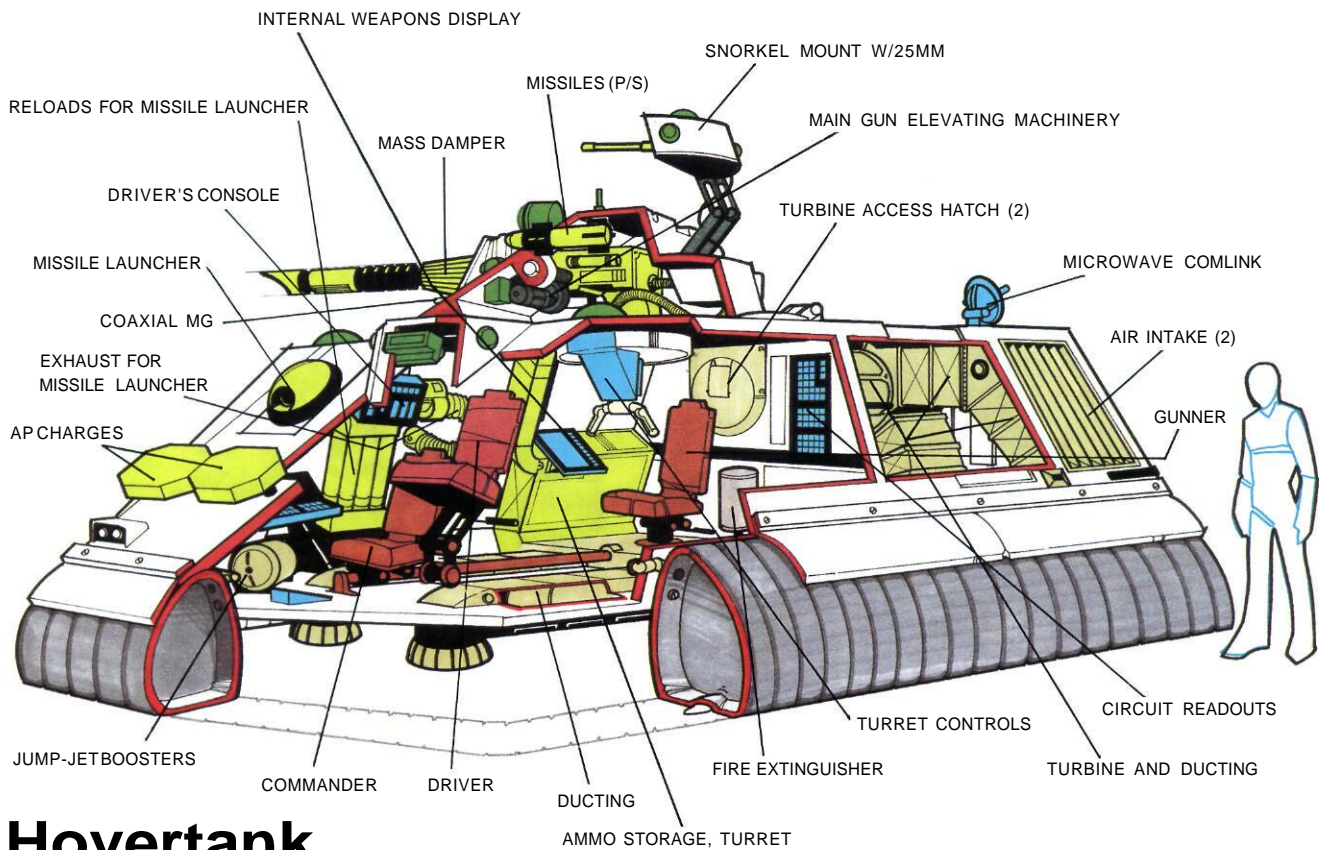
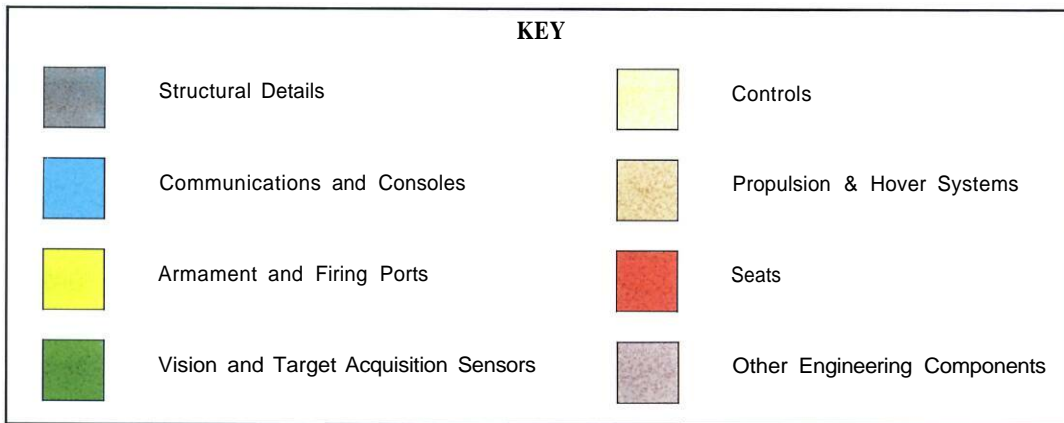

Hovortank

GfPzTr-XIII

Nationality: German

Armament: J-F A-7 Plasma Gun, 30mm AGL, *Luchs* missile

Crew: 3

In Service With: Germany, Azania, UK, and limited service with some colonial armies

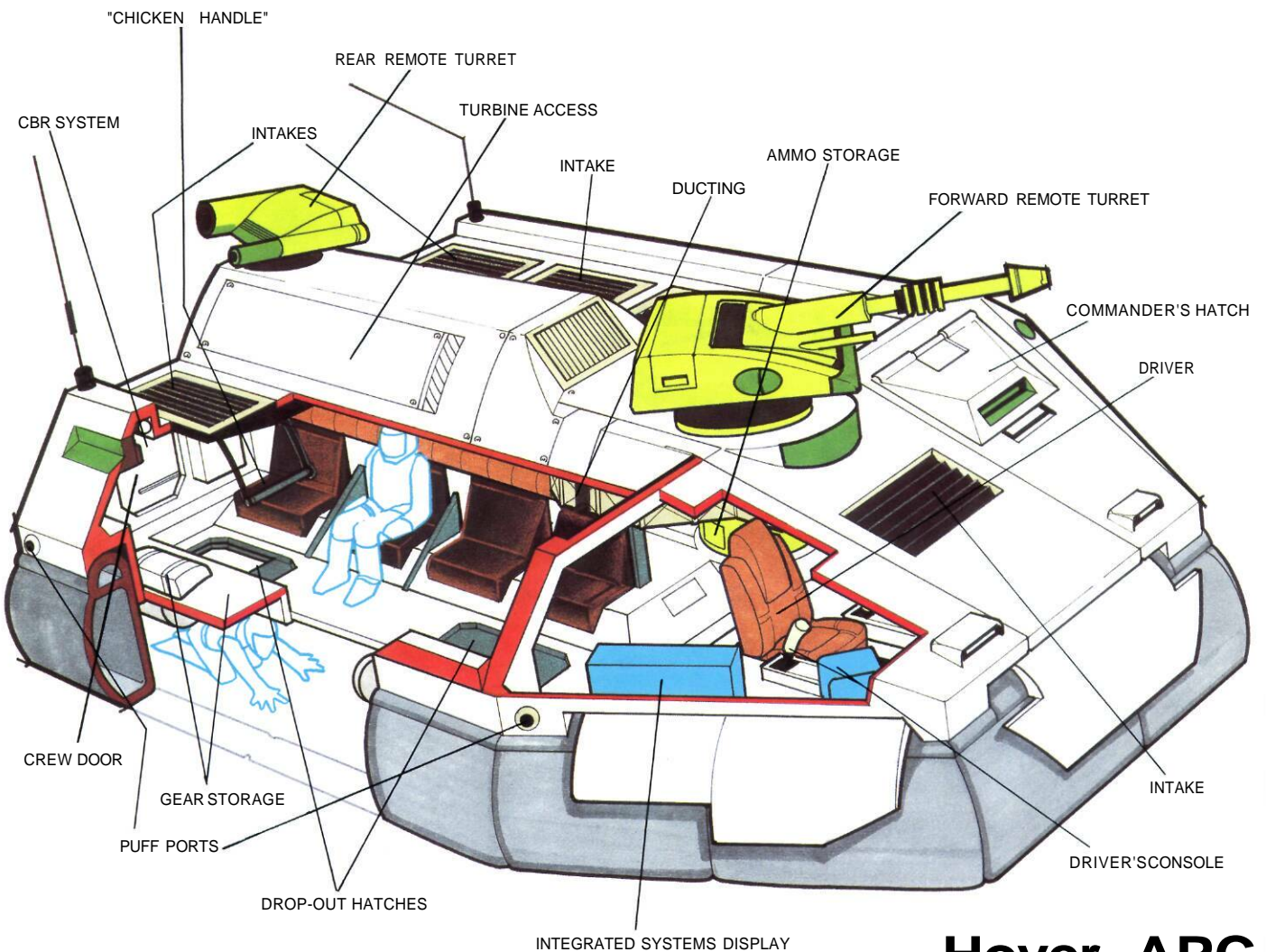

Hover APC

LkPz-IX

Nationality: German

Armament: 7cm MD gun, 5.5mm MG, *Luchs* missiles

Crew: 2

In Service With: Germany, Azania, Russia, and some colonial armies

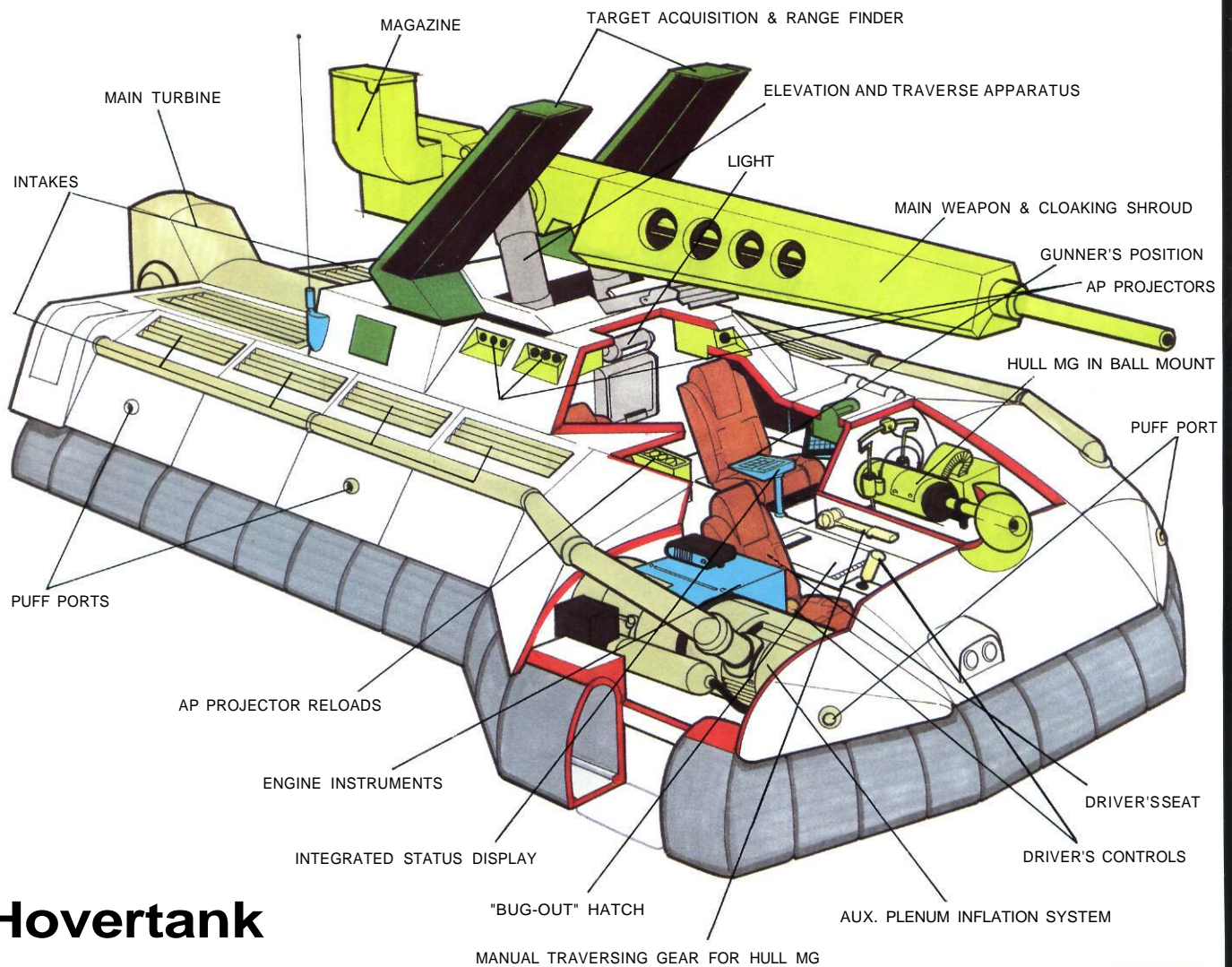

M24A3

Nationality: American

Armament: M707 Plasma Gun, Striker missiles

Crew: 3

In Service With: America, Texas, Canada, and numerous colonial armies and mercenary units

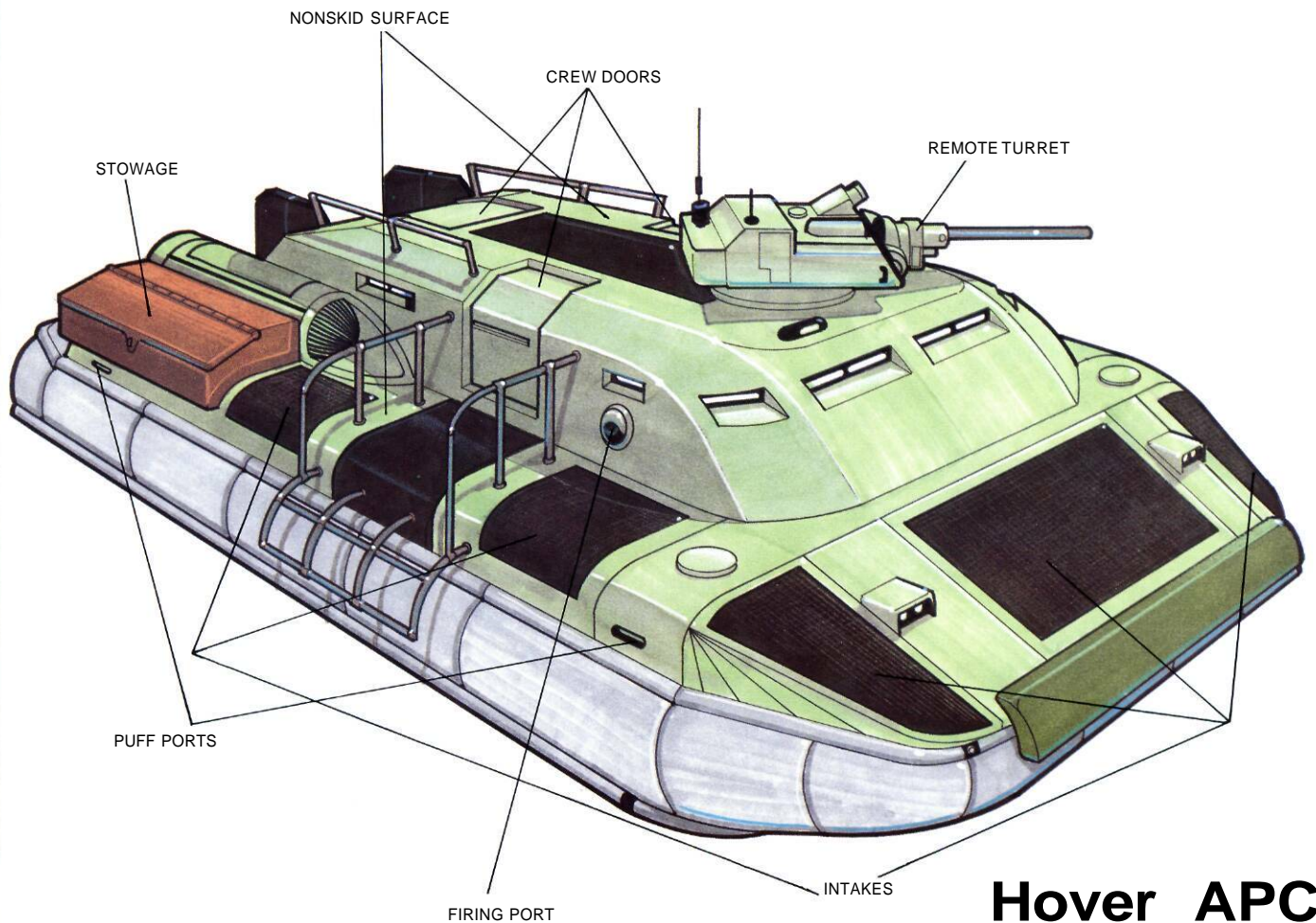

Hover APC

M9

Nationality: American

Armament: 7cm MD gun, coaxial and AA MGs

Crew: 3

In Service With: America, Canada, and some colonial armies

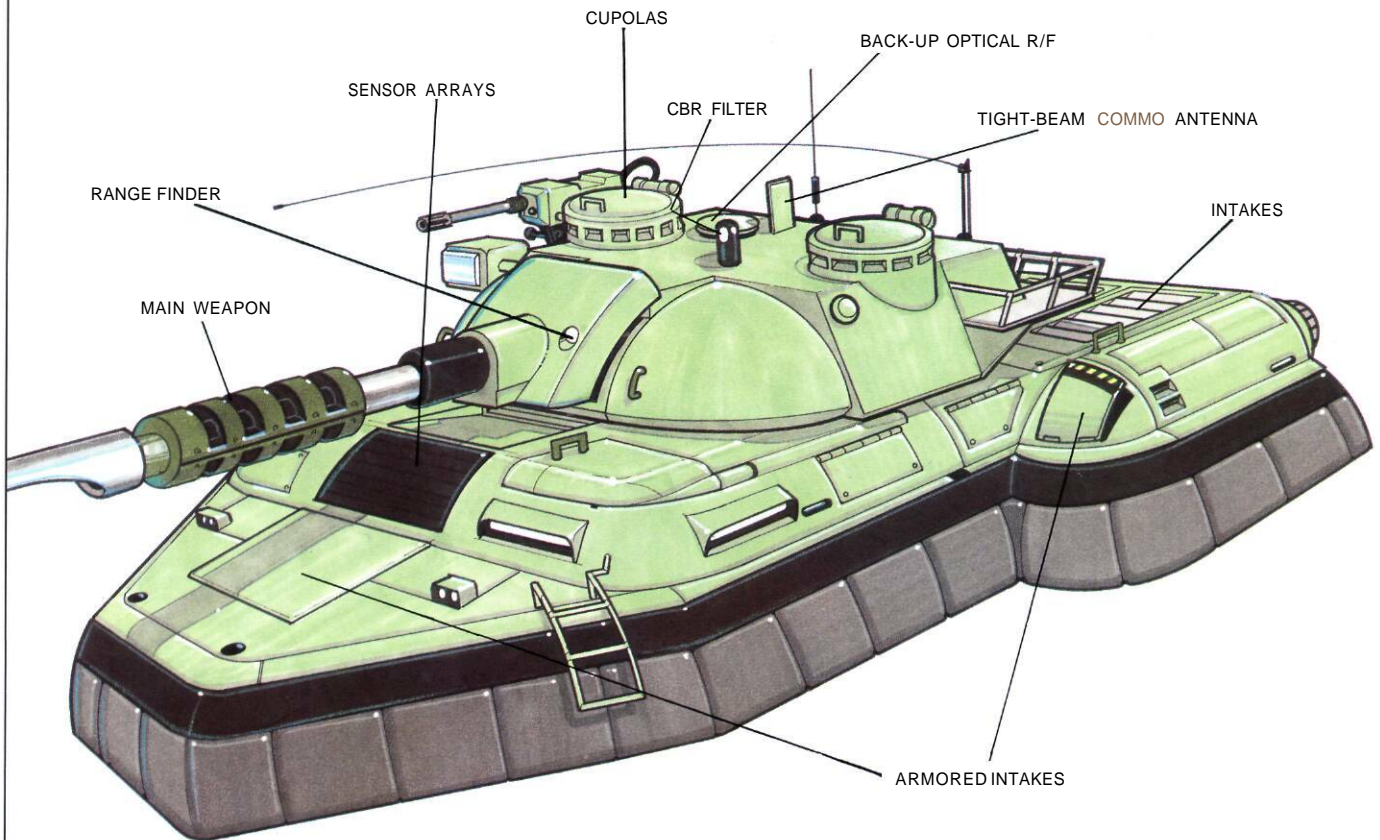

Hovortank

Kangaroo IV

Nationality: Australian

Armament: CLP-1A Plasma Gun (in version depicted below)

Crew: 3

In Service With: Australian reserve units, Indonesia, Spain, Tanstaaf Free Legion (Aurore), and other colonial armies

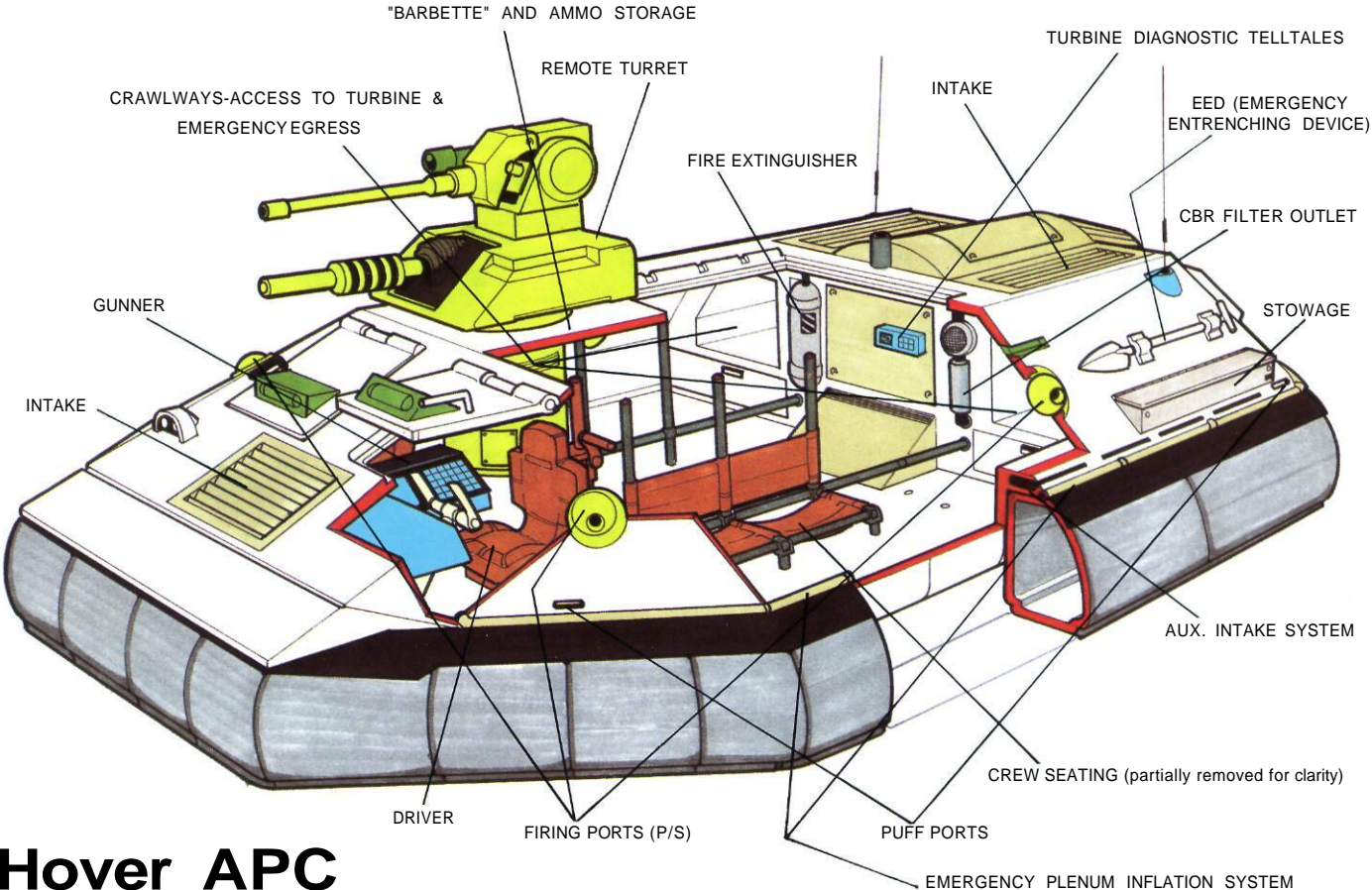

Hover APC

GROUND VEHICLE Guide

M myriad vehicles are produced by the factories of Earth and the human colonies of deep space. Vehicles are needed for exploration, for combat, and for transport of cargo and people. From the smallest two-passenger snowskimmer to the largest cargo hovercraft, vehicles make life on the frontier possible. It is, after all, a long walk home.

The **Ground Vehicle Guide** presents 34 vehicles and their variants, both civilian and military, all fully illustrated. The full panoply of ground vehicles in the **2300 AD** universe is covered, ranging from small, two-passenger vehicles (such as the Matsu Snow-Demon) upward through American, French, and German combat vehicles (including the most modern types) to the largest ground tanks and cargo hovercraft.

Whether the players are assembling an exploratory expedition for an uncharted world, equipping a mercenary unit, or are simply curious about the vehicles of the **2300 AD** universe, the **Ground Vehicle Guide** will more than satisfy their needs. Game statistics for each vehicle are included with the illustrations. Players can look at the cutaways and imagine their characters sitting inside the vehicles. Referees can use the illustrations to improve their descriptions of game events. The **Ground Vehicle Guide** cannot help but make a game of **2300 AD** more exciting.

Color plates depict either cutaways or exterior views of the American M9 hovertank and M24A3 hover APC, the French CC-12, the German LkPz-IX and GfPzTr-XIII, and the Australian Kangaroo-IV. The module includes patches and vehicle emblems in full color, and color illustrations of add-on vehicle accessories (including a Pentapod air cleaner) which can be fitted

onto just about anything.

Vehicle accessories include packages to permit the vehicles to operate in extreme heat, extreme cold, unbreathable atmospheres, and vacuum environments. Alternative weapons are covered for many of the military vehicles, and local variations are discussed (and often illustrated).

The **Ground Vehicle Guide** covers several vehicles first presented in the basic **2300 AD** game, including the Bridgeport Swift Songbird, the Explorer ATV, and others, but it presents new information on all of these. Twenty-two of the vehicles, however, are entirely new and have never appeared before. These include the American M9 hovertank, the Manchurian Type 27 main battle tank, and four new Kafer vehicles: the "Cockroach Car," the "Crawler II," the "Floater," and the aptly named "Behemoth."

Cargo transport is not neglected—the **Ground Vehicle Guide** illustrates conventional, airfilm, and maglev railroad trains, covering principles of operation, car types, and other details. A civilian heavy truck is included (as well as the field-expedient armored personnel carrier that the truck can be converted into), plus a large-capacity cargo hovercraft.

All in all, the **Ground Vehicle Guide** is a resource and reference work that no **2300 AD** player or referee can afford to be without.

Design.....Loren K. Wiseman
Additional Design..Lester W. Smith,
Frank A. Chadwick

Since 1973



PO Box 1646
Bloomington, IL 61702-1646

