

2300TM

1033

William H. Keith Jr. and Lester W. Smith

Mission ARCTURUS



KS '87

Desperate rescue behind the Kafer lines

Game Designers' Workshop

2300

MISSION ARCTURUS

Introduction.....	2
An Invitation.....	4
Aboard the <i>Bassompierre</i>	6
The Marines.....	8
The Combat Walkers.....	10
The Advisors.....	12
Arcturus System.....	14
Station Arcture.....	16
What <i>Bassompierre</i> Sees.....	19
The Briefing.....	21
Entry and Abandonment.....	22
First Impressions.....	24
Catastrophe.....	26
Ambush.....	28
Survivor.....	30
To the Rescue.....	31
At the Core.....	32
Kafers at Bay.....	34
Assault.....	37
The Worm Turns.....	38
After the Storm.....	42
Xenopsychologist's Report.....	44
Armor/Damage Revisions.....	45
NPC Index.....	46
All About Kafers.....	48

<i>Design</i>	William H. Keith Jr. and Lester W. Smith
<i>Development</i>	Lester W. Smith and Frank Chadwick
<i>Art Direction</i>	Barbie Pratt
<i>Sr. Graphic Designer</i>	Lauretta Oblinger
<i>Graphic Designer</i>	Dana Reischauer
<i>Art Assistant</i>	Jim Kuntz
<i>Cover Art</i>	Steve Venters
<i>Interior Art</i>	Rob Caswell, Liz Danforth, and Tom Peters
<i>Typesetting Manager</i>	Michelle Sturgeon
<i>Typesetting Assistant</i>	Kelly Walsh

Copyright©1987 Game Designers' Workshop, Inc. All rights reserved. Printed in USA. Made in USA. ISBN 0-943580-45-5.

Traveller: 2300 is GDW's trademark for its science-fiction, role-playing game set in the 24th century.

Traveller® is a registered trademark of Game Designers' Workshop.

PO Box 1646, Bloomington, Illinois 61702-1646 USA

G A M E D E S I G N E R S ' W O R K S H O P

Introduction

Mission Arcturus is an adventure for use with GDW's science-fiction role-playing game **Traveller: 2300**. In this adventure, players will take on the roles of members of an expedition to discover what has happened to the scientific station at Arcturus. This mission begins at Aurore.

Aurore is currently the battleground in a vicious and unrelenting war being fought between her human colonists and a hostile and implacable alien race known as the Kafers. The history of Aurore, details on the course of the Kafer War, and initial information on the Kafers themselves are all laid out in greater detail in the first of the Kafer War scenarios from GDW, *Kafer Dawn*.

In brief, contact with the Kafers was first made in 2395 by a French research outpost orbiting the star Arcturus, four and a half light years out-arm from Eta Bootis. Two years later all communication with the French station abruptly ceased, and it is now assumed that the station was destroyed by a surprise—and unprovoked—attack by the Kafers. The following year, in 2398, a Kafer armada struck Eta Bootis, and the Kafer War began in earnest.

While *Mission Arcturus* is designed to stand alone and can be played without reference to previous **Traveller: 2300** game products, it is recommended that referees who intend to lead their player group through this scenario first take them through one or more of the scenarios described in *Kafer Dawn*. This will familiarize the players with the nature of the Kafer War. Further, it will *prepare* them to play the part of advisors to the mission team, a very prestigious position and one suited well to wanderers and mercenaries (common occupations for player characters). Alternatively, players may take the part of nearly any of the NPCs in this module or replace those NPCs with their own characters.

A second GDW product, the *Aurore Sourcebook*, gives additional background information on Aurore which will be of use to referees planning to set a long-term campaign on that planet. The adventure in *Mission Arcturus* can spring very easily from such a campaign.

Mission Arcturus is divided into the following sections:

This *Introduction*, followed by a referee's synopsis.

An Invitation to the player characters from Kommodore Wilhelm Lutke to join the mission. This chapter explains to the referee how to get the player characters involved.

A description of life *Aboard the Bassompierre*, the vessel which carries the mission to the Arcturus system.

A chapter detailing *The Marines*, in this case American, with whom the player characters will be working.

Details about *The Combat Walkers* which will be backing up Marine Fireteam One.

Descriptions of *The Advisors*, veterans of the ground fighting with the Kafers on Aurore.

A description of *Arcturus System Entry* and its visual impact upon humans.

A description of the mission's first view of *Station Arcture*.

The Briefing which is given to the mission members before the marines enter the station.

A dozen chapters detailing individual locations and encounters within the station, including a chapter describing the Kafers, for referees who have not run them before.

A description of what is resolved *After the Storm*.

A *Xenopsychologist's Report* of what can be determined of Kafer psychology and sociology from data gathered as a result of the mission.

A chapter describing revisions to the basic game's armor rules.

And an *NPC Statistic Index*. (Please note the explanation in this section of how skill levels may be determined from NPC experience levels.)

WARNING
IN ORDER TO PRESERVE SUSPENSE,
ONLY REFEREES SHOULD READ BEYOND THIS POINT.

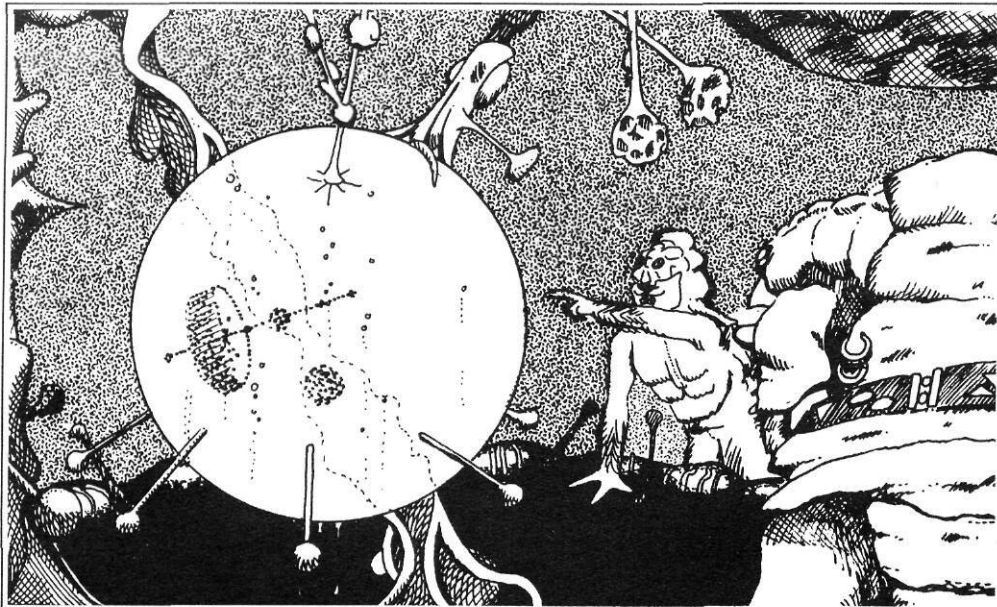

REFEREE'S SYNOPSIS

This synopsis will give the *referee* an overview of the events that will take place over the course of the adventure and will let him or her in on events behind the scenes.

Initially, the player characters are invited to join *Mission Arcturus*, a mission to determine what has occurred at the scientific station at Arcturus since contact with it was lost three years ago. The trip from Aurore to Arcturus takes a little over one standard day, and the characters can occupy their time in several ways. They can explore the *Bassompierre*, getting to know its layout; they can study reports about the layout of Station Arcture, in preparation for their upcoming boarding mission; and undoubtedly they will get to know the other members of their mission team.

Once the *Bassompierre* arrives in system, the player characters will be able to watch on vid screens in their quarters as the ship approaches the star. Eventually they will sight Station Arcture. They will then discover that the station has been hit and breached in several places by heavy weapons fire and that something alien looking is attached to the reactor end. The station's spin habitat is not doing its normal spin; instead, the entire station is doing a slow, wobbly spin. The overall impression is one of abandonment.

The *Bassompierre* halts a few kilometers away from the station, and the player characters are briefed as to how the mission is to proceed. Three fireteams and their attached personnel, each in a separate vessel, will be sent to within a few hundred meters of the station. From that point, space-suited individuals, towing an anchor line from their vessel, will cross by jet pack to a breached portion of the station hull. Other members of the team will proceed along the anchor line.

Fireteam One will enter through the breach in the spin habitat; Two will enter through the shattered observatory; and Three will enter through the destroyed docking bay.

Once inside, each team will begin to explore their portion of the station. As they begin, a pair of Kafer warships passes through Arcturus system, and the *Bassompierre* is forced to give chase, leaving the fireteams behind. Shortly thereafter, radio contact is lost between the fireteams, apparently due to Kafer attacks on Fireteams Two and Three.

Fireteam One proceeds alone, encounters a few Kafer ambushes, and discovers a human hostage. He seems pretty dubious about being rescued. He does, however, let them know that there are more human hostages on board at the reactor end, where the Kafers are attempting to hook up a Kafer stutterwarp in order to take Station Arcture to one of their bases.

The fireteam fights its way to the reactor, defeats the Kafers there, and deals with irate hostages who have developed an attachment to their captors. Finally the *Bassompierre* returns.

2295: Station Arcture reports contact with the vessel of a previously unknown alien race. Attempts to communicate with the vessel are unsuccessful, and the vessel leaves Arcturus system.

2297: All contact is lost with Station Arcture.

2298: Kafers invade the Eta Bootis system, defeat the human fleets there, and land an army on Aurore. The remnants of the human fleets escape to Hochbaden. Later that year, the human fleets receive reinforcements from Earth and return to Eta Bootis. Once there, they destroy the Kafer invasion force and recapture Aurore. Small units of Kafer ground forces remain to be fought on the planet.

2299: Late in the year, an American cruiser division is sent to reconnoitre the Arcturus system. The division encounters a tough Kafer rearguard but succeeds in driving it off, mortally wounded, at the expense of one of the division's two cruisers. The other cruiser returns to Eta Bootis.

2300: Kommodore Wilhelm Lutke decides to seize the opportunity, before higher authority arrives from Earth, to lead a mission to Station Arcture in order to determine if there are any survivors among the station's crew and, if so, to rescue them.

An Invitation

Mission Arcturus begins on the planet Aurore, preferably after the player characters have played out the scenarios presented in the first **Traveller: 2300** Kafer War module, *Kafer Dawn*. The referee may, if it is preferred, introduce a new player or player group into this adventure, however. If the players have played scenarios from *Kafer Dawn* or *Aurore Sourcebook*, their characters are most likely veterans of the ground fighting with the Kafers on Aurore. In this case, they will join *Mission Arcturus* as expert advisors to the American Marines who have never fought Kafers themselves. If, on the other hand, the players are not familiar with Kafers either from *Kafer Dawn* or from *Aurore Sourcebook*, they may either play the parts of members of Fireteam One or the combat walker pilots who have been attached to that fireteam, or, if their own characters have the necessary skills, they can serve as replacements for any of these NPCs. (Both Fireteam One and the combat walker pilots are detailed later in this book).

AN INVITATION TO A JOURNEY

At the beginning of *Mission Arcturus*, the player characters are on Aurore, where they have come to fight the Kafers. The mastermind of *Mission Arcturus*, Kommodore Wilhelm Lutke, is looking for people to flesh out his mission group. The core of this group consists of the crew of the *Bassompierre* (a Suffren-class cruiser which made up part of the reinforcement force sent from Earth to the ESA fleets which had been driven from Eta Bootis) and the company of American Marines which the *Bassompierre* was carrying. Because the *Bassompierre* was pretty much held in reserve during the fighting in which Eta Bootis was recaptured from the Kafers, her crew remains fairly inexperienced in battling Kafer ships, and the American Marines have had no experience with Kafers at all.

As the fighting on Aurore's surface continues, Kommodore Lutke wishes to avoid depleting the number of Kafer-experienced fighters there. His plan is to take a filled crew which has not had experience with Kafers and supplement it with a handful of advisors who have. He still has a few openings both for advisors and for non-Kafer-experienced fighters, but all other crew positions have been filled. (If the referee prefers, other sorts of skilled individuals might be recruited for this mission, provided that there is a logical reason for attaching them to the marine fireteam.)

Kommodore Lutke has temporarily established his headquarters at La Cite d'Aurore, the French colonial capital of Aurore, and it is to here that the player characters are summoned. Exactly how this summons is delivered is left to the referee's discretion and will depend on the characters' current situation, employment, and orders. If they are members of a military or paramilitary force, Kommodore Lutke can simply request help from their commander, who can order them to report to Lutke. If, on the other hand, they have arrived at Aurore as free-lancers, they might receive an invitation to make an appointment with Lutke, or one of his recruiters might meet them on the street.

Once the player characters have been approached with an invitation or orders, there remains the problem of getting them to La Cite d'Aurore. In some cases, this might be an adventure in itself. If necessary, Kommodore Lutke will have obtained authorization from the French Colonial Administration for transportation for the player characters (military jet or other air transport) from any spaceport or airfield, such as Port Blackjack outside of Tanstaaf, to La Cite d'Aurore.

KOMMODORE WILHELM LUTKE

Kommodore Lutke is, of course, the man most credited with having driven the Kafers from the Eta Bootis system. This is not only because he happened to be the head of the fleets sent from Earth to reinforce the remnants of the Eta Bootean fleet which had escaped to Hochbaden, it is also because he took *de facto* command of the combined fleet and, by a combination of audacity and williness, defeated the Kafers.

Kommodore Lutke is planning to retire from service when he returns to Earth. However, he has been more than pleased to have the opportunity to end his career with the glory of a Kafer defeat to his credit. Because of this and because he believes in running with the initiative once



you have it, Lutke has come up with the plan of taking the *Bassompierre* to Arcturus before the Kafers have time to recuperate from the sortie which the fleets from Hochbaden recently made. What he hopes to gain from this mission (besides a bit of personal glory) is information about the Kafers, which should be stored in the computers of Station Arcture—information such as from what system they might have come.

REMUNERATION

If the characters are already members of an established military unit (i.e., *not* a mercenary unit such as the Tanstaaf! Free Legion), it would be a simple thing to order them to accompany the expedition. However, they will first be asked to volunteer, and a combat/hazardous duty pay incentive of Lv500 per man per week will be offered as further inducement.

If the characters are free agents currently in the employ of a private Auroran citizen or corporation, or if they are mercenary soldiers serving with the Legion or a local militia, they will be paid whatever they are earning already, plus the Lv500 combat bonus mentioned above. If the characters are currently unemployed, their fee will be negotiable but will be *at least* Lv600 per person per week. Arrangements will be made to deposit the pay regularly with any bank on Aurore, Earth, or elsewhere.

Length of service is not specified in the contract. Kommodore Lutke will explain that the expedition is expected to spend between two and six months in the Arcturan system, but he can make no promises about how long the characters will be gone.

KOMMODORE WILHELM LUTKE

Kommodore Lutke is a man in his late sixties, with a stocky body in which heavy muscle is beginning to turn to flab with age. He still looks imperious, however.

He is a Veteran NPC in both Space Military and Administrator.

NPC Motivation

Results: Spade Ace: *Despite his advanced age, Kommodore Lutke is an energetic, confident man—the sort who inspires others to follow his lead. As fortune would have it, he has come to the Eta Bootis system at just the right time. That is, the Kafers have been driven out of the system, and Kommodore Lutke was the fellow who led that effort. Slowly, but inexorably, the Kafers are being rooted from Aurore as well. Emotion is high among the humans here to deal the Kafers another blow by retaking the Arcturus system as well. Consequently, Kommodore Lutke is having no trouble getting volunteers for his mission. Spade 10: Lutke desires to retire with one last, glorious victory on his record. Driving the Kafers from Eta Bootis qualifies, but he sees the opportunity to recapture Station Arcture as frosting on the cake.*

Aboard the *Bassompierre*

This chapter presents important information about the physical layout of the *Bassompierre*, the cruiser which Kommodore Lutke's mission group is taking to Arcturus. The *Bassompierre* is a Suffren-class cruiser and was named after the French Admiral who led the force of ESA auxiliary cruisers against Argentina's cruiser squadron in the First Battle of Alpha Centauri, A.D. 2162.

FRENCH SUFFREN-CLASS CRUISER

Original Date of Design: December 4, 2276

First Example Laid Down: March 19, 2278

First Example Completed: August 15, 2281

Fleets of Service: France

Dimensions: 140 meters in length, 25 meters in diameter (average), with extended spin habitats reaching to a radius of 60 meters.

Crew: *Bridge:*15, *Tactical Action Center:* 35, *Engineering:* 22, *Shipboard Vessels:* 6, *Ship's Security:* 20, *Ship's Troops:* 350, *Steward:* 1, *Scientific:* 5, *Medical:* 8.

Performance Characteristics

Warp Efficiency: 3.34, *Power Plant:* 300 MW Fusion, *Fuel:* None, *Range:* 7.7, *Mass:* 22,050.11 tons, *Cargo Capacity:* None, *Comfort:* 0, *Total Life Support:* 500, *Price:* Lv381,500,000.

THE BASSOMPIERRE: A GENERAL DESCRIPTION

As can be seen from the diagram, the *Bassompierre* may be divided into six sections of approximately equal length. The first of these sections consists of a number of solar panels, normally kept in a folded, conical configuration. In fact, the only purpose of these panels is to provide power for life support and communication functions if the ship's power plant suffers severe damage. This was an experimental measure decided upon during the Suffren-class's early design, to take advantage of the fact that the greatest majority of battles between space-faring craft take place relatively close to a star.

Next is a section devoted to the ship's spin habitats. The *Suffren* design has three spin capsules set 120 degrees apart from each other. Each of these habitats can hold up to about 165 people along with their life support. The ship's medical section is also housed in these spin capsules: one four-man medical center in capsule 1 and a two-man sick bay/pharmacy in each of the others. Capsule 2 also holds the ship's brig, and capsule 3 houses much of the scientific section. The *Suffren-class* is designed in such a way that during combat the pylons supporting the spin habitats can be folded back along the length of the ship, laying the spin capsules onto the engineering section. In this way the ship's profile is narrowed, making it more difficult to be targeted, and direction changes can be made much more easily as well without the pylons extended. The entire operation of folding the habitats for combat normally takes a total of 22 minutes (although it *can* be done in as little as six if the capsules are empty of crew and loose equipment). Normally one company of French troops is housed in each of these spin habitats, but on this mission a single American marine company is divided between the three—one platoon for each, plus their vacc suits and equipment.

The next section houses the bridge, as well as security section work stations and the scientific section's zero-g laboratory facilities. There is little else to be said about it.

Next is the engineering section. Airlocks in the outer hull of this section match with partners on the spin habitats, allowing free passage from engineering to the spin habitats when they are folded flat for combat. Engineering also stores the marines' heavier equipment and such things as the combat walkers which have been brought on this mission. The final section of the ship houses the power plant and drives. The power plant, of course, takes up the majority of the

THE BASSOMPIERRE

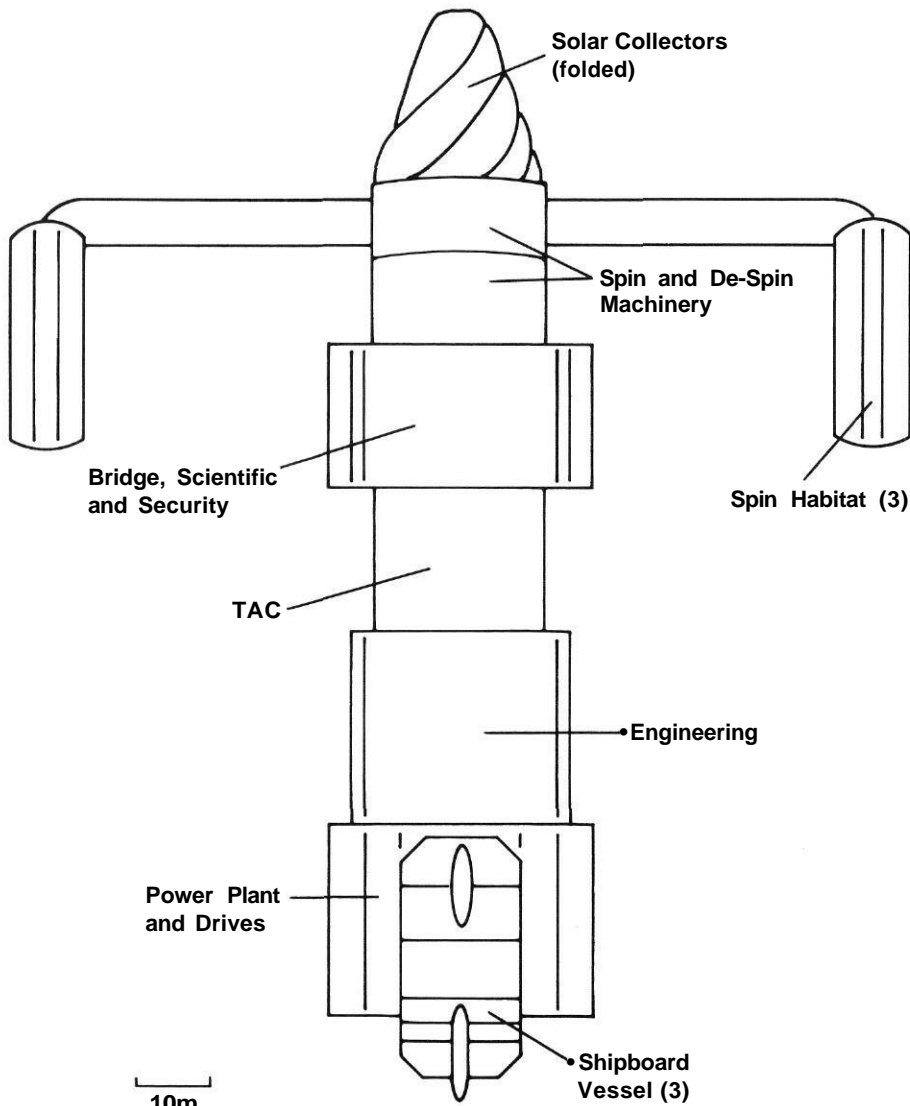

space. Fastened to the outer hull of this section are three ship's vessels, accessed by passageways which lead from engineering. Each of these vessels measures approximately 35 meters by 15 meters by 4 meters. Each ship's vessel operates as a landing craft and can carry a full platoon of marines, plus their equipment, besides its wheeled surface exploration vehicle.

PLAYER CHARACTER ACCOMMODATIONS

As player characters are attached to Fireteam One of First Platoon, they will be housed in spin habitat 1 with the rest of First Platoon. During the trip to the fringes of Arcturus system (a total time of about 32 hours) they will be allowed to wander the ship pretty much at will, although the power plant, drives, and ship's vessels will be off limits. Once the system has been reached, however, everyone will be expected to be at station for the approach to Station Arcture. For the marines, this means staying in their quarters. During this time, the spin habitats will be folded flat, and the accesses between them and engineering will be opened.

The Marines

MARINE WEAPONS

The following are weapons used by the First Marine Special Forces Company. Most Marines carry M-5s. Due to the danger of breaching a hull, only Sergeant Ortega will carry one. Corporal Yeager will carry a Traylor Model 10 riot gun. Lance Corporal Lang will carry a Type 720 machinegun; and Private Bucheger, an FTE-10.

M-5 Assault Rifle

The Traylor Arms M-5 was chosen the standard assault rifle for Marine forces in 2293. A development of the M-2 "nine-forty-four," it uses a binary propellant system rather than the M-2's fixed cartridges and mounts an integral 30mm grenade launcher under the barrel.

Type: 9mm binary propellant assault rifle (with 30mm grenade launcher)
Country: USA
Weight (empty): 4.2 kg
Length: 79 cm (bulk = 2)
Action: Single shot or bursts
Ammunition: 9 x 12mm APHE
Muzzle Velocity: 700 mps (area fire 400 mps)
Magazine: 50 rounds with propellant gas bottle. Catalyst gas bottle with charge for 600 aimed shots or 200 bursts.
Magazine Weight: 0.5 kg
Recharge Bottle Weight: 0.1 kg
ROF: 3 (area fire 5)
Area Fire Range: 600 m
Area Fire Burst: 10 (AFV= 1.5)
Area Fire Range: 300 m
DP Value: 1 (aimed fire and area fire)
Price: Lv675 (Lv3 50-round disposable magazine; Lv2 recharge bottle).

The *Bassompierre* carries an entire company of American Marines on loan to Kommodore Lutke for the duration of this mission. The total number of persons in the company is 80, five of whom are officers. The remaining 75 are divided into three platoons of 25 persons each, one of which is the platoon sergeant. The remaining 24 persons in the platoon are divided into three squads of eight Marines each, and each squad is further divided into two fire teams, each of which consists of a team leader, two riflemen, and a plasma gunner. The five officers mentioned earlier are the company's commanding officer, the executive officer, and three platoon leaders.

As mentioned earlier, the *Bassompierre*, being a Suffren-class cruiser, has been built with room for about 350 ship's troops. This leaves plenty of room aboard the *Bassompierre* for the American Marine company that is aboard for this trip, as well as their combat walker pilots and Kafer-experienced advisors. Officers' quarters are, of course, a bit more commodious than those for the rest of the troops.

Quarters for the player characters will, of course, depend upon what role they fill in this mission. Their alternatives are as follows: they will either play the part of the Marines of Fireteam One, Squad One, First Platoon, or they will portray characters attached to that fireteam. In the first case, they will be housed with the rest of First Platoon. This will also be the case if they are combat walker pilots. If they are advisors, however, they will be housed in spare officers' quarters.

FIRETEAM ONE, SQUAD ONE, FIRST PLATOON

In the 24th century, an individual soldier can deliver much more firepower to the battlefield than ever before. As a consequence of this increased individual power, military thinking has tended to favor much smaller units than ever considered before. Consequently, the basic unit of combat is beginning to shift from the squad to the fireteam. Individual fireteams are often deployed independently as the situation warrants. The squad still retains importance in battles where fair distances have to be traversed, as one fireteam can hold position and make cover fire while another moves forward.

The slightly more independent status of the individual fireteam has caused it to be listed in a more official manner; hence an individual marine will be known to other marines not just by his battalion, company, platoon, and squad, but also by his fireteam. In order to prevent confusion, fireteams are numbered by platoon rather than by squad, with Fireteams One and Two making up First Squad, Fireteams Three and Four making up Second Squad, and so on.

The following marines are in Fireteam One, First Squad, First Platoon, of Charlie Company (the marine company aboard the *Bassompierre*).



Sergeant Raoul Ortega

Sergeant Raoul Ortega is the fireteam leader for First Squad's Fireteam One. He is a big, brawling man who likes to challenge other platoon members (not fellow fireteam members) to arm wrestle matches. Few take him up, and he seeks "new blood." Loud, aggressive, and sometimes obnoxious, he is an energetic leader and a good man to have on your side in a fight.

Sergeant Ortega is a Veteran in Space Military.

NPC Motivation Results: *Club 10:* Ortega loves a good fight. *Spade 4:* He also loves to brag about his past exploits and those of his fireteam. However, his bragging is good-natured rather than arrogant, and Ortega is well-liked by most of the men and women in First Platoon and is highly respected by the other members of Fireteam One.



Corporal Kelly Yaeger

Corporal Kelly Yaeger is a short, red-haired, attractive young woman who affects a surly, cynical, brassy personality. She has developed a reputation as being "one tough marine," and men in the First Platoon who have had their advances rebuffed by her joke that she is "the best man in the outfit." However, the attitude that she allows everyone to see is merely a defensive mechanism which she has assumed for the sake of her own survival in a tough-as-nails unit.

Corporal Yaeger is an Experienced NPC in Space Military.

NPC Motivation Results: *Heart Queen:* Corporal Kelly Yaeger is very deeply—and also secretly—in love with Lance Corporal Lang (see Corporal Lang's description below). *Club 3:* Yaeger is not intimidated by any threats or violence which she may encounter.



Lance Corporal Peter "Long Pete" Lang

Tall, quiet, and retiring, Lance Corporal Peter Lang is plasma-gunner for Fireteam One. He is secretly in love with Corporal Kelly Yaeger. Her death or capture could transform Lang into a berserk warrior who cannot be restrained by his squad mates.

Lance Corporal Lang is an Experienced NPC in Space Military.

NPC Motivation Results: *Heart Queen:* Lang loves Yaeger and would die for her. Their relationship has been kept secret at his insistence, partly because of Corps regulations, mostly to avoid harassment by the other members of their platoon. *Black Joker:* While Lang is completely normal and is friendly and likable, if something were to happen to Corporal Yaeger, he would become insane with murderous rage. Under certain circumstances, his rage could be directed against other humans if it was obvious that another character's stupidity or cowardice had resulted in Yaeger's death.

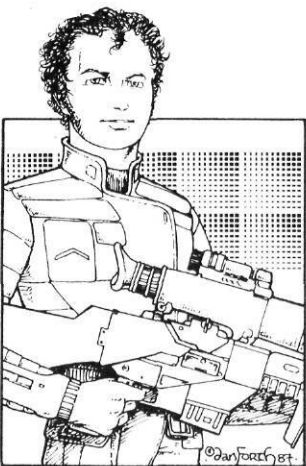

Private James Bucheger

Private James "Jimmy" Bucheger is the smallest man in the platoon. At 161 cm, he barely made the height requirements for enlistment. He takes kidding about his height from his squad mates with silent determination and outward good humor. His boot camp instructors noted that he seems driven to outperform everyone else in his unit. An expert marksman, he voluntarily carries a French-made FTE-10 sniper's rifle when the situation warrants it, lugging the weapon's 12-1/2 kilos uncomplainingly, always rejecting offers to help him "hump his weapon." His determination to excel has won him the respect of most of the others in his platoon.

Private Bucheger is a Green NPC in Space Military but has a Combat Rifleman skill level of 5.

NPC Motivation Results: *Spade 7:* Bucheger has been sensitive about his height ever since he was a boy in school. Driven by the need to prove himself as good as or better than any of his peers, he is viewed with mild astonishment and considerable respect by others in his unit, even while they are gently goading him with "short jokes." *Heart 4:* Bucheger's drive to excel is moderated somewhat by the fact that he is friendly and outgoing. This means that instead of growing resentful of the teasing which he receives, he simply accepts it for what it usually is—the most obvious way in which his friends can pay him affectionate attention. Rest assured that anyone who might try to really belittle Bucheger for his short stature would find himself on the receiving end of Bucheger's flying fists.

FTE-10 (Fusil Tiraleur d'Elite-10)

The FTE-10 is described in the **Traveller: 2300** Player's Manual.

Traylor Model 10 Riot Gun

The Traylor Model 10 is listed in the **Traveller: 2300** Player's Manual.

Kaskaskia Arms Type 720 Machinegun

Designed as a domestic American machinegun, it was adopted after modifications by the Marines in 2289. It is similar in most respects to the Manchurian Type 381, though slightly heavier, longer, and more durable. Critics note that the extractor mechanism is sensitive to fouling from the cartridge discharge. In the hands of inexperienced soldiers, the Model 720 is prone to jams. The Marines are trained to keep their weapons clean—the image of the Marine cleaning his weapon between combats has become a legend.

Marine 720s rarely jam.

Type: 7.5mm squad machinegun
Country: U.S.
Weight (empty): 8 kg
Length: 130 cm
Action: single shots or bursts
Ammunition: 7.5 x 32mm fixed cartridge ball
Muzzle Velocity: 940 mps
Magazine: 150-round cassette or 50-round magazine
Magazine Weight (cassette): 2 kg
Magazine Weight (50-round magazine): .8 kg
ROF: 5
Aimed Fire Range: 800 m (WOO m on mount)
Area Fire Burst: 20 (AFV=2)
Area Fire Range: 600 m (760 m on mount)
DP Value: .07
Price: Lv900 (Lv2 for box of 100 rounds; Lv6 for empty cassette; Lv1 for empty magazine).

The Combat Walkers

This chapter describes the combat walkers included in this mission, as well as the pilots who use them. To pilot a combat walker requires a new combat skill: Combat Walker Pilot. This is a Related Skill for the Ground Military career, or, in the case of the BH-21C (see below), for the Space Military career.

THE FRENCH BH-21 COMBAT WALKER

Nation: France *Weight:* 230kg *Crawl:* Not allowed *Walk:* 10 m *Trot:* 20 m *Run:* Not allowed
Power Supply: Internal rechargeable power cell *Power Duration:* 24 hours *Integral Armament:* Quinn-Darlan Mk 4-A1 PGCW *Sensor Range:* 6 km *Signature:* 2 *Area Protected:* All Armor
Value: 8 *Signature:* 2 *Initiative Penalty:* -4 *Price:* Lv17,000.

BH-21, Basic Model: The BH-21 combat walker is a French-made, powered suit of combat armor. Movement of the suit is operated by motors that are slaved to sensors on the pilot's limbs. That is, the pilot makes fine movements within the suit, and these are amplified and translated into broader movements by the suit. The BH-21 is very sensitive to operator movement; consequently, it requires experience to operate the suit smoothly without causing exaggerated motions. Other functions of the suit, such as claw function, sensor display, temperature modification, and the like, are controlled by fingertip keyboards within the suit's arms.

During combat, an armored shield covers the faceplate, and the operator relies upon computer generated images provided by a sensor array on top of the helmet. These images can be displayed as a normal field of vision, or, by compressing the image horizontally, the operator's field of vision can be increased to any *degree*, including a full 360-degree panoramic view. Obviously, it requires an experienced operator to take advantage of such a view.

Powerful gyroscopes located within the suit make it very difficult to knock off its feet. This is very important, considering that once a suit is down, it is unable to either move or arise on its own. The armor also has pumps with heavy filters to provide the operator with a constant supply of clean air from outside the suit. There are two emergency exits on the suit; each is jettisoned by explosive bolts which must be triggered by the pilot. One of these exits makes up the chest plate of the walker; the other is the normal entry hatch on its back.

The left arm of the BH-21 has an attached Quinn-Darlan Mk 4-A1 PGCW (plasma gun, combat walker). This weapon may either be aimed and fired by the pilot's arm movements, or, preferably, it may be slaved to the walker's head. In this second mode, the operator turns the head to line up a target with cross-hairs on the internal display. The arm moves automatically to bring the weapon to bear on that point. The firing mechanism is triggered by the pilot's jaw.

The usual uniform for a BH-21 combat walker pilot is charcoal gray briefs and a T-shirt. Getting into the walker is an involved process which requires the aid of at least one assistant. This assistant's main tasks are to run down a checklist of all the interior movement sensors, to ensure that they are located on the pilot's limbs correctly, and to make sure that the rear hatch is dogged down. The entire process takes about 15 minutes.

BH-21B: The BH-21 B is simply a normal BH-21 that has been adapted for use in noxious or extremely thin atmospheres. The heavy pumps are replaced with pressurized tanks of air for the operator, and the walker's joint and hatch seals are more extensive.

BH-21C: The BH-21 C model is a further adaptation of the BH-21 B. It is intended for use in zero or *near-zero* gravity and no atmosphere. Seals on this model are even bulkier than in the BH-21 B. Also, the rear hatch on the BH-21 C is a separate piece nearly 30 cm thick and houses a Space Operations Maneuvering Package (EEOS: French, "Empaquetage de Evolvement de Operation Spatial"). This is basically a very advanced jet pack, and is controlled by the suit's finger keyboard in a second function mode. When getting into this model, two assistants are required to lift the EEOS into place and seal it.

This model has a slightly larger viewplate to provide a wider angle of view when the combat sensor screen is not in use.



SERGEANT VIKKI MARCOTTE

Sergeant Vikki Marcotte is a retiring, pretty, dark-haired girl who has established a reputation as a good combat walker operator through her efficiency and quiet determination. Marcotte is not the type to panic in an emergency, and it is expected that she would maintain an outward calm in the performance of her mission even in the face of certain death.

Sergeant Marcotte is an Experienced NPC in Ground Military.

NPC Motivation

Results: Heart 10: *Sergeant Vikki Marquette has a high commitment to fairness and reacts with anger to injustice, brutality, or stupidity.* Heart 7: *She mixes well with new acquaintances and is strongly motivated by loyalty to any group to which she is assigned.*

BH-21C

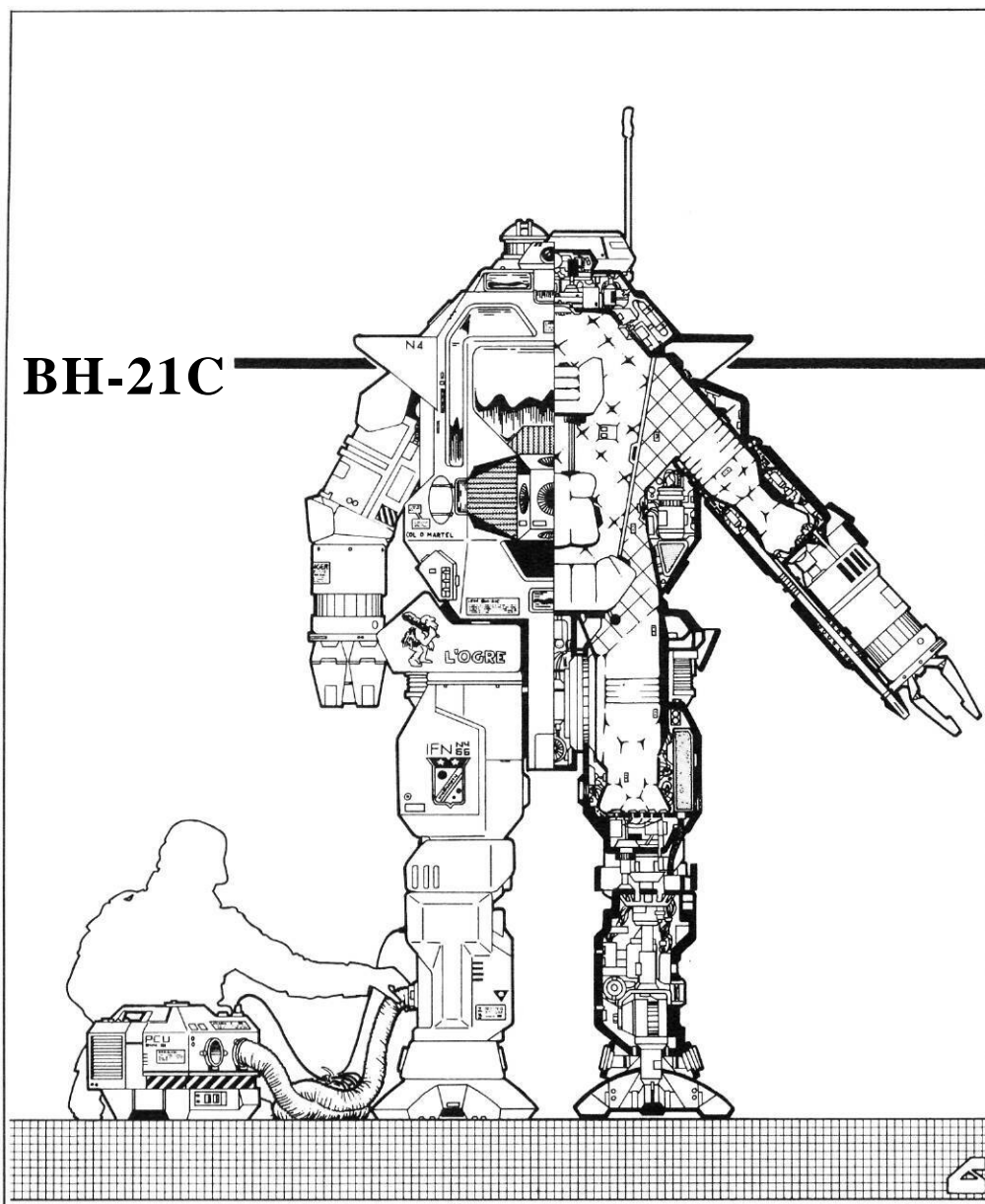

MISSION ARCTURUS COMBAT WALKER PILOTS

The two combat walker pilots in the mission are described in the sidebars of this chapter. Both began their careers in ground military and were subsequently trained in the use of the BH-21 basic model. When the BH-21 C was designed, the decision was made to use experienced BH-21 pilots to be trained in operation of the BH-21C. Future BH-21C pilots will be trained from the ranks of space military rather than ground military careers.



CAPORAL PHILLIP MASSEY

Massey is a solitary man who takes pride in being a "lone wolf." As a combat walker operator, he projects an attitude of great disdain for infantry, claiming that their purpose is to clear the way for heavier equipment, such as combat walkers, to come forward and "do the real work." Massey avoids emotional attachments to anyone. "You have to look out for Number One, because no one else is going to" is his stock answer when criticized for his lack of cooperation with units to which he is assigned. At heart, he is a coward. Massey will not expose his combat walker to fire except when he has no choice, such as during a retreat from overwhelming odds.

Caporal Massey is a Green NPC in Ground Military.

NPC Motivation

Results: Spade Jack: *Massey is a braggart who annoys everyone he meets with his attitude of aloof superiority and his constant criticism.* Diamond Jack: *His aloofness, however, is really just a rationalization for his selfish acts of cowardice.*

The Advisors

If the player characters are experienced in fighting Kafers, they should serve as advisors to the American marine company, and there is no need to use the characters detailed in this chapter. In this case, these characters may be used as NPCs in another adventure, or they might be assigned to the other fireteams which will be entering Station Arcture. If the players have not had experience in running characters against Kafer opponents, they should play the part of one of the marines or combat walker pilots in this book, or they should replace those characters with characters of their own design. In no case should players who have not experienced Kafer warfare play the part of the advisors detailed below.

Each of these advisors has been recruited from the Tanstaaf Free Legion.



SERGEANT MICHAEL "MAD MIKE" VINCENT

With 18 years of experience in the Australian Special Air Service (SAS, a special forces unit), Sergeant Michael "Mad Mike" Vincent is a veteran of many skirmishes. His last duty before leaving the SAS and signing on with the Tanstaaf Free Legion was as a drill instructor. It was as a trainer in survival techniques that he was hired by the TFL. He is well known as having the demeanor of a very tough D.I. but has a peculiar reputation in his use of language. Surprisingly, he has never been known to use profanity-that old, traditional standby of D.I.s since the time of Caesar's legions-but he has been heard to chew out a recruit for 10 minutes running in rich and colorful detail, never using more than mildly vulgar language and never repeating himself.

"Mad Mike" Vincent is a Veteran in Ground Military.

NPC Motivation Results: *Heart Jack:* Sergeant Vincent, despite his rather rough exterior, is an excellent source of good advice in almost any situation. *Club 4:* He is not intimidated by violence or threats. In addition, he is strongly motivated by a sense of loyalty to the mission which he has joined.



SERGEANT WALKER MCGUIRE

A tall, lanky man with a weathered face, Sergeant Walker McGuire is another Aussie who joined the Tanstaaf Free Legion although he had had no previous military experience. Instead, McGuire began his *career* in the police force of Australia's colony in the King system.

McGuire is a very vocal fellow who will gladly give his opinion of anything and everything. The only problem is getting him to shut up. He seems to be very critical of mistakes that others make, but, in all fairness, he also seems very straightforward about his own. The fact of the matter is that McGuire is not so much critical as he is painfully honest. He never learned the value of keeping quiet and letting something blow over.

McGuire's conversations are classically Australian with frequent utterances of "G'day, mate" and "No worries, mate." He refers to Kafers as Bunyips (a sort of Australian "Bigfoot").

Walker McGuire is an Experienced NPC in Law Enforcement.

NPC Motivation Results: *Heart King:* Walker McGuire is scrupulously, even painfully, honest. He can be trusted not only to keep his word, but to speak his mind about whatever occurs to him. *Club 3:* Also, although he does not seek violence, he is very accepting of its efficacy in solving many problems.

RUNNING THE ADVISORS

When using these advisors as NPCs, the referee should keep his or her own knowledge of what is typical for Kafer activity firmly in mind and simply have the advisors advise the players of those facts.

Also, if the players are having a rough time of it, the advisors might even be able to predict exactly how the Kafers are going to act in a particular encounter, which can give the players the edge they need in that encounter.



CORPORAL HOWARD PADEREWSKI

A Pole by birth, Corporal Howard Paderewski is the archetypical short, tough kid who seems to turn up in any small military unit. He is, in his own words, an "operator" and expends considerable skill and effort in evading the rules and making money.

His apparent greed stems from his image of success, which is directly related to how much money a person makes or how much influence he wields. Since it is obvious that he will never get rich on a mercenary's pay, he is determined to make a fortune by other means, if necessary, and to be known as a sharp, smooth operator.

Paderewski has a seemingly incredible chain of contacts—"I know a guy who can get it for you, for the right price"—which, on this mission, makes him the marines' main source of unauthorized liquor. (The first thing Paderewski did upon coming aboard ship was to establish a good working relationship with one of the ship's English-speaking drive engineer's mates, in order

to establish a source for whiskey from the strictly illegal still run by members of the ship's drive gang.)

Howard Paderewski is a Green Troubleshooter.

NPC Motivation Results: *Diamond 6:* For Howard Paderewski, everything has a price. He is not, strictly speaking, open to bribes, and he is loyal to his friends, but his image of himself is of a big-time operator who has the savvy and the contacts to make it big in a tough universe. *Spade 5:* Paderewski is driven by the need to be both important and loved. While not a braggart, he glories in his reputation of being able to procure the impossible through his contacts and connections.



PRIVATE JOHN KING

Like Paderewski, John King considers himself an "operator." His area of expertise is not in establishing clandestine contacts, however, but in gambling. He shares Marine Sergeant Ortega's constant search for "fresh blood," but for the purpose of enlisting them as victims in his card games rather than in tests of strength. King's honesty has been frequently and vociferously challenged by his victims, but he has never been proven to cheat.

King is not, in fact, a card cheat, but he has a very, very good memory for faces, cards, and numbers. The talent stands him in good stead in the various forms of poker which he prefers.

King is a native of Aureore and hates the Kafers passionately. He sees no reason not to kill any that the mission might meet. John King is an Experienced NPC in Ground Military.

NPC Motivation Results: *Diamond 4:* John King is interested in making money, though it is the challenge of winning the money

more than desire for wealth for its own sake which drives him. *Heart 2:* He is also amiable, outgoing, and likable. He uses his easy manner, however, to set up unsuspecting victims for his "poker strikes," as he calls them. King is as likely to spend the money he has won on a party for his victims as to keep it himself.

ADVISOR WEAPONRY

*These advisors come with a variety of weaponry, as may be seen below. (Details on each of these weapons can be found in the **Traveller: 2300** Player's Manual.)*

"Mad Mike" Vincent: Vincent carries an Australian weapon, the DunArmCo Close Assault Gun.

Walker McGuire: McGuire carries a Stracher P-11 m automatic pistol.

Howard Paderewski: Paderewski wants to capture a Kafer and, consequently, carries a Quinn Optronics Restraint Carbine.

John King: King wants to kill as many Kafers as possible and so has chosen to carry a Rorttmann LK-1 35-01 laser rifle.

Arcturus System

The following narrative should be read to the players.

SYSTEM ENTRY

When you're outpacing the light that carries the image, it takes a computer to process what you see on a ship's screen while she's in stutterwarp, and the colors you get are never quite right. Approaching Arcturus, the star looks paler and yellower than it really is, with that curious double-image blur that always accompanies a super-c stutterwarp processed image.

So it is with something like shock and something like reverent awe that you gather around the bridge repeater screen on one wall of your living module when the Bassompierre's stutterwarp efficiency falls to the point that you drop below c. The computer keeps processing for you, of course, eliminating the distortions caused by relativistic speeds. But now that the ship's computers have more information to work with, the image comes through as whole and solid and as glorious as if you are seeing it with your own eyes.

Color.

Endless color.

You would think that a K2 star ought to be deep orange. It isn't so much that Arcturus isn't orange...but that it is so much else. The star fills the screen, deep and somber orange, but with flecks of mottled, writhing color broken across its surface, as though you are hanging suspended above a huge vat of molten gold. The photosphere is shot through with reds and yellows which refuse to blend in with those seething golden orange fires of splendor. The surface is a dark, mottled patchwork of shades ranging from red to deep purple.

And Arcturus is not set against an empty void, but rather seems held captive in a faintly luminescent web, strand upon far-flung strand of reds and blues and violets, as Arcturus' light touches the haze of gases boiling from the star's photosphere.

Golden light floods from the screen, touching your faces, gilding the edges of racked equipment canisters and military starship furnishings.

It's a long time before anyone speaks. Private Bucheger finally breaks the silence. "My God in heaven," is all he says.

SYSTEM REPORT

An extract from *Le manuel de la Navigation des Etoiles de Blancharde*, edition 2295.

ARCTURUS

Name: Alpha Bootis, Arcturus, **Coordinates:** X: -28.0, Y: -18.4, Z: 11.7, **Type:** K2 III, **Mass:** 4 Sol, **Luminosity:** 115 Sol, **Radius:** 25 Sol.

System Notes: Arcturus (the name means "Guardian of the Bear," a reference to the star's location in relationship to the constellation of Ursa Major, as seen from Earth) is the fourth brightest star in Earth's heavens. Arcturus has attracted special attention from Terran astronomers since the mid-20th Century because it is the nearest known example of a Population II star.

According to the hierarchy of cosmology as it is currently understood, Population I stars are the bright, hot, young, and relatively metal-rich stars of the galaxy's spiral arms. Population II stars are the old, red, metal-poor stars of the galactic core and of the galactic halo which extends as a vast and diffuse sphere for thousands of parsecs out beyond our galaxy's readily defined structure. It is believed that Population II stars are old—ancient—relics of the early days of the galaxy's formation, when hydrogen and helium were the sole building blocks for creating stars. As those first stars aged, the more massive ones turned super nova, cooking new, heavier elements in the transmutation furnaces of their exploding cores and casting them forth as debris into interstellar space. Gradually, this "enriched medium"—hydrogen and helium plus newly created heavy elements—coalesced into new stars. These new stars had heavier elements in their makeup. These were the stars which formed along the Shockwaves created in the mass of dust and gas which circled the galaxy's core in a flat plane—the stars of the galaxy's spiral arms.

Earth's sun is one of these Population I stars. Indeed, all stars with planets are Population I stars, since Population II stars are made up almost exclusively of hydrogen and helium, with none of the heavier elements necessary to build planets. In fact, every atom in the universe heavier than hydrogen or helium—including all the oxygen and nitrogen and iron and calcium and everything else which makes up every human's body—was born within the death throes of dying stars, the old Population II stars such as Arcturus, as well as the newer Population I stars such as Sol. The vast majority of stars in the general neighborhood of our sun are Population I stars, since the sun is one of the stars of the galaxy's spiral arms.

Arcturus is an intruder, however. Its spectrum identifies it as an old, metal-poor, Population II star, and it has one of the highest relative velocities of any star yet observed. This is because it is actually passing through the plane of our galaxy. It is believed that Arcturus is a member of the galactic halo, and that it is pursuing an independent orbit about the center of our galaxy which is highly inclined to the galactic plane. Since it is not travelling with the flow of local stars in the galactic plane in the Sun's neighborhood but is in fact plunging through it, it has a very high relative velocity—nearly 744 kilometers per second. At 37 light years from Sol, it is now approaching the closest point on its path past Earth's sun—will reach that point in only another few thousand years—then will continue off on its way about the galactic core, fading from the sight of men entirely in another half million years.

Thus Arcturus, ancient and worldless, has attracted the keen attention of Earth's astrophysical community. By studying the processes within its heart, scientists hope to come closer to understanding the actual chain of events which led from the Big Bang to Man. A deep space observatory, Station Arcture, has been established in distant orbit about Arcturus, with a large staff of astrophysicists and astronomers to study the Population II star at close hand.

SYSTEM ANALYSIS

Arcturus is a giant star, its color a deep orange. It is beautiful when viewed from close up, its colors a melding of golds and reds and orange which holds men and women captive, spellbound.

It is not entirely true that Arcturus is planetless. Arcturus is not literally a first generation (Population II) star; many generations have come and gone since the universe was first created, and many old, Population II stars such as Arcturus have some metal lines in their spectra—not many, but some. Arcturus is banded by faint rings of meteoric dust and ice, with some few isolated, rocky chunks of planetoid size. Much of this debris may be matter swept up by the star during its rapid passage through the galaxy's spiral arms. There is a family of comets, too, a far-scattered and distant Oort cloud left over from the star's genesis eons ago.

Arcturus is about 4.6 light years from Eta Bootis. The travel time, even limited by the slowest of the allied squadron's ships, will be no more than two or three days. From Arcturus, four other paths are open to worlds closer than the 7.7 light year maximum range imposed by current limits on human technology: DM + 18 2776 (also accessible from Eta Bootis), DM + 19 2881, DM +16 2708, and Ross 52. None of the last three star systems have yet been visited by humanity. There has been considerable speculation during the past several years about whether the Kafers approached Eta Bootis by way of Arcturus from one of these stars or whether their faster-than-light drive technology is superior to humanity's, allowing them to exceed the 7.7 light year range limit.

Station Arcture

This chapter describes the deep space observatory facility known as Station Arcture (Arcturus Station). A diagram is included to establish the overall layout of Station Arcture. (Maps of individual locations are provided as necessary with the text of the appropriate scenes.)

Players should be allowed to look this information over to become familiar with it, as it represents what they would learn of the station from design reports, briefings, and the like. The *referee* may wish to provide photocopies for the players, but once their characters have entered the station, these copies should be collected once again, and the players should be required to proceed from memory.

STATION DESIGN

The structure of Station Arcture was originally designed as an orbital space colony such as may be found at L-4 and L-5 in the Earth-Moon system and within the solar systems of several of the long-colonized core worlds. The station's designers felt that the crew would need a large facility, partly as a base for their large astronomical facility and partly to counteract the effects of loneliness and isolation in a relatively small crew four and a half light years from the nearest other human presence. Also, it was decided that as Arcturus has no planets capable of supporting a large civilian population, Station Arcture should be designed with the end in mind that it would eventually serve as a city in orbit around that star.

By using an existing design, the project saved money. Most of the station was constructed in large sections in orbit around Tithonus (Eta Bootis A-II). Each section was then transported as external bulk cargo to Arcturus, where the whole was assembled.

The space station is in orbit some five astronomical units out—about the distance between Earth's Sun and Jupiter. At that distance, with the mass of Arcturus four times that of Sol, the station circles Arcturus once in almost 5.6 years, half the time it takes Jupiter to complete a single circuit of the Sun.

Station Arcture consists of a long, slender axis 800 meters long. At one end (arbitrarily termed the "upper" end since there is no sensation of gravity to distinguish up from down) is the astrophysical observatory; at the opposite, "lower," end is the fusion reactor which provides power for the complex. Near the top of the axis is the station's spin habitat, a wheel with a radius of 250 meters. At the hub of the wheel, surrounding the central axis, is the de-spin module. This is a collar around the central axis designed to allow the axis to remain stationary while the spin habitat rotates around it. This design was adopted since the astronomers needed a stable, non-rotating platform for their observations and because zero-g is useful for handling heavy cargo. Some distance below the de-spin module is an assemblage of constructions attached to the station's axis. These include storage areas for cargo and supplies and the station docking area. The dock and cargo areas are, of course, always in zero-g.

A level by level description of the station is given below, beginning with its central shaft, then proceeding with specific locations along that shaft, starting from the observatory end and working to the fusion plant. Certain changes in the expected structure of the station are described separately, following the area descriptions below.

Central Shaft: The central shaft of Station Arcture is essentially a hollow tube with a diameter of 10 meters. Within this tube runs the station's Core Transport System (CTS). The Core Transport System consists of two parallel conduits running the length of the station axis, from the observatory to the fusion reactor pod, with stops along the way at each of the station's levels. Running within these conduits are core transports, featureless, streamlined pods containing enough web-work "seats" for 20 people.

Observatory: The observatory on the upper end of Station Arcture is a complex of lab facilities, telescopes, cameras, computers, and instrumentation assembled for the purpose of studying Arcturus.

Computer Section: The computer section level of Station Arcture is devoted to the hardware and central access to the station's main computer. This computer handles all of the

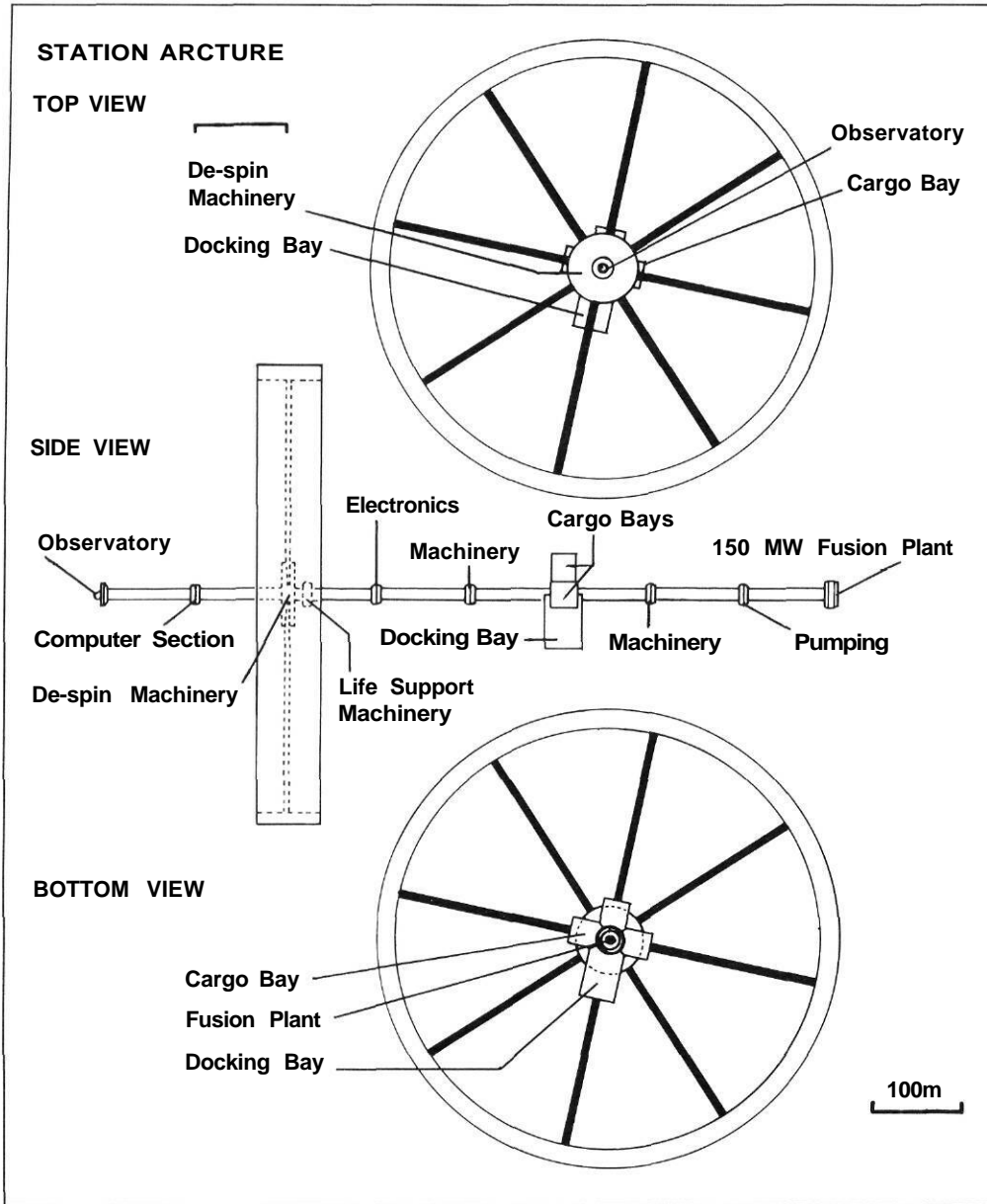

information processing aboard the station as well as the routine tasks of maintaining life support, power, and systems control. The station observatory depends upon the computer to align and aim telescopic and camera systems as well as to process and analyze data from observations.

De-spin Machinery: At the hub of the wheel, surrounding the central axis, is the de-spin module. This is a collar around the central axis designed to allow the axis to remain stationary while the spin habitat rotates around it.

Spin Habitat: Near the top of the axis is the station's spin habitat. This is a wheel with a radius of 250 meters. It rotates almost two times every minute, the centrifugal force duplicating the effects of a one-g gravity field. As in all such wheel habitat systems, "down" is out, away from the hub, while "up" is in the direction of the central hub. The spin habitat was designed to provide the station crew with artificial gravity to protect their health over the long months of their duty rotation.

The spin habitat contains two levels, each divided into 24 sections about 70 meters square.

The spin habitat's eight hubs connect with every third section. In Station Arcture, only the first five sections were inhabited, and the 24th (which is adjacent to the first) contains Central Authority, the station's administrative center.

Life Support: The accessway at the life support level opens onto the machinery which maintains the purity of Station Arcture's water and air as well as that which monitors station temperature and regulates the flow of heated water from the reactor end of the station.

Electronics: The location marked "Electronics" gives access through locked panels to the central nexus of the station's critical electronic circuitry. A special key is required to open these panels, and this key can only be obtained from Central Authority. Beyond the panels is a tightly fitted *maze* of delicate fiber optic and wire pathways.

Machinery: The machinery access consists of nothing more than circular corridors around the central axis, with panels on the outside wall opening into a conglomeration of pumping, air conditioning, and life support machinery. As is the case with the electronics access, these panels cannot be opened without a special key from Central Authority.

Docking Bay: The interior of the docking bay measures 60 meters wide x 40 meters high by 50 meters deep. It is, in fact, an extremely large airlock normally sealed by twin sliding panels. It is large enough to hold cutters, ship's boats, and even small supply lighters.

Cargo Hold: This is a series of interconnecting bays, each measuring 30 meters x 30 meters x 40 meters in which are stored supplies for the station and its crew.

Station Axis Passageway: At the level of the docking and cargo bays, a passageway encircles the station axis. Doors from the docking and cargo bays open into this passageway's outer wall, and doors in its inner wall open to the Core Transport System.

Machinery: This machinery access level is similar to the one mentioned above.

Pumping: The pumping access opens onto a bay lined with pumping machinery and control panels. It is here that water from the station reservoirs is pumped "down" to the reactor pod or "up" to the inhabited portions of the station. The equipment in this area is self-regulating, though when the station was operational, there was usually a two-man watch at the main control console.

Fusion Plant: Past the shielding at the top of the fusion reactor pod is the reactor control room. This is a small (10 meters wide X 7 meters deep X 3 meters high) control room which directly monitors the station's fusion reactor. In normal operation, the reactor is kept running at all times, though usually at only about 20 percent of its full output. Certain special operations—such as starting or stopping spin on the spin habitat—require 70 percent power or more.

What *Bassompierre* Sees

The characters will have little to do aboard the *Bassompierre* when the ship first arrives in the Arcturus system. Word will be passed down to Sergeant Ortega through the marines' CO that there are no signs of Kafer vessels or facilities within hundreds of astronomical units of the star, that Station Arcture has been located in its orbit where expected, and that the ship is now making a cautious approach to the station. On every mind will be the worry that the Kafers have somehow armed or booby-trapped the obviously derelict space station and are waiting for their chance to deal the humans some crippling blow.

Long-range scans of the station reveal that the fusion plant is still running, but at a drastically reduced, powered-down level, with less than 10 percent of its normal power output. The spin habitat no longer rotates independently; the entire structure rotates with it and is also slowly wobbling as it continues in its orbit about the star.

The fact that the entire station is spinning and wobbling is both blessing and curse. It makes it unlikely that the Kafers have somehow armed the station (one suggestion which may arise is that the Kafers have somehow hidden a small warship inside the station's shell). If the Kafers were planning such a trap, it seems likely they would halt the tumble in order to have a stable platform for guns or missiles. On the other hand, the station's movement will make an approach and docking maneuver quite difficult.

Another speculation about the nature of a possible trap which might arise during the approach is the possibility that the Kafers have somehow booby-trapped the station—perhaps with a thermonuclear device set to explode when Terran ships draw near. It is for just this reason that the operational plan calls for the *Bassompierre* to remain at some distance from the station while the marines go across to investigate.

As the *Bassompierre* gets closer, long-range telescopic scans will make it clear that the station has suffered serious damage, apparently from a military attack. One whole section of the spin habitat's outer hull has been torn open. It is scored and blackened by what appear to have been high-energy laser pulses, and in places the hull plates are torn and peeled back by internal explosions. Wiring, conduits, and shredded steel supports trail from the wound, giving the station a singularly disemboweled look. Deep radar scans of the entire system have located thousands of small, distant radar contacts which are believed to be bits of debris from the station which have torn free during the past three years and assumed their own independent orbits about Arcturus.

Two other portions of the station have been hit as well. The observatory has been almost completely annihilated; possibly the Kafers thought it might be a weapons system location. The docking bay has also taken heavy damage. It is likely that the Kafers recognized it for what it was and feared that small fighters might be launched from it. This is assuming, of course, that Kafer supposition follows lines of reasoning similar to those of humans. It might be simply that they fired upon it because it was bigger than anything else upon the station except for the spin habitat, which has been hit as well.

The one other obvious change to Station Arcture lies at the reactor end. A large, partially completed construct, about 75 meters in diameter and 100 meters long, is attached there. It is obviously not of human origin.

Besides the reactor pod, scans for radiation and power output indicate that power still operates in those portions of the station that have not been shot up. What this means is that there could very well be something alive on the station. That "something" could be a band of human survivors—or a Kafer ambush party.

The following narrative may be read to the players to set the scene for them.

STATION APPROACH

You all crowd up close to the view screen to get a good look at Arcturus Station when the Bassompierre moves up into visual range of the place.

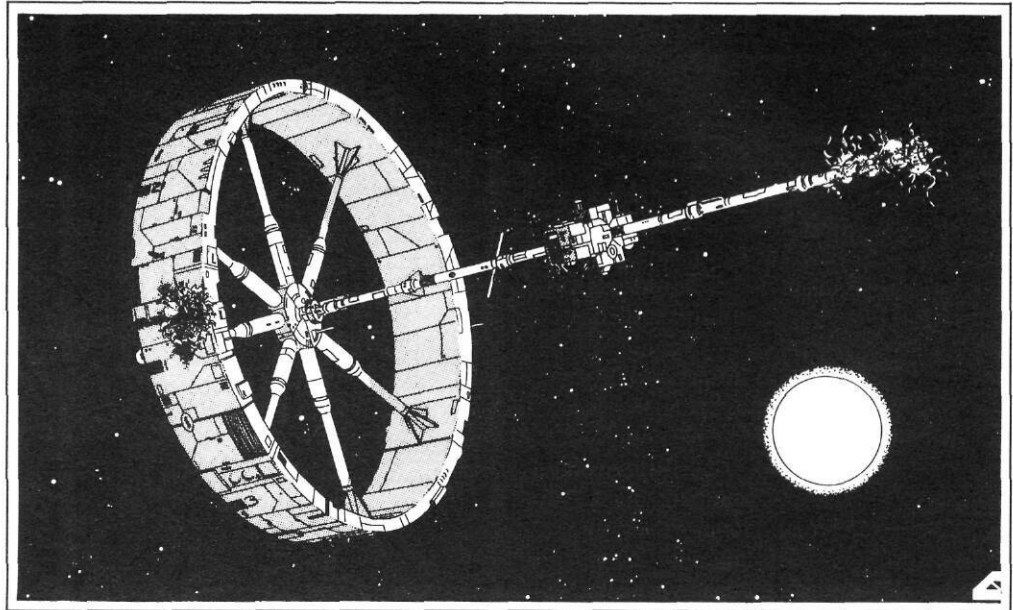

It isn't an encouraging sight.

The place has been hit hard, that's for certain. The station was designed with a big, rotating wheel that is supposed to provide artificial gravity for the scientists on board, but the central axis of the station was always supposed to align with Arcturus. The first thing you notice is that it's not just the wheel part of the station that's turning—the whole station is.

Sergeant Ortega tries to explain it, something to do with conservation of momentum. Arcturus Station's wheel was turning at something like just under two turns per minute. When something stopped that turning, the rotational momentum of the wheel didn't just vanish. It had to go somewhere, and where it went was into the rest of the station. The result is that the whole structure, a construction nearly a kilometer long, is now performing a slow, graceful, wobbling orbit around Arcturus.

It isn't until you get closer that you can see the burns and gashes in the flank of the wheel... or see the debris trailing off into space. And what's really eerie is that there's something alien-looking attached to the station's reactor end—it looks almost as if it's growing there.

The Briefing

The decision has been made that three marine fireteams will make the passage across to the station by ship's vessels, one to enter at each breach. All three fireteams are to come from First Platoon. Fireteam One of First Squad (the fireteam which the player characters are with) will enter through the hole in the spin habitat, as the interior of the spin habitat will give the combat walkers more room to maneuver than can be found in the rest of the station, as well as more simulated gravity than in the station's axis. Fireteam Two will enter through the remains of the docking bay, and Fireteam Three of Second Squad will enter through the hole where the observatory used to be.

One real problem with all three of these approaches is that it will be impossible for the ship's vessels to actually dock there. If the station were spinning normally, both the docking bay and the observatory would be motionless, and a ship's vessel could move right up to them—the spin habitat would, of course, be rotating to quickly to allow for easy docking. But with the entire station both spinning and wobbling, a docking approach is out of the question, especially with broken cables and girders projecting from the chosen entry locations.

The solution that has been decided upon is for the vessels to approach to within a few hundred meters, then have marines in space suits traverse that distance by jet pack, while towing a line that will anchor the vessel and allow other marines to follow. The players' fireteam will use the modified combat walkers to cross the distance initially.

The next difficulty that the fireteams will face is the danger incurred by vacc-suited figures when moving around inside the wreckage. Because of the station's tumble, none of the areas will quite be zero-g. There will be a weak but definite tug "down" away from the very center of the station's rotation. This axis of rotation is an imaginary line around which the station is wobbling. The result is that one outer wall of the observatory end will always be perceived as "down," and things will always fall in that direction, albeit very slowly. At the docking bay, the breached outer wall is "down," but the amount of wobble is considerably less and therefore easier to deal with. Because of the much greater diameter of the spin habitat, nearly half a G will be felt, and the wobble will make the floor seem to always be tilted a few degrees.

The spin habitat will therefore be the most difficult and dangerous of the entries, and player characters will have to be very careful. A slip could result in a character losing his footing and falling into wreckage which could tear his suit...or falling through the hole in the station's hull and into space. Each vacc suit is equipped with emergency transmitters and enough air to keep the individual alive long enough for a rescue to be made...but the rescue will take time and will be of no use whatsoever if the individual tears his suit on a projecting bit of sharp metal as he falls past the torn outer hull plates.

Once inside, the fireteams are to cautiously explore the station and report by radio what they find. All firearms are to be kept on "safe" until other orders are given. All team members, except the walker pilots, are issued full-body inertial armor.

Entry and Abandonment

This chapter describes what is to be discovered when Fireteam One enters Station Arcture's spin habitat.

ENTRY

When Fireteam One crosses to the breach in Station Arcture's spin habitat (please see the task in the sidebar), they will find that it is nearly 15 meters in diameter. The space inside is completely dark. Once they have entered and begin to shine some lights around, they will find that the hole lies almost centrally between four buildings which are each about 10 meters square and two stories high. Whatever caused the breach also damaged these buildings extensively.

From what remains standing, however, the team will discover that in appearance these buildings are much like modern houses, unevenly stacked layers with plenty of glass walls, broad verandas and patios, with neat little walkways and avenues lying between them. It looks almost like any residential block on Earth, with the exception that instead of grassy lawns, these houses are separated by the gray plastic foam used as a building substrate.

The other obvious differences are that the block has a ceiling about four or five meters overhead, everything is presently open to the vacuum of space, and, because of the station's present wobble, everything seems to be leaning about 10 degrees to one side. This slant changes through all of the points of the compass about once a minute, making the floor seem to roll beneath the characters. A task roll should be made at this time to avoid motion sickness (see the sidebar on the next page).

Four paths lead away from the breach in the hull. On the diagram (page 25), these point toward the observatory end of the station (marked "North"), the reactor end (marked "South"), in the direction of spin (marked "East"), and anti-spinward (marked "West"). Future references to direction will simply use the North/South/East/West designations.

If the group goes south or east, they will soon come to a bulkhead which forms the boundary of this section of the station. If they go North or West, they will pass through another block of four houses, similar to the ones near the breach, before reaching a bulkhead. Each bulkhead is clearly marked with a "3," designating this as Section Three of the spin habitat.

The east and west bulkheads each have an airlock in their centers, allowing access to the next section in each direction. These airlocks are more than large enough to allow passage for the combat walkers. Close to the eastern airlock, the characters will find a spot in the bulkhead where a carefully melted-out hole has been crudely patched over with a tack-welded steel plate. A laser cutting torch of Kafer manufacture will be found lying nearby.

The inference will be fairly obvious: the Kafers blasted the station's hull at Section Three, entered, then cut their way through into the next pressurized section. It may be assumed that they did not want to take the time to figure out how to open the human airlock, especially as it was probably keyed closed from the other side by defenders. Afterward, someone welded the cut opening shut again.

Sergeant Ortega has a book of access codes which can be used to unlock the airlock. It is important to note that the eastern airlock will respond to one of these access codes, but the western one will not open at all any more.

ABANDONMENT

During the time that Fireteam One is exploring Section Three, it will be in constant radio communication with the *Bassompierre* and the other two fireteams. The other fireteams report findings similar to those of Fireteam One.

Just as Fireteam One is preparing to enter the next section, however, an urgent message is sent by the *Bassompierre*. A pair of Kafer warships has just come through the system and is heading for Aurore. The *Bassompierre*, of course, was originally assigned as defense for that system, and Eta Bootis is less than well protected with its absence.

The *Bassompierre* has no real choice but to head for Aurore immediately. If it leaves now,

Task: To cross to rotating structure: Difficult. Vacc Suit or any Space Crew skill. 1 second x distance in meters.

Referee: This task allows the character to jump off from a space craft and, using a jet pack for maneuvering, catch hold of a moving structure such as the exterior of the station spin habitat. Most mishaps will result in the character rebounding without injury, forcing him to make the attempt again. Serious mishaps could result in injury, or in the character drifting away into space, requiring rescue. Safety lines can be used to reduce the risk of such attempts.

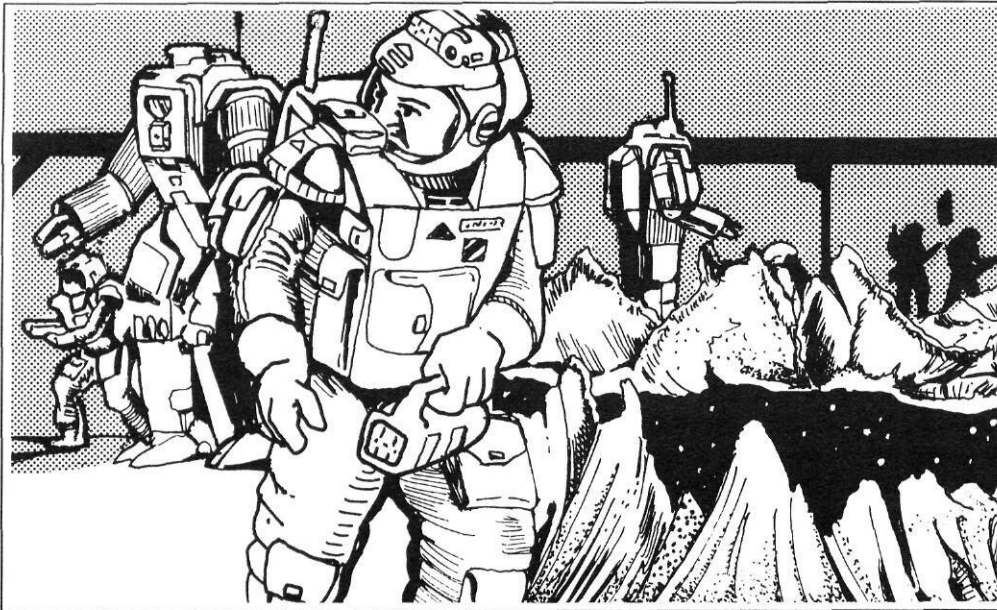

it can beat the Kafers there and ensure that the defenders are warned in time to be prepared. There is no time to await the return of the fireteams to the ship. Kommodore Lutke promises to come back for them once he sees how the tide of battle is going at Eta Bootis. In the meantime, orders are for all three fireteams to gather together, find a defensible location, and wait it out.

Task: To avoid disorientation: Difficult. Vacc Suit or any Space Crew skill. Instant.

Referee: The slight artificial gravity caused by the Station Arcture's wobble does not align well with visual clues such as floors and ceilings, and this can cause disorientation or vertigo. A minor mishap will result in mild nausea or vertigo. A major mishap will result in severe disorientation, and could require the character to check his Coolness Under Fire to avoid panic. A serious mishap will result in panic (which could lead to injury in close quarters) or severe nausea.

This task should also be rolled once when the characters enter through the breach in the spin habitat, with a serious mishap resulting in damage to the character's vacc suit or loss of footing causing the character to "fall" out of the station and into space.

First Impressions

One thing is for certain: the breached shell of spin habitat Section Three is not a safe, comfortable place to wait for the return of the *Bassompierre*. The *referee* should role play communications with Fireteams Two and Three to decide where the groups should meet, and Fireteam One will then want to move along.

SECTION TWO

When the members of Fireteam One proceed through the airlock to the east, they will find the adjacent station habitat section—Section Two—to be well lit. It also shows plenty of signs of a firefight. There are a few scars and bullet holes caused by human weapons (there was a small, armed security force attached to the facility), but most of the damage seems to have been caused by Kafer hand weapons. Houses have been blasted and burned almost indiscriminately. In this section alone, the skeletons of twenty-four men and women will be found, most showing signs of being cut down by Kafer weaponry.

The advisors, with their experience in fighting Kafers, will be able to recognize the telltale indications of damage caused by Kafer weapons. The Kafer 75-01 laser rifle known as the "Flashlight" is an extremely powerful 0.7 megajoule laser weapon which does explosive damage to bone when it strikes a human target. There are numerous pieces of Kafer equipment lying about to confirm the attackers' identity. Even a casual search will turn up Kafer weapons, unexploded grenades, "cattle prods," and food sticks.

This section does hold a breathable atmosphere, but it is a bit cold, and the air carries a stale smell of decay from the carnage committed here three years ago. Most of the skeletons in this section are quite clean and are still clad in the remnants of artificial fabric clothing. A few are desiccated, almost mummified, but in three years almost everything of the bodies save the bones has rotted away.

There are no Kafer bodies lying about.

SECTION ONE

Section One, the next habitat section to the east of Section Two, is the easternmost of the five sections which housed the research team. Section Five is the westernmost. Therefore Section Three, where the Kafers breached the hull, was the very center.

The diagram in this chapter shows a sample layout for each of these sections.

These first five sections formed the community of Etoile d'Or (French "Golden Starlight"). The buildings in Sections One and Two will be found to have been completely burned, though there are no signs of an extended firefight. Evidence will suggest that the battle to defend Arcurus Station—such as it was—was fought in Section Two, right next to where the Kafers broke through from Section Three. The defenders were overwhelmed, and the Kafers forced their way through to Section One without meeting serious resistance.

They destroyed everything they could anyway. The skeletons of seventeen more humans will be found scattered in clumps throughout the ruins, as though they were cut down by laser and automatic fire as the victims attempted to flee.

It will be difficult to accurately assess much of the evidence found. While the station's tumble does produce a weak artificial gravity field, it is oriented in a different fashion from what the spin habitat's normal rotation created. Many of the skeletons, for example, are jumbled together in a way that suggests they were jostled about quite a bit after death.

One of the characters will make one interesting discovery, however: a white flag made from a piece of torn material and tied to a broken-off whip antenna. It is lying off by itself, with no skeletons nearby. While the flag *could* have been removed from its original position (by the station's motion or by a curious Kafer), the discovery will suggest that some survivors were at least *trying* to surrender—however ludicrous the notion that Kafers would understand what a white flag was supposed to mean.

Please note that the flag does not show signs of violence. There are no blood stains on it,

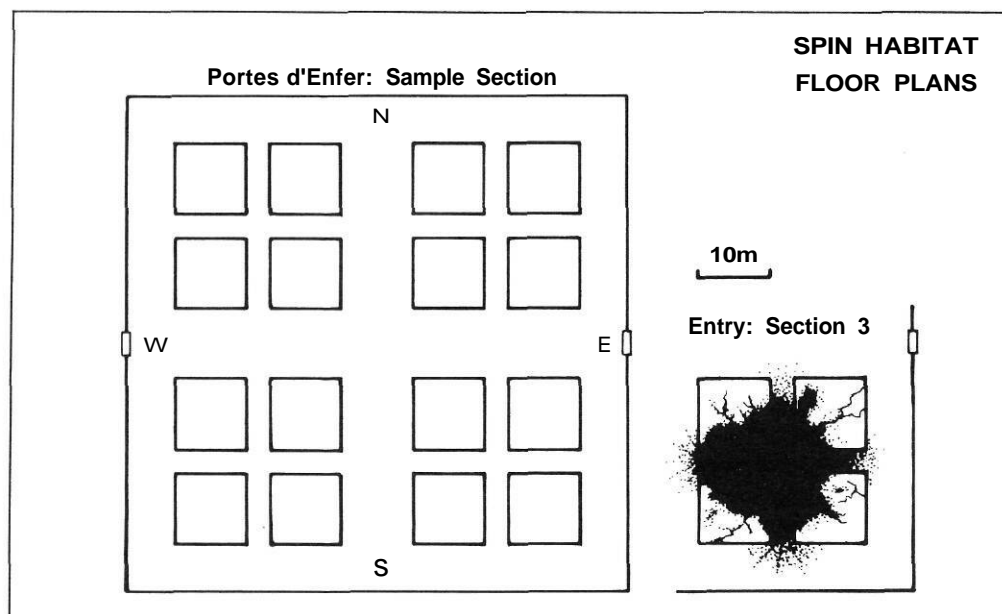

nor is it scorched or tattered as it would be from weapons fire. There is no clue as to what happened to its makers—whether they were killed or captured. The find will raise the possibility that there were survivors—at least for a time after the attack—and should lead the group to search deeper into the station for further clues rather than simply attempting to rendezvous with the other fireteams and establish a defensible position.

Catastrophe

The referee should read the following narrative section to the players at this time.

While you've been working your way through Sections Two and One, the other fireteams have also been on the move, but in much lower gravity. You've heard their voices chattering over the radio, and you've probably been wishing they'd take this all a bit more seriously, but then they haven't been the ones finding the bodies.

Suddenly disaster strikes. The radio erupts into a chaos of noise. Overriding everything else is an ear-piercing electronic wail, but beneath it you think you can make out the sounds of shouts of anger, cries of pain and fear, and the barking of powerful weapons. Within a few minutes, the electronic howling reaches an excruciatingly painful intensity. You try alternate frequencies, but to no avail. You've completely lost contact with the other teams.

First the ship; now your buddies. You're beginning to feel really alone.

At this point, someone in the group might question the wisdom of going any farther. If none of the players do, it is certain that *Caporal Massey* (one of the combat walker pilots) will. He suggests strongly that the group simply hide in one of the buildings of Section One until the *Bassompierre* returns.

Sergeant Ortega will not agree to this at all, and the other marines will follow his lead. If everyone else agrees to continue on, Massey will as well, simply to keep from being left by himself.

CENTRAL AUTHORITY

Just east of Section One lies Section 24, commonly known as Central Authority. This entire section is taken up by administrative offices. Central Authority appears to have been systematically ransacked. Every computer terminal in the structure has been smashed, and many of the offices have been burned. (A diagram of Central Authority is included in this chapter.)

A careful search of the section will reveal several disquieting discoveries:

(1) Three different locked rooms in one of the offices (marked "A" on the diagram) have a total of fourteen human skeletons inside them. The shackles which bound them together are still in place on the skeletons' wrists and necks. It *looks* as though the Kafers locked chained prisoners inside the rooms then wandered off and forgot about them, leaving them to starve to death.

(2) Worse, in a large, well-lit, circular building (marked "B" on the diagram), a skeleton can be found shackled spread-eagled across a large table. Evidence (the rib cage has been sawed open) suggests that the Kafers were attempting to dissect one of their prisoners. Five more human skeletons lay in a jumbled heap in a nearby corner. Examination of the skeletons suggests they were dissected.

One important point should be mentioned here. Nowhere during any of the player characters' studies of the skeletons aboard Station Arcture will any sign be found that the Kafers ate their human captives. The Kafers have acquired a reputation among the colonists on Aurore for eating humans. The German name they have for humans—Fleischwesen—can be translated as "meat beings," and this has encouraged rumors of what Kafers do to human captives. While the player characters will find ample evidence of horror on board the space station, such as the starvation and dissection of prisoners, there will be no evidence that the Kafers actually used their prisoners for food. The referee should not point this fact out, however, unless the players themselves think to ask about it.

LEAVING SECTION 24

The fireteam may decide to continue on from Section 24 in either of two different directions. One is to continue east, progressing from one spin habitat section to the next. The second direction is up. Above Sections One through 24 lies another level of sections which are labeled Sections 25 through 48. Elevators connect every third lower section to its neighbor above, and

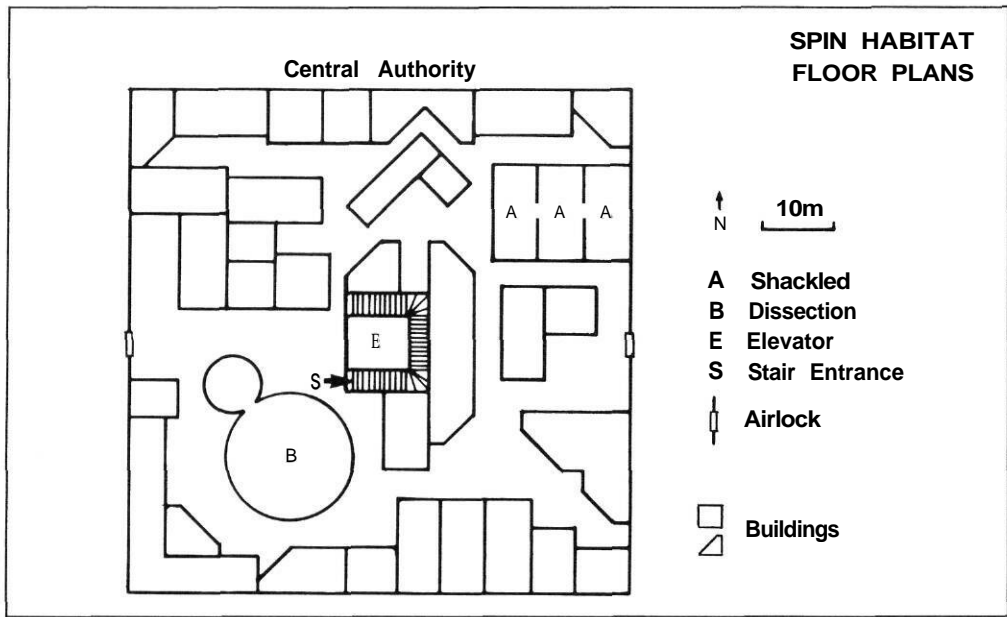

SECTION LAYOUT

Those sections listed in the left column lie directly below their matching sections in the right column. Those pairs which have elevators connecting them and which are accessed by a spoke are printed in bold.

1	25
2	26
3	27
4	28
5	29
6	30
7	31
8	32
9	33
10	34
11	35
12	36
13	37
14	38
15	39
16	40
17	41
18	42
19	43
20	44
21	45
22	46
23	47
24	48

that upper neighbor is also connected to one of the station's eight spokes. The sidebar on this page lists which upper sections are above which lower sections, as well as which pairs are connected by elevator and are accessed by a spoke.

Ambush

This chapter describes what Fireteam One discovers as it searches sections east of Central Authority and the ambush which takes place when the team moves upward to the next level.

EASTWARD

The sections which lie east of Central Authority are outlined below. For clarity's sake, they are discussed in three distinct groupings.

Sections 23 to Seven: If the players have decided to proceed eastward from Section 24 instead of upward, they will find that Sections 23 through Seven contain homes and offices similar to those in Etoile d'Or, but unfinished. They were placed here against the day when Station Arcture would become a true city in space. Most of these buildings remain undamaged by the Kafers, but occasionally one may be found blasted and burned with three or four human bodies in the wreckage. If the players wish to keep count of the bodies they encounter, it should be noted that there are a total of 68 in Sections 23 through Seven.

Section Six: Section Six looks like a scene from hell. It was originally just another section of unfinished homes and offices like those in Sections Seven through 23. Now, less than half of the lighting panels in the ceiling are still lit, and the rest have been shattered. In the resulting dimness, the members of the team can see that all that remains of the buildings in this section are twisted, broken girders arising from an uneven field of jagged rubble. Bodies lie all around, both human and Kafer—over a hundred total. If the players decide to search through the rubble to determine an accurate body count, the *referee* should have them roll for the first task in the sidebar.

Success at this task will reveal two things. The first is an accurate human body count: 38 individuals (compared to about 60 to 70 Kafers). The second is that while 17 of the bodies wear only station uniforms; the other 21 wear a few pieces of Kafer battle armor and are holding Kafer weapons. In every case, it looks as if the bodies were stripped of anything useful; only terribly damaged pieces of armor or weaponry remain. At this point the players should roll for the second task in the sidebar.

Success at this second task should reveal to the player the horrifying realization that Section Six has been used as an arena in which the station personnel were given Kafer weapons and armor and were forced to fight bands of Kafer warriors.

Sections Five and Four: Sections Five and Four are the westernmost sections of Etoile d'Or. The buildings in these two sections show definite signs of having been inhabited by humans long ago, as well as signs of Kafer searches. One building, in the extreme southeast corner of Section Four (please use the diagram on page 25 for reference), displays indications of having been occupied very recently, probably by humans. That is, there is much less dust here than elsewhere; there are bundles of blankets and pillows in the corners of one room; there is a collection of packaged human foods (including a few empties), a chess set, a few books, and, most telling, a shaving kit on the sink in the bathroom—with a damp face cloth.

There is no one to be found anywhere nearby, however.

UPWARD

When the group finally decides that it is time to work toward the station's axis, they will find that the only means of gaining the next level, where they can then enter one of the spokes, are the elevators which are located in every third section or the stairwells which wind around those elevators. The elevators in every section but 6 (which has been demolished along with its stairs) are operable, and the stairwells are clear of obstruction. The combat walkers will fit into the elevators, but it would be extremely difficult and very noisy trying to get them up the stairs. When the group ascends to the next level and opens the stairwell and elevator doors, they will be struck immediately by two things: (1) the impression that this level is dark and bare and (2) a Kafer ambush.

Task: To search through rubble: Routine. Intelligence and Survival. 1 hour.

Task: To determine the significance of the discovery: Difficult. Intelligence or Psychology. Instant.

KAFER AMBUSH PARTY STATISTICS

Size: 17
Strength: 11
Dexterity: 13
Endurance: 15
Determination: 16
Intelligence: 5/12
Eloquence: -
Education: -

"Donderbus": A rugged, heavy, close-assault shotgun which may fire propelled grenades.

Type: 19mm Automatic Shotgun Weight (empty): 4.5 kg Length: 70.5 cm (Bulk=2) Action: Single shot or bursts Ammunition: 19 x 58 mm fixed cartridge buckshot (6x8mm slugs), or 19mm grenade (see below) Muzzle Velocity: 402 mps Magazine: 8-round box magazine Magazine Weight: 0.8 kg ROF: 2 Aimed Fire Range: 85 meters Area Fire Burst: 4 rounds (AFV=0.8) Area Fire Range: 65 meters DP Value: 0.5 (x6).

Type: 19mm high-explosive armor-piercing propelled grenade DP Value: As tamped explosion (EP=3) Weight: 0.3 kg.

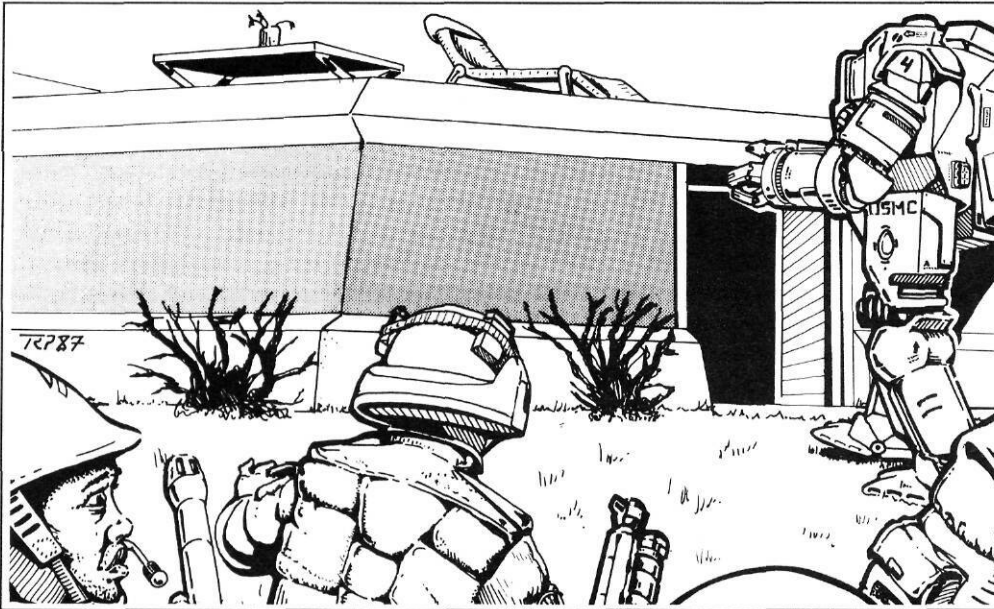

Note: Basic facts about Kafers and their equipment are covered in detail in other **Traveller: 2300** products. Those referees who have not yet seen those products should immediately read page 48 before going on.

This ambush party consists of 10 individuals, each carrying a heretofore unseen Kafer weapon, a sort of shotgun which the survivors on the station have named the "Donderbus." Players, of course, will not pick this name up until later in the adventure. (Statistics for the Kafers and the "Donderbus" are listed in the sidebar on this page.) Each Kafer is carrying three magazines of standard shells and one of propelled grenades.

The Kafer ambush party has been electronically monitoring the elevators on this level, waiting for the fireteam to come up. If the players did not use the elevator for some reason, then the Kafers were drawn by the noise the combat walkers made in coming up the stairs. In any event, although they have had to run to reach this elevator in time, and although they have not had much time to set up, they are a hand-picked group of Kafers who are smarter than average, and they have been practicing ambush techniques. The one thing that is going to throw a wrench into their plan is the presence of the combat walkers. These Kafers have practiced this ambush technique over and over with buckshot, and until they get smart, they will not think to use their grenade magazines unless they run out of buckshot first.

To run combat for this encounter, the *referee* may simply use the diagram of Central Authority on page 25 for the layout of the elevator and stairs, regardless of which section the fireteam actually ascended from. As the sections in the upper level are bare, the lines denoting office walls should be ignored. The Kafers are lying in the dark on their bellies to make themselves difficult targets; they are spread in a semicircle 30 meters away from the elevator and are two meters apart from one another. The humans are, of course, in the lighted elevator and/or stairwell and will have to bring some light to bear on the Kafers before they can return fire.

If the Kafers have enough time to get smart under fire, they will suddenly realize how futile it is to attack the BH-21s with buckshot and will load grenade magazines.

Survivor

Task: To interrogate a hostage: Routine. Psychology. 15 seconds.

When the fireteam has finished with the Kafer ambush, a quick search of this large, empty spin habitat section will reveal a living human captive crouched down in one of the corners behind the Kafer ambush party. He is not frightened, just distant and uncooperative. He will decline any offers of aid, and he will refuse to travel with the fireteam unless they tie his hands to demonstrate that he has been captured and is not willingly cooperating. Instead of viewing the members of the fireteam as rescuers, he sees them as troublemakers come to disturb the delicate balance in the situation at the station. He sincerely doubts that they will be able to survive against the Kafers and believes that they will probably get him killed as well.

He will volunteer that his name is Laforet, but to get any useful information out of him, someone in the group will have to roll for the task in the sidebar.

The *referee* should play Laforet as an intractable, irritating enigma. It is likely that the players will be totally mystified by his attitude. That attitude is, however, simply a manifestation of "hostage syndrome," in which, in order to survive, a hostage begins to identify deeply with his or her captors. (At this point the *referee* might wish to read the explanation given on pages 42-43 to gain a fuller understanding of the outlook of the Kafers' prisoners.) Laforet will disagree with any schemes or arguments the players might come up with, pointing out any flaws in vivid detail.

Important: If at any point someone strikes Laforet, he will grow very attentive and will immediately obey any order which closely follows the blow. This is how the Kafers have dealt with him and his fellow captives, and it is now a conditioned response

WHAT HAS HAPPENED ON STATION ARCTURE

Each time a member of the fireteam makes a successful task roll to interrogate Eugene Laforet, a bit of information will be revealed. Those bits of information are listed below in the order in which they will be learned. Laforet will deliver each of them dispassionately, as if he were reciting a history that he had no part in.

(1) My name is Eugene Laforet, I am from Lumiere d'Aube on Aurore, and I am a life support systems mechanic.

(2) There are six of us left alive here; the other five are being held in the fusion reactor's control pod.

(3) The Kafers made us leave Etoile d'Or when they got word that a human ship was in system, and they took us all to the reactor pod. But we left some stuff at Etoile d'Or by accident that would tell you there were humans on board the station. The Kafers didn't want you to find it, so they brought me along to pick it up, and you got on board before we got there, so they decided to ambush you.

(4) The Kafers killed all but 44 of us in their assault on the station. Six of us were at the computer center and the rest were in Sections Four and Five of Etoile d'Or. Those who were in those sections of Etoile d'Or are all dead now; the Kafers made them fight groups of their warriors, and they studied the results, always trying different tactics.

(5) The Kafers have been making the rest of us work to hook up the fusion reactor to the stutterwarp they've been building on the station. They won't let us see the workings of the stutterwarp, though.

EUGENE LAFORET

Eugene Laforet is, as he says, a life support systems mechanic from Aurore. He is about 35 years of age, stands 140 centimeters tall, and weighs about 75 kilograms.

Laforet is a Green Colonist NPC.

NPC Motivation

Results: Diamond 2: *Eugene Laforet came to Station Arcture mainly because it was an opportunity to make a good deal of money at his craft. Red Joker: Because of what he has suffered at Kafer pseudo-hands, Laforet is no longer strictly sane by human standards, but if given therapy on a colony world, he will recover.*

To the Rescue

Once the fireteam has learned that there are still five other human survivors being held at the reactor end of the station and that they are working on hooking up a Kafer stutterwarp drive to the human-built reactor, it is assumed that the players will want to rescue those captives and prevent the stutterwarp from being completed. First, however, they will have to make their way to the station axis and the Core Transport System. This chapter describes how they must proceed to get there. A diagram is included to help the referee visualize the layout.

THE SPOKE SHAFTS

The eight spokes from the central hub open at deck level in the upper deck in 10-meter-wide columns running from floor to ceiling. Inside each spoke are two elevator shafts and an emergency ladder shaft. Panels next to the elevator doors hold buttons which call the spoke elevators. The system is designed so that one elevator is climbing each spoke while the second descends. Persons waiting for an elevator to arrive at either end of the spoke rarely have to wait more than one minute. The trip from one end to the other takes about one minute.

The ladders in each spoke are provided for emergencies (such as total power failure) and were also used by workers during the construction of the station. Each ladder is 205 meters high, but even under full spin only the furthest 20 to 30 meters are under anything approaching one full G, and a person's weight grows progressively less as he or she ascends towards the hub. The last third of the trip can be made literally flying up the ladder hand over hand, with the feet never even touching the rungs. The entire climb takes about five or six minutes.

Once again, the elevators are large enough to hold the combat walkers, but the doorways to the ladders are too small to allow them to pass. It would be possible to cut or blast away the edges of a doorway to allow room for the walkers to enter a ladder shaft if the players are determined to do so, but getting the combat walkers up the first 30 meters of ladder will be difficult, even in the half G that the station is now experiencing. To do so, the combat walker pilots should roll for the task in the sidebar.

LEVEL 5: SPIN HABITAT ACCESS

When the group exits the elevator and/or ladder shaft, they will find themselves in the lower toroid corridor of the spin habitat access chamber (please see the diagram). Gravity here is so low as to be near weightlessness; it is enough, however, to give a clear indication of "up" and "down." About every 10 meters is another elevator/ladder access leading back to the spin habitat, each labeled with the number of the spin habitat section to which it leads. Between elevators number 27 and 48, there is a set of handholds leading upward (toward the station's axis).

This set of handholds leads to another, smaller, toroid with handholds in "ceiling" and "floor." During normal operation, this corridor is noisy with the sound of the heavy machinery that turns the spin habitat. With that machinery operating, the ceiling of the corridor remains fixed, and the rest of the corridor turns with the spin habitat. Persons moving from spin habitat to station axis do so by leaping from the floor to the ceiling and grasping a handhold to halt their spin. Persons moving from axis to spin habitat do so by leaping from ceiling to floor and grasping a handhold to begin moving with the habitat.

A door in the ceiling opens into the Core Transport System. Since the entire station is currently spinning, the members of the fireteam will have to use the ceiling handholds to remain on the ceiling while calling for a core transport car and waiting for its arrival.

SPIN HABITAT ACCESS

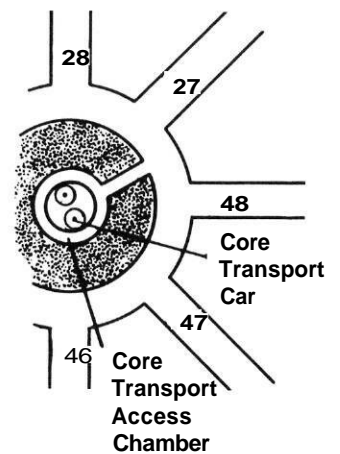

Task: To climb a ladder in a combat walker: *Difficult.*
Combat Walker. 1 minute.

At the Core

This chapter describes Station Arcture's Core Transport System and what transpires during the fireteam's travel on it.

CORE TRANSPORT SYSTEM

The Core Transport System (CTS) consists of two parallel tubes running the length of the station axis from the observatory to the fusion reactor pod, with stops along the way at each of the station's levels. Running within these tubes are core transports, which are featureless, streamlined cars containing enough webwork "seats" for twenty people. The CTS is summoned at any of the various levels in much the same way as an elevator. When a car arrives, doors in both the axis wall and the CTS pod open, allowing station personnel to drift into the car where they secure themselves by straps into the restraining webs of the seats. A control panel by the car's door allows its run to be programmed. Stops are listed in the sidebar.

Stops can be individually punched in, or the car can be programmed to make either all stops along the way or an "express zip" in one direction or the other. Travel time varies but averages about 20 seconds between each level, plus 30 to 60 seconds for each level stopped at, depending on the number of people getting in or out. There are two cars. The station computer manages things so that one car is always travelling in one direction while the other car travels in the other. There is rarely more than a five-minute wait for an available car, and the usual wait is a minute or less.

It should be mentioned that with room for 20 people, the core transport car can easily hold the eight people and two combat walkers of the fireteam, plus their one rescued hostage. Even the fact that the walkers will effectively have to lie flat during the trip will cause no problems, as there is almost no gravity to prevent their maneuvering from any position. There is enough gravity to make loose objects, such as the ends of seat straps, drift toward the "roof" of the car.

FIRETEAM DESTINATIONS

The players will most likely want to simply get into the car that arrives and punch in a nonstop trip to the reactor control pod or someplace close to that location.

"Up" Station

If, instead of heading for the reactor control pod, the players wish to take the car toward the observatory end, the referee should allow them, but Laforet will make the comment that, "It doesn't matter what you do; the Kafers will soon have the stutterwarp hooked up and we'll all be going to their homeworld anyway."

Laforet is mistaken; the Kafers are nowhere near to successfully powering their stutterwarp engine from the human fusion plant, but the players do not know that, and Laforet's comment ought to get them very excited about hurrying to the reactor control pod.

If the comment no effect, and if for some reason the players still wish to go "up" toward the observatory, the referee may allow them to key in their destination. Shortly after the car begins to move, it will suddenly halt (see *A Snag*, in the next chapter, *Kafers at Bay*). If the team continues upward on its own power, its members will find the other levels to be locked, requiring a key from Central Authority. If they force the doors, they will find no Kafers inside the de-spin machinery section, but inside the computer section (a 2x2x6 meters room) another group of 10 Kafers is lying in ambush. The Kafers have wedged themselves into position against the computer consoles to brace themselves for firing weapons in near weightlessness. In order to return fire, each member of the human team will have to successfully perform one of the two tasks in the sidebar on the next page.

Referee's Note: Any mishap during combat will indicate that some damage has been caused to the computer control console. This will not affect automatic functions of the station, but it will render further operator control from this console difficult to impossible, depending upon the seriousness of the mishap rolled.

CORE TRANSPORT STOPS

Level 1: *Observatory*

Level 2: *Computer Bay*

Level 3: *De-spin*

Machinery Bay

Level 4: *Spin Habitat*

Access Level

Level 5: *Life Support*

Level 6: *Electronics Bay*

Level 7: *Machinery*

Access

Level 8: *Machinery*

Access

Level 9: *Docking and*

Cargo Bays

Level 10: *Machinery*

Access

Level 17: *Water Tank*

Pumping Station Access

Level 12: *Fusion Reactor Control Pod*

CORE TRANSPORT CAR

TOP VIEW

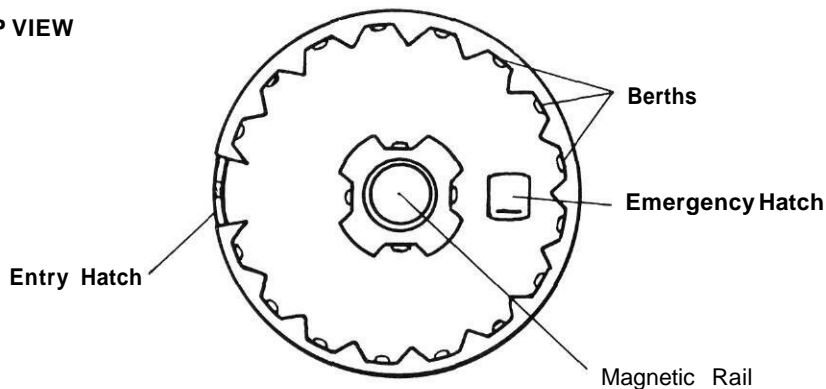

SIDE VIEW

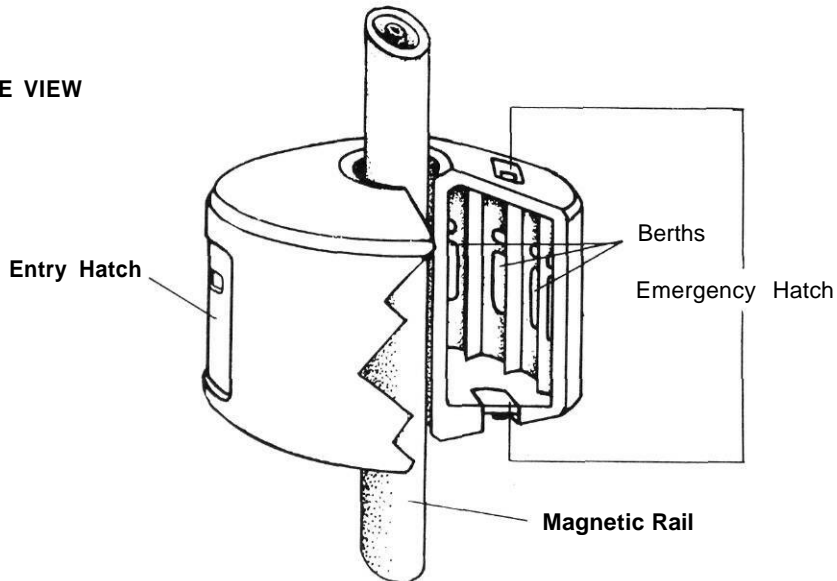

"Down" Station

If the players key in a destination "down" station from the spin habitat access, the car will take them nearly to Level Seven before stopping unexpectedly (see *A Snag*, in the next chapter). If they stopped of their own accord at Level Five or Six, when they re-enter the car, it will refuse to move.

If they force open the locked doors of Levels Five, Six, Seven, or Eight (life support, electronics, and machinery access, each of which requires a key from Central Authority), they will find them to be deserted.

Task: To reach a support in zero-g combat: Routine. Tactics and Vacc-Suit or any Space Crew Skill. 1 second.

Referee: Success at this task will negate the necessity for rolling on the one below.

Task: To fire a projectile weapon in zero-g: Difficult. Vacc-Suit or any Space Crew Skill and Combat Rifleman or Sidearm (depending upon the weapon used). Instant.

Referee: This skill allows the character to fire a recoil weapon (any weapon with a "kick" to it) under conditions of zero-g. The technique requires bracing against the expected recoil in such a way that the weapon's kick neither propels the firer into a wall nor sets him or her to spinning helplessly. Mishaps result in the character becoming helpless (rebounding from bulkhead to bulkhead or spinning in midair, for instance), in injury, or in loss of the weapon as it sails off into space.

Kafers at Bay

This chapter continues the description of what happens to the fireteam after they exit the core transport car.

A SNAG

When the fireteam keyed in a destination on the core transport car's control board, the Kafers in the computer section noted the command on the display there and shut down the car's power. It will go no further. The fireteam must exit the car through either the upper or lower emergency exits (see the car diagram in the last chapter). If they do not disable the car before leaving it, a few minutes later the Kafers in the computer section will begin running it up and down the core transport tunnel, hoping to run the group over. Avoiding the moving car is a task as listed in the sidebar. If the group fires on the car, treat all hits from "up" station as front hits and all hits from "down" station as rear hits. The car's statistics are listed in the sidebar. Any Vehicle Damage result of 6 or above will render the car inoperable.

Task: To avoid a core transport car: Routine. Dexterity and Vacc Suit or any Space Crew Skill. Instantaneous.

Referee: Failure at this task causes blunt trauma damage with a DPV of 2.

ONWARD

Once the group has dealt with the core transport car, they will be free to continue toward the reactor control pod. When they reach the level of the cargo bays, however, they will find the entrance to the access chamber is open, and one quick, unidentifiable noise will be heard from inside.

CARGO AND DOCKING BAY ACCESS CHAMBER

At the level of the docking and cargo bays, a passageway encircles the station axis. This is the cargo and docking bay access chamber. Doors open onto this passageway from the docking and cargo bays from the outer wall. Doors on the inner wall open to the Core Transport System. (Please see the diagram in this chapter.) This entire chamber is designed to serve as an airlock in cases of emergency, such as the loss of air from one of the bays.

When the fireteam enters the access chamber, they will find that the door to the central cargo bay is open. From inside, that one quick, unidentifiable sound comes once again. The access chamber itself shows signs of a recent firefight. There are scorch marks all about, and spent shell casings lie in several places on the far wall (the direction of the very weak gravity here). No bodies, Kafer or human, are to be found, however.

CARGO HOLD

This is a series of interconnecting bays containing many large (5m x 2m or larger) plastic cylinders full of supplies for the station and the station's crew. Items stored in the cylinders include food, clothing, tools, spare parts and electronics, spares for and duplicates of the observatory instruments, cameras, and computers, and "stores"—a catch-all phrase referring to such sundries as toothpaste, toilet paper, pocket computers, and personal jewelry. The cargo containers are grouped by contents (all food in one area, all cameras in another), and the contents are listed and catalogued in the station's central computer. Each container is secured by nylon straps to a gantry-like arrangement of struts which fill the weightless compartment.

A terminal which allows limited access to the ship's computer (lists and quantities of stores only) is positioned in each cargo bay near the door to the station axis.

Unknown to the fireteam, a total of 13 Kafers are hiding in cargo bays A and C—seven are in A, and six are in C. (These Kafers have the same characteristics as those on page 29.) When the fireteam enters bay B, from whence the noise (the sound of an empty shell casing tossed from bay C hitting the floor of bay B) came, the Kafers will give them time to get the whole group inside; then the Kafers from bay A will rush into the access chamber and attempt to close the door to bay B behind the humans while the Kafers in bay C fire several armor piercing grenade rounds into bay B. Their plan, which they have practiced over and over, is to lock the humans inside, then breach a wall of the bay with the grenades leaving the humans within to suffocate.

TRANSPORT CAR STATISTICS

Type: Cable car Crew: None Weight: 400 kg Armor: Suspension: 0.2 All faces: 0.3 Cargo: 20 passengers Max Speed: 18 kph Combat Movement: 150 m.

DOCKING AND CARGO BAYS

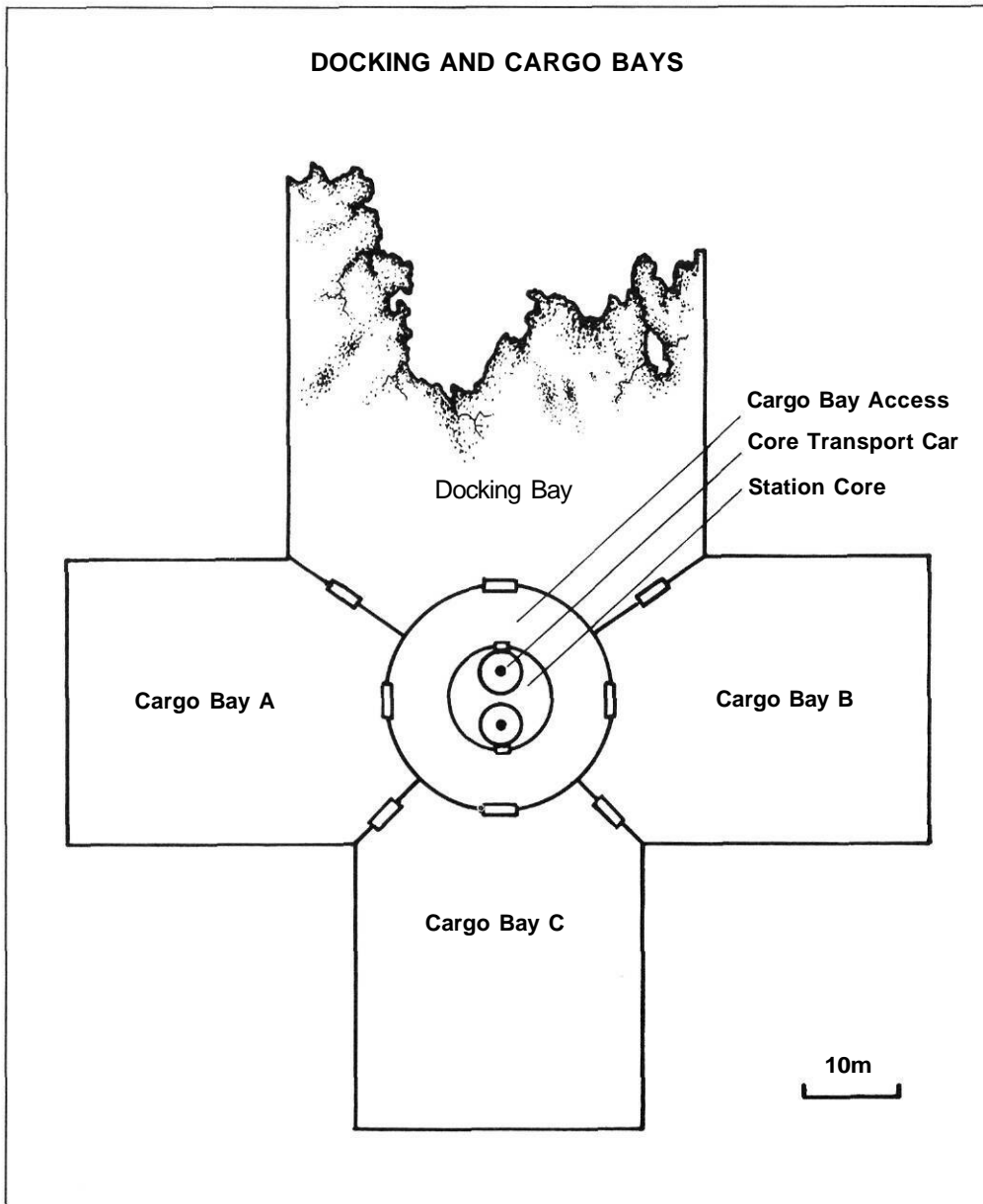

If any members of the team remain in the access chamber while other members search the bay, the Kafers will not be able to seal off the bay. Instead, they will react as Kafers normally do when faced with a surprise: they will mill about until they get smart under fire (if any survive that long).

It is, of course, possible that the Kafers in bay C will still breach the hull. The hull is made of a triple layer of five-centimeter-thick hardened steel, so it has an armor value of 1.0. Because of the space between each layer, however, each round will only penetrate one layer, leaving a hole seven centimeters in diameter. Thus, to breach the hull the same spot in it must be hit three times by aimed fire. Two Kafers can stand in the doorway between bays B and C and fire at any one time. Because they have been practicing this procedure (with buckshot), they will both aim for the same spot on the far wall. Difficulty for this shot is up one level for its small size. The Kafers' chances of succeeding are greater, of course, once they become smart.

The cargo in the bay will automatically serve the human fireteam as partial cover against

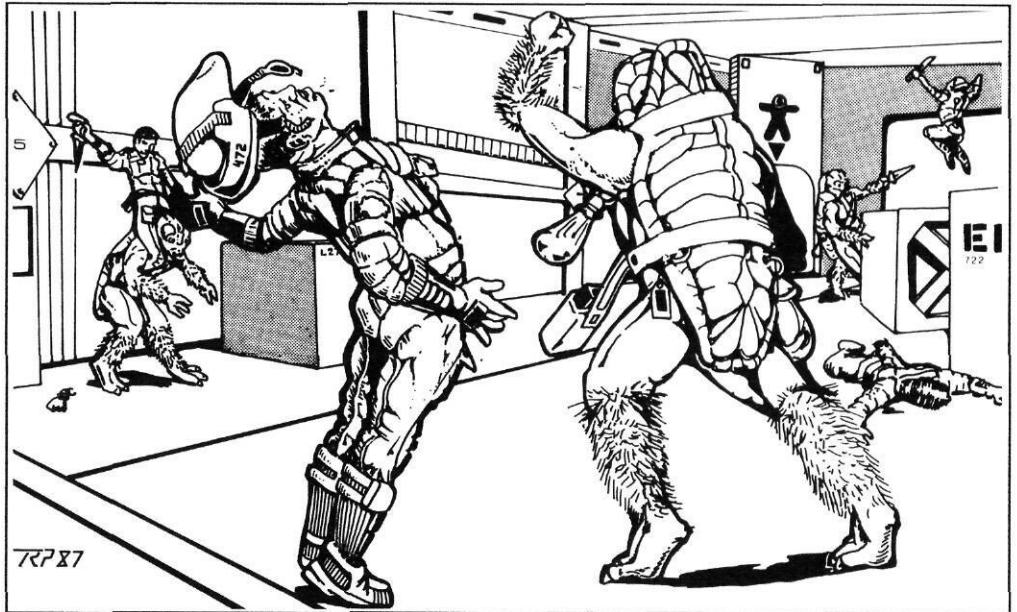

fragmentation from the grenade rounds hitting the hull, and it can serve as full cover if they wish to crouch behind it.

It is very possible that the Kafers will manage to breach the hull but not get the humans locked inside to suffocate. It is also possible that the combat walkers might accidentally breach the hull here if they return fire on the Kafers and roll a mishap. If bay B is closed off, it will take about two minutes for all of the air inside to leak out unless something (a cargo cylinder for example) is laid over the hole to seal it. If the bay is *not* closed off, air from the rest of the station will continue to replace what is being depleted for many hours. Naturally, whoever wins the fight at the cargo bays will close off bay B to prevent further loss of atmosphere from the station.

RESUPPLY

If the humans win this battle, they may wish to search through the supplies in the cargo bays. As mentioned before, there is a computer terminal near the door of each bay if the players desire to use it. If they would rather not, they may simply search the bays for themselves, reading the contents of each cylinder as it is printed upon its side. It may come as a surprise to the group, but the Terran French Government has some weapons stored in bay A. There are 50 FAM-90s (please see the *Player's Manual* for details), 150 empty magazines, and 20,000 rounds of 4.5 x 20mm flechette ammunition, as well as 180 30mm high-explosive propelled grenades. To find this material is a task, as outlined in the sidebar.

It will take an individual about 15 minutes to clean the packing oil from one of these weapons and to reassemble it.

Other items of use to the player characters may be found here as well if the referee desires, but there are no other weapons.

Task: To find the weapons: Routine. Computer or Information Gathering. 30 seconds.

Assault



When the fireteam leaves the docking bays and continues down station, its members will find Levels Nine and Ten (machinery and pumping station accesses) to be locked. Forcing the door will prove these areas to be empty.

Just in front of the doors to the fusion plant, however, they will find a group of 12 Kafers waiting for them behind a barricade improvised from metal plates (construction steel, 4 millimeters thick) tack welded together. This barricade covers half of the tunnel, making it about six meters long. Therefore, only four Kafers can line up along it at a time.

Seven of the Kafers here have the same statistics as those on page 29; they are also carrying "Donderbusses." Four of the remaining five have normal Kafer statistics (see page 48), but with an intelligence of 6/13; they are armed with the usual Kafer "Thud Guns" (see the sidebar on this page). The final Kafer is an officer of some sort with normal Kafer statistics, except for his intelligence, which is 8/14; he is armed with a standard Kafer "Horse Pistol" (see sidebar) and a prod for stimulating his subordinates.

In the fight which ensues, the Kafers will hesitate, doing nothing (they have not trained for this tactic) until they get smart. Then the seven Kafers with "Donderbusses" will come boiling over the wall at the humans while the four with "Thud Guns" back them up with fire. Those four and the officer will remain behind the barrier until the humans defeat them.

"Horse Pistol": An extremely rugged, heavy revolver.

Type: 14.5mm revolver
Weight: 1.3 kg (Bulk=0)
Length: 31 cm Action: Single shots
Ammunition: 14.1 x 31 mm fixed-cartridge ball
Muzzle Velocity: 490 mps
Magazine: 6-round cylinder
Weight of 6 Rounds: 0.2 kg
ROF: 5
Aimed Fire Range: 80 m
Area Fire Burst: 3 rounds
Area Fire Range: 40 m
DP Value: 0.9.

"Thud Gun": An assault rifle/grenade launcher similar in some respects to the German SK-19.

Type: 12.1mm assault rifle with integral 27.2cm grenade launcher
Weight (empty): 6.5 kg
Length: 76.2 cm (Bulk=2)
Action: Single shot or burst
Ammunition: 12.1x31 mm APHE
Muzzle Velocity: 610 mps
Magazine: 66-round box magazine
Magazine Weight: 2 kg
ROF: 2
Aimed Fire Range: 500 m
Area Fire Burst: 10 (AFV= 1.5)
Area Fire Range: 300 m
DP Value: 1.1.

Type: 27.2mm grenade launcher
Muzzle Velocity: 375 mps
Magazine: 9-round tubular magazine
ROF: 2
Aimed Fire Range: 600 m
DP Value: As explosion (EP=4).

The Worm Turns

This chapter describes what the fireteam encounters in the reactor control pod.

REACTOR CONTROL POD DESCRIPTION

Just "above" a layer of shielding at the top of the fusion pod is the reactor control pod. This is a small (10m x 7m x 3m high) control room which directly monitors the station's fusion reactor. Duplicate controls and monitors exist at two separate auxiliary control panels within the room, but when the station was operational, a two-man watch was generally maintained at the main console in the center. (Please see the diagram in this chapter.)

The reactor was intended to be kept running at all times, though usually at only about 20 percent of its full output. Certain special operations, such as starting or stopping the spin habitat, require 70 percent power or more.

Again it should be noted that radiation levels within the pod are low enough to present no danger to humans.

THE CORNERED WOLVES

Once the fireteam has won past the Kafers at the barricade, it will be discovered that the door to the reactor control pod is locked—the group will have to break it down. They may wish to be careful about simply shooting it open as they have been told that there are five more humans inside.

When they break it open, they will immediately receive fire from two more Kafer officers within the room. (Please see the diagram for the room layout.) The junior of the two (a distinction not obvious to the fireteam members) is firing a "Horse Pistol" (see the sidebar on page 37); the senior is using a laser rifle known to humans as a "Flashlight" (see the sidebar on this page). (For the two Kafers' statistics, please see the sidebar on the next page.) Each is partially concealed behind a reactor control panel. There are also five humans in the room, crouched in the north corners.

THE EYE OF THE STORM

When the firefight ends, if the fireteam has killed the senior Kafer officer—which is very likely—the referee should read the following narrative to the players.

A stunned silence drops all around you between the moment the weapons stop blasting and the moment your helmet's noise suppressors click off. Sounds rush back in of a sudden: the hiss of air ventilation, the ping of white-hot metal cooling to a dull red where the Kafer's laser scored the wall above your head—you can feel the heat radiating from it on your cheek. You follow your team members into the control pod and look down on the bodies of the dead Kafers, then up to the five shocked faces of the hostages in the corners.

They begin to move. They advance cautiously toward the panel behind which the biggest Kafer lies. They crouch down around him, and one of the women reaches hesitantly to touch him. She snatches her hand back, then slowly turns to the nearest member of your group, her mouth open in incredulity, her eyes wide. She stands.

"You killed him!" she states, as if unable to believe it. You see your compatriot's answering grin.

Suddenly she leaps upon him, obscenities flying with foam from her lips. She claws, hammers, kicks, and tears at him, as he, shocked, tries vainly to ward her off. It takes four of you to subdue her.

You look up from where you hold her on the floor and meet the obstinate stares of the other captives.

So much for thanks.

"Flashlight": A Kafer laser rifle with integral grenade launcher.

Type: 75.07 laser rifle with integral 27.2mm grenade launcher Weight (empty): 5 kg Length: 76.2 cm Action: Single shot Pulse Energy: 0.7 mj Muzzle Velocity: c Magazine: A Kafer power cell with energy for 12 pulses Magazine Weight: 1.8 kg ROF: 5 Aimed Fire Range: 7300 m DP Value: 2.

Type: 27.2mm grenade launcher Muzzle Velocity: 375 mps Magazine: 9-round tubular magazine ROF: 2 Aimed Fire Range: 600 m DP Value: As explosion (EP=4).

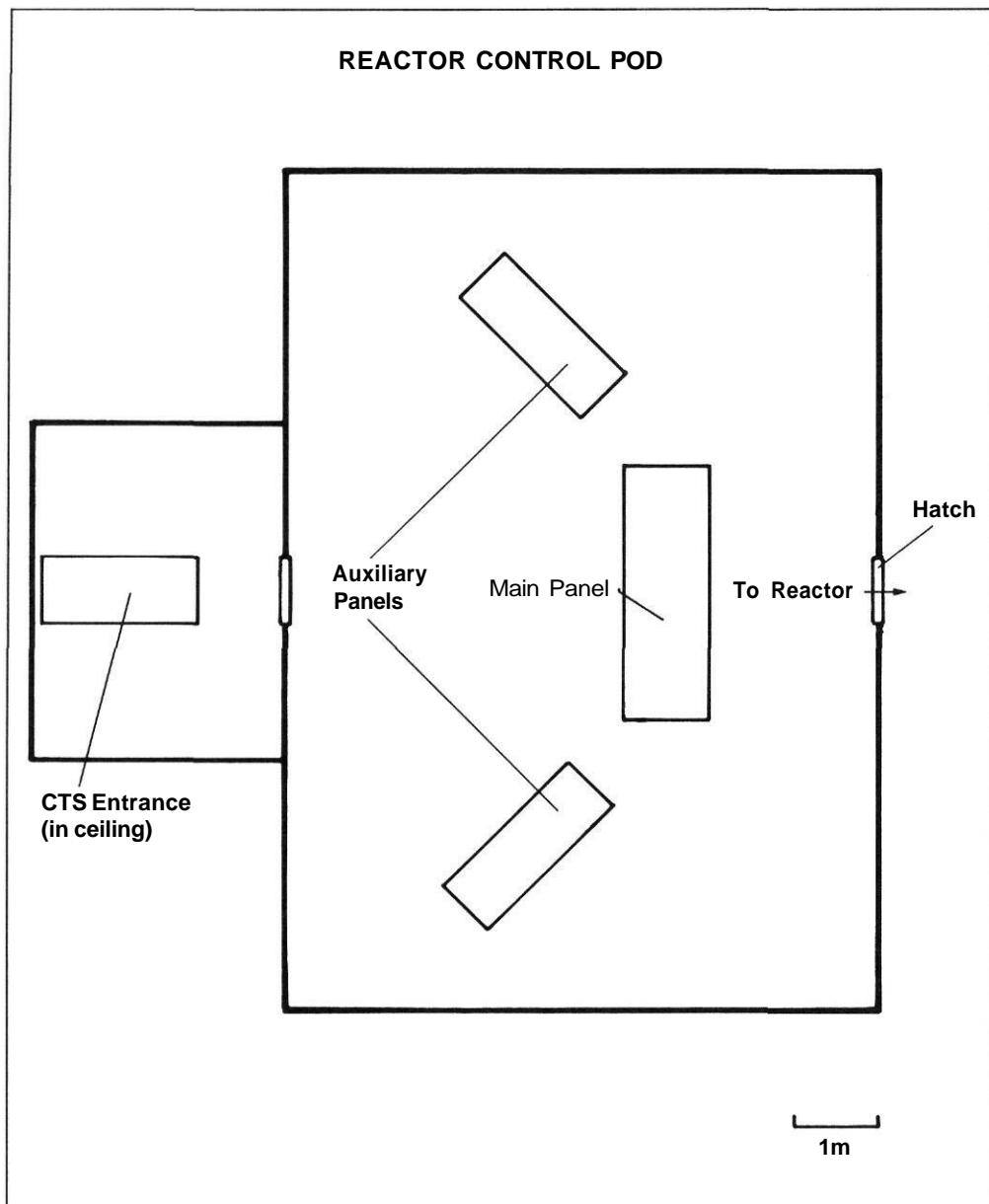

THE HOSTAGES

Interrogating the hostages will be difficult as they are all sullen and uncommunicative. To gain any information from them, someone in the fireteam must pick out an individual (other than the woman on the floor) and make a roll for the task in the sidebar on page 30. Each successful roll will reveal the name and background of the hostage that is being questioned. Further successful rolls for this task will also reveal the identity of the woman on the floor and the fact that the hostages do not know how many more Kafers there are on the station. If questioned specifically about the big Kafer officer, the hostages' reply will be that they called him "Sartre" because he had a fondness for that existentialist writer's works. No other information will be given about "Sartre."



The hostages are as follows:

Claude Dupont

Claude Dupont is a renowned astrophysicist who is about 55 years old, 182 cm tall, and weighs 81 kg. He had just left the observatory and had gone to the computer level when the Kafers attacked the station three years ago. All of his assistants and associates in the observatory were killed when the Kafers destroyed it with heavy laser fire from their ship.

Claude Dupont is a Green NPC with an Elite rating in Astronomy, Geology, and Physics.

NPC Motivation Results: *Heart Queen:* Claude Dupont loves astrophysics with a passion, and he has a talent for it. Unfortunately, he has never been as good at the mundane business of living in human society. *Black Joker:* Without a stable relationship to the rest of the human race, Dupont has been pushed over the edge of sane behavior by his experiences with the Kafers. He will simply not respond to any order or even suggestion unless it is preceded by a blow. It is likely that he will never recover.

Emma Quinnette

Emma Quinnette is one of Station Arcture's administrators. She is 37 years old, 160 cm tall, and weighs 63 km. Quinnette was conferring with Francois Clemenceau (see below) in the reactor control pod, when the Kafers struck the station.

Emma Quinnette is a Green NPC with a Veteran rating as an Administrator.

NPC Motivation Results: *Heart 9:* Ever since she was a child, Emma Quinnette has responded with indignation to injustice and brutality. As she grew older, this grew to a sense of "righteous" indignation, with no pity to be shown for those who would perpetrate such crimes. She became cruel in her hatred of cruelty. *Black Joker:* In the Kafers, Quinnette has met her match. She has been driven into such a pit of self-loathing by her helplessness before their brutality that only by violent retribution will she ever recover. If put back into human society, she is likely to end up exploding with rage at some trifling wrong and murdering the culprit.

Francois Clemenceau

Francois Clemenceau is a junior fusion reactor engineer. He is 27 years old, stands 1 75 cm

tall, and weighs 79 kg. He was, of course, in the reactor control pod when the Kafers struck. Francois began his career in Beta Canum's French Colonial Navy and consequently has had some combat training.

Francois Clemenceau is an Experienced NPC in Space Military.

NPC Motivation Results: *Spade 6:* Francois Clemenceau was really just beginning his career when the Kafers struck Station Arcture. As an ex-Navy man, he realized long ago that life is not fair (boot camp will teach a person that if nothing else will), but that a person can still make the most of what he or she has. Clemenceau wanted to eventually be manager of a fusion reactor facility. *Red Jack:* Despite the fact that Clemenceau has adapted to the Kafer way of life, that adaptation has not really touched him to the core, and he is likely to recover and go on to manage a fusion plant.

Andrea DuPlessis

Andrea DuPlessis is a journalist who was gathering material for an article concerning Station Arcture. She managed to talk the officials in charge into letting her actually spend some time on the station. When the Kafers attacked, she was in the computer room interviewing one of the programmers. If she recovers from her experience with the Kafers, her fame as a journalist is virtually guaranteed.

Andrea DuPlessis is an Experienced Journalist NPC.

NPC Motivation Results: *Spade 10:* Andrea DuPlessis wanted to be a famous journalist, regardless of what it might cost—other people, that is. She believed that it is a carnivore's universe, in which the strong and smart take what they want from the weak and stupid. *Red Joker:* Although she will recover from having adapted to the Kafers, she is likely to be a long time in doing so because they have unintentionally given her a lesson in what her philosophy of life really means.

Claire Laval

Claire Laval is a fairly well known xenopsychologist who came to Station Arcture shortly after the Kafers entered the Arcturus system for the first time. Her hope was that she would be there when and if they ever returned. She got her wish. When the Kafers returned, Laval hurried to the computer room in excitement to try to communicate with them. Due to her training, Laval was the first crew person to adapt to the Kafer takeover of the station, and, despite appearances to the contrary, she will be the first to really recover now that they have left.

Clair Laval is an Experienced Contact NPC.

NPC Motivation Results: *Heart 4:* Clair Laval is a very flexible, accepting person by nature, and her training in psychology strengthened those traits, for she began to understand why people do the stupid things they do. Her fascination with psychology led her to an interest in the psychology of non-human creatures. *Red Joker:* Although Laval appears to her rescuers to be the most insane of the captives, it is because her knowledge of psychology gave her the flexibility to almost *become* a Kafer. That same flexibility will allow her to quickly recover.

KAFER ALERT

While the fireteam members are interrogating the captives they have rescued, the last Kafers on the station, who have not received word from their Commander (the big Kafer officer on the floor of the reactor control pod), will come to investigate. They will, of course, fight to enter the room. If the fireteam has not been to the computer room near the top of the station, that group will be the first group to come, followed about 30 minutes later by another group of 11 whom the fireteam missed in the spin habitat. (Please use the information in the sidebar of page 29 to run these groups.) After that, there will be no further attacks.

KAFER OFFICER STATISTICS

The following statistics apply to the two officers inside the reactor control pod.

Junior Officer

Size: 16
Strength: 12
Dexterity: 12
Endurance: 15
Determination: 17
Intelligence: 8/13
Eloquence: -
Education: -

Senior Officer

Size: 19
Strength: 14
Dexterity: 12
Endurance: 16
Determination: 18
Intelligence: 11/14
Eloquence: -
Education: —

After the Storm

After the last Kafer attack has been made, the referee should read the following narrative to the players:

You've been moving and fighting all day. Now the adrenaline begins to fail you, and you feel a profound sense of disappointment as you look at those six sullen faces—the captives you've set free. The woman who went crazy after your group killed that big Kafer officer finally calmed down enough to be released. Laval, that's her name, Claire Laval, the xenopsychologist. She's sitting over with the others now; they're all looking at your group with suspicion. As you watch her, suddenly she clouts one of the others on the head, hard, and tells him to move over. He does, without complaint.

They don't act any better than the Kafers, you think to yourself.

Your group passes the next several hours in discomfort, taking turns dozing fitfully. Finally, someone decides that there probably aren't any more Kafers on the station—otherwise they'd have been here by now. Sergeant Ortega sends most of the group out to search the rest of the station while a few stay back to watch over the captives. You look at the time display in the cuff of your gauntlet and realize with a shock that it's been over 24 hours since the Bassompierre left you stranded.

Over the course of the next two days, you have a chance to search every corner of the station. Someone finds Fireteam Three up near the observatory. They're all dead. The Kafers must have tossed the bodies of Fireteam Two out through the shattered docking bay.

Many of you take the chance to go down through the maintenance passages of the reactor to look at the Kafer stutterwarp. It's the strangest looking thing you ever saw, outside of the views you've had of Pentapod work. But the Pentapods have been demonstrating a grace about their projects lately, capturing curves that mimic the rhythms of the sea. This, on the other hand, combines an insectoid sense of bulk with one of pure utility. There's nothing beautiful about it, any more than there's anything beautiful about an empty locust husk or the cast off rattle of a rattlesnake. Fascination, yes, but not beauty.

A pall hangs over the time as it passes. The unspoken worry on everyone's mind is, "Will the Bassompierre return before the Kafers do?" Even the captives seem nervous and restless, although you're not sure why.

Then Ortega comes running from the computer room. "Let's load up people," he shouts, "The Bassompierre's back."

You make your crossing to the ship's vessel in which you first came here. The captives are brought along in vacc suits from the station. They're really acting antsy.

As you approach the Bassompierre, you begin to feel almost like your old selves again. The Kommodore must believe Arcturus system to be safe for a while, because the ship's spin habitats are up and running.

As you watch the Bassompierre swell in the view screen, you reflect that although you only spent a day and a half on her when coming here, she seems like home. You do notice some scars on her sides that weren't there before. She's had a baptism of fire too, it seems.

Once on board, you're asked to perform the final duty of accompanying the captives to the sick bay. From the look on the Kommodore's face, you know that he is paying you an honor in this, rather than letting someone else finish off the task you began. Martial music flares from the ship's speakers as you accompany the captives to the spin habitat access. They look a bit startled. You usher them into an elevator and key it to go "down." Boy, it's beginning to feel great to be home!

Suddenly, the xenopsychologist woman buries her face in her hands and starts to weep. You look at the captives and notice that a few of the others have tears standing in their eyes.

"What's wrong?" you ask. The question hangs in the air for a moment, unanswered.

"The music," she finally responds, without looking up.

You stop to listen. It's just elevator music; you hadn't even paid it any attention. After a few moments, you identify it—Beethoven's Sixth, Pastoral, Symphony, one of the richest, gentlest



pieces ever written. You can feel it easing your tensions away, and you realize that it was working on you subconsciously before now.

"It's beautiful," the woman says, and she looks up and painfully tries a tentative, tremulous smile. You watch her, enthralled, and the eyes that look back at you, while still full of pain, are the eyes of a human once again.

REFEREE'S EXPLANATION

Once the captives have been examined by the *Bassompierre's* medics, word will get back to the players that they are suffering from a "hostage syndrome," in which they have learned to identify deeply with their captors. This deep identification with the Kafers was necessary for the captives to cope with the stress of living in a Kafer-oriented environment. Most of the captives are beginning to show some signs that their chances of coming out of it with therapy are good, although there are a couple who seem very deeply scarred and may never recover.

Xenopsychologist's Report

The conclusion to Claire Laval's report on Kafer psychology, submitted 7 / June 2300 to His Majesty Nicolas Ruffin, Emperor of France.

CONCLUSION

Much is evident, then, from our Kafer "Sartre's" excitement over the real Sartre's theme in *The Wall*. "Sartre's" statement that "He understands! This writer understands that the moment of complete being is felt only when facing death," is more than just a philosophical agreement with an existentialist author. Together with the constant brutality and violence which we witnessed among the Kafers, "Sartre's" exuberance over *The Wall* confirms that not only do Kafers experience a sudden increase in intelligence when under the threat of great violence, but violence is the only thing that prevents their culture from losing the intelligence they have gained thus far. Therefore, Kafer officers do not strike their subordinates to force them to carry out their orders, nor do they strike them to get their attention. Instead, *they strike them to make them intelligent enough to understand their orders in the first place!*

While humans have developed a "long-term" intelligence as a means of survival, Kafers have developed a "short-term" intelligence instead. When faced with a problem of survival, humans can remember solutions that were tried before (even if they merely observed those solutions being used by another human) and choose the one that worked the best. A Kafer, on the other hand, when faced with a problem of survival, finds its intelligence increasing but must create its solution anew each time. Put another way, when its intelligence is high, it can *recognize* a solution that is suggested by the situation, but it cannot *remember* solutions from other, similar situations—at least not with the facility of a human.

What this discovery does not answer for us is the question of why the Kafers have attacked humans so unmercifully and without provocation. I would suggest two possibilities.

The first is that the Kafers fear humanity. Why do they fear us, when we have not provoked them? It is because they recognize the fact that, on the average, human beings are more intelligent than Kafers are. To them this means not only that we are more likely to outwit them but also that our culture must be many times more violent than theirs in order to promote such intelligence. They believe then that they are fighting for their existence against a foe who outmatches them in both cunning and in potential for violence.

The second possibility is that the Kafers recognize that, in other races, intelligence need not be short-term. But, in their desire to raise the average intelligence of their masses, Kafer leaders have seized upon humans as their new "bogey-man." This view of "us" against "them" has certainly been the source of many wars between humans; the Kafers have an even more valid reason to take it.

These two possibilities are, of course, unproven speculations. Only the passage of time will reveal the correct answer to us. But we must be ready to seize that answer when it comes and develop a response which will defuse the Kafers' need to fight with humanity. If we do not, then we are likely to be locked into a war we cannot end, against an enemy whose resources are unknown to us.

Armor/Damage Revisions

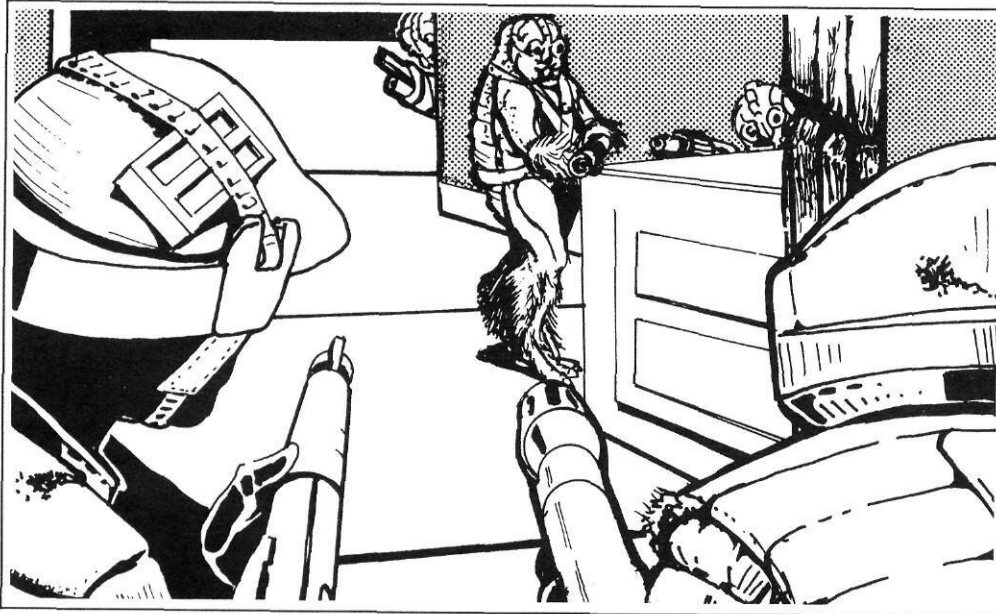

This chapter is a summary of the Combat Armor section of Aurore Sourcebook. It is included here because of its importance in running close combat in Mission Arcturus.

INTRODUCTION

The rules for personal armor use in the *Player's Manual* are unclear, and the armor values listed are incorrect. The following rules should be used for both armor and close-range damage.

PERSONAL ARMOR

Types of personal armor are: non-rigid, rigid, and inertial. Non-rigid armor is made of flexible material which is tough and resists puncture by a bullet or energy beam. It doesn't inhibit the wearer's movement as much as rigid armor does. Rigid armor is made of solid pieces. Inertial armor is flexible like non-rigid armor but becomes rigid when struck by a fast-moving projectile (such as a bullet or a piece of shrapnel). The differences among non-rigid, rigid, and inertial armor are only important when resolving blunt trauma injuries. In the case of normal damage, the armor's value is subtracted from the DP value of the round, and the difference is used to determine the seriousness of the wound, as explained in the basic game rules.

NON-PENETRATING KINETIC ENERGY ROUNDS

A kinetic energy round with a DP value less than that of the armor will not penetrate but will cause blunt trauma or stun damage. If the round hits rigid or inertial armor, it inflicts stun damage; if it hits non-rigid armor, it inflicts blunt trauma damage. In all cases, half of the armor value is subtracted from the round's DP value, and the seriousness of the wound is reduced one level.

CLOSE-RANGE FIRE

All fire combat weapons have their DP value doubled when firing at a target within close range.

ARMOR LISTING

The following corrected armor values supersede those listed in the basic game's Player's Manual:

Helmet:	1
High-Threat Combat Helmet:	2
Steel Helmet:	0.2
Chainmail Vest:	0.1
Rigid Breastplate:	1
Non-rigid Vest:	0.6
Inertial Armor Vest:	0.8
Full-body Non-rigid Armor:	0.3
Full-body Inertial Armor:	0.4
Full-body Combat Armor:	1
BH-21 Combat Walker:	8
Kz-7 Combat Walker:	10

NPC Index

NPC EXPERIENCE LEVELS

In *Mission Arcturus*, NPCs are not only given an experience level, they are also given an occupation. In this book, the experience level indicates not only the normal things from the basic game rules but also what the NPC's average skill level in those skills related to his or her occupation. This helps the referee when rolling tasks for NPCs. The table below lists what average skill level an NPC at a given experience level has in the primary and related skills for his or her occupation.

NPC EXPERIENCE/SKILL LEVELS

<i>Experience</i>	<i>Primary Skill Level</i>	<i>Secondary Skill Level</i>
Green	0	
Experienced	1	0
Veteran	2	1
Elite	3	2

NPC LISTING

The remainder of this chapter lists all of the human NPCs in *Mission Arcturus* in order of appearance. Information on each is given in an abbreviated form. The intent is to provide the referee with essential information while reminding him or her of the NPC's motivations.

The Commander

Kommodore Wilhelm Lutke

Kommodore Lutke is a Veteran NPC in both Space Military and Administrator.

NPC Motivation Results: *Spade Ace*: A natural leader. *Spade 10*: Wants to retire with glory.

The American Marines

Sergeant Raoul Ortega

Sergeant Ortega is a Veteran in Space Military.

NPC Motivation Results: *Club 10*: Likes a fight. *Spade 4*: A good-natured braggart.

Corporal Kelly Yaeger

Corporal Yaeger is an Experienced NPC in Space Military.

NPC Motivation Results: *Heart Queen*: Loves Lang (below). *Club 3*: Not afraid of violence.

Lance Corporal Peter "Long Pete" Lang

Lance Corporal Lang is an Experienced NPC in Space Military.

NPC Motivation Results: *Heart Queen*: Loves Yaeger (above). *Black Joker*: Could become dangerous if Yaeger dies.

Private James Bucheger

Private Bucheger is a Green NPC in Space Military, but has a Combat Rifleman skill level of 5.

NPC Motivation Results: *Spade 7*: His shortness drives him to excel. *Heart 4*: Amiable.

The French Combat Walker Pilots

Sergent Vikki Marcotte

Sergent Marcotte is an Experienced NPC in Ground Military.

NPC Motivation Results: *Heart 10*: Respects justice. *Heart 7*: Very loyal.

Caporal Phillip Massey

Caporal Phillip Massey is a Green NPC in Ground Military.

NPC Motivation Results: *Spade Jack:* An obnoxious braggart. *Diamond Jack:* Actually a coward.

The Advisors**Sergeant Michael "Mad Mike" Vincent**

"Mad Mike" Vincent is a Veteran in Ground Military.

NPC Motivation Results: *Heart Jack:* Gives good advice. *Club 4:* Used to violence.

Sergeant Walker McGuire

Walker McGuire is an Experienced NPC in Law Enforcement.

NPC Motivation Results: *Heart King:* Painfully honest. *Club 3:* Used to violence.

Corporal Howard Paderewski

Howard Paderewski is a Green Troubleshooter.

NPC Motivation Results: *Diamond 6:* Money means status. *Spade 5:* Needs to be respected.

Private John King

John King is an Experienced NPC in Ground Military.

NPC Motivation Results: *Diamond 4:* Likes to win money at cards. *Heart 2:* Amiable.

Hostages**Eugene Laforet**

Laforet is a Green Colonist NPC.

NPC Motivation Results: *Diamond 2:* Wants to make a living. *Red Joker:* Presently "not sane," but will recover.

Claude Dupont

Claude Dupont is a Green NPC with an Elite rating in Astronomy, Geology, and Physics.

NPC Motivation Results: *Heart Queen:* Loves Astrophysics, blunders with people. *Black Joker:* Driven to lonely insanity, will not recover.

Emma Quinnette

Emma Quinnette is a Green NPC with a Veteran rating as an Administrator.

NPC Motivation Results: *Heart 9:* Righteously cruel. *Black Joker:* Insanely, murderously, vengeful.

Francois Clemenceau

Francois Clemenceau is an Experienced NPC in Space Military.

NPC Motivation Results: *Spade 6:* Wants to be a success. *Red Jack:* Temporarily "not sane," but will recover through perspective.

Andrea DuPlessis

Andrea DuPlessis is an Experienced Journalist NPC.

NPC Motivation Results: *Spade 10:* The strong take what they want. *Red Joker:* Seeing that in Kafers has destroyed her view; will recover, but changed.

Claire Laval

Claire Laval is an Experienced Contact NPC.

NPC Motivation Results: *Heart 4:* Very flexible and understanding. *Red Joker:* Almost became a Kafer; will flex back to human quickly.

All About Kafers

This chapter will provide the *referee* who has had no experience in running Kafer NPCs just what he or she needs to know in order to play them, as well as what the advisors should know. It should be remembered during play, however, that one of the results of this mission is the publication of the *Xenopsychologist's Report* near the end of this book. The *referee* should be careful that the advisors are portrayed as not knowing that information so that none of it slips out during play.

APPEARANCE

Kafers are two-meter tall non-human bipeds. The articulation of their joints is similar to that of humans, but they are more heavily muscled. Parts of their bodies, including their upper heads and backs, are encased in a horny, spiny carapace. Elsewhere their skin is tough, with short, coarse bristles on their lower arms and legs. Their hands consist of three mutually opposing thumbs, and they lack the strength of a human grip. Their eyes are small, deep-set under heavy brow ridges, and darkly pigmented. Kafer mouths are complex organs consisting of multiple handling, tearing, shredding, and sucking appendages. Most humans feel revulsion and disgust at the Kafer appearance, which is often compared to that of a Terran lobster or insect. The name "Kafer," in fact, was applied to them by German troops on Aurore. The word means *bug* in German and, in a darkly humorous twist, also happens to be an old slang term for a young, pretty girl.

KAFERS IN COMBAT

Generally, when role playing Kafers in combat, the *referee* should consider them to be Green NPCs during the first moments and allow them no advantage for tactical skill. After the first few moments of confusion (1 D6 combat turns), all Kafers become Veteran NPCs, and all Kafer officers become Elite. It *always* requires four light wounds to incapacitate any Kafer at any time, however.

Note: *The Kafers in this module break these generalizations somewhat when performing a particular function, such as ambush, for which they have been specially trained. They will, however, continue to perform exactly as they have been trained, demonstrating no tactical inventiveness even if an unforeseen circumstance renders their trained response useless. That is, of course, until their sudden shift in status from Green to Veteran NPCs; then they will show all of the cleverness of any other Kafer a few moments into combat.*

During role play of combat, the *referee* should stress how clever the Kafers have become in combat *after* that first noticeable confusion. They will exhibit seemingly superhuman skill in determining the best place and manner to attack and in infiltrating human lines. They will use cunning tricks including feigning death and hiding in burned-out buildings and the like. They will note human concern for non-combatants and comrades and use captured humans as screens. They are adept at identifying human officers and picking them off in order to disorganize the human's command structure.

This change in Kafer combat abilities will last for as long as they remain under fire, for as long as humans remain in sight, and for approximately 30 minutes after the end of the battle. Thirty minutes after they are no longer receiving fire or have humans in sight, they will revert to the same intellectual levels they exhibited before combat began.

STATISTICS

Typical Kafer NPC stats are as follows:

Size: 18

Strength: 12

Dexterity: 12

Endurance: 16

Determination: 15

Intelligence: 2/12

Eloquence: -

Education: -

These values will vary somewhat from individual to individual but can be used as a starting point. Kafer Intelligence is always low until shortly after combat begins; then it jumps by as much as 10 points or more. Not all Kafers have a basic Intelligence of 2. (The Kafers in Station Arcture have all been hand-picked for higher intelligence, for example.) Officers and some other veterans have intelligence levels as high as 6 or 8, and some very rare individuals have basic Intelligence levels of 10 or 12 at all times. Kafer Intelligence is never raised above 14 during combat, however.

2300™

Mission ARCTURUS

Station Approach: We all crowded up close to the view screen to get a good look at Arcturus Station when our ship moved up into visual range of the place. It wasn't an encouraging sight.

The place had been hit hard, that was for certain. The station was designed with a big, rotating wheel that was supposed to provide artificial gravity for the scientists on board, but the central axis of the station was always supposed to align with Arcturus. The first thing we noticed was that it wasn't just the wheel part of the station that was turning—the whole station was.

Contact with the implacable, warlike alien race known as the Kafers was first made in 2395 by a French research outpost orbiting the star Arcturus, four and a half light years out-arm from Eta Bootis. Two years later, all communication with the French station abruptly ceased, and it is now assumed that the station was destroyed by a surprise—and unprovoked—attack by the Kafers. The following year, in 2398, a Kafer armada struck Eta Bootis, and the Kafer War began in earnest.

Eventually the Kafers were driven back from Eta Bootis system (except for a small number of ground troops

which remain to threaten the safety of the colonists on the planet Aurore) and even from Arcturus, where the ill-fated research station hangs in orbit around that giant, enigmatic star. But the victorious human forces were unable to remain at Arcturus, being forced to return to Hochbaden for sorely needed repairs and supplies. *Station Arcture* remained unexplored, the fate of its crew a mystery.

One German Kommodore decided to seize the moment, determined to take a multi-national mission team from Eta Bootis to *Station Arcture* before the Kafers could return and before his superiors could react. He planned the mission team with the purposes of reconnaissance and rescue—*Mission Arcturus*.

You are invited to join *Mission Arcturus* and to explore what's left of the human research station between the battle fleets.

Design.....William H. Keith Jr.
and Lester W. Smith
Development.....Lester W. Smith
Art Director.....Barbie Pratt
Cover Art.....Steve Venters

GDW Game Designers' Workshop
Since 1973

PO Box 1646, Bloomington, IL 61702-1646



0 86079 01033 1

Copyright©1987, Game Designers' Workshop. All rights reserved.
Printed in the U.S.A. Made in the U.S.A. ISBN 0-943580-45-5.

