

# MEGATRAVELLER WORLD



B U I L D E R ' S H A N D B O O K



Approved for use with MEGATRAVELLER



Digest Group Publications



<b>WORLD DETAIL SHEET</b>			1. Date of Preparation		2. World UWP																		
<b>SIZE-RELATED</b>			3. Diameter		4. Density		5. Mass		6. Gravity		7. Primary Mass (Star)		8. Orbit Nbr (Planet)		9. Orbital Period (Planet)								
10. Rotation Period		11. Axial Tilt		12. Orbital Eccentricity		13. Seismic Stress		14. Asteroid Belt Zones		15. Primary Mass (Planet)		16. Orbit Nbr (Satellite)		17. Orbital Period (Satellite)									
<b>ATMOSPHERE-RELATED</b>				18. Atmosphere Composition				19. Surface Pressure		20. Stellar Luminosity		21. Orbit Factor		22. Energy Absorption									
23. Greenhouse Effect		24. Base Temperature		25. Orbital Ecc. Mod		26. Latitude Temp Effects		27. Axial Tilt Effects		0.00=		0.25=		0.50=		0.75=		1.00=					
28. Daytime Plus		29. Nighttime Minus		30. Native Life? <input type="checkbox"/> Yes <input type="checkbox"/> No		31. Atmospheric Terraforming? <input type="checkbox"/> Yes <input type="checkbox"/> No original:		32. Greenhouse Effect Terraforming? <input type="checkbox"/> Yes <input type="checkbox"/> No new:		33. Albedo Terraforming <input type="checkbox"/> Yes <input type="checkbox"/> No new:													
34. Atmosphere/Temperature/Terraforming Notes																							
<b>HYDROSPHERE-RELATED</b>				35. Hydrographic Percentage				36. Hydrosphere Composition								37. Nbr Tectonic Plates							
38. Hydrosphere Terraforming? <input type="checkbox"/> Yes <input type="checkbox"/> No original:				39. Terrain Terraforming? <input type="checkbox"/> Yes <input type="checkbox"/> No				40. Nbr Major Continents/Oceans				41. Nbr Minor Continents/Oceans				42. Nbr Major Islands/Small Seas				43. Nbr Archipelagoes/Scattered Lakes			
44. Notable Volcanoes																45. Weather Control? <input type="checkbox"/> Yes <input type="checkbox"/> No							
46. Natural Resources																							
47. Processed Resources																							
48. Manufactured Goods																							
49. Information																							
<b>POPULATION-RELATED</b>				50. Total Population				51. Local Customs															
52. Primary Cities (list name, population, starport/spaceport)																							
53. Secondary Cities (list name, population, spaceport)																							
54. Tertiary Cities (list name, population, spaceport)																							
55. Social Outlook—Progressiveness						56. Social Outlook—Aggressiveness						57. Social Outlook—Extensiveness											
Attitude <input type="checkbox"/> Radical <input type="checkbox"/> Progressive <input type="checkbox"/> Conservative <input type="checkbox"/> Reactionary Action <input type="checkbox"/> Enterprising <input type="checkbox"/> Advancing <input type="checkbox"/> Indifferent <input type="checkbox"/> Stagnant						Attitude <input type="checkbox"/> Expansionistic <input type="checkbox"/> Competetive <input type="checkbox"/> Unaggressive <input type="checkbox"/> Passive Action <input type="checkbox"/> Militant <input type="checkbox"/> Neutral <input type="checkbox"/> Peaceable <input type="checkbox"/> Conciliatory						Attitude <input type="checkbox"/> Monolithic <input type="checkbox"/> Harmonious <input type="checkbox"/> Discordant <input type="checkbox"/> Fragmented Action <input type="checkbox"/> Xenophilic <input type="checkbox"/> Friendly <input type="checkbox"/> Aloof <input type="checkbox"/> Xenophobic											
<b>GOVERNMENT-RELATED</b>				58. Representative Authority				<input type="checkbox"/> Executive <input type="checkbox"/> Legislative <input type="checkbox"/> Judicial				<input type="checkbox"/> Ruler <input type="checkbox"/> Elite Council <input type="checkbox"/> Several Councils <input type="checkbox"/> Demos											
59. World Government Description				60. Other Authority				<input type="checkbox"/> Executive <input type="checkbox"/> Legislative <input type="checkbox"/> Judicial				<input type="checkbox"/> Ruler <input type="checkbox"/> Elite Council <input type="checkbox"/> Several Councils <input type="checkbox"/> Demos											
				61. Other Authority				<input type="checkbox"/> Executive <input type="checkbox"/> Legislative <input type="checkbox"/> Judicial				<input type="checkbox"/> Ruler <input type="checkbox"/> Elite Council <input type="checkbox"/> Several Councils <input type="checkbox"/> Demos											
<b>LAW-RELATED</b>				63. Uniformity of Law				<input type="checkbox"/> Undivided <input type="checkbox"/> Territorial <input type="checkbox"/> Personal				62. Religious Profile (optional)											
64. Legal Profile (optional)																							
<b>TECHNOLOGY-RELATED</b>				65. Technology Profile				Common — Quality of Life — Achievement Tech Levels — Military — Novelty Transportation															
High Common Low Common Energy Computers/Robotics Communications Medical Environment								Novelty Heavy Military Personal Military Space Transport Air Transport Water Transport Land Transport															

# World Builder's Handbook

Learn how to survey exotic alien worlds with the Imperial Scouts...

Build highly detailed, exotic alien worlds to explore...

Here in one volume is extensive information on how to create fully detailed worlds and background for creating your own exciting Scout survey missions.

*World Builder's Handbook* is the comprehensive guide to surveying and detailing worlds. *World Builder's Handbook* consists of these sections:

- **Survey and Exploration** is for **MegaTraveller** players. It details the survey, exploration, landing party, and contact procedures used by the Scouts. This section discusses other topics, too — like what has happened to the Scouts in the rebellion, determining sentence, and so on.

- **Survey Equipment** is also for players. Packed with new high-tech equipment, this section includes information on vacc suits, sensors, vehicles, and complete plans for the *Donosev* Class Scout Survey Vessel.

- **Detailing a World** is for the Traveller referee. It shows how to take the Traveller UWP stats for a world and expand them into an accurate, detailed description of the world's temperature, oceans, continents, seismic activity, resources, cities, starports, cultural outlook, local customs, government and legal structure, and technological achievements.

- **Mapping a World** tells how to create a carefully detailed world map, accurate to the world details produced from the "Designing a World" section.

- Using World Data discusses how to use the expanded world information to introduce a new level of exciting realism into a game session.

## THE BASIC TRAVELLER PLANET

The Universal World Profile (UWP) is used by **MegaTraveller** as the standard for recording coded information about a world. It consists of starport, size, atmosphere, hydrosphere, population, government, law level, tech level, bases, trade classes, travel zone, detailed data (population multiple, number of planetoid belts, number of gas giants, allegiance, and stellar data).

Any world can be described by the basic UWP. These brief stats serve as the starting point for *World Builder's Handbook*.

Additional useful materials include pens, pencils, notebook paper, hex grid or square grid graph paper, and colored markers. A calculator or home computer is helpful for some calculations in this book.

## DIE ROLLING CONVENTIONS

*World Builder's Handbook* uses the common die rolling conventions for **MegaTraveller**.

**Throw:** That die roll required to achieve a stated effect. If only a number is stated, it must be rolled exactly. A number followed by a plus (such as 7+) indicates that number or greater must be rolled. Similarly, a number followed by a minus (such as 3-) indicates that number or less must be rolled.

**Number of Dice:** Generally a dice throw involves a roll of two six-sided dice. Throws requiring more (or fewer) dice are clearly stated. For example, a throw calling for one die would be stated as 1D.

**Die Modifiers:** Die roll modifiers (abbreviated DM) are always preceded by either a plus or a minus. Thus the notation DM+3 indicates that three is added to the dice roll before it is used. Some throws will be written to include a constant modifier; for instance, 2D-7 indicates that the throw required is a roll of 2D with a DM of -7 immediately applied.

**Numbers from 0 to 9:** Certain rules call for the generation of a digit from 0 to 9. The best way to generate these numbers is with a ten-sided die.

However, it is also possible to roll 2D-2 (using regular six-sided dice) and get a number from 0 to 10. Just reroll if you get 10. However, this method creates a highly skewed distribution, centered around 5. For those who find this unacceptable, the following more involved method of generating numbers from 0 to 9.

Roll 1D for an even or odd number. If the result is even, roll 1D-1 for a number from 0 to 5 — reroll if the result is 5. If the result of the first roll was odd, roll 1D+4 for a number from 5 to 10. Reroll if the result is 10. This method gives an even distribution, with all digits equally likely to occur.

**HOW TO USE THIS BOOK** Generally, the referee will use the section *Detailing a World* to generate the copious details about an individual world (or worlds) from the world UWP stats. During an adventuring session, the referee then has at her disposal a tremendous amount of useful detail about the world as the players adventure on it.

The referee can also use *Detailing a World* to detail a world as yet *unexplored*. The players can then use the section *Survey and Exploration* to discover the attributes the referee has already generated. The act of surveying and exploring an unknown world can be an exciting basis for an adventure.

A third option is for players to survey and explore a world that the referee has no data on, with each specific item of data generated from *Detailing a World* by the referee as the players request it. The world's UWP is actually "discovered" as the survey proceeds.

## CREDITS

**Design and Development:** Joe D. Fugate Sr., J. Andrew Keith, Gary L. Thomas

**Additional Design:** Robert Parker, Nancy Parker, James Holden, Rob Caswell, Ed Edwards

**Artwork:** Cover — A. C. Farley; Interior — Rob Caswell, Joe D. Fugate Sr.

# Survey and Exploration

Two offices of the Imperial Scouts — the Survey Office and the Exploration Office — are responsible for surveying and exploring worlds. When the Scouts study a star system and its worlds, they follow certain procedures. In this section, we discuss these procedures in some detail.

**The Survey Office:** Depending on what is being studied, the Survey Office spends various amounts of time in various systems and on various worlds. Different means of classifying surveys are listed, based on time spent and type of survey.

A planetographer's checklist describes typical techniques a survey crew might use, from the time they decide to jump into a system, through the readings made at system's edge and in orbit around a world, to the world's surface. To illustrate, the operation of the *Donosev* Class sensor control center is described.

A variety of sensors are used in surveys: the EMS array detects objects and sources of electromagnetic energy, the densitometer detects and classifies objects by density, the neutrino sensor detects and classifies atomic-based energy sources, and the neural activity sensor detects and classifies most lifeforms by their "brainwave patterns".

Proper operation of these sensors is important to the success of a survey mission; examples within illustrate how to use these sensors effectively.

A variety of equipment has special uses on survey missions, included are a multitude of equipment. The largest piece of equipment used on a survey, of course, is the ship itself: complete plans and description for the *Donosev* Class Scout Survey Vessel are given as well.

From the survey data, the Scouts compile maps and navigational charts of the Imperium and surrounding areas.

**The Exploration Office:** Once the star system and its worlds have been surveyed from space, the exploration branch (or "dirtside Scouts") takes over. The dirtside Scouts gather and update data about the cultures, flora, and fauna that exist across the Imperium and surrounding areas.

Comprehensive landing party procedures are given, with notes about equipment used during different steps.

Identifying and contacting sentient life forms is discussed. Once contact has been made, it is imperative that an efficient and effective means of communication be developed as soon as possible. A brief history of language in the Imperium opens the doors to a new skill and detailed equipment for dealing with languages, both new and old.

A variety of equipment has special uses on exploration missions, providing highly technological means of transportation, communication, protection, and data gathering. Each of these devices is detailed and illustrated.

## SURVEYING STAR SYSTEMS AND WORLDS

In order to maintain up-to-date information on the Imperium and the regions surrounding it, the Imperial Interstellar Scout Service conducts surveys on an ongoing basis. Although all systems are surveyed, not every system is surveyed to the same degree of detail. The Scouts divide their system surveys into five classes:

**Class I:** These surveys are the most brief, usually taking only 2D hours to complete. Probes and landing parties are almost never deployed. The Scouts reserve Class I surveys primarily for the survey of a new system.

Whenever an unsurveyed system is first encountered, the Scouts have a standing order: perform a class I survey (from interstellar range) on the new system as soon as possible. A class I survey may be conducted from as far away as one to two parsecs — close enough to allow the determination of basic stellar data and the possible presence of gas giants. The key goals are: chart the precise location of the new system, determine the system ecliptic, note stellar data, and establish the presence of large gas giants, if any. The average survey time is 1 hour per detectable body.

**Class II:** This kind of survey takes 2D days, and may use probes at the commander's initiative. Landing parties are rare. Class II surveys are usually used as the first insystem survey of a new system or as a special survey to determine only a limited amount of information (the survey ship is sent into the system for a specific purpose, and leaves as soon as the question has been answered).

In a class II initial system survey, all planetary bodies over 800km in diameter are noted, as well as any planetary satel-

lites over 200km in diameter and the dimensions and density of asteroid belts and rings are measured. The survey takes an average of 4 to 8 days. The actual duration, of course, largely depends on the complexity of the star system.

**Class III:** These surveys, which are the most common, take 2D weeks, including the deployment of probes into the habitable zone. Landing parties may be used at the commander's initiative.

Most system surveys are of this class. The Scouts perform physical profiles of all significant bodies, and do an ephemeris of the bodies' orbital motions. A orbital map of the main world is made. Using orbital examination, the Scouts determine a preliminary UWP. At the commander's discretion, the UWP may be augmented by some on-planet observation and exploration. The average time to complete such a survey is about 50 days.

**Class IV:** A class IV survey typically takes 2D months. Probes are sent into the system's habitable zone, and landing parties visit the habitable zone's worlds. Both major Imperium-wide surveys (published in 420 and 1065) were Class IV surveys.

The most common class IV survey undertaken by the Scouts is the intensive study of the main world. The world's surface is accurately mapped. Explorers examine the basic geology of the world and collect organisms so as to type the indigenous biology. Native sophonts are studied, but not usually contacted. The average such class IV survey lasts about 30 weeks.

**Class V:** These surveys take 2D years (or more). Probes

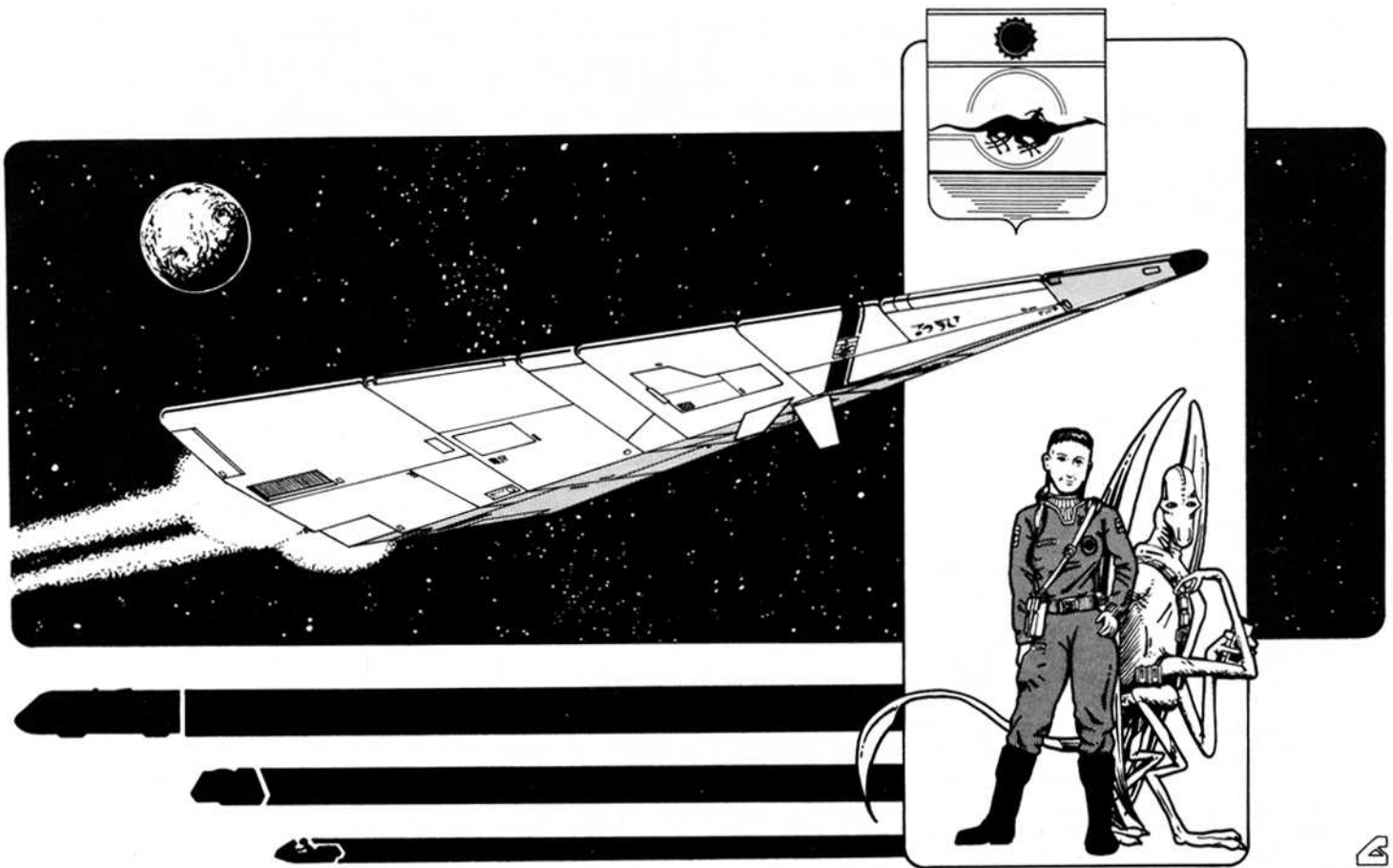

and landing parties are sent to all surveyed bodies. In most cases, an extensive Class V survey is performed only when requested by the surveyed system's government or by the Imperial military.

A common reason for a class V survey of a system is as a precursor to colonization. The Scouts undertake many detailed and time-consuming studies: they model planetary dynamics (including atmosphere, oceans, solar, vulcanism, and major migratory patterns), and they measure the stability of the climate. Basic resources necessary to sustain a colony are identified. A superficial examination of resources useful in economic exploitation is made, and native sophonts, if any, are contacted. The average class V survey takes 5 to 10 years to complete.

In a survey (as opposed to an exploration), contact with local sentients is avoided. The duration and extent of the survey must take this factor into account. Landing parties typically use the neural activity sensor to locate local life forms; non-sentients may be captured as specimens, while sentients are avoided.

In many non-contact surveys, landing parties are not used. Notice that surveys can also be classified by range: long range scan (1-2 parsecs distant), system perimeter scan (50,000-100,000 AUs from primary), outer system scan (beyond habitable zone), inner system scan (between habitable zone and primary), or habitable zone scan.

Other possible survey classifications are: whether active or passive sensors are used, whether probes are used, and whether landing parties are used.

Specialized surveys may be made of the habitable zone of a system, the system's gas giants, planetoid belts, or the star itself. Some systems are resurveyed because newer sensors are available.

Thus, a survey may be a Class II system perimeter probe scan, or a Class IV habitable zone landing party resurvey, for example. Particularly disconcerting to a Scout is the so-called Class V "desk scan", which occurs if he is involuntarily transferred from the Field to the Bureaucracy.

#### THE PLANETOGRAPHER'S CHECKLIST

With the planetographer's checklist, referees can instantly generate "into the unknown" adventures for their players.

Have each player generate a Scout character. Use the *Donosev* Class Survey Scout described in this book, and generate as many NPC Scouts as needed to fill out the crew. Choose a location and let the players have at it. At each stage of the survey, they will learn more about the area they are in.

After they decide which way to go and lay in the course, their ship can jump to the system to be surveyed. When they reach it, there may be possible ship encounters as they study and approach desirable worlds.

The referee does not need to have an entire system gen-

# PLANETOGRAPHER'S CHECKLIST

## 1 Setup

Determine the type and class of survey.

*Remember that some survey sensors are active rather than passive; using active sensors could give away the ship's presence, which may not be wise if contact is to be avoided at all costs.*

## 2 From 1 Parsec Out

- Use the densitometer to determine the number of stars.
- Use the densitometer to estimate the presence of gas giants in the system.
- Use EMS array spectrography to determine stellar types.

## 3 At System's Edge

- Use densitometer to measure the mass of each star.
- Use densitometer to locate all possible major bodies and planetoid belts.
- Use densitometer to measure the mass of each major body.
- Use EMS spectrography to determine stellar compositions with greater accuracy.
- Use neutrino sensor to determine the stellar energy profile of each star — this shows the internal structure and stability of each given star.
- Use EMS array to determine general location, type, and intensity of radio transmissions, both artificial and natural.
- Determine the UWP size digit for each major body in the system.

## 4 In Planetary Orbit

- Use EMS array to map the surface.
- Use densitometer to locate major plate boundaries and significant near-surface mineral deposits.
- Use EMS array to locate major climatic features such as icecaps, deserts, and major air and ocean currents.
- Use the EMS array to determine the presence or absence of a magnetosphere for the world and to locate radiation belts.
- Use EMS array spectrography to determine the general atmospheric composition.
- Use the EMS array to determine the world's albedo and a rough estimate of its greenhouse effect.
- If artificial radio transmission was detected earlier, use EMS array to pinpoint sources.
- The UWP atmosphere and hydro-sphere digits can be estimated.

## 5 In Upper Atmosphere

- Continue survey as desired, using close range for higher accuracy.
- Use densitometers, environment sensors, and EMS array to finish accurate mapping.
- Use EMS array spectrography and chromatography to precisely determine atmospheric composition data.
- Use the EMS array to locate local magnetic anomalies.
- Use EMS array to get an initial reading on local sources of radioactivity.
- Use EMS array to ascertain terrain types.
- Use densitometers and EMS infrared sensors to search for minor faults and volcanism.
- The UWP atmosphere and hydro-sphere digits can be precisely determined.

## 6 On World Surface

- Continue survey as desired, using surface and lower atmosphere sensor scans for greater accuracy.
  - Use vacc suits and standard anti-contamination procedures for newly explored worlds.
  - Collect samples as desired.
  - Use neural activity sensor to avoid sentient life.
- Complete dirtside exploration procedures, including standards for contacting native life, are detailed elsewhere in this book.*

erated, but it helps if he does have detailed information on some world he has not yet used. In this way, wherever the characters go, the referee can use that system as their destination. Using this technique will not keep the referee's campaign consistent with the published Traveller universe, but if the referee uses a border area or an area with unpublished world profile information, conflicts will be minimized.

If the referee wants to maintain consistency, he must pre-generate some information, or be fast on his feet (or dice) when the characters arrive. He can have the players make task rolls to give himself more time. Meanwhile the referee can generate important information as the group discovers it. Various other adventure possibilities will present themselves as the referee generates system data.

### THE HOLOGRAPHIC SURVEY STATION

The "holo pit" is the hub of shipboard survey activity on *Donosev* class vessels. The holo pit lies in the forward section of the ship, in a round room with a diameter of 12 meters. The pit itself is hexagonal, about 4.5 meters on a side and 1.5 meters deep. In the holo pit are stations for a lead surveyor and four survey assistants.

The number of surveyors in the holo pit at any one time depends of course on the intensity and importance of the survey, but no matter how many are there, one is designated the lead surveyor, and he sits at the lead station. The lead surveyor is usually the crew member with the greatest level of survey skill, but when running different shifts of round-the-clock operations, this is not always true.

Meanwhile, on the bridge the pilot mans his station and the navigator takes the mission control station. The accuracy and completeness of the survey results depend not only on the survey skills of the crew members in the pit and the accuracy of the survey instruments they control, but also on the skills of the pilot and navigator, who must orient the ship properly for the sensors to operate most effectively.

In all cases, the ship's computer correlates and pre-analyzes the data — with this feedback, the crew can get the maximum amount of accurate survey data in the minimum amount of time.

Each computerized station in the holo pit has its own controls, which can be configured to operate any combination of sensors. In a typical survey, the four survey stations will be divided up as follows:

- One operator at the densitometer and neutrino sensor.
- One surveyor operates any probes being used.
- Two operators share the EMS sensor array.
- The lead surveyor coordinates this activity between surveyors and the bridge crew.

The computer presents the data via holographic projection so each surveyor sees just the information important to him. For example, while pinpointing an artificial radio transmission on a world's surface, a surveyor might see a projection of an area's geographic features with the radio source highlighted. Meanwhile, the computer includes graphs and digital readouts in the display to show the transmission's other characteristics, such as frequency and strength.

At the same time, the surveyor operating the densitometer would see, from his station, an entirely different projection, along with other information pertaining to his survey.

When a surveyor detects something unusual, important, or just interesting, he reports this to the lead surveyor in two

### THE IMPERIAL INTERSTELLAR SCOUT SERVICE In the Shattered Imperium

The charter of the Imperial Interstellar Scout Service (IISS) — that of maintaining interstellar communication and conducting ongoing exploration — has been markedly affected in the wake of Emperor Strephon's assassination. A key thread binding the Imperium's member worlds is rapid and reliable communication, provided by the Scout-supported express boat network. With the death of Strephon, the resulting unraveling of the Imperium, and the trend toward new governing factions — the binding power of the x-boat thread is all but gone.

Initially, most Scouts reacted to the "faction trend" by taking a neutral status. It was hoped a neutral stand would enable the Scouts to keep all communication routes open. Though this strategy worked for a time, several factions failed to recognize the express boat network's neutrality. Ships were either turned back, captured, or destroyed as they attempted to cross the nebulous borders of the growing rebellion factions.

Many hoped the Imperium's splintering would be a temporary phase, but by 1118 it became obvious matters were getting worse. Bowing to pressures within the domains of the various growing factions, the Imperium-spanning x-boat network fell into disarray over the course of 1118 and 1119. With the loss of a cohesive x-boat network, it became all too apparent the shattering of the Imperium was more than a passing event.

The role of the Scouts changed as their fleets swore allegiance to the local faction. The degree of change varied from faction to faction, depending on the faction's needs and ultimate goals.

In some areas, such as the Domain of Deneb under Norris or the region under Margaret's control, the role of the Scouts has changed in only minor ways. Considering the political climate, these two factions have added intelligence gathering to the Scout's duties. Margaret has actually expanded the Scout's exploration role, focusing their efforts on Hinterworlds and Glimmerdrift Reaches.

Those Scout units at the Imperial core (under the command of Lucan) have been directed to the Illeish fronts in Dagudashaag and Zarushagar sectors. Here, most of the Scouts' *Donosev* survey vessels have been pressed into service as spy ships, since the quality of the *Donosev's* sensors has few peers.

The Interstellar Scout Service under Dulinor's rule has been renamed to the Interstellar Development Service (or IDS). With a strategic mission combining both trade and exploration, the IDS is responsible for assessing and meeting the trade needs of worlds both within and beyond the empire — the goal being, of course, to build a strong allegiance with such worlds by actively meeting the needs of their inhabitants. Along the way, the IDS is to do all it can to spread the good word of the ascension of Emperor Dulinor to the Imperial throne.

ways. He calls out the data to the lead surveyor, while at the same time queuing the computer report onto a list at the lead surveyor's station. The oral report does not contain as much information as the computer report, but it alerts the lead surveyor sooner.

From the information accumulating, the lead surveyor decides which items deserve more attention. He calls these out to the appropriate surveyors, while queuing these back onto their computer lists. At the same time, he can pass on survey requests to the navigator on the bridge by using the computer reports queued at his station.

The navigator, at the mission control station, prioritizes the survey requests to the computer, and passes them onto the pilot via computer. The pilot maneuvers the ship, and once it is in position for proper sensor operation, the computer notifies the lead surveyor that the sensor is ready. The pilot must also keep a close eye on the ship's course, to make sure no maneuvering hazards go unnoticed while everyone else is preoccupied with the survey.

### SURVEY LANDING PARTIES

Landing parties are more common on exploration missions than on survey missions, but some brief comments on survey landing parties are in order.

As mentioned, landing parties may be sent down to check findings of unusual interest or to pick up resource specimens. Survey parties avoid contact with indigenous life forms, but are always armed for self-defense. Survey parties usually spend 1D hours on the surface. In any event, the Scouts are always equipped to survive in the environment they enter, which often means equipment such as grav belts and their versatile duty vacc suits (although the vacuum mode is often not needed on a habitable world).

Extended surveys on a world's surface are sometimes conducted to gather more information on the world's ecology, geology, seismic activity, weather patterns, and resources. Landing parties will look for edible organisms, dangerous plants and animals, pathogenic microorganisms, agricultural and pharmaceutical potential of local life, accessibility of resources already located from orbit, stable and unstable terrain areas, volcanoes, faults, adaptations of local life to prevailing conditions, and dangerous weather. Such landing parties remain on the planet (one week at a time with resupply breaks) for 2D weeks unless otherwise ordered.

More details of landing party procedures are given in the exploration section.

### EXPLORATION

The Exploration Office of the Imperial Interstellar Scout Service is responsible for exploration of areas previously discovered but not explored, or incompletely charted. It is divided into the *Exploration Branch* and the *Contact and Liaison Branch*.

The *Exploration Branch* undertakes actual exploration of space and planets, compiling data on local flora and fauna, on planetological features, and on hazards to navigation or dangers to individuals.

The *Contact and Liaison Branch* was originally charged with locating, making first contact (and maintaining friendly relations) with non-human intelligent races. As the Imperium expanded, the C&L Branch was given the additional

duty of acquainting the various races of the Imperium with each other's cultures, and with smoothing over the inevitable conflicts that arise between cultures. Another function of the C&L Branch is the controlled dissemination of technological information to backward worlds within the Imperium, with a goal of bringing them up to Imperial standards slowly enough to minimize cultural shock effects.

Even though most sentient races in and around the Imperium were contacted long ago, on rare occasions a previously undiscovered intelligent life form is found, and the C&L branch must make first contact. The section "First Contact" discusses these situations in further detail.

**Contrasting Survey and Exploration:** Although all the parts of the Imperial Interstellar Scout Service cooperate with one another, not all Scouts are the same. The specialization of function is evident both in the formal training and in the skills learned while on a mission.

Both Survey and Exploration personnel learn how to conduct themselves while wearing vacc suits. Space skills, including engineering, gunnery, navigator, pilot, ship's boat, and ship tactics, can be learned by those in either office. Since Scouts in either office can find themselves in hostile environments, survival skills are important to both. Jack-of-all-trades skill is also common to both offices: well-rounded individuals are vital to the Scout Service's missions.

Survey skill, the mapping and charting of star systems, is exclusive to members of the Survey Office. This office puts more of an emphasis on pilot, engineering, and vacc suit skills, as its members spend more of their working hours travelling in space.

The Exploration Office, on the other hand, teaches its members several skills useful to their missions. Air/raft and general vehicle skills are important to those travelling about on the surface of a world. Recon skill allows the discreet observation of animals and alien cultures. And if worst comes to worst, exploring Scouts may get more than one chance to learn gun combat.

Both offices have special schools. Members of either office can be sent to Specialist School, where medical, mechanical, computer, administration, and gunnery skills are taught, as well as special strength training. Both offices also offer Field Training, where vehicle, air/raft, recon, survival, navigation, and survey skills can be learned.

The Exploration Office also offers Intelligence School and Contact School to its staff. Intelligence School teaches forgery, streetwise, brawling, bribery, gun combat, and survival skills. Contact School provides formal training in survey, liaison, streetwise, survival, pilot, and gun combat skills.

In general, the work of the Survey Office is done mostly from space, although some planetary mapping and sample gathering may be conducted from a planet's surface.

Exploration missions are carried out in the field, face to face with the local world, where the Scouts attempt to learn about the varied phenomena, life forms, and cultures spread about the Imperium's 11,000 worlds.

**Coordination Between Offices:** It is typical for members of both offices to be aboard a Scout survey vessel, such as one from the *Donosev* class.

The surveyors spend most of their time in the holo pit during a survey operation, travelling to the surface of the planet only for special purposes, when shipboard sensors can not provide the degree of detail desired.



Exploration Branch landing parties are the planetside experts. Many Scout survey ships carry a complement from both branches. An exploration party typically consists of three Scouts, an enclosed air/raft, and the necessary equipment. The air/raft serves as shelter for the Scouts and carries a week's worth of supplies, including handheld or raft-carried versions of the sensors, chemical analysis kits, seismographs, biological sample kits, and culture media. The raft carries a mechanic's kit and spare parts for itself.

Holorecorders are used for behavioral studies of animals and people. If the Scouts are to contact local sentients they approach unarmed. A second armed party, waiting out of sight but within radio range, supports the contact group.

Scout explorers collect specimen samples of life forms and watch for signs of undiscovered sentience. They are responsible for keeping the ethnographic reports on the Imperium's worlds up to date by observing and re-observing the local culture.

Explorers also have their share of work away from the field. Specimens must be catalogued and further analyzed. Full-scale computer analyses can cross-correlate cultural characteristics using extensive Scout databases.

The ship has entered the star system. It's time for the personnel of the Exploration Branch to head for the world's surface, to meet whatever awaits...

#### LANDING PARTY CONTACT PROCEDURES

The most common Scout survey and exploration starships are those of the *Donosev* class. Exploration Office landing parties are deployed in groups, three Scouts to an air/raft.

Several groups work in the same region, supporting each other and sharing information by radio or laser contact.

For a first landing, skills such as survival, sensor operation, survey, biology, chemistry, geology, and of course air/raft are needed.

The first contact landing party must wear uniform vacc suits and follow standard decontamination procedures on returning, pending the biological report on the planet. When cleared for unprotected exposure, Scouts must take prophylactic doses of antibiotics and antiviral agents.

Scouts can do a thorough biological survey even while avoiding the local populace. The chemical analysis "sniffer", linked to a hand computer, can determine food value of a plant from a 10 gram sample. Leaf, seed, fruit and root samples should all be tested. Soil and air bacteria should be cultured on a variety of media and tested for chemical activity.

Any potentially useful plant or animal must have natural enemies or controls. Since past experiences have taught the dangers of importing just one species, an interrelated group of species must be studied and approved for possible export to other planets.

Open contact should never be attempted with a pre-spaceflight culture. An exploration crew should be landed in a secluded area first, and attempt to observe without being seen. Neural activity sensor readings should be collected on each species noted. An extremely primitive race is difficult to distinguish from non-sentients, so extreme care is in order whenever the NAS reading is "intelligent" or "semi-intelligent". Oceans should not be overlooked as a possible home of intelligent life, but land is statistically more likely.

#### IISS Service Emblem



#### Exploration Office



#### Communications Office



#### Survey Office (Imperial Grand Survey)



#### THE FIELD OFFICES

The offices of the Scout Service are divided into the *Bureaucracy* and the *Field*. Three offices in the Scout service comprise the field: the Exploration Office, the Communications Office, and the Survey Office (still referred to as the *Imperial Grand Survey* in some areas).

**Exploration Office:** This office explores previously discovered areas, or areas that are incompletely charted. This office also makes the first contact (rare today) and maintains friendly relations with all intelligent races. In addition, the Exploration Office is to monitor the dissemination of technological information to backward worlds, with the goal being to minimize the shock effects on their culture.

**Communications Office:** This office oversees interstellar message and data transmission. The Communications office operates the Express Boat Service and the Imperial Courier Service.

**Survey Office (Imperial Grand Survey):** The Survey Office maintains the maps and charts of the Imperium and of areas outside the Imperium that are of importance to it. This office is responsible for resurveying and updating the basic navigational charts of the Imperium, and for mapping world surfaces when necessary. Areas outside the Imperium are also surveyed and mapped. Such outside area maps may be used for navigation, settlement, or planning, and are essential in times of war. External mapping generally takes place in regions already explored by the Exploration Office.



See "Defining What Constitutes Sentience" for detailed procedures.

Not all planets have only a single sentient race. On rare occasions, two or more intelligent races may occupy non-competing niches; as for instance, one aquatic and one land-dwelling, or one tropical and one arctic or mountainous high-altitude. If two or more are found, all must be studied. If they are in competition, the Scout Service must not take sides.

If the intelligent race of a planet is human or humanoid, ship's stores will make up replicas of local costume from holophotos and the contact crew can pass themselves off as strangers to the territory at first. If the race is quite alien in form and apparently not scientifically sophisticated, no closer contact should be attempted. Holorecords and sound recordings will be stored and analyzed, but the race must be left alone until their technology develops further.

Sophisticated aliens present the most interesting problem in contact. An open landing in an unarmed ship's boat near a population center is standard procedure, but may be varied at the captain's discretion. Radio or light-signal contact is advised if a sufficient language base is worked out.

Under no circumstances is the first open contact to be made with weapons visible. (And some people wonder why Scouts have such poor survival statistics!) Attempt should be made to convey friendship, to indicate the existence of the Imperium, to show the advantages of technology and commerce, and to observe as much as possible of the new race's culture and science. At least one member of a contact party must have linguistics skill, one should have liaison skill, and all should be broadly knowledgeable about science.

Not all cultures which are scientifically ready for contact will accept it. Hostility from natives should be a sign to Scouts to withdraw to a safe distance and try another plan.

A full survey of a contacted culture includes:

- ratings in all areas of technology
- census figures (recent local census data may be acceptable but should be spot-checked)
- analysis of government(s)
- recorded and written language with lexicons and grammars developed in cooperation with native scholars

- records of fine and practical art works
- summary of laws that may affect future visitors
- sociologist's report on attitudes, customs, and religion.

On balkanized planets this should be repeated for each major nation.

Large gatherings of people are very fruitful subjects of observation when determining government. However, it can be difficult to distinguish political rallies from religious services and either of them from sales meetings, sports, and entertainments until the language can be understood. If any large meetings are seen being broken up by uniformed forces, the government cannot be listed as charismatic and is not likely to be democratic. If the actions of the crowd appear violent or criminal, however, this does not apply.

Very isolated areas, of course, may not be responsible to the planetary government or even aware of it at all, but these do not affect the determination of government type.

Law levels can be estimated by observing any citizens who carry arms, watching police actions, and recording any broadcast or proclaimed information about laws and their enforcement.

Technology is usually openly displayed and typically a culture's tech level can be estimated with no more than a week of observation.

#### PROCEDURES WHEN DIRECT CONTACT IS RISKY

Concealed surveys contain as much of the above as can be obtained with instruments and disguised landing parties. Such surveys are done when open contact is deemed unwise, and they present many challenges to a Scout's ingenuity.

City size can be estimated from high altitude sensor scans, using formulas to determine how much food can be transported into the city regularly. Daily food needs of human and all known non-human races are on file in Scout Service shipboard library computers. Rural population can be estimated directly from these scans.

Certain government types can be deduced, or eliminated, by remote observation as well. Obviously, if a definite war is in progress, the planet is balkanized or in revolt. A captive planetary government is not possible without spaceflight and interplanetary communications by the owners. No single bureaucracy (or oligarchy or dictator) can rule an entire planet without fast communications. If a non-balkanized planet lacks radio or telegraphy, it is probably feudal, having either nobles, priests, or technocrats in charge of limited areas.

It is often possible to locate the central authority by observing the movements of couriers and by finding the wealthiest area. Government seats are often large and ornate buildings compared to their surroundings, so a spy camera (perhaps a "private eye" robot) introduced into one of these buildings will frequently provide valuable insights into the workings of a government. If discovered, the spy camera may also provide a measure of governmental paranoia.

Even with the best efforts possible, a concealed survey will make some mistakes and miss some major keys to planetary behavior. However, since visits to a planet that has not been openly contacted are not frequent, the damage done by such errors should be limited.

## IMPERIAL CULTURE

Imperial culture today is remarkably similar to that of the pre-jump humans of Terra. Many worlds still show their peculiarities, of course (especially those at lower tech levels) — but for all practical purposes, the general mindset of the Imperial population traces its roots back to old Earth, before the contact with the Vilani of the First Imperium in -2422.

### THE FIRST IMPERIUM (-10,000 through -2204)

As a species, humans were alien to the world of Vland, imported there by the Ancients for reasons unknown today. When the Final War was over, these humans found themselves alone in an unfriendly environment. Native plant and animal life was not edible to the Vilani, but special means were developed to process foodstuffs for human use. This aspect of Vilani culture, surprisingly enough, is not unique, and parallels can be found on a variety of worlds. Even on ancient Terra, poisonous manioc (after being processed) comprised 85 percent of the diet for one group of South American Indians.

In the case of the Vilani, the "shugilii" (as these food processors were known) kept their techniques secret, exerting influence over the primitive Vilani culture in this way. As the Vilani advanced technologically and domesticated more plants and animals, the shugilii developed more techniques, but guarded them carefully from outsiders.

Some sophontologists believe that a social structure for the Vilani was developed by the Ancients, and that the Vilani clung to this after their captors were gone. Groups of Vilani from widely separated geographic areas had similar (albeit primitive) governmental structures.

The nobility of Vland can trace itself back to these village chiefs. The early Vland society allowed nobles to marry more than once; this tended to preserve the property owned by a family. Not only could a noble man have more than one wife, but a noble woman could have more than one husband. The third child of any noble was noble; other children were commoners.

By the time the Vilani reached tech level 4, monogamy prevailed, but the custom of passing nobility on only to the third child continued until their conquest by the human culture of Terra. This tended to keep the number of nobles constant, but there were other ways to achieve this special status. New, lower level nobles could be created by the actions of higher nobles.

The languages of Vland diverged over time. Glottochronologists have attempted to reconstruct the original Vilani language, hoping thereby to get a glimpse into the culture of the Ancients, but these efforts have been largely unsuccessful. Vilani art eventually developed into a written form for these languages. By the time the Vilani had achieved the power of space flight (around -10,000), one language (Old High Vilani) was dominant on the world.

Vilani traced kinship through both parents. When a young couple married, residence was bilocal: the couple would decide whether to live with the bride's family or the

groom's family.

Vilani culture was conservative, competitive, and surprisingly harmonious.

### THE TERRAN IMPACT (-2204 through -650)

With the conquest of the Vilani by the Terrans, the culture of Vland and the First Imperium was greatly altered. The conquering humans spoke a different language and had different social customs.

Many Vilani reacted to this influx of Terrans in ways that helped preserve them as a distinct race even while adopting Terran customs to conform to their conqueror's ways. For the first time in 30,000 years, the Vilani were not at the top of the social ladder, and they imitated culturally their social betters.

For one thing, the Vilani nobles adopted the Terran custom of passing nobility on to all children of a noble. With the diminishing political importance of Vilani nobles, this change meant the difference between survival and death of the Vilani noble classes.

Anglic, the official Terran language, was the language spoken by these new rulers, and the Vilani gradually adopted it.

When the Rule of Man ended, the isolation imposed by the technological regression of the Long Night allowed widely scattered worlds to again develop cultural uniqueness. Worlds with large Vilani populations tended to revert toward their original social institutions and customs; other minor human races did the same.

### THE THIRD IMPERIUM (-650 to 1117)

When Cleon finally forged the Sylean Federation into the Third Imperium, again establishing a central government over the human worlds, a mixed Vilani-Terran culture became dominant; a certain homogeneity is guaranteed by the intercommunication between worlds afforded by the mass media.

The basic culture of the Third Imperium, then, is the result more than 10,000 years of history. Political influences, brought about by the changes in power, have brought with them changes in the way people live together.

But most human populated worlds in the Imperium share certain basic cultural postulates, remarkably similar to those found among old Earth societies at tech level 8.

One clue to the source of modern Imperial culture is the fact that Galanglic became the official language of the Third Imperium. Galanglic, short for "Galactic Anglic", is a direct descendant of Anglic, the language used during the Rule of Man. And, of course, Anglic was a popular global language on old Earth before the Vilani contact.

In the Solomani Rim area today, political pressures have produced a radical, expansionistic, and somewhat militant social structure, quite different from either the old Vilani or old Terran cultures.

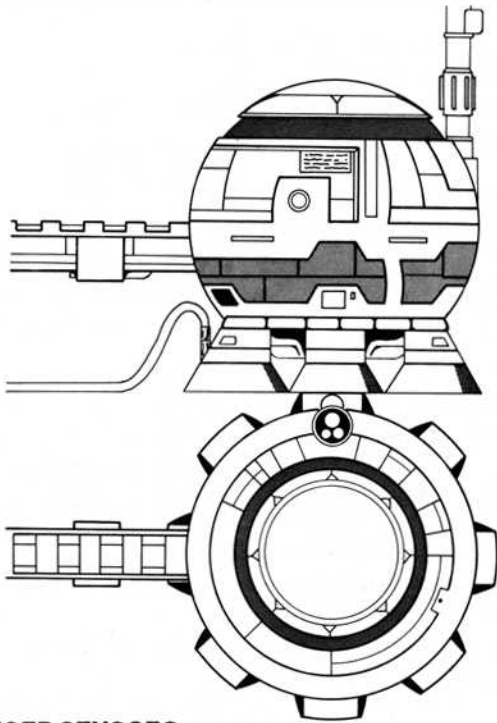

### RANGED SENSORS

The Scouts use many ranged sensors (both in vehicles and handheld) to augment their senses. A ranged sensor (as opposed to a non-ranged one) senses something that is farther away than 5 meters. To do this long-distance sensing, ranged sensors do two things: they scan and they pinpoint.

The scan function allows a sensor to sweep wide areas in search of something. The pinpoint function, on the other hand, allows the sensor to zero in on a particular location or "target" for very precise and specific readings.

A sensor pinpoint requires a specific target. For this reason, a sensor scan is often done before a sensor pinpoint in order to locate potential targets for the follow-up pinpoint sensor readings.

Sensors also come in two varieties: active and passive.

Active sensors work by projecting a sensing beam at a given area or target. Active sensors thus locate *objects*.

Passive sensors work by remotely sensing and amplifying the area or target's natural emissions. Passive sensors thus locate *sources*.

While active sensors tend to provide more precise information, they are more risky. Since an active sensor is itself an emission source, the target of an active sensor scan or pinpoint will likely: 1) detect that they are being sensed, 2) locate the one doing the sensing by following the beam back to its source, and 3) jam the sensing beam, rendering the sensor useless — or worse yet, perform a hostile action against the one doing the active scan.

Passive sensors, by their nature, must be more sensitive to minor fluctuations in the natural emission they are sensing. Because of this, passive sensors often have substantial amplification circuits. Also, a clever sensor target may be able to mask some of its emissions, causing the passive sensor to return an erroneous reading.

The sensors in common use include the: EMS sensors, densitometer, neutrino sensor, and the neural activity sensor.

### EMS SENSORS

Among the different sensors that have been developed over the years, some of the most useful to a planetographer

are descendants of the lowly camera. As technology advances, the camera is integrated with other electromagnetic sensors and computer enhancement, until scientists develop the first crude integrated electromagnetic sensor array at tech level 9. This technology is called electromagnetic spectrum sensing or EMS.

A proper understanding of the electromagnetic spectrum reveals why an array of different EMS sensors is needed. Various types of electromagnetic energy behave differently, even though each is part of a continuous spectrum. From low to high frequency, the type of energy progresses from radio through microwave (also called the radio frequency or RF bands), heat, infrared, visible light, ultraviolet, and x rays, to gamma rays and beyond. Since each type of energy occupies only a small part of the spectrum, no one sensor is effective over the entire range of frequencies.

Various sensors, from handheld, to vehicle mounted, to starship mounted exist to handle EMS sensing. The PRIS field glasses is a common handheld EMS sensor. On vehicles and starships, the EMS array is popular at tech levels over 9 (both passive and active versions are available).

**The Active EMS Array:** The active array detects *objects*. The active array does this by sending out wide-beam electromagnetic emissions in an attempt to locate and classify objects from the reflected signal.

The active EMS array offers three options: radar, m-radar (microwave radar), and ladar.

**Radar:** A general-purpose sensor used for object scans and object pinpoint images. Radar is sensitive to disturbances in the reflected beam, and so is good at detecting some very "tenuous" objects such as debris, water vapor, dust clouds, sand clouds, and the like. Radar can be used for either area scans or pinpoint images.

**M-Radar (Microwave Radar):** Similar to radar, m-radar is also sometimes called "all-weather" radar because of its excellent penetration value. This property makes it much less sensitive to disturbances in the path of the reflected beam. M-radar can be used for either area scans or pinpoint images.

**Ladar:** A line-of-sight laser "radar", capable of very precise pinpoint images. Ladar cannot do area scans; it can only provide pinpoint images.

**The Passive EMS Array:** The passive array detects electromagnetic energy *sources*. When using the entire passive EMS array, a simultaneous scan is actually being conducted with three distinct sensor groups. A long dipole or wire antenna detects long waves. A parabolic dish or similar device detects short waves and microwaves. A set of optics detects the IR, visible light, and UV bands. A smaller sensory arm detects X rays and gamma rays.

An EMS image can be put directly into computer memory, allowing the image to be manipulated with ease: it can be instantly reduced, enlarged, or rotated with little loss of definition, and can be compared with another image to detect any change between the two. The resulting processed image is three dimensional.

Full spectrum, computer-enhanced orbital EMS scans can give the surface temperature of a world with such precision that the only way to get better results is to measure the temperature directly from the surface.

Electromagnetic band readings can be:

**Long-Wave Radio:** Power line networks, lower end of radio broadcast band.

**Short-Wave Radio:** Broadcast FM radio, television, radar.

**Microwave Radio:** M-radar, microwave transmissions.

**Heat/IR:** Any source of heat, from low tech maneuver drives (TL 9 or less), to fusion waste radiators on most space

vessels, to living beings.

*Light:* Any source of visible light, including low-tech (TL 12 or less) lasers and ladar.

*UV:* Ultraviolet light from stars, certain artificial lights, some special-purpose lasers and ladar.

*X-ray:* High tech lasers and ladar (TL 13 or more), jump grid and thruster emissions, as well as natural sources such as stars and gas giants.

*Gamma:* Nuclear explosions and stars.

### THE DENSITOMETER

The remote densitometer, an outgrowth of gravitic technology, uses an object's natural gravity to directly measure the object's density (that is, its mass per unit volume).

The densitometer provides a 3D density map of the scanned object or region. Within certain limitations, an object's elemental makeup can be deduced from the densitometer's scan data.

A densitometer is a passive sensor that depends on an object's natural gravity for a reading. An object with an artificial gravity field will distort the the densitometer reading if that object is closer than planetary range.

Further, a densitometer can not be used at all if the sensor itself resides in an area of artificial gravity, unless the sensor has been gravity shielded. Gravity shielding increases the weight, volume, cost, and power requirements of a densitometer. Handheld densitometers are never gravity shielded, while starship densitometers are always gravity shielded. Vehicle portable densitometers may or may not be gravity shielded, depending on whether or not they are to be used from operating grav vehicles.

When using a densitometer, a cubic region is scanned to determine the general density of objects in the scan region. Penetration is the depth to which density differentiation is possible on objects within the scan area. Resolution of the 3D density map also depends on the range setting.

The density levels differentiated by a densitometer include:  
*Vacuum:* Indicates zero density.

*Gaseous:* Indicates an extremely low density, with very little liquid or solid present; densitometers are generally set to ignore gaseous density when used in an area with an atmosphere. However, a pinpoint scan for gaseous density can prove useful if trying to determine from a distance if an object in the vacuum of space contains any gas.

*Liquid:* Indicates a low density, often associated with liquids. Examples include petrochemicals and water.

*Nonmetal Solid:* Indicates a solid with low or moderate density. Examples include paper, wood, rubber, pumice, plastic, glass, sand, stone, and concrete.

*Light Metal:* Indicates a medium density solid with metallic properties. Examples include magnesium and aluminum.

*Medium Metal:* Indicates a dense solid with metallic properties. Examples include iron, copper, zinc, silver, tin.

*Heavy Metal:* Indicates a very dense solid with metallic properties. Examples include platinum, gold, mercury, lead, uranium, and any superdense material.

*Artificial Grav Field:* The scan area contains an artificial gravity field field — no other reading is possible. Artificial grav fields can be detected only at planetary distance or less; beyond this range, artificial grav fields do not interfere.

### THE NEUTRINO SENSOR

The neutrino sensor, a development of research into subatomic particles, is the instrument used most often for detecting high energy sources.

Since neutrinos travel in straight lines from their source, it is easy to determine the direction to their source. The range to the source must be determined by dispersion of the particles rather than by attenuation because of distance. Because of this property of neutrinos, to pinpoint the exact range to the source requires that the sensor take multiple readings from more than one location to estimate the range using triangulation.

Neutrino sensors are passive sensors. They give scan readings similar to EMS sensors. However, because a neutrino sensor is usually used to sense high energy power plant emissions, it is difficult for to mask a power plant from neutrino detection. For this reason, neutrino sensors are among the most reliable sensors for detecting fusion and fission powered vessels.

A neutrino sensor provides its power reading by estimating the power plant's output in watts. In addition, a superdense hull deflects neutrinos ever-so-slightly, and a sensitive neutrino sensor can detect the hull shadow from a superdense hull. From this shadow, the sensor can construct a precise outline of the craft's hull — allowing remarkably reliable identification of a craft at great distances.

### THE NEURAL ACTIVITY SENSOR

Developed from tech level 12 psionic helmet theory, the neural activity sensor (NAS) was first used medically. It remotely detects the electrical activity of a life form's central nervous system and classifies it according to amount and complexity. The data system compares the activity pattern to known types of life, especially intelligent life.

The neural activity sensor is a passive sensor. Because of range limitations, the NAS is used only in probes and by landing parties. An area scan is done first, to determine if any subjects are within range. The readings indicate number, range, and motion of beings exhibiting neural activity in the area. A pinpoint scan can classify the identified creatures according to intelligence.

Braip pattern readings include:

*Simple:* The neural activity of the creature or group of creatures is low-level.

*Complex:* The being or beings have highly developed brains, and should be scanned for possible intelligence.

*Cluttered:* A number of different life forms are grouped in one area, muddling the readings.

Neural class readings include:

*Unknown:* The pattern matches no known pattern.

*Human/Vargr:* The pattern matches Terran brain patterns.

*Aslan:* Matches Aslan brain patterns.

*Droyne:* Matches Droyne brain patterns.

*K'Kree:* Matches K'kree brain patterns.

*Hiver:* Matches Hiver brain patterns.

*Other:* Resembles one of the minor races the sensor is programmed to recognize.

Intelligence readings shown are:

*Lower Form:* Very simple brain, handles only sensations, reflexes, instincts. Examples: worms, insects, fish.

*Not intelligent:* Limited learning ability. Examples: cattle, birds, bees.

*Semi-intelligent:* Adequate brain capacity but lacks complexity of true sentience. Examples: dogs, apes, non genetically-manipulated dolphins.

*Intelligent:* Very complex brain functions characteristic of sentient life. Neural class identifies the type of intelligence if it is a known form.

### FIRST CONTACT

On the whole, the habitable zone worlds of the Imperium were contacted long ago, are fairly well explored, and have at least an adequate spacefaring technology. Because of this, the Scouts of the Third Imperium rarely perform first contact activities today. But exceptions do exist. When these exceptions occur, the Exploration office must perform its most challenging task—the first contact.

For various reasons, a sentient culture may have been overlooked. Some of these reasons are:

*The race is barely sentient.* It is sometimes difficult to distinguish a true semi-intelligent lifeform from a quasi-intelligent lifeform. A good example is the Minlad of Kaiid (Lishun 0621), finally determined in 1104 to be true sentients, rather than just semi-intelligent animals. This is perhaps the most difficult and most controversial reason why a sentient race may be overlooked.

*The race leaves little evidence of its existence.* Even given the sophistication of modern tech 15 sensors, it is impossible to adequately scan and explore every square centimeter of a world's surface without allocating decades or even centuries to the task. Without an adequate reason to devote to such an effort, races that do little to change their environment are hard to find.

Such races are probably small in number, and possess a relatively low technology. Other times, the race may live in an unusual environment, such as underground or underwater, or even in a jungle or ice-field on a low population or low tech world. Or the race may not want to be found.

*The race may be an unrecorded transplant, or in an unexpected location.* From time to time, stories surface of a shipwrecked crew found on an out-of-the-way world—if they are able to survive, and they go undiscovered long enough, their descendants could develop into an entirely new local culture where none existed before.

Wal-ta-ka (Deneb 2713) is an example of such a culture. The miners on Wal-ta-ka were forced from their protective domes onto the bright side of the tidally-locked planet when a disaster occurred in 234. Visiting traders found the mining colony destroyed and presumed all were dead. The descendants of the surviving miners weren't found until 130 years later—by which time they had developed a full-fledged sub-culture with unique customs and a new language descended from Galanglic.

*The race may live on a world with a hostile environment, not capable of supporting life as we know it.* This situation is a double jeopardy—not only may the world be difficult and dangerous to explore, the explorers will not be expecting to find sentient life.

*The race may be undiscovered for a combination of the above reasons.* The race might be barely sentient and live in an unexpected or hostile environment. The race may be an unrecorded transplant that leaves little evidence of its existence. The race may be presumed to have died out long ago, when in fact a small number of them still exist. Many other possibilities exist.

### CONTACTING A NEW RACE

The Scouts have defined procedures for making a first contact with a newly discovered sentient race. The procedures reflect the experience gained from the many first contacts made during the early centuries of the Third Imperium.

The procedures begin from the moment the Scouts enter

a new star system, although such precontact procedures are seldom necessary any more. About the only time the Scouts use the precontact procedures is when dealing with developing cultures on interdicted worlds.

The following sections describe the Scouts first contact procedures in detail.

### PRECONTACT PROCEDURES

The survey of a planet for intelligent life begins as the Scout ship enters a star system. The passive EMS array is set to pick up any signals being broadcast or beamed between planets.

Broadcast radio signals, if noted, are tech level 5 minimum, and should be recorded for linguistic analysis. Bearings should be taken to locate transmission source and probable destination: communications traffic between planets is tech level 7-8 minimum.

If computer analysis indicates coded transmissions, military or diplomatic use is probable and may indicate balkanization. An absence of transmissions does not rule out higher tech levels, since some races learn to contain their signals in tight beams, without leakage into space.

The habitable zone of the star is checked for life-bearing planets first. While densitometer crews make charts of all bodies in the system, the ship should take up a polar orbit around the planet being studied and conduct a ball-of-twine photographic survey, in visible and infrared light.

Visible light will locate any major cities on the night side as well as the day, while infrared will indicate cultivated areas (regular patches of "cool" color) and heat-producing industry. An absence of any construction suggests a primitive agrarian society, or perhaps a hunting and gathering culture.

The sensor scans should also have a number of comparison sequences run to locate any movement on the planetary surface. This is a critical item in finding sentient races, and in placing their tech level. For example: if a race is sentient and early tech level 0, they move very little and at slow speeds.

From late tech level 0 to tech level 3, there would be extensive association between sentients and their domesticated animals. Tech levels 1 through early 4 use sails in water travel if the planet has any hydrosphere to speak of. Above tech level 4, sentients usually use mechanical transportation instead of animals.

The infrared scans, when computer enhanced, show temperatures and weather patterns on the surface. This information frequently has a bearing on where the local sentients, if any, may be found. Spectrographic analysis (optical EMS) of the atmosphere gives the contact team information as to the conditions they will have to deal with on the surface of the planet.

Communications officers must remain alert for any attempted contact from a society showing some degree of industrialization. If broadcast language samples are available, Scouts skilled in linguistics and liaison must prepare a friendship message as soon as possible.

An advanced race should be contacted even if the messages are mutually unintelligible, simply to announce the ship's presence and indicate a willingness to talk. Refusal to answer a hail may be construed as a reason to send up missiles instead of messages! Pictorial communications, when mechanically possible, are usually best understood.

### DEFINING WHAT CONSTITUTES "SENTIENCE"

What is an intelligent being? Variations in environment and physical form can lead to wide differences in a species's adaptations. Older definitions often need to be overhauled.

Before human colonization is permitted, a Scout exploration team has the responsibility of deciding whether a world has any native intelligent life. Any race that shows as "intelligent" or "semi-intelligent" on the neural activity sensor is closely observed for signs of sentient behavior.

Imperial xenologists find that three areas of development must interact to bring a species to the level labeled as "sentient". These are: language, social structure, and tools (environmental manipulation, in whatever manner is physically possible for that specific race). What follows are a series of steps for each level, from low animals to unquestioned sentients.

### CONCEPTUAL THOUGHT

Conceptual thought, as evidenced by language, remains a major sign of intelligence. The key area is not the ability to label concrete objects but the ability to treat concepts as units in new concepts and thus to develop "conceptual ladders". Abstraction enables a race to envision the future and plan for it rather than to live in an eternal present, guided only by instinct.

Language begins, usually, with sounds or signals for emotions. A Terran cat's purr is an example, as is the harmonic hum of the Messierian nebon. Beyond this is the deliberate use of a sound to convey a message: the alarm snort of a deer or the slapping of a rouppa's tail would be in this category. A third step uses distinguishable sounds or signals to refer to different concrete objects. The Terran baboon gives a different warning cry for a tiger than for a hawk or eagle, and his group responds accordingly, climbing to high thin branches to avoid a tiger, but finding thick foliage to foil a hawk or eagle.

More difficult than naming a thing is referring to its attributes. Still, ro'bolla worms do this when describing the distance and direction to the best waterholes. This is a borderline behavior when determining intelligence.

Abstraction beyond attributes involves grouping things by some one common attribute and giving the group a single label. This is the key to conceptual ladders and the gateway to knowledge. There were aboriginal tribes on Terra as the Solomani entered their space age who still could not abstract, though they were definitely human.

Their language contained a name for every tree within their ken but no generic term "tree". They could not count beyond the number of their fingers. Their memories of the past were recited by rote, in detail, and they could not give a synopsis or state a length of time between events. These were primitive men, indeed!

Conceptual language enables a being to think of what is not immediately present, in time or space. Planning for the future, imagining new ways of doing things, and analyzing things logically all depend on this skill. Written language is a tremendous help for storing knowledge in something less volatile than a living brain. It facilitates cooperation and the bestowal of information to new generations.

Language comes in unexpected forms at times, such as the songs of Terran whales or the Hiver language of gestures. Even scents may be a form of deliberate communication. No translator machine exists which can cope with all

### DEFINING "LIFEFORM"

In Imperial year 17, Cleon Zhunastu declared, "Any *sentient lifeform* within the Imperial borders, regardless of its origin, is a protected being, and thus a *citizen* of the Third Imperium." Under this definition, any sentient *lifeform* within the Imperium is automatically an Imperial citizen. If a lifeform can be shown to be sentient, it is a protected being under Imperial law. Robots, while perhaps sentient, are not a lifeform, and thus are not citizens.

Identifying a lifeform on a low tech world is usually a fairly routine matter, but in a high tech society, distinguishing between a lifeform and a non-lifeform may not be so obvious. Here are some of the more common difficulties the Imperium has had to face:

**Cyborgs:** Technically speaking, an individual with a high percentage of computerized electro-mechanical body parts is a "cybernetic organism" or "cyborg." Many Imperial human cultures consider "cyborg" to be a vulgar and slanderous term. Using it in polite company to refer to anyone, especially someone among the nobility, may have serious consequences.

At higher tech levels, prosthetic and bionic body parts become ever more common.

**Clones:** A clone, or more specifically a full-body clone, is an "offspring" created from a single cell in the laboratory, rather than through the normal reproductive process. Such an offspring is a genetic duplicate of the single donor, and thus has only one parent. In all other respects, a full-body clone is identical to a normal offspring; the real oddity is the unnatural manner in which the offspring was conceived. The clone is its own person, with its own mind just like any child of another.

At tech level 16, the ability to develop adult clones, complete with the basic memory patterns of the original, becomes a reality. This is not yet the ability to transfer one's consciousness into the clone, just the ability to make "memory copies". These techniques have just started to appear in the Imperium within the last 50 years.

To date, the Imperium considers such clones to be quite illegal, since this is "tampering with the mind of a sentient lifeform, similar in concept to psionics" according to a ruling made by Emperor Paulo III in 1070.

**Androids:** An android is technically a "synthetic man, created from biological materials." Androids, a combination of cloning and genetic engineering, are rare. Literally, they are artificially created organic beings.

Androids can take any form, from monster to midget to normal size, limited only by the natural constraints of biology. However, they are almost always incapable of reproduction — this is imposed not by technology but by the laws of most high-tech worlds. Sometimes, they are even identified by special tattoos or markings.

In any event, an android is a sentient lifeform, and thus an Imperial Citizen.

**In the Shattered Imperium:** With the current state of affairs in the divided Imperium, some of the factions do not agree with the Imperium's stand that "Any *sentient lifeform* within the borders, regardless of its origin, is a protected being, and thus a *citizen*". These are dark times for the rights of sentient lifeforms, and especially so-called "artificial" ones.\*

the possibilities, so the Scout team must be alert to any means being used to exchange information. Psionics is the most difficult to discover.

### SOCIAL STRUCTURE

Certain societal structures are necessary to a species' development into reasoning beings. One requirement, to which no exception has yet been found, is that adults must educate their young. If adults lay eggs and then leave them, or die before the eggs hatch, none of the adult's acquired knowledge and skills can be passed on to the young, and no cumulative learning can take place.

In many races, though not all, care for the young implies a pair bond that lasts at least through one breeding cycle. Others raise their young collectively. Even Hivers, while they ignore their larvae, do teach their adolescents.

Another great step forward occurs when members of the species group together rather than wander as solitary individuals. Cooperation then becomes possible, enabling the group to undertake tasks that a lone individual could not handle. Division of labor sometimes occurs in relatively low-level societies such as insect hives, but the different roles are instinctual rather than learned. The advantages of cooperation and the division of labor accrue when individuals, by concentrating their efforts, can improve their performance. More efficient work benefits both the worker and his group.

The dawn of sentience comes with the innovator. The being who invents a new way of dealing with problems is the cause of all technological progress. Instinctive behaviors are exactly alike in all members of the race, which gives the Scout a way of differentiating instinct from ingenuity. The absence of innovation is the reason why Terran bees, for all their highly ordered society, cannot be considered intelligent but are locked on the instinctual level.

Sometimes inaccurately labeled as altruism, the impulse to protect the group as a whole and not just oneself is another by-product of cooperation in higher animals and sentients. Compassion and care for the sick and injured are also signs of greater development in animals. These behaviors promote the kind of social order the individual can best live in. Advanced sentients never outgrow the impulse to preserve their species and especially their own children.

### USING TOOLS

A first definition of man was "a tool-using animal". However, many non-sentients use implements to aid them. The revised definition was "a tool-making animal", requiring modification of an implement to make it usable. When Terran apes were seen to strip twigs to use as "fishing poles" in termite nests, anthropologists again revised their definition to say that sentients "make tools to make tools".

This is actually too restrictive, since a species without manipulative members may be highly intelligent despite its inability to use tools or fire. The dolphin of Terra is an example of this class, as is the lasat of Zurr. Special consideration must be given to psionic creatures, who may manipulate their environment by telekinesis with no material tools at all. A theory was advanced in 508 that psionics was linked to intelligence, but the theory was abandoned after the anolas of Pysadi were found to be psionic.

"Animals adapt to their environment; man adapts his environment to suit himself." Usually true, but what of the Terran beaver? He not only builds a lake to suit himself, but may dig a canal several hundred meters into the woods to

float his chosen logs to the construction site. Sylean cultivator moths are farmers who create the soil in which to grow their fungi from bark. The means of adapting the environment must be judged.

Control of fire, in any atmosphere that permits it, was considered a definite mark of sentience until the maniku were found on Kimu in the Daibei sector. These primates observed that lightning-caused fires roasted the pods of a tree whose pods were poisonous when raw. The maniku began carrying torches from these fires to set off other patches of trees. Unfortunately this also sets off brush fires and trims the maniku population somewhat. The maniku are not sentient despite their use of fire.

The new Scout Contact Manual points out that the ability to make fire from scratch is a sign of intelligence, even more so than the making of stone knives or other tools. Carrying fire from place to place is not sufficient in itself.

Aesthetics are commonly an interest of more advanced species, but some lower animals decorate their homes (e.g., the agidda bird) while some advanced races disdain aesthetics entirely.

The domestication of other animals to one's own purpose can begin very low on the intelligence scale, as in the leading of aphids by honeydew ants on Terra, but such cases are rare. In general, a species that uses and cares for another (not in the sense of symbiosis) is a good candidate for a closer inspection.

### ONCE SENTIENCE IS DETERMINED

If a race is in fact sentient, what then? A developing sentient race is placed under the protection of the Scout service. This occasionally means declaring the planet a red zone but this is not absolutely necessary.

A race with less than tech level 5 development is generally not informed of the existence of the Imperium as such, but trade is often conducted discreetly. This is for the protection of the Imperials quite as much as the natives, since technology is likely to be mistaken for magic on backward worlds and may start a witch hunt.

Without the proper license, it is against Imperial law to sell, to races below tech 5, artifacts which are more than one tech level above the planet's. (This assumes that the low-tech world is part of the Imperium and not a red zone.)

In any case, characters caught selling energy weapons to a stone-working race are in trouble. Once a race has the scientific outlook necessary to believe that beings could come from other planets, they may become actual members of the Imperium. Any member race may buy any available technology, but the economics of intersystem trade usually prevent major abuses of this right. Most planets still develop their own sciences, though at an accelerated rate.

Killing any sentient without cause is murder. This is one of the few crimes that Imperial law defines, both on planets and between the stars.

Official decisions regarding the fate of a minor race whose sentience is in doubt must be settled by a panel including field experts in the Scout Service (one-half the members), Scout administrators (one-fourth of the members), and Imperial nobility (one-fourth the members).



## LANGUAGES IN THE IMPERIAL REGION

With the linguistic diversity of the Imperium and the surrounding alien cultures, it is also important from a political and mercantile viewpoint that communication flow as smoothly as possible. To better understand the activities of the Scouts in dealing with the intricacies of languages, we will look at the history of language in explored space.

## A HISTORICAL AND CULTURAL OVERVIEW

The earliest language known to have existed in the Imperium is the language (or languages) of the Ancients, the mysterious and now-extinct race that roamed this part of the galaxy 300,000 years ago. While nothing is known of their languages today, speculation as to their forms is rife. Few Ancient artifacts show any sign of written language, although now and again one is found with external markings on it. The entire extant corpus of the written Ancient language would take fewer than 100 pages of actual-size photographs. Unfortunately, this body of writing is as diverse as other features of Ancient sites, and shows little uniformity from one world to another.

Some of the best evidence for the language of the Ancients was the site excavated at Antiquity/Ian (Corridor 0806). Sounds emanated from one room at the site, but scientists are unsure whether the noise was an aural language or music. Other artifacts from the site included some visual display data, but an evident written language was never found. Unfortunately, this site was sealed up in an accident in 1101 and has not been reopened.

Since most devices we use today do include some written instructions or other insignia, some linguists have speculated that the Ancients did not have a written language, but instead relied on some form of aural or psionic communications. These scientists conclude that the few markings found are only religious symbols with mystical meaning.

One thing we do know about the Ancients is that they transported human stock from Terra throughout this area of space, although the reasons for this dispersal are still unknown. There are currently forty-six known and identified human subspecies within explored human space. Each developed a diversity of languages similar to that found on Terra, different numbers of inhabitants and societal structure notwithstanding.

As humans spread on their respective worlds, their languages tended to split, developing new forms. At the time the Terrans reached tech level 8, almost 3,000 different languages were in use there, along with 8,000 dialects, although only 101 had over 1 million speakers. The Terran languages can be grouped into 12 main language families and 50 smaller ones.

The Terrans at that time had five official languages in their United Nations: Chinese, French, English, Russian, and Spanish. Since the United Nations controlled the first Terran excursions using jump technology, these five languages increased in importance. The technological primacy of English eventually brought it to the forefront, and it was made the official language of the Terran Confederation during the war with Vland.

The Vilani, who started into space about 9,000 years before the Terrans, had already codified their languages into what is now known as Old High Vilani. This language, with periodic additions from new technology, and the gradual changes any language experiences over time, served the First Imperium until the time of the Rule of Man.

Galanglic is short for "Galactic Anglic", the official language of the Third Imperium. Galanglic is a direct descendant of Anglic, the language used during the Rule of Man (-2204 through -1776). The popularization of Galanglic is important to

the Imperium, because a common language known by all is beneficial to commerce. On many worlds, Galanglic is in fact a second language, used only in dealing with offworlders and Imperial officials.

## ALIEN LANGUAGES

For similar reasons, most of the major races each use only one language today. All Aslan (with the exception of a few lost colonies) share a common language and culture. All K'kree share a common language and culture, highly conservative and tradition-bound.

The language of the Zhodani is a constant throughout the Consulate, adopted as a standard in the 300th Olympiad. A few dialects exist, but they tend to arise from the jargon of specific occupations rather than being differences in language. The Zhodani enforce their common language and culture by means of psionic techniques against dissenters and overrapid change.

The Hiver written language has become the standard within the Hive Federation. Local cultures may retain their own languages, but any which have interstellar interactions are also conversant with Hiver written language.

In the case of the Droyne, for centuries only the vast distances separating their worlds from each other concealed the fact that all had a common language. That is not to say that every Droyne spoke the same language; indeed, different Droyne communities spoke different languages, often very different languages. But all Droyne communities shared one common language—Oynprith, the language used in the coin casting ceremony. Outsiders missed Oynprith simply because it was not used in public very often; it had a status as a ritual or ceremonial language, much like the status of Latin on Terra.

The Vargr are exceptional in that they are a major race which still shows a high degree of linguistic diversity, although a few languages do have high numbers of speakers. One of the Gvegh family of languages, for example, is spoken by about 60% of the Vargr encountered in the Spinward Marches and neighboring Gvurrdon sector. These languages include Gvegh, Gvegh-Aek, Knithnour, Uedhu, and Taeksu.

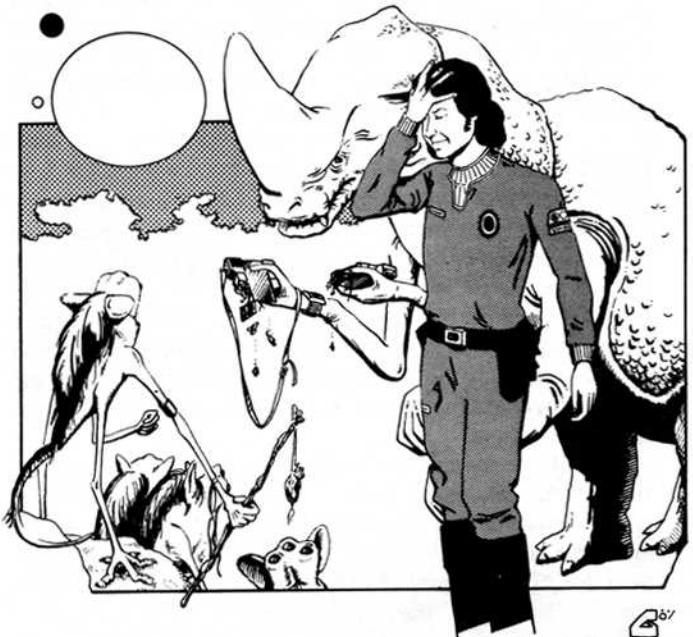

Example of a mishap during language translation.

## SOCIETY AND CULTURE

With 11,000 worlds in the Imperium, a startling variety of cultures has sprung up. Since society consists of living individuals who change and grow, culture itself, which is transmitted by society as a whole, also changes and grows. Much of the culture extant 10,000 years ago is now gone forever. Some of the culture of only a few years ago has also passed into history.

Customs come into being on some world, and may be modified until unrecognizable over the years. Eventually, the custom may disappear entirely, only to spring up later on another world.

Historically, those who studied culture were known as "anthropologists", because they studied man, or *anthropos* in Greek. Today, these scientists are called "sophontologists", because they study all intelligent (*sophos*) life. This term is sometimes applied to those who study the biological mechanisms of humans and aliens; here we are concerned only with cultural sophontology.

To discuss the cultures of the Third Imperium and the surrounding areas, we need first to understand what culture is. Culture includes all the non-instinctual behavior patterns of a sophont that are learned from other members of society. A sophont abandoned as a baby on a desert island would grow up without a culture if it survived at all.

Culture defines how sophonts work, how they play, how they worship (or even whether they worship). Art, music, architecture, literature, and language are all outgrowths of culture. How laws are made, how individuals obey them, and how lawbreakers are dealt with all reflect the culture of the society.

What do they eat? Where do they live? With whom do they live? Who are their relatives? How are children reared? Who works and who plays? How are the sick, elderly, and deceased treated? All these questions are in the domain of the cultural sophontologist.

Not counting the Ancients, of whom we have too little knowledge to do more than speculate, sophontologists study cultures spanning from the present back about 50,000 years. Naturally, some of this study deals with cultures long dead: archaeology, a branch of sophontology, is able to unlock the keys to these cultures.

## BASIC CULTURAL TYPES

Every culture changes over time, since the individuals belonging to that culture change over time. Typically, a developing race of sophonts passes through several stages once it achieves intelligence. While these stages correspond roughly to the development of technology, none of these cultures are "simple" just because their technology is simple. Some of the most puzzling knots sophontologists must unravel are found among the earlier stages of subsistence techniques.

It is also important to understand that, in the view of sophontologists, no culture is "better" or "worse" than another culture. The purpose of every culture is to help its members survive. If the culture fails in this task, it will disappear (or evolve into something different) as its members die. For those untrained in sophontology, it is particularly difficult not to believe that one's own culture is the "best". This belief is known as "ethnocentrism", and sophontolo-

gists must be careful not to let it contaminate their studies.

At the earliest stage, the members of the race practice a "hunting-gathering" culture. (In fact, more gathering than hunting is usually done, but the order of the terms was established eons ago.) Individuals in the society usually do not have fixed dwellings, but wander from place to place in search of the basic necessities of food and water. Although these cultures are usually at the lowest tech levels, this should not imply that they lack gadgetry. Some very sophisticated ways of dealing with one's environment can be found even at tech level 0.

Although hunter-gatherers seldom live exclusively in one place, temporary shelters may be built at different stops along the trail and family bonds may be particularly strong. Small groups typically band together for a period of time and roam over a particular area before breaking up and reforming other groups. Hunter-gatherers are individualistic, usually with little formal government.

A society next reaches the level of "horticulture". At this stage, more permanent structures are built for housing and the cultivation of the soil begins. Carnivorous and omnivorous sophonts start to raise animals on a small scale at this stage of cultural development. With the establishment of larger villages, governmental institutions start to appear, usually under the rule of a village chief or council.

Horticultural societies may be widespread, with literally thousands of villages, and yet have no formal government at a level higher than that of the individual village.

The dividing line between horticulture and the next level is one of degree. "Agriculture" requires better tools and more efficient techniques over a wider area, with correspondingly better results. Horticultural societies dig gardens; agricultural societies farm. With food more plentiful, life is more secure, and the members of the society have more leisure time. This gives rise to more art, music, and literature. It also gives time for scientific development, necessary before highly technological cultures can be established.

At the horticultural and agricultural stages of development, some societies adapt to their environments by practicing "pastoralism", domesticating animals and raising them as a principal food source, rather than growing plants for food.

## TECHNOLOGY AND CULTURE

It is the claim of some sophontologists that technology determines culture: these scientists, given a description of the science and gadgetry used by the society, believe they can accurately predict all other aspects of the culture. Whether this is true or not, a certain degree of consistency has come into being in the Imperium, particularly on worlds at tech level 8 and above.

True, the basic culture of the Imperium has changed much through the more than 10,000 years of recorded history. Political influences, brought about by the changes in power, have brought with them changes in the way people live together.

But most worlds in the Imperium share certain basic cultural postulates, remarkably similar to those found among Terran technological societies at tech level 8.

# Survey Equipment

The Scouts use a wide array of equipment in a survey or exploration mission. This section details many of the more important items of survey equipment:

**Sensors:** Sensors are devices used to augment and extend the natural senses. The Scouts use many sensory devices in the performance of their job. Several sensors are presented in this section. They include the densitometer, neural activity sensor, image convertor binoculars, PRIS field glasses, medical scanner, and sniffer.

**Personal-Assist Hardware:** Personal-assist hardware is any portable device that makes ones job get done easier or quicker. The personal-assist hardware presented here includes the floater, gyrocompass, multichronometer, language translator, handheld communicator, comdots, remote earpiece, lasercom relay, and data/display headset.

**Clothing and Protective Gear:** Any clothing or protective gear worn by a Scout fits into this category. The clothing and protective gear from this section includes the general-purpose vacc suit, portable life-support backpack, tailored vacc suit, light-duty vacc suit, hostile environment vacc suit, and utility vest.

**Vehicles:** The Scouts use many forms of transportation to traverse a world's surface. The vehicles commonly used include the grav belt, g-tube, grav "bike", 4-man air/raft, and the Kankurur g-carrier.

**Space Vessels:** Surveying the universe requires state-of-the-art space vessels loaded with sensors. No vehicle better represents the combination of economy and quality than the 400-ton *Donosev* class survey vessel. Complete deck plans of this ubiquitous vessel are provided.

## EQUIPMENT SHEETS

The next several pages present equipment on **Mega-Traveller** equipment sheets, using a format of one item of equipment per page. The sheets are organized for maximum playability and usefulness to players.

Each sheet focuses on one specific item of equipment, and provides the stats for versions from several tech levels. An illustration shows one representative sample of the equipment so you can see what the equipment looks like.

Further, each sheet includes a text description, a task library, and a place for logging usage. In short, all a player needs to know to use the item of equipment is there on one sheet.

Players should get a copy of the sheets for the equipment they have in their possession. Then, at any time, the sheet a player has represents their current inventory. To keep the sheets from falling on the floor or from getting soiled, it is a good idea for each player to have a folder or large envelope to keep their equipment sheets in.

## SENSORS

Some of the sensory devices in this section are "ranged sensors", while others are not. A ranged sensor can detect sources or objects beyond short range (5 meters) — an example of a ranged sensor is the image convertor binoculars. Other sensors are not ranged, however. Non-ranged sensors only sense things close at hand — for example, the sniffer is not a ranged sensor.

The reason for this distinction — ranged versus non-ranged — is because the tasks for a ranged sensor are handled a little differently than the tasks for a non-ranged sensor.

**Non-Ranged Sensors:** Essentially, to use a non-ranged sensor, a character just needs to point it at something and take a reading (and thus roll a task). That's about all there is to it.

The task library for a non-ranged sensor lists what kind of readings the sensor gives. Non-ranged sensors do not use the Sensor Reading Panel.

**Ranged Sensors:** Ranged sensors, however, work a bit differently.

To use a ranged sensor, the character must state a range and direction (use a hexagonal direction — roll 1D for a number from 1 to 6).

From the range, determine the task difficulty. Depending on how good the task roll was, the player may get one of several possible readings:

Exceptional Failure: no coherent readings

Failure: strong sources/large objects only

Success: all but faint sources/small objects

Exceptional Success: all sources/objects at given range

Each task lists the information that the specific sensor gives. For your convenience, a Sensor Reading Panel is provided for you to use to plot sensor readings.

**Ranged Sensor Example:** Using PRIS field glasses at night, a character picks up a heat/IR source in the sky at very distant range (he rolled a general area scan task while on night watch). He rolled success at his task, but the our secret referee's roll failed. So we tell the player the source is moderate in intensity, increasing, and several in number (this is a distortion because the secret roll failed — the source is, in fact, only one in number).

The player says his character will do an active object pinpoint to see what this source is. He rolls an ActObjPin task (see the PRIS equipment sheet) and succeeds (as does the secret roll this time). His pinpoint sensor results are: acceleration of none, speed of 300 kph, motion is toward, number is one (that's different this time!), and size is small — it must be a craft of some kind. The character does not have his PRIS hooked to a computer with library data (even a hand computer), so he gets no positive ID.

However, we give the player an index card on which we have sketched the following rough silhouette that appears in his PRIS viewfield:



He immediately recognizes it as a Kankurur G-Carrier.

### RANGE KEY

M medium	5m - 50m
L long	50m - 250m
VL very long	250m - 500m
D distant	500m - 5km
VD very distant	5km - 50km
RG regional	50km - 500km
CN continental	500km - 5,000km
PL planetary	5,000km - 50,000km
FO far orbit	50,000km - 0.5Mkm
XO extreme orbit	0.5Mkm - 5Mkm
IP interplanetary	5Mkm - 1AU
SY system	1AU - 1,000AU
SS substellar	1,000AU - 100,000AU
ST stellar	100,000AU - 1 parsec
IS interstellar	1 parsec - 2 parsec
SB subsector+	2 parsecs+

### PATTERN

- simple
- complex
- cluttered

### NEURAL CLASS

- unknown
- human/vargr
- aslan
- droyne
- k'kree
- hiver
- other

### EM BAND

- longwave RF
- shortwave RF
- microwave RF
- IR/heat
- light
- UV
- x-rays
- gamma rays

### MOTION

- Closing
- ↗ Toward
- ↖ Away
- ← Leaving
- ↓ Parallel

### ACCEL

- none
- speeding up
- slowing down

### NUMBER

- single
- several
- multitude

### SPEED

speed to nearest 10 kph, 100 kph, or 1,000 kph

### DURATION

- constant
- intermittent
- increasing
- decreasing

### POWER

power to the nearest kilowatt, megawatt, or gigawatt

### INTENSITY

- below bkgnd (neutrino only)
- faint (f)
- moderate (M)
- strong (S)
- dangerous (D)
- fatal (F)

Give intensity at sensor if player does not know range.

### INTENSITY AT SENSOR

	Intensity at Source					
	F	D	S	M	f	
M	F	D	S	M	f	—
L	F	S	M	f	—	—
VL	F	S	f	—	—	—
D	F	M	—	—	—	—
VD	F	M	—	—	—	—
RG	D	f	—	—	—	—
CN	D	—	—	—	—	—
PL	D	—	—	—	—	—
FO	S	—	—	—	—	—
XO	S	—	—	—	—	—
IP	M	—	—	—	—	—
SY+	f	—	—	—	—	—

### INTELLIGENCE

- lower form
- not intell
- semi-intell
- intelligent

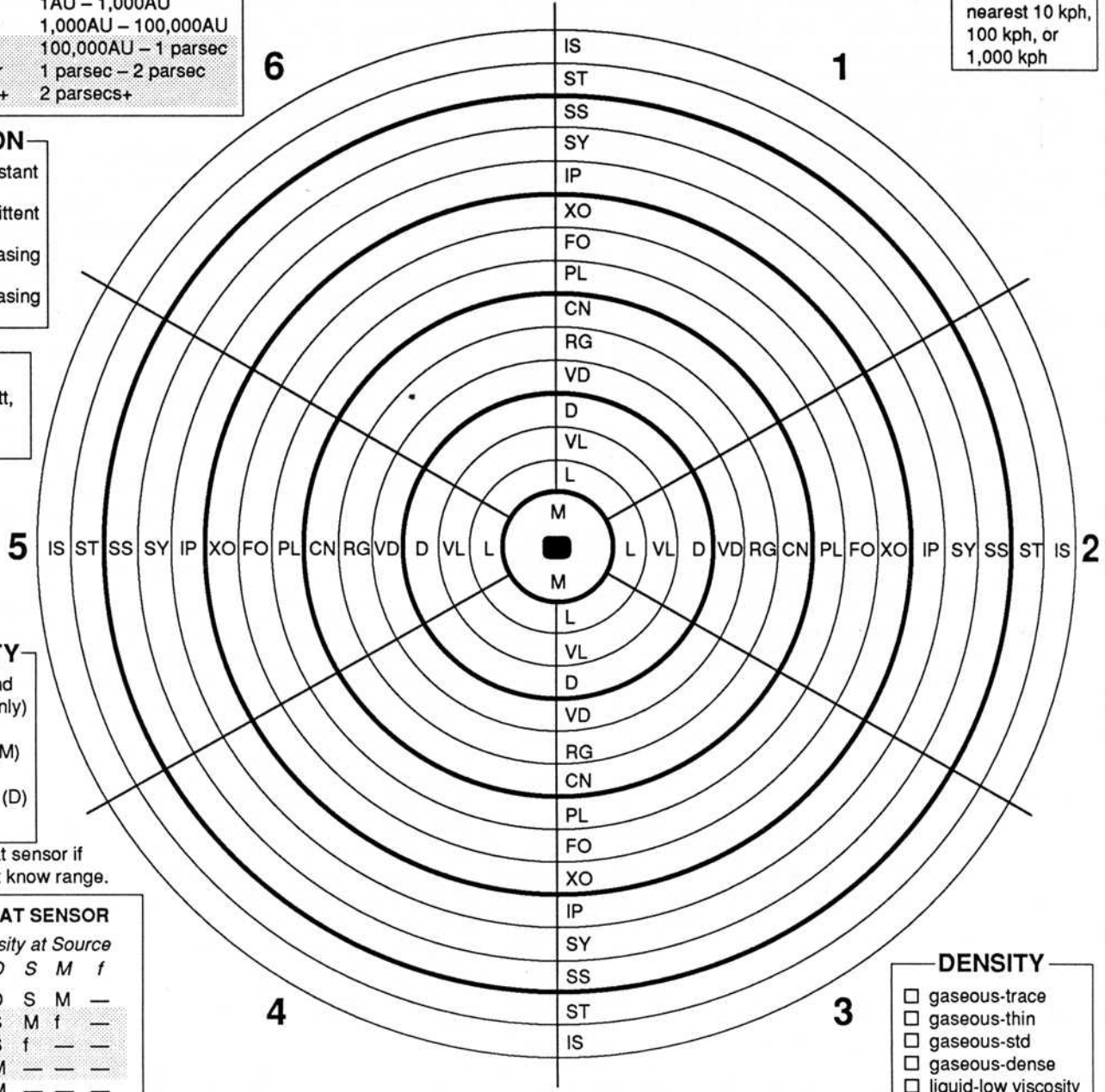

- ### VOLUME
- volume to nearest liter, kiloliter, or tons displacement
- tiny (<10 tons)
  - small (10-100 tons)
  - avg (100-10,000 tons)
  - large (10,000-1,000,000 tons)
  - huge (>1,000,000 tons)

- ### SIZE
- tiny (<10 tons)
  - small (10-100 tons)
  - avg (100-10,000 tons)
  - large (10,000-1,000,000 tons)
  - huge (>1,000,000 tons)

- ### STATE
- vacuum
  - gaseous
  - liquid
  - solid
  - artificial grav fld

- ### DENSITY
- gaseous-trace
  - gaseous-thin
  - gaseous-std
  - gaseous-dense
  - liquid-low viscosity
  - liquid-med viscosity
  - liquid-high viscosity
  - solid-nonmetal
  - solid-light metal
  - solid-medium metal
  - solid-heavy metal
  - superdense

# SENSOR READOUT PANEL

# HANDHELD DENSITOMETER

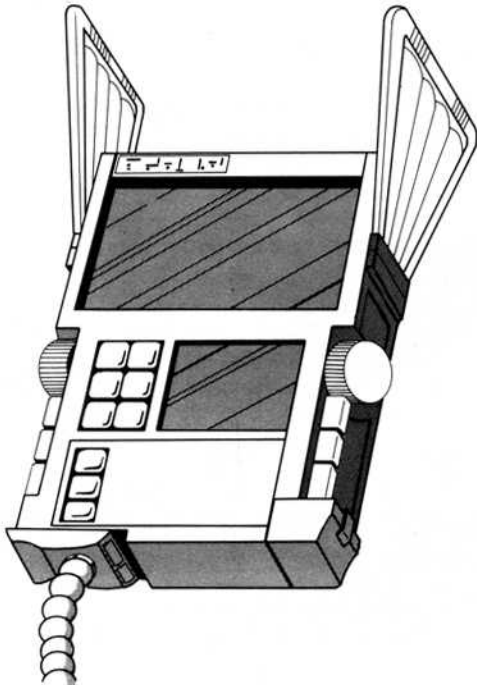

## EQUIPMENT STATISTICS

TL Type	Vol	Wt	Price
○ 14 Handheld Densitometer-14	15 liters	7kg	Cr15,000
○ 15 Handheld Densitometer-15	3.0 liters	2kg	Cr25,000
○ 16 Handheld Densitometer-16	2.6 liters	1.5kg	Cr40,000

## SUPPLEMENTAL STATISTICS (OPTIONAL)

TL	Charge Duration	Operating Noise	Power	
			Usage	Comments
○ 14	15 days	humming	0.16kw	Penetration 1m
○ 15	15 days	soft hum	0.06kw	Penetration 50m
○ 16	30 days	none	0.02kw	Penetration 100m

## USAGE RECORD (OPTIONAL)

Each square represents 1 day (24 hours) of usage

○ TL14:	<input type="checkbox"/> <input type="checkbox"/> <input type="checkbox"/> <input type="checkbox"/> <input type="checkbox"/> <input type="checkbox"/> <input type="checkbox"/> <input type="checkbox"/> <input type="checkbox"/> <input type="checkbox"/> <input type="checkbox"/> <input type="checkbox"/> <input type="checkbox"/> <input type="checkbox"/> <input type="checkbox"/> <input type="checkbox"/> <input type="checkbox"/> <input type="checkbox"/> <input type="checkbox"/> <input type="checkbox"/> <input type="checkbox"/> <input type="checkbox"/>
○ TL15:	<input type="checkbox"/> <input type="checkbox"/> <input type="checkbox"/> <input type="checkbox"/> <input type="checkbox"/> <input type="checkbox"/> <input type="checkbox"/> <input type="checkbox"/> <input type="checkbox"/> <input type="checkbox"/> <input type="checkbox"/> <input type="checkbox"/> <input type="checkbox"/> <input type="checkbox"/> <input type="checkbox"/> <input type="checkbox"/> <input type="checkbox"/> <input type="checkbox"/> <input type="checkbox"/> <input type="checkbox"/>
○ TL16:	<input type="checkbox"/> <input type="checkbox"/> <input type="checkbox"/> <input type="checkbox"/> <input type="checkbox"/> <input type="checkbox"/> <input type="checkbox"/> <input type="checkbox"/> <input type="checkbox"/> <input type="checkbox"/> <input type="checkbox"/> <input type="checkbox"/> <input type="checkbox"/> <input type="checkbox"/> <input type="checkbox"/> <input type="checkbox"/> <input type="checkbox"/> <input type="checkbox"/> <input type="checkbox"/> <input type="checkbox"/>

## NOTES:

Tech Level 15 version illustrated

## DESCRIPTION

The handheld densitometer is an outgrowth of gravitic technology. Using an object's natural gravitational attraction, the remote densitometer can classify the object's density.

The resulting densitometer scan is a three-dimensional density map of the scanned object or region.

## TASK LIBRARY

To do an PasObjScan with a handheld densitometer:  
[varies], Sensor Ops, Edu, 6 sec (unskilled OK, uncertain)

Referee: Task difficulty depends on range:

M L VL D VD RG CN PL FO+  
S S S R D D F I —

This task finds objects. Gives: direction, state, size.

Simultaneous readings from two locations separated by at least distant range also gives: accel, speed, motion.

Some truth gives false sources, misses some sources, or distorts data.

To do an PasObjPin with handheld densitometer:  
[varies], Sensor Ops, Edu, 6 sec (uncertain)

Referee: Task difficulty depends on range:

M L VL D VD RG CN PL FO+  
TL14 S S S R D D F I —

M L VL D VD RG CN PL FO XO+  
TL15+ — S S S R R D F I —

This task pinpoints an object whose location is already known. Gives: volume, density, range, accel, speed, motion, number, size, ID (ID only if linked to library data).

On some truth, some readings distorted.

To repair a damaged densitometer:  
[varies], Electronics, Gravitics, [varies]

Referee: Difficulty depends on the damage level of the sensor: use the standard damage and repair guidelines. Time increments for shop repair are as follows:

superficial damage ..... 30 sec  
minor damage ..... 2 min  
major damage ..... 1 hrs  
destroyed ..... 2 hrs

For field repair, double the time increment, in addition to other standard increases.





# "PRIS" FIELD GLASSES

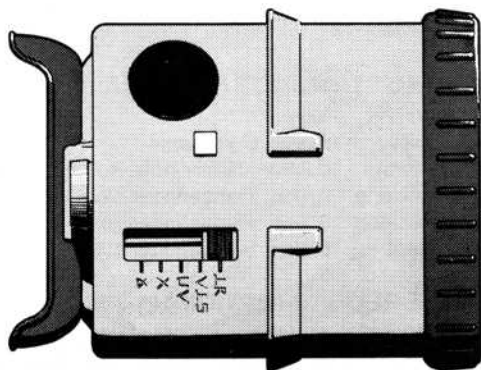

## EQUIPMENT STATISTICS

TL	Type	Vol	Wt	Price
○ 12	PRIS Field Glasses-12	3.0 liters	2.0kg	Cr25,000
○ 13	PRIS Field Glasses-13	2.5 liters	1.8kg	Cr20,000
○ 14	PRIS Field Glasses-14	2.0 liters	1.5kg	Cr15,000
○ 15	PRIS Field Glasses-15	1.0 liters	1.0kg	Cr13,500

## SUPPLEMENTAL STATISTICS (OPTIONAL)

TL	Charge Duration	Operating Noise	Power Usage	Comments
○ 12	1 day	buzz/click	0.12kw	Magnification 100x
○ 13	3 days	soft buzz	0.10kw	Magnification 225x
○ 14	4 days	soft hum	0.08kw	Magnification 275x
○ 15	7 days	silent	0.04kw	Magnification 350x

## USAGE RECORD (OPTIONAL)

Each square represents 1 day (24 hours) of usage

○ TL12:	<input type="checkbox"/>	<input type="checkbox"/>	<input type="checkbox"/>	<input type="checkbox"/>	<input type="checkbox"/>	<input type="checkbox"/>	<input type="checkbox"/>	<input type="checkbox"/>	<input type="checkbox"/>	<input type="checkbox"/>	<input type="checkbox"/>
○ TL13:	<input type="checkbox"/>	<input type="checkbox"/>	<input type="checkbox"/>	<input type="checkbox"/>	<input type="checkbox"/>	<input type="checkbox"/>	<input type="checkbox"/>	<input type="checkbox"/>	<input type="checkbox"/>	<input type="checkbox"/>	<input type="checkbox"/>
○ TL14:	<input type="checkbox"/>	<input type="checkbox"/>	<input type="checkbox"/>	<input type="checkbox"/>	<input type="checkbox"/>	<input type="checkbox"/>	<input type="checkbox"/>	<input type="checkbox"/>	<input type="checkbox"/>	<input type="checkbox"/>	<input type="checkbox"/>
○ TL15:	<input type="checkbox"/>	<input type="checkbox"/>	<input type="checkbox"/>	<input type="checkbox"/>	<input type="checkbox"/>	<input type="checkbox"/>	<input type="checkbox"/>	<input type="checkbox"/>	<input type="checkbox"/>	<input type="checkbox"/>	<input type="checkbox"/>

## NOTES:

Tech Level 12 version illustrated

## DESCRIPTION

The Portable Radiation Imaging system (PRIS) can be set to observe images in the spectral range from infrared to gamma rays. The front surface of the PRIS is transparent to all radiation; just behind it is a series of lenses tailored to various bands.

Magnification strength is adjustable — a built-in flywheel for gyroscopic stabilization insures a steady field of view at all magnifications.

## TASK LIBRARY

To do a PasEngScan with PRIS field glasses:  
[varies], Sensor Ops, Edu, 1 sec (unskilled OK, uncertain)

*Referee:* Task difficulty depends on range:

M L VL D VD RG CN PL EQ+  
S S S R D D F I —

This task finds sources. Gives: EM band, intensity, duration, number, and direction. Simultaneous readings from two locations separated by at least distant range gives: range, accel, speed, motion. Requires a computer link between both sensors.

Some truth gives false sources, misses some sources, or distorts data.

To do an ActObjPin with PRIS field glasses:  
[varies], Sensor Ops, Edu, instant (unskilled OK, uncertain)

*Referee:* Task difficulty depends on range:

M L VL D VD  
S S S R D

This task pinpoints an object whose location is already known. Can also be used to pinpoint an energy source if that source is an object in range. Gives: range, accel, speed, motion, number, size, ID (ID only if linked to library data).

On some truth, some readings distorted.

To repair damaged PRIS field glasses:  
[varies], Electronics, Edu, [varies]

*Referee:* Difficulty depends on the damage level: use the standard damage and repair guidelines. Time increments for shop repair are as follows:

superficial damage ..... 2 min  
minor damage ..... 5 min  
major damage ..... 3 hrs  
destroyed ..... 6 hrs

For field repair, double the time increment, in addition to other standard increases.



# MED SCANNER

## EQUIPMENT STATISTICS

TL	Type	Vol	Wt	Price
○ 10	Med Scanner-10	2 liters	1.0kg	Cr25,000
○ 12	Med Scanner-12	0.2 liters	0.1kg	Cr10,500

## SUPPLEMENTAL STATISTICS (OPTIONAL)

TL	Charge		Operating Power		Comments
	Duration	Noise	Usage		
○ 10	7 days	beeping	9.0w		Handheld size
○ 12	7 days	beeping	1.0w		Pocket size

## USAGE RECORD (OPTIONAL)

Each square represents 1 day (24 hours) of usage

○ TL10:	□	□	□	□	□	□	□	□	□	□
○ TL12:	□	□	□	□	□	□	□	□	□	□

## NOTES:

TL 10 and TL12 versions illustrated

## DESCRIPTION

A doctor or nurse need only to press a med scanner probe against the patient's chest and moments later, the scanner accurately determines body temperature, blood pressure, pulse rate, respiration rate, level of neural activity, fluid balance and other important data.

Once the reading is made, the device records the values in the scanner's memory. These records can be called up later for review. The scanner can be set so that if readings reach a certain level (either high or low), the scanner beeps to alert the attending physician. Adhesive pads allow attaching the scanner temporarily to the chest for this purpose.

A med scanner is optimized for a given race, so using it on members of another alien race does not work. One exception: the same device can be used for humans and Vargr.

Tech 12+ vacc suits have contacts allowing use of a med scanner without removing the suit.

## TASK LIBRARY

To use a med scanner to perform diagnosis:  
Routine, Medical, Edu (unskilled OK)

*Referee:* A med scanner allows *instant* diagnosis of injury. For diagnosis of sickness, the time increment is reduced by one-half.

To modify a med scanner for another race:  
Difficult, minimum of Medical or Electronics, Edu, 1 hour (uncertain)

*Referee:* Use the lower level of medical and electronics skills to determine the skill DM. If the character does not have both skills, the task is Impossible. Once the device is converted, it can not be used for the original race without successfully performing this task again. If the result of this task is *Some Truth*, then all subsequent tasks using the modified scanner require exceptional success to be successful.

To repair a damaged med scanner:  
[varies], Electronics or Computer, Edu, [varies]

*Referee:* Difficulty depends on the damage level: use the standard damage and repair guidelines. Time increments for shop repair are as follows:

superficial damage .....	1 min
minor damage .....	5 min
major damage .....	2 hrs
destroyed .....	5 hrs

For field repair, double the time increment, in addition to other standard increases.

# BIO-SCANNER (SNIFFER)

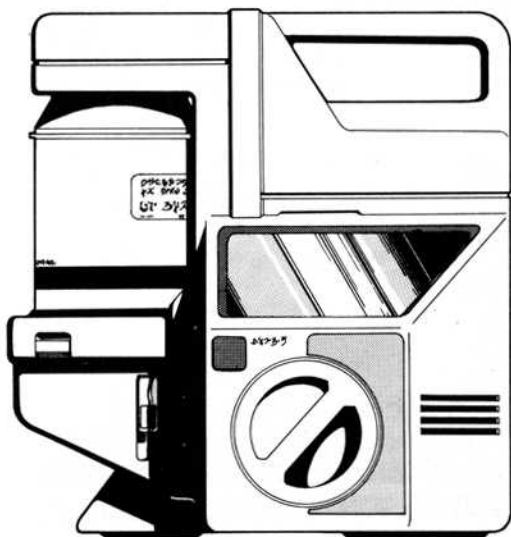

## EQUIPMENT STATISTICS

TL	Type	Vol	Wt	Price
○ 13	Bio-Scanner (Sniffer)-13	20 liters	7.0kg	Cr500,000
○ 15	Bio-Scanner (Sniffer)-15	8 liters	3.5kg	Cr350,000
○ 16	Bio-Scanner (Sniffer)-16	3 liters	1.5kg	Cr150,000

## SUPPLEMENTAL STATISTICS (OPTIONAL)

TL	Charge	Operating	Power	Usage	Comments
○ 13	24 hours	hiss/clunk	2.5kw	Analysis is slow, range under 1m	
○ 15	4 days	soft hiss	0.6kw	Analysis is faster, range 1m	
○ 16	10 days	soft hiss	0.2kw	Analysis is much faster, range 5m	

## USAGE RECORD (OPTIONAL)

Each square represents 1 day (24 hours) of usage



Tech Level 15 version illustrated

## NOTES:

## DESCRIPTION

An advancement of volatile chemical molecular analysis technology, the bio-scanner "sniffer" scans for evidence of biological/ metabolic activity in the area. It is a highly advanced combination sampler/analyzer. Not only is the bio-scanner useful for biological studies, but it also helps with regular chemical analysis.

The unit incorporates both analyzer and collector into one. It has 2 modes and corresponding equipment: one mode for mass sampling (scanning) and one mode for minute sampling (pinpoint reading).

The evidence of biological activity must be within short range (5m) of the scanner—anything beyond short range is undetectable.

## TASK LIBRARY

To recognize or categorize a familiar organism:

Routine, Biology, Edu, (time incr varies: TL13:10 min; TL15:1 min; TL16:10 sec) (uncertain)

*Referee:* Success at this task allows one of the following: ecological classification, determination of potential hazards to other lifeforms, estimate of potential uses (form of food, commercial value). Total truth gives the exact identity of the familiar organism. Hunting serves as one level less in biology skill with familiar organisms.

To recognize or categorize an unfamiliar organism:

Difficult, Biology, Edu, (time incr varies: TL13:10 min; TL15:1 min; TL16:10 sec) (uncertain)

*Referee:* Success at this task allows one of the following: ecological classification, determination of potential hazards to other lifeforms, estimate of potential uses (form of food, commercial value).

To repair a damaged sniffer:

[varies], Mechanical or Electronics, Edu, [varies]

*Referee:* Difficulty depends on the damage level: use the standard damage and repair guidelines. Time increments for shop repair are as follows:

superficial damage ..... 30 sec

minor damage ..... 2 min

major damage ..... 2 hrs

destroyed ..... 4 hrs

For field repair, double the time increment, in addition to other standard increases.

# FLOATER

## EQUIPMENT STATISTICS

TL	Type	Vol	Wt	Price
○ 10	Floater-10	400 liters	110kg	Cr30,000
○ 13	Floater-13	400 liters	100kg	Cr30,000
○ 15	Floater-15	400 liters	95kg	Cr30,000

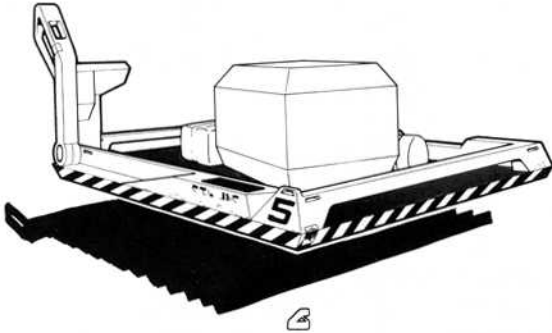

## SUPPLEMENTAL STATISTICS (OPTIONAL)

TL	Duration	Noise	Usage	Comments
○ 10	36 days	hum	200 liters	Thrust: 890kg
○ 13	60 days	soft hum	200 liters	Thrust: 900kg
○ 15	120 days	none	200 liters	Thrust: 905kg

## USAGE RECORD (OPTIONAL)

Each square represents 3 days (72 hours) of usage

○ TL10:	[16 squares]
○ TL13:	[16 squares]
○ TL15:	[16 squares]

## NOTES:

Tech Level 13 version illustrated

## DESCRIPTION

With the advent of artificial grav technology in a big way at tech level 10, most societies construct all manner of platforms for transporting heavy cargos. One popular category of cargo platform is the floater — essentially a self-propelled cargo platten of sorts.

Most floaters are between 1 and 2 meters square, and can carry several hundred kilograms of bulky cargo. Each of the floaters shown here can propel itself at up to 5kph — the speed of a brisk walk. Each floater includes a fold-down control pedestal, a flashing warning strobe, cargo tie-downs, and an open end to allow for platform drainage.

## TASK LIBRARY

To use a floater for 8 hours without incident:  
Routine, Grav Veh, Dex (fateful)

*Referee:* For long-term usage of a floater, you can short-cut this task by just rolling 3 times per week.

To repair a damaged floater:  
[varies], Gravitics, Edu, [varies]

*Referee:* Difficulty depends on the damage level: use the standard damage and repair guidelines. Time increments for shop repair are as follows:

superficial damage ..... 10 sec  
minor damage ..... 1 min  
major damage ..... 30 min  
destroyed ..... 2 hrs

For field repair, double the time increment, in addition to other standard increases.

# GYROCOMPASS



## EQUIPMENT STATISTICS

TL	Type	Vol	Wt	Price
○ 9	Gyrocompass-9	8 liters	3kg	Cr1,100
○ 11	Gyrocompass-11	4 liters	1.5kg	Cr1,500
○ 13	Gyrocompass-13	2.5 liters	1.0kg	Cr1,800
○ 15	Gyrocompass-15	1.0 liters	0.5kg	Cr2,000

## SUPPLEMENTAL STATISTICS (OPTIONAL)

TL	Charge Duration	Operating Noise	Power Usage	Comments
○ 9	24 hrs	whirr	0.2kw	Self-precensing in 1 hr
○ 11	48 hrs	soft whirr	0.1kw	Self-precensing in 30 min
○ 13	7 days	soft hum	0.05kw	Self-precensing in 10 min
○ 15	30 days	silent	0.02kw	Self-precensing in 2 min

## USAGE RECORD (OPTIONAL)

*Each square represents 1 day (24 hours) of usage*

○ TL9:	<input type="checkbox"/>	<input type="checkbox"/>	<input type="checkbox"/>	<input type="checkbox"/>	<input type="checkbox"/>	<input type="checkbox"/>	<input type="checkbox"/>	<input type="checkbox"/>	<input type="checkbox"/>	<input type="checkbox"/>	<input type="checkbox"/>	<input type="checkbox"/>	<input type="checkbox"/>	<input type="checkbox"/>	<input type="checkbox"/>	<input type="checkbox"/>	<input type="checkbox"/>	<input type="checkbox"/>	<input type="checkbox"/>	<input type="checkbox"/>	<input type="checkbox"/>
○ TL11:	<input type="checkbox"/>	<input type="checkbox"/>	<input type="checkbox"/>	<input type="checkbox"/>	<input type="checkbox"/>	<input type="checkbox"/>	<input type="checkbox"/>	<input type="checkbox"/>	<input type="checkbox"/>	<input type="checkbox"/>	<input type="checkbox"/>	<input type="checkbox"/>	<input type="checkbox"/>	<input type="checkbox"/>	<input type="checkbox"/>	<input type="checkbox"/>	<input type="checkbox"/>	<input type="checkbox"/>	<input type="checkbox"/>	<input type="checkbox"/>	<input type="checkbox"/>
○ TL13:	<input type="checkbox"/>	<input type="checkbox"/>	<input type="checkbox"/>	<input type="checkbox"/>	<input type="checkbox"/>	<input type="checkbox"/>	<input type="checkbox"/>	<input type="checkbox"/>	<input type="checkbox"/>	<input type="checkbox"/>	<input type="checkbox"/>	<input type="checkbox"/>	<input type="checkbox"/>	<input type="checkbox"/>	<input type="checkbox"/>	<input type="checkbox"/>	<input type="checkbox"/>	<input type="checkbox"/>	<input type="checkbox"/>	<input type="checkbox"/>	<input type="checkbox"/>
○ TL15:	<input type="checkbox"/>	<input type="checkbox"/>	<input type="checkbox"/>	<input type="checkbox"/>	<input type="checkbox"/>	<input type="checkbox"/>	<input type="checkbox"/>	<input type="checkbox"/>	<input type="checkbox"/>	<input type="checkbox"/>	<input type="checkbox"/>	<input type="checkbox"/>	<input type="checkbox"/>	<input type="checkbox"/>	<input type="checkbox"/>	<input type="checkbox"/>	<input type="checkbox"/>	<input type="checkbox"/>	<input type="checkbox"/>	<input type="checkbox"/>	<input type="checkbox"/>

Tech Level 15 version illustrated

## NOTES:

### DESCRIPTION

A necessary improvement in navigational equipment for other worlds is the self-precensing gyrocompass.

The gyrocompass does not need a magnetic field to operate, and sets itself automatically. When a landing party stops on the surface of the world, the gyrocompass senses the world's rotational motion and sets itself.

The gyrocompass can be linked with a hand computer or map box, thereby providing accurate information as to one's current location on the surface of a world.

### TASK LIBRARY

To use a gyrocompass to find direction (north, south, east west):  
Routine, Sensor Op, Recon (unskilled OK)

*Referee:* For a tech level 9 gyrocompass, make this task uncertain.

To use a gyrocompass link to find location:  
Routine, Sensor Op, Recon

*Referee:* For a tech level 9 gyrocompass, make this task uncertain.

To repair a damaged gyrocompass:  
[varies], Electronics, Edu, [varies]

*Referee:* Difficulty depends on the damage level: use the standard damage and repair guidelines. Time increments for shop repair are as follows:

superficial damage ..... 30 sec  
minor damage ..... 2 min  
major damage ..... 1 hrs  
destroyed ..... 2 hrs

For field repair, double the time increment, in addition to other standard increases.

# MULTICHRONOMETER

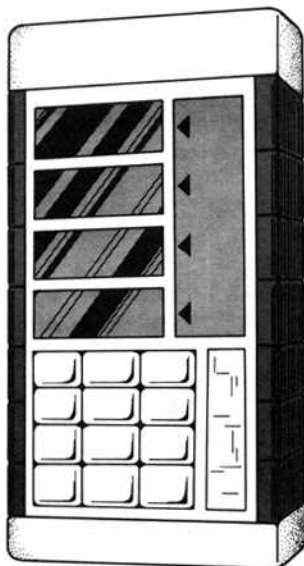

Tech Level 10 version illustrated

## EQUIPMENT STATISTICS

TL	Type	Vol	Wt	Price
○ 9	Multichronometer-9	0.2 liters	0.1kg	Cr500
○ 10	Multichronometer-10	0.1 liters	—	Cr200

## SUPPLEMENTAL STATISTICS (OPTIONAL)

TL	Charge Duration	Operating Noise	Power Usage	Comments
○ 9	24 hrs	none	3w	
○ 10	7 days	none	1w	Includes computer link

## USAGE RECORD (OPTIONAL)

*Each square represents 1 day (24 hours) of usage*

- TL9:
- TL10:

## NOTES:

## DESCRIPTION

An important device, but one easily overlooked by those who have never left their home planets, is the multichronometer. This timepiece sets itself, in one planetary rotation, to local zero meridian time, local solar time, and local sidereal time. A setting allows for automatic time zone corrections according to world size. The multichronometer also keeps Imperial standard time.

The sidereal and zero meridian times are of interest mainly to the astronomer and navigator, giving them the spin plane of the world, its year length, and other information.

## TASK LIBRARY

To use a multichronometer to determine local time:

Routine, Edu

*Referee:* Remember to allow time for auto setting (1 rotation period). Optionally, the chronometer can be set manually, if the rotation period is known.

To repair a damaged multichronometer:

[varies], Electronics, Edu, [varies]

*Referee:* Difficulty depends on the damage level of thebinoculars: use the standard damage and repair guidelines. Time increments for shop repair are as follows:

superficial damage ..... 30 sec  
 minor damage ..... 2 min  
 major damage ..... 1 hrs  
 destroyed ..... 2 hrs

For field repair, double the time increment, in addition to other standard increases.

# LANGUAGE TRANSLATOR

## EQUIPMENT STATISTICS

TL	Type	Vol	Wt	Price
○ 9	Language Translator-9	3 liters	2.0kg	Cr2,000
○ 10	Language Translator-10	3 liters	1.5kg	Cr1,000
○ 12	Language Translator-12	2 liters	1.0kg	Cr800
○ 14	Language Translator-14	0.5 liters	0.5kg	Cr800

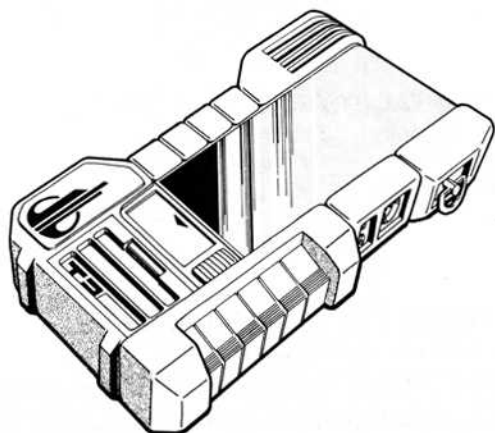

## SUPPLEMENTAL STATISTICS (OPTIONAL)

TL	Charge	Operating	Power	Comments
Duration	Noise	Usage		
○ 9	24 hrs	silent	0.025kw	Audio output limited/ no visual
○ 10	2 days	silent	0.05kw	Improved audio/limited video
○ 12	1 wk	silent	0.01kw	Quality audio/quality video
○ 14	1 wk	silent	0.01kw	Pocket sized unit

## USAGE RECORD (OPTIONAL)

Each square represents 1 day (24 hours) of usage

○ TL9:	<input type="checkbox"/>	<input type="checkbox"/>	<input type="checkbox"/>	<input type="checkbox"/>	<input type="checkbox"/>	<input type="checkbox"/>	<input type="checkbox"/>	<input type="checkbox"/>	<input type="checkbox"/>	<input type="checkbox"/>	<input type="checkbox"/>	<input type="checkbox"/>	<input type="checkbox"/>	<input type="checkbox"/>	<input type="checkbox"/>	<input type="checkbox"/>	<input type="checkbox"/>	<input type="checkbox"/>
○ TL10:	<input type="checkbox"/>	<input type="checkbox"/>	<input type="checkbox"/>	<input type="checkbox"/>	<input type="checkbox"/>	<input type="checkbox"/>	<input type="checkbox"/>	<input type="checkbox"/>	<input type="checkbox"/>	<input type="checkbox"/>	<input type="checkbox"/>	<input type="checkbox"/>	<input type="checkbox"/>	<input type="checkbox"/>	<input type="checkbox"/>	<input type="checkbox"/>	<input type="checkbox"/>	<input type="checkbox"/>
○ TL12:	<input type="checkbox"/>	<input type="checkbox"/>	<input type="checkbox"/>	<input type="checkbox"/>	<input type="checkbox"/>	<input type="checkbox"/>	<input type="checkbox"/>	<input type="checkbox"/>	<input type="checkbox"/>	<input type="checkbox"/>	<input type="checkbox"/>	<input type="checkbox"/>	<input type="checkbox"/>	<input type="checkbox"/>	<input type="checkbox"/>	<input type="checkbox"/>	<input type="checkbox"/>	<input type="checkbox"/>
○ TL14:	<input type="checkbox"/>	<input type="checkbox"/>	<input type="checkbox"/>	<input type="checkbox"/>	<input type="checkbox"/>	<input type="checkbox"/>	<input type="checkbox"/>	<input type="checkbox"/>	<input type="checkbox"/>	<input type="checkbox"/>	<input type="checkbox"/>	<input type="checkbox"/>	<input type="checkbox"/>	<input type="checkbox"/>	<input type="checkbox"/>	<input type="checkbox"/>	<input type="checkbox"/>	<input type="checkbox"/>

## NOTES:

Tech Level 12 version illustrated

## DESCRIPTION

The Language Translator serves efficiently as an inexpensive translation device. Normally, the translator transmits to a remote earpiece or commdot.

Individual memclips are needed for both the source and target language — to translate from Vargr to K'kree, for example, two memclips are needed. The translator can hold up to six memclips. Four peripheral outlets support accessories for unique communication modes such as light, smell, ultra-high or ultra-low frequency sound, touch, and pictorial display. Internal memory allows copying an entire memclip if necessary. Blank memclips cost Cr10.

This unit performs well when translating one spoken sentence after another in a variety of languages, however, subtle nuances of meaning may not be preserved. (For the utmost in precise language translation, one of the powerful translator robots on the market is ideal.)

## TASK LIBRARY

To perform translation of a conversation:  
Difficult, Linguistics, Int (fateful)

*Referee:* If translating offline video/text, this task is Routine. Treat mishaps as follows:  
superficial ..... Some nuances not conveyed.  
minor ..... Meaning is misleading although some correct meaning exists.  
major ..... Totally incorrect meaning conveyed. If to an NPC, roll NPC reaction.

To create a language memclip:  
Difficult, Linguistics, Edu, 1 month (uncertain)

*Referee:* The resulting memclip has a skill level of one less than the creator's skill, to a maximum skill level of 3. As far as the uncertain results:

No truth ..... Secretly lower memclip skill level by 2 (minimum level of 0).  
minor ..... Secretly lower memclip skill level by 1 (minimum level of 0).

To repair a damaged language translator:  
[varies], Electronics or Computer, Edu, [varies]

*Referee:* Difficulty depends on the damage level: use the standard damage and repair guidelines. Time increments for shop repair are as follows:

superficial damage ..... 1 min  
minor damage ..... 5 min  
major damage ..... 2 hrs  
destroyed ..... 4 hrs

For field repair, double the time increment, in addition to other standard increases.







# REMOTE EARPIECE

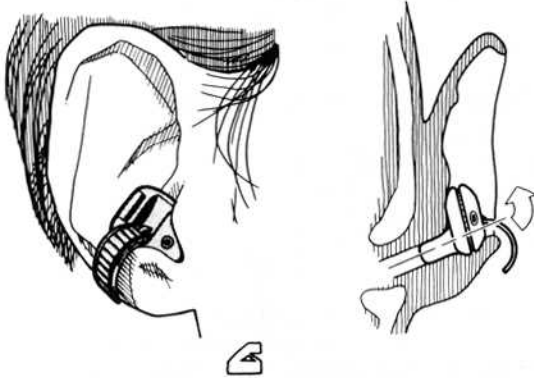

### EQUIPMENT STATISTICS

TL	Type	Vol	Wt	Price
○ 8	Remote Earpiece-8	0.2 liters	0.1kg	Cr75
○ 12	Remote Earpiece-12	0.2 liters	0.1kg	Cr75
○ 14	Remote Earpiece-14	0.2 liters	0.1kg	Cr150
○ 16	Remote Earpiece-16	0.2 liters	0.1kg	Cr300

### SUPPLEMENTAL STATISTICS (OPTIONAL)

TL	Charge Duration	Operating Noise	Power Usage	Comments
○ 8	8 hours	none	0.01kw	Rng D (5km)
○ 12	1 day	none	0.01kw	Rng VD (50 km), multiplex 2
○ 14	4 days	none	0.01kw	Rng RG (500km), multiplex 4
○ 16	12 days	none	0.01kw	Rng CN (5,000km), multiplex any

### USAGE RECORD (OPTIONAL)

Each square represents 1 day (24 hours) of usage

○ TL8:	<input checked="" type="checkbox"/> <input checked="" type="checkbox"/> <input checked="" type="checkbox"/> <input checked="" type="checkbox"/> <input checked="" type="checkbox"/> <input checked="" type="checkbox"/> <input checked="" type="checkbox"/> <input checked="" type="checkbox"/>
○ TL12:	<input type="checkbox"/> <input type="checkbox"/> <input type="checkbox"/> <input type="checkbox"/> <input type="checkbox"/> <input type="checkbox"/> <input type="checkbox"/> <input type="checkbox"/>
○ TL14:	<input type="checkbox"/> <input type="checkbox"/> <input type="checkbox"/> <input type="checkbox"/> <input type="checkbox"/> <input type="checkbox"/> <input type="checkbox"/> <input type="checkbox"/> <input type="checkbox"/> <input type="checkbox"/>
○ TL16:	<input type="checkbox"/> <input type="checkbox"/> <input type="checkbox"/> <input type="checkbox"/> <input type="checkbox"/> <input type="checkbox"/> <input type="checkbox"/> <input type="checkbox"/> <input type="checkbox"/> <input type="checkbox"/> <input type="checkbox"/> <input type="checkbox"/>

### NOTES:

Tech Level 14 version illustrated

## DESCRIPTION

The remote earpiece can both send and receive voice communication. An earpiece communicator tends to be a short range device — an orbiting ship or other long-range destination can be contacted by linking to a laser communicator or a landing vehicle radio as a repeater.

The earpiece picks up the voice of the wearer via the vibrations in the wearer's skull. Dialog transmitted to the earpiece is just as distinct as dialog spoken to a handheld communicator.

High-tech versions include a multiplexer allowing the earpiece to be connected to other communicator or computer devices.

## TASK LIBRARY

To use an earpiece communicator:  
Routine, Communication, Edu (unskilled OK)

*Referee:* For ideal conditions, make this task Simple. For poor conditions make this task Difficult.

To repair a damaged earpiece communicator:  
[varies], Electronics, Edu, [varies]

*Referee:* Difficulty depends on the damage level: use the standard damage and repair guidelines. Time increments for shop repair are as follows:

superficial damage ..... 1 min  
minor damage ..... 4 min  
major damage ..... 1 hrs  
destroyed ..... 2 hrs

For field repair, double the time increment, in addition to other standard increases.

# LASERCOM RELAY

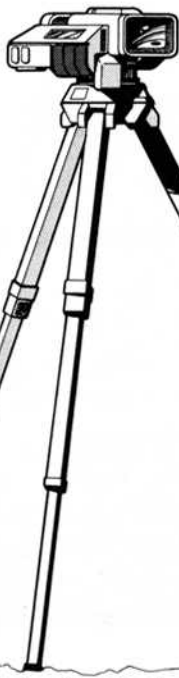

Tech Level 10 version illustrated

## EQUIPMENT STATISTICS

TL	Type	Vol	Wt	Price
○ 10	Lasercom Relay-10	5 liters	1.5kg	Cr2,500
○ 11	Lasercom Relay-11	4 liters	1.2kg	Cr2,500
○ 13	Lasercom Relay-13	3.5 liters	1.0kg	Cr2,000
○ 15	Lasercom Relay-15	3.0 liters	0.8kg	Cr1,500

## SUPPLEMENTAL STATISTICS (OPTIONAL)

TL	Charge Operating Power			Comments
	Duration	Noise	Usage	
○ 10	1 day	soft hum	0.17kw	Rng VD (50km)
○ 11	1 day	none	0.18kw	Rng RG (500 km)
○ 13	2 days	none	0.22w	Rng CN (5,000km), better pen
○ 15	3 days	none	0.35w	Rng PL (50,000km), better pen

## USAGE RECORD (OPTIONAL)

*Each square represents 1 day (24 hours) of usage*



### NOTES:

## DESCRIPTION

The laser communicator is a line-of-sight device, and as such is subject to atmospheric conditions. The extreme range of the lasercom relay is seldom needed on a world's surface, as the distance to the horizon limits the range first. Still, the relay's range does allow tight-beam contact with an orbiting ship as it goes overhead.

The laser communicator's main advantage is that it provides a tight beam, and therefore private, means of communication. Sets of laser communicators can also be lined up to form a "repeater" network. Spaced at a horizon to horizon distance, the units can instantly convey a message around a world by retransmitting it from station to station.

## TASK LIBRARY

To use a lasercom relay to contact an orbiting vessel:  
Difficult, Communication, Edu (unskilled OK)

*Referee:* For ideal conditions, make this task Routine; for poor conditions make this task Formidable.

To configure a lasercom relay network:  
Routine, Communication, Edu

*Referee:* This task assumes the relays are already in place. For ideal conditions, make this task Simple. For poor conditions make this task Difficult.

To use a lasercom relay network to communicate without being discovered:  
Routine, Communication, Edu

*Referee:* For ideal conditions, make this task Simple; for poor conditions make this task Difficult.

To repair a damaged lasercom relay unit:  
[varies], Electronics or Communications, Edu, [varies]

*Referee:* Difficulty depends on the damage level: use the standard damage and repair guidelines. Time increments for shop repair are as follows:

superficial damage	..... 1 min
minor damage	..... 5 min
major damage	..... 1 hrs
destroyed	..... 2 hrs

For field repair, double the time increment, in addition to other standard increases.

# DATA/DISPLAY HEADSET



## EQUIPMENT STATISTICS

TL	Type	Vol	Wt	Price
<input type="radio"/>	12 Data/Display Headset-12	0.2 liters	0.1kg	Cr2,500
<input type="radio"/>	13 Data/Display Headset-13	0.1 liters	0.1kg	Cr5,000
<input type="radio"/>	15 Data/Display Headset-15	0.1 liters	0.1kg	Cr5,000
<input type="radio"/>	16 Data/Display Headset-16	0.1 liters	—	Cr10,000

## SUPPLEMENTAL STATISTICS (OPTIONAL)

	Charge	Operating	Power	
TL	Duration	Noise	Usage	Comments
<input type="radio"/>	12 8 hours	none	0.02kw	2D display image
<input type="radio"/>	13 7 days	none	0.01kw	3D display
<input type="radio"/>	15 15 days	none	0.01kw	3D display
<input type="radio"/>	16 30 days	none	0.005kw	3D display

## USAGE RECORD (OPTIONAL)

Each square represents 1 day (24 hours) of usage

<input type="radio"/>	TL12:	<input checked="" type="checkbox"/>	<input checked="" type="checkbox"/>	<input checked="" type="checkbox"/>	<input checked="" type="checkbox"/>	<input checked="" type="checkbox"/>	<input checked="" type="checkbox"/>	<input checked="" type="checkbox"/>	<input checked="" type="checkbox"/>	<input checked="" type="checkbox"/>	<input checked="" type="checkbox"/>	<input checked="" type="checkbox"/>	<input checked="" type="checkbox"/>	<input checked="" type="checkbox"/>	<input checked="" type="checkbox"/>	<input checked="" type="checkbox"/>	<input checked="" type="checkbox"/>	<input checked="" type="checkbox"/>	<input checked="" type="checkbox"/>	<input checked="" type="checkbox"/>	<input checked="" type="checkbox"/>	<input checked="" type="checkbox"/>
<input type="radio"/>	TL13:	<input type="checkbox"/>	<input type="checkbox"/>	<input type="checkbox"/>	<input type="checkbox"/>	<input type="checkbox"/>	<input type="checkbox"/>	<input type="checkbox"/>	<input type="checkbox"/>	<input type="checkbox"/>	<input type="checkbox"/>	<input type="checkbox"/>	<input type="checkbox"/>	<input type="checkbox"/>	<input type="checkbox"/>	<input type="checkbox"/>	<input type="checkbox"/>	<input type="checkbox"/>	<input type="checkbox"/>	<input type="checkbox"/>	<input type="checkbox"/>	<input type="checkbox"/>
<input type="radio"/>	TL15:	<input type="checkbox"/>	<input type="checkbox"/>	<input type="checkbox"/>	<input type="checkbox"/>	<input type="checkbox"/>	<input type="checkbox"/>	<input type="checkbox"/>	<input type="checkbox"/>	<input type="checkbox"/>	<input type="checkbox"/>	<input type="checkbox"/>	<input type="checkbox"/>	<input type="checkbox"/>	<input type="checkbox"/>	<input type="checkbox"/>	<input type="checkbox"/>	<input type="checkbox"/>	<input type="checkbox"/>	<input type="checkbox"/>	<input type="checkbox"/>	<input type="checkbox"/>
<input type="radio"/>	TL16:	<input type="checkbox"/>	<input type="checkbox"/>	<input type="checkbox"/>	<input type="checkbox"/>	<input type="checkbox"/>	<input type="checkbox"/>	<input type="checkbox"/>	<input type="checkbox"/>	<input type="checkbox"/>	<input type="checkbox"/>	<input type="checkbox"/>	<input type="checkbox"/>	<input type="checkbox"/>	<input type="checkbox"/>	<input type="checkbox"/>	<input type="checkbox"/>	<input type="checkbox"/>	<input type="checkbox"/>	<input type="checkbox"/>	<input type="checkbox"/>	<input type="checkbox"/>

## NOTES:

Tech Level 13 version illustrated

## DESCRIPTION

This headset represents a significant breakthrough in display technology — it can be interfaced with virtually any number of devices of the same or lower tech level, using a multiplexer. The multiplexer not only coordinates the devices for the user but also synchronously records the multiple data signals onto one standard data clip for later review.

It is common for any technician using equipment to wear one of these. Their use is also common among bridge and engineering personnel on starships as well as smaller craft. For example, a surveyor flying in a grav belt and using a neural activity sensor can control both the sensor and his grav belt from his headpiece. If he is also wearing a vacc suit, he can monitor and control his life-support status as well.

The headset allows the wearer to use eye motion to control the movement of device control settings. With practice, the use of the headset to control multiple devices can become as instinctive as flipping a light switch to turn on the lights. When desired, the headpiece can be swung out of the way above the head; when the display is turned off, it is transparent.

About three percent of the population find it difficult to focus properly on the headpiece and are unable to use the device. To determine this for a character, roll 2D when he is generated. A result of 2 disqualifies the character from wearing a headpiece.

## TASK LIBRARY

To use a data/display headset:

Routine, Sensor Op, Edu

*Referee:* Roll only when using the headset for significant device control actions.

To multiplex a device to a data/display headset:

Routine, Sensor Op, Edu

To repair a damaged headset:

[varies], Electronics, Edu, [varies]

*Referee:* Difficulty depends on the damage level: use the standard damage and repair guidelines. Time increments for shop repair are as follows:

superficial damage ..... 1 min  
minor damage ..... 5 min  
major damage ..... 2 hrs  
destroyed ..... 5 hrs

For field repair, double the time increment, in addition to other standard increases.

# GENERAL PURPOSE VACC SUIT

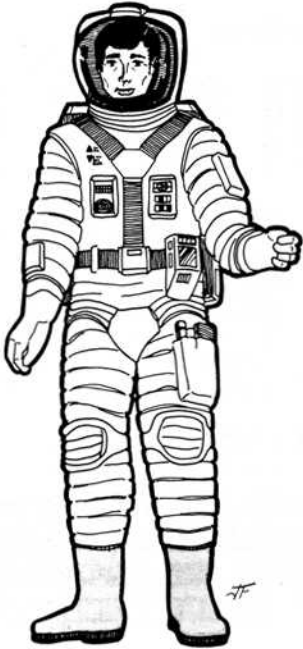

Tech Level 11 version illustrated

### EQUIPMENT STATISTICS

TL	Type	Vol	Wt	Price
○ 9	Gen Purpose Vacc suit-9	3.6 kliters	8kg	Cr7,000
○ 10	Gen Purpose Vacc suit-10	2.7 kliters	6kg	Cr7,000
○ 11	Gen Purpose Vacc suit-11	1.8 kliters	4kg	Cr7,000
○ 12	Gen Purpose Vacc suit-12	0.9 kliters	2kg	Cr7,000
○ 13	Gen Purpose Vacc suit-13	0.7 kliters	1kg	Cr13,000

### SUPPLEMENTAL STATISTICS (OPTIONAL)

#### Charge

TL	Duration	Comments
○ 9	see PLSS	Aarmor=5, encumbrance to Dex -3
○ 10	see PLSS	Aarmor=5, encumbrance to Dex -3
○ 11	see PLSS	Aarmor=5, encumbrance to Dex -2
○ 12	see PLSS	Aarmor=6, encumbrance to Dex -1
○ 13	see PLSS	Aarmor=6, encumbrance to Dex -1, self-sealing

### PLSS USAGE RECORD (OPTIONAL)

Each square represents \_\_\_\_\_ of usage

○ TL9:																				
○ TL10:																				
○ TL11:																				
○ TL12:																				
○ TL13:																				

### NOTES:

## DESCRIPTION

At lower tech levels, general purpose vacc suits are unwieldy and uncomfortable, but they become lighter and more flexible with each technological advance. At the higher tech levels, the suits provide improved armor protection. At tech level 13, the suit becomes self-sealing.

General purpose vacc suits consist of suit, gloves, boot, and standard helmet; they protect against temperatures from +100°C to -110°C and pressures of up to 5 atm.

These suits all require a PLSS backpack for power and oxygen. The PLSS backpacks are listed on a separate sheet.

## TASK LIBRARY

To put on or take off a GP vacc suit:

Routine, Vacc Suit, Dex, 12 sec (unskilled OK)

*Referee:* This task becomes Simple if the vacc suit is TL12+..

To use a GP vacc suit without incident:

Routine, Vacc Suit, Dex (unskilled OK, fateful)

*Referee:* Roll once for short excursions — two or three times for longer outings.

To apply a patch to a breached GP vacc suit:

Routine, Dex, 2 sec

*Referee:* Since a combat round is 6 sec, this task may take several rounds. After the first round, apply 1D damage to the character in the suit each round until the suit is patched.

To repair a damaged GP vacc suit:

[varies], Mechanical, Dex, [varies]

*Referee:* Difficulty depends on the damage level: use the standard damage and repair guidelines. Time increments for shop repair are as follows:

superficial damage ..... 1 min

minor damage ..... 5 min

major damage ..... 1 hr

destroyed ..... 2 hrs

For field repair, double the time increment, in addition to other standard increases.

# PORTABLE LIFE SUPPORT SYSTEM (PLSS A)

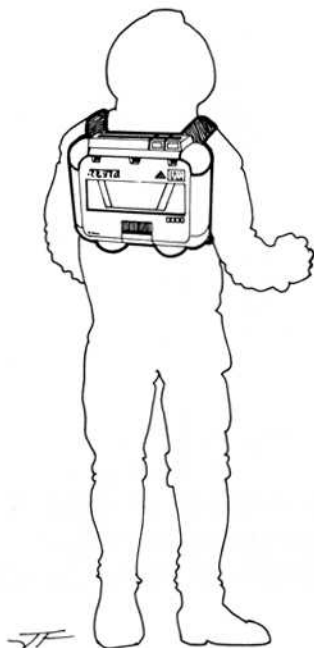

## EQUIPMENT STATISTICS

TL	Type	Vol	Wt	Price
○ 9	PLSS A-9	11 liters	7.0kg	Cr3,000
○ 12	PLSS A-12	7 liters	4.0kg	Cr3,000
○ 14	PLSS A-14	1.5 liters	0.5kg	Cr3,000

## SUPPLEMENTAL STATISTICS (OPTIONAL)

TL	Charge Duration	Operating Noise	Power Usage	Comments
○ 9	4 hrs	none	0.35kw	Standard oxy refill
○ 12	4 hrs	none	0.25kw	High press. oxy refill
○ 14	12 hrs	none	0.5kw	Ultra hi-press. oxy refill (recycle)

## USAGE RECORD (OPTIONAL)

Each square represents 3 hours of usage

○ TL9:	<input checked="" type="checkbox"/>	<input checked="" type="checkbox"/>	<input checked="" type="checkbox"/>	<input checked="" type="checkbox"/>	<input checked="" type="checkbox"/>	<input checked="" type="checkbox"/>	<input checked="" type="checkbox"/>	<input checked="" type="checkbox"/>	<input checked="" type="checkbox"/>	<input checked="" type="checkbox"/>
○ TL12:	<input checked="" type="checkbox"/>	<input checked="" type="checkbox"/>	<input checked="" type="checkbox"/>	<input checked="" type="checkbox"/>	<input checked="" type="checkbox"/>	<input checked="" type="checkbox"/>	<input checked="" type="checkbox"/>	<input checked="" type="checkbox"/>	<input checked="" type="checkbox"/>	<input checked="" type="checkbox"/>
○ TL14:	<input type="checkbox"/>	<input type="checkbox"/>	<input type="checkbox"/>	<input type="checkbox"/>	<input type="checkbox"/>	<input type="checkbox"/>	<input type="checkbox"/>	<input type="checkbox"/>	<input type="checkbox"/>	<input type="checkbox"/>

## NOTES:

Tech Level 12 version illustrated

## DESCRIPTION

A portable life support system (PLSS) is a necessity with a vacc suit — the PLSS is a self-contained unit that supplies the suit with its power and air supply. The PLSS backpack plugs into the back of any of the standard vacc suit designs, and it is operated from the suit's standard controls.

The PLSS A unit is the lightest and most compact of the various PLSS units. It also has the shortest duration.

## TASK LIBRARY

To put on or take off a PLSS unit:

Routine, Vacc Suit, Dex, 12 sec (unskilled OK)

*Referee:* This task becomes Simple if the unit is TL14.

To recharge a used PLSS unit:

Routine, Vacc Suit, Edu, 20 min (unskilled OK)

To repair a damaged PLSS suit:

[varies], Electronics, Edu, [varies]

*Referee:* Difficulty depends on the damage level: use the standard damage and repair guidelines. Time increments for shop repair are as follows:

superficial damage ..... 2 min

minor damage ..... 5 min

major damage ..... 2 hrs

destroyed ..... 5 hrs

For field repair, double the time increment, in addition to other standard increases.

# PORTABLE LIFE SUPPORT SYSTEM (PLSS B)

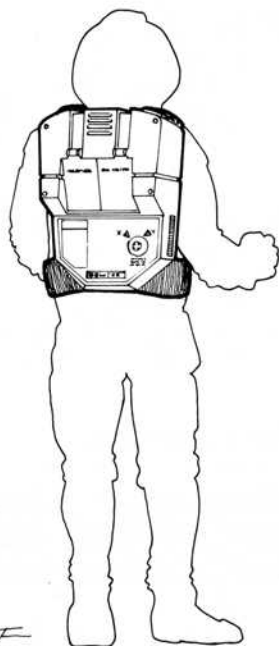

Tech Level 12 version illustrated

## EQUIPMENT STATISTICS

TL	Type	Vol	Wt	Price
<input type="radio"/>	9 PLSS B-9	20 liters	14.5kg	Cr5,000
<input type="radio"/>	12 PLSS B-12	16 liters	11.0kg	Cr5,000
<input type="radio"/>	14 PLSS B-14	3.5 liters	2.5kg	Cr5,000

## SUPPLEMENTAL STATISTICS (OPTIONAL)

TL	Charge Duration	Operating Noise	Power Usage	Comments
<input type="radio"/>	9 24 hrs	none	0.75kw	Standard oxy refill (recycle)
<input type="radio"/>	12 24 hrs	none	0.65kw	High press. oxy refill (recycle)
<input type="radio"/>	14 24 hrs	none	0.95kw	Ultra hi-press. oxy refill (recycle)

## USAGE RECORD (OPTIONAL)

Each square represents 3 hours of usage

<input type="radio"/>	TL9:	<input type="checkbox"/> <input type="checkbox"/> <input type="checkbox"/> <input type="checkbox"/> <input type="checkbox"/> <input type="checkbox"/> <input type="checkbox"/> <input type="checkbox"/> <input type="checkbox"/> <input type="checkbox"/> <input type="checkbox"/>	<input type="checkbox"/> <input type="checkbox"/> <input type="checkbox"/> <input type="checkbox"/> <input type="checkbox"/> <input type="checkbox"/> <input type="checkbox"/> <input type="checkbox"/> <input type="checkbox"/> <input type="checkbox"/>
<input type="radio"/>	TL12:	<input type="checkbox"/> <input type="checkbox"/> <input type="checkbox"/> <input type="checkbox"/> <input type="checkbox"/> <input type="checkbox"/> <input type="checkbox"/> <input type="checkbox"/> <input type="checkbox"/> <input type="checkbox"/>	<input type="checkbox"/> <input type="checkbox"/> <input type="checkbox"/> <input type="checkbox"/> <input type="checkbox"/> <input type="checkbox"/> <input type="checkbox"/> <input type="checkbox"/> <input type="checkbox"/> <input type="checkbox"/>
<input type="radio"/>	TL14:	<input type="checkbox"/> <input type="checkbox"/> <input type="checkbox"/> <input type="checkbox"/> <input type="checkbox"/> <input type="checkbox"/> <input type="checkbox"/> <input type="checkbox"/> <input type="checkbox"/> <input type="checkbox"/>	<input type="checkbox"/> <input type="checkbox"/> <input type="checkbox"/> <input type="checkbox"/> <input type="checkbox"/> <input type="checkbox"/> <input type="checkbox"/> <input type="checkbox"/> <input type="checkbox"/> <input type="checkbox"/>

## NOTES:

### DESCRIPTION

A portable life support system (PLSS) is a necessity with a vacc suit — the PLSS is a self-contained unit that supplies the suit with its power and air supply. The PLSS backpack plugs into the back of any of the standard vacc suit designs, and it is operated from the suit's standard controls.

The PLSS B unit is moderate weight unit with a useful duration of 24 hours.

### TASK LIBRARY

To put on or take off a PLSS unit:

Routine, Vacc Suit, Dex, 12 sec (unskilled OK)

*Referee:* This task becomes Simple if the unit is TL14.

To recharge a used PLSS unit:

Routine, Vacc Suit, Edu, 20 min (unskilled OK)

To repair a damaged PLSS unit:

[varies], Electronics, Edu, [varies]

*Referee:* Difficulty depends on the damage level: use the standard damage and repair guidelines. Time increments for shop repair are as follows:

superficial damage .....	2 min
minor damage .....	5 min
major damage .....	2 hrs
destroyed .....	5 hrs

For field repair, double the time increment, in addition to other standard increases.

# PORTABLE LIFE SUPPORT SYSTEM (PLSS C)

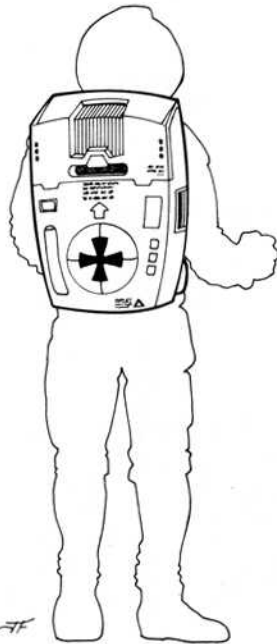

## EQUIPMENT STATISTICS

TL	Type	Vol	Wt	Price
○ 9	PLSS C-9	55 liters	29.0kg	Cr8,000
○ 12	PLSS C-12	30 liters	18.0kg	Cr8,000
○ 14	PLSS C-14	7 liters	3.5kg	Cr8,000

## SUPPLEMENTAL STATISTICS (OPTIONAL)

TL	Charge Duration	Operating Noise	Power Usage	Comments
○ 9	48 hrs	none	1.3kw	Standard oxy refill (recycle)
○ 12	48 hrs	none	1.2kw	High press. oxy refill (recycle)
○ 14	48 hrs	none	1.6kw	Ultra hi-press. oxy refill (recycle)

## USAGE RECORD (OPTIONAL)

Each square represents 3 hours of usage

○ TL9:	<input type="checkbox"/>	<input type="checkbox"/>	<input type="checkbox"/>	<input type="checkbox"/>	<input type="checkbox"/>	<input type="checkbox"/>	<input type="checkbox"/>	<input type="checkbox"/>	<input type="checkbox"/>	<input type="checkbox"/>	<input type="checkbox"/>	<input type="checkbox"/>	<input type="checkbox"/>	<input type="checkbox"/>	<input type="checkbox"/>	<input type="checkbox"/>	<input type="checkbox"/>	<input type="checkbox"/>	
○ TL12:	<input type="checkbox"/>	<input type="checkbox"/>	<input type="checkbox"/>	<input type="checkbox"/>	<input type="checkbox"/>	<input type="checkbox"/>	<input type="checkbox"/>	<input type="checkbox"/>	<input type="checkbox"/>	<input type="checkbox"/>	<input type="checkbox"/>	<input type="checkbox"/>	<input type="checkbox"/>	<input type="checkbox"/>	<input type="checkbox"/>	<input type="checkbox"/>	<input type="checkbox"/>	<input type="checkbox"/>	<input type="checkbox"/>
○ TL14:	<input type="checkbox"/>	<input type="checkbox"/>	<input type="checkbox"/>	<input type="checkbox"/>	<input type="checkbox"/>	<input type="checkbox"/>	<input type="checkbox"/>	<input type="checkbox"/>	<input type="checkbox"/>	<input type="checkbox"/>	<input type="checkbox"/>	<input type="checkbox"/>	<input type="checkbox"/>	<input type="checkbox"/>	<input type="checkbox"/>	<input type="checkbox"/>	<input type="checkbox"/>	<input type="checkbox"/>	<input type="checkbox"/>

## NOTES:

Tech Level 12 version illustrated

## DESCRIPTION

A portable life support system (PLSS) is a necessity with a vacc suit — the PLSS is a self-contained unit that supplies the suit with its power and air supply. The PLSS backpack plugs into the back of any of the standard vacc suit designs, and it is operated from the suit's standard controls.

The PLSS C unit is the heaviest and has the greatest duration of the various PLSS units. A PLSS C unit includes a thruster unit capable of 1gee acceleration for 60 seconds.

## TASK LIBRARY

To put on or take off a PLSS unit:

Routine, Vacc Suit, Dex, 12 sec (unskilled OK)

*Referee:* This task becomes Simple if the unit is TL14.

To recharge a used PLSS unit:

Routine, Vacc Suit, Edu, 20 min (unskilled OK)

To repair a damaged PLSS suit:

[varies], Electronics, Edu, [varies]

*Referee:* Difficulty depends on the damage level: use the standard damage and repair guidelines. Time increments for shop repair are as follows:

superficial damage ..... 2 min

minor damage ..... 6 min

major damage ..... 3 hrs

destroyed ..... 6 hrs

For field repair, double the time increment, in addition to other standard increases.

# TAILORED VACC SUIT



Tech Level 15 soft helmet version

## EQUIPMENT STATISTICS

TL	Type	Vol	Wt	Price
○ 14	Vacc suit, soft helmet-14	0.2 kliters	—	Cr12,000
○ 14	Vacc suit, hard helmet-14	0.2 kliters	1.0kg	Cr13,200
○ 15	Vacc suit, soft helmet-15	0.2 kliters	—	Cr9,000
○ 15	Vacc suit, hard helmet-15	0.2 kliters	1.0kg	Cr10,200

## SUPPLEMENTAL STATISTICS (OPTIONAL)

TL	Duration	Comments
○ 14	see PLSS	A armor=7, no encumbrance, duration x 0.5
○ 14	see PLSS	A armor=7, no encumbrance
○ 15	see PLSS	A armor=7, no encumbrance, duration x 0.5
○ 15	see PLSS	A armor=7, no encumbrance

## PLSS USAGE RECORD (OPTIONAL)

Each square represents \_\_\_\_\_ of usage

○ TL14:	<input type="checkbox"/>	(x 0.5)
○ TL14:	<input type="checkbox"/>	
○ TL15:	<input type="checkbox"/>	(x 0.5)
○ TL15:	<input type="checkbox"/>	

## NOTES:

## DESCRIPTION

When Scouts are in the field away from civilization, (for example, when on shipboard survey or planetside wilderness exploration), the field duty uniform is the tailored Tech Level 15 vacc suit.

These suits protect against temperatures from +100°C to -110°C and pressures of up to 5 atmospheres. The suit includes a soft helmet and gloves, and can easily be used with a PLSS unit. The most common field configuration is the soft helmet, gloves, and PLSS A.

When the environment doesn't call for a sealed vacc suit, the soft helmet and gloves can be folded up and stored in one of the pockets on the vacc suit. Even unsealed, the suit is comfortable: it provides uniform cooling or heating—making it particularly comfortable in hot or cold environments (+50°C to -10°C).

For minor rips and tears (minor damage), the suit is automatically self-sealing.

## TASK LIBRARY

To put on or take off a tailored vacc suit:  
Simple, Vacc Suit, Dex, 6 sec (unskilled OK)

To use a tailored vacc suit in vacuum mode without incident:  
Routine, Vacc Suit, Dex (unskilled OK, fateful)

*Referee:* Roll once for short excursions — two or three times for longer outings.

To apply a patch to a torn tailored vacc suit:  
Routine, Dex, 2 sec

*Referee:* Since a combat round is 6 sec, this task may take several rounds. After the first round, apply 1D damage to the character in the suit each round until the suit is patched.

To repair a damaged tailored vacc suit:  
[varies], Mechanical, Dex, [varies]

*Referee:* Difficulty depends on the damage level: use the standard damage and repair guidelines. Time increments for shop repair are as follows:

superficial damage ..... 15 sec  
minor damage ..... 1 min  
major damage ..... 1 hr  
destroyed ..... 2 hrs

For field repair, double the time increment, in addition to other standard increases.



# LIGHT DUTY VACC SUIT



Tech Level 12 version illustrated

## EQUIPMENT STATISTICS

TL	Type	Vol	Wt	Price
○ 10	Light Duty Vacc Suit-10	19.0 liters	1.5kg	Cr15,750
○ 12	Light Duty Vacc Suit-12	16.5 liters	1.4kg	Cr14,500
○ 14	Light Duty Vacc Suit-14	15.0 liters	1.1kg	Cr13,300

## SUPPLEMENTAL STATISTICS (OPTIONAL)

Charge			
TL	Duration	Comments	
○ 10	15 min	Armor=(1), no encumbrance	
○ 12	20 min	Armor=(2), no encumbrance	
○ 14	30 min	Armor=2, no encumbrance	

## USAGE RECORD (OPTIONAL)

Each square represents 1 min of usage

○ TL10:	[10 squares]	_____
○ TL12:	[12 squares]	_____
○ TL14:	[14 squares]	_____

## NOTES:

### DESCRIPTION

The light duty vacc suit is a lightweight and comfortable alternative to the general purpose vacc suit. The suit is designed to work for short periods of time under mildly hostile atmospheric conditions. It can be worn under clothes or armor.

The suit includes a special air cartridge that supplies air for 15 to 30 minutes. A standard PLSS backpack can be used instead, if desired.

The suit protects against temperatures +50°C to -40°C and pressures up to 2.5 atm.

### TASK LIBRARY

To put on or take off a light duty vacc suit:

Routine, Vacc Suit, Dex, 12 sec (unskilled OK)

*Referee:* This task becomes Simple if the vacc suit is TL12+..

To use a light duty vacc suit without incident:

Routine, Vacc Suit, Dex (unskilled OK, fateful)

*Referee:* Roll once for short excursions — two or three times for longer outings.

To apply a patch to a torn light duty vacc suit:

Routine, Dex, 2 sec

*Referee:* Since a combat round is 6 sec, this task may take several rounds. After the first round, apply 1D damage to the character in the suit each round until the suit is patched.

To repair a damaged light duty vacc suit:

[varies], Mechanical, Dex, [varies]

*Referee:* Difficulty depends on the damage level: use the standard damage and repair guidelines. Time increments for shop repair are as follows:

superficial damage .....	15 sec
minor damage .....	1 min
major damage .....	1 hr
destroyed .....	2 hrs

For field repair, double the time increment, in addition to other standard increases.

# HOSTILE ENVIRONMENT VACC SUIT

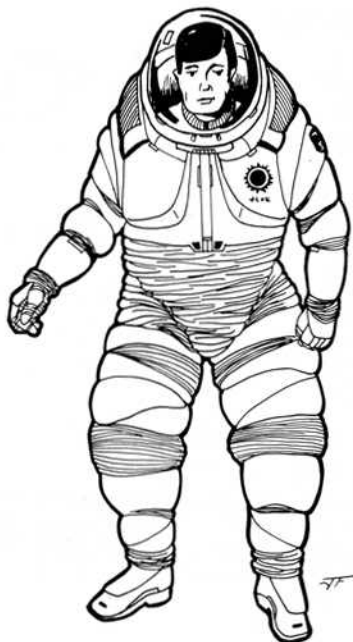

Tech Level 13 version illustrated

## EQUIPMENT STATISTICS

TL	Type	Vol	Wt	Price
○ 8	Hostile Environ Vacc suit-8	4.6 kliters	35kg	Cr12,000
○ 9	Hostile Environ Vacc suit-9	4.1 kliters	40kg	Cr16,000
○ 12	Hostile Environ Vacc suit-12	3.7 kliters	10kg	Cr18,000
○ 13	Hostile Environ Vacc suit-13	5.9 kliters	55kg	Cr100,000
○ 14	Hostile Environ Vacc suit-14	5.7 kliters	45kg	Cr150,000

## SUPPLEMENTAL STATISTICS (OPTIONAL)

TL	Charge	Duration	Comments
○ 8	see PLSS	Armor=6	encumbrance to Dex -3
○ 9	see PLSS	Armor=7	encumbrance to Dex -3
○ 12	see PLSS	Armor=8	encumbrance to Dex -3
○ 13	see PLSS	Armor=12	encumbrance to Dex -3, powered
○ 14	see PLSS	Armor=18	encumbrance to Dex -2, powered

## PLSS USAGE RECORD (OPTIONAL)

Each square represents \_\_\_\_\_ of usage

○ TL8:																						
○ TL9:																						
○ TL12:																						
○ TL13:																						
○ TL14:																						

## NOTES:

## DESCRIPTION

Hostile environment suits are usually hard molded and specially designed for corrosive or insidious atmospheric conditions. They have extra heavy shielding around the joints. This makes them heavier and more unwieldy, but when they are needed, nothing else will do.

The TL 8 suit protects against temperatures +150°C to -160°C and pressures up to 10 atm.

The TL 9 suit protects against temperatures +200°C to -180°C and pressures up to 10 atm.

The TL 12 suit protects against temperatures +500°C to -180°C and pressures up to 100 atm.

The TL 13 suit protects against temperatures +1300°C to -200°C and pressures up to 1000 atm.

The TL 14 suit protects against temperatures +1800°C to -250°C and pressures up to 1500 atm.

## TASK LIBRARY

To put on or take off a hostile environ vacc suit:

Routine, Vacc Suit (or Battle Dress if powered), Dex, 1 min

To use a hostile environ vacc suit without incident:

Routine, Vacc Suit (or Battle Dress if powered), Dex (fateful, hazardous)

*Referee:* Roll once for short excursions — two or three times for longer outings.

To apply a patch to a breached hostile environ vacc suit:

Difficult, Dex, 6 sec

*Referee:* Since a combat round is 6 sec, this task may take several rounds. After the first round, apply 2D damage to the character in the suit each round until the suit is patched. If the environment is *very hostile*, this task is Formidable.

To repair a damaged hostile environ vacc suit:

[varies], Mechanical, Dex, [varies]

*Referee:* Difficulty depends on the damage level: use the standard damage and repair guidelines. Time increments for shop repair are as follows:

superficial damage	.....	1 min
minor damage	.....	10 min
major damage	.....	2 hrs
destroyed	.....	4 hrs

For field repair, double the time increment, in addition to other standard increases.

# UTILITY VEST



Tech Level 12 version illustrated

## EQUIPMENT STATISTICS

TL	Type	Vol	Wt	Price
○ 6	Utility Vest-6	7 liters	—	Cr100
○ 8	Utility Vest-8	6 liters	—	Cr250
○ 12	Utility Vest-12	4 liters	—	Cr600

## SUPPLEMENTAL STATISTICS (OPTIONAL)

TL	Duration	Comments
○ 6	indefinite	Cotton Cloth, 6 liters of storage
○ 8	indefinite	Ripstop Nylon Cloth, 7.5 liters of storage
○ 12	indefinite	Levanex Cloth, 12 liters of storage

## NOTES:

## DESCRIPTION

The utility vest is a handy adjunct to the field excursion wardrobe. Its light weight and many storage pockets make it useful for carrying all manner of equipment. The vest can be easily put on and taken off because of its zipper closure in the front.

The tech 12 version of the vest is made of levanex, a high-tech fabric. Levanex is a light yet tough fabric that is impossible to rip. The fabric also acts as a good vapor barrier from the outside in, but ventilates well from the inside out. The pockets on the tech 12 version are a special stretch variation of levanex (called levanex-R). The pockets can be over-stuffed and they will stretch, and still remain tightly sealed — providing an excellent barrier to outside moisture. Levanex also resists lightly corrosive environments quite well.

## TASK LIBRARY

To use a utility vest on a outing without incident:  
Routine, Dex, Int (fateful)

*Referee:* Only roll if the vest not the tech 12 version. For a typical outing, roll once. For longer trips, roll two or three times.

To repair a damaged vest:  
[varies], Dex, Edu, [varies]

*Referee:* Difficulty depends on the damage level: use the standard damage and repair guidelines. Time increments for shop repair are as follows:

superficial damage ..... 10 sec  
minor damage ..... 1 min  
major damage ..... 10 min  
destroyed ..... 4 hrs

For field repair, double the time increment, in addition to other standard increases.



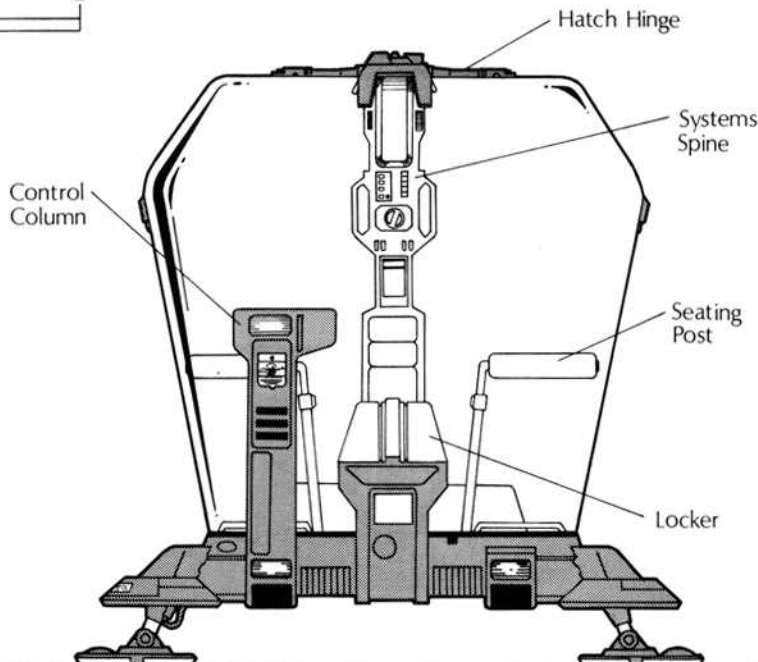
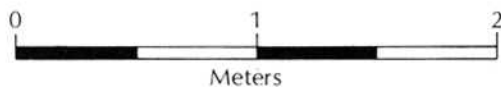

FRONT VIEW

**ENCLOSED TWO-MAN CASLINE G-TUBE**

- CraftID:** *Casline* G-Tube, TL 12, Cr342,000
- Hull:** 1/2, Disp=0.5, Config=4USL, Armor=1F, Unloaded=0.9 tons, Loaded=1.0 tons
- Power:** 1/2, Fuel Cell x 2=0.18Mw, Dur=2/6
- Loco:** 1/2, LP Lt Grav, Thrust=1.2 tons, NOE=160kph, Cruise=225kph, Top=300kph, MaxAccel=0.25G
- Commo:** Radio=Cont (5,000km)
- Sensors:** Act EMS=Dist (5km), Headlights x 2, ActObjScan=Form
- Off/Def:** Hardpoints=1
- Control:** Dyn Link, HUD
- Accom:** Crew=1 (Operator), Seats=Cramped x 2, Env=Basic env, basic ls, inert comp
- Other:** Fuel=0.4kl, Cargo=0.14kl, ObjSize=Small, EmLevel=Moderate

The *Casline* class G-tube is essentially an enclosed, air-conditioned "grav belt" for two people.

The G-tube includes a heads-up status display for the operator, who should have air/raft skill or grav belt skill for safe operation. It has 2 seating posts (side by side), a 140 liter locker, a control panel, a heater/air conditioner, a sealed environment (the equivalent of a tech level 9 PLSS B for two people, giving a duration of 24 hours), landing and navigation lights, a continental range communicator, and a distant range full-band EMS sensor.

Each passenger also has enough room to carry up to 25 liters of equipment (50 liters total) in the riding area. The

occupants can fit in the G-tube while wearing a tech level 14+ vacc suit or a tech level 10+ light duty vacc suit. Standard vacc suits of tech level 13 or less are too bulky to allow the occupants to fit in the G-tube.

A fuel capacity of 400 liters provides the power for 48 hours hours of 1,200kg thrust.

The ride in the G-tube is very smooth. Although riders are not sitting, but rather leaning against one of the seat posts with their feet slipped under floor straps, inertial compensators guarantee comfort. Even if the vehicle were flying upside down, with their eyes closed the riders would be unaware of any sensation of motion.

**TASK LIBRARY:**

- To fly a g-tube without incident:  
Routine, Grav Veh, Dex (fateful)
- Referee:* Roll once for short trips, two or three times for longer journeys.

To repair a damaged g-tube:  
[varies], Gravitics, Edu, [varies]  
*Referee:* Difficulty depends on the damage level: use the standard damage and repair guidelines. Time increments for shop repair are as follows:

- superficial damage ..... 2 min
- minor damage..... 15 min
- major damage..... 6 hrs
- destroyed..... 15 hrs

For field repair, double the time increment, in addition to other standard increases.

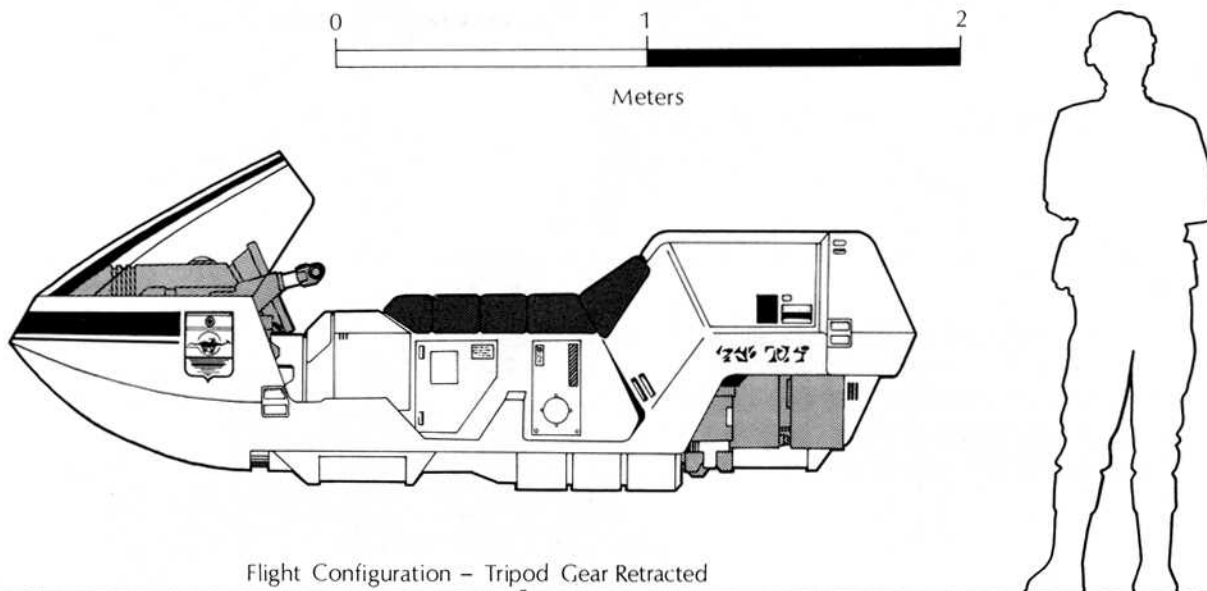

Flight Configuration - Tripod Gear Retracted

**TWO MAN TRASEA GRAV "BIKE"**

- CraftID:** Trasea Grav Bike, TL 12, Cr171,600
- Hull:** 1/2, Disp=0.25, Config=4SL, Armor=1F, Unloaded=1.0 tons, Loaded=1.1 tons
- Power:** 1/2, Fuel Cell x 3=0.27Mw, Dur=2/6
- Loco:** 1/2, LP Hvy Grav, Thrust=1.3 tons, NOE=160kph, Cruise=225kph, Top=300kph, MaxAccel=0.25G
- Commo:** Radio=Rgnl (500km)
- Sensors:** Act EMS=Dist (5km), Headlights x 2, ActObjScan=Form
- Off/Def:** Hardpoints=1
- Control:** Computer=0 x 2, DynLink, HUD
- Accom:** Crew=1 (Operator), Seats=Cramped x 2, Open-topped
- Other:** Fuel=0.6kl, Cargo=0.05kl, ObjSize=Small, EmLevel=Moderate

The *Trasea* class grav "bike" is a popular alternative to a grav belt. It costs very little more than a grav belt and has cargo space besides. In addition, it can carry a second rider, who can work (or shoot) undistracted while the pilot flies the craft.

The vehicle also includes complete computer control (with backup) allowing the operator to work undistracted while the craft flies itself to the desired destination. Manual control is recommended during hazardous or combat situation, however.

The craft's parabolic nose and windshield are designed both for streamlined flight and to protect its riders. Carrying 600 liters of fuel, the craft can mount 1,300kg of thrust for up to 48 continuous hours. In 8 hour shifts, the fuel supply will last for 6 full days. A hatch in the rear opens to a cargo space of 50 liters.

The grav bike has built-in avionics, giving it good nap-of-earth abilities, which the belt does not have. Since, however, the bike has no inertial compensators, certain precautions are necessary for NOE flights.

**TASK LIBRARY:**

To fly a grav "bike" without incident:  
 Routine, Grav Veh, Dex (fateful)  
*Referee:* Roll once for short trips, two or three times for longer journeys.

To avoid nausea on a grav bike NOE flight:  
 Difficult, Grav Veh, End (fateful)  
*Referee:* One roll per NOE flight. If a mishap occurs:  
 Superficial — character is sick; roll again  
 Minor — character must slow craft or reroll as hazardous  
 Major — character must stop craft or reroll as hazardous.  
 Above tech level 10, drugs are available that make this task unnecessary.

To repair a damaged grav bike:  
 [varies], Gravitics, Edu, [varies]  
*Referee:* Difficulty depends on the damage level: use the standard damage and repair guidelines. Time increments for shop repair are as follows:

superficial damage .....	2 min
minor damage.....	15 min
major damage.....	6 hrs
destroyed.....	15 hrs

For field repair, double the time increment, in addition to other standard increases.

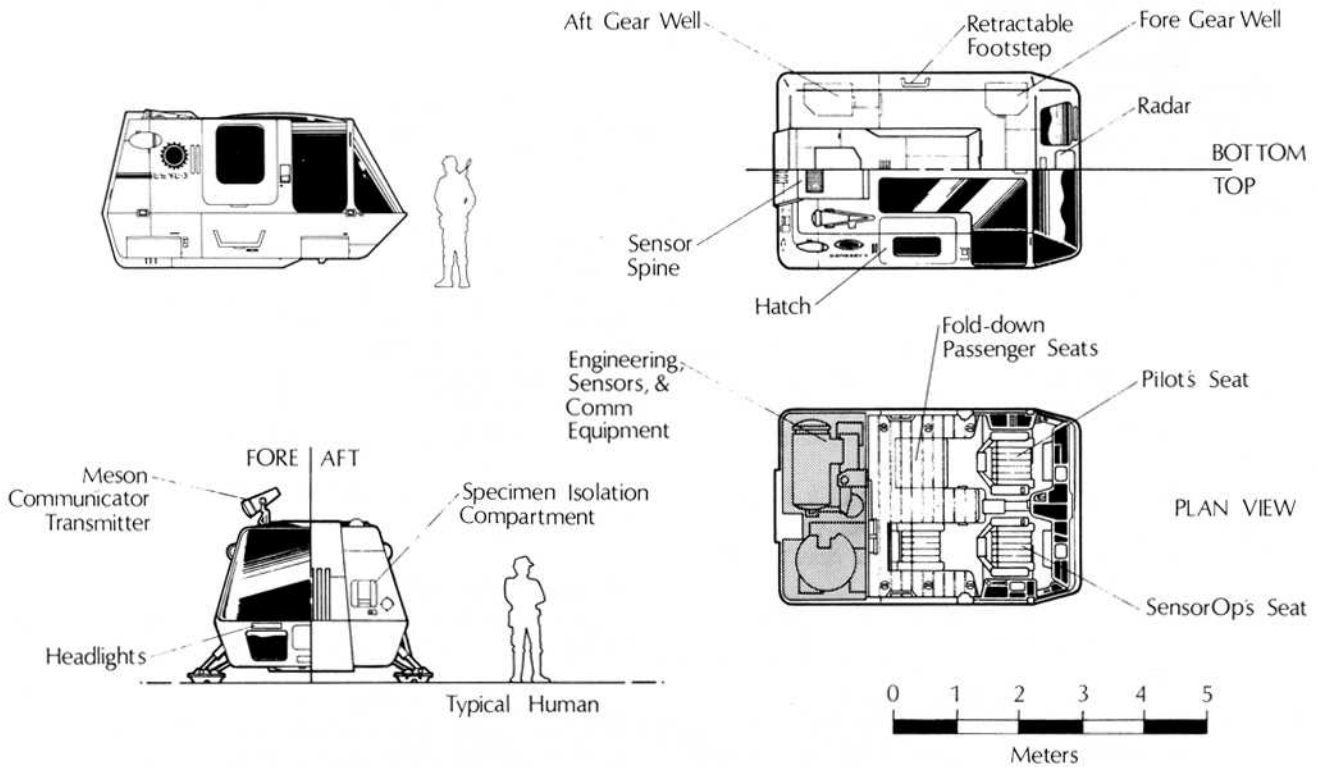

**FOUR MAN HURRICANE AIR/RAFT**

- CraftID:** Hurricane Air/Raft, TL 15, Cr5,085,600
- Hull:** 3/7, Disp=3, Config=4USL, Armor=10G, Unloaded=10 tons, Loaded=17 tons
- Power:** 1/2, Fusion=6Mw, Dur=20/59
- Loco:** 1/2, Std Grav, Thrust=21 tons, NOE=190kph, Cruise=180kph, Top=240kph, MaxAccel=0.2G
- Commo:** Radio=Cont (5,000km) x 2, Meson=Cont (5,000km)
- Sensors:** Act EMS=Dist (50km), Neutrino=10kw, Pass EMS=VDist (50km), Headlights x 2, Densitometer=HiPen/1km, NAS Sensor=VLong (0.5km), ActObjScan=Diff, ActObjPin=Diff, PassObjScan=Rout, PassObjPin=Rout, PassEngScan=Rout, PassEngPin=Rout (see page 46)
- Off/Def:** Hardpoints=1
- Control:** Computer=0/bis x 2, Holo Dyn Link x 1, HUD
- Accom:** Crew=1 (Operator), Seats=Adequate x 4 Env=Basic env, basic ls, ext ls, grav plates, inert comp
- Other:** Fuel=4kl, Cargo=7kl, ObjSize=Small, EmLevel=Moderate

The Hurricane class air/raft is a popular model with all-imperial military services, but especially popular with Scouts. More than 60,000 of these vehicles are in use by the Scouts throughout the Imperial region.

With its fuel supply of 4,000 liters, the air/raft has an oper-

ational duration of 20 full days, or 60 days with 8-hour shifts.

The air/raft's sealed environment can be pressurized to provide full life support for its crew. EMS active and passive sensors, a neutrino sensor, and a densitometer give a full range of information to the surveyors on board. A meson communicator allows near-instant contact with any other station within continental range.

Besides the pilot and three passengers, the air/raft can carry 7 kiloliters of cargo. With two passenger seats folded out of the way, the vehicle can carry twice as much cargo: 14 kiloliters in all.

Three Hurricane air/rafts are typically carried by a Donosev class Scout survey ship.

**TASK LIBRARY:**

To fly an air/raft without incident:

Routine, Grav Veh, Dex (fateful)

Referee: Roll once for short trips, two or three times for longer journeys.

To repair a damaged air/raft:

[varies], Gravitics, Edu, [varies]

Referee: Difficulty depends on the damage level: use the standard damage and repair guidelines. Time increments for shop repair are as follows:

- superficial damage ..... 2 min
- minor damage..... 20 min
- major damage..... 8 hrs
- destroyed..... 20 hrs

For field repair, double the time increment, in addition to other standard increases.

**TL15 KANKURUR G-CARRIERTASK LIBRARY:**

**CraftID:** Kankurur G-Carrier, TL 15, Cr10,630,600  
**Hull:** 10/25, Disp=11, Config=4SL, Armor=10G, Unloaded=55 tons, Loaded=82 tons  
**Power:** 1/2, Fusion=25Mw, Dur=20/60  
**Loco:** 1/2, Std Grav, Thrust=99 tons, NOE=190kph, Cruise=180kph, Top=240kph, MaxAccel=0.2G  
**Commo:** Radio=Cont (5,000km) x 2, Meson=Planetary (50,000km)  
**Sensors:** Act EMS=Dist (50km), Pass EMS=VDist (50km), Neutrino=10kw, Densitometer=HighPen/1km, NAS Sensor=VLong (0.5km), Headlights x 2, ActObjScan=Diff, ActObjPin=Diff, PassObjScan=Rout, PassObjPin=Rout, PassEngScan=Rout, PassEngPin=Rout  
**Off/Def:** Hardpoints=1  
**Control:** Computer=0/bis x 2, Holo Dyn Link, HUD  
**Accom:** Crew=1 (Operator), Seats=Roomy x 6, Env=Basic env, basic ls, ext ls, grav plates, inert comp  
**Other:** Fuel=22kl, Cargo=27kl, ObjSize=Small, EmLevel=Moderate

The *Kankurur* class G-Carrier, manufactured by the Imperial megacorporation Ling Standard Products, is heavily used by the Scouts and the Navy. The craft mounts a full array of sensors and a planetary range meson communicator, which makes the *Kankurur* quite useful for survey and reconnaissance missions.

The *Kankurur* class was designed in 1095; the first model was commissioned in 1097. Individual models are named after significant life forms on member worlds of the Imperium. The *kankurur* is a large bird of prey native to Vland. Capable of carrying up to 20kg in its talons, the bird was trained and used like the Terran carrier pigeon. The *kankurur* could carry not only paper messages, but also small cargoes.

The vehicle is of tech level 15 construction throughout, with features to support both survey and exploration missions with full crews.

With its fuel supply of 22,000 liters, the air/raft has an operational duration of 20 full days; this equates to 60 days of 8-hour shifts.

With its ultraheavy grav modules providing 99 tons of thrust, the Scout G-carrier has a top speed of 240kph, with a cruising speed of 180kph and a NOE speed of 190kph.

The G-carrier's sealed environment can be pressurized to provide full life support for its crew. An airlock in the aft section opens to the roof as well as aft. A galley, four fold-up bunks, and a fresher allow extended missions.

EMS active and passive sensors, a neutrino sensor, and a densitometer give a full range of information to the surveyors on board. A meson communicator allows near-instant contact with any other station within planetary range.

Besides the pilot and five passengers, the G-carrier can carry 7 kiloliters of cargo in the main cabin and 20 kiloliters

in the airlock. Unloaded, the craft weighs 55 tons; with crew and maximum cargo, it weights 88 tons. The G-carrier as described costs MCr10.631.

**TASK LIBRARY:**

To fly a G-carrier without incident:  
 Routine, Grav Veh, Dex (fateful)  
*Referee:* Roll once for short trips, two or three times for longer journeys.

To repair a damaged G-carrier:  
 [varies], Gravitics, Edu, [varies]  
*Referee:* Difficulty depends on the damage level: use the standard damage and repair guidelines. Time increments for shop repair are as follows:  
 superficial damage ..... 2 min  
 minor damage..... 20 min  
 major damage..... 8 hrs  
 destroyed..... 20 hrs  
 For field repair, double the time increment, in addition to other standard increases.

**SENSOR OPERATION**

Here are the Sensor Difficulty Tables (difficulty is by range) for the various vehicles presented in this section.

**Kankurur G-Carrier and Hurricane Air/Raft:**

ActObjScan (active sensor search for objects):  
 ActObjPin (active sensor pinpoint of located objects):

<u>M</u>	<u>L</u>	<u>VL</u>	<u>D</u>	<u>VD</u>	<u>RG</u>	<u>CN</u>	<u>PL</u>	<u>FO</u>	<u>XO+</u>
—	S	S	S	R	R	D	F	I	—

PasObjScan (passive sensor search for objects):  
 PasObjPin (passive sensor pinpoint of located objects):  
 PasEngScan (passive sensor search for sources):  
 PasEngPin (passive sensor pinpoint of located sources):

<u>M</u>	<u>L</u>	<u>VL</u>	<u>D</u>	<u>VD</u>	<u>RG</u>	<u>CN</u>	<u>PL</u>	<u>FO</u>	<u>XO</u>	<u>IP+</u>
—	—	S	S	S	R	R	D	F	I	—

**Trasea Grav "Bike" and Casline G-Tube:**

ActObjScan (active sensor search for objects):

<u>M</u>	<u>L</u>	<u>VL</u>	<u>D</u>	<u>VD</u>	<u>RG</u>	<u>CN</u>	<u>PL</u>	<u>FO+</u>
S	S	S	R	D	D	F	I	—



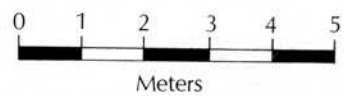
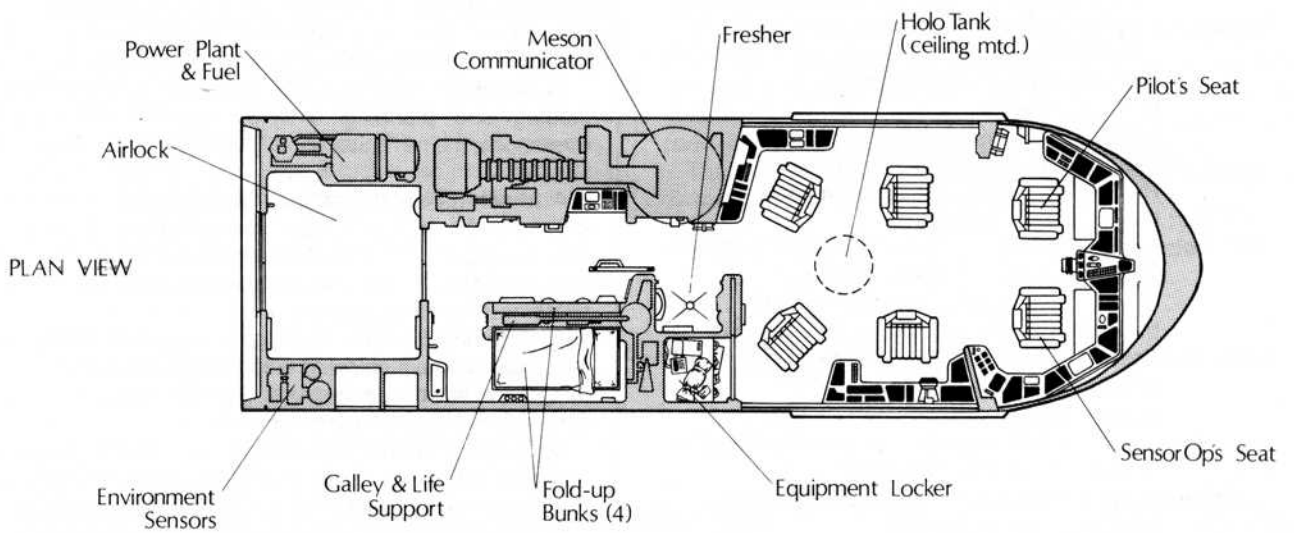
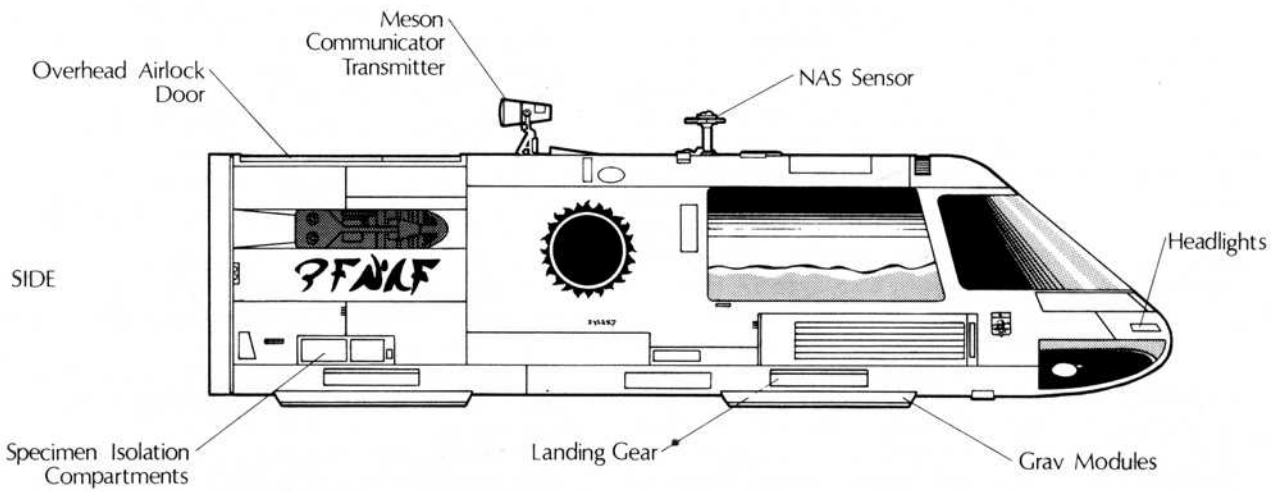
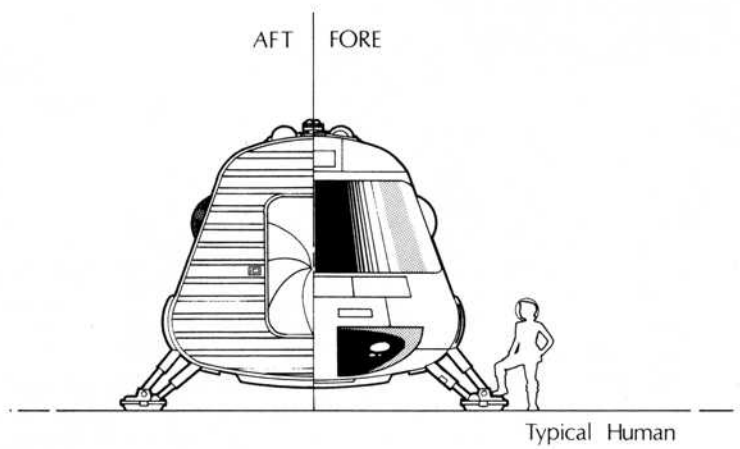

# IISS Survey G-Carrier

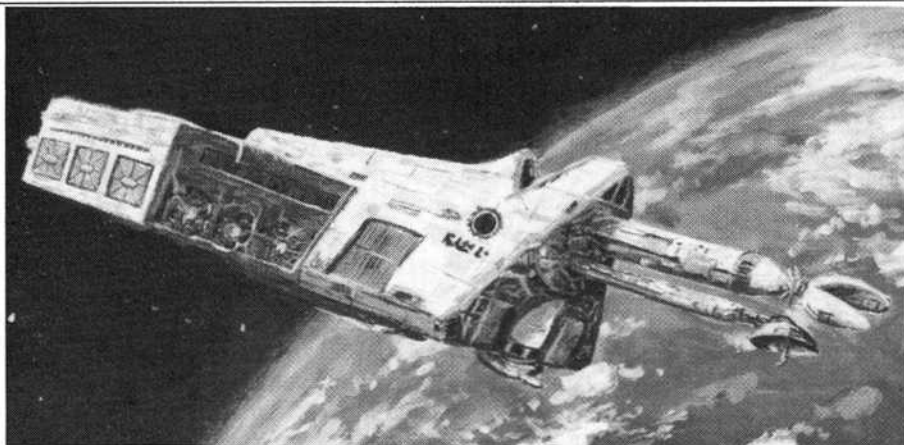

### DONOSEV CLASS SURVEY STARSHIP

Villemina Donosev held the post of Master Chief Surveyor of the Imperial Grand Survey when the First Survey was published in 420. Her unstinting devotion was instrumental in bringing the hundred-year project to a successful close. When a new class of ship was commissioned for the Second Survey, it was decided to name the class for her. Individual ships are named for famous scouts in the Imperial service.

The ship is categorized as "SZ", or "Scout experimental", and in fact three different versions of this ship have been built. The most recent, described here, was the result of improvements to sensor placement made during the Second Survey.

### UNIVERSAL CRAFT PROFILE

**CraftID:** *Donosev* Scout Survey Ship, Type SZ, TL15, MCr145.177\*

**Hull:** 360/900, Disp=400, Config=4USL, Armor=40G, Unloaded=3,590 tons, Loaded=4,270 tons

**Power:** 3/6, Fusion=3,565Mw, Duration=100

**Loco:** 18/36, Maneuver=2; 15/30, Jump=3; NOE=190kph, Agility=2

**Commo:** Radio=systemx2, MesonCom=regionx2, LaserCom=systemx2, MaserCom=systemx2

**Sensors:** PassiveEMS=interstellarx2, ActiveEMS=farOrbitx2, Densitometer=highPen/1kmx2, Neutrino=1kwx3, ActObjScan=Rout, ActObjPin=Rout, PasObjScan=Rout, PasObjPin=Rout, PasEngScan=Simp, PasEngPin=Rout

**Off/Def:** Hardpoints=4, DefDM=+9

**Control:** Computer=5/fibx4, Panel=holodynamic linkx30, Special=headsUp holodisplayx10, large holodisplayx1, Environ=basic env, basicIs, extendIs, grav plates, inertial comp

**Accomm:** Crew=10 (Command=1, Bridge=1, Engineer=1, Maint=1, Flight=3, Medical=1, Survey Specialists=2), Staterooms=10, SubCraft=40-ton modular cutter + 1 fuel module + 1 lab module, 3-ton air/raftx3

**Other:** Cargo=270kl, Fuel=1,790kl, ObjSize=avg, EMLevel=moderate

\*price includes cost of modular cutter and one extra module.

Using a 400-ton hull, the *Donosev* Class Survey Scout is used to continually resurvey the interior regions of the

Imperium, updating maps and charts and maintaining beacons and markers for astrogation hazards.

Construction and material standards for exterior features, interior details, and interior conditions are typical of those found in Imperial military vessels.

As is the case with most modern Scout vessels, the *Donosev* Class Survey Scout is not equipped for use in hostile areas.

When a *Donosev* Class Survey Scout is on a survey (as opposed to exploration mission), its crew of 10 typically includes the following members with the minimum skill levels

shown: a pilot (pilot-2), a navigator (navigation-2), an engineer (engineering-2), a doctor (medical-3), a lead surveyor (survey-2), and several surveyors (survey-1). Air/raft-1, ship's boat-1, and survival-1 are other important skills that should be possessed by some combination of the surveyors.

The configuration shown here, with a small craft bay holding three *Hurrican* class air/rafts, is the most common. Twenty seven percent of the *Donosev* class vessels, however, are a variant design that carries one *Kankurur* class G-carrier instead of the three smaller air/rafts. In this version, the lower deck is an additional 2 meters high to accommodate the G-carrier's additional height. In addition, the landing bay is 1.5 meters wider to allow for the *Kankurur's* greater width.

The numbered areas shown on the deck plan are as follows:

**1. Bridge:** The forward wall of the bridge contains a large window, giving a view of the area fore and starboard of the vessel. All of the non-engineering functions of the ship except for piloting can also be controlled from the holo pit (Area 41) when the ship is in orbit around a world or otherwise surveying a starsystem.

**2. Pilot Station:** The pilot station is always occupied by a Scout with a skill of at least pilot-2. Adjustments to an orbit are common during a survey, as are adjustments to ship orientation. The pilot from this station controls general operations of the ship, including instructions to engineering.

**3. Navigator Station:** The navigator is responsible for plotting and planning a ship's course. During survey operations, the navigator usually operates the mission control station.

**4. Mission Control Station:** The navigator sits here during a survey. He receives requests from the lead surveyor, who oversees operations in the holo pit. The navigator monitors the position of the ship and the status of ship sensors, and tells the pilot where the ship needs to be.

**5. Engineer Station:** The engineering station on the bridge is a slave panel, displaying status of the maneuver drive, the jump drive, and the power plant, as well as reporting on energy consumption by various ship operations.

**6. Fuel Purification Plant:** Free fuel can be scooped from a gas giant or ocean using the cutter, as long as the fuel is purified before it is used in the ship's engines or power plant.

**7. Lounge:** Scout survey voyages can be long and tedious; the ship's lounge is better than most found on military vessels. It includes both recreation and eating areas.

**8. Galley:** Food and food preparation equipment is housed here.

**9. Stateroom:** Staterooms on *Donosev* class vessels are

made to be comfortable for extended expeditions. Each stateroom is three tons, about fifty percent larger than typical starship staterooms.

**10. Stateroom:**

**11. Stateroom:**

**12. Stateroom:**

**13. Stateroom:**

**14. Stateroom:**

**15. Stateroom:**

**16. Jump Drive:** A 16-ton jump drive allows jump-3, using 120 tons of fuel, or shorter jumps at a cost of 40 tons per jump.

**17. Jump Engineering Station:** An engineer mans this station to calibrate the jump drive and to monitor the drive during entry into jump.

**18. Maneuver Drive:** A 20-ton maneuver drive allows 2G acceleration.

**19. Cargo Hold:** The cargo hold has a capacity of 15 tons. The hold can be pressurized if desired. Special baffles reduce the amount that the hold's artificial atmosphere mixes with the atmosphere of the rest of the ship. Even so, most samples are kept in airtight containers.

**20. Cargo Hold Airlock:** The outer door to the hold is 4.5m wide and 3m tall.

**21. Power Plant:** A 12-ton power plant supplies 12 energy points, using 12 tons of fuel. This allows power for 4 weeks, including time spent in jump.

**22. Power Plant Main Engineering Station:** An engineer operates this station on an as-needed basis.

**23. Power Plant Secondary Engineering Station:** An engineer operates this station on an as-needed basis.

**24. Power Plant Secondary Engineering Station:** An engineer operates this station on an as-needed basis.

**25. Computer:** The Model/5 computer is supported by extensive data banks, accounting for its larger than normal size. About two trillion words of data are stored online. The massive processing capacity supports not only the usual bridge and engineering functions, but also the sensors and holo pit display. The main console is located in this area. The computer, avionics, sensors, and holo display use fully one-fourth of the ship's electrical power.

**26. Air/Raft Garage Airlock:** Access to the air/raft garage from within the ship is provided through this airlock.

**27. Survey Module Hangar Airlock:** Access to the survey module hangar from within the ship is provided through this airlock. Also at this location, an iris valve in the ceiling leads up to A Deck for emergency use.

**28. Laboratory:** The research laboratory houses special equipment for specimen study, as well as technical facilities for calibration and maintenance of handheld survey devices.

**29. Stateroom:**

**30. Air/Raft Garage Area A:** Survey air/rafts hold four passengers (or two passengers and four tons of cargo) and are enclosed. Cruising speed is 100 kph.

**31. Air/Raft Garage Area B:**

**32. Air/Raft Garage Area C:**

**33. Commander's Office:** The pilot of a Scout survey ship is commander of the mission, and as such merits a private office as well as a stateroom.

**34. Commander's Stateroom:**

**35. Avionics:** Avionics equipment on a *Donosev* class vessel includes a transponder, a gyroscope, and general instruments for flying the ship.

**36. Survey Module Hangar:** Two 30-ton modules are available for use with the cutter: a fuel skimmer module and a survey module. The fuel skimmer module is intended to dive into gas giants and skim their hydrogen gas for fuel. The module may be used to dip water from oceans as well. It carries 28 tons of fuel. One trip into the atmosphere of a gas giant and back takes three hours, so the ship can be refueled in five trips, or 15 hours. The survey module is used for suborbital surveys, when a special-purpose, closer scan is needed.

**37. Cutter Hangar:** The cutter consists of a 20-ton frame, which is used in combination with one of the 30-ton modules. The combination is capable of 4G operations and carries a crew of one (pilot). When the survey module is used, a lead surveyor assists the pilot while up to four other surveyors gather data using the module's instruments. The cutter has a four-ton bridge with a Model/1 computer. When the cutter is operated without a module, it has a smaller total displacement and thus greater performance: its 4G acceleration is increased to 6G.

**38. Cutter Hangar Airlock:** Access to the cutter hangar from within the ship is provided through this airlock.

**39. Survey Office:** The lead surveyor uses this office to coordinate the ongoing gathering of information, and to assemble the data collected into its final form.

**40. Lead Survey Stateroom:**

**41. Holographic Survey Station:** The "holo pit" has stations for the lead surveyor and four survey assistants. More detail on holo pit operations and procedures can be found elsewhere in this book.

**42. Probe Storage and Launching:** A variety of special-purpose probes may be used during a world survey, particularly when unsafe conditions prevent the use of landing parties. These probes are stored and launched from this area.

As an example, *Donosev* vessels generally carry several remote NAS probes. The probe's batteries power its grav locomotion and sensors for up to 24 hours at a time, and its continental range communicator allows total control of its operations from the orbiting ship.

The neural activity sensor (the functional equivalent of a TL 15 NAS handheld model) is guided by a surveyor who can see and hear what is going on around the probe, by means of an audio microphone and a holographic camera, complete with telescopic and light intensifying abilities.

The probe, illustrated below, is a cylinder 0.1 meters in diameter and about 1 meter long:

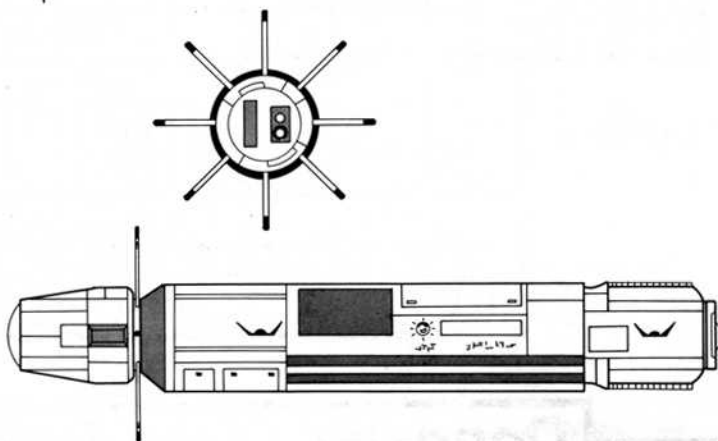

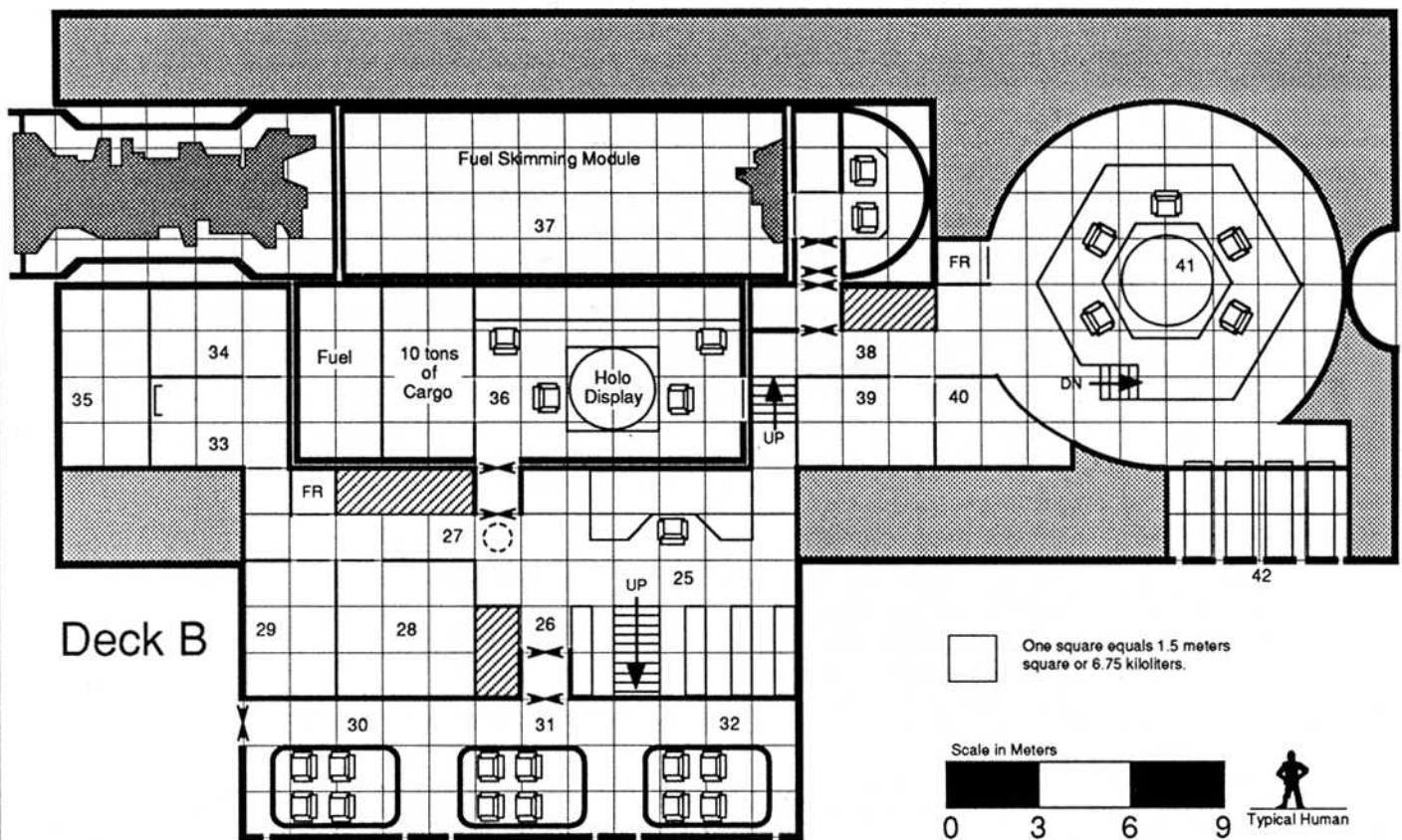
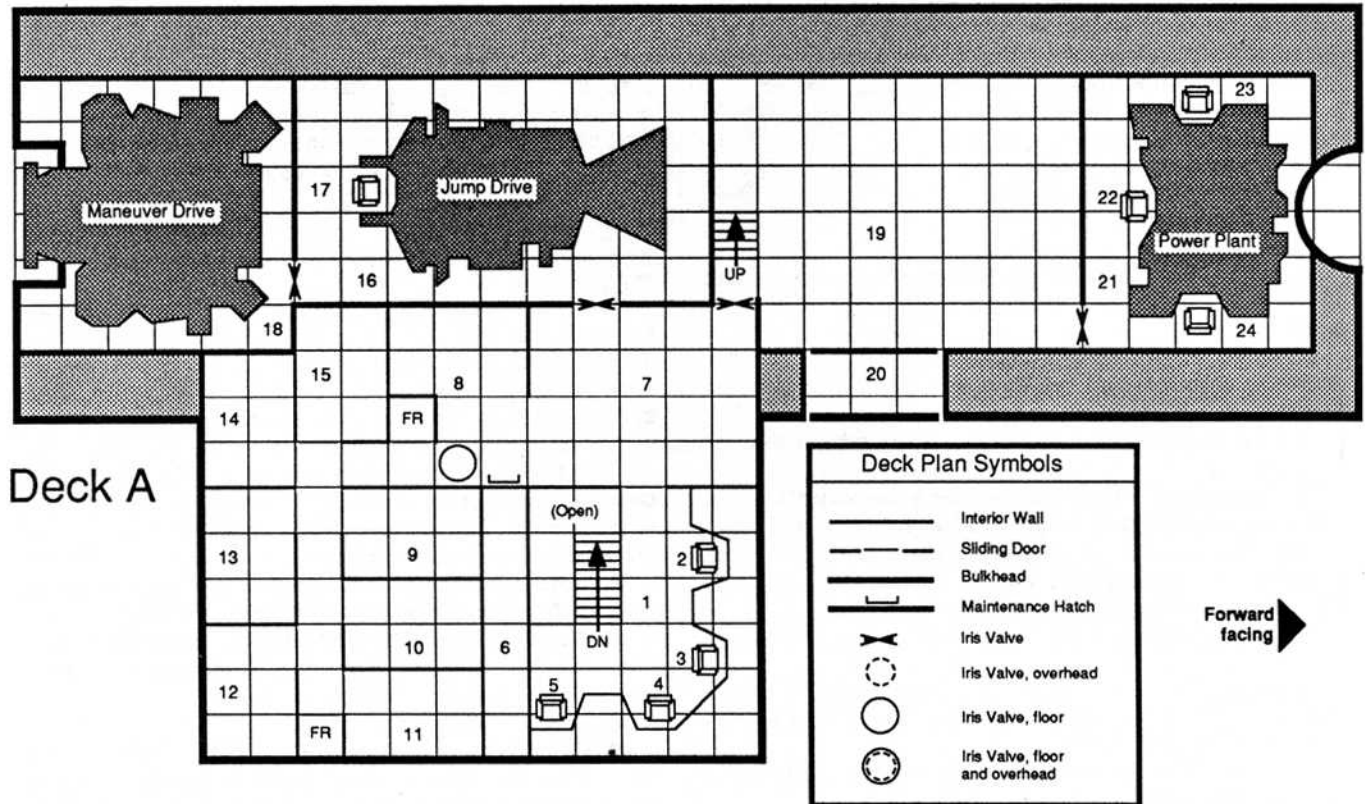

**Donosev Class Scout Survey Ship**

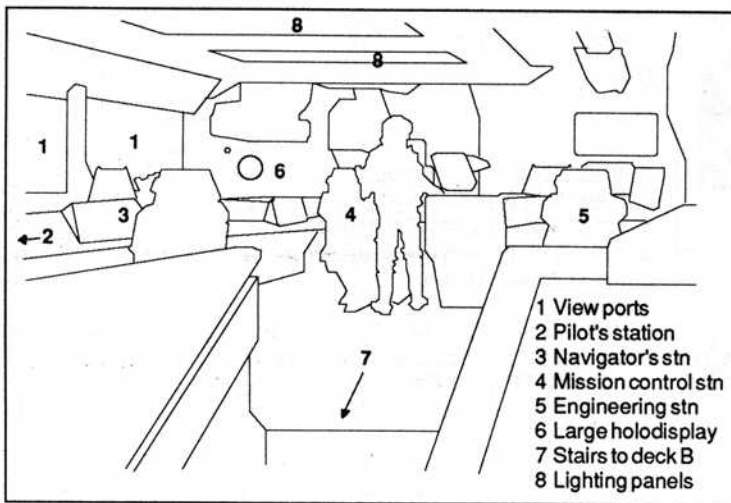
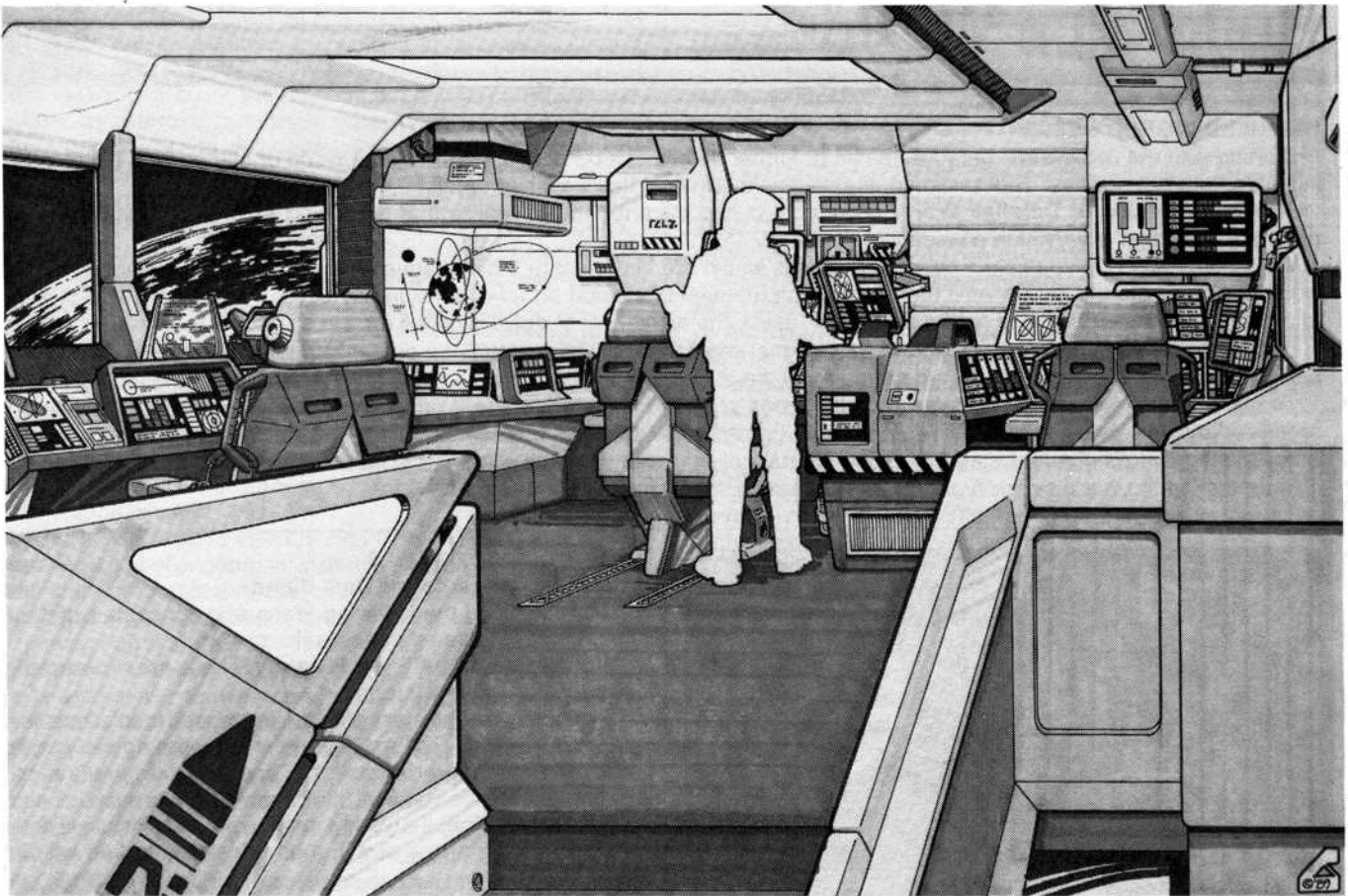

**Front View**

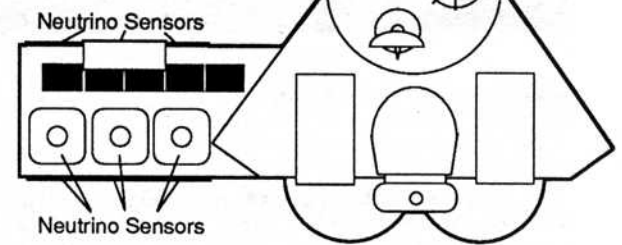

**Side View**

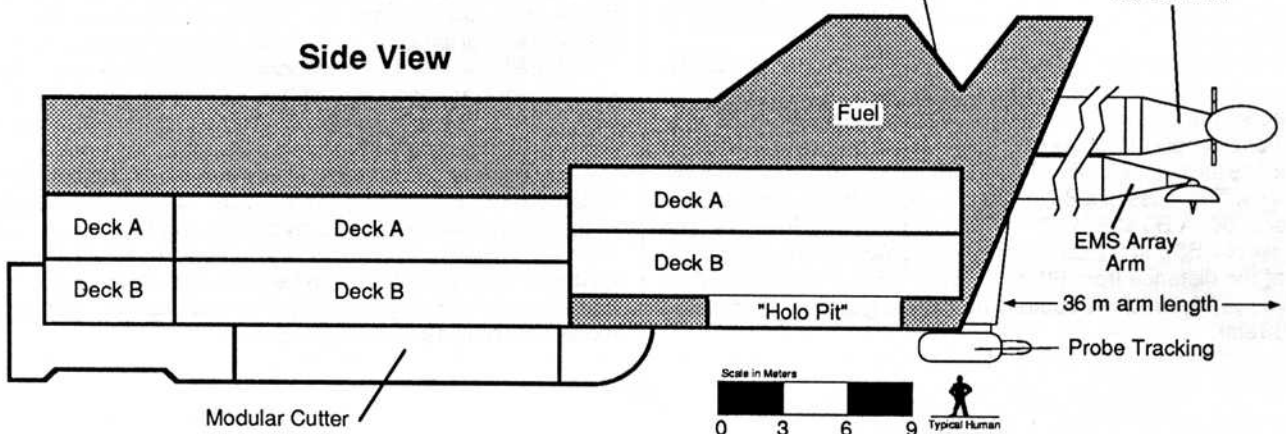

# Building a World

## DETAILED WORLD DESIGN

Starting with the basic UWP data, a myriad of further details can be added, resulting in a world or star system full of exciting adventure possibilities. This section presents how to arrive at this wealth of detail.

**The Practicalities of Detailed World Design:** It is important for you to realize that producing extra world detail with the rules in this section is *very* time consuming.

We recommend that you select only those details which are important to a given adventure. Alternatively, select a specific world and generate the details until there is enough material to support an adventure. In any case, the extra detail is tedious to produce, and the effort need not be expended unless the extra level of detail is called for.

(With experience generating detailed world designs, you can also "short circuit" the process somewhat by just estimating or picking reasonable values without going through all the steps.)

To make it easy to detail only the parts of the world you are interested in, the World Design step charts in this section are organized by Universal World Profile (UWP) digit. For example, to detail the items related to the UWP size digit, consult the *Size-Related Details* charts. Using just those charts, not only can you determine the world's size more exactly, but you can also determine the world's density, mass, gravity, and other size-related details.

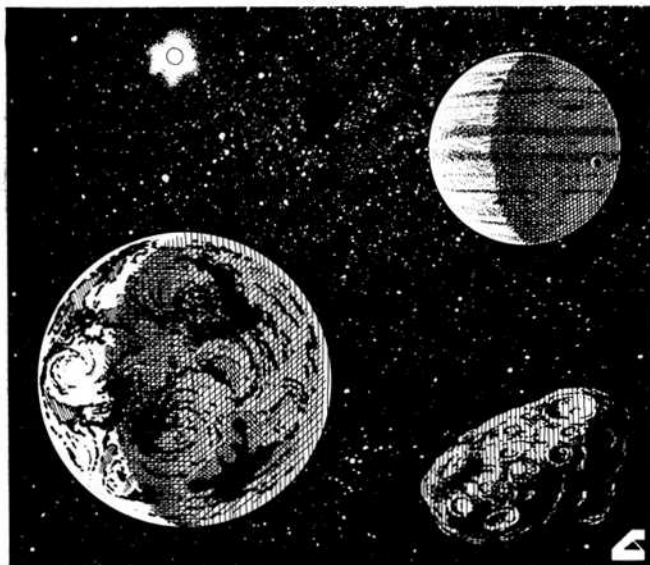

## DETAILED WORLD DESIGN

### General Concepts And Definitions

General concepts and terms referred to on all the world building step charts are explained below.

**Star System Orbital Zones:** All through the step charts in world design, reference is made to "Orbital Zones". As an aid to you, the Star System Orbital Zones charts from page 27 of the *MegaTraveller Referee's Manual* have been reprinted at the front of the step charts section.

**Interpolation:** The data for stars is presented for the spectral types with decimal subclassifications 0 and 5. The decimal subclassifications 1, 2, 3, 4 or 6, 7, 8, 9 can be determined using interpolation.

Interpolation calls for determining a percentage of the distance the desired point is from an end point, and applying that percentage to the difference between the end points.

For example, the mass of a B3 Ia star can be interpolated from the Stellar Masses table in step 7a of the size related detail charts. The mass of a B0 Ia star is 60, while the mass of a B5 Ia star is 30. A B3 star is 3/5 of the distance from B0 to B5. The mass of a B3 star is thus equal to 60 (the B0 star mass) minus 3/5 of the distance from 60 to 30 ( $60 - 30 = 30$ ). Taking 3/5 of 30 gives us 18, which we subtract from 60, to get 42 — the mass of a B3 star.

## SIZE-RELATED DETAILS

### Important Concepts and Definitions

Understanding the following terms and concepts is helpful when using the size-related step charts.

**World Mass, Density, and Gravity:** These are expressed in terms of "earths", that is, earth=1.

**Stellar Mass:** The mass of a star, expressed in solar masses.

**Orbital Period:** The term "local year" refers to a given world's orbital period, while the terms "year" and "standard year" refer to the Imperial standard year of 365 days of 24 hours each.

**Rotation Period:** If a world's rotation period is infinite (it does not spin about its axis at all), then it is tidally locked with its primary.

**Axial Tilt:** Axial tilt has no meaning if the world is tidally locked.

**Orbital Eccentricity:** Orbital eccentricities are generally small and minor in their effects on a world's environment. However, "extreme" orbital eccentricity can produce quite unusual effects, especially on otherwise Terran type worlds.

**Seismic Stress Factor:** The stress factor describe a world's likelihood of geologic activity.

**Planetoid Belts:** Planetoid belts (or asteroid belts) are accumulations of rock chunks and ice chunks not large enough to qualify as planets. A world size of zero in a planetary orbit indicates a planetoid belt is located there.

Detailing a planetoid belt is somewhat different from detailing a planet, and a special set of steps are provided. The special terms used in defining planetoid belts are discussed below.

**Types of Planetoids:** There are four basic types of planetoids that can be found in belts: nickel-iron, stony, carbonaceous, and icy.

**Nickel-Iron Planetoids:** Nickel-iron planetoids contain a high quantity of nickel-iron, and as such are sources of metal. Nickel-iron planetoids also frequently contain deposits of valuable dense metals or radioactives. Nickel-iron asteroids, the most valuable kind of asteroid, are typically a medium gray in color.

**Stony Planetoids:** The most common of all planetoids, these stony chunks are primarily just "big rocks" composed of silicon compounds. There is rarely any market for these asteroids. Stony asteroids generally are light gray and or tan in color.

**Carbonaceous Planetoids:** These planetoids are composed of carbon compounds somewhat like tar. The primary elements of these asteroids -- carbon, hydrogen, oxygen, and so on -- have value mainly in systems without a hospitable mainworld. Carbonaceous planetoids can be used to make oil, synthetics, and even food and water. Carbonaceous asteroids are commonly dark brown to dull black in color.

**Icy Planetoids:** Dirty ice-balls of frozen water, ammonia, and methane, these ice chunks are primarily of value as a source of hydrogen fuel. In systems where gas giants cannot be used for one reason or another, these asteroids become particularly valuable. Icy asteroids can vary in color throughout the spectrum, from bright white to dull black, depending on the impurities mixed in with the ice.

**Belt Zones:** Most belts exhibit a series of areas or zones where a high percentage of a given asteroid type can be found.

**The Nickel-Iron Zone (N-Zone):** This area contains mostly nickel-iron and stony planetoids. Some icy or carbonaceous asteroids may be found.

**The Mixed Zone (M-Zone):** This is a transitional zone where the proportions of nickel-iron and carbonaceous asteroids shift from the concentrations of the N-zone to those of the C-zone. The most common planetoid type in this zone is stony.

**The Carbonaceous Zone (C-Zone):** This term applies to the outer zone where mostly stony and carbonaceous asteroids may be found. If the belt has icy planetoids, they are most likely in this zone as well.

**Ring Systems:** In effect, a ring system is a planetoid belt orbiting a planet or gas giant instead of orbiting a star. Ring systems are predominately one planetoid type, either nickel-iron (rare), stony, carbonaceous, or icy.

An icy ring system is often spectacular — like Saturn's rings, for instance. A stony ring system (or the rare nickel-iron one) is less impressive, and a carbonaceous ring is often quite dark.

**Gas Giants:** Gas giants are unlike planets in many respects, differing in size, composition, atmosphere, as well as in other ways. Detailing a gas giant is different from detailing a planet — special steps in the charts cover gas giants.

**Size:** Size is the most obvious feature of a gas giant. Size ranges from 40,000 kilometers to 240,000 kilometers or more in diameter. Standard practice measures the diameter at the point where atmospheric pressure is 1 atmosphere.

**Composition:** If a solid core exists, it will be roughly the size of a large rocky planet, but surface conditions will be infinitely more hostile. Only the tremendous pressure of the encircling gas layers keeps such a hot rocky core in a solid state.

Surrounding the core is an ocean of liquid gas (usually hydrogen, ammonia, or methane) thousands of kilometers deep. The tremendous weight of the planet's atmosphere presses upon this ocean, causing it to behave like a sea of liquid metal with thermally and electrically conductive properties.

**Atmosphere:** Above the solid and liquid central regions of the planet lies the gaseous atmosphere itself. Here, a mix of hydrogen, helium, methane, ammonia, and many other gaseous compounds may exist. Winds can blow at speeds of up to 1,500 kilometers per hour in the atmosphere of a gas giant; tremendous convection currents rise, driven by the great heat of the core; massive permanent storms (such as the Great Red Spot of Jupiter and the Eye of Assiniboia) sometimes wreak havoc on vast areas capable of encompassing multiple worlds the size of Terra or Regina.

At the cloudtops, temperatures fall to around 150 degrees below zero celsius. Atmospheric pressure, drops to just a few atmospheres. Rain sometimes falls from these clouds: as water at higher altitudes, or as ammonia at lower ones.

**Brown Dwarfs:** A special type of large gas giant is the brown dwarf. A brown dwarf is an immense gas giant just short of the critical mass threshold needed to become a small star. Gravitational pressure is insufficient to ignite the dwarf's atmosphere into a sustained fusion reaction. Consequently, a brown dwarf gives off considerable heat, but shines less brightly than all but the smallest true stars.

Brown dwarfs can act as miniature primaries, providing heat and light for nearby worlds. Although brown dwarfs could theo-

retically warm satellites to habitable temperatures, satellites rarely orbit brown dwarfs. Solar system formation theory attributes this deficiency to accretion by the brown dwarf — the gravitational field of the growing brown dwarf attracts all matter in the vicinity, thereby making the formation of satellites highly unlikely. The brown dwarf's own composition also mitigates later satellite formation by collision with itself and other bodies.

## ATMOSPHERE-RELATED DETAILS

### Important Concepts and Definitions

Understanding the following terms and concepts is helpful when using the atmosphere-related step charts.

**Atmospheric Composition:** The various possible values from the charts are explained below:

**Tainted Atmospheres:** There are a variety of reasons why an atmosphere might be considered tainted:

**Disease:** Indicates the atmosphere carries microorganisms, viruses, fungi, spores or other such life forms which can be harmful to humans. It is possible that inhabitants (even humans native to the world) could be immune to these diseases, but visitors may be affected.

**Gas Mix:** Indicates that there is some element of the gas mix which is generally harmful to humans. Adaptation by humans is highly unlikely.

**High Oxygen:** Indicates an excessively high proportion of oxygen in the atmosphere. Persons breathing the atmosphere unaided may be subject to oxygen intoxication, loss of judgment and coordination, giddiness, and eventual unconsciousness. Adaptation by the inhabitants may occur.

**Pollutants:** Generally indicates that specific industrial chemicals, suspended debris, or radioactive pollutants are present in the atmosphere. Industrial worlds usually have this kind of taint. Pollutants are sometimes a specialized case of "gas mix".

**Sulfur Compounds:** Denotes a situation resulting from high volcanism. The world should be given a high seismic stress factor; volcanoes will be common. This is another case of gas mix.

**Low Oxygen:** Indicates that the proportion of oxygen is too low. Persons breathing the atmosphere unaided will pass out, and could suffer brain damage from an oxygen shortage. Adaptation by the inhabitants may occur.

**Exotic Atmospheres:** The gas mix of exotic atmospheres is unbreathable. For specific gas mixes, see the topic "Unusual Atmospheric Compositions" on the next page.

The notation "irritant" indicates the atmosphere is a borderline case between exotic and corrosive, possibly requiring more than a simple oxygen supply to survive. An "occasional corrosive" atmosphere is one which is generally exotic, but sometimes becomes corrosive. An example might be a nitrogen/oxygen atmosphere which, under certain conditions, precipitates nitric acid, a corrosive agent.

**Corrosive Atmosphere:** The corrosive atmosphere table concentrates on pressures and temperatures. See "Unusual Atmospheric Compositions" for specific gas mixes. An atmosphere may be corrosive because of the gas mix, or because of temperature effects.

**Insidious Atmospheres:** The table for insidious atmospheres gives the basic cause of the atmosphere's danger. See "Unusual Atmospheric Compositions".

"Gas mix" denotes that the atmosphere is composed of a highly corrosive combination of gases (or a gas which is simply difficult to keep out, such as simple hydrogen).

"Radiation" indicates the presence of high radioactivity; cumulative exposure limits activity outside the protection of heavily shielded structures.

**Unusual Atmospheric Compositions:** Exotic, corrosive, and insidious atmospheres require some special consideration concerning composition.

Few worlds have an atmosphere composed of a single chemical. Most atmospheres have a complex gas mix that includes a variety of specific elements, some in great amounts, others barely detectable.

A world's atmosphere consists of active and inert gases. On Terra, for example, the atmosphere consists of nitrogen (78%), oxygen (21%), carbon dioxide, argon and other gases (1%). While there is 3 times as much nitrogen (N<sub>2</sub>) as there is oxygen (O<sub>2</sub>), oxygen is the active gas in the Terran atmosphere; it is the oxygen that is essential to the chemical reactions of Terran life.

Thus when determining the composition of an unusual atmosphere, simply identify the atmosphere's active gas(es), which may only be a fraction of the total atmospheric gas mix.

Some of the possible gases are discussed below.

**Carbon Dioxide (CO<sub>2</sub>):** A non-irritant gas, CO<sub>2</sub> occurs commonly, either by itself or in various combinations.

Worlds with carbon dioxide in the atmosphere may be in the early stages of developing carbon-based life (although within just a few hundred million years the atmosphere will have changed completely). On the other hand, the local life may be evolving in a totally alien direction — perhaps with life forms which draw their energy from sunlight (without using photosynthesis), or from thermal, radioactive, chemical, or even more unusual sources.

Carbon dioxide atmospheres have the property of trapping heat, causing a high greenhouse effect, which may force the world's base temperature far above the range in which humans can flourish without complete protective equipment. A runaway greenhouse effect (over 100%) can rapidly turn a world into a hostile inferno (and thus be rated as a corrosive or insidious atmosphere).

**Nitrogen (N<sub>2</sub>):** A semi-irritant gas, nitrogen is relatively inert in atmospheres with standard temperatures and pressures. If nitrogen and oxygen are present in an atmosphere with unusual temperature and pressure conditions, the atmosphere becomes more hostile, forming nitrides (nitrogen-oxygen compounds) or nitric acid (NHO<sub>3</sub>). Nitrogen occurs in world atmospheres more often than any other gas.

**Methane (CH<sub>4</sub>):** A non-irritant gas, methane (also known as "natural gas") is dangerous if mixed at a low (7-14%) concentration with a standard oxygen-nitrogen atmosphere. Any spark can cause the methane to explode and burn fiercely. This can pose a hazard to adventurers if methane leaks into their habitat, space ship, or vacc suit. Pure methane is an odorless, colorless gas, making detection almost impossible.

It is unlikely that free oxygen will be found in an atmosphere containing a significant amount of methane. Methane generally occurs as an active component of the atmosphere on large, cold worlds (size 8+, base temperature below -20°C, dense or very dense atmosphere). There are exceptions — the moon Titan (size 3) in the Terran solar system has methane in its atmosphere, but it is also a very cold world.

**Ammonia (NH<sub>3</sub>):** An irritant gas, ammonia requires protective measures even in mild concentrations. Unlike methane, ammonia has a sharp, pungent odor, and leaks are quickly noticed.

Worlds with ammonia are much like those with methane: large, cold, and with standard to very dense pressure.

Ammonia is postulated as an alternative to oxygen as a life-supporting gas. Ammonia is more active than oxygen, so a world harboring ammonia-based life will likely have a cold, very dense atmosphere.

**Chlorine (Cl<sub>2</sub>):** An irritant gas, chlorine is greenish-yellow in color, and a deadly poison even in small concentrations, although it can be detected by odor long before it reaches a lethal level. It is far more dangerous to exposed skin than ammonia, and requires head-to-toe protective clothing. An

atmosphere with chlorine is corrosive in all but the smallest concentrations.

A world with a significant amount of chlorine in its atmosphere would have a mysterious and eerie environment, with the shifting yellow-green haze causing the landscape to waver in a murky green half-light, hiding and distorting objects and shapes.

The superior reactive properties of chlorine make it a prime candidate as a life-supporting gas. Chlorine is similar to oxygen, reacting readily in the same ways as oxygen in various chemical processes. Life forms evolving in a chlorine atmosphere would be quite alien in appearance, and might be more active and energetic than their oxygen gas counterparts.

**Fluorine (F<sub>2</sub>):** A corrosive gas, an atmosphere with fluorine are considered corrosive at best. Fluorine shares many properties with chlorine, including the possibility of supporting completely alien forms of life. It is easily detected by smell and color, but can be quickly lethal if a significant leak occurs.

**Sulfur Compounds:** A variety of sulfur compounds can be found in various atmospheres, from non-irritant to corrosive.

Sulfur compounds in the atmosphere can result from prolonged heavy industrialization, or can occur naturally from heavy volcanic activity.

Sulfur compounds are a possible alternative to the more usual carbon-based organic chemistry. Such life forms would be totally alien.

**Hydrogen (H<sub>2</sub>):** A non-irritant gas, hydrogen is not poisonous. However, like methane, hydrogen combines explosively with oxygen. A spark can cause an explosion, followed by the precipitation of water, the product of the combination of these two elements. Hydrogen will make up a significant proportion of the atmosphere on large, cold worlds, and is often found in combination with methane and ammonia.

The smallest and lightest of atoms, hydrogen poses a special problem that can require an atmosphere containing any significant amount of it to be rated insidious. The atoms are so small that they can seep right through fabrics, plastics, and even solid metal in a process known as diffusion. An airtight seal is not necessarily hydrogen-tight. Starship hulls and the walls of buildings can be sealed against hydrogen leakage; vacc suits, however, can not.

**Further Considerations:** Worlds with exotic atmospheres are essentially Terran in everything but atmosphere. An exotic irritant atmosphere with sufficient concentration of the active gas becomes corrosive. Corrosive effects requiring the use of a protective suit can be the result of factors other than just the gas mix. No matter what the gas mix, a very low or very high temperature will kill an unprotected human in a matter of minutes.

Worlds with extremely high temperatures can include oxygen, carbon dioxide, nitrogen, chlorine, fluorine, or sulfur compounds. Low temperature worlds tend to have methane, ammonia, and hydrogen in their atmosphere.

Corrosive atmospheres can, with sufficient concentrations or proper temperature and pressure, be considered insidious. For example, a world with a high percentage of chlorine at standard pressure and temperature can be expected to have large amounts of hydrogen chloride gas in the air and seas of hydrochloric acid. Hydrochloric acid would fall as rain.

When combining gases, their effects are combined. Some fairly common mixes are carbon dioxide; carbon dioxide and sulfur dioxide; methane, ammonia, and hydrogen; chlorine and nitrogen; fluorine and carbon dioxide; fluorine and sulfur tetrachloride; hydrogen; carbon dioxide and nitrogen; methane and ammonia; chlorine and carbon dioxide; chlorine and disulfur dichloride; and fluorine and nitrogen.

**Native Life:** Many worlds have locally evolved native life.



Note that a world can have a UWP population stat greater than zero and not have locally evolved native life. In this case, the local population is a transplant from another world. The world may harbor local plant and animal life forms, also transplanted.

**Atmospheric Terraforming:** Atmospheric terraforming refers to significant improvements in the world's original composition by its inhabitants. This type of terraforming is the most difficult and requires the highest tech level; it is not surprising, then, that it is also the least common.

If atmospheric terraforming has been conducted on the world, the old original atmosphere can be determined if desired. The atmospheric terraforming progression, from the best atmospheric conditions to the worst, is untainted, tainted, exotic, corrosive, and insidious.

The current world UWP atmosphere digit must remain unchanged, since the terraforming has already occurred.

**Greenhouse Effect Terraforming:** Greenhouse effect terraforming refers to global modifications to the world's original greenhouse effect by its inhabitants.

If global greenhouse effect terraforming has been conducted on the world, a more favorable base temperature can be recomputed using an abnormal greenhouse effect (any greenhouse effect improvement beyond 10% is uncommon).

Occasionally, the modification will result in a less favorable greenhouse effect, perhaps even to the point of an accidental runaway greenhouse effect (over 100%).

**Albedo Terraforming:** Albedo terraforming refers to global modifications to the world's original albedo (and thus its energy absorption) by its inhabitants.

If global albedo terraforming has been conducted on the world, a more favorable base temperature can be recomputed using a modified energy absorption (any improvement beyond  $\pm 0.05$  is uncommon). Occasionally, the modification results in an unfavorable energy absorption change.

**Surface Atmospheric Pressure:** The air pressure found at the "surface level" of a world. Surface level is identical to sea level on worlds with a hydrosphere; on other worlds, surface level is the level where the most significant fraction of a world's surface lies.

Results from the charts are in terms of atmospheres, a measure of pressure in which Terra's pressure rates at 1 atm. This surface atmospheric pressure can be manipulated to show the effects of different altitudes or depths (see the chapter "Using the World Data").

**Surface Temperature:** World surface temperatures have a major bearing on the process of detailing a world.

**Tidally-Locked Worlds:** Before determining temperature data, establish the world's rotation period to make sure that the world is not tidally locked. The chapters "Mapping the World" and "Using World Data" describe other considerations when dealing with tidally locked worlds.

**Base Surface Temperature:** The base surface temperature is an average, and thus an abstract figure. Avoid a literal reliance on statements like "the surface temperature of Caledon is 15°C", which is similar to saying "it was 20°C on the planet Earth today". Many locations on a world's surface can experience significant variations from the base temperature. The base temperature is, in fact, merely a starting point from which actual temperatures are calculated.

**Orbital Eccentricity:** Assign a time of year to apastron (furthest separation from the star) and periastron (closest approach). Eccentricity need not coincide with local seasons. A result of "extreme" orbital eccentricity is included in the charts to permit special, highly unusual cases. You can also assign a value higher than those given in the charts, and proceed from there. Such cases can produce quite unusual effects, especially on otherwise Terran worlds.

Orbital eccentricity also causes seasons to have different lengths; this is seen most in the lengths of transition seasons.

**Axial Tilt and Seasons:** A method used by many cultures to divide the local year into roughly equal segments. Two is a minimum, but additional subdivisions might be used for long planetary years. A typical year with four seasons includes: summer, winter and two transition periods (spring and fall). The world's axial tilt is usually the main determinant of seasonal variations.

**Binary and Trinary Stars:** The movements of binary and trinary suns require the calculation of luminosity for each of 3 points: closest approach, farthest separation, and the median distance. Using this information in the temperature formulas yields a base mean surface temperatures for each of these instances

## POPULATION-RELATED DETAILS

### Important Concepts and Definitions

Understanding the following terms and concepts is helpful when using the population-related step charts.

**Cities:** The term "city" is used to represent a conglomerate "urban region". For example, the entire southwestern region of California from Santa Barbara to San Diego is one "city" called simply *Los Angeles*.

**Orbital Cities:** Some or many of the cities generated may be in orbit rather than on the world's surface. Each orbital "city" may consist of one or more orbital habitats.

**Progressiveness:** Deals with a society's basic desire to improve and progress.

**Progressiveness Attitude:** Indicates how the local inhabitants will react to an idea or action that is new, unusual, or contrary to local precedent. The values results include:

**Radical:** The population prefers change to static conditions. In extreme cases, any new idea, no matter what its merits, is a good idea.

**Progressive:** The population believes change to be good and healthy. They readily accept promising new ideas.

**Conservative:** The population tends to be afraid of change. Extensive effort may be needed to convince them a change is needed.

**Reactionary:** The population believes all change to be bad and reacts strongly whenever change is suggested.

**Progressiveness Action:** Indicates the likelihood that the society will change or be in a state of flux. The possible values include:

**Enterprising:** The population exhibits a significant drive and desire to progress. Progress tends to be far-reaching.

**Advancing:** The population has a fair measure of drive. Definite measurable progress exists.

**Indifferent:** The population lacks a drive to progress. Some progress exists, but its movement borders on immeasurable.

**Stagnant:** The population's progress has ground to a complete standstill. In extreme cases, the lack of progress may have become regression.

Social changes of this type occur over a period of years, decades, and sometimes even a century or more. It is left to you to determine just how frequently the social changes occur. Changing the situation on a world is useful for reminding the players that the universe is not a static one.

**Aggressiveness:** Describes the society's basic combativeness and belligerence.

**Aggressiveness Attitude:** Indicates how the local inhabitants react to the thought of forcing themselves on others. The possible values include:

**Expansionistic:** The population prefers to use force; compromise is rarely an option.

**Competitive:** The population prefers the use of force, but does not rule out compromise as an option.

**Unaggressive:** The population prefers compromise to the use of force.

**Passive:** The population prefers inaction to the use of force.

**Aggressiveness Action:** Indicates likelihood that the locals will resort to the use of force to impose their will on others. The possible values include:

**Militant:** The population openly displays their military might. They readily express their support for solving problems using military means.

**Neutral:** The population seldom flaunts their military might. They readily express their willingness to fight in self-defense if needed.

**Peaceable:** The population never flaunts their military might. They suggest using force to solve problems only as a last resort.

**Conciliatory:** The population refrains from building any significant military might. They will do anything to avoid a military confrontation.

**Extensiveness:** Tells how cohesive the world's populace is on a local level, and how open the population is to being among the interstellar community.

**Global Extensiveness:** Indicates the likelihood that a given individual or group conforms to the local social views. The possible values include:

**Monolithic:** The world's population stands solidly united in its views. No observable dissension exists.

**Harmonious:** The world's populace generally agrees on major issues, although observable dissension may exist.

**Discordant:** The world's population strongly disagrees on major issues. Dissension definitely exists.

**Fragmented:** The world's population holds widely diverse views. Dissension is the rule.

**Interstellar Extensiveness:** Indicates the general reaction of the local population to obvious offworlders. The possible values include:

**Xenophilic:** The local populace prefers offworlders. In extreme cases, the locals treat offworlders with a nauseating devotion.

**Friendly:** The populace is congenial to offworlders. Locals often treat offworlders favorably.

**Aloof:** The populace reacts coolly to any offworlders. The local population may sometimes even be downright unfriendly.

**Xenophobic:** The populace has xenophobic tendencies. At the very least they have a severe distrust of any offworlders. In extreme cases, the locals abhor offworlders.

## GOVERNMENT-RELATED DETAILS

### Important Concepts and Definitions

Understanding the following terms and concepts is helpful when using the government-related step charts.

**Government Organization:** Any government must perform three functions, and whether or not the bodies performing these functions are differentiated by the government, it is instructive to look at them abstractly.

**Legislative:** The legislative branch of a government makes law. In simpler terms, the legislative branch tells everyone what to do.

**Executive:** The executive branch of a government enforces the law. In simpler terms, the executive branch makes sure that it is done.

**Judicial:** The judicial branch of a government interprets the law. In simpler terms, the judicial branch decides whether it was done right.

Naturally, no government is so cut and dried, even the early Terran example upon which this model is based. But it is convenient to distinguish these three functions for game purposes.

These duties may overlap, so one person or governmental

body subsumes both the legislative and executive functions, for example. It may also be that the separate parts of the government share these functions. For example, a Ministry of Trade might set import taxes (legislative), collect those taxes (executive), and judge cases where the taxes have not been paid (judicial). In this case, the Ministry would exercise all three functions, but only in the arena of trade. Other parts of the government would have jurisdiction over other aspects of life.

The government digit assigned by the Scouts to a world corresponds most often to the legislative "branch", but may be derived from the structure of the executive or judicial "branches" if they seem more significant in their workings.

**Government Types:** The government details on the charts describe the representative authority and its type of organization. The possible values are:

**Ruler:** One to three powerful individuals control the functions of the government.

**Elite Council:** One group, with from four to a thousand members, confers and decides upon the acts of the government.

**Several Councils:** Several councils, whether equal in power or ranked according to some system, each exercise influence over the government.

**Demos:** The entire population decides the acts of the government. In many cases, various qualifications will be established to lessen the participation of some classes of citizens.

**Religion:** Most sophont species develop religions during their climb to civilization. Religion begins as an attempt to explain the world and the many questions of life, the universe, and existence. Religions often evolve into philosophical schools which set down modes of conduct intended to lead the believer to a better existence.

In the Imperium, there is freedom of religion. So long as the actions of a church or sect do not threaten the peace and security of the Imperial populace, the religious belief is acceptable. Religious organizations not in conflict with Imperial harmony are welcome on all civilized worlds.

Including religion in MegaTraveller is optional—those who are offended by the idea of developing new religions, or those who feel that religion will be passe in 50th Century and beyond can ignore the concept entirely. We leave it to you to invent the details of the beliefs, teachings, sacred texts, and so on.

**The Religious Profile:** This Profile is a series of seven codes describing the various aspects of a religion.

**God View:** This entry describes the religion's basic beliefs of a supreme being or beings and the part played by the deity/deities in everyday life.

**Spiritual Aim:** Describes the central tenet of the religion: the belief which defines the religion's appeal and promise. Actually, any given religion may have several of the beliefs given in the list in its scriptures, but the Spiritual Aim stands single one out as dominant. Note that the aims listed still leave the referee with quite a bit of input into the actual religious beliefs and goals.

**Devotion Required:** Indicates the degree to which individual believers are involved in religion-oriented activities such as prayers, sacrifices, meditation, teaching, studying, and so on. It suggests both the "fanaticism" of the religion (how much it controls daily life) as well as the importance of religious activities to belief and acceptance by the religious community. In game terms, it adds insight into how the religion functions.

**Organization Structure:** Conveys the structure of the religious group. Rigid church hierarchies tend to be large, ponderous, dogmatic, shrouded in ritual or mysticism, and inaccessible to the common worshipper — while looser structures generally fail to recruit, collect, or direct in ways that promote the religion.

**Liturgical Formality:** Itemizes the nature of worship. "High Church" services, long on ritual but with little or no input allowed from the common worshipper, contrast sharply with less formal

sects that freely discuss, even question, the fundamentals of their faith as they explore its meanings and ramifications.

**Missionary Fervor:** Describes the degree to which the religion seeks out converts and supporters. Missionary Fervor indicates how likely an adherent is to strike up a religiously-oriented conversation, or how often church members may be pressured into contributions of time, money, or other support.

**Numbers of Adherents:** Indicates the number of followers. This is an exponent digit, identical to the UWP population code.

## LAW-RELATED DETAILS

### Important Concepts and Definitions

Understanding the following terms and concepts is helpful when using the law-related step charts.

It is more difficult to make precise rules for law levels than for government types. The law related details given on the charts are largely suggestions — you as referee must rely on your sense of the game to temper any law-related details.

**Law Level:** The degree to which the law interferes with individual actions. This level is affected to some degree by the type of government prevalent in the area. Still, two very similar governments may have widely different law levels. As a general rule of thumb, bureaucracies and dictatorships try to exert finer degrees of control than do democracies.

Law Level also indicates how vigorously laws are enforced. At low law levels, there may be no police: individual citizens must bring charges against lawbreakers themselves. At high law levels, police may be unrelenting in their pursuit of criminals, and statutes of limitations may not exist.

**Uniformity Of Law:** Who must observe the law? Do some laws apply to one group and not another? Or do the laws apply equally to all? Three categorizations answer these questions:

**Undivided:** In many governments, one set of laws applies equally to all. Advantages of this system are a consistency of justice and the resulting simplification of the judicial function.

**Territorial:** In some governments, different laws apply differently depending on where a person is. By moving across a territorial boundary, a given act may change from legal to illegal, or vice versa, even though the government has not changed.

**Personal:** It is not uncommon, unfortunately, for different laws to apply to different persons under the same governmental authority. The distinction applied by the government may be based on sex, religious beliefs, race, wealth, age, job, caste, tribal membership, or world of birth.

It is also possible for a government to combine these types of influence. For example, one set of laws may apply to Vargr in one area, while a second legal code applies to Vargr in another, while a third governs humans in both regions.

**Detailed Law Levels:** The law can involve itself in many different spheres of conduct. The following detailed law levels are given on the charts:

**Weapons:** How law level applies to possession and use of weapons is already detailed in the regular rules; keep in mind that these are general guidelines and may vary slightly from one government to another. The stricter the law level, the more weapons are restricted.

**Trade:** In the realm of business, the law can intrude in a number of ways. At the lowest levels, the only law might be caveat emptor—let the buyer beware. At higher levels, laws against fraud and deception may be enforced. At still higher levels, the state may prohibit certain types of businesses or regulate them by requiring licenses or other permits.

**Criminal Law:** What activities are considered to be crimes? At lower law levels, actions which use physical force to harm other individuals or their property are the only ones prohibited. At higher levels, almost any activity can be considered criminal.

**Civil Law:** Even if a particular action is not criminal, the situa-

## SOME GOVERNMENT EXAMPLES

**Regina:** This subsector capital (Spinward Marches 1910 A788899-C) is an impersonal bureaucracy. The government related charts tell us Regina has 3 separate branches of government, with the judicial branch most prominent.

Looking at the charts, we see that impersonal bureaucracies always are "several councils"; checking the charts for the other branches tells us the executive branch is an elite council, and the legislative branch is a demos.

From this data, we use our imagination: with a law level of 9 and an impersonal bureaucratic court system, being arrested on Regina is an unpleasant experience. Suspects may be rounded up en masse when a crime has been committed, and it might be weeks after a trial has convicted one of them before the rest are finally cleared. Meanwhile, those arrested must report their whereabouts and activities to the police every few hours. However, the trials are usually fair.

The executive branch consists of 4 persons chosen by lot. Each year, 4 citizens are chosen at random to share the oversight of the government. Each has veto power over the other, providing a check against tyranny at the cost of inefficiency and no small degree of confusion. Once a citizen has served in this capacity, he is ineligible to serve again.

The inhabitants of Regina as a whole make the laws for the world. Laws are proposed by the judicial and executive branches, and weekly elections are held to confirm or reject these laws. A complicated computer network is used to conduct these elections. All native-born Reginans are eligible to vote, with no other restrictions. Thus immigrants have no voice in the government, but newborn babes, criminals, and the insane do, if they have Regina birth certificates.

**Mora:** Mora is the sector capital for the Spinward Marches, but of course it has its own local government. The step charts tell us the government of Mora (Spinward Marches 3124 AA99AC7-F) is split into 3 authorities, corresponding roughly to 1 for each branch. Next, we find that the judicial branch is the representative authority, so we know that it is a charismatic oligarchy from the government characteristic digit of C. Next, we discover this judiciary function is carried out by an elite council.

The charts tell us that the executive branch is also an elite council and we have a single ruler for the legislative branch.

Now to flesh out this information. Mora is a matriarchy, in which most of the governmental positions are held by women (determined by a flash of inspiration.) The courts of the world are headed by the "Eleven Brides", so called because their duties to the government are so demanding of their time that they do not take husbands, but rather are "married" to their work as judges. Laws (with a characteristic of 7) are stricter and more intrusive than those on Rhyllanor, but are still about average for most of the worlds in the Imperium.

The executive branch is the "Caucus", 33 women who oversee the administrative activities of the government. There is no separate police force on Mora; the laws are carried out by the planet's army. (This was decided by looking at the "unaggressive" yet "militant" attitudes determined using the social rules of this book.)

The legislative branch consists of the Duchess Delphine the Matriarch, in her own right a charismatic dictator (although the Scouts published the world's government statistic based on the structure of the judicial branch). The Duchess makes all the laws herself, and so far she has done well enough at it that most Morans are happy under her rule.

tion may involve a wrong committed against another person or his property, and the government may set up rules that allow the harmed individual to collect from the perpetrator. Often, such losses are the result of negligence.

**Personal Freedom:** What may a person say? With whom may he associate? Where can he travel? What books may he read? How can he worship? What can he think? These questions deal with personal freedoms.

## TECHNOLOGY-RELATED DETAILS

### Important Concepts and Definitions

Understanding the following terms and concepts is helpful when using the technology-related step charts.

Before you determine the Technology Profile, you must first determine the world's Social Outlook.

**The Technology Profile:** The profile consists of 14 entries detailing both the levels of technology commonly enjoyed by the populace and the levels of achievement on the world.

The Technology Profile is divided into three blocks:

- Common Tech Levels
- Achievement Tech Levels
- Novelty Tech Level

**The Common Tech Levels:** The common tech levels are divided into two values: high common, and low common.

High common is the highest level of technology commonly enjoyed by the world's population. This is the tech level typically encountered near the starport and in the most modern urban areas. This is also the tech level listed in the world's UWP stats.

Because high common represents the tech level of manufactured goods typically available near the local world's starports, most forms of equipment that a character might acquire near a starport will be of this tech level.

Low common represents the level of technology enjoyed by the bulk of the world's population. It can be much lower than the tech level of goods commonly available near the starport.

Low common indicates the minimum tech level the characters can always find on the world no matter where they go. The low common and high common tech levels may be the same, indicating there is a consistent level of technology worldwide.

When comparing the two common tech levels, the referee should decide who has access to any tech levels above the low common figure. This could be important in resolving encounters or in describing surroundings during an adventure.

As an illustration of how the high common and low common tech level works, consider Terra circa 1985. The high common tech level is 8, and the low common tech level is early tech level 6. Globally, the tech level enjoyed by the bulk of Terra's 5 billion population is the low common tech level of 6, even though certain areas (mostly urban North America, Europe, and some parts of Asia) possess the high common tech level of 8.

**The Achievement Tech Levels:** The achievement tech levels represent the best technology the world has been able to achieve locally. In the cases where the achievement tech level exceeds the high common tech level, the achievement tech level represents the forefront of technological research: a level of technology not yet available to the general population.

The achievement tech levels are divided into: quality of life tech levels, transportation tech levels, and military tech levels.

Quality of Life technology encompasses five basic areas: energy production, computer/robotics, communications, medical, and environmental engineering. These technology areas are essential to the world's quality of life and form the basis for the technological achievements in the two other subgroups.

**Energy Production Technology:** Indicates the culture's ability to make use of energy. Use of energy is fundamental to many other technological developments. Once cheap fusion power comes on the scene, it supersedes all other forms of

energy production. Where fusion plant size becomes a problem, batteries or fuel cells are still required.

**Computers/Robotics Technology:** Indicates the culture's progress in the creation and use of high-tech computer circuitry. Computers are fundamental to many other technological developments. The computers/robotics tech level determines the basic availability of computers and robots.

**Communications Technology:** Indicates the culture's use of long-range communication devices. Communications technology depends largely on developments in computers/robotics.

**Medical Technology:** Indicates the quality of biological research and medical care available. Medical technology also depends heavily on developments in computers/robotics.

**Environmental Engineering Technology:** Indicates the ability of the culture to manipulate their environment. It establishes the chance that terraforming projects are underway, and dictates how cities and large civil engineering works are constructed.

Transportation technology covers the four transportation areas: land, water, air, and space. Transport technology depends in a large part on quality of life achievements.

**Land Transport Technology:** Indicates the population's methods of land transport. Once grav locomotion arrives, land, water, and air transport merge.

**Water Transport Technology:** Indicates the population's achievements in transport over their oceans and seas. Special cases are waterworlds (where land transport is rare) and planets where grav vehicles are present, since grav locomotion blends land, sea, and air transport into a unified whole.

**Air Transport Technology:** Represents the availability of various forms of air transportation. Vacuum worlds have no air transport until gravitics are invented. Again, gravitic vehicles blend the various planet bound transportation technologies into a single technology. As grav locomotion improves, air transport ultimately merges with orbital space transport.

**Space Transport Technology:** Indicates the world's local achievements in space travel. Space transport is independent of breakthroughs in gravitics.

Military technology defines the two key technological areas: personal military and heavy (vehicle-based) military. Personal military technology depends a lot on the achievements attained in the quality of life group, while heavy military technology depends mostly on the achievements in the transportation technology group.

**Personal Military Technology:** Indicates the culture's advancements in personnel-carried weapons and armor. Personal military technology covers everything from clubs to disintegrator weapons.

**Heavy Military Technology:** Indicates the culture's advancements in long-range vehicle-oriented weapons and armor. Heavy weapon systems include such things as artillery, support weapons, and combat vehicles.

**The Novelty Tech Level:** The novelty tech level indicates the tech level that may sometimes be found on the world, but is far from common. The novelty tech level represents a level of local technology that is rarely encountered unless specifically sought out.

The novelty tech level is frequently higher than the high common tech level. Novelty technology can be the artifacts or products of a previous (sometimes more highly advanced) culture, imported goods from nearby advanced worlds, or local experimental prototypes.

# STAR SYSTEM ORBITAL ZONES

## 1 Orbit Zones

The tables below show the conditions found in the various planetary orbits around stars.

### Code Meaning

- Inside sphere of star (no planets possible).
- Unavailable (planet vaporized).
- | Inner zone (hot and inhospitable).
- H Habitable zone (life may exist).
- O Outer zone (cold and inhospitable).

## 2 Orbit Zones for Star Size Ia (Bright Supergiant)

Orbit	B0	B5	A0	A5	F0	F5	G0	G5	K0	K5	M0	M5	M9
1	—	—	—	—	—	—	—	—	—	—	—	—	—
2	—	—	—	—	—	—	—	—	—	—	—	—	—
3	—	—	—	—	—	—	—	—	—	—	—	—	—
4	—	—	—	—	—	—	—	—	—	—	—	—	—
5	—	—	—	—	—	—	—	—	—	—	—	—	—
6	—	—	—	—									
7	—												
8													
9													
10													
11						H							
12		H	H	H	H	O	H	H	H	H	H	H	H
13	H	O	O	O	O	O	O	O	O	O	O	O	O
14	O	O	O	O	O	O	O	O	O	O	O	O	O

## 3 Orbit Zones for Star Size Ib (Weaker Supergiant)

Orbit	B0	B5	A0	A5	F0	F5	G0	G5	K0	K5	M0	M5	M9
1	—	—	—	—	—	—	—	—	—	—	—	—	—
2	—	—	—	—	—	—	—	—	—	—	—	—	—
3	—	—	—	—	—	—	—	—	—	—	—	—	—
4	—	—	—	—	—								
5	—	—											
6	—												
7	—												
8													
9													
10				H	H	H	H	H					
11		H	H	O	O	O	O	O	O	H	H		
12		O	O	O	O	O	O	O	O	O	O	H	H
13	H	O	O	O	O	O	O	O	O	O	O	O	O
14	O	O	O	O	O	O	O	O	O	O	O	O	O

## 4 Orbit Zones for Star Size II (Bright Giant)

Orbit	B0	B5	A0	A5	F0	F5	G0	G5	K0	K5	M0	M5	M9
1	—	—	—	—	—	—	—	—	—	—	—	—	—
2	—	—	—										
3	—	—											
4	—	—											
5	—												
6	—												
7													
8				H	H	H	H	H					
9			H	O	O	O	O	O	H	H			
10			O	O	O	O	O	O	O	O	H		
11		H	O	O	O	O	O	O	O	O	O	H	H
12	H	O	O	O	O	O	O	O	O	O	O	O	O
13	O	O	O	O	O	O	O	O	O	O	O	O	O

## 5 Orbit Zones for Star Size III (Giant)

Orbit	B0	B5	A0	A5	F0	F5	G0	G5	K0	K5	M0	M5	M9
1	—	—											
2	—	—											
3	—	—											
4	—	—											
5	—												
6	—				H	H	H						
7				H	O	O	O	H	H				
8			H	O	O	O	O	O	H	H			
9			O	O	O	O	O	O	O	O	O	H	H
10		H	O	O	O	O	O	O	O	O	O	O	O
11		O	O	O	O	O	O	O	O	O	O	O	O
12	H	O	O	O	O	O	O	O	O	O	O	O	O
13	O	O	O	O	O	O	O	O	O	O	O	O	O

## 6 Orbit Zones for Star Size IV (Subgiant)

Orbit	B0	B5	A0	A5	F0	F5	G0	G5	K0
0	—	—	—						
1	—	—							
2	—	—							
3	—								
4	—								H
5	—				H	H	H	O	O
6	—			H	H	O	O	O	O
7			H	O	O	O	O	O	O
8			O	O	O	O	O	O	O
9		H	O	O	O	O	O	O	O
10		O	O	O	O	O	O	O	O
11		O	O	O	O	O	O	O	O
12	H	O	O	O	O	O	O	O	O
13	O	O	O	O	O	O	O	O	O

## 7 Orbit Zones for Star Size V (Main Sequence)

Orbit	B0	B5	A0	A5	F0	F5	G0	G5	K0	K5	M0	M5	M9
0	—	—								H	H	O	O
1	—	—								O	O	O	O
2	—	—						H	H	O	O	O	O
3	—	—					H	O	O	O	O	O	O
4	—					H	O	O	O	O	O	O	O
5	—				H	O	O	O	O	O	O	O	O
6				H	O	O	O	O	O	O	O	O	O
7			H	O	O	O	O	O	O	O	O	O	O
8			O	O	O	O	O	O	O	O	O	O	O
9		H	O	O	O	O	O	O	O	O	O	O	O
10		O	O	O	O	O	O	O	O	O	O	O	O
11		O	O	O	O	O	O	O	O	O	O	O	O
12	H	O	O	O	O	O	O	O	O	O	O	O	O
13	O	O	O	O	O	O	O	O	O	O	O	O	O

## 8 Orbit Zones for Star Size VI (White Dwarf)

Orbit	F5	G0	G5	K0	K5	M0	M5	M9
0					O	O	O	O
1			H	H	O	O	O	O
2		H	O	O	O	O	O	O
3	H	O	O	O	O	O	O	O
4	O	O	O	O	O	O	O	O

## 9 Orbit Zones for Star Size D (Subdwarf)

Orbit	DB	DA	DF	DG	DK	DM
0	H	O	O	O	O	O
1	O	O	O	O	O	O
2	O	O	O	O	O	O
3	O	O	O	O	O	O
4	O	O	O	O	O	O

# SIZE RELATED DETAILS 1

## 1 Basic World Type

If the world is a gas giant, go to step 3a. If the world size is 0 (asteroid/planetoid belt), go to step 4a. Otherwise, continue on to step 2a.

## 2a Planet Diameter

Roll 2D-7 (giving a range from -5 to +5; reroll a "+5" result), multiply by 100 (-500 to +400), and add to the UWP size x 1,000. (If size S, UWP size is 0.6).

Multiply by 1.6 for a size in kilometers.

**Example:** A world has a UWP size of 5 (a basic diameter of 5,000 miles). We roll 2D-7 and get -3. Multiplying by 100 gives -300, which we subtract from the basic size of 5,000 to get 4,700 miles, a number we refine to 4,782 miles. Converting to kilometers (4,782 x 1.6) gives a final diameter of 7652 kilometers.

## 2b Planet Density

To determine a planet's density, first roll on the table below:

Dice (2D)	DENSITY TYPE
1-	Heavy Core
2-10	Molten Core
11-14	Rocky Body
15+	Icy Body

### DMs:

If size 4-, DM+1  
If size 6+, DM-2

If atm3-, DM+1  
If atm6+, DM-2

If outer zone orbit, DM+6

Next, determine the exact density by rolling 3D on proper column below.

When done with this step, go to step 5.

Die Roll (3D)	Heavy Core	Molten Core	Rocky Body	Icy Body
3	1.10	0.82	0.50	0.18
4	1.15	0.84	0.52	0.20
5	1.20	0.86	0.54	0.22
6	1.25	0.88	0.56	0.24
7	1.30	0.90	0.58	0.26
8	1.35	0.92	0.60	0.28
9	1.40	0.94	0.62	0.30
10	1.45	0.96	0.64	0.32
11	1.50	0.98	0.66	0.34
12	1.55	1.00	0.68	0.36
13	1.60	1.02	0.70	0.38
14	1.70	1.04	0.72	0.40
15	1.80	1.06	0.74	0.42
16	1.90	1.08	0.76	0.44
17	2.00	1.10	0.78	0.46
18	2.25	1.12	0.80	0.48

**Note:** Density is expressed in standard densities (Terra=1, or 5.517 grams per cubic centimeter).

**Example:** A world has a UPP size of 5, an atmosphere of 2, and orbits in the habital zone. The Density Type table shows only a +1 DM for atmosphere 2. We roll 2D and get 11 with the DM, yielding a type of "Rocky Body".

Moving to the second table, rolling 3D on the Rocky Body column results in an 11, for a density (K) of 0.66 standard.

## 3a Gas Giant UWP Size

Depending on the gas giant size (small or large), roll on the appropriate table below to arrive at a UWP size.

### SMALL GAS GIANT SIZE

Die (2D)	UWP Size
2	20
3	30
4	40
5	50
6	60
7	60
8	70
9	80
10	80
11	90
12	100

### LARGE GAS GIANT SIZE

Die (3D)	UWP Size
3	110
4	120
5	130
6	140
7	150
8	150
9	160
10	170
11	180
12	190
13	200
14	210
15	220
16	230
17	240
18	Brown dwarf

**Example:** We have a large gas giant, so we roll 3D on the large gas giant table and get 14. Our large gas giant has a UWP size of 210 (210,000 miles).

## 3b Gas Giant Diameter

Roll 2D-7 (giving a range from -5 to +5; reroll a "+5" result), multiply by 1,000 (-5,000 to +4,000), and add to the UWP size x 1,000.

Multiply by 1.6 for a size in kilometers.

**Example:** A gas giant has a UWP size of 210. We roll 2D-7 and get 2. Multiplying the 2 by 1,000 gives 2,000, which we add to the basic size of

210,000 to get 212,000 miles. Converting to kilometers (212,000 x 1.6) gives a final diameter of 339,200 kilometers.

## 3c Gas Giant Density

Roll 3D on the table below to arrive at the gas giant's density.

Go to step 5 when done with this step.

Die Roll (3D)	Gas Giant Density
3	0.10
4	0.11
5	0.12
6	0.13
7	0.14
8	0.16
9	0.18
10	0.20
11	0.22
12	0.23
13	0.24
14	0.26
15	0.27
16	0.28
17	0.29
18	0.30

**Note:** If the density is less than 0.15, the gas giant has no solid core. If the density is between 0.15 and 0.25, the gas giant has a solid core of frozen gases. If the density is over 0.25, the gas giant has a solid rocky core.

**Example:** We roll 3D and get 9, giving our gas giant a density of 0.18, so it has a solid core of frozen gases.

## 5 World Mass

Compute the world's mass as:

$$M = K \times (R + 8)^3$$

Where:

M = Mass in standard masses (Terra=1).

K = Planet's density.

R = UWP size digit (use 0.6 for size S).

**Example:** A UWP size 5 world has a 0.66 density. Dividing 5 by 8 gives 0.625; 0.625 cubed is 0.244. Multiplying 0.244 by the density of 0.66 gives a mass of 0.161 standard.

## 6 World Gravity

Compute surface gravity as:

$$G = M \times (64 + R^2)$$

Where:

G = Gravity in standard gees (Terra=1).

M = Planet's mass.

R = UWP size digit (use 0.6 for size S).

**Example:** A UWP size 5 world has a mass of 0.161. Dividing 64 by 5 squared gives 2.56. Multiplying 2.56 by the mass of 0.161 yields a surface gravity of 0.41g.

# SIZE RELATED DETAILS 2

## 4a Asteroid/Planetoid Diameter

Roll on the table below to determine the predominate body diameter in the asteroid/planetoid belt.

### PREDOMINATE BODY DIAMETER

Die	Diameter	Disp Tons
(2D)		
2	1m	under 1 ton
3	5m	5 tons
4	10m	50 tons
5	25m	500 tons
6	50m	5,000 tons
7	100m	50,000 tons
8	300m	1 million tons
9	1km	50 million tons
10	5km	5 billion tons
11	50km	5 trillion tons
12	500km	5,000 trillion tons

**Note:** Thirty percent or more of the belt asteroids approach the predominate diameter. The rest are a variety of smaller sizes — although a very few planetoids (1 percent or so) may be larger. To find if any larger planetoids exist, roll on the table below.

### MAXIMUM PLANETOID BODY DIAMETER

Die	Result
(1D)	
1	as rolled
2	as rolled
3	up to 1km
4	up to 10km
5	up to 100km
6	up to 1,000km

**Example:** Rolling 2D on the Predominate Body Diameter table gives a result of 7, or 100m (50,000 tons displacement). Further, rolling 1D on the Maximum Diameter table gives a result of 5, meaning that there may be a few planetoids whose diameter approaches 100 km. The diameter of the bodies in this belt is written as: 100m/100km.

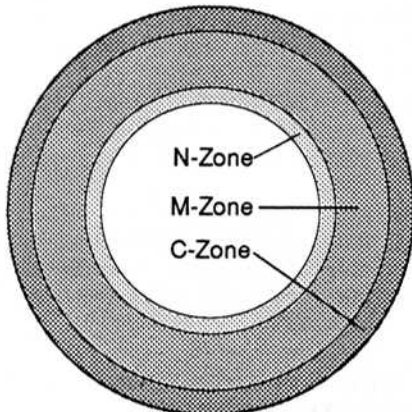

Typical Asteroid Belt Cartography

## 4b Asteroid/Planetoid Belt Zones

Roll on the table below to determine the predominate belt zone.

### Dice (2D) PREDOMINATE ZONE

- 4- N-Zone (nickel-iron)
- 5-8 M-Zone (mixed)
- 9+ C-Zone (carbonaceous and/or ice)

### DMs:

- Orbit inside habitable zone, -4
- Orbit outside habitable zone, +2

Next, roll on the proper table below for the percentage size of all belt zones.

### Dice (2D) N-ZONE PREDOMINATE

2	n-40	m-30	c-30
3	n-40	m-40	c-20
4	n-40	m-40	c-20
5	n-40	m-40	c-20
6	n-40	m-40	c-20
7	n-50	m-40	c-10
8	n-50	m-40	c-10
9	n-50	m-40	c-10
10	n-50	m-30	c-20
11	n-60	m-50	c-10
12	n-60	m-40	c-20

### Dice (2D) M-ZONE PREDOMINATE

2	n-20	m-50	c-30
3	n-30	m-50	c-20
4	n-20	m-60	c-20
5	n-20	m-60	c-20
6	n-30	m-60	c-10
7	n-20	m-70	c-10
8	n-10	m-70	c-20
9	n-10	m-80	c-10
10	n-10	m-80	c-10
11	n-0	m-80	c-20
12	n-0	m-90	c-10

### Dice (2D) C-ZONE PREDOMINATE

2	n-20	m-30	c-50
3	n-20	m-30	c-50
4	n-20	m-30	c-50
5	n-10	m-30	c-60
6	n-10	m-30	c-60
7	n-10	m-20	c-70
8	n-10	m-20	c-70
9	n-10	m-10	c-80
10	n-0	m-10	c-80
11	n-0	m-10	c-80
12	n-0	m-20	c-80

**Note:** The percentages given are approximate; they can vary by  $\pm 5$  percent. When n-0 is given for the nickel-iron zone, there are not enough nickel-iron asteroids in the belt for it to have a discernable n-zone.

**Example:** Rolling 2D on the Predominate Zone table, we get an 11. The asteroid belt orbits in the habitable zone, so we do not apply any DMs to our roll. A final result of 11 means the C-Zone is predominate.

Thus we roll 2D on the C-Zone Predominate table, getting a 9. Looking on the table, we see this gives us a result of "n-10 m-10 c-80". Roughly 10% of our belt is an n-zone, another 10% is an m-zone, and the remaining 80% is the c-zone.

## 4c Belt Orbit Width

Roll on the table below to determine the belt's orbit width in AUs.

### Die (2D) BELT ORBIT WIDTH

2	0.01 AU
3	0.05 AU
4	0.1 AU
5	0.1 AU
6	0.5 AU
7	0.5 AU
8	1.0 AU
9	1.5 AU
10	2.0 AU
11	5.0 AU
12	10.0 AU

### DMs:

- Orbit 1-4, DM-3
- Orbit 5-8, DM-1
- Orbit 9-12, DM+1
- Orbit 13+, DM+2

**Note:** To convert a belt width in AUs to its width in kilometers, multiply by 150 million.

**Example:** The belt in question is in orbit 4, meaning we apply a DM of -3 to the roll on this table. We roll 2D and get a roll of 2 with the DMs, so this belt is only 0.01 AUs wide. To convert this width to kilometers, we multiply by 150 million, giving a belt width in kilometers of 1.5 million.

## 4d Belt Profile Notation

List the data from these tables in a single line to provide a summary profile of an asteroid belt. For example, list:

100m/100km, n-10 m-10 c-80, 0.01AU for the belt from the examples in this section. Other belt profile examples include:

5m, n-0 m-80 c-20, 0.1AU

5km/100km, n-30 m-70 c-10, 1.5 AU

The latter belt looks to be a particularly rich one for beltlers, with its large body size, vast width, and relatively large n-zone.

# SIZE RELATED DETAILS 3

## 7 Planet Orbital Period

Determine the orbital period for the world. This orbit is *around the central star*.

If the world is a satellite, then also compute the world's orbital period around the central planet (step 8).

## 7a Stellar Mass

Lookup the mass of the central star on one of the tables below.

### STELLAR MASSES

Spectral Class	Ia	Ib	II	III
B0	60	50	30	25
B5	30	25	20	15
A0	18	16	14	12
A5	15	13	11	9
F0	13	12	10	8
F5	12	10	8.1	5
G0	12	10	8.1	2.5
G5	13	12	10	3.2
K0	14	13	11	4
K5	18	16	14	5
M0	20	16	14	6.3
M5	25	20	16	7.4
M9	30	25	18	9.2

Spectral Class	IV	V	VI	Spec	D
B0	20	18	—	B	0.26
B5	10	6.5	—	A	0.36
A0	6	3.2	—	F	0.42
A5	4	2.1	—	G	0.63
F0	2.5	1.7	—	K	0.83
F5	2	1.3	0.8	M	1.11
G0	1.75	1.04	0.6		
G5	2	0.94	0.528		
K0	2.3	0.825	0.430		
K5	—	0.570	0.330		
M0	—	0.489	0.154		
M5	—	0.331	0.104		
M9	—	0.215	0.058		

## 7b Orbital Distance

Lookup the orbital distance, below.

Orbit Nbr	AU
0	0.2
1	0.4
2	0.7
3	1.0
4	1.6
5	2.8
6	5.2
7	10.0
8	19.6
9	38.8
10	77.2
11	154.0
12	307.6
13	614.8
14	1,229.2
15	2,458.0
16	4,915.6
17	9,830.8
18	19,661.2
19	39,322.0

## 7c Orbital Period

Using the following formula, compute the orbital period.

$$P = \sqrt{D^3 / M}$$

Where:

P = Period in standard years. Multiply by 365.25 to convert to days.

D = Distance in AUs.

M = Mass of central star in solar masses.

**Example:** The central star is a type M5V, with a mass (M) of 0.331. The planet is in orbit 4, or a distance (D) of 1.6 AUs. The computation is: 1.6 cubed equals 4.096; dividing this by 0.331 yields 12.375; taking the square root gives us 3.52 standard years. Multiplying by 365.25 results in an orbital period of 1,285.7 standard days.

## 8 Satellite Orbital Period

If the world is a satellite, then also compute the world's orbital period around the central planet. Otherwise, skip this step (go on to step 9).

## 8a Orbital Distance

Multiply the central planet's diameter by the satellite's orbital distance (in diameters) to get the satellite's orbital distance in kilometers.

**Example:** The diameter of the central planet is 5,678km, and the satellite orbits at 25 diameters. The satellite's orbital distance is 5,678 x 25, or 141,950km.

## 8b Orbital Period

Using the following formula, compute the orbital period.

$$P = \sqrt{\frac{(D/400,000)^3 \times 793.64}{M}}$$

Where:

P = Period in standard days.

D = Distance in kilometers.

M = Mass of central planet in earth masses.

**Example:** The central planet's mass (M) is 0.48. The satellite orbital distance (D) is 141,950km. The computation is: 141,950/400,000 and then cubed equals 0.0447; multiplying by 793.64 gives us 35.476; dividing this by 0.48 yields 73.908; taking the square root gives us an orbital period of 8.60 standard days.

## 9 Rotation Period

Compute the basic rotation period using the formula below:

$$P = (A \times 4) + 5 + M/D$$

Where:

P = Rotation period in standard days.

A = Dice roll: 2D-2.

M = For a planet, use the mass of central star in solar masses. For a satellite, use the mass of the central planet.

D = For a planet, use the distance from the central star in AUs. For a satellite, divide the distance from the central planet (in kilometers) by 400,000.

If the result is greater than 40, roll 2D and consult the table below:

## KEY TO ORBITAL PERIOD TYPES

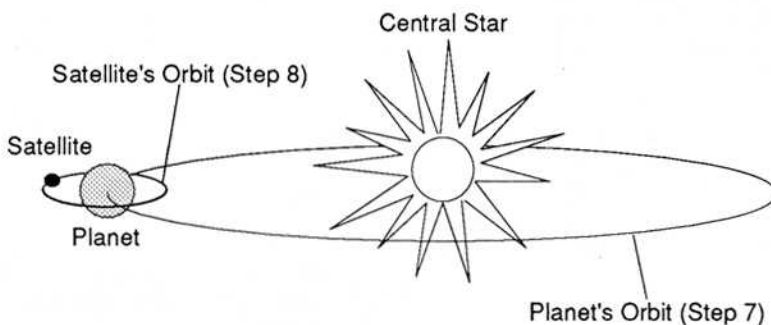



# SIZE RELATED DETAILS 4

## ROTATION PERIOD

### Dice SPECIAL CASES

#### (2D) Rotation

- 2 1Dx10 days (retrograde)
- 3 1Dx20 days
- 4 1Dx10 days
- 5 use rotation unchanged
- 6 tidal lock
- 7 tidal lock
- 8 tidal lock
- 9 use rotation unchanged
- 10 1Dx10 days
- 11 1Dx50 days
- 12 1Dx50 days (retrograde)

**Note:** Days are standard days consisting of 24 hours.

For results expressed in tens of days, further refine the figure if desired to get a result in exact days.

To further refine rotations expressed as days, add 1D-3 x 4 hours to the basic rotation period to arrive at a rotation period in actual hours.

For color, the exact rotation period can be further described in minutes (0-59) and seconds (0-59), if desired.

**Example:** Our planet orbits at 1.6 AUs from the central star, which has a mass of 0.331. Working our way through the rotation period formula: we roll 2D-2 and get 4. Multiplying by 4 and adding 5 yields 21. The star's mass of 0.331 divided by 1.6 gives us 0.20. Adding this to our 21 give us a rotation period of 21.2 standard hours, or 21 hours, 12 minutes.

Since the rotation period is less than 40 hours, we do not need to consult the special cases table.

We want a final rotation period expressed in minutes and seconds, so we settle on a detailed rotation of 21 hours, 12 minutes, and 2 seconds (21h 12m 2s).

## 10 Axial Tilt

Determine the world's axial tilt by rolling 2D on the table below:

Dice	AXIAL TILT
(2D)	
2-3	0° + (2D-2)
4-5	10° + (2D-2)
6-7	20° + (2D-2)
8-9	30° + (2D-2)
10-11	40° + (2D-2)
12	roll 1D below...
1-2	50° + (2D-2)
3	60° + (2D-2)
4	70° + (2D-2)
5	80° + (2D-2)
6	90°

**Example:** Rolling 2D on the Axial Tilt table results in a 7, giving a table entry of 20° + (2D-2)°. Rolling 2D-2 gives a 7, for an axial tilt of 27°. We add some additional color and come up with a final detailed axial tilt of 27° 44' 7.4".

the first satellite is 1200+(7x64), or 2. The second satellite is 600+(25x64), or 0. Adding these values together for both satellites gives an M of 2. Finally, S is 1.7 + 1.6, or 1. The computed stress factor is thus -1+3+2+1, or 5.

## 11 Orbital Eccentricity

Determine the world's orbital eccentricity by rolling 2D on the table below:

Dice	ORBITAL ECCENTRICITY
(2D)	
2-7	0.000
8	0.005
9	0.010
10	0.015
11	0.020
12	Roll 1D below...
1	0.025
2	0.050
3	0.100
4	0.200
5	0.250
6	extreme (ref's choice)

**Example:** We roll 2D on the Orbital Eccentricity table and get 11, indicating 0.020 as the eccentricity.

## 12 Seismic Stress Factor

The stresses which cause seismic activity stem from several sources, including the nature of the world, its distance from its star, the size and distance of planetary satellites and so on.

To compute a stress factor for a world:

$$F = X + P + M + S$$

Where:

F = Seismic Stress Factor for the world.

X = Roll of 1D-3.

P = Heavy Core = 1D-2.

Molten Core = 1D-3.

Rocky Body, Icy Body = 0.

M = Satellite diameter in km + (orbit number x 64). Compute for each satellite orbiting the world, and add all results together to get M.

S = Mass of central star in solar masses (step 7a) + world's orbital distance from the star in AUs (step 7b).

**Example:** A molten core world has 2 satellites (one, diameter 1200 km, orbiting 7 diameters out and another, diameter 600 km, 25 diameters distant). The world orbits its star (stellar mass of 1.7) at 1.6 AU's. Rolling 1D-3 for X in the formula results in -1. Rolling 1D-3 for P (molten core) gives 3. Computing M:

# ATMOSPHERE RELATED DETAILS 1

## 1 Atmospheric Composition

If the atmosphere is type 3, 5, 6, 8, D, E, or F, then the composition is: "standard oxygen-nitrogen mix." Proceed to step 2.

If the atmosphere is type 0 or 1, there is no atmosphere to speak of, so the composition is: "none." Proceed to step 2.

If the atmosphere is type 2, 4, 7, or 9, then the composition is: "standard oxygen-nitrogen mix, with \_\_\_\_ taint." To fill in the blank, roll on the composition table, below:

### ATMOSPHERIC COMPOSITION

Dice Tainted  
(2D) (2,4,7,9)

2	Disease
3	Gas Mix
4	High Oxygen
5	Pollutants
6	Sulfur Compounds
7	Pollutants
8	Sulfur Compounds
9	Pollutants
10	Low Oxygen
11	Gas Mix
12	Disease

If the atmosphere is type A, roll on the table below:

### ATMOSPHERIC COMPOSITION

Dice Exotic  
(2D) (A)

2	Very Thin, Irritant
3	Very Thin
4	Thin
5	Thin, Irritant
6	Standard
7	Standard, Irritant
8	Dense
9	Dense, Irritant
10	Very Dense
11	Very Dense, Irritant
12	Occasional Corrosive

If the atmosphere is type B, roll on the table below:

### ATMOSPHERIC COMPOSITION

Dice Corrosive  
(2D) (B)

2	Below -100°C
3	Very Thin, -100°C to -25°C
4	Very Thin, -25°C to 50°C
5	Very Thin, 50°C to 100°C
6	Normal, -200°C to -25°C
7	Normal, -25°C to 50°C
8	Normal, 50°C to 100°C
9	Very Dense, -200°C to -25°C
10	Very Dense, -25°C to 50°C
11	Very Dense, 50°C to 100°C
12	Over 100°C

If the atmosphere is type C, roll on the table below:

### ATMOSPHERIC COMPOSITION

Dice Insidious  
(2D) (C)

2	Gas Mix
3	Gas Mix
4	Radiation
5	Temperature
6	Pressure
7	Gas Mix
8	Pressure
9	Temperature
10	Radiation
11	Gas Mix
12	Gas Mix

**Example:** A world has an atmosphere UWP digit of 2 (very thin, tainted). Rolling 2D on the Atmospheric Composition table results in a roll of 4, giving a taint of high oxygen.

## 2 Surface Atmospheric Pressure

Roll 2D on the table below:

### SURFACE ATMOSPHERIC PRESSURE (in atmospheres)

\_\_\_\_\_ Atmosphere Type \_\_\_\_\_

Dice Trace (2D)	V.Thin (1)	Thin* (2-3)	Thin* (4,5,F)	Std (6-7)	Dense (8-9)	Very Dense†
2	0.01	0.10	0.43	0.76	1.50	2.50
3	0.05	0.12	0.45	0.80	1.60	5.00
4	0.05	0.14	0.48	0.85	1.70	10.00
5	0.06	0.16	0.50	0.90	1.80	25.00
6	0.06	0.18	0.50	0.95	1.90	50.00
7	0.07	0.20	0.50	1.00	2.00	100.00
8	0.07	0.23	0.55	1.00	2.00	150.00
9	0.07	0.25	0.60	1.10	2.20	200.00
10	0.08	0.30	0.65	1.20	2.20	250.00
11	0.08	0.35	0.70	1.30	2.40	500.00
12	0.09	0.40	0.75	1.40	2.40	750.00

\*For type F atmospheres (thin, low), roll on this column and subtract 0.20.

†Very Dense atmospheres occur in atmosphere types D or E, or on the Atmospheric Composition table for atmospheres type A, B, or C.

**Example:** A world has an atmosphere UWP digit of 2 (very thin, tainted). Rolling 2D on the Surface Atmospheric Pressure table results in a roll of 2, giving a surface pressure of 0.10 atm.

## 3 Surface Temperature

The next series of steps allow you to determine detailed information about the world's surface temperature.

## 3a Stellar Luminosity

Lookup the luminosity of the central star on one of the tables below.

### STELLAR LUMINOSITY

Spectral Class	Ia	Ib	II	III
B0	27.36	22.80	20.31	18.09
B5	21.25	14.70	11.68	9.05
A0	18.09	11.07	6.85	4.09
A5	16.87	10.40	5.40	3.08
F0	15.72	9.27	4.95	2.70
F5	15.03	8.45	4.75	2.56
G0	16.09	8.84	4.86	2.66
G5	17.27	9.49	5.22	2.94
K0	17.65	10.40	5.46	3.12
K5	18.09	11.95	7.04	4.23
M0	18.49	14.65	8.24	4.66
M5	18.95	17.27	11.05	6.91
M9	19.38	18.49	11.28	7.20

Spectral Class	IV	V	VI	Spec	D
B0	16.87	15.38	—	B	0.46
B5	6.69	6.12	—	A	0.27
A0	3.53	3.08	—	F	0.13
A5	2.47	2.00	—	G	0.09
F0	2.09	1.69	—	K	0.08
F5	1.86	1.37	0.99	M	0.07
G0	1.60	1.05	0.75		
G5	1.49	0.90	0.66		
K0	1.47	0.81	0.58		
K5	—	0.53	0.40		
M0	—	0.45	0.32		
M5	—	0.29	0.21		
M9	—	0.18	0.09		

**Example:** The central star is a type F5V, which has a luminosity of 1.37.

## 3b Orbit Factor

Lookup the orbit factor of the planet on the table below.

Orbit	Factor
0	836.345
1	591.385
2	447.045
3	374.025
4	295.693
5	223.523
6	164.021
7	118.277
8	84.484
9	60.046
10	42.569
11	30.140
12	21.326
13	15.085
14	10.668
15	7.544
16	5.335
17	3.772
18	2.667
19	1.886

**Example:** The planet, in orbit 4, has an orbit factor of 295.693.

# ATMOSPHERE RELATED DETAILS 2

## 3C Energy Absorption

If the world atmosphere is type 0-3, lookup the value on the table below:

### WORLD ATMOSPHERE 0-3

World Hyd	Not Habital Zone	Habital Zone
0	0.800	0.900
1	0.744	0.829
2	0.736	0.803
3	0.752	0.811
4	0.738	0.782
5	0.753	0.789
6	0.767	0.795
7	0.782	0.802
8	0.796	0.808
9	0.810	0.814
A	0.818	0.818

If the world atmosphere is type 4-9, lookup the value on the table below:

### WORLD ATMOSPHERE 4-9

World Hyd	Not Habital Zone	Habital Zone
0	0.800	0.900
1	0.811	0.900
2	0.789	0.860
3	0.799	0.860
4	0.774	0.820
5	0.747	0.780
6	0.718	0.740
7	0.687	0.700
8	0.654	0.660
9	0.619	0.620
A	0.619	0.619

If the world atmosphere is type A-D, F, lookup the value on the table below:

### WORLD ATMOSPHERE A-D, F

World Hyd	Not Habital Zone	Habital Zone
0	0.680	0.740
1	0.646	0.697
2	0.635	0.672
3	0.644	0.676
4	0.625	0.648
5	0.599	0.613
6	0.570	0.577
7	0.537	0.539
8	0.500	0.500
9	0.500	0.500
A	0.500	0.500

If the world atmosphere is type E, lookup the value on the table below:

### WORLD ATMOSPHERE E

World Hyd	Not Habital Zone	Habital Zone
0	0.800	0.900
1	0.811	0.900
2	0.807	0.882
3	0.817	0.883
4	0.813	0.866
5	0.809	0.850
6	0.805	0.836
7	0.800	0.821
8	0.794	0.807
9	0.787	0.793
A	0.773	0.773

**Example:** A world has an atmosphere UWP digit of 2, a hydrosphere digit of 6, and orbits in the habital zone. Looking on the World Atmosphere 0-3 table, we see the energy absorption factor for this world is 0.767.

## 3d Greenhouse Effect

To determine the world's greenhouse effect, consult the table below:

### GREENHOUSE EFFECT

Atmos Code	Atmosphere Type	Greenhouse Effect
0	None	1.00
1	Trace	1.00
2	Very Thin, Taint	1.00
3	Very Thin	1.00
4	Thin, Tainted	1.05
5	Thin	1.05
6	Standard	1.10
7	Standard, Tainted	1.10
8	Dense	1.15
9	Dense, Tainted	1.15
A	Exotic	see below
B	Corrosive	see below
C	Insidious	see below
D	Dense, High	1.15
E	Ellipsoid	1.10
F	Thin, Low	1.00

If the world's atmosphere is A, B, or C, roll 2D on the table below to determine the greenhouse effect.

### EXOTIC ATMOSPHERES GREENHOUSE EFFECT

Die	Atm A	Atm B, C
2	1.2	1.2
3	1.2	1.3
4	1.3	1.4
5	1.3	1.5
6	1.4	1.6
7	1.4	1.7
8	1.5	1.8
9	1.5	1.9
10	1.6	2.0
11	1.6	2.1
12	1.7	2.2

**Example:** A world has an atmosphere UWP digit of 2. Consulting the Greenhouse Effect table, we find this world has a Greenhouse Effect of 1.00.

## 3e Base Temperature

Compute the base surface temperature using this formula:

$$T = L \times O \times E \times G$$

Where:

T = World's Base Mean Surface Temperature (in degrees Kelvin; subtract 273 to get degrees Celsius).

L = Luminosity of the central star.

O = Orbital factor for the world.

E = Energy absorption factor for the world.

G = Greenhouse effect for the world.

**Example:** A world orbits a star that has a luminosity of 1.37. The orbital factor for the world's orbit is 295.693. The world's energy absorption is 0.767, and the greenhouse effect is 1.00. Plugging these values into the formula we have:  $1.37 \times 295.693 \times 0.767 \times 1.00$ , giving us a base mean surface temperature of 310.7°K. Converting to degrees Celsius, we subtract 273, giving us a final base mean surface temperature of 37.7°C.

## 4 Orbital Eccentricity Effects

Compute the modification from orbital eccentricity using these formulas:

$$T_c = O \times +30$$

$$T_f = O \times -30$$

Where:

T<sub>c</sub> = Temperature at closest approach.

T<sub>f</sub> = Temperature at farthest separation.

O = Orbital eccentricity.

**Example:** We have previously determined a world to have an orbital eccentricity of 0.020. This gives a closest approach temperature modifier of +0.6°C and a farthest separation modifier of -0.6°C.

### AN ECCENTRIC ORBIT

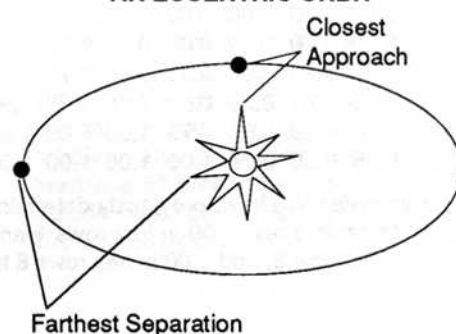

# ATMOSPHERE RELATED DETAILS 3

## 5 Latitude Temperature Effects

Determine the temperature modification effects of latitude from the table below:

### LATITUDE TEMPERATURE MODIFIERS

Hex Row	Size 1	Size 3,2	Size 4,5	Size 6,7	Size 8,9	Size A
1	+9	+12	+15	+18	+21	+24
2	+6	+8	+10	+12	+14	+16
3	+3	+4	+5	+6	+7	+8
4	0	0	0	0	0	0
5	-3	-4	-5	-6	-7	-8
6	-6	-8	-10	-12	-14	-16
7	-9	-12	-15	-18	-21	-24
8	-12	-16	-20	-24	-28	-32
9	-15	-20	-25	-30	-35	-40
10	-18	-24	-30	-36	-42	-48
11	-21	-28	-35	-42	-49	-56

**Example:** For a size 4 world, the latitude modifiers are: +15, +10, +5, 0, -5, -10, -15, -20, -25, -30, -35.

## 6a Axial Tilt Base Increase

Determine the maximum increase in temperature due to axial tilt (summer season) with this formula:

$$T = A \times +0.6$$

Where:

T = Base temperature increase during summer.

A = Axial tilt in degrees.

**Example:** We have previously determined a world to have an axial tilt of 27°. The base temperature increase is thus +16°C (rounded) in the summer.

## 6c Axial Tilt Latitude Effects

Determine the axial tilt temperature factor for a given hex row from the table below:

### AXIAL TILT EFFECTS

Hex Row	Degree of Axial Tilt													
	0	1	2-3	4-5	6-8	9-12	13-16	17-22	23-28	29-34	35-44	45-59	60-85+	
1	0.00	0.00	0.00	0.00	0.00	0.00	0.00	0.00	0.00	0.00	0.25	0.50	0.75	1.00
2	0.00	0.00	0.00	0.00	0.00	0.00	0.00	0.00	0.00	0.25	0.50	0.75	1.00	1.00
3	0.00	0.00	0.00	0.00	0.00	0.00	0.00	0.25	0.50	0.75	1.00	1.00	1.00	1.00
4	0.00	0.00	0.00	0.00	0.00	0.00	0.25	0.50	0.75	1.00	1.00	1.00	1.00	1.00
5	0.00	0.00	0.00	0.00	0.00	0.25	0.50	0.75	1.00	1.00	1.00	1.00	1.00	1.00
6	0.00	0.00	0.00	0.00	0.25	0.50	0.75	1.00	1.00	1.00	1.00	1.00	1.00	1.00
7	0.00	0.00	0.00	0.25	0.50	0.75	1.00	1.00	1.00	1.00	1.00	1.00	1.00	1.00
8	0.00	0.00	0.25	0.50	0.75	1.00	1.00	1.00	1.00	1.00	1.00	1.00	1.00	1.00
9	0.00	0.25	0.50	0.75	1.00	1.00	1.00	1.00	1.00	1.00	1.00	1.00	1.00	1.00
10	0.00	0.25	0.50	0.75	1.00	1.00	1.00	1.00	1.00	1.00	1.00	1.00	1.00	1.00
11	0.25	0.50	0.75	1.00	1.00	1.00	1.00	1.00	1.00	1.00	1.00	1.00	1.00	1.00

**Example:** We have previously determined a world to have an axial tilt of 27°. The axial tilt factors are: 0.00 in hex rows 1 and 2, 0.25 in hex row 3, 0.50 in hex row 4, 0.75 in hex row 5, and 1.00 in hex rows 6 to 11.

## 7a Length of Day and Night

To compute the length of daytime or nighttime divide the rotation period by 2.

**Example:** A world has a rotation period of 28 days. Dividing by 2, daytime or nighttime lasts 14 days.

## 7b Rotation-Luminosity Factor

Compute a rotation luminosity factor using the following formula:

$$R = L + \sqrt{D}$$

Where:

R = Rotation-luminosity factor.

L = Luminosity for the primary star (from step 3a).

D = Distance from the primary star (in AUs).

**Example:** We have a world that is 1.6 AUs from a type F5V star. Looking at step 3a, we see the luminosity for the star is 1.37. Computing the square root of 1.6 gives 1.26. Dividing 1.37 by 1.26 yields a rotation luminosity factor of 1.09.

## 7c Daytime Rotation Effects

Compute the average temperature increase during the day from the table:

### DAYTIME TEMPERATURE EFFECTS

Atm Pressure	+Per Hour of Daylight	Absolute Maximum Plus Temperature
None (0)	1.0°x R	(Base + 273) x 0.1 x R
Trace (1)	0.9°x R	(Base + 273) x 0.3 x R
V.Thin (2,3,F)	0.8°x R	(Base + 273) x 0.8 x R
Thin (4,5)	0.6°x R	(Base + 273) x 1.5 x R
Standard (6,7)	0.5°x R	(Base + 273) x 2.5 x R
Dense (8,9)	0.4°x R	(Base + 273) x 4.0 x R
V. Dense (D,E)	0.2°x R	(Base + 273) x 5.0 x R

**Note:** R is the rotation-luminosity factor from step 7b, above.

At no time can the +per hour of daylight exceed the absolute maximum plus temperature.

**Example:** A world with no atmosphere has a base mean surface temperature of 95°C, a rotation of 28 days, and an R of 1.09. Looking on the Rotation Temperature Effects table using the atmospheric pressure entry of "None", we find that we add 1.0° x 1.9, or 1.9° per hour. We have 336 hours of daylight (14 days x 24 hours per day), which means we would add 638°. However, the "absolute limit" column indicates that we can add at most +70°C [(95+273]x0.1x1.9).

# ATMOSPHERE RELATED DETAILS 4

## 7d Nighttime Rotation Effects

Compute the average temperature decrease during nighttime from the table:

### NIGHTTIME TEMPERATURE EFFECTS

Atm Pressure	-Per Hour of Night	Absolute Maximum Minus Temperature
None (0)	20.0°C	(Base + 273) x 0.80
Trace (1)	15.0°C	(Base + 273) x 0.70
V.Thin (2,3,F)	8.0°C	(Base + 273) x 0.50
Thin (4,5)	3.0°C	(Base + 273) x 0.30
Standard (6,7)	1.0°C	(Base + 273) x 0.15
Dense (8,9)	0.5°C	(Base + 273) x 0.10
V. Dense (D,E)	0.2°C	(Base + 273) x 0.05

**Note:** The rotation-luminosity factor is not used for the nighttime calculations since the primary star does not shine on the world's night side.

At no time can the -per hour of night exceed the absolute maximum minus temperature.

**Example:** Computing the nighttime temperature drop for the same world as step 7b gives us -6720° C (20°Cx336 hours). However, the "absolute limit" column computation tells us at most we can subtract 294.4° C [(95+273)x0.80].

## 8 More Complex Situations

These rules favor an terran planet in a system with a single star. Systems with more than one star, or a world tidally locked with its star involve some special considerations.

Steps 9 and 10 discuss how to handle these more complex situations.

## 9 Binary or Trinary Stars

The problem with multiple star systems is how to handle the complex variations in the energy striking the planet from the other stars.

The easiest way to deal with such complexities is to treat the system as if it has a single star with a modified luminosity.

A *close companion* is easily dealt with by just adding the luminosity of the two stars together.

A *far companion* is so distant that its effect can be ignored.

A *near companion* orbiting among the planets presents the complex situation. Handle such a complex situation by computing three luminosity variations:

**Closest Separation:** Compute the effective luminosity addition for the closest approach of the companion star using this formula:

$$L_c = L + \sqrt{C_d - W_d}$$

Where:

$L_c$  = Effective luminosity added by the companion star at its closest separation from the world in question.

$L$  = Luminosity factor (from the table in step 3a) for the companion star.

$C_d$  = Distance of the companion star from the primary star (in AUs).

$W_d$  = Distance of the world from the primary star (in AUs).

**Farthest Separation:** Compute the effective luminosity addition for the farthest separation of the companion star using this formula:

$$L_f = L + \sqrt{C_d + W_d}$$

Where:

$L_f$  = Effective luminosity added by the companion star at its farthest separation from the world in question.

$L$  = Luminosity factor (from the table in step 3a) for the companion star.

$C_d$  = Distance of the companion star from the primary star (in AUs).

$W_d$  = Distance of the world from the primary star (in AUs).

**Mean Separation:** Compute the effective luminosity addition for the mean separation of the companion star using this formula:

Where:

$$L_m = L + \sqrt{(C_d + W_d) \div 2}$$

$L_m$  = Effective luminosity added by the companion star at its mean separation from the world in question.

$L$  = Luminosity factor (from the table in step 3a) for the companion star.

$C_d$  = Distance of the companion star from the primary star (in AUs).

$W_d$  = Distance of the world from the primary star (in AUs).

**Timing:** Determine the timing of the temperature changes by examining the orbital periods of the companion star and the orbital period of the world.

Compute a base temperature and a temperature worksheet for the various luminosities.

Three base temperatures and three temperature worksheets are usually sufficient.

## 10 Tidally Locked Worlds

Temperature computations work differently if the world is tidally locked with its primary star.

The base temperature applies to the twilight region between the world's light and dark side, rather than hex row 4. By convention, the twilight region is in hex row 1 on the map (both rows on each side of the equator).

Further, by convention, the top hexrows are on the dayside, and the bottom hexrows are on the nightside.

Use the maximum plus for the daytime plus computed in step 7c, since daytime is effectively infinite.

To determine the latitude mod per hexrow on the dayside, divide the daytime plus by the world's UWP size digit. (The dayside temperature must never exceed the maximum daytime plus in any hex row, however.)

Use the maximum minus for the nighttime minus computed in step 7d, since nighttime is effectively infinite.

To determine the latitude mod per hexrow on the nightside, divide the nighttime minus by the world's UWP size digit. (The nightside temperature must never exceed the maximum nighttime minus in any hex row, however.)

Axial tilt has no effect, since the world does not rotate.

Orbital eccentricity works just like normal.

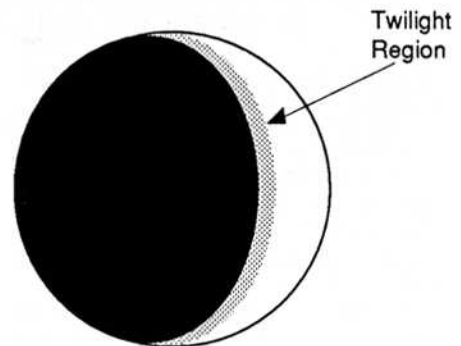

**Example:** We have a tidally locked size 3 world with base temperature of 26°C. The world's maximum daytime plus is 57°C, and the maximum minus is 239°C. The latitude mod per dayside hexrow is 57 divided by 3, or 19°C. The latitude mod per nightside hexrow is 239 divided by 3, or 80°C.

# ATMOSPHERE RELATED DETAILS 5

## 11 Temperature Worksheet

Produce a temperature worksheet for the world, combining all of the temperature effects. A temperature worksheet is constructed as follows:

HIGHEST POSSIBLE TEMP COMPUTATION										LOWEST POSSIBLE TEMP COMPUTATION									
Col:	1	2	3	4	5	6	7	8	9	10	11	12	13	14	15				
Hex	Base	Latitude	Summer			Daytime			Orbit	Col	Winter	Axial Tilt	Col	Nighttime	Orbit	Col			
Row	Temp	Mod	Col	1+2	Plus	Factor	Col	4x5	Plus	Ecc	Plus	3+6+7+8	Minus	Factor	11x12	Minus	Ecc	Minus	13+14
1	9	+21	30		+16	0.00	+0	+5	+1			36	-26	0.00	+0	-7	-1		22
2	9	+14	23		+16	0.00	+0	+5	+1			29	-26	0.00	+0	-7	-1		15
3	9	+7	16		+16	0.25	+4	+5	+1			26	-26	0.25	-7	-7	-1		2
4	9	+0	9		+16	0.50	+8	+5	+1			23	-26	0.50	-13	-7	-1		-12
5	9	-7	2		+16	0.75	+12	+5	+1			20	-26	0.75	-20	-7	-1		-25
6	9	-14	-5		+16	1.00	+16	+5	+1			17	-26	1.00	-26	-7	-1		-39
7	9	-21	-12		+16	1.00	+16	+5	+1			10	-26	1.00	-26	-7	-1		-46
8	9	-28	-19		+16	1.00	+16	+5	+1			3	-26	1.00	-26	-7	-1		-53
9	9	-35	-26		+16	1.00	+16	+5	+1			-4	-26	1.00	-26	-7	-1		-60
10	9	-42	-33		+16	1.00	+16	+5	+1			-11	-26	1.00	-26	-7	-1		-67
11	9	-49	-40		+16	1.00	+16	+5	+1			-18	-26	1.00	-26	-7	-1		-74

↑ Base Temp for Hex Row      ↑ Axial Tilt Temp Plus in Summer      ↑ Highest Temp for Hex Row      ↑ Lowest Temp for Hex Row

**Example:** The worksheet above was constructed for a UWP size 8 world with a dense atmosphere, an axial tilt of 26°, a rotation period of 25 hours, and an orbital eccentricity of 0.020. The temperature values used were: base temperature of 9°C, summer plus of 16°C, winter minus of 26°C, daytime plus of 5°C, nighttime minus of 7°C, and an orbital eccentricity plus/minus of 1°C.

## 12 Native Life

Determine if native life exists on a world by rolling 2D roll for 10+, with the following DMs:

- if atm 0, DM-3
- if atm 4-9, DM+4
- if hyd 0, DM-2
- if hyd 2-8, DM+1
- if base temp below -20°C, DM-1
- if base temp over +30°C, DM-1
- if primary star type G or K, DM+1
- if primary star type F, A, or B, DM-1

**Example:** A world has a UWP atmosphere digit of 2, a UWP hydrosphere of 6, a base temperature of 18°C, and orbits a type F star. The net DM is zero. A roll of 2D gives a result of 12 meaning the world does have locally evolved native life.

## 13 Atmospheric Terraforming

Determine if atmospheric terraforming has occurred using the table below. Add all appropriate values to yield a number. Roll 2D for this number or less. The current UWP atmosphere digit remains unchanged, since the terraforming has already occurred.

**Example:** A size 2 world has an atmosphere of 6, hydrosphere of 4, a population of 9, a tech level of 12, and has no native life. Consulting the Wide Scale Terraforming table for atmosphere yields a 7 (+2+0+0+1+2+2). Rolling 2D results in a 6: this world had widescale atmospheric terraforming performed sometime in its past.

## 14 Greenhouse Effect Terraforming

Determine if greenhouse effect terraforming has occurred using the table below. Add all appropriate values to yield a number. Roll 2D for this number or less. If greenhouse effect terraforming has occurred, consider altering the current greenhouse effect by up to ±10%. (Optionally, consider a runaway greenhouse effect of over 100%.)

**Example:** We use the same world as in step 10, and consult the Wide Scale Terraforming table for greenhouse effect. We get an 8 (+2+0+0+2+2+2). Rolling 2D results in an 8: this world has done widescale greenhouse effect terraforming.

## 15 Albedo Terraforming

Determine if albedo terraforming has occurred using the table below. Add all appropriate values to yield a number. Roll 2D for this number or less. If albedo terraforming has occurred, consider altering the current energy absorption by up to ±0.05.

**Example:** Using the same world as the step 10 example again, we consult the Wide Scale Terraforming table for albedo. We arrive at 9 (+2+0+0+2+3+2). Rolling 2D results in a 12: this world has not done any widescale albedo terraforming.

### WIDE SCALE TERRAFORMING †

Type	Size					Atm		Hyd				Pop			Tech				Life*	
	1,2	3,4	5,6	7,8	9+	0	C	0	1-4	5-9	A	0-4	5-7	8+	0-4	5-8	9-11	12+	Yes	No
Atmosphere	+2	+1	0	-1	-2	-5	-5	-1	0	0	+1	-3	0	+1	-10	-1	+1	+2	-4	+2
Greenhouse	+2	+1	0	-1	-2	-5	-5	+1	0	+1	+2	-2	0	+2	-10	+1	+2	+2	-2	+2
Albedo	+2	+1	0	-1	-2	-5	0	+2	0	0	+1	-2	0	+2	-10	+1	+2	+3	-2	+2

\*Life refers to life native to the world

† At least one hex on the world map has been affected by massive terraforming efforts

# HYDROSPHERE RELATED DETAILS 1

## 1 Hydrographic Percentage

Roll 2D-7 (giving a range from -5 to +5; reroll a "+5" result), and add to the UWP hydrographic digit x 10.

**Example:** A world has a UWP hydrographic digit of 6, representing a basic hydrographic percentage of around 60%. We roll 2D and get 6; subtracting the DM of 7 gives a result of -1. Adding this to the UWP digit of 6 x 10 gives 60-1, for a final detailed percentage of 59%.

## 2 Hydrographic Composition

In most cases, state that the hydrosphere of a world is "liquid water". However, a world's seas may vary under these conditions:

**Tainted Atmosphere (2,4,7,9):** An unusual gas mix can cause hydrographic composition to become tainted. Other times, the taint will have no effect. It is up to you to decide if the taint also affects the water.

Tainted water requires purification to be used for drinking or cooking. Tainted water is also usually dangerous to swimmers. State composition as "tainted liquid water".

**Exotic Atmosphere (A):** The hydrosphere on an exotic atmosphere world is "tainted liquid water" on a 2D roll of 10+; otherwise state the composition as "atmosphere related chemical mix".

**Corrosive Atmosphere (B):** The hydrosphere of such a world is rarely water. State the composition as "atmosphere related chemical mix".

**Insidious Atmosphere (C):** The makeup of the hydrosphere is dependent upon the nature of the atmosphere.

Extreme temperatures, pressures, or unusual gas mixes tend to exclude water; state the composition as "atmosphere related chemical mix".

Where radiation is the primary problem, the world may and may not have water. If it does have liquid water, it might be dangerous because of the radiation taint. If water is present, state the composition as "tainted liquid water", otherwise use "atmosphere related chemical mix".

**Example:** A taint of high oxygen has no affect on our hydrosphere, so we state it as "liquid water."

## 3 Tectonic Plates

Only a molten or heavy core world has a chance of multiple major plates; rocky bodies and icy bodies automatically have only one tectonic plate.

The number of major plates on a molten or heavy core world is established by taking UWP size + UWP hydrosphere, and subtracting 2D. A result of 1 or less indicates that there is little geological activity on the planet, with the entire surface being one major plate (and, perhaps, a few minor plates).

**Example:** A molten core world has a UWP size of 8 and a UWP hydrosphere of 3, which yields a sum of 11. Subtracting a 2D roll of 5 means this world has 6 tectonic plates.

## 4 Hydrographic Terraforming

Consult the Wide Scale Terraforming table below to determine if hydrographic terraforming has already occurred on a world.

Add all the indicated values appropriate to the world conditions to yield a number. A throw of 2D for this number or less means hydrographic terraforming has been conducted on the world.

If hydrographic terraforming has occurred, the old original hydrographic percentage can be determined if desired (the modification will rarely have been more than  $\pm 5\%$ ).

Do not change the current world UWP hydrographic digit, since the terraforming has already occurred.

**Example:** A size 2 world has an atmosphere digit of 6, a hydrosphere digit of 4, a population digit of 9, a tech level of 12, and does not have native life. Consulting the Wide Scale Terraforming table for hydrosphere yields a number of 11 (+2+0+1+2+3+3). Rolling 2D for this number (11 or less) results in an 8: this world has had global hydrographic terraforming performed sometime in the past. We decide the locals experimented with raising the hydrographic percentage, and after raising it an additional 1%, decided the effort was not worth it, and have discontinued the project.

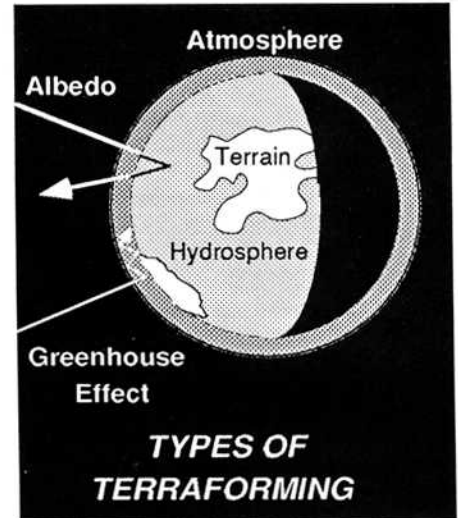

## 5 Terrain Terraforming

Consult the Wide Scale Terraforming table below to set the chance that hex-sized terrain terraforming has occurred on a world.

Add all the indicated values appropriate to the world conditions to yield a number. A throw of 2D for this number or less means hex-sized terrain terraforming has occurred on the world.

**Example:** A size 2 world has an atmosphere digit of 6, a hydrosphere digit of 4, a population digit of 9, a tech level of 12, and does not have native life. Consulting the Wide Scale Terraforming table for terrain yields a number of 14 (+4+0+3+4+3). There is no need to roll 2D for this number: the result is automatic. This world has had hex-sized terrain terraforming performed — once again we stipulate that the terrain terraforming was the indirect result of the aborted hydrographic terraforming project.

WIDE SCALE TERRAFORMING †

Type	Size					Atm		Hyd				Pop			Tech				Life*	
	1,2	3,4	5,6	7,8	9+	0	C	0	1-4	5-9	A	0-4	5-7	8+	0-4	5-8	9-11	12+	Yes	No
Hydrosphere	+2	+1	0	-1	-2	-4	0	0	+1	+1	0	-2	0	+2	-10	+1	+2	+3	0	+3
Terrain	+4	+3	+2	+1	0	-4	0	+1	0	0	0	-2	0	+2	-10	+1	+3	+4	0	+3

\*Life refers to life native to the world

† At least one hex on the world map has been affected by massive terraforming efforts

# HYDROSPHERE RELATED DETAILS 2

## 6 Continents and Oceans

Determine either the number of continents or the number of oceans. Which you do depends on the world's detailed hydrographic percentage from step 1.

If the percentage is 50% to 99%, consult the Continents table to determine the number of continents.

Should the detailed hydrographic percentage be 100%, then there is no significant land surface: the number of major and minor continents are both zero.

If the percentage is 1% to 49%, consult the Oceans table to determine the number of oceans.

A true 0% hydrosphere indicates there is no significant water surface (no free-standing water anywhere); the number of major and minor oceans is zero. This does not necessarily indicate the absence of water vapor in the air or in subterranean water supplies — there just isn't any usable surface water.

**Example:** A world has a UWP hydrographic digit of 6 and a hydrographic percentage of 59% from step 1, which means we must consult the Continents table. Rolling 1D+ (6x3) gives a result of 23. From the table, we find the world has 1D major continents and 2D-2 minor continents. After rolling the dice as indicated, we find the world has 1 major continent and 4 minor continents.

## 7 Volcanoes

To determine the number of volcanoes on the world, roll 2D-7 and add the seismic stress factor+2 (drop fractions). Make this roll once for each continent, or 1D times where only one continent exists. The results give the number of important volcanoes on each land mass.

Undersea volcanoes can be ignored, except where undersea colonization is important (such as on a tech level 10+ water world). If they are determined, the same procedure applies, once per ocean or 1D times for a water world.

**Example:** A world has 6 continents and a stress factor of 5. Rolling six times, 2D-7 + stress factor+2, gives: 2+3+0+2+0+3, or 10 notable volcanoes on the world.

Roll 1D + (UWP hydrographic code x 3)

### CONTINENTS TABLE

(use when hydrographic percentage is 50% to 99%)

Die	Major Continents	Minor Continents	Other Land Masses
16	2D+1	1D-1	3D-3 Major islands, 2D archipelagoes
17	2D+1	2D-2	3D-3 Major islands, 2D archipelagoes
18	2D+1	3D-3	3D-3 Major islands, 2D archipelagoes
19	2D	1D-1	3D-3 Major islands, 2D archipelagoes
20	2D	2D-2	3D-3 Major islands, 2D archipelagoes
21	2D	3D-3	3D-3 Major islands, 2D archipelagoes
22	1D	1D-1	3D-3 Major islands, 2D archipelagoes
23	1D	2D-2	3D-3 Major islands, 2D archipelagoes
24	1D	3D-3	3D-3 Major islands, 2D archipelagoes
25	1D-1	1D	3D-3 Major islands, 2D archipelagoes
26	1D-1	2D	3D-3 Major islands, 2D archipelagoes
27	1D-1	3D	3D-3 Major islands, 2D archipelagoes
28	1D-2	1D-1	3D-3 Major islands, 2D archipelagoes
29	1D-3	1D-2	3D-3 Major islands, 2D archipelagoes
30	1D-4	1D-3	2D Major islands, 2D archipelagoes
31	0	0	1D-3 Major islands, 2D archipelagoes
32	0	0	Archipelagoes
33	0	0	Archipelagoes
34	0	0	Archipelagoes
35	0	0	No significant land surface
36	0	0	No significant land surface

Roll 1D + (UWP hydrographic code x 3)

### OCEANS TABLE

(use when hydrographic percentage is 1% to 49%)

Die	Major Oceans	Minor Oceans	Other Bodies of Water
1	0	0	No significant water surface
2	0	0	No significant water surface
3	0	0	Scattered lakes
4	0	0	Scattered lakes
5	0	0	Scattered lakes
6	0	0	1D-3 Small seas, 2D scattered lakes
7	1D-4	1D-3	2D-3 Small seas, 2D scattered lakes
8	1D-4	1D-2	3D-3 Small seas, 2D scattered lakes
9	1D-3	1D-1	3D-3 Small seas, 2D scattered lakes
10	1D-3	1D-1	3D-3 Small seas, 2D scattered lakes
11	1D-2	1D-1	3D-3 Small seas, 2D scattered lakes
12	1D-2	2D-2	3D-3 Small seas, 2D scattered lakes
13	1D-1	1D-1	3D-3 Small seas, 2D scattered lakes
14	1D-1	2D-2	3D-3 Small seas, 2D scattered lakes
15	1D-1	3D-3	3D-3 Small seas, 2D scattered lakes
16	1D	1D-1	3D-3 Small seas, 2D scattered lakes
17	1D	2D-2	3D-3 Small seas, 2D scattered lakes
18	1D	3D-3	3D-3 Small seas, 2D scattered lakes
19	1	1D-1	3D-3 Small seas, 2D scattered lakes
20	1	2D-2	3D-3 Small seas, 2D scattered lakes
21	1	3D-3	3D-3 Small seas, 2D scattered lakes



# HYDROSPHERE RELATED DETAILS 3

## NATURAL RESOURCES

Resource	Density				- Atmosphere -		- Population -		Technology				- Life* -	
	Heavy Core	Molten Core	Rocky Body	Icy Body	Atm 4-9	Atm 0-3,A+	Pop 0-4	Pop 5+	Tech 0-3	Tech 4-6	Tech 7-11	Tech 12+	Yes	No
Agricultural	+1	+4	+4	-4	+1	-3	0	0	+1	0	-1	-2	+5	0
Ores	+8	+7	+3	0	0	+1	0	0	+1	0	0	+1	0	0
Radioactives	+7	+5	+3	0	0	+1	0	0	+1	0	0	+1	0	0
Crystals	+6	+5	+2	0	0	0	0	0	+1	0	0	+1	0	0
Compounds	+5	+6	+1	-4	0	+1	0	0	+1	0	0	+1	+1	-1

\*Life: "Life" refers to life native to the world

## PROCESSED RESOURCES

Resource	Density				- Atmosphere -		- Population -		Technology				- Life* -	
	Heavy Core	Molten Core	Rocky Body	Icy Body	Atm 4-9	Atm 0-3,A+	Pop 0-4	Pop 5+	Tech 0-3	Tech 4-6	Tech 7-11	Tech 12+	Yes	No
Agroproducts	0	+1	+1	0	+2	0	+1	+2	+1	+2	+1	+1	+5	0
Metals	+2	0	0	-1	0	+1	-1	+1	-1	+2	+4	+5	0	0
Non-Metals	+1	0	0	-1	+1	+1	0	+1	0	+2	+4	+6	+3	0

\*Life: "Life" refers to life native to the world

## MANUFACTURED GOODS

Resource	- Atmosphere -		- Population -			- Government -				Technology				- Life* -	
	Atm 4-9	Atm 0-3,A+	Pop 0-4	Pop 5-8	Pop 9+	Gov 0,1	Gov 2-6	Gov 7	Gov 8+	Tech 0-3	Tech 4-6	Tech 7-11	Tech 12+	Yes	No
Parts	0	+1	-1	+1	+2	-1	+1	+2	0	0	0	+2	+4	+1	0
Durables	0	+1	-1	+2	+3	-1	+1	+2	0	0	+1	+2	+3	+1	0
Consumables	0	+1	-1	+1	+4	-1	+1	+2	+1	0	+1	+2	+4	+1	0
Weapons	0	+1	-1	0	+1	0	+1	+3	+1	0	+1	+1	+2	+1	0

\*Life: "Life" refers to life native to the world

## INFORMATION

Resource	- Population -			- Government -				- Law Level -				Technology			
	Pop 0-4	Pop 5-8	Pop 9+	Gov 0,1	Gov 2-6	Gov 7	Gov 8+	Law 0-2	Law 3-6	Law 7-9	Law A+	Tech 0-3	Tech 4-6	Tech 7-11	Tech 12+
Recordings	0	+1	+2	0	+1	+1	+2	0	+1	+2	+3	-3	+1	+2	+3
Artforms	0	+2	+3	0	+1	+2	0	0	0	0	0	+2	+1	+1	+1
Software	0	+1	+4	0	+1	+1	+1	0	+1	+2	+3	-9	0	+1	+4
Documents	-1	0	+1	0	+1	+2	+4	0	+2	+4	+6	0	+1	+3	+1

\*Life: "Life" refers to life native to the world

## 8 Resources and Goods

The Natural Resources table, Processed Resources table, Manufactured Goods table, and the Information table are used to set the chance of any particular resource or good being present on a world.

For each listed resource or good entry, add all the indicated values appropriate to the world conditions to yield a number. A throw of 2D for this number or less means the indicated resource or good is present on the world in significant quantities.

**Example:** A molten core world has an atmosphere digit of 2, a population digit of 5, a tech level of 7, and has native life. Consulting the Natural Resources table for agricultural goods

yields a number of 5 (+4-3+0-1+5). Rolling 2D for this number (5 or less) results in a 7: this world does not readily have natural agricultural resources.

## 9 Weather Control

If the world's tech level is at least 8, weather control may have been introduced. Roll 2D — if the result is less than both the world's tech level and the world's population, weather control is practiced.

**Example:** A world's UWP tech level is 10 and its UWP population digit is 7. Rolling 2D gives 3, which is less than the tech level and the population digit. Weather control is practiced on this world.

# POPULATION RELATED DETAILS 1

## 1 Total World Population

To determine the total world population, use the formula below:

$$T = M \times 10^P$$

where:

T = Total world population.

M = Population multiplier.

P = UWP population digit.

To get a more detailed population figure, also determine the second and third digits of the population figure.

**Example:** We have a world with a population multiplier of 6 and a UWP population digit of 7. We compute the total world population and get 60,000,000. We determine the second and third digits to be 9 and 3, for a final total world population of 69,300,000.

## 2 Cities If Population < 1,000,000

Roll 1D; if the result is greater than the UWP population digit, all inhabitants are in a single town or community. In this case, the world has one primary city and no secondary or tertiary cities; otherwise, go on to the following steps. If the UWP population digit is 3 or less, and this roll fails, there are no cities at all.

**Example:** A world has a UWP population digit of 4 and a total world population of 84,500. We roll 1D and get a 1 — we continue on to the next steps since we did not get greater than the population digit of 4. Had we rolled a 5 or more, all of the inhabitants would have been in a single city.

## 3 Cities

The following steps determine the number and size of the world's cities.

### 3a Very Large Cities (UWP Pop)

Occasionally, the bulk of a world's population may live in only a few very large cities. Roll 3D; if less than the world's UWP population digit, one or more large cities with a population digit the same as the world's UWP population exist on the world.

Determine the population multiplier of each city as a digit from 1 to 9. No matter what, the sum of all city population multipliers cannot exceed the world's population multiplier - 1.

Continue to create more cities until the limit of the world's population

## Population information in the UWP

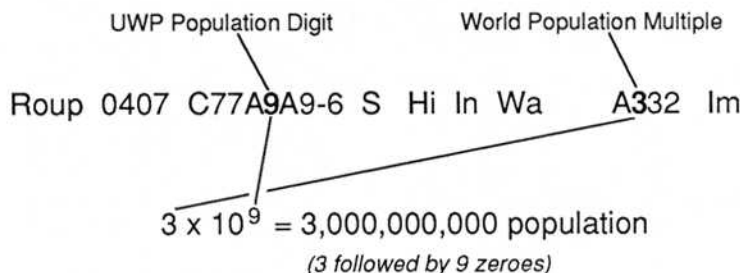

multiplier - 1 is reached.

A world will quite often not have any cities of this size.

**Example:** A world has a population digit of A and a population multiple of 8. Rolling 3D results in 9, which is less than the UWP population of 10: cities with a population digit of 10 exist on the world. We determine the population multiplier of the first city to be 2. We roll the population multiplier for a second city and get 9.

The combined population multipliers for the two cities is 11, which is more than the world's population multiplier - 1, or 7 — so the second city can have a population multiplier no larger than 5. This way, the sum of the two city's population multipliers (2+5) does not exceed the world's population multiplier - 1 (7).

This world of 80 billion has two very large cities, one with 50 billion, and another with 20 billion.

### 3b Unallocated Population

Once all the very large cities have been determined, compute how much of the population remains unallocated.

Subtract the population of the very large cities from the total world population. This result is the *available population* for the smaller primary cities (step 3c).

If there were no very large cities, the available population equals the total world population.

**Example:** We have a world with a total population of 84,700,000,000. Subtracting the population of the two very large cities of 53,400,000,000 and 21,300,000,000, we arrive at an unallocated population of 10,000,000,000. This is the population available for creating further large cities.

### 3c Large Cities (UWP Pop - 1)

Roll 2D; if less than the world's UWP population digit, one or more cities of with a population the size of the UWP population - 1 exist on the world.

Determine the population multiplier of each city. Continue rolling population multipliers for additional cities until the combined total of all the cities' populations equals or exceeds half of the available population.

**Example:** Continuing with the world above (a population digit of A and a population multiple of 8); rolling 2D results in 5, which is less than the UWP population digit of 10. Cities exist with a population digit of one less than the world's population digit — that is, cities with a population digit of 9 exist. Rolling for the population multiplier of the first city we get 7.

Our available population at this point is 10,000,000,000, so the result of 7 gives us a city with a population of  $7 \times 10^9$ , or 7,000,000,000 — which is more than half of the available population. Thus, we don't generate any more cities of this size.

The world has one primary city with a population of 7,350,000,000.

### 3d Unallocated Population

Once all the large cities have been determined, compute how much of the population remains unallocated.

Subtract the population of the large cities from the available population (determined in step 3b) to get the amount of population available for medium-large cities in step 3e.

**Example:** We have an available population of 10,000,000,000. Subtracting the population of the large cities of 7,350,000,000, we arrive at an unallocated population of 2,650,000,000. This is the population available for creating medium-large cities.

## POPULATION RELATED DETAILS 2

### 3e Medium-Large Cities (UWP Pop - 2)

Roll 1D; if less than the UWP population digit, cities of size UWP population - 2 exist on the world. Rather than roll for individual cities (which sometimes may amount to several dozen), use the following shortcut formula:

$$N = (A \div 10^P) \times (1D + 9)$$

Where:

N = Number (round fractions) of cities of size UWP population - 2.

A = Available population from step 3d.

P = World UWP population digit.

1D = Roll of 1 die.

**Note:** These cities are assumed to have an average population multiple of 5. When dealing with large numbers of cities (over 20), there will be 3D-3% of these cities with a population multiplier of 9. If we have 100 cities, for example, there will be 1 to 15 cities with a population multiplier of 9. This way, a reasonable number of the largest cities can be singled out and listed individually, if desired.

**Example:** Continuing with the example world, we roll 1D and get 3, which is less than the UWP population digit of 10 — cities of this size exist.

The world UWP population digit (P) for this world is 10, and the available population (A) is 2,650,000,000. We roll 1D to use in the computation and get 6. The calculation for the number of medium-large cities is thus  $(2,650,000,000 \div 10,000,000,000) \times (6+9)$ , or 3.9, which rounds to 4. The world has four cities with a population of about 500 million.

### 3f Unallocated Population

Once the medium-large cities have been determined, compute how much of the population remains unallocated.

Subtract the total population of the medium-large cities from the available population (determined in step 3d) to get the amount of population available for moderate-size cities in step 3e.

**Example:** We have an available population of 2,650,000,000. Subtracting the total population of the medium-large cities  $(500,000,000 \times 4)$ , we arrive at an unallocated population of 650,000,000. This is the population available for creating moderate-size cities.

### 3g Moderate-Size Cities (UWP Pop - 3)

Cities with a population digit of UWP population - 3 automatically exist on the world. Rather than roll for individual cities (which may amount to over a hundred), use the following shortcut formula:

$$N = (A \div 10^P) \times (1D + 9) \times 10$$

Where:

N = Number (round fractions) of cities of size UWP population - 3.

A = Available population from step 3f.

P = World UWP population digit.

1D = Roll of 1 die.

**Note:** see the note in step 3e. That note applies to this step as well.

**Example:** Using the example world, which has a world UWP population digit (P) of 10, and an available population (A) of 650,000,000. We roll 1D to use in the computation and get 2. The calculation for the number of moderate-sized cities is thus  $(650,000,000 \div 10,000,000,000) \times (2+9) \times 10$ , or 7.2, which rounds to 7. The world has seven cities with a population of about 50 million.

### 3h Unallocated Population

Once the moderate-size cities have been determined, compute the unallocated population.

Subtract the total population of the moderate-size cities from the available population determined in step 3f to get the amount of population available for small cities in step 3i.

**Example:** We have an available population of 650,000,000. Subtracting the total population of the moderate size cities  $(50,000,000 \times 7)$ , we arrive at an unallocated population of 300,000,000. This is the population available for creating small cities.

### 3i Small Cities (UWP Pop - 4)

Cities with a population digit of UWP population - 4 automatically exist on the world. Rather than roll for individual cities (which may amount to hundreds), use the following shortcut formula:

$$N = (A \div 10^P) \times (1D + 9) \times 100$$

Where:

N = Number (round fractions) of cities of size UWP population - 4.

A = Available population from step 3h.

P = World UWP population digit.

1D = Roll of 1 die.

**Note:** see the note in step 3e. That note applies to this step as well.

**Example:** Using the example world again — it has world UWP population digit (P) of 10, and an available population (A) of 300,000,000. We roll 1D to use in the computation and get 3.

The calculation for the number of small cities is thus  $(300,000,000 \div 10,000,000,000) \times (3+9) \times 100$ , or 36. The world has 36 cities with a population of about 5 million.

### 3j Unallocated Population

Once the small cities have been determined, compute the unallocated population.

Subtract the total population of the small cities from the available population (step 3h) to get the population available for very small cities in step 3k.

**Example:** We have an available population of 300,000,000. Subtracting the total population of the small cities  $(5,000,000 \times 36)$ , we arrive at an unallocated population of 120,000,000. This is the population available for creating very small cities.

### 3k Very Small Cities (UWP Pop - 5)

Cities with a population digit of UWP population - 5 automatically exist on the world. Rather than roll for individual cities (which may amount to many hundreds), use the following shortcut formula:

$$N = (A \div 10^P) \times (1D + 9) \times 1,000$$

Where:

N = Number (round fractions) of cities of size UWP population - 5.

A = Available population from step 3j.

P = World UWP population digit.

1D = Roll of 1 die.

**Note:** see the note in step 3e. That note applies to this step as well.

**Example:** Once again using the example world — it has world UWP population digit (P) of 10, and an available population (A) of 120,000,000. We roll 1D to use in the computation and get 1.

The calculation for the number of small cities is thus  $(120,000,000 \div 10,000,000,000) \times (1+9) \times 1,000$ , or 120. The world has 120 cities with a population of about 5 hundred thousand.

# POPULATION RELATED DETAILS 3

## 4 Primary, Secondary, Tertiary Cities

The cities with the largest population digits are designated as primary cities. Several of the largest population digit levels may be combined together as long as the total number of primary cities does not exceed 10.

Secondary cities are those with a population digit one less than the primary cities; tertiary cities are all the cities which remain whose population digit is at least one less than the secondary cities'.

## 5 Starports and Spaceports

The world starport/spaceport type is, of course, already known. Designate one primary city to include a starport/spaceport of the type in the world's UWP.

For each remaining primary city, roll 2D for less than or equal to the city population digit to place another port of that size in the city. If the roll fails, roll 1D on the table below to yield the primary city's port type.

### STARPORTS AND SPACEPORTS

#### World Starport/Spaceport Class

Die	A	B	C	D	E	X	F	G	H	Y
1	D	F	H	H	Y	Y	H	Y	Y	Y
2	C	D	G	H	Y	Y	G	H	Y	Y
3	C	D	F	G	H	Y	G	H	H	Y
4	B	C	F	G	H	H	G	G	H	Y
5	B	C	E	G	H	H	F	G	H	Y
6	B	B	D	E	H	H	F	G	H	Y
7	B	B	C	E	E	H	F	G	H	Y
8	A	B	C	D	E	H	F	G	H	Y

#### DMs:

If city pop 6+, DM +1

If city pop 8+, DM +2

If the world's tech level is 5+, each city (primary, secondary, and tertiary) automatically has a spaceport of type H present.

If the world's tech level is 10+, each secondary city automatically has a spaceport of type F.

**Example:** A tech level 15 world has a type A starport, and a UWP population digit of 8. The world has 3 primary cities, 24 secondary cities, and 185 tertiary cities. One primary city automatically has a type A starport. Consulting the Starports and Spaceports table for the other two primary cities and rolling 1D (plus a DM of +2 because of the city population) gives two type B starports at the other primary cities. Since the world is tech level 15, the 24 secondary

cities each automatically have a type F spaceport and all the 185 tertiary cities automatically have type H spaceports.

## 6 Orbital Cities

If a world has a type A, B, or C atmosphere, no native life, and its tech level is 9+, then roll 3D-3. If this roll is less than or equal to the world's population digit, then tech level - 6 of the population is in permanent orbit.

If the above is not true, then determine the number and size of orbital cities as below:

*For class A starports*, there is at least one orbital city (of at least secondary size) for each class A starport on the ground. There does not always need to be a ground class A starport — in some cases, the orbital class A starport is all there is.

*For class B starports*, there must be at one orbital city (of at least tertiary size) no matter how many class B starports are on the ground. There does not always need to be a ground class B starport at all: the orbital starport may be all there is.

*For class C starports and class F spaceports*, there is an orbital city on a roll of 2D for less than both the world's tech level and the world's population. The orbital city may be all there is in some cases; there may be no ground port. The orbital city can be no larger than secondary city size, and may be smaller.

In all cases, the absolute limit of the population that can be in permanent orbit is the world's tech level - 6.

**Note:** Worlds with a government type of 12 or more tend to have fewer inhabitants in orbit.

**Example:** A world has two ground class A starports, over 20 class F spaceports, a UPP population digit of A, and a tech level of 15. The absolute population limit that can be in orbit is 9 (billions). Two of the secondary cities are placed in orbit: one for each class A starport on the ground. We easily roll less than the tech level (15) and the population digit (10) on 2D, so we place another secondary city in orbit to serve the class F ground spaceports.

## 7 Social Outlook

The following steps (7a through 7c) allow you to determine the social outlook of the world's population.

### 7a Progressiveness

Roll 2D on the tables below to determine the progressiveness attitudes and actions of the world's population.

#### PROGRESSIVENESS

##### Dice

(2D) Attitude

2	Radical
3	Radical
4	Progressive
5	Progressive
6	Progressive
7	Progressive
8	Conservative
9	Conservative
10	Conservative
11	Conservative
12	Reactionary
13	Reactionary

##### DMs:

If Pop 6+, DM+1

If Pop 9+, DM+2

If Law A+, DM+1

##### Dice

(2D) Action

2	Enterprising
3	Enterprising
4	Enterprising
5	Enterprising
6	Advancing
7	Advancing
8	Advancing
9	Advancing
10	Indifferent
11	Indifferent
12	Indifferent
13	Stagnant

##### DMs:

If Conservative, DM+3

If Reactionary, DM+6

If Law A+, DM+1

**Example:** A world has a population digit of 8 and a law level of 9. We have a DM of +1 on the Attitude table — we roll 2D and get 6 with the DM, for a result of "Progressive".

We have no DMs on the Action table. We roll 2D, which results in a 7. The Action is "Advancing".

# POPULATION RELATED DETAILS 4

## 7b Aggressiveness

Roll 2D on the tables below to determine the aggressiveness attitudes and actions of the world's population.

### AGGRESSIVENESS

Dice

(2D) Attitude

2	Expansionistic
3	Expansionistic
4	Competitive
5	Competitive
6	Competitive
7	Unaggressive
8	Unaggressive
9	Unaggressive
10	Unaggressive
11	Passive
12	Passive
13	Passive

DMs:

If Law A+, DM+1

Dice

(2D) Action

2	Militant
3	Militant
4	Militant
5	Neutral
6	Neutral
7	Neutral
8	Neutral
9	Peaceable
10	Peaceable
11	Peaceable
12	Conciliatory
13	Conciliatory

DMs:

If Expansionistic, DM-2

If Competitive, DM-1

If Passive, DM+2

If Law A+, DM+1

**Example:** Using the example world from step 7a again, we have a no DMs on the Attitude table. Rolling 2D gives 9, for a result of "Unaggressive".

We likewise have no DMs on the Action table. We roll 2D, and get a 10. The Action is "Peaceable".

## 7c Extensiveness

Roll 2D on the extensiveness tables to determine the global and interstellar extensiveness of the world's population.

### EXTENSIVENESS

Dice

(2D) Global

2	Monolithic
3	Monolithic
4	Harmonious
5	Harmonious
6	Harmonious
7	Harmonious
8	Discordant
9	Discordant
10	Discordant
11	Discordant
12	Fragmented
13	Fragmented

DMs:

If Gov 2-, DM+1

If Gov 7, DM+4

If Gov F, DM-1

If Passive, DM+2

If Law 4-, DM+1

If Law A+, DM-1

Dice

(2D) Interstellar

2	Xenophilic
3	Xenophilic
4	Friendly
5	Friendly
6	Friendly
7	Friendly
8	Aloof
9	Aloof
10	Aloof
11	Aloof
12	Xenophobic
13	Xenophobic

DMs:

If Starport A, DM-2

If Starport B, DM-1

If Starport D, DM+1

If Starport E, DM+2

If Starport X, DM+3

If Conservative, DM+2

If Reactionary, DM+4

If Law A+, DM+1

**Example:** The example world (Gov 9, Starport A) has no DMs on the Global table. Rolling 2D gives 7, for a result of "Harmonious".

We have a -2 DM on the Interstellar table. Rolling 2D-2 gives 6, a result of "Friendly".

## 8a Number of Customs

Roll 1D to determine the number of prominent local customs. Then roll that many times on the table below to determine which follow-on table to use.

### LOCAL CUSTOMS

Die Which Table

1	Dressing Habits
2	Eating Habits
3	Living Quarters
4	Family Practices
5	Miscellaneous Customs 1
6	Miscellaneous Customs 2

**Example:** We roll 1D and get 3. Next we roll three times on the local customs table and get "Dressing Habits" twice, and "Miscellaneous Customs 2" once.

## 8b Dressing Habits

If the step 8a result was "Dressing Habits", roll 1D+1D on the table below. If the result has an asterisk (\*), go to step 8h to find the practicing group.

### DRESSING HABITS

Die+

Die Result

11	Same clothes for all sexes
12	Unusual clothes*
13	Unusual clothes*
14	Unusual clothes*
15	Unusual headgear*
16	Unusual headgear*
21	Shaved heads*
22	Shaved heads*
23	Hair never cut*
24	Hair never cut*
25	Unusual hair color*
26	Unusual hair color*
31	Unusual hairdos*
32	Unusual hairdos*
33	Unusual hairdos*
34	Unusual eyebrows*
35	Unusual facial alterations*
36	Unusual body alterations*
41	Unusual fingernails*
42	Unusual fingernails*
43	Unusual toenails*
44	Unusual toenails*
45	Unusual cosmetics*
46	Unusual cosmetics*
51	Unusual cosmetics*
52	Unusual jewelry*
53	Unusual jewelry*
54	Unusual jewelry*
55	Unusual accessories*
56	Unusual accessories*
61	Unusual handgear*
62	Unusual handgear*
63	Tatooring on face*
64	Tatooring on body*
65	Tatooring on body*
66	Hidden tatooring*

\*Roll on Practicing Group table (step 8h) to find which group practices custom.

**Example:** We roll 1D twice, getting a 6 and a 3, giving us "Tatooring on face". Rolling on the Practicing Group Table, we get "Scientific Figures" who do this.

# POPULATION RELATED DETAILS 5

## 8c Eating Habits

If the step 8a result was "Eating Habits", roll 1D+1D on the table below. If the result has an asterisk (\*), go to step 8h to find the practicing group.

### EATING HABITS

Die+

Die Result

11	Unusual foods*
12	Unusual foods*
13	Unusual beverages*
14	Unusual beverages*
15	Unusual food preparation*
16	Unusual food preparation*
21	Segregated during meals*
22	Segregated during meals*
23	Vegetarians*
24	Vegetarians*
25	Carnivorous*
26	Carnivorous*
31	Omnivorous*
32	Omnivorous*
33	Certain colored food taboo*
34	Certain colored food taboo*
35	Certain shaped food taboo*
36	Certain food sources taboo*
41	Eat in special location*
42	Eat only in private*
43	Eat in special orientation*
44	Eat with unusual utensils*
45	Eat only at home*
46	Eat only at home*
51	Eat at unusual times*
52	Eat at unusual times*
53	Eat only certain times*
54	Eat only certain ways*
55	Rituals before eating*
56	Rituals after eating*
61	One sex eats other's leftovers
62	One age eats other's leftovers
63	One group eats other's leftovers**
64	One class eats other's leftovers
65	One race eats others leftovers
66	Cannibalistic*

\*Roll on the Practicing Group table (step 8h) to determine which group practices the custom.

**Example:** We roll 1D twice, getting a 2 and a 6, giving us "Carnivorous". Rolling on the Practicing Group Table, we get "Certain Age Groups". We decide the elderly on this world must eat meat only.

## 8d Living Quarters

If the step 8a result was "Living Quarters", roll 1D+1D on the table below. If the result has an asterisk (\*), go to step 8h to find the practicing group.

### LIVING QUARTERS

Die+

Die Result

11	Live privately*
12	Live privately*
13	Live apart in groups*
14	Live apart in groups*
15	Live in special locations*
16	Live in special locations*
21	Live at place of work*
22	Live at place of work*
23	Live at place of work*
24	Live under special conditions*
25	Live under special conditions*
26	Confined to quarters*
31	Live under special care*
32	Have extravagant quarters*
33	Have extravagant quarters*
34	Have minimal quarters*
35	Have minimal quarters*
36	Have minimal quarters*
41	Have unusual quarters*
42	Have unusual quarters*
43	Quarters are taboo**
44	Quarters are taboo**
45	Quarters are taboo**
46	Quarters must be visited**
51	Quarters must be visited**
52	Quarters must be visited**
53	Live with extended families*
54	Live with groom's family*
55	Live with bride's family*
56	Live with children's family*
61	Live with relatives*
62	Live in communal housing*
63	Live in communal housing*
64	Live in communal housing*
65	Live only in certain terrain*
66	Must move around*

\*Roll on the Practicing Group table (step 8h) to determine which group practices the custom.

\*\*Roll twice on the Practicing Group table (step 8h) to determine who is to visit or not visit whose quarters.

**Example:** We roll 1D twice, getting a 2 and a 1, giving us "Live at place of work". Rolling on the Practicing Group Table, we get "Certain geographic regions". We decide that on this world, those who live in undersea housing live where they work.

## 8e Family Practices

If the step 8a result was "Family Practices", roll 1D+1D on the table below. If the result has an asterisk (\*), go to step 8h to find the practicing group.

### FAMILY PRACTICES

Die+

Die Result

11	Child named by ...*
12	Child named for living relative
13	Child named for dead relative
14	Child named for hero
15	Child named for ...*
16	Child named for object
21	Child renamed at adulthood
22	Child renamed when marries
23	Marriage arranged by ...*
24	Marriage performed by ...*
25	Marriage arranged by parents
26	Marriage arranged by parents
31	Marriage performed by parents
32	Marriage only within group*
33	Remarriage prohibited*
34	Remarriage required*
35	Groom's family pays dowery*
36	Bride's family pays dowery*
41	Dowery paid by outsider*
42	Very short marriages the rule*
43	Very long marriages the rule*
44	Non-marriage the rule*
45	Very short marriages prohibited*
46	Very long marriages prohibited*
51	Non-marriage prohibited*
52	Divorce and remarriage required*
53	Widow must marry husband's relative*
54	Widow/Widower must commit suicide*
55	Widower must marry wife's relative*
56	Onerous prerequisite to marriage*
61	Onerous prerequisite to marriage*
62	Marriage only at certain times*
63	Marriage must be blessed by ...*
64	Polyandry practiced*
65	Polygyny practiced*
66	Communal polygamy practiced*

\*Roll on the Practicing Group table (step 8h) to determine which group practices the custom.

**Example:** We roll 1D twice, getting a 1 and a 3, and get "Child Named for dead relative".

# POPULATION RELATED DETAILS 6

## 8f Miscellaneous Customs 1

If the step 8a result was "Miscellaneous Customs 1", roll 1D+1D on the table below. If the result has an asterisk (\*), go to step 8h to find the practicing group.

### MISCELLANEOUS CUSTOMS 1

Die+	Die Result
11	Unusual sleep location*
12	Unusual sleep time*
13	Unusual sleep duration*
14	Unusual sleep orientation*
15	Special language for ...*
16	Sacred symbols for*
21	Unusual duties for ...*
22	Anonymity required for ...*
23	Drinking/drugs prohibited*
24	Drinking/drugs required*
25	Bodily abuse prohibited*
26	Bodily abuse required*
31	Special privileges for ...*
32	Special privileges for ...*
33	Special privileges prohibited*
34	Unusual greetings*
35	Unusual greetings*
36	Unusual mannerisms for ...*
41	Unusual leavetakings*
42	Unusual secret societies*
43	Closed meetings taboo*
44	Psionics allowed for*
45	Psionics mean instant death*
46	Cloning allowed for*
51	Cloning required for*
52	Cloning prohibited for*
53	Robots allowed for*
54	Robots required for*
55	Robots prohibited for*
56	High-tech allowed for*
61	High-tech required for*
62	High-tech prohibited for*
63	Offworld contact allowed for*
64	Offworld contact required for*
65	Offworld contact prohibited for*
66	Unusual gift-giving customs*

\*Roll on the Practicing Group table (step 8h) to determine which group practices the custom.

**Example:** We roll 1D twice, getting a 5 and a 5, giving us "Robots prohibited for\*". Rolling on the Practicing Group Table, we get "Certain sex". We decide that this world prohibits men from owning a robot.

## 8g Miscellaneous Customs 2

If the step 8a result was "Miscellaneous Customs 2", roll 1D+1D on the table below. If the result has an asterisk (\*), go to step 8h to find the practicing group.

### MISCELLANEOUS CUSTOMS 2

Die+	Die Result
11	Free food/clothing required for*
12	Free food/clothing prohibited for*
13	Free education required for*
14	Free education prohibited for*
15	Unusual punishment required for*
16	Unusual punishment prohibited for*
21	Unusual training required for*
22	Unusual training prohibited for*
23	Unusual responsibilities*
24	Fixed times for visiting ...*
25	Bargaining/haggling required*
26	Bargaining/haggling prohibited*
31	Travelling far away required*
32	Travelling far away prohibited*
33	Unusual holidays for ...*
34	No holidays for ...*
35	Unusual leisure/recreation*
36	Regimented leisure/recreation*
41	Unusual maturity ceremony*
42	Unusual attitudes toward ...*
43	Unusual significance of flora*
44	Unusual significance of fauna*
45	Unusual significance of smell*
46	Unusual significance of sound*
51	Unusual significance of color*
52	Unusual significance of air*
53	Unusual significance of water*
54	Unusual significance of light*
55	Unusual significance of clothing*
56	Unusual significance of computers*
61	Unusual significance of technology*
62	Unusual significance of robots*
63	Unusual significance of art*
64	Unusual significance of superstition*
65	Daytime (siesta) rest period required*
66	Daytime (siesta) rest period prohibited*

\*Roll on the Practicing Group table (step 8h) to determine which group practices the custom.

**Example:** We roll 1D twice, getting a 3 and a 3, giving us "Unusual holidays for...\*". Rolling on the Practicing Group Table, we get the entire populace. We decide that this world has a "festival" that lasts 20 days, during which all work ceases.

## 8h Practicing Group

Once you have arrived at the given local custom, roll 1D. If the result is less than 4, all of the population practices the custom.

Otherwise, roll 1D+1D on the table below.

### PRACTICING GROUP

Die+	Die Result
11	Certain political groups
12	Certain political groups
13	Certain geographic regions
14	Certain geographic regions
15	Certain sex
16	Certain sex
21	Certain sex
22	Enforcement figures
23	Entertainment figures
24	Heroic Figures
25	Athletic Figures
26	Certain races
31	Certain races
32	Certain races
33	Religious figures
34	Religious figures
35	Military figures
36	Military figures
41	Certain occupations
42	Certain occupations
43	Political figures
44	Political figures
45	Medical figures
46	Medical figures
51	Certain age groups
52	Certain age groups
53	Scientific figures
54	Scientific figures
55	Academic figures
56	Academic figures
61	Low social class
62	Low social class
63	High social class
64	High social class
65	Convicted criminals
66	Convicted criminals

**Example:** We roll 1D first, to see if we even need to roll on this table. We get a 1, which is less than 4 — we do not go any further. The entire populace practices this particular custom.

# GOVERNMENT RELATED DETAILS 1

## 1 Representative Authority Guide

To determine the representative authority for a given government type, consult the table below. If the table below calls for a die roll, make it and then go to step 3.

### GOVERNMENT ORGANIZATION GUIDE

Gov UWP	Description	Action to take for... Representative Authority
0	No government structure	No authority—skip to step 8
1	Company/Corporation	Consult step 2
2	Participating Democracy	Always <i>Demos</i>
3	Self-Perpetuating Oligarchy	Roll 1D: 1-4, <i>Elite Council</i> ; 5-6, <i>Several Councils</i>
4	Representative Democracy	Consult step 2
5	Feudal Technocracy	Consult step 2
6	Captive Government	Consult step 2
7	Balkanization	Consult step 1a
8	Civil Service Bureaucracy	Always <i>Several Councils</i>
9	Impersonal Bureaucracy	Always <i>Several Councils</i>
10	Charismatic Dictator	Roll 1D: 1-5, <i>Ruler</i> ; 6, <i>Elite Council</i>
11	Non-Charismatic Dictator	Roll 1D: 1-5, <i>Ruler</i> ; 6, <i>Elite Council</i>
12	Charismatic Oligarchy	Roll 1D: 1-4, <i>Elite Council</i> ; 5-6, <i>Several Councils</i>
13	Religious Dictatorship	Consult step 2, reroll if result is <i>Demos</i>
14	Religious Autocracy	Consult step 2, reroll if result is <i>Demos</i>
15	Totalitarian Oligarchy	Roll 1D: 1-4, <i>Elite Council</i> ; 5-6, <i>Several Councils</i>

**Example:** A world has a UWP government type of 12. Consulting this guide, we find we must roll 1D to find the representative authority. We roll 1D and get 3, for a result of "Elite Council". The leading (and thus representative) authority on this world is an elite council.

### 1a Balkinized Worlds

Roll 1D-1 to determine the number of major governmental powers on the world. Distribute the world's population UWP among the various governments.

Next, roll 2D-7+(world population UWP-1) to determine the local government type of each rival government. Ignore and reroll a result of 7.

Finally, roll 2D-7+local government type to determine the law level of each rival government.

Treat each rival government as an independent world government when using these rules to detail a government. Therefore, follow the rules in this section for each government to arrive at its detailed organization.

**Example:** A balkinized world has a population of 75,400,000. Rolling 1D-1 yields 5, giving us five major rival governments on the world. We arbitrarily distribute the population between them as follows: 1) 40 million, 2) 15 million, 3) 10 million, 4) 7 million, 5) 3 million.

Rolling for each rival government's type we get: 1) a 5 gov type, 2) a 5 gov type, 3) a 4 gov type, 4) a 3 gov type, and 5) a B government type.

Rolling for each rival government's law level we get: 1) a 9 law level, 2) an 8 law level, 3) a 3 law level, 4) a 7 law level, and 5) an E law level.

## 2 Representative Authority

Roll 2D on the table below to determine the representative authority's organization.

### ORGANIZATION TYPES

Die	Organization
2	Demos
3	Elite Council
4	Elite Council
5	Elite Council
6	Ruler
7	Ruler
8	Several Councils
9	Several Councils
10	Several Councils
11	Several Councils
12	Demos

**Example:** A world's UWP government type is 4, so according to step 1, we roll 2D on the table in this step. The roll is 7, meaning the populace selects a single ruler as their sole representative.

## 3 Division of Authority

Roll 1D on the table below to determine the world's division of governmental authority.

### DIVISION OF GOVERNMENT AUTHORITY

Die	Division of Authority
1	3-way division
2	3-way division
3	2-way division
4	2-way division
5	No division
6	No division

If the result is *2-way division*, go to step 6.

If the result is *No division*, go to step 8.

Otherwise, continue to step 4.

**Example:** We roll 1D on this table and find our government has a two-way division of authority. That means we then jump ahead to step 6.

## 4 3-Way Division

Roll 1D on the table below to determine the split of the three-way authority.

### 3-WAY GOVERNMENT AUTHORITY

Die	Authority	Other Authorities
1	Executive	Legislative, Judicial
2	Executive	Legislative, Judicial
3	Legislative	Executive, Judicial
4	Legislative	Executive, Judicial
5	Judicial	Executive, Legislative
6	Judicial	Executive, Legislative

**Example:** We have a world that has a three-way split of government authority, so we roll 1D on this table. We get a 1, which means the representative authority is the executive section, while the other less prominent authorities are the legislative and judicial sections.

## RELIGIOUS PROFILE

	BD8696-6
God View	1
Spiritual Aim	2
Devotion Req.	3
Organization	4
Liturgical Form.	5
Missionary Fervor	6
Number Adherents	7



# GOVERNMENT RELATED DETAILS 2

## 5 Organization of Other Authorities

Roll 2D on the table below for each of the other two government authorities to determine their organization. Having done that, go to step 8.

ORGANIZATION TYPES	
Die	Organization
2	Demos
3	Elite Council
4	Elite Council
5	Elite Council
6	Ruler
7	Ruler
8	Several Councils
9	Several Councils
10	Several Councils
11	Several Councils
12	Demos

**Example:** We have a world that has an executive section that is run by a single, powerful ruler. We roll on this table for the judicial section and get "Elite Council". For the legislative section we get "Several Councils."

This world's government organization is very similar to that of the United States, with a single ruler in the executive section, an elite council for the judicial section, and several councils for the legislative section.

## 6 2-Way Division

Roll 1D on the table below to determine the split of the two-way authority.

### 2-WAY GOVERNMENT AUTHORITY

Die	Representative Authority	Other Authority
1	Executive & Judicial	Legislative
2	Executive & Judicial	Legislative
3	Executive & Legislative	Judicial
4	Executive & Legislative	Judicial
5	Executive & Legislative	Judicial
6	Legislative & Judicial	Executive

**Example:** A world has representative authority that is demos. Rolling once on this table we get a 3. The representative demos authority is executive and legislative, while the other authority is judicial.

## 7 Organization of Other Authority

Roll 2D on the table below for the other government authority to determine its organization.

ORGANIZATION TYPES	
Die	Organization
2	Demos
3	Elite Council
4	Elite Council
5	Elite Council
6	Ruler
7	Ruler
8	Several Councils
9	Several Councils
10	Several Councils
11	Several Councils
12	Demos

**Example:** A world has an executive-legislative section that is demos. Rolling once on this table for the judicial section, we get "Several Councils".

## 8 Religious Profile (Optional)

If the world's government type is D or E, then details of the world government's religion may be useful. The following series of steps allow developing a special religious profile for the religion.

However, if you find the idea of including religion in MegaTraveller to be offensive, then by all means, skip these steps.

### 8a God View

If the government is type D, roll 2D-2+UWP Tech Level on the God View table.

If the government is type E, roll 2D+3D-5 on the God View table.

**Example:** A world has a government type D and a tech level of 10. We roll 2D-2+10 on the god view table, and get a result of 16. We thus must choose the table maximum of 15 — Philosophical Atheism.

### GOD VIEW

Level	View
0	Animism. All natural phenomena and objects (trees, rivers, wind, etc.) are caused or inhabited by spirits or demigods.
1	Polytheistic animism. Certain natural phenomena are associated with specific gods or goddesses, arranged in a distinct hierarchical order.
2	Polytheism. Multiple gods (probably with lingering animistic associations or titles) exist, each of roughly the same importance.
3	Rational polytheism. A multiplicity of gods is viewed as numerous different aspects of a handful of true divinities.
4	Dualism. Two mutually antagonistic gods or principles, one good and one evil, exist; their struggle is mirrored in nature and in moral/ethical problems.
5	Interactive Monotheism. A single god exists and is interested in the daily actions of sophonts.
6	Influential Monotheism. God interacts with sophonts only at key moments in life.
7	Crisis Monotheism. God is involved in mortal affairs only at crucial moments of history.
8	Remote monotheism. God exists, but is not generally available. A select few interactions in mortal affairs may occur from time to time.
9	Deism. God created the universe, but thereafter took no part in mortal affairs, and is permanently out of reach.
A(10)	Pantheism. God is not a personality—God is everything and everything is God.
B(11)	Agnosticism. It is impossible to know whether or not there is a God.
C(12)	Rational Atheism. A rejection of the existence of a Supreme Being on the basis of science, logic, or reasoning.
D(13)	Skeptical Atheism. A rejection of the existence of a Supreme Being on the basis of personal, non-rational conviction ("faith").
E(14)	Atheism. A total rejection of the existence of a Supreme Being; complete lack of religious beliefs.
F(15)	Philosophical Atheism. A failure to understand the concept of a Supreme Being. The question of religious beliefs is meaningless.

# GOVERNMENT RELATED DETAILS 3

## 8b Spiritual Aim

Roll 2D-2+(God View + 3) on the Spiritual Aim table.

**Example:** A world has a god view of 15. We roll 2D-2+5 on the Spiritual Aim table, and get 12. The believers seek to preserve the knowledge and wisdom of the past.

## 8c Devotion Required

Roll 2D-7+Spiritual Aim on the Devotion Required table.

**Example:** A world has a spiritual aim of 12. We roll 2D-7+12 on the Devotion Required table, and get 12. The believers must be involved in some annual observance.

## 8d Organization Structure

Roll 2D-7+Devotion Required on the Organization Structure table.

**Example:** A world has a devotion required of 12. We roll 2D-7+12 on the Organization Structure table, and get 15. No organization of any kind exists, so the religion is very personal. Since this is a religious dictatorship government, we decide the state religion must require every individual to prove they have performed their annual duty. Beyond that, no formal religious meetings or leaders exist.

### SPIRITUAL AIM

Level	Aim
0	Worshippers are a chosen elite who deserve to dominate.
1	Worshippers will be rewarded in this life. Prayers are answered, regardless of their nature.
2	Worshippers will be saved from some imminent disaster.
3	Reincarnation with a karma doctrine. One's level in the next life is based on one's devotion and/or morality in this one.
4	Reincarnation is accomplished via personal choice of the next vehicle for the soul. Strength of character enables the individual to choose the best possible form for a new incarnation.
5	Statistical reincarnation causes a return in an essentially random form, but how one faces each life builds merit for an ultimate, distant afterlife.
6	Worshippers will be received into paradise when they die.
7	Worshippers will avoid being condemned to a place of eternal punishment (presumably, again, by going to paradise).
8	Ethical and moral standards are their own reward, regardless of the possibility of heavenly rewards or punishments.
9	Believers perform charitable acts to build a better society for posterity.
A(10)	Believers seek to promote peace, harmony, and order to improve the quality of life for all.
B(11)	Believers seek to expand the frontiers of knowledge through inquiry and speculation.
C(12)	Believers seek to preserve the knowledge and wisdom of the past.
D(13)	Believers seek to improve their own lives by self-discipline and training.
E(14)	An Epicurean philosophy—"Eat, drink, and be merry, for tomorrow we die." Hedonism is the only proper purpose in life.
F(15)	Nihilism—there is no purpose to life, and nothing to be gained by living. Beliefs along these lines are often symptomatic of a mal-adjusted or dangerously unstable society or personality.

### DEVOTION REQUIRED

Level	Frequency
0	Constant devotion. No word, act, deed, or thought that isn't connected with religious belief should ever be tolerated.
1	Several times per hour
2	Hourly
3	Several times per day
4	Daily
5	Several days per week
6	Weekly
7	Semi-weekly
8	Monthly
9	Semi-monthly
A(10)	Quarterly
B(11)	Bi-annually
C(12)	Yearly
D(13)	Several times during life
E(14)	At least once before death
F(15)	None

### ORGANIZATION STRUCTURE

Level	Structure
0	The religious hierarchy assumes the functions of government. A theocracy.
1	Rigid hierarchy answerable to a central authority with minimal decision-making at lower levels.
2	Rigid hierarchy with most decisions on a regional level.
3	Rigid hierarchy with most decisions on a planetary level.
4	Rigid hierarchy with most decisions on a local level.
5	Loose hierarchy answerable to a central authority with minimal decision-making at lower levels.
6	Loose hierarchy with most decisions on a regional level.
7	Loose hierarchy with most decisions on a planetary level.
8	Loose hierarchy with most decisions on a local level.
9	Loose hierarchy with most decisions up to individual worshippers.
A(10)	No organization above regional level.
B(11)	No organization above planetary level.
C(12)	No organization above local level.
D(13)	Local organization without regulations.
E(14)	Loose, highly informal organization.
F(15)	No organization of any kind.

# GOVERNMENT RELATED DETAILS 4

## 8e Liturgical Formality

Roll 2D-7+Organization Structure on the Liturgical Formality table.

**Example:** A world has a organization structure of 15. We roll 2D-7+15 on the Liturgical Formality table, and get a 20. Since 15 is the highest you can go, we take that result. The state religion is highly personal, with no conversations about it allowed.

## 8f Missionary Fervor

Roll 2D-2 on the Missionary Fervor table.

**Example:** We roll 2D-2 on the Missionary Fervor table, and get a 6. Local citizens are willing to convert any individual who is interested (in private, of course) to the state religion.

## 8g Number of Adherents

Roll 3D-Missionary Fervor on the Number of Adherents table. The result cannot be less than the world UWP-1 for a state religion — otherwise reroll. If the result is greater than the local world population, then offworlders also subscribe to this religion.

**Example:** We have a world with a UWP population digit of 7. We roll 3D-6 on the Number of Adherents table, and get a 6, with is just at the limit. Several million people belong to the state religion.

### LITURGICAL FORMALITY

Level	Description
0	"Word of God" is pronounced by living oracles (statues, computers, deified leaders, prophets, mediums, etc.). Services are tightly controlled by priesthood.
1	Holy writings exist, but are accessible only to the highest church authorities.
2	Holy writings are accessible only to certain specific levels of authority.
3	Services are conducted by rote in a "holy tongue" few worshippers understand.
4	Services are conducted by rote in common languages.
5	Very formal church ritual coupled with minimal teaching of holy writings.
6	Formal church ritual and very limited teaching.
7	Rituals are combined with moderate teaching.
8	Rituals are combined with an open teaching policy.
9	Emphasis is laid on communal teaching with limited ritual.
A(10)	Formal study groups focus on discussion and interpretation of church writings.
B(11)	Formal study groups include philosophical inquiry into questions not covered in holy writings, but under rigid methods of preserving the sanctity of fundamental topics.
C(12)	Informal study groups with extensive limitations on allowable subject matter.
D(13)	Highly informal liturgy with some limitations on topics of references.
E(14)	Complete informality. Open exchange of ideas and concepts in a conversational setting.
F(15)	Religion does not enter into conversations at any time; although some philosophical questions may crop up from time to time, no one organizes "services" or "worship" around such matters.

### MISSIONARY FERVOR

Level	Description
0	Zealous and willing to convert any sophont.
1	Zealous among a limited number of sophont races.
2	Zealous but intolerant of other sophont races.
3	Active and willing to convert any sophont.
4	Active among a limited number of sophont races.
5	Active but intolerant of other sophont races.
6	Ordinary and willing to convert any sophont.
7	Ordinary among a limited number of sophont races.
8	Ordinary but intolerant of other sophont races.
9	Occasional.
A(10)	Conversion attempts are highly infrequent.

### NUMBER OF ADHERENTS

Level	Number
0	1-9
1	10-99
2	100-999
3	1000-9999
4	10,000-99,999
5	100,000-999,999
6	1,000,000-9,999,999
7	10,000,000-99,999,999
8	100,000,000-999,999,999
9	1,000,000,000-9,999,999,999
A(10)	10,000,000,000-99,999,999,999
B(11)	100,000,000,000-999,999,999,999

# LAW RELATED DETAILS 1

## 1 Uniformity of Law

To determine the uniformity of law, roll 2D on the table below.

### UNIFORMITY OF LAW

Die	Uniformity
2	Personal
3	Personal
4	Personal
5	Personal
6	Territorial
7	Territorial
8	Undivided
9	Undivided
10	Undivided
11	Undivided
12	Undivided

DMs:

- +2 if Extensiveness Monolithic
- 1 if law level A+

**Example:** A world has a law level of 12 and a global extensiveness of harmonious. Looking at the table above, we find we have a DM of -1. Rolling 2D on the table and applying the DM of -1 we get a 9. The uniformity of law on this world is "Undivided".

## LEGAL PROFILE

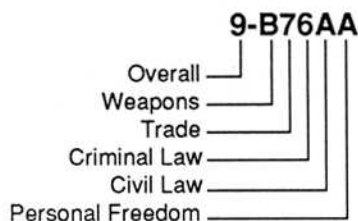

## 2 Legal Profile (Optional)

The world's UWP Law Level is used as the overall entry in the legal profile. To determine the other values in the legal profile, roll 2D-7+UWP government code for each entry.

**Example:** A world has a government of 8 and law level of 12.

The overall law level is 12. We roll 2D-7+8 for each of the other law level entries in the profile, and get C-AA575A as the legal profile.



# TECHNOLOGY RELATED DETAILS 1

## 1 High Common Tech Level

The world's UWP tech level is the high common tech level.

**Example:** A world has a UWP tech level of C. This is also the high common tech level.

## 2a Low Common TL Limits

Determine the world's low common upper and lower tech level limits as follows:

Upper limit: High common.

Lower limit: High common + 2 (drop fractions).

**Example:** A world has a high common of C. The low common upper limit is 12, and the lower limit is 6.

## 2b Low Common Tech Level

Determine the low common tech level by using the formula below:

$$T = H + M + P + G$$

where:

T = Low common tech level.

H = High common tech level.

M = Tech level modifier, determined by rolling 2D on the table below.

### TECH LEVEL MODIFIER

Die	TL Mod
2	-1D
3	-2
4	-1
5	—
6	—
7	—
8	—
9	—
10	+1
11	+2
12	+1D

P = Tech level modifier based on world UWP population:

if world pop 5-, +1

if world pop 9+, -1

G = Tech level modifier based on global extensiveness:

if monolithic, +1

if discordant, -1

if fragmented, -2

The computed low common tech level must fit within the limits determined in step 2a.

**Example:** A world has a high common of C, a UWP population of 9 and a global extensiveness of harmonious. We roll 2D for the value of M and get 4, giving us -1 for M. Plugging the appropriate values into the formula we have: 12-1-1+0, or a low common tech level of 10, or A.

The value 10 easily fits within the limits of 12 and 6 from step 2a.

## TECHNOLOGY PROFILE

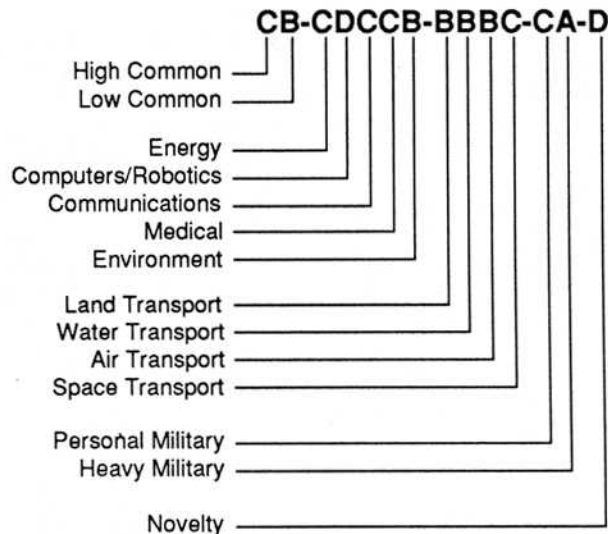

## 3a Energy TL Limits

Determine the world's energy upper and lower tech level limits as follows:

Upper limit: High common + high common + 5 (drop fractions).

Lower limit: High common + 2 (drop fractions).

**Example:** A world has a high common of C. The energy upper limit is 14, and the lower limit is 6.

## 3b Energy Tech Level

Determine the low common tech level by using the formula below:

$$T = H + M$$

where:

T = Energy tech level.

H = High common tech level.

M = Tech level modifier, determined by rolling 2D on the table below.

### TECH LEVEL MODIFIER

Die	TL Mod
2	-1D
3	-2
4	-1
5	—
6	—
7	—
8	—
9	—
10	+1
11	+2
12	+1D

The computed energy tech level must fit within the limits determined in step 3a.

**Example:** A world has a high common of C. We roll 2D for the value of M and get 4, giving us -1 for M. Plugging the appropriate values into the formula we have: 12-1, or an energy tech level of 11, or B.

The value 11 fits within the limits of 14 and 6 from step 3a.

## 4a Computer/Robotics TL Limits

Determine the world's computer/robotics upper and lower tech level limits as follows:

Upper limit: Energy upper limit.

Lower limit: Upper limit + 3 (drop fractions).

**Example:** A world has an energy upper limit of 14. The computer/robotics TL limits are thus 14 and 11.

## 4b Computer/Robotics Tech Level

Determine the low common tech level by using the formula below:

$$T = H + M + P$$

where:

T = Computer/robotics tech level.

H = High common tech level.

M = Tech level modifier, determined by rolling 2D on the table below.

### TECH LEVEL MODIFIER

Die	TL Mod
2	-1D
3	-2
4	-1
5	—
6	—
7	—
8	—
9	—
10	+1
11	+2
12	+1D

P = Tech level modifier based on world UWP population:  
if world pop 5-, +1  
if world pop 9+, -1

The computed tech level must fit within the limits determined in step 4a.

# TECHNOLOGY RELATED DETAILS 2

**Example:** A world has a high common of C, and a UWP population of 9. We roll 2D for M and get 7, giving us 0. Plugging the appropriate values into the formula we have: 12+0-1, or a computer/robotics tech level of 11, or B.

The value 11 just fits within the limits of 14 and 11 from step 4a.

## 5a Communications TL Limits

Determine the world's communication upper and lower tech level limits as follows:

Upper limit: Energy upper limit.

Lower limit: Upper limit + 3 (drop fractions).

**Example:** A world has an energy upper limit of 14. The communication limits are 14 and 11.

## 5b Communications Tech Level

Determine the low common tech level by using the formula below:

$$T = C + M$$

where:

T = Communications tech level.

C = Computer/Robotics tech level.

M = Tech level modifier, determined by rolling 2D on the table below.

### TECH LEVEL MODIFIER

Die	TL Mod
2	-1D
3	-2
4	-1
5	—
6	—
7	—
8	—
9	—
10	+1
11	+2
12	+1D

The computed communications tech level must fit within the limits determined in step 5a.

**Example:** A world has a computer/robotics tech level of 11. We roll 2D for the value of M and get 9, giving us 0 for M. Plugging the appropriate values into the formula we have: 11+0, or a communications tech level of 11, or B.

The value 11 is within the limits of 14 and 11 from step 5a.

## 6a Medical TL Limits

Determine the world's medical upper and lower tech level limits as follows:

Upper limit: Energy upper limit.

Lower limit: 0.

**Example:** A world has an energy upper limit of 14. The medical upper limit is 14 and its lower limit is 0.

## 6b Medical Tech Level

Determine the medical tech level by using the formula below:

$$T = C + M + I$$

where:

T = Medical tech level.

C = Computer/Robotics tech level.

M = Tech level modifier, determined by rolling 2D on the table below.

### TECH LEVEL MODIFIER

Die	TL Mod
2	-1D
3	-2
4	-1
5	—
6	—
7	—
8	—
9	—
10	+1
11	+2
12	+1D

I = Tech level modifier based on Interstellar extensiveness: if xenophilic, +1

The computed medical tech level must fit within the limits determined in step 6a.

**Example:** A world has a computer/robotics tech level of 11, and an interstellar extensiveness of friendly. We roll 2D for the value of M and get 6, giving us 0 for M. Plugging the appropriate values into the formula we have: 11+0+0, or a medical tech level of 11, or B.

The value 11 is easily within the limits of 14 and 0 from step 6a.

## 7a Environment TL Limits

Determine the world's environment upper and lower tech level limits as follows:

Upper limit: Energy upper limit.

Lower limit: Upper limit - 5.

**Example:** A world has an energy upper limit of 14. The environment upper limit is 14 and its lower limit is 9.

## 7b Environment Tech Level

Determine the environment tech level by using the formula below:

$$T = H + M + A + H$$

where:

T = Environment tech level.

H = High common tech level.

M = Tech level modifier, determined by rolling 2D on the table below.

A = Tech level modifier based on the world's UWP atmosphere:

if atm not 5,6, or 8, +1

H = Tech level modifier based on the

world's UWP hydrosphere:  
if hyd is 0 or 10, +1

### TECH LEVEL MODIFIER

Die	TL Mod
2	-1D
3	-2
4	-1
5	—
6	—
7	—
8	—
9	—
10	+1
11	+2
12	+1D

The computed environment tech level must fit within the limits determined in step 7a.

**Example:** A world has a high common tech level of C, a UWP atmosphere of 8 and a hydrosphere of 8. We roll 2D for the value of M and get 6, giving us 0 for M. Plugging the appropriate values into the formula we have: 11+0+0+0, or an environment tech level of 11, or B.

The value 11 is within the limits of 14 and 9 from step 7a.

## 8a Land Transport TL Limits

Determine the world's land transport upper and lower tech level limits as follows:

Upper limit: Energy upper limit.

Lower limit: Upper limit - 5.

**Example:** A world has an energy upper limit of 14. The land transport upper limit is 14 and its lower limit is 9.

## 8b Land Transport Tech Level

Determine the land transport tech level by using the formula below:

$$T = E + M + H$$

where:

T = Land Transport tech level.

E = Energy tech level.

M = Tech level modifier, determined by rolling 2D on the table below.

### TECH LEVEL MODIFIER

Die	TL Mod
2	-1D
3	-2
4	-1
5	—
6	—
7	—
8	—
9	—
10	+1
11	+2
12	+1D

H = Tech level modifier based on the world's UWP hydrosphere:  
if hyd is 10, -1

# TECHNOLOGY RELATED DETAILS 3

The computed land transport tech level must fit within the limits determined in step 8a.

**Example:** A world has an energy tech level of 11, and a hydrosphere of 8. We roll 2D for the value of M and get 9, giving us 0 for M. Plugging the values into the formula we have:  $11+0+0$ , or a land transport tech level of 11, or B.

The value 11 is within the limits of 14 and 9 from step 8a.

## 9a Water Transport TL Limits

Determine the world's water transport upper and lower tech level limits as follows:

Upper limit: Land transport tech level.

Lower limit: Upper limit - 5.

**Example:** A world has a land transport tech level of 11. The water transport upper limit is 11 and its lower limit is 6.

## 9b Water Transport Tech Level

If the land transport tech level is 10 or more, then make the water transport tech level the same as the land transport tech level.

Otherwise, determine the water transport tech level by using the formula below:

$$T = L + M + H$$

where:

T = Water transport tech level.

L = Land transport tech level.

M = Tech level modifier, determined by rolling 2D on the table below.

### TECH LEVEL MODIFIER

Die	TL Mod
2	-1D
3	-2
4	-1
5	—
6	—
7	—
8	—
9	—
10	+1
11	+2
12	+1D

H = Tech level modifier based on the world's UWP hydrosphere: if hyd is 0, -1

The computed water transport tech level must fit within the limits determined in step 9a.

**Example:** A world has a land transport tech level of 11, and a hydrosphere of 8. Since the land transport tech level is more than 10, then the water transport tech level becomes the same as the land transport tech level — 11 (or B).

## 10a Air Transport TL Limits

Determine the world's air transport upper and lower tech level limits as follows:

Upper limit: 9 if land transport tech level is below 10; otherwise the limit is the land tech level.

Lower limit: Upper limit - 5, but never less than 2.

**Example:** A world has a land transport tech level of 11. The air transport upper limit is 11 and its lower limit is 6.

## 10b Air Transport Tech Level

If the land transport tech level is 10 or more, then make the air transport tech level the same as the land transport tech level.

If the world's UWP atmosphere is 0, and the air transport upper limit is 9, then the air transport tech level is automatically 0.

Determine the air transport tech level by using the formula below:

$$T = E + M$$

where:

T = Air transport tech level.

E = Energy tech level.

M = Tech level modifier, determined by rolling 2D on the table below.

### TECH LEVEL MODIFIER

Die	TL Mod
2	-1D
3	-2
4	-1
5	—
6	—
7	—
8	—
9	—
10	+1
11	+2
12	+1D

If the resulting air transport tech level is 2, then the air transport tech level automatically becomes 0.

The computed air transport tech level must fit within the limits determined in step 10a.

**Example:** A world has an energy tech level of 11, and a UWP atmosphere of 8. Since the land transport tech level is more than 10, then the air transport tech level becomes the same as the land transport tech level, which is 11 (or B) in this case.

## 11a Space Transport TL Limits

Determine the world's space transport upper and lower tech level limits as follows:

Upper limit: Energy upper limit.

Lower limit: Upper limit - 3.

**Example:** A world has an energy upper limit of 14. The environment upper limit is 14 and its lower limit is 11.

## 11b Space Transport Tech Level

Determine the space transport tech level by using the formula below:

$$T = X + M + S + I$$

where:

T = Space Transport tech level.

X = The lower of energy tech level or computers/robotics tech level.

M = Tech level modifier, determined by rolling 2D on the table below.

### TECH LEVEL MODIFIER

Die	TL Mod
2	-1D
3	-2
4	-1
5	—
6	—
7	—
8	—
9	—
10	+1
11	+2
12	+1D

S = Tech level modifier based on the world's UWP starport: if starport A or B, +1

I = Tech level modifier based on the interstellar extensiveness: if friendly or xenophilic, +1 if aloof or xenophobic, -1

The computed space transport tech level must fit within the limits determined in step 11a.

**Example:** A world has an energy tech level of 11 and a computer/robotics tech level of 11, a starport A and an interstellar extensiveness of friendly. We roll 2D for the value of M and get 9, giving us 0 for M.

Plugging the appropriate values into the formula we have:  $11+0+1+1$ , or a space transport tech level of 13, or D.

The value 13 is within the limits of 14 and 11 from step 11a.

## 12a Personal Military TL Limits

Determine the world's personal military upper and lower tech level limits as follows:

Upper limit: Energy upper limit.

Lower limit: 0.

**Example:** A world has an energy upper limit of 14. The personal military upper limit is 14 and its lower limit is 0.

## 12b Personal Military Tech Level

Determine the personal military tech level by using the formula below:

# TECHNOLOGY RELATED DETAILS 4

$$T = E + M + A + B$$

where:

T = Personal military tech level.

H = Energy tech level.

M = Tech level modifier, determined by rolling 2D on the table below.

A = Tech level modifier based on the aggressiveness attitude:

if expansionistic, +1

if passive, -2

B = Tech level modifier based on the aggressiveness action:

if militant, +1

if conciliatory, -1

The computed personal military tech level must fit within the limits determined in step 12a.

**Example:** A world has an energy tech level of 11, an aggressiveness attitude of unaggressiveness, aggressiveness action of peaceable. We roll 2D for the value of M and get 10, giving us +1 for M. Plugging the appropriate values into the formula we have:  $11+1+0+0$ , or a personal military tech level of 12, or C.

The value 12 is within the limits of 14 and 0 from step 12a.

## 13a Heavy Military TL Limits

Determine the world's heavy military upper and lower tech level limits as follows:

Upper limit: Energy upper limit.

Lower limit: 0.

**Example:** A world has an energy upper limit of 14. The environment upper limit is 14 and its lower limit is 0.

## 13b Heavy Military Tech Level

Determine the heavy military tech level by using the formula below:

$$T = L + M + A + B$$

where:

T = Heavy military tech level.

H = Land transport tech level.

M = Tech level modifier, determined by rolling 2D on the table below.

A = Tech level modifier based on the aggressiveness attitude:

if expansionistic, +1

if passive, -2

B = Tech level modifier based on the aggressiveness action:

if militant, +1

if conciliatory, -1

The computed heavy military tech level must fit within the limits determined in step 13a.

**Example:** A world has a land trans-

port tech level of 11, an aggressiveness attitude of unaggressiveness, aggressiveness action of peaceable. We roll 2D for the value of M and get 3, giving us -2 for M. Plugging the appropriate values into the formula we have:  $11-2+0+0$ , or a personal military tech level of 9.

The value 9 is within the limits of 14 and 0 from step 12a.

## 14 Novelty Tech Level

Determine the novelty tech level by following these guidelines:

- Find the highest UWP tech level from among the nearest class A starport worlds; this represents the "novelty import" tech level. If the local world's starport class is X, the novelty import tech level is zero.

- Find the highest achievement tech level; this represents the "local prototype" tech level.

- The referee can assign a tech level to a prior culture if he wishes; this represents the "local artifact" tech level. Otherwise, use zero for the local artifact tech level.

The highest of these tech levels becomes the novelty tech level.

**Example:** Of the class A starports near our example world, the highest tech level among the nearby worlds is the tech level 13.

The highest achievement tech level for the example world is the space transport tech level of 13.

We decide there was no prior culture on the example world, so the prior culture tech level is zero.

In comparing the three areas, we have a tie between the novelty import tech level of 13 and the prototype tech level of 13. So the novelty tech level of our example world is obviously 13.

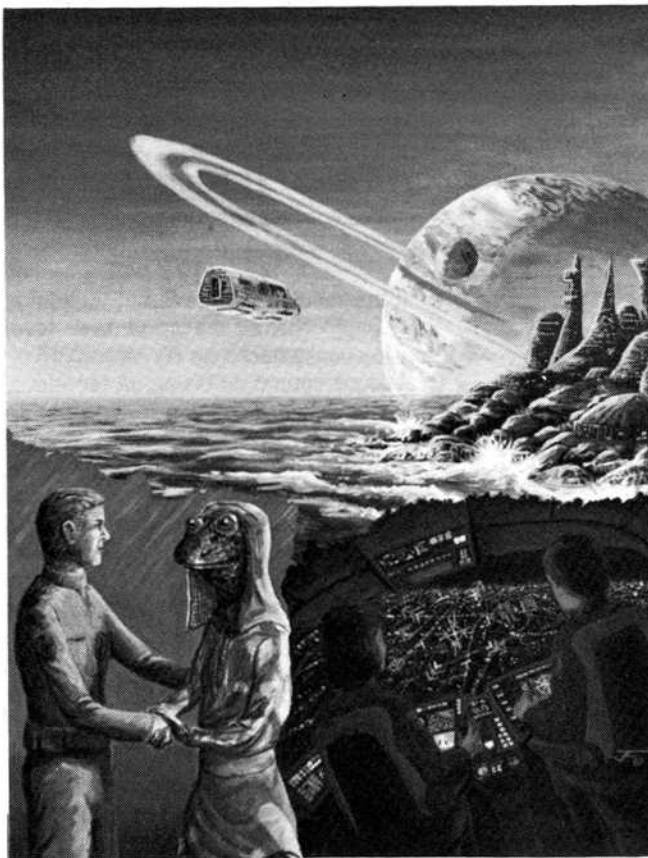



# Mapping a World

This chapter describes how to draw an accurately detailed world map from the data on the World Detail Sheet.

**World Map Grid:** Traveller uses a hex grid in the form of a flattened icosahedron (20-sided solid) for mapping the surface of a world, referred to as the "World Map Grid". By using the icosahedron, the world's surface is depicted with minimal distortion.

The World Map Grid is divided into twenty interlocking triangles (hereafter referred to as "map triangles") of 25 hexes each, for a total of 500 hexes per map. The equator is 35 hexes in length. Each hex is approximately 9° from north to south (top of the map is north, bottom is south, and equator is the center line). Two lines are also present, running at 30° N and 30° S latitude.

## USEFUL MAPPING FORMULAS

When mapping a world, here are some useful formulas for scales and scale conversions:

Circumference of a sphere: diameter in km x 3.14159  
Hex scale in km: circumference ÷ 35  
Total nbr of world map hexes: 500  
Number of hexes per triangle: 25

## MAPPING TECTONIC PLATES

Tectonic plates come in a variety of shapes, occurring as blocks of contiguous hexes. The World Detail Sheet indicates the number of major tectonic plates a world has: roll on the table below to determine the number of hexes in each tectonic plate.

## SIZE OF TECTONIC PLATES

Die	Size in Hexes
1	2D x 5
2	2D x 10
3	2D x 15
4	2D x 20
5	2D x 25
6	2D x 30

By default, the last tectonic plate is always as large as the number of hexes left on the world map grid. Exact placement of the plate boundaries is left to the one drawing the map; the key elements of reasonable plate boundaries are logic and imagination.

The plate boundaries are sketched lightly in pencil on the world map grid. They do not actually appear on the final map of the world, but are useful for determining the layout of continents and oceans, establishing seismic effects, and in locating certain terrain features on the final map.

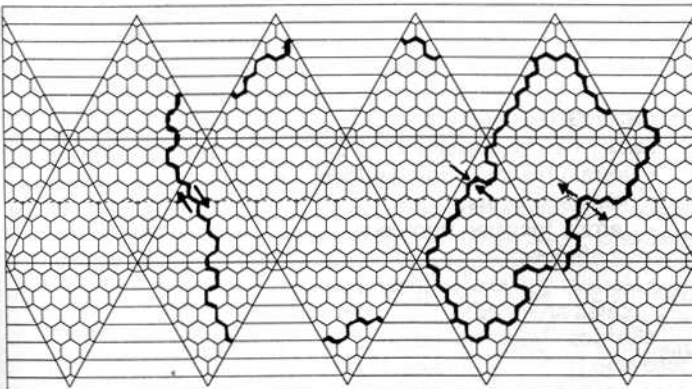

Example: The world Regina, with tectonic plates mapped.

**Tectonic Plate Movement:** For each plate boundary, roll 2D to determine plate movement.

On 2-5, the plates are "converging"; 6-8, the plates are "transversing", and on 9-12 are "diverging".

*Converging plates* are coming together, causing heavy seismic activity and mountain building.

*Transversing plates* are moving sideways in relation to each other, forming prominent fault lines such as California's San Andreas fault.

*Diverging plates* are moving apart, creating vast trenches.

## CONTINENTS AND OCEANS

Once the tectonic plates have been located, outlines of continents and oceans can be established.

This procedure is governed by the world's detailed hydrographic percentage. Notice that a world with a UWP hydrographic digit of 0 may have an actual hydrographic percentage of 0% to 4%; a world with a UWP hydrographic digit of A may have an actual hydrographic percentage of 95% to 100%.

**Mapping When the Hydrographic Percentage is 0% to 49%:** If the actual hydrographic percentage of a world is 1% to 49%, mapping determines the location of the oceans, seas, and lakes; the land area is located automatically as a by-product of locating the bodies of water. A true 0% hydrosphere indicates that no free standing water is present on the surface anywhere, and mapping proceeds directly to determining terrain.

**Total Number of Water Hexes:** Multiply the actual hydrographic percentage by 5. Thus, a world with an actual hydrographic percentage of 33% will have 165 water hexes.

**Scattered Lakes:** Scattered lakes are very small bodies of water; a hex containing scattered lakes is considered to be 1/2 of a hex of water surface. Scattered lakes are determined prior to calculating small seas, minor oceans, or major oceans; divide the number of scattered lakes by two and subtract it from the total number of water hexes.

If a planet's total hydrosphere is scattered lakes, there will be no significant sea or ocean; such a world is likely to have many swampy areas around these clusters of lakes.

If a planet's total hydrosphere is not scattered lakes, there will always be 2D hexes of scattered lakes present. See the "Other Bodies of Water" column on the Oceans Table (see the hydrographics related charts).

**Small Seas:** Small seas are bodies of water covering roughly 1 hex of water surface. The "Other Bodies of Water" column on the Oceans Table indicates how many small sea hexes a world has. The small sea hexes are deducted from the total number of water hexes before the size of major and minor oceans are established.

**Major Oceans:** A major ocean is a body of water that covers 15% or more of the world's water surface area. For example, if a world is determined to have 160 hexes covered by water, each major ocean must have at least 24 hexes. If there is only one major ocean, and no minor oceans present, almost all of the water surface of the world will be in a single body of water.

**Minor Oceans:** Any water surface left after major oceans have been designated is divided among the minor oceans present. A minor ocean covers less than 15% of the world's water surface area. Most minor oceans are small, often even less than 10% of the world's water surface area; establish the exact size as desired.

**Any body of water** can have major islands (roughly 1 hex of land area) and archipelagoes (roughly 1/2 hex of land area).

**Mapping When the Hydrographic Percentage is 50% to 100%:** If the actual hydrographic percentage of a world is 50% to 100%, mapping determines the location of the continents; the oceans are located automatically as a by-product of locating the land masses. Should the hydrographic percentage be 100%, then any land which is present on the world will be a few incidental islands, if there is any land at all.

**Total Number of Land Hexes:** Multiply the actual hydrographic percentage by 5 and subtract the result from 500. For example, a world with an actual hydrographic percentage of 83% will have 85 land hexes ( $500 - [83 \times 5]$ ).

**Archipelagoes:** Archipelagoes are groupings of small islands, considered to be 1/2 of a hex of land surface. Archipelagoes are determined prior to calculating major islands, minor continents, or major continents; divide the number of archipelago hexes by two and subtract the result from the total number of land hexes.

If a planet's total land surface is not archipelagoes, there will still be 2D hexes of archipelagoes present. See the "Other Land Masses" column on the Continents Table (hydrographics related charts).

**Major Islands:** Major islands are land areas covering roughly 1 hex. The "Other Land Masses" column on the Continents Table indicates how many major island hexes a world has; deduct the number of major island hexes from the total number of land hexes before the size of major and minor continents are established.

**Major Land Masses:** A major land mass is an area of land covering at least 15% of the land surface area of the world. The Terrain equivalents of major land masses are Eurasia (37%), Africa (20%), and North America (16%). The other continents are minor land masses according to these rules.

**Minor Land Masses:** Any land surface remaining after major continents have been designated is divided among the minor land masses. A minor land mass covers less than 15% of the world's land surface. Most minor land masses are less than 10% of a world's land surface; establish the exact size as desired.

**Remember that any land mass** can have land-locked small seas (roughly 1 hex of water area) and scattered lakes (roughly 1/2 hex of water area).

**Placement:** Once the general form of the world's continents and oceans has been developed, placement is next. This process requires a certain amount of creativity—and cannot be regulated by rules or random tables. General guidelines are given below, but you must be the final judge of what looks right for a specific world.

When placing continents, it is best to divide them up as evenly as possible among the various plates, ideally with one continent per plate. If there are more continents than plates, some continents must be doubled up on one plate. If there are fewer, some plates will lack a continent.

**Overlap:** As a continent is placed on a given plate, roll 2D. On 2-7, the continent is placed in the center of the plate with no overlap onto adjacent plates (unless it is too large to fit). On 8+, the continent is placed so that it overlaps onto an adjacent plate (the exact amount of overlap is up to you). An overlap can indicate the location of seismic disturbances, and can influence the charting of terrain features, especially mountain ranges. This is explained in detail later.

**Isthmus:** Any time two continents are separated by only one hex, they are joined by an isthmus on a roll of 9+.

**Strait:** Likewise, any time two oceans are separated by only one hex, they are joined by a strait on a roll of 9+.

The exact placement of features is, of course, up to you when creating the map, but the die rolls help introduce a certain degree of randomness.

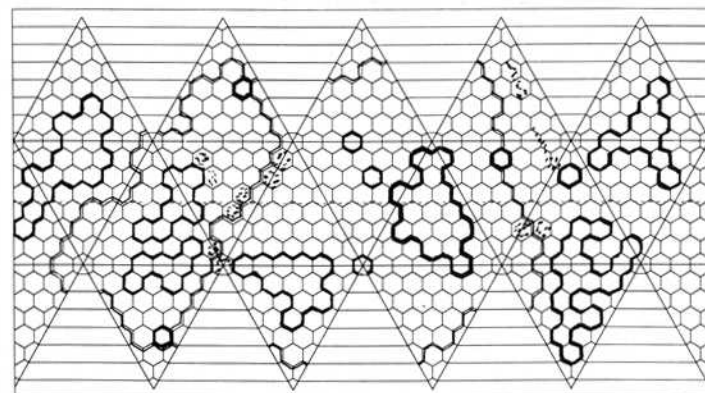

Example: Map of Regina, with the land masses placed.

## DRAWING THE MAP

Once the locations of the continents and oceans are known, they are sketched in. The size of each is determined as discussed previously.

Drawing the map is a creative process, balancing an eye for what is aesthetically pleasing with good judgment of the scientific possibilities. For example, even if you like the "nice, crinkly bits" of fjords, they might not look suitable as equatorial terrain, since fjords typically result from glaciation. (Some of these details suggest themselves when data on terrain and temperatures are assembled.)

Once the outlines of continents and oceans have been sketched in, the basic mapping step is complete. For further refinements, other data must be considered.

## MAPPING TERRAIN

Terrain can be classified into three general categories:

- terrain resulting from surface features such as mountains and rivers;
- terrain resulting from local life forms, such as jungles or steppes;
- terrain artificially influenced by civilization, such as cities and roads.

**Surface Features Terrain:** Surface features include the following types: mountains, rugged, and open. An additional type, tundra, is any open hex adjacent to the freezing line of a world. Placement of surface features is described below.

**Freezing Line:** In the northern hemisphere, a world's permanent freezing line is located north of the hex row in which the temperature is below 0°C year-round. A similar situation exists in the southern hemisphere.

A temperature worksheet is used to locate this hex row. (See atmosphere related details for guidelines on how to create this worksheet.)

Within the freezing line, place sheet ice on both land and water, and place tundra hexes on any open land hex in the hex row just beyond the freezing line.

**Glaciation:** If the world has ever experienced major changes in climate, it is possible that glaciation will have caused significant changes in terrain, primarily by carving mountains. Roll 1D-1; this is the number of hexes from the freezing line towards the equator that the polar caps once extended. Land areas within that radius have a greater chance of mountainous terrain (see "Mountains", below).

Where extreme variations in surface temperature occur regularly (from axial tilt, orbital eccentricity, or whatever), determine the limits of the freezing line at the coldest time of year, and use this as the baseline for the glaciation roll.

**Mountains:** Mountains are caused either by the actions of plate tectonics, or by the effects of glaciation. (Other causes are possible, but these are the primary causes.)

Mountain ranges are represented by mountain hexes, with rugged hexes often adjoining the mountain chains. Most mountains are placed along plate boundaries (see "Tectonic Plate Movement"). A total of  $[(2D-2) \times 1D]\%$  of the land hexes are mountain or rugged; the exact number of each and their placement is up to you, but placement should conform roughly to the plate boundary.

Outward from the glaciation line determined previously, each "map triangle" can contain 1D additional rugged hexes (up to the limit of available land hexes, of course) with an equivalent number of mountain hexes.

**Notable Volcanoes:** Place the volcano hexes with a strong bias towards placement in converging or transverse plate boundary areas. First preference of placement should be rugged terrain or on islands and archipelagoes. Second preference is any hex adjacent to a mountain hexside.

Once all such hexes have been used up, other volcanoes may be placed freely.

**Volcanic Hexes:** In addition to major volcanoes, 1D-1 other volcanic hexes may optionally be placed anywhere on the world, ignoring plate boundaries but still following other preferences. A volcanic hex contains many smaller volcanoes of various sizes and conditions.

Volcanoes may influence the presence of certain resource types in specific areas.

**Rivers:** Rivers are optional, as they have little effect at this scale. They may be included for local "color", however.

On each continent (or within each map triangle containing at least 10 all-land hexes if there is only a single continent on the world) there will be 1D-1 major rivers. Major rivers are 1D hexes in length.

Placement of rivers varies. They generally originate in mountains, rugged areas, lakes, or small seas, and flow toward larger bodies of water. If rivers are available for a continent, and the continent includes jungle (determined below), at least one river should flow through that jungle. Rivers can be drawn to conform to hexsides, or they may be drawn within hexes instead, whichever you prefer.

**Life Influenced Terrain:** If no life is present on the world,

all hexes are immediately considered desert. If life is present, follow the guidelines below in developing various terrain types.

**Deserts:** Deserts can occur in three different ways.

**Continental deserts** are placed on any continent where ten or more contiguous, non-rugged, non-tundra land hexes are present, and a dice throw greater than or equal to the world's UPP hydrographic digit is made. If a desert result occurs, roll 2D-1 for the number of desert hexes to be placed. Actual placement is left to the referee; except when necessary, deserts of this type do not occur in coastal hexes, but this is the only general limit. Where only one continent is present, check once per map triangle containing 10+ contiguous open hexes, instead.

**Windshadow deserts** occur because of mountain barriers that block movement of air containing moisture. There will be H-1D such desert hexes, where H is the UWP hydrographic digit. Place them in any hex adjacent to rugged hexes or mountain hexsides, but never adjacent to water hexes. There are no other requirements, and the available hexes are divided as the referee desires.

**Coastal deserts** occur in coastal hexes. There will be H-2D coastal desert hexes, where H is the UWP hydrographic digit. They may be placed on any coastal hex within four hexes of the polar caps. Exact locations are up to you.

**Jungles and Rain Forests:** Jungle and Rainforest hexes are generally placed in regions where temperatures are between 20°C and 40°C. If a group of 10 contiguous, non-desert, non-rugged hexes exists on a continent within this temperature range (or a map triangle, where only one continent exists), and a throw less than or equal to the UWP hydrographic digit is made on 2D, a jungle will be present.

Contiguous hexes can also, for jungles only, include adjacent islands and archipelagoes. When a jungle exists, roll 2D-1 for the number of jungle hexes to be placed.

Jungle and Rainforest hexes must be within 3 hexes of an ocean or sea, and may not be placed adjacent to desert hexes or outside the appropriate temperature range. Islands and archipelagoes may be included in the jungle placement process. Exact placement, within these guidelines, is up to you.

**Open/Forest:** All remaining hexes immediately become Open/Forest hexes. In the absence of civilization, these hexes will be heavily wooded, in some cases comparable to jungle.

**Civilization Influenced Terrain:** If there is intelligent life present on a world, additional terrain features may be present.

**Cities:** Placement of cities is largely a matter of personal choice, but a few general guidelines are noted.

At tech levels 0-3, cities of larger than population digit 5 should be placed only in open terrain (not jungles, deserts, oceans, ice caps, rugged, etc.).

Tech levels 4-6 permit placement of population digit 5+ cities in rugged or desert terrain, in addition to open terrain.

Tech levels 7-9 permit population digit 5+ cities to be placed in jungles, in addition to previous terrain types.

Tech levels 10+ allow placement of population digit 5+ cities in oceans or on ice caps. Thus, from tech level 10 and beyond, there are no barriers to settlement. At tech level 10+, it is also conceivable that each hex may hold a number of cities equal to the tech level, regardless of size.

**Special Cases:** In some cases, technological limitations may make city placement impossible. When this happens,

place the city anyway, but note the discrepancy. This should be explained in some reasonable fashion, to suit conditions on the world and personal taste in backgrounds. One good example might be an undersea city on a world with declining technology; the inhabitants are no longer capable of repairing problems, and hence are at the mercy of the first natural disaster that strikes.

**Roads:** Significant roads may be mapped if the tech level is between 5 and 10. Beyond tech level 10, the popularity of grav technology typically makes roads obsolete.

**"Settled" Hexes:** Open hexes adjacent to cities will be settled. At tech level 11+, any hex adjacent to a city is automatically considered settled, including ocean hexes. Settled terrain is generally inhabited lightly, and given over to agriculture or occupied by small communities.

If the atmosphere is not between 4 and 9, there are no "settled" hexes regardless of technology.

**Starports/SpacePorts:** Starports may be placed in or adjacent to the city hexes they belong to. Spaceports are always placed in the city hex.

**Terraforming:** If a world has conducted terrain terraforming, one or more hexes have had their terrain type modified. The most common type of terrain terraforming is to improve desert terrain into arable land (clear or settled) for agricultural use. The types of terrain terraforming include; from desert to prairie; from prairie to clear; from clear to wooded; from wooded to forest; from forest to rainforest; from rainforest to forest; from forest to wooded; from wooded to clear; from clear to prairie (accidental); and from prairie to desert (accidental).

Given sufficient time, the terraforming can include more than one level of transformation. An extreme (and rare) example of this would be to terraform desert into rainforest over a period of time.

The extent of the terraforming (how many hexes it includes) is up to the one mapping the world. Higher tech level terraforming (tech level 12+) tends to be more extensive.

### ALIEN WORLDS

This material assumes roughly Terran conditions. This is a deliberate bias, but should not restrict you from creating otherworldly conditions. It is impossible to write rules for every eventuality and still to have a manageable book, so implementing rare and unusual conditions is left up to the individual referee and players.

For example, you may wish to have a jungle-type terrain that flourishes in different temperature ranges than given here. If so, extend the jungle rules to permit these alien jungles in appropriate areas. In another instance, a world known to hold the remnants of a post-nuclear holocaust culture might have a whole new type of desert ("radioactive") placed at various points.

Use these rules as a foundation: modifications can be (and, in fact, should be) logically created and consistently applied.

### TIDALLY LOCKED WORLDS

A tidally locked world is a world that has an infinite rotation period with its primary star.

For such worlds, it is sometimes more convenient to treat the map projection differently than described above.

Tidally locked worlds keep the same hemisphere toward the star at all times and the other in perpetual darkness.

There are great extremes of temperature from one side to the other, with the "twilight" band—the rim where the sun is always near the horizon—being the area usually (but not always) closest to livable temperatures.

Since the area of greatest interest in terms of population and habitation is the twilight band, rather than the world's equator, a world map can be drawn in an alternate projection which more conveniently displays the twilight band.

The top of the grid is designated as the sunward side, the bottom as the nightside. The "equator" on the map becomes the twilight zone band. Along the center band, the north and south poles of the world may be located (17.5 hexes apart); half-way between them, an up-and-down line marking the equator may be inserted.

Keep in mind the unfamiliar orientation, however. This projection variant is very useful for twilight zone mapping, with the hot and cold regions to sunward and nightward slightly distorted, but also less frequently visited.

Rules for temperature variation must then be changed slightly to use these mapping conventions for dayside and nightside. The temperature is hottest at the top of the map, and coldest at the bottom. The base mean surface temperature occurs in the twilight band.

Such a world will be one of climatic extremes: only in a relatively thin band of constant twilight will life generally be able to flourish (though this depends on the base temperature). Mapping should reflect these surface conditions—ice sheets covering the cold regions, sunbaked deserts on the hot side.

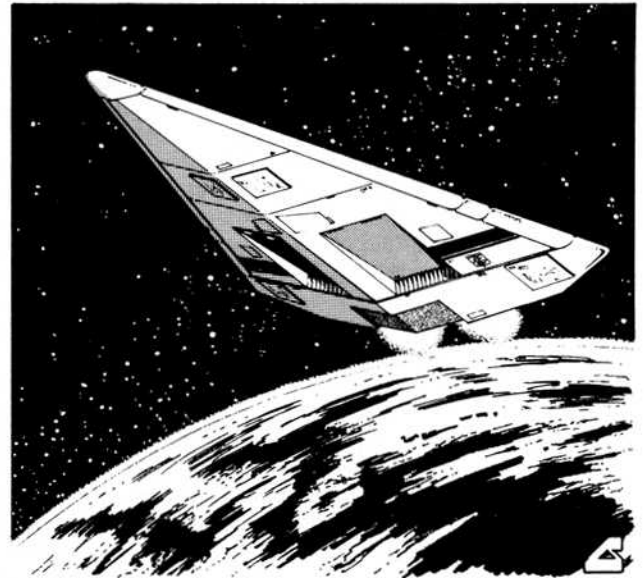

# WORLD MAP GRID

1. Date of Preparation

115-1106

2. World Name (and UWP)

Regina

3. Hexagon Scale in Kilometers (circumference divided by 35)

1 hex=1074 km

4. Subsector and Sector Location of World

Regina/Spinward Marches

This geodesic map grid divides the spherical surface of any globe into twenty triangles, each of which is further divided into hexagons. Note terrain identities and other planetographic features of the world in these hexagons. Total number of map hexes per triangle: 25. Total number of map hexes: 500.

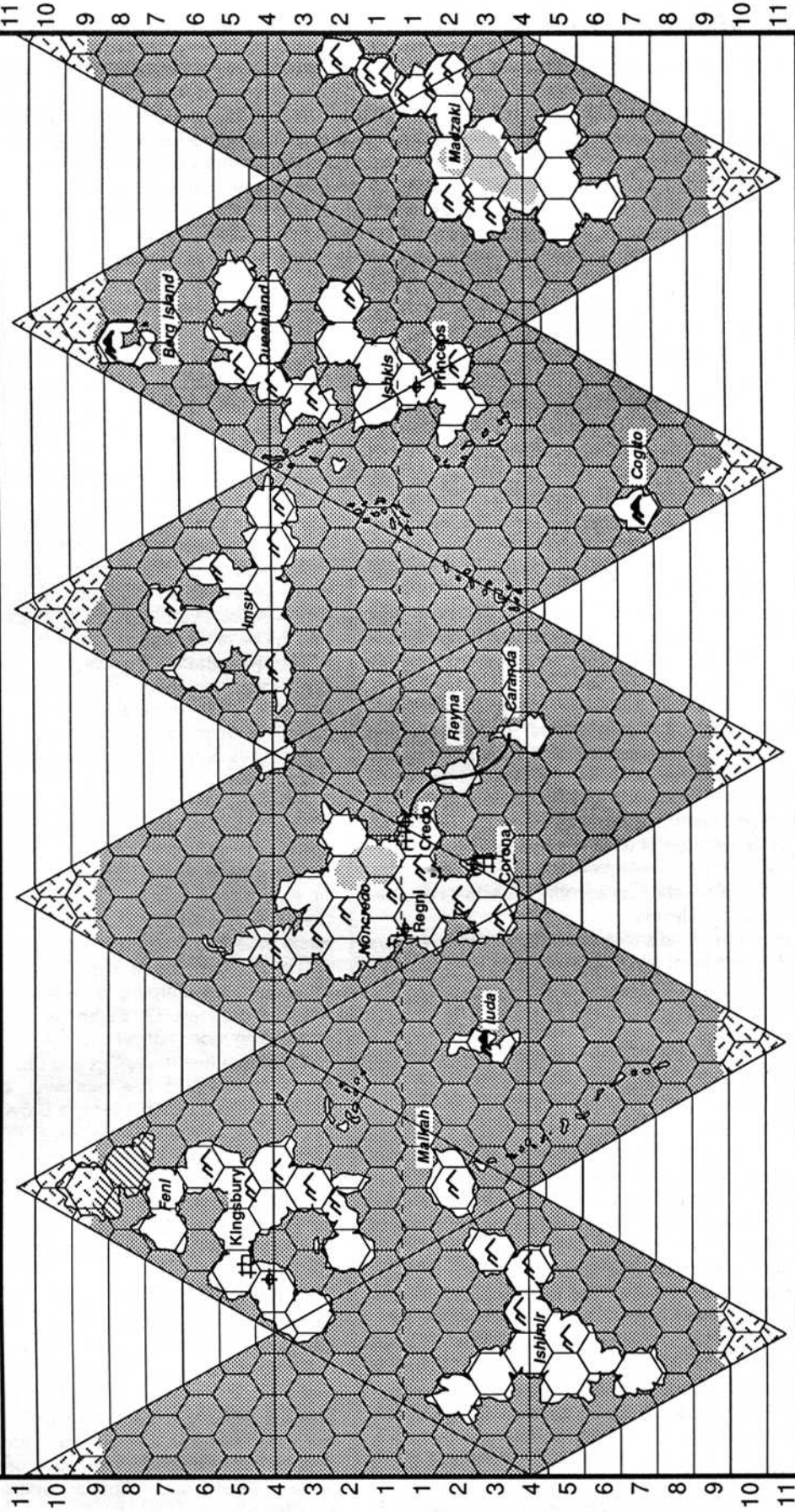

IS Form 21

World Map Grid (Large)

# Using World Data

Sometimes just coming up with a reasonable interpretation for the last four stats of the basic world UWP (population, government, law level, and tech level) can be a real challenge. This section discusses difficult to interpret aspects of world data.

All of this information can be used to add extra spice to an adventure or campaign. World Builder's cultural data can be used to generate a rich homeworld background for player characters or major NPCs.

Local temperature, climate, weather, and seismic quakes all add color to an adventure. This section tells how to use world data to determine conditions and to generate unusual events. Information is also given on using law levels, fines and punishment, and even planetary defenses. Guidelines are also given for using a world's size and atmosphere as interesting complications in an adventure.

## INTERPRETING WORLD UWP STATS

When trying to reconcile a world's UWP and data listing stats with one another, difficulties sometimes occur. This section examines the effects world data stats can have on each other. Understanding these relationships can make all the difference when deciphering a seemingly incompatible array of world stats.

**Starports:** The tech level of a world is seldom tied to the starport tech level. Most worlds consider the starport to be extraterritorial, and when the Scouts consider the world's technology ratings, they typically ignore any technology within the starport's bounds.

Even so, technology from a high-tech starport does "leak out" onto a lower tech world. This technology leakage is represented by the DMs used for starports when determining the world's tech level using the basic rules.

As an example of technology leakage, consider the US military bases in Vietnam in the early 1970s. The surrounding countryside was about tech level 4 to 5, while the military base was tech level 7. When a TL 7 truck was deemed unrepairable, the base might decide to sell the truck to the locals. The locals may get the truck running, although its performance is probably far short of what the base personnel consider acceptable.

The starport DMs also take into account the effects of interstellar trade on local tech levels.

No matter what the world's tech level is, starports always have a minimum tech level which exists within the starport's borders. These minimums are:

- Class A Starport: TL 10
- Class B Starport: TL 9
- Class C Starport: TL 8
- Class D Starport: TL 7
- Class E Starport: TL 6
- Class X Starport: TL 0

Thus if a world has a class A starport and a tech level less than 10, the starport tech level is always at least 10.

If the world's UWP tech level exceeds the minimum level for the starport, use the world UWP tech level as the tech level of the starport facilities.

**Military Bases:** The presence of Scout bases, Imperial Naval bases, and colonial Navy bases may or may not have an effect on the world's tech level.

In many cases, the base is ignored by the Scouts when considering tech level. To understand why, consider Edwards Air Force Base in California. Can commercial and private aircraft routinely use the Edwards Air Force Base facilities? No, they can't: it is a government military facility, and there are plenty of non-military facilities elsewhere. The same holds true of bases in most star systems.

On the other hand, some military bases are considered by

the Scouts when they are determining the primary (i.e., the most prominent) world in the system, and its tech level. A corresponding example is the American Army forts of the old west. Anyone passing through could seek refuge in the fort and get supplies. The same holds true of bases in some star systems.

The bottom line on military bases is this: take your pick. The Scout base, Imperial Naval base, or colonial Navy base facilities can be declared as "included in the UWP" if you want to allow free access to the base's facilities. But the more common situation (especially if the world UWP doesn't seem to make sense in light of the military base) is to declare the military facilities as off-limits to commercial and private starships, and the base facilities as "not included in the UWP".

**Zero Population Worlds:** Some of the strangest planets in the Survey of the Imperium are listed as having no population, yet have a government, law level, or tech level. How can no people have government or technology? There are ways, and these ways can make a zero population planet into an exciting adventure situation.

First, remember that a zero population digit means from 0 to 9 people in permanent residence on or around the planet. Transients do not count, nor do military personnel stationed there for a few months or years. A zero-population world may be a park planet with a few caretakers, or a privately owned preserve of a noble; a tourist world without special facilities could have millions of visitors per year, yet a population digit of 0 and no permanent residents. It can be a research station, an automated starport, or a wilderness training planet for Imperial marines. Or it can be really empty, or have only developing races not yet counted as a true sentient race.

If a planet has a starport and tech level only, it is probably an automated port. The tech level does not necessarily refer to the starport. For instance, a B class port on a tech level 3 planet may be there as access to the remains of a vanished civilization, whose relics are tech 3. The tech level may refer to accommodations available on a hunting preserve world.

A class E starport, and a tech level of 5 or more (other digits 0) usually means a mechanical beacon of the indicated tech level. Occasionally an exile world or a hermitage also fits this class.

The range of governments (2D-7+pop) for zero-population worlds is 0-5. Here are some possible explanations for these governments when the world has a zero population digit:

0. "No government, or family bonds only" generally means that the few people on the world are responsible to someone offworld. Although rare, it is not unheard of that a single family will have laid claim a whole world and set out to tame it. This digit can also be used for the government of a military training ground, or any such situation where all the inhabitants are temporary.

1. "Company/corporation" means that this planet is wholly owned by a business. It may be a warehouse planet, or an executive resort, or it may be mined for valuable resources, either mechanically (with robots) or by crews in rotation, due perhaps to rigorous working conditions.

2. "Participating democracy" is the most natural government type for less than 10 people, but implies that they are on their own. A research group (self-supporting) might have such a government. So might a religious group in retreat. Castaways would develop one, but would be unlikely to remain on the world after a survey ship had arrived. Political exiles might rule themselves by mutual agreement.

3. A "self-perpetuating oligarchy" is usually ruled by an elite noble class where blood line or some other selection process determines the succession. Many worlds in the core of the Imperium are privately owned by noble families and some are kept unpopulated except by those families and their retainers or robot servants. In addition, the Imperial government itself keeps a few worlds as parks or museums, and holds worlds with developing races in trust (under Scout management).

4. A "representative democracy" means that this world is represented in some other world's legislature (as a small colony perhaps), or that transients may be represented before a council of permanent residents. There are cases of planets claimed by educational institutions (often with relics of past civilizations) where students go, running the world with a representative government of their own. However, the students must still answer to the offworld faculty.

5. A "feudal technocracy" is likely to indicate a scientific group led by their top scholar. Under extreme conditions on a planet with valuable resources, prospectors might put themselves under the orders of a knowledgeable guide (a permanent resident) and this could be called a technocracy also.

A red zone with no population is usually either an exile world or a ruin with dangerous residues from a war. It may also be interdicted by Scout authority to protect indigenous flora and fauna.

All these factors and possibilities can be juggled to explain the particular UWP of any world with zero population. Thus, any zero population world can become an intriguing place, well worth exploring by your players.

### LOCAL TEMPERATURE

Besides the effects shown in the world design section, some other factors can affect local temperature.

**Altitude:** If the locale is on a significantly elevated part of the planet (say a mountain or a plateau) the phenomenon known as "lapse rate" comes into play. Temperature decreases at a rate of 1° per 200 meters above "surface level" (sea level on worlds with oceans, or an arbitrary determination of the referee's on other worlds). Thus a point 1 kilometer above surface level will be 5° colder than a point at surface level, on the average.

**Water:** The presence of a significant body of water can also alter the local temperature. Water moderates temperatures in areas near it (say within 5 km) during the summer by minus 1-6°C and adds 1-6°C during winter.

The same holds true of day and night temperature variations near water—the same 1-6° variation lowers the day temperature and raises the night temperature in areas within 5 km of a large body of water.

**Terrain Variations:** Regardless of the atmosphere of the world, some locations experience random variation. A

desert, for instance, will tend to have less heat retention at night than a smog-bound city. You may wish to assign modifiers to temperature based on such considerations.

**Random Variations:** The temperature calculations yield basic temperature ranges; various essential extremes will occur pushing temperatures up and down. Determining these random variations are up to the referee.

### WEATHER EFFECTS

The main type of weather affecting a session are fog and precipitation, which affects both visibility and movement.

**Visibility:** Fog and precipitation affect visibility in the same manner as night. Fog, rain, and snowfall increase the difficulty of all spotting tasks by one level.

Vision enhancement devices treat weather effects as night, with the following exceptions:

- IR devices (active and passive) do not work in rain or snowfall.

- Thermal imaging devices may see personnel only out to distant range in rain. They do not work in snowfall.

- Radar has its range cut in half in rain and snowfall; all-weather radar may see normally.

- Illum rounds, searchlights, and light amplification devices do not work in any reduced-visibility weather conditions.

**Movement:** After prolonged rainfall, normal ground will become mud. Wheeled vehicles pay double movement to move through snow; tracked vehicles move as normal.

### PLANETARY ENVIRONMENT

The basic combat rules assume an Earth-like planet (size 8, with a standard atmosphere). Planets with different sizes, gravities, and atmospheres have various additional effects, as explained below.

**Planetary Size:** The distance to the horizon is the upper limit on spotting and direct fire range, and depends upon planetary size. The table below gives the range to the horizon on worlds of the diameter specified (in km). The number in parentheses is the world UWP size code.

<i>Radius</i>	<i>Range to Horizon</i>
800(1)	Very Long
1600(2)	Distant
2400(3)	Distant
3200(4)	Distant
4000(5)	Distant
4800(6)	Distant
5600(7)	Very Distant
6400(8)	Very Distant
7200(9)	Very Distant
8000(A)	Very Distant

**Atmosphere Type:** Atmosphere type has a number of effects. Thin, standard, and dense are all breathable; tainted atmospheres are breathable after poisonous gases have been filtered out. Very thin and trace atmospheres are too thin to breathe. Exotic, corrosive, and insidious atmospheres are very dense, unbreathable, and increasingly dangerous.

**Air Cushion Vehicles (ACVs):** When determining the speed of an ACV, divide by 2 for dense, exotic, corrosive, and insidious atmosphere worlds. An ACV will not work on trace or vacuum atmosphere worlds.

**Energy Weapon Fire:** The listed penetration/attenuation of an energy weapon (laser, plasma gun, or fusion gun) is

increased as shown on the table below for the stated atmospheres. These constants affect range for the purposes of penetration only, and do not alter the range at which a weapon may hit.

For example, a laser pistol-9 in a very thin atmosphere still requires a difficult task to hit at long range, but still has a penetration of 4 at that range instead of 2.

<i>Atm</i>	<i>Pen Mod</i>
Vacuum	+3 bands
Trace	+2 bands
Very Thin	+1 band
Thin	No change
Standard	No change
Dense	No change
Exotic	-1 band
Corrosive	-1 band
Insidious	-1 band
Dense High	-1 band
Ellipsoid	No change
Thin Low	No change

### UNDERSTANDING THE LAW DETAILS

Law is the influence that a government has over a population. At one end of the scale, anarchy prevails, and all are free to act under whatever whims move them at the moment. At the opposite extreme, the insidious fingers of the government reach into every nook and cranny of activity, no matter how personal.

When an individual breaks a law, the government reacts, to prevent the lawbreaker from committing the same crime again, to exact retribution for the victim, and to punish the wrongdoer.

Different civilizations conduct these tasks in different ways — the way each civilization does these tasks is through its laws.

**Law Enforcement:** Enforcement can be particularly important to the characters, because they may commit a crime unobserved. At a low law level, the transgression may be ignored by the authorities. If the law level is high, police will often be relentless in their hunt for the characters, using any available evidence they can find.

**Law In The Imperium:** With 11,000 worlds to choose from, there are a variety of lawmaking bodies in the Imperium. Depending on where the characters are, one or more of these may apply to their actions.

**Local Law:** At the local level, laws are different for each world, or even each country on balkanized worlds. These laws then extend only to behavior on that particular world, and characters can not be punished for actions they commit elsewhere.

In particular, note that the "law level" digit is meant to apply principally to the urban areas near a starport. Wilderness areas on a world usually have lower law levels, especially in the area of enforcement: where there are no police, there are no laws, as the Vargr say. At high tech levels, of course, it is easier for police to observe wrongdoings and collect clues even in uninhabited areas, so this distinction does not apply.

**Local Interstellar Law:** Sectors and subsectors can and do establish laws that must be obeyed on every world within their boundaries. Usually, these laws concern themselves with diplomatic relations and Imperial taxes. Characters should be aware, however, that laws at this level often establish extradition procedures. Adventurers who flee a world

after committing a crime there may gather undue attention from police everywhere they go.

In a few cases, several member worlds in the Imperium may have a closer governmental relationship. The most common reason for this is a captive world or colony, but there are instances of worlds banding together into small political units. Local laws in these situations may extend over all the worlds involved.

**Imperial Law:** The Imperium for the most part is a trade protectorate, and its principal legal duties are protecting the space between member worlds from piracy and foreign attack. Imperial laws also set up a minimum standard of behavior for every world within its borders.

For example, murder (killing a sentient being without provocation) is an Imperial crime. Where local laws do not adequately prohibit murder, Imperial law would apply. Naturally, this rarely happens except in open space.

Imperial law is enforced by Imperial nobility and Imperial troops. Where possible, criminals are brought to the nearest world where a fair trial can be held under the procedures of the local law.

**Crime And Punishment:** Once a court has tried and convicted a criminal, it usually imposes some punishment. These vary by type, usually according to the kind of crime committed.

**Fines:** Small fines are often imposed for minor, non-violent offenses, but fines for trade law violations might be up in the millions of credits. For minor offenses, determine the fine by rolling 4D x Cr10. The fines for trade law violations are up to the referee.

**Corporal Punishment:** Usually applied for more serious crimes, corporal punishments are of three types.

Restrictions on activity are the mildest of corporal punishments, usually involving a prison term for some specified time. Under certain arrangements, criminals may be released early, but must report their activities to the authorities for some time after this release. For minor crimes, the jail term is usually 2D days. For local major crimes, on a 2D roll for less than the law level, the prison term is 4D years. If the 2D roll is equal or greater than the law level, the prison term becomes 1D+2 decades.

Injury and death may be inflicted upon the criminal as a punishment. Limbs are sometimes removed for theft, and murder and other serious crimes are often punished by death. Of particular note is Easter (Solomani Rim 1802), where looking at the ruler's face is punishable by being blinded. The referee must determine if this type of punishment exists for a given crime.

Banishment seems like a lenient punishment, but it is severe to the person who must leave his world or country and live apart from his family and friends. The early Greeks on Terra banished one of their countrymen every year by a vote of all the citizens (demos as defined above). Those punished in this way could return only after ten years of enforced absence. As with injury or death, the referee must determine if this type of punishment exists for a given crime.

**Guidelines on Setting the Severity of Punishment:** The harshness with which criminals are dealt varies considerably from world to world. A crime punishable by death on one world might merit only a small fine on another. Since it is impossible to give strict rules for every world, the following guidelines should help.

The severity of punishment varies inversely to the law level. That is, punishments are lax at the highest law levels



and more severe the lower the law level gets. This variation is easy to understand.

At low law levels, only the most serious offenses are considered to be criminal, and so naturally punishment for any crime is harsh. At the highest law levels, where every act is a crime and every citizen is a criminal, it is virtually impossible to punish every infraction, so minor offenses are often overlooked. Unfortunately, a character who upsets a minor bureaucrat on such a world may find himself receiving special visits from the police for these "crimes". (This is not to imply, either, that serious crimes are punished in a modest manner at high law levels.)

#### COORDINATING GOVERNMENT AND LAW LEVELS

The law level of a world can give an extra glimpse into the "enthusiasm" which the three branches of government show for their work. An infinite variety is possible by combining all the possible values of the different characteristics.

On a low law level world, the legislative branch will "keep its nose out of people's business", promulgating only a minimum of laws to protect its citizenry. The small executive branch will also exert its influence in a minimal way to make sure that these laws are enforced. When lawbreakers are apprehended, the judicial branch will conduct quick trials, although often meting out harsh sentences for serious crimes.

On a high law level world, the legislative branch will interest itself in every sphere of activity, producing a multitude of laws. The executive branch, often weighed down in an inefficient bureaucratic structure, will enforce these laws in a heavy-handed way, often over the objections of the citizens. Trials might drag on for years, with the judicial branch swamped by a heavy work load made worse by overprecise procedural rules.

In game terms, characters will have many more dealings with individuals from the executive part of the government. Of course, if characters disobey laws they may also find themselves introduced to the judicial functions after being arrested by the executive branch.

#### CULTURAL BACKGROUND IN A HURRY

For practical purposes, you can use twentieth-century Western civilization as a cultural model for the Imperium. The cultural profile is progressive and advancing, competitive and neutral, discordant and friendly.

For very quick cultural details for any world, the Local Customs Tables in the population-related details subsection can be used even if no other part of this book is used, to immediately give a local flavor to any world.

**Example:** We want to develop local customs for Regina, which has a tech level of 12. We roll once on the Local Custom Table and get a 2, which tells us we need to roll on the Eating Habits table.

Rolling on the Eating Habits Table gives us "Unusual Foods\*" on the table. The asterisk means we need to also roll on the Applicable Groups Table to find out who eats the unusual foods. We roll and find that the low social classes have the unusual food.

Now our imagination must fill in the details. We decide that Regians believe strongly in a "gleaning custom", where the lowest class citizens are expected to clean the tailings from a harvested field for much of their food supply.

#### UNDERSTANDING THE TECHNOLOGY PROFILE

The basic tech level in a world's UWP provides a general guide to the technology available on the world. The Technology Profile provides a detailed picture of the world's technological abilities.

By examining the achievement tech levels and comparing them to the high and low common tech levels, it is possible to draw some useful conclusions about conditions on the world.

**Achievement Tech Level Greater Than High Common:** This represents a technological area in which the world is forging ahead through experiments and research. Breakthroughs are occurring, but little practical use has yet to be made of the discoveries or inventions.

Characters may be able to locate and make use of this technology in an adventure if they are desperate, but any such technology likely consists of a handful of prototypes of dubious reliability.

**Achievement Tech Level Between High Common and Low Common:** This represents a technological area in which the world has local manufacturing and distribution capability. Research and development are ongoing, but no major breakthroughs have been made recently.

If the tech level is below high common, any high common items in this specific technology area are imported and likely cost more than usual.

**Achievement Tech Level Less Than Low Common:** This represents a technological area in which the world has great technological difficulty.

Many explanations for this exist:

- The world, for whatever reason, has no pressing need for this area of technology;
- The world may actually be expending great energy and resources trying to advance in this area, but efforts have yet to produce meaningful results. A technological disaster could be the cause of this; alternatively, some sort of "cultural block" could make research in this area impractical.
- The populace may prefer offworld goods to local goods—in other words, there is no market for this type of technology if it is locally manufactured.

If characters want items of low common tech level or above, and the technology area has an achievement level below low common, the items will be imported and very expensive.

The maximum tech level commonly encountered in the Imperium is 15, with an occasional tech level 16. Tech levels over 16 are almost never encountered in the official Traveller universe except as artifact tech levels. There is only one exception to this in the entire Imperium: Sabmiqys (Antares 2117). Sabmiqys possesses an active, developing tech 17 culture. But because of social reasons the population of Sabmiqys is planet bound. Their space transport tech level is 8: they are without jump drive capability.

#### OTHER TECH LEVEL NOTES

Worlds with a tech level of 10 or less often contain some areas on the world that have only been superficially explored. In cases where the tech level is 11 or more, then if the world's population code is less than 6, the world typically contains some superficially explored areas. Worlds with a tech level of 7 or less generally have several large unexplored regions.

**PLANETARY DEFENSES**

Planetary defenses are of two types: active and passive. Active systems are designed to inflict damage on enemy starships attempting to bombard the planet or land troops, while passive defenses limit the ability of enemy forces to inflict damage on the world.

The most common form of active defense in the deep meson gun site. A deep meson gun is a meson gun of ship ordnance size buried in a deep underground chamber. As a planet itself is transparent to the meson beam, the meson gun can fire at any target desired, while the site itself is effectively impossible to locate. Only when the gun site's surface sensors and target acquisition devices have been destroyed or captured can the gun be silenced. This generally requires the use of ground troops or extensive planetary bombardment. At lower tech levels, laser and missile sites are used as well, but are much less effective and more vulnerable.

Passive defenses center on major population concentrations, and take the form of damper projectors and large (city-sized) meson screens. The atmosphere of a planet itself provides an effective shield against long-range laser and particle accelerator fire, although vacuum worlds lack this protection and thus generally surrender if an enemy bombardment force penetrates its system defense boats.

The vehicle design section and the starship design section can be used to develop the appropriate planetary defenses within these guidelines.

**SEISMIC QUAKES**

Seismic quakes of enough intensity to be noteworthy are rare, but do happen from time to time.

Implement a quake as a special predetermined event. Prefer worlds with a high planetary stress factor.

The quake is major if a roll of less than or equal to the planet's stress factor is made; otherwise the quake is minor.

A major quake has a magnitude of 2D-2; a minor quake has a magnitude of 1D-1.

**Quake Effects:** Each character is "hit" by the quake if a roll on 2D of less than or equal to the quake magnitude is made against that character. A "to avoid" task using dexterity should be defined to enable the character to avoid the hit; if the throw is failed, he will suffer a mishap.

**Aftershocks:** A major quake will be followed by a number of "aftershocks" equal to the quake's magnitude, over a period of 2D hours following the initial quake. Minor quakes do not produce aftershocks.

**Predicting or Controlling Seismic Activity:** Reliable quake prediction appears at tech level 8. At TL 8+, roll less than tech level on 2D to predict a quake. If successful, delay the quake, and warn the characters that it will occur.

At tech level 10, controlling quakes is often possible. On a 3D roll for the TL-, the quake magnitude can be reduced by TL + 2 (round fractions down). The roll must be made individually for various quakes. A DM-1 is allowed if the population of a city in the quake hex is 6+.

## Get World Builder's Handbook on Computer!

(For most computers, including IBM PC, Macintosh, Apple II, Commodore 64/128)



Why spend endless hours detailing your worlds by hand when you can get your computer to generate all the details in a few minutes?

All the rules presented here in World Builder's Handbook are faithfully reproduced by this computer program. Just key in the world UWP, and the program does the rest. (The program will also read the sector data files below and produce a one-page world details sheet for each system!) No Preorders Please.

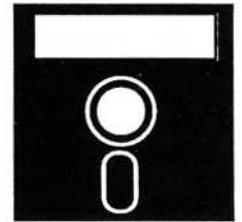

Available January 1990

**World Builder's on Computer**

\$ 24.95 (IBM, Mac)  
\$ 29.95 (Apple II, Commodore) re

**Second Survey Data on Computer**

\$ 24.95 (IBM, Mac)  
\$ 29.95 (Apple II, Commodore)  
(All Macintosh versions use HyperCard.)

UWP data for 37 sectors in and near the Imperium. The World Builder's program can read this data and generate world detail sheets to your heart's content.

**Index for World Builder's Handbook**

Send a #10 SASE to Digest Group Publications, 8979 Mandan Ct., Boise, Idaho 83709

# WORLD MAP GRID

This geodesic map grid divides the spherical surface of any globe into twenty triangles, each of which is further divided into hexagons. Note terrain identities and other planetographic features of the world in these hexagons.  
 Total number of map hexes per triangle: 25. Total number of map hexes: 500.

1. Date of Preparation

2. World Name (and LPP)

--	--	--	--	--	--	--	--	--	--

3. Hexagon Scale in Kilometers (circumference divided by 35)

4. Subsector and Sector Location of World

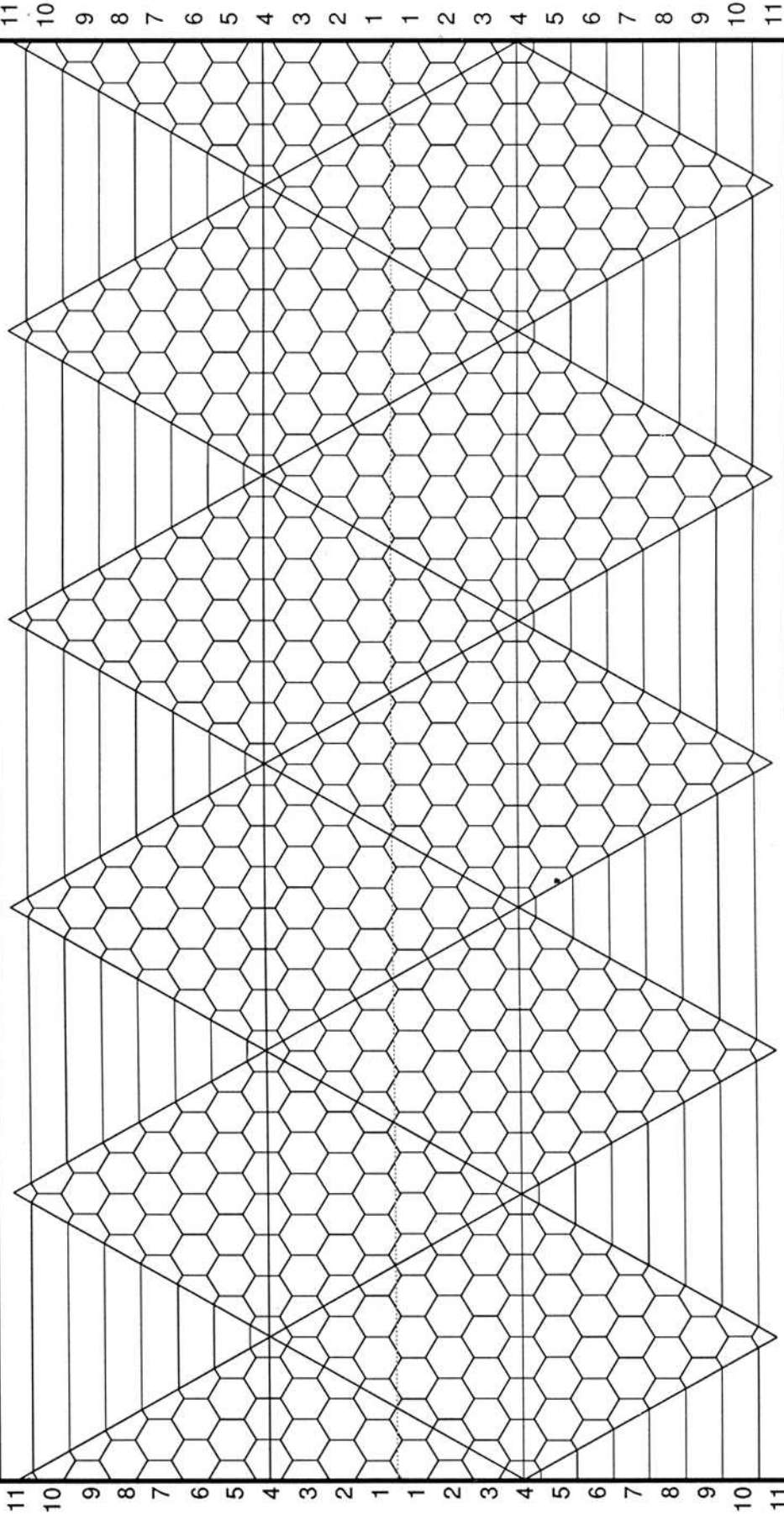

IS Form 21

World Map Grid (Large)

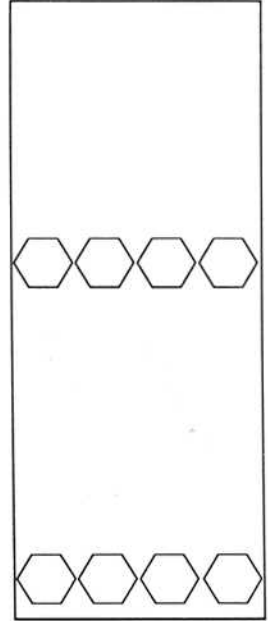

# WORLD

## B U I L D E R ' S H A N D B O O K

Learn How the Imperial Scouts Survey and Explore New Worlds...

And Learn How to Build Exciting and Interesting New Worlds of Your Own With These Extensive Rules!

**Contents include —**

- **Survey Procedures:** Procedures used by the Scouts to survey and explore worlds.

- **Survey Equipment:** Thirty pages of detailed equipment sheets for players to use on survey and exploration missions. Includes sensors, personal-assist hardware, clothing and protective gear, vehicles, and complete plans of the *Donosev* Survey Starship used by the Scouts.

- **Sensor Readout Panel:** Comprehensive sensor readout panel for use with all manner of sensory equipment, from lowly handheld sensors all the way to powerful starship sensor arrays.

- **Extensive World Building Section:** Detail your worlds to a level of detail you never thought possible. Create new environments with exotic alien cultures. Includes rules for detailing not only Terran-like worlds, but also more unusual locations such as:

- Asteroid Worlds

- Gas Giants

- Tidally-Locked Worlds

- **Mapping a World:** Guidelines on how to properly map the world you have built.

**For Use With MegaTraveller—**

This book is intended for use with *MegaTraveller*. It requires that you have a copy of the game rules.

A Scout survey team takes advantage of the first light on Deyis II, seeking to verify recent rumors of unusual lifeforms on the world. The Scout in the left foreground is pleased because his neural activity sensor has just registered a "semi-intelligent, unknown" lifeform 500 meters ahead. Meanwhile, his partner waives to her fellow Scouts hovering overhead in their *Kankurur* G-Carrier. The Scouts from the G-Carrier, in grav belts, are coming to help home in on the newly discovered lifeform.

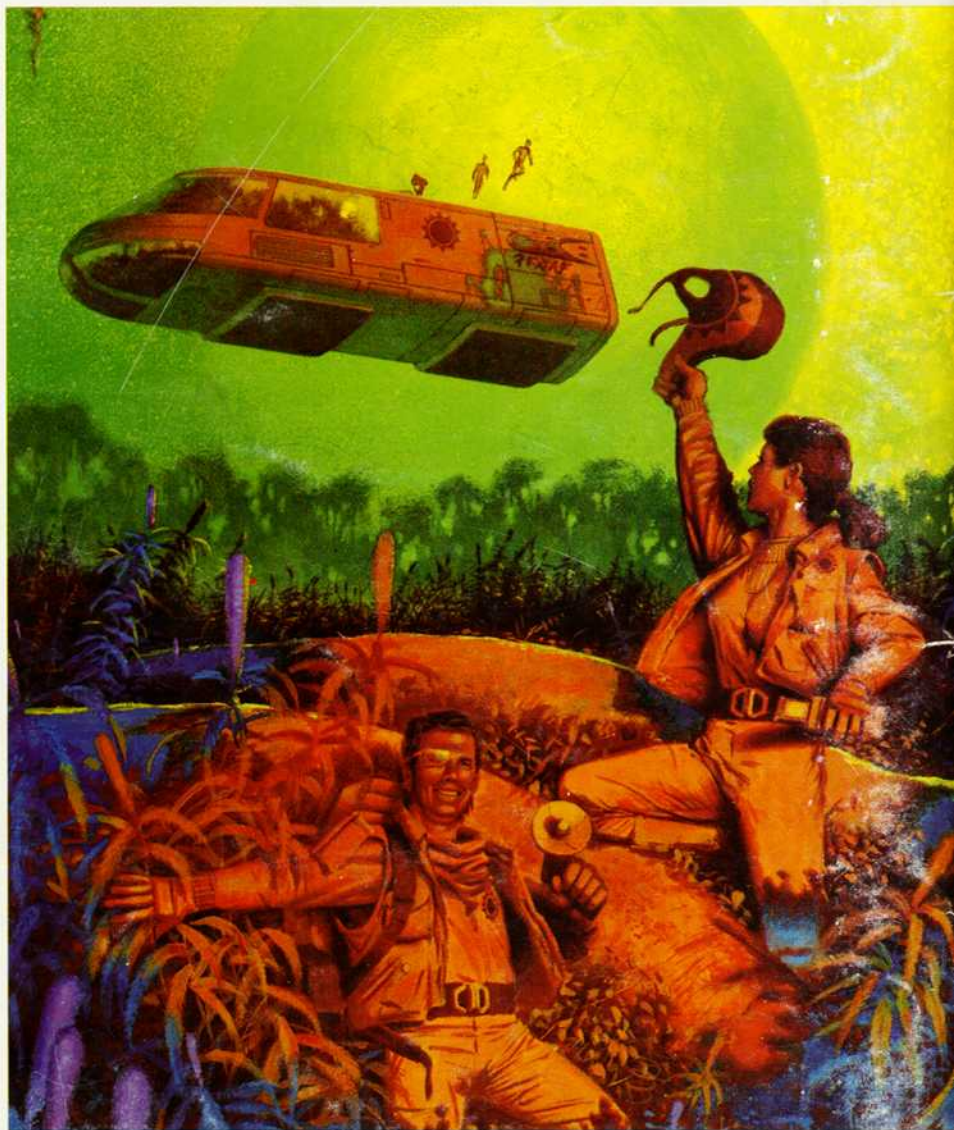

Digest Group Publications, 8979 Mandan Ct., Boise, ID 83709-5850

Traveller® is GDW's registered trademark for its far future science-fiction role-playing system. *MegaTraveller* and the *Shattered Imperium* are trademarks of GDW and are used with permission.

Copyright©1989 by Digest Group Publications. All rights reserved. No part of this publication may be reproduced in any form or by any means without written permission from the publisher. Printed in the USA. Portions of this book are taken from *Traveller* and *MegaTraveller* materials published by Game Designers' Workshop, and are copyright© 1987, 1988, and 1989 by GDW, Inc.

DGP-875-1195