

MEGATRAVELLER STARSHIP



O P E R A T O R ' S M A N U A L VOL. I



88

Approved for use with MEGATRAVELLER



Digest Group Publications

EXTERNAL ELEVATIONS OF A BEOWULF CLASS TYPE 'A' FREE TRADER

Permission granted to photocopy this page for use in applying your own custom color schemes.

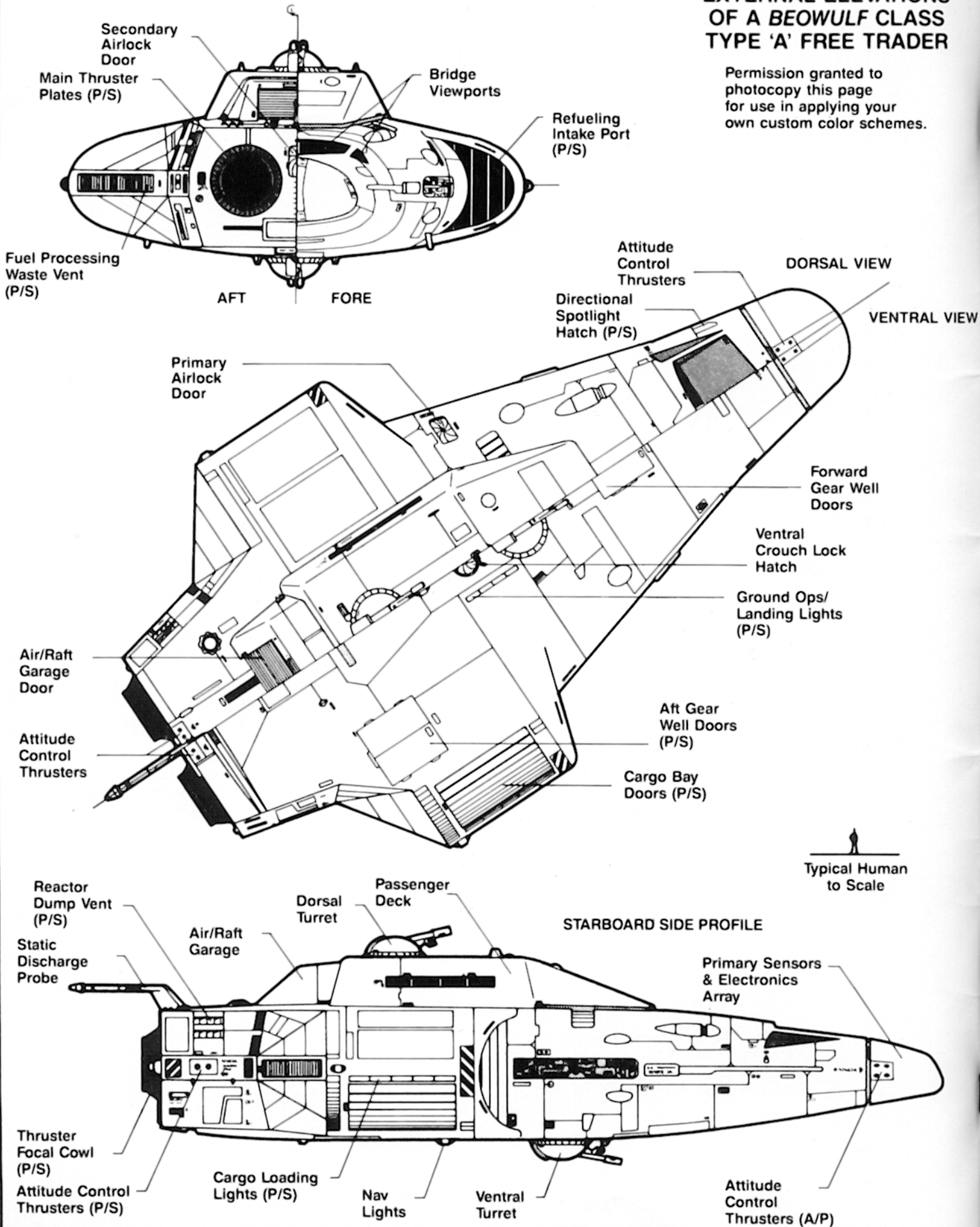

Starship Operators Manual, Volume 1

Second Edition

No single craft embodies the essence of **MegaTraveller** better than the starship. The average **MegaTraveller** adventurer spends at least half of his game life on a starship, travelling from star system to star system. It seems only fitting that a set of volumes be devoted entirely to the starship.

Here is the first volume of a set covering the **MegaTraveller** starship at a new level of detail. The **MegaTraveller** player and referee no longer need argue over the finer points of how a jump drive works, or waste precious game time debating over starship security systems. These topics and many more are described, explained, and illustrated in the *Starship Operator's Manual* series.

The *Starship Operator's Manual, Volume 1* is divided into three basic sections:

- Starship Systems
- The 200-ton Free Trader
- Game Rules for Starship Operation

Each section is described in more detail below.

STARSHIP SYSTEMS

This section gives the reader a run-down of the typical systems found on a **MegaTraveller** starship, written as if taken from an Imperial journal on the topic.

Each system description includes its historical development, its theory of operation, its major system components (complete with a diagram), and miscellaneous topics of interest about the specific starship system.

A highlight of this section is a series of colorful observations by an experienced starship captain called the "old timer".

THE 200-TON FREE TRADER

This section illustrates the layout of the classic **Traveller** vessel, the 200-ton *Beowulf* class Free Trader. Included are a highly detailed and annotated set of plans, as well several illustrations showing many locations around the ship.

Together, the plans and the illustrations form a thorough treatment of a starship typical of the **MegaTraveller** universe. This method of presenting a **MegaTraveller** starship sets a new standard in starship presentation, and greatly aids in visualizing what a futuristic starship is really like.

GAME RULES

No book on starships would be complete without including new rules pertaining to starship operation. If you really get into operating a starship, with these rules, you can actually feel like a crew member on your starship, controlling its every action.

It is our hope that with the help of this book, more time will be spent adventuring and less time consumed in frustrating arguments about how starships work. One of the real joys of producing this series is seeing the result take shape, and discovering for ourselves, once and for all, how **MegaTraveller** starships really work!

INTRODUCING THE "OLD TIMER"

In the course of compiling these books, we realized we could make them much more interesting if we could explain things "hands on", taking readers behind the scenes to see how ideas could be applied. The best way to do this, we thought, would be to find someone with considerable service, both in the military and as a merchant.

The man we found was more than willing to tell us what he knew. "Too often," he says, "some young buck gets a notion to head into space without knowing what he's about. He loses his shirt or his life. If what I have to say can improve the chances that a crew is safer, or a cargo arrives on time, or a merchant turns an honest profit, then I'm glad to help."

Our advisor asked to remain anonymous, perhaps because some of his opinions are, shall we say, counter to current wisdom. Besides, he thought he might mislead people with his personality. "I don't want anyone to listen to me because of some damn-fool medal pinned to my chest. I want people to listen because what I say is right. But it's not up to me — it's what works. If someone wants to try things a different way, and if he finds his way is better, then more power to him. I don't know everything, and I don't claim to."

Another reason for anonymity was to preserve some semblance of privacy. "All I need is to have a crew of kids lookin' to me to decide when and how they should blow their noses. I live my life, and they should live theirs. The best way people learn, anyway, is by making mistakes. I just hope I save someone from death or bankruptcy — you might learn something from such a mistake, sure, but it's hard to apply the lesson."

So what can we tell people, we asked.

"Folks will want to know about me? I doubt it. But you can tell 'em I served with the Navy, up in the Marches, and did a good job of it, too — least as how a few Zhos found that out the hard way. After the wars were over, I put some money down on a trader and started into business. I'm doing okay, making payments on time, and I could buy another ship if I weren't salting money away for my retirement.

"If people want to call me something, they can call me the 'Old Timer' — my crew calls me that, behind my back, and I'll be damned if they don't think that I haven't caught on."

CREDITS

Design and Development: Joe D. Fugate Sr., Gary L. Thomas, William W. Connors, Rob Caswell.

Additional Design: Tom Peters, David McCoy, Karl JM Martin, Mike Mikes, Howard Leidner, Rob Prior, Nancy Parker, Robert Parker, Ed Edwards, Bill Hezeltine.

Artwork: Rob Caswell, Bryan Gibson, Joe D. Fugate Sr., Patty Fugate, Tom Peters, William H. Keith.

Maneuver Drive

The maneuver drive is the starship's "legs" for moving about in normal space (as opposed to jumpspace). The maneuver drive makes it possible for a vessel to travel from one point to another in space.

There are two common types of maneuver drive in the modern spacecraft: gravitic and thruster. At lower tech levels, other forms are found, such as: chemical rockets, ion drives, solar sails, and fusion rockets.

HISTORY

For most races, early forms of space travel employ sub-light chemical rockets. Very slow and bulky, these devices barely allow a culture to expand through its own solar system, let alone to the stars. Of course, there are exceptions. The Zhodani, for instance, made their first trips into space by psionic teleportation.

Following these crude beginnings, a number of other methods of space travel are often developed. For many, the attainment of fusion power allows craft to travel throughout the local star system with great regularity. Others employ solar sails and drift gracefully among their worlds in majestic craft like giant fragile butterflies blown on the stellar winds. Even the Zhodani were quickly forced to abandon psionic travel into space in favor of more conventional means.

Eventually, most races begin using gravitic propulsion for thrust within a star's gravity well. Beyond the strong pull of gravity, however, drives of this type rapidly drop off in efficiency, limiting their ability to propel a ship in the outer reaches of the local star system.

For missions outside of the local star system, many advanced cultures have employed ramjets. Craft of this nature rely on a vast electromagnetic "funnel" to gather the scattered atoms of hydrogen adrift in interstellar space for use as fuel in their fusion drives.

Upon reaching tech level 11, breakthroughs in quantum physics lead to reactionless thruster plates. Faster and more efficient than gravitic propulsion systems, thruster plates represent the most modern form of slower-than-light transportation available to any known race.

THEORY

The gravitic drive relies on interaction with the graviton. The graviton, a massless sub-atomic particle, is the carrier of gravitational force.

The gravitic drive produces a field which, in effect, alters the way incoming gravitons react with the ship. In so doing, the grav-propelled craft is able to use normally attractive gravitons for thrust in any direction. It is worth noting that this basic ability to affect the way in which gravitons interact is fundamental to many other fields of modern physics and engineering.

Thrusters are somewhat more advanced than gravitic propulsion units, but operate in a similar manner. Their development is an outgrowth of the combined effects of both gravitic technologies (as defined above) and nuclear damper technologies (as defined elsewhere in this text). By reacting with both the strong and weak nuclear force,

thrusters are able to produce a reactionless thrust which allows a spaceship to move at high speed even beyond the limits of a strong gravitational field.

Aspects of thruster technology which involve the strong nuclear force deal with the behavior of the gluon (a particle which binds quarks together at the sub-atomic level), and were directly responsible for the evolution of meson technology (which itself is based on quarks).

DESCRIPTION

The chief engineer and his staff are responsible for the correct operation of the maneuver drive. The following text describes the components on the maneuver drive diagram.

Thruster Plates: The most important piece of technology employed by modern maneuver drives is the thruster plate. Although the plates can be located anywhere on the hull and still function, convention calls for them to be located in the aft sections of the ship.

Thruster plates can attain full propulsion only in a single direction, usually due aft, but can be used to provide thrust in any direction. Outside of an arc formed at about 20 degrees from the primary direction of thrust, propulsion drops off fairly quickly. When directed to provide thrust in a perpendicular direction, the plates can generate about 25% of their normal thrust. If directed to provide negative thrust and cause the ship to 'back-up', plate output drops to about 10% of full thrust. Thus, a craft with a 3G maneuver drive can apply a maximum braking force of 0.3G without changing its attitude. Further examples of the use of maneuver drives are cited in the Usage section below.

Thruster Control: Energy from the ship's main power plant is channeled directly into its thruster control unit. Here, it is stored briefly before being directed to power

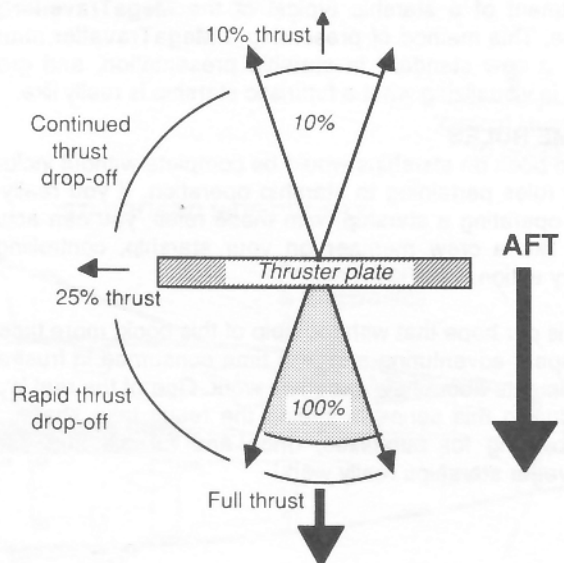

specific portions of the thruster plates and propel the ship. Although the overall instructions for the thruster control unit are provided by the main computer, a local processor links the maneuver drive to the normal space avionics array and provides exacting control of the unit during operation.

Orientation: The orientation subsystem enables the ship to control its direction of flight and orientation attitude.

With the advent of superdense composite materials at higher tech levels, inertial gyroscopic systems for reorientating the ship become practical. Housed at the starship's center of mass, these units are fitted in an assembly kept in near-vacuum and revolve at speeds approaching one million RPM. The tremendous inertial force generated from the device actually allows the starship to "push itself off" the flywheel by means of a surrounding sphere of focused grav modules. Thus, the ship actually rotates about the gyro when changing its orientation.

With such velocities of revolution, it is imperative that these gyros include fail-safe devices. In cases where the gyro flywheel has broken free of its housing (from system failure, battle damage, or whatever), the flywheel can tear through the ship, leaving a devastating wake.

A number of solutions to the fail-safe problem have been implemented, but the cleanest method to date has proven to be simple inertial braking. In this procedure, the outer gyro housing is fitted with its own heavy-duty inertial compensators attached to an integral power source. In order to neutralize the flywheel motion, the compensators are activated to provide braking. This reduces the flywheel's energy to easily manageable levels, but such a procedure requires that the entire gyro assembly be refitted before the system can be restarted.

Some smaller gyro-fitted vessels do away with the inertial braking system to reduce the bulk, and rely solely on jettisoning the entire gyro assembly if a crisis situation arises. Though this is a viable solution, jettisoning the gyro package can itself be dangerous, and, of course, results in the total loss of an expensive gyro system.

All ships (including gyro-equipped vessels) carry auxiliary thrusters, usually a gas-jet attitude control system. On gyro-equipped vessels, the gas-jet system acts as a backup to the gyro system.

The combination of both cost and risk have limited the use of the inertial gyro system on commercial space vessels. Naval architects, however, generally prefer the more exacting orientation control possible with the gyro system.

A craft which has been deprived of its gyroscope is forced to rely on its auxiliary thrusters — and to a limited degree, its main thruster plates — for changing attitude.

RELATED TOPICS

The following text covers some topics related to maneuver drive operation and usage.

Thruster Plate Scale: So far, attempts to scale down thruster plate technology to sizes useful for craft below about 20 tons displacement have proven unsuccessful. The power-to-thrust ratio of such small thruster plates is so poor that straight anti-grav technology is preferable.

Lateral Thrust: Since the output of a drive falls to 25% when it is providing lateral thrust, it would seem that a 4G maneuver drive is required for a starship to hover above

the ground on a planet with a 1G field. In fact, because a starship obtains full thrust directly aft, hovering is often done in a nose-up attitude.

Remember that a vessel with both an internal gravity field in the floor and with inertial compensators can continue to keep its internal onboard "down" directly toward the floor. Passengers on a ship maintaining this nose-up attitude will not be aware of their unusual orientation unless they look outside. By gradually shifting the direction of thrust, a hovering starship can slowly "fall" forward and settle into a horizontal (that is, lateral) landing position.

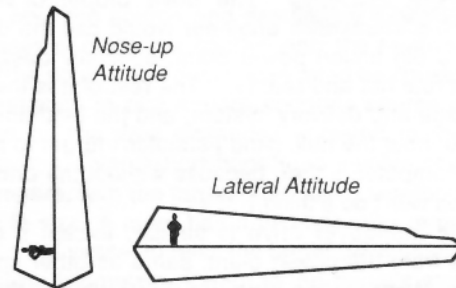

Vessels without inertial compensators must have all onboard crew and passengers securely strapped in order to perform such a nose-up hovering maneuver. Alternatively, the ship's architect can deliberately design a vessel without inertial compensators so that it lands and takes off in an up-ended position. In this case, the floors will be parallel to the aft of the craft, rather than to its belly.

Pushing the Drive Limits: If called upon to do so, a vessel can force the maneuver drive beyond its normal operating limits for a period of time, but this must be undertaken with care. Using overdrive is the most common way for a ship with a maneuver drive less than 4G to hover in a lateral attitude, rather than in a nose up position.

The more pronounced the overdrive, the closer the engineer must monitor the drive status. The plates may be overdriven by up to 40% for extended periods of time (days) with few harmful effects if the overage is done skillfully.

On the other hand, overdriving the plates by up to 400% (as in the case of a 1G ship trying to do a lateral hover at takeoff or landing) takes the upmost care, and can only be done for brief periods of time (under 5 minutes). While overdriving the plates at such extreme levels, the engineer must pay very close attention to the drives to make sure no overloads develop or warning lights appear.

Observing an Operating Maneuver Drive: When a maneuver drive is in operation, it builds up a slight ionization field around the thruster plates. This phenomenon, which is not unlike St. Elmo's Fire, causes the plates to acquire a faint aura of blue light while producing thrust.

The intensity of the ionization is greater when the drive is operating at higher levels. Thus, a drive providing full thrust (or in overdrive) glows more brightly than one which is at half thrust. It is possible to estimate the maximum acceleration of a craft based on its current acceleration and the brightness of its thruster ionization.

Attempts to reduce the ionization effect have always resulted in a loss of thrust, so that it is now accepted as an inescapable side-effect of the maneuver drive's operation.

MANEUVER DRIVE



Sometimes people get confused by the way starship hands talk, and "drive" is one of those words that always throws 'em. Passengers on a tour want to see the "jump drive", but they don't realize the jump drive is a collection of components stretching from one end of the ship to the other.

The "drive" proper, or what the engineer would call the drive, is just a big fusion power plant, specially designed to burn real hot and real fast. The rest of it is the power storage and delivery system, and the lanthanum grid throughout the hull. (And I shouldn't forget to mention the computer, either, because without the brains, the brawn won't do a thing.)

The maneuver drive is similar, except it gets its juice from the power plant, same as other ship systems. What makes it go are the thrusters, these big plates mounted on the stern of the ship. You could ask some physicist if you wanted the straight skinny; all I know is that there are particles that push against these things and actually move the ship.

There's no reason the thruster plates have to be hooked onto the stern; they could go up front or inside, for that matter. Whatever makes this work builds up a lot of light and heat though, so it's a lot easier to sink them from outside.

I heard of a green Naval architect who figured that mounting the thrusters up front would be better. I don't know how many megacredits the brass spent on this idea, until someone ran a holo simulation of what one of these beasts would look like.

Here's the vessel, sneaking up on some blockade runner, except that the thrusters are lit up like a supernova. Passive EMS would've picked it up in a second. It was a dumb idea — the only time I'd want the extra oomph was when I was running, anyhow.

Speaking of oomph, the only person that can supply it is your engineer. Sure, your drive has a rating stenciled on the side, but if you need 110 percent, then you'll be glad you paid extra to get an engineer who could make the drive whistle.

Thrusters aren't a vessel's only options, of course. Old model ships sometimes use chemical thrusters, but they're harder and harder to find nowadays away from low-tech worlds. Chemicals are more expensive to run, less reliable, and just plain dirtier — most places have too many regulations to make it easy to use chemicals. Some restrict chemical thrusters to orbital stations only.

I've even seen solar sails used, but never on a long-term commercial basis. When I was in the Navy, I heard of a ship that lost both its m-drive and j-drive, and the chief engineer managed to fashion an emergency solar sail to limp the ship back to where it could be repaired. I don't know, though, if it ever really happened.

MANEUVER DRIVE

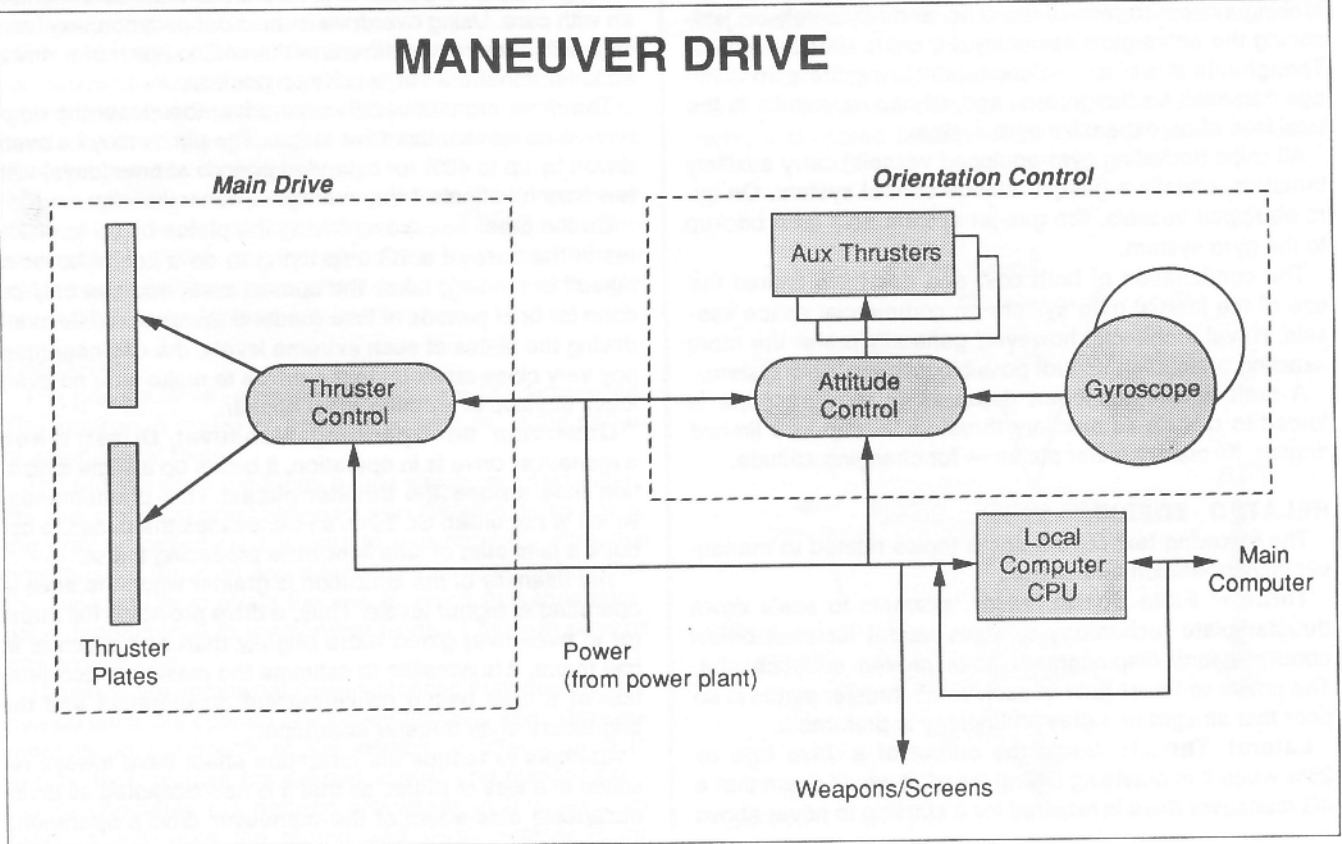

Flight Controls

The flight controls are the navigation "nerve center" of the space vessel. These controls point the craft in the right direction so it can get where it's going.

Two types of controls exist for controlling space flight: those for normal space and those for jumpspace.

HISTORY

The need to plot an accurate course for a journey first comes on the scene when a culture begins to travel its world's oceans. With the destination port out of sight, and no distinguishing landmarks available along the way from which to judge direction, most cultures turn to the stars for navigation. Navigation for space travel is a logical extension of such early marine navigation.

Early navigation relies heavily on mechanical devices (such as the sextant, telescope, paper charts, ruler, and dividers) for plotting courses and measuring progress.

By tech level 6, the basic mechanical controls are enhanced (by such things as mechanical plotters, navigation calculators using an array of gears, and so on). The controls become more specialized in order to aid plotting and measurement tasks. As electronics appear, electronic versions of the same mechanical controls are built.

The electronic computer is the single most significant advancement for aiding the navigator in his duties. Complex course computations become more reliable and can be done much quicker. At first, the electronic controls are simply linked to a computer for limited assistance. By tech level 9, the computer technology spreads to the electronic controls themselves. Thus all controls have some inherent intelligence of their own, as well as being linked to the main computer or computers.

With such computer linked controls, in a sense all controls are part of the computer's "control panel". As craft complexity increases, this control interface becomes a bottleneck for the operator. The advent of dynamic linked controls allows the operator to reconfigure (and store for later instant recall) his preferred control panel layout, which greatly simplifies his task of controlling the vessel. Holodynamic controls, a further extension of dynamic controls, allow the operator to configure the controls as if they were actual three-dimensional objects.

As computer-linked control technology progresses, the computer can correlate massive amounts of data and solve complex navigational problems very quickly. The computer becomes an increasingly useful assistant to the operator — freeing him to make the high level strategic decisions, and letting the computer figure out the low level tactics necessary to carry out the operator's desires.

THEORY

The navigational problem of going the right direction starts with a basic question: "where am I now?" Once that question can be reliably answered, then the solution to: "what direction is it to my destination?" becomes almost trivial. Thus the challenge of navigation has always been to answer "where am I?" more accurately. As craft velocities

increase, a *quick* answer to "where am I?" becomes vital.

Plotting a course between celestial bodies is considerably more difficult than plotting a course between two surface seaports. World-based marine navigation is two-dimensional, while celestial navigation involves three dimensions. Unlike world surface seaports, in space the destination port is changing position relative to the source port. Actually, *both* the source and destination are moving, but for purposes of plotting a course, only the relative change between the source and destination need be considered.

The challenge to plot a more accurate course is further magnified by the vast distances involved in the typical space voyage. Even "short hops" can involve several million kilometers, with the target often just a few thousand kilometers in size. A mere half a percent error in navigation can cause the vessel to miss the target destination by up to half a million kilometers. Factor in the target's motion, and an error of many millions of kilometers can easily occur.

Jumpspace navigation is even more more difficult. It is not intuitively obvious how to control a jump so that the vessel reaches the selected destination star system. Because of this problem, jump navigation errors tend to be more prevalent at lower tech levels.

Several types of journeys exist in modern space flight navigation:

Normal space: In normal space flight, a major consideration is the effects of gravity. The navigator who plots a course without giving due consideration to the gravitational pull of nearby celestial bodies may produce a course which cancels out much of the thrust Gs from the maneuver drive.

The thing every navigator wants to avoid is losing too much drive thrust to counteracting an outside body's slowing gravitational pull. Theoretically, the maneuver drive's job is to provide pure acceleration aimed at overcoming the craft's own inertia. This is true only in a gravity-free environment, however.

Since the in-system navigation environment is far from gravity free, a good navigator aims for the next best thing: keep the gravitational effects on the ship more or less constant. In other words, don't fly into a gravity well (within 100 diameters of a massive body) if you can avoid it.

In-system trips can be classified into certain categories based on navigation considerations. The trips listed below can have either endpoint as the source or the destination:

Travelling between a world's surface and orbit: This involves going through a world's atmosphere (if any) and selecting the desired orbit (most worlds define a variety of orbit levels, from low to high). Plotting this type of course can be tricky because traffic density tends to be heaviest close to a world. Careful, attentive navigation and piloting is a must this close in.

Often, higher tech worlds have tight beam EMS flight vectors for starship use. The starship just locks onto the beam, and follows it in (or out).

Travelling between world orbit and jump point: This is actually one of the simplest navigation problems, because

unlike most other space navigation situations, the destination jump point is *fixed* relative to the world.

Travelling between world orbit and one of the world's orbiting satellites: This navigation problem is similar to travelling to jump point, except now one end point (the satellite) is moving, relative to the primary.

Travelling between two planets or two satellites orbiting about a primary: This is the most difficult type of in-system navigation, because it typically involves the greatest distances and the greatest differences in relative motion. Also, intervening celestial bodies tend to complicate the flight path such that the proverbial "straight shot" just isn't available.

Jumpspace: Jumpspace flight must also consider gravity, but for different reasons. The likelihood of a misjump increases greatly within 100 diameters of a massive body, and is virtually guaranteed within 10 diameters. So a key goal in jumpspace navigation is: get outside of the gravity well, which for all practical purposes begins at the 100-diameter boundary.

Only two basic jumpspace navigation problems exist:

System to System Jumps: This is the basic type of travel that makes going between the stars both possible and prac-

tical. The desired goal here is an accurate and safe *jump vector*. Such a good jump vector is the result of some extremely complex calculations — so complex in fact, that it takes an ultra-high speed, parallel processing starship computer several minutes to solve the problem. (By way of comparison, the calculations are so complex that it would take a tech level 5 single threading computer decades to compute the answer.)

Some of the critical input variables include exact jump position relative to the origin world, exact jump exit position relative to the destination world, the relative motion between the two systems, the ship's current heading and speed, and the exact instant at which the jump is to take place.

From this data, the computer derives the energizing sequence for the hull jump net. This sequence puts the ship into jumpspace on the proper vector to get the ship to the desired destination. The timing of the hull net sequence must be accurate to within nanoseconds, or a misjump is likely. Obviously, a computer is required to get such accurate timing.

A property inherent in the jump vector computations is that they become significantly harder to solve for long distances, thus taking longer to compute and becoming more

FLIGHT CONTROLS



Where your ship goes, you go. If the pilot swings the vessel into an asteroid belt and butts it up against some rock, that's where they'll find you later. There are simulators that'll start someone off, but the only way to learn to fly is to punch the board.

But how to learn safely, that's the life-and-death question. Sure there's a way. He's called the copilot. More about that later.

Right now I think I'll let you in on a little secret. I've got the best pilots of any ship in the Marches. For that matter, I've got the best damned bridge crew of any ship in the Marches. It's not too hard to spot real ability if you know how.

When I've got an opening, I put out the word at places where I know spacers hang out, then I wait for somebody to show up. If he's worked on a sub, he never gets aboard. That's the first trick. (Forgive an old man a few prejudices — but I'm set in my ways.)

The next thing is to bring the candidate onto the bridge, set him down in the chair, and ask him to demonstrate what he knows against a simulation. Then keep your eyes open. The computer will score him, sure, and you can doublecheck that number later, but watch him right now and you'll know whether you want him or not.

Does he reconfigure the board? If he doesn't, show him the hatch. That's my secret. A man who knows his business chooses his tools carefully. They've got these wading birds on Kinorb. You walk in among a flock of them, and you might never get loose. Walk

left, the flock walks left. Walk right, the flock walks right. Speed up, and they all hurry along beside you. Stop, and the whole flock waits.

That's not what I want in a crewman. I want somebody who makes up his own mind and does what he thinks best, in the way that he thinks best. If a man doesn't have the confidence to reconfigure a board on your ship so that he can do it his way, he's not the best you can get.

As an added test (once he's passed this one), pick another config at random and set the panel up that way. Run the simulation again, and see how much his performance drops off. An experienced hand won't suffer more than, say, 25%, and that should decrease over the course of the test. "Judge a workman by his tools," they say, and that's the first hurdle, but I say a good man can use whatever he's got to his best advantage.

Whoever invented dynamic configs deserves a medal — I'd give him all of mine. Imagine the chaos we'd have without them. A kid joins the Navy on Vland, learns the ropes, and then musters out and joins a merchant company operating out of the Marches.

So what happens? The merchant vessel he's on was built by a company light-years away from the yard that fabbed the dreadnought. All the controls are different: the power switch that was under the thumb of his left hand is now under the third finger of his right. The heads-up attitude display is now flat on the board, and the blue light that signaled a problem is an amber one on the merchant. If he doesn't scuttle her first time out of the dock, you're lucky.

With a dynamic config, he keys in the layout he likes, and if he wants to further customize the panel, he moves the controls around and logs it in the

subject to error. Also, the hull net energizing sequence for longer jumps involve rapid, pulsating energy shifts that tax the ability of a jump governor to perform them. Therefore, an long jumps are slightly riskier than shorter jumps.

In-system Microjumps: If the distance to be travelled in normal space is great enough, it is possible that a *jump* within the same system will be faster than travelling the same distance with maneuver drive. Such an in-system jump is subject to many of the problems of normal space in-system navigation, although a trip using jump does not traverse the intervening distance in normal space, of course.

Since microjumps are so short, the vector calculations for microjumps are significantly easier to solve than even the vector calculations for a one parsec jump. In addition, the hull net energizing sequence very straightforward. For these reasons, many of the earliest uses of jump technology are for long distance in-system travel.

DESCRIPTION

The navigator and pilot are responsible for the correct operation of the flight controls. The following text describes the components shown on the flight control diagram.

Normal Space Group: The normal space flight control

group provides the means for controlling the ship's flight in normal space (as opposed to jumpspace). These controls are typically operated by the pilot, with supplemental input from the navigator.

Normal Space Flight Controls: This panel controls the normal space navigation computer (that is, the local CPU). Flight related information about the ship's main drive, orientation controls, power plant, sensors, and communications is available via links between these systems and the navigation computer.

Among other things, this panel allows the operator to display a tactical plot of the ship's past, present, and future course, and to see the position of the ship relative to other ships and celestial bodies in the system. The operator can try alternate course plots — the navigation computer will query the local CPU's of the other systems (main drive, avionics, and so on) to determine if the ship is capable of achieving the desired course plot. On high-tech vessels with holographic heads-up display capabilities or with a large holodisplay, this plot is a full three-dimensional image.

Normal Space Nav Computer (Local CPU): The main drive link provides the means for the navigation computer to query the main drive to learn of its status and potential

computer so he can call it up any time he wants.

There are moments on the bridge, too many moments, that call for split-second thinking. You set that panel up to your liking — you live with that panel — you *marry* that panel — and it will always be right there when you need it. Your fingers (and feet, if you use them, but I never do) learn every inch of the board, and you can fly a ship in your sleep. A skilled crewman never looks at the controls — his eyes are on the telltales and other displays.

If a man's skilled with the configs, too, he can handle any board in a crisis. Commo needs help setting up a line-of-sight during a battle? Fine, if nav's not tied up it takes him a second to pull up commo's board at his station. That's why it's so critical that your bridge crew be skilled at several tasks.

Personally, when I configure a panel I always ignore the leg controls. I don't stop my crew from using them, because a man knows what he likes or he doesn't know anything. But I was never much of a dancer, either, and I feel like my legs just flail around under the console.

I keep the most common controls under my index fingers, but I won't overlap. If there's two things I need to do at once, they've got to lie under different fingers. I'm left handed, so I put anything I need quick under those fingers. I use my thumbs as anchors, mostly. If controls need locked, sure, I'll put in a toggle where I want it, but if the control needs a sensitive touch but still must be held down, I put it under a thumb so the rest of my hand can still swivel around to all the positions.

Another good place for anchors is the little fingers. Little fingers are good, too, to set up alternative controls. For example, on my commo board I like my left index to handle fine tuning of radio frequency, but

once I've zeroed in on what I want, that spot's wasted. So when I'm ready to transmit the burst, my right pinkie holds what I call my "second set". Then the burst pad is under my left index where fine tuning normally is. Once the burst is through, I let up my pinkie and I can reset the frequency if I want to.

I keep any displays I want in front of me, using heads-up holo. If the station can't handle a holo, I'll use a data-display/recorder headpiece, but I don't like to because I get tired faster.

The main displays are right in front all the time. I map telltales to the center in a contrasting color — for the important ones, I use a mixture of red and green, chosen so they clash with each other. I don't like 'em to blink, because I want to look at them and catch the info at any time. The split second between blinks might be the split second I need to make the decision. Choose your own colors; your eyes are different from mine.

I use my right third finger to move the telltale once I've spotted it, and I never use this finger for any other purpose on any board. The warning light appears, in the center as I said, then once I've noted it I punch the board and the light moves off to one side. They're all set so that if the condition lasts over a certain time, the telltale will reappear, and I'll just punch it over to the side again if I'm handling it. I want to know, but once it's in my brain I don't need to keep staring at the light all the time.

If you're not human, of course, little of this applies to you, and I apologize for wasting your time. But you'll be thankful for the dynamic configs. Can you imagine a K'krøe trying to drive a human board, or a Vargr pushing a Hiver panel?•

ability to provide the needed thrust.

The orientation control link registers the ship's current orientation attitude and gives feedback as to the ability to maneuver to a new heading. This link, coupled with the navigation computer, also gives the operator pitch, yaw, and roll statistics about flight maneuvers currently in progress.

The power plant link gives the power plant's status and its ability to meet the demands of the main drive and orientation control. Typically, this involves little more than monitoring the power plant's status, since the main drives and orientation control are also linked to the navigation computer. However, under certain circumstances, it is possible for the operator to "overdrive" the main thruster plates with extra power from the power plant and supplement the ship's basic orientation agility (see orientation control). This technique is somewhat risky and if continued for an extended period could damage the main drive, so it is only recommended when emergency agility is absolutely required.

The communications/sensors link is an especially important one. Most Imperial star systems have several reference beacons that establish for the navigation computer the alignment of coordinates in common use for that system — vital information for "getting your bearings" upon first entering any system. Without this frame of reference, plotting a course in a strange system becomes immensely more difficult and can take hours or even days.

Jumpspace Group: The jumpspace flight control group allows controlling the ship's entry into and out of jumpspace (as opposed to normal space). These controls are typically operated by the navigator, with supplemental input from the pilot.

Jumpspace Flight Controls: This panel controls the jumpspace navigation computer or local CPU. Status information about the ship's jump drive is available via a link between the jump drive and the navigation computer. A sensor link also provides the navigation computer with current stellar information.

This panel allows the operator to display a plot of the ship's present heading and orientation in the current star system, and to see the potential new heading in any other star system within jump range. The plot can also show gravity well limits in either the source or destination system (both the 10-diameter and 100-diameter limit), and can suggest recommended jump points in both the source and destination system.

Once the desired destination system and destination jump point have been selected, the navigation computer can begin computing the hull net energizing sequence necessary to put the ship on the proper "jump vector" for the destination. These computations are extremely complex, and take a minimum of several minutes to resolve. Without the proper jump vector from the navigation computer, a misjump is virtually guaranteed.

Jumpspace Nav Computer (Local CPU): The jump drive link allows the navigation computer to query the jump drive to learn of its status and ability to initiate a jump.

The sensor link gives valuable long-range sensor information to the navigation computer about the destination system. This information, coupled with prerecorded "star chart" data, allows the jump navigation computer to provide the

operator with informative and up-to-date visual plot displays. However, the farther the jump, the less reliable the sensor input becomes, and the more the navigation computer must rely on prerecorded data.

The navigation computer also provides the jump governor with the vital hull net energizing sequence (see jump drive) from the results of its jump vector computations.

RELATED TOPICS

The following text covers some topics related to flight control operation and usage.

Engineers' Contribution to Flight: Good engineers can often get a little extra acceleration from a starship's maneuver drive. Couple that with a good course plot by the navigator and good execution by the pilot, and several hours can be shaved off long in-system space voyages.

Jump Vectors: When computing a jump vector, the ship's *exact* jump entry time (within *seconds*) is a critical input variable to the jump vector calculations. The more accurate the prediction of the exact instant of jump exit is, the safer and more reliable the jump.

Another critical input variable is the ship's exact location relative to the origin world, and hence the ship's orientation to the nearby world's gravity well. Again, the more accurate the value, the more reliable the jump becomes.

The effect of the time and location jump variables is this: the ship must be at the predicted location when it says it will be, or the navigation computer's pre-computed jump vector will be unreliable. The common way most ships avoid this problem is to put off performing the jump vector calculations as long as possible. Beginning the calculations just as the vessel approaches the jump point is considered ideal.

In most instances, an unreliable jump vector causes little more than a minor error in the location at which the ship will exit jumpspace. This is not a problem unless the erroneous exit puts the ship on an unavoidable collision course with a celestial body or busy traffic lane in the destination system. In extreme cases, a vector error can put the ship's jump exit point within a gravity well in the destination system, thereby causing the ship to violently exit jumpspace on the edge of the gravity well.

Violent Jump Exits: A violent jump exit can cause any number of problems, from minor to catastrophic. Generally a violent jump exit does little more than causing superficial hull stress damage, which is easily repaired. In more extreme cases, a violent jump exit can cause crew members to go insane or complete ship systems to short out.

FLIGHT CONTROL

Normal Space Navigation

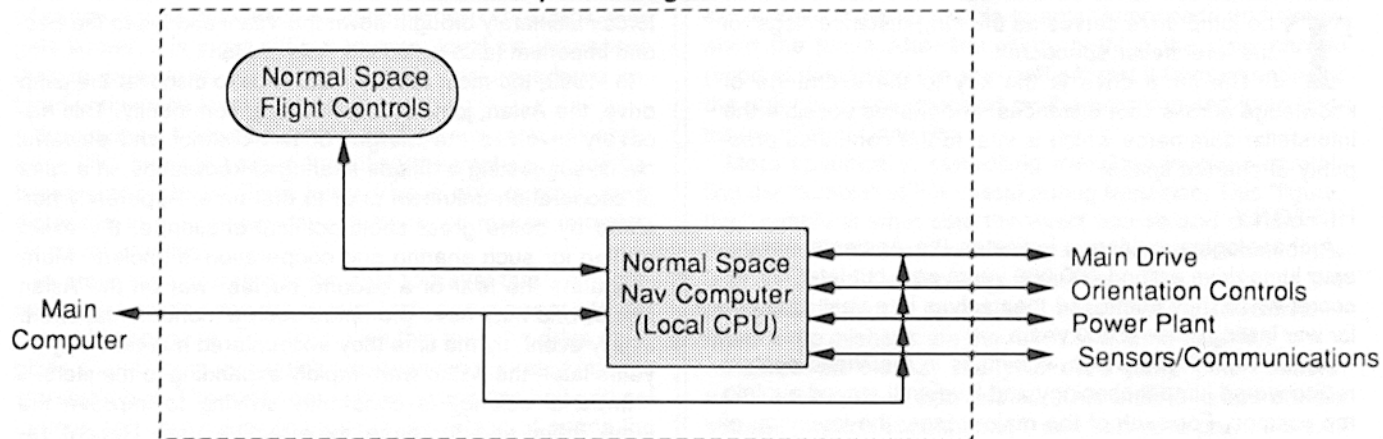

Jump Space Navigation

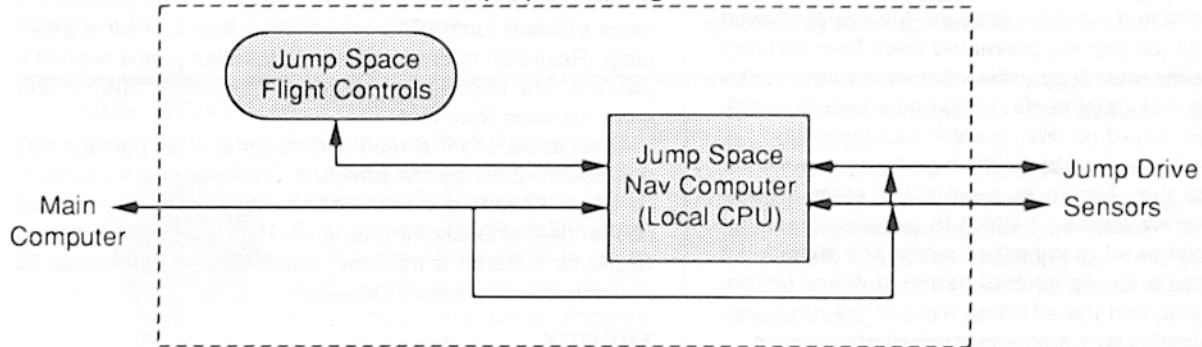

JUMP DRIVE

Zuchai Crystal Energy Sink Array

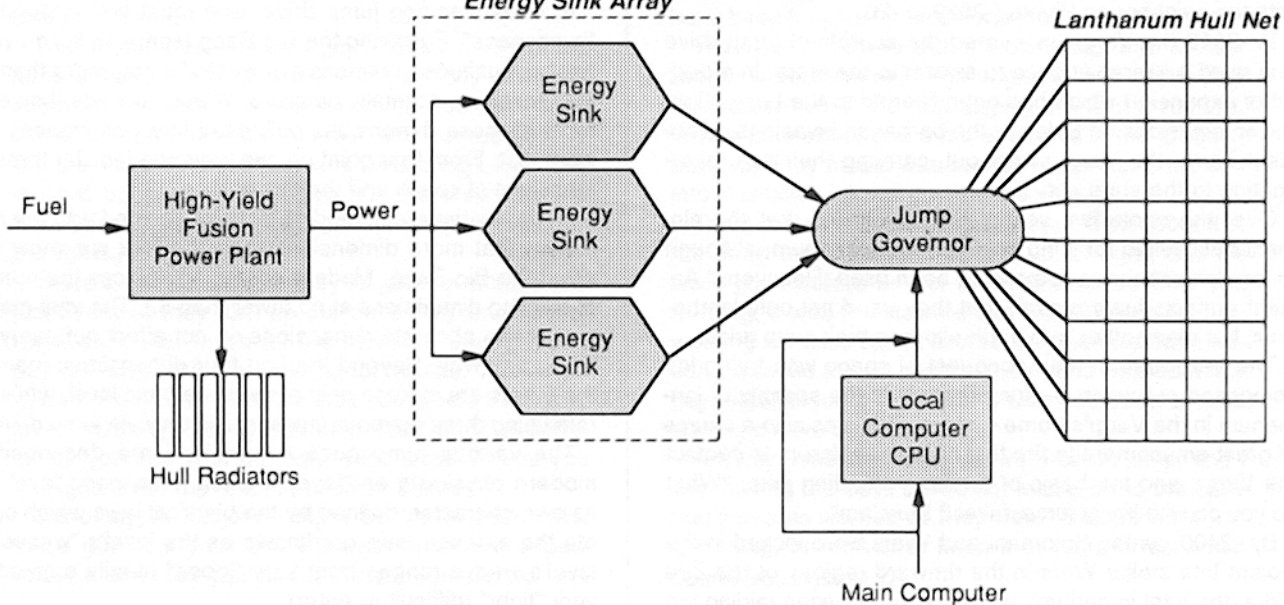

The jump drive serves as the long-distance "legs" of the interstellar spacecraft.

The jump drive is the key to the exchange of knowledge across vast distances, and makes possible the interstellar commerce which is vital to the continued prosperity of charted space.

HISTORY

Archaeological evidence indicates the Ancients discovered jump drive around 400,000 years ago, but later lost its secret when they destroyed themselves in a vast interstellar war lasting some 2,000 years.

About 10,000 years ago, scientists in the Vland system rediscovered jump technology and Humaniti moved out into the cosmos. For each of the major races, the invention of jump drive has meant the dawn of a new era in their history.

By the time the Zhodani invented jump-1 drive in -5415, the Vilani had attained jump-2. However, the slightly flawed Vilani theories of jumpspace prevented them from building further upon their technology. When they encountered the newly starfaring Solomani some 3,000 years later in -2422, the Vilani still employed no drive greater than jump-2.

In -4698 the Hivers developed their earliest jump drives. Almost at once they began to explore the stars around them and seek new worlds on which to establish colonies. Unlike the societies of many other races, the expanding Hiver culture had a strong internal harmony. Many factors contributed to this, and the effect on most of the newly established Hive worlds was a general spirit of cooperation.

Less than a century after the Hiver discovery of jump drive, the nearby K'kree likewise discovered jumpspace travel. Although a fanatically conservative culture, the K'kree gradually started to explore the stars about them. Their first contacts with alien races sparked a violent xenophobic reaction within their society and culminated in a war with the neighboring Hivers (-2029 to -2013).

In -3810 the Vargr uncovered the secrets of jump drive and used it almost at once to swarm to the stars. In a period of expansion which has been likened to the Long Night raider incursions on Sylea or the barbarian invasions on ancient Terra, the Vargr swept out, carrying their natural in-fighting to the stars.

Over the centuries, scientists have found that the element best suited for jump field grids is lanthanum, although other elements have sometimes been used. Recovered Ancient artifacts have proven that they used not only lanthanum, but many other rare earth alloys in their jump grids.

The Vargr began their conquest of space with hull grids composed of barium — due primarily to the scarcity of lanthanum in the Vargr's home system. This was also a source of great amusement to the first human explorers to contact the Vargr, and the basis of the long-standing joke: "What do you do with Vargr jump drives? Bury 'em".

By -2400, as the Solomani and Vilani were locked in the violent Interstellar Wars in the rimward regions of the Ziru Sirka (the First Imperium), while the Vargr began raiding the coreward systems. The combined disruption of both these

forces ultimately brought down the Vilani and led to the Second Imperium (also called the Rule of Man).

In -1999, the most recent major race to discover the jump drive, the Aslan, joined the interstellar community. This discovery involved the merger of two distinct and powerful clans, suggesting a unique sharing of knowledge, in a spirit of cooperation unknown prior to that time. Apparently heralded by some great socio-political challenge, the exact reason for such sharing and cooperation is unclear. Many speculate the fear of a second nuclear war on the Aslan homeworld may have prompted such a monumental effort. In any event, by the time they encountered humaniti only 19 years later, the Aslan were rapidly expanding to the stars.

Imperial science is constantly striving to improve the jump drive and increase its effectiveness. Recent researches (primarily conducted by the Jumpspace Institute of Deneb) have hinted at the potential development of a more efficient jump drive which uses less fuel for a given jump. Research to date indicates controlled jumps beyond 6 parsecs are impossible, although misjumps often cover more distance than that.

As an aside, the first recorded misjump of 36 parsecs was attained in -2381 by the privateer *Starfarer* in the Interstellar Wars. Following a fierce encounter with a Vilani armed courier fleet at Boskone (Solomani Rim 1214), the escaping *Starfarer* suffered a misjump which carried her across 36 parsecs into Aldebaran Subsector.

THEORY

The operation of jump drive is quite complex, and varying theories exist as to why it works. Even the greatest scientists of the Imperium admit they do not fully understand the principles behind the workings of jump drive. The following description, based in large part on the works of the Jumpspace Institute at Deneb, is greatly simplified.

In understanding jump drive, one must first understand "jumpspace". Following the Big Bang (some 15 billion years ago) a multitude of dimensions existed — far more than the four which we normally perceive. Within seconds, however, most of these dimensions collapsed into nothingness and were lost. From that point on, we have the familiar three dimensions of space and the one of time.

However, the era of modern physics dawned with the realization that more dimensions than the four we know survived the Big Bang. Modern cosmology places the number of existing dimensions at no fewer than 62. The vast majority of these alternate dimensions do not affect our everyday life in any way. Beyond the first four dimensions, many of the others are in force only at the subatomic level, while the remaining three dozen are accessible only via jump drive.

The various jumpspace dimensions are described by modern physicists as "levels". Each jumpspace level has its own character, defined by the physical laws which operate there: these laws are known as the level's "weave". A level's weave ranges from very "loose" (easily entered) to very "tight" (difficult to enter).

Currently, there are six jumpspace levels which the major

paces routinely make use of. Each jumpspace level is associated with an approximate distance traveled in parsecs, and is normally identified by a number.

A ship making a three-parsec jump, for example, is travelling through "level three jumpspace" or more simply "jump-3" space. Since the weave of each higher jumpspace level gets tighter, it is more difficult to enter level six jumpspace than to enter level one. To date, only misjumps have entered jumpspace level seven or higher.

Jumpspace becomes useful to four-dimensional creatures (like humaniti) when travelling the vast distances between star systems. Since jump drive is able to cover such distances in only seven days, jumpspace makes interstellar travel practical.

In order for a starship to be able to travel through jumpspace, the ship's jump drive must first open a portal into the desired jumpspace. To accomplish this feat, the drive energizes a lanthanum grid which has been incorporated into the starship's hull. The vast energy flow across this hull grid net causes an "unraveling" to begin in the region of space the ship occupies. As the discharge of the drive energies to the hull grid increases, the unraveling becomes great enough to open up a "rift" in the weave of jumpspace.

Once this rift has been made, the starship is able to make the "transition" from normal space into jumpspace. Transition is almost instantaneous and must be carefully controlled, for the entire fate of the voyage is determined at the critical transition instant. Accidents that occur before transition make the ship unable to enter jumpspace and simply abort the jump. After transition, nothing the crew can do (short of destroying the ship) will prevent it from emerging at the point in space specified by the precomputed jump vector (see Flight Controls).

More specifically, controlling transition involves controlling the "tumble" of the vessel during transition. This "figurative" tumble is what sets the exact course and duration of the jump. Tumble is controlled by careful manipulation of the lanthanum grid energizing sequence. This instant is the most critical in the entire split-second jump transition — many jump mishaps are the result of a faulty tumble.

As the rift closes, the protective jump field "bubble" around the ship is also sealed. This bubble keeps out the strange physics of jumpspace, and serves to provide a safe region for the ship, where the normal physics of our universe operate. The bubble follows the contour of the jump grid exactly, and appears as a dull, gray, undulating "wall"

JUMP DRIVE



I always dim the lights before the navigator starts the final jump sequence. We don't have to do it, of course, but there's a long tradition by Vilani pilots to do it. In the early days (about 10,000 years ago), the jump systems weren't what they are today, and a lot of captains found out that they needed every watt of power to make a safe jump. So they cut

most of the lights on the vessel just to make sure.

I don't mind admitting that I'm superstitious, and I was trained by Vilani pilots: laugh if you want to, but I always dim 'em.

That doesn't mean that I go overboard. My ship's jump drive doesn't have a set of gold coins underneath its floor bolts, the way a Droyne would do, and I don't beat the first crew member who comes aboard, like the Vargr. Superstition isn't what brings luck: skill is what brings luck. If you've got the crew and the ship, you've got all the luck you need. (But I still dim the lights.)

There's a few captains, they've got the attitude that just because they turn up the drive only once every two weeks that that's all the attention they have to pay it. Those jokers are asking for trouble. You've got to treat your jump drive the way you would treat your lover: nothing's too good for it. You think that because you see your girl only twice a month that you can ignore her the rest of the time? Just try it.

Seriously, a misjump might be better than what you'd get from your girl. I learned this from experience. I won't tell you about the womenfolk, but I've

been in two misjumps, and I'm not looking forward to the next one.

Once, in the Fourth Frontier War, we came out of jump and the rest of the fleet was missing. We figured something was wrong because about half the crew had spent the week coughing up their guts in the freshers. (You don't need to know whether I was among them.)

Anyway, the navigator spotted right off where we were, and after checking systems over for two days, we headed back for the rendezvous point. You should have seen the look on those Zhos' faces when we showed up. They thought we were part of a second armada held in reserve, and it wasn't 10 minutes that their whole fleet had jumped out. Our captain would have been knighted if he'd done it on purpose.

The other time was with my own ship, and we lost two crew because of it. The engineer was on the final countdown when the grid display showed a rupture. Tore a hole about half a meter across in the aft bulkhead, and my medic was sucked out of her bunk and into that black inkwell outside the ship.

There wasn't a damn thing that I could do about it at the time: the jump field closed up all right, and we were gone before any of us even realized Doc was missing. It was the steward that went looking for her, wearing his vacc suit of course, but the field deformation extended too far into the room, and he died a few days later of jump sickness. If Doc had been around we might have saved him.

Anyway, nine days later we were still in jump, and I was having the devil's time not letting on to the crew that I was as worried as they were. Discipline's a fragile thing, and I had to keep it or none of us would

Continued on page 12

about a meter from the surface of the ship's hull.

After about 150-185 hours, the ship finally emerges from jumpspace back into our own universe. Regardless of the distance travelled, the average duration of a jump is about 168 hours, plus or minus 10%. This normal deviation is caused primarily by minor errors in the jump vector. In extreme cases, this error can be far greater and has proven fatal to more than one group of travellers.

DESCRIPTION

The chief engineer and his staff are responsible for the correct operation of the jump drive. The following text describes the components shown on the jump drive diagram.

High-Yield Fusion Power Plant: Entering jumpspace requires large amounts of energy. A special high-yield fusion power plant incorporated within the jump drive itself provides this energy. The jump drive power plant consumes copious quantities of fuel very quickly in order to charge the energy sinks (typically zuchai crystals) with high-grade energy in preparation for the jump transition.

Energy Sink Array: The energy produced by the jump drive's power plant is stored in an array of high-energy sinks (also sometimes called "jump capacitors"). Most ships

found within the Imperium use a network of zuchai crystals as the energy sink array.

No other known sink construct can retain such high levels of energy without decomposing as can zuchai crystals. However, the crystals will begin to decompose and break-down after two or three hours if not discharged. In extreme cases, the crystals can explosively decompose and do significant damage to the ship.

Zuchai crystals are also exceptionally efficient at storing a near perfect "impression" of the energy as generated, which has both an advantage and a disadvantage. The advantage is very little stored energy is lost from leakage. The disadvantage is the power input charging the crystals must be consistent: any fluctuations in the input are mirrored in the output when the crystals are drained. Thus both the quantity and the quality of the charge are important.

Once fully charged, two surges of energy are released to the hull grid. The first (the smaller) "warms up" the jump grid by establishing a base charge in the hull net, and the second (the larger) tears open jumpspace, establishes the tumble, and sets up the protective jump field around the ship.

Hull Radiators: An unavoidable by-product of the sudden conversion of so much fuel to energy is waste

Continued from page 11

make it. You've heard of people who are "jump crazy"? It's the fear of it that gets 'em — they have to be pumped up with tranquilizers to take a star trip. Imagine having a whole crew like that.

The navigator acted busy the whole time, bless his soul, and the rest of the crew thought he knew what he was doing, but it was all just a show. There wasn't a digit he or his computer could gnaw on to tell us anything about where we were or where we were headed.

Two days later, we came out. I flagged an "all systems", and the crew got to work. If the navigator hadn't been sound asleep, he could have told us where we were in 20 seconds, but comms might have beat him to it. With our transponder blaring out, he picked up an auto-signal welcoming us to "Jewell, capital of the subsector". Trouble was, we weren't headed for Jewell. We'd come out 11 parsecs from where we'd gone in.

We pulled into orbital and went over the systems with a fine-toothed comb. One of the Zuchai crystals had a hairline fracture in it. Couldn't see it without a 'scope, but I lost two good friends and two months' profit because of it.

One thing about jumping that I always enjoy is the sheer beauty of it — not inside the ship, of course — all you can see from there is so much gray. But from outside, watching a ship go into jump just takes my breath away every time. The whole thing takes maybe 20 seconds, but if you're lucky enough to see it you'll remember it for a lot longer.

The lanthanum network spread throughout the hull turns blue, or rather the ship does all along its lines. The thing looks like one of those computer drawings

that naval architects use. It doesn't light up all at once, either, but extends from one point to another, however the navigator set it up for whatever jump vector he's trying to hit.

So once this grid shape is formed, the whole area around the hull starts glowing this same shade of blue. A couple seconds later and the ship's gone, and this blue patch just shrinks down into a point before fading completely.

When a ship comes out of jump, the whole sequence is reversed: first there's the blue glow, then the ship appears out of nowhere, and the glow fades a little so you can see the grid lines, and then they're erased, one by one.

It's harder to see a ship come out of jump, of course, because you don't know where to look. I remember growing up, when my sister and I used to watch the ships moving away from the orbital port. They had 'scopes set up in the view areas, so you could watch them for hours, and when they got far enough away, then zip zip with the lines, then that blue glow, and then nothing to see at all.

We especially liked to watch the alien ships, because their grid patterns were always different than what we were used to. Droyne, I guess, always used a hexagon shape, and Aslan ships had whorls and spirals all over them. In the war, I watched a few Zho get away: triangles is what they used. Never saw a Hiver or K'kree ship, so I can't say what they look like. Vargr, though, look like a hodgepodge, and I can't tell you why. Must be hell for their navs to plot the right sequence.

conversion of so much fuel to energy is waste low-grade heat energy. The heat is vented via a series of thermal transfer techniques: superconducting hull radiators built into the hull, and convection techniques using some of the liquid hydrogen fuel as coolant and expelling it with the fusion by-products out the rear of the ship. During the pre-jump power build up, the ship presents a significant I/R signature, particularly from the rear.

Jump Governor: When the command is given to jump, energy from the zuchai crystals is directed into the jump governor. This device, which incorporates its own highly accurate computer system, is linked to the ship's main computer system for guidance and backup. With utmost precision, the governor applies initial bursts of energy (about 20% of the charge) in the proper sequence to the lanthanum net (which is incorporated in the hull of the ship), thereby "warming up" the grid. At this point, if anything out of the ordinary is detected, it is possible to abort the jump.

The next step, the transition phase, commits the craft to the jump. It is impossible to abort the jump once transition has started.

The transition phase begins when the jump governor feeds the remaining portion of the energy stored in the zuchai crystal array (the remaining 80% of the charge) to the hull grid, opening the weave of the desired jumpspace level. Once this opening is made, the craft tumbles into the breach and leaves normal space.

Lanthanum Hull Grid Net: This grid, usually made of the rare earth element lanthanum, is built into the hull. The grid is fairly coarse, spaced about one meter between grid lines. During jump transition, the power fed to the hull grid is routed to specific sections of the grid by the jump governor. By exactly controlling (to within microseconds) the routing of the surges, the vessel's tumble is controlled, which properly di-

rects the path of the ship through jumpspace. In fact, during the crucial instant of transition tumble, the entire course the ship will take is irreversibly established. There is no such thing as a mid-course correction once in jumpspace.

RELATED TOPICS

The following text covers some topics related to jump drive operation and usage.

Jump Preparation: Before a starship leaves port, the navigator is responsible for the flight plan outlining the trip to the jump point, and the vessel's planned jump vector from that point. This plan is filed with the local authorities, who approve or deny it.

As the ship approaches the specified jump point, the navigator typically instructs the computer to begin the final computations for the jump vector. The computer runs through a final checklist with the pilot, navigator, and engineer to assure that all is well. Once the checklist is verified and the jump vector is calculated, the jump begins.

Jumping In a Gravity Well: While it is possible to enter jumpspace from anywhere (even sitting in a docking bay on the surface of a planet), there are certain practices which are recommended.

First and most important, the gravitational effects of nearby massive bodies must be considered. Within 10 diameters of a world or any massive body (even another starship), the proximity of the mass so distorts the fabric of space (and jumpspace) that any transition made is often disastrous. Between 10 and 100 diameters, the effect gradually drops off. Jumps made from within this region are still hazardous and should be avoided. Beyond 100 diameters, the transition to jumpspace is considered safe so long as no other factors adversely affect the procedure.

Oddly enough, it seems that nature has provided certain safeguards which prevent an object from exiting jumpspace while inside the 100 diameter limit. Any craft whose jump vector calls for it to break into normal space within the 100 diameters limit automatically precipitates violently out of jumpspace upon reaching that limit. In some cases, this can cause severe damage the ship or its crew (see Flight Controls). p. 8

Further, the normal laws of conservation of mass and energy apply to a craft entering and leaving jumpspace. Thus a craft which is travelling at 150 kilometers per second when it jumps will be moving at the same velocity and direction when it re-enters our universe.

In cases where the origin and destination stars have a great proper motion with respect to each other, the navigation computer automatically compensates for it in the jump vector computations. If factors such as this were not considered, the ship may find itself hurtling through space at an undesirable speed and direction in the new system, and be unable to counter with its remaining fuel supply.

Crew Activities: For the engineering crew, the pre-jump and transition periods involve feverish activity as every aspect of the jump preparation must be carefully monitored and controlled. While the ship is in transit to its destination, there is little for the crew to do except monitor the jump field bubble and maintain the rest of the ship's equipment. The crew typically devotes much of the time spent in jump to the general maintenance and upkeep of other ship systems, and to the care of any passengers who might be

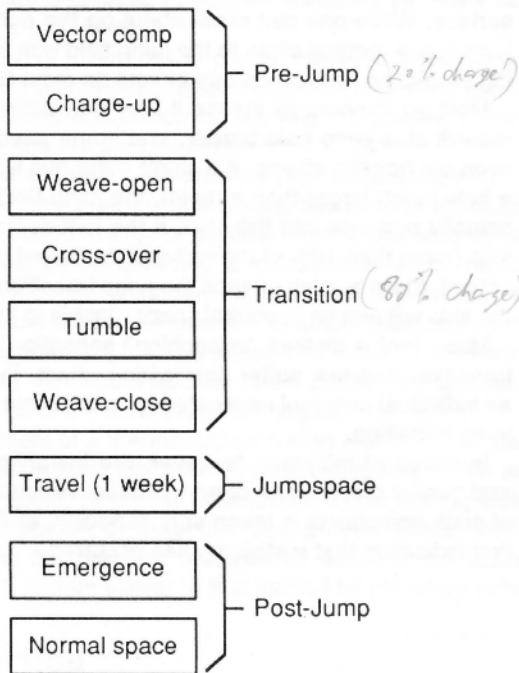

Jump Drive Op Phases

might be aboard.

Several hours before the predicted time for reentry into normal space, the ship's computer alerts the crew to stand ready. All hands are expected to be at their stations at least one watch before breakout for routine system checks. Although the actual retransition is rarely abnormal, precautions are taken to avoid mishaps in normal space which might be the result of uncharted obstacles in the path of the ship, clandestine pirate activity, or other surprises.

Misjumps: Sometimes, despite all precautions, something goes wrong with a jump transition, and a misjump occurs.

Apart from gravitational perturbations, the second most common cause of misjumps is contaminated fuel. On rare occasions, an unusual gas mix in the fuel causes the jump fusion power plant to load the zuchai crystals with a charge that is ever-so-slightly skewed, and a misjump results. Scout and military drive jump governors are more sensitive to such variations in the zuchai crystal charge, and are thus more resistant to misjumps from unrefined fuel.

Misjumps can be classified by their effects: temporal, spatial, and combined. Each is dangerous and can result in the loss of the ship or crew, even if destruction at the time of jump transition is avoided.

In a temporal misjump, the craft reaches the intended destination point, but a jump time duration error occurs (also called a jump relativity error). In such cases, the amount of time the craft remains in jumpspace may vary from 40 to 160 percent of normal.

In many cases, a temporal misjump is nothing more than an inconvenience to the passengers and crew. In fact, it is possible for such a misjump to bring the ship to its destination ahead of schedule. However, in extreme cases, the voyage may take so long that supplies dwindle and life support or fuel reserves fail. When this happens, the ship emerges from jumpspace with no survivors.

A spatial misjump forces the craft to arrive at a point in space other than its destination, although the time spent in jump is the normal 150 to 185 hours.

Often, spatial misjumps are disastrous because there is no assurance that the craft will emerge from jumpspace anywhere near a star system. A ship which suddenly finds itself lost between the stars without a functional jump drive is almost certainly doomed. About the only recourse is for the ship to vector toward the nearest star and accelerate to the limit of its maneuver drive fuel supply. At 0.1 lightspeed, a system one parsec distant will still take over 30 years to reach. The only hope the occupants have of surviving is to go into low berth for the duration of the trip.

A combined misjump is a dramatic event which causes the travellers to be subjected to combined effects of both a temporal and a spatial misjump.

Microjumps: The use of a jump drive to cover distances far less than a parsec is termed a microjump. There are numerous reasons for the use of microjumps by both commercial and military craft.

In any trip where the normal space travel time is greater than travelling the equivalent distance with jump drive, it is advantageous to use jump drive instead. In the Terra system, for example, a starship with a 1 gee maneuver drive may instead jump when travelling from Terra to Uranus,

Neptune, or Pluto. The military craft stationed at the Imperial Naval Facility on Pluto make routine use of microjumps to travel to Terra and Luna.

Observing Jumpspace Transition: To an outside observer, the entry of a ship into jumpspace is a most spectacular sight. It begins when the jump grid is first warmed up during the preparation for jump. The lanthanum traces in the hull slowly build up a faint blue-white glow which forms a crisscross pattern across the surface of the ship.

When the Captain orders the ship into jumpspace, the increased energy flow causes the pattern to suddenly become so bright it is almost painful to look at with the naked eye. A blue "energy haze" forms about the ship as the weave of the targeted jumpspace level is disturbed. Finally, too fast for the eye to follow, the ship seems to collapse into a line along its central axis and quickly shrinks to a brilliant point of light before it vanishes completely. Only the blue haze remains to mark the passage into jumpspace, and that quickly fades.

To an observer aboard a starship, the process is far less spectacular. One second he is looking at a normal star field with a glare from the energized lanthanum hull grid clearly visible; the next, he can see only the undulating gray "nothingness" of the protective jump field.

Dropping out of jumpspace is simply the reverse of the above. For one aboard a starship, the stars simply wink back into existence and the sky turns black again.

To those looking at a starship returning to normal space, a blue haze begins to form. For an instant, a point of brilliant blue-white light forms at its center, which suddenly stretches out to become a line and then bursts into the brilliant three-dimensional grid pattern made by the lanthanum hull web. The haze fades out slowly behind the ship, while the grid quickly loses its charge and returns to normal.

Jump Field Bubble: The "wall" of the protective jump field bubble surrounding a ship in jumpspace does not routinely touch the ship, but hovers about a meter from the hull surface. While one can crawl about on the hull of a ship in jumpspace, getting close to the jump field with little intervening protection has dangerous effects on most lifeforms.

Most go temporarily insane if they get within a few centimeters of a jump field barrier, and some never recover or even die from its effects. If a ship's outer hull is breached by a hole much larger than a meter, the jump field barrier may actually protrude into the ship. If the hull damage is extensive (more than 10% of the hull grid destroyed in a single location), there is a fair chance the jump transition will fail, and the ship will remain in normal space, unable to jump.

Many feel a distinct "wrenching" sensation during jump transition, but few suffer any lasting effect. In rare cases, an individual may feel nauseated for a brief time following the jump transition.

In cases of misjump, however, the instances of nausea and similar discomforts often increase. An unusual number of such complaints is taken very seriously, as it often is the first indication that a misjump has occurred.

Power Plant and Fuel

A starship's power plant is the "heart" of the vessel, providing the ship with the energy it requires for operation. Without a power plant, no other onboard systems would function and the craft would be unable to move through normal space.

The power plant requires fuel to operate. In all modern craft, this fuel is hydrogen. Cheap and easy to obtain, hydrogen is the most common element in the universe and can be found in many local world environments.

HISTORY

Early spacecraft designs draw their power mainly from solar panels and batteries, while later designs depend upon fuel cells or nuclear fission reactors. All of these, however, are quickly outdated with the development of cheap nuclear fusion at tech level 9. From that point on, refinements in this technology permit greater and greater amounts of power to be produced from smaller and smaller power plants.

From the time of their inception at tech level 9, fusion power plants gradually become more effective until, at tech level 15, they have triple the output and half the volume of their earlier counterparts. Current experiments indicate tech level 16 fusion plants can produce three and a half times the power generated by those used at tech level 9 while occupying only one-quarter the space.

THEORY

The process of fusion employed by modern power plants is fairly easy to understand and has been well understood for centuries. An understanding of fusion reactions typically begins about tech level 6. Uncontrolled hydrogen fusion reactions are employed in nuclear weapons by many cultures at this tech level.

The secret of fusion power plants, however, depends upon achieving a controlled fusion reaction. Controlling hydrogen fusion requires overcoming two major problems, namely "triggering" the reaction, and then "containing" it.

To trigger a fusion reaction, very high temperatures must be attained. In modern power plants, this is done with high-intensity focused energy or particle beams, powered by superbatteries. By bombarding a microscopic target region within the reaction chamber, intense heat is produced almost at once. When the reaction chamber has been sufficiently "warmed up", fuel is injected and instantly converted into plasma. Additional bombardment pushes the temperature higher and the fusion reaction begins.

Containment of a thermonuclear fusion reaction is in itself a monumental task. For early systems, magnetic fields are often employed. At higher tech levels, these are replaced by a combination of magnetic and gravitic fields. While maintaining the reaction, these fields suspend the fusing plasma in a pattern similar to that formed by planetary radiation belts.

DESCRIPTION

The chief engineer and his staff are responsible for the correct operation of the ship's power plant and fuel tank-

age. The following text describes the components shown on the power plant and fuel diagram.

Power Plant Section: The power plant section provides the ship with its power for operation of all ship systems (other than the jump drive, which has its own power plant).

Batteries: The batteries are needed to provide power to the lasers used to start the fusion reaction. Also, the batteries serve as an energy backup in the event of a power plant failure.

Fusion Power Plant: The fusion power plant takes in hydrogen from the fuel tank and through a fusion reaction outputs power for the ship's systems.

Power Distribution Center: Based on instructions from the power plant computer, the power distribution center routes the power output from the fusion plant to the various ship systems as needed.

Hull Radiators: The hull radiators are used to vent excess heat and unusable by-products from the power plant's fusion reaction. The heat is vented via both superconducting radiators and convection using liquid hydrogen fuel (vented with the fusion by-products). By-products are vented through nozzle-like fixtures, typically mounted on the rear of the vessel. The vented by-products provide little if any, thrust.

Power Plant Computer (Local CPU): The power plant computer controls the power plant operation. The local computer is connected to the ship's main computer, which acts as a backup to the local CPU in the event that it fails.

The computer link also provides the power distribution net with the information it needs to route the power around the ship to the various systems based on need.

The engineering staff works with the power plant computer to control power routing. The computer tells the engineers what the power needs of the ship systems are, and gives the status of the power plant output. The engineering staff uses this information to arrive at strategic guidelines for the computer to follow in supplying ship power -- the computer implements the actual tactical steps which fulfill those guidelines.

Fuel Section: The fuel section holds and controls the starship's fuel supply.

Fuel Scoops: The fuel scoops allow the starship to perform wilderness refueling by skimming a gas giant's atmosphere. When the vessel swoops down into the gas giant's outer atmosphere, the atmospheric gases are pushed into the ship through the fuel scoops.

Purification Plant: Once the raw fuel has been taken into the ship, whether from a gas giant or a water ocean, it must be purified into hydrogen and stored in the fuel tank.

Aux Fuel In/Out: The auxiliary fuel in/out connection is the standard fuel intake used during routine starship refueling at a starport. This intake is also the standard input point for ocean water gathered during an ocean refueling. Starport fuel typically goes straight to the fuel tank (unless it is unrefined), while ocean water must first be routed through

the purification plant for conversion into hydrogen.

Pump: The pump is the central routing unit for the fuel going in and out of the fuel system.

Fuel Tank: The fuel "tank" is actually a series of separate interconnected compartments for storing both raw and refined fuel.

Waste: During the refinement process, any unusable waste by-products from the fuel purification plant are dumped from the ship via the waste line.

RELATED TOPICS

Starship fuel is generally broken into two categories: refined and unrefined.

Refined Fuel: Refined fuel is preferred since it has been stripped of any impurities which might adversely affect the operation of the power plant or jump drive. Refined fuel is most commonly obtained at a starport. Scout vessels and similar military craft receive fuel from stockpiles maintained for them at their bases without cost.

When purchased, refined hydrogen costs an average of Cr35 per kiloliter. In systems without gas giants or wet worlds, where the only source of fuel is the port authority,

this cost can be up to six times higher.

Unrefined Fuel: Unrefined fuel is available from a wide variety of sources. Most commonly, it is obtained by skimming the atmosphere of a gas giant. In other cases, a starship can refuel using water from a lake or ocean. In desperate situations, fuel can be obtained from ice rings, polar caps, or even cometary bodies.

The major drawback to using unrefined fuel, however, is that it can alter the amount of energy supplied to the ship's jump drive and cause a misjump (see Jump Drive).

Most commercial and military craft have the capability of taking in unrefined fuel and processing it into refined fuel onboard. This is done via a fuel purification plant and normally requires about six hours to purify all of the fuel in a ship's tanks.

Once a starship has fuel in its tanks, it may start up its power plant. •

POWER PLANT AND FUEL



The power plant on a starship is one of the most reliable systems aboard — and a good thing, too, because everything depends on it. If you're out of juice, you don't move, you don't eat, you don't stick to the floor, you don't breathe, and you don't call for help.

In my days, I've only seen one power plant give up the ghost, and that was when we took a hit during the Fourth Frontier War. We were doing blockade duty in Denotam. Any fool can make a profit running blockades, and the Navy's interdiction only guarantees that folks will pay premium prices — it's like a magnet to every starship in the subsector, so we had our hands full.

Unfortunately, the Zhos didn't heed the blockade either, and one day when we were about 40 diams out, the navigator picked up a vessel on his densitometer coming around the far side of the star. EMS didn't show a thing — the ship was too far away, too close to the star, and didn't have its transponder going. That didn't mean a lot, since a lot of merchant vessel transponders quit working the closer they get to a blockaded world.

The pilot thought we'd just run into another profiteer, but nav double-checked the scan and the neutrino print matched the Shiva, a common Zho escort. Commo narrowcast the coded info to our pals insystem while the fleet tactic program prepped the gunners.

We took out the Zho, but not before one of their missiles knocked out our power plant. It's a matter

of policy not to vector toward a body; if you lose your power, you're sucked into its gravity well without a choice, but the Zho didn't know this rule, I guess. Our carefully calculated turn wasn't complete when we took the shot. We figured that our ship had about a day and a half before it landed peacefully on the surface of the system's star.

In a situation like that, there are three alternatives: try to fix the drive; pull up a companion vessel and transfer across; or jump. We spent a day trying to patch things up, but the damage was too extensive. We wasted a few watts on a signal explaining the situation to our pals (who were busy mopping up the Zhos), and then jumped.

There wasn't anything wrong with the jump drive; if we could have run it slow without burning it up we could have used it for power, but jump reactors aren't built for that. We had batteries to last life support for two weeks, so we chanced it and headed back for help.

Nav calculated a jump that would even out our trajectory; we came out 115 diameters from Mirriam, nearly motionless in space. The Navy sent out a tug, and we were all transferred to other vessels while the *Larana* was put back in drydock for a while.

Fuel supply is just as important as the drive: if it don't eat, it don't work! Even worse, if you dump hydrogen all over your ship, you're just asking for it. I've seen captains ignore the catalyst levels on the tanks' doublewalls while their decks just filled up with escaping fuel. That's a sure way to irritate other ships, too: you can burn out a slow EMS circuit if they've pointed it toward your fireball when you blow. •

POWER PLANT and FUEL

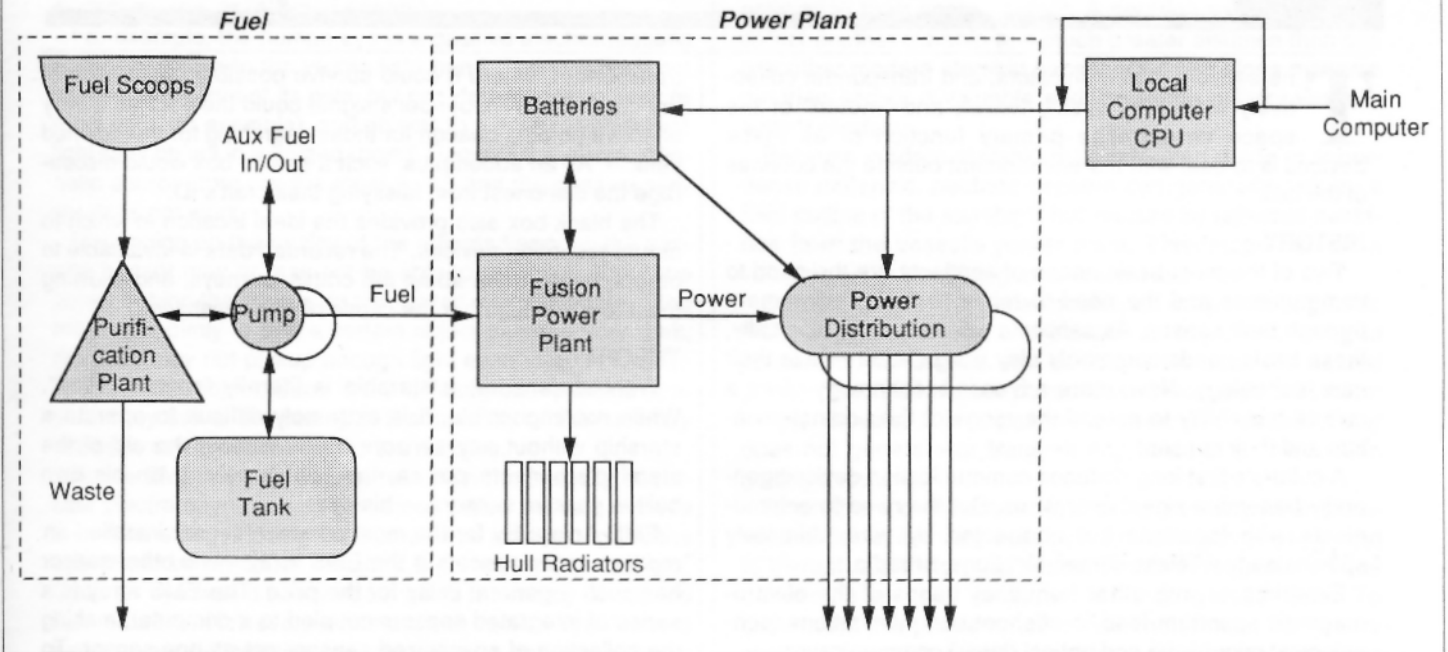

SENSORS, COMMUNICATIONS, TRANSPONDER

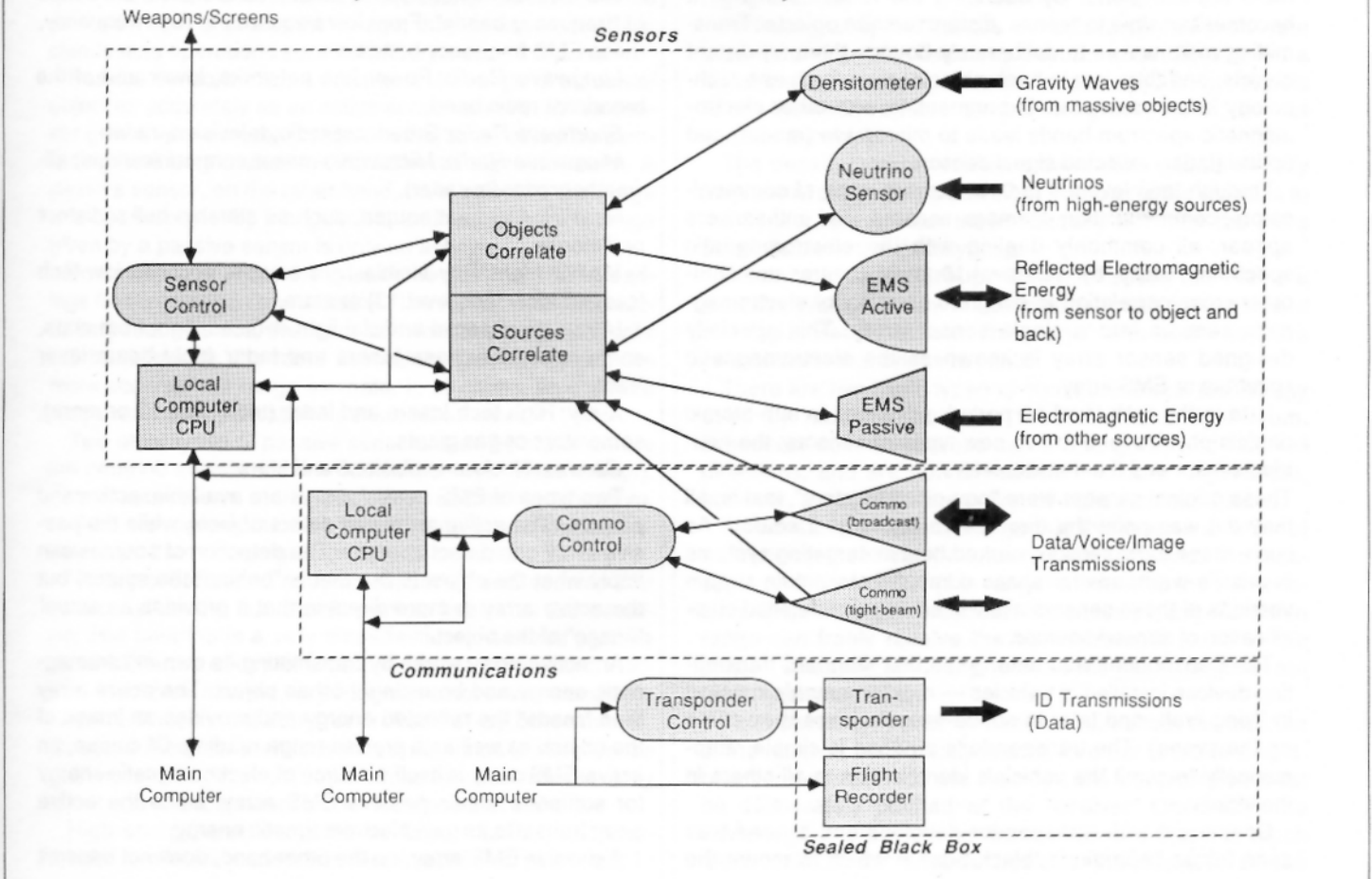

Sensors, Communicators and Transponders

The sensors, communicators, and transponder collectively form the "eyes", "ears", and "mouth" of the space vessel. The primary function of all these devices is to deal with the environment outside the confines of the hull.

HISTORY

Two of the most basic needs of sentients are the need to communicate and the need to relate to their environment through their senses. As sentients advance technologically, these basic needs commonly play a significant role in their new technology. New, more advanced technology gives a culture the ability to extend the range of their communication and their senses.

A culture's first long-distance communication devices generally transmit a signal over wires. But the need to communicate with locations not connected by wire ultimately spawns early wireless communications, or radio.

Experiments with other frequency bands of the electromagnetic spectrum lead to offshoot communications technologies: microwave and optical (laser) communication.

Early in the development of radio transmitters and receivers, most soon learn that metallic objects tend to reflect radio transmissions. By decoding the reflected signal, it becomes possible to "sense" distant metallic objects. Transmitting radio waves to deliberately bounce them off distant objects, and thus locate such objects, gives birth to a technology known as radar. Experimenting with other electromagnetic spectrum bands leads to microwave (madar) and optical (ladar) reflected signal sensors.

Through tech levels 6 to 9, a dizzying array of communicators, communication jammers, sensors, and anti-sensors appear, all commonly dealing with the electromagnetic spectrum. Finally, by tech level 10, most cultures use computer cross-correlation to integrate a variety of electromagnetic sensors into a single sensor array. This specially designed sensor array is known as the electromagnetic spectrum or EMS array.

Late in the tech level 10 period, advances in sub-atomic particle physics lead to two new types of sensors: the neutrino sensor and the densitometer.

These original sensors were "non-discriminatory", that is, all they did was point the direction to the largest source. As such, these early sensors worked best as targeting systems in missile warheads for space combat. Later, main-stream versions of these sensors allow scanning and detailed classification of sensed sources.

The transponder was among the first standard transmitting devices installed in vehicles — most commonly installed in flying craft, and later in space vessels (once they come on the scene). The transponder's purpose is simple: automatically transmit the vehicle's identification to all others in the vicinity.

Concurrent with transponder development, a need was seen for an impervious "black box" in which to mount the

transponder, where it could survive possible destruction of the craft. The transponder's signal could then act as a very effective homing beacon for those searching for the downed vehicle. As an added plus, such a sealed box would discourage the dishonest from falsifying their craft's ID.

The black box also provides the ideal location in which to mount recording devices. The recorded data is invaluable to others, telling them about the craft's journeys, and allowing them to piece together the cause of most mishaps.

THEORY

Without sensors, a starship is literally "running blind". While not impossible, it is extremely difficult to operate a starship without any sensors. Even without the aid of the starship's sensors per se, the pilot is relying on his own built-in passive sensors — his eyes.

EMS Array: By far the most common sensor installed on modern space vessels is the EMS array — no other sensor has such a general utility for the price. The EMS array is a series of integrated sensors coupled to a computer, making the collection of specialized sensors act as one sensor. To the operator, the EMS array appears to be one sensor dealing with much (if not all) of the electromagnetic spectrum.

The electromagnetic spectrum can be broken into a series of "frequency bands". From low frequency to high frequency, these EMS frequency bands are:

Longwave Radio: Power line networks, lower end of the broadcast radio band.

Shortwave Radio: Broadcast radio, television, radar.

Microwave Radio: Microwave/maser communications, all-weather radar (m-radar).

Heat/IR: Any heat source, such as starship hull radiators or lifeforms.

Visible Light: Any visible light source, such as low-tech lasers (below tech level 13) or stars.

Ultraviolet: Special artificial light sources, light from stars, some special-purpose lasers and ladar (tight-beam laser "radar").

X-ray: High tech lasers and ladar (tech level 13 or more), some stars or gas giants.

Gamma: Nuclear explosions and stars.

Two types of EMS sensor arrays are available: active and passive. The active array can detect *objects*, while the passive array can detect *sources*. The detection of sources can imply what the object is like that is "behind" the source, but the active array is more direct in that it provides an actual "image" of the object itself.

An active array works by transmitting its own electromagnetic energy and bouncing it off an object. The active array then "reads" the reflected energy and provides an image of the object, as well as a precise range reading. Of course, an active EMS array is itself a source of electromagnetic energy for someone else's passive EMS array, since the active array transmits its own electromagnetic energy.

A passive EMS array, on the other hand, does not transmit

any electromagnetic energy of its own, but instead just "reads" the electromagnetic energy available to it from other sources. As such, a passive array will detect only an object if that object is a source of electromagnetic energy (either its own energy, or reflected energy).

For example, the human eye is a passive electromagnetic sensor sensitive to the visible light band. The eye does not generate any light of its own, but can detect light sources (a room light, for example), and objects that themselves reflect light (any object in a lighted room). Remove the electromagnetic source (turn out the room light), and the passive sensor does not work.

Depending on the quality of the reflected energy, the passive sensor may or may not be able to tell much about the object behind the source. In the lighted room example, if the room was dimly lit and a certain object seemed very dark, the eyes may not pick up enough light even to allow identification of the object. Such is the difficulty with passive sensors: they are at the mercy of the intensity of the naturally available energy sources they are sensing.

Active EMS sensors are not reliant on the intensity of outside electromagnetic sources, since active sensors provide their own energy. Using the human eye analogy again, the eye would be an active sensor if it generated its own light. Such an eye would never again be at the mercy of outside light sources. However, a human with "active eyes" would have a very difficult time sneaking into a dark room full of humans with normal "passive eyes".

So it goes with active sensors. They make one show up quite nicely on everyone else's passive sensors. While active sensors give a better image, they do not work well in clandestine operations such as military surprise attacks.

Passive sensors cannot determine the range to a source/object as accurately as an active sensor can. An active sensor gets a very accurate range reading to an object by computing how long it takes for the reflected signal to return. A passive sensor, on the other hand, must calculate the range to a source/object by triangulation, and even then, the range given by a passive sensor is only an estimate.

To use triangulation, the passive sensor must take readings from more than one location. The farther apart the secondary readings are, the more accurate the range estimate will be. Likewise, the more secondary readings taken, the more accurate the range estimate. In all cases, an accurate range estimate by a passive sensor takes *time*.

Two other types of passive sensors used by starships are the neutrino sensor and the densitometer (or mass sensor). These sensors are more specialized and more expensive, and so are more commonly found on military and paramilitary ships than on straight commercial vessels.

Neutrino Sensor: A neutrino sensor detects sources that emit or reflect the sub-atomic particle known as the *neutrino*. The neutrino is a very small, almost massless particle given off in the decay of a neutron into a proton and electron. Neutrinos interact very little with other matter, and as a result are rarely deflected or "reflected" by other matter. One kind of matter that does reflect neutrinos is *superdense* matter, although even superdense matter reflects only about one to two percent of the neutrinos that strike it.

High energy reactions such as fission, fusion, and anti-matter annihilation are abundant supplies of neutrinos. In

fact, a neutrino sensor can classify a high-energy power plant into the type of reaction and its approximate energy output just by its neutrino emissions. Neutrino sensors are thus effective for classifying starship power plants and estimating their energy output. A neutrino sensor can also detect another starship at a much greater distance than can any other modern starship sensor. This fact alone makes a neutrino sensor a valuable addition to the military vessel's sensor cluster.

Because modern starship hulls are often made of superdense materials, neutrino sensors can generally pick up a faint outline of the starship's hull caused by reflected neutrinos from the vessel's power plant. This image can be a valuable aid in identifying an unknown starship.

Densitometer: The densitometer, an outgrowth of gravitic technology, can detect and classify an object according to its density. To do this, the densitometer uses the natural gravity which all matter possesses. Since a densitometer simply detects, it is a passive sensor. The densitometer does not generate or transmit any fields of its own when getting a reading.

Given that a densitometer is dealing with very weak gravitational fields, it is very sensitive. Artificial gravity fields tend to disrupt and distort the sensor readings, especially if the densitometer itself is in an artificial gravity field. To circumvent this problem, the densitometer must be "gravity shielded", which further increases the complexity and expense of the sensor. All modern starship densitometers must be gravity shielded, or the readings they give would be highly suspect.

Artificial gravity fields have a much faster "drop-off" rate than natural gravity fields, so beyond about 50,000 km a densitometer's readings are no longer affected by objects which themselves have an artificial gravity field (such as another starship).

The densitometer provides a three-dimensional density map of the object being scanned. The closer the object is to the sensor, the greater the resolution, and thus the more detail visible in the density map.

Communications Group: Communications are vital to a starship. Without a way to communicate with the outside, a starship is literally its "own little world", with all the negative connotations that brings to mind.

There are two basic types of communications technology used by modern starships: broadcast and tight-beam. Broadcast communications come and go to and from all directions, and are non-directional in nature. Tight-beam, however, are straight-line or line-of-sight communications.

Broadcast has the advantage that the precise location of the receiver need not be known. One just sends the message, and the receiver (if in range) will receive the transmission. Of course, with broadcast transmission, anyone within range can freely receive the transmission if tuned to the proper channel. Similarly, broadcast transmissions are much easier to jam.

Tight-beam, on the other hand, requires that the location of the receiver be explicitly known. In order to make a tight-beam transmission to the receiver, the transmission must be deliberately pointed at the receiver. Obviously, the advantage of a tight-beam transmission is that it is much more difficult for anyone besides the receiver of the

is there a black market for stolen transponders?

message to tap into or jam the transmission.

A special hybrid of broadcast and tight-beam transmission exists known as *directional broadcast*. Essentially, a directional broadcast transmission is just a broadcast transmission limited to a certain direction. A directional transmission is not nearly as tight a transmission as a true tight-beam, and so is easier to intercept. Because a directional broadcast transmission is still just a limited form of broadcast, jamming a broadcast transmission also jams a directional broadcast transmission.

Radio communications are broadcast. LaserComm, maserComm, and mesonComm are all tight-beam forms of communications.

Most starships also have a special communications link to their main computer. By using a special access code, for example, outside starship A can "connect" its main computer to starship B's main computer, and manipulate starship B from starship A's control panels. Such a computer link is rare, however, and generally used only during training maneuvers or in times of emergency.

Transponder Group: The transponder is actually just a specialized broadcast communicator. The transponder

constantly transmits the starship's identification via broadcast radio. Thus, when a starship enters a system, other vessels are automatically aware of its presence.

The transponder is mounted in a totally sealed "black box", and to tamper with the box without proper authorization is a crime. The ship's ID may not be altered or changed without the consent of the proper authorities.

Any starship can turn off its transponder signal if it feels that such an action is warranted by the circumstances (when trying to evade pirates, for example), but to do so is risky. Most military vessels are instructed to "shoot first and ask questions later" if they encounter an unidentified vessel in-system that has no transponder signal.

Military starships can select from a variety of transponder settings all the way from no signal, to a simple ID of "this is an Imperial warship", to the full standard vessel ID. No vessel, military or otherwise, is required to detail its armament or defenses in its transponder ID. Depending on the need, some Imperial military vessels may have exaggerated transponder IDs. An example of an exaggerated ID may be "this is the Imperial warship *Fedrella*, 100,000 tons displacement, jump-4, maneuver-5, crew 5,000", when in fact

**SENSORS, COMMUNICATIONS, AND
TRANSPONDERS**



Transponders are one of those touchy subjects that it's hard to do justice to. A transponder can save your life, or can cost you a fortune. It all depends on when it's blaring and who's listening.

The transponder's case, if you're running legal, is sealed at the factory, and the only way to change its signal is to have an Imperially-licensed technician come aboard. The gadget is mounted in a hard to reach spot in the hull, usually, and the box around it is the same stuff the Navy uses to make battle dress.

Wired into the bridge's commo station, it's got one switch, and only one switch. Under normal circumstances, you're required to turn the transponder on. If your ship is in a "certified" emergency, you can turn the transponder off. I always thought it was a good piece of luck that the transponder doesn't know what a certified emergency is.

The Imperium doesn't want pirates to nab you, so you're allowed to shut down so your ship doesn't act like a homing beacon, but the authorities don't understand that some customs duties are piracy, too. Smugglers aren't supposed to switch off when they jump in, but a lot of them do.

It's not that easy, though, to escape the watchful eyes of the taxman. You have to remember that the transponder case also houses your vessel's flight recorder, and that thing's got a memory as long as a comet's tail. Anybody who dumps out that log can tell in a real hurry whether you've been skirting the law. You're not going to change that log, either, un-

less you've got a lot more computer know-how than I've got, because they use one of those new-fangled security codes to encrypt the stuff. "In cooperation with Imperial investigators", you can read it. But that misses the point, somehow.

Maybe I should backjump here a bit and point out that I'm not advising anyone to tamper with their transponders, and I'm not saying I've ever done it myself. But whenever I talk to young folks like yourself, they always seem to ask about transponders, so I thought I'd beat you to the punch and explain without having to listen to your fool questions.

Anyway, the cleverest set-up I ever saw was a ship that had two transponders, and a gizmo to simulate regular ship activities for the extra one. Took the customs agents a long while to figure out what he was doing, but they eventually caught him.

I've also seen guys use a lot of equipment to jam their own signal, so they can just leave the transponder on all the time. That always seemed like too much trouble to me.

I'll give you one rule about transponders: nothing you try will last forever. If you're going to fool around, you've got to bank on eventually getting caught. And you've got to figure if it will be worth it when you are. A lot of merchants seem to make a lot of money and still keep their noses clean.

Military transponders are different from the civilian models, and I know a lot of smugglers who would pay dearly for a military job. The transponder is completely configurable — anything you want it to broadcast, it can. This is convenient for a cruiser, say, because it can jump into a system and pretend to be such-and-such a fat trader. If the other ships insystem aren't on their toes with their other

the ship is only 25,000 tons displacement.

DESCRIPTION

The navigator is ultimately responsible for the operation of the sensors, communications, and transponder. The following text describes the components shown on the diagram.

Sensors Group: The sensors provide the ship with vital information about the outside. Civilian ships usually mount only EMS sensors, and then sometimes only an active array. Military ships commonly mount all sensor types.

Densitometer: This is the densitometer sensor mount, usually an oblong or oval construct at the end of a boom. This mount detects natural gravity waves from massive objects.

Neutrino: This is the neutrino sensor mount, usually one or more spherical constructs on the hull of the craft. This mount detects neutrino emissions from high-energy sources.

EMS Active: This is the EMS array active mount, usually a long cylinder or a series of parabolic dishes. This mount reflects electromagnetic energy off objects.

EMS Passive: This is the EMS array passive mount, usually a long pipe-like boom. This mount detects electromagnetic emissions from various sources.

Objects Correlate: This computer unit correlates individual object-oriented sensor readings into a highly informative combined reading. The correlated data is passed to the sensor controls.

Sources Correlate: This computer unit correlates individual source-oriented sensor readings into a highly informative combined reading. The correlated data is passed to the sensor controls.

Sensor Control: This unit is a complex array of displays and operator controls, used for presenting and manipulating the sensor data. Together with the main sensor computer, this unit carries out operator commands.

Via these controls, the operator can request that the sensors automatically scan for or track various targets, make "best guess" estimates as to what the reading is, plot course projections of detected objects, and the like.

Sensors Computer (Local CPU): The sensors computer ties together all the sensor data, and manages the positioning of the sensors for the operator. It also alerts the operator

sensors, they may discover the truth too late.

Speaking of sensors, it reminds me of an incident when we were working out of Frenzie. We had a fresh commo officer on board, name of Niim, and the crew just wouldn't let him alone.

Once we jumped, nav asked this young kid to take over his station while he went to the fresher. The kid sits down, only to start picking up passive EMS on the sensors. He stared at the panel, reconfigured it, and stared some more. The rest of the bridge crew were trying not to let on; we were in on the prank and wanted it to go on as long as it could.

Nav was just outside the door, running the whole set-up from his hand computer. He'd loaded a sensor simulation into his station, and what commo saw now was a fleet of Zhodani cruisers out there in jumpspace. The simulation was a real beauty; after a few seconds, our passive started picking up their active scans. The only thing Niim couldn't figure out was how all this was happening in jumpspace. He didn't say anything about it, because he thought it was some kind of error, but he checked over the systems, and I could see it was gnawing on him.

The icing on the cake was when his own station's telltale started flashing. He didn't want to walk away from nav and the sensors, so he reconfigured the panel so he could handle radio ops too. He piped the signal into his earphones, and nearly fell out of the chair. Here was a Zhodani voice, heavily accented, whispering, "We're coming to get you, Niim."

Commo spun around and stared at me, stark terror in his eyes, and nav never forgave me for bursting out laughing.

Anyway, a ship doesn't have to restrict itself to radio, but radio is the only means of broadcasting

information, so that's what the transponder uses, and radio is the easiest to communicate over when you don't know your exact position or the exact position of your target.

Some military and Scout vessels prefer mesons, because they're straight-line narrowcast and don't depend on line of sight. A meson communicator can cut right through a star if it wants to, no extra charge. Doesn't mean they're any good as weapons, though, any more than a bullet could be used as a missile: it's a matter of scale.

Which reminds me of another reason you want a skilled commo onboard if you're conducting military ops. Say you're in a fleet of six ships, and the command ship has an expert in tactics on board. Your life depends on that officer's brain, and if you can't contact it, you might not get a second chance.

So meanwhile, your pilot is swinging the ship this way and that, dodging missiles or whatever. If your vessel has a spinal mount, every time the gunners want to take a shot the pilot has to move the ship to line up the muzzle with the target. Even with the smaller movable mounts, you've got the problem of sandcasters on one side and lasers on the other.

What this all means is that narrowcast transmissions have to be carefully calculated, too, just as accurately as a beam weapon. If your commo isn't up to it, you're cut off from the brains of your fleet. You could use broadcast, I suppose, if you don't mind turning your vessel into a big homing beacon for the enemy's EMS. But I wouldn't be talking to you if you were stupid, so I don't need to say any more about that idea.

to any new sensor readings that may appear.

The local computer is connected to the ship's main computer, and acts as a backup to the local CPU if it fails.

Communications Group: The ship's communicators connect it to the outside, and allow exchanging information with others. Civilian ships usually mount only a system-range radio broadcast system, while many military ships mount both system-range broadcast and tight-beam communications hardware.

Broadcast: This is the broadcast radio communicator mount, typically a rod-like boom. This mount can both send and receive transmissions.

Tight-beam: This is the tight-beam communicator mount, typically a series of conical boxes or cylinders. This mount, which may consist of any combination of laserComm, maserComm, or mesonComm, can both send and receive transmissions.

Commo Control: This unit is an array of displays and operator controls, used for presenting and manipulating communications data. Together with the communications computer, this unit carries out operator commands.

Via these controls, the operator can request that the communicators automatically scan for signals, automatically reply to certain messages, and the like.

Communications Computer (Local CPU): The communications computer manages the communications system for the operator. It also alerts the operator to any incoming signals and their sources.

The local computer is connected to ship's main computer, which backs up the local CPU in the event that it fails.

Sealed Black Box Group: The sealed black box contains some of the ship's most sensitive hardware from a legal point of view. Tampering with the contents of this sealed box without proper approval from the authorities is highly illegal. If such tampering is suspected, it could result in the impounding of the starship.

Transponder: The transponder maintains a constant transmission of the ship's identity. The transponder signal is broadcast radio, which can be picked up by other ship's radio communicators and passive EMS sensors. **Flight Recorder:** The recorder simply records a log of all starship communications and ship internal systems activity. The ship's main computer collects this information and provides it to the recorder.

The collection process and the link between the ship's computer and the flight recorder is via a hardware unit that cannot be accessed programmatically from the computer.

Transponder Control: On civilian vessels this is little more than an off and on switch. On military vessels, several levels of ID are possible, as well as an off and on switch.

A vessel (especially a civilian one) must have a very good reason for turning off their transponder signal. Turning the transponder signal off without due cause is illegal. If such activity is suspected, it could result in the impounding of the offending vessel.

RELATED TOPICS

The following text covers some topics related to sensor, communicator, and transponder operation and usage.

Remote Sensor Probes: Sometimes it is advantageous to send the sensor "where the action is", rather than merely observe from a distance. For this, a variety of sensor

probes are available. A sensor probe is most commonly a missile whose "warhead" consists of a sensor package and a communicator. Some sensors (such as neural activity sensors) have such a limited range that the only practical method of using them in deep space settings is with a probe.

Communicator Nomenclature: In order to uniquely identify communicators, the following standard format is used:

TypeComm Range-TL

Type is the specific communications system (Radio, Laser, Maser, Meson). The suffix Comm indicates a communicator. Range is the word description of the range of the device; TL is the tech level of the device. For example, RadioComm Planetary-5, LaserComm FarOrbit-10, MaserComm System-14, or MesonComm Planetary-15.

Communication Channels: Without some sort of organization, communicator use would be chaotic. A wide variety of named channels (sometimes called frequencies) are used for radio communications. Channels are named by their use or user: Navy channels, Scout channels, traffic control channels, and others.

For example, normal communications between three Imperial Navy close escorts travelling in formation would use a Navy channel. When the ships enter a star system, they would communicate with system traffic control using the Traffic Control Channel. When they encountered a non-navy ship, they would open communications using the Hailing channel. If they became involved in combat, they would switch to a Tactical channel. All would routinely monitor the Distress channel, and their group commander would probably assign specific ships to monitor various other channels.

Communication System Directories: Directories are automated lists of available channels within a star system accessible on demand from communicators within the system.

One major problem that communicator users encounter is determining what channels are being used for what purposes. In a static environment (for example, users permanently assigned to a specific world) it is easy to assign channels for a variety of uses and to publish that information to users.

Within the Imperium, systems with a tech level of 8 or higher maintain a standard *directory*. Directories are always on the same standard channel within the Imperium; accessing the system's directory (using the RadioCommunicator) inputs a complete list of standard channels within the system into a ship's computer.

For example, upon entering the Regina system, a ship has information about standard channels such as Navy, Scout, Distress, and Hailing. It doesn't know system-specific channels such as Market Prices, Passage Reservations, Entertainment. Once the Directory has been accessed, the ship's computer knows what channels are available.

Pirate Ships: Pirate ships often alter their transponders so they can transmit any one of a variety of ship IDs. The desired ID is selectable via a control on the bridge. However, the pirate must be clever about selecting these alternate IDs. If the false IDs do not match the ship's power output or displacement, most nearby ships will quickly suspect foul play if the strange vessel's transponder signal does not match their sensor readings.

Main Computer and Security

The computer is the "brains" of the space vessel. Not only does the typical starship have its central or main computer, but each ship system also possesses its own local computer. On the modern starship, the computer is truly "everywhere".

Security is the ship's "internal defenses". All starships incorporate some type of internal security system which, at the very least, prevents unauthorized personnel from entering hazardous areas. At the other end of the spectrum, higher levels of security can be implemented to ward off hijackers or even boarding parties.

HISTORY

Computers first appear at about tech level 5 as crude mechanical devices, often little more than adding machines or a similar form of simple "number cruncher". As most cultures advance to tech level 6, the electronic computer comes on the scene, as does early space travel.

The first craft to incorporate computers as an integral part of their operation are generally atmospheric flying vehicles, often as early as tech level 5. These early computers are often used as navigation aids, but little more.

The continued miniaturization of electronics, combined with the computer's dramatic increases in processing power, lead to the computer becoming an integral part of most craft's control systems by tech levels 8 and 9. As a craft's systems become more and more dependent on computer direction, redundant computer links become the rule. The extra processors can share tasks during periods of heavy load on the main processor, plus they can take over processing completely if the main processor should fail.

Advances in storage technology at tech levels 8 and 9 from magnetic media to optical media result in an order of magnitude jump in storage capacity. This, coupled with advances in parallel processing, allows the computer to process much more information more quickly, thereby making better, more "intelligent" decisions. The proliferation of expert systems at these tech levels testify to this trend.

Tech levels 12 and 13 herald the next major advances: reliable synaptic processors and holocrystal storage. Again, the computer's decisions become still more "intelligent", even seeming to exhibit true intuition at times. At these tech levels and beyond, the computer starts to seem more like a crew member than a part of the starship.

The earliest forms of spacecraft at tech 6 do not normally incorporate any type of onboard security systems. In general, a culture's first missions into space are made by elite personnel and the need for such devices is rarely seen.

As space travel becomes more common, the need for adequate security increases. With the advent of passenger and armed military vessels, basic protective devices are installed. As access to outer space becomes more and more frequent, the sophistication of such systems improves.

By the time a culture reaches tech level 8, it has generally opened up the frontier of space to a wide array of commercial interests, and with them come security systems to keep secrets from prying eyes. In general, security at this level

includes electronic locks and magnetic card readers to keep selected areas free from unwanted intrusion.

With the dawning of tech level 9, systems which have been in place on the ground find their way onto the spacecraft. Among these are voice and fingerprint readers.

As starship traffic increases, another surge in security technology is required. The possibility of interstellar flight to avoid prosecution or similar star-spanning crimes makes security on new craft of vital importance. With that in mind, tech 9 starships normally incorporate retinal scanners for absolute identification of those onboard.

Tech 10 medical breakthroughs lead to the first generation of active metabolic scanners on starships. These systems provide proof of identity difficult to circumvent.

Up until this point, however, all of the systems employed require the active participation of those being checked. For example, a retinal scanner required the subject to look into an eyepiece. At tech level 12, the first passive systems are introduced. From that point on, absolute security is possible without the occupants feeling watched in any way.

THEORY

A modern starship's main computer and security systems involve many important concepts.

Computer: On the modern starship, there is no "main computer that controls everything", as such. While there is a main ship's computer, its role is to act as an information center rather than a controller.

Each ship system has its own local computer; the main computer provides them with supplementary information. In the event of a local system's failure, the main computer can serve as its backup. But the main computer can cease to function with the only loss being more difficult communication between various ship systems, and the loss of state-room computer terminals.

The likelihood of losing the ship's main computer, though, is very slim, because the minimum redundancy on most vessels is three separate main CPUs (central processing units). In addition, the main computer area on most ships includes a comprehensive collection of spare parts in storage cabinets. In a pinch, other local CPUs of the other starship systems can even take over some of the server functions performed by the ship's main computer.

In short, about the only way to remove a starship's ability to use its onboard computing power is to destroy the ship, since computing power is distributed throughout the ship. The main computer's primary function, then, is to act as a "file server" the the rest of the ship's systems. A modern starship's computer processing is thus very resilient, and very hard to "turn off" or "kill". This is as it should be, for the modern starship is totally dependent on computer processing. Without some form of constant computer assistance, the modern starship just will not function -- period.

Security: The earliest forms of security systems are all active in nature. That is, they require that the subject make an effort to identify himself. In general, this is done via some form of pattern recognition.

COMPUTER AND SECURITY SYSTEMS



As smart as anyone is, your ship is helpless without a computer. All starships, for just that reason, have at least three identical computers, in different areas of the ship, any of which can take over operations. Every system has a built-in computer, too.

Computers are remarkable tools. What they really do is multiply our abilities. For example, I myself can't turn on the switches for the jump drive hull net fast enough, in the right order, even if I had it all written out in front of me. Instead, the computer handles the details, and "I" from the nav chair can do it. The computer makes me more powerful than I am.

The computer is also a powerful coordinator. It can take a wealth of data and boil it down to real information. Take, for example, the last hour or so before jump. The computer takes nav's time and jump coordinates, and figures out a maneuver trajectory to be at the right spot at the right time with the right velocity. Simultaneously, it figures a host of alternate scenarios, knowing that the actual coordinates could be off a bit when the moment comes.

Meanwhile, other computers are making sure that the power plant is producing enough juice, that the particles in the thrusters are aimed right, and that the jump drive reactor is pumped up hot enough. Still other computers are keeping both eyes on the sensors, to figure out where you are and where you're going, and keeping the m-drive aimed straight at the jump point. When the ship's at the target, things move *fast*. All the power stored up from the j-drive has to be pushed out to the lanthanum at once, but in a split-second sequence.

Once jump transition is over, of course, all that the computer has to do is make sure you can breathe, and minor stuff like that.

Fortunately, it doesn't all have to be done by one computer, and in fact most systems use what they call "dedicated" computers. Your main computer sits quietly in the background, available to take over if any of the smaller units fails.

The main computer also handles a lot of centralized data. If you're carrying passengers, I heartily recommend you subscribe to a regular library data service and make sure that there are terminals in each cabin and lounge. For one thing, this gives passengers something to do, and that keeps 'em out of your hair. I don't mind people wandering around a little — they paid for their passage — but there's nothing worse than having folks walk up to you and ask questions while you're trying to get something done. If you've got a library data setup on board, then the passengers can watch holos, or read, or listen to music, or whatever.

Make sure, too, that you buy an SIS — "Ship-

board Information Service" — for whatever kind of vessel you have. That way, it can answer a lot of questions that folks have about operations.

Besides, if your steward knows his job, he can just make that SIS sing, and passengers eat it up. The program gets a lot of its info off the nav panel, and things are almost automatic from then on. Passengers can tune their terminals to the SIS station, and the blasted thing will keep them occupied the whole voyage. Tells 'em when to walk up to the lounge to get a good view, describes everything in sight once they get there, keeps a regular posting of how far the vessel is, everything!

The SIS also organizes "special events" — say, a dance in the lounge one night, with all the latest music from hundreds of worlds, thanks to the library data service. It usually runs a contest, too, to see who can best predict the moment the ship comes out of jump. Don't laugh — it keeps 'em busy, and that's exactly what you want.

One other thing that the computer does for you is run the anti-hijacking program — programs, really, since they run in concert throughout all the systems. "It's no fun losing your ship, even if you aren't sold into slavery," according to the old saying.

Crew members are all recognizable to the computer, just like to you or me. The bridge door, for example, just won't open unless it detects an authorized person outside it. Even if some passenger came to the door, he couldn't get the door to open unless the computer recognizes him as crew.

Which isn't to say that I never allow visitors on my bridge. I won't let folks on during operations, but once we're in jump there isn't a lot for a bridge crew to do, and some passengers really enjoy taking a tour. (I've known a few that didn't want to know anything about it — thought they were safer that way — but I've never understood it.)

If someone did gain control of my bridge, they'd have to keep some of the crew with 'em, because I use random verification sequences on all my boards. At any time (but less often during an emergency), the computer might insist that the operator of the station press his palm to a sensor that reads it. If he's not authorized to run that board, the computer shuts him down right then and there.

The sensor does good, too, because it makes sure that whoever owns the hand is still kicking. I've heard of hijackers cutting off people's arms to trick older systems, but it wouldn't work on my setup.

Incidentally, the computer security system works both ways. If the computer catches someone tinkering where he oughtn't, the whole crew knows it. No klaxon sounds, so the hijackers don't realize they've been detected, but the crew knows, and I've taught 'em what to do. We've had four attempts, and never lost a ship, a passenger, or a stick of cargo. There were a few hijackers, though, who left jumpspace before the week was up.

Electronic locks are simple computer terminals which make use of a preset combination which must be keyed in before access is granted. For security's sake, these codes may be changed from time to time.

Magnetic readers require the insertion of a special card to be passed. The card is read by the scanner and a specific code phrase or number is input to the computer. The subject is asked for this code and, if they cannot produce it, access is denied and security personnel are alerted.

Voice readers maintain a record of the voiceprint of all who are authorized to enter an area. Access is granted only if the words spoken to the mechanism match the stored data. It is not normally possible to fool such a device by disguising one's voice.

Fingerprint readers work in the same fashion. In each case, an optical comparison of the subject's hand is made and matched against records stored in the main computer's memory. Print readers match up the creases and folds on the surface of the skin.

Retinal scanners match the patterns of blood vessels in the subject's retina with those on record. In some cases, these incorporate an active security feature which, if a match is not made, triggers a bright flash of light that causes temporary blindness.

Active metabolic scanners require a sample of tissue from the subject. The exact nature of this varies with the device and may range from a drop of blood to a strand of hair. The sample is quickly analyzed and a verdict reached.

Passive metabolic scanners represent the state of the art in security systems. As such, they are found on almost all high-tech starships within the Imperium.

A scanner is installed at every important junction in the ship's corridors and in every room. Anyone who is near a scanner is swept with an ultrasonic beam which provides a complete profile of his physiology. In addition to a complete record, the individuals external features and bones are measured and checked for healing scars. Brainwaves are picked up by remote sensors, and medical implants (pacemakers, fillings, bionic limbs, and so on) are checked. All of the compiled information is matched with the existing record and instant confirmation of identity is received.

DESCRIPTION

The engineer and his staff are ultimately responsible for the ship's main computer and security systems. The following text describes the components shown on the main computer and security diagram.

Main Computer: The ship's main computer (commonly located near the bridge) acts mainly as the communications hub to the rest of the ship's systems.

Main Computer CPU: This is the ship's main CPU. Most vessels have three CPUs, two of which serve as backup. Processing is often traded between all three CPUs, to both share the load for better throughput, and to insure all three computers are in working order. If any of the three systems fail, an alarm will sound on the bridge and in engineering.

Main Computer Console: This is the main computer console, generally located near the computer. This console includes both input and display devices, and is mainly used for checking the main computer status or for debugging.

Aux Computer Links: These links connect the main computer to all the other local processors in each of the ship's

systems. If a local system fails, the main computer can take over the functions of the local system.

Online Storage: This storage is always available to the ship's main computer and thus all of the ship's systems. This storage, typically an array of holocrystal readers (tech levels 13+) or optical disk readers (tech levels 9 to 12), includes the ship's vast collection of library data.

Removable Storage: This storage can be swapped out for other data space or information as needed. Most commonly, removable storage is used to backup online storage, or to load updates to online storage.

Terminal Filter: This links the main computer to all the stateroom computer terminals throughout the ship. This link includes built-in security filters that prevent stateroom occupants from gaining access to the main computer, and ultimately all ship systems. Circumventing the terminal filter without alerting the ship's computer of the activity is not only impossible, it is illegal. A ship's captain will take a dim view of any such attempts.

Security: With a security system, the captain of a ship has complete knowledge of the actions and locations of his crew at any time. If an emergency arises, this information can save vital seconds.

Security Sensors: These sensors can be any combination of active or passive sensors. Placement varies (depending on the sensor type) but at a minimum they are strategically placed throughout the ship. Depending on the cultural philosophy of the ship's captain regarding privacy, the passenger staterooms may or may not have security sensors. Generally however, security sensors are limited to public access areas (corridors, galley, and so on) and to areas restricted to just the crew (bridge, engineering, and so on).

Terminal Traffic Monitor: Terminal traffic going through the terminal filter is monitored by this device. It searches for any unusual traffic patterns; if any are discovered, the watch officer is notified of a possible security breach.

Alarm Panel: If a security violation is detected, the watch officer is notified and further instructions are requested. Through the alarm panel, the watch officer monitors the violation, and instructs the security computer with the proper action to take (jump the grav up to 6 Gs, gas the room, or whatever). At higher tech levels, the security computer also gives suggestions as to possible options available.

Security Computer (Local CPU): Data from the ship's security sensors is fed into a local computer. If something seems to be wrong, the computer is alerted and it sets off an alarm on the alarm panel at once. Until a response is received from the watch officer, the security computer takes whatever limited actions it deems necessary to reduce the security breach. In the event of a failure in the local CPU, the main computer can take over the local CPU's function.

RELATED TOPICS

The following text covers some topics related to hull and environment operation and usage.

Synaptic Starship Computers: Beginning at tech 13, starship computers begin to incorporate synaptics into their CPUs. As a result, the starship computer begins to seem more like one of the crew than just a machine. Many crew members become quite attached to the ship computer, and dislike any negative comments made about it by outsiders.

Synaptic computers can, on rare occasions, go insane or

make foolish judgment calls. This likelihood increases (slightly) at tech 14 and 15 as starship computers incorporate more and more synaptics. To offset this apparently negative aspect of synaptics, higher tech synaptic computers are increasingly better at giving operating advice.

While it is possible to deliberately switch off the synaptic processing, it is somewhat akin to giving the computer a "lobotomy" of sorts. Many crew members report such a "de-synapticized" computer exhibits a total lack of "life" and a disturbing lack of comprehension.

Passive Scanners: The passive metabolic scanners employed on most starships do more than just spot imposters. They provide detailed information on a subject's possessions and emotional state. A typical response to the Captain's query about Crewman Jones might be as follows:

"Crewman Annabell Jones just left her cabin and is heading aft toward the main entrance to the jump drive. She has her mechanical tool kit secured to her belt, a snub pistol loaded with high explosive ammunition in her right hand, and is wearing a ship's jumper. She appears to be very nervous and quite angry. Do you wish more specific details?"

If the Captain desired, he could determine if Crewman Jones was intoxicated, whether her jumper was made of normal cloth or ballistic fabric, and who the last person was that she spoke with. If he felt that she was a danger to the ship or its crew, he could order all doors secured against her and deny her access to a potential target.

Additional Security: On some craft, the security systems itself can take direct action to stop a potential hazard. Guards or security robots can be alerted or, in extreme cases, automated defenses can be activated. Among the most common of these are sleep or tear gas vents.

On ships which lack such automated defenses, the craft's environmental systems can be turned against hostile forces. Gravity can be suddenly increased or its direction altered, air can be pumped out of a secured area, and lights can be cut off or made blinding. In short, it is almost impossible for anyone but a highly trained professional to seize control of a starship, either in flight or on the ground.

High Tech Recognition Sensors: By tech level 15, recognition sensors appear. These optical sensors can recognize individuals simply on sight, the same way we all recognize each other. "Sure, I recognize him, that's Jeremy Tolman" -- it's just that simple. Such sensors operate just like a crew member when recognizing an individual, and are as difficult to fool, too.

Personal ID Chips: At lower tech levels (tech levels 9 to 11), starship crew members often carry some sort of ID chip on their persons identifying them as crew, as well as giving their names, job positions, ranks, and so on. This way, the precise location of any individual can be determined at a moment's notice. (Anybody know where the captain is?) These ID chips also automatically permit or deny access to certain areas based on job position.

The disadvantage of such a system, of course, is that all one need do to appear to be a particular crew member (such as the captain), is to steal his ID chip. An ID chip system is usually smart enough to detect two people with the same position (such as two captains) to be a security breach, however. Also, sometimes the steward does need to get into engineering to help out during an emergency, but the security system might not let him because he has been defined as being off limits to engineering.

MAIN COMPUTER and SECURITY

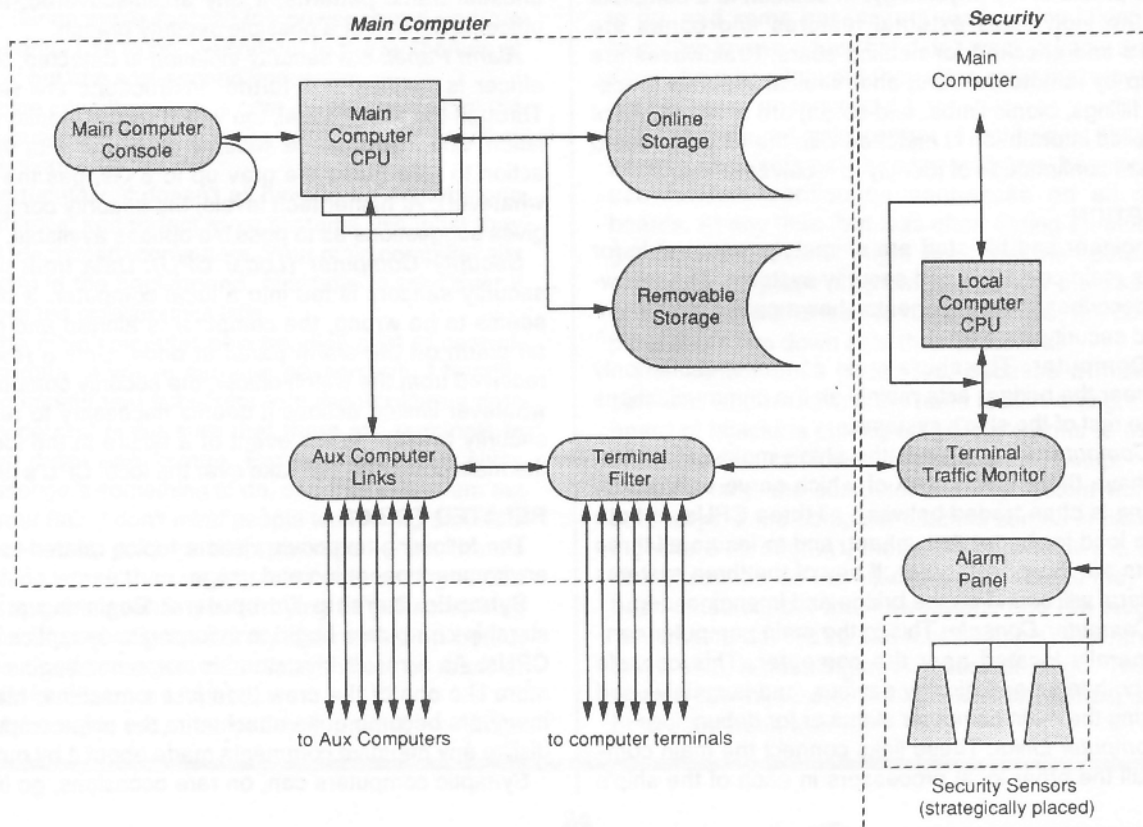

Hull and Environment

The hull and its sealed environment form the ship's "body". Although the details of a starship's hull and inside environment may seem obvious at first glance, a closer examination can reveal some very interesting aspects about its construction and function.

HISTORY

Spacecraft first appear in most cultures at about tech level 6. These early space vehicles often employ quite crude hull construction and environmental controls.

Hull: The first spacecraft hulls are generally crafted from soft steel and similar heavy metal alloys.

Development of new alloys progresses from soft steel to hard steel. However, even these alloys become rapidly outdated as the flow of engineering advances follows a culture's early space explorations.

At tech levels 8 and 9, most cultures begin to deploy new craft whose hulls are made of several composite layers. Similar to ceramics in structure, these new materials revolutionize the battlefield by making armored units far lighter and more maneuverable while maintaining their armor protection. Composites prove effective enough that they remain popular throughout tech levels 8 and 9. The techniques of composite hull fabrication remain largely unchanged until the introduction of crystaliron at tech 10.

Although the methods for creating crystaliron generally appear at tech level 9, it must be produced in orbit because the manufacturing process requires a weightless environment. Such an environment can also be obtained on a world's surface once gravitic technology becomes widespread at tech level 10.

At tech level 12, the increasing power of artificial gravity technology results in the development of superdense armor. Produced by compressing the molecular structure in extremely high gravity fields, this newly created class of material is able to withstand assaults that would have overwhelmed lesser armor.

A totally unrelated development in hull construction also appears at about tech level 12: chameleon starship hulls. Just as personal combat armor produced in this period is able to alter its exterior emissions by means of a chameleon circuit, many starships built from tech level 12 on incorporate this hull technology.

With the dawn of tech level 14 comes another major innovation in craft hull armor protection, bonded superdense. An advancement of superdense technology, bonded superdense incorporates an integral circuit which aligns the hull atoms for maximum strength.

Environment: Early spacecraft have only the crudest life support capability. Crew conditions are often uncomfortable and adequate only for a limited duration. One of the major considerations of low tech spacecraft is mass. With less effective propulsion systems available, the designers of early spacecraft cannot afford to pack the spacecraft with gear that does nothing more than make the mission a "nice trip" for the crew. Hence, crew comfort is often sacrificed for spacecraft viability.

As propulsion technology improves, more space becomes available for better environmental systems. As gravitic drives replace reaction drives and fusion becomes the primary means of providing power, the problems of mass become much easier to deal with.

Modern spacecraft devote a great deal of space to making the onboard conditions for the crew and passengers as comfortable as possible. Indeed, a traveller on a large luxury liner may find a more pleasant environment than can be found on many worlds within the Imperium.

THEORY

A starship's hull and environmental control typically consist of many systems.

Hull: Lower-tech hulls crafted from hard and soft steel are nothing more than ferrous metal shells. By employing materials which share the characteristics of both metals and ceramics, composite hulls offer greater protection to those aboard a craft while weighing less than normal ferrous hulls. Careful alignment of the hull layers serves to brace its structure, and allows the stress from an impact to be distributed across a wide area of the vessel's hull.

With gravitics comes a plethora of changes to a culture's standards of living. The uses of gravitic technology extend far beyond those which seem obvious at first. One such spin-off technology is the fabrication of crystaliron.

Crystaliron hulls are forged of lightweight ferrous metal alloys which are manufactured in a perfect zero-gravity environment. In such a setting, iron can be "grown" in a manner similar to some crystals. Free from the disturbing influences of gravitational fields, the structure of crystaliron can be tailored to provide maximum strength and minimum weight.

As gravitic technology continues to improve, much stronger grav fields can be created and maintained. By the time a culture reaches tech 12, high intensity gravity fields allow superdense alloys to be created.

Creating a superdense hull begins by selecting the hull material (usually crystaliron). When the hull is formed, it is subjected to massive gravitational fields. The internal nuclear forces are manipulated, and the atomic structure undergoes a partial collapse. As a result, the density of the hull (and thus its durability) is greatly enhanced while its thickness is minimized.

At later tech levels, the merger of gravitic and nuclear damper technology permits the atomic structure of a superdense hull to be enhanced even further. The result, known as "bonded superdense" armor, can provide the same protection for a vessel as normal superdense armor, but at roughly half the thickness.

All hulls incorporate within them a series of thermal radiator strips which permit the vessel to dissipate excess heat which might be hazardous to the crew of the ship. At times of extreme energy production (such as during the preparation for jump) these strips can grow visibly hot as they shed unwanted heat.

The chameleon circuit used on many higher-tech starships allows them to actually alter their appearance. The

hull circuit alters the frequency of electromagnetic energy (usually limited to the IR, visible light, and UV segments of the spectrum) reflected or emitted by the ship.

A series of refinements in material science, gravitics, and nuclear damper technology allows altering the hull surface so that it absorbs more or less light. By selecting different frequencies, the appearance of the craft can be altered to our eyes and even to sensors.

Environment: The environmental systems can be broken down into these areas: climate, provisions, and gravitics.

Climate control consists of controlling the craft's internal temperature, humidity, atmosphere, lighting, and sonics. The provision system deals with the supply of food and drink, and with the recycling of waste products. The internal gravitic array consists of grav plates, and optionally, inertial compensators.

When a hull is first laid down, the inner surface is equipped with gravitic plates which give the crew complete control over the internal gravitation fields on their vessel. During normal flight operations a single "down" direction is selected and quickly becomes the standard for the routine operation of the ship. In most cases, this lines up with the "belly" of the ship. In addition, the hull is gravity shielded to prevent the internal artificial gravity field from extending beyond the ship. Without such shielding, a crowded starport would quickly become a chaos of conflicting gravitational fields.

The other aspect of most ship's gravitic arrays is the inertial compensators. The inertial compensators are directed by the main computer in response to inertial forces as the vessel moves. This way, as the ship changes course, those onboard feel no sensation whatsoever of movement. Inertial compensators can normally respond to and counter fluctuations of up to six gravities.

DESCRIPTION

The engineer and his staff are ultimately responsible for the hull and inside environment. The text below describes the components on the hull and environment diagram.

Airlock: Airlocks serve a simple function: they permit the occupants of the ship to travel from one environment (inside the ship) to another (outside the ship) and vice versa without disturbing either of the two. Almost every spaceship is equipped with at least one airlock, although there are exceptions. Extremely small craft such as fighters, for example, do not normally incorporate airlocks.

To operate the airlock, the operator steps into it and closes the iris valve or hatch behind him. Air is pumped into or out of the chamber as required to make the environment in the lock similar to that which the operator is planning to enter, and the other hatch opens to permit exit. In actuality, the behind-the-scenes process is somewhat more complex.

A series of safety interlocks normally prevents both ends of the airlock from being open at the same time. If either end is opened, the iris valve or hatch at the other end remains secured in place.

In the event of an emergency, the door on either end can be ejected by means of explosive bolts triggered by means of a sealed touchpad. In most cases, the explosive bolts would be employed only in rescue situations.

A less dramatic means of opening the airlock in an emergency uses a manual windlass which, although slower than the explosive bolts, leaves the airlock functional afterwards.

Airlock Controls: All airlocks incorporate three data displays. The exterior door display shows data on the environment outside of the ship, the interior door display shows the ship's interior conditions, and the third display inside shows the environment within the airlock itself. If all three locations are within a certain range of each other, the doors on both ends can be opened at once. Otherwise, only a single door on either end can be open at any one time.

Airlock Chamber: Inside the typical airlock is an emergency cabinet which contains a vacc suit, patch kit, fire extinguisher, and first-aid kit. Also inside most airlocks is a power socket for the operation of tools and such.

Airlock Computer (Local CPU): The airlock computer controls the airlock operation. The local computer is connected to the ship's main computer, which acts as a backup to the local CPU in the event that it fails.

Environmental Systems: The environmental systems control the ship's climate, usage of provisions, and gravitics.

Temperature: Most temperature regulators are fairly simple in design and operation. Based on input from the local computer system and the master computer, they maintain an even temperature in any room of the ship.

Humidity: Humidity in various rooms of the ship is controlled via the normal air circulation system. If the air is too humid, excess moisture is removed as the air is recirculated. In a similar manner, if the air is too dry, additional moisture is added to the air circulating through the room.

Atmosphere: The gas mix of the air can be varied for each region of the ship sealed by a bulkhead. Also, a wide array of scents can be added to the basic atmospheric gas mix.

Many ships incorporate an atmospheric release of sleep-inducing gas as part of their internal security system (see the Security section).

Lighting: Most areas of the ship are illuminated by broad light panels or strips on the ceiling. These panels produce visible light without heat. When an electrical current is applied, the panel begins to glow faintly. If more light is desired, additional current is applied and the glow intensifies. Complete control over the color of light is possible, as is its brightness and focal point. Various settings permit the area to be lighted with anything from a dim red glow to a brilliant violet glare to dark with glistening pinpoints of light (resembling a night sky with stars).

Sonics: Sonic climate control is separate and distinct from the ship's internal communications network. Sonic climate control provides each occupant the desired background noise he prefers in his stateroom (if they want any at all). Options include everything from white noise static to ocean surf with birds.

Food/Fluids: Most starships incorporate at least a token galley for food storage and preparation. Here, a variety of preserved foods is available from a computer controlled kitchen. Most meals are stored in a condensed state until selected by a crewman or passenger.

Liquid refreshment, however, is generally available at several points throughout the ship. Conduits running from the galley provide the user with any of several types of drink.

Waste/Recycle: Due to the frequency with which most

commercial starships can take on supplies, there is little need for waste recycling. Ships which operate for extended periods of time without visiting port, on the other hand, often do have extensive waste reclamation ability.

Biological wastes, table scraps, and similar refuse are stored until a certain quantity is acquired and then broken down by means of a combined aerobic and pyrolytic process. The waste is rapidly decomposed in a chamber which contains a reduced oxygen atmosphere and microorganisms which have been specially tailored to survive only within the confines of the recycling system.

The refuse breaks down quickly into gases which are stored until used in various ways (such as the replenishment of the atmosphere aboard ship) and other liquids which are chemically isolated and stored for use. In large scale systems, these by-products can even be used to fabricate additional food stores when they are mixed in proper combinations and supplemented with various nutritional additives.

Gravity: To a certain degree, each occupant can vary the gravity in his stateroom. Some starships maintain a standard field inside their ships. Others gradually alter the gravity field as they travel from world to world.

To better understand the advantages of the alteration approach, consider the following example. The free trader *Koordar* lifts off from Beck's World (Spinward Marches 2204) with the floor field set to match the planet's one gee environment. The vessel jumps to Enope (Spinward Marches 2205). During the week that the *Koordar* is in jumpspace, the computer gradually alters the internal gravity to match Enope's normal 0.125 gee field. In this way, the passengers and crew are somewhat prepared for the gravity environment of the world to which they are heading.

Military vessels are an exception to this rule. It is standard operating procedure for an Imperial military craft to maintain a constant one gee field at all times. Other exceptions can be found among the various minor races both inside and outside of the Imperium. For example, Dolphins, an aquatic minor race from Terra, normally maintain zero gravity on their ships so they can move freely about.

Normal operational parameters permit the crew to create a gravitational field of up to 1.5 gees. Upon direct authorization of the commanding officer, the floor fields can be increased to as much as three gees.

Inertial Compensators: The inertial compensators are directed by the main computer in response to normal ship

HULL AND ENVIRONMENT



I'll never forget the first time I got stuck in an airlock. I was 18 years old, and had just enlisted in the Navy a month before. I'd spent two weeks at Macene, and then been transferred to Jae Tellona. (I know what you kids are saying: "Two weeks training and then onto a ship?" Just remember, there was a war on at the time.)

Anyway, I'd had a pretty good education at home, and the Navy'd trained me as a sensor technician, so when the neutrino sensor gave out for no reason, they sent me and another tech out to fix it. We put off going as long as we could — but the computer didn't show anything wrong with the circuits, so we assumed micrometeor damage and went out to check.

Fixing the sensor was about what we expected — an hour of work, complicated only because we had to vacc weld it. Coming back, I suddenly remembered that I'd tacked my hand computer to the hull so I could look at it while working with both hands, so I turned around to get it and the other tech cycled through before me.

So I get through the outer door, key in the sequence, and the valve moves about three quarters of the way and stops. It didn't bother me much, I'd almost grown up in an airlock, and I'd seen doors jam before. Except that this one wasn't closed, but wasn't really open either. I was still in vacuum, and didn't want to risk squeezing through the doorway to go out and over to the starboard lock. Iris valves are specially designed so they can't close if anything's in

them, but one thing I'd learned in life — *never* stick your hand through an iris valve that's stuck, unless you'd like your friends to call you "Lefty".

Still didn't bother me, except that my suit radio starts blaring an "all stations" — remember what I said about there being a war?

I'm not sure how much you know about starship design, but some don't have inertial compensators.

And the airlocks don't have crash couches, either.

They do have bulkheads, though, and I had several opportunities to study each of them at close range before I had a chance to grab the safety handles. Still, it was a job to hang on, and I was grateful that the *Allamu* had only 4 Gs acceleration or I might have been thrown around even more. It ended up all right, or I wouldn't be here telling you about it today, but it's not something I recommend to anyone.

Which reminds me of a saying our training officer was fond of: "You're never too close to a vacc suit." We used to have drills for it. Into the vacc suit, out of the vacc suit, into the vacc suit, out of the vacc suit, the chief could keep us going for hours at a time if he didn't think we were doing it right.

Sure we were tired, but he said we'd be worse when we had to get into 'em, and he was right. We trained in the dark, of course, because no telling what the situation will be when it finally happens.

Final exam was held inside a pressurized room with double walls. They had it set up so they could depressurize it in a couple of minutes. A klaxon would sound, the lights would go off, and you had two minutes to pull your suit on, in explosive decompression, in the dark. If you couldn't make it you got ground duty or a medical discharge, depending on

Continued on page 30

inertia from moving about and maneuvering. Despite the best efforts of the computer, violent maneuvers may occasionally be felt by the occupants.

Environ Controls: There is seldom a shipwide standard environmental setting. The climate a passenger from a desert world might find comfortable is probably not the same as one from a water world would select. Because of this, the staterooms (and other rooms as well, such as the bridge) on most vessels are equipped with a complete array of environmental controls. During normal flight operations, an occupant can set the environment of the room to any climate which he finds comfortable.

Of course, there are limits to the flexibility of such systems. The atmosphere on a starship operated by a family of Dolphins, for example, is maintained at very high humidity levels, making almost every area of the craft much too humid for most humans. In a region which is as diversely populated as the Third Imperium, many such environmental conflicts exist.

Common areas of the ship (such as the corridors or galley) are controlled by the main computer under direction from the Captain. A "default" environment is selected so that everyone on board is as comfortable as possible.

Again, such a compromise is not always possible. If one of the passengers on a ship is an alien who finds a trace of hydrogen cyanide in his air to be fragrant and refreshing, a vessel with mainly humans on board would not introduce such a poison into the entire ship's main air supply.

Environmental Computer (Local CPU): The environmental computer (one per room on the ship) handles the operator commands given to the environmental systems. Each local computer is connected to the ship's main computer, which acts as a backup to the local CPU in the event that it fails.

Accessways: Access from one area of the ship to another is possible through doors, hatchways, and corridors.

Portal: The most common portal (or door) found on a starship is the simple sliding door. Employed in situations where strength is not a concern (such as the entrance to a stateroom), these are little more than heavy sheets of ceramic or plastic. Doors of this type are not airtight.

The common portal used in bulkheads is the iris valve. It provides an airtight seal, and yet fully retracts into the wall when open, just as does a sliding door. Most wall-mounted iris valves open automatically when sensing approaching objects. Floor/ceiling-mounted iris valves, however, must be opened manually by means of a touchpad; the valve will

Continued from page 29

how long you could hold your breath.

Fortunately, the atmo systems on a vessel are some of the best, and I've never had to pull on a suit inside a ship when there wasn't a war on. I still practice, though, and so do all my crewmembers, once a month for a half hour or so. You never are too close to a vacc suit.

Speaking of atmo systems, there's a lot more to it than most passengers realize. It's not so much a matter of recycling air; most systems use a pressurized oxygen-nitrogen mix, and the recycling gadgetry is kept around only for backup. But the real problem is keeping the place smelling clean. Think of what the inside of a vacc suit smells like if you put it away without proper care after using it, then multiply that by 10 crew members and 10 passengers, and remember that it builds up for a week (or more if you operate orbital), and you start to get the picture.

The air has to be kept circulating, and constantly cleaned and refreshed. Some ships will use scents, artificial or otherwise, to try to liven things up, but I've never gone for it and none of my crew or passengers have ever asked, so I don't use it. I understand, though, that K'kree ships pay more attention to the smells than to the gas mix. If my nose were as sensitive as theirs, there would have been times in the Navy when I'd have had to skip chow.

Sound's another part of enviro systems that people overlook. A ship's a noisy place; any one of the drives could bust an eardrum if it wanted to. They quiet them down with sound generators that cancel out a lot of the hum, but they're still loud. The engineers have to live with it, though, so they use ear

protectors with commo built in. Even buck passengers soon learn to recognize these guys with their "ears" on. (I've always thought it made 'em look like those lizards from Mongo, but I wouldn't say it to anyone's face.)

The rest of the ship is protected by insulating walls and the like, so a passenger's cabin could be next to a drive and he wouldn't know it.

Grav's another system essential to a ship. Most people enjoy the feeling of weightlessness the first time they try it (if they don't get sick, that is), but zero-G isn't healthy for weeks at a time. Being thrown about a cabin during maneuvers isn't any fun, either.

Grav plates are vital to the ship's operations. I've known ships that took off without qualified gravitics techs on board, but I've never been the captain of one.

If the plates ever go out, passengers are in real trouble. Somebody not used to low gee can get hurt pretty quick. "How do you break your leg going downstairs in low gee? In three easy steps." It's an old joke, but true. I've also heard of folks who decided to enjoy the zero-G and float around their cabins. If the systems come back on suddenly, they usually regret it.

We also steadily adjust the grav plates over the week, so that if we pick up passengers from one world and are travelling to one with higher gee, we can turn it up gradually and they're not so flummoxed when they disembark.

issue a warning signal that must be overridden if someone or something is on it when instructed to open.

A closing iris valve slowly shuts to allow those within the portal to clear it and escape potential injury. Most iris valves are equipped with sensors that prevent them from closing completely when something (or someone) is inside them, but remaining in a closing iris valve is not recommended. (If necessary, an iris valve can be instructed to seal itself in under one second, regardless of obstructions.) Most iris valves employ a manual opening and closing system for backup in the event of a power failure.

A cheaper means of providing access to less travelled bulkhead-sealed areas of a starship is the manual hatch, which must be instructed to open by hand. Most manual hatches provide a windlass system for opening them during a power failure. A hatch can be locked from either side but, again, the ship's computer can override any locked hatch and open it. Hatches are airtight.

Accessway Controls: This is a touchpad control panel allowing the portal to be locked or manually opened. Iris valves and hatches will not open if they register a significant pressure differential on one side. The only way to get them to open in this case is to issue a special access override code via the ship's computer. Some iris valves and hatches also incorporate explosive bolts for use in opening the portal in an emergency.

Doppler Motion Sensor: Most sliding doors and iris valves incorporate doppler motion sensors, which detect an object moving toward the door and cause it to quickly open. The sensor can be set to "lock" by means of the accessway control touchpad mounted near the door. A locked door can be opened only from the side on which it was originally locked, or can be overridden by means of a special access code instruction given to the ship's computer.

Accessway Computer (Local CPU): The accessway computer (one per portal on the ship) handles the operator commands given to the portal. Each local computer is connected to the ship's main computer, which acts as a backup to the local CPU in the event that it fails. The main computer link also allows overriding the local portal commands by the use of a special access code.

RELATED TOPICS

The following text covers some topics related to hull and environment operation and usage.

Hull exterior extras: Many starship hulls include a series of power outlets and safety line clips across the entire surface. Variations on this include power outlets that require an access code to use, or safety line clips that extend or retract on command (to reduce drag on airframe hulls).

Chameleon hulls: The chameleon circuit in many starship hulls allows the ship to do a number of interesting things. In addition to altering the ship's external color, this technology can be used to disguise his ship if it has landed in the wilderness, for example. The reverse is also possible, of course: a crashed or disabled starship could be turned fluorescent orange to make its location obvious to search teams.

Exacting computer control over the circuit which manifests this function even allows patterns to be created on the hull, heralds to be displayed, or names to become

lettered as desired. Nearly all starships make use of this device to customize the ship in some way on a portion of the hull. Solomani traditionally decorate the nose of a craft, while the Zhodani color the tail sections, and the Vilani stylize the underside of the ship. Other races often employ their own unique methods of customization.

Pirates and privateers often make use of chameleon hulls to strike terror into the hearts of potential victims. A pirate ship will often close on another craft using false transponder identification and then suddenly turn jet black as it comes within visual range. A touch sometimes seen among Solomani pirates is the display of a great white skull and crossbones on the exterior of the hull. Vilani pirates often make use of their traditional flaming eye in a similar manner.

Ship naming conventions: When a starship is constructed, it is generally given a name by its owner. Since many pieces of installed equipment may come and go during a starship's life, either due to upgrades, replacement of damaged or worn out components, or even simple changes of taste, the name given to the ship refers primarily to the ship as an entity. Thus, whatever changes might be made to the ship's systems, tradition permits renaming a ship only if major structural changes have been affected.

Perhaps the most striking example of this tradition occurred during the Long Night when a Vegan fleet came across a number of derelict Terran starships. After an examination, they were towed into port, repaired, and refitted to make them suitable for use by the Vegans. However, in deference to those who once served aboard them, the Vegans retained the original names of the vessels. Thus it was that the Vegan fleet came to possess the battleships *New York* and *Beijing*, as well as the destroyers *Coyote*, *Jackal*, and *Timberwolf*.

Many ships across the Third Imperium are often built to very similar specifications. The advantages of such a practice are many and range from reduced construction costs to ease of crew transfers from one vessel to another. Ships built to similar design specifications are considered fit into a certain "class" of vessel. A class is often named for the first example of its type to be laid down (although not always the first to be completed).

The *Beowulf* class free-trader, for example, is one of the most common classes of ship to be found in the Imperium. By tradition, all ships of this type are named for fictional characters and heroes. A Vilani owner might name his craft the *Ashi Hagarr*, after the ancient mythological hero of a major polytheistic religion on early Vland, while a Solomani owner might select the name *Icarus* or *Peter Pan*.

Internal walls: Many internal walls are constructed of light-weight materials such as plastic or inexpensive metal alloys. Very important or dangerous areas of the ship, on the other hand, generally have heavy-duty bulkheads as walls. For example, a starship's bridge is always isolated from the rest of the ship by a layer of hull metal. Further, the drive sections are surrounded by bulkheads.













Areas sealed by bulkheads will maintain their internal environments in the event the hull is breached in an adjacent area. Ordinary internal walls will not maintain their internal environments, and are not airtight.

Hull and Environment Section is Continued on Pg. 44

BOWULF CLASS

200-TON FREE TRADER

LEGEND

- | | | | |
|---|---------------------------------|---|-------------------------------|
|  | ceiling mtd.
iris valve |  | window |
|  | floor mtd.
iris valve |  | airtight
bulkhead |
|  | floor & clg. mtd.
iris valve |  | interior
partition |
|  | iris valve |  | access
panel |
|  | acceleration
couch |  | sliding
door |
|  | fresher |  | folding airtight
partition |

Fire Control
(P/S)

Air Raft

Air Raft
Garage

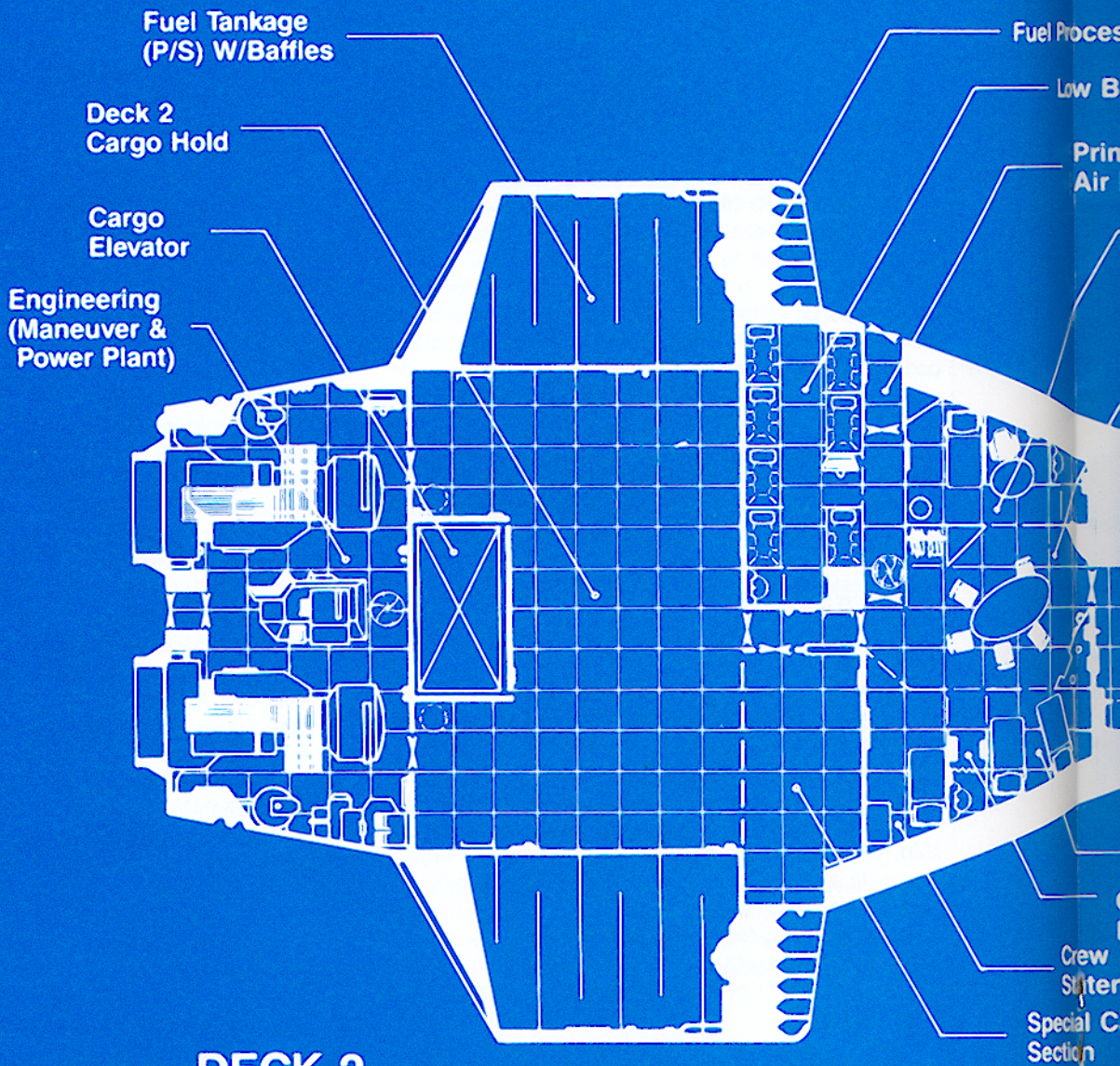
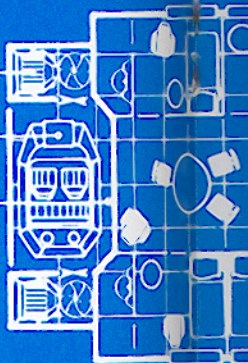

DECK 2

DECK 1

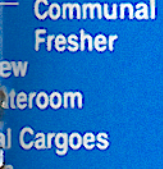
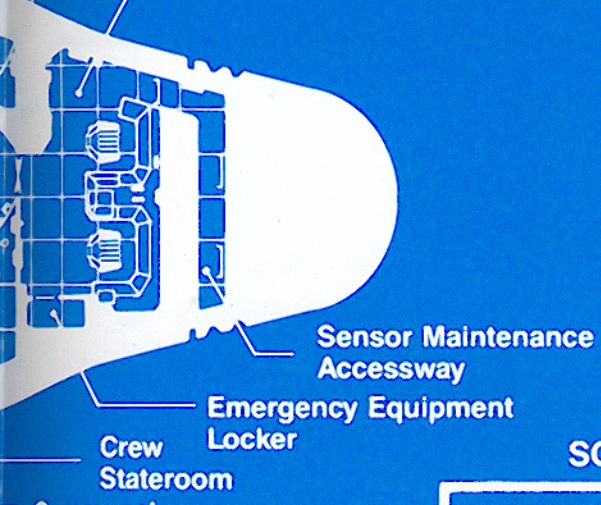
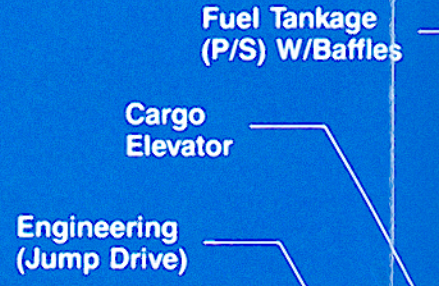
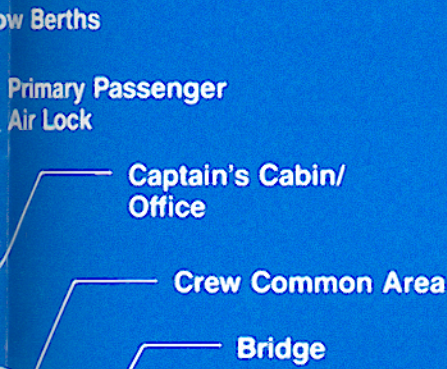
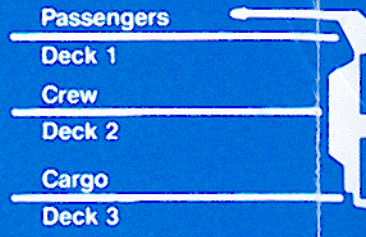
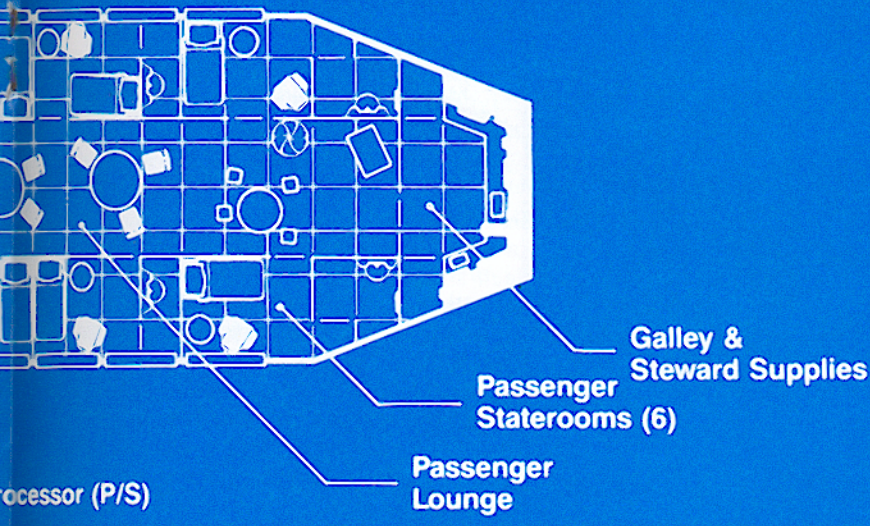

SCALE

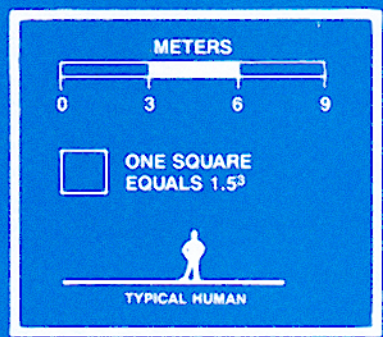

DECK 3

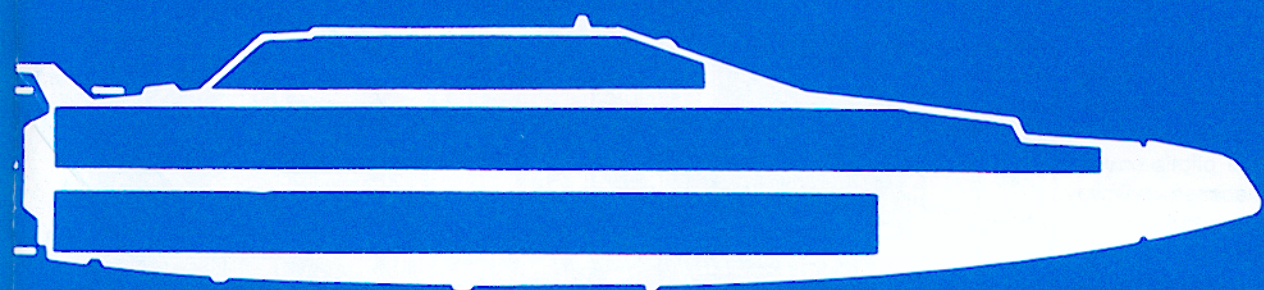

DECK LAYOUT CUTAWAY

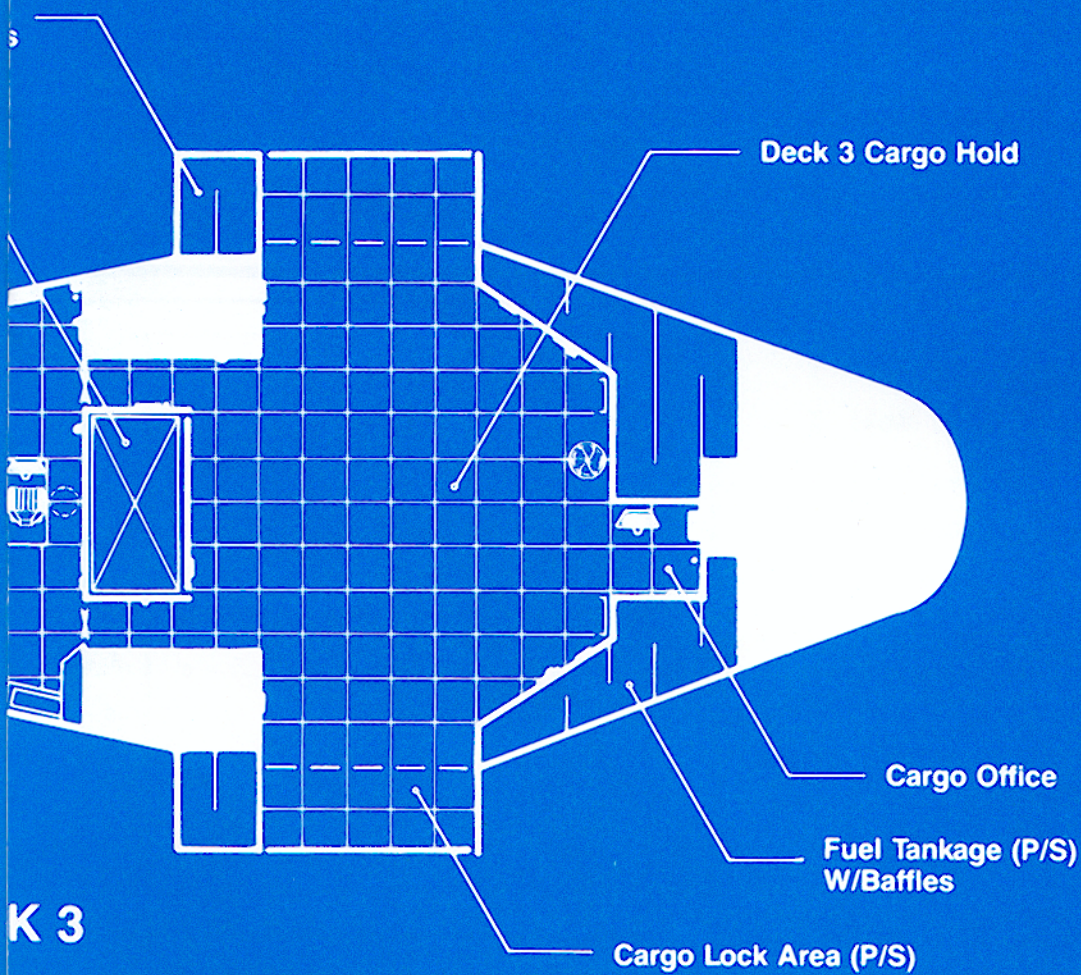

Drawn by Rob Caswell

BRIDGE

Besides the pilot and copilot/navigator stations shown, the bridge houses the ship's main computer just behind the acceleration couches. This station includes the holocrystal library data files, test outputs, and spare parts storage.

Also behind the acceleration couches: a refreshment station that dispenses drinks and snacks, fire extinguishers, two emergency lockers with vacc suits and emergency gear, and storage cabinets with spare parts and tools.

To the left side of the pilot's couch is a cover leading to an avionics access crawlway.

Any ship function is available from the bridge, although the primary bridge control functions are flight, navigation, communications, security, and sensor operations. The copilot couch has a control stick similar to the pilot's and can be used as a repeater for piloting the ship.

The holodynamic control consoles are featureless, touch-sensitive panels. These panels can be altered to display whatever the user wishes, even in three-dimensions complete with tactile feedback. Once configured, the setup can be saved and later recalled at a moment's notice.

The acceleration couches not only provide durable seating, but have these additional features:

- A restraint harness.
- A self-contained environmental system, using independent battery power. This system can be linked into a vacc suit when conditions dictate.
- Each couch can move forward or backward along a track in the floor and can swivel 360 degrees.
- Each couch includes fold out work surfaces.

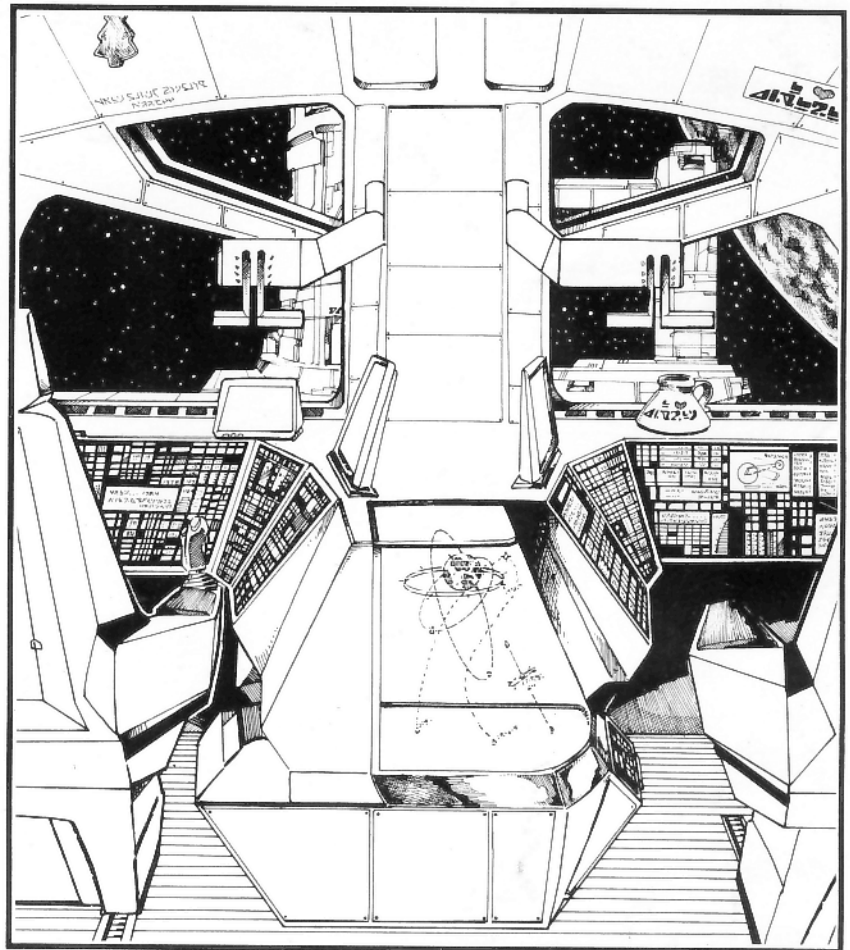
**BRIDGE**

- 1 Pilot's acceleration couch
- 2 Copilot's acceleration couch
- 3 Navigation holodisplay
- 4 View ports
- 5 Pilot's holodynamic panels
- 6 Copilot's holodynamic panels
- 7 Flat reconfigurable displays
- 8 Pilot's control grip
- 9 Holographic displays (both panel and forward heads-up)

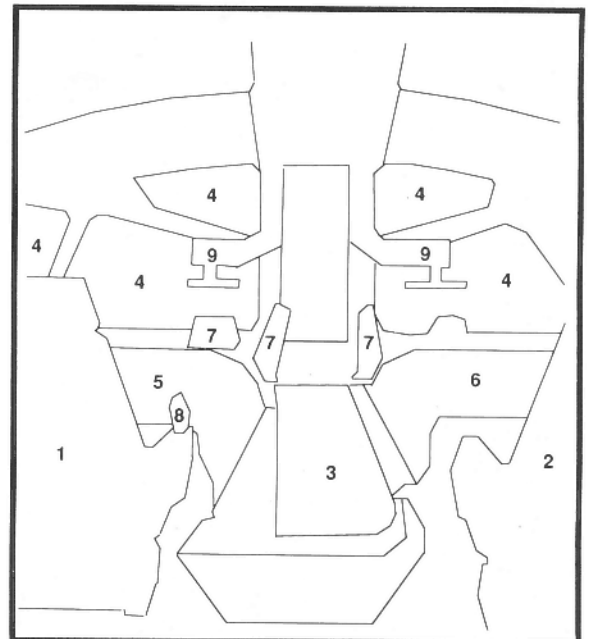

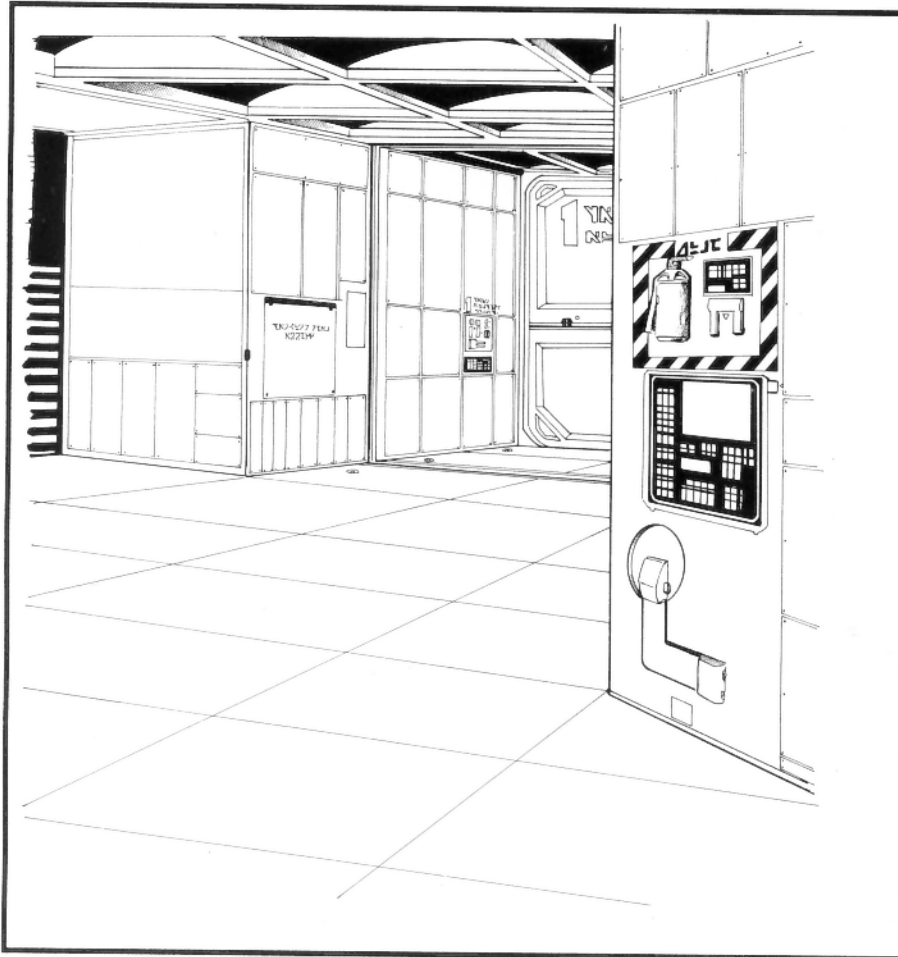

CARGO HOLD

The ceiling in this area is lattice-work with light panels set in between. The distance from the floor to ceiling is four meters — one meter higher than standard deck height.

The cargo hold is carpeted.

Most cargo is taken aboard in standard cargo containers, which have on their surfaces a company logo, a manifest readout, and any special handling symbols.

There are two cargo bay doors in this area: one port and one starboard (the port one can be seen in the background). There is a secondary partition door which folds into the floor and can be used as a cargo airlock.

In the aft area of the hold (beyond the left side of the picture) is an enclosed elevator for moving cargo to the second deck hold.

Just to the right foreground beyond this picture is the main cargo hold workstation.

CARGO HOLD

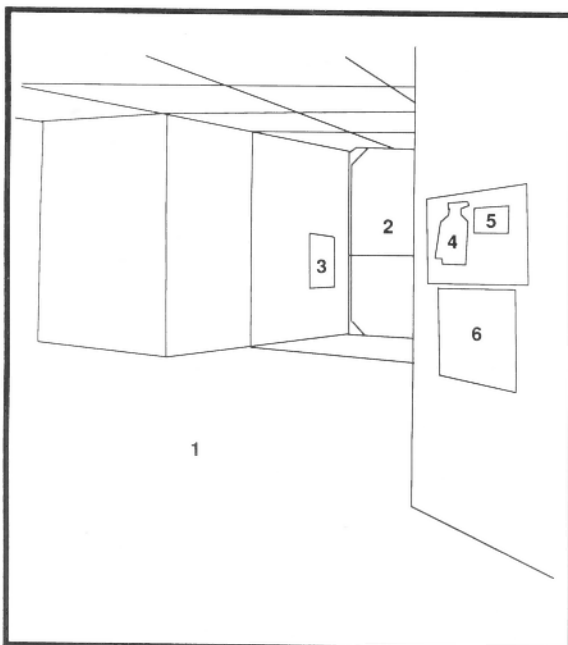

- 1 Cargo bay area
- 2 Main outer cargo door
- 3 Cargo airlock controls
- 4 Fire extinguisher
- 5 Emergency alarm panel
- 6 Cargo hold environmental panel

CORRIDOR/AIRLOCK

This segment of corridor shows the main airlock entrance to the vessel. While in flight, the inner airlock iris valve is normally closed. This scene shows the inner valve open, as is common while in port.

Notice that the inner airlock iris valve opens flush to the walls and floor with no rim, and thus can be walked over as any other section of the floor.

Just beyond the scene are floor and ceiling iris valves near the right wall with access via a ladder set into the wall. Next to the ladder are the iris valve controls. The floor valve is flush with the floor, again with no rim. It can be walked on just like any other portion of the floor. Sensors detect anyone standing on the floor iris when a command has been given from below to open it. A gentle alarm is sounded to warn the individual to stand back while the valve opens.

Also just beyond this view, the walls sport a comm panel and an alarm console next to an emergency equipment cabinet holding fire extinguishers, spare vacc suits, and so on.

This area is carpeted, as are all accessible areas of the ship except for engineering. The carpeting in the passenger section of the ship tends to be the most plush.

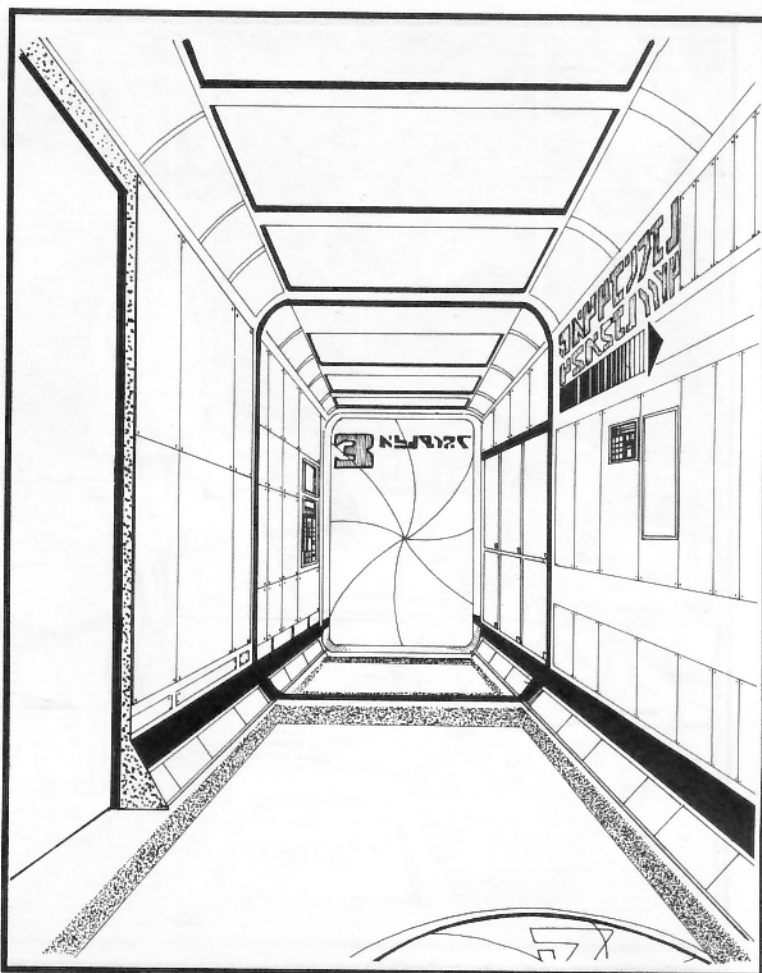

CORRIDOR/AIR LOCK

- 1 Main entrance corridor
- 2 Main entrance airlock
- 3 Outer airlock door
- 4 Airlock control panels (with view screen)
- 5 Inner airlock door
- 6 Sliding door to low berths
- 7 Lighting panels

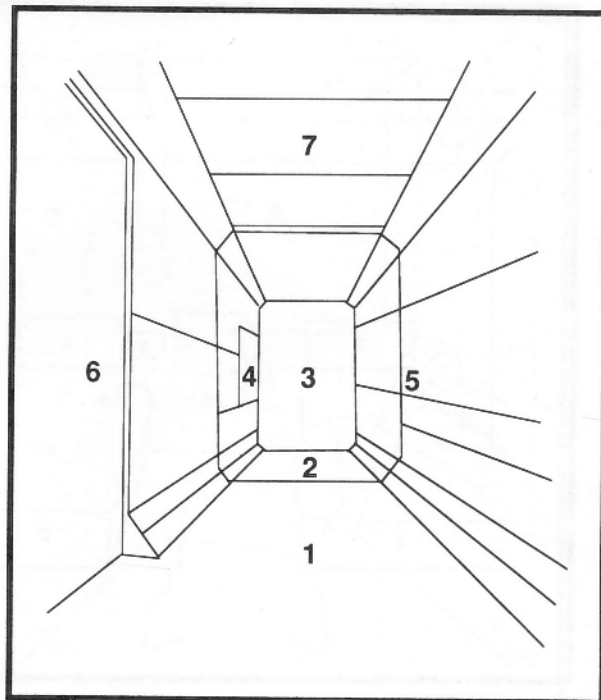

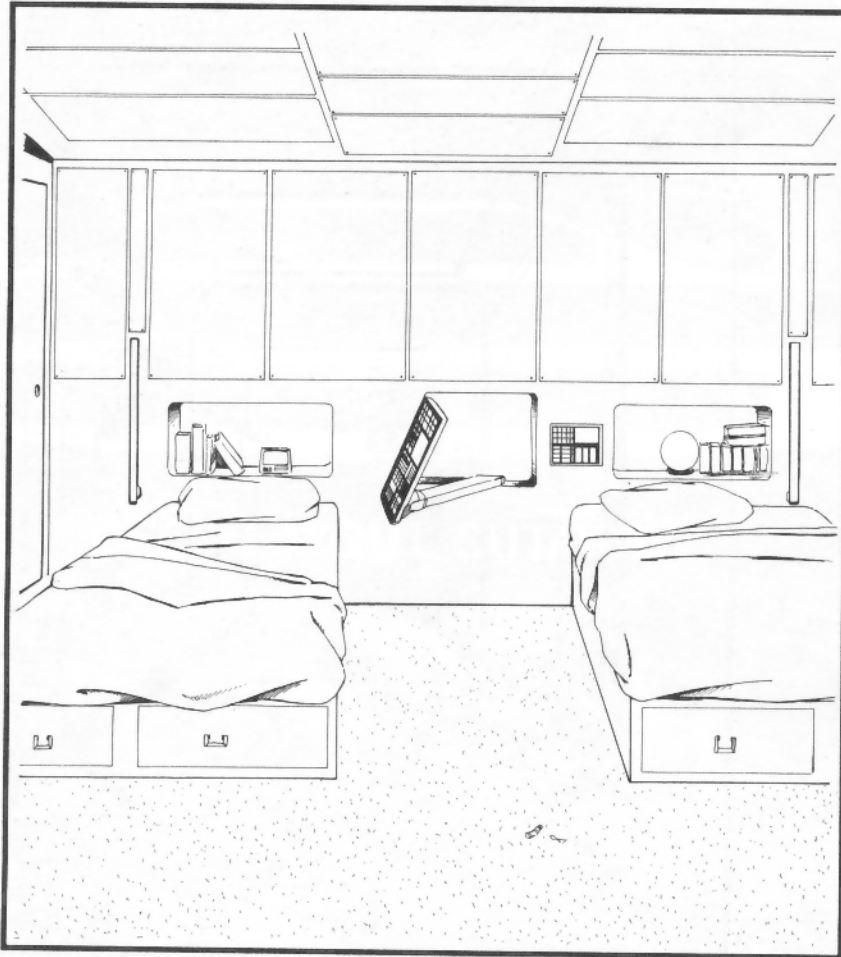

CREW STATEROOMS

The crew's beds have storage cabinets built into their bases. Next to the beds are small dynamically reconfigurable panels, used primarily for communications and as mini-entertainment consoles. The computer terminal is on a hinged, swiveling arm and can be oriented to face either bed. Many ship's functions can be operated from here in a pinch (provided you have proper clearance). Thus a crewman could work on the cargo manifest or even a navigation plot without ever leaving his bed.

Other features of the room:

- Carpeted floors.
- A chair (less plush than those provided for passengers).
- Walls finished in plastic and metal. Along the wall are fold-down table tops, storage cabinets, and shelves.
- A small wardrobe.
- Standard (non-luxury) light panels in the ceiling.
- An environmental control console (controlling lights, sound, temperature, atmosphere, humidity, and gravity).
- A refreshment station (similar to that on the bridge).
- A locker with vacc suits and emergency gear.

CREW STATEROOM

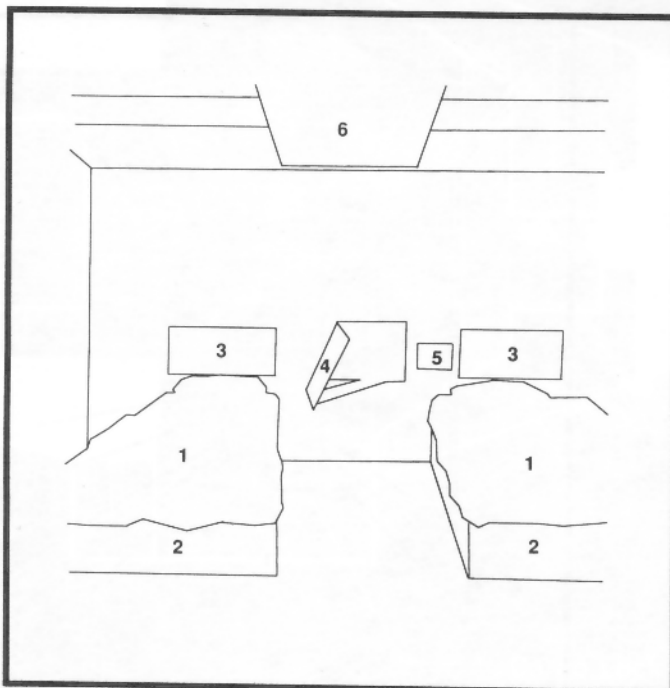

- 1 Bed
- 2 Under-bed storage
- 3 Headboard storage
- 4 Movable computer terminal
- 5 Stateroom environmental panel
- 6 Lighting panels

WEAPON STATION

The weapon station is the gunner's complete control center during a battle. From here, the gunner can monitor the status of all activity outside the ship, with full sensor repeater controls available.

The console includes three panels:

- A central turret panel, complete with communications and sensor controls, as well as turret settings and engineering readouts.
- A targeting panel, complete with track-ball.
- A third backup panel with critical manual controls in the event of a failure during battle.

Above the panels are a number of tactical situation screens and sensor displays.

The seating for the station is an acceleration couch, slightly smaller than those found on the bridge.

Just beyond the scene in the foreground is a floor-mounted iris valve. This iris valve provides access (with proper security clearance) into and out of the weapon station.

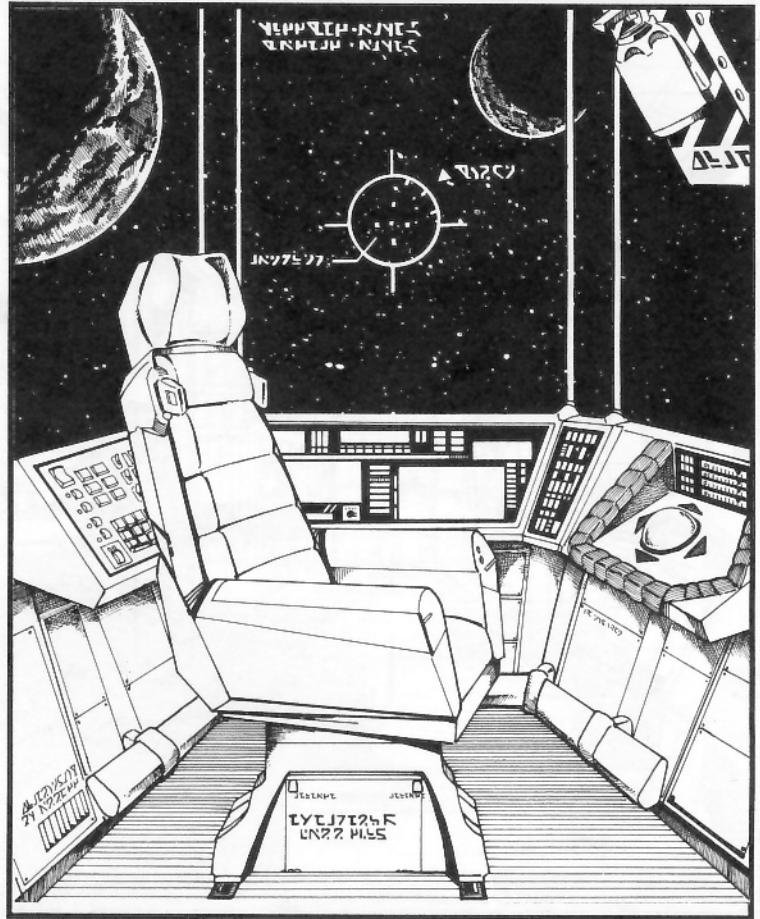

WEAPON STATION

- 1 Gunner's acceleration couch
- 2 Main turret panel
- 3 Targeting panel
- 4 Tactical situation displays
- 5 Backup panel
- 6 Fire extinguisher and alarm panel

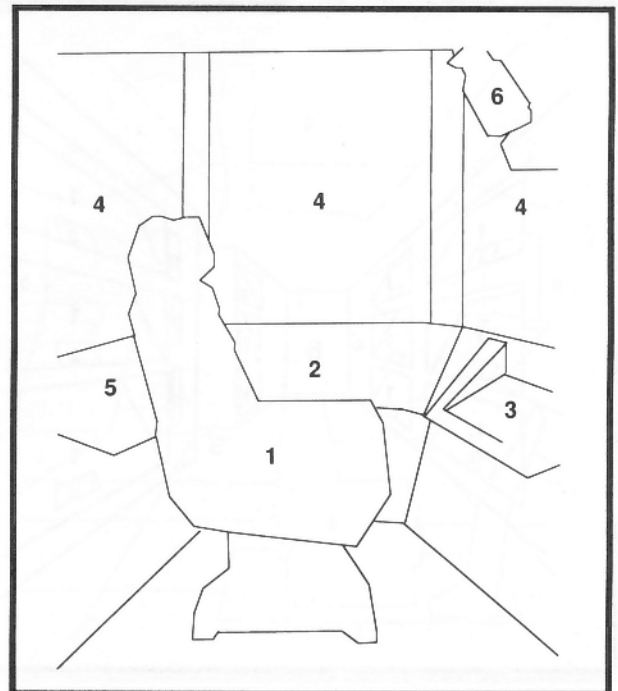

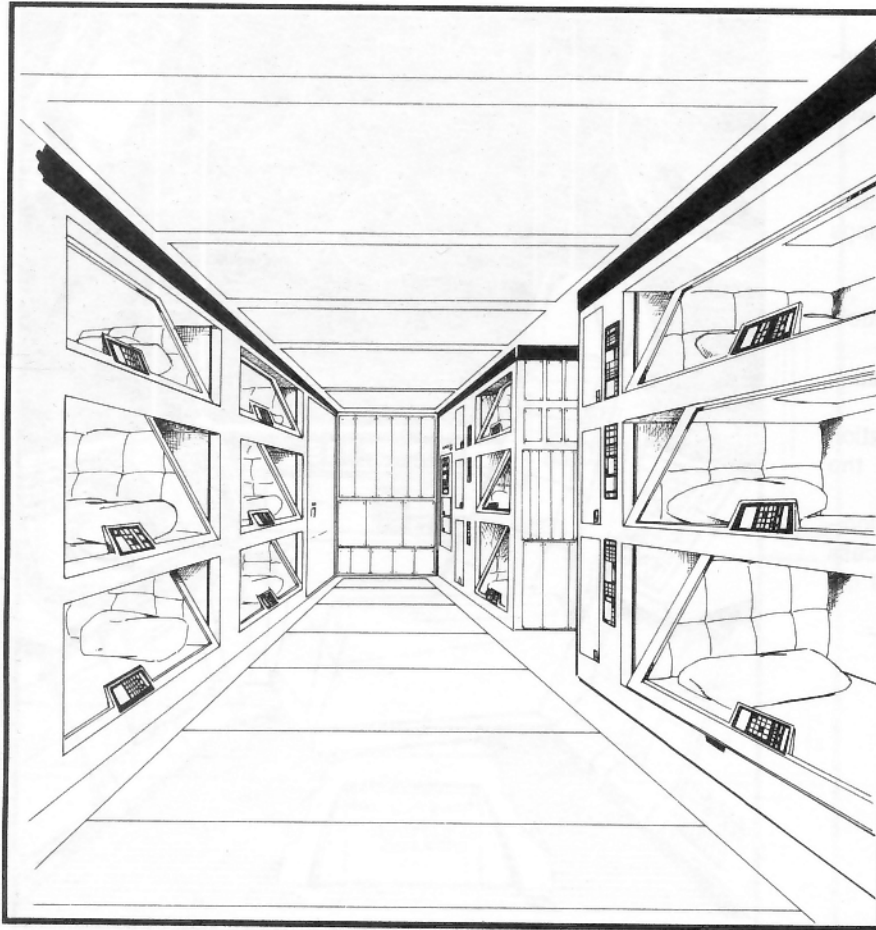

LOW BERTHS

The low berths are little more than glorified bunks with padded interiors. At the end of this room is a series of general storage lockers where each occupant can store a minimum of belongings (their regular clothes, and a couple of small items, not to exceed 50 kg). In addition, this room has:

- A small fresher.
- A refreshment station.

Each berth has a system monitor screen next to it, and each door has a readout of the berth occupant's vital signs.

Each low berth passenger is provided with a one-piece garment to wear during the trip. This garment includes monitors and probes linked to the monitors on each bunk.

LOW BERTHS

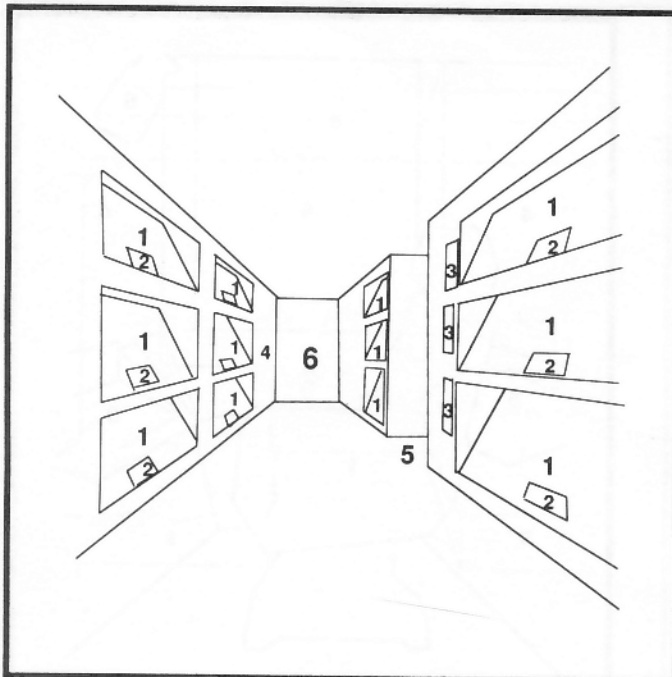

- 1 Low berth view panels
- 2 Occupant vital signs readouts
- 3 Individual low berth controls
- 4 Fresher
- 5 Doorway to main airlock corridor
- 6 Common storage lockers

JUMP DRIVE

The jump drive power plant takes up most of this room. There are several considerable power conduits leading into it from the power plant located in the floor below the floor grating. The drive power plant has several access panels and small readouts on its surface.

This area also has comm panels, tool bays, spare parts compartments, emergency alarm panels, fire extinguishers, vacc suit lockers, and first aid kits. The catwalk provides access to the upper surfaces of the power plant.

The engineering station has a dynamically reconfigurable panel on a control stalk and an acceleration couch similar to those found on the bridge.

The room is well lit by both ceiling and wall light panels.

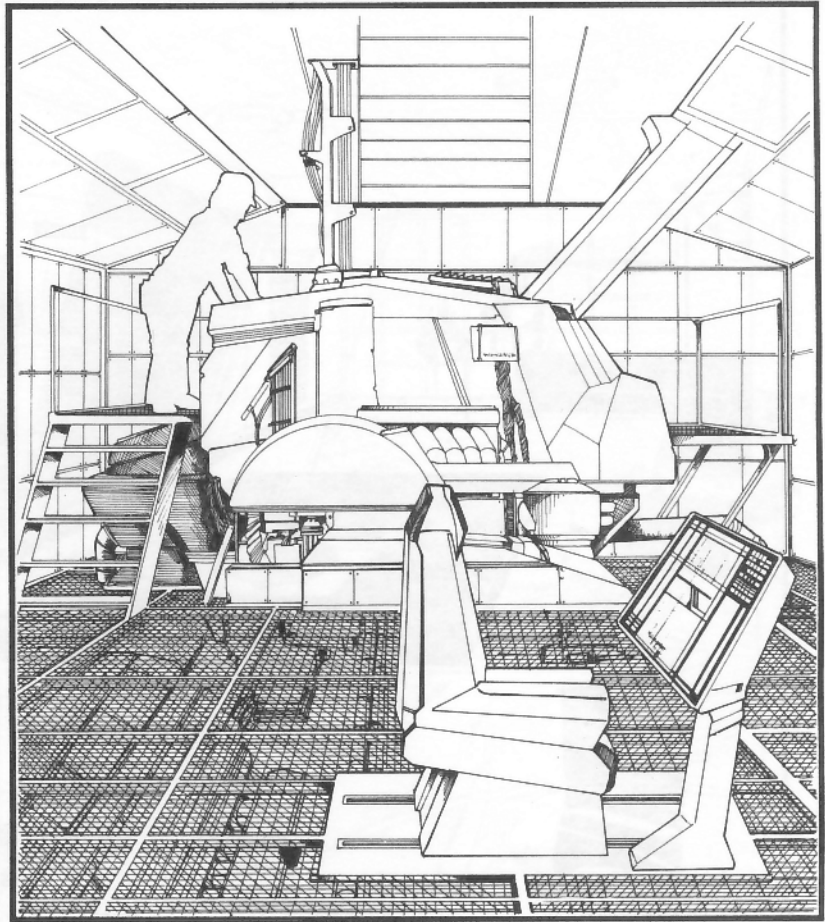

JUMP DRIVE

- 1 Jump drive power plant
- 2 Access catwalk
- 3 Engineer's acceleration couch
- 4 Jump drive control stalk
- 5 Hull grid distribution mains and fuel delivery mains (under floor grating)
- 6 Lighting panels
- 7 Secondary hull grid conduit

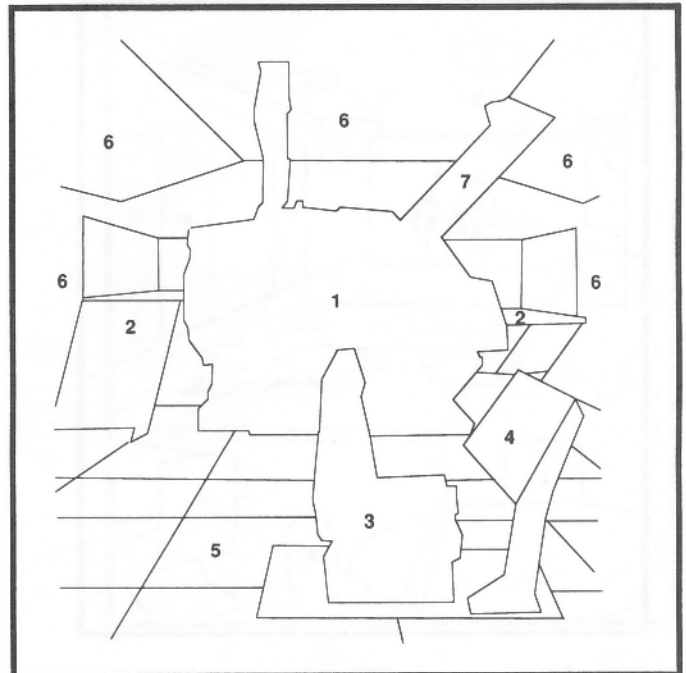

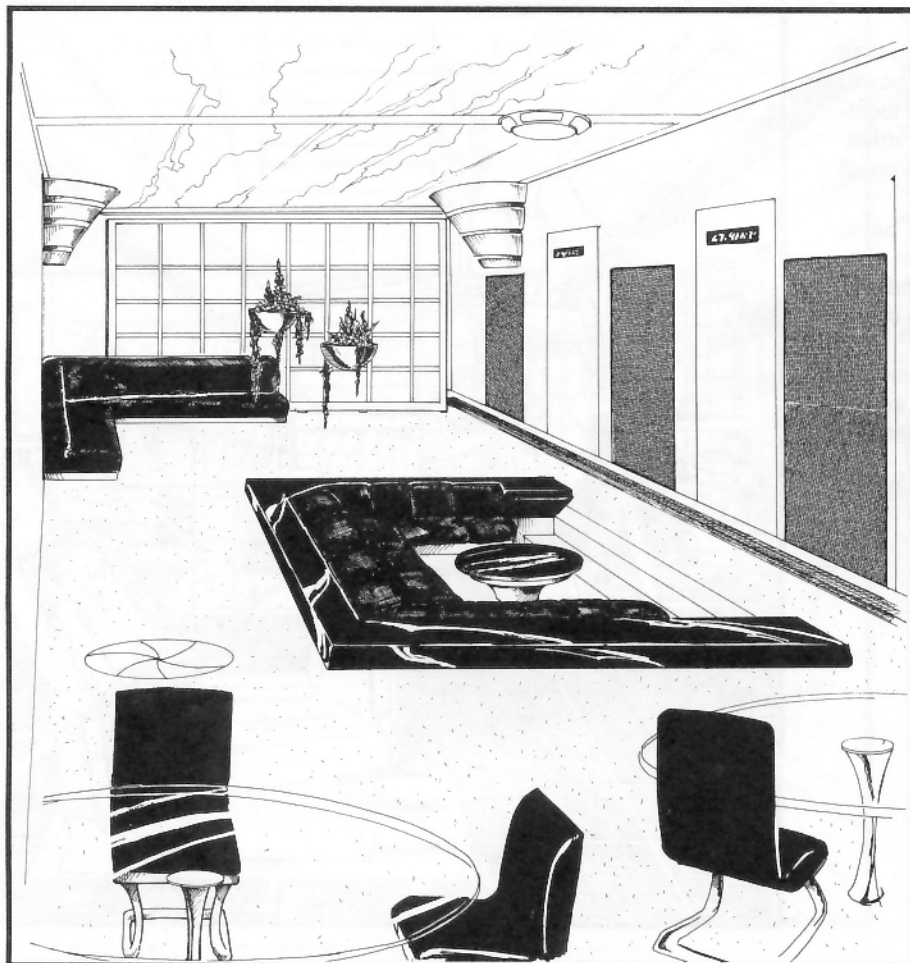

PASSENGER LOUNGE

The most often customized area of any commercial vessel is the passenger common areas or lounge. The lounge in this picture is no exception.

This lounge has been plushly carpeted and lavishly furnished. The lounge decor includes walls finished in a fine wood paneling, various exotic plants scattered about, and fine art on the walls.

The dining area includes two tables with chairs. In the background, beyond the lattice screen, is the galley, where the steward prepares selected dishes for the passengers.

In the middle distance is a circle of soft chairs surrounding a game table, complete with an overhead entertainment holo-projector.

All the stateroom doors have readout panels which display brief information about the current occupant.

In the ceiling are luxury light panels, capable of displaying a variety of sky scenes and lighting levels.

PASSENGER LOUNGE

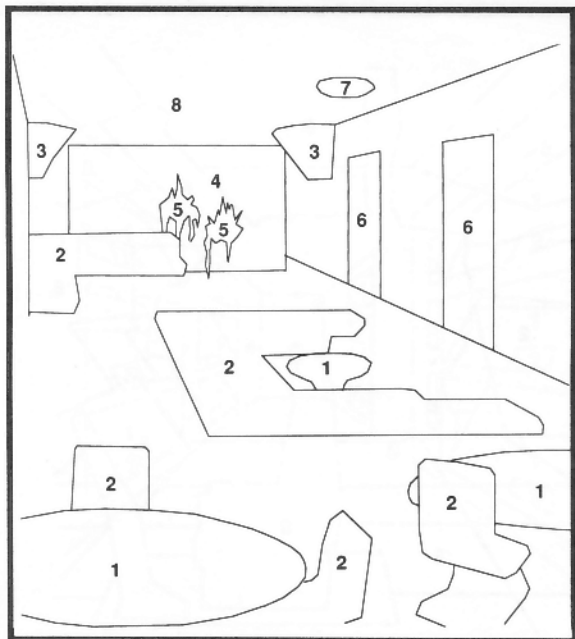

- 1 Tables
- 2 Chairs
- 3 Decorative security sensors
- 4 Galley divider screen
- 5 Decorative plants
- 6 Stateroom doors
- 7 Ceiling entertainment holo-projector
- 8 Luxury lighting panels (simulated sky shown)

PASSENGER STATEROOM

Two of the wall panels in the passenger's room are actually projection screens, which can be used to view entertainment or to project "live" computer-generated environmental scenes (e.g., a tropical beach scene with waving palms and lapping waves, complete with motion, sound, and smells). Projections are selected from an entertainment console set into the wall.

The bed is larger and more plush than a crew bunk. There is a similar computer terminal on a swinging arm, but no ship functions can be operated from here.

The walls are finished in a fine, stained wood, with cabinets and open shelves lining the non-projectable walls. Each stateroom has a viewport which can be opaqued at the user's command. There is a trough running along the wall filled with green plants. The floors are finished in a plush carpeting.

Furniture includes assorted chairs, small tables, random pillows, and miscellaneous art (small sculptures, paintings, and holograms).

The ceiling is a one-piece light panel which can be used as a projectable surface to display such things as filled night skies. An entertainment holo-projector retracts into the ceiling.

The room has its own fresher and an inconspicuous emergency locker (with vacc suits or rescue balls).

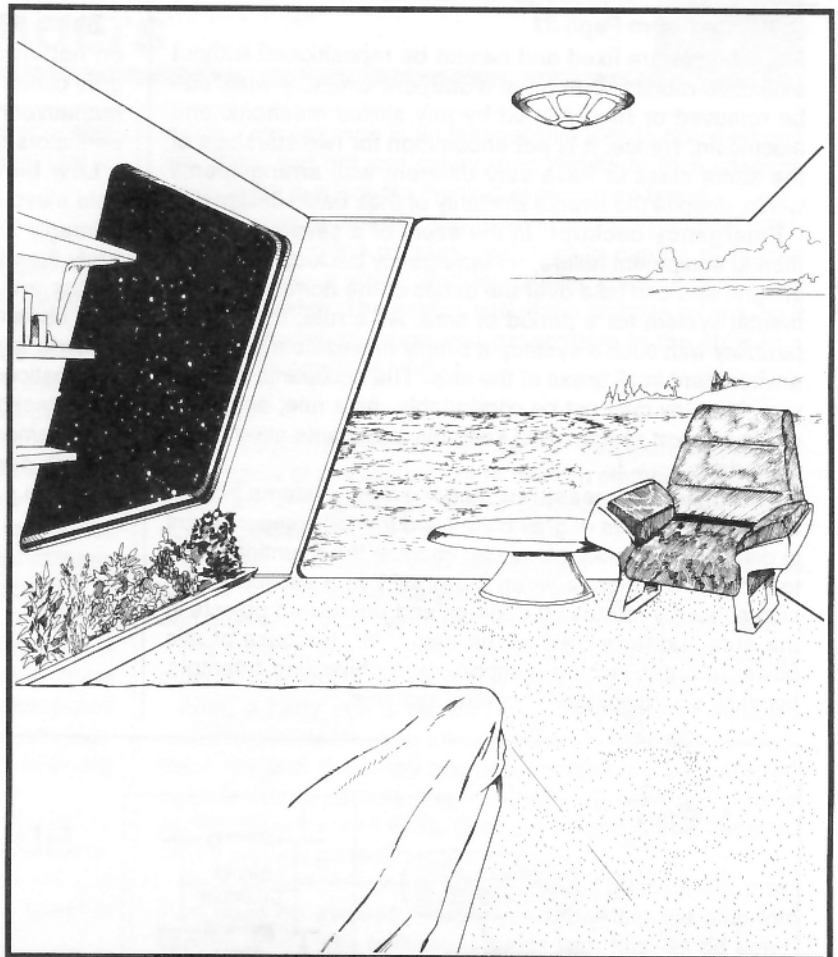

PASSENGER STATEROOM

- 1 Large bed
- 2 Under-bed storage
- 3 Plush chair
- 4 Multipurpose table
- 5 Projector walls (moving ocean scene with sound shown)
- 6 Large view port
- 7 Ceiling entertainment holoprojector
- 8 Luxury lighting panels (clear cloudless sky shown)
- 9 Decorative vegetation
- 10 Storage shelves

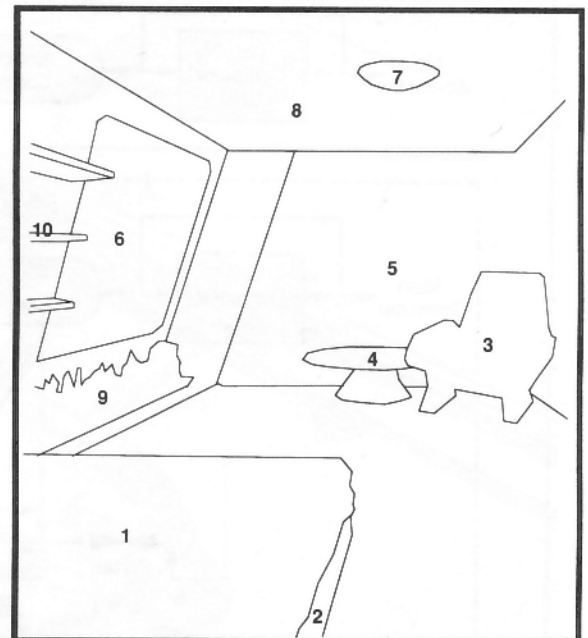

Continued from Page 31

Bulkheads are fixed and cannot be repositioned without extensive rebuilding effort at a starport. Ordinary walls can be removed or repositioned by any skilled mechanic and electrician. Hence, it is not uncommon for two starships of the same class to have very different wall arrangements within, despite the overall similarity of their basic designs.

Emergency backup: In the event of a severe environmental equipment failure, an emergency back-up system is integral and can take over the duties of the normal environmental system for a period of time. As a rule, there is no flexibility with such a system. It simply maintains a minimum environment in all areas of the ship. The occupants will survive, but they may not be comfortable. As a rule, emergency life support systems will keep the occupants alive for up to 30 days.

Anti-hijacking measures: Anti-hijacking systems include warping the effects of grav plates and inertial compensators to disable the hijacker. One can imagine the daunting effect to a hijacker's morale when the gravity in a section of the ship suddenly rotates 90 degrees and unsecured objects in the area suddenly "fall" to the new floor. Because of this powerful anti-hijacking weapon, many hijacking attempts begin by disabling gravitic control systems.

Ships without inertial compensators: Some starships do not incorporate inertial compensators. A ship's normal grav plates can compensate somewhat for ship inertia while maneuvering, but the pilot of a vessel without inertial compensators must be careful to avoid high-gee maneuvers.

Low berths: Late in the tech level 9 period, cryogenic cold sleep appears. Initial applications of low berths center primarily around medical applications (trying to slow down body functions to gain time in medical emergencies). Low berths are also commonly used in long-distance sub-light trips aboard space vessels.

Modern space vessels still use low berths for medical applications, but the more common use of low berths is for low passage travel. Low passage is an inexpensive way to travel among the stars, and not any more risky than middle or high passage when there is adequate medical expertise on board.

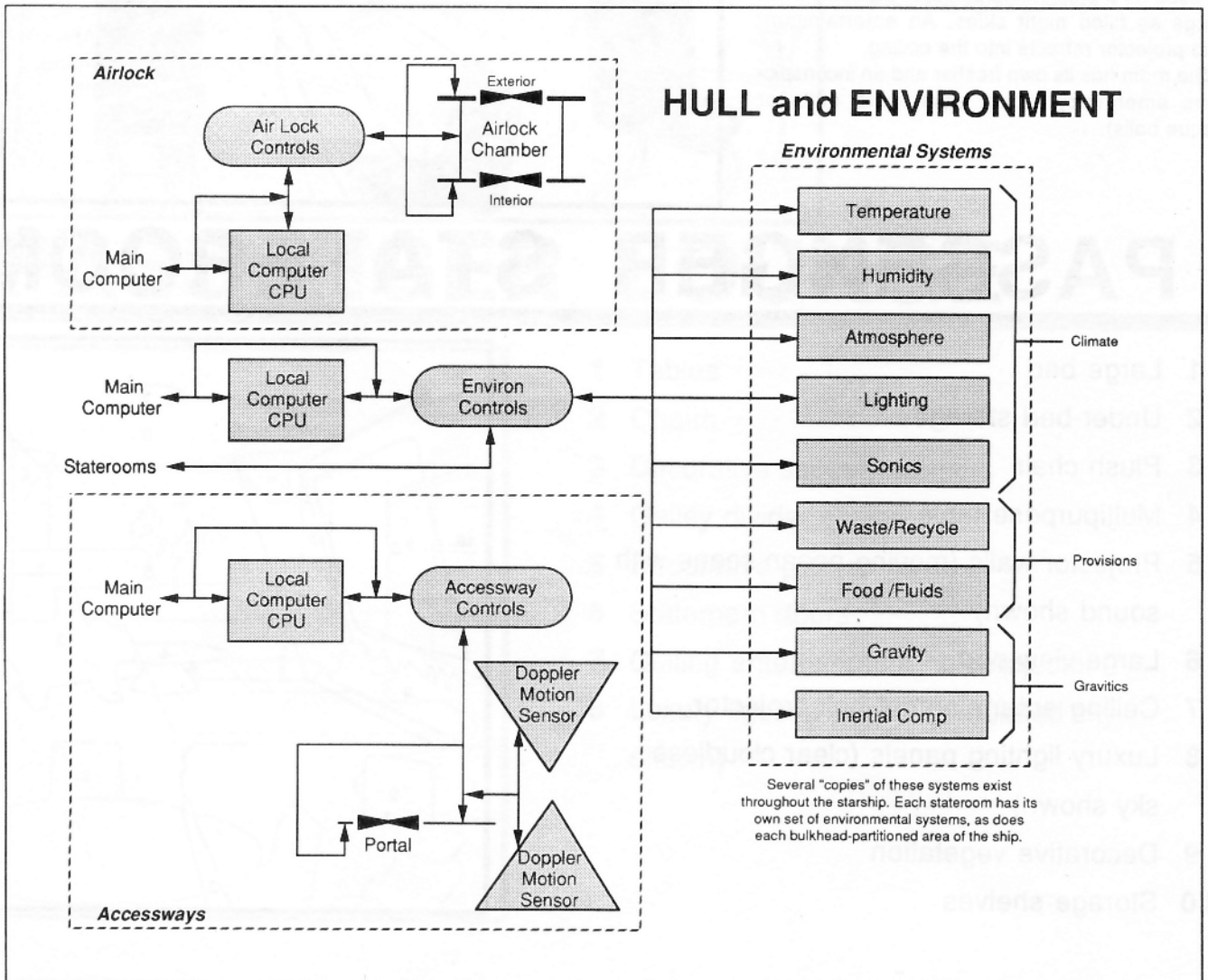

Cargo and Passengers

The cargo and passenger related systems of a starship give the starship its reason for existing: that is, to transport.

HISTORY

Since the very beginnings of a culture's ventures into space, the primary reason for going has been to transport either cargo or passengers off the world.

Most of the earliest cargo payloads are satellites or other orbital devices and parts. Because of cramped conditions and the perceived risk of space travel, the earliest passengers are only the crew themselves.

At tech levels 8 and 9, most cultures establish orbital stations above their worlds. With the appearance of such stations, the demand for true passenger travel into space begins. In time, tourism adds to the demand as inhabitants from the surface want to go into space just for recreation.

During late tech level 9, many cultures reach out to explore the distant reaches of their own star systems, as well as star systems near their own. With this expansion, great increases in travel times occur, along with all its associated problems. Meeting the passenger's needs, making sure they are comfortable, providing them with something to do during the long voyage — all become of great concern.

Many cultures solve these problems by putting most of the passengers in cryogenic hibernation, also called low berth. Low berth greatly reduces a passenger's demands on ship resources, and thus is much cheaper. Low berth travel is especially popular in sub-light interstellar vessels.

Initial applications of low berth technology center around its obvious medical use of slowing down body functions and thus gain time in medical emergencies. Modern space vessels occasionally use low berths for medical applications, but the more common use of low berths is for low passage

travel. Low passage is an inexpensive way to travel among the stars, and not any riskier than middle or high passage when there is adequate medical expertise on board.

The development of jump drive opens up practical interstellar travel to the masses. Journeys to nearby stars take no more than a week, and interstellar commerce at once becomes viable. The golden age of the starship dawns, as it can now transport cargo and passengers to the stars in a reasonable period of time.

THEORY

Both cargo transport and passenger transport present the same types of problems that the modern starship must solve if they are to be delivered to their destination at a profit. Specifically, these problems are:

Fragile: Both cargo and passengers are delicate. If due care is not exercised, cargo can be damaged or destroyed, and passengers can be injured or even inadvertently killed.

Because of this problem, much of any starship's design must be devoted to protecting its cargo and passengers.

First, a hefty hull is needed to protect against radiation and micro-meteors, and preserve the all-important environment. Second, the cargo and passengers must be protected against harsh maneuvers so that they are not thrown against bulkheads or walls. Grav plates and inertial compensators provide protection against this.

Next, violent changes in temperature or atmospheric pressure must be avoided. Properly sub-dividing the ship into various areas with bulkheads helps with this, as do emergency decompression kits (see related topics).

Lastly, passengers (and some cargoes) get hungry and need to be entertained. The modern starship must provide for these needs. If high passage passengers are to be carried, just meeting the basic needs of food and entertainment

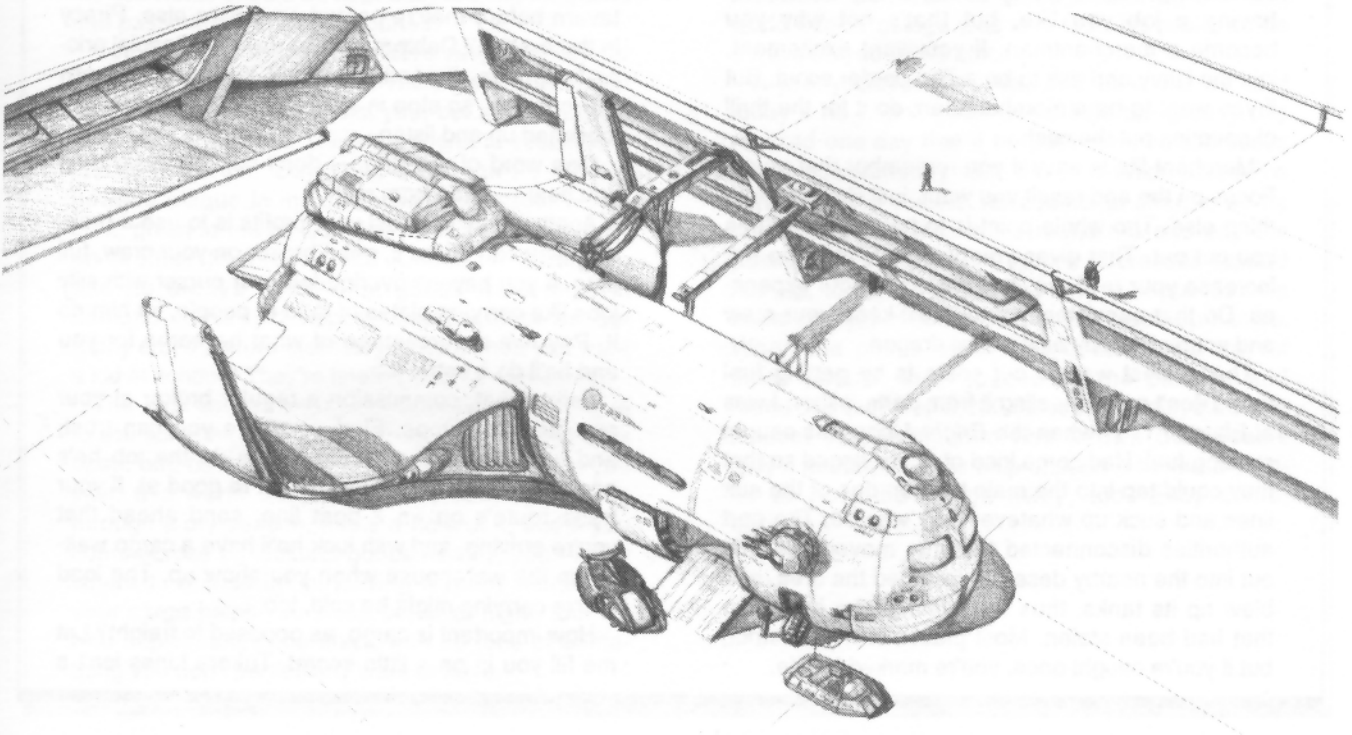

is not enough — *special* valet or steward service is required.

Bulky: Cargo and passengers take up lots of space, and as such they are bulky. While most passengers can move themselves about the ship, cargo requires cargo handlers and equipment to aid in shuffling it around the hold.

Passengers are especially bulky and require inordinate amounts of space in relation to their size. The average cash return for a given starship tonnage is better for speculative cargo than it is for passengers.

For example, a high passage passenger brings in Cr10,000, and requires a minimum stateroom of 4 displacement tons. Per ton, then, a high passage passenger brings in Cr2,500. A ton of speculative cargo brings in an average of Cr4,000 to Cr5,000 per ton. For this reason, most starships transport *cargo* as their primary commodity, with

passengers being a secondary source of income. Even large passenger vessels often make more money from filling out their cargo holds with speculative cargo than they make from transporting passengers.

Costly: Passengers (and some cargoes) can be costly to transport. When environmental resources must be consumed, they must be replaced once the ship reaches port. Termed "life support", these resources cost an average of Cr2,000 per passenger or crew member on board the ship.

Certain delicate cargoes also require "life support", at a cost of about Cr500 per ton displacement. This works out to be equivalent to the cost of carrying a single passenger in 4 displacement tons, since $Cr500 \times 4 = Cr2,000$.

The starship operator must recoup these costs if he is to stay in operation.

MERCHANT OPERATIONS



I remember one young fellow who came to me when we were docked at Equus, and said he wanted to know if I had any crew positions open. I asked him why he wanted to be a merchant, and he spouted off some nonsense about adventure and excitement. I told him the truth, plain and simple: I always have room on

my crew for the right kind of crewman, but he wasn't it.

I learned it from my first merchant captain, who wouldn't let any of his crew forget for even a moment: "You're in this to make as many credits as you can, or you're a damned fool!" Sure, trade can be exciting, and there's nothing at all wrong with having a job you like, but that's not why you become a merchantman. If you want excitement, join the Navy and ask to be a Zho border scout. But if you want to be a merchantman, do it for the thrill of counting out the cash.

Merchant life is easy if you remember that much. Focus on the end result you want, just like with anything else. The whole point is to take in more than you put out. That gives you two goals to strive for: increase your revenue, and decrease your expenses. Do that consistently and you'll keep your crew and yourself happy as a parrot dragon.

The easiest way to cut costs is by getting fuel free. I don't mean stealing it from ports, either. I was at Efate in 1101 when the *Bright Moon* was caught stealing fuel. Had some kind of pump rigged so that they could tap into the main tank on one of the aux lines and suck up whatever they wanted. The port authorities disconnected the line, moved the ship out into the nearby desert, evacuated the area, and blew up its tanks, thus "reclaiming" the hydrogen that had been stolen. Most places aren't as strict, but if you're caught once, you're marked for life.

Skimming is a good idea, though. Don't ever buy a ship that isn't equipped with a fuel purification plant. The difference in cost between free fuel from a gas giant and pure fuel from the port is probably about double the amount of your profit on a jump.

Conserve when you can. Berths that aren't occupied don't need life support if you've got good bulkheads. And food supplies — oh, nevermind, just hire a good purser and let him at it. I shouldn't have to tell you every fool detail.

Keep your ears open and your profits will be higher. Find a place where people talk, go there, and listen. My favorite place? A bar near the starport. You don't have to guzzle down drinks — becoming an alcoholic is a good way to lose your ship. But get a simple drink, or zela juice, or whatever — something to hold in your hand and sip from time to time — and find out what folks are talking about. New regs at the starport? They'll talk about them in the tavern before they're posted anywhere else. Piracy in the system? Debtors slow to pay off? Special prices for goods at nearby worlds? You want to learn these things, so stop in where people's tongues are loosened up and listen.

One word of warning — don't believe everything you hear — even from me.

Another way to boost your profits is to use a broker. If you can afford it, get a broker on your crew, full time. If you haven't overloaded your purser with silly jobs like carrying plates of food to people, let him do it. Pay him a percentage of what he earns for you and he'll do a better job.

Failing that, commission a regular broker at your regular trade stops. Find someone you can trust, and use him all the time. Let him do the job he's good at, while you do the job you're good at. If your trade route's on an X-boat line, send ahead that you're arriving, and with luck he'll have a cargo waiting in the warehouse when you show up. The load you're carrying might be sold, too.

How important is cargo, as opposed to freight? Let me fill you in on a little secret. Tukera Lines isn't a

DESCRIPTION

The purser staff (a single steward on the smallest vessels) is responsible for cargo and passengers. The text below describes the cargo and passengers diagram.

Cargo Hold: The cargo hold "main exit" is generally through the cargo hold airlock. Because the cargo hold airlock must accommodate large or bulky cargoes, the cargo hold airlock is usually larger than the ship's main entrance airlock (the main entrance airlock on most starships is designed for use only by the crew and passengers).

Airlock Chamber: Essentially identical to the airlock chamber described in the Hull and Environment section.

Airlock Controls: Essentially identical to the airlock controls described in the Hull and Environment section.

Airlock Computer (Local CPU): The airlock computer controls the airlock operation. The local computer is connected

to the ship's main computer, which acts as a backup to the local CPU in the event that it fails.

Environ Controls: The cargo hold is often separated from the rest of the ship by a bulkhead, and has its own environ controls. This permits the cargo hold's environment to be set and controlled independent of the rest of the ship.

Stateroom: Staterooms vary in size and luxury. Staterooms devoted strictly to members of the crew generally have little in the way of extras. Staterooms used strictly by middle passage passengers will have more extras, while a stateroom whose primary occupants will be high passage passengers has the most in the way of luxurious extras. Staterooms on very small starships often must serve any or all possible occupants, and so will lean toward the luxurious end of the scale.

Entertainment Terminal: This multipurpose "terminal" may

transport company. Sure, they transport things — but that's not where they make their money. Tukera Lines is a trading company. Most of their loads consist of goods that they own, bought at one world and resold at the next for a profit.

Lucky for you, your ship won't be as big as one of theirs, so you have a choice. You can make good money renting out space at Cr1,000 a ton, something a long-liner can't do. Their overhead is so high that they actually *lose* money on freight in their biggest ships. But they get by. Their own shipyards, their own warehouses, their own brokers — even their own starports, on some worlds. Don't worry about your big competitors, they're in a different class entirely, with different problems and different solutions to those problems.

As far as getting freight is concerned, this is another job for — you guessed it — the purser. He and his assistants should be kept busy looking for goods and passengers to be transported.

You, though, as captain, have responsibility for finding speculative cargoes. The purser or a broker on commission might assist you, but the full weight is on your shoulders. There's a secret to success, in just four words: "Buy Low, Sell High". I have a howood plaque in my cabin with those four words on it, given to me by a broker I dealt with in Leedor on Aramis. That fellow had a nose for a bargain, and he always knew what goods were most in demand at the next stop. Remember those astrogaphy cross-culture classes you had when you were a kid in school? They're finally good for something.

The best way to engage in speculative trading is to sell something before you buy it. Keep your eyes open, and be aware of conditions on the worlds you visit. If a world without weather control is going through a dry season, make a note of it, and if you come across agricultural goods nearby, you'll know where to unload them. Having a ready market for your cargo helps you sleep better at night, too. It's real unpleasant to be stuck with 30 tons of something you don't particularly want to have.

One last story, one you may have heard before, but bear with an old timer. Seems there was this subsidized merchant up in Vilis Subsector, who'd been lucky enough to get hold of a mail route. Great things if you can get 'em: Cr25,000 guaranteed per trip, maximum of five tons of mail. The only hitch for this fellow was that the mail wouldn't be sent unless there was at least a ton and a half of it ready to go.

But here was an enterprising young man, who could see the way the wheels of bureaucracy turned, so he hooked up his own crank and turned them. When he'd set down at a starport, he'd check to see how much mail was waiting for his next stop, and if there wasn't enough, he'd get busy writing letters to push it over the limit.

Sometimes he'd mail trinkets; another time he sent individually wrapped copies of a day's printed newspaper; once he had a printer run off a few thousand "petitions" to some official on the next world over. Postage was less than his profit, so he always stayed in the black.

A pretty clever gimmick, and he'd still be at it today if he hadn't been just a little too greedy. He realized one day that if he put improper addresses on the interplanetary stuff, the destination post office would send it back at no additional charge, so he could clear fifty thou on a round trip and pay the postage only once. The return addresses tripped him up, though. He couldn't very well put his own name on 'em, of course, so he just made up names. When the postal authorities couldn't find any of these people, they opened up the parcels, and found that they had 6,000 defective holocrystals that a local electronics firm had thrown out. Seems they'd paid some nice ship captain a hundred credits to haul the things away, too. Easy come, easy go. •

actually be several stations placed about the stateroom, rather than merely a single all-inclusive panel. This terminal "group" serves a variety of purposes. Not only can the stateroom occupant select from a wide variety of pre-recorded two- and three-dimensional visual entertainment — audio and even olfactory recordings are available.

The terminal includes communication facilities, allowing the occupant to communicate with anyone in or outside the ship. Of course, outside communication is not possible while in jumpspace, but only while in normal space.

In the modern starship, the terminal panels are dynamically reconfigurable, just as are the bridge controls and all other controls on the vessel.

Environ Controls: These controls allow the passenger to alter the stateroom's environmental conditions somewhat to suit his or her tastes. See the Hull and Environment section for more details.

Stateroom Computer (Local CPU): The stateroom computer controls the stateroom's environmental conditions, based on the settings of the environ controls. The local computer is connected to the ship's main computer, which acts as a backup in the event the local CPU fails.

Low Berth: A low berth is essentially a bunk, covered by a transparent enclosure, hooked to medical equipment for inducing and maintaining cryogenic sleep.

Low Berth Computer (Local CPU): The low berth computer controls the low berth operation, and monitors the passenger's vital body functions while he is in cryogenic sleep. The local computer is connected to the ship's main computer, which acts as a backup in the event the local CPU fails.

Low Berth Controls: These control the cryogenic sleep process. The user sets the controls when he first gets into the berth. After he enters cryogenic suspension, only a qualified crew member may tamper with the controls or later revive the low berth occupant. Medical expertise is recommended during the revival process, since some passengers are known sometimes to have various allergic-type reactions upon revival from cryogenic suspension.

RELATED TOPICS

The following text covers some topics related to weapon and screen operation and usage.

Stowaways: A starship's resources are carefully monitored by the starship's computers. If the usage of resources is unusually high, the starship's computer can predict that there may be a stowaway onboard. After monitoring the life support usage for two or three days, the computer may even be able to predict where the stowaway may be found.

Such a technique is not foolproof, however. Life-support resource usage can vary widely. The reliability of computer stowaway predictions falls off rapidly as the number of occupants on board the vessel increases.

In order to minimize the likelihood of stowaways, if a starship's cargo can handle the stress without damage, many starships set their cargo hold environment to a vacuum atmosphere for the duration of the voyage. Such a practice effectively eliminates the concern that there may be stowaways in the hold.

Standard Decor: Most starships have soft carpet throughout the ship — at least on the floors, and sometimes even on the walls and ceiling. Since those onboard must spend an entire week cooped up inside the ship, the carpeting

makes moving about the ship more comfortable and appealing. The carpeting in areas frequented by passengers tends to be more plush.

As an exception, some parts of engineering may not have carpeting — they may have gratings, heavy screen, or soft metal instead.

Many vessels also have crafted wood paneling walls in the staterooms, or even programmable walls that can display any pattern desired, including video or holo images such as ocean scenes.

The ceiling light panels can likewise be programmed for many different colors and intensities of light, including the appearance of a night sky with stars.

Most staterooms include some plants, paintings, or sculpture to enhance the decor.

Some furniture is usually included, often at least a small table and a chair. Most staterooms also include at least one refreshment station (as do many corridors).

Many staterooms with one wall on the hull have a window. During the time spent in jump, most vessels are designed so the stateroom window can show a scene or pattern just like any other wall. Many take advantage of this feature because the random pulsating gray of the jump field is uncomfortable to look at. Some even report that looking at the field makes them nauseated or causes them to hallucinate.

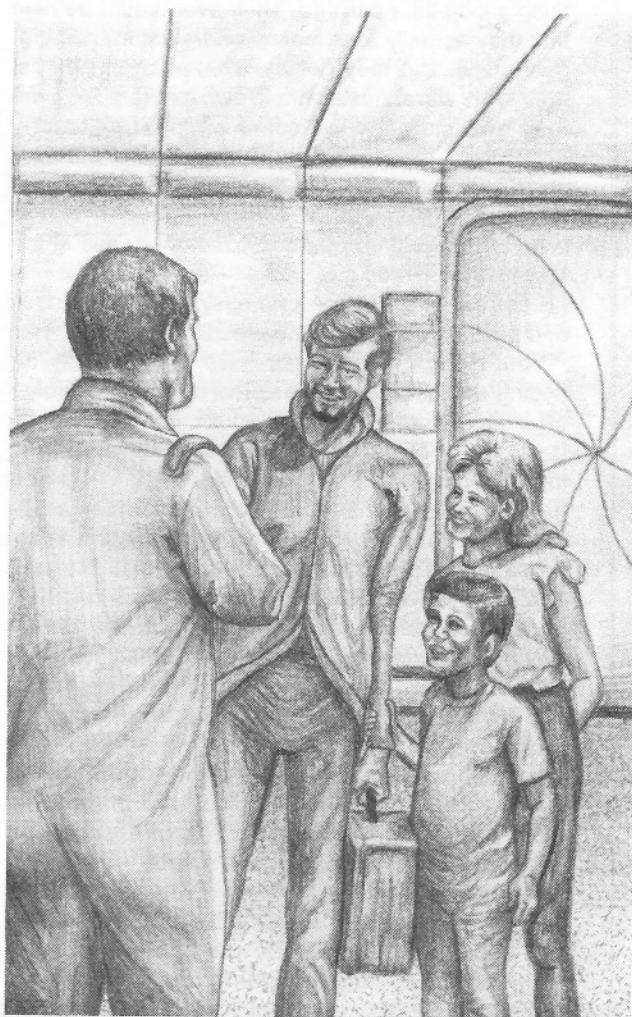

CARGO and PASSENGERS

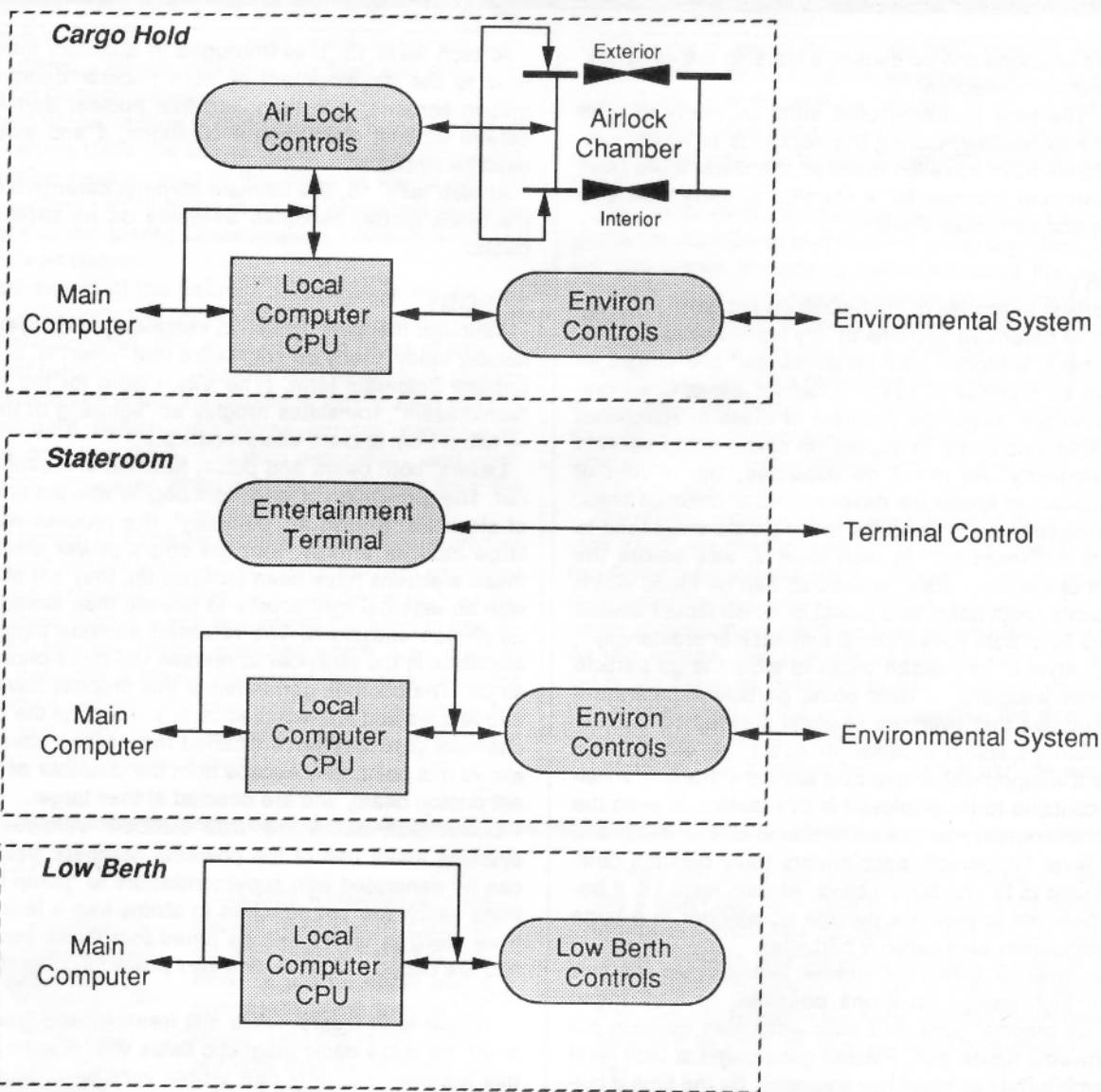

Emergency Kits: Most staterooms include some form of emergency gear, all the way from a basic first-aid kit, to simple vacuum suits, to rescue bubbles.

A rescue bubble (also called a rescue ball) consists of a small, inflatable metal-plastic film bubble with a zip seal "door". The bubble, when fully inflated, measures just over one meter in diameter. It contains enough air to sustain one individual for one to two hours.

Another item available on some starships (especially the larger ones) is one or more "lifeboats". These are very small craft whose sole purpose is to give the crew and passengers a way to escape from a starship that has become a dangerous place to be.

Various views exist among starship designers as to the need for lifeboats on a space vessel. They take up valuable space that could be devoted to improving on board

conditions. Many do not even include them, because (they argue) where are the fleeing survivors going to go? Likely as not, they won't be anywhere near a habitable world. So what good does a lifeboat do them? Other designers insist that even a minuscule chance to escape to safety is better than no chance at all.

Luxury Liners: A few truly luxurious liners exist in the Imperium and its surrounds. These starships charge a premium price for space travel, anywhere from two to five times the normal high passage ticket price.

More than a few travellers pay the price, however, for these ships are the ultimate in comfort and luxury. Suite-sized staterooms are the norm, as are such extravagant luxuries as swimming pools, walkthrough terraria stocked with interesting flora and fauna, and other such facilities — all designed to make the trip a most enjoyable experience.

Weapons and Screens

The weapons and screens of a starship are its "teeth" and its "protection".

The best prepared craft must be ready to offer resistance to hostility. During the centuries in which sentient lifeforms have travelled between the stars, there have been numerous reasons for a starship to carry offensive weapons and defensive shields.

HISTORY

The earliest examples of spacecraft do not normally carry weapons or defensive systems of any type. The reason for this is simple: weapons take up space and add weight — both of which primitive lift systems cannot afford. Once gravitic technology eases the problem of mass in spacecraft design, weapons begin to appear on space-going vessels more frequently. As might be expected, the advent of armed spacecraft forces the development of armored ones.

The earliest forms of weapons found on starships tend to be lasers and missiles. At tech level 7, well before the invention of the jump drive, spacecraft can be found which mount lasers (both beam and pulse) or which mount missile launchers (with both conventional and nuclear ordinance).

At tech level 8, spacecraft begin to mount large particle accelerator weapons. At this point, particle accelerators are so massive that even the smallest such systems must be installed as spinal mounts. In effect, an early spinal mount is a weapon with a ship built around it. Particle accelerators continue to be employed in this fashion in even the most technologically advanced systems of the Imperium. At tech level 10, particle accelerators have become compact enough to fit into 50-ton bays. At tech level 14, it becomes possible to mount a particle accelerator in a large turret (sometimes also called a barbette).

At tech level 10, fusion and gravitic technologies combine to make high-energy weapons possible. At first, these appear as plasma guns, but later advances develop the more powerful fusion gun. Plasma guns begin at tech level 10 as large turrets or small bay weapons. By the time a culture attains tech level 12, they often begin building fusion weapons in roughly the same configurations as the earlier plasma weapons.

At tech level 12, a new weapon rivaling the sheer destructiveness of nuclear weapons appears: the meson gun. Although later available as a bay weapon, the meson gun begins as a strictly spinal-mounted weapon.

In order to counter the attacks of other vessels, many starships employ a wide variety of defenses. The most basic of these is simple armor. In an effort to resist attacks better, an armored starship devotes more interior space to additional bracing and thicker hull plating.

The simplest defensive system is the sandcaster, which acts to obscure the ship to laser and high energy weapon fire by dissipating the energy bolt. Sandcasters become available as early as tech level 7.

By tech level 10, gravitic research has led to the creation of repulsors, primarily to thwart incoming missile attacks.

At tech level 12, breakthroughs in quantum mechanics lead to the development of both nuclear dampers and meson screens. It is theorized that nuclear dampers will defend against disintegrator weapons, if and when they become available.

At tech level 15, the ultimate starship defensive system, the black globe, becomes available on an experimental basis.

THEORY

Although the term "laser" is commonly employed in our society today, many do not realize that "laser" is, in fact, an ancient Solomani term. (The Vilani word for the weapon, "eshkhazem", translates roughly as "lightning of the gods" — taken from ancient Vilani legends.)

Lasers, both beam and pulse, function in a similar manner. The generation of laser light begins with the energizing of electrons. Known as "pumping", this process requires a large input of energy from the ship's power plant. Once these electrons have been pumped up, they are stimulated with an external light source to release their stored energy as photon emissions. The released photons trigger other electrons in the chamber to release still more photons and so on. The photons generated in this process have similar frequencies and are reflected back and forth in the pumping chamber until they have attained the desired intensity levels. At this point, they escape from the chamber as a coherent photon beam, and are directed at their target.

Lower tech lasers are "free electron" versions. These systems make use of the powerful magnetic fields which can be generated with superconductors to "pump up" electrons which are not attached to atoms into a lasing state. Free electron lasers can be tuned to specific frequencies and are capable of producing very powerful coherent beams of light.

Higher tech lasers, while still free electron types, augment the more basic magnetic fields with gravitic ones. In this manner, not only can visible light be produced, but other wavelengths of the electromagnetic spectrum can be produced as well (IR, UV, x rays, and so on). Although these advanced weapons normally fire x rays, they can be adjusted to fire in the more conventional visible light frequencies employed by lower tech lasers.

Missiles are made up of three major subsystems: the launcher, the delivery subsystem, and the warhead. Most missiles are built in a standard configuration, which makes it possible for them to be fired from virtually any starship-mounted launcher. The launcher is usually little more than a protective rack which holds the missile until it receives a command to fire.

Once fired, the missile's delivery subsystem takes over and the weapon heads for the target. Lower tech missiles make use of liquid or solid fuel thrusters to reach their target, while higher tech versions (tech level 9+) may employ gravitic drives. Additional information on gravitic technology can be found in the section on Maneuver Drives.

The missile delivery subsystem also contains the guidance and detonation controls. Guiding a missile to its target is a difficult task which can be accomplished in various ways.

For example, a missile may be directed to its target by signals transmitted to it from the craft which launched it. In other situations, a missile must fend for itself and rely on its own internal homing system.

Examples of the various homing systems include infrared seeking (which track the target by its thermal signature), mass seeking (which react to the mass of the target), or neutrino seeking (which home in on the emissions made by the target's power plant.) Other seeking systems exist, but they are not as common.

The final aspect of the delivery subsystem is the trigger. This device controls the conditions under which the missile warhead is detonated. The most common types of triggers are: contact (which explode the warhead on impact), proximity (which detonate when the missile is simply near the target), intelligent (which recognizes various patterns or strategies, counters them, and then detonates), and command (which detonates when a code is received from the firing ship).

The last portion of a missile is the warhead. There are five basic types of missile warhead: conventional high explosive (a traditional explosive charge), focused force high explosive (a shaped charge which maximizes the blast in one direction), nuclear (an atomic warhead which uses nuclear fission to generate a blast), enhanced radiation (a fission weapon which reduces the blast but greatly increases the radiation), and fusion (a warhead which employs a hydrogen fusion reaction to produce a blast).

In turn, there are two subtypes of fusion warheads: clean (which employs a laser system to trigger the fusion reaction, thus avoiding any significant radiation release) and dirty (which uses a fission bomb as a trigger and creates a massive radioaction release).

High energy weapons include both plasma and fusion weapons. Fusion and plasma weapons make use of similar technology. In both cases, a "charge" of gas is injected into the magnetic firing chamber of the weapon. This gas is then superheated via laser bombardment and released toward the target.

The crucial difference between a plasma gun and a fusion gun is the duration of containment in the chamber. The plasma gun allows the gas to become heated just short of a fusion reaction. In a fusion weapon, containment continues until the gas begins a fusion reaction. Of the two approaches, the fusion version yields the most devastating weapon.

Particle accelerators make use of powerful magnetic fields to increase the velocity of charged atomic particles and, thus, to impart greater energy levels to them. All particle accelerators have three components: the source, the tube, and the accelerator.

The source module generates a burst of high energy protons which are injected into the weapon's tube. Once inside the doughnut-shaped tube, superconducting magnets begin to accelerate the protons. Within seconds, the protons begin accumulating mass as they attain relativistic speeds. As this occurs, the strength of the accelerator's magnetic fields increases to keep the proton stream in check. When the energy level of the protons reaches the desired level, they are released toward the target.

The impact of a proton burst from a particle accelerator

WEAPONRY



Starship weaponry is a big subject, and I won't claim to be an expert where I'm not. Most of what I know about gunnery is in the form of the usual slogans and catchphrases that every Navy recruit or starship hand learns over the years. I don't think in slogans, and I don't advise you to, so you'll have to take

this for what it's worth.

"Know your enemy." This old saw probably dates back to Alaaru the Swift on ancient Vland, but it's still true today, and you'll be sorry if you forget it. You've got to know something, or you're just swinging in the dark. Vargr pirates use entirely different tactics than Zho military forces. If you cook all your food in the same pan, I guarantee you won't like the taste. You need to act differently under different circumstances.

"Never trust a computer to do a man's job." High-tech equipment makes life more convenient, sure. Computers multiply the talents of the individual

using them. But if the original talent is zero, multiplying it won't add up to much. I've seen ship designs where the architects figured out that the computer control system was powerful enough to handle the guns without a gunner. I wouldn't trust my cargo to one, though, let alone my skin. The computer has to be there to help, of course, but the gunner's the key.

"Never waste a hardpoint." If you've got a ship, and it has hardpoints, then you better spend the extra money on something, anything, to use up that hardpoint. It doesn't have to be a meson gun, either, but you're foolish if you don't take advantage of the ship's design. If you don't have the power, install something that doesn't need as much, like a missile.

"The best defense is a good offense." Yes, I know this one's as old as the moons of Mora, but I maintain that if you've only got *one* hardpoint, it's useless to install a sandcaster on it — unless you're devoid of extra power, that is. It's a little hard to come at your enemy with "your guns a-blaring" if all you've got is a stupid sandcaster. Keep your enemy hopping, and he'll fire less at you, and you won't need the sandcaster.

produces a massive explosion and the release of vast quantities of radiation. However, particle accelerators are not effective through an atmosphere.

Meson guns make use of the principles of the strong nuclear force. The meson gun depends on the property of "confinement" which causes quarks to bind together only in combinations that have no "color". Normal physical laws require that each of the three colors of quarks (red, green, and blue) occur only in clusters joined together by a string of gluons.

Quarks can also be grouped in positive/negative combinations of the same color. It is this positive/negative grouping which gives the meson gun its punch. Quarks which form into these unstable combinations (i.e., red and anti-red or green and anti-green) are known as mesons. Such combinations are highly unstable and destroy themselves almost instantly.

The nature of mesons is such that they are unaffected by normal matter. In combat, this permits them to pass through anything which might be between the attacking ship and the final target. By the same token, meson guns can be employed to fire at targets deep within a starship or far beneath the surface of a world.

Careful manipulation of meson firing velocity (approaching relativistic speeds, and thus altering the time duration of their half-life) permits the gunner to control the length of time before the meson decays. With this knowledge, the weapon can be made to discharge a meson "packet" contained by a damper "bottle". The packet arrives at the target ship and passes through its hull, decaying or "detonating" deep inside it. When the meson packet detonates, it causes a powerful explosion and a tremendous release of radiation.

Armor, the simplest form of passive defense which a starship can employ, is primarily covered in the section on Hulls. Although there is more to an armored hull than just a "thick hide", the ship must also devote portions of its interior to extra structural bracing. This is accomplished by applying knowledge of stress loads and shock distribution when the ship is designed.

Sandcasters are employed by many craft to defeat attacking lasers and high energy weapons. These systems are made up of a caster and a canister (which holds the "sand" prior to its dispersal.) When the crew of a ship wishes to employ its sandcasters, a canister of sand is loaded into the device and its contents are "shot" into space

around the ship. When an energy beam passes through the sand field, its beam is broken up and its energy wasted.

Repulsors are used by starships to divert or detonate incoming missiles before they reach the target vessel. Repulsors make use of focussed gravitic projectors (see the section on Maneuver Drives) to upset the guidance and flight mechanisms of attacking missiles.

It is also worth noting that repulsors have been employed effectively against small fighters in some cases. This is best understood when one considers that the impact of a repulsor on a fighter produces structural damage similar to that which might be caused by an impact with a solid object. It is not uncommon for an object which is moving at a very high speed (either a missile or small fighter) to be torn apart by the beam.

Nuclear dampers, which become available at tech level 12, permit starships to protect themselves from the most dreaded of missile based weapons, the nuclear warhead. Starships equipped with dampers are able to project a field which can enhance or degrade the strong nuclear force within the missile's warhead, causing a warhead which relies on atomic fission to fail. While dampers are effective against fission weapons and fusion weapons which employ fission triggers, nuclear dampers are useless against laser-detonated fusion warheads.

Meson screens act somewhat like nuclear dampers, but against mesons. A meson screen affects the delicate balance which permits the mesons to hold off their decay. By disrupting this carefully nurtured state, the mesons spontaneously break down and release their energy while still far from the target.

Black globes represent the summit of modern defensive systems. Unlike other defenses, which can thwart only a single type of attack, the black globe provides a measure of defense unequalled by any other type of shield. The operational characteristics of a black globe are complex and beyond the scope of all but the most advanced of Imperial cultures.

The black globe operates by virtually cutting across the basic forces which hold space together. An operational black globe interrupts the passage of all particles, virtual or actual, and completely isolates the object inside it from the outside universe. The globe is actually an extension and amplification of the nuclear damper and meson screen, which both depend on the manipulation of the strong nuclear force.

Unlike those lesser shields, however, the black globe also

SICK BAY



You wouldn't believe me if I told you how many ships I've seen take off without a medic on board. Anybody that would fly without a physician needs a psychiatrist.

If you've got low passage berths, of course, you have to have a physician on most worlds to meet certification. And if you don't have one, you aren't going to attract

many paying customers, because most low passengers are smart enough to ask for a written guarantee that you'll have a medic on board at all times, particularly during disembarking. I've never heard of a low passage death with an attending physician, and I'd call it murder if someone died waking up without one.

Even if you don't have low passengers, you need a doc for the other passengers and your crew. Unless you keep everyone on board quarantined, sooner or later you'll pick up some bug on some world you travel to, and if you don't have a doc you'll be sorry. •

shuts out other physical forces. It halts all known forms of particle (including the neutron and meson). Gravitons which impact the globe are similarly stopped, as are electromagnetic fields.

Energy which is absorbed by the field is shunted into the zuchai energy sinks inside the ship. Here, the energy is kept until it can be vented from the ship via the hull radiators. The absorbed energy from a black globe is of such a low grade that it is virtually useless for any other application besides release as heat.

Ships which are unable to release the stored energy before it reaches its maximum level are in grave danger. At excessively high volumes of stored energy, an energy sink's crystalline structure will suddenly break down. The zuchai crystals instantly lose their superconductive storage properties and become conventional semiconductors. During such a breakdown, much of the energy which the crystals hold turns to heat and the ship is all but vaporized by the resulting energy sink degradation.

DESCRIPTION

The gunnery crew is responsible for the proper operation of the weapons and screens. The following text describes the components shown on the weapons and screens diagram.

Even though the term weapon is exclusively used, weapon or screen could be used interchangeably in the following descriptions. Each weapon mount and screen contains identical major system components.

Gunnery/Screen Station: This station provides the gunner with complete information on the military situation around the ship. All detected objects and energy sources are identified and displayed, along with the computer's evaluation of their potential threat. With training, a gunner can examine the display and quickly decipher the events which are unfolding around the ship. From this critical information, a good gunner can instantly select the optimum target for the weapon system under his control.

Once the safety interlocks (see Related Topics) are removed, the weapon system is fully engaged. At this point, power from the ship's main fusion plant is fed into the weapon and its fire control systems. This station gets information from the ship's sensors and orientation control to insure accurate firing.

Bridge Repeater: This duplicates the readings of each gunnery/screen station on the bridge.

Weapon Mount or Screen Generator: This is the weapon mount (or screen generator) itself. Depending on the design philosophy of the ship's designer, the gunnery/screen station may or may not be located in the weapon mount.

Weapon Computer (Local CPU): The weapon computer (one per weapon station on the ship) handles the operator commands given to the weapon. Each local computer is connected to the ship's main computer, which acts as a backup to the local CPU in the event that it fails.

In addition to constantly updating information about current happenings around the ship, the computer estimates future actions or possible tactics which the enemy might employ. For example, the computer may suggest that a ship which is registering high infrared and neutrino emissions

may be making ready to jump.

Once the gunner selects a target, the computer takes over and all firing is done by the local CPU. The distances involved and the speeds at which the targets are travelling makes manual fire control useless. Computer fire control is vital in space combat engagements.

RELATED TOPICS

The following text covers some topics related to weapon and screen operation and usage.

Station Location: Varying opinions exist as to the best location for a gunnery control station. Some designers place the station in the weapon mount itself, others place it at some location far from the mount.

Those in favor of the station in the mount argue that such a placement gives the gunner immediate feedback as to the status of the turret. It is also much harder, they say, for combat damage to blind the gunner as to the status of his turret. If the control station is far from the actual weapon mount, combat damage may black out the gunner's station. When the gunner is in the mount, the only combat damage that can black out the gunner station is the destruction of the mount itself.

On the other hand, argue other designers, putting the gunner's station away from the weapon mount removes the need for the mount to be large enough to accommodate a crew member — and larger mounts are much more expensive. In addition, a remote gunner can control more than one weapon mount, and can remain relatively safe deep inside the starship.

Weapon Interlocking: During normal flight operations, weapon stations are kept powered down to prevent mishaps or accidental firing. When the ship's crew is called to their battle stations, the first of three safety interlocks is released from the bridge by the ship's captain and power is channeled from the power plant to both the fire control stations and the weapons themselves.

The actual use of the offensive devices listed above, as well as the normally defensive sandcaster and repulsor systems, begins at this point with the acquisition of the target(s) by the fire control station from which they are operated. Since nearly all starship combat takes place at ranges which make the combatants invisible to the naked eyes, sensor and computer augmentation is a requirement.

A good gunner makes the most of all the information supplied by the ship's computer and sensors. Once the gunner selects his or her target, the computer conducts ranging and similar computations and displays the results to the gunner for evaluation.

When it becomes clear to the captain that hostilities are probable, the secondary interlock is released and the weapons are fully linked to their targeting systems. At this point, the gunner makes any last minute suggestions to the computer about firing his weapon. Although these vary with each of the weapons systems described above, such suggestions include things like the selection of a frequency setting for lasers or the energy level to be imparted to the protons in a particle accelerator.

When the order is given to attack or return fire, the captain releases the tertiary interlock and the gunners are given full control over their weapons. At this point, they can

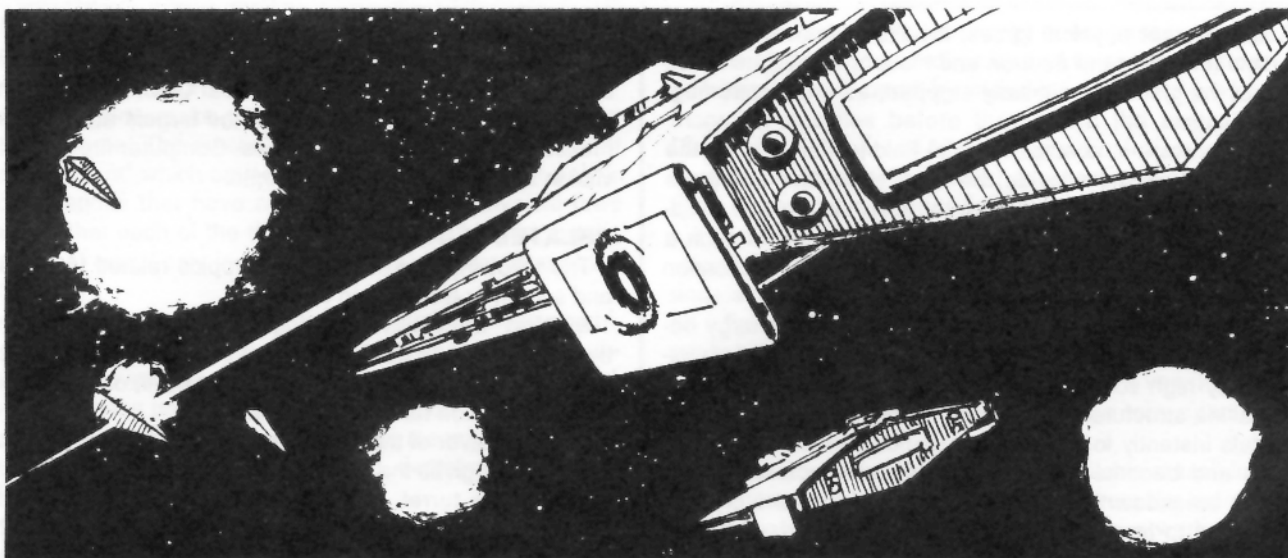

fire on targets at will. In some cases, the captain will co-ordinate the attacks into a single volley of fire. Most frequently, however, gunners are free to use their own discretion in the timing and targeting of attacks.

Screen Interlocking: Passive defensive systems (nuclear dampers, meson screens, and black globes) are operated in a similar manner. Like weapons, they are controlled with a three-layered system of interlocks which insures that they are not accidentally activated. In most cases, the interlocks for screens are released at the same time as those for the active defenses and weapons described above.

When the primary interlock is removed, power is fed to the shield generators and they are "warmed up" to make them ready for possible application. A detailed checklist is run

through by the computer at this point to ensure that the screen is in optimum operating condition.

When the second interlock is released, full power is fed to the defenses and the ship becomes able to erect its defensive shields. At this point, the operators examine the approaching ships on their displays, and decide on the best course of action to counter any potential threat.

With the release of the tertiary interlock, the screen is deployed and the ship is ready to repel any attacks made against it.

WEAPONS and SCREENS

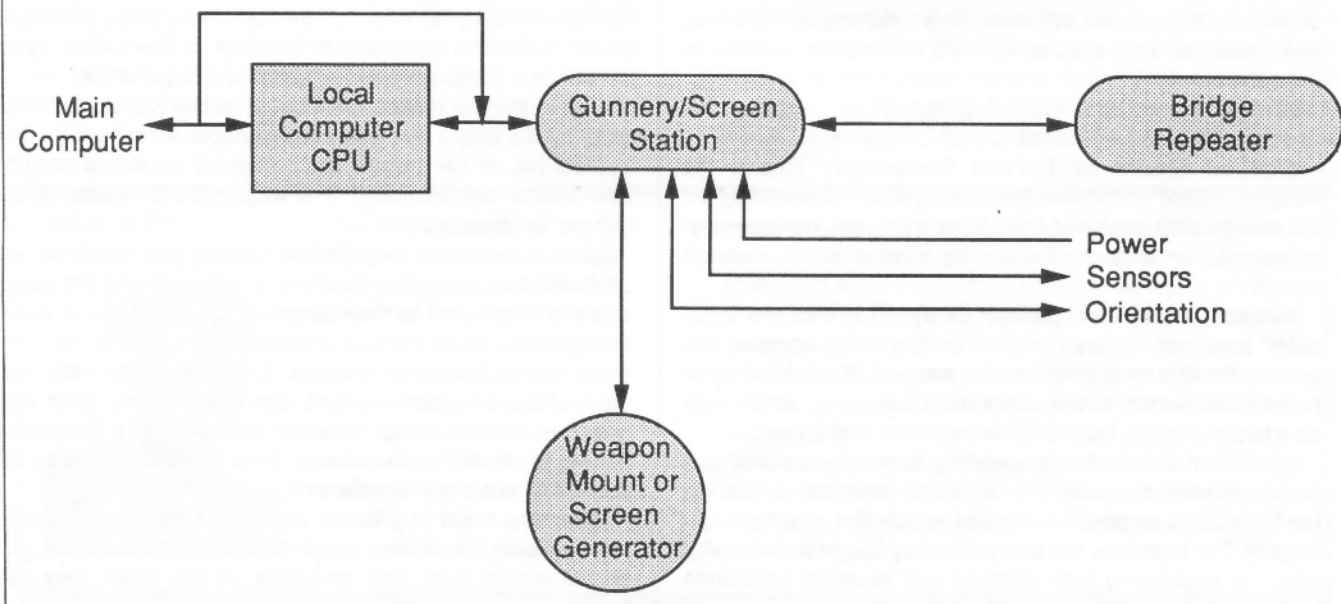

Crew Duties

As advanced as robotic science is, there is no large starship in the Imperium that can operate with an all-robot crew. Only through the concerted efforts of intelligent, skilled, *living* crew members can there be a safe, comfortable, and profitable journey from one world to another.

The various crew positions can be grouped roughly into four categories of function: those with command duties, those charged with the safe operation of the starship, those who support the comfort of passengers and the security of cargo, and those having military roles. This division is not perfect, as some positions overlap. The pilot, for example, while necessarily a critical part of the operational crew, may also be the ship's captain and so be part of the command crew as well.

Not all ships have separate individuals for each function listed here. In the simplest case, for example, a single pilot may fill the shoes of an entire crew on a 100-ton Scout ship.

COMMAND CREW

All members of the command crew need to be minimally proficient at administration; leadership skill is also quite useful.

Owner: The will of the owner of the vessel is the literal driving force behind the ship's production and daily operation. If a single individual does not have the capital needed to finance a ship, the owner may be a group of individuals, a business, or a government that has pooled its assets or talents, sharing in the control of the ship and thereby its profits or losses. It is the owner who decides upon the ship's design and the general goal of its operations.

Captain: The captain directs the day-to-day operations of the ship; he has authority over its route, its cargos, and the activities of its crew. On ships of small independent merchant companies, the captain may also be the owner of the vessel. In any case, the captain serves as "owner-aboard": he is responsible for the ship's actions in much the same way that the owner of a robot is responsible for anything that the machine does.

The captain is also typically the pilot or navigator on smaller vessels. In lieu of a fixed salary, the captain may draw his pay as a percentage of the ship's profits.

Ship's Administrator: On larger vessels, or those owned cooperatively, it is not uncommon to find a crewman who handles administrative details for the captain or owner. Interstellar law and ship accounting are both tasks complex enough to deserve this extra attention.

OPERATIONAL CREW

All members of a **bridge crew** need to be minimally proficient at operating a computer, a skill they usually have by virtue of the experiences they have growing up on high-tech worlds.

Pilot: The pilot is specifically responsible for moving the ship safely between its landing or docking point and its jump point. He accomplishes this with the assistance of the

navigator (who computes the vessel's insystem course) and the piloting computer, which helps keep track of the myriad details involved in propulsion and steering.

Copilot: The copilot can be considered a backup pilot, and, on some larger vessels, the duties of piloting the craft may be divided between more than one individual. On smaller vessels, the copilot may also serve as navigator, sensor operator, and/or communications operator.

Navigator: The post of navigator is one of the most demanding on a starship. Without an effective navigator skills, the vessel cannot safely move about in normal space, nor can it safely traverse the vast interstellar distances in jumpspace.

Besides these duties, the navigator on the smaller vessel must be skilled in the use of ship's sensors.

Sensor Operator: The sensor operator, with the assistance of the computer, must interpret the images the sensors see. On any ship, the sensor operator uses his equipment to calculate the ship's precise location, and to sense the location of celestial bodies, making possible both insystem navigation and interstellar jumps.

On military ships (or other ships in war zones), the sensor operator's importance is magnified. The ship's sensors are necessary to detect enemy presence and weaponry, to protect the ship in a battle, and to allow it to best counteract any threat.

The post of sensor operator is often filled by the navigator or copilot on smaller vessels.

Communications Operator: When a vessel enters a system, it is the commo's responsibility to communicate its intentions to local authorities, and further to convey any reply to the ship's captain.

On military ships, the commo must be quick and precise in his ability to send and receive narrowcast messages between friendly vessels that may be moving at speeds of thousands of kilometers per hour relative to one another.

The post of communications operator is often filled by the navigator or copilot on smaller vessels.

The **engine and operations crew** is responsible for the proper functionality of the ship's systems.

Engineer: Starship engineers have as their typical day-to-day duties the operation of the fusion power plants which provide energy for the jump and maneuver drives. The jump drive and maneuver drive also fall under the purview of the engineer. These systems are among the most complex on the modern starship, and require monitoring to insure they are performing at their peak efficiency.

The complexity of these systems usually necessitates the efforts of several crew members on larger vessels. One engineer is thus selected as the chief engineer, who counts among his duties the supervision of the rest of the engineering staff.

Computer Operator: Large ships sometimes have full-time computer operators on board, who can write custom programs to handle the operations of the vessel. But

even the smallest ship needs someone on board who knows something about computers. All ship systems include computer subsystems — it is virtually impossible to escape the presence of a computer somewhere in the ship.

Electrician: The engineering staff should include at least one crewman with skill in analyzing and repairing electronic components and electrical systems.

Gravitics Technician: The artificial grav plates and inertial compensators within the ship are not critical to its performance, but passengers and crew certainly feel their loss when they do not function correctly. The gravitics technician insures that these units keep running.

More importantly, though, the maneuver drive's thruster plates operate on a principal that takes advantage of gravitic science. Without its maneuver drive, a vessel would be helpless to the forces of gravity and inertia, as liable to drift forever in space as to be sucked into a planet's atmosphere or a star's inferno. The engineering staff should include at least one crewman with skill in analyzing and repairing gravitics systems.

The **flight crew** handles ship's vehicles such as cutters, air/rafts, ship's boats, shuttles, and other small onboard craft. Particularly on vessels which are not streamlined, these vehicles are the "ship away from the ship", providing access to the surfaces of worlds and the fuel of gas giants.

The ship's vehicle operators may be separate crewmen, but on smaller ships these functions are often handled by the pilot or copilot.

SUPPORT CREW

The members of the support crew need to be proficient at a variety of skills.

Medic: A medic on a starship is not a luxury any more than oxygen is. The medic is responsible for the health of the crew and any passengers aboard; his duties require that he keep up to date on the diseases prevalent on any worlds in the area of the the starship's trade routes.

When the ship reaches its destination, the medic must carefully revive passengers in low berth. In battle, the medic may be called upon to revive the frozen watch, again carefully but not as leisurely.

On smaller vessels, the medic's position may be covered by a crewman with medical skill.

Steward: It is too easy for the uninformed to assume that the steward is little more than a spacefaring butler, one who shines shoes left outside a cabin and ferries dishes of food back and forth between the galley and the lounge. While the steward does perform these tasks, the post is one of much greater responsibility.

The steward acts as purser, in charge of money matters on board the ship. When a crewman is paid, when a bill of lading is compared to the goods delivered, when a passenger brings personal belongings on board, or when the broker buys or sells cargo, it is the steward who insures that these matters are dealt with correctly.

The steward also has authority over other crew members insofar as the comfort and safety of the passengers and crew are concerned. He may instruct the engineer to adjust the life support and grav field of a passenger's cabin. He

may seek medical advice when a passenger complains of physical discomfort. The steward may even direct the bridge crew to move the vessel to a certain port where goods are waiting to be loaded.

On many vessels, these tasks are performed by a number of stewards, supervised by a chief steward.

Security: On smaller commercial vessels, the security post becomes just another job that the steward and his staff must attend to, along with their many other duties. But on a large merchant or military ship, a separate security crew guarantees that cargo and passengers are safe, and that infractions of duty are properly dealt with. In conjunction with the computer operator, security is also responsible for the continued operation of the anti-hijacking program.

Cargo Hand: Under the direction of the steward, cargo hands load and unload goods from the hold. Even the smallest of vessels can use cargo hands as regular crew members, especially when the cargo is perishable or fragile. (In these circumstances, of course, the cargo hold is not usually depressurized.) Many ships, though, rely for their hands on those provided by the particular starport or warehouse. On higher tech worlds, cargo handling is typically performed by robots.

Broker: A good broker can find "last-minute" freight if the vessel has not filled up when ready to go. Even so, some worlds will not generate enough exports to fill the cargo hold of every vessel leaving the system. For these vessels, there is another way to make money. Buying goods for one amount and selling them for another can multiply the capital available to the vessel. It is the broker who handles these transactions.

On many merchant vessels, the captain has the highest experience in brokering goods, but the broker does not have to be the captain — or even a human. Many vessels rely on broker robots, such as the famous Tukera Traders, which are a fixture on that vessel's ships. For less than half a million credits, a starship can have available expert legal and brokering skills.

Finally, almost every starport has its "broker's row", where freelancers have their offices. Advertising that their proximity makes them more efficient, these brokers' services are used by many ships.

Trader: While the broker is the crew member who handles the nuts and bolts details of financial transactions, it is the trader who analyzes the markets from world to world and predicts the price that a good will garner when sold. Again, on smaller merchant ships, this is likely to be the captain, who will have experience in both brokering and trading. Robots are also available to serve as traders.

MILITARY CREW

The members of the military crew need to be proficient at the key combat skills of weapon operation, sensor operation, and tactics.

Gunner: Gunners are vital to a vessel with gunnery aboard, both to operate the weapons and to keep them in good repair. In concert with the gunnery computer systems, which coordinate sensor and communications data, the gunner decides when to fire at which target. Larger weapon systems such as bay weapons and spinal mounted guns may require a crew of gunners to monitor and maintain them

during a battle.

While the weapons themselves must of course be mounted on the hull of a vessel, in many cases gunners' stations are somewhere within the ship, often far from the hardpoints.

Ship's Troops: Soldiers on a ship may be boarding parties or planet-bound troops who will be offloaded. Ship's troops are not often found on non-military vessels (although pirate vessels often carry troops).

Frozen Watch: A large military vessel is dependent on all its systems running up to speed at all times. In the course of battle, though, personnel may suddenly become

unavailable for service because of injury. One solution to this problem is that of the frozen watch.

As an example, suppose that 80 crew members are killed by radiation from enemy meson fire. Medics on board could revive the frozen watch (extra crew members resting in low berths) to restore the ship's complement.

Tacticians: If a ship is part of a battle contingent, or expects to fight individually against other ships, a good tactician is worth his weight in gold. Both ship tactics and fleet tactics are useful skills in this regard. Unarmed commercial vessels rarely have tacticians on board.

CREW MATTERS



Dealing with the crew is perhaps the most crucial part of running a ship successfully. I don't care who you are or what experience you've had, if you're on a large ship you can't do everything yourself. Somebody's got to help, and if you're the captain, it's your job to make sure that everyone does his share.

Somebody has to be leader. If you're not up to it, find somebody who is, because when a decision has to be made nobody else is going to make it. Space isn't a game. If something goes wrong, people will get hurt, or money will be lost, and it will be on your shoulders.

The first rule of management is that you have to understand what's going on. This seems obvious, but a lot of self-appointed captains would be helpless in any post other than captain. You don't have to be an expert at everything (although being an expert at something certainly doesn't hurt), but you should have basic knowledge of what each crew member is doing. If you don't understand what tasks need to be done, and what tools and knowledge are necessary to carry out those tasks, then you won't be able to order them done at the right times.

If your crew is small, say less than 10 people, you can cope with handling each man individually. But if your crew is larger than this, you'll have to set up a chain of command so that things can get done without your having to stick your nose into every piece of business.

What this means is that if you have three engineers, make sure that one is the chief engineer, with a nicer nameplate on his cabin and a bigger salary. That way you can give him the big picture of what you want done, and he can translate that into the little niggling details for the other engineers. It also means you need to come down hard on only one person — he'll convey your urgency to the others without any extra effort on your part.

The same with stewards, pilots, gunners, flight crew, ship's troops, whatever — put one of 'em in charge and let him boss the rest. You can do the same thing with your bridge crew, if you're not qualified to be on it, by putting the pilot or navigator in charge. If your ship's big enough, you might even have an extra layer of "sub-captains" below you.

I remember my first captain in the Navy, Seiika Peri. He believed in leading by example, and never wasted any words unless he was calling someone on the carpet. Peri was smart enough not to have an office, either, any more than any other crew member had one. If you needed to see him on a private matter, you could go to his cabin; if he needed to see you, he'd find you. There wasn't a place on that ship that he wouldn't go, and like as not he *would* go there. Looked as though he was just wandering around, but he knew what he was doing. Every crew member knew that Peri might walk in any time, so he kept things shipshape. He also knew that he could ask Peri for anything, and if Peri agreed that he needed it, Peri would find a way to get it.

I try to run things the way he did, and when something new comes up, I often find myself thinking, "What would Peri have done?" He did know how to set a good example.

As for my own crew, they know they can see me any time about any subject. They also know that I trust 'em — I don't try to tell them how to do their jobs, I just tell them the results I expect. How they accomplish it is their problem. If I wanted a crew of robots, I would have bought one.

I don't hire a crewman, either, if he's worked for a subsidized merchant. I've had plenty of arguments over this with other captains, but I think working a sub builds up bad habits. These boys don't have to do their damndest, because somebody else is always there to cough up the credits. Every once in a while I relent and hire somebody who looks promising, but I always go back to my original rule, it seems. Maybe I just don't have the good luck in hiring subs that other captains have. But then again, I think I pull down the profit more often than they do, too, so maybe there's something to it.

RELATIVE SIZE CHART

FOR SELECTED MEGATRAVELLER STARSHIPS

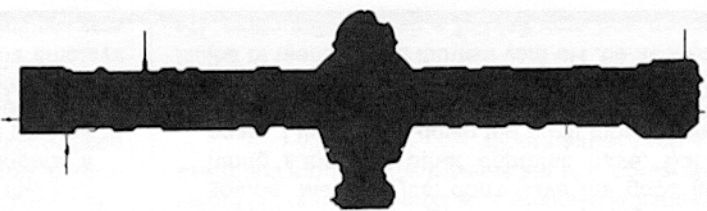

Kugashin Class 400 Ton Lib Ship



Besowul Class 200 Ton Free Trader

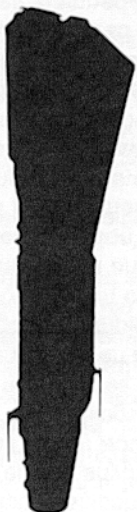

Empress Marava Class 200 Ton Far Trader



Akkigish Class 400 Ton Subsidized Merchant



50 Ton Modular Cutter



95 Ton Shuttle



10 Ton Launch



Lady of Shallich Class 200 Ton Yacht



Suleiman Class 100 Ton Scout/Counter



Iramda Class 10 Ton Fighter



Animal Class 200 Ton Safari Ship



30 Ton Ship's Boat



40 Ton Pinnace

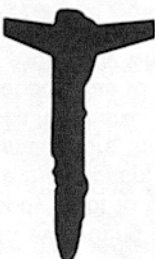

40 Ton Slow Pinnace



30 Ton Slow Boat

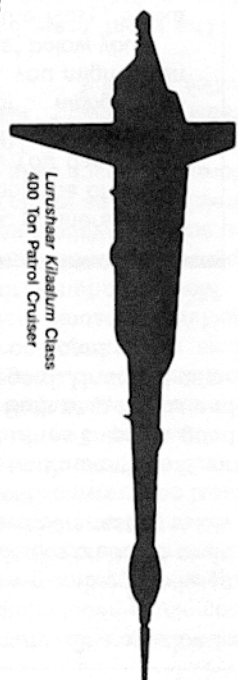

Lunshaar Kilaalum Class
400 Ton Patrol Cruiser



Nishemari Class 400 Ton Corsair



Dragon Class 400 Ton SDB



Gazelle Class 300 Ton Close Escort

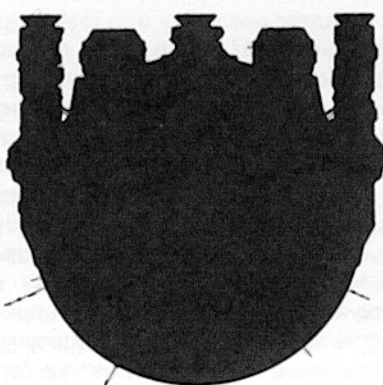

Broadsword Class 800 Ton Merc Cruiser

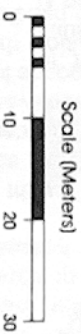

Typical Humans

Game Rules For Starship Operations

This section presents highly detailed starship operating procedures for use in a **MegaTraveller** game. Be forewarned, however, because of the level of detail, these rules are optional: they are not meant for general use.

General-purpose starship operating rules are given in the "Travelling" chapter on page 86 of the **MegaTraveller Imperial Encyclopedia**.

WARNING TO REFEREES:

Use these rules only when extra detail is called for!

The extra detail in these rules makes them highly involved. Failing to heed this warning risks bogging down adventure action with boring details.

We cannot stress this enough. Use these rules only when the adventure focus clearly calls for extra-detailed starship operations. In many adventures, the most appropriate way to handle a starship flight is simply to declare to the players: "The trip was uneventful. Okay, you are there."

On the other hand, an *entire adventure session* could be built around "a race to get to the gas giant before the enemy does", or "a desperate three-parsec journey to the icy moon to rescue the stranded party before it's too late". Coaxing a little extra performance from your ship could be an exciting and integral part of such an adventure. It is for these times that the rules in this section are presented.

T CHARTS

Each procedure is organized into a task chart, or just *T chart* for short. The T chart is simply a highly visual version of the standard **MegaTraveller** step flowchart.

Each T chart includes one or more related procedures, presented as a series of steps connected by arrows. To perform the procedure, just start at step 1 and follow the arrows, doing the action or task presented in each step.

KEY TASKS

Throughout the T charts, certain *key tasks* are repeatedly referenced. Rather than reiterate the detailed steps for these key tasks, they are given their own T chart called *Key Tasks*.

ACCESS AND SECURITY

Below are some additional game notes about access and security.

Cycling an Airlock: The normal cycling process of an airlock typically takes less than a minute. An emergency control inside the airlock allows the occupant to abort the cycle process at any time. The steps are:

- Close both hatches
- Pressurize/depressurize airlock (5 seconds x UWP atm code). For example, if the airlock contained a standard (type 6) atmosphere, it would take 30 seconds to depressurize.
- Perform routine decontamination (1 minute).
- Open end of airlock where outside pressure matches inside pressure (checked by airlock).

Decontamination begins with a bombardment of x-rays for 30 seconds followed with 30 seconds of exposure to ultraviolet light. In cases where unusual precautions are indicated, this can be augmented with one minute of temperature extremes, 30 seconds of ultrasonics, or one minute of harsh chemical agents.

If desired, decontamination can be eliminated, but the referee should make a note of the situation and define a Routine (uncertain) task for the airlock cycle, and implement a later "foreign agent" mishap on some truth.

Control Settings for Sliding Doors: The following settings apply to sliding doors:

- Doppler open (normal unlocked setting, opens to approaching traffic).
- Manual open only (requires the user to push keypad to open).
- Lock (must be unlocked from the same side).
- Crew lock (opens only to crew members).
- Crew open (door is locked, but any crew member can open).

Control Settings for Iris Valves: The following settings apply to iris valves:

- Doppler open (normal unlocked setting, opens to approaching traffic).
- Manual open only (requires the user to push keypad to open).
- Pressure lock (normal setting, locks if more than 0.5 atm pressure differential).
- Lock (must be unlocked from the same side).
- Crew lock (opens only to crew members).
- Crew open (door is locked, but any crew member can open).
- Explosive open (requires a confirmation to execute, 10 second countdown followed by 2 second sound and light alarm).

Control Settings for Hatches: The following settings apply to hatches:

- Manual open only (hatches always require the user to push keypad to open).
- Lock (must be unlocked from the same side).
- Crew lock (opens only to crew members).
- Crew open (door is locked, but any crew member can open).
- Explosive open (requires a confirmation to execute, 10 second countdown followed by 2 second sound and light alarm).

Antihijack Tranq Gas: Non-lethal standard (TL 9-11) or dose-controlled (TL 12+) tranq gas agents (non-persistent) are commonly used as an antihijacking measure on all starships. Typical damage from gas is 1 damage point per round until the character becomes unconscious. See the **MegaTraveller Players' Manual**, page 94 for a detailed description of effects.

Gas is available in all areas of the ship, and can only be ordered by an individual who identifies himself as a legitimate crew member to the computer.

Key Tasks

Guidelines for general-purpose tasks used on the other T charts.

Computing travel time

Use to compute the transit time between any 2 points in normal space.

1 Using the travel time formula

$$T = \sqrt{D \times (1-P)} + (G \times 32,400)$$

Where:

T = Time in hours to travel the given distance.

➔ To convert to standard days: divide T by 24.

➔ To convert to minutes: multiply T by 60.

➔ To convert to seconds: multiply T by 3,600.

D = Distance to be travelled in kilometers (for example, if the distance is 150,000,000 km, then D is 150,000,000; if the distance is 400,000 km, then D is 400,000).

P = Performance improvement percentage divided by 100.

G = Maneuver drive G rating.

Example

The situation:

- Need to travel 150,000,000 km (D=150,000,000) as quickly as possible.
- Maneuver-1 starship (G=1).
- Pilot's performance +5% (P=0.05; see performance-based tasks).

The computation:

$$\sqrt{150,000,000 \times (1-0.05)} + (1 \times 32,400)$$

The result:

66.3 hours.

Note: If your calculator won't handle numbers this large: divide the D by 1,000,000, do the calculation, and then multiply the result by 1,000 (the square root of 1,000,000, for the mathematicians).

Estimating task duration in advance

Use to estimate a task's probable duration in advance.

1 Doing the estimate

To estimate a task's duration ahead of time:
Difficult, related skill, Int (uncertain)

Referee: Use the related skill from the task being estimated. If successful, have the player roll the 3D duration roll ahead of time to arrive at the estimated duration for the task in question. When the actual task is performed, determine the actual duration by rolling 1D - 1D and adding the result to the estimate.

If **some truth**, roll 1D + 1D (that is, 2D) and add the result to the estimate for the actual task duration.

Example

The situation:

- Predict how long to repair the maneuver drive.
- The repair requires engineering skill.
- The repair has a 1 hour time increment.

The task:

To estimate the duration of the repair task:
Difficult, Engineering, Int (uncertain)

The result:

The player succeeds at the estimate task, rolls 3D, and gets an estimate of 7 hours. Later, when the player does the repair, he rolls 1D followed by 1D, giving a 2 and a 4.

• **If referee got a total truth estimate:**
7 + (2 - 4) = 5 hours actual duration.

• **If referee got a some truth estimate:**
7 + (2 + 4) = 13 hours actual duration.

Handling performance-based tasks

Use on tasks that allow trying for improved results.

1 Select the task

The player may select the task difficulty from the table below. The more difficult the task, the greater the potential improvement.

Difficulty	Qualifier	Improvement	
		+% on Success*	Best of...
Simple	—	none	—
Routine	—	DM x (1D - 2)	—
Difficult	fateful	DM x (1D - 2)	2 rolls
Formidable	fateful, hazardous	DM x (1D - 2)	4 rolls
Impossible	fateful, hazardous	DM x (1D - 2)	6 rolls

*On exceptional success, use the DM as the minimum percentage improvement.

Example

The situation:

- Player willing to try a difficult task.
- Player has a DM of 4 on the task.
- Player gets exceptional success on the task attempt.

The result:

Rolls 1D-2 and gets a -1 on first roll, and a 0 on the second roll. Since he can take best of two, he takes 0, but DM of 4 x 0 = 0. However, he got exceptional success, so his improvement = +4% (which is his DM).

Executing system cross-checks

Use to execute a system cross-check.

1 Doing the system cross-check

On tasks where the difficulty is marked with an asterisk (*), a system cross-check is recommended. To perform a system cross-check, the player must specify a cautious attempt.

If the player fails to do a cautious attempt, the task becomes uncertain. If the referee's secret roll fails, implement a warning light event sometime later.

2 Implementing a warning light event

Inform the players that the system (which they failed to cross-check) exhibits a warning light situation.

Once the warning light event has occurred, define a fateful task that must be performed in order to keep

Normal Space Flight

Use this procedure when the starship needs to travel between any two points in normal space.

Summary of Procedure

- Navigator gets desired destination from captain (step 1)
- Navigator determines the basic course distance D (steps 2 – 11)
- **(optional)** Navigator estimates travel time T (step 12)
- Navigator determines best distance D from basic course (step 13)
- Engineer determines best maneuver drive thrust G (step 14)
- Pilot determines actual transit time T by flying course (step 15)

1 Navigator gets desired destination from

If destination is another star system, then the normal space destination becomes the jump point. Otherwise... destination will be some other location within the local star system.

2 Navigator determines the basic course

Select the type of trip...

World Surface to Orbit

World Orbit to Jump

World Orbit to World

3 Determine distance (D) to world orbit

Consult the Orbit table below for the value of D.

ORBIT TABLE (in kilometers)

World Size	Std Orbit	High Orbit
0	5	25
1	20	100
2	40	200
3	60	300
4	80	400
5	100	500
6	120	600
7	140	700
8	160	800
9	180	900
A	200	1,000
Sm GG	800	4,000
Lg GG	1600	8,000

step 5

step 6

Explanation

Standard Orbit: Most common type of orbit used; also called a low orbit.

High Orbit: A much higher orbit, not used as often as a standard orbit.

To achieve a high orbit, first fly to a low orbit. Then fly the extra distance to get to the high orbit.

Geosync Orbit: A very high orbit that remains stationary over a given location on the rotating world. To achieve a geosync orbit, first fly to a low orbit. Then fly the additional distance to get to the geosync orbit. To determine the correct geosync orbit for a given world, use the formula shown.

$$O = 5078 \times (m \times p^2)^{.33} \div (D + 2)$$

Where:

O = geosync orbit in km
p = rotation period of world in hours
m = mass of world in earths
D = diameter of world in km

**Geosync
Orbit
Formula**

4 Effects of Atmosphere

Do only if world atm UWP = 2+

Multiply distance (D) by the UWP atmosphere digit (minimum of 1).

This simulates the need to restrict speed while travelling through an atmosphere, in order to avoid dangerous heat build up on the hull.

Example

The situation:

- World size 8
- Atmosphere UWP of 6
- We want to achieve a standard orbit.

The result:

D is 160 km. However, since we are travelling through an atmosphere, we use a D of 160 x 6 or 960 km.

step 12

step 12

5 Determine distance D from world orbit to jump point

If performing a jump at 10 diameters (not recommended), use the "10 diam." column from the table below to determine distance D from orbit.

If performing a jump at 100 diameters (recommended), use the "100 diam." column from the table below together to get distance D.

JUMP POINT TABLE (in k.m)

World Size	10 Diam.	100 Diam.
0	2,000	20,000
1	16,000	160,000
2	32,000	320,000
3	48,000	480,000
4	64,000	640,000
5	80,000	800,000
6	96,000	960,000
7	112,000	1,120,000
8	128,000	1,280,000
9	144,000	1,440,000
A	160,000	1,600,000
Sm GG	600,000	6,000,000
Lg GG	1,200,000	12,000,000

Example

The situation:

- World size 8
- We want a 100 diameter jump point

The result:

Distance D is 1,280,000km.

Normal Space Flight, continued

6 World orbit to world orbit

Select the type of trip...

Satellite orbit to satellite orbit (same planet)

Planetary orbit to planetary orbit

8 Determine radius of source and destination planetary orbits

To determine radius of a planetary orbit, consult the table below.

PLANETARY ORBITS

Orbit Nbr	Orbit Radius (in km)
0	29,900,000
1	59,800,000
2	104,700,000
3	149,600,000
4	239,300,000
5	418,900,000
6	777,900,000
7	1,495,500,000
8	2,932,000,000
9	5,804,000,000
10	11,548,000,000
11	23,038,000,000
12	46,016,000,000
13	91,972,000,000
14	183,885,000,000
15	367,711,000,000
16	735,363,000,000
17	1,470,666,000,000
18	2,941,274,000,000
19	5,882,488,000,000

Example

The situation:

- Source world is planet in orbit 3
- Destination world is satellite which orbits planet. This planet is in planetary orbit 7.

The result:

Radius of orbit 3 = 149,600,000km.
Radius of orbit 7 = 1,495,500,000.

Note: Notice that even though the actual destination in orbit 7 is a satellite of the planet, and not the planet itself, we have ignored this extra complication.

7 Determine radius of source and destination satellite orbits

To determine radius of a satellite orbit multiply the satellite's orbit number by the value in the table below.

SATELLITE ORBIT RADII TABLE (in kilometers)

World Size	Orbit Radii
0	200
1	1,600
2	3,200
3	4,800
4	6,400
5	8,000
6	9,600
7	11,200
8	12,800
9	14,400
A	16,000
Sm GG	60,000
Lg GG	120,000

Example

The situation:

- World size 8
- Source satellite in orbit 25
- Destination satellite in orbit 60

The result:

D for orbit 25 = 25 x 12,800 = 320,000km.
D for orbit 60 = 60 x 12,800 = 768,000km.

10 Determine type of course between orbits

Consult the table below to determine the type of course.

COURSE BETWEEN ORBITS

I — O position —	1	2	3	4	5	6
position 1	A	B	C	D	C	B
2	B	A	B	C	D	C
3	C	B	A	B	C	D
4	D	C	B	A	B	C
5	C	D	C	B	A	B
6	B	C	D	C	B	A

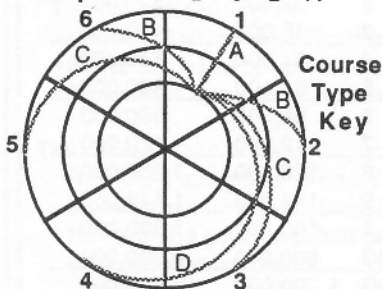

Example

The situation:

- Outer world in O₁.
- Inner world in I₆.

The result:

Cross indexing O₁ and I₆ on the table gives course type B.

9 Determine orbital positions

- Determine **outer** body position (O) by rolling 1D on chart below.
- Determine **inner** body position (I) by rolling 1D on chart below.

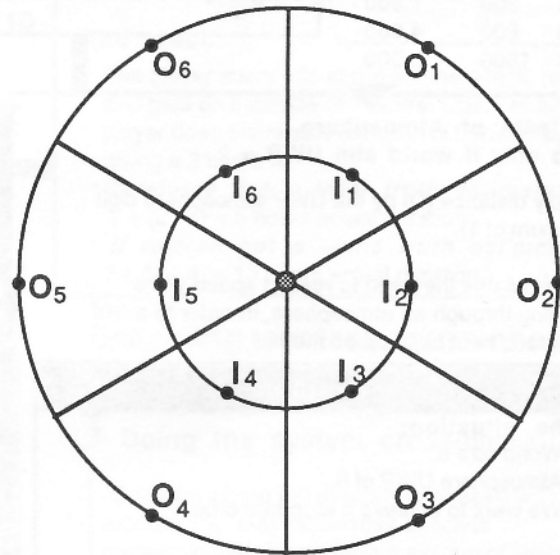

Example

The situation:

- Source world is in orbit 6
- Destination world is in orbit 3
- Source world is outer body (O) and destination world is inner body (I)

The result:

Rolling 1D for outer orbit gives 1. Outer world is in O₁.
Rolling 1D for inner orbit gives 6. Inner world is in I₆.

step 11

Normal Space Flight, continued

1 1 Determine D from course type
Determine the formula from the course type by using the table below. Compute D using the formula.

DISTANCE (D)	
Course	Formula to get D
A	$O - l$
B	$(O - l) \times 2$
C	$(O - l) \times 3$
D	$(O - l) \times 4$

Where:
O=Orbit O radius
l=Orbit l radius

Example
The situation:
• Course type = B
• Outer orbit radius = 777,900,000
• Inner orbit radius = 149,600,000
The computation:
 $(777,900,000 - 149,600,000) \times 2$
The result
D is 1,256,600,000km.

1 2 Navigator estimates travel time T
The navigator can compute a travel time estimate from the basic value of D and the ship's standard acceleration as G. Use P=0 in this case.

Example
The situation:
• D = 1,256,600,000km.
• Maneuver-2 starship (G=2).
• P=0
The computation:
 $\sqrt{1,256,600,000 \times (1-0) + (2 \times 32,400)}$
The result:
Estimated travel time is 139.3 hours, or 5.8 days.

1 4 Engineer determines best maneuver drive
To optimize maneuver drive performance for a flight: [difficulty], Engineering or Gravitics/2, Edu, 2 min
Referee: Performance-based task.

Example
The situation:
• Engineer's skill level = 5
• Engineer's Edu DM = +2
• Engineer selects a difficulty level of **difficult**
Maneuver-2, so G = 2
The result:
Task roll with DMs is 11, giving success. The player rolls 1D two times, getting no better than a 1 either time for an improvement [DM x (1D-2)] of: 7 x (1-2), or -7%, which in this case is actually a detriment. Our engineer is having a bad day. The revised G is thus 93% for this trip.

1 3 Navigator determines best distance D from basic course
To optimize a basic flight path for distance: [difficulty], Navigation, Edu, Time=10 min + Computer TL
Referee: Performance-based task. Divide 10 min by the starship computer's tech level to get the time increment for this task.

Example
The situation:
• Navigator's skill level = 3
• Navigator's Edu DM = +1
• Navigator selects a difficulty level of **difficult**
• Computer TL = 12, for a time increment of .83 min
• Basic value of D = 1,256,600,000
The result:
Task roll with DMs is 12, giving success. As per the performance-based task procedure, the player rolls 1D two times, taking the best of the 2 rolls. Of the two rolls, 1 and 6, the best roll is 6. The performance improvement [formula: DM x (1D-2)] is thus: 4 x (6-2), or 16%. The navigator has thus improved D by 16%, which gives a shorter D that is 84% of the basic value. Best D = 1,256,600,000 x 0.84 = 1,055,544,000km

1 5 Pilot determines actual transit time T by flying course
To optimize a spacecraft's flight once D and G are known: [difficulty], Pilot or Ship's Boat, Edu, absolute
Referee: Performance-based task. The time duration for this task is T, the computed travel time of the flight.

Example
The situation:
• Best D = 1,055,544km
• Best G = 1.86 gees
• Pilot's skill level = 2
• Pilot's Edu DM = +2
• Pilot selects a difficulty level of **routine**
The result:
The task roll with DMs is 10, giving exceptional success. Player rolls 1D, getting a 5. The improvement percent is: 4 x (5 - 2), or +12%. (With exceptional success, minimum plus is 4%.) The actual transit time computation becomes:
 $\sqrt{1,055,544,000 \times (1 - 0.12) + (1.86 \times 32,400)}$
for a result of 124.2 hours, or about 5.2 days. This is about 15 hours ahead of the navigator's original estimate of 139.3 hours.

DONE

Jumpspace Flight

Use this procedure when the starship needs to travel between any two points in jumpspace.

Summary of Procedure

- Navigator determines desired jump vector (step 1)
- Engineer charges up energy sinks (step 2)
- Navigator engages jump drive (step 3)
- All hands prepare for jump exit (step 4)
- Jump exit occurs (step 5)
- Navigator determines ship's location in normal space (step 6)

1 Navigator determines desired jump

To generate the desired jump vector:
Routine*, Navigation or Pilot/2, Edu, Time = table below
Referee: This task is totally dependent on the availability of a jump navigation computer. An impending warning light event from this task could spell a misjump or a violent jump exit. *On a mishap, see Other Tasks*

JUMP VECTOR GENERATION

TL	Task		Ship	
	Time	Avg	Cbt	Turns
	Incr	Mins		
9	6 min	80	4	
10	4 min	60	3	
11	2 min	40	2	
12	1 min	20	1	
13	30 sec	10	1	
14	15 sec	5	0	
15	7 sec	3	0	
16	4 sec	1	0	

Example

The situation:

- Navigator's skill = 3
- Navigator's Edu DM = 1
- Computer TL = 12, giving task time increment = 1 min

The result:

Navigator specifies system cross-checks (cautious attempt), making this task simple instead of routine. The doubled time roll with DMs becomes 18 minutes to generate the jump vector.

2 Engineer charges up energy sinks

To insure that a uniform energy sink charge exists:
Routine*, Engineering, Edu, 2 min

Referee: The engineer uses this task to monitor the charge-up process. A warning light event from this task usually results in failure to go into jump, or perhaps energy sink damage from a faulty charge. *If a mishap occurs, see Other Tasks*

Example

The situation:

- Engineer's skill = 5
- Engineer's Edu DM = 2
- Engineer declines system cross-checks, which makes the task uncertain

The result:

Engineer rolls 12 with DMs, for exceptional success. Referee secretly rolls 9 with DMs, for a result of total truth. The referee tells the engineer: "You are confident you have a good charge." This is, of course, completely true. The time roll with DMs gives a duration of 10 minutes to perform the charge-up. The engineer declares: "All systems are go for the jump."

3 Navigator engages jump drive

To engage the jump drive:
Routine*, Engineer, Navigator's Edu (fateful)
Referee: While the navigator "pushes the button", both the engineer and navigator monitor the jump transition together. *On a mishap, see Other Tasks.*

Inside 100 diameters, this task becomes difficult* (hazardous, fateful).

Inside 10 diameters, this task becomes formidable* (hazardous, fateful).

There is a high risk the jump field will not close if more than 10% of the ship's hull net is missing in any one location. How could this happen?

1. From any critical surface hit in starship combat.
 2. Compute percent of hull net damage = (number surface hits x 100) ÷ hull disp
- If this number is greater than 10, then high risk.

In these cases, the jump task becomes...
Difficult*, Engineer, Navigator's Edu (hazardous, fateful)

4 All hands prepare for jump exit

Starting at 120 hours from jump entry, all hands should be placed on jump exit alert. Jump exit generally occurs at about 160 hours, but may occur as early as 120 hours or as late as 200 hours.

Referee:

Hours in jump space = $124 + (2D \times 6)$
Misjumps can alter this figure.

Example

Referee rolls 2D, getting 9.
The hours in jumpspace = $124 + (9 \times 6) = 178$ hours, or 7.4 days.

5 Jump exit occurs

Roll 2D on the table below.

Die	Exit type	Mishap
10-	—	—
11	uneven exit	1D (crew)
12	rough exit	1D (hull)
13	violent exit	2D (system)
14	violent exit	2D (crew)
15	violent exit	3D (system)

DM: If warning light event during this jump, +3

Mishaps...

crew: affects 10% of those onboard (round up)

hull: affects hull only

system: affects a single ship system (see *Other Tasks*).

Example

The situation:

- Engineer's skill = 5
- Navigator's Edu DM = 1
- Engineer declines cross-checks, making task uncertain

The result:

Navigator rolls 16 for exceptional success. Referee rolls 12 for total truth. The referee declares: "A very smooth transition. Everything's working great."

6 Navigator determines ship's location in

To determine location in normal space upon jump exit:
Routine, Navigation, Sensor Ops, 1 min (uncertain)

Referee: If this task is performed without the aid of system beacon readings, the task becomes Difficult, and the time increment becomes 1 hour. This task must be successful before meaningful normal space navigation can occur.

DONE

Other Tasks

This chart contains assorted tasks and tables relating to starship operations.

Roll 2D on the following table whenever you need to randomly select a ship system as the object of some event (such as for a malfunction mishap).

WHICH SHIP SYSTEM

Die System

- 2 Cargo/Passenger
- 3 Weapons
- 4 Flight controls
- 5 Sensors/Commo
- 6 J-drive/M-drive
- 7 Access
- 8 Power plant
- 9 Fuel
- 10 Environment
- 11 Low berths
- 12 Hull

ANNUAL MAINTENANCE

Failure to Do Annual Maintenance

Failure to do annual maintenance makes *all* tasks using that system (uncertain). On some truth, implement a warning light event. If a mishap does later occur, because the ship has not yet performed annual maintenance, roll 3D instead of

Optionally, secretly roll 3D for the number of weeks past the 12-month "annual boundary" at which to begin the uncertain task rolls. Thus, at some point past the annual maintenance deadline, warning light events will start to occur with disturbing regularity.

Jump Drive Overhaul (A or B Starports only)

To overhaul a jump drive (per 100 disp tons of ship): Formidable*, Engineering, Mechanical, 2 days
Referee: Two individuals can add their skills together on this task. Different teams per 100 tons can work simultaneously.

Pwr Plant Overhaul (A, B, or C Starports only)

To overhaul a power plant drive (per 100 disp tons of ship): Difficult*, Engineering, Mechanical, 1 day
Referee: Two individuals can add their skills together on this task. Different teams per 100 tons can work simultaneously.

Minor Repairs (A, B, C, or D Starports only)

To perform minor repairs on all systems during annual maintenance (per 100 disp tons of ship): Routine*, Electronics, Mechanical, 1 day
Referee: Up to three individuals can add their skills together on this task. Different teams per 100 tons can work simultaneously.

JUMP MISHAPS

Superficial: Jump relativity error occurs. The ship remains in jumpspace 80 + (3D x 10) hours before emerging in the destination system.

Minor: Jump relativity error occurs. Also when the ship emerges in the destination system it is 1D x 100,000,000km away from its intended exit point in the destination system.

Major: Jump relativity error occurs. Ship misjumps. Throw 1D for the number of dice to throw. Then throw that number of dice for the distance (in parsecs) the ship travelled. Finally, throw 1D for the direction of the misjump.

Destroyed: The ship is destroyed.

WILDERNESS REFUELING

Gas Giants

To skim a gas giant atmosphere for starship fuel:

Routine, Pilot, Navigation, 1 hour (hazardous)

Referee: Mishaps can include simple turbulence, excessive radiation exposure, collisions with debris, or heat damage to the hull.

Gas Giant Rings

To locate a body suitable for starship fuel (ice) in a gas giant's rings:

Difficult, Sensor Op, Edu, 2 hours

Referee: The gas giant must have a ring for this task to be allowed. This task locates the fuel source. See the general task below for getting the ice into the ship's fuel tanks.

Oceans

To refuel a starship from an ocean:

Routine, Pilot, Sensor Ops, 30 min

Referee: The starship must be piloted to the world's surface before this task may be attempted. Possible mishaps include rough seas and encounters with unfriendly aquatic lifeforms.

Icy Planets or Moons

If a detailed workup of the star's system exists, simply have the players fly their craft to the planet or moon in question. Otherwise, roll 2D: 10+ for such a body to exist in the system. Prefer a gas giant moon or outer system planet for the location. Once the players have arrived, see the general task below for getting the ice into the ship's fuel tanks.

Asteroid Belts

To locate a body in a planetoid belt suitable for starship fuel (ice):

Difficult, Sensor Op, Edu, 1 day

Referee: The ship must be flown into the asteroid belt to perform this task. See the general task below for getting the ice into the ship's fuel tanks.

Comets

To locate a cometary body suitable for starship fuel (ice):

Formidable, Sensor Op, Edu, 10 days

Referee: Once the comet has been located, see the general task below for getting the ice into the ship's fuel tanks.

Getting Ice as Fuel

To "mine" an icy body for unrefined fuel:

Routine, Vacc Suit, Mechanical, varies:see below (hazardous)

Referee: The time increment varies depending on how much fuel there is to be collected: use 1 min per kiloliter of fuel to be collected.

BASIC REPAIRS TASK GUIDE

Basic repair skills needed to repair ...

J-Drive

Engineering, Edu

M-Drive

Engineering or Gravitics/2, Edu

Power Plant

Engineering, Edu

Life-support, environment

Electronics, Edu

Computers

Computer or Electronics/2, Edu

Sensors

Electronics or Computer, Edu

Communications

Electronics or Commo, Edu

Hull

Mechanical or Engineering/2, Edu

Fuel systems

Mechanical or Engineering/2, Edu

Access portals

Mechanical or Electronic, Edu

Weapons and screens

Computer or Electronics, Edu

Basic repair time increment guide...

Superficial damage: minutes

Minor damage: hours

Major damage: days

Destroyed damage: weeks

INDEX

Agility, 8

- air lock, 28, 29, 30, 47
- Ancients, 10
- anti-hijacking, (see security systems)
- armor, 50, 52
- artificial grav, 3, 15, 19, 25, 26, 27, 28, 28, 29, 44, 45, 50, 52, 53, 56
- Aslan, 10, 12
- atmosphere effects of flight, 61
- avionics, 3, 7

Barium (in jump nets), 10

- batteries, 15, 17
- Big Bang, 10
- black box, 18, 20, 22
- black globe, 50, 53, 54
- bridge crew, 6, 7, 25, 55
- broker, 46, 47, 56
- broker robots, 56
- bulkheads, 31, 44

Captain, 11, 14, 25, 26, 30, 53, 55, 56

- cargo, 45-49
- cargo handlers, 45, 56
- cargo hold, 45, 46, 47
- chameleon circuit, 27, 28, 44
- chemical rockets, 2, 4, 50
- command crew, 55
- communications, 7, 8, 12, 17-22, 47, 55
- communication channels, 26, 27
- computer, 2-4, 5-9, 12-14, 17-22, 23-26, 47, 48, 51, 53
- computer insanity, 26
- computer operator, 55, 56
- configurable controls, 5, 6, 48
- copilot, 6, 55
- course plots, 7
- crew duties, 55-57

Decor, 48

- densitometer, 17, 18, 19, 21
- directional broadcast, 20, 21
- Dolphins, 30, 31
- doors, 31, 44
- Droyne, 11, 12
- dynamic linked controls, 5

Electrician, 44, 56

- emergency kit, 45, 48, 59
- EMS, 4, 17, 18, 19, 21
- engineer, 2, 4, 8, 11, 12, 13, 15, 16, 25, 29, 31, 55, 56, 61-65
- entertainment, 45, 47
- environment, 27-31, 44, 46, 47, 48
- estimating task duration, 60

First Imperium, (Ziru Sirka), 10

- flight controls, 5, 7, 8, 9
- flight crew, 56
- food, 30, 45, 46
- Fourth Frontier War, 11, 16
- frozen watch, 56, 57
- fuel, 15-17
- fuel purification, 15, 16, 46
- fuel tanks, 15, 16
- fusion drive, 2
- fusion, nuclear, 15, 19, 50, 51

Gas-jet attitude controls, 3

- grav, artificial, (see artificial grav)
- grav modules, (see artificial grav)
- gravitic drive, 2, 50, 56
- gravitic technology, (see artificial grav)
- gravitics technician, 56
- gravitons, 2, 53
- gravity (wells), 5, 6, 8, 13, 14
- gunners, 52-56
- gunnery control stations, 53, 54, 57

Hard points, 51

- heads-up display, 6, 7
- Hiver, 7, 10, 12

holodynamic controls, 5

- hull radiators, 9, 13, 15, 28, 53
- hull, 27-31, 44

Imperium, (or Third Imperium), 10, 22, 25, 29, 31

- inertial braking, 3
- inertial compensators, 3, 29, 30, 31, 44, 45, 56
- inertial gyroscopes, 3
- ion drives, 2
- iris valve, 29, 30, 31

Jump drive, 4, 8, 9, 10, 11, 12, 13, 15, 16, 45, 50

- jump entry, 8, 12, 13, 14
- jump exit, 8, 12, 13, 14, 61, 64
- jump field "bubble", 12, 13, 14
- jump governor, 7, 8, 13, 14
- jump net, (see Lanthanum grid)
- jump point, 6, 8, 62
- jump sickness, 8, 11, 14
- jump vector, 6, 8, 11, 12, 13, 64
- jumpspace, 5, 6, 7, 8, 10, 11, 12, 13, 14, 55
- jumpspace flight, 64
- Jumpspace Institute of Deneb, 10

Key tasks, 59, 60

- K'kree, 7, 10, 12
- Lanthanum grid, 4, 6-14, 29
- lasers, 18, 20, 22, 50, 51, 54
- leg controls, 7
- library data, 25
- life support, 46, 48, 56
- lifeboats, 49
- Long Night, 10, 31
- low berths, 14, 44, 45, 48, 52
- luxury liners, 49

Magnetic fields, 15

- maintenance, 16
- main drive, (see maneuver drive)
- maneuver drive, 2-4, 7, 8, 9, 14, 56, 63
- medic, 11, 52, 56
- merchant vessels, 6, 16, 45, 46, 49
- meson guns, 50, 52
- meson screens, 50, 52, 53, 54
- mesons, 2, 20, 22, 53, 54
- microjump, 7, 14
- misjump, 6, 10, 11, 14, 16
- missile guidance systems, 51
- missiles, 50

Naming conventions, 31

- navigation, 5, 6, 7, 8, 23
- navigation devices, early, 5
- navigator, 5, 7, 8, 11, 12, 13, 16, 21, 56, 61-65
- Navy (military ships), 3, 4, 6, 14, 16, 22, 29, 30, 51, 55, 57
- neutrino sensor, 16, 18, 19, 21
- normal space flight, 61-63
- nuclear damper technology, 2, 28, 29, 50, 52, 53, 54
- nuclear forces, (strong, weak), 2, 52, 53

Operations crew, 55

- optional operating rules, 59-65
- orbit tables, 61, 62
- orbiting stations, satellites, 4, 6, 45, 62
- orientation subsystem, 3, 4, 7, 8, 9
- overdriving thrusters, 3, 4, 8

Particle accelerators, 50, 51, 52, 54

- passengers, 14, 25, 28, 29, 30, 31, 45-49
- performance tasks, 59, 60
- pilot, 6, 7, 8, 13, 16, 18, 55, 61, 63, 64
- pirates, 14, 22, 27, 31, 46, 51, 57
- plasma guns, 50, 51
- power distribution, 15
- power plant, 3, 4, 7, 8, 9, 12, 14, 15-17
- pump, 16
- purser, 45, 46, 56

Radar, madar, ladar, 18

- radio, 18, 20, 21
- ramjets, 2
- repulsors, 50, 52, 54
- reference beacons, 8

relative size chart, 58

Safety interlocks, 53, 54

safety regulations, 11

- Saint Elmo's Fire, (ionization), 3
- sandcaster, 25, 50, 51, 52, 54
- screens, 50-54
- Second Imperium, (Ramshackle Empire), 10
- security systems, (anti-hijacking), 23-26, 29, 44, 56

- (voice readers, fingerprint readers, retinal scanners, active metabolic scanners, electronic locks, magnetic readers, passive metabolic scanners, sensors, terminal traffic monitor, alarm panel)

sensor operator, 55

- sensor probes, 22
- sensors, 7, 8, 17-22, 53, 55
- Shipboard Information Service, 24
- ship's troops, 57
- simulation, 4, 6, 21
- skimming a gas giant, 16, 17, 46, 65 (see also wilderness refueling)
- Solomani, 10, 31, 50
- spinal mount, 3, 21, 50
- star charts, 8
- Starfarer (ship), 10
- staterooms, 20, 46, 47, 48, 49
- steward, 11, 26, 45, 56
- stowaways, 48
- subsidized routes, (mail), 7, 47, 57
- superdense composite, 3, 19, 28
- support crew, 56
- system cross-check, 60

Tacticians, 57

- teleportation, 2
- Terra, system, 14
- thrusters, 2-4, 8, 51
- tight-beam, 5, 19, 20, 22
- trader, 56
- transponder, 12, 17-22
- travel time formula, 60, 64
- Tukera Lines, 47, 56
- "tumble", 11, 12, 13

Vacc-suit, 30, 31, 49

- Vargr, 7, 10, 11, 12, 51
- Vegans, 31
- Vilani, 10, 11, 31, 50
- Vland, 6, 10

Warhead, 51

- warm and cold starts, 17
- warning-light event, 60, 65
- waste recycling, 30
- watch officer, 20
- weapons, 50-54
- "weave", 10, 11, 13, 14
- wilderness refueling, 65

Zhodani, 2, 10, 11, 12, 16, 21, 31, 46, 51

- Ziru Sirka, (see First Imperium)
- zuchai crystals, 12, 13, 14, 53

Selected Type 'A' Profiles

PERSUASIVE ARGUMENT

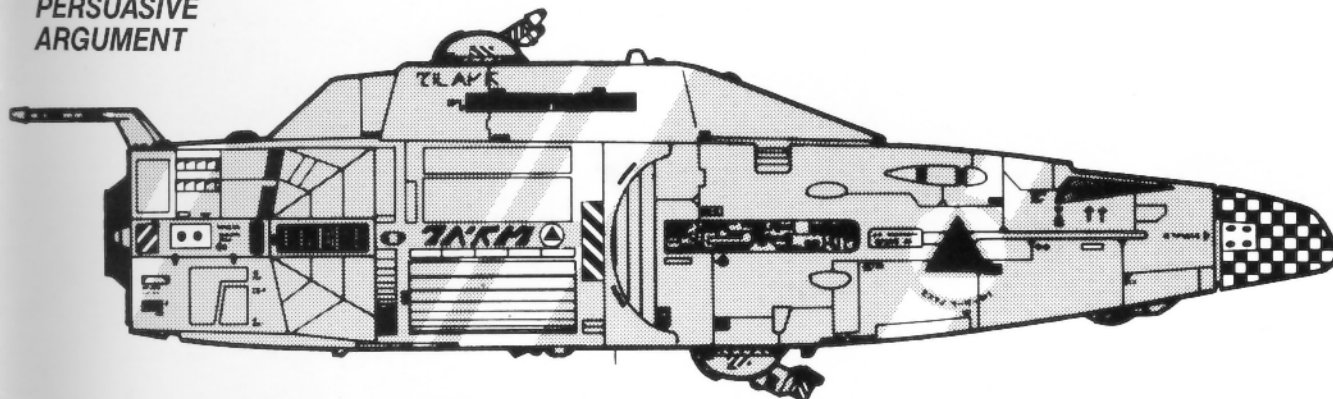

With the threat of Vargr raiding in Corridor Sector, *Persuasive Argument's* captain, Adrel Vaskin, sunk herself in debt to up-gun her craft, hoping to make it a commodity of safe transport. Unfortunately, the *Argument* did not generate the demand she had hoped, and the vessel now runs at a financial loss. This has led Vaskin to pursue cargoes with a more lucrative price tag, and often of questionable legality.

The *Argument* brandishes a triple pulse laser in its dorsal turret and a triple missile turret, ventrally. Vaskin has also recently "acquired" a surplus military sensor suite, seen hanging down from below the bow.

The bright color scheme of the *Argument* easily distinguishes it at any port. Finished in an overall light blue tone, the ship is crossed by a gold stripe aft, a gold and smaller bronze stripe cutting across the midsection, and a red stripe forward, straddling the rather over-sized Vaskin Corp. logo. The ship's nose is finished in an interesting black and white checkerboard design.

SHIDAKA

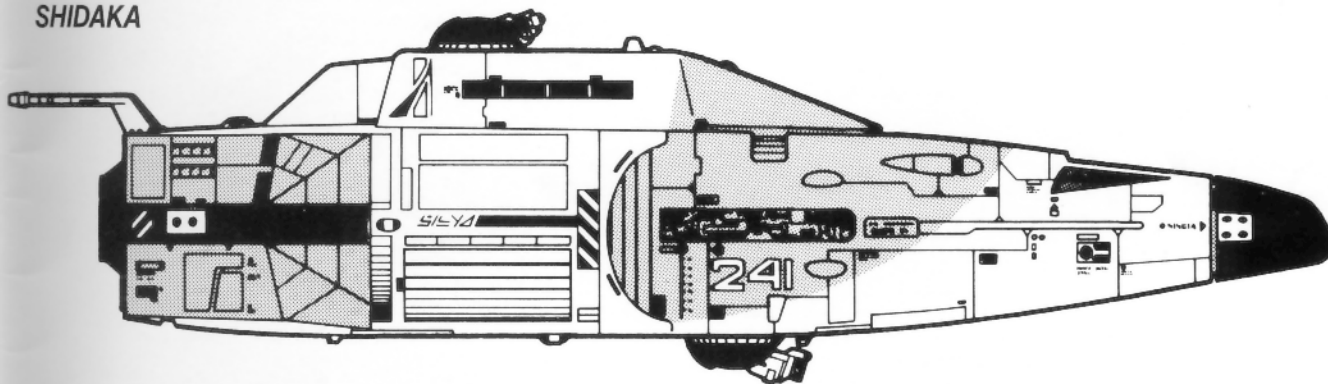

Co-commanded by the Aslans Tlea and Kyura (short forms of their actual names), the *Shidaka* carries out its activities in the Rimward end of the Spinward Marches. The ship serves under the Hlararei Trade Group (HTG), a clan-owned company which engages in mercantile ventures out of New Rome in Glisten Subsector. The recent influx of Aslan colonists into the area has given rise to some hostile reactions from the Marches's human populace in regards to indigenous Aslan industries such as the HTG.

Shidaka mounts two turrets: one fitted with a sandcaster and twin pulse lasers, the other with a single missile launcher. Beyond minor interior accommodations to suit its predominantly Aslan crew, the *Shidaka* is a fairly standard ship of its type.

Coloration of the ship is in a light gray tone, with swatches of red bracketing the drive section and running over the top of the mid-section. The craft's turrets and nose are painted jet black, with a stripe of this color splitting the red finish by the drive section. The HTG logo is prominently displayed on the sides of the passenger deck.

GIMUQSHABIKA

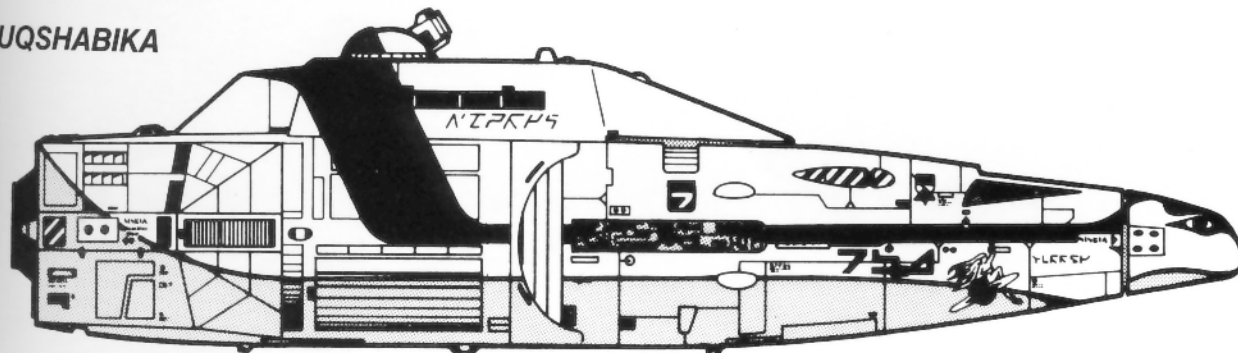

Operating in the long-civilized regions of the Imperial core, the free trader *Gimuqshabika* uses a backwater route between the worlds of Ketola and Irlu to conduct its business. The ship's master, Sten Kurlush, has an almost fanatic attitude towards his vessel's upkeep. He fills the *Gimuqshabika* only with refined fuel, which leads to his removal of the craft's static discharge probe, used only during gas giant skimming operations. The ship mounts a single dorsal turret with a defensive triple sandcaster installed.

Using white as the base color, the *Gimuqshabika* sports a lavender underbelly, delineated by a dark purple stripe. A gloss black band runs from over the passenger deck, forward, to the "eye-adorned" nose. Characteristic nose art and company initials adorn the vessel's sides below the bridge.

STARSHIP

O P E R A T O R ' S M A N U A L

Whether you're stationed on a merchant ship, a Navy cruiser, or a corsair . . .

Whether you're a captain, an engineer, a pilot, a broker, or just a hand who swabs the deck . . .

Whether you want to travel from world to world, start up a maneuver drive, or scoop fuel from a gas giant . . .

. . . You need to read the *Starship Operator's Manual Vol. 1*.

Everything you've ever wanted to know about starship operations.

Contents include—

- **Systems:** How things work, including details of jump drive, maneuver drive, power plant, sensors, transponder, flight controls, computer, weapons, hull, and cargo hold.

- **Procedures:** Step-by-step instructions on navigating a course, going into jumpspace, starting up a power plant, getting more "oomph" from a maneuver drive, and lots more.

- **Crew Duties:** Over 20 positions described, telling who does what and why.

- **"The Old Timer":** Expert advice on Starship operation from an "old time" merchant captain.

- **Deck Plans:** All-new deck plans for the *Free Trader* class starship, along with interior views of the ship.

- **Index:** A complete catalog of the contents.

For Use With MegaTraveller

This module is intended for use with **Traveller** or **MegaTraveller**. It requires that you have a copy of the game rules.

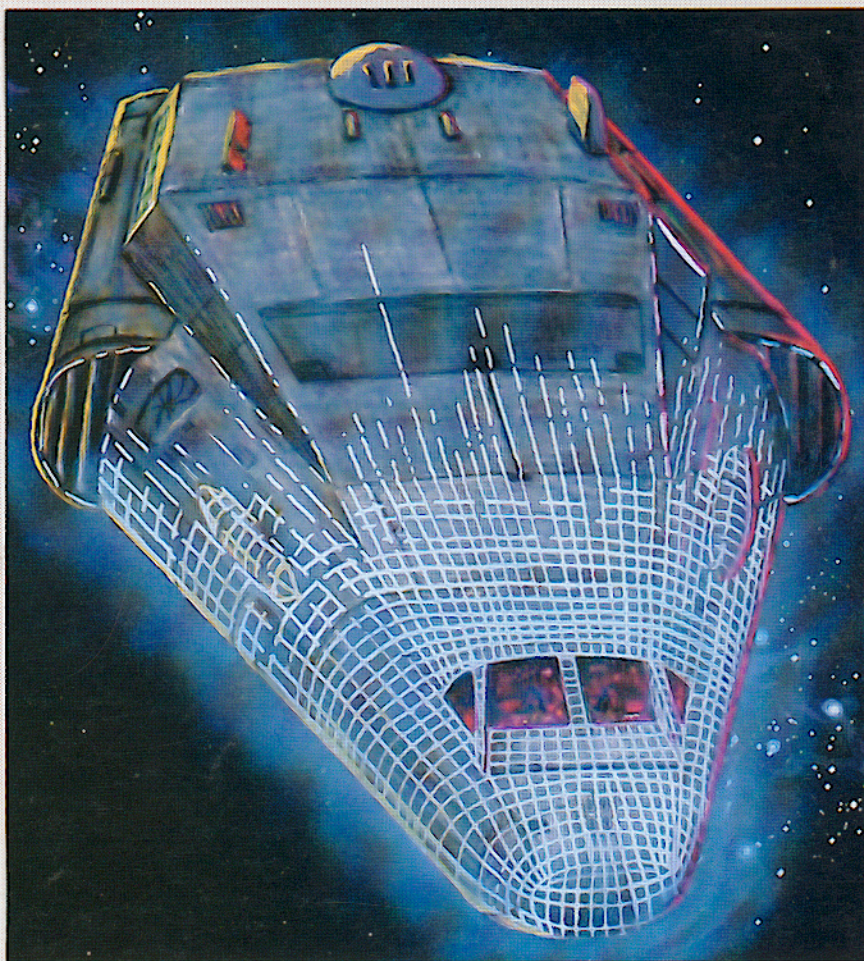

*The lanthanum grid in the starship's hull lights up only seconds before a *Free Trader* goes into jump.*

Digest Group Publications, 8979 Mandan Ct., Boise ID 83709-5850

Traveller® is GDW's registered trademark for its science-fiction role-playing game system. **MegaTraveller** and The Shattered Imperium are trademarks of GDW and are used with permission.

Copyright © 1988 by Digest Group Publications. All rights reserved. No part of this supplement may be reproduced in any form or by any means without written permission from the publisher. Printed in the USA. Portions of this supplement are taken from *Traveller* and *MegaTraveller* materials published by Game Designers' Workshop, and are copyright © 1988 by GDW, Inc.

DGP-872-0895