

MEGATRAVELLER

0218

# FIGHTING SHIPS

OF THE SHATTERED IMPERIUM

Marc  
W.  
Miller



Science-  
Fiction  
Adventure  
in the  
Shattered  
Imperium

**GDW**  
GAMES



*Marc W. Miller*

**MEGATRAVELLER™**

# **FIGHTING SHIPS**

OF THE SHATTERED IMPERIUM

Science-Fiction Role-Playing  
in the Shattered Imperium



# Table of Contents

<b>Fighting Ships</b> .....	5	CA-15 Cruiser Armored .....	46
Mission of the Imperial Navy .....	5	CM-12 Cruiser Missile .....	48
Five Broad Ship Types .....	5	CS-15 Cruiser Strike .....	49
Seven Broad Fleet Types .....	5	CH-14 Cruiser Heavy .....	50
Four Broad Squadron Types .....	6	CH-15 Cruiser Heavy .....	51
Fleets and Squadrons Diagram .....	7	CJ-15 Cruiser Imperial .....	52
Naval Activity in the Rebellion .....	8	<b>Carriers</b> .....	<b>54</b>
Privateers .....	8	Imperial Carriers Diagram .....	55
Couriers .....	8	VF-12 Carrier Fleet .....	56
Ship Listings .....	8	TV-12 Tanker Vehicle .....	57
Imperial Squadron Diagram .....	9	VF-12 Carrier Fleet .....	58
<b>Battleships</b> .....	<b>10</b>	VS-13 Carrier Strike .....	60
Imperial Battleships Diagram .....	11	VS-14 Carrier Strike .....	61
BB-11 Battleship .....	12	VS-15 Carrier Strike .....	62
BB-12 Battleship .....	14	VL-15 Carrier Light .....	63
BB-13 Battleship .....	15	VP-15 Carrier Provincial .....	64
BI-13 Dreadnought .....	16	<b>Escorts</b> .....	<b>66</b>
BI-14 Dreadnought .....	17	Imperial Escorts Diagram .....	67
BI-15 Dreadnought .....	18	ED-11 Escort Destroyer .....	68
BL-13 Battleship Light .....	20	ED-12 Escort Destroyer .....	69
BL-14 Battleship Light .....	21	ED-13 Escort Destroyer .....	70
BL-15 Battleship Light .....	22	ED-14 Escort Destroyer .....	71
BM-15 Battleship Missile .....	24	ED-15 Escort Destroyer .....	72
BH-14 Battle Heavy .....	26	EF-12 Escort Fleet .....	74
BH-15 Battle Heavy .....	27	EM-13 Escort Missile .....	76
BT-14 Battle Tender .....	28	EM-15 Escort Missile .....	77
BR-14P Battle Rider .....	30	EF-15 Escort Fleet .....	78
BR-14M Battle Rider .....	31	FS-15 Strike Fighter .....	80
BT-15 Battle Tender .....	32	<b>Auxiliaries</b> .....	<b>82</b>
BR-15P Battle Rider .....	33	Imperial Auxiliaries Diagram .....	83
BR-15M Battle Rider .....	34	TF-11 Tanker Fleet .....	84
TB-15 Tanker Battle .....	35	TF-12 Tanker Fleet .....	86
BZ-15 Battle Experimental .....	36	TF-13 Tanker Fleet .....	87
BS-15 Battleship Strike .....	38	TF-14 Tanker Fleet .....	88
<b>Cruisers</b> .....	<b>40</b>	TF-15 Tanker Fleet .....	89
Imperial Cruisers Diagram .....	41	TT-13 Transport Tanker .....	90
CA-11 Cruiser Armored .....	42	TZ-15 Tanker Rift .....	91
CA-12 Cruiser Armored .....	43	TM-11 Tanker Missile .....	92
CA-13 Cruiser Armored .....	44	TM-12 Tanker Missile .....	93
CA-14 Cruiser Armored .....	45	7N-15 Special Nonstandard .....	94

12

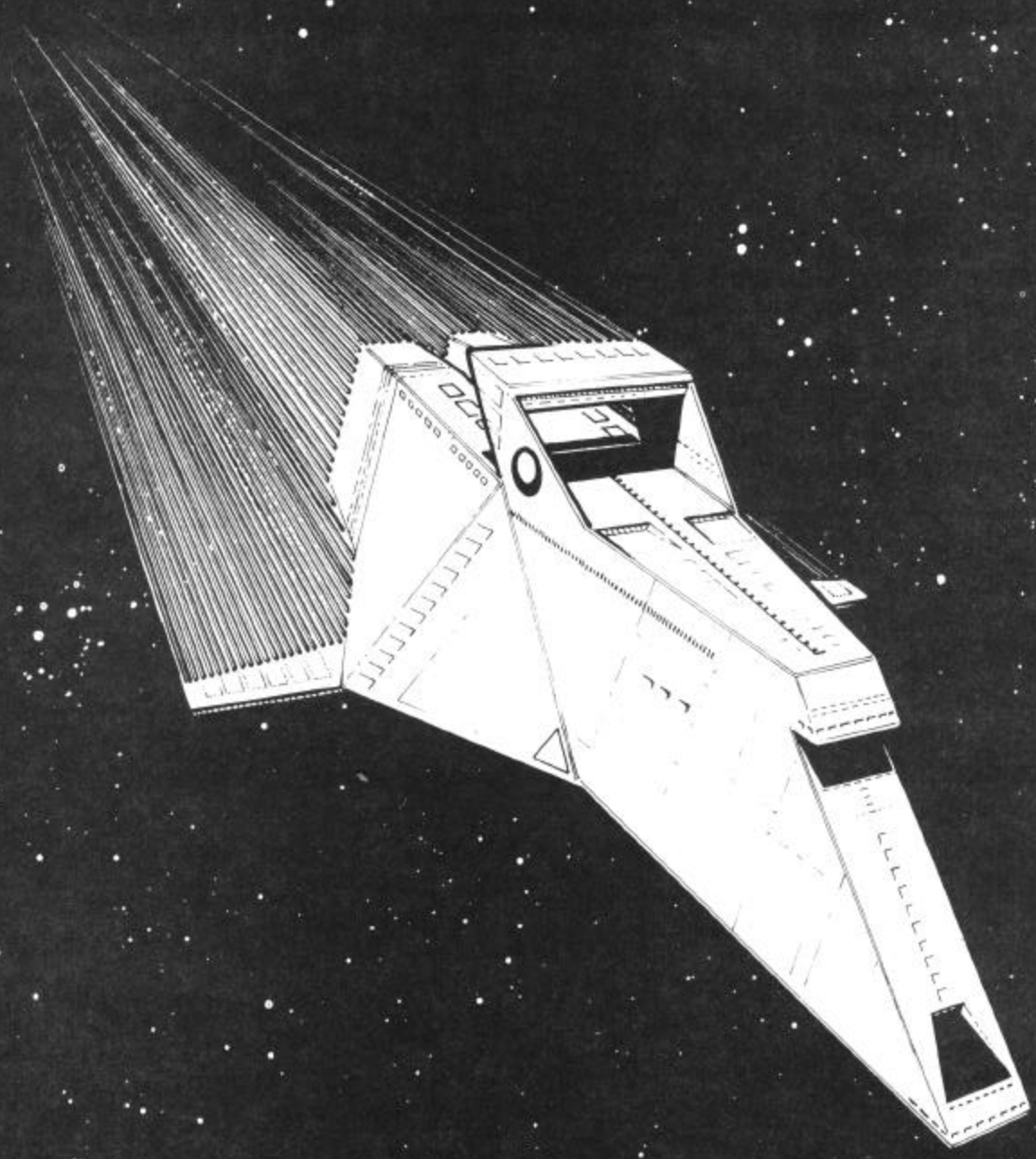

BR-14M

# Fighting Ships

Over the course of its 1000-year history, the Imperial Navy has developed and refined its needs for fighting ships based on its experience in conflicts with interstellar neighbors and in response to established internal needs for peacekeeping within the empire.

The Imperial Navy uses the term *ship* for any vessel capable of jump. It uses a variety of terms (including *boat*, *rider*, and *monitor*) to identify all other vessels.

## MISSION OF THE IMPERIAL NAVY

The Third Imperium is a government of governments. The territory of the Imperium consists of nearly 10,000 star systems, each of which contains one or more inhabited worlds and many less-exploited worlds. Where there is a population, there is usually a government, and the Imperium encourages local government responsibility for the day-to-day activities of the world.

**The Imperial Sea:** In metaphor, the Imperium is a broad sea, with each world an island with its own government. The Imperium rules not the islands, but the sea of space between the worlds. Its responsibilities include encouragement, regulation, and protection of trade between worlds, regulation of interworld relations (diplomacy), and protection of the Imperium against dangers from its external and internal enemies.

But the Imperium is not without its planet bases. Most inhabited worlds have their own governments which rule with little or no Imperial interference. That still leaves the nearly 100,000 uninhabited worlds (most of them the frozen planets beyond the life zone) which are Imperial territory. That also leaves select planets which have always been Imperial territory—capitals, naval depots, restricted or protected worlds, and resource preserves.

**The Navy's Mission:** The Imperial Navy is the armed force which patrols the Imperial sea of stars. Its mission is to maintain the peace and security of the Imperium. The navy is the force that defends the Imperium against aggression by its neighbors. The navy is the force that protects internal trading and transport ships from piracy and raiders. Finally, the navy protects the worlds of the Imperium from each other.

The Imperial Navy is also the armed force used by the Imperium as its agency of conquest. The Imperial Navy is the only force capable of carrying the power of the Imperium into new territory. And the Imperial Navy is, by its very existence, a deterrent to the aggression of enemies of the Imperium.

**The Organization of the Imperial Navy:** The navy is organized into fleets, each of which is composed of squadrons, which are themselves composed of individual ships. The ships are the heart of the Imperial Navy, and the organizations containing them serve to provide direction and control over their actions.

## FIVE BROAD SHIP TYPES

The Imperial Navy acknowledges five broad ship types in its service: scouts, escorts, cruisers, carriers, and battleships. Each type has its own function within the overall mission of the navy.

**Battleships:** The power of the Imperial Navy is concentrated in its battleships. The definition of a battleship is a ship which, due to its armament and protection, is capable of standing in the line of battle. When a battleship meets any lesser type of ship, its victory is almost guaranteed. When battleships on two sides meet, victory goes to the better armed, better armored, and better directed ship.

The broad type of battleship is further divided into many more clearly defined types. Besides battleships, there are dreadnoughts,

battle riders, and battle tenders.

**Dreadnought:** A dreadnought is a superbattleship, designed to be the best possible battleship. The Imperial Navy places the dreadnought designation on its latest, most-effective battleships, redesignating them simply as battleships when their superior abilities are supplanted by newer construction.

The concept of dreadnought does not mean that battleships are not built as well. Due to the expense of dreadnoughts, the Imperial Navy also acquires battleships as such.

**Battle Rider:** A battle rider is a nonjump-capable vessel which is otherwise armed and armored like a battleship. By eliminating the jump drives and their associated controls and power plant support, the internal space they would occupy may be allocated to additional armor, weaponry, or agility. Of any two vessels of equal tonnage, a battle rider (which is not burdened with jump drives and required jump drive support) would logically be superior to a jump-capable battleship.

**Battle Tender:** A battle tender is a ship designed to carry battle riders into battle.

**Cruisers.** Cruisers are more lightly armored and less heavily armed than battleships. To unarmed, unarmored ships, this difference is negligible, since a cruiser can easily attack and destroy any noncombatant ships. Cruisers are assigned to support battleships and carry combat to areas where a battleship is not considered necessary.

**Carriers:** Carriers are designed to carry large numbers of small combat craft, which in turn attack the enemy's combatants or world surfaces.

**Escorts:** Escorts are vessels intended to protect and assist larger vessels. They are capable of independent action, but are usually assigned to support battleships and cruisers.

**Scouts:** Scouts are survey and exploration ships normally employed in the scout service. They are transferred to naval duty in time of war or when otherwise necessary. Many scout ships are couriers for the navy.

## SEVEN BROAD FLEET TYPES

The Imperial Navy classifies its fleets by the type of activity they are expected to undertake: assault, battle, interdiction, penetration, strike, reserve, and depot. In these categories, reserve and depot are inactive ship pools not normally given tactical missions.

**Assault fleets** are assigned world attack missions. They are sent into a star system to carry surface forces to the mainworld in order to assault and conquer world surface territory. In easy cases, an assault fleet carries forces to a small, low population world which is easily reduced. The true challenge to an assault fleet is the high population world: The fleet will carry tens of thousands of troops for world-invasion operations, then resupply the beachhead that they establish, while helping repel the local force's efforts to eliminate the invasion forces.

**Battle fleets** are the main combat units of the navy. They are assigned battleships and are expected to meet and destroy any

enemy ships they encounter. By definition, battleships in battle fleets are the strongest forces the Imperial Navy can bring to bear.

*Interdiction fleets* are assigned siege-oriented missions. They are sent into a star system to surround its mainworld and stop all traffic to and from the world. They are also expected to conduct bombardments and containment operations which will force the mainworld to surrender.

*Penetration fleets* are given long-range raid missions. They are expected to drive deep into enemy territory and attack important objectives (like enemy bases, industry, starports, or shipyards). After they have destroyed their objectives, they must return to friendly territory. Penetration fleets are expected to be self-sufficient for long periods of time.

*Strike fleets* are strategic supplements to the battle fleets. They support the flanks of the battle fleets with maneuverability and firepower. Often a strike fleet will be assigned to clear a system that a battle fleet will need to pass through. Strike fleets are used for diversions while the battle fleet proceeds to its primary objective, and strike fleets protect the flanks of battle fleets in major battles.

*Reserve fleets* are primarily holding formations which provide the details of bureaucratic support until their ships are assigned to fleets with specific missions. The primary activity a reserve fleet undertakes is training.

*Depot fleets* are inactive ship pools. Ships which are not in service but which may be reactivated are assigned to the depot fleets.

## FIVE BROAD SQUADRON TYPES

The Imperial Navy maintains five major squadron types: BatRons, CruRons, AssaultRons, TankRons, and ScoutRons. Any squadron type may be in any fleet type, depending on the specific mission being performed.

**BatRon:** Battle squadrons are created from battleships and are intended to meet the best of the enemy fleet, engage it, and destroy it. Their purpose is battle. Battle squadrons are usually reinforced with large numbers of auxiliary ships, including refueling shuttles, escorts, and support cruisers. In addition, they are accompanied by a number of fleet couriers which carry communications between squadrons.

**CruRon:** Cruiser squadrons are organized with cruisers and are intended to support BatRons in space combat. Although a cruiser cannot defeat a battleship in one-on-one combat, a number of cruisers can overwhelm a lone battleship, and this occasionally happens. The function of the CruRon is to hold or delay a BatRon early in a battle.

CruRons are strong units. When no BatRon is around, they are easily the strongest type of squadron available. In addition to supporting BatRons, they are given the mission of supporting planetary surface operations once the space battle has been won. Cruisers are the ships that bombard the planetary surface, conduct siege warfare, and cover the invading AssaultRons. CruRons are accompanied by a variety of auxiliaries, including shuttles, transports, and fleet couriers. Every CruRon is assigned a bulk ordnance carrier which resupplies it with bombs and missiles.

**AssaultRon:** The assault squadron is composed of troop transports and supporting ships. Capable of carrying hundreds of battalions of invading troops, the AssaultRon's mission is to transport troops, their equipment, and their supplies from star system to star system, and to deliver troops from orbit to a disputed planetary surface.

AssaultRons tend to be homogeneous units, each equipped with only one type of ship. Thus, the 10897th Imperial Assault Transport Squadron would be equipped for troop transport, while the 9705th Assault Invasion Squadron would be equipped to deliver the troops to an invasion beachhead on a world surface.

**TankRon:** Tanker squadrons are special-purpose units dictated by the need for Imperial Navy vessels to travel farther than their fuel tankage will allow. TankRons carry large quantities of fuel and are positioned to refuel other squadrons as they cross territory which would not otherwise provide fuel resources for them.

**ScoutRons:** Scout squadrons are composed of ships assigned to the Imperial Interstellar Scout Service. They rarely serve as ScoutRons; instead, the ships are assigned to other squadrons based on need. For example, many fleet couriers are considered scout-type ships. When a fleet courier assigned to BatRon 10 is sent with dispatches to BatRon 11, it is automatically reassigned to BatRon 11 when it arrives. Ships awaiting assignment to serving squadrons are assigned to a ScoutRon, as are ships being resupplied or undergoing repairs.

**Squadron Classification:** Squadrons are classified by their position within the hierarchy of the Imperium. Regular squadrons are front-line units equipped with the best possible ships and personnel. Colonial squadrons are equipped with obsolescent (but still serviceable, rather than obsolete) ships and with personnel with somewhat less training and experience. System squadrons are not jump-capable, but are rather equipped with SDBs and monitors, and staffed with local personnel.

*Regular squadrons* are assigned to the numbered fleets of the Imperium and stationed at naval bases within the Imperium. Regular squadrons carry the term *Imperial* in their name. For example, Imperial BatRon 11 is a regular squadron.

*Colonial squadrons* are assigned to the numbered reserve fleets of the subsectors. They are based at worlds which can provide personnel and technology to support them: worlds with tech code Early Stellar+ (TL9+) and High Population (Pop 9+). Colonial squadrons carry the term *colonial* in their name. For example, Colonial TankRon 4051 is a colonial squadron.

*System squadrons* are not assigned to any fleet. They are based in a home system with tech code Early Stellar+ (TL9+) and Moderate Population (Pop 4+). System squadrons carry either the term *defense* or the name of their system or both in their name. For example, Defense CruRon Regina is the system squadron for the Regina system. When several system squadrons are in a system, they are numbered as well.

**Squadron Numbers:** Squadrons are numbered for identification purposes. The number may precede the name (as in 172nd Battle Squadron) or it may follow the name (as in BatRon 172). Either system is acceptable.

**The Effects of the Rebellion:** The Rebellion has affected how squadrons are identified.

As the Rebellion has progressed, some individual squadrons have developed a loyalty to their commander as opposed to the Imperium or to a specific faction. In such cases, the squadron has taken the name of the commander (for example, CruRon Riksdotter is the former Imperial CruRon 500).

Changing loyalties have also forced changes in the use of the terms *Imperial* and *colonial* with regard to squadrons. The Imperium under Lucan continues to use the term *Imperial*.

Dulinor of Illeish maintains that he is the head of the Imperium, and as an article of faith also continues to use the term *Imperial*. Increasingly, squadrons are being identified by the term *Illel* (which actually means of *Illeish*, but by definition from Dulinor also means *Imperial*). For example, Illel BatRon 23.

Squadrons loyal to Margaret's faction claim loyalty to the Imperium, but not to Lucan. They have replaced the term *Imperial* with *eagle* (recalling Margaret's heraldic symbol). For example, Eagle CruRon 560.

Vilani units have replaced *Imperial* with the Vilani word for star: *Sirka*. For example, Sirka BatRon 19 or Star BatRon 19.

# Imperial Fleets and Squadrons

One or more system squadrons. Individual worlds with sufficient resources may raise system squadrons for defense. System squadrons are incapable of jump and are not part of any fleet.



One numbered fleet  
One reserve fleet

One or more colonial squadrons. Individual worlds with sufficient resources may raise their own colonial squadrons. Colonial squadrons are part of the reserve fleet.



One or more regular squadrons. Imperial regular squadrons are assigned to naval bases. Regular squadrons are part of the Imperial numbered fleet.

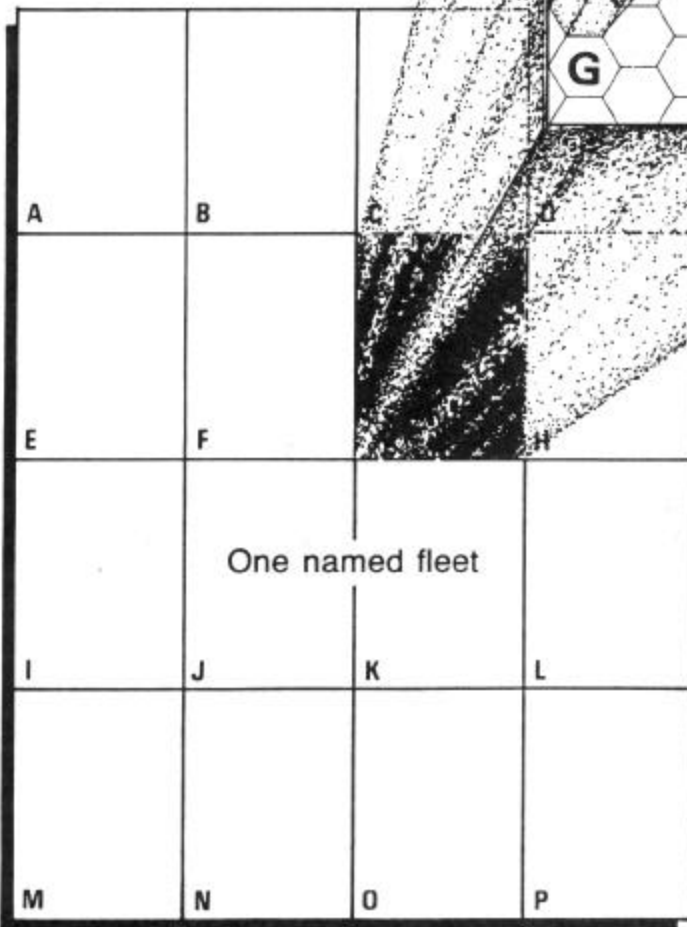

One named fleet

## SUBSECTOR

The Imperium maintains one numbered fleet for each of its subsectors; that fleet contains a variety of squadrons at naval bases in the subsector. The Imperium also maintains one numbered reserve fleet for each of its subsectors. Equipped with older ships, the reserve fleet provides training and reinforcements to the navy.

## SECTOR

The Imperium maintains one named fleet for each of its sectors; that fleet usually contains one numbered fleet for each of the subsectors within the sector.

The League of Antares uses *league* instead of *Imperial* on its squadron designations. During the period when the league was part of the Julian Protectorate, the squadrons used *protectorate* instead of *league*. For example, League CruRon 341 or Protectorate CruRon 341.

Norris of Regina has refused to acknowledge the decline of the Imperium, but also refuses to ally with any of the factions of the Rebellion. On principle, he has continued to use the old terminology for squadron designations. Starting in about 1120, he began renaming both Imperial and colonial squadrons as domain squadrons. For example, the former Imperial BatRon 43 has become Domain BatRon 43.

The Federation of Daibei has substituted *federal* for *Imperial* (for example, Federal CruRon 998). Also, factions have established new numbering systems for squadrons as time has passed.

## NAVAL ACTIVITY IN THE REBELLION

The Rebellion creates a unique naval situation: battles between forces which are equipped and trained more or less identically. The differences that are brought to battles result from the specific availability of forces and how they are committed by the faction's leaders.

Tactically, victory in battles of the Rebellion will go to the better tactician because, on the average, the forces in the fight are identical. Consequently, the edge goes to the side with strategic superiority: A faction which can accumulate and hold strategic advantage will ultimately prevail.

**Missions in the Rebellion:** The Imperial Navy forces, regardless of the faction they are fighting, have three specific missions:

- Conquer territory.
- Defend territory.
- Inflict losses on the enemy.

**Conquer Territory:** Each faction strives to include and govern as much territory as possible.

Many small systems with low populations are easily swayed by the mere presence of naval vessels from a specific faction. The systems are there for the taking; the faction need only send the proper number of ships to the system and declare that the system now "belongs" to it. For the most part, it is even possible to then leave the system ungarrisoned and undefended.

The fewer high population systems call for a greater display of naval power. They may be defended by local forces, and the conquering naval task force must be strong enough to avoid the potential embarrassment of a defender victory, no matter how short-lived. But naval forces are primarily a show of force. They interfere with commerce; they blockade a world from the rest of the Imperium. They can bomb a world back to the stone age, but such activity is counterproductive, and such barbaric tactics are appropriate only when a world is actively allied with an opposing faction in the Rebellion and refuses to stop.

Territory is also conquered when the enemy is driven from it. A star system occupied by an enemy fleet can be conquered by attacking that enemy and driving it from the system. A valuable star system may be the scene of continuing battles as one faction tries valiantly to conquer it and its defenders steadfastly refuse to be forced out.

**Defend Territory:** The necessary converse of territorial conquest is territorial defense. Once a faction has staked its claim to territory, it must defend it with sufficient energy and determination to repel the enemy. Ideally, a proper defense discourages the enemy before an attack is mounted. Proper naval defense of a system also helps the local population perceive that it is being defended (and for those with potential loyalties to the other side, that resistance is useless).

**Inflict Losses:** The ultimate resolution of the Rebellion depends on enough factions abandoning the fight. While territorial losses will help force such a result, factions also respond to naval losses. Thus, it becomes the mission of naval forces to seek out and destroy the enemy's naval forces. When such damage is inflicted with relatively small losses for the attacker, it is positive and beneficial. The pitfall to avoid is any appreciable losses to one's own side when attempting to inflict losses on the enemy.

## PRIVATEERS

One role not normally taken by the Imperial Navy is that of privateer. Dating back to the days of sea navies, governments have issued letters of marque and reprisal which allow a ship captain to attack enemy shipping, and seize cargo and goods. Many smaller Imperial Navy ships have been issued such instructions by their faction and sent off to raid the trade lanes of the enemy.

The raided enemy has another word for this activity: piracy. To the raided enemy, pirates are little better than criminals, subject to harsh combat action if discovered and to the death penalty if captured.

Privateers lead a difficult existence. They cruise for months along the trade lanes, raiding shipping for goods and supplies. When successful, they also drive off the very ship traffic they need to survive and attract naval forces to suppress them. Virtually no port of call is safe for them, so small, clandestine bases become essential if their ships are to be hidden and resupplied. After a long mission, they return to their own territory for needed maintenance and new orders.

## COURIERS

Communications remains an overriding concern for every faction in the Rebellion.

Each faction has reason to contact and communicate with almost every other faction at some time. However, such communications are always a delicate undertaking to be handled by carefully arranged courier missions.

## SHIP LISTINGS

The data in this book covers some of the ships of the Imperial Navy on the eve of the Rebellion. The ships shown have been taken into service by virtually all factions of the Rebellion, and these ships (as well as other ships ranging from light cruisers and alien warships to converted merchants) have participated in the naval battles which have followed.

**Ship Identification:** Ships are identified by their type and tech level. Thus, the Imperial tech level 12 missile cruiser is shown as a CM 12 missile cruiser. This system has sufficient diversity to show most of the ships in the navy. Ships are grouped by broad class, with a short statement about ship type at the beginning of each chapter. Also included is a chart showing the evolution of the ship designs involved.

**Ship Information:** The basic Imperial ship information as shown in the *MegaTraveller Referee's Manual* is given for each ship. Especially interesting designs are also illustrated.

**Batteries:** Ship weapons information is shown with weapons ratings and battery quantities. In addition, the actual weapons installations with numbers of weapons are shown. Using this information, it is possible to rerate the batteries to other numbers if the individual commander so desires. For example, the BL-14 is shown with 300 batteries of BLaser-4 in the ship rating. The comments section shows that the BL-14 is equipped with triple-turret BLaser (900/3), which means 900 BLasers in triple mounts. They could be rerated as 150 BLaser-5, 90 BLaser-6, 60 BLaser-7, 42 BLaser-8, or 30 BLaser-9.



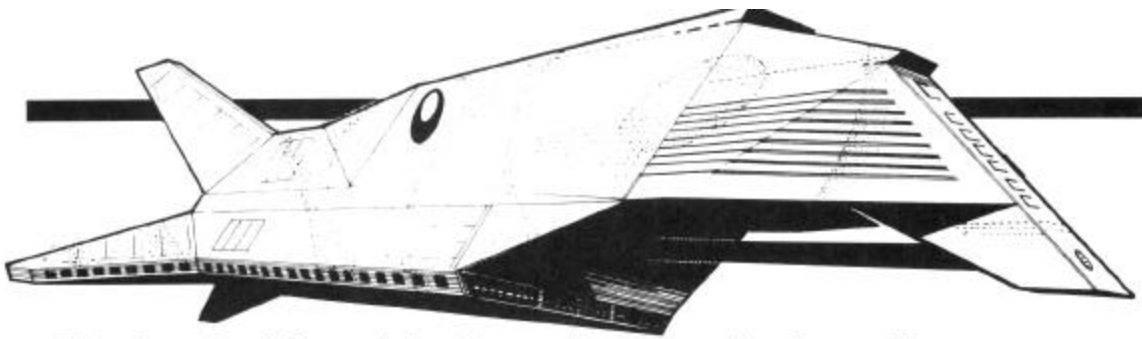

The battleships of the Imperium are designed to overcome any opponent in battle. As technology advances, these designs also advance, both to take advantage of any possible technological benefits, and to experiment with new strategies and construction techniques.

The technological basis for Imperial battleships is the BB-11. From it was developed the BB-12 and then the BB-13. The light battleship line (BL-13, BL-14, and BL-15) was based on the BB-12, but showed great innovation in producing a smaller tonnage vessel. The BS-15 and BM-15 are also members of this line.

At TL13, it was decided to produce a superbattleship, the BI-13, which was later developed into the BI-14. The BI-15 was an independent design.

The heavy battleship line (BH-14 and BH-15) is a hybrid of the lessons learned and techniques developed in both the BI-13 and the BB-13.

The battle rider system was developed in an attempt to produce the benefits of the BB-13 in greater numbers. The BT/R-14 system was the result. The BT/R-15 system is an evolution of the BT/R-14.

Finally, the BZ-15 takes the battle rider system one step further and places a battle rider on a battleship for combat support deployment. This design is a hybrid of the BT/R-15 system and the BL-15.

---

# Battleships

---

The power of the Imperial Navy is concentrated in its battleships. The definition of a battleship is a ship which, due to its armament and protection, is capable of standing in the line of battle. When a battleship meets any lesser type of ship, its victory is almost guaranteed. When battleships on two sides meet, victory goes to the better armed, better armored, and better directed ship.

# Imperial Squadron Organizations

BATRON (Typical)

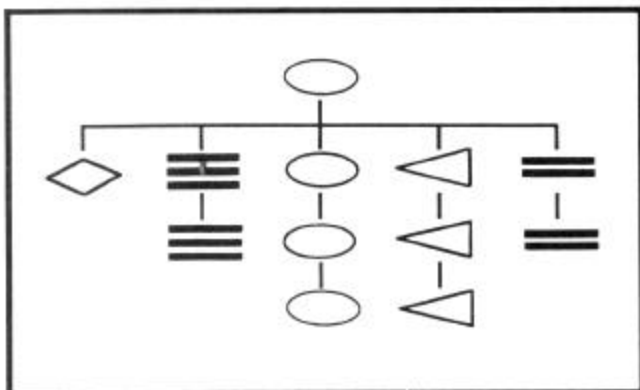

BATRON (Battle Rider)

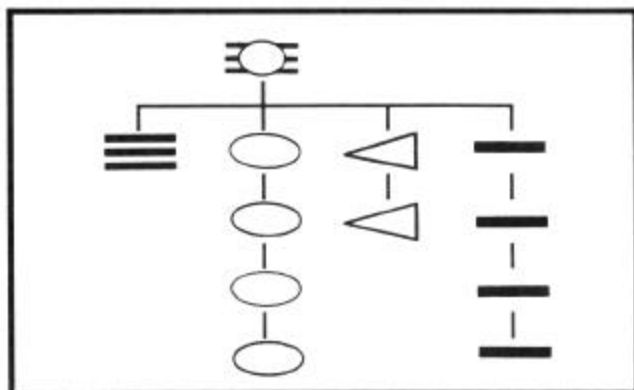

CRURON (Typical)

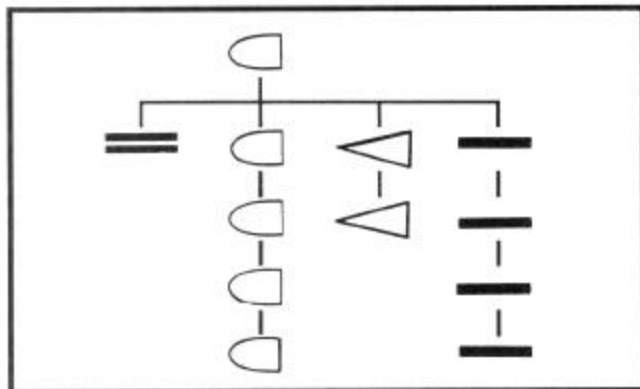

ASSAULTRON (Typical)

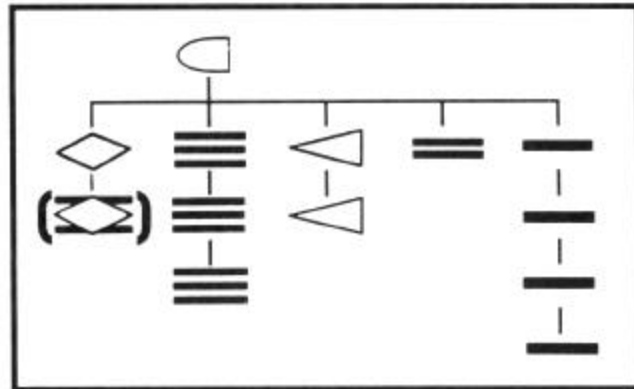

CRURON (Carrier)

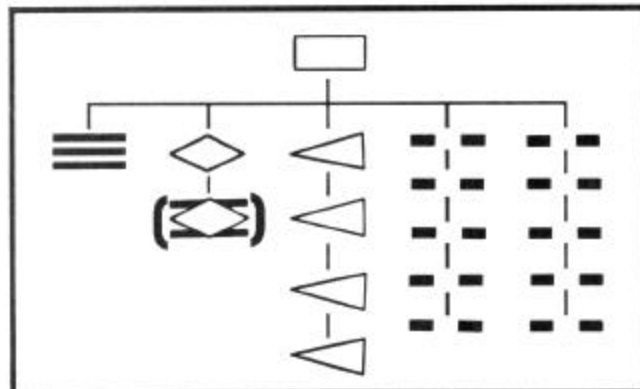

TANKRON (Typical)

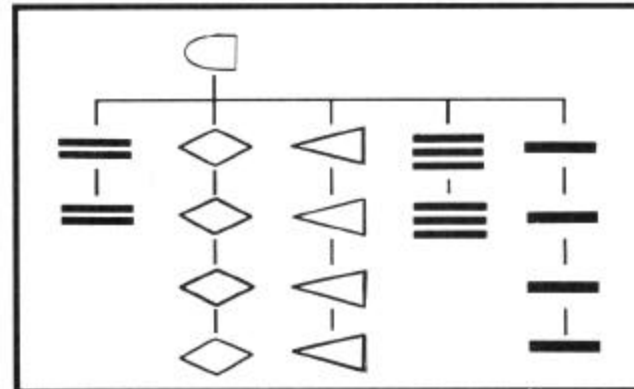

 Battleship

 Cruiser

 Tanker

 Escort

 Auxiliary

 Carrier

 Battle Tender

 Scout

 Dromedary

 Fighter

 Transport

**(Indicates Alternate)**

# Imperial Battleships

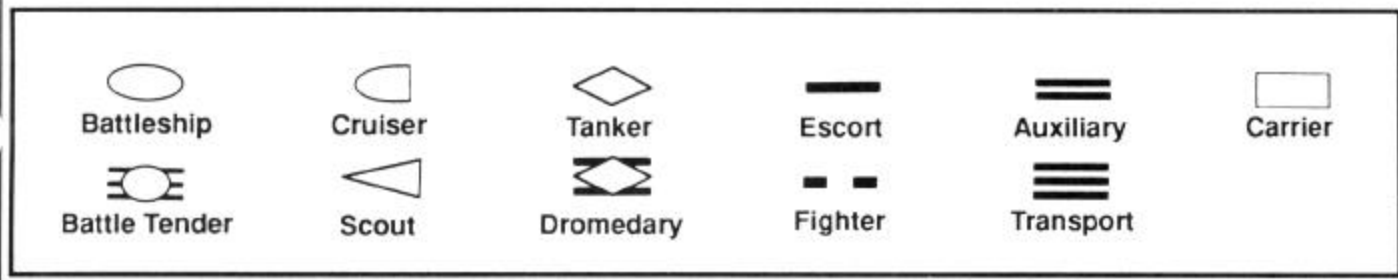
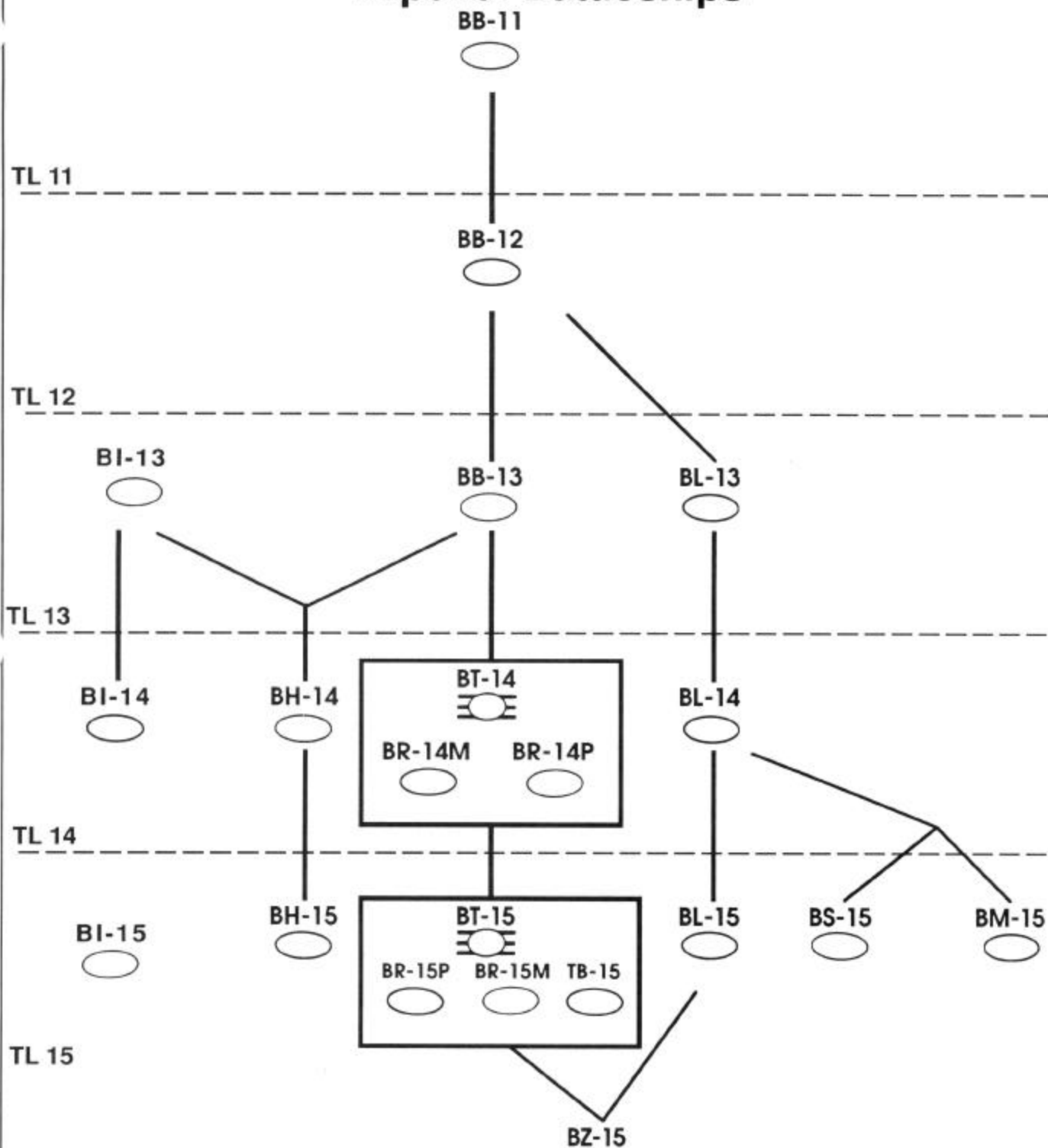

# BB-11 BATTLESHIP

**CraftID:** Battleship, Type BB, TL=B (Average Stellar), MCr1,710,602

**Hull:** 270000/675000, Disp=300000, Config=4SL, Armor=110E,  
Unloaded=172917086, Loaded=173042978

**Power:** 12252/24504, Fusion=3308183 Mw, Duration=30/90days

**Loco:** 21600/43200, Maneuver=3Gs, 8100/16200, Jump=2,  
NOE=150, Cruise=2137.5kph, Top=2850kph,  
Agility=0

**Commo:** RadioComm Planetary-11x1, RadioComm FarOrbit-11x1, RadioComm System-11x1,  
LaserComm Planet-11x1, LaserComm FarOrbit-11x1, LaserComm System-11x1,  
MaserComm Planet-11x1, MaserComm FarOrbit-11x1, MaserComm System-11x1

**Sensors:** EMM Packagex1,  
EMS-A-11 FarOrbitx2, EMS-A-11 Planetaryx2,  
EMS-P-11 Interplanetaryx2, EMS-P-11 SubStellarx2, EMS-P-11 Interstellarx2,  
Jam EMS-A-11 FarOrbitx2, Jam EMS-A-11 Planetaryx2,  
Neutrino (1000 Mw) Sensor-11x2,  
HiPen Densit-0.001x2,  
ActObjScan=Difficult, ActObjPin=Difficult,  
PasObjScan=Formidable, PasObjPin=Formidable,  
PasEngScan=Routine, PasEngPin=Formidable

**Off:** ParticleAccel=070, MesonGun=B0x

Batt. 5/0 Batt. 1/0

Bear. 3/0 Bear. 1/0

PlasmaGun=x50

Batt. 5

Bear. 3

Missiles=x84, BeamLaser=x4

Batt. 60/100 Batt. 100

Bear. 36/60 Bear. 60

**Def:** DefDM=3,

Sandcasters=xx7

Batt. 36

Bear. 21

**Control:** Computer=Model/5x3,

Panel=CP-DynamicLinkedx107195, Special=HeadsUpDisplayx107195,

Environ=Basic Environment, Basic Life Support, Extended LS, Grav Plates, Inertial Compensators

**Accom:** Crew=23,778 (79x300),

(Bridge=218, Engineering=633, Maintenance=12,514,

Gunners=5465, Flight Crew=5465, Ship's Troops=300,

Command=3255, Stewards=797, Frozen Watch=0, Medical=196),

Additional Staterooms=200,

LowBerths=0 (FrozenWatch)+200 (Medical), EmergencyLowBerths=200,

SubCraft=30-ton craftx200,

Magazines=40 50-ton magazines (214 battery-rounds)

**Other:** Cargo=3156 tons (42,618 kliters),

Fuel=133218 tons (1798445 kliters), Fuel Purification Plant (purifies tankage in six hours),

ObjSize=Large, Fuel Scoops (fills tanks in five hours),

EmLevel=Moderate,

Battery Round=1260 missiles,

Electronic Circuit Protection

**Comments:** 100-ton Bay ParticleAccelerator-7x50,

Spinal MesonGun-Bx1,

50-ton Bay PlasmaGun-5x50,

100-ton Bay Missile-8x60,

Triple Turret Missile (1200/3),

Triple Turret BLaser (1200/3),

Triple Turret Sand (360/3)

The BB-11 is little more than a jump-capable monitor. Its relatively low tech level does make it useful for the lower range of technologically endowed worlds of the Imperium.

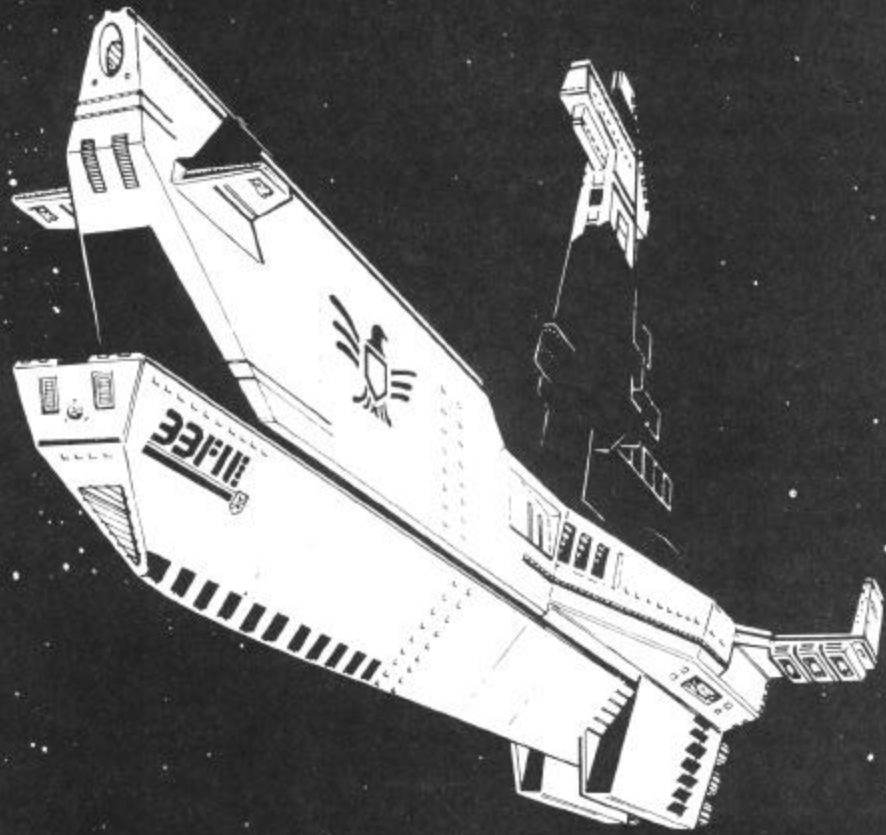

BB-11

T.

# BB-12 BATTLESHIP

**CraftID:** Battleship, Type BB, TL=C (Average Stellar), MCr2,057,516

**Hull:** 270000/675000, Disp=300000, Config=3SL, Armor=110F,  
Unloaded=145437392, Loaded=145562799

**Power:** 12622/25244, Fusion=3408059 Mw, Duration=24/72days

**Loco:** 21600/43200, Maneuver=3Gs, 10800/21600, Jump=3,  
NOE=160, Cruise=2137.5kph, Top=2850kph,  
Agility=0

**Commo:** RadioComm Planetary-12x1, RadioComm FarOrbit-12x1, RadioComm System-12x1,  
LaserComm Planet-12x1, LaserComm FarOrbit-12x1, LaserComm System-12x1,  
MaserComm Planet-12x1, MaserComm FarOrbit-12x1, MaserComm System-12x1

**Sensors:** EMM Packagex1,  
EMS-A-12 FarOrbitx2, EMS-A-12 Planetaryx2,  
EMS-P-12 Interplanetaryx2, EMS-P-12 SubStellarx2, EMS-P-12 Interstellarx2,  
Jam EMS-A-12 FarOrbitx2, Jam EMS-A-12 Planetaryx2,  
Neutrino (1 Mw) Sensor-12x2,  
HiPen Densit-0.05x2,  
ActObjScan=Difficult, ActObjPin=Difficult,  
PasObjScan=Difficult, PasObjPin=Difficult,  
PasEngScan=Routine, PasEngPin=Formidable

**Off:** ParticleAccel=080, MesonGun=K0x

Batt. 50 Batt. 1

Bear. 30 Bear. 1

PlasmaGun=x60

Batt. 6

Bear. 4

Missiles=x94, BeamLaser=xx5

Batt. 60/100 Batt. 120

Bear. 36/60 Bear. 72

**Def:** DefDM=4,

Sandcasters=xx5

Batt. 60

Bear. 36

**Control:** Computer=Model/6x3,

Panel=CP-DynamicLinkedx110404, Special=HeadsUpDisplayx110404,

Environ=Basic Environment, Basic Life Support, Extended Life Support, Grav Plates, Inertial Compensators

**Accom:** Crew=21,927 (73x300)

(Bridge=176, Engineering=605, Maintenance=12,905,

Gunners=4104, Flight Crew=4104, Ship's Troops=100,

Command=3001, Stewards=735, Frozen Watch=0, Medical=181),

Additional Staterooms=100,

LowBerths=100 (Medical), EmergencyLowBerths=100,

SubCraft=50-ton craftx60, 200-ton craftx10,

Magazines=40 50-ton magazines (214 battery-rounds)

**Other:** Cargo=6870 tons (92,757 kliters),

Fuel=132,705 tons (1,791,521 kliters), Fuel Purification Plant (purifies total fuel tankage in six hours),

ObjSize=Large, Fuel Scoops (fills tanks in five hours),

EmLevel=Moderate,

Battery Round=1260 missiles,

Electronic Circuit Protection

**Comments:** 100-ton Bay ParticleAccelerator-8x50,

Spinal MesonGun-Kx1,

50-ton Bay PlasmaGun-6x50,

100-ton Bay Missile-9x60,

Triple Turret Missile (1200/3),

Triple Turret BLaser (1200/3),

Triple Turret Sand (360/3)

# BB-13 BATTLESHIP

**CraftID:** Battleship, Type BB, TL=D (Average Stellar), MCr939,026

**Hull:** 270000/675000, Disp=300000, Config=3SL, Armor=100F,  
Unloaded=62081751, Loaded=62244379

**Power:** 16856/33712, Fusion=4551220 Mw, Duration=24/72days

**Loco:** 13500/27000, Maneuver=2Gs, 13500/27000, Jump=4,  
NOE=170, Cruise=1590kph, Top=2120kph,  
Agility=0

**Commo:** RadioComm Planetary-13x1, RadioComm FarOrbit-13x1, RadioComm System-13x1,  
LaserComm Planet-13x1, LaserComm FarOrbit-13x1, LaserComm System-13x1,  
MaserComm Planet-13x1, MaserComm FarOrbit-13x1, MaserComm System-13x1

**Sensors:** EMM Packagex1,  
EMS-A-13 FarOrbitx2, EMS-A-13 Planetaryx2,  
EMS-P-13 Interplanetaryx2, EMS-P-13 SubStellarx2, EMS-P-13 Interstellarx2,  
Jam EMS-A-13 FarOrbitx2, Jam EMS-A-13 Planetaryx2,  
Neutrino (0.1 Mw) Sensor-13x2,  
HiPen Densit-0.1x2,  
ActObjScan=Difficult, ActObjPin=Difficult,  
PasObjScan=Difficult, PasObjPin=Difficult,  
PasEngScan=Routine, PasEngPin=Difficult

**Off:** ParticleAccel=080, MesonGun=P0x

Batt. 50 Batt. 1

Bear. 30 Bear. 1

PlasmaGun=x60

Batt. 50

Bear. 30

Missiles=x95, BeamLaser=xx6

Batt. 60/100 Batt. 120

Bear. 36/60 Bear. 72

**Def:** DefDM=5,

MesonScreen-3,

NucDamper-3,

Sandcasters=xx7

Batt. 36

Bear. 22

**Control:** Computer=Model/7fibx3,

Panel=CP-HoloLinkedx9590, Special=HeadsUpHoloDisplayx9590,

Environ=Basic Environment, Basic Life Support, Extended Life Support, Grav Plates

**Accom:** Crew=8462 (28x300)

(Bridge=49, Engineering=531, Maintenance=4054,

Gunners=2098, Flight Crew=2098, Ship's Troops=100,

Command=1158, Stewards=283, Frozen Watch=0, Medical=69),

Additional Staterooms=100,

LowBerths=0 (FrozenWatch)+100 (Medical), EmergencyLowBerths=100,

SubCraft=50-ton craftx60, 200-ton craftx10,

Magazines=40 50-ton magazines (214 battery-rounds)

**Other:** Cargo=342 tons (4624 kliters),

Fuel=172,092 tons (2,323,251 kliters), Fuel Purification Plant (purifies total fuel tankage in 12 hours),

ObjSize=Large, Fuel Scoops (fills tanks in five hours),

EmLevel=Moderate,

Battery Round=1260 missiles,

Electronic Circuit Protection

**Comments:** 100-ton Bay ParticleAccelerator-8x50,

Spinal MesonGun-Px1,

50-ton Bay PlasmaGun-6x50,

100-ton Bay Missile-9x60,

Triple Turret Missile (1200/3),

Triple Turret BLaser (1200/3),

Triple Turret Sand (360/3)

# BI-13 DREADNOUGHT

**CraftID:** Dreadnought, Type BI, TL=D (Average Stellar), MCr1,547,939

**Hull:** 630000/1575000, Disp=700000, Config=2SL, Armor=90F,  
Unloaded=49092478, Loaded=49483193

**Power:** 41398/82796, Fusion=11177549 Mw, Duration=24/72days

**Loco:** 31500/63000, Maneuver=2Gs, 31500/63000, Jump=4,  
NOE=170, Cruise=1590kph, Top=2120kph,  
Agility=0

**Commo:** RadioComm Planetary-13x1, RadioComm FarOrbit-13x1, RadioComm System-13x1,  
LaserComm Planet-13x1, LaserComm FarOrbit-13x1, LaserComm System-13x1,  
MaserComm Planet-13x1, MaserComm FarOrbit-13x1, MaserComm System-13x1

**Sensors:** EMM Packagex1,  
EMS-A-13 FarOrbitx2, EMS-A-13 Planetaryx2,  
EMS-P-13 Interplanetaryx2, EMS-P-13 SubStellarx2, EMS-P-13 Interstellarx2,  
Jam EMS-A-13 FarOrbitx2, Jam EMS-A-13 Planetaryx2,  
Neutrino (0.1 Mw) Sensor-13x2,  
HiPen Densit-0.1x2,  
ActObjScan=Difficult, ActObjPin=Difficult,  
PasObjScan=Difficult, PasObjPin=Difficult,  
PasEngScan=Routine, PasEngPin=Difficult

**Off:** ParticleAccel=080, MesonGun=P0x

Batt. 200 Batt. 1

Bear. 100 Bear. 1

Missiles=x97, BeamLaser=xx9

Batt. 200/90 Batt. 90

Bear. 100/45 Bear. 45

**Def:** DefDM=5,

MesonScreen-3,

NucDamper-3,

Sandcasters=xx9

Batt. 60

Bear. 30

**Control:** Computer=Model/7fibx3,

Panel=CP-HoloLinkedx31172, Special=HeadsUpHoloDisplayx31172,

Environ=Basic Environment, Basic Life Support, Extended Life Support, Grav Plates

**Accom:** Crew=15,569 (22x700)

(Bridge=138, Engineering=1269, Maintenance=6106,

Gunners=4255, Flight Crew=4255, Ship's Troops=1000,

Command=2131, Stewards=522, Frozen Watch=0, Medical=128),

Additional Staterooms=100,

LowBerths=0 (FrozenWatch)+100 (Medical), EmergencyLowBerths=100,

SubCraft=50-ton craftx10, 1000-ton craftx10,

Magazines=52 50-ton magazines (121 battery-rounds)

**Other:** Cargo=2079 tons (28,069 kliters),

Fuel=413,454 tons (5,581,634 kliters), Fuel Purification Plant (purifies total fuel tankage in 12 hours),

ObjSize=Large, Fuel Scoops (fills tanks in five hours),

EmLevel=Moderate,

Battery Round=2900 missiles,

Electronic Circuit Protection

**Comments:** 100-ton Bay ParticleAccelerator-8x200,

Spinal MesonGun-Px1,

100-ton Bay Missile-9x200,

Triple Turret Missile (2700/3),

Triple Turret BLaser (2700/3),

Triple Turret Sand (1800/3)



**CraftID:** Dreadnought, Type BI, TL=E (High Stellar), MCr1,657,290  
**Hull:** 630000/1575000, Disp=700000, Config=2SL, Armor=91G, Unloaded=30627975, Loaded=31019340  
**Power:** 41517/83034, Fusion=11209827 Mw, Duration=24/72days  
**Loco:** 31500/63000, Maneuver=2Gs, 31500/63000, Jump=4, NOE=180, Cruise=1590kph, Top=2120kph, Agility=0  
**Commo:** RadioComm Planetary-14x1, RadioComm FarOrbit-14x1, RadioComm System-14x1, LaserComm Planet-14x1, LaserComm FarOrbit-14x1, LaserComm System-14x1, MaserComm Planet-14x1, MaserComm FarOrbit-14x1, MaserComm System-14x1, EMS-A-14 FarOrbitx2, EMS-A-14 Planetaryx2, EMS-P-14 Interplanetaryx2, EMS-P-14 SubStellarx2, EMS-P-14 Interstellarx2, Jam EMS-A-14 FarOrbitx2, Jam EMS-A-14 Planetaryx2, Neutrino (0.01 Mw) Sensor-14x2, HiPen Densit-0.25x2, ActObjScan=Difficult, ActObjPin=Difficult, PasObjScan=Routine, PasObjPin=Routine, PasEngScan=Simple, PasEngPin=Routine  
**Off:** ParticleAccel=090, MesonGun=S0x  
 Batt. 200 Batt. 1  
 Bear. 100 Bear. 1  
 Missiles=xA7, BeamLaser=xx9  
 Batt. 200/90 Batt. 90  
 Bear. 100/45 Bear. 45  
**Def:** DefDM=6, MesonScreen-3, NucDamper-6, Sandcasters=x9  
 Batt. 60  
 Bear. 30  
**Control:** Computer=Model/8fibx3, Panel=CP-HoloLinkedx21304, Special=HeadsUpHoloDisplayx21304, Environ=Basic Environment, Basic Life Support, Extended Life Support, Grav Plates  
**Accom:** Crew=11,892 (16x700) (Bridge=70, Engineering=936, Maintenance=4870, Gunners=2692, Flight Crew=2692, Ship's Troops=1000, Command=1628, Stewards=398, Frozen Watch=0, Medical=98), Additional Staterooms=100, LowBerths=0 (FrozenWatch)+100 (Medical), EmergencyLowBerths=100, SubCraft=50-ton craftx100, 1000-ton craftx10, Magazines=52 50-ton magazines (121 battery-rounds)  
**Other:** Cargo=4294 tons (57,974 kliters), Fuel=414,142 tons (5,590,930 kliters), Fuel Purification Plant (purifies total fuel tankage in 12 hours), ObjSize=Large, Fuel Scoops (fills tanks in five hours), EmLevel=Moderate, Battery Round=2900 missiles, Electronic Circuit Protection  
**Comments:** 100-ton Bay ParticleAccelerator-9x200, Spinal MesonGun-Sx1, 100-ton Bay Missile-Ax200, Triple Turret Missile (2700/3), Triple Turret BLaser (2700/3), Triple Turret Sand (1800/3)

**CraftID:** Dreadnought, Type BI, TL=F (High Stellar), MCr3,306,716  
**Hull:** 630000/1575000, Disp=700000, Config=2SL, Armor=100G, Unloaded=61476477, Loaded=61868003  
**Power:** 41547/83094, Fusion=11217826 Mw, Duration=24/72days  
**Loco:** 31500/63000, Maneuver=2Gs, 31500/63000, Jump=4, NOE=190, Cruise=1590kph, Top=2120kph, Agility=0  
**Commo:** RadioComm Planetary-15x1, RadioComm FarOrbit-15x1, RadioComm System-15x1, LaserComm Planet-15x1, LaserComm FarOrbit-15x1, LaserComm System-15x1, MaserComm Planet-15x1, MaserComm FarOrbit-15x1, MaserComm System-15x1, MesonComm System-15x1  
**Sensors:** EMS-A-15 FarOrbitx2, EMS-A-15 Planetaryx2, EMS-P-15 Interplanetaryx2, EMS-P-15 SubStellarx2, EMS-P-15 Interstellarx2, Jam EMS-A-15 FarOrbitx2, Jam EMS-A-15 Planetaryx2, Neutrino (0.01 Mw) Sensor-14x2, HiPen Densit-1x2, ActObjScan=Difficult, ActObjPin=Difficult, PasObjScan=Routine, PasObjPin=Routine, PasEngScan=Simple, PasEngPin=Routine  
**Off:** ParticleAccel=090, MesonGun=T0x  
 Batt. 200 Batt. 1  
 Bear. 100 Bear. 1  
 Missiles=xA7, BeamLaser=xx9  
 Batt. 200/90 Batt. 90  
 Bear. 100/45 Bear. 45  
**Def:** DefDM=7, MesonScreen-3, NucDamper-9, Sandcasters=xx9  
 Batt. 60  
 Bear. 30  
**Control:** Computer=Model/9fibx3, Panel=CP-HoloLinkedx20956, Special=HeadsUpHoloDisplayx20956, Environ=Basic Environment, Basic Life Support, Extended Life Support, Grav Plates  
**Accom:** Crew=16277 (23x700) (Bridge=56, Engineering=795, Maintenance=9159, Gunners=2160, Flight Crew=2160, Ship's Troops=1000, Command=2228, Stewards=545, Frozen Watch=0, Medical=134), Additional Staterooms=200, LowBerths=0 (FrozenWatch)+100 (Medical), EmergencyLowBerths=100, SubCraft=50-ton craftx100, 1000-ton craftx10, Magazines=None  
**Other:** Cargo=13,314 tons (179,742 kliters), Fuel=414,313 tons (5,593,234 kliters), Fuel Purification Plant (purifies total fuel tankage in 12 hours), ObjSize=Large, Fuel Scoops (fills tanks in 12 hours), EmLevel=Strong, Battery Round=2900 missiles, Electronic Circuit Protection  
**Comments:** 100-ton Bay ParticleAccelerator-9x200, Spinal MesonGun-Tx1, 100-ton Bay Missile-Ax200, Triple Turret Missile (2700/3), Triple Turret BLaser (2700/3), Triple Turret Sand (1800/3)

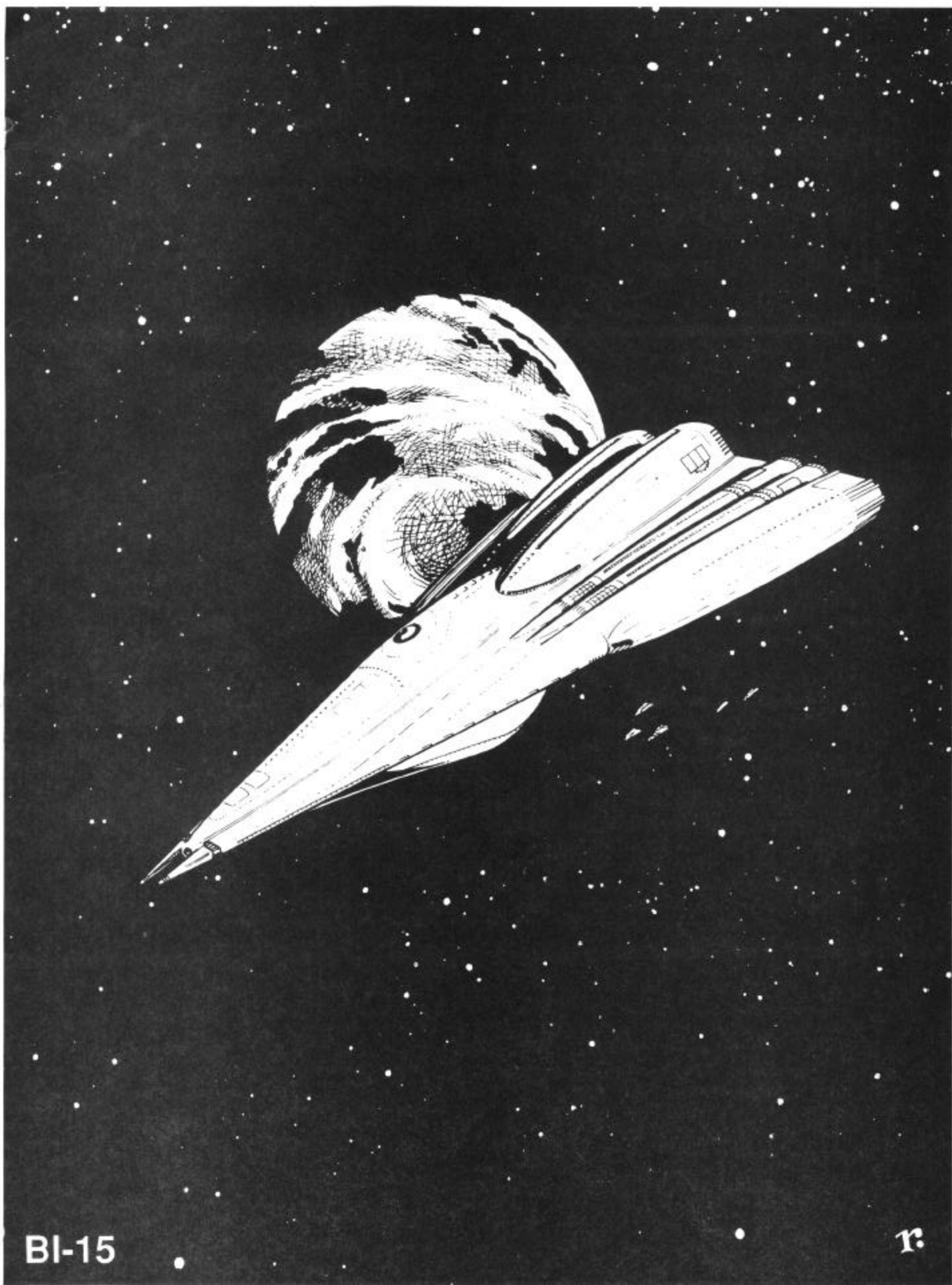

BI-15

r:

**CraftID:** Battleship Light, Type BL, TL=D (Average Stellar), MCr1,243,067  
**Hull:** 180000/450000, Disp=200000, Config=4SL, Armor=110F, Unloaded=110804440, Loaded=110900009  
**Power:** 8876/17752, Fusion=2396757 Mw, Duration=24/72days  
**Loco:** 14400/28800, Maneuver=3Gs, 9000/18000, Jump=4, NOE=170, Cruise=2137.5kph, Top=2850kph, Agility=0  
**Commo:** RadioComm Planetary-13x1, RadioComm FarOrbit-13x1, RadioComm System-13x1, LaserComm Planet-13x1, LaserComm FarOrbit-13x1, LaserComm System-13x1, MaserComm Planet-13x1, MaserComm FarOrbit-13x1, MaserComm System-13x1  
**Sensors:** EMM Packagex1, EMS-A-13 FarOrbitx2, EMS-A-13 Planetaryx2, EMS-P-13 Interplanetaryx2, EMS-P-13 SubStellarx2, EMS-P-13 Interstellax2, Jam EMS-A-13 FarOrbitx2, Jam EMS-A-13 Planetaryx2, Neutrino (0.1 Mw) Sensor-13x2, HiPen Densit-0.1x2, ActObjScan=Difficult, ActObjPin=Difficult, PasObjScan=Difficult, PasObjPin=Difficult, PasEngScan=Routine, PasEngPin=Difficult  
**Off:** ParticleAccel=R80  
 Batt. 1/30  
 Bear. 1/20  
 FusionGun=x70  
 Batt. 30  
 Bear. 20  
 Missiles=x84, BeamLaser=xx5  
 Batt. 30/150 Batt. 150  
 Bear. 20/97 Bear. 97  
**Def:** DefDM=5, Sandcasters=xx7  
 Batt. 36  
 Bear. 23  
**Control:** Computer=Model/7x3, Panel=CP-HoloLinkedx12451, Special=HeadsUpHoloDisplayx12451, Environ=Basic Environment, Basic Life Support, Extended Life Support, Grav Plates, Inertial Compensators  
**Accom:** Crew=8986 (44x200), (Bridge=61, Engineering=340, Maintenance=5797, Gunners=963, Flight Crew=963, Ship's Troops=100, Command=1230, Stewards=301, Frozen Watch=0, Medical=74), Additional Staterooms=100, LowBerths=0 (FrozenWatch)+100 (Medical), EmergencyLowBerths=400, SubCraft=50-ton craftx60, 400-ton craftx10, Magazines=34 50-ton magazines (246 battery-rounds)  
**Other:** Cargo=584 tons (7888 kliters), Fuel=101,130 tons (1,365,266 kliters), Fuel Purification Plant (purifies total fuel tankage in 12 hours), ObjSize=Large, Fuel Scoops (fills tanks in five hours), EmLevel=Moderate, Battery Round=930 missiles, Electronic Circuit Protection  
**Comments:** Spinal ParticleAccel-Rx1, 100-ton Bay ParticleAccelerator-8x30, 50-ton Bay FusionGun-7x30, 50-ton Bay Missile-8x30, Triple Turret Missile (900/3), Triple Turret BLaser (900/3), Triple Turret Sand (360/3)

# BL-14 BATTLESHIP LIGHT

**CraftID:** Battleship Light, Type BL, TL=E (High Stellar), MCr1,242,734

**Hull:** 180000/450000, Disp=200000, Config=4SL, Armor=110G,  
Unloaded=60330370, Loaded=60426542

**Power:** 8987/17974, Fusion=2426682 Mw, Duration=24/72days

**Loco:** 14400/28800, Maneuver=3Gs, 9000/18000, Jump=4,  
NOE=180, Cruise=2137.5kph, Top=2850kph,  
Agility=0

**Commo:** RadioComm Planetary-14x1, RadioComm FarOrbit-14x1, RadioComm System-14x1,  
LaserComm Planet-14x1, LaserComm FarOrbit-14x1, LaserComm System-14x1,  
MaserComm Planet-14x1, MaserComm FarOrbit-14x1, MaserComm System-14x1

**Sensors:** EMM Packagex1,  
EMS-A-14 FarOrbitx2, EMS-A-14 Planetaryx2,  
EMS-P-14 Interplanetaryx2, EMS-P-14 SubStellarx2, EMS-P-14 Interstellarx2,  
Jam EMS-A-14 FarOrbitx2, Jam EMS-A-14 Planetaryx2,  
Neutrino (0.01 Mw) Sensor-14x2,  
HiPen Densit-0.25x2,  
ActObjScan=Difficult, ActObjPin=Difficult,  
PasObjScan=Routine, PasObjPin=Routine,  
PasEngScan=Simple, PasEngPin=Routine

**Off:** ParticleAccel=S90  
Batt. 1/30  
Bear. 1/20  
FusionGun=x80  
Batt. 30  
Bear. 20  
Missiles=x96, BeamLaser=xx4  
Batt. 30/50 Batt. 300  
Bear. 20/32 Bear. 195

**Def:** DefDM= 6,  
NucDamper-6,  
Sandcasters=xx5  
Batt. 60  
Bear. 39

**Control:** Computer=Model/8x3,  
Panel=CP-HoloLinkedx9167, Special=HeadsUpHoloDisplayx9167,  
Environ=Basic Environment, Basic Life Support, Extended Life Support, Grav Plates, Inertial Compensators

**Accom:** Crew=6634 (33x200)  
(Bridge=35, Engineering=252, Maintenance=4267,  
Gunners=676, Flight Crew=676, Ship's Troops=100,  
Command=908, Stewards=222, Frozen Watch=0, Medical=54),  
Additional Staterooms=100,  
LowBerths=0 (FrozenWatch)+100 (Medical), EmergencyLowBerths=400,  
SubCraft=50-ton craftx60, 400-ton craftx10,  
Magazines=45 50-ton magazines (326 battery-rounds)

**Other:** Cargo=5062 tons (68,342 kliters),  
Fuel=101,769 tons (1,373,884 kliters), Fuel Purification Plant (purifies total fuel tankage in 12 hours),  
ObjSize=Large, Fuel Scoops (fills tanks in five hours),  
EmLevel=Moderate,  
Battery Round=930 missiles,  
Electronic Circuit Protection

**Comments:** Spinal ParticleAccel-Sx1,  
100-ton Bay ParticleAccelerator-9x30,  
50-ton Bay FusionGun-8x30,  
50-ton Bay Missile-9x30,  
Triple Turret Missile (900/3),  
Triple Turret BLaser (900/3),  
Triple Turret Sand (360/3)

**CraftID:** Battleship Light, Type BL, TL=F (High Stellar), MCr1,246,820

**Hull:** 180000/450000, Disp=200000, Config=4SL, Armor=110G,  
Unloaded=60365891, Loaded=60467704

**Power:** 10459/20918, Fusion=2824163 Mw, Duration=23/69days

**Loco:** 14400/28800, Maneuver=3Gs, 9000/18000, Jump=4,  
NOE=190, Cruise=2137.5kph, Top=2850kph,  
Agility=0

**Commo:** RadioComm Planetary-15x1, RadioComm FarOrbit-15x1, RadioComm System-15x1,  
LaserComm Planet-15x1, LaserComm FarOrbit-15x1, LaserComm System-15x1,  
MaserComm Planet-15x1, MaserComm FarOrbit-15x1, MaserComm System-15x1

**Sensors:** EMM Packagex1,  
EMS-A-15 FarOrbitx2, EMS-A-15 Planetaryx2,  
EMS-P-15 Interplanetaryx2, EMS-P-15 SubStellarx2, EMS-P-15 Interstellarx2,  
Jam EMS-A-15 FarOrbitx2, Jam EMS-A-15 Planetaryx2,  
Neutrino (0.01 Mw) Sensor-14x2,  
HiPen Densit-1x2,  
ActObjScan=Difficult, ActObjPin=Difficult,  
PasObjScan=Routine, PasObjPin=Routine,  
PasEngScan=Simple, PasEngPin=Routine

**Off:** ParticleAccel=T90  
Batt. 1/30  
Bear. 1/20  
FusionGun=x90  
Batt. 30  
Bear. 20  
Missilesx96, BeamLaser=xx9  
Batt. 30/50 Batt. 30  
Bear. 20/33 Bear. 20

**Def:** DefDM=7,  
MesonScreen-1,  
NucDamper-9,  
Sandcasters=xx7  
Batt. 36  
Bear. 23

**Control:** Computer=Model/9x3,  
Panel=CP-HoloLinkedx7756, Special=HeadsUpHoloDisplayx7756,  
Environ=Basic Environment, Basic Life Support, Extended Life Support, Grav Plates, Inertial Compensators

**Accom:** Crew=5654 (28x200)  
(Bridge=27, Engineering=227, Maintenance=3616,  
Gunners=555, Flight Crew=555, Ship's Troops=100,  
Command=774, Stewards=189, Frozen Watch=0, Medical=46),  
Additional Staterooms=100,  
LowBerths=0 (FrozenWatch)+100 (Medical), EmergencyLowBerths=200,  
SubCraft=50-ton craftx60, 400-ton craftx5,  
Magazines=50 50-ton magazines (362 battery-rounds)

**Other:** Cargo=2195 tons (29,632 kliters),  
Fuel=107,738 tons (1,454,469 kliters), Fuel Purification Plant (purifies total fuel tankage in 12 hours),  
ObjSize=Large, Fuel Scoops (fills tanks in five hours),  
EmLevel=Moderate,  
Battery Round=930 missiles,  
Electronic Circuit Protection

**Comments:** Spinal ParticleAccel-Tx1,  
100-ton Bay ParticleAccelerator-9x30,  
50-ton Bay FusionGun-9x30,  
50-ton Bay Missile-9x30,  
Triple Turret Missile (900/3),  
Triple Turret BLaser (900/3),  
Triple Turret Sand (360/3)

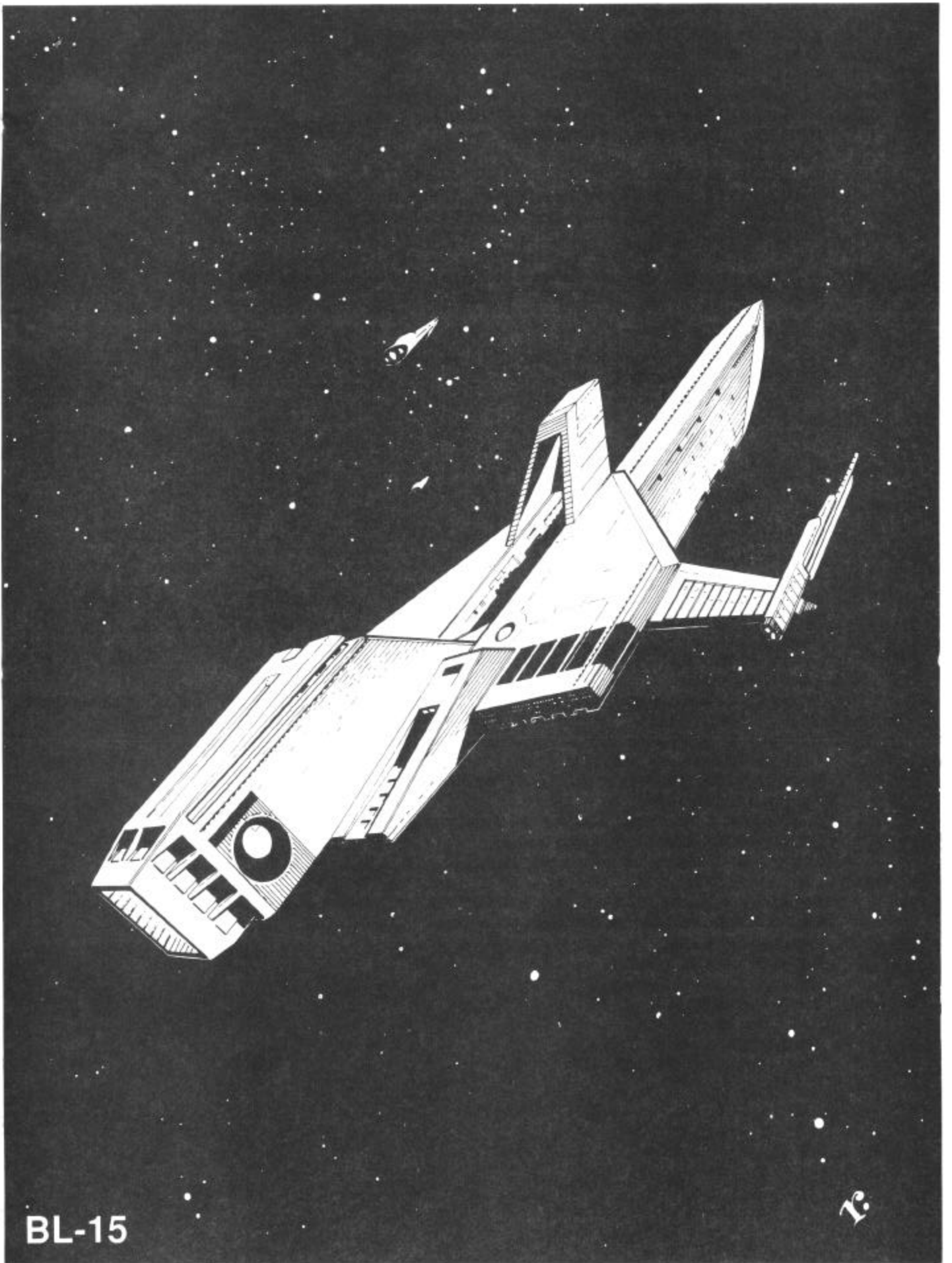

BL-15

73

**CraftID:** Battleship Missile, Type BM, TL=F (High Stellar), MCr9,355,821  
**Hull:** 450000/1125000, Disp=500000, Config=3SL, Armor=120G, Unloaded=262454467, Loaded=262715092  
**Power:** 14959/29918, Fusion=4039110 Mw, Duration=42/126days  
**Loco:** 9000/18000, Maneuver=1Gs, 22500/45000, Jump=4, NOE=190, Cruise=900kph, Top=1200kph, Agility=0  
**Commo:** RadioComm Planetary-15x2, RadioComm FarOrbit-15x2, RadioComm System-15x2, LaserComm Planet-15x2, LaserComm FarOrbit-15x2, LaserComm System-15x2, MaserComm Planet-15x2, MaserComm FarOrbit-15x2, MaserComm System-15x2  
**Sensors:** EMM Packagex1, EMS-A-15 FarOrbitx2, EMS-A-15 Planetaryx2, EMS-P-15 Interplanetaryx2, EMS-P-15 SubStellarx2, EMS-P-15 Interstellarx2, Jam EMS-A-15 FarOrbitx2, Jam EMS-A-15 Planetaryx2, Neutrino (0.01 Mw) Sensor-14x2, HiPen Densit-1x2, ActObjScan=Difficult, ActObjPin=Difficult, PasObjScan=Routine, PasObjPin=Routine, PasEngScan=Simple, PasEngPin=Routine  
**Off:** MesonGun=T0x  
 Batt. 1  
 Bear. 1  
 Missiles=x90, BeamLaser=x6  
 Batt. 300 Batt. 600  
 Bear. 200 Bear. 300  
**Def:** DefDM=7, MesonScreen-1, NucDamper-9, Sandcasters=xx7  
 Batt. 150  
 Bear. 75  
**Control:** Computer=Model/9x3, Panel=CP-HoloLinkedx61857, Special=HeadsUpHoloDisplayx61857, Environ=Basic Environment, Basic Life Support, Extended Life Support, Grav Plates, Inertial Compensators  
**Accom:** Crew=37,188 (74x500) (Bridge=148, Engineering=397, Maintenance=28741, Gunners=1238, Flight Crew=1238, Ship's Troops=0, Command=5090, Stewards=1247, Frozen Watch=0, Medical=307), Additional Staterooms=0, LowBerths=0 (FrozenWatch)+0 (Medical), EmergencyLowBerths=0, SubCraft=50-ton craftx10, 1000-ton craftx4, Magazines=43 50-ton magazines (1451 battery-rounds)  
**Other:** Cargo=15,313 tons (206,729 kliters), Fuel=275,793 tons (3,723,211 kliters), Fuel Purification Plant (purifies total fuel tankage in 12 hours), ObjSize=Large, Fuel Scoops (fills tanks in five hours), EmLevel=Moderate, Battery Round=200 missiles, Electronic Circuit Protection  
**Comments:** Spinal MesonGun-Tx1, 50-ton Bay Missile-9x200, Triple Turret BLaser (6000/3), Triple Turret Sand (1500/3)



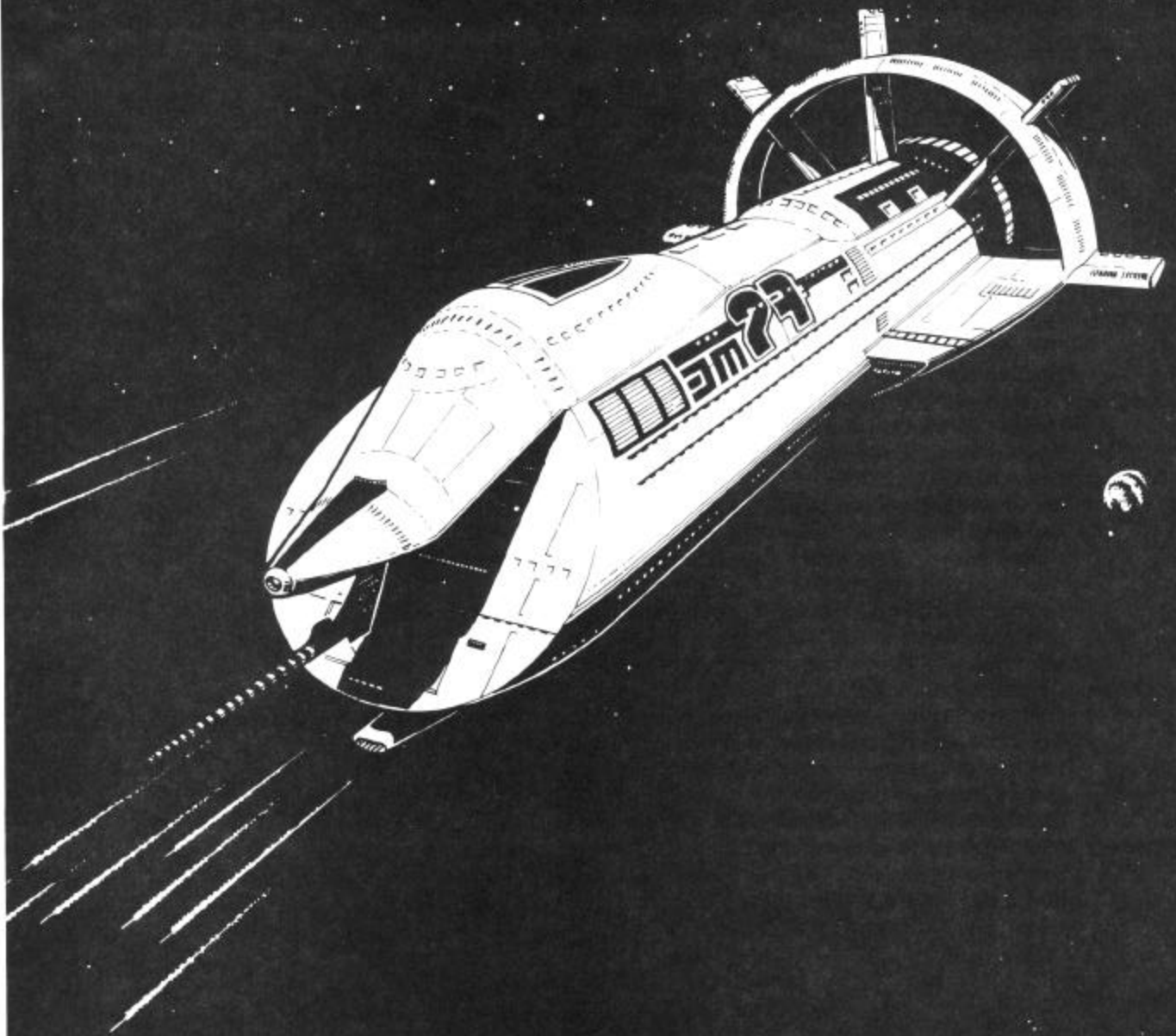

BM-15

R

# DIP 14 BATTLE HEAVY

**CraftID:** Battle Heavy, Type BH, TL=E (High Stellar), MCr17,086,769  
**Hull:** 630000/1575000, Disp=700000, Config=2SL, Armor=120G, Unloaded=325892504, Loaded=326187686  
**Power:** 23847/47694, Fusion=6438839 Mw, Duration=24/72days  
**Loco:** 12600/25200, Maneuver=1Gs, 31500/63000, Jump=4, NOE=180, Cruise=900kph, Top=1200kph, Agility=0  
**Commo:** RadioComm Planetary-14x1, RadioComm FarOrbit-14x1, RadioComm System-14x1, LaserComm Planet-14x1, LaserComm FarOrbit-14x1, LaserComm System-14x1, MaserComm Planet-14x1, MaserComm FarOrbit-14x1, MaserComm System-14x1  
**Sensors:** EMM Packagex1, EMS-A-14 FarOrbitx2, EMS-A-14 Planetaryx2, EMS-P-14 Interplanetaryx2, EMS-P-14 SubStellarx2, EMS-P-14 Interstellarx2, Jam EMS-A-14 FarOrbitx2, Jam EMS-A-14 Planetaryx2, Neutrino (0.01 Mw) Sensor-14x2, HiPen Densit-0.25x2, ActObjScan=Difficult, ActObjPin=Difficult, PasObjScan=Routine, PasObjPin=Routine, PasEngScan=Simple, PasEngPin=Routine  
**Off:** ParticleAccel=050, MesonGun=S0x  
     Batt.           50   Batt.           1  
     Bear.           25   Bear.           1  
     Missiles=x90  
     Batt.       600  
     Bear.       300  
**Def:** DefDM=6, MesonScreen-3, NucDamper-6  
**Control:** Computer=Model/8fibx3, Panel=CP-HoloLinkedx125009, Special=HeadsUpHoloDisplayx125009, Environ=Basic Environment, Basic Life Support, Extended Life Support, Grav Plates  
**Accom:** Crew=83,865 (119x700) (Bridge=363, Engineering=687, Maintenance=61,274, Gunners=1516, Flight Crew=1516, Ship's Troops=5000, Command=11,480, Stewards=2812, Frozen Watch=0, Medical=693), Additional Staterooms=500, LowBerths=0 (FrozenWatch)+0 (Medical), EmergencyLowBerths=200, SubCraft=50-ton craftx20, 2000-ton craftx5, Magazines=42 50-ton magazines (472 battery-rounds)  
**Other:** Cargo=24,719 tons (333,711 kliters), Fuel=312,361 tons (4,216,885 kliters), Fuel Purification Plant (purifies total fuel tankage in 60 hours), ObjSize=Large, Fuel Scoops (fills tanks in five hours), EmLevel=Moderate, Battery Round=600 missiles, Electronic Circuit Protection  
**Comments:** 50-ton Bay ParticleAccelerator-5x50, Spinal MesonGun-Sx1, 50-ton Bay Missile-9x600

**CraftID:** Battle Heavy, Type BH, TL=F (High Stellar), MCr17,083,896

**Hull:** 630000/1575000, Disp=700000, Config=2SL, Armor=120G,  
Unloaded=325885351, Loaded=326185141

**Power:** 24694/49388, Fusion=6667404 Mw, Duration=24/72days

**Loco:** 12600/25200, Maneuver=1Gs, 31500/63000, Jump=4,  
NOE=190, Cruise=900kph, Top=1200kph,  
Agility=0

**Commo:** RadioComm Planetary-15x1, RadioComm FarOrbit-15x1, RadioComm System-15x1,  
LaserComm Planet-15x1, LaserComm FarOrbit-15x1, LaserComm System-15x1,  
MaserComm Planet-15x1, MaserComm FarOrbit-15x1, MaserComm System-15x1

**Sensors:** EMM Packagex1,  
EMS-A-15 FarOrbitx2, EMS-A-15 Planetaryx2,  
EMS-P-15 Interplanetaryx2, EMS-P-15 SubStellarx2, EMS-P-15 Interstellarx2,  
Jam EMS-A-15 FarOrbitx2, Jam EMS-A-15 Planetaryx2,  
Neutrino (0.01 Mw) Sensor-14x2,  
HiPen Densit-1x2,  
ActObjScan=Difficult, ActObjPin=Difficult,  
PasObjScan=Routine, PasObjPin=Routine,  
PasEngScan=Simple, PasEngPin=Routine

**Off:** ParticleAccel=050, MesonGun=T0x  
Batt. 50 Batt. 1  
Bear. 25 Bear. 1  
FusionGun=x90  
Batt. 40  
Bear. 20  
Missiles=x90, BeamLaser=xx4  
Batt. 400 Batt. 30  
Bear. 200 Bear. 15

**Def:** DefDM=7,  
MesonScreen-3,  
NucDamper-9

**Control:** Computer=Model/9fibx3,  
Panel=CP-HoloLinkedx106030, Special=HoldsUpHoloDisplayx106030,  
Environ=Basic Environment, Basic Life Support, Extended Life Support, Grav Plates

**Accom:** Crew=71,396 (101x700)  
(Bridge=247, Engineering=591, Maintenance=51,847,  
Gunners=914, Flight Crew=914, Ship's Troops=5000,  
Command=9773, Stewards=2394, Frozen Watch=0, Medical=590),  
Additional Staterooms=500,  
LowBerths=0 (FrozenWatch)+0 (Medical), EmergencyLowBerths=200,  
SubCraft=50-ton craftx20, 2000-ton craftx5  
Magazines=100 50-ton magazines (1687 battery-rounds)

**Other:** Cargo=50060 tons (675,823 kliters),  
Fuel=317,237 tons (4,282,712 kliters), Fuel Purification Plant (purifies total fuel tankage in 60 hours),  
ObjSize=Large, Fuel Scoops (fills tanks in 5 hours),  
EmLevel=Moderate,  
Battery Round=400 missiles,  
Electronic Circuit Protection

**Comments:** 50-ton Bay ParticleAccelerator-5x50,  
Spinal MesonGun-Tx1,  
50-ton Bay FusionGun-9x40,  
50-ton Bay Missile-9x400,  
Triple Turret BLaser (90/3)

# BT-14 BATTLE TENDER

**CraftID:** Battle Tender, Type BT, TL=E (High Stellar), MCr382,528  
**Hull:** 630000/1575000, Disp=700000, Config=4SL, Armor=65G, Unloaded=6643911, Loaded=7030165

**Power:** 37639/75278, Fusion=10162555 Mw, Duration=22/66days  
**Loco:** 12600/25200, Maneuver=1Gs, 37800/75600, Jump=5, NOE=180, Cruise=900kph, Top=1200kph, Agility=0

**Commo:** RadioComm Planetary-14x1, RadioComm FarOrbit-14x1, RadioComm System-14x1, LaserComm Planet-14x1, LaserComm FarOrbit-14x1, LaserComm System-14x1, MaserComm Planet-14x1, MaserComm FarOrbit-14x1, MaserComm System-14x1

**Sensors:** EMM Packagex1, EMS-A-14 FarOrbitx2, EMS-A-14 Planetaryx2, EMS-P-14 Interplanetaryx2, EMS-P-14 SubStellarx2, EMS-P-14 Interstellax2, Jam EMS-A-14 FarOrbitx2, Jam EMS-A-14 Planetaryx2, Neutrino (0.01 Mw) Sensor-14x2, HiPen Densit-0.25x2, ActObjScan=Difficult, ActObjPin=Difficult, PasObjScan=Routine, PasObjPin=Routine, PasEngScan=Simple, PasEngPin=Routine

**Off:** ParticleAccel=090  
Batt. 10  
Bear. 5  
Missiles=x94  
Batt. 10/10  
Bear. 5/5

**Def:** DefDM=6, MesonScreen-6, NucDamper-6, Sandcasters=xx4  
Batt. 10  
Bear. 5

**Control:** Computer=Model/8fibx3, Panel=CP-HoloLinkedx2900, Special=HeadsUpHoloDisplayx2900, Environ=Basic Environment, Basic Life Support, Extended Life Support, Grav Plates

**Accom:** Crew=1807 (2x700) (Bridge=8, Engineering=917, Maintenance=432, Gunners=89, Flight Crew=89, Ship's Troops=0, Command=247, Stewards=60, Frozen Watch=0, Medical=14), Additional Staterooms=100, LowBerths=0 (FrozenWatch)+0 (Medical), EmergencyLowBerths=200, SubCraft=50-ton craftx20,30000-ton craftx3, Magazines=2 50-ton magazines (192 battery-rounds)

**Other:** Cargo=17,827 tons (240,671 kliters), Fuel=408,734 tons (5,517,914 kliters), Fuel Purification Plant (purifies total fuel tankage in six hours), ObjSize=Large, Fuel Scoops (fills tanks in five hours), EmLevel=Moderate, Battery Round=70 missiles, Electronic Circuit Protection

**Comments:** 100-ton Bay ParticleAccelerator-9x10, 50-ton Bay Missile-9x10, Triple Turret Missile (60/3), Triple Turret Sand (30/3)

12

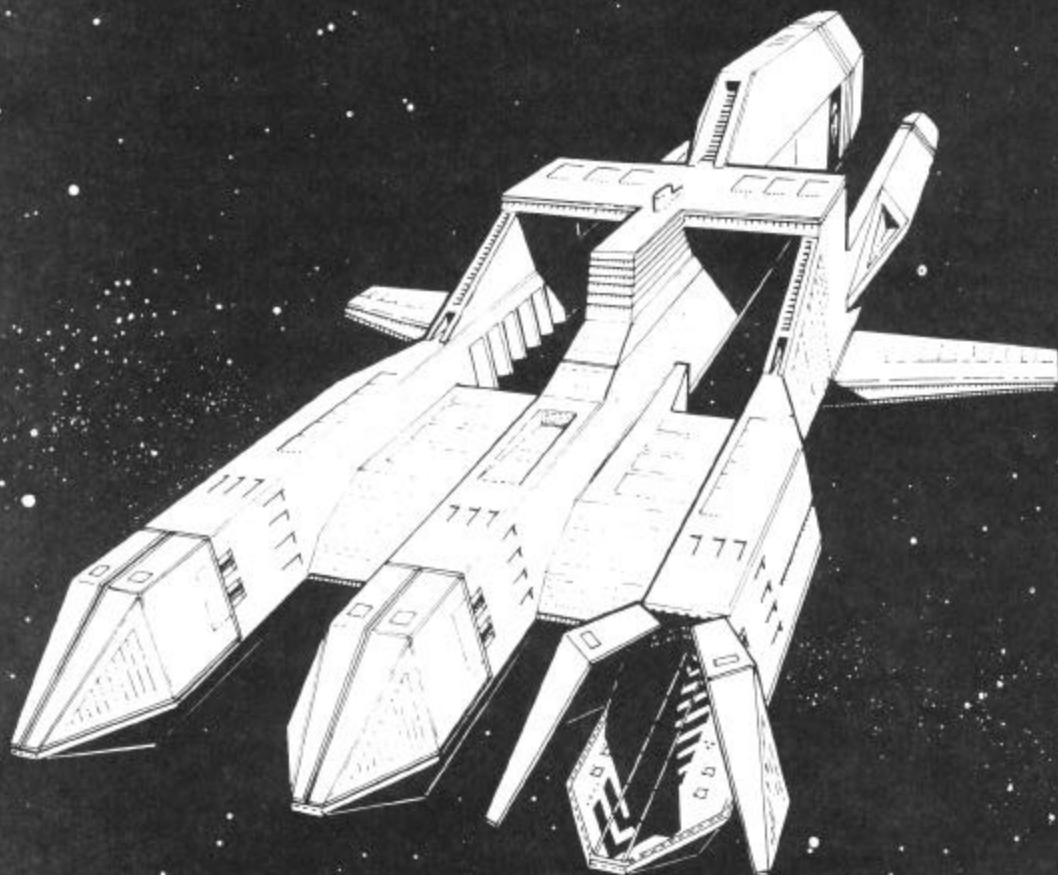

BT-14

**CraftID:** Battle Rider, Type BR, TL=E (High Stellar), MCr61,078  
**Hull:** 27000/67500, Disp=30000, Config=4SL, Armor=90G, Unloaded=3208944, Loaded=3218625  
**Power:** 4742/9484, Fusion=1280507 Mw, Duration=9/27days  
**Loco:** 3780/7560, Maneuver=5Gs, 0/0, Jump=0, NOE=180, Cruise=2880kph, Top=3840kph, Agility=0  
**Commo:** RadioComm Planetary-14x2, RadioComm FarOrbit-14x2, RadioComm System-14x2, LaserComm Planet-14x2, LaserComm FarOrbit-14x2, LaserComm System-14x2, MaserComm Planet-14x2, MaserComm FarOrbit-14x2, MaserComm System-14x2  
**Sensors:** EMM Packagex1, EMS-A-14 FarOrbitx2, EMS-P-14 SubStellarx2, Jam EMS-A-14 Planetaryx2, Neutrino (0.01 Mw) Sensor-14x2, HiPen Densit-0.25x2, ActObjScan=Routine, ActObjPin=Routine, PasObjScan=Routine, PasObjPin=Routine, PasEngScan=Routine, PasEngPin=Routine  
**Off:** ParticleAccel=S90, MesonGun=05x  
 Batt. 1/8 Batt. 4  
 Bear. 1/7 Bear. 4  
 Missiles=x94, BeamLaser=xx4  
 Batt. 10/5 Batt. 10  
 Bear. 9/5 Bear. 9  
**Def:** DefDM=7, MesonScreen-6, NucDamper-6, Sandcasters=xx3  
 Batt. 10  
 Bear. 9  
**Control:** Computer=Model/8x3, Panel=CP-HoloLinkedx296, Special=HeadsUpHoloDisplayx296, Environ=Basic Environment, Basic Life Support, Extended Life Support, Grav Plates  
**Accom:** Crew=649 (21x30) (Bridge=2, Engineering=64, Maintenance=151, Gunners=301, Flight Crew=301, Ship's Troops=0, Command=89, Stewards=21, Frozen Watch=0, Medical=5), Additional Staterooms=0, LowBerths=0 (FrozenWatch)+0 (Medical), EmergencyLowBerths=0, SubCraft=50-ton craftx8, Magazines=1 50-ton magazines (270 battery-rounds)  
**Other:** Cargo=485 tons (6555 kliters), 300,000 tons is fuel tankage for distribution, Fuel=10,244 tons (138,294 kliters), Fuel Purification Plant (purifies self fuel tankage in 10 hours), ObjSize=Large, Fuel Scoops (fills tanks in five hours), EmLevel=Moderate, Battery Round=25 missiles, Electronic Circuit Protection  
**Comments:** 100-ton Bay ParticleAccelerator-9x8, 100-ton Bay MesonGun-5x4, 50-ton Bay Missile-9x10, Triple Turret Missile (15/3), Triple Turret BLaser (60/3), Triple Turret Sand (30/3)

**CraftID:** Battle Rider, Type BR, TL=E (High Stellar), MCr34,871  
**Hull:** 27000/67500, Disp=30000, Config=4SL, Armor=80G, Unloaded=1503837, Loaded=1511908  
**Power:** 3953/7906, Fusion=1067486 Mw, Duration=9/27days  
**Loco:** 2970/5940, Maneuver=4Gs, 0/0, Jump=0, NOE=180, Cruise=2550kph, Top=3400kph, Agility=0  
**Commo:** RadioComm Planetary-14x2, RadioComm FarOrbit-14x2, RadioComm System-14x2, LaserComm Planet-14x2, LaserComm FarOrbit-14x2, LaserComm System-14x2, MaserComm Planet-14x2, MaserComm FarOrbit-14x2, MaserComm System-14x2  
**Sensors:** EMM Packagex1, EMS-A-14 FarOrbitx2, EMS-P-14 SubStellarx2, Jam EMS-A-14 Planetaryx2, Neutrino (0.01 Mw) Sensor-14x2, HiPen Densit-0.25x2, ActObjScan=Routine, ActObjPin=Routine, PasObjScan=Routine, PasObjPin=Routine, PasEngScan=Routine, PasEngPin=Routine  
**Off:** ParticleAccel=090, MesonGun=S0x  
 Batt. 10 Batt. 1  
 Bear. 9 Bear. 1  
 Missiles=x90, BeamLaser=xx4  
 Batt. 10 Batt. 10  
 Bear. 9 Bear. 9  
**Def:** DefDM=7, MesonScreen-6, NucDamper-6, Sandcasters=xx4  
 Batt. 10  
 Bear. 9  
**Control:** Computer=Model/8x3, Panel=CP-HoloLinkedx257, Special=HeadsUpHoloDisplayx257, Environ=Basic Environment, Basic Life Support, Extended Life Support, Grav Plates  
**Accom:** Crew=606 (20x30) (Bridge=2, Engineering=53, Maintenance=63, Gunners=376, Flight Crew=376, Ship's Troops=0, Command=83, Stewards=20, Frozen Watch=0, Medical=5), Additional Staterooms=0, LowBerths=0 (FrozenWatch)+0 (Medical), EmergencyLowBerths=0, SubCraft=50-ton craftx2, Magazines=1 50-ton magazines (675 battery-rounds)  
**Other:** Cargo=61 tons (830 kliters), 300,000 tons is fuel tankage for distribution, Fuel=8539 tons (115,288 kliters), Fuel Purification Plant (purifies self fuel tankage in 10 hours), ObjSize=Large, Fuel Scoops (fills tanks in five hours), EmLevel=Moderate, Battery Round=10 missiles, Electronic Circuit Protection  
**Comments:** 100-ton Bay ParticleAccelerator-9x8, Spinal MesonGun-Sx1, 50-ton Bay Missile-9x10, Triple Turret BLaser (60/3), Triple Turret Sand (30/3)

**CraftID:** Battle Tender, Type BT, TL=F (High Stellar), MCr146,616  
**Hull:** 450000/1125000, Disp=500000, Config=3SL, Armor=40G, Unloaded=2675504, Loaded=2859745  
**Power:** 8516/17032, Fusion=2299331 Mw, Duration=22/66days  
**Loco:** 9000/18000, Maneuver=1Gs, 27000/54000, Jump=5, NOE=190, Cruise=900kph, Top=1200kph, Agility=0  
**Commo:** RadioComm Planetary-15x1, RadioComm FarOrbit-15x1, RadioComm System-15x1, LaserComm Planet-15x1, LaserComm FarOrbit-15x1, LaserComm System-15x1, MaserComm Planet-15x1, MaserComm FarOrbit-15x1, MaserComm System-15x1  
**Sensors:** EMM Packagex1, EMS-A-15 FarOrbitx2, EMS-A-15 Planetaryx2, EMS-P-15 Interplanetaryx2, EMS-P-15 SubStellarx2, EMS-P-15 Interstellarx2, Jam EMS-A-15 FarOrbitx2, Jam EMS-A-15 Planetaryx2, Neutrino (0.01 Mw) Sensor-14x2, HiPen Densit-1x2, ActObjScan=Difficult, ActObjPin=Difficult, PasObjScan=Routine, PasObjPin=Routine, PasEngScan=Simple, PasEngPin=Routine  
**Off:** ParticleAccel=090  
 Batt. 10  
 Bear. 9  
 Missiles=x90, BeamLaser=xx4  
 Batt. 10 Batt. 10  
 Bear. 9 Bear. 9  
**Def:** DefDM=7, MesonScreen-9, NucDamper-9, Sandcasters=xx4  
 Batt. 10  
 Bear. 5  
**Control:** Computer=Model/9fibx3  
 Panel=CP-HoloLinkedx940, Special=HeadsUpHoloDisplayx940  
 Environ=Basic Environment, Basic Life Support, Extended Life Support, Grav Plates, Inertial Compensators  
**Accom:** Crew=646 (1x500)  
 (Bridge=2, Engineering=383, Maintenance=27, Gunners=80, Flight Crew=80, Ship's Troops=0, Command=88, Stewards=21, Frozen Watch=0, Medical=5), Additional Staterooms=100, LowBerths=0 (FrozenWatch)+0 (Medical), EmergencyLowBerths=200, SubCraft=50-ton craftx20, 30000-ton craftx6  
 Magazines=2 50-ton magazines (1350 battery-rounds)  
**Other:** Cargo=533 tons (7205 kliters), Fuel=194,964 tons (2,632,023 kliters), Fuel Purification Plant (purifies total fuel tankage in six hours), ObjSize=Large, Fuel Scoops (fills tanks in five hours), EmLevel=Moderate, Battery Round=10 missiles, Electronic Circuit Protection  
**Comments:** 100-ton Bay ParticleAccelerator-9x10, 50-ton Bay Missile-9x10, Triple Turret BLaser (60/3), Triple Turret Sand (30/3)



# BR-15P BATTLE RIDER

**CraftID:** Battle Rider, Type BR, TL=F (High Stellar), MCr497,454

**Hull:** 27000/67500, Disp=30000, Config=3SL, Armor=115G,  
Unloaded=25512123, Loaded=25520281

**Power:** 3597/7194, Fusion=971230 Mw, Duration=10/30days

**Loco:** 4590/9180, Maneuver=6Gs, 0/0, Jump=0,  
NOE=190, Cruise=3150kph, Top=4200kph,  
Agility=0

**Commo:** RadioComm Planetary-15x2, RadioComm FarOrbit-15x2, RadioComm System-15x2,  
LaserComm Planet-15x2, LaserComm FarOrbit-15x2, LaserComm System-15x2,  
MaserComm Planet-15x2, MaserComm FarOrbit-15x2, MaserComm System-15x2

**Sensors:** EMM Packagex1,  
EMS-A-15 FarOrbitx2,  
EMS-P-15 SubStellarx2,  
Jam EMS-A-15 Planetaryx2,  
Neutrino (0.01 Mw) Sensor-14x2,  
HiPen Densit-1x2,  
ActObjScan=Routine, ActObjPin=Routine,  
PasObjScan=Routine, PasObjPin=Routine,  
PasEngScan=Routine, PasEngPin=Routine

**Off:** ParticleAccel=T90, MesonGun=09x

Batt. 1/10 Batt. 2

Bear. 1/9 Bear. 2

Missiles=x90, BeamLaser=xx4

Batt. 11 Batt. 10

Bear. 10 Bear. 9

**Def:** DefDM=8,  
MesonScreen-9,  
NucDamper-9,  
Sandcasters=xx4  
Batt. 10  
Bear. 9

**Control:** Computer=Model/9x3,  
Panel=CP-HoloLinkedx3088, Special=HeadsUpHoloDisplayx3088,  
Environ=Basic Environment, Basic Life Support, Extended Life Support, Grav Plates

**Accom:** Crew=2171 (72x30)  
(Bridge=6, Engineering=45, Maintenance=1500,  
Gunners=224, Flight Crew=224, Ship's Troops=0,  
Command=297, Stewards=72, Frozen Watch=0, Medical=17),  
Additional Staterooms=0,  
LowBerths=0 (FrozenWatch)+0 (Medical), EmergencyLowBerths=0,  
SubCraft=40-ton craftx5,  
Magazines=1 50-ton magazines (613 battery-rounds)

**Other:** Cargo=33 tons (448 kliters), 300,000 tons is fuel tankage for distribution,  
Fuel=8633 tons (116,547 kliters), Fuel Purification Plant (purifies self fuel tankage in 10 hours),  
ObjSize=Large, Fuel Scoops (fills tanks in five hours),  
EmLevel=Moderate,  
Battery Round=11 missiles,  
Electronic Circuit Protection

**Comments:** 100-ton Bay ParticleAccelerator-9x10,  
100-ton Bay MesonGun-9x2,  
50-ton Bay Missile-9x11,  
Triple Turret BLaser (60/3),  
Triple Turret Sand (30/3)

# BR-15M BATTLE RIDER

**CraftID:** Battle Rider, Type BR, TL=F (High Stellar), MCr146,094

**Hull:** 27000/67500, Disp=30000, Config=3SL, Armor=100G,  
Unloaded=7157798, Loaded=7165284

**Power:** 3300/6600, Fusion=891178 Mw, Duration=10/30days

**Loco:** 4590/9180, Maneuver=6Gs, 0/0, Jump=0,  
NOE=190, Cruise=3150kph, Top=4200kph,  
Agility=0

**Commo:** RadioComm Planetary-15x2, RadioComm FarOrbit-15x2, RadioComm System-15x2,  
LaserComm Planet-15x2, LaserComm FarOrbit-15x2, LaserComm System-15x2,  
MaserComm Planet-15x2, MaserComm FarOrbit-15x2, MaserComm System-15x2

**Sensors:** EMM Packagex1,  
EMS-A-15 FarOrbitx2,  
EMS-P-15 SubStellarx2,  
Jam EMS-A-15 Planetaryx2,  
Neutrino (0.01 Mw) Sensor-14x2,  
HiPen Densit-1x2,  
ActObjScan=Routine, ActObjPin=Routine,  
PasObjScan=Routine, PasObjPin=Routine,  
PasEngScan=Routine, PasEngPin=Routine

**Off:** ParticleAccel=090, MesonGun=T0x

Batt. 8 Batt. 1

Bear. 7 Bear. 1

Missiles=x90, BeamLaser=xx4

Batt. 11 Batt. 10

Bear. 10 Bear. 9

**Def:** DefDM=8,

MesonScreen-9,

NucDamper-9,

Sandcasters=xx4

Batt. 10

Bear. 9

**Control:** Computer=Model/9x3,

Panel=CP-HoloLinkedx917, Special=HeadsUpHoloDisplayx917,

Environ=Basic Environment, Basic Life Support, Extended Life Support, Grav Plates

**Accom:** Crew=803 (26x30),

(Bridge=2, Engineering=43, Maintenance=406,

Gunners=198, Flight Crew=198, Ship's Troops=0,

Command=110, Stewards=26, Frozen Watch=0, Medical=6),

Additional Staterooms=0,

LowBerths=0 (FrozenWatch)+0 (Medical), EmergencyLowBerths=0,

SubCraft=40-ton craftx6,

Magazines=1 50-ton magazines (613 battery-rounds)

**Other:** Cargo=90 tons (1221 kliters), 300,000 tons is fuel tankage for distribution,

Fuel=7921 tons (106,941 kliters), Fuel Purification Plant (purifies self fuel tankage in 10 hours),

ObjSize=Large, Fuel Scoops (fills tanks in five hours),

EmLevel=Moderate,

Battery Round=11 missiles,

Electronic Circuit Protection

**Comments:** 100-ton Bay ParticleAccelerator-9x8,

Spinal MesonGun-Tx1,

50-ton Bay Missile-9x11,

Triple Turret BLaser (60/3),

Triple Turret Sand (30/3)

# TB-15 TANKER BATTLE

**CraftID:** Tanker Battle, Type TB, TL=F (High Stellar), MCr32,872

**Hull:** 27000/67500, Disp=30000, Config=3SL, Armor=80G,  
Unloaded=1479463, Loaded=1483420

**Power:** 1744/3488, Fusion=471104 Mw, Duration=10/30days

**Loco:** 4590/9180, Maneuver=6Gs, 0/0, Jump=0,  
NOE=190, Cruise=3150kph, Top=4200kph,  
Agility=0

**Commo:** RadioComm Planetary-15x2, RadioComm FarOrbit-15x2, RadioComm System-15x2,  
LaserComm Planet-15x2, LaserComm FarOrbit-15x2, LaserComm System-15x2,  
MaserComm Planet-15x2, MaserComm FarOrbit-15x2, MaserComm System-15x2

**Sensors:** EMM Packagex1,  
EMS-A-15 FarOrbitx2,  
EMS-P-15 SubStellarx2,  
Jam EMS-A-15 Planetaryx2,  
Neutrino (0.01 Mw) Sensor-14x2,  
HiPen Densit-1x2,  
ActObjScan=Routine, ActObjPin=Routine,  
PasObjScan=Routine, PasObjPin=Routine,  
PasEngScan=Routine, PasEngPin=Routine

**Off:** BeamLaser=xx4

Batt. 10

Bear. 9

**Def:** DefDM=8,  
MesonScreen-9,  
NucDamper-9,  
Sandcasters=xx4  
Batt. 10  
Bear. 9

**Control:** Computer=Model/9x3,  
Panel=CP-HoloLinkedx207, Special=HeadsUpHoloDisplayx207,  
Environ=Basic Environment, Basic Life Support, Extended Life Support, Grav Plates

**Accom:** Crew=160 (5x30)  
(Bridge=2, Engineering=28, Maintenance=72,  
Gunners=22, Flight Crew=22, Ship's Troops=0,  
Command=22, Stewards=5, Frozen Watch=0, Medical=1),  
Additional Staterooms=0,  
LowBerths=0 (FrozenWatch)+0 (Medical), EmergencyLowBerths=0,  
SubCraft=50-ton craftx4,  
Magazines=None

**Other:** Cargo=15,286 tons (206,369 kliters), 300,000 tons is fuel tankage for distribution,  
Fuel=4187 tons (56,532 kliters), Fuel Purification Plant (purifies self fuel tankage in six hours),  
ObjSize=Large, Fuel Scoops (fills tanks in five hours),  
EmLevel=Moderate,  
Battery Round=0 missiles,  
Electronic Circuit Protection

**Comments:** Triple Turret BLaser (60/3),  
Triple Turret Sand (30/3)

# BZ-15 BATTLE EXPERIMENTAL

**CraftID:** Battle Experimental, Type BZ, TL=F (High Stellar), MCr413,759

**Hull:** 450000/1125000, Disp=500000, Config=4SL, Armor=80G,  
Unloaded=10625684, Loaded=10865907

**Power:** 23406/46812, Fusion=6319776 Mw, Duration=23/69days

**Loco:** 9000/18000, Maneuver=1Gs, 22500/45000, Jump=4,  
NOE=190, Cruise=900kph, Top=1200kph,  
Agility=0

**Commo:** RadioComm Planetary-15x1, RadioComm FarOrbit-15x1, RadioComm System-15x1,  
LaserComm Planet-15x1, LaserComm FarOrbit-15x1, LaserComm System-15x1,  
MaserComm Planet-15x1, MaserComm FarOrbit-15x1, MaserComm System-15x1,  
MesonComm System-15x1

**Sensors:** EMS-A-15 FarOrbitx2, EMS-A-15 Planetaryx2,  
EMS-P-15 Interplanetaryx2, EMS-P-15 SubStellarx2, EMS-P-15 Interstellarx2,  
Jam EMS-A-15 FarOrbitx2, Jam EMS-A-15 Planetaryx2,  
Neutrino (0.01 Mw) Sensor-14x2,  
HiPen Densit-1x2,  
ActObjScan=Difficult, ActObjPin=Difficult,  
PasObjScan=Routine, PasObjPin=Routine,  
PasEngScan=Simple, PasEngPin=Routine

**Off:** ParticleAccel=090, MesonGun=T0x

Batt. 90 Batt. 1

Bear. 45 Bear. 1

FusionGun=x90

Batt. 3

Bear. 2

Missiles=xA7, BeamLaser=xx9

Batt. 180/70 Batt. 70

Bear. 90/35 Bear. 35

**Def:** DefDM=7,

MesonScreen-3, NucDamper-9,

Sandcasters=xx7

Batt. 90

Bear. 45

**Control:** Computer=Model/9fibx3,

Panel=CP-HoloLinkedx10496, Special=HeadsUpHoloDisplayx10496,

Environ=Basic Environment, Basic Life Support, Extended Life Support, Grav Plates

**Accom:** Crew=3360 (6x500)

(Bridge=33, Engineering=476, Maintenance=660,

Gunners=1472, Flight Crew=1472, Ship's Troops=100,

Command=460, Stewards=112, Frozen Watch=0, Medical=27),

Additional Staterooms=0,

LowBerths=0 (FrozenWatch)+100 (Medical), EmergencyLowBerths=0,

SubCraft=50-ton craftx10, 30000-ton craftx3,

Magazines=None

**Other:** Cargo=3000 tons (40,501 kliters),

Fuel=254,204 tons (3,431,758 kliters), Fuel Purification Plant (purifies total fuel tankage in 12 hours),

ObjSize=Large, Fuel Scoops (fills tanks in 0.1 hours),

EmLevel=Strong,

Battery Round=2280 missiles, Electronic Circuit Protection

**Comments:** 100-ton Bay ParticleAccelerator-9x90,

Spinal MesonGun-Tx1,

50-ton Bay FusionGun-9x3,

100-ton Bay Missile-Ax180,

Triple Turret Missile (2100/3),

Triple Turret BLaser (2100/3),

Triple Turret Sand (900/3)

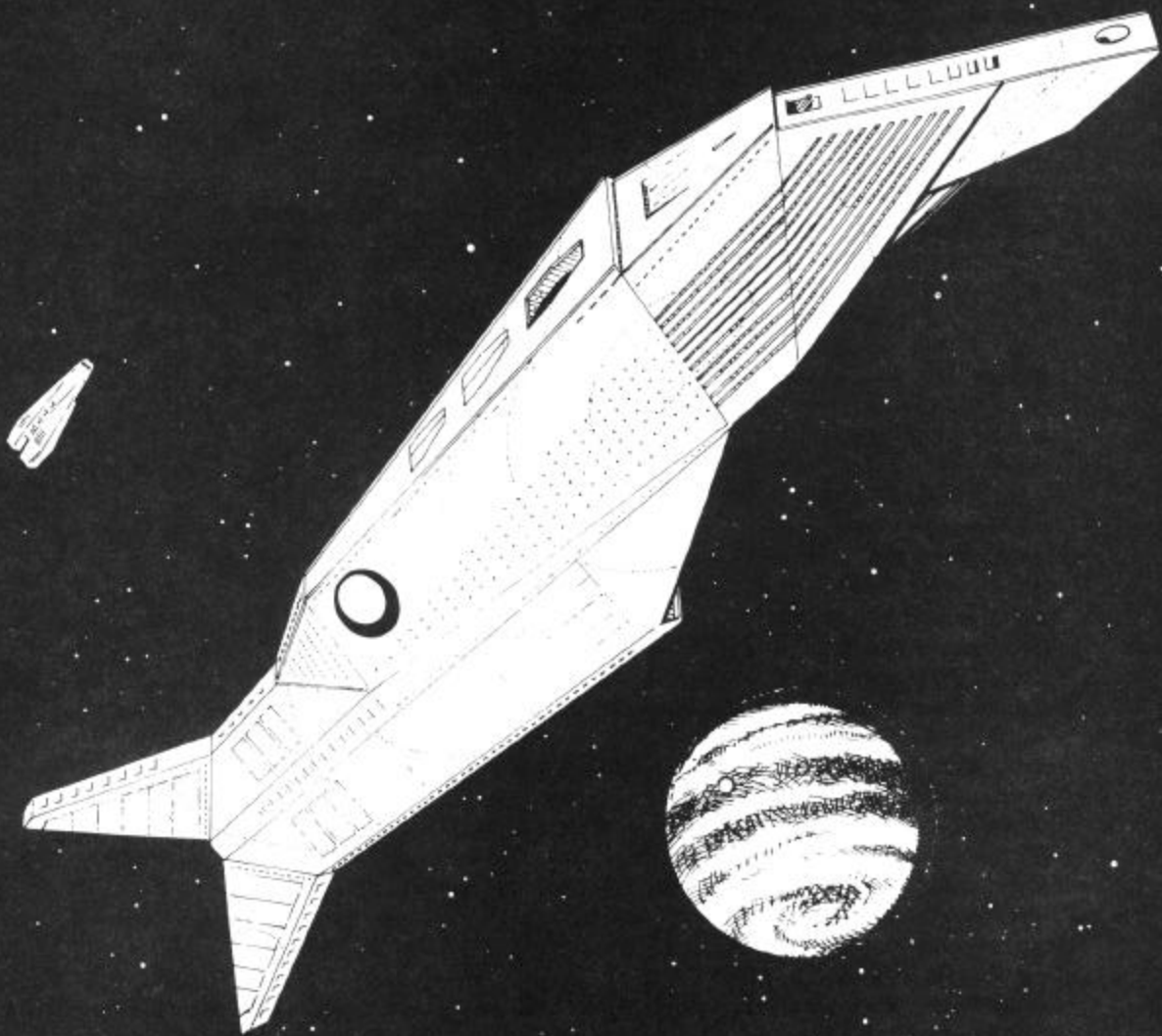

BZ-15

R.

# BS-15 BATTLESHIP STRIKE

**CraftID:** Battleship Strike, Type BS, TL=F (High Stellar), MCr1,234,337

**Hull:** 180000/450000, Disp=200000, Config=4SL, Armor=110G,  
Unloaded=59857999, Loaded=59979879

**Power:** 5850/11700, Fusion=1579664 Mw, Duration=42/126days

**Loco:** 3600/7200, Maneuver=1Gs, 12600/25200, Jump=6,  
NOE=190, Cruise=900kph, Top=1200kph,  
Agility=0

**Commo:** RadioComm Planetary-15x1, RadioComm FarOrbit-15x1, RadioComm System-15x1,  
LaserComm Planet-15x1, LaserComm FarOrbit-15x1, LaserComm System-15x1,  
MaserComm Planet-15x1, MaserComm FarOrbit-15x1, MaserComm System-15x1

**Sensors:** EMM Packagex1,  
EMS-A-15 FarOrbitx2, EMS-A-15 Planetaryx2,  
EMS-P-15 Interplanetaryx2, EMS-P-15 SubStellarx2, EMS-P-15 Interstellarx2,  
Jam EMS-A-15 FarOrbitx2, Jam EMS-A-15 Planetaryx2,  
Neutrino (0.01 Mw) Sensor-14x2,  
HiPen Densit-1x2,  
ActObjScan=Difficult, ActObjPin=Difficult,  
PasObjScan=Routine, PasObjPin=Routine,  
PasEngScan=Simple, PasEngPin=Routine

**Off:** ParticleAccel=T00, MesonGun=09x

Batt. 1 Batt. 5

Bear. 1 Bear. 4

Missiles=x90, BeamLaser=xx6

Batt. 100 Batt. 90

Bear. 65 Bear. 70

**Def:** DefDM=7,

MesonScreen-1,

NucDamper-9,

Sandcasters=xx7

Batt. 36

Bear. 30

**Control:** Computer=Model/9x3,

Panel=CP-HoloLinkedx7711, Special=HeadsUpHoloDisplayx7711,

Environ=Basic Environment, Basic Life Support, Extended Life Support, Grav Plates

**Accom:** Crew= 5274 (26x200)

(Bridge=27, Engineering=195, Maintenance=3633,

Gunners=458, Flight Crew=458, Ship's Troops=0,

Command=722, Stewards=176, Frozen Watch=0, Medical=43),

Additional Staterooms=0,

LowBerths=0 (FrozenWatch)+0 (Medical), EmergencyLowBerths=0,

SubCraft=50-ton craftx10, 1000-ton craftx2,

Magazines=50 50-ton magazines (3375 battery-rounds)

**Other:** Cargo=2233 tons (30,151 kliters),

Fuel=128,974 tons (1,741,150 kliters), Fuel Purification Plant (purifies total fuel tankage in 12 hours),

EmLevel=Moderate,

Battery Round=100 missiles,

Electronic Circuit Protection

**Comments:** Spinal ParticleAccelerator-Tx1,

100-ton Bay MesonGun-9x5,

50-ton Bay Missile-9x100,

Triple Turret BLaser (900/3),

Triple Turret Sand (360/3)

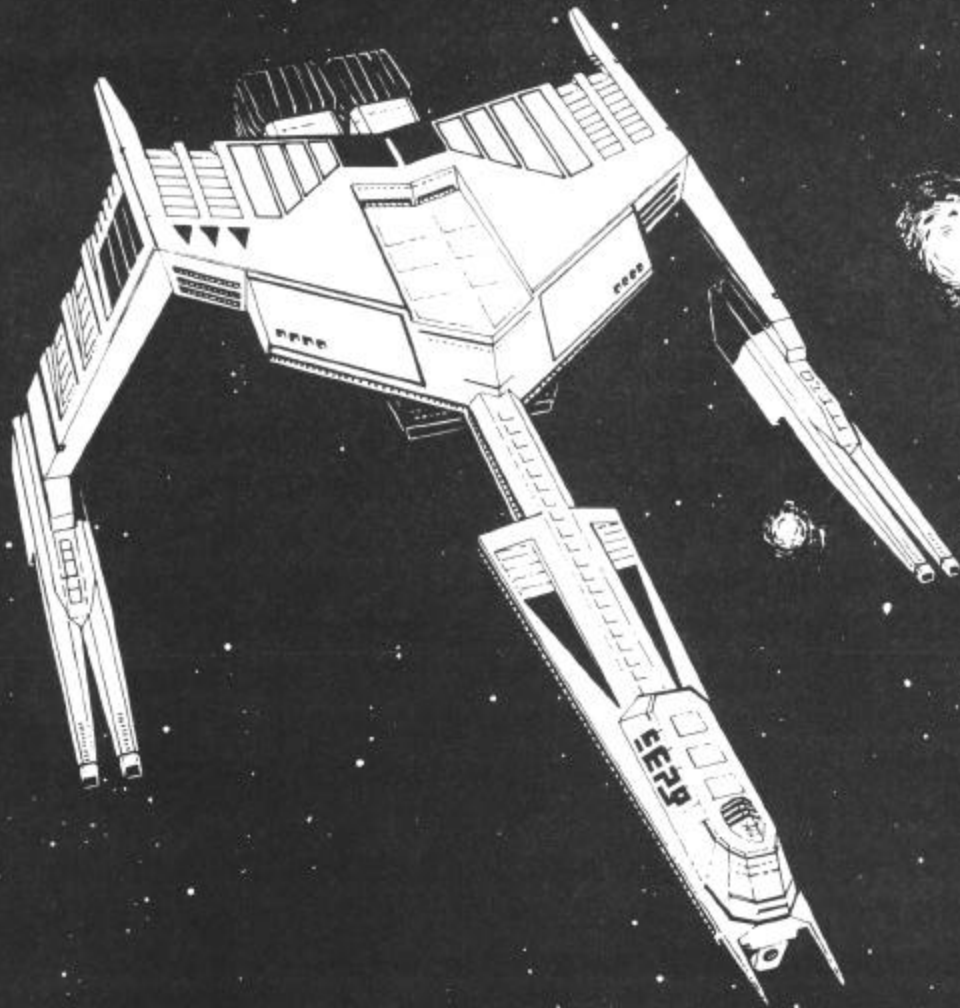

BS-15

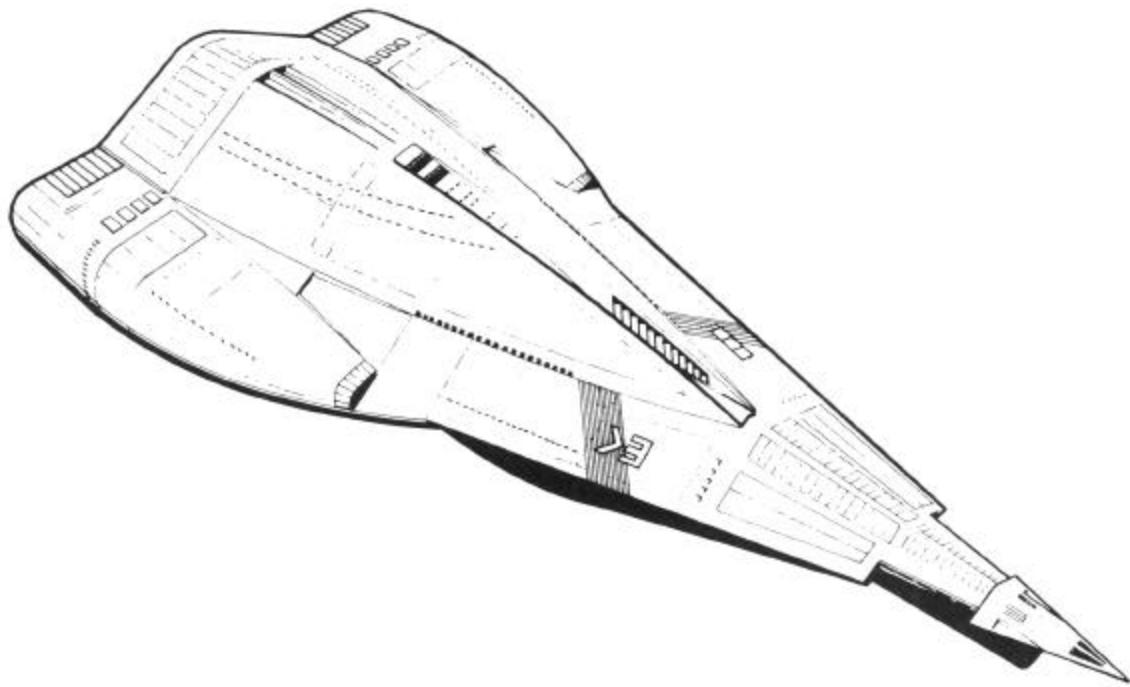

The standard cruiser at tech level 11 is the CA-11. It has developed and evolved through the tech levels to the present CA-15. At the same time, a variety of variants have been produced which take advantage of the basic CA-11/-15 structures and devote them to specialized uses.

The CM-12 missile cruiser was developed to emphasize the power benefits of missile armaments.

The CH-14 and CH-15 series were developed as a heavier cruiser.

The CJ-15 Rift cruiser was produced to allow cruiser patrols within the Rift and carries the higher jump drive capacities that such operations require.

---

# Cruisers

---

Cruisers are more lightly armored and less heavily armed than battleships. To unarmed, unarmored ships, this difference is negligible since a cruiser can easily attack and destroy any noncombatant ships. Cruisers are assigned to support battleships and carry combat to areas where a battleship is not considered necessary.



# Imperial Cruisers

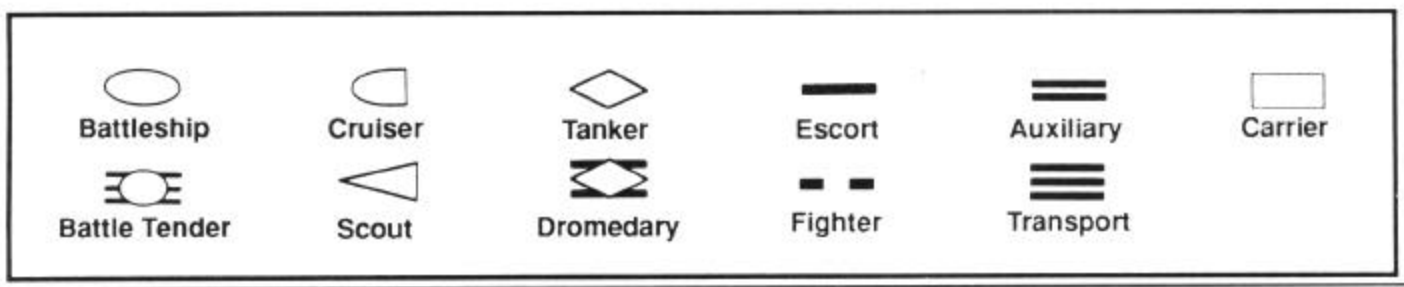
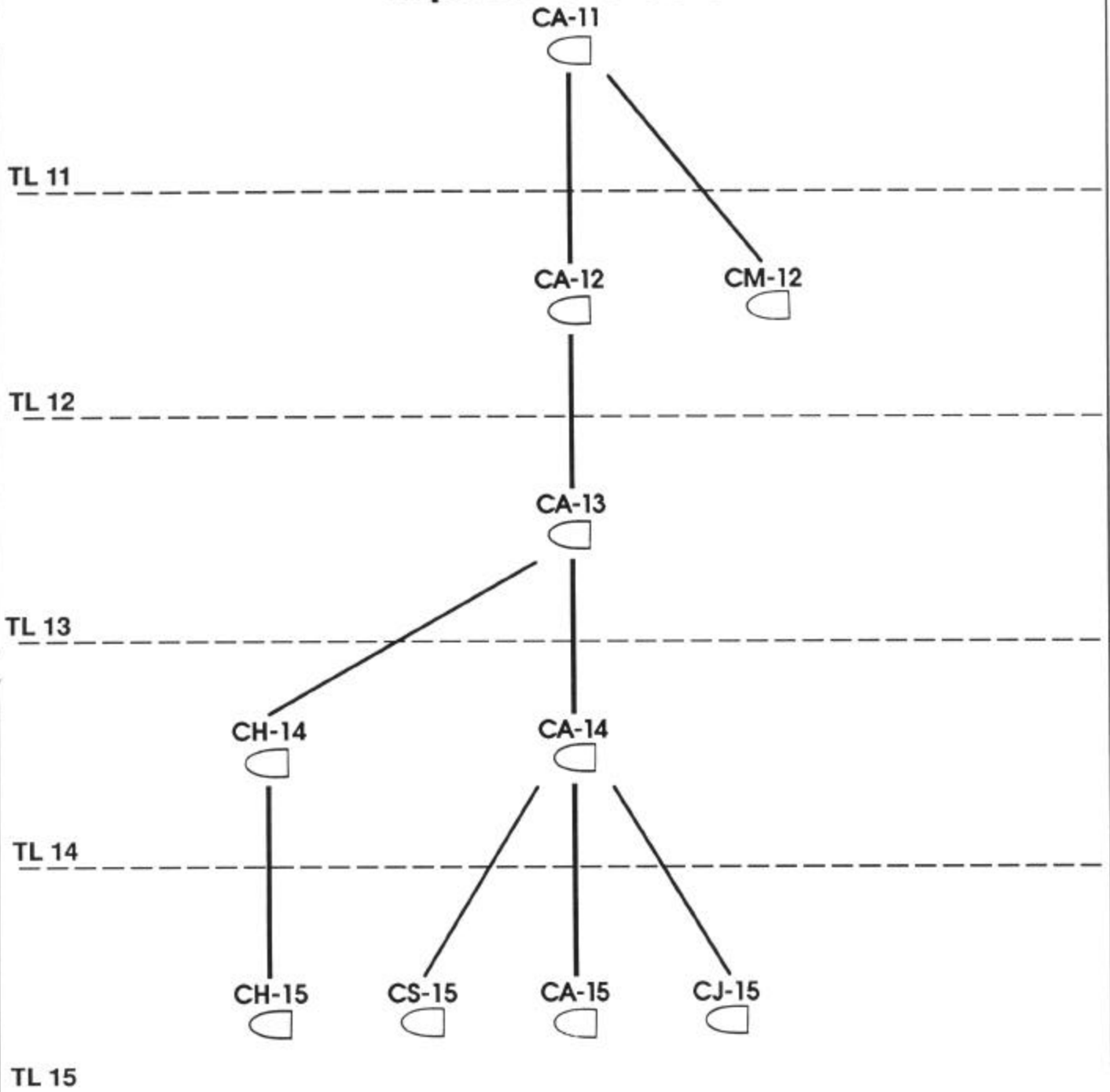

# CA-11 CRUISER ARMORED

**CraftID:** Cruiser Armored, Type CA, TL=B (Average Stellar), MCr54,601

**Hull:** 90000/225000, Disp=100000, Config=4SL, Armor=60E,  
Unloaded=1921344, Loaded=1965556

**Power:** 6019/12038, Fusion=1625386 Mw, Duration=22/66days

**Loco:** 9900/19800, Maneuver=4Gs, 2700/5400, Jump=2,  
NOE=150, Cruise=2550kph, Top=3400kph,  
Agility=1

**Commo:** RadioComm Planetary-11x2, RadioComm FarOrbit-11x2, RadioComm System-11x2,  
LaserComm Planet-11x2, LaserComm FarOrbit-11x2, LaserComm System-11x2,  
MaserComm Planet-11x2, MaserComm FarOrbit-11x2, MaserComm System-11x2

**Sensors:** EMM Packagex1,  
EMS-A-11 FarOrbitx2,  
EMS-P-11 SubStellarx2,  
Jam EMS-A-11 Planetaryx2,  
Neutrino (1000 Mw) Sensor-11x2,  
HiPen Densit-0.001x2,  
ActObjScan=Routine, ActObjPin=Routine,  
PasObjScan=Formidable, PasObjPin=Formidable,  
PasEngScan=Routine, PasEngPin=Formidable

**Off:** ParticleAccel=K70  
Batt. 1/10  
Bear. 1/7  
Missiles=x83, BeamLaser=xx6  
Batt. 60/20 Batt. 13  
Bear. 42/14 Bear. 9

**Def:** DefDM=4,  
Sandcasters=xx4  
Batt. 50  
Bear. 33

**Control:** Computer=Model/5fibx3,  
Panel=CP-DynamicLinkedx3477, Special=HeadsUpDisplayx3477,  
Environ=Basic Environment, Basic Life Support, Extended Life Support, Grav Plates, Inertial Compensators

**Accom:** Crew= 2457 (24x100)  
(Bridge=6, Engineering=274, Maintenance=32,  
Gunners=1217, Flight Crew=1217, Ship's Troops=400,  
Command=333, Stewards=81, Frozen Watch=24, Medical=20),  
Additional Staterooms=0,  
LowBerths=24 (FrozenWatch)+0 (Medical), EmergencyLowBerths=0,  
SubCraft=50-ton craftx10, 100-ton craftx10,  
Magazines=10 50-ton magazines (375 battery-rounds)

**Other:** Cargo=2085 tons (28150 kliters),  
Fuel=46785 tons (631602 kliters), Fuel Purification Plant (purifies total fuel tankage in six hours),  
ObjSize=Large, Fuel Scoops (fills tanks in five hours),  
EmLevel=Moderate,  
Battery Round=180 missiles,  
Electronic Circuit Protection

**Comments:** Spinal ParticleAccel-Kx1,  
100-ton Bay ParticleAccelerator-7x10,  
100-ton Bay Missile-8x60,  
Triple Turret Missile(120/3),  
Triple Turret BLaser(195/3),  
Triple Turret Sand(150/3)

This design sacrifices armor (60 versus the desired 80) and endurance (only 22 days) in order to meet other performance requirements.

# CA-12 CRUISER ARMORED

**CraftID:** Cruiser Armored, Type CA, TL=C (Average Stellar), MCr56,494

**Hull:** 90000/225000, Disp=100000, Config=3SL, Armor=57F,  
Unloaded=1549537, Loaded=1596772

**Power:** 5949/11898, Fusion=1606336 Mw, Duration=21/63days

**Loco:** 9900/19800, Maneuver=4Gs, 3600/7200, Jump=3,  
NOE=160, Cruise=2550kph, Top=3400kph,  
Agility=1

**Commo:** RadioComm Planetary-12x2, RadioComm FarOrbit-12x2, RadioComm System-12x2,  
LaserComm Planet-12x2, LaserComm FarOrbit-12x2, LaserComm System-12x2,  
MaserComm Planet-12x2, MaserComm FarOrbit-12x2, MaserComm System-12x2

**Sensors:** EMM Packagex1,  
EMS-A-12 FarOrbitx2,  
EMS-P-12 SubStellarx2,  
Jam EMS-A-12 Planetaryx2,  
Neutrino (1 Mw) Sensor-12x2,  
HiPen Densit-0.05x2,  
ActObjScan=Routine, ActObjPin=Routine,  
PasObjScan=Difficult, PasObjPin=Difficult,  
PasEngScan=Routine, PasEngPin=Formidable

**Off:** ParticleAccel=Q80  
Batt. 1/10  
Bear. 1/7  
Missiles=x93, BeamLaser=xx6  
Batt. 60/20 Batt. 13  
Bear. 42/14 Bear. 9

**Def:** DefDM= 5  
Sandcasters=xx4  
Batt. 50  
Bear. 35

**Control:** Computer=Model/6fibx3  
Panel=CP-DynamicLinkedx122, Special=LgHoloDisplayx122  
Environ=Basic Environment, Basic Life Support, Extended Life Support, Grav Plates, Inertial Compensators

**Accom:** Crew=1819 (18x100)  
(Bridge=5, Engineering=251, Maintenance=61,  
Gunners=1032, Flight Crew=1032, Ship's Troops=100,  
Command=249, Stewards=61, Frozen Watch=0, Medical=15),  
Additional Staterooms=10,  
LowBerths=0 (FrozenWatch)+0 (Medical), EmergencyLowBerths=0,  
SubCraft=50-ton craftx10, 100-ton craftx5,  
Magazines=10 50-ton magazines (375 battery-rounds)

**Other:** Cargo=569 tons (7693 kliters),  
Fuel=49984 tons (674796 kliters), Fuel Purification Plant (purifies total fuel tankage in 12 hours),  
ObjSize=Large, Fuel Scoops (fills tanks in five hours),  
EmLevel=Moderate,  
Battery Round=180 missiles,  
Electronic Circuit Protection

**Comments:** Spinal ParticleAccel-Qx1,  
100-ton Bay ParticleAccelerator-8x10,  
100-ton Bay Missile-9x60,  
Triple Turret Missile(120/3),  
Triple Turret BLaser(195/3),  
Triple Turret Sand(150/3)

The upgrade of the J-2 TL-11 CA to J-3 TL-12 necessitates some tradeoffs:  
Slight reductions in ship's troops, endurance, armor, and subcraft are needed to offset the added  
jump-drive and fuel requirements of the new design.

# CA-13 CRUISER ARMORED

**CraftID:** Cruiser Armored, Type CA, TL=D (Average Stellar), MCr99,870

**Hull:** 90000/225000, Disp=100000, Config=3SL, Armor=75F,  
Unloaded=4118485, Loaded=4165185

**Power:** 4844/9688, Fusion=1308124 Mw, Duration=21/63days

**Loco:** 9900/19800, Maneuver=4Gs, 4500/9000, Jump=4,  
NOE=170, Cruise=2550kph, Top=3400kph,  
Agility=0

**Commo:** RadioComm Planetary-13x2, RadioComm FarOrbit-13x2, RadioComm System-13x2,  
LaserComm Planet-13x2, LaserComm FarOrbit-13x2, LaserComm System-13x2,  
MaserComm Planet-13x2, MaserComm FarOrbit-13x2, MaserComm System-13x2

**Sensors:** EMM Packagex1,  
EMS-A-13 FarOrbitx2,  
EMS-P-13 SubStellarx2,  
Jam EMS-A-13 Planetaryx2,  
Neutrino (0.1 Mw) Sensor-13x2,  
HiPen Densit-0.1x2,  
ActObjScan=Routine, ActObjPin=Routine,  
PasObjScan=Difficult, PasObjPin=Difficult,  
PasEngScan=Routine, PasEngPin=Difficult

**Off:** ParticleAccel=R40  
Batt. 1/17  
Bear. 1/13  
Missiles=x93, BeamLaser=xx8  
Batt. 60/40 Batt. 10  
Bear. 42/28 Bear. 7

**Def:** DefDM=5,  
NucDamper-3,  
Sandcasters=xx4  
Batt. 50  
Bear. 35

**Control:** Computer=Model/7fibx3,  
Panel=CP-HoloLinkedx1038, Special=HeadsUpHoloDisplayx1038,  
Environ=Basic Environment, Basic Life Support, Extended Life Support, Grav Plates, Inertial Compensators

**Accom:** Crew=1592 (15x100)  
(Bridge=4, Engineering=187, Maintenance=263,  
Gunners=684, Flight Crew=684, Ship's Troops=100,  
Command=218, Stewards=53, Frozen Watch=0, Medical=13),  
Additional Staterooms=10,  
LowBerths=0 (FrozenWatch)+0 (Medical), EmergencyLowBerths=0,  
SubCraft=50-ton craftx10, 100-ton craftx10,  
Magazines=3 50-ton magazines (112 battery-rounds)

**Other:** Cargo=2202 tons (29732 kliters),  
Fuel=49,418 tons (667,147 kliters), Fuel Purification Plant (purifies total fuel tankage in 12 hours),  
ObjSize=Large, Fuel Scoops (fills tanks in five hours),  
EmLevel=Moderate,  
Battery Round=180 missiles,  
Electronic Circuit Protection

**Comments:** Spinal ParticleAccel-Rx1,  
50-ton Bay ParticleAccelerator-4x17,  
100-ton Bay Missile-9x60,  
Triple Turret Missile (120/3),  
Triple Turret BLaser (210/3),  
Triple Turret Sand (150/3)  
The TL-13 Heavy Cruiser is the first such design to achieve what the Imperial Navy considers minimum acceptable performance: J-4 and 4-Gs.

# CA-14 CRUISER ARMORED

**CraftID:** Cruiser Armored, Type CA, TL=E (High Stellar), MCr124,234

**Hull:** 90000/225000, Disp=100000, Config=2SL, Armor=80G,  
Unloaded=3589000, Loaded=3637370

**Power:** 5195/10390, Fusion=1402782 Mw, Duration=21/63days

**Loco:** 9900/19800, Maneuver=4Gs, 4500/9000, Jump=4,  
NOE=180, Cruise=2550kph, Top=3400kph,  
Agility=0

**Commo:** RadioComm Planetary-14x2, RadioComm FarOrbit-14x2, RadioComm System-14x2,  
LaserComm Planet-14x2, LaserComm FarOrbit-14x2, LaserComm System-14x2,  
MaserComm Planet-14x2, MaserComm FarOrbit-14x2, MaserComm System-14x2

**Sensors:** EMM Packagex1,  
EMS-A-14 FarOrbitx2,  
EMS-P-14 SubStellarx2,  
Jam EMS-A-14 Planetaryx2,  
Neutrino (0.01 Mw) Sensor-14x2,  
HiPen Densit-0.25x2,  
ActObjScan=Routine, ActObjPin=Routine,  
PasObjScan=Routine, PasObjPin=Routine,  
PasEngScan=Routine, PasEngPin=Routine

**Off:** ParticleAccel=S90  
Batt. 1/15  
Bear. 1/13  
Missiles=xA3, BeamLaser=xx8  
Batt. 60/50 Batt. 11  
Bear. 42/35 Bear. 8

**Def:** DefDM=6,  
OptiNucDamper-1,  
Sandcasters=xx4  
Batt. 50  
Bear. 35

**Control:** Computer=Model/8fibx3,  
Panel=CP-HoloLinkedx938, Special=HeadsUpHoloDisplayx938,  
Environ=Basic Environment, Basic Life Support, Extended Life Support, Grav Plates, Inertial Compensators

**Accom:** Crew=1315 (13x100)  
(Bridge=2, Engineering=142, Maintenance=275,  
Gunners=492, Flight Crew=492, Ship's Troops=100,  
Command=180, Stewards=44, Frozen Watch=0, Medical=10),  
Additional Staterooms=10,  
LowBerths=0 (FrozenWatch)+0 (Medical), EmergencyLowBerths=0,  
SubCraft=50-ton craftx10, 100-ton craftx10,  
Magazines=4 50-ton magazines (128 battery-rounds)

**Other:** Cargo=305 tons (4129 kliters),  
Fuel=51,185 tons (691,001 kliters), Fuel Purification Plant (purifies total fuel tankage in six hours),  
ObjSize=Large, Fuel Scoops (fills tanks in five hours),  
EmLevel=Moderate,  
Battery Round=210 missiles,  
Electronic Circuit Protection

**Comments:** Spinal ParticleAccel-Sx1,  
100-ton Bay ParticleAccelerator-9x15,  
100-ton Bay Missile-Ax60,  
Triple Turret Missile (150/3),  
Triple Turret BLaser (225/3),  
Triple Turret Sand (150/3)

# CA-15 CRUISER ARMORED

**CraftID:** Cruiser Armored, Type CA, TL=F (High Stellar), MCr124,009

**Hull:** 90000/225000, Disp=100000, Config=2SL, Armor=80G,  
Unloaded=3582156, Loaded=3630455

**Power:** 5180/10360, Fusion=1398779 Mw, Duration=21/63days

**Loco:** 9900/19800, Maneuver=4Gs, 4500/9000, Jump=4,  
NOE=190, Cruise=2550kph, Top=3400kph,  
Agility=0

**Commo:** RadioComm Planetary-15x2, RadioComm FarOrbit-15x2, RadioComm System-15x2,  
LaserComm Planet-15x2, LaserComm FarOrbit-15x2, LaserComm System-15x2,  
MaserComm Planet-15x2, MaserComm FarOrbit-15x2, MaserComm System-15x2

**Sensors:** EMM Packagex1,  
EMS-A-15 FarOrbitx2,  
EMS-P-15 SubStellarx2,  
Jam EMS-A-15 Planetaryx2,  
Neutrino (0.01 Mw) Sensor-14x2,  
HiPen Densit-1x2,  
ActObjScan=Routine, ActObjPin=Routine,  
PasObjScan=Routine, PasObjPin=Routine,  
PasEngScan=Routine, PasEngPin=Routine

**Off:** ParticleAccel=T90  
Batt. 1/15  
Bear. 1/13  
Missiles=xA3, BeamLaser=xx8  
Batt. 60/40 Batt. 10  
Bear. 42/28 Bear. 7

**Def:** DefDM=7,  
OptiNucDamper-1,  
Sandcasters=xx4  
Batt. 50  
Bear. 35

**Control:** Computer=Model/9fibx3,  
Panel=CP-HoloLinkedx813, Special=HeadsUpHoloDisplayx813,  
Environ=Basic Environment, Basic Life Support, Extended Life Support, Grav Plates, Inertial Compensators

**Accom:** Crew=1224 (12x100)  
(Bridge=2, Engineering=120, Maintenance=214,  
Gunners=390, Flight Crew=390, Ship's Troops=200,  
Command=166, Stewards=40, Frozen Watch=12, Medical=10),  
Additional Staterooms=10,  
LowBerths=12 (FrozenWatch)+0 (Medical), EmergencyLowBerths=0,  
SubCraft=50-ton craftx10, 100-ton craftx10,  
Magazines=5 50-ton magazines (160 battery-rounds)

**Other:** Cargo=1104 tons (14,915 kliters),  
Fuel=51,110 tons (689,992 kliters), Fuel Purification Plant (purifies total fuel tankage in six hours),  
ObjSize=Large, Fuel Scoops (fills tanks in five hours),  
EmLevel=Moderate,  
Battery Round=210 missiles,  
Electronic Circuit Protection

**Comments:** Spinal ParticleAccel-Tx1,  
100-ton Bay ParticleAccelerator-9x15,  
100-ton Bay Missile-Ax60,  
Triple Turret Missile (150/3),  
Triple Turret BLaser (210/3),  
Triple Turret Sand (150/3)

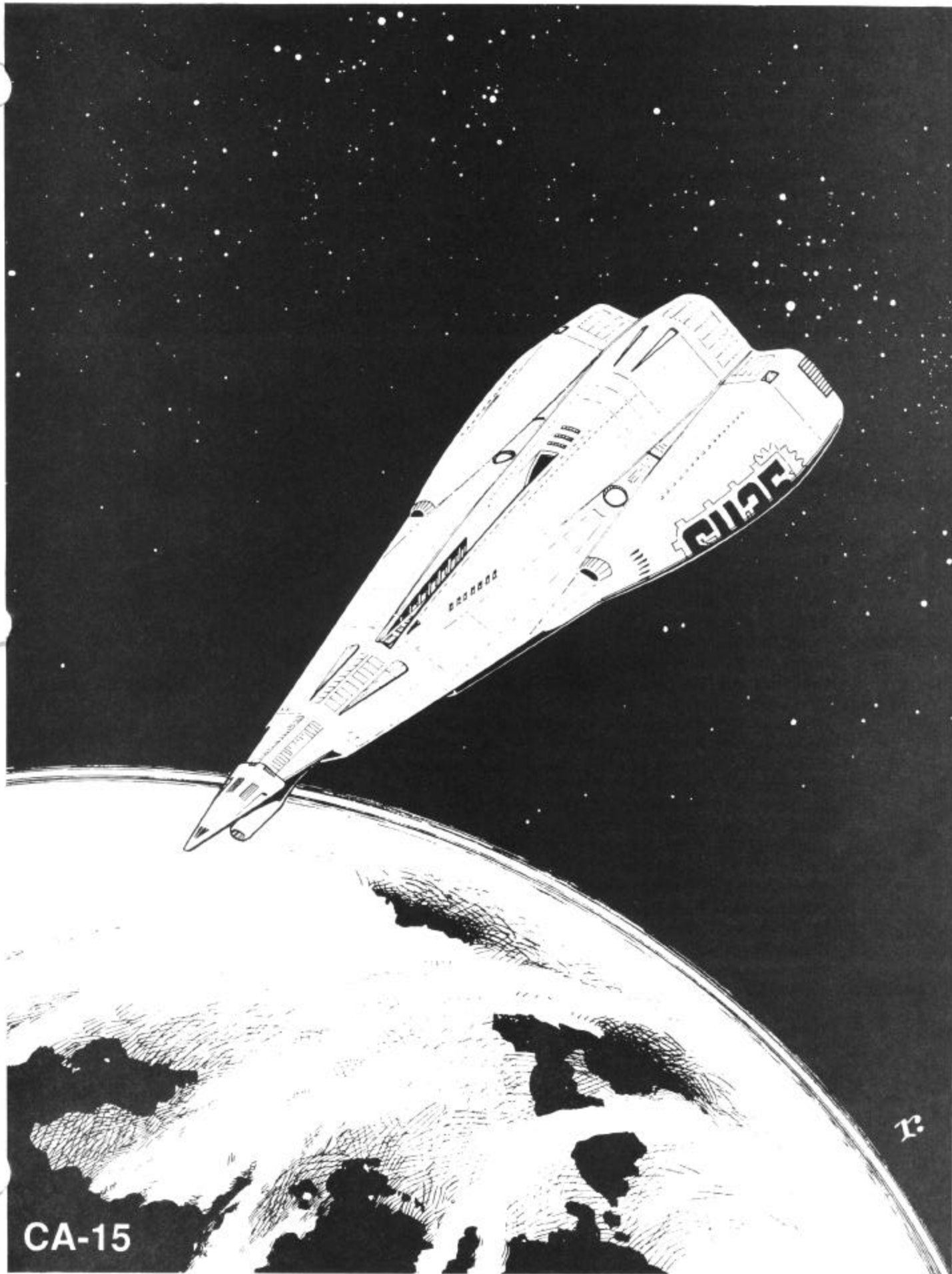

CA-15

12

# CM-12 CRUISER MISSILE

**CraftID:** Cruiser Missile, Type CM, TL=C (Average Stellar), MCr134,895

**Hull:** 90000/225000, Disp=100000, Config=3SL, Armor=80F,  
Unloaded=5874039, Loaded=5914667

**Power:** 4354/8708, Fusion=1175719 Mw, Duration=22/66days

**Loco:** 9900/19800, Maneuver=4Gs, 3600/7200, Jump=3,  
NOE=160, Cruise=2550kph, Top=3400kph,  
Agility=0

**Commo:** RadioComm Planetary-12x2, RadioComm FarOrbit-12x2, RadioComm System-12x2,  
LaserComm Planet-12x2, LaserComm FarOrbit-12x2, LaserComm System-12x2,  
MaserComm Planet-12x2, MaserComm FarOrbit-12x2, MaserComm System-12x2

**Sensors:** EMM Packagex1,  
EMS-A-12 FarOrbitx2,  
EMS-P-12 SubStellarx2,  
Jam EMS-A-12 Planetaryx2,  
Neutrino (1 Mw) Sensor-12x2,  
HiPen Densit-0.05x2,  
ActObjScan=Routine, ActObjPin=Routine,  
PasObjScan=Difficult, PasObjPin=Difficult,  
PasEngScan=Routine, PasEngPin=Formidable

**Off:** ParticleAccel=080, MesonGun=K0x

Batt.	2	Batt.	1
Bear.	2	Bear.	1

Missiles=x93, BeamLaser=xx2	
Batt. 60/50	Batt. 30
Bear. 42/35	Bear. 21

**Def:** DefDM=4,  
NucDamper-1,  
Sandcasters=xx4  
Batt. 30  
Bear. 21

**Control:** Computer=Model/6fibx3,  
Panel=CP-DynamicLinkedx240, Special=LgHoloDisplayx240,  
Environ=Basic Environment, Basic Life Support, Extended Life Support, Grav Plates, Inertial Compensators

**Accom:** Crew=4881 (48x100)  
(Bridge=20, Engineering=219, Maintenance=568,  
Gunners=3108, Flight Crew=3108, Ship's Troops=50,  
Command=668, Stewards=163, Frozen Watch=0, Medical=40),  
Additional Staterooms=5,  
LowBerths=0 (FrozenWatch)+5 (Medical). EmergencyLowBerths=0,  
SubCraft=50-ton craftx10, 100-ton craftx5,  
Magazines=14 50-ton magazines (262 battery-rounds)

**Other:** Cargo=288 tons (3892 kliters),  
Fuel=42991 tons (580389 kliters), Fuel Purification Plant (purifies total fuel tankage in 15 hours),  
ObjSize=Large, Fuel Scoops (fills tanks in five hours),  
EmLevel=Moderate,  
Battery Round=360 missiles,  
Electronic Circuit Protection

**Comments:** 100-ton Bay ParticleAccelerator-8x2,  
Spinal MesonGun-Kx1,  
100-ton Bay Missile-9x60,  
Triple Turret Missile (300/3),  
Triple Turret BLaser (90/3),  
Triple Turret Sand (90/3)



# CS-15 CRUISER STRIKE

**CraftID:** Cruiser Strike, Type CS, TL=F (High Stellar), MCr122,203  
**Hull:** 90000/225000, Disp=100000, Config=3SL, Armor=80G, Unloaded=3236079, Loaded=3291511  
**Power:** 5369/10738, Fusion=1449682 Mw, Duration=30/90days  
**Loco:** 1800/3600, Maneuver=1Gs, 3600/7200, Jump=3, NOE=190, Cruise=900kph, Top=1200kph, Agility=1  
**Commo:** RadioComm Planetary-15x1, RadioComm FarOrbit-15x1, RadioComm System-15x1, LaserComm Planet-15x1, LaserComm FarOrbit-15x1, LaserComm System-15x1, MaserComm Planet-15x1, MaserComm FarOrbit-15x1, MaserComm System-15x1  
**Sensors:** EMM Packagex1, EMS-A-15 FarOrbitx2, EMS-P-15 SubStellarx2, Jam EMS-A-15 Planetaryx2, Neutrino (0.01 Mw) Sensor-14x2, HiPen Densit-1x2, ActObjScan=Routine, ActObjPin=Routine, PasObjScan=Routine, PasObjPin=Routine, PasEngScan=Routine, PasEngPin=Routine  
**Off:** ParticleAccel=090, MesonGun=T4x  
Batt. 10 Batt. 1/2  
Bear. 7 Bear. 1/2  
FusionGun=x90  
Batt. 10  
Bear. 7  
Missiles=xA4, BeamLaser=xx6  
Batt. 50/25 Batt. 25  
Bear. 35/18 Bear. 14  
**Def:** DefDM=8, NucDamper-9, Sandcasters=xx3  
Batt. 20  
Bear. 14  
**Control:** Computer=Model/9fibx3, Panel=CP-HoloLinkedx609, Special=HeadsUpHoloDisplayx609, Environ=Basic Environment, Basic Life Support, Extended Life Support, Grav Plates, Inertial Compensators  
**Accom:** Crew=1151 (11x100) (Bridge=2, Engineering=93, Maintenance=270, Gunners=357, Flight Crew=357, Ship's Troops=0, Command=157, Stewards=38, Frozen Watch=0, Medical=9), Additional Staterooms=10, LowBerths=0 (FrozenWatch)+0 (Medical), EmergencyLowBerths=0, SubCraft=10-ton craftx100, 100-ton craftx5, Magazines=9 50-ton magazines (303 battery-rounds)  
**Other:** Cargo=821 tons (11,085 kliters), Fuel=58,658 tons (791,885 kliters), Fuel Purification Plant (purifies total fuel tankage in 60 hours), ObjSize=Large, Fuel Scoops (fills tanks in five hours), EmLevel=Moderate, Battery Round=200 missiles, Electronic Circuit Protection  
**Comments:** 100-ton Bay ParticleAccelerator-9x10, Spinal MesonGun-Tx1, 50-ton Bay MesonGun-4x2, 50-ton Bay FusionGun-9x10, 100-ton Bay Missile-Ax50, Triple Turret Missile (150/3), Triple Turret BLaser (150/3), Triple Turret Sand (60/3)

# CH-14 CRUISER HEAVY

**CraftID:** Cruiser Heavy, Type CH, TL=E (High Stellar), MCr92,765

**Hull:** 90000/225000, Disp=100000, Config=4SL, Armor=80G,  
Unloaded=3220757, Loaded=3250276

**Power:** 3221/6442, Fusion=869820 Mw, Duration=21/63days

**Loco:** 4500/9000, Maneuver=2Gs, 2700/5400, Jump=2,  
NOE=180, Cruise=1590kph, Top=2120kph,  
Agility=0

**Commo:** RadioComm Planetary-14x2, RadioComm FarOrbit-14x2, RadioComm System-14x2,  
LaserComm Planet-14x2, LaserComm FarOrbit-14x2, LaserComm System-14x2,  
MaserComm Planet-14x2, MaserComm FarOrbit-14x2, MaserComm System-14x2

**Sensors:** EMM Packagex1,  
EMS-A-14 FarOrbitx2,  
EMS-P-14 SubStellarx2,  
Jam EMS-A-14 Planetaryx2,  
Neutrino (0.01 Mw) Sensor-14x2,  
HiPen Densit-0.25x2,  
ActObjScan=Routine, ActObjPin=Routine,  
PasObjScan=Routine, PasObjPin=Routine,  
PasEngScan=Routine, PasEngPin=Routine

**Off:** ParticleAccel=S50

Batt. 1/10

Bear. 1/7

FusionGun=x80

Batt. 10

Bear. 7

Missiles=xA4, BeamLaser=xx7

Batt. 60/20 Batt. 15

Bear. 42/14 Bear. 10

**Def:** DefDM=6,

NucDamper-6,

Repulsors=x3x, Sandcasters=xx4

Batt. 1 Batt. 50

Bear. 1 Bear. 35

**Control:** Computer=Model/8fibx3,

Panel=CP-HoloLinkedx744, Special=HeadsUpHoloDisplayx744,

Environ=Basic Environment, Basic Life Support, Extended Life Support, Grav Plates

**Accom:** Crew=1522 (15x100)

(Bridge=2, Engineering=82, Maintenance=155,

Gunners=452, Flight Crew=452, Ship's Troops=500,

Command=208, Stewards=51, Frozen Watch=0, Medical=12),

Additional Staterooms=0,

LowBerths=0 (FrozenWatch)+0 (Medical), EmergencyLowBerths=0,

SubCraft=50-ton craftx5, 100-ton craftx10,

Magazines=3 50-ton magazines (112 battery-rounds)

**Other:** Cargo=2627 tons (35,472 kliters),

Fuel=31,236 tons (421,694 kliters), Fuel Purification Plant (purifies total fuel tankage in 12 hours),

ObjSize=Large, Fuel Scoops (fills tanks in five hours),

EmLevel=Moderate,

Battery Round=180 missiles,

Electronic Circuit Protection

**Comments:** Spinal ParticleAccel-Sx1,

50-ton Bay ParticleAccelerator-5x10,

50-ton Bay FusionGun-8x10,

100-ton Bay Missile-Ax60,

Triple Turret Missile (120/3),

Triple Turret BLaser (225/3),

Triple Turret Sand (150/3),

50-ton Repulsor Bayx1

# CH-15 CRUISER HEAVY

**CraftID:** Cruiser Heavy, Type CH, TL=F (High Stellar), MCr397,217

**Hull:** 90000/225000, Disp=100000, Config=4SL, Armor=100G,  
Unloaded=15880338, Loaded=15936248

**Power:** 3263/6526, Fusion=88118 Mw, Duration=50/150days

**Loco:** 4500/9000, Maneuver=2Gs, 3600/7200, Jump=3,  
NOE=190, Cruise=1590kph, Top=2120kph,  
Agility=0

**Commo:** RadioComm Planetary-15x2, RadioComm FarOrbit-15x2, RadioComm System-15x2,  
LaserComm Planet-15x2, LaserComm FarOrbit-15x2, LaserComm System-15x2,  
MaserComm Planet-15x2, MaserComm FarOrbit-15x2, MaserComm System-15x2

**Sensors:** EMM Packagex1,  
EMS-A-15 FarOrbitx2,  
EMS-P-15 SubStellarx2,  
Jam EMS-A-15 Planetaryx2,  
Neutrino (0.01 Mw) Sensor-14x2,  
HiPen Densit-1x2,  
ActObjScan=Routine, ActObjPin=Routine,  
PasObjScan=Routine, PasObjPin=Routine,  
PasEngScan=Routine, PasEngPin=Routine

**Off:** ParticleAccel=T50  
Batt. 1/10  
Bear. 1/7  
FusionGun=x90  
Batt. 10  
Bear. 7  
Missiles=xA4, BeamLaser=xx7  
Batt. 60/20 Batt. 16  
Bear. 42/14 Bear. 11

**Def:** DefDM=7  
NucDamper-9  
Repulsors=x5x, Sandcasters=xx4  
Batt. 1 Batt. 50  
Bear. 1 Bear. 35

**Control:** Computer=Model/9fibx3,  
Panel=CP-HoloLinkedx2537, Special=HeadsUpHoloDisplayx2537,  
Environ=Basic Environment, Basic Life Support, Extended Life Support, Grav Plates

**Accom:** Crew= 2527 (25x100)  
(Bridge=5, Engineering=80, Maintenance=1060,  
Gunners=362, Flight Crew=362, Ship's Troops=500,  
Command=346, Stewards=84, Frozen Watch=0, Medical=20),  
Additional Staterooms=30,  
LowBerths=0 (FrozenWatch)+0 (Medical), EmergencyLowBerths=200,  
SubCraft=50-ton craftx10, 100-ton craftx10,  
Magazines=3 50-ton magazines (112 battery-rounds)

**Other:** Cargo=995 tons (13445 kliters),  
Fuel=59163 tons (798709 kliters), Fuel Purification Plant (purifies total fuel tankage in 12 hours),  
ObjSize=Large, Fuel Scoops (fills tanks in five hours),  
EmLevel=Moderate,  
Battery Round=180 missiles,  
Electronic Circuit Protection

**Comments:** Spinal ParticleAccel-Tx1,  
50-ton Bay ParticleAccelerator-5x10,  
50-ton Bay FusionGun-9x10,  
100-ton Bay Missile-Ax60,  
Triple Turret Missile (120/3),  
Triple Turret BLaser (240/3),  
Triple Turret Sand (150/3),  
50-ton Bay Repulsorx1

# CJ-15 CRUISER IMPERIAL

**CraftID:** Cruiser Imperial, Type CJ, TL=F (High Stellar), MCr119,900

**Hull:** 90000/225000, Disp=100000, Config=2SL, Armor=80G,  
Unloaded=3371134, Loaded=3426607

**Power:** 3291/6582, Fusion=888816 Mw, Duration=30/90days

**Loco:** 4500/9000, Maneuver=2Gs, 6300/12600, Jump=6,  
NOE=190, Cruise=1590kph, Top=2120kph,  
Agility=0

**Commo:** RadioComm Planetary-15x2, RadioComm FarOrbit-15x2, RadioComm System-15x2,  
LaserComm Planet-15x2, LaserComm FarOrbit-15x2, LaserComm System-15x2,  
MaserComm Planet-15x2, MaserComm FarOrbit-15x2, MaserComm System-15x2

**Sensors:** EMM Packagex1,  
EMS-A-15 FarOrbitx2,  
EMS-P-15 Interstellarx2,  
Jam EMS-A-15 Planetaryx2,  
Neutrino (0.01 Mw) Sensor-14x2,  
HiPen Densit-1x2,  
ActObjScan=Routine, ActObjPin=Routine,  
PasObjScan=Routine, PasObjPin=Routine,  
PasEngScan=Simple, PasEngPin=Routine

**Off:** ParticleAccel=T90  
Batt. 1/10  
Bear. 1/7  
Missiles=xA3, BeamLaser=xx6  
Batt. 60/50 Batt. 10  
Bear. 42/35 Bear. 7

**Def:** DefDM=7,  
OptiNucDamper-1,  
Repulsors=x5x, Sandcasters=xx4  
Batt. 1 Batt. 50  
Bear. 1 Bear. 35

**Control:** Computer=Model/9fibx3,  
Panel=CP-HoloLinkedx761, Special=HeadsUpHoloDisplayx761,  
Environ=Basic Environment, Basic Life Support, Extended Life Support, Grav Plates, Inertial Compensators

**Accom:** Crew=1017 (10x100)  
(Bridge=2, Engineering=108, Maintenance=231,  
Gunners=360, Flight Crew=360, Ship's Troops=100,  
Command=139, Stewards=34, Frozen Watch=0, Medical=8),  
Additional Staterooms=10,  
LowBerths=0 (FrozenWatch)+10 (Medical), EmergencyLowBerths=250,  
SubCraft=50-ton craftx5, 100-ton craftx5,  
Magazines=10 50-ton magazines (321 battery-rounds)

**Other:** Cargo=588 tons (7948 kliters),  
Fuel=58,701 tons (792,473 kliters), Fuel Purification Plant (purifies total fuel tankage in six hours),  
ObjSize=Large, Fuel Scoops (fills tanks in five hours),  
EmLevel=Moderate,  
Battery Round=210 missiles,  
Electronic Circuit Protection

**Comments:** Spinal ParticleAccel-Tx1,  
100-ton Bay ParticleAccelerator-9x10,  
100-ton Bay Missile-Ax60,  
Triple Turret Missile (150/3),  
Triple Turret BLaser (150/3),  
Triple Turret Sand (150/3),  
50-ton Bay Repulsorx1

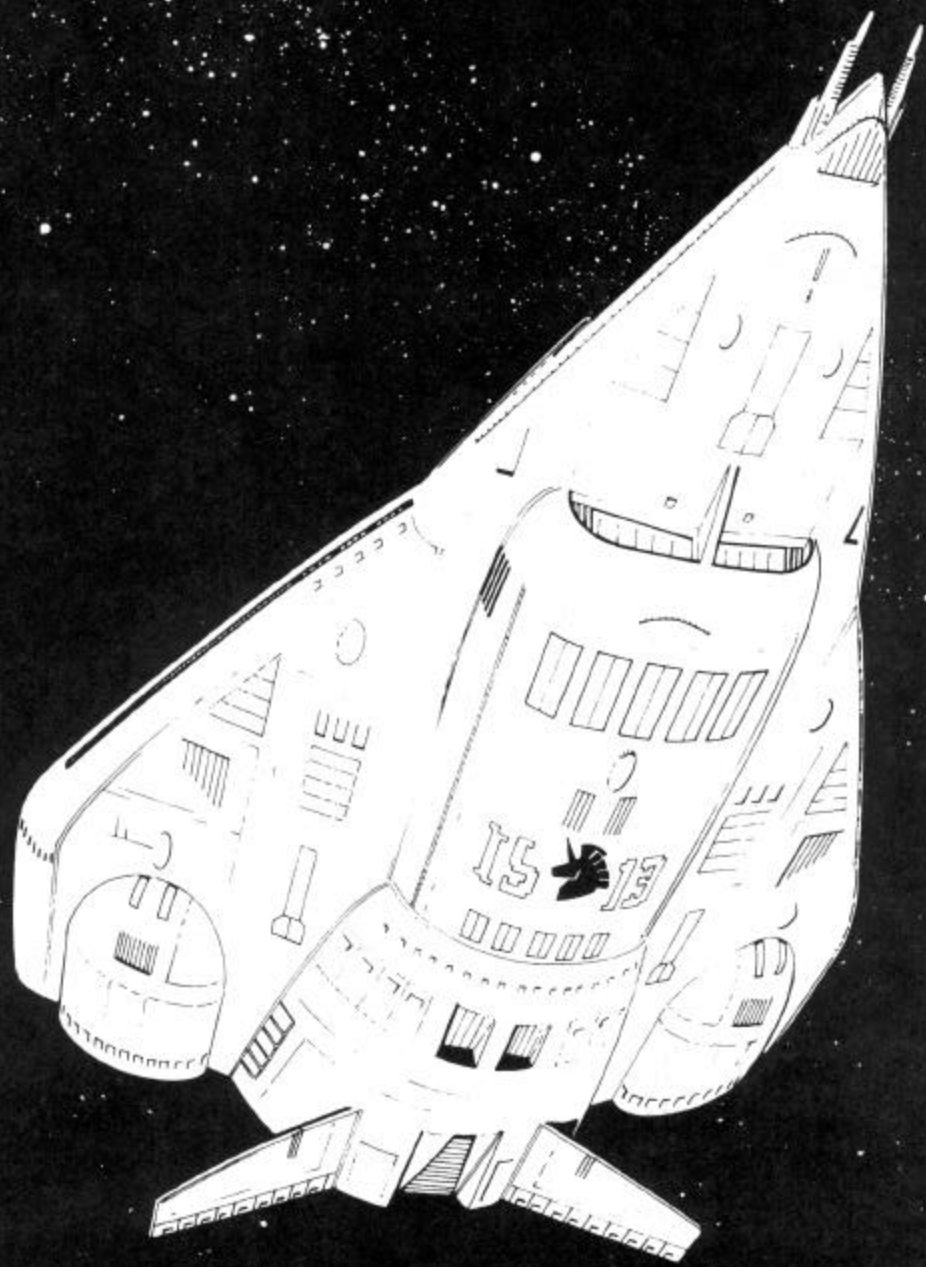

CJ-15

12

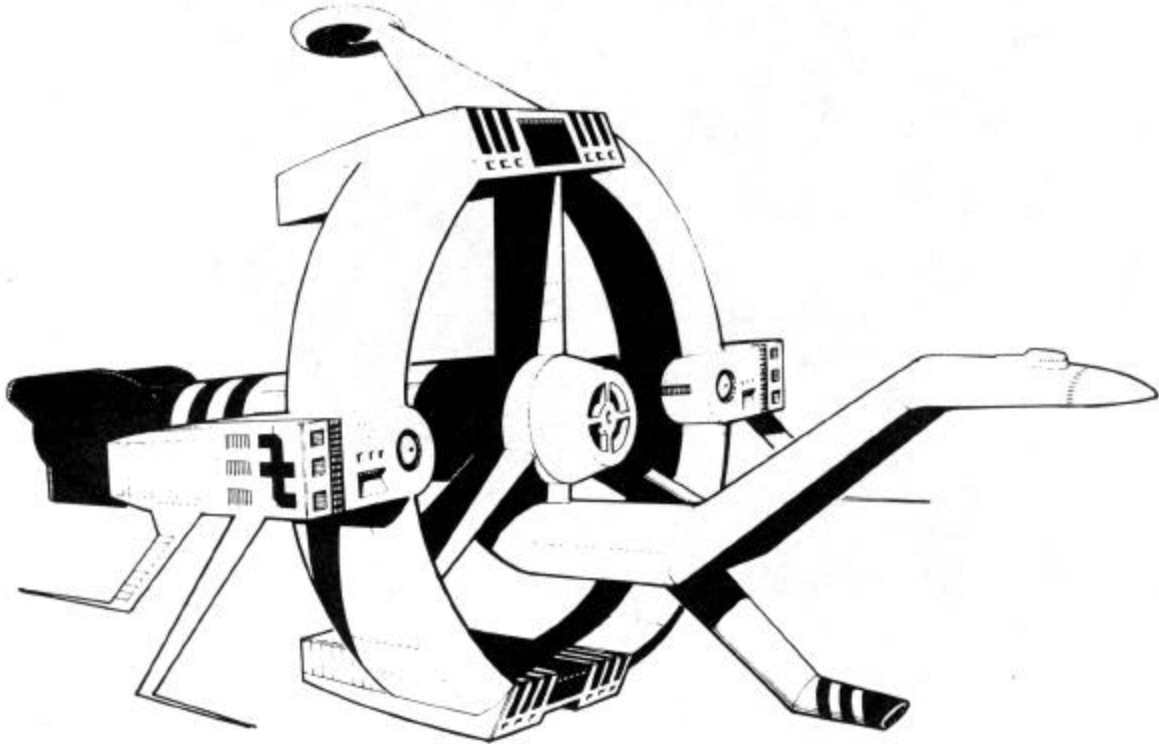

The massive fleet carrier VF-11 was produced to provide support for the vast numbers of fighters that fleet tactics require. The size and design of the VF-11 call for an independent refueling tanker, the TV-11. The technological development of the VF-11 into the VF-12 also called for a similar tanker, but rather than design a new vessel, the TV-11 was used without change.

The VS-13/-15 series is a new line of carriers designed independent of the VF-11/-12 series.

The higher-tech trend is to smaller carriers. The VL-15 light carrier and the even smaller VP-15 pocket carrier are examples of this trend.

---

# Carriers

---

Carriers are designed to carry large numbers of small combat craft, which in turn attack the enemy's combatants or world surfaces.

# Imperial Carriers

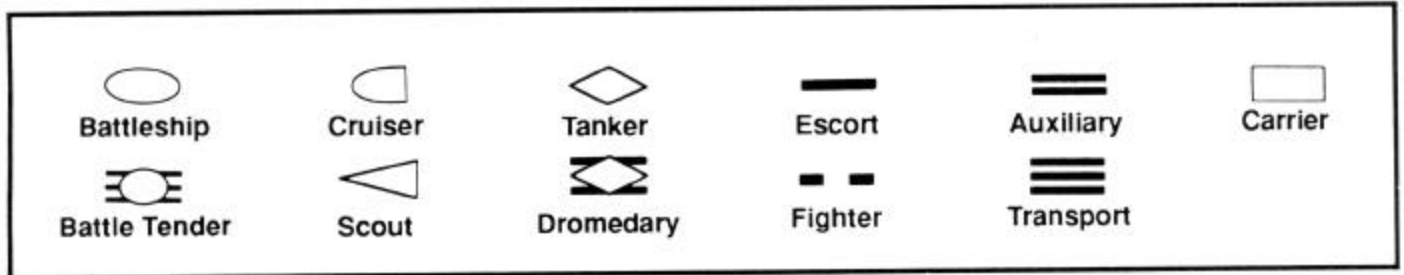
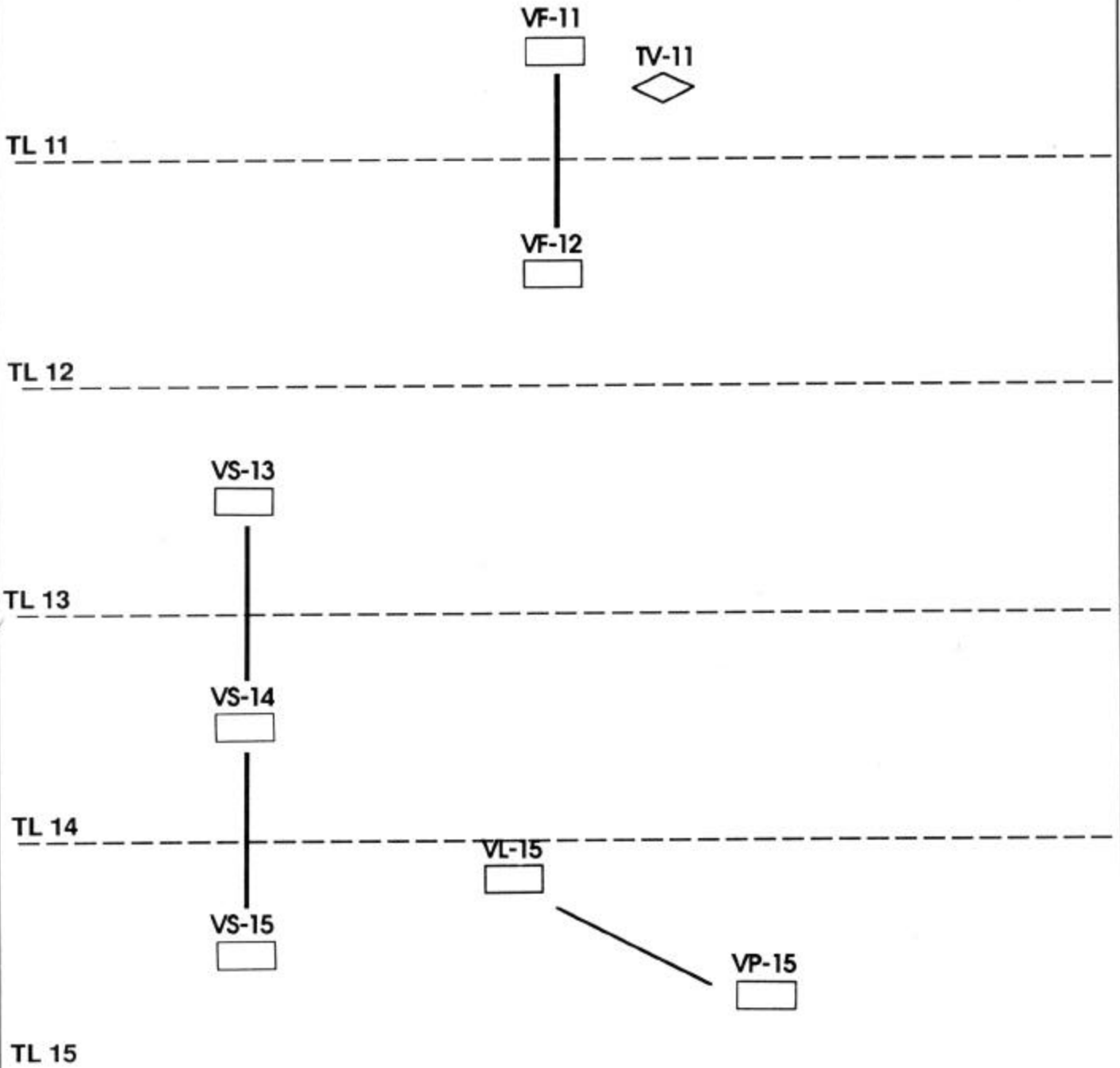

# VF-12 CARRIER FLEET

**CraftID:** Carrier Fleet, Type VF, TL=B (Average Stellar), MCr17,476

**Hull:** 90000/225000, Disp=100000, Config=7, Armor=46E,  
Unloaded=622247, Loaded=641797

**Power:** 789/1578, Fusion=213292 Mw, Duration=30/90days

**Loco:** 1800/3600, Maneuver=1Gs, 2700/5400, Jump=2,  
NOE=150, Cruise=900kph, Top=1200kph,  
Agility=0

**Commo:** RadioComm Planetary-11x2, RadioComm FarOrbit-11x2, RadioComm System-11x2,  
LaserComm Planet-11x2, LaserComm FarOrbit-11x2, LaserComm System-11x2,  
MaserComm Planet-11x2, MaserComm FarOrbit-11x2, MaserComm System-11x2

**Sensors:** EMM Packagex1,  
EMS-A-11 FarOrbitx2,  
EMS-P-11 SubStellarx2,  
Jam EMS-A-11 Planetaryx2,  
Neutrino (1000 Mw) Sensor-11x2,  
HiPen Densit-0.001x2,  
ActObjScan=Routine, ActObjPin=Routine,  
PasObjScan=Formidable, PasObjPin=Formidable,  
PasEngScan=Routine, PasEngPin=Formidable

**Off:** Missiles=x72

Batt. 10/50

Bear. 7/35

**Def:** DefDM=3,

Sandcasters=xx4

Batt. 50

Bear. 35

**Control:** Computer=Model/5fibx3,

Panel=CP-DynamicLinkedx1300, Special=HeadsUpDisplayx1300,

Environ=Basic Environment, Basic Life Support, Extended Life Support, Grav Plates

**Accom:** Crew=1293 (12x100)

(Bridge=2, Engineering=101, Maintenance=-1,

Gunners=47, Flight Crew=47, Ship's Troops=100,

Command=175, Stewards=42, Frozen Watch=12, Medical=10),

Additional Staterooms=200,

LowBerths=12 (FrozenWatch)+0 (Medical), EmergencyLowBerths=0,

SubCraft=50-ton craftx400, 10000-ton craftx1,

Magazines=20 50-ton magazines (900 battery-rounds)

**Other:** Cargo=28595 tons (386045 kliters),

Fuel=20687 tons (279285 kliters), Fuel Purification Plant (purifies total fuel tankage in 12 hours),

ObjSize=Large,

EmLevel=Moderate

Battery Round=150 missiles,

Electronic Circuit Protection

**Comments:** Triple Turret Missile (150/3),

Triple Turret Sand (150/3),

50-ton Missile Bay-7x10



# TV-12 TANKER VEHICLE

**CraftID:** Tanker Vehicle, Type TV, TL=B (Average Stellar), MCr1178  
**Hull:** 9000/22500, Disp=10000, Config=3SL, Armor=40E,  
Unloaded=50692, Loaded=50871  
**Power:** 78/156, Fusion=21297 Mw, Duration=10/30days  
**Loco:** 180/360, Maneuver=1Gs, 0/0, Jump=0,  
NOE=150, Cruise=900kph, Top=1200kph,  
Agility=0  
**Commo:** RadioComm FarOrbit-11x2,  
LaserComm FarOrbit-11x2  
**Sensors:** EMS-P-11 Interplanetaryx2,  
Neutrino (1000 Mw) Sensor-11x2,  
HiPen Densit-0.001x2,  
ActObjScan=Impossible (No Active EMS), ActObjPin=Impossible (No Active EMS),  
PasObjScan=Formidable, PasObjPin=Formidable,  
PasEngScan=Routine, PasEngPin=Formidable  
**Def:** DefDM=4  
**Control:** Computer=Model/5fibx3,  
Panel=CP-DynamicLinkedx7, Special=HeadsUpDisplayx7,  
Environ=Basic Environment, Basic Life Support, Extended Life Support, Grav Plates  
**Accom:** Crew=13 (1x10)  
(Bridge=2, Engineering=3, Maintenance=4,  
Gunners=0, Flight Crew=0, Ship's Troops=0,  
Command=1, Stewards=0, Frozen Watch=0, Medical=1),  
Additional Staterooms=0,  
LowBerths=0 (FrozenWatch)+0 (Medical), EmergencyLowBerths=0,  
SubCraft=20-ton craftx1,  
Magazines=None  
**Other:** Cargo=8782 tons (118,569 kliters),  
Fuel=189 tons (2555 kliters), Fuel Purification Plant (purifies total fuel tankage in 60 hours),  
ObjSize=Large, Fuel Scoops (fills tanks in five hours),  
EmLevel=Moderate,  
Electronic Circuit Protection

# VF-12 CARRIER FLEET

**CraftID:** Carrier Fleet, Type VF, TL=C (Average Stellar), MCr21,767

**Hull:** 90000/225000, Disp=100000, Config=7, Armor=46F,  
Unloaded=712254, Loaded=737097

**Power:** 1567/3134, Fusion=423307 Mw, Duration=30/90days

**Loco:** 4500/9000, Maneuver=2Gs, 2700/5400, Jump=2,  
NOE=160, Cruise=1590kph, Top=2120kph,  
Agility=0

**Commo:** RadioComm Planetary-12x2, RadioComm FarOrbit-12x2, RadioComm System-12x2,  
LaserComm Planet-12x2, LaserComm FarOrbit-12x2, LaserComm System-12x2,  
MaserComm Planet-12x2, MaserComm FarOrbit-12x2, MaserComm System-12x2

**Sensors:** EMM Packagex1,  
EMS-A-12 FarOrbitx2,  
EMS-P-12 SubStellarx2,  
Jam EMS-A-12 Planetaryx2,  
Neutrino (1 Mw) Sensor-12x2,  
HiPen Densit-0.05x2,  
ActObjScan=Routine, ActObjPin=Routine,  
PasObjScan=Difficult, PasObjPin=Difficult,  
PasEngScan=Routine, PasEngPin=Formidable

**Off:** Missiles=xx2

Batt. 50

Bear. 35

**Def:** DefDM=4,

Sandcasters=xx4

Batt. 50

Bear. 35

**Control:** Computer=Model/6fibx3,  
Panel=CP-DynamicLinkedx380, Special=LgHoloDisplayx380,  
Environ=Basic Environment, Basic Life Support, Extended Life Support, Grav Plates

**Accom:** Crew=1457 (14x100)  
(Bridge=26, Engineering=115, Maintenance=12,  
Gunners=40, Flight Crew=40, Ship's Troops=0,  
Command=199, Stewards=48, Frozen Watch=0, Medical=12),  
Additional Staterooms=200  
LowBerths=0 (FrozenWatch)+0 (Medical), EmergencyLowBerths=0,  
SubCraft=40-ton craftx500, 10000-ton craftx1,  
Magazines=20 50-ton magazines (900 battery-rounds)

**Other:** Cargo=12,759 tons (172,254 kliters),  
Fuel=26,288 tons (354,890 kliters), Fuel Purification Plant (purifies total fuel tankage in 12 hours),  
ObjSize=Large,  
EmLevel=Moderate,  
Battery Round=150 missiles,  
Electronic Circuit Protection

**Comments:** Triple Turret Missile (150/3),  
Triple Turret Sand (150/3)

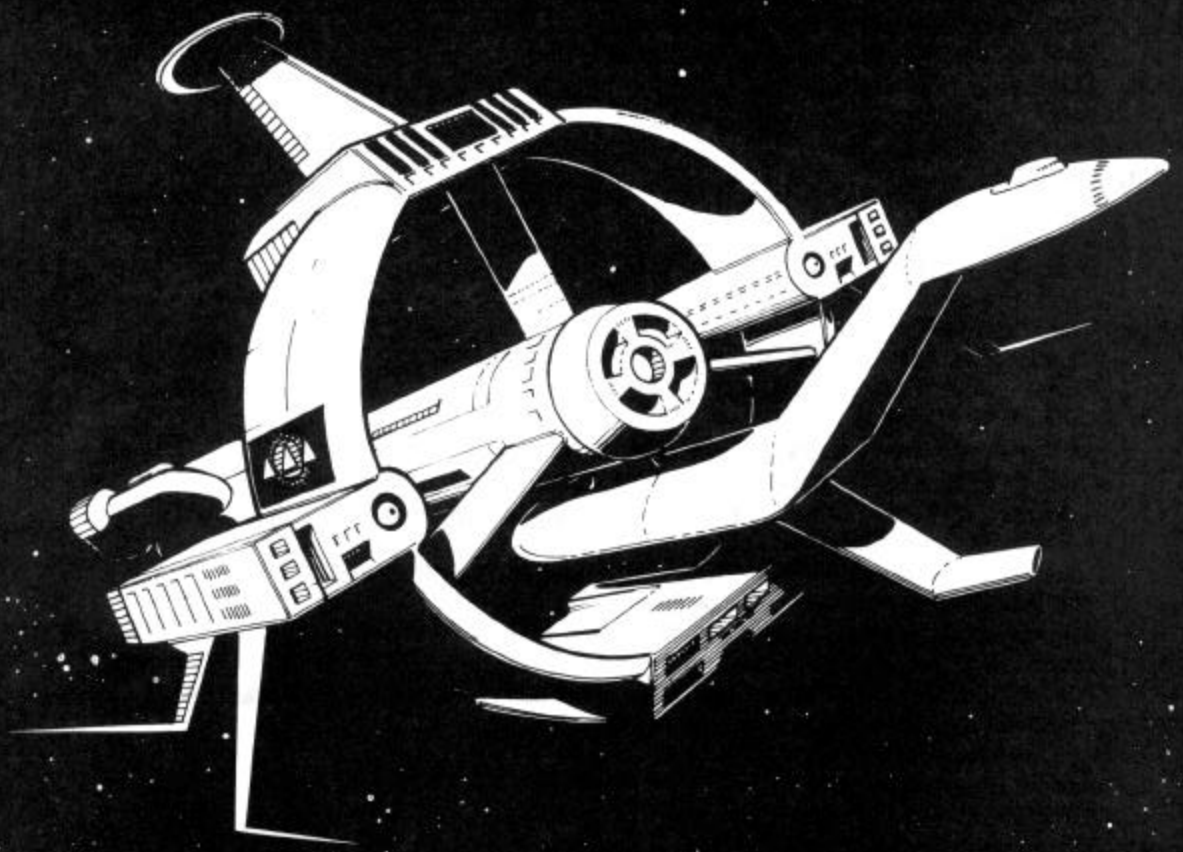

VF-12

13

# VS-13 CARRIER STRIKE

**CraftID:** Carrier Strike, Type VS, TL=D (Average Stellar), MCr27,564

**Hull:** 90000/225000, Disp=100000, Config=3SL, Armor=46F,  
Unloaded=664408, Loaded=695495

**Power:** 1096/2192, Fusion=296102 Mw, Duration=30/90days

**Loco:** 1800/3600, Maneuver=1Gs, 4500/9000, Jump=4,  
NOE=170, Cruise=900kph, Top=1200kph,  
Agility=0

**Commo:** RadioComm Planetary-13x3, RadioComm FarOrbit-13x3, RadioComm System-13x3,  
LaserComm Planet-13x3, LaserComm FarOrbit-13x3, LaserComm System-13x3,  
MaserComm Planet-13x3, MaserComm FarOrbit-13x3, MaserComm System-13x3

**Sensors:** EMM Packagex1,  
EMS-A-13 FarOrbitx2, EMS-A-13 Planetaryx2,  
EMS-P-13 Interplanetaryx2, EMS-P-13 SubStellarx2, EMS-P-13 Interstellarx2,  
Jam EMS-A-13 FarOrbitx2, Jam EMS-A-13 Planetaryx2,  
Neutrino (0.1 Mw) Sensor-13x2,  
HiPen Densit-0.1x2,  
ActObjScan=Difficult, ActObjPin=Difficult,  
PasObjScan=Difficult, PasObjPin=Difficult,  
PasEngScan=Routine, PasEngPin=Difficult

**Off:** Missiles=xx4, BeamLaser=xx4

Batt. 50 Batt. 100

Bear. 35 Bear. 70

**Def:** DefDM=5,

NucDamper-3,

Sandcasters=xx4

Batt. 100

Bear. 70

**Control:** Computer=Model/7fibx3,

Panel=CP-HoloLinkedx456, Special=HeadsUpHoloDisplayx456,

Environ=Basic Environment, Basic Life Support, Extended Life Support, Grav Plates

**Accom:** Crew=1828 (18x100)

(Bridge=2, Engineering=99, Maintenance=22,

Gunners=129, Flight Crew=129, Ship's Troops=0,

Command=250, Stewards=61, Frozen Watch=0, Medical=15),

Additional Staterooms=100,

LowBerths=0 (FrozenWatch)+0 (Medical), EmergencyLowBerths=0,

SubCraft=30-ton craftx600, 100-ton craftx10,

Magazines=40 50-ton magazines (900 battery-rounds)

**Other:** Cargo=18,175 tons (245,370 kliters),

Fuel=32,896 tons (444,096 kliters), Fuel Purification Plant (purifies total fuel tankage in 12 hours),

ObjSize=Large, Fuel Scoops (fills tanks in five hours),

EmLevel=Moderate,

Battery Round= 300 missiles,

Electronic Circuit Protection

**Comments:** Triple Turret Missile (300/3),

Triple Turret BLaser (300/3),

Triple Turret Sand (300/3)

# VS-14 CARRIER STRIKE

**CraftID:** Carrier Strike, Type VS, TL=E (High Stellar), MCr27,457

**Hull:** 90000/225000, Disp=100000, Config=3SL, Armor=46G,  
Unloaded=537502, Loaded=568399

**Power:** 1068/2136, Fusion=288598 Mw, Duration=30/90days

**Loco:** 1800/3600, Maneuver=1Gs, 4500/9000, Jump=4,  
NOE=180, Cruise=900kph, Top=1200kph,  
Agility=0

**Commo:** RadioComm Planetary-14x3, RadioComm FarOrbit-14x3, RadioComm System-14x3,  
LaserComm Planet-14x3, LaserComm FarOrbit-14x3, LaserComm System-14x3,  
MaserComm Planet-14x3, MaserComm FarOrbit-14x3, MaserComm System-14x3

**Sensors:** EMM Packagex1,  
EMS-A-14 FarOrbitx2, EMS-A-14 Planetaryx2,  
EMS-P-14 Interplanetaryx2, EMS-P-14 SubStellarx2, EMS-P-14 Interstellarx2,  
Jam EMS-A-14 FarOrbitx2, Jam EMS-A-14 Planetaryx2,  
Neutrino (0.01 Mw) Sensor-14x2,  
HiPen Densit-0.25x2,  
ActObjScan=Difficult, ActObjPin=Difficult,  
PasObjScan=Routine, PasObjPin=Routine,  
PasEngScan=Simple, PasEngPin=Routine

**Off:** Missiles=xx4, BeamLaser=xx4

Batt.	50	Batt.	100
Bear.	35	Bear.	70

**Def:** DefDM=6,  
Sandcasters=xx4  
Batt. 100  
Bear. 70

**Control:** Computer=Model/8fibx3,  
Panel=CP-HoloLinkedx380, Special=HeadsUpHoloDisplayx380,  
Environ=Basic Environment, Basic Life Support, Extended Life Support, Grav Plates

**Accom:** Crew=1739 (17x100)  
(Bridge=2, Engineering=73, Maintenance=16,  
Gunners=88, Flight Crew=88, Ship's Troops=0,  
Command=238, Stewards=58, Frozen Watch=0, Medical=14),  
LowBerths=0 (FrozenWatch)+0 (Medical), EmergencyLowBerths=0,  
SubCraft=30-ton craftx600, 100-ton craftx10,  
Magazines=40 50-ton magazines (900 battery-rounds)

**Other:** Cargo=18727 tons (252825 kliters),  
Fuel=32695 tons (441395 kliters), Fuel Purification Plant (purifies total fuel tankage in 12 hours),  
ObjSize=Large, Fuel Scoops (fills tanks in five hours),  
EmLevel=Moderate,  
Battery Round=300 missiles,  
Electronic Circuit Protection

**Comments:** Triple Turret Missile (300/3),  
Triple Turret BLaser (300/3),  
Triple Turret Sand (300/3)

# VS-15 CARRIER STRIKE

**CraftID:** Carrier Strike, Type VS, TL=F (High Stellar), MCr35,898  
**Hull:** 90000/225000, Disp=100000, Config=3SL, Armor=49G,  
Unloaded=638897, Loaded=679820,  
**Power:** 1153/2306, Fusion=311426 Mw, Duration=30/90days  
**Loco:** 1800/3600, Maneuver=1Gs, 6300/12600, Jump=6,  
NOE=190, Cruise=900kph, Top=1200kph,  
Agility=0  
**Commo:** RadioComm Planetary-15x3, RadioComm FarOrbit-15x3, RadioComm System-15x3,  
LaserComm Planet-15x3, LaserComm FarOrbit-15x3, LaserComm System-15x3,  
MaserComm Planet-15x3, MaserComm FarOrbit-15x3, MaserComm System-15x3  
**Sensors:** EMM Packagex1,  
EMS-A-15 FarOrbitx2, EMS-A-15 Planetaryx2,  
EMS-P-15 Interplanetaryx2, EMS-P-15 SubStellarx2, EMS-P-15 Interstellarx2,  
Jam EMS-A-15 FarOrbitx2, Jam EMS-A-15 Planetaryx2,  
Neutrino (0.01 Mw) Sensor-14x2,  
HiPen Densit-1x2,  
ActObjScan=Difficult, ActObjPin=Difficult,  
PasObjScan=Routine, PasObjPin=Routine,  
PasEngScan=Simple, PasEngPin=Routine  
**Off:** Missiles=xx4, BeamLaser=xx4  
Batt. 50 Batt. 100  
Bear. 35 Bear. 70  
**Def:** DefDM=7,  
NucDamper-9,  
Sandcasters=xx4  
Batt. 100  
Bear. 70  
**Control:** Computer=Model/9fibx3,  
Panel=CP-HoloLinkedx481, Special=HeadsUpHoloDisplayx481,  
Environ=Basic Environment, Basic Life Support, Extended Life Support, Grav Plates  
**Accom:** Crew=1852 (18x100)  
(Bridge=2, Engineering=81, Maintenance=18,  
Gunners=171, Flight Crew=171, Ship's Troops=0,  
Command=253, Stewards=62, Frozen Watch=0, Medical=15),  
Additional Staterooms=100,  
LowBerths=0 (FrozenWatch)+0 (Medical), EmergencyLowBerths=0,  
SubCraft=30-ton craftx600, 100-ton craftx10,  
Magazines=10 50-ton magazines (187 battery-rounds)  
**Other:** Cargo=4259 tons (57,509 kliters),  
Fuel=43,304 tons (584,613 kliters), Fuel Purification Plant (purifies total fuel tankage in 12 hours),  
ObjSize=Large, Fuel Scoops (fills tanks in five hours),  
EmLevel=Moderate,  
Battery Round=360 missiles,  
Electronic Circuit Protection  
**Comments:** 50-ton Bay Missile-9x60,  
Triple Turret Missile (300/3),  
Triple Turret BLaser (300/3),  
Triple Turret Sand (300/3)

# VL-15 CARRIER LIGHT

**CraftID:** Carrier Light, Type VL, TL=F (High Stellar), MCr3152  
**Hull:** 9000/22500, Disp=10000, Config=4SL, Armor=40G,  
Unloaded=54878, Loaded=58360  
**Power:** 164/328, Fusion=44394.25071673 Mw, Duration=30/90days  
**Loco:** 180/360, Maneuver=1Gs, 450/900, Jump=4,  
NOE=190, Cruise=900kph, Top=1200kph,  
Agility=0  
**Commo:** RadioComm Planetary-15x3, RadioComm FarOrbit-15x3, RadioComm System-15x3,  
LaserComm Planet-15x3, LaserComm FarOrbit-15x3, LaserComm System-15x3,  
MaserComm Planet-15x3, MaserComm FarOrbit-15x3, MaserComm System-15x3  
**Sensors:** EMS-A-15 FarOrbitx2,  
EMS-P-15 SubStellarx2,  
Jam EMS-A-15 Planetaryx2,  
Neutrino (0.01 Mw) Sensor-14x2,  
HiPen Densit-1x2,  
ActObjScan=Routine, ActObjPin=Routine,  
PasObjScan=Routine, PasObjPin=Routine,  
PasEngScan=Routine, PasEngPin=Routine,  
**Off:** Missiles=xx3, BeamLaser=xx4  
Batt. 30 Batt. 30  
Bear. 30 Bear. 30  
**Def:** DefDM=8,  
OptiNucDamper-1  
**Control:** Computer=Model/9fibx3,  
Panel=CP-HoloLinkedx22, Special=HeadsUpHoloDisplayx22,  
Environ=Basic Environment, Basic Life Support, Extended Life Support, Grav Plates  
**Accom:** Crew=302 (30x10)  
(Bridge=2, Engineering=7, Maintenance=1,  
Gunners=24, Flight Crew=24, Ship's Troops=0,  
Command=41, Stewards=10, Frozen Watch=0, Medical=2),  
Additional Staterooms=30,  
LowBerths=0 (FrozenWatch)+0 (Medical), EmergencyLowBerths=30,  
SubCraft=20-ton craftx100, 100-ton craftx3,  
Magazines=4 50-ton magazines (300 battery-rounds)  
**Other:** Cargo=622 tons (8397 kliters),  
Fuel=3683 tons (49,731 kliters), Fuel Purification Plant (purifies total fuel tankage in 12 hours),  
ObjSize=Large, Fuel Scoops (fills tanks in five hours),  
EmLevel=Moderate,  
Battery Round=90 missiles,  
Electronic Circuit Protection  
**Comments:** Triple Turret Missile (90/3),  
Triple Turret BLaser (90/3)

# VP-15 CARRIER PROVINCIAL

**CraftID:** Carrier Provincial, Type VP, TL=F (High Stellar), MCr8252

**Hull:** 27000/67500, Disp=30000, Config=4SL, Armor=40G,  
Unloaded=163588, Loaded=174194

**Power:** 517/1034, Fusion=139615 Mw, Duration=30/90days

**Loco:** 540/1080, Maneuver=1Gs, 1350/2700, Jump=4,  
NOE=190, Cruise=900kph, Top=1200kph,  
Agility=0

**Commo:** RadioComm Planetary-15x3, RadioComm FarOrbit-15x3, RadioComm System-15x3,  
LaserComm Planet-15x3, LaserComm FarOrbit-15x3, LaserComm System-15x3,  
MaserComm Planet-15x3, MaserComm FarOrbit-15x3, MaserComm System-15x3

**Sensors:** EMS-A-15 FarOrbitx3,  
EMS-P-15 SubStellarx3,  
Jam EMS-A-15 Planetaryx3,  
Neutrino (0.01 Mw) Sensor-14x3,  
HiPen Densit-1x3,  
ActObjScan=Routine, ActObjPin=Routine,  
PasObjScan=Routine, PasObjPin=Routine,  
PasEngScan=Routine, PasEngPin=Routine

**Off:** BeamLaser=xx6  
Batt. 30  
Bear. 27

**Def:** DefDM=8,  
OptiNucDamper-1,  
Sandcasters=xx4  
Batt. 60  
Bear. 54

**Control:** Computer=Model/9fibx3,  
Panel=CP-HoloLinkedx101, Special=HeadsUpHoloDisplayx101,  
Environ=Basic Environment, Basic Life Support, Extended Life Support, Grav Plates

**Accom:** Crew=968 (32x30)  
(Bridge=2, Engineering=21, Maintenance=1,  
Gunners=47, Flight Crew=47, Ship's Troops=0,  
Command=132, Stewards=32, Frozen Watch=0, Medical=8),  
Additional Staterooms=30,  
LowBerths=0 (FrozenWatch)+0 (Medical), EmergencyLowBerths=100,  
SubCraft=20-ton craftx350, 100-ton craftx5

**Other:** Cargo=999 tons (13491 kliters),  
Fuel=11223 tons (151511 kliters), Fuel Purification Plant (purifies total fuel tankage in 6 hours),  
ObjSize=Large, Fuel Scoops (fills tanks in five hours),  
EmLevel=Strong,  
Battery Round=0 missiles,  
Electronic Circuit Protection

**Comments:** Triple Turret BLaser (300/3),  
Triple Turret Sand (180/3)



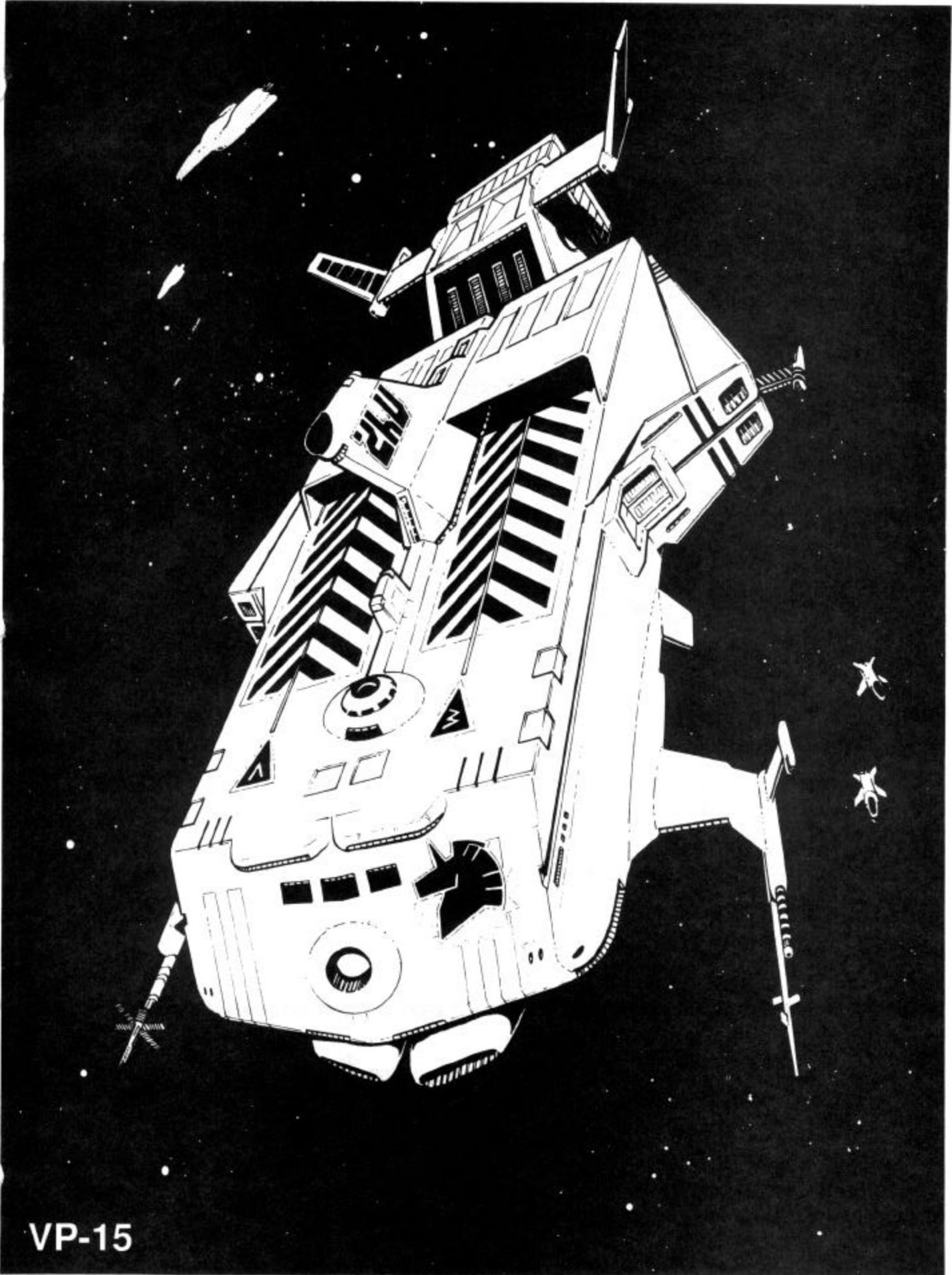

VP-15

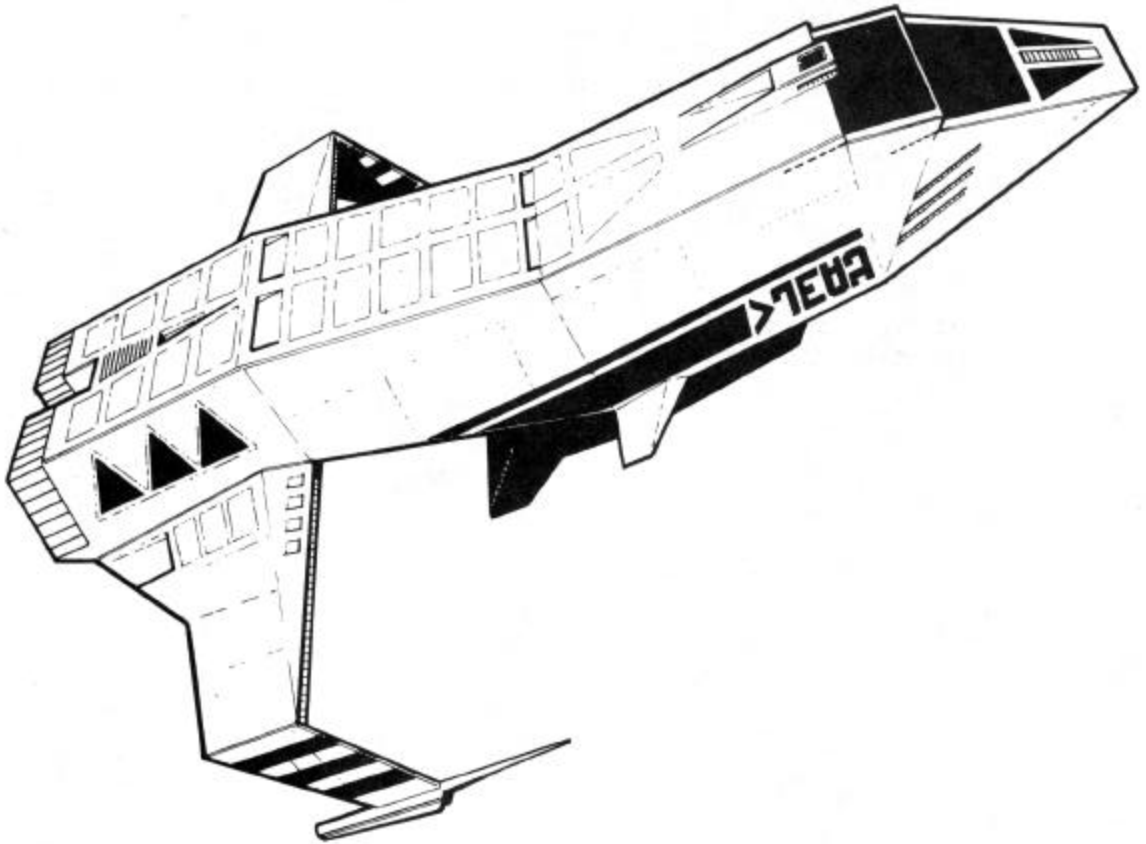

The mainstay of the escort fleet is the ED series. These escort destroyers are typical of Imperial needs. The ED-13, derived from the ED-12, was relatively unsuccessful, and the naval architects returned to the ED-12 for inspiration for the later ED-14.

The EF-12 served as the design basis for two divergent ship types: the escort fleet (and later escort strike designs) and the escort missile EM-13/-15.

---

# Escorts

---

Escorts are vessels intended to protect and assist larger vessels. They are capable of independent action, but are usually assigned to support battleships and cruisers.

# Imperial Escorts

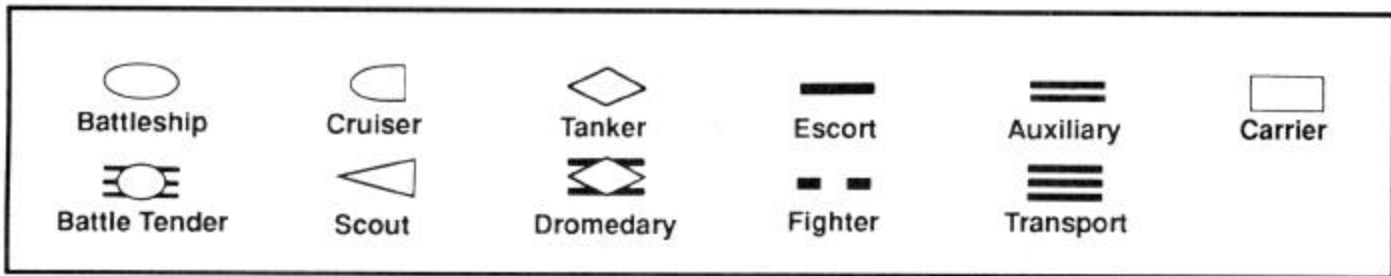
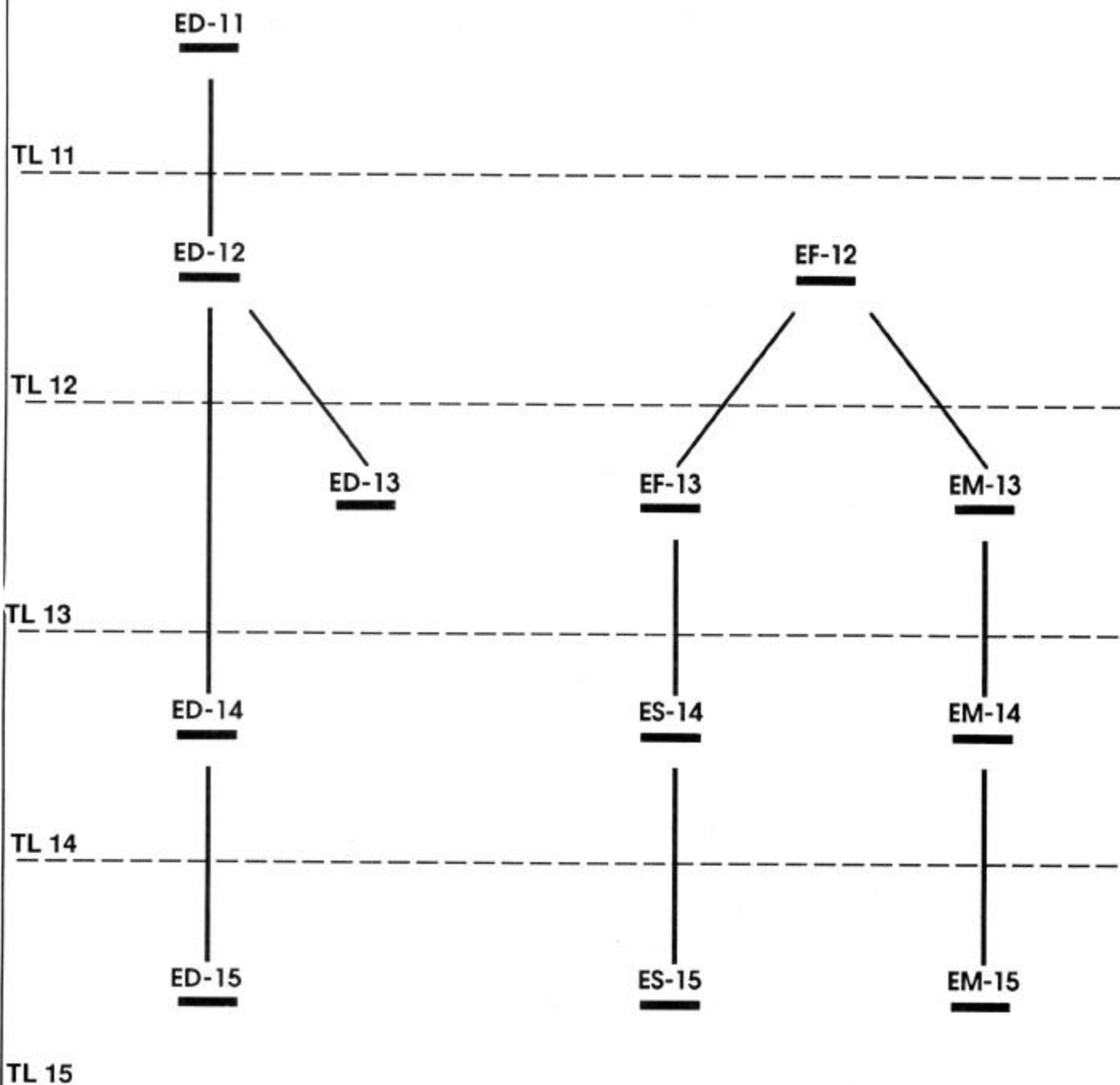

# ED-11 ESCORT DESTROYER

**CraftID:** Escort Destroyer, Type ED, TL=B (Average Stellar), MCr7651

**Hull:** 9000/22500, Disp=10000, Config=1SL, Armor=60E,  
Unloaded=262304, Loaded=267618

**Power:** 687/1374, Fusion=185536 Mw, Duration=25/75days

**Loco:** 990/1980, Maneuver=4Gs, 270/540, Jump=2,  
NOE=150, Cruise=2550kph, Top=3400kph,  
Agility=1

**Commo:** RadioComm FarOrbit-11x2,  
LaserComm Planet-11x2,  
MaserComm FarOrbit-11x2

**Sensors:** EMM Packagex1,  
EMS-A-11 FarOrbitx2,  
EMS-P-11 SubStellarx2,  
Jam EMS-A-11 Planetaryx2,  
Neutrino (1000 Mw) Sensor-11x2,  
HiPen Densit-0.001x2,  
ActObjScan=Routine, ActObjPin=Routine,  
PasObjScan=Formidable, PasObjPin=Formidable,  
PasEngScan=Routine, PasEngPin=Formidable

**Off:** ParticleAccel=070

Batt. 2

Bear. 2

Missiles=xx2, BeamLaser=xx6

Batt. 45 Batt. 6

Bear. 45 Bear. 6

**Def:** DefDM=5,

Sandcasters=xx5

Batt. 5

Bear. 5

**Control:** Computer=Model/5fibx3,  
Panel=CP-DynamicLinkedx473, Special=HeadsUpDisplayx473,  
Environ=Basic Environment, Basic Life Support, Extended Life Support, Grav Plates

**Accom:** Crew=172 (17x10)  
(Bridge=2, Engineering=30, Maintenance=24,  
Gunners=73, Flight Crew=73, Ship's Troops=10,  
Command=23, Stewards=5, Frozen Watch=0, Medical=1),  
Additional Staterooms=0,  
LowBerths=0 (FrozenWatch)+0 (Medical), EmergencyLowBerths=0,  
SubCraft=50-ton craftx2,  
Magazines=1 50-ton magazines (75 battery-rounds)

**Other:** Cargo=204 tons (2759 kliters), 300,000 tons is fuel tankage for distribution,  
Fuel=5623 tons (75,911 kliters), Fuel Purification Plant (purifies self fuel tankage in six hours),  
ObjSize Large, Fuel Scoops (fills tanks in five hours),  
EmLevel=Moderate,  
Battery Round=90 missiles,  
Electronic Circuit Protection

**Comments:** 100-ton Bay ParticleAccelerator-7x2,  
Triple Turret Missile (90/3),  
Triple Turret BLaser (90/3),  
Triple Turret Sand (30/3)

# ED-12 ESCORT DESTROYER

**CraftID:** Escort Destroyer, Type ED, TL=C (Average Stellar), MCr7599

**Hull:** 9000/22500, Disp=10000, Config=1SL, Armor=60F,  
Unloaded=235384, Loaded=240763

**Power:** 668/1336, Fusion=180540 Mw, Duration=23/69days

**Loco:** 990/1980, Maneuver=4Gs, 360/720, Jump=3,  
NOE=160, Cruise=2550kph, Top=3400kph,  
Agility=1

**Commo:** RadioComm FarOrbit-12x2,  
LaserComm Planet-12x2,  
MaserComm FarOrbit-12x2

**Sensors:** EMM Packagex1,  
EMS-A-12 FarOrbitx2,  
EMS-P-12 SubStellarx2,  
Jam EMS-A-12 Planetaryx2,  
Neutrino (1 Mw) Sensor-12x2,  
HiPen Densit-0.05x2,  
ActObjScan=Routine, ActObjPin=Routine,  
PasObjScan=Difficult, PasObjPin=Difficult,  
PasEngScan=Routine, PasEngPin=Formidable

**Off:** ParticleAccel=080

Batt. 2

Bear. 2

Missiles=xx2, BeamLaser=xx6

Batt. 45 Batt. 6

Bear. 45 Bear. 6

**Def:** DefDM=6,

Sandcasters=xx5

Batt. 5

Bear. 5

**Control:** Computer=Model/6fibx3,  
Panel=CP-DynamicLinkedx14, Special=LgHoloDisplayx14,  
Environ=Basic Environment, Basic Life Support, Extended Life Support, Grav Plates

**Accom:** Crew=148 (14x10)  
(Bridge=2, Engineering=27, Maintenance=18,  
Gunners=62, Flight Crew=62, Ship's Troops=10,  
Command=20, Stewards=4, Frozen Watch=0, Medical=1),  
Additional Staterooms=0,  
LowBerths=0 (FrozenWatch)+0 (Medical), EmergencyLowBerths=0,  
SubCraft=50-ton craftx2,  
Magazines=1 50-ton magazines (75 battery-rounds)

**Other:** Cargo=124 tons (1682 kliters), 300,000 tons is fuel tankage for distribution,  
Fuel=5691 tons (76,829 kliters), Fuel Purification Plant (purifies self fuel tankage in six hours),  
ObjSize=Large, Fuel Scoops (fills tanks in five hours),  
EmLevel=Moderate,  
Battery Round=90 missiles,  
Electronic Circuit Protection

**Comments:** 100-ton Bay ParticleAccelerator-8x2,  
Triple Turret Missile (90/3),  
Triple Turret BLaser (90/3),  
Triple Turret Sand (30/3)

# ED-13 ESCORT DESTROYER

**CraftID:** Escort Destroyer, Type ED, TL=D (Average Stellar), MCr7742

**Hull:** 9000/22500, Disp=10000, Config=1SL, Armor=60F,  
Unloaded=235693, Loaded=241254

**Power:** 613/1226, Fusion=165598 Mw, Duration=23/69days

**Loco:** 990/1980, Maneuver=4Gs, 450/900, Jump=4,  
NOE=170, Cruise=2550kph, Top=3400kph,  
Agility=1

**Commo:** RadioComm FarOrbit-13x2,  
LaserComm Planet-13x2,  
MaserComm FarOrbit-13x2

**Sensors:** EMM Packagex1,  
EMS-A-13 FarOrbitx2,  
EMS-P-13 Interplanetaryx2,  
Jam EMS-A-13 FarOrbitx2,  
Neutrino (0.1 Mw) Sensor-13x2,  
HiPen Densit-0.1x2,  
ActObjScan=Routine, ActObjPin=Routine,  
PasObjScan=Difficult, PasObjPin=Difficult,  
PasEngScan=Routine, PasEngPin=Difficult

**Off:** ParticleAccel=080

Batt. 1

Bear. 1

Missiles=xx4, BeamLaser=xx7

Batt. 20 Batt. 6

Bear. 20 Bear. 6

**Def:** DefDM=7

**Control:** Computer=Model/7fibx3,  
Panel=CP-HoloLinkedx76, Special=HeadsUpHoloDisplayx76,  
Environ=Basic Environment, Basic Life Support, Extended Life Support, Grav Plates

**Accom:** Crew=107 (10x10)  
(Bridge=2, Engineering=21, Maintenance=15,  
Gunners=47, Flight Crew=47, Ship's Troops=0,  
Command=14, Stewards=3, Frozen Watch=0, Medical=1),  
Additional Staterooms=3,  
LowBerths=0 (FrozenWatch)+0 (Medical), EmergencyLowBerths=0,  
SubCraft=40-ton craftx2,  
Magazines=1 50-ton magazines (55 battery-rounds)

**Other:** Cargo=3 tons (42 kliters), 300,000 tons is fuel tankage for distribution,  
Fuel=5885 tons (79455 kliters), Fuel Purification Plant (purifies self fuel tankage in six hours),  
ObjSize=Large, Fuel Scoops (fills tanks in five hours),  
EmLevel=Moderate,  
Battery Round=121 missiles,  
Electronic Circuit Protection

**Comments:** 100-ton Bay ParticleAccelerator-8x1,  
100-ton Bay Missile-9x1,  
Triple Turret Missile (120/3),  
Triple Turret BLaser (90/3)

# ED-14 ESCORT DESTROYER

**CraftID:** Escort Destroyer, Type ED, TL=E (High Stellar), MCr7417

**Hull:** 9000/22500, Disp=10000, Config=2SL, Armor=60G,  
Unloaded=163565, Loaded=169012

**Power:** 566/1132, Fusion=152999 Mw, Duration=24/72days

**Loco:** 990/1980, Maneuver=4Gs, 450/900, Jump=4,  
NOE=180, Cruise=2550kph, Top=3400kph,  
Agility=1

**Commo:** RadioComm FarOrbit-14x2,  
LaserComm Planet-14x2,  
MaserComm FarOrbit-14x2

**Sensors:** EMM Packagex1,  
EMS-A-14 FarOrbitx2,  
EMS-P-14 SubStellarx2,  
Jam EMS-A-14 Planetaryx2,  
Neutrino (0.01 Mw) Sensor-14x2,  
HiPen Densit-0.25x2,  
ActObjScan=Routine, ActObjPin=Routine,  
PasObjScan=Routine, PasObjPin=Routine,  
PasEngScan=Routine, PasEngPin=Routine

**Off:** ParticleAccel=090

Batt. 1

Bear. 1

Missiles=xx4, BeamLaser=xx7

Batt. 20 Batt. 6

Bear. 20 Bear. 6

**Def:** DefDM=8,

OptiNucDamper-1,

Sandcasters=xx5

Batt. 5

Bear. 5

**Control:** Computer=Model/8fibx3,  
Panel=CP-HoloLinkedx61, Special=HeadsUpHoloDisplayx61,  
Environ=Basic Environment, Basic Life Support, Extended Life Support, Grav Plates

**Accom:** Crew=124 (12x10)  
(Bridge=2, Engineering=15, Maintenance=5,  
Gunners=38, Flight Crew=38, Ship's Troops=30,  
Command=17, Stewards=4, Frozen Watch=0, Medical=1),  
Additional Staterooms=0,  
LowBerths=0 (FrozenWatch)+0 (Medical), EmergencyLowBerths=0,  
SubCraft=50-ton craftx6,  
Magazines=1 50-ton magazines (56 battery-rounds)

**Other:** Cargo=35 tons (474 kliters), 300,000 tons is fuel tankage for distribution,  
Fuel=5763 tons (77,813 kliters), Fuel Purification Plant (purifies self fuel tankage in 12 hours),  
ObjSize=Large, Fuel Scoops (fills tanks in five hours),  
EmLevel=Moderate,  
Battery Round=120 missiles,  
Electronic Circuit Protection

**Comments:** 100-ton Bay ParticleAccelerator-9x1,  
Triple Turret Missile (120/3),  
Triple Turret BLaser (90/3),  
Triple Turret Sand (30/3)

# ED-15 ESCORT DESTROYER

**CraftID:** Escort Destroyer, Type ED, TL=F (High Stellar), MCr7757

**Hull:** 9000/22500, Disp=10000, Config=2SL, Armor=60G,  
Unloaded=166674, Loaded=172229

**Power:** 670/1340, Fusion=180975 Mw, Duration=21/63days

**Loco:** 990/1980, Maneuver=4Gs, 450/900, Jump=4,  
NOE=190, Cruise=2550kph, Top=3400kph,  
Agility=1

**Commo:** RadioComm FarOrbit-15x2,  
LaserComm Planet-15x2,  
MaserComm FarOrbit-15x2,

**Sensors:** EMM Packagex1,  
EMS-A-15 FarOrbitx2,  
EMS-P-15 SubStellarx2,  
Jam EMS-A-15 Planetaryx2,  
Neutrino (0.01 Mw) Sensor-14x2,  
HiPen Densit-1x2,  
ActObjScan=Routine, ActObjPin=Routine,  
PasObjScan=Routine, PasObjPin=Routine,  
PasEngScan=Routine, PasEngPin=Routine

**Off:** ParticleAccel=090

Batt. 2

Bear. 2

Missiles=x90, BeamLaser=xx4

Batt. 4 Batt. 20

Bear. 4 Bear. 20

**Def:** DefDM=9,

MesonScreen-1,

OptiNucDamper-1,

Sandcasters=xx5

Batt. 5

Bear. 5

**Control:** Computer=Model/9x3,

Panel=CP-HoloLinkedx48, Special=HeadsUpHoloDisplayx48,

Environ=Basic Environment, Basic Life Support, Extended Life Support, Grav Plates

**Accom:** Crew=76 (7x10)

(Bridge=2, Engineering=14, Maintenance=8,

Gunners=37, Flight Crew=37, Ship's Troops=0,

Command=10, Stewards=2, Frozen Watch=0, Medical=1),

Additional Staterooms=0,

LowBerths=0 (FrozenWatch)+0 (Medical), EmergencyLowBerths=0,

SubCraft=40-ton craftx1,

Magazines=1 50-ton magazines (1687 battery-rounds)

**Other:** Cargo=12 tons (174 kliters), 300,000 tons is fuel tankage for distribution,

Fuel=5878 tons (79,355 kliters), Fuel Purification Plant (purifies self fuel tankage in 12 hours),

ObjSize=Large, Fuel Scoops (fills tanks in five hours),

EmLevel=Moderate,

Battery Round=4 missiles,

Electronic Circuit Protection

**Comments:** 100-ton Bay ParticleAccelerator-9x2,

50-ton Bay Missile-9x4,

Triple Turret BLaser (60/3),

Triple Turret Sand (30/3)





ED-15

12

# EF-12 ESCORT FLEET

**CraftID:** Escort Fleet, Type EF, TL=C (Average Stellar), MCr3059

**Hull:** 7200/18000, Disp=8000, Config=4SL, Armor=40F,  
Unloaded=75628, Loaded=79797

**Power:** 334/668, Fusion=90327 Mw, Duration=40/120days

**Loco:** 576/1152, Maneuver=3Gs, 216/432, Jump=2,  
NOE=160, Cruise=2137.5kph, Top=2850kph,  
Agility=0

**Commo:** RadioComm Planetary-12x1, RadioComm FarOrbit-12x1, RadioComm System-12x1,  
LaserComm Planet-12x1, LaserComm FarOrbit-12x1, LaserComm System-12x1,  
MaserComm Planet-12x1, MaserComm FarOrbit-12x1, MaserComm System-12x1

**Sensors:** EMM Package x1,  
EMS-A-12 FarOrbit x2, EMS-A-12 Planetary x2,  
EMS-P-12 Interstellar x2,  
Jam EMS-A-12 Planetary x2,  
Neutrino (1 Mw) Sensor-12x2,  
HiPen Densit-0.05x2,  
ActObjScan=Difficult, ActObjPin=Difficult,  
PasObjScan=Difficult, PasObjPin=Difficult,  
PasEngScan=Routine, PasEngPin=Formidable

**Off:** ParticleAccel=040

Batt. 1

Bear. 1

PlasmaGun=x60

Batt. 1

Bear. 1

Missiles=x80, BeamLaser=xx4

Batt. 3 Batt. 15

Bear. 3 Bear. 15

**Def:** DefDM=6

**Control:** Computer=Model/6x3,

Panel=CP-DynamicLinkedx157, Special=HeadsUpDisplayx157,

Environ=Basic Environment, Basic Life Support, Extended Life Support, Grav Plates, Inertial Compensators

**Accom:** Crew=162 (20x8)

(Bridge=2, Engineering=15, Maintenance=-7,

Gunners=66, Flight Crew=66, Ship's Troops=50,

Command=22, Stewards=5, Frozen Watch=0, Medical=1),

Additional Staterooms=0,

LowBerths=0 (FrozenWatch)+0 (Medical), EmergencyLowBerths=0,

SubCraft=50-ton craftx4,

Magazines=None

**Other:** Cargo=458 tons (6190 kliters),

Fuel=4411 tons (59,557 kliters), Fuel Purification Plant (purifies total fuel tankage in 12 hours),

ObjSize Large, Fuel Scoops (fills tanks in 5 hours),

EmLevel=Faint,

Battery Round=3 missiles,

Electronic Circuit Protection

**Comments:** 50-ton Bay ParticleAccelerator-4x1,

50-ton Bay PlasmaGun-6x1,

50-ton Bay Missile-8x3,

Triple Turret BLaser (90/3)

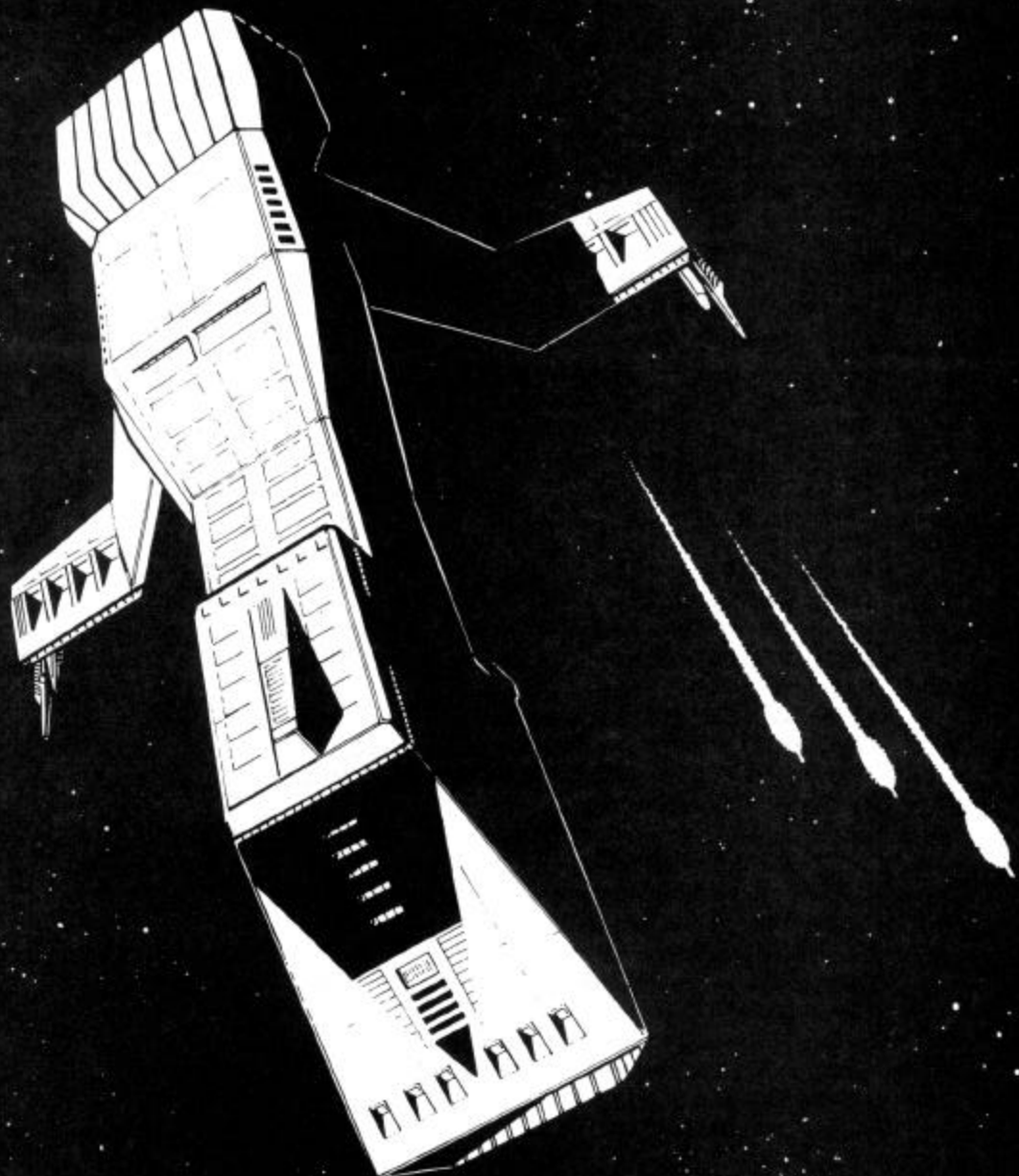

EF-12

R.

# EM-13 ESCORT MISSILE

**CraftID:** Escort Missile, Type EM, TL=D (Average Stellar), MCr1939

**Hull:** 4500/11250, Disp=5000, Config=2SL, Armor=40F,  
Unloaded=45561, Loaded=48085

**Power:** 177/354, Fusion=48023 Mw, Duration=45/135days

**Loco:** 360/720, Maneuver=3Gs, 135/270, Jump=2,  
NOE=170, Cruise=2137.5kph, Top=2850kph,  
Agility=0

**Commo:** RadioComm Planetary-13x1, RadioComm FarOrbit-13x1, RadioComm System-13x1,  
LaserComm Planet-13x1, LaserComm FarOrbit-13x1, LaserComm System-13x1,  
MaserComm Planet-13x1, MaserComm FarOrbit-13x1, MaserComm System-13x1

**Sensors:** EMM Packagex1,  
EMS-A-13 FarOrbitx2, EMS-A-13 Planetaryx2,  
EMS-P-13 Interstellarx2,  
Jam EMS-A-13 Planetaryx2,  
Neutrino (0.1 Mw) Sensor-13x2,  
HiPen Densit-0.1x2,  
ActObjScan=Difficult, ActObjPin=Difficult,  
PasObjScan=Difficult, PasObjPin=Difficult,  
PasEngScan=Routine, PasEngPin=Difficult

**Off:** Missiles=x90, BeamLaser=xx4

Batt. 3 Batt. 10

Bear. 3 Bear. 10

**Def:** DefDM=7,

NucDamper-3

**Control:** Computer=Model/7x3,  
Panel=CP-HoloLinkedx50, Special=HeadsUpHoloDisplayx50,  
Environ=Basic Environment, Basic Life Support, Extended Life Support, Grav Plates, Inertial Compensators

**Accom:** Crew=105 (21x5)  
(Bridge=2, Engineering=7, Maintenance=7,  
Gunners=27, Flight Crew=27, Ship's Troops=50,  
Command=14, Stewards=3, Frozen Watch=0, Medical=1),  
Additional Staterooms=4,  
LowBerths=0 (FrozenWatch)+0 (Medical), EmergencyLowBerths=0,  
SubCraft=50-ton craftx4,  
Magazines=1 50-ton magazines (2250 battery-rounds)

**Other:** Cargo=166 tons (2243 kliters),  
Fuel=2670 tons (36057 kliters), Fuel Purification Plant (purifies total fuel tankage in 12 hours),  
ObjSize=Large, Fuel Scoops (fills tanks in five hours),  
EmLevel=Faint,  
Battery Round=3 missiles,  
Electronic Circuit Protection

**Comments:** 100-ton Bay Missile-9x3,  
Triple Turret BLaser (30/3)

# EM-15 ESCORT MISSILE

**CraftID:** Escort Missile, Type EM, TL=F (High Stellar), MCr2207

**Hull:** 4500/11250, Disp=5000, Config=2SL, Armor=40G,  
Unloaded=40800, Loaded=43532

**Power:** 151/302, Fusion=41021 Mw, Duration=45/135days

**Loco:** 360/720, Maneuver=3Gs, 225/450, Jump=4,  
NOE=190, Cruise=2137.5kph, Top=2850kph,  
Agility=0

**Commo:** RadioComm Planetary-15x1, RadioComm FarOrbit-15x1, RadioComm System-15x1,  
LaserComm Planet-15x1, LaserComm FarOrbit-15x1, LaserComm System-15x1,  
MaserComm Planet-15x1, MaserComm FarOrbit-15x1, MaserComm System-15x1

**Sensors:** EMM Packagex1,  
EMS-A-15 FarOrbitx2, EMS-A-15 Planetaryx2,  
EMS-P-15 Interstellarx2,  
Jam EMS-A-15 Planetaryx2,  
Neutrino (0.01Mw) Sensor-14x2,  
HiPen Densit-1x2,  
ActObjScan=Difficult, ActObjPin=Difficult,  
PasObjScan=Routine, PasObjPin=Routine,  
PasEngScan=Simple, PasEngPin=Routine

**Off:** Missiles=xA0, BeamLaser=xx4

Batt. 3 Batt. 10

Bear. 3 Bear. 10

**Def:** DefDM=9,  
OptiNucDamper-1

**Control:** Computer=Model/9x3,  
Panel=CP-HoloLinkedx16, Special=HeadsUpHoloDisplayx16,  
Environ=Basic Environment, Basic Life Support, Extended Life Support, Grav Plates, Inertial Compensators

**Accom:** Crew=84 (16x5)  
(Bridge=2, Engineering=5, Maintenance=-8,  
Gunners=15, Flight Crew=15, Ship's Troops=50,  
Command=11, Stewards=2, Frozen Watch=0, Medical=1),  
Additional Staterooms=4,  
LowBerths=0 (FrozenWatch)+0 (Medical), EmergencyLowBerths=0,  
SubCraft=50-ton craftx3,  
Magazines=1 50-ton magazines (2250 battery-rounds)

**Other:** Cargo=13 tons (184 kliters),  
Fuel=2890 tons (39,026 kliters), Fuel Purification Plant (purifies total fuel tankage in 12 hours),  
ObjSize=Large, Fuel Scoops (fills tanks in five hours),  
EmLevel=Faint,  
Battery Round=3 missiles,  
Electronic Circuit Protection

**Comments:** 100-ton Bay Missile-Ax3,  
Triple Turret BLaser (30/3)

# EF-15 ESCORT FLEET

**CraftID:** Escort Fleet, Type EF, TL=F (High Stellar), MCr9215  
**Hull:** 18000/45000, Disp=20000, Config=4SL, Armor=40G, Unloaded=195092, Loaded=206487  
**Power:** 980/1960, Fusion=264695 Mw, Duration=30/90days  
**Loco:** 1980/3960, Maneuver=4Gs, 900/1800, Jump=4, NOE=190, Cruise=2550kph, Top=3400kph, Agility=0  
**Commo:** RadioComm Planetary-15x1, RadioComm FarOrbit-15x1, RadioComm System-15x1, LaserComm Planet-15x1, LaserComm FarOrbit-15x1, LaserComm System-15x1, MaserComm Planet-15x1, MaserComm FarOrbit-15x1, MaserComm System-15x1  
**Sensors:** EMM Packagex1, EMS-A-15 FarOrbitx2, EMS-A-15 Planetaryx2, EMS-P-15 Interstellarx2, Jam EMS-A-15 Planetaryx2, Neutrino (0.01 Mw) Sensor-14x2, HiPen Densit-1x2, ActObjScan=Difficult, ActObjPin=Difficult, PasObjScan=Routine, PasObjPin=Routine, PasEngScan=Simple, PasEngPin=Routine  
**Off:** Missiles=xx5, BeamLaser=xx6  
Batt. 15 Batt. 36  
Bear. 14 Bear. 34  
**Def:** DefDM=8, OptiNucDamper-1  
**Control:** Computer=Model/9x3, Panel=CP-HoloLinkedx48, Special=HeadsUpHoloDisplayx48, Environ=Basic Environment, Basic Life Support, Extended Life Support, Grav Plates, Inertial Compensators  
**Accom:** Crew=122 (6x20) (Bridge=2, Engineering=24, Maintenance=1, Gunners=66, Flight Crew=66, Ship's Troops=0, Command=16, Stewards=4, Frozen Watch=0, Medical=1), Additional Staterooms=10, LowBerths=0 (FrozenWatch)+0 (Medical), EmergencyLowBerths=0, SubCraft=50-ton craftx4, Magazines=2 50-ton magazines (75 battery-rounds)  
**Other:** Cargo=412 tons (5570 kliters), Fuel=12,058 tons (162,790 kliters), Fuel Purification Plant (purifies total fuel tankage in 12 hours), ObjSize=Large, Fuel Scoops (fills tanks in five hours), EmLevel=Moderate, Battery Round=180 missiles, Electronic Circuit Protection  
**Comments:** Triple Turret Missile (180/3), Triple Turret BLaser (360/3)

12

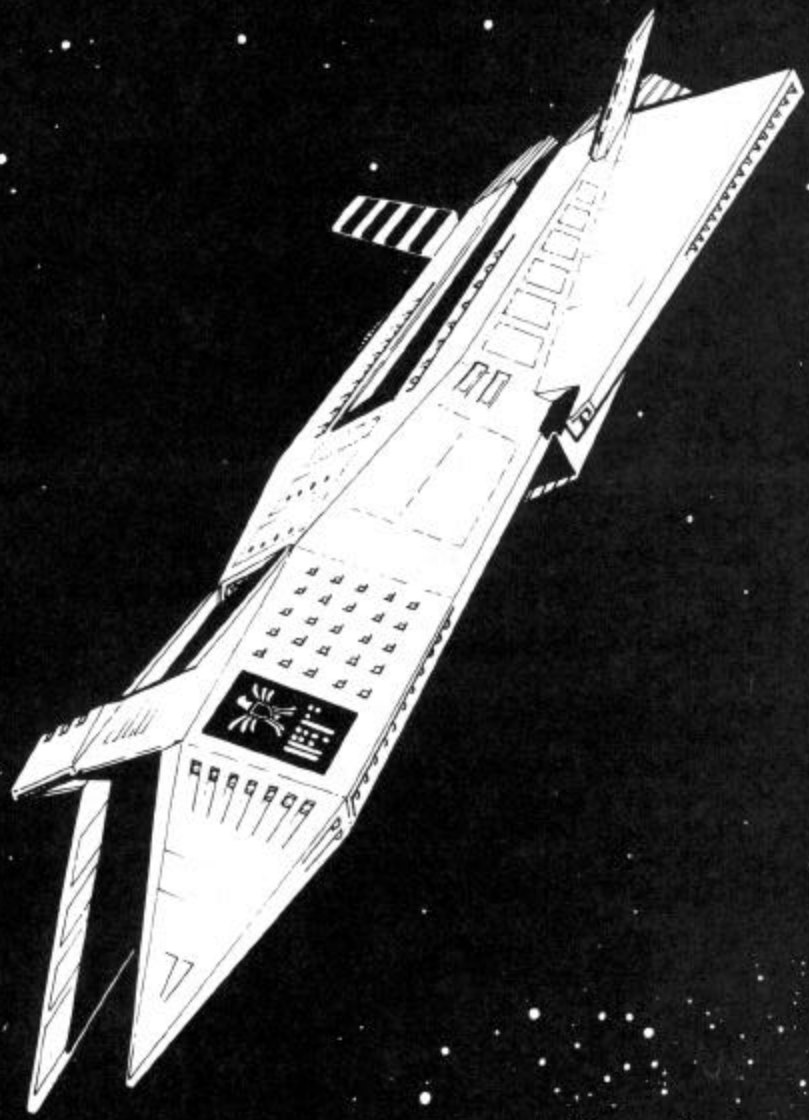

EF-15

# FS-15 STRIKE FIGHTER

**Craft ID:** Strike Fighter, Type FS, TL15, MCr 116.0584+6.121

**Hull:** 18/45, Disp=20, Config=1AF, Armor=40G,  
Unloaded=349.873 tons, Loaded=354.9324 tons

**Power:** 7/10, Fusion=1152,  
Noncombat Duration (no weapons or agility=5/15),  
Combat Duration=1/3

**Loco:** 5/8, Maneuver=6,  
NOE=190kph, Cruise=2835kph, Top=3780kph,  
Vacuum Cruise=3150kph, Vacuum Top=4200kph

**Commo:** Laser=Systemx3, Radio=Systemx3

**Sensors:** EMMask, ActiveEMS=System, PassiveEMS=System,  
Densitometer=LoPen/250km, Neutrino=10Kw,  
ActObjScan=Routine, ActObjPin=Routine,  
PasObjScan=Routine, PasObjPin=Routine,  
PasEngScan=Simple, PasEngPin=Routine

**Off:** PulseLaser=xx2, Missile=x02

Batt. 2 Batt. 1

Bear. 2 Bear. 1

**Def:** DefDM=+17

**Control:** Computer=9x3, Panel=Holodynamic Linkx21,  
Environ=Basic Environment, Basic Life Support, Extended Life Support, Grav Plates, Inertial Compensators,  
Airlock

**Accom:** Crew=2 (Pilot=1, Commander=1), small stateroom=1,  
roomy seat=2

**Other:** Cargo=3, Fuel=29.421, Fuel Scoops,  
HE battery-rounds=36

ObjSize=Average, EMLevel=Moderate (none if noncombat)

**Comments:** The standard Imperial strike fighter. This fighter is the minimum size capable of mounting thruster plates, so it is the minimum size practical for deep space combat. Its large Mod/9 computer allows it to fight on even terms with much larger vessels, and its small size and high agility make it very hard to hit. One small stateroom is provided for the crew of two, allowing for longer missions.



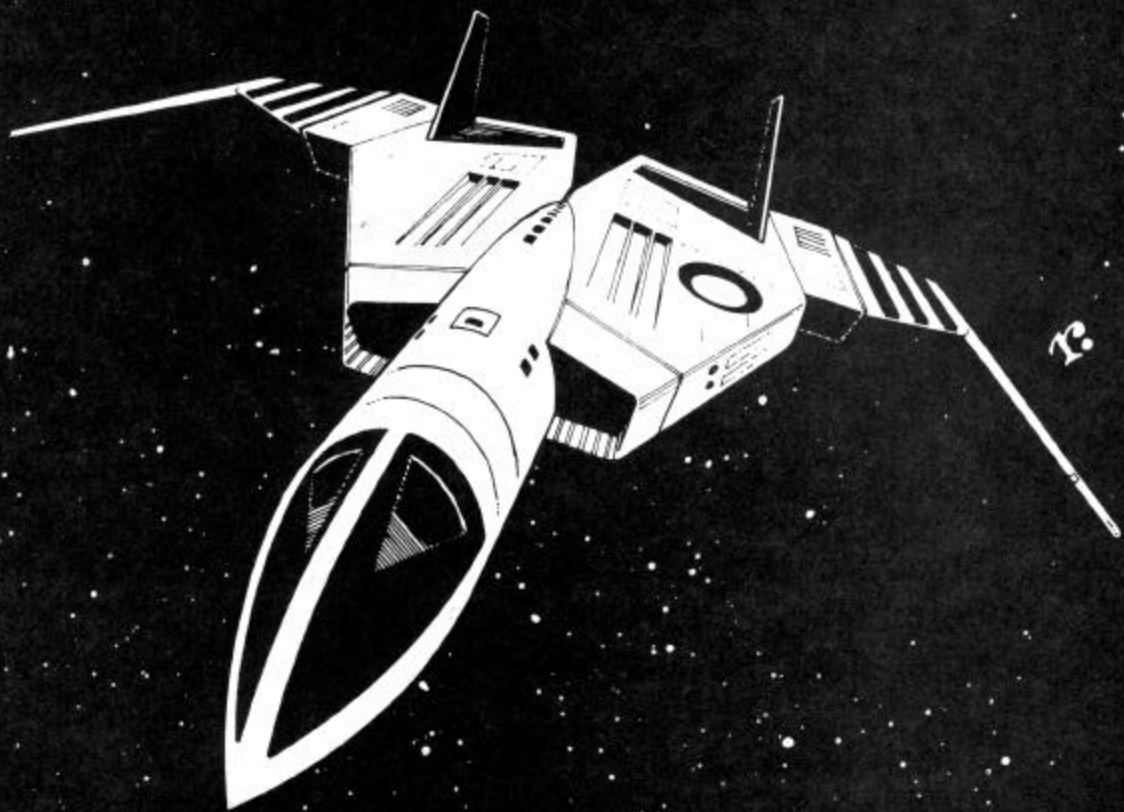

72

FS-15

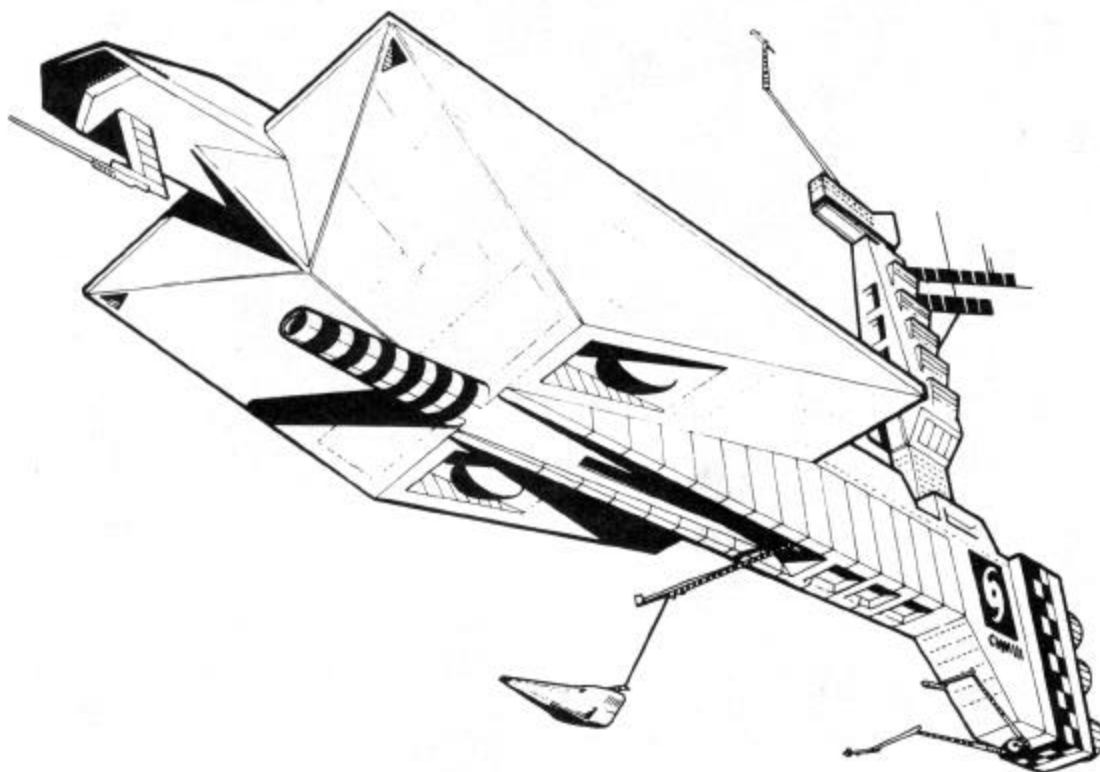

Tankers and support ships are always necessary in the Imperial Navy. Originally, the navy produced ships for two separate functions: tanker (TF-11/-12) and resupply (TM-11/-12).

At tech level 13, the TF-13 was improved to create the Dromedary TT-13, a combined tanker and resupply ship. Although the TT-14 and TT-15 were produced in prototype form, they did not show sufficient advantage over the TT-13 and have not been produced in quantity.

The TZ-15 is a special-purpose ship: the Rift tanker designed to support operations in the sparse territory of the Rifts.

---

# Auxiliaries

---

Auxiliaries are supposed to be the noncombatants of the fleet. They linger on the fringes of the battle area and resupply the fighting ships with fuel, missiles, and provisions. Many are not armed, but experience says some auxiliaries do face combat and need to be capable of at least defending themselves.

# Imperial Auxiliaries

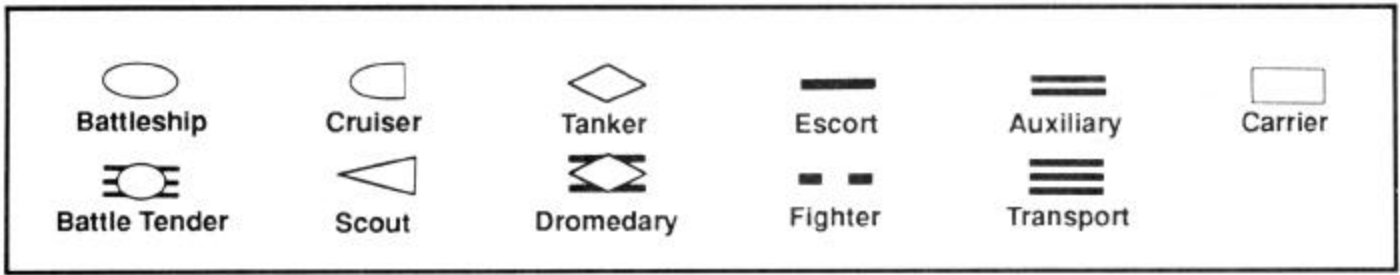
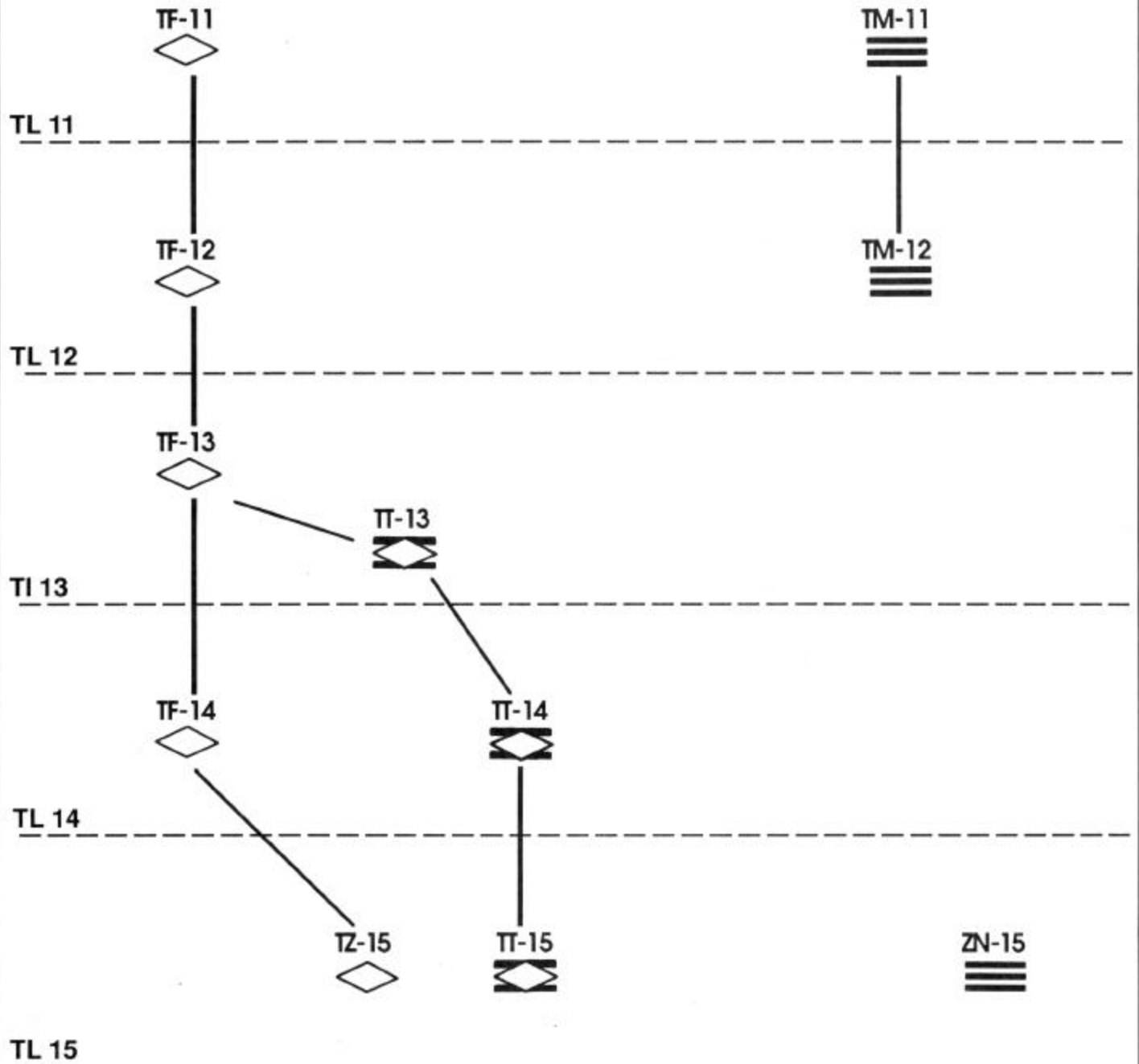

# TF-11 TANKER FLEET

**CraftID:** Tanker Fleet, Type TF, TL=B (Average Stellar), MCr84,225  
**Hull:** 450000/1125000, Disp=500000, Config=4SL, Armor=40E,  
Unloaded=2159756, Loaded=2253364  
**Power:** 4556/9112, Fusion=1230130 Mw, Duration=22/66days  
**Loco:** 9000/18000, Maneuver=1Gs, 13500/27000, Jump=2,  
NOE=150, Cruise=900kph, Top=1200kph,  
Agility=0  
**Commo:** RadioComm Planetary-11x2, RadioComm System-11x2,  
LaserComm Planet-11x2, LaserComm System-11x2,  
MaserComm Planet-11x2, MaserComm System-11x2  
**Sensors:** EMS-A-11 FarOrbitx2,  
EMS-P-11 SubStellarx2,  
Jam EMS-A-11 Planetaryx2,  
Neutrino (1000 Mw) Sensor-11x2,  
HiPen Densit-0.001x2,  
ActObjScan=Routine, ActObjPin=Routine,  
PasObjScan=Formidable, PasObjPin=Formidable,  
PasEngScan=Routine, PasEngPin=Formidable  
**Off:** Missiles=xx4, BeamLaser=xx3  
Batt. 10 Batt. 40  
Bear. 5 Bear. 20  
**Def:** DefDM=3,  
Sandcasters=xx4  
Batt. 40  
Bear. 20  
**Control:** Computer=Model/5fibx3,  
Panel=CP-DynamicLinkedx5460, Special=HeadsUpDisplayx5460,  
Environ=Basic Environment, Basic Life Support, Extended Life Support, Grav Plates, Inertial Compensators  
**Accom:** Crew=855 (1x500)  
(Bridge=20, Engineering=516, Maintenance=57,  
Gunners=75, Flight Crew=75, Ship's Troops=0,  
Command=117, Stewards=28, Frozen Watch=0, Medical=7),  
Additional Staterooms=100,  
LowBerths=0 (FrozenWatch)+0 (Medical), EmergencyLowBerths=0,  
SubCraft=100-ton craftx5, 1000-ton craftx5,  
Magazines=10 50-ton magazines (562 battery-rounds)  
**Other:** Cargo=321,103 tons (4,334,894 kliters), 300,000 tons is fuel tankage for distribution,  
Fuel=99,055 tons (1,337,254 kliters), Fuel Purification Plant (purifies self fuel tankage in 12 hours),  
ObjSize=Large, Fuel Scoops (fills tanks in five hours),  
EmLevel=Strong,  
Battery Round=120 missiles,  
Electronic Circuit Protection  
**Comments:** Triple Turret Missile (120/3),  
Triple Turret BLaser (120/3),  
Triple Turret Sand (120/3),  
Required fuel tankage=99,055 tons,  
Carries additional 300,000 tons of fuel for distribution,  
Cargo and stores=21,000 tons

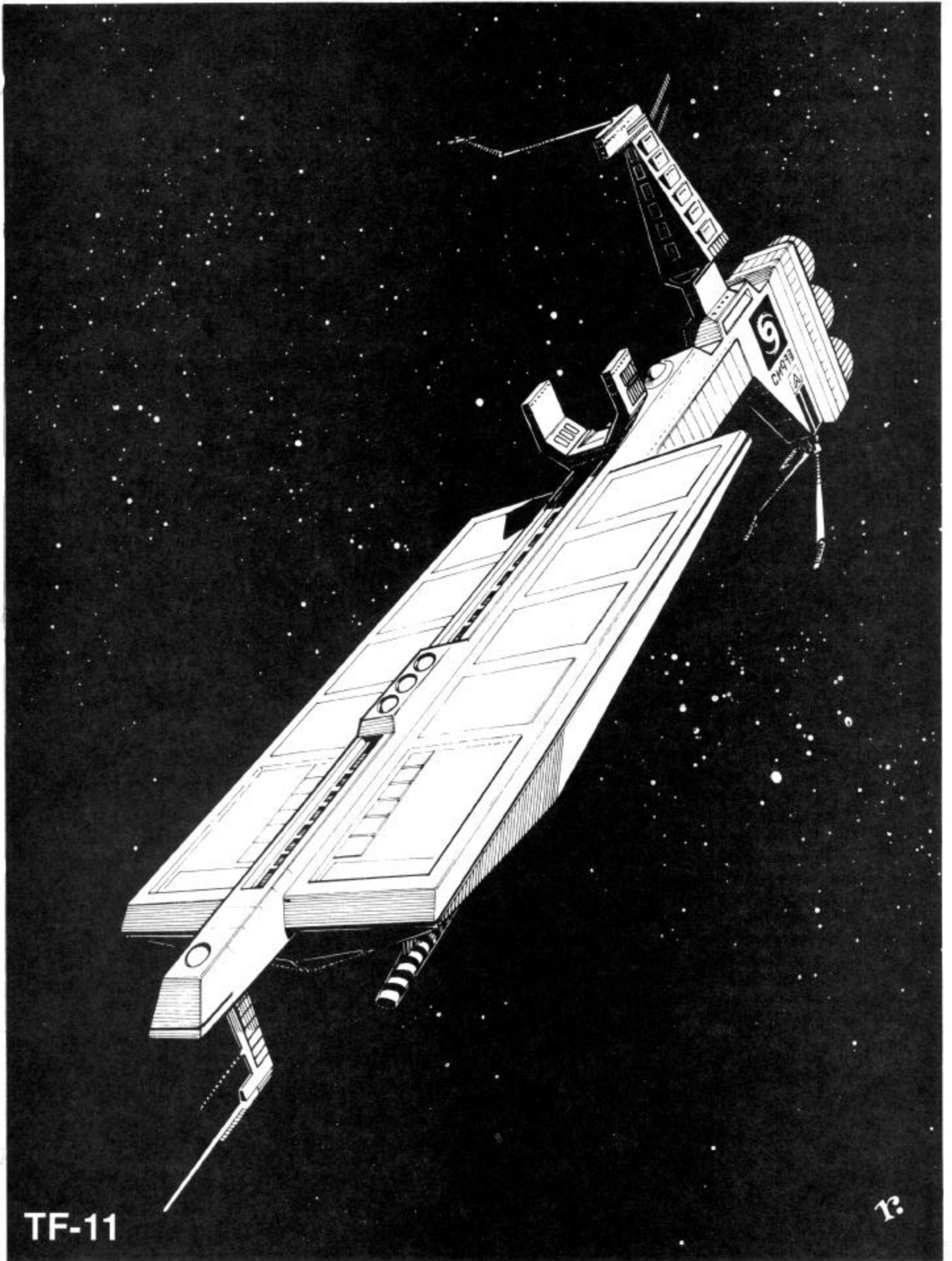

TF-11

12

# TF-12 TANKER FLEET

**CraftID:** Tanker Fleet, Type TF, TL=C (Average Stellar), MCr85,414

**Hull:** 450000/1125000, Disp=500000, Config=3SL, Armor=40F,  
Unloaded=2067910, Loaded=2174288

**Power:** 4472/8944, Fusion=1207600 Mw, Duration=35/105days

**Loco:** 9000/18000, Maneuver=1Gs, 13500/27000, Jump=2,  
NOE=160, Cruise=900kph, Top=1200kph,  
Agility=0

**Commo:** RadioComm Planetary-12x2, RadioComm System-12x2,  
LaserComm Planet-12x2, LaserComm System-12x2,  
MaserComm Planet-12x2, MaserComm System-12x2,

**Sensors:** EMS-A-12 FarOrbitx2,  
EMS-P-12 SubStellarx2,  
Jam EMS-A-12 Planetaryx2,  
Neutrino (1 Mw) Sensor-12x2,  
HiPen Densit-0.05x2,

ActObjScan=Routine, ActObjPin=Routine,  
PasObjScan=Difficult, PasObjPin=Difficult,  
PasEngScan=Routine, PasEngPin=Formidable

**Off:** Missiles=xx2, BeamLaser=xx3

Batt. 40 Batt. 10

Bear. 20 Bear. 5

**Def:** DefDM=4,

Sandcasters=xx4

Batt. 40

Bear. 20

**Control:** Computer=Model/6fibx3,

Panel=CP-DynamicLinkedx299, Special=LgHoloDisplayx299,

Environ=Basic Environment, Basic Life Support, Extended Life Support, Grav Plates, Inertial Compensators

**Accom:** Crew=722 (1x500)

(Bridge=23, Engineering=437, Maintenance=59,

Gunners=40, Flight Crew=40, Ship's Troops=0,

Command=99, Stewards=24, Frozen Watch=0, Medical=5),

Additional Staterooms=100,

LowBerths=0 (FrozenWatch)+100 (Medical), EmergencyLowBerths=0,

SubCraft=100-ton craftx5, 1000-ton craftx5,

Magazines=5 50-ton magazines (281 battery-rounds)

**Other:** Cargo=308,172 tons (4,160,324 kliters), 300,000 tons is fuel tankage for distribution,

Fuel=112,569 tons (1,519,692 kliters), Fuel Purification Plant (purifies self fuel tankage in 12 hours),

ObjSize=Large, Fuel Scoops (fills tanks in five hours),

EmLevel=Strong,

Battery Round=120 missiles,

Electronic Circuit Protection

**Comments:** Triple Turret Missile (120/3),

Triple Turret BLaser (30/3),

Triple Turret Sand (120/3),

Required fuel tankage=99,055 tons,

Carries additional 300,000 tons of fuel for distribution,

Cargo and stores=8000 tons

# TF-13 TANKER FLEET

**CraftID:** Tanker Fleet, Type TF, TL=D (Average Stellar), MCr98,220

**Hull:** 450000/1125000, Disp=500000, Config=4SL, Armor=40F,  
Unloaded=2,211,333, Loaded=2,356,554

**Power:** 4472/8944, Fusion=1207652 Mw, Duration=50/150days

**Loco:** 9000/18000, Maneuver=1Gs, 18000/36000, Jump=3,  
NOE=170, Cruise=900kph, Top=1200kph,  
Agility=0

**Commo:** RadioComm Planetary-13x2, RadioComm System-13x2,  
LaserComm Planet-13x2, LaserComm System-13x2,  
MaserComm Planet-13x2, MaserComm System-13x2

**Sensors:** EMS-A-13 FarOrbitx2,  
EMS-P-13 SubStellarx2,  
Jam EMS-A-13 Planetaryx2,  
Neutrino (0.1 Mw) Sensor-13x2,  
HiPen Densit-0.1x2,  
ActObjScan=Routine, ActObjPin=Routine,  
PasObjScan=Difficult, PasObjPin=Difficult,  
PasEngScan=Routine, PasEngPin=Difficult

**Off:** Missiles=xx3, BeamLaser=xx4  
Batt. 40 Batt. 10  
Bear. 20 Bear. 5

**Def:** DefDM=5,  
Sandcasters=xx4  
Batt. 40  
Bear. 20

**Control:** Computer=Model/7fibx3,  
Panel=CP-HoloLinkedx989, Special=HeadsUpHoloDisplayx989,  
Environ=Basic Environment, Basic Life Support, Extended Life Support, Grav Plates, Inertial Compensators

**Accom:** Crew=614 (1x500)  
(Bridge=4, Engineering=403, Maintenance=33,  
Gunners=30, Flight Crew=30, Ship's Troops=0,  
Command=84, Stewards=20, Frozen Watch=0, Medical=5),  
Additional Staterooms=100,  
LowBerths=0 (FrozenWatch)+100 (Medical), EmergencyLowBerths=0,  
SubCraft=100-ton craftx5, 1000-ton craftx5,  
Magazines=5 50-ton magazines (281 battery-rounds)

**Other:** Cargo=261,959 tons (3,536,452 kliters), 300,000 tons is fuel tankage for distribution,  
Fuel=153,673 tons (2,074,591 kliters), Fuel Purification Plant (purifies self fuel tankage in 12 hours),  
ObjSize=Large, Fuel Scoops (fills tanks in five hours),  
EmLevel=Strong,  
Battery Round=120 missiles,  
Electronic Circuit Protection

**Comments:** Triple Turret Missile (120/3),  
Triple Turret BLaser (30/3),  
Triple Turret Sand (120/3),  
Required fuel tankage=153,673 tons,  
Carries additional 250,000 tons of fuel for distribution,  
Cargo and stores=11,000 tons

# TF-14 TANKER FLEET

**CraftID:** Tanker Fleet, Type TF, TL=E (High Stellar), MCr98,226

**Hull:** 450000/1125000, Disp=500000, Config=4SL, Armor=40G,  
Unloaded=1976441, Loaded=2101372

**Power:** 4472/8944, Fusion=1207591 Mw, Duration=30/90days

**Loco:** 9000/18000, Maneuver=1Gs, 18000/36000, Jump=3,  
NOE=180, Cruise=900kph, Top=1200kph,  
Agility=0

**Commo:** RadioComm Planetary-14x2, RadioComm System-14x2,  
LaserComm Planet-14x2, LaserComm System-14x2,  
MaserComm Planet-14x2, MaserComm System-14x2

**Sensors:** EMS-A-14 FarOrbitx2,  
EMS-P-14 SubStellarx2,  
Jam EMS-A-14 Planetaryx2,  
Neutrino (0.01 Mw) Sensor-14x2,  
HiPen Densit-0.25x2,  
ActObjScan=Routine, ActObjPin=Routine,  
PasObjScan=Routine, PasObjPin=Routine,  
PasEngScan=Routine, PasEngPin=Routine

**Off:** Missiles=xx3, BeamLaser=xx4

Batt. 40 Batt. 10

Bear. 20 Bear. 5

**Def:** DefDM=6,

Sandcasters=xx4

Batt. 40

Bear. 20

**Control:** Computer=Model/8fibx3,  
Panel=CP-HoloLinkedx721, Special=HeadsUpHoloDisplayx721

Environ=Basic Environment, Basic Life Support, Extended Life Support, Grav Plates, Inertial Compensators

**Accom:** Crew=461 (0x500)

(Bridge=2, Engineering=297, Maintenance=24,

Gunners=22, Flight Crew=22, Ship's Troops=0,

Command=63, Stewards=15, Frozen Watch=0, Medical=3),

Additional Staterooms=100,

LowBerths=0 (FrozenWatch)+100 (Medical), EmergencyLowBerths=0,

SubCraft=100-ton craftx5, 1000-ton craftx5,

Magazines=5 50-ton magazines (281 battery-rounds)

**Other:** Cargo=284,504 tons (3,840,806 kliters), 300,000 tons is fuel tankage for distribution,  
Fuel=132,202 tons (1,784,732 kliters), Fuel Purification Plant (purifies self fuel tankage in 12 hours),

ObjSize=Large, Fuel Scoops (fills tanks in five hours),

EmLevel=Strong,

Battery Round=120 missiles,

Electronic Circuit Protection

**Comments:** Triple Turret Missile (120/3),

Triple Turret BLaser (30/3),

Triple Turret Sand (120/3),

Required fuel tankage=132,202 tons,

Carries additional 270,000 tons of fuel for distribution,

Cargo and stores=14,000 tons



# TF-15 TANKER FLEET

**CraftID:** Tanker Transport, Type TF, TL=F (High Stellar), MCr98,335

**Hull:** 450000/1125000, Disp=500000, Config=4SL, Armor=40G,  
Unloaded=1972776, Loaded=2117677

**Power:** 4444/8888, Fusion=1200026 Mw, Duration=50/150days

**Loco:** 9000/18000, Maneuver=1Gs, 18000/36000, Jump=3,  
NOE=190, Cruise=900kph, Top=1200kph,  
Agility=0

**Commo:** RadioComm Planetary-15x2, RadioComm System-15x2,  
LaserComm Planet-15x2, LaserComm System-15x2,  
MaserComm Planet-15x2, MaserComm System-15x2

**Sensors:** EMS-A-15 FarOrbitx2,  
EMS-P-15 SubStellarx2,  
Jam EMS-A-15 Planetaryx2,  
Neutrino (0.01 Mw) Sensor-14x2,  
HiPen Densit-1x2,  
ActObjScan=Routine, ActObjPin=Routine,  
PasObjScan=Routine, PasObjPin=Routine,  
PasEngScan=Routine, PasEngPin=Routine

**Off:** Missiles=xA0

Batt. 1

Bear. 1

**Def:** DefDM=7,

Sandcasters=xx4

Batt. 40

Bear. 20

**Control:** Computer=Model/9fibx3,  
Panel=CP-HoloLinkedx612, Special=HeadsUpHoloDisplayx612,  
Environ=Basic Environment, Basic Life Support, Extended Life Support, Grav Plates, Inertial Compensators

**Accom:** Crew=394 (0x500)

(Bridge=2, Engineering=252, Maintenance=19,  
Gunners=6, Flight Crew=6, Ship's Troops=10,  
Command=54, Stewards=13, Frozen Watch=0, Medical=3),  
Additional Staterooms=100,  
LowBerths=0 (FrozenWatch)+100 (Medical), EmergencyLowBerths=0,  
SubCraft=100-ton craftx5, 1000-ton craftx5,  
Magazines=500 50-ton magazines (3,375,000 battery-rounds)

**Other:** Cargo=238,924 tons (3,225,478 kliters), 300,000 tons is fuel tankage for distribution,  
Fuel=153,334 tons (2,070,015 kliters), Fuel Purification Plant (purifies self fuel tankage in 12 hours),  
ObjSize=Large, Fuel Scoops (fills tanks in five hours),  
EmLevel=Strong,  
Battery Round=1 missiles,  
Electronic Circuit Protection

**Comments:** 100-ton Bay Missile-Ax1,  
Triple Turret Sand (120/3)

# TT-13 TRANSPORT TANKER

**CraftID:** Tanker Transport, Type TT, TL=D (Average Stellar), MCr98,280

**Hull:** 450000/1125000, Disp=500000, Config=4SL, Armor=40F,  
Unloaded=2210027, Loaded=2354928

**Power:** 4444/8888, Fusion=1200037 Mw, Duration=50/150days

**Loco:** 9000/18000, Maneuver=1Gs, 18000/36000, Jump=3,  
NOE=170, Cruise=900kph, Top=1200kph,  
Agility=0

**Commo:** RadioComm Planetary-13x2, RadioComm System-13x2,  
LaserComm Planet-13x2, LaserComm System-13x2,  
MaserComm Planet-13x2, MaserComm System-13x2

**Sensors:** EMS-A-13 FarOrbitx2,  
EMS-P-13 SubStellarx2,  
Jam EMS-A-13 Planetaryx2,  
Neutrino (0.1 Mw) Sensor-13x2,  
HiPen Densit-0.1x2,  
ActObjScan=Routine, ActObjPin=Routine,  
PasObjScan=Difficult, PasObjPin=Difficult,  
PasEngScan=Routine, PasEngPin=Difficult

**Off:** Missiles=x90

Batt. 1

Bear. 1

**Def:** DefDM=5,

Sandcasters=xx4

Batt. 40

Bear. 20

**Control:** Computer=Model/7fibx3,  
Panel=CP-HoloLinkedx996, Special=HeadsUpHoloDisplayx996,  
Environ=Basic Environment, Basic Life Support, Extended Life Support, Grav Plates, Inertial Compensators

**Accom:** Crew=598 (1x500)

(Bridge=4, Engineering=402, Maintenance=31,

Gunners=10, Flight Crew=10, Ship's Troops=10,

Command=82, Stewards=20, Frozen Watch=0, Medical=4),

Additional Staterooms=100,

LowBerths=0 (FrozenWatch)+100 (Medical), EmergencyLowBerths=0,

SubCraft=100-ton craftx5, 1000-ton craftx5,

Magazines=500 50-ton magazines (3375000 battery-rounds)

**Other:** Cargo=237,665 tons (3,208,485 kliters), 300,000 tons is fuel tankage for distribution,  
Fuel=153,334 tons (2,070,022 kliters), Fuel Purification Plant (purifies self fuel tankage in 12 hours),

ObjSize=Large, Fuel Scoops (fills tanks in five hours),

EmLevel=Strong,

Battery Round=1 missiles,

Electronic Circuit Protection

**Comments:** 100-ton Bay Missile-9x1,  
Triple Turret Sand (120/3),  
Required fuel tankage=153,334 tons,  
Carries additional 100,000 tons of fuel for distribution,  
Cargo and stores=137,000 tons

# TZ-15 TANKER RIFT

**CraftID:** Tanker Rift, Type TZ, TL=F (High Stellar), MCr141,332  
**Hull:** 630000/1575000, Disp=700000, Config=4SL Armor=40G,  
Unloaded=2684912, Loaded=2859729

**Power:** 6248/12496, Fusion=1687157 Mw, Duration=30/90days

**Loco:** 12600/25200, Maneuver=1Gs, 25200/50400, Jump=3,  
NOE=190, Cruise=900kph, Top=1200kph,  
Agility=0

**Commo:** RadioComm Planetary-15x2, RadioComm System-15x2,  
LaserComm Planet-15x2, LaserComm System-15x2,  
MaserComm Planet-15x2, MaserComm System-15x2

**Sensors:** EMS-A-15 FarOrbitx2,  
EMS-P-15 SubStellarx2,  
Jam EMS-A-15 Planetaryx2,  
Neutrino (0.01 Mw) Sensor-14x2,  
HiPen Densit-1x2,  
ActObjScan=Routine, ActObjPin=Routine,  
PasObjScan=Routine, PasObjPin=Routine,  
PasEngScan=Routine, PasEngPin=Routine

**Off:** Missiles=xx3, BeamLaser=xx4  
Batt. 40 Batt. 10  
Bear. 20 Bear. 5

**Def:** DefDM=7,  
Sandcasters=xx4  
Batt. 40  
Bear. 20

**Control:** Computer=Model/9fibx3,  
Panel=CP-HoloLinkedx892, Special=HeadsUpHoloDisplayx892,  
Environ=Basic Environment, Basic Life Support, Extended Life Support, Grav Plates, Inertial Compensators

**Accom:** Crew=544 (0x700)  
(Bridge=2, Engineering=352, Maintenance=41,  
Gunners=18, Flight Crew=18, Ship's Troops=0,  
Command=74, Stewards=18, Frozen Watch=0, Medical=4),  
Additional Staterooms=100,  
LowBerths=0 (FrozenWatch)+100 (Medical), EmergencyLowBerths=0,  
SubCraft=100-ton craftx5, 1000-ton craftx5,  
Magazines=1 50-ton magazines (56 battery-rounds)

**Other:** Cargo=403,125 tons (5,442,188 kliters), 300,000 tons is fuel tankage for distribution,  
Fuel=184,990 tons (2,497,376 kliters), Fuel Purification Plant (purifies self fuel tankage in 60 hours),  
ObjSize=Large, Fuel Scoops (fills tanks in five hours),  
EmLevel=Strong,  
Battery Round=120 missiles,  
Electronic Circuit Protection

**Comments:** Triple Turret Missile (120/3),  
Triple Turret BLaser (30/3),  
Triple Turret Sand (120/3),  
Required fuel tankage=184,990 tons,  
Carries additional 400,000 tons of fuel for distribution,  
Cargo and stores=3000 tons

# TM-11 TANKER MISSILE

**CraftID:** Tanker Missile, Type TM, TL=B (Average Stellar), MCr32,666

**Hull:** 180000/450000, Disp=200000, Config=4SL, Armor=40E,  
Unloaded=886125, Loaded=922906

**Power:** 1689/3378, Fusion=456202, 19000545 Mw, Duration=22/66days

**Loco:** 3600/7200, Maneuver=1Gs, 5400/10800, Jump=2,  
NOE=150, Cruise=900kph, Top=1200kph,  
Agility=0

**Commo:** RadioComm Planetary-11x2, RadioComm System-11x2,  
LaserComm Planet-11x2, LaserComm System-11x2,  
MaserComm Planet-11x2, MaserComm System-11x2

**Sensors:** EMS-A-11 FarOrbitx2,  
EMS-P-11 SubStellarx2,  
Jam EMS-A-11 Planetaryx2,  
Neutrino (1000 Mw) Sensor-11x2,  
HiPen Densit-0.001x2,  
ActObjScan=Routine, ActObjPin=Routine,  
PasObjScan=Formidable, PasObjPin=Formidable,  
PasEngScan=Routine, PasEngPin=Formidable

**Off:** Missiles=xx2, BeamLaser=xx3

Batt. 40 Batt. 40

Bear. 26 Bear. 26

**Def:** DefDM=3,

Sandcasters=xx4

Batt. 40

Bear. 26

**Control:** Computer=Model/5fibx3,  
Panel=CP-DynamicLinkedx2542, Special=HeadsUpDisplayx2542,  
Environ=Basic Environment, Basic Life Support, Extended Life Support, Grav Plates

**Accom:** Crew=413 (2x200)  
(Bridge=4, Engineering=204, Maintenance=23,  
Gunners=75, Flight Crew=75, Ship's Troops=0,  
Command=56, Stewards=13, Frozen Watch=0, Medical=3),  
Additional Staterooms=100,  
LowBerths=0 (FrozenWatch)+0 (Medical), EmergencyLowBerths=0,  
SubCraft=100-ton craftx5, 1000-ton craftx5,  
Magazines=1000 50-ton magazines (56,250 battery-rounds)

**Other:** Cargo=77,209 tons (1,042,321 kliters), 300,000 tons is fuel tankage for distribution,  
Fuel=38,921 tons (525,437 kliters), Fuel Purification Plant (purifies self fuel tankage in 12 hours),  
ObjSize=Large, Fuel Scoops (fills tanks in five hours),  
EmLevel=Strong,  
Battery Round=120 missiles,  
Electronic Circuit Protection

**Comments:** Triple Turret Missile (120/3),  
Triple Turret BLaser (120/3),  
Triple Turret Sand (120/3)

# TM-12 TANKER MISSILE

**CraftID:** Tanker Missile, Type TM, TL=C (Average Stellar), MCr38,684

**Hull:** 180000/450000, Disp=200000, Config=4, Armor=40E,  
Unloaded=944752, Loaded=990983

**Power:** 1689/3378, Fusion=456239 Mw, Duration=22/66days

**Loco:** 3600/7200, Maneuver=1Gs, 7200/14400, Jump=3,  
NOE=150, Cruise=900kph, Top=1200kph,  
Agility=0

**Commo:** RadioComm Planetary-11x2, RadioComm System-11x2,  
LaserComm Planet-11x2, LaserComm System-11x2,  
MaserComm Planet-11x2, MaserComm System-11x2

**Sensors:** EMS-A-11 FarOrbitx2,  
EMS-P-11 SubStellarx2,  
Jam EMS-A-11 Planetaryx2,  
Neutrino (1000 Mw) Sensor-11x2,  
HiPen Densit-0.001x2,  
ActObjScan=Routine, ActObjPin=Routine,  
PasObjScan=Formidable, PasObjPin=Formidable,  
PasEngScan=Routine, PasEngPin=Formidable

**Off:** Missiles=xx2, BeamLaser=xx3

Batt. 40 Batt. 40

Bear. 26 Bear. 26

**Def:** DefDM=3,

Sandcasters=xx4

Batt. 40

Bear. 26

**Control:** Computer=Model/5fibx3,  
Panel=CP-DynamicLinkedx2962, Special=HeadsUpDisplayx2962,  
Environ=Basic Environment, Basic Life Support, Extended Life Support, Grav Plates

**Accom:** Crew=471 (2x200)  
(Bridge=5, Engineering=251, Maintenance=23,  
Gunners=75, Flight Crew=75, Ship's Troops=0,  
Command=64, Stewards=15, Frozen Watch=0, Medical=3),  
Additional Staterooms=100,  
LowBerths=0 (FrozenWatch)+0 (Medical), EmergencyLowBerths=0,  
SubCraft=100-ton craftx5, 1000-ton craftx5,  
Magazines=1000 50-ton magazines (56250 battery-rounds)

**Other:** Cargo=64,925 tons (876,493 kliters), 300,000 tons is fuel tankage for distribution,  
Fuel=48,922 tons (660,447 kliters), Fuel Purification Plant (purifies self fuel tankage in 12 hours),  
ObjSize=Large, Fuel Scoops (fills tanks in five hours),  
EmLevel=Strong,  
Battery Round=120 missiles,  
Electronic Circuit Protection

**Comments:** Triple Turret Missile (120/3),  
Turret BLaser (120/3),  
Triple Turret Sand (120/3)

# ZN-15 SPECIAL NONSTANDARD

**CraftID:** Special Nonstandard, Type ZN, TL=F (High Stellar), MCr24,909

**Hull:** 67500/168750, Disp=75000, Config=1SL, Armor=40G,  
Unloaded=423526, Loaded=470292

**Power:** 2932/5864, Fusion=791815 Mw, Duration=49/147days

**Loco:** 1350/2700, Maneuver=1Gs, 2700/5400, Jump=3,  
NOE=190, Cruise=900kph, Top=1200kph,  
Agility=0

**Commo:** RadioComm Planetary-15x1, RadioComm FarOrbit-15x1, RadioComm System-15x1,  
LaserComm Planet-15x1, LaserComm FarOrbit-15x1, LaserComm System-15x1,  
MaserComm Planet-15x1, MaserComm FarOrbit-15x1, MaserComm System-15x1

**Sensors:** EMM Packagex1,  
EMS-A-15 FarOrbitx2,  
EMS-P-15 SubStellarx2,  
Jam EMS-A-15 Planetaryx2,  
Neutrino (0.01 Mw) Sensor-14x2,  
HiPen Densit-1x2,  
ActObjScan=Routine, ActObjPin=Routine,  
PasObjScan=Routine, PasObjPin=Routine,  
PasEngScan=Routine, PasEngPin=Routine

**Off:** MesonGun=T9x  
Batt. 1/1  
Bear. 1/1  
FusionGun=x90  
Batt. 10  
Bear. 8  
Missiles=xx3, BeamLaser=xx4  
Batt. 20 Batt. 20  
Bear. 15 Bear. 15

**Def:** DefDM=8, MesonScreen-9, NucDamper-9, BlackGlobe-1,  
Sandcasters=xx4  
Batt. 20  
Bear. 15

**Control:** Computer=Model/9fibx3,  
Panel=CP-HoloLinkedx158, Special=HeadsUpHoloDisplayx158,  
Environ=Basic Environment, Basic Life Support, Extended Life Support, Grav Plates, Inertial Compensators

**Accom:** Crew=403 (5x75)  
(Bridge=2, Engineering=59, Maintenance=5,  
Gunners=236, Flight Crew=236, Ship's Troops=0,  
Command=55, Stewards=13, Frozen Watch=0, Medical=3),  
Additional Staterooms=10,  
LowBerths=0 (FrozenWatch)+0 (Medical), EmergencyLowBerths=0,  
SubCraft=10-ton craftx10, 100-ton craftx2,  
Magazines=None

**Other:** Cargo=688 tons (9291 kliters),  
Fuel=49,487 tons (668,087 kliters), Fuel Purification Plant (purifies total fuel tankage in 60 hours),  
ObjSize=Large, Fuel Scoops (fills tanks in five hours),  
EmLevel=Moderate,  
Battery Round=60 missiles,  
Electronic Circuit Protection

**Comments:** Spinal MesonGun-Tx1,  
100-ton Bay MesonGun-9x1,  
50-ton Bay MesonGun-4x1,  
50-ton Bay FusionGun-9x10,  
50-ton Bay Repulsor-5x10,  
Triple Turret Missile (60/3),  
Triple Turret BLaser (60/3),  
Triple Turret Sand (60/3)

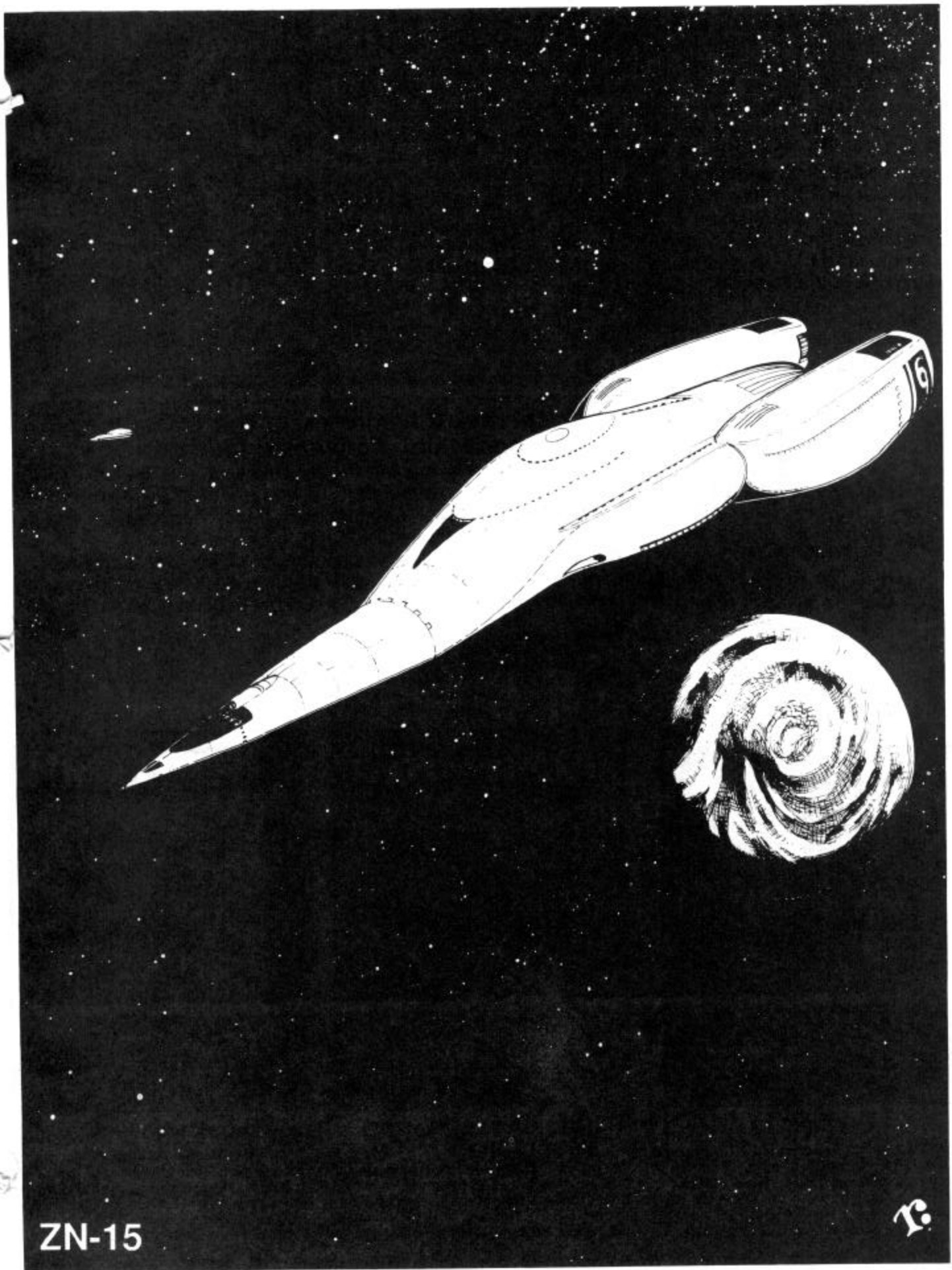

ZN-15



# Knightfall

## The Legacy of the Long Night.

It was just a routine trade expedition in Massilia sector. But suddenly the tides of war shifted, and Emperor Lucan's forces overran the world. Now, the characters are prisoners of war, and their ship has been confiscated. They must escape and track down their stolen starship. During the search, they stumble on secrets that could put an end to this cursed Rebellion once and for all.

The search for their starship takes them to an Imperial knight with information about a fabled lost city of technological wonders from the Long Night period. If he can find it, its marvelously high technology could help Margaret's faction prevail in the Rebellion.



**Knightfall.**  
96-page book. GDW: 0219. \$10.  
Coming in September 1990.



## Rebels' Tales

### 5 Desperate Adventures in the Rebellion. Sourcebook and Adventure Module.

The Rebellion is sweeping the Imperium, and in its wake, it has disrupted the very fabric of Imperial society. **Rebels' Tales** is a sourcebook of information about the Rebellion and its effects on the Imperium.

**Rebels' Tales** provides an opportunity for players to use the information in the sourcebook as they play five desperate scenarios set against the background of the Rebellion.

**Rebels' Tales.**  
96-page book. GDW: 0220. \$10.  
Coming in November 1990.

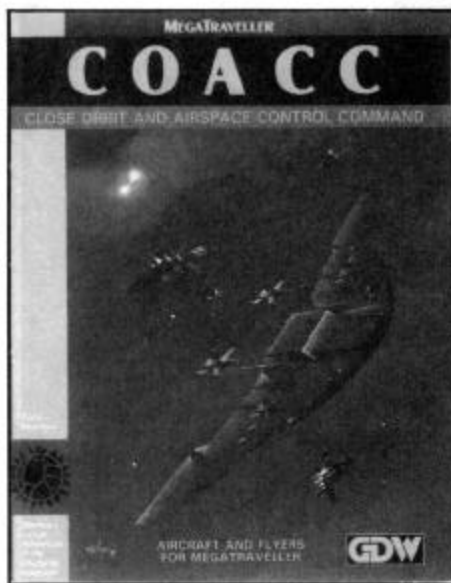

### COACC

COACC controls aircraft in the Imperium. Here is aircraft pilot character generation, aircraft design and combat, plus a campaign to win the Rebellion on one world.

96-page book. GDW: 0216. \$10.00.



### REFEREE'S COMPANION

Rules expansions for the **Mega-Traveller** referee: includes large-scale combat, timekeeping, communications, research, mapping, technology, and aliens.

96-page book. GDW: 0215. \$10.00.

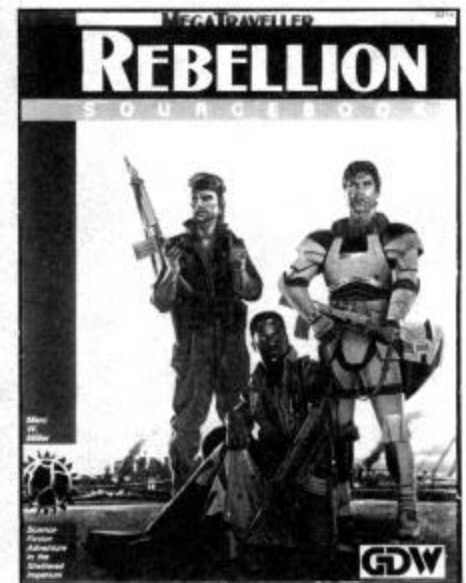

### REBELLION SOURCEBOOK

A fierce Rebellion shakes the Imperium—each faction fights for a piece of the rich star-spanning empire. Here are the Rebellion's sides, leaders, territories, and equipment.

96-page book. GDW: 0214. \$10.00.

Game Designers' Workshop, PO Box 1646, Bloomington, IL 61702-1646



MEGATRAVELLER

# FIGHTING SHIPS

## OF THE SHATTERED IMPERIUM

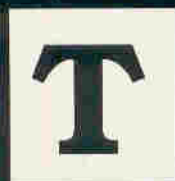

The Imperial Navy never planned for the worst of all possible contingencies: a far-flung Rebellion that would shatter the empire into squabbling factions. And with each faction went a portion of the navy's fighting strength.

Now, Imperial ship fights Imperial ship as the Rebellion drives the entire Imperium into chaos.

**Fighting Ships of the Shattered Imperium** is a compendium of immense battleships and cruisers that served with the Imperial fleet and now serve with the fleets of the many factions of the Rebellion. Included in this book are standard statistical descriptions of 58 ships, with illustrations for 16 of the most interesting.

- Battleships and dreadnoughts from tech level 11 to 15. Examples include battle tender/rider systems for tech levels 14 and 15.
- Cruisers, including the standard cruisers from tech level 11 to 15, plus strike cruisers, missile cruisers, and the jump-6 rift cruiser.
- Carriers, from the standard fleet carriers to the newest light carrier and pocket carrier.
- Escorts, from the ED-series escort destroyers to the escort fleet and escort missile ships that maneuver with the fleet.
- Auxiliaries, from the standard fleet tankers to the dromedary combination tanker and resupply ship, plus the rift tanker for operations in the Rifts.

**Fighting Ships of the Shattered Imperium**—a compendium of 58 starships for **MegaTraveller**.

Intended for **MegaTraveller** referees and players. Intermediate complexity. Suitable for some solitaire use. Requires the **MegaTraveller** role-playing game system.

0218 10.00



0 86079 00218 3



Made in the U.S.A.  
Printed in the U.S.A.



Copyright©1990, GDW, Inc. All rights reserved. ISBN 1-55878-050-5.

P.O. Box 1646  
Bloomington, IL 61702-1646