

REBELLION

S O U R C E B O O K



Marc
W.
Miller



Science-
Fiction
Adventure
in the
Shattered
Imperium

GDW

Factions of the Rebellion

Territories controlled by the factions as of 1120.

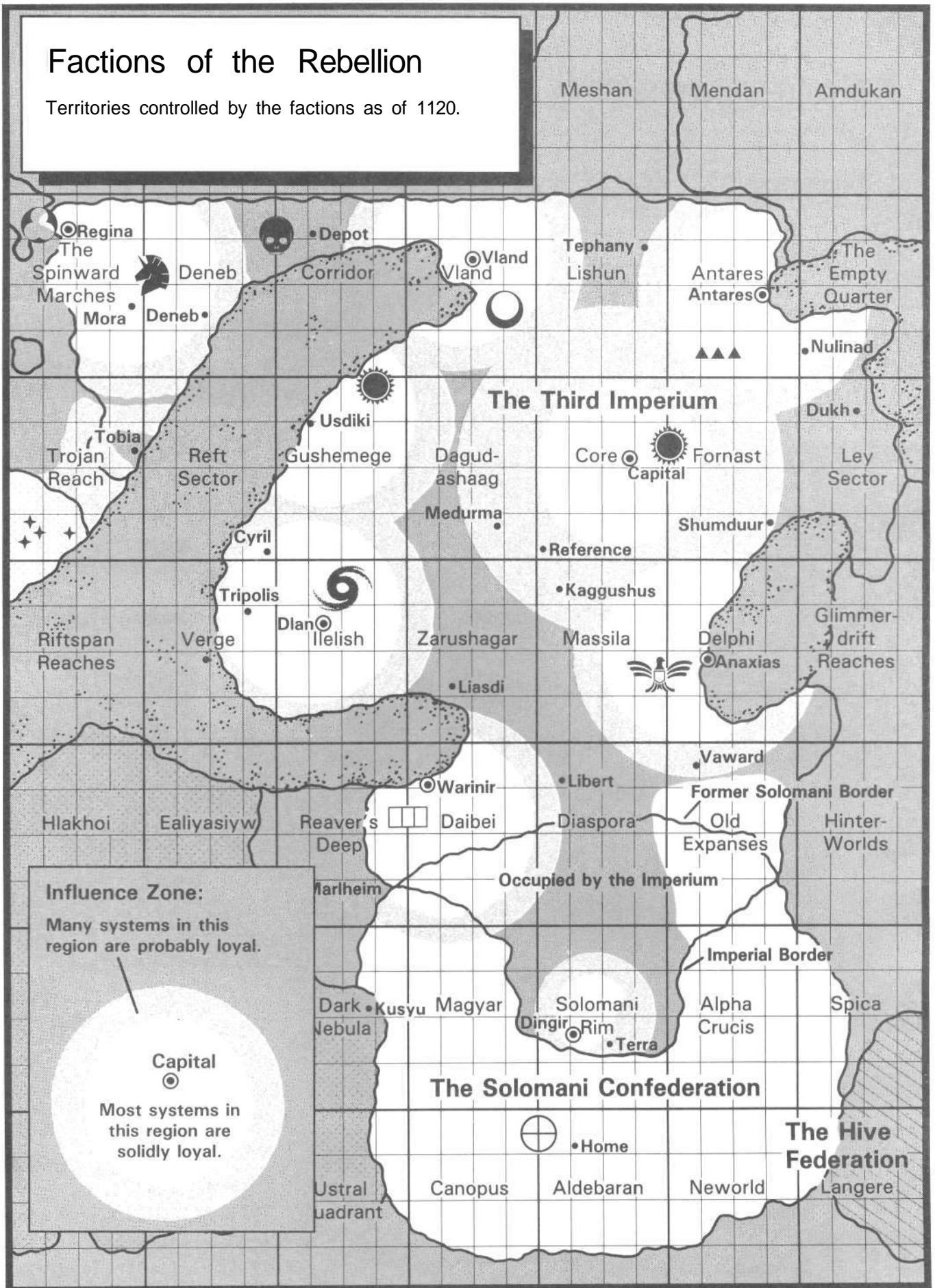

Marc W. Miller

REBELLION

S O U R C E B O O K

MEGATRAVELLER™

Science-Fiction Role-Playing
in the Shattered Imperium



Rebellion Sourcebook is a compilation of data and background about the Rebellion that is currently sweeping the Imperium of the **MegaTraveller** universe.

The History of the Imperium Working Group (HIWG) is a support organization dedicated to exploring the future history of the Imperium and the ramifications of the Rebellion on that history. Some of the information in this sourcebook is based on HIWG's work. Special thanks are due to Ed Edwards, Mike Mikesh, Gregg Giles, and Jefferson Swycaffer.

Credits

Design.....Marc W. Miller
Additional Design.....Frank Chadwick,
Joe D. Fugate, Jr.,
Gary Thomas,
John Meyers,
Ed Edwards,
Mike Mikesh,
Gregg Giles,
Jefferson Swycaffer.
Cover Illustration.....A.C. Farley
Interior Illustrations.....Steve Crompton,
A.C. Farley,
Liz Danforth,
Tom Peters,
Rob Caswell,
Jeff Dee,
Bryan Gibson,
Tim Bradstreet.
Art Director.....Barbie Pratt
Graphic Design and Production.....Lauretta Oblinger,
Dana Reischauer,
James R. Kuntz,
Rob Reed.
Text Manager.....Michelle Sturgeon
Typesetting.....Michelle Sturgeon
Text Processing.....Carol Etter,
Elysabeth Dzik,
Tim Ryan,
Karen Lumb.

MegaTraveller

Rebellion Sourcebook

Copyright©1988 GDW. All Rights Reserved. Printed in USA. Made in USA. No part of this work may be reproduced in any form or by any means without written permission from the publisher.

ISBN 0-943580-63-3

1 2 3 4 5 6 7 8 9

Traveller® is GDW's registered trademark for its science-fiction role-playing game system. **MegaTraveller** and The Shattered Imperium are trademarks of GDW.



PO Box 1646
Bloomington, IL 61702
USA

Table of Contents



| | |
|--|--------------------|
| Factions of the Rebellion..... | Inside Front Cover |
| Introduction..... | 5 |
| The Assassination..... | 6 |
| Two Stories..... | 8 |
| The Rebellion..... | 10 |
| One Clear Choice..... | 12 |
| Ripples Through the Imperium..... | 15 |
| The Imperial Family..... | 17 |
| Nature of Rebellion..... | 20 |
| Imperial Fleets..... | 26 |
| Imperial Fleets and Squadrons..... | 26 |
| Imperial Navy Command Channels..... | 28 |
| Fleets of the Imperium..... | 30 |
| Aslan Naval Organization..... | 31 |
| Imperial Navy Depots..... | 33 |
| The Armies of the Imperium..... | 36 |
| Agencies..... | 40 |
| Factions of the Rebellion..... | 42 |
| Lucan..... | 44 |
| Dulinor..... | 46 |
| Margaret..... | 48 |
| Varian..... | 50 |
| Strephon..... | 51 |
| Viand..... | 52 |
| Antares..... | 54 |
| Morris..... | 56 |
| Aslan..... | 58 |
| Vargr..... | 62 |
| Daibei..... | 64 |
| Zhodani..... | 66 |
| Solomani..... | 68 |
| Historical Notes on the Rebellion..... | 70 |
| 1116—On the Eve of the Rebellion..... | 71 |
| 1117—The First Reactions..... | 72 |
| 1118—The Lines Are Drawn..... | 73 |
| 1119—The War Heats Up..... | 74 |
| 1120—The Long Haul Begins..... | 75 |
| An Equipment Catalog for the Rebellion..... | 76 |
| Imperial Rampart-Class Fighter..... | 77 |
| Vargr <i>Aek Naz</i> -Class Battle Cruiser..... | 78 |
| Vargr <i>Foghoks</i> -Class Heavy Cruiser..... | 79 |
| Imperial Common Transport..... | 80 |
| Imperial <i>SEH</i> -Class Light Cruiser..... | 81 |
| Imperial <i>Voroshilef</i> -Class Battleship..... | 82 |
| Imperial <i>Planet</i> -Class Heavy Cruiser..... | 83 |
| Imperiallines Frontier Transport Tl..... | 84 |
| Imperiallines Frontier Transport TJ..... | 85 |
| Imperial <i>Trepida</i> Grav Tank..... | 86 |
| Imperial <i>Astrin</i> Grav APC..... | 87 |
| Aslan <i>Ihatef</i> -Class Colonial Transport..... | 88 |
| Aslan <i>Weakhto</i> -Class Colonial Intruder..... | 89 |
| Zhodani <i>Z-80</i> Grav Tank..... | 91 |
| Nail Mission..... | 92 |
| Mapping Sectors..... | 96 |
| Blank Sector Map..... | Inside Back Cover |

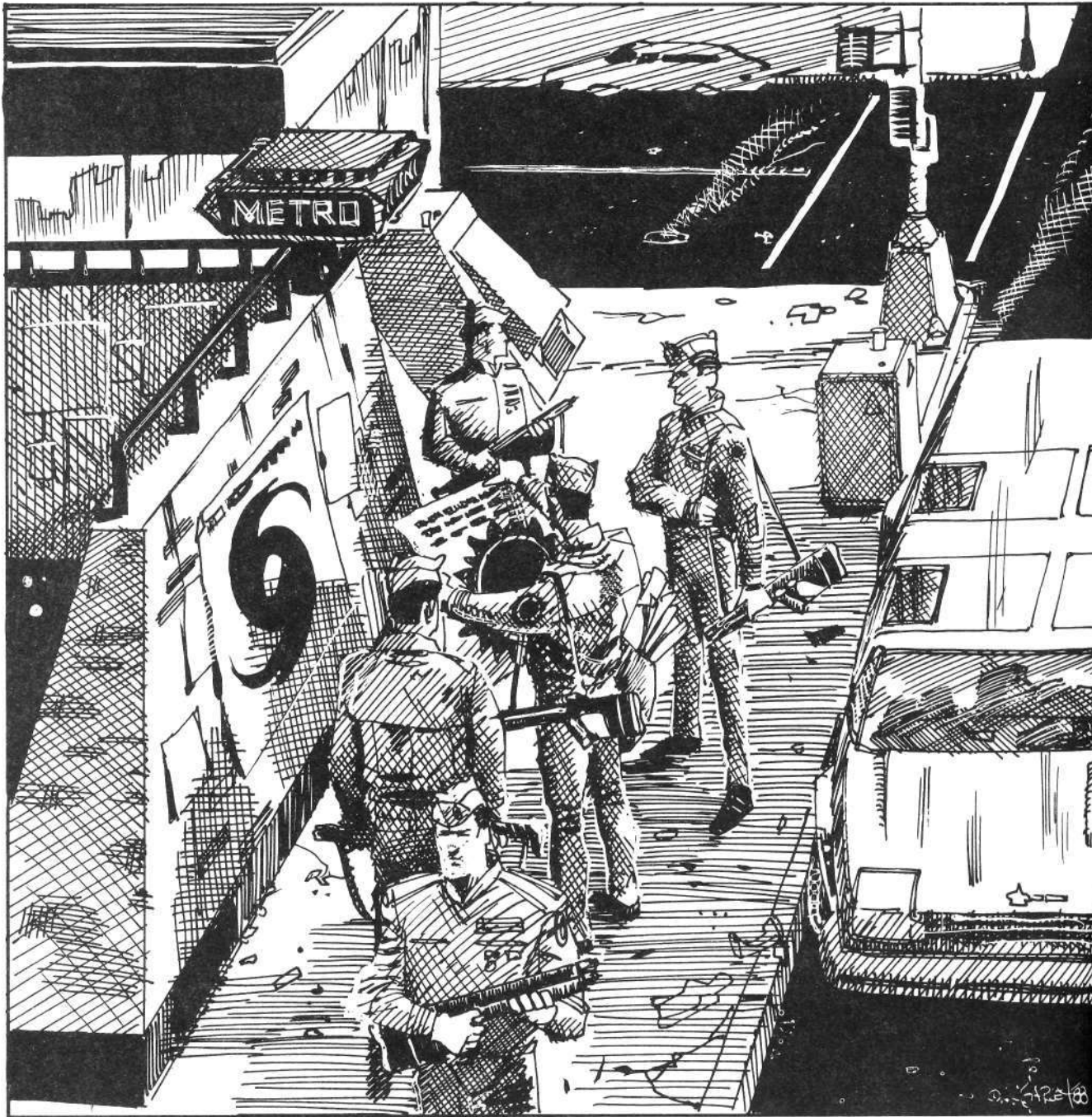

The vitality of the newly founded Imperium was evidenced by its rapid expansion and economic growth. The time was right for a new empire; the human populations of the territory wanted and needed this vast interstellar government. The Third Imperium was an expression of the people who populated it: strong, vital, ambitious.

A thousand years later, the strength and vitality of the human populations were missing; all that remained was the ambition, and that ambition was channeled inward. No longer did the population see expansion as the means to a better future; leaders looked at redistributing the wealth of the Imperium and at carving out petty duchies within the known boundaries of the empire.

Against this background, it was inevitable for some small stimulus to trigger the fall of the Imperium. And once that happened, there was no turning back.

In the founding days of the Imperium, great men dreamed great dreams...and achieved them. In the last days of the Imperium, petty men dreamed petty dreams...and achieved them too.

REBELLION

S O U R C E B O O K

The assassination of Emperor Strephon triggered a chain of events that echoed throughout the Imperium. The Rebellion, encompassing a number of distinct factions, each with their own aims and ideologies, became the dominant factor in every relationship within the empire. No activity could ignore the Rebellion and its effects on Imperial society.

This *Rebellion Sourcebook* contains the basic history and background of the Rebellion and its effects on MegaTraveller adventures. Referees and players can use it to enhance their role-playing activities within the Imperium and its Rebellion.



The Assassination

The Imperial palace is not strictly *on* Capital. It hangs over Capital like a gigantic steel ball. Access is strictly controlled; the antigravity palace is in reality a safe, secure fortress for the Imperial family.

But Strephon's assassin was invited in. The Archduke of Ilelish was one of the Imperium's highest ranking nobles. He was elevated to Archduke by Strephon himself in 0000; he stands as one of five Archdukes within the Imperium. And he brought his ceremonial magnum revolver with him.

The Throne Room: The Long Hall stretches 100 meters from the Visitors' Entrance to the throne room. Its floor is a crimson sidewalk flanked by glowing crystal pillars, while atop the pillars are the banners of the 20 sector Dukes whose fiefs make up the Third Imperium. When the Emperor holds court, the pillared area is filled with nobles and guests eager to witness the most important social events of the year.

At the far end of the sidewalk is the Octagon—the throne room itself. In the center of the octagonal room is a triangular marble dias which supports the Iridium Throne. Behind the throne stand the standards of the Imperium. To the left is the crest of the Emperor's family; to the right is the crest of the Empress's family; in the center (and twice the size of the other two standards) is the Imperial sunburst.

Behind the throne is a grand vista of the skyline of the city below, which is actually a projected holographic image display. Image projectors can project information, data, or pictures for the court or the Emperor as desired.

The Iridium Throne: The shining Iridium Throne is often considered synonymous with the Emperor. The throne is a teardrop-shaped hemisphere mounted on a powered rotating base. All possible comforts are provided for the Emperor by this throne, as well as a fair degree of armor protection. Traditionally, the Emperor sits in his Iridium Throne and receives the new nobles of the Imperium, entertains guests and ambassadors, and views recorded messages from high ranking nobles requesting aid or assistance.

THE IMPERIAL GUARD

The Imperial Guard consists of 11 regiments of highly trained, superbly equipped troops dedicated to the protection of the Emperor and the Imperial palace. Accepted as one of the elite formations of the Imperial armed forces, the Imperial Guard is a respected unit with a long and honored tradition.

One purpose of the Imperial Guard is to provide a symbol of political unity for the Imperium. One regiment is drawn from each of the seven Domains of the Imperium, with each serving a one month tour of duty as honor regiment in rotation.

The current honor regiment is the Ilelish Guard, drawn from the Domain of the Archduke of Ilelish.

DULINOR'S AUDIENCE

The Archduke Dulinor procured a scheduled audience with Strephon. Such a meeting on a formal basis conveyed that a very important, formal matter was to be discussed. Speculation at the time was that Dulinor would request some form of special assistance for his Domain, probably economic development assistance. Dulinor was well-known as a champion of the masses.

Strephon's day was filled with audiences. By tradition, nobles and guests were received in order of their social or noble rank, with the lowest ranks first. Before lunch, the mundane details were taken care of: Businessmen received Im-

perial appointments. Various noble titles were awarded to members of the court. Inherited titles were confirmed; having a title confirmed by the hand of the Emperor was a high point in the social whirl of Capital.

After lunch, more important matters were handled. Higher ranking nobles provided formal reports of conditions, problems, even court trials throughout the Imperium. Most of the business was noted and deferred for later consideration and decision.

As the next to the last order of business for the day, the Aslan Yerlyaruiwo ambassador presented his credentials to the Emperor. The Emperor, in an impromptu gesture, mentioned to the ambassador that there remained only one order of business left in the day, and invited him to join the Imperial family on the dias while it was handled. Then the Emperor and the ambassador would be able to retire to private chambers for a continued discussion of Imperial-Aslan affairs.

Dulinor presented himself at the appointed time and strode the long crimson sidewalk to the throne room. He stopped proudly before the Emperor, greeted him calmly and with friendship, and then stepped forward. The Emperor rose to greet him, stepping forward himself. At that point, Dulinor swept back his black cape, drew his magnum revolver, and began firing. His first shot hit the Emperor, killing him instantly. His second shot hit the Empress, killing her instantly. By this time, some members of the court were beginning to scream. The more prudent were dropping to the floor. The honor guard

stepped from its position near the walls of the throne room.

Dulinor kept firing. His shots were in a timed sequence. The next was intended for the Grand Princess, but the Yerlyaruiwo ambassador took the bullet. The fourth shot killed Ciencia Iphegenia. Dulinor stopped firing and looked at the chaos.

The gunfire continued. The Ilelish Guard, forewarned, was picking off the military guard. Investigation would reveal that only the Ilelish Guard had live ammunition; an arms room sergeant had substituted dummy rounds for the rest.

Dulinor let the gunfire stop. He then stepped to Strepthon's body, stripped off his crown and picked up his scepter, and walked to the Iridium Throne. Someone screamed and lunged from the crowd; a guard shot him dead. Dulinor sat on the throne and said, "I hereby proclaim myself Dulinor I, Emperor of the Eleven Thousand Worlds of the Third Imperium, by right of assassination. All loyal citizens shall hear me and obey."

Dulinor then rose and stepped down from the dias. He was met by a cameraman who gave him the holocrystal from his video camera. He was then immediately flanked by Imperial Guards who whisked him from the room.

AFTER THE FACT

Video cameras routinely broadcast the events of the throne room throughout the palace. The assassination was carried live on the palace network, but a small computer monitor on the circuits prevented it from being sent outside the palace. This pre-planned step by Dulinor kept those outside the palace in the dark for crucial minutes.

Inside the Imperial palace, the Ilelish Guard began its own pre-planned steps to take control. The plan was that the other guard units would be locked in their barracks while the Ilelish Guard seized control. A string of accidents frustrated that plan.

An officer in the Household Cavalry had an accident, bumped into a cart, and accidentally discharged his ceremonial sub-machinegun. Such an accident would normally be a disciplinary offense, but in this case, the cartridge in the gun failed to discharge: It was a dummy. The officer reported the offense,

an unusual problem, to his superior. They investigated, confirmed that many of the cartridges were dummies, and took steps to remedy the situation. By then, it was 1500 hours.

When the Ilelish Guard triggered the computer to isolate the other guard units, they were already out and on alert. Dulinor, in the company of his personal guard, faced at least three small pockets of guards before he reached the Imperial residence. It soon became clear that he would have to leave the palace.

FLIGHT

A contingency plan was implemented. Dulinor and two aides changed into Imperial Navy uniforms. Another guard donned a black cloak (to better appear to be Dulinor). Some of the Ilelish Guard switched insignia to look like members of the Household Cavalry. While the main body of Ilelish Guards barricaded themselves in the Imperial residence on what they knew to be a suicide mission, the assassin slipped away.

Dulinor and his escort made their way to the Aircraft Operations Center. Taking charge by force of will and apparent rank, Dulinor hustled several officers, including himself and two aides, into an air/raft and dropped the 500 meters to the palace grounds. The air/raft entered a concealed shaft and continued to the Naval Central Command Complex beneath the palace.

One of Dulinor's aides reported the assassination to a guard commander in the complex and slipped away. Dulinor and the aides proceeded to the starport where they boarded a waiting cutter for orbit. Within two hours of the assassination, Dulinor was bound outsystem en route for Ilelish.

The Ilelish Guard fought on for two days. Parts of the palace were gutted by the efforts of the Imperial Marine Guard to dislodge the assassin and the Ilelish Guard. Even when the siege ended, it was not immediately clear whether the assassin had fled or had been killed in the fighting.

In the coming months, it would become very clear that the assassin was still alive.

On Capital the immediate search began for the Emperor's heir.

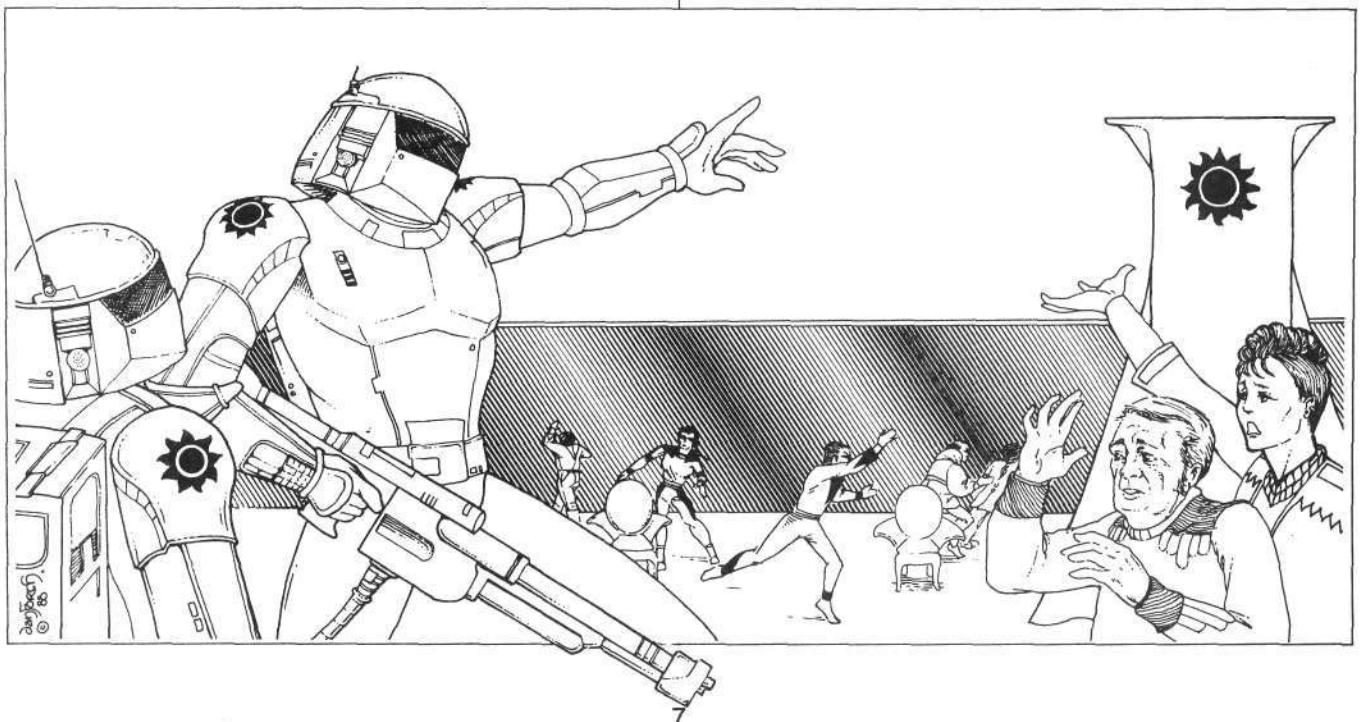



Two Stories

The twin Princes, Varian and Lucan, are Emperor Strephon's nephews. Their mother, Lydia, was Strephon's younger sister. The twins, born five minutes apart in 1094, have lived in the Imperial palace since their parents' death in 1108.

The twins' status as Princes was always considered a pleasant convenience; neither expected to ever ascend the throne. The Alkhalikoi line proceeded through the Grand Princess, bypassing the twins and their branch of the family. Only in the event that Strephon, Iolanthe, and Iphigenia all died would the twins be in line for the throne.

Dulinor's plan to assassinate Strephon necessarily included steps to eliminate any other potential heirs to the throne within the Alkhalikoi line. Dulinor himself would kill Strephon, the Empress Iolanthe, and the Grand Princess Ciencia Iphigenia in an audience at the throne room. Dulinor's naval aide would locate and kill Lucan and Varian wherever they were in the palace. Dulinor's seneschal was prepared to find and kill the Empress and the Grand Princess if they did not attend the audience. The Ilesh Guard, deliberately stocked with soldiers loyal to Dulinor, would seize control of the palace. If the plan worked perfectly, the Imperial palace would be in Dulinor's hands by the end of the day; there would be no immediate heirs to the throne to contest Dulinor's claim; and a new era of enlightenment and prosperity would dawn on the Third Imperium.

THE PLAN TO ELIMINATE THE TWIN PRINCES

Some facts are known. Five people were in the twin Princes' apartments just before the assassination: Varian, Lucan, Elia (Varian's female acquaintance), an armed bodyguard (a standard assignment), and Sublieutenant Trace Windhoek (an Imperial Navy intelligence officer helping plan for an upcoming excursion). The apartments themselves consisted of a large central room with several adjoining private rooms. A sunken center area, plush furniture, and numerous doorways made the whole complex ideal for lavish parties.

Dulinor's naval aide, Sublieutenant Volante Imprey, located

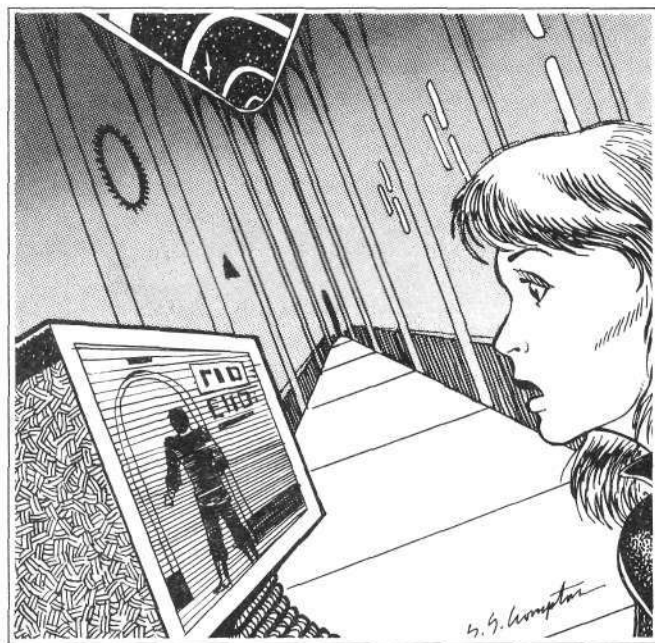

the whereabouts of Lucan and Varian in the complex, and at the appointed time, he called on the two of them. Security cameras recorded his actions as he entered at precisely 1517, which was the exact time that Strephon was being assassinated.

The security cameras inside the twin Princes' apartments, like most security cameras in living areas for the Imperial family, do not feed directly to a central recording and monitoring station. Instead of feeding to a central recording and monitoring station, they have an image cassette that must be physically removed from the cameras to be scanned. (Note that the cameras do feed alarm and exception signals to monitoring guard stations.) The cameras and their cassettes inside the twin Princes' apartments were destroyed in the ensuing violence.

The two Princes were known to be arguing loudly just prior to the assassination. A guard passing in the corridor heard the exchange when the door to the complex was opened momentarily. The twins were known to periodically have loud, heated arguments.

What happened in those minutes after the naval aide entered the apartments has been a matter for widespread conjecture, with a wide variety of speculations being made. Lucan has made a public statement. Varian, Elia, the bodyguard, and Imprey are dead. Windhoek, at this time, has not been apprehended.

LUCAN'S STORY

Lucan's story was released as a prepared statement by the Imperial Office of Information on 133-1116. It has been widely disseminated throughout the Imperium.

The day of terror began ordinarily enough. Lucan and Varian were preparing for their series of courtesy visits and audiences that generally characterize their usual day in the palace. A

wide variety of guests and callers began to appear in mid-afternoon.

When Imprey burst into the twin Princes' apartments, he tripped on a loose rug. His pistol discharged as he fell, killing a guard in the room. Both Lucan and Varian dove for cover immediately; Elia froze for a moment and then collapsed with fright. Windhoek began grappling with Lucan, and at first, Lucan thought it was a gallant naval officer trying to protect him. When Windhoek's hands wrapped around his throat, Lucan realized there were two assassins in the room. Lucan struggled and managed to knock Windhoek out. During that time, Imprey recovered and fired a few more wild shots, then began stalking the two Princes. While Imprey searched the room's alcoves and recesses, Lucan hid quietly beneath the bed. As soon as he had a chance, Lucan dashed for the dead guard and snatched up the SMG. Calling to Varian to "Run for it!" he waited until he heard a door slam (that slam later turned out to be Windhoek leaving), then stood up and sprayed the assassin with 9mm slugs. Then he, too, dashed out of the room.

By this time, the alarms could be heard sounding all over the palace. Strephon was dead; Dulinor was on the video screens claiming the throne. Marine guards came in and took charge of the emergency situation, hustling Lucan off to safety immediately.

The twin Princes' apartments were cleared by Marine guards later. There they found four bodies: the naval aide (who was killed by a 9mm slug to the head), the guard, Varian, and Elia (these three all dead from 7mm slugs). The assassin had gotten Varian before Lucan could save him. Windhoek is still missing.

WINDHOOK'S STORY

Windhook's story was transcribed privately by a computer information agency at Inarli in Corridor Sector. It has been widely disseminated throughout the Imperium.

Windhoek was assigned to coordinate routine protocol on an excursion the twin Princes were scheduled to undertake later in the year. His duties amounted to carefully filling out a questionnaire dealing with the Princes' preferences for environment, food, drink, entertainment, and comfort. The process was expected to take about an hour.

Windhoek arrived slightly before 1500. As he entered, he heard heated words being exchanged between Varian and Lucan; from what he could hear, Lucan was apparently distressed because Elia had decided to leave Lucan and become Varian's female acquaintance. Windhoek waited uncomfortably by the main door until the exchange ended. Meanwhile, Sublieutenant Imprey arrived. Because Windhoek and Imprey knew each other, they exchanged pleasantries while they waited. When the naval aide burst into the twin Princes' apartments, he started firing immediately, forcing everyone—Lucan, Varian, Elia, and a guard in the room—to dive for cover. The guard responded with a hail of slugs, one of which killed Imprey. As the four stood over the dead body, wondering about why this had happened, the video screens flashed coverage of Dulinor's assassination of Strephon then in progress. Lucan realized the potential of the situation immediately. He quietly picked up the assassin's pistol and calmly shot the SMG-armed

guard first, and then Varian, then Elia, and last he took a shot at Windhoek. Naturally enough, Windhoek evaluated the situation and realized the danger quickly enough to flee before he was killed.

Catching the coverage of Strephon's assassination as he ran down the halls, Windhoek knew immediately that his life was effectively forfeit. He then made his way directly to the Administrative Offices, already in an uproar, and just stood around looking important. Eventually (after maybe 10 minutes), a naval commander grabbed Windhook's shoulder and told him to personally carry a bundle of orders to the Aircraft Operations Center sealing the palace off. Windhoek took two marines with him and made his way down 20 floors. He reached the Aircraft Operations Center without incident. Strangely, it seemed to be operating normally during the crisis. Some officers stood around acting numb, but no one was doing anything out of the ordinary.

Windhoek decided to take advantage of the situation. He did not deliver the orders to seal off the palace to the Aircraft Operations Center. Instead, he joined a party of three naval officers, gave orders to his marine companions to go on a wild goose chase, and commandeered an air/raft. The four of them then flew down to the Naval Central Command Complex located underground, directly below the palace. From there, he made his way to the starport, made use of a computer terminal to write (forge) himself some orders, and boarded an Imperialines-type TJ cruiser bound for the Imperial border, hoping to live long enough to reach it. Within a few weeks, he had switched ships four times and used every trick that Naval Intelligence had ever taught him, hoping against hope that a young naval lieutenant could hold out against what must be the whole Imperium chasing him.

Which story is true? Only two men alive know....





The Rebellion

The moment that the rebellion started can be determined quite specifically. Video cameras recorded the event; precise timers noted exactly when the first shot was fired.

At 1517 hours on 132-1116, Dulinor, the Archduke of Ilelish, fired four shots from his personal sidearm, and in succession, assassinated the Emperor Strephon, the Empress Iolanthe, the Grand Princess Ciencia Iphegenia, and the Aslan Yerlyaruiwo ambassador. The throne room was in immediate turmoil.

1116

The year the news of the assassination spread throughout the Imperium.

Archduke Dulinor fled Capital immediately, retreating to his own territories in Ilelish where he had already prepared an uprising to support his claim for the throne. In the days immediately following the assassination, the Emperor's nephew Lucan took power, declared a state of emergency, and crowned himself Emperor. When the Moot opposed such swift action, he dissolved the assembly and took steps against those nobles who were outspoken in opposition to him.

Lucan also dispatched fleets in pursuit of Dulinor, and broadcast messages to all parts of the Imperium condemning Dulinor and calling for support of Imperium against all of its enemies.

Most of 1116 was taken up in the transmission of the news from Capital to all parts of the Imperium. As the news was absorbed, the many constituent factions of the Imperium made choices for the next course of action.

1117

The year the basic factions established themselves.

Solomani fleets on the Imperial border crossed it as soon as official word of the assassination reached them. Their advances into Imperial territory were resisted, but the Solomani border was pushed forward some 20 parsecs. Terra was recaptured by the Solomani. Imperial forces were forced to consolidate in the Vegan Autonomous Region, surrounded by Solomani fleets.

Dulinor's fleets clashed with Lucan's fleets, establishing a battle line about midway between Capital and Dlan. Numerous clashes produced tremendous attrition in both sides' fleets, and by mid-year, they had settled into a firm stalemate.

A confidential message was circulated throughout the Imperial fleets by supporters of Margaret. Critical of Lucan, it promised the support of the Moot for a faction that supported Margaret as the legitimate heir to the throne. Despite steps by Lucan's security forces, several crucial fleets sided with Margaret in a concerted withdrawal from the battle lines. Margaret's mutiny stripped six fleets from Lucan's control and

then allowed her to establish a secure stronghold in Delphi sector.

In order to reinforce the fight against Dulinor, Lucan made a deliberate decision to strip (on a strictly temporary basis) the frontiers of fleets. Corridor, Lishun, and Old Expanses all received their orders early in the year. Old Expanses was, by this time, under attack from the Solomani (although Lucan was not yet aware of the fact); when the fleet was withdrawn from the sector, the nobles of Old Expanses saw no alternative but to surrender. By late in the year, the Solomani had completely taken over more than 16 subsectors of border territory. Lishun Fleet withdrew and transferred to the battlefield in Zarushagar and Dagudashaag sector. For a few months, Lishun remained stable, but it was then rocked with a succession of Vargr invasions; as the Vargr saw little or no resistance, they became bolder and bolder, pushing their incursions nearly to the edge of Core sector itself. Corridor Fleet left that sector about mid-year. Always subject to Vargr raids, after the withdrawal Corridor felt the sting of Vargr plunderers almost immediately. Along with the raids came the cutting of both the trade and communications routes to the Spinward Marches and the frontier.

Dulinor mounted a strong offensive intended to cut support for Lucan while at the same time building support for himself. Several fast fleets were dispatched into Lucan's territory to function as commerce raiders and strike cruisers. They spent their time disrupting trade by raiding merchant shipping and by making strikes against High Population worlds supporting Lucan. They served their purpose by diverting many of Lucan's sorely needed fleets from the front line in an extended chase of the raiders.

In mid-year, announcements were made that Strephon was alive at the Imperial vacation palace in Gushemege. Loyal citizens were called upon to support Strephon in organizing forces to destroy Dulinor and unseat Lucan. Both Dulinor and Lucan took extensive steps to suppress news of Strephon's return.

Fleets in the Domain of Deneb were transferred to reinforce the Domain's coreward borders in order to control Vargr corsairs. At about this time, Aslan ihatei fleets on the borders of the Spinward Marches found that territory unable to resist

intrusions, and Aslan ihatei began settling on hospitable border worlds. Fleets under Norris command attempted to halt these invasions, but the fleets were spread thin by earlier deployments.

1118

The year each faction struggled to strengthen its own position while weakening all the others.

Viand naturally felt threatened by the advances of Vargr in neighboring Lishun and Corridor sectors. When Lucan demanded a portion of Viand's fleets to reinforce the assault on Dulinor, Viand solidly refused and declared its independence. Viand recreated its traditional government—the Vilani Empire.

Antares, under Brzk, found itself fighting a losing battle against Lucan's forces and negotiated an alliance with the Julian Protectorate just beyond the Imperial border. Within months, this relationship was transformed into an absorption into the Protectorate. Lucan's forces were compelled to back off.

Lucan, while searching for additional fleets to reinforce his battle lines against Dulinor, ordered Daibei fleet to transfer to Zarushagar sector. The sector nobles refused this order and announced that they too would take an independent and neutral path.

1119

The year the Rebellion settled down to a dedicated battle to the death between Lucan and Dulinor.

Other factions contributed their forces to resolving squabbles between them, picking away at Lucan or Dulinor or both, or just trying to survive the chaos that was enveloping the empire.

THE LONG-TERM REBELLION

Each faction of the Rebellion quickly established a base of power. At and within a reasonable radius of that established base of power, the faction could expect to hold a fairly solid base of power. That reasonable radius, computed based primarily on travel times, works out to about 20 parsecs for each faction.

Beyond 20 parsecs from a faction's base of power, controlling and directing worlds becomes quite a difficult proposition for the faction. Fleets need orders; armies need supplies and support; and, in addition, attacks need coordination. And the farther the battlefields are moved from the base of power of the faction, the more difficult they are to direct and control. Losing battles is expensive, but on the other hand, so is winning them. Even committing fleets and forces uses up resources that might be needed by the faction more desperately later. The least expensive course of action is to cautiously prepare, building strength while waiting for the other side to make a mistake.

Beyond the roughly 20 parsec radius of power, the territory of the Imperium became a no man's land, left alone, completely to its own devices. Commerce raiders swept through the subsectors looking for merchants that they could commandeer. And raiders struck out at small, sparsely populated worlds in campaigns meant to force the allegiance of these worlds to

swing to one faction or another.

Stuck among the systems of the no man's land were the prizes of the Rebellion: Those were the highly valued High Population worlds. Together the High Population worlds represented the key to the Rebellion. Control of the High Population worlds of the Imperium represents control of more than 90 percent of the empire's population. The faction that controls the High Population worlds controls the citizens that make up the Imperium. Controlling worlds alone is useless unless the technological innovators, the consumers, the markets, and the labor forces of the High Population worlds are also controlled.

In 1119, the basic boundaries of the factions were drawn. Factions then settled in to the protracted campaign to control the hearts and the minds of the people of the Imperium. The final outcome of the Rebellion depended on which factions managed to gain control the High Population worlds of the Imperium.

Campaigns against the High Population worlds changed the nature of rebellion warfare. Star fleets can continue to fight for space lanes forever, but to gain control of a High Population world, it is necessary for a faction to find a way to control the hearts and minds of the people who inhabit that world. On some worlds, the threat of space bombardment is frightening enough to produce sincere pledges of loyalty from inhabitants and give the faction control... pledges which last until the next space fleet arrives. On some worlds, loyalty can be bought by the highest bidder. And on some worlds, loyalty can be won by a superior philosophy. But no matter what method is used, on all worlds loyalty must be won in some way, whether by space fleets, money, or by rhetoric. These campaigns for the individual worlds of the Imperium are the focus of the Rebellion. The ultimate winner of the Rebellion will be the faction that can successfully wage campaigns for the hearts and minds of the people of the Imperium. (Indeed, if one faction can ever possibly even hope to be successful in capturing every heart and every mind in the empire.)

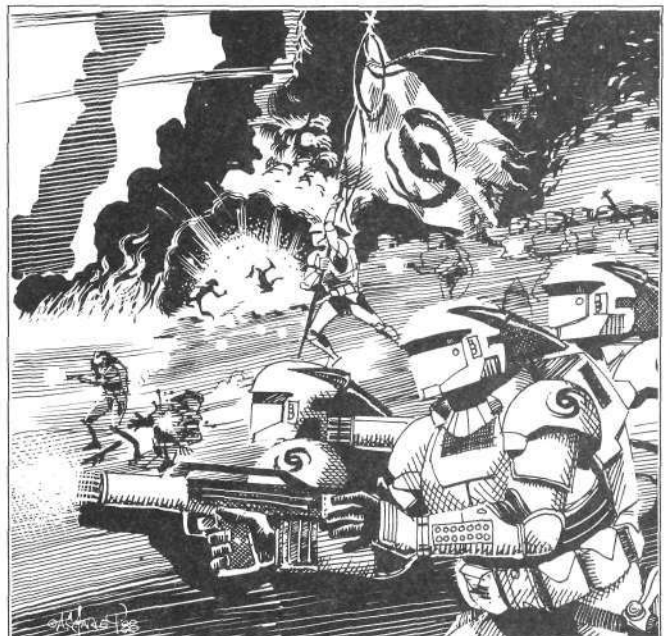

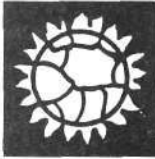

One Clear Choice

The Imperium has, over the centuries, built its power by being the best possible choice for anyone and everyone within its jurisdiction. Imperial citizens receive benefits that are impossible to attain anywhere else. Imperial corporations pursue profitable enterprises within the framework of a peaceful empire dedicated to encouraging trade and commerce. Imperial nobles wield power over the largest human government ever.

Political scientists acknowledge that there can hardly be unanimous agreement about government among 15 trillion citizens across hundreds of parsecs. Too many diverse interests and too many individuals make perfect agreement impossible. But the Imperium has established itself as the dominant government of human space by providing a reasonable environment for active trade, peaceful settlement, and technological progress. Clearly the majority have elected to support the Imperial government, whether actively or passively, because there is no clear choice of an alternative. While many governments could be worse, no one can agree on one that would be better.

THE IMPERIAL CHOICE

The Imperial choice is acknowledged as preferable throughout the spectrum of Imperial society.

Nobles: The pinnacle of Imperial power is the Emperor. All nobles within the Imperium ultimately owe their allegiance and their loyalty to that one person. The nobles support the Emperor because he is the source of their fortunes, their security, their power, their glory, their very livelihoods. Many nobles inherited their titles; others received them as direct grants from the Emperor. Noble titles are awarded for merit, as a reward for favors or support, as endowments, or just by Imperial whim. They are rewards for actions and behaviors that support the Imperium.

A common practice is to give vocal dissidents noble rank and to co-opt them into working within the system. The Imperium opens its arms and its upper ranks to include a broad spectrum of philosophies and ideologies within its borders. As a result, every noble has one clear choice when he or she is called upon to choose, and that choice is the status quo.

Commerce: Businesses operating within the Imperium operate within a system that encourages capitalism, competition, return on investment, and profits. Government interference in business is limited and intended to create more business rather than restrict it. Every business has one clear choice, and that choice is the status quo.

Citizens: The influence of the Imperium on the lives of its citizens is pervasive, but not obtrusive. The Imperium puts no great burden on the average citizen: Taxes are built into the price structure of goods and services; Imperial laws and courts are just and fair; Imperial services are reasonably efficient. Citizens rarely even consider alternatives to the Imperial system.

Everyone gains when the existing power structure is supported: the noble, the people, the government, business interests, everyone.

The structure of the Imperium is designed to provide clear choices. When called upon to choose, the nobles support the Emperor. When the Emperor dies, the successor is determined by heredity. Clear choices give clear answers.

ALTERNATIVES TO A CLEAR CHOICE

But what happens if there is no clear choice? Under the thin veneer of clear choices, the component worlds, nobles, businesses, and citizens of the Imperium harbor a maze of conflicting priorities and allegiances. Divergent ideologies, loyalties, racial backgrounds, technological prejudices, and millions of preferences all lie beneath this surface layer of one clear choice. Within the framework of the one clear choice of the Imperium, all of those preferences and conflicts are slowly worked out by a process of compromise and negotiation. But when the one clear choice is eliminated, each individual follows his or her or its own conscience.

The result is anarchy.

If Dulinor had killed only Strephon, the one clear choice would be the Grand Princess Ciencia Iphegenia. A simple succession ceremony would have established the new Empress. A vendetta against Dulinor would have begun, with the renegade Archduke ultimately hunted down and executed. The Imperium itself would have continued as before.

If Dulinor's plan had succeeded, the one clear choice would have been Dulinor. A more elaborate succession ceremony would have elevated him to the throne governing 8976 star systems. The reins of power would have changed, but the Imperium itself would have continued as before.

Instead, circumstances intervened. The plan to eliminate the two Imperial nephews—Varian and Lucan—failed. Unforeseen resistance in the Imperial Palace forced Dulinor to flee Capital before his succession was fully implemented. The circumstances of Varian's death pointed to Lucan rather than Dulinor. Suddenly, there was no one clear choice to hold the Imperium together.

THE NOBLES' CHOICES

In the face of no clear choice, every noble in the realm was thrown upon his own conscience to decide what was best for the Imperium, for himself, and for his own causes. Unless and until one clear choice emerged, every noble would continue to make those choices that reflected a greater and greater divergence of preference and loyalty.

Solomani: Solomani nobles, originally created to garner their participation within the framework of Imperial government, found their loyalty to the Solomani cause reemerging as their one clear choice. Nobles from nonhuman races found, as the Imperium that protected their minority status collapsed, that their one clear choice was a path of independence or neutrality. Nobles in the sectors dominated by Dulinor were confronted with a choice of resisting Dulinor's power structure and surrendering their own power, or of acquiescing and supporting the Archduke. Although decisions were made both ways, the majority found one clear choice was bending with the wind.

Lucan: Lucan, rumored to have killed his twin brother in order to himself ascend the throne, seized power quickly enough to assure the loyalty and the support of the Imperial Guard and much of the armed forces on Capital. At the seat of power of the Imperium, nobles found their own one clear choice was to support the man who held the reins of power.

As Lucan gave orders to seek out and destroy Dulinor, the might of the Imperium was shifted into a campaign to crush the rebellion. Because of Dulinor's resources and advance planning, the crushing blows were thwarted or parried. Lucan was forced to divert Imperial fleets from the frontiers in order to continue the battle. When he transferred the Corridor Fleet, it stripped that sector of its defenses against the Vargr beyond the border. When he transferred the Lishun Fleet, he effectively reduced the Imperial defense against the Vargr by half.

Dulinor: Dulinor made his own choice long ago. Driven by a strong sense of duty and a commitment to the Imperium, he made it his own goal to improve the clear choice of the Imperium for every citizen. Over time, the conservatism of the nobles and the slow pace of Imperial response forced him to conclude that the Imperium could be better under his own rule. In a rare move within the structure of the Imperium, Dulinor chose against the Imperium.

Margaret: The rise of Lucan produced profound doubts in the minds of many Imperial nobles about the future of the Imperium. They cast about for a clear choice for a viable Emperor (or Empress) and settled on Margaret as their candidate. Margaret accepted the mandate as her own expression of a clear choice.

Viand: Viand sector, home of the ancient capital of the First Imperium, faced the possibility that its own fleet would be transferred, making it vulnerable to Vargr invasions. The sector found its own clear choice and seceded from Imperial authority to create (or recreate) the glory of the First Imperium.

Antares: The Archduke of Antares originally believed that he was the Moot's one clear choice to succeed the slain Emperor. Subsequent events convinced him that the Moot would never select a nonhuman as Emperor. At the same time, Lucan stripped Lishun sector of its fleet, leaving Antares' border vulnerable to outside threats. Archduke Brzk found his one

clear choice was to declare independence for his sector, joining it with the more stable Julian Protectorate just across the border. The nobles of the sector, familiar with Brzk as a superior, found one clear choice was to follow his lead.

Daibei: Daibei sector found itself caught between the advances of the Solomani, the threat of Dulinor, and the possibility that Lucan would withdraw its fleet. In pursuit of security for the sector, the majority of Daibei's nobles elected armed neutrality. Their one clear choice, like so many others, found them rejecting the Imperium.

Norris: And on the farthest borders of the Imperium, the Spinward Marches sought its own one clear choice. Its clear leader, Norris, the newly appointed Archduke of Deneb, plainly declared his own loyalty to the Imperium while avoiding a declaration of which leader of the Imperium owned that loyalty. Yet even in the face of an unwavering loyalty to the Imperium, the interests of the Archduke, his followers, and his Domain began to diverge from the interests of the Imperium from the first day of the Rebellion.

OTHERS' CHOICES

Businesses, political leaders, and ordinary citizens are influenced by the same factors that influence the nobles of the Imperium. Business, in pursuit of profit and stability, clearly chooses the stability of the Imperium. The collapse of the Imperium, however, forces business to follow the lead of the nobles. Whatever political stability follows from the nobles' choices is at least better than active opposition to the new status quo. Similar considerations apply to political leaders and to ordinary citizens.

The rebellion is a contest between the factions of the Imperium as they struggle to become the one clear choice everyone in the empire can agree on. Time, violence, argument, persuasion, and exhaustion will make all citizens accept the final result. What that final result will be—a unified empire under Lucan, Dulinor or Margaret, or a fragmented empire with any number of pieces—remains for the future to reveal.



Ripples in the Imperium

Concentric circles show the propagation of information about Strephon's assassination on 132-1116. The first date on each ring is the date information arrived at jump-6; the second shows the date information arrived by express boat.

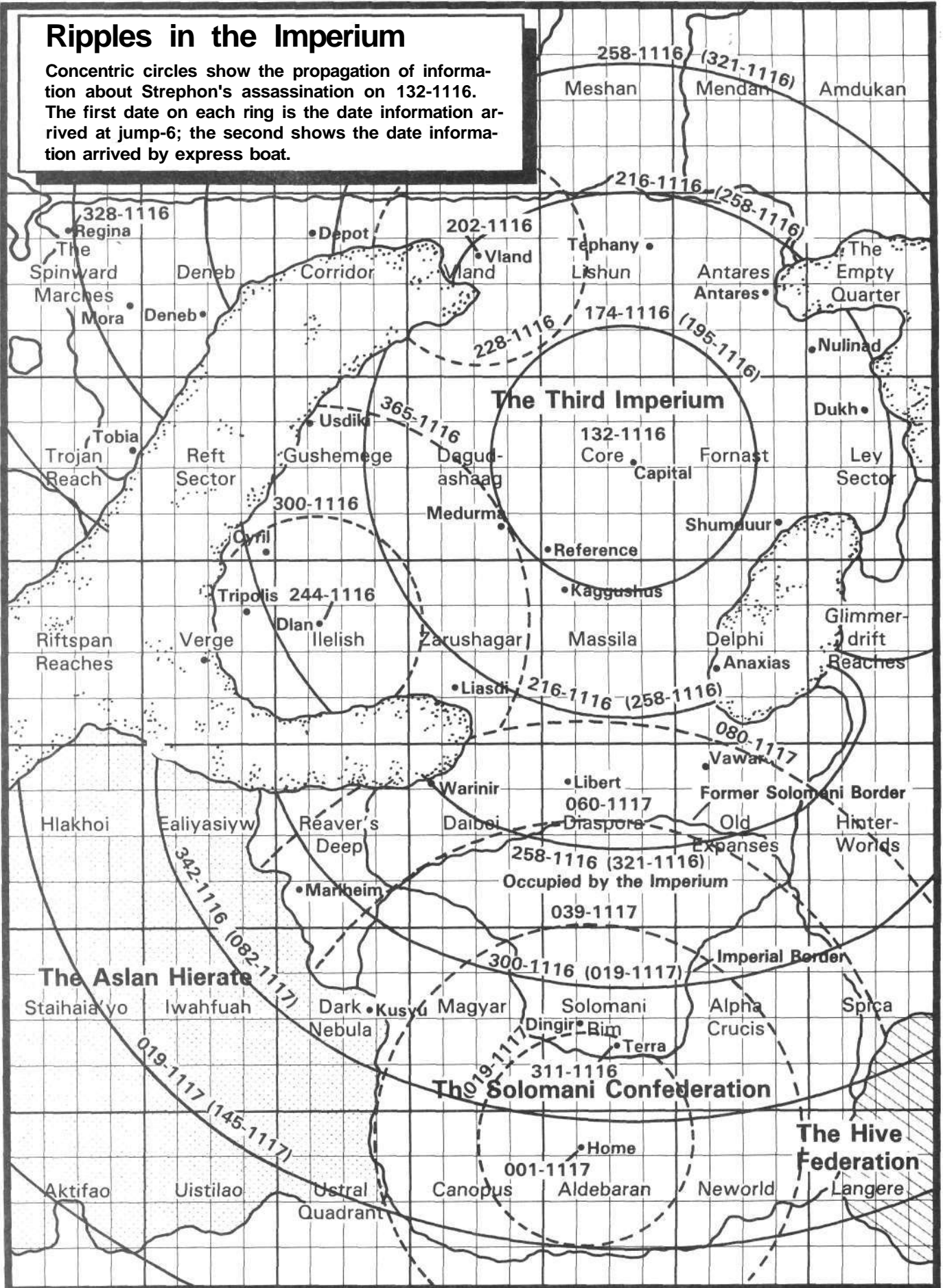

Ripples Through the Imperium

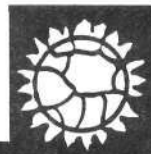

The Rebellion, once triggered, spreads throughout the Imperium like the ripples of many stones thrown into a pond. Emanating outward from Dulinor's four pistol shots on 132-1116, the ripples washed over each of the worlds of the Imperium in succession. And from each of those worlds, the reactions to the assassination then swept outward again, until the entire structure of the empire was awash with the ripples and currents of the Rebellion.

Unlike ripples on a pond, however, the news of the assassination and of the rebellion travelled out at different speeds to different places. Official word travelled at one speed; an advance warning was reached somewhat faster; Dulinor's forces had a notion, before the assassination even occurred, that an Imperium-shattering move was afoot. Since knowledge is power, foreknowledge is greater power.

INTERSTELLAR COMMUNICATIONS

Word of the assassination was spread by three primary means: the public express boat routes, the Imperial Navy's Couriers, and the Imperiallines covert Signal TJ transport network. In addition, news travelled on commercial liners and transports in the course of ordinary trade.

Express Boats: The entire Imperium is crisscrossed by a network of express boats which carry electronic mail and information for businesses, governments, individuals, and news services. Operated by the Imperial Interstellar Scout Service (and in effect an interstellar postal service), the express Boats help bind the Imperium together by speeding the flow of information at the fastest practical speeds.

Express Boats (xboats) travel standard, established routes within the Imperium. They carry electronic messages using special transmission systems. Stations for the deposit and delivery of xboat messages are maintained on most worlds along the xboat routes.

The standard xboat routes are travelled at jump-4—four parsecs per week. A message from Capital will reach Viand in 19 weeks; it will reach the Spinward Marches in 51 weeks.

Speeds greater than jump-4 are available, but they are increasingly more expensive at jump-5 and jump-6 (speeds greater than jump-6 are theoretically impossible). The cost of a jump-6 xboat network is high enough to make a universal jump-6 xboat network inefficient. But there is another reason. Because knowledge is power, the Imperial government realized long ago that establishing a jump-5 or jump-6 network would mean giving up the ability to receive information early. Knowing vital facts before they become general knowledge is essential to a well-run bureaucracy.

So the Imperial bureaucracy routinely dispatches information along secret, government-only courier routes to selected high-level nobles within the Imperium. Such dispatches provide bureaucrats and nobles with advance word of important developments before the news becomes general knowledge.

Two distinct, partially duplicated, jump-6 networks are main-

tained by the Imperium: the Naval Couriers, and the Imperiallines Signal TJ System.

Naval Couriers: The Imperial Navy maintains a force of jump-6 ships which represent the best technology the Imperium can buy. Theoretically part of the Imperial Navy's force structure, Fleet Couriers are carried on the rolls as tactical couriers which relay information between squadrons of the fleet. An overstrength of the Fleet Couriers makes some of them always available to carry government dispatches to the worlds of the Imperium.

Naval Couriers carry dispatches for the navy and for the Imperial bureaucracy. Couriers can carry a few tons of cargo, and maybe a passenger or two, but their primary function, like xboats, is to carry information.

The Imperial Navy, in its own effort to speed up the flow of information being carried by its couriers, created a clandestine refueling station deep within the Great Rift during the 800s. Located six parsecs from Ashishinipar (in Corridor sector), the station and its shortcut allows a jump-6 Fleet Courier to carry dispatches from Capital to Regina in two weeks less than carrying them along the normal route through Viand and around the edge of the Rift.

Imperiallines Signal TJ System: Imperiallines is a tramp freighter operator with trade stations located at many type C starports throughout the Imperium. The company maintains a low profile as the operator of a fleet of jump-2 frontier transports carrying cargo from outlying systems to the major trade route worlds.

Type TJ Frontier Transports operate at the direction of the Emperor, or, more properly, they operate at the direction of his agents. TJs can carry hundreds of tons of cargo, up to a dozen passengers, and gigabytes of electronic messages. They can simply carry messages, but the frontier transports are also designed to carry equipment and agents in the service of the Imperium.

Imperiallines is owned, through a morass of untraceable interlocking companies and holders, by the Office of Personal Transportation of the Imperial Household. Although a profit-

making enterprise in its own right, Imperiallines is the Emperor's own secret courier network.

The company's fleet is ostensibly composed of hundreds of jump-2 type TI Frontier Transports. Each 2000-ton ship carries about 1100 tons of cargo. Actually, about half of the ships are a variant jump-6 type TJ. Externally identical to the type TI, the type TJs carry less than 300 tons of cargo and load more fuel. Mingled in with the plodding type TIs, the TJs are virtually impossible to monitor and track.

THE WORD SPREADS

When Strephon was assassinated on 132-1116, word of the deed went out immediately.

The Imperial Navy immediately sent out word by its fleet couriers to all the naval bases within six parsecs of Capital; from those bases, fleet couriers then proceeded to all naval bases within six parsecs of them; the chain continued until every Imperial naval base was notified of the death of the Emperor. As each naval base was informed, its intelligence section immediately notified the base commander, who in turn notified fleet and squadron commanders. High ranking Imperial nobles were also provided with the information. But no general announcement was made. Instead, naval and noble leaders with the information used it to prepare an official announcement for the general public that would inevitably come on the official news services.

The Imperiallines TJ system reacted with the same speed that the navy did. Primed and ready for any major emergency, the TJ system provided immediate notification to its own operators and to the many clandestine projects that it was supporting at the time of the assassination.

The news services filed stories and dispatched them immediately on the xboat network. As the story broke on each world, governments declared official periods of mourning and made vague pronouncements about the future.

A Typical Notification: When Strephon was assassinated on 132-1116, hundreds of ships left Capital with news of the Emperor's death. The news eventually reached Regina, 130 direct parsecs from Capital.

Imperiallines TJs radiated from Capital to the company offices throughout the empire. Individual ships were assigned a sequence of offices to notify. One ship was assigned to transport a notification to Regina and the Spinward Marches. Because its route was selected for the greatest possible speed, it arrived at Depot in Corridor on 251-1116, having bypassed Viand to take a slightly faster route. Proceeding directly through Corridor and Deneb sectors, it arrived at Regina on 328-1116. The journey took 196 days and averaged jump-4.64.

Naval Couriers began notifying naval bases immediately. Many possible chains of notification existed; the swiftest notification travelled across the Great Rift, passed through Deneb on 286-1116, and arrived at Regina on 342-1116. The trip took 210 days and averaged jump-4.33.

Express boats relayed the message from system to system along the established routes. The first xboat news of the assassination arrived at Viand on 265-1116, at Depot in Corridor on 349-1116, at Deneb on 54-1117 and at Regina on 124-1117. The news arrived 357 days after the assassination (an average of jump-2.55). It was announced on that date.

THE USURPER'S PLANS

Dulinor cheated. He already knew about the assassination. When he left for Capital and his fateful audience with the Emperor, he already knew his plans. Files of announcements and releases were already stored and ready for the trigger signal. When he fled Capital with his squadron, he had absolute knowledge of what had happened. For Dulinor, knowledge was an advantage to be used.

Dulinor fled Capital aboard his squadron flagship, the Sargon, a jump-6 cruiser assigned to the Illeish sector fleet. He reached the first worlds of the Domain of Illeish after seven weeks of continuous jumping; as he entered his domain, he rendezvoused with a prepositioned squadron at Urak (on 182-1116). As his squadron jumped through the Domain of Illeish toward Dlan, individual ships split off to visit major worlds and release Dulinor's proclamation announcing the demise of the Emperor and his own assumption of the throne. When Dulinor arrived at his estates on Dlan (on 244-1116), he formally announced himself as Emperor; the announcement was made far before any possible Imperial announcements could be.

Dulinor's first announcements gained him considerable advantage. Citizens tended to believe what they heard from the news services. In the absence of any contradictory reports, the citizenry was naturally led to believe the accuracy of Dulinor's announcements. In the early days of the Rebellion, most citizens of the Domain of Illeish believed Dulinor to be the reigning Emperor. Express boat news carrying Lucan's version of the assassination began appearing in the Domain of Illeish about 210-1116. It would have reached Dlan, at the center of the domain, about 330-1116, but Dulinor's forces intercepted the news and suppressed it. In some parts of the domain, the Express boat network never carried any alternative coverage of the assassination. Lucan was portrayed as the usurper, and Lucan's forces were shown as rebels against Dulinor's rightful reign.

Control of information was a critical part of Dulinor's plans. By predetermining what information was available, he was able to shape public opinion and public support of his own reign. With the advantage of 10 weeks (more in some parts of his domain), he entrenched himself before any contradictory statements were ever heard.

Dulinor used his time advantage to consolidate his position. Dependable news of Dulinor's actions made its way back to Lucan, but it took time in doing so. A good, solid picture of Dulinor's plans and actions was clearly available to Lucan and his naval staff by about 045-1117.

THE SOLOMANI FRONT

The instant Strephon died, several independent Solomani agents on Capital each made his own way to the central starport and began the urgent journey to the Solomani Confederation. The news that the Emperor was dead was an important fact that could influence the course of Solomani policy for years to come.

The first secret reports reached Terra on 311-1116, and the Solomani capital of Home on 001-1117. Solomani agents, as well as Imperial leaders, received the news at about the same



THE IMPERIAL FAMILY—1116

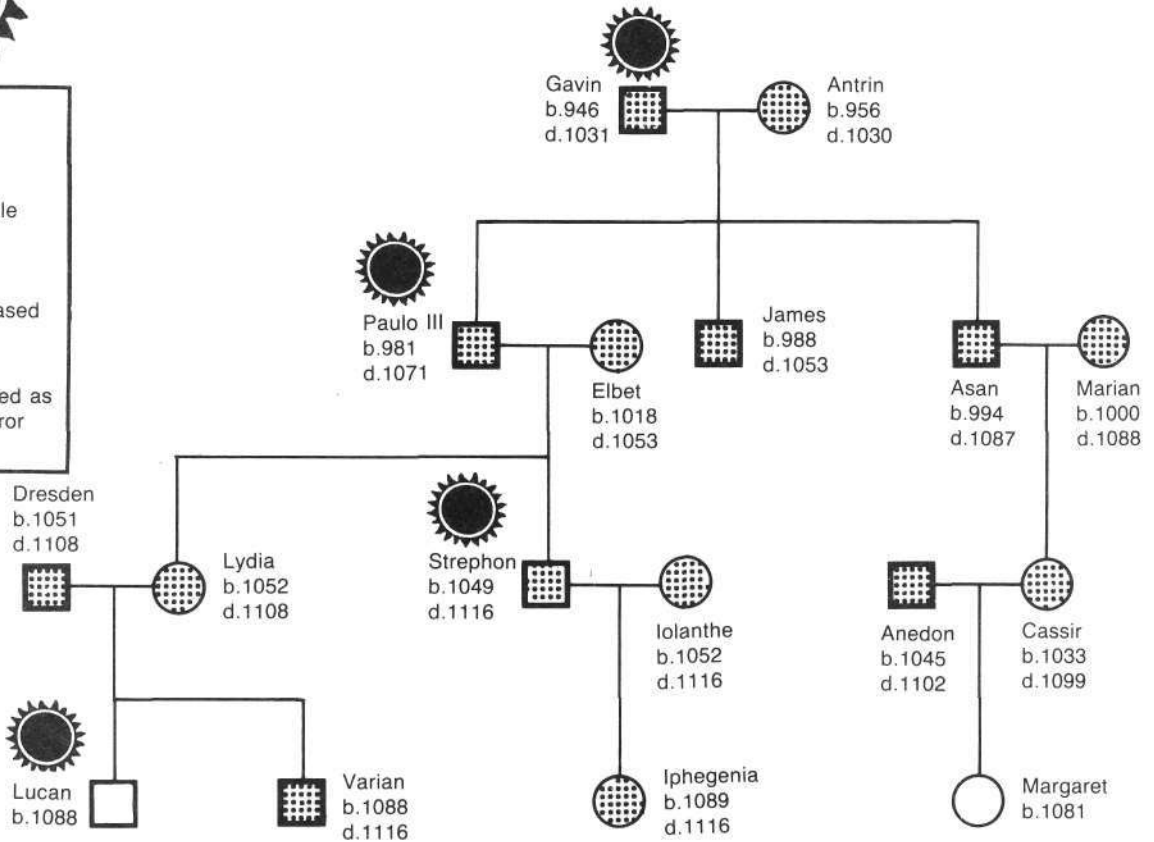
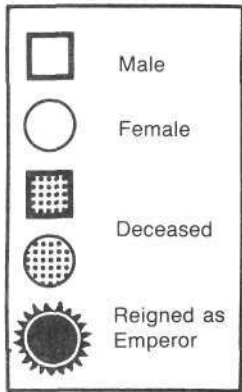

THE IMPERIAL FAMILY

The throne of the Imperium normally passes to the senior heir of the Emperor when he dies. In the case of Strephon, however, his senior heir was killed at the same time he was. Naturally enough, some discussion of the merits of other heirs' claims has followed in the wake of his death.

Ciencia Iphegenia: Only child and daughter of Emperor Strephon and Empress Iolanthe.

The Grand Princess was the perfect candidate for the throne. Her very title of Grand Princess, traditionally bestowed on the acknowledged heir of the Emperor when he comes of age, declared to the Imperium and to the universe that she was accepted in Imperial society as the successor to Strephon when he died.

Because Strephon died before Ciencia Iphegenia, the mantle of the Imperium theoretically passed to her despite the fact that there was no time for an acknowledgement or a coronation. If Ciencia had herself had heirs, they would then have a priority claim on the throne. Unfortunately, the Grand Princess was unmarried and died childless.

Varian: Elder of twin nephews of the Emperor Strephon. Son of Duke Dresden and Princess Lydia.

After the Grand Princess, the next living candidate for

the throne was Prince Varian. As the Emperor's nephew (son of the Emperor's younger sister Lydia), Varian was always aware of the thin thread that could lead him to the throne. He also knew that there was little, if any, chance of him really assuming the throne. As with the Grand Princess, if Varian had had heirs, they would have had a priority claim to the throne, but he died unmarried and childless.

Lucan: Younger of twin nephews of the Emperor Strephon. Son of Duke Dresden and Princess Lydia.

Prince Lucan stood third in line after Varian. Birth five minutes later forever put him behind his brother.

Margaret: First cousin, once removed of the Emperor Strephon. Margaret shares the same great-grandfather (the Emperor Gavin) with Emperor Strephon.

The Duchess Margaret (not close enough to the throne to be a princess) lives far from the social whirl of the Imperial court. Regardless of her relatively high noble rank, she would be competing with archdukes and admirals for a dominant social position. She has chosen to be a big fish in a smaller pond, holding court in the social circles of Delphi and Massilia sectors. Her marriage to Count Blaine Trulla Tukera (Tukera Lines family) has assured her of wealth and him of influence. They make a great couple at the pinnacle of society across the two sectors.



time, but by tacit agreement, neither made a public announcement.

News of Strepthon's assassination was received with great interest by all three powers within the Solomani government. The Solomani Confederation Navy and Army saw great potential in a military campaign against the Imperium, especially against an empire already divided by an internal struggle over succession the the throne. The High Council of the Solomani Party agreed that weakness in the Imperium should be exploited. Solomani Security, always rabid in pursuit of its mission of "maintenance and protection of the Solomani Cause against all enemies," already had plans in place to invade the Imperium and recover the territory of the old Solomani Autonomous Region.

Each of the three powers undertook independent planning in response to Strepthon's assassination. As each revealed its plans to the other two, they all realized that they were in accord. Chairman Trinoch, head of the Solomani Party, emerged as the charismatic shaper of the plan and leader of the offensive.

The xboat channels arrived at Terra on 037-1117 and at home on 117-1117. Solomani fleets had received orders "to be opened only in the event of the Emperor's death." The news of Strepthon's assassination was the signal for a broad front advance into Imperial territory along the Solomani border. Within weeks, Solomani fleets crossed the border, pushing Imperial border fleets back an average of two subsectors.

Daibei: Many of the retreating Imperial fleets accumulated in Daibei sector. By the end of 1117, the Solomani could advance no farther. The temporary border was only slightly short of the Solomani goal—the old Solomani border.

The Solomani Rim: The first Solomani move was retaking Terra and driving the Imperial fleets out. Imperial forces rallied in the Vegan Autonomous Region and established defenses for the connecting links between Vega and the Imperial capital.

The Old Expanses: Late in 1117, Solomani fleets had moved into portions of the Old Expanses Sector, steadily pushing the border coreward. By the end of the year, approximately a third of the sector was under Solomani control.

THE EARLY DAYS OF THE REBELLION

Throughout much of 1117, the course of the Rebellion was shaped by the two great confrontations ongoing within the Imperium: Dulinor's insurgence within the Domain of Illeish, and the Solomani attacks on Imperial territory within the Domain of Sol. Both were characterized by massive fleet movements, disruption of interstellar trade, and widespread destruction of installations and supporting industry.

In the initial days of this fighting, the local fleets and squadrons of the Imperial Navy bore the brunt of the losses and the responsibility for the fighting. Both the Solomani and Dulinor's forces knew their mission and their strategy, while Imperial forces necessarily had to fight in the dark; the new Emperor had not yet even been notified of the fighting, let alone given any specific orders.

By about 090-1117, Lucan was well aware of Dulinor's rebellion and of his control of the Domain of Illeish. Imperial fleets were already mobilized and fighting against Dulinor's forces. Dulinor, with the advantage of prior planning and quick

reaction times, was winning in his campaign to control Illeish. He was also succeeding in some parts of neighboring sectors. And even as those forces fought, the ripples had not yet reached some of the borders of the Imperium.

Lucan's response to Dulinor was the first crucial misstep of his reign. Lucan panicked.

He ordered two of the strongest fleets in the empire (Corridor Fleet and Old Expanses Fleet) transferred to Core sector to reinforce the effort against Dulinor. When the orders were issued on 095-1117, he still had no idea of the problems it would cause.

The transfer order reached the Old Expanses on 224-1117. The Sector Admiral, never questioning his orders, began immediate preparations for the relocation, with the first squadrons leaving within a week. Over the course of the next 60 days, every possible ship was dispatched. The defense of the Old Expanses was left in the hands of the reserve squadrons of the Navy. In the face of continued Solomani fleet actions, a rise in Solomani political activity in the sector, and being left defenseless by the Emperor, the sector Duke negotiated a voluntary incorporation into the Solomani Confederation.

The transfer order reached Corridor on 221-1117. Corridor Fleet, vastly overstrength for the territory it patrolled, was staffed by personnel from throughout the Imperium. Its mission, one it had pursued for centuries, was to protect the passage through Corridor of Imperial commerce and communications. Although abandoning that mission was difficult, the Emperor's transfer order made it clear that a higher mission was being assigned: to help save the Imperium from the rebel Dulinor. Corridor Fleet assembled at Depot on 242-1117 and began a long convoy to Core sector. The defense of the sector was left to a scattering of reserve squadrons. Peace, even without the massive Corridor Fleet patrols, continued for a time. Late in the year, several Vargr raiding expeditions made tentative forays into the sector. When they met only minimal opposition, they grew bolder and others followed. Express boat traffic came to a halt. Merchant ships cancelled their scheduled routes through the sector. By the end of 1117, Corridor sector was in chaos.

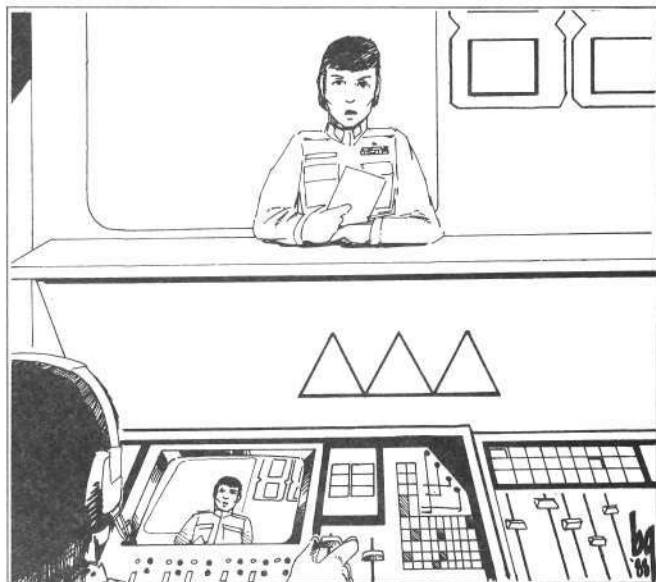



The Nature of Rebellion

Rebellion is a struggle against established government; its purpose is to wrest control of the government from those in power and to shift that power to new holders. The means of rebellion are varied: It is possible to take control of the government in a bloodless coup; control can be seized by military action; or the people themselves can rise up and throw out the current government.

Classical rebellion is a form of warfare. Armies and navies fight for control of specific places or populations. Once they take control, they can exert the power of a government even as they struggle to extend their reach to more and more territory. Ultimately, the factions of the rebellion reach a point where further struggle is pointless; one may be a clear winner, or several may agree to an uneasy peace.

Definitions: The purpose of the following definitions is to help provide a better understanding of the technique and nature of the Rebellion.

Rebellion: An uprising intended to change or overthrow an existing government.

Faction: A cohesive group characterized by allegiance to a specific cause. The existing government is a faction; more than one rebel faction may also exist.

Loyal: Those firm in their allegiance to the existing government.

Rebel: Those who owe allegiance to a faction other than the existing government.

THE REBELLION IN THE IMPERIUM

Regardless of the form or structure of government, the ultimate power of the Imperial government lies with the people. If the people accept their government, there is little that can be done to tear it down. On the other hand, if the people object to their government, all of the alternatives become possible.

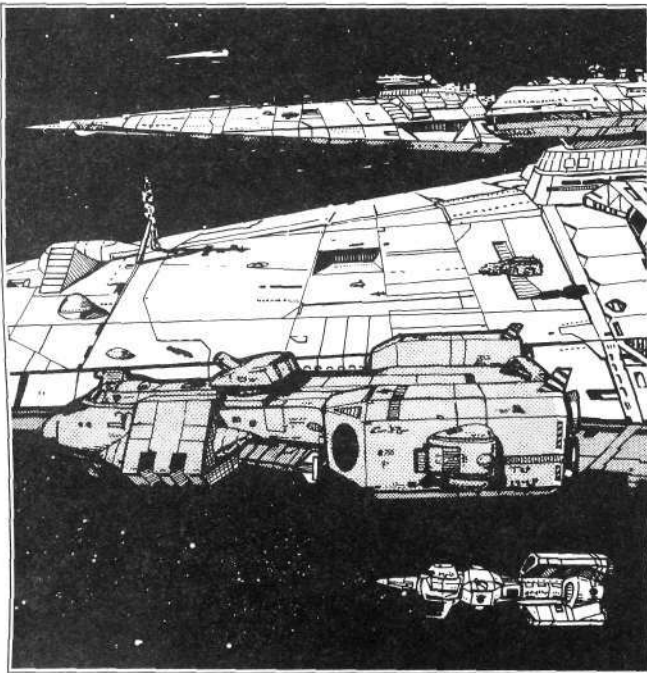

The assassination of Strephon opened the door to rebellion by making possible a variety of alternative governments. Dulinor's claim to be the new Emperor, where it was accepted, made it possible for his forces to become the government of Imperial territory. Lucan's claim to be the new Emperor, because it was accepted by some of the citizenry, made it equally possible for his supporters to control parts of the Imperial government. Where people rejected both Lucan and Dulinor, it became possible for others to step into the power vacuum and seize power.

Lucan considers Dulinor's actions a rebellion against the established Imperium as led by Lucan; every other faction which does not accept Lucan as Emperor is also engaged in rebellion. Dulinor considers (or at least publicly states) that Lucan is a rebel against the Imperium as led by Dulinor; as with Lucan, Dulinor considers everyone who does not accept his authority to be a rebel.

Other factions use the term rebellion as a convenient label. Viand more properly considers its action a revolution to re-establish its lost glory. Daibei cares little for the precise term used; its war is one of survival. Outsiders such as the Vargr and the Aslan do not consider themselves actually part of the rebellion; they are chewing on the edges, taking what they want from a weakened prey.

THE AIMS OF REBELLION

There is one major goal for rebellion: to seize control of the government. Everything else the rebels do is a means to that single end. Rebel star fleets which rain destruction down onto a world do so in order to force it to accept the rebels; loyal star fleets use the same means to force a world to reject the rebels.

Armies which attack or hold cities do so to keep control of population. Rebels who resist the government do so to make the government give up in a struggle that costs too much in money, lives, time, or ethics. Ultimately, every action that rebels or loyal forces take is directed toward seizing or holding control of the government.

Seizing control of a government is a difficult task. It can't be achieved simply by holding a building or a military camp or a city. Instead, the seizure must convince the citizens themselves that the rebels have the power to govern, and that resistance is not worth the effort. Indeed, rebels are saying to the existing government that the rebels are more capable of governing; if enough citizens side with the rebels, control of the government naturally passes to the rebels.

Subordinate Goals: In a rebellion many people are involved, and their own view of the struggle's goals may diverge from the simple one of seizing control of the government. Citizens under an oppressive government may feel themselves wronged; their own need for revenge becomes confused with the goals of the rebellion. Some see the chaos of the rebellion as an opportunity to make money; they become profiteers anxious for the struggle to continue so that they can continue to make money. Some less obvious profiteers see the rebellion as an enhancement to their careers; they have the opportunity to advance in rank and prestige, and they realize that the potential for advancement remains only as long as the struggle continues.

Keeping Score: Although a rebellion is aimed at seizing control of the government, the path to victory is not an easy one. The final result is achieved only after a long series of steps that establish the ability and the power of the successful faction.

During a rebellion, every faction needs to keep score by tallying its victories and its defeats. Too many defeats cause a faction's supporters to lose commitment and search for someone else to support; victories draw new supporters.

STRATEGIES OF THE REBELLION

The single goal of every faction in a rebellion is control. The existing government begins with a decided advantage because it has control of most aspects of government and can expect to keep control if no specific effort is made to take that control away. Rebel factions, on the other hand, can operate in secret to plan their moves, and they can decide to strike at specific targets at a time and place of their choosing.

There are at least four specific objectives which factions must attempt to control. If the objective is important enough, control of it is sufficient to provide control of the government. More likely, as control of all four objectives shifts into the hands of a faction, control of the government follows.

Resources: Resources include raw materials for industry, food production facilities, and factories for production of goods. Control of resources provides economic power to a faction. When a faction controls resources, it has a base which produces income to support other actions, and it has access to production facilities which can equip and support its members.

Pathways: Pathways include routes by which resources are shipped, information is transmitted, and population moves. Control of pathways provides a measure of control over the movement of resources, information, and population, and that control can be used to influence, restrict, or prohibit access.

Information: Information includes data about events, technology, commerce, industry, and history. Control of information allows that information to be manipulated, slanted, or restricted, and can be used to influence the perceptions of the population.

Population: Population includes all of the citizens who are subject to the existing government. Control of all population effectively confers control of the government, but rarely is a faction able to obtain such a broad measure of control. Instead, power transfers to a faction when it controls a sizable fraction

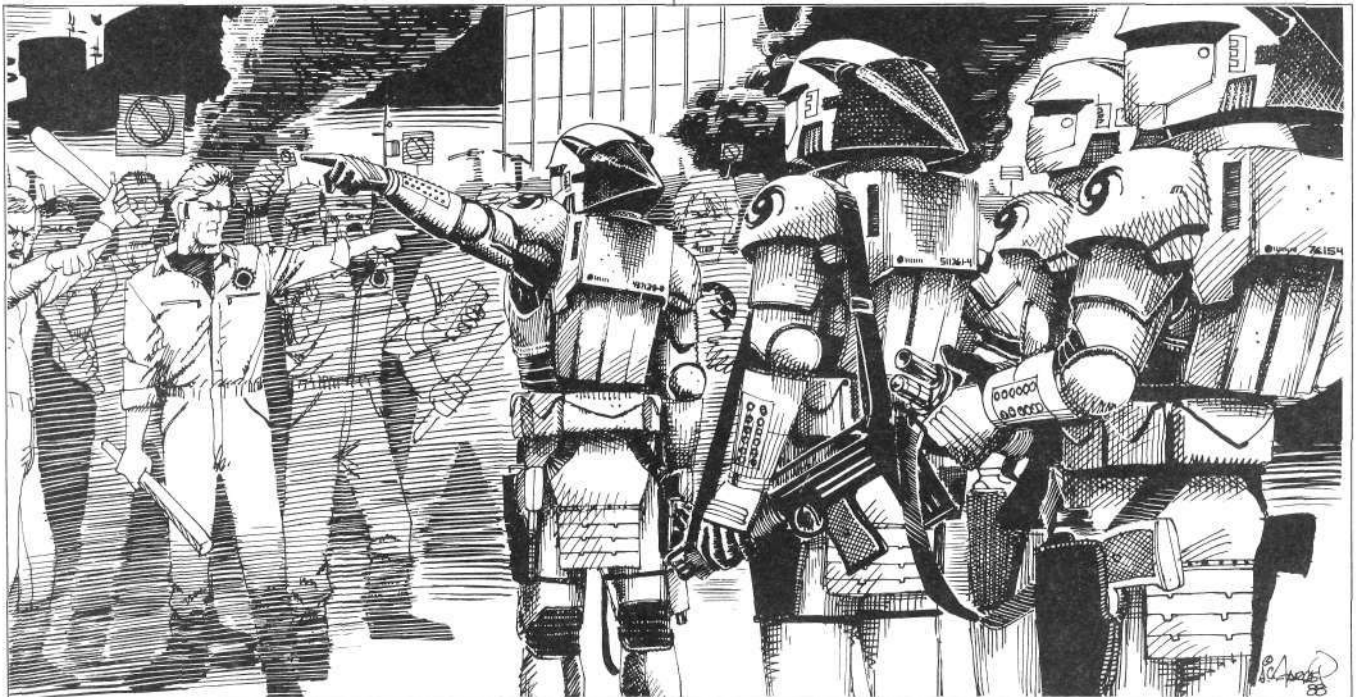

of the population and is able to convince enough of the remaining population not to resist the faction.

The interaction of these four controllable aspects of society is an interesting challenge to any faction striving for control. Population is ultimately what must be controlled by a faction. When a faction controls population, it controls the basic source of power for government, and no government can rule for any length of time if the population does not accept (not necessarily support, just accept) the government. Control of resources can be used to apply pressure to population to accept a faction: The approach may be a negative one in which resources are withheld (a siege is a good example of withholding resources in order to pressure a population), or the approach may be a positive one (e.g., bribes). Control of information makes it possible for a faction to influence population; through the falsification, slanting, providing, or withholding of information, a population can be influenced to support a specific faction.

Control of pathways is a shortcut to the control of both resources and information; if a faction controls pathways, then it is capable of allowing or restricting the flow of resources and of information, without actually controlling them.

TACTICS OF THE REBELLION

While the strategies of rebellion define what a faction must control in order to ultimately win, they do not spell out what must actually be done. The tactics of rebellion are manifold: They may be direct or subtle, or they may be threatening, overtly violent, or totally inoffensive. Any action which will ultimately bring support to a faction is an acceptable one.

Votes: A vote is a specific way that the preference of the population can be determined. It is an expression of control of the population, rather than a method of controlling population. A winning faction can point to the results of a vote as support for its side. If the vote is not clear-cut, those factions which receive relatively high fractions of the total vote can all claim that they are backed by the population.



A faction which has a great measure of control of a population can call for a vote and use the results to further reduce opposition by other factions. When a clear-cut vote establishes a faction as in control of the population, the power base of other factions effectively collapses.

In a very real sense, a strong vote in favor of a faction establishes it as the population's single clear choice and thus eliminates further conflict for that population.

Sieges: A siege is the use of military might to control resources. Armies or armed forces can besiege a city or a community, denying them access to such resources as food, water, or air. Navies can besiege whole worlds.

The purpose of a siege is to control a world (sometimes it is restricted to controlling a community). By controlling resources, the attacking faction seeks to force the world to surrender and to accept the faction. Controlling the world may provide control of the population; it may instead provide control of pathways (if the world is on an important route), resources (native to the world), or information.

An example of a siege involves a space fleet restricting or denying access to a world. By cutting off trade and resupply, a sieging space fleet may force a world to surrender.

A siege is rarely possible against High Population worlds because they tend to be self-sufficient.

Strike: A strike is an application of force to destroy (rather than control) resources, information, population, or opposing forces.

The purpose of a strike is to eliminate things which a faction cannot control in order to deny control of them to other factions.

An example of a strike involves a space fleet attacking a planetary industrial center. By destroying the center, it denies the resource to another faction. A subsidiary benefit of a strike may include pressure on a population to accept the attacking faction in order to avoid further strikes.

Raid: A raid is a strike characterized by surprise.

The purpose of a raid is to eliminate things which a faction cannot control in order to deny them to other factions. Some raids are instead concerned with achieving control, even if only temporarily.

An example of a raid involves a small force which attacks an enemy position. The raid's mission may be to destroy enemy forces, or it may be to kidnap an enemy leader.

Patrol: A patrol is an application of force to control a pathway.

The purpose of a patrol is to establish control of one or more pathways, or failing that, to deny control of the pathway to the enemy.

An example of a patrol involves a space fleet which regularly travels along a pathway and drives off any enemy or unfriendly forces which may be present.

Demonstration: A demonstration is a display of force intended to convince a population (or its leaders) of the strength of a specific faction.

The purpose of a demonstration is to achieve a goal without engaging in battle. If the opposing side can be convinced of the futility of opposition, the result can often be gained without engaging in battle.

An example of a demonstration is the destruction of a small

asteroid using nuclear missiles; when the opposition understands that the attacker has the ability and the motivation to use its available force, it may surrender or negotiate instead.

Bluff: A bluff is a false display of strength. When a faction does not have sufficient strength to actually win, it may instead choose to act like it has the strength.

The purpose of a bluff is to avoid a conflict (by frightening off the opposition) or to delay a conflict (until sufficient strength is available).

An example of a bluff involves a demonstration in which the observed actions have been faked.

CONTROL OF HIGH POPULATION WORLDS

Within the Imperium, the vast majority of population lives on or over the surfaces of its High Population worlds. Fewer than 10 percent of the empire's worlds (actually about 8.3 percent) have population levels of nine (equivalent to billions) or A (equivalent to 10 billions). Yet these worlds easily account for more than 90 percent of the population of the Imperium. High Population worlds hold the billions of Imperial citizenry; all the other worlds taken together account for an average of 342 million each, with most having far fewer inhabitants.

As the domiciles of the majority of Imperial population, the High Population worlds of the Imperium are a vital key to its control. Population provides a vast pool of technological and market resources. Assuming intellectual ability occurs evenly throughout the population, it is concentrated on High Population worlds just like population is. A concentration of population also produces a concentration of consumers and a vast market for goods and services. Finally, the concentration of population produces a correspondingly large tax base which helps to support the Imperium as it provides governmental services.

The Imperium is not an empire of empty worlds: It ultimately derives its power and its authority from the citizens it governs. High Population worlds are a vital key to the control of the Imperium because they represent the vast majority of the citizens of the Imperium. A faction which controls no High Population worlds has no power base among the citizenry; a faction which controls only the High Population worlds of the empire controls enough population to enable it to claim control of the Imperium.

Methods of Controlling High Population Worlds: High Population worlds control themselves. It is the consensus of opinion of the total population that determines what faction the world supports in the Rebellion. Until the consensus accepts and backs a specific faction, the world remains in an uneasy state of neutrality, buffeted by the efforts of various factions to control it.

Factions trying to control a High Population world face massive obstacles to their success; the process is necessarily dedicated to controlling the hearts and the minds of the people. If the ideology of the faction is not at least palatable to the world, it will never be accepted. Assuming there is some potential that the world will accept the faction's ideology, there must follow a campaign to convince the world to actively choose the faction as its preference.

Campaigns can take any number of approaches. A faction

may promise advantages in trade or markets. Leaders may be promised rewards or benefits. The ideology of the faction may be revised or deliberately distorted in order to present it in the best possible light. The faction may institute terrorism attacks in order to force acceptance as the lesser of two evils. Information may be manipulated, or news managed in order to convince or to trick the population into supporting a specific faction. A campaign may concentrate on a majority fraction of the population and promise it benefits at the expense of minorities. Minorities may be singled out and promised better status in return for support of a specific faction. All campaigns on a High Population world have a single purpose: to convince the population to support a specific faction.

The Campaign on Shagipka: Shagipka lies only three parsecs from Dlan and was one of the first worlds to which Dulinor directed his attention. Dulinor's campaign on Shagipka/Ileish (1321 B671989-E) began as soon as the Archduke arrived on Dlan. After the assassination of Strephon, Dulinor proceeded directly back to Dlan in order to make his own announcement of his succession to the throne. Shagipka received the news within a week of its release on Dlan. At the same time, Dulinor established controls on the new stories carried on the xboat network, effectively precluding anyone on Shagipka from hearing differing views. Shagipka's civil service bureaucracy was already accustomed to receiving notifications, orders, and instructions from Dulinor as a member of the Imperial nobility. His statements to the government now carried with them a ring of authority; at the same time, Dulinor's cutoff of opposing views made it difficult for Shagipka's government to actively oppose him.

Dulinor's campaign also made it clear to the government that there was no clear alternative to the acceptance of him. Fleet maneuvers showed that Dulinor controlled all naval forces in the region. Dulinor instituted a small levy on goods imported to Shagipka and ordered that a tax stamp with his likeness and the words Emperor Dulinor I be attached to every incoming



shipment. The bureaucracy incorporated the procedure into its own list of procedures and almost naturally accepted the transition from Strephon to Dulinor. Most other activities continued as usual. The population was not presented with a choice so much as an accomplished fact. Because the population already knew and accepted Dulinor as their own Archduke, they were able to accept his elevation to Emperor.

The Campaign on Shunim: Shunim is a colony of Shagipka, lying two parsecs away. Dulinor's campaign on Shunim/Ileish (1323 C768966-B) made use of his previously acquired control of Shagipka to extend his circle of power. Because Shagipka already accepted Dulinor, it was a natural process to assign to the Shagipkan bureaucracy the task of assuring Shunim's loyalty to Dulinor.

The major emphasis on Shunim rested on Dulinor's basic thesis, stating that the Imperium should do more for the individual worlds of the empire. For Shunim, this struck a responsive chord with its promises of more attention to the needs of the people. At the same time, the restriction on incoming information made it nearly impossible for any opposing views to be considered on the world. Dulinor gained the upper hand by shutting out the competition before it could start.

THE VAST SPACE BETWEEN THE STARS

The traditional territory of the Imperium has been the vast spaces between the stars. Its star fleets, although based on worlds, are charged with patrolling star systems and between star systems to maintain order, to protect trade and commerce, and to provide security. The very fact that the Imperial star fleets patrol space between the worlds prevents most of the potential piracy, raids, and invasions.

The competing factions all considered control of the trade and communications routes between the stars to be of paramount importance. Those with large star fleet assets employed them to deny regions to other factions, and to wrest new regions from opposing factions. Those with smaller star fleet assets had to be content with harassing other factions and occasional raids of commerce.

Star fleets provide great benefits to those factions that control them. Their very basic purpose is to provide transportation between systems. Beyond that, the fleets allow a faction to attempt to control pathways and information; they can be used to deny pathways, information, and resources to other factions. Fleets are essential for the conduct of sieges against worlds. They are necessary in order to conduct strikes and raids. Star fleets are used to patrol space and to keep opposing factions away.

The Campaign Against Duumur: The industrial world of Duumur/Dagudashaag (2529 C5299BB-E) lies somewhat off the main trade and communications route of the Imperium. Duumur has an extremely profitable industrial base, made possible in part by the ability to dump waste heat and pollutants into the environment. On the other hand, Duumur is dependent on imports for a large fraction of its nutrients and organic raw materials.

At one time, the world was ruled by a flamboyant dictator who helped direct its industrial output toward profitable markets within the sector. When he died, his successor proved to be much less flamboyant and somewhat less effective. At the

same time, the mood of the world population turned inward and isolationist.

As the news of the Rebellion unfolded, the population of Duumur took a neutral stance; although portions of the population declared support for Dulinor, Lucan, or Margaret, the majority remained undecided. The government, reflecting this majority stance, continued its taxation payments to the Imperium but also allowed open media access to all factions of the Rebellion.

Emperor Lucan, when informed of Duumur's lack of total support, ordered the world to stop its treasonous tolerance of anti-Lucan propaganda. When the world government made half-hearted attempts to halt the broadcasts and failed, Lucan ordered the Navy to take steps of its own.

The Imperial Navy had no capability of invading and occupying a world, so it settled in for a siege of the world by deploying the Imperial 219th Fleet to halt all access to the world. The plan was to force the government into submission. Squadrons of the fleet monitored surface broadcasts and systematically destroyed any communicator broadcast stations which produced anti-Lucan (or pro-anyone else) propaganda. At the same time, pro-Lucan propaganda was produced and broadcast by the fleet in orbit above the world.

The result was a strengthening of support for other factions. Factions supporting Margaret, Dulinor, Viand, and Varian have gained strength on Duumur. A full fleet supporting Lucan was tied down in orbit around one world. Blockade runners made immense profits smuggling past the blockade. The siege itself continues.

The Campaign Against Trill: As worlds lie farther and farther from the centers of factional power, each faction is less and less able to force its will on them. Instead, campaigns must be fought for the hearts and minds of the citizens, even as parallel campaigns by opposing factions are tolerated. Trill/Gushemege (2029 A784977-F) is a balkanized industrial world lying near the Great Rift. Trill's many distinct nations all jealously guard their own independence, in addition to their borders; differences existing between the nations make it possible for a variety of factions to be supported by a variety of nations.

Trill has 15 major nations (each with a population of about 100 million). Factions supporting Lucan, Dulinor, Margaret, and Viand have managed to gain a foothold in at least two nations each; the others remain undecided and open to persuasion. The reappearance of Strephon produced immediate support for his faction in four nations, but there was no clear consensus of support for one specific faction as of 1118.

Each faction makes use of its foothold on Trill to propagandize neighboring uncommitted nations. Since no faction holds a clear advantage, all must force themselves to tolerate the existence of the others. Even-pitched battles and military campaigns on Trill are forced to observe and respect national borders or risk retaliation by the offended country and alienation from other nations.

Were Trill closer to a specific faction's base of power, it might be able to blockade and besiege the planet. Trill however, lies far enough from every major faction to make laying siege a difficult proposition; in addition, Trill's nations' own spacecraft could provide enough resistance to break a siege.

THE FIGHTERS' INVOLVEMENT

Massive campaigns to control High Population worlds require hundreds of ships and millions of fighters. No one fighter can hope to single-handedly win a world for his faction. Yet each fighter must do his part in order for the ultimate battle to be won.

Those parts are myriad and include:

Participation in Battles: Any soldier must necessarily participate in battles for his faction. They may be defensive battles protecting vital assets, or they may be assaults intended to take territory from the enemy. They may be quick surgical strikes that will eliminate a vital strong point, or they may be long-range intrusions into enemy territory. All battles ultimately support a faction by their victory or hinder it with their loss. Major factions such as Dulinor or Lucan will constantly commit their forces to a series of space battles which require starship operations and continually replaced crews. Some campaigns on world surfaces will require soldiers in all manner of military units.

Espionage: Vital information about enemy factions can help shape the course of a faction's strategies and actions. Finding, recording, and transferring such information to faction representatives is a vital activity for any faction supporter. Every faction needs agents who can find information and return it to their headquarters; information must be gathered about even friendly factions.

Covert Operations: Some fighters will be called upon to fight in secret, attacking, raiding, or sabotaging the assets of other factions in order to remove them from the fight at a crucial time. Such operations are best mounted in secret so that responsibility cannot be traced.

Disinformation: Necessarily, some activities during the Rebellion will be aimed at either misleading or misdirecting a faction. Direct lies, if they are repeated long enough and loud enough, have a way of becoming the truth. Some fighters may be called upon to repeat these lies (disinformation) in support

of the faction's goals.

Courier Duty: Carrying messages for a faction is essential if that faction's activities are to be coordinated. Courier duty is dangerous and difficult, but someone has to do it. Information is the key to many aspects of the Rebellion; couriers are required to carry messages from place within a faction's territory or between factions.

Strikes: Some factions have special missions that they feel must be undertaken; fighters must be ready to answer the call of their faction.

Recruiting: New fighters must be found for every faction. Recruiting new ones is an ongoing problem and priority.

Winning the Hearts and Minds of the People: Every faction is dedicated to winning the hearts and minds of the people, especially on High Population worlds. Specific campaigns on contested High Population worlds range from political campaigns involving advertising, public relations, and voting, to military campaigns intended to eliminate the opposition. Fighters for a faction must be ready to become involved in such campaigns when required.

Nail Missions: For want of a nail, the shoe was lost; for want of a shoe, the horse was lost; etc. Every faction has detailed plans for detailed campaigns that require support in the way of information, equipment, and personnel. An especially important priority is the nail mission: the operation in search of a vital person, bit of information, or piece of equipment. If this *nail* is found and returned in time, the faction's project can be successful. But if it isn't found and returned in time, a crucial battle could be lost.

For example, a campaign against the Vargr in Deneb sector may require a battleship which is now undergoing repairs; those battleship repairs need a vital part which is available only on its sister ship, in the hands of Dulinor's forces 85 parsecs away. The nail mission is to find that sister ship, steal the repair part, and return to the shipyard before it is overrun by invading Vargr.

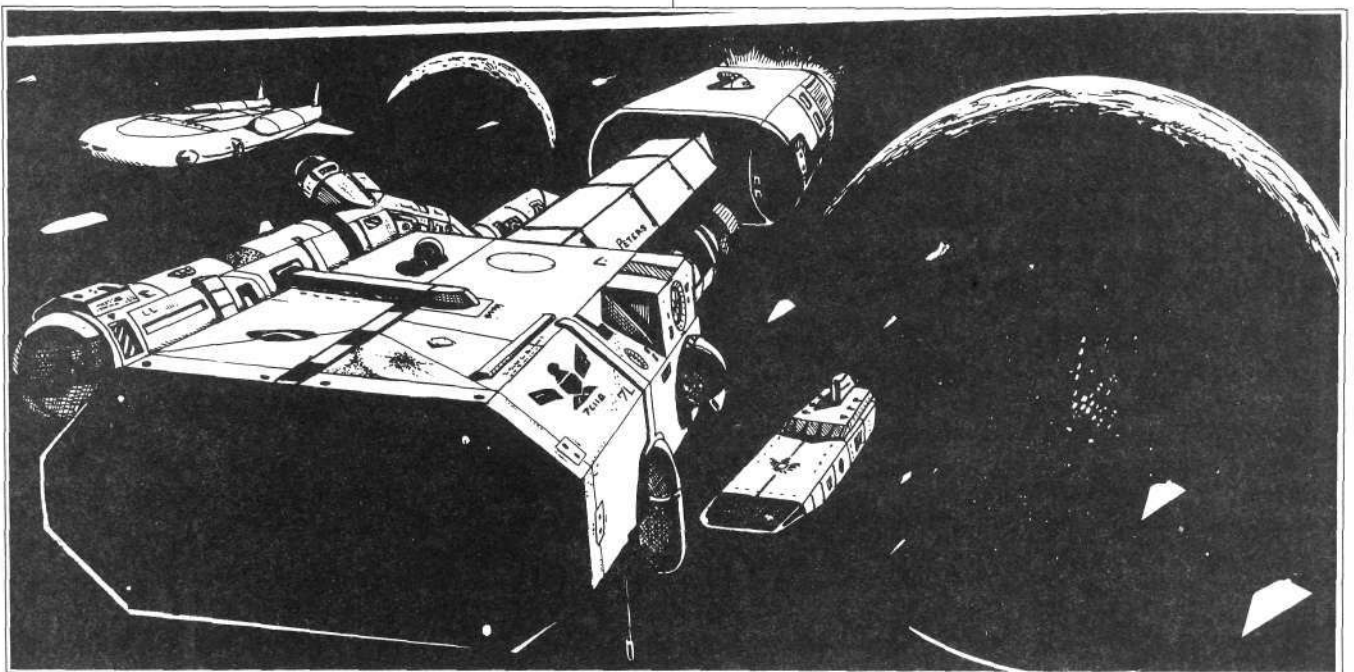

Fleets of the Imperium

Numbered fleets were assigned to the subsectors shown as of 1116, on the eve of the Rebellion.

Fleets 309, 310, 311, and 312 are also at Capital.

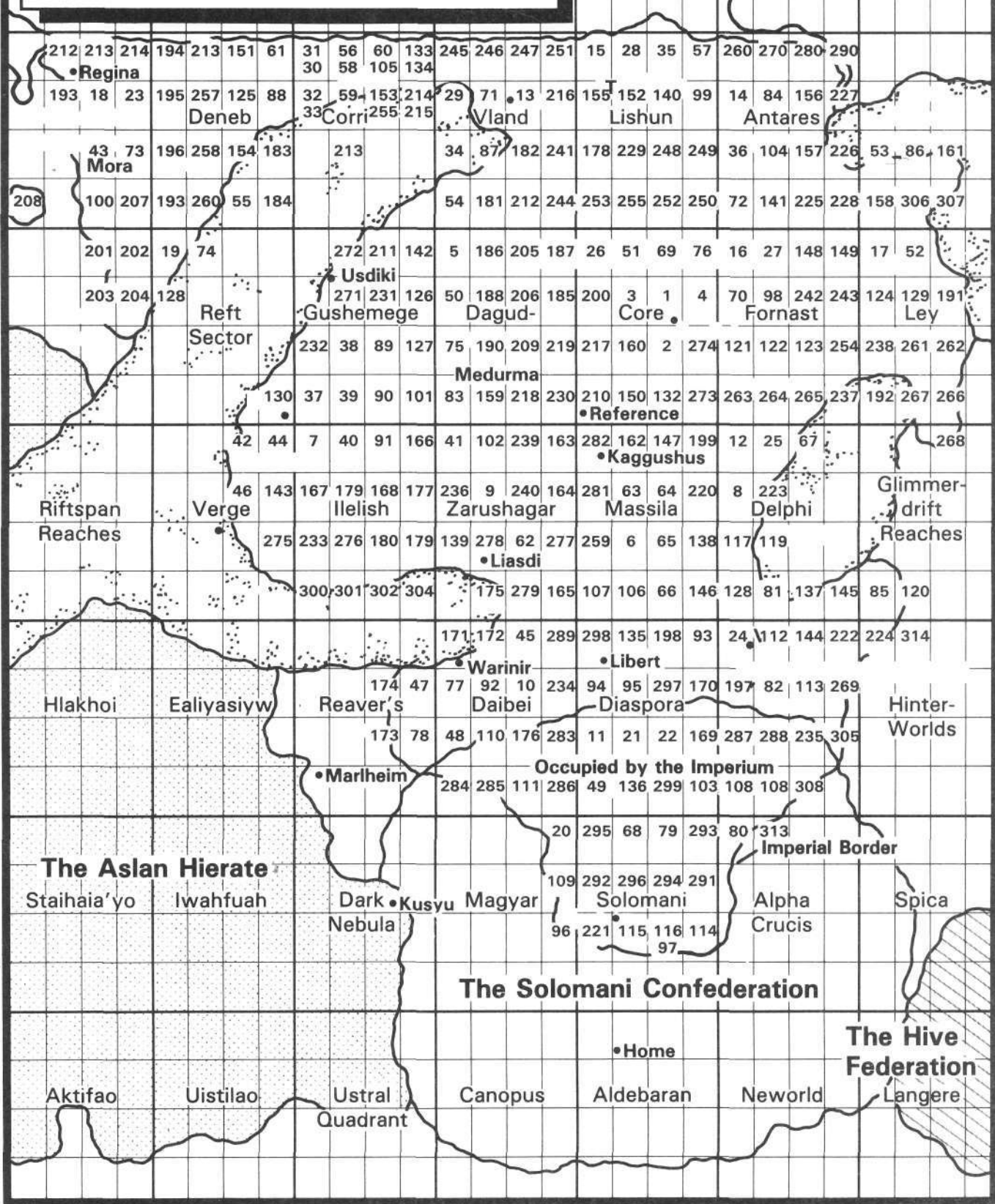

Imperial Fleets



Organization is essential to the star-spanning Imperial Navy; command control is best exercised when orders flow down through levels of organization. The Imperial Navy has established several levels of organization in order to better control and coordinate the operations and activities of its numerous ships. At their lowest level, Imperial ships are organized into squadrons (from three to 10 similar ships). Squadrons are grouped into permanent numbered fleets (usually three to 10 squadrons per fleet), although squadrons or individual ships may also be detached into temporary task forces for specific missions. Numbered fleets (usually within a single Imperial sector) are grouped into named fleets.

The channels of command within the Imperial Navy are exceptionally clear at the lowest levels of the fleets, and exceptionally cloudy at the highest levels.

The captain of each ship has complete control of its crew and its operations; he or she answers only to the squadron commander. Each squadron commander controls every ship in the squadron, and answers only to the numbered fleet admiral.

Admirals, whether they command numbered or named fleets, or work in the halls of the Naval High Command, must consider more than simple naval strategy in their orders and decisions. Most admirals are nobles, and they must consider the twists and turns of the noble hierarchy and protocol when they act. Admirals must answer to several different authorities: the Duke of the subsector in which a fleet is located, the Duke of a sector in which a fleet operates, the Archduke of a domain in which the fleet is assigned. Technically, only higher ranking naval officers can give orders; as a practical matter, nobles insinuate themselves into the channels of command. A good admiral knows when to follow which orders, and how to gracefully avoid the orders he shouldn't follow.

FLEETS

Each sector of the Imperium theoretically has a group of fleets numbering about 1000 ships. This number includes combat vessels such as cruisers, carriers, battleships, and some escorts; it does not include auxiliaries, support ships, and scouts.

The term *fleet* is used in two distinct ways: A *numbered* fleet is a group of several squadrons; a *named* fleet is an assembly of two or more numbered fleets. For example, the Imperial 16th Fleet consists of the 172nd Battle Squadron, the 231st Cruiser Squadron, and the 858th Escort Squadron. The Imperial Corridor Fleet (appropriately stationed in Corridor sector) is composed of the Imperial 16th, 27th, 41st, and 70th Fleets.

Numbered Fleets: The Imperium has about 320 numbered fleets (approximately one for each subsector within the empire). A numbered fleet, depending on its mission, may have between two and 10 squadrons amounting to between 50 and 200 ships. Numbered fleets are commanded by fleet admirals. A numbered fleet may have a descriptor (which does not count as a name) in its designation: for example, the 19th Battle Fleet, the 1st Provisional Fleet, and the 99th Penetration Fleet.

Numbered Reserve Fleets: The Imperium also has about 320 numbered reserve fleets (also approximately one for each subsector within the Imperium). Reserve fleets are equipped with obsolescent—but still useful—starships which have been retired from front-line Imperial service; they are staffed by personnel serving in the Reserves (technically in the service of

the Imperium, but without the status of strict Imperial Navy duty).

Reserve fleets are usually numbered in a sequence beginning with 1001 (for example, the 1077th Reserve Fleet). Reserve fleets are technically considered part of the forces of a named fleet, but are rarely moved out of their original subsector.

Named Fleets: The Imperium has 28 named sector fleets which range in size from two numbered fleets to more than 20. In the standard naval organization of the Imperium, each sector has a named fleet which is composed of one numbered fleet from each subsector. The Alpha Crucis Fleet, which contains the 80th Fleet and the 313th Fleet, is little more than a standing support organization and a command structure that channels orders from the navy to the numbered fleets in the Alpha Crucis sector patrolling the border. The Corridor Fleet, actively engaged in border protection along the contested border with the Vargr in Corridor sector, is an active fleet with 16 numbered fleets under its command.

Special Fleets: Doctrine also provides for the creation of named fleets at any time; such special fleets carry names that denote their function or their mission. Specially named fleets are a common way of deploying and controlling large numbers of ships. Dulinor has brought together large numbers of ships under the name Loyal Fleet; Lucan, intent on finding and destroying Dulinor, has created the Vengeance Fleet.

Rebellious Fleets: The participating forces in the Rebellion, regardless of their loyalty or allegiance, all started with the same organization. Over time, each of the factions may find

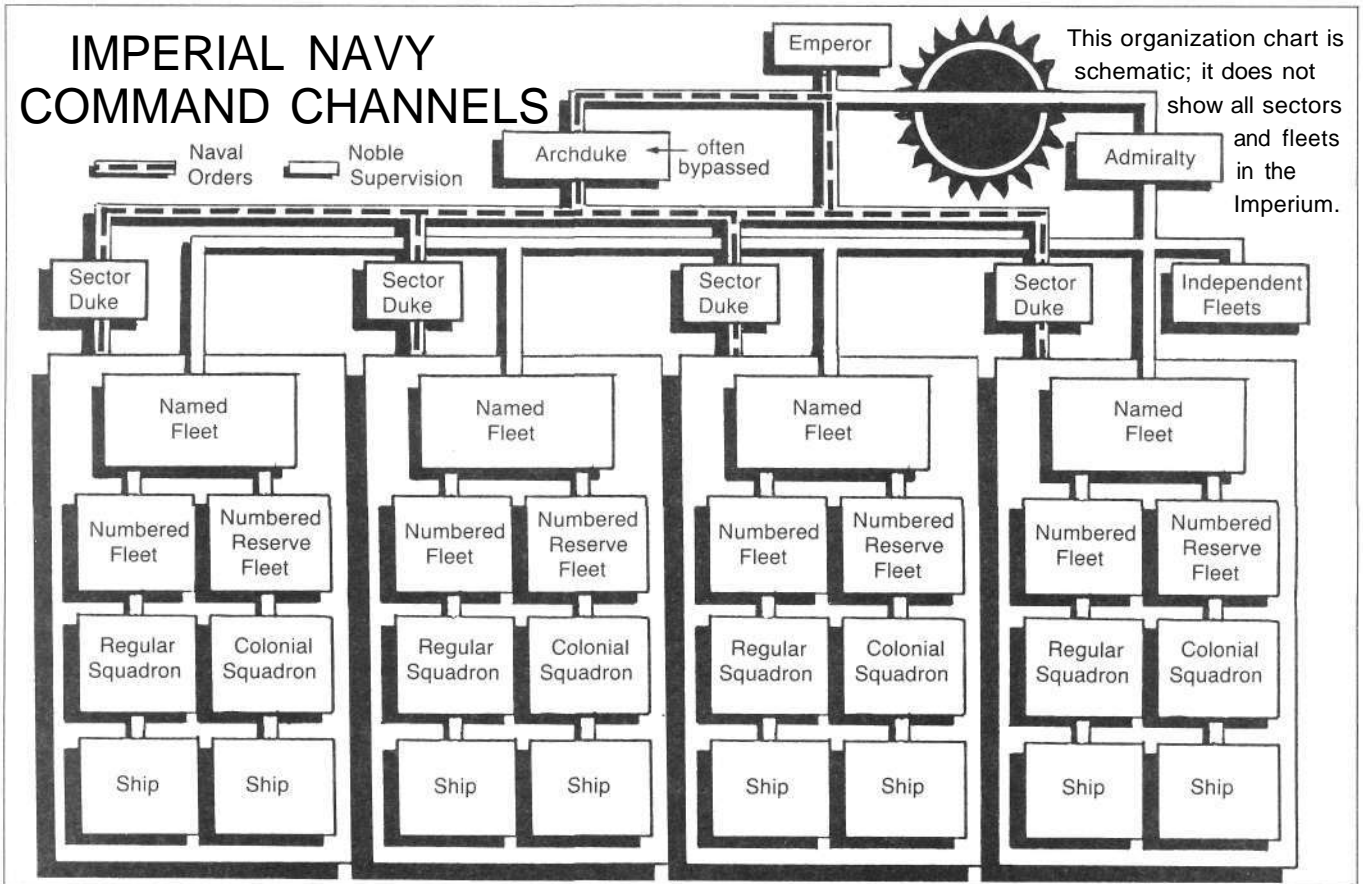

newer or better organizations for their naval units, but they all base their organization on Imperial tactics, training, and doctrine. Thus, it is not unusual to find two mirror-image units (for example, the 167th Fleet and the 217th Fleet) on opposite sides of the Rebellion; their allegiance was determined by the vagaries of location, in addition to the choice of their commanders.

SQUADRONS

Starships are rarely employed alone in battle. Instead they are assigned to squadrons which group ships together for mutual support. Squadrons consist of two or more ships of the same type and class, plus any supporting ships which can provide support, escort, or reinforcement. Supporting ships are usually not involved in the tactical operations of the squadron and are often ignored when figuring ship totals.

Large squadrons will have many auxiliary ships; depending on strategic and tactical needs, they may be refueling ships, troop shuttles, fleet couriers and courier tenders, command ships, intelligence processing ships, transports, or repair stations.

Individual ships are capable of jump and maneuver on their own, and they are not permanently tied together. It is possible for a commander to split a squadron, especially for simple errands, routine port calls, or to spread forces over a large area. But division of forces also removes ships from the control of the squadron commander and weakens any strategic or tactical advantage he might have. Consequently, squadron-splitting is a peacetime occurrence. In time of war, the

squadron is the basic unit of naval force.

Squadron Types: There are many types and classes of ships. The Imperial Navy has, however, established only five basic squadron types within its organization: BatRons, CruRons, ScoutRons, AssaultRons, and TankRons.

BatRons (Battle Squadrons) are formed from battleships or battleriders and are intended to meet the best of the enemy fleet, engage it, and destroy it. Their purpose is battle. Battle squadrons are usually reinforced with large numbers of auxiliary ships, including refueling shuttles, troop transports, and small escorts. In addition, they are accompanied by a large number of fleet couriers to allow the fast transfer of information and battle intelligence to higher commands.

CruRons (Cruiser Squadrons) are organized from cruisers and are intended to support the BatRons in space combat. In one-on-one battles, cruisers can never win against battleships; sufficient numbers of cruisers, however, can overwhelm a battleship. CruRons are occasionally called upon to support BatRons by holding off some enemy battleships or CruRons early in a battle. CruRons have a secondary mission to support planetary surface operations once the space battle has been won; they are the ships that bombard the planetary surface and cover the invading AssaultRons. CruRons are accompanied by a variety of auxiliaries including shuttles, transports, and fleet couriers. Every CruRon is assigned a bulk ordnance carrier to resupply its needs for bombs and missiles.

ScoutRons (Scout Squadrons) are composed of the ships assigned to the Imperial Interstellar Scout Service. When necessary, Scout Service ships normally assigned to

exploration, communications, or cartography are diverted to defensive or reconnaissance duties. ScoutRons are heterogeneous; they are composed of a wide variety of ships suited to a wide variety of purposes.

AssaultRons (Assault Squadrons) are composed of troop transports and measure their capacity in hundreds of battalions. They have a mission to carry troop units from point to point and to deliver troops from orbit to a disputed planetary surface.

TankRons (Tanker Squadrons) are a special type of squadron whose mission is dictated by technology. Strategic requirements from time to time require the transfer of squadrons along courses that cannot provide fuel for the ships. TankRons are positioned to refuel squadrons on such routes, or they may accompany a squadron on such a route.

HIERARCHY OF SQUADRONS

Squadrons are classified according to their position within the hierarchy of the Imperium. Regular squadrons are front-line units equipped with the best possible ships and personnel. Colonial squadrons are equipped with obsolescent (but still serviceable) ships and with personnel having somewhat less training and experience. System squadrons are not jump-capable. Instead, they are equipped primarily with system defense boats and monitors, and staffed by entirely local personnel.

Regular squadrons are assigned to the numbered fleets of the Imperium and are based at naval bases within the Imperium.

Colonial squadrons are assigned to the numbered reserve fleets of the subsectors. They are based at worlds which can provide personnel and technology to support them: worlds with tech code Early Stellar + (Tech Level 9+) and High Population (Population 9+).

System Squadrons are not assigned to any fleet. Instead of such an assignment, they are based in a home system with tech code Early Stellar (Tech Level 9+) and Moderate Population (Population 4+).

OTHER STAR-FARERS

Many variations of the Imperial model are used for naval organization by other star-farers.

Aslan: Aslan starships often operate independently within their established territory. Their organization of starship units is influenced primarily by their own needs and missions. Although it is possible to see their organization in terms of Imperial fleets and squadrons, it is important to note the distinctions.

When ships venture beyond the safe interior of their borders (including venturing beyond clan borders into other clan territory), they are organized into *hryo* (literally, this means "six," but the common translation is squadron) which usually has six ships, but may range in size from two to 12. Hryo are organizations or command structures established to ensure that proper orders are given and missions are carried out. Unlike Imperial squadrons, hryo are heterogeneous: They may contain any type of ship, and usually contain several different types of ship. A single hryo might include two clan transports to carry personnel and goods, two cruisers to provide protection, and two scouts to provide reconnaissance in new systems. Hryo

are identified by the name of the hryo commander, typically an Aslan space officer captain.

The ultimate source of authority for the Aslan lies with each individual clan. Starship command is awarded by the clan to powerful individuals who have a purpose and proper training or experience; command of a hryo is also awarded by the clan leader.

Aikoho (translated as fleet, the word means "many ships") is a general term for a large number of ships. It may include any number of starships, all of which are themselves organized into any number of squadrons. An aikoho is created only when there is a specific purpose for it. Aslan doctrine sees the need for only three types of fleet: the battle fleet, the trade fleet, and the migration fleet (also called an *ihatei* fleet).

Most clans have standing battle fleets to defend their worlds or important trade centers. Additional battle fleets are created when called for by hostilities or strategy. Each battle fleet is commanded by a single Aslan Fleet Admiral who answers to a Clan Admiral. The Clan Admiral himself answers to the *ko*, the head of the clan.

Trade fleets consist of transport and merchant ships along with enough armed ships to support and defend the cargo carriers. Each trade fleet is managed by a director because its emphasis is more mercantile than military; the armed squadrons within the trade fleet are commanded by Admirals or Captains, depending on their size and strength.

Migration fleets carry excess population in search of new worlds to settle and exploit. These are the instrument by which the Aslan clans expand their territory. *Ihatei* fleets are raised by the clan, with their ships and equipment paid for by the families of those who will travel with it. The *ihatei* fleet is commanded by a single Clan Admiral answerable only to the *ko*; since the fleet will travel outside clan territory, the Clan Admiral becomes answerable to no one as long as he continues to respect the principles and reputation of the clan.

Migration fleets are themselves organized into trade and

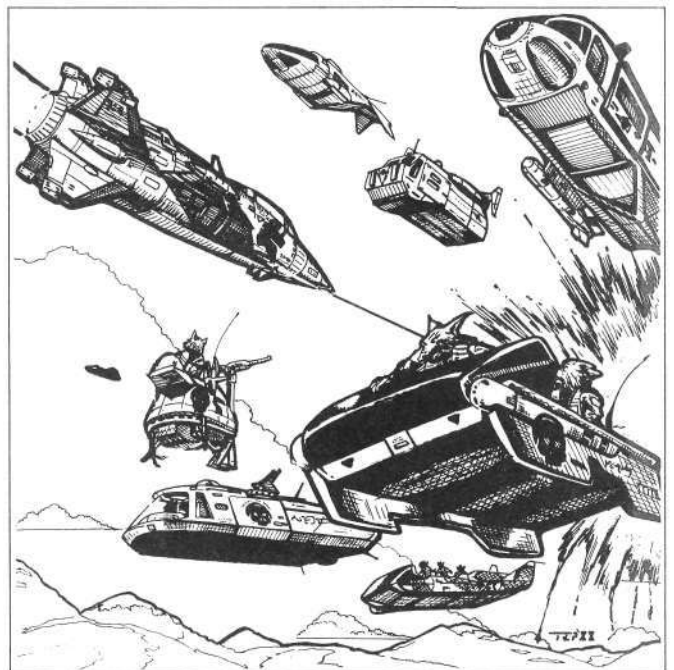

IMPERIAL FLEETS AND SQUADRONS

One or more system squadrons. Individual worlds with sufficient resources may raise system squadrons for defense. System squadrons are incapable of jump and are not part of any fleet.



One numbered fleet
One reserve fleet

One or more colonial squadrons. Individual worlds with sufficient resources may raise their own colonial squadrons. Colonial squadrons are part of the reserve fleet.

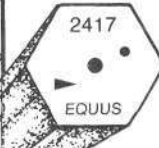

One or more regular squadrons. Imperial regular squadrons are assigned to naval bases. Regular squadrons are part of the Imperial numbered fleet.

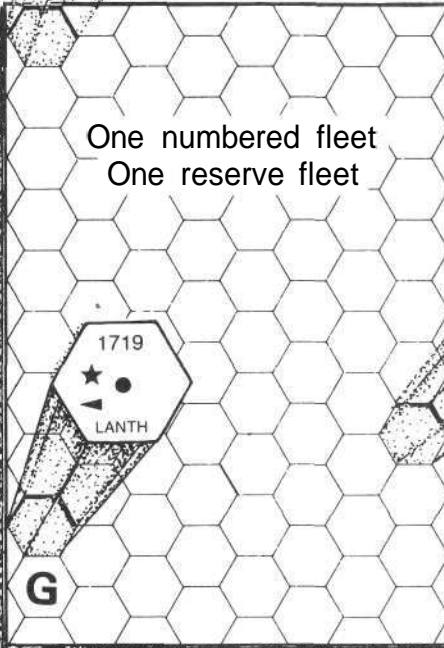

SUBSECTOR

The Imperium maintains one numbered fleet for each of its subsectors; that fleet contains a variety of squadrons at naval bases in the subsector. The Imperium also maintains one numbered reserve fleet for each of its subsectors. Equipped with older ships, the reserve fleet provides training and reinforcements to the navy.

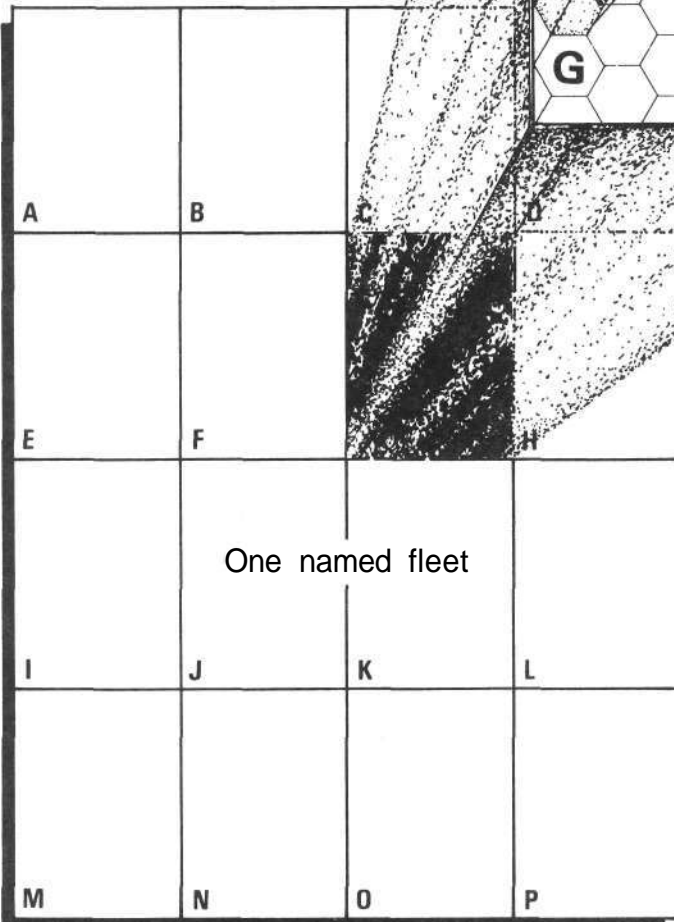

SECTOR

The Imperium maintains one named fleet for each of its sectors; that fleet usually contains one numbered fleet for each of the subsectors within the sector.



ASLAN NAVAL ORGANIZATION

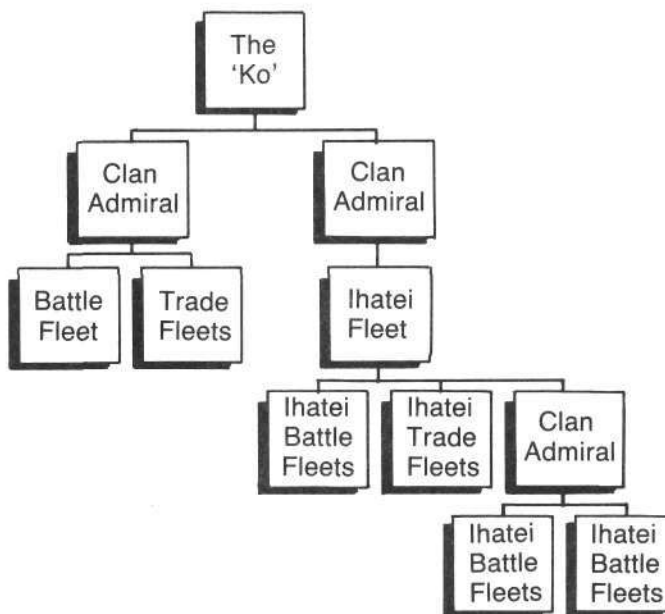

battle fleets with their associated command structure.

When an ihatei fleet arrives at a world suitable for settlement and colonization, it transfers much of its cargo and personnel to the world surface and the process begins. The ihatei fleet remains in existence; however, its battle fleet component provides defense for the new settlement, while the trade fleet provides commercial support and establishes trade channels.

In time, the settlement will produce its own ihatei, and they will venture in search of new worlds to conquer with their own ihatei fleet. The colony will support it by providing ships and some financing; a new Clan Admiral (answerable to the present Clan Admiral) will be appointed.

Vargr: The nature of Vargr society and psychology make it difficult for groups of Vargr to maintain a loyalty to, and an association with, specific leaders for any appreciable length of time. Vargr loyalty constantly shifts as newer or stronger personalities rise in power. As organizations (such as squadrons or fleets) grow larger, there is a natural tendency for them to be pulled apart by rivalries for leadership within the group. As a result, Vargr rarely create formal ship organizations which are larger than the squadron.

Ship commanders are powerful individuals in Vargr society; squadron commanders are even more powerful. But both types of commander are in a constant struggle to maintain their positions. As an individual becomes more powerful, others naturally (and in Vargr society quite acceptably) try to take over that position. Ship commanders are under great pressure to produce benefits for their followers; squadron commanders are

under similar pressure. Rarely does a Vargr have enough personal charisma to be able to hold a fleet of several squadrons together.

As a result, the largest Vargr ship unit is the independent squadron. Its commander is an independent leader, answering to no higher authority. At the same time, he is responsible to his subordinates and his supporters for results: He must produce victories and their resultant plunder or booty, or someone else (who can produce) will replace him.

Zhodani: Zhodani naval organization is the closest in form and substance to Imperial naval organization. Ships are organized into squadrons; squadrons are grouped into subsector-based fleets; subsector-based fleets are organized into sector-based fleets. The five basic squadron types remain the same.

The Zhodani add only one innovation to the Imperial scheme of naval organization, that being a sixth type of squadron, the command squadron. A command squadron consists of several very fast couriers; each courier carries a single telepath who can relay quickly the conceptual commands of fleet commander to the squadron commanders in a system. The telepath may be briefed by the fleet commander before the battle and then carries the concepts to the squadron commanders, or he may actually relay on-the-spot commands from a fleet commander operating in the same system. Using psionic talents allows the fleet admiral to quickly and efficiently instruct his subordinates as to strategy, logic, and supporting priorities for a specific naval operation.

Depots of the Imperium

Depots are shown with a ★ symbol.

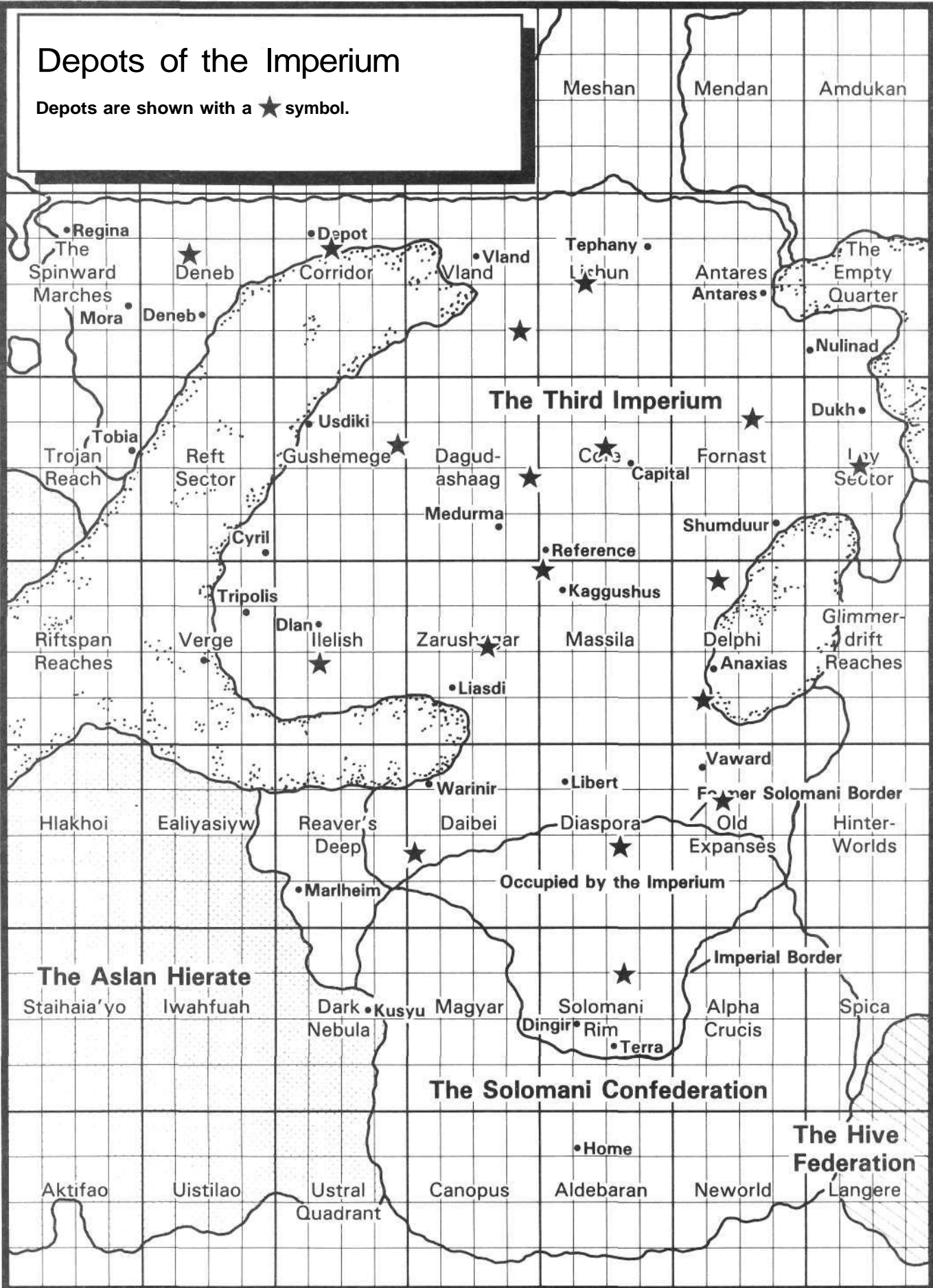

Imperial Navy Depots



The focus of the Imperial Navy's base and support system is its network of depots. The navy maintains 19 depots (with one exception, one per sector) to support its fleets.

Naval depots are huge harboring areas for starships, naval personnel, and supporting services. A depot typically encompasses an entire star system and has an unlimited capacity for starships. The navy provides three distinct types of services to its ships at depots: maintenance (which includes upgrade, repair, overhaul, and even construction), personnel services, and training.

Maintenance Services: A major focus for each naval depot is the maintenance of the navy's starships. Ships are brought to the depot for periodic inspection, annual overhauls, upgrades and installation of new equipment, and repair of damage incurred in the course of operations. In peace time, routine maintenance services are a valuable activity; in time of war, the service is invaluable. Depots stand constantly available to repair and return to service battle-damaged ships in a minimum time.

Depots keep on hand a stock of repair and replacement parts that would be unavailable at any one place anywhere else in the Imperium.

Personnel Services: Depots are a natural assignment for large numbers of naval personnel. All skills that the navy needs are required at a depot. Support services, administration, dependent support, housing, recreation, and technical services are all needed on a continuing basis at the depot. With such a large staff available, a depot becomes a natural replacement center, providing crew rotation and replacement from its own assets as they are needed.

Training: Each depot is naturally given the task of providing training for naval personnel. Because of the many different services a depot provides, it is uniquely suited to training personnel for those services. As a result, a depot maintains an extensive training establishment, providing in-depth training for all aspects of starship technology.

In addition, the vast areas of the depot system (because they are exclusively available to the navy) lend themselves to tactical training in the use of starship weaponry, and to squadron and fleet maneuvers which hone the skills of crews.

DEPOT FLEETS

Typically, each depot maintains three fleets (each of several squadrons) on station: a training fleet, a mothball fleet, and a defense fleet.

The Training Fleet: In order to provide proper experience for new or transferred crewmembers, a depot maintains a training fleet equipped with ships commonly encountered in the sector. In addition, the fleet contains adversary squadrons trained in the tactics to be expected from potential enemies that the navy will encounter. Adversary squadrons are pitted against Imperial squadrons that call at the depot for training. The adversary squadrons of depot training fleets are generally considered to be the best trained and most effective squadrons in the Imperial Navy.

The Mothball Fleet: Depots are used for storage of obsolete or obsolescent naval vessels that cannot be economically operated, but which retain some value for the moment. As starship classes are retired from service, some are transferred to the reserve fleets while others are stored until a use for them can be found or until they are scrapped. Because a depot encompasses an entire system and is under the complete control of the navy, it is an ideal secure storage location for such ships.

Most ships in the mothball fleet have been subjected to a

preservative treatment to minimize the effects of age and wear. The fleet's ships can be returned to service after a period of preparation (usually a couple of weeks). Some ships are assigned to cannibalization squadrons, and they are slowly scrapped as parts are taken from them to refit or repair other ships still in service. Finally, some of the ships in the mothball fleet are actually repair and refit auxiliaries which provide basic services to the fleet.

The Security Fleet: The depot's security fleet has the mission of defense of the depot from all possible dangers. The fleet maintains system defense boats, early warning squadrons, and normal battle squadrons which provide comprehensive security for the system.

WAR OF THE DEPOTS

In times of peace, the depots of the Imperium are able to relax and enjoy an almost lazy existence. The Imperial depots are located at a distance far enough away from the Imperial borders that they are rarely threatened by any external forces. The depots have serviced the fleets of the empire in a routine rotation sequence that rarely varies. Only the occasional war has upset the routine of the depots, but even then, the disruption is short-lived. Some Imperial civil servants have lived their whole lives without the depot they work for ever going on alert.

DEPOTS OF THE IMPERIUM

Imperial depots are traditionally named for the sector in which they are placed; for example, the Imperial depot in Corridor sector is named Depot/Corridor.

| Name | Hex | UWP | — | Remarks | Allegiance | Gas Giant? |
|--------------------|------|-----------|---|----------|------------|------------|
| Depot/Deneb | 1613 | A100644-G | D | Na Ni Va | No | |
| Depot/Corridor | 1511 | A686354-F | D | Lo Ni | — | G |
| Depot/Viand | 2728 | A594677-9 | D | Ag Ni | VI | |
| Depot/Lishun | 1219 | D788367-7 | D | Lo Ni | — | |
| Depot/Antares | 2021 | B544556-C | D | Ag Ni | An | |
| Depot/Gushemege | 3016 | A3406AB-E | D | Ni Po De | St | |
| Depot/Dagudashaag | 3121 | A310244-D | D | Lo Ni | Im | |
| Depot/Core | 1518 | A86A422-F | D | Ni Wa | Im | |
| Depot/Fornast | 1811 | A878210-A | D | Lo Ni | Im | |
| Depot/Ley | 1420 | A453532-A | D | Ni Po | Im | |
| Depot/Ilelish | 1022 | B362558-C | D | Ni | II | |
| Depot/Zarushagar | 1920 | A6888CF-6 | D | | — | |
| Depot/Massilia | 0301 | B78A777-C | D | Wa Ri | Im | |
| Depot 1/Delphi | 0832 | A583447-A | D | Ni | Ma | |
| Depot 2/Delphi | 1205 | A787200-A | D | Ni | Ma | G |
| Depot/Daibei | 0326 | A9B9520-F | D | Ni | Da | G |
| Depot/Diaspora | 2018 | C000765-D | D | As Na | — | |
| Depot/Old Expanses | 1213 | A00055A-F | D | As Ni | So | |
| Depot/Solomani Rim | 1911 | A00066D-F | D | As Ni Na | So | |

Allegiance Abbreviations: — = No continuing control. An = Antares. Da = Daibei. II = Ilelish. Im = Imperial. Ma = Margaret. No = Morris. So = Solomani. St = Strephon. VI = Viand.

The Rebellion has changed all that. Depots, with the ability to service the war fleets of the Imperium, have become not only vital support elements for every faction of the Rebellion, but

they have also become battlefields which are constantly fought over by a large number of both raiding fleets and invading forces.

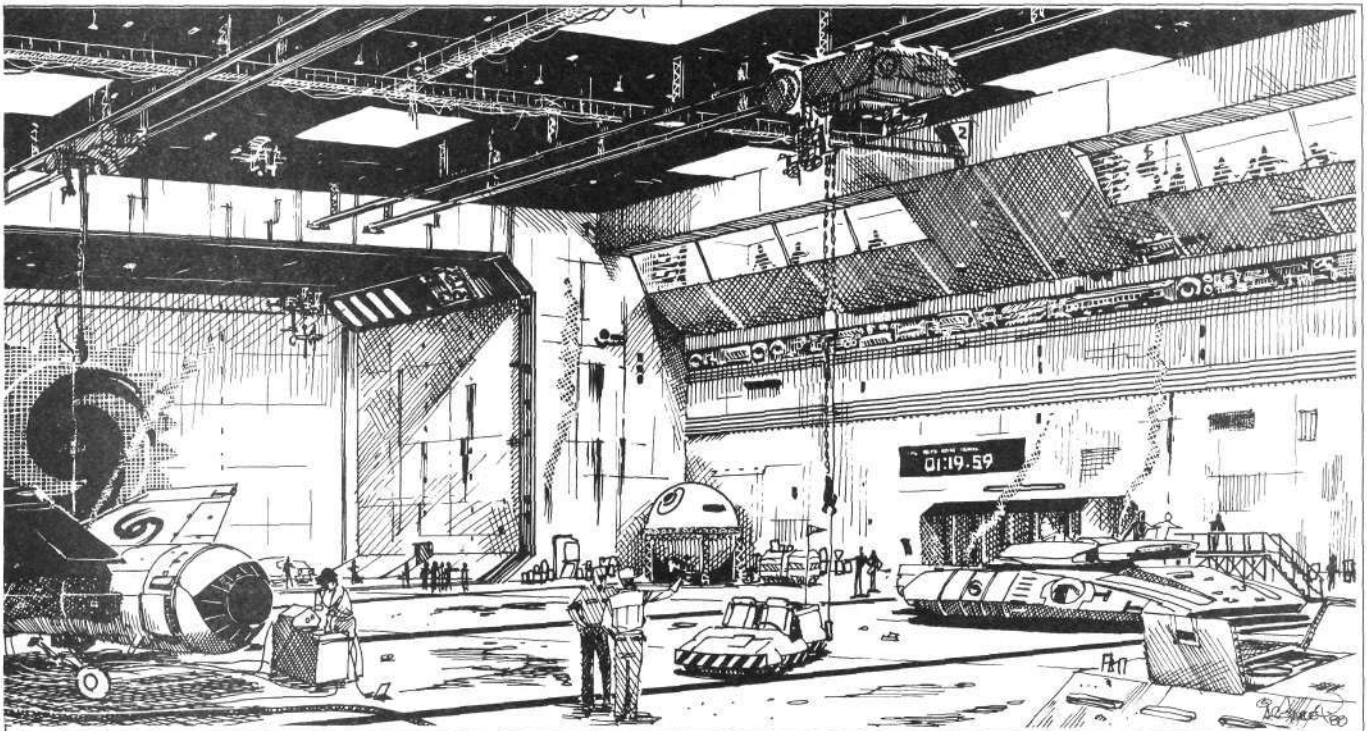

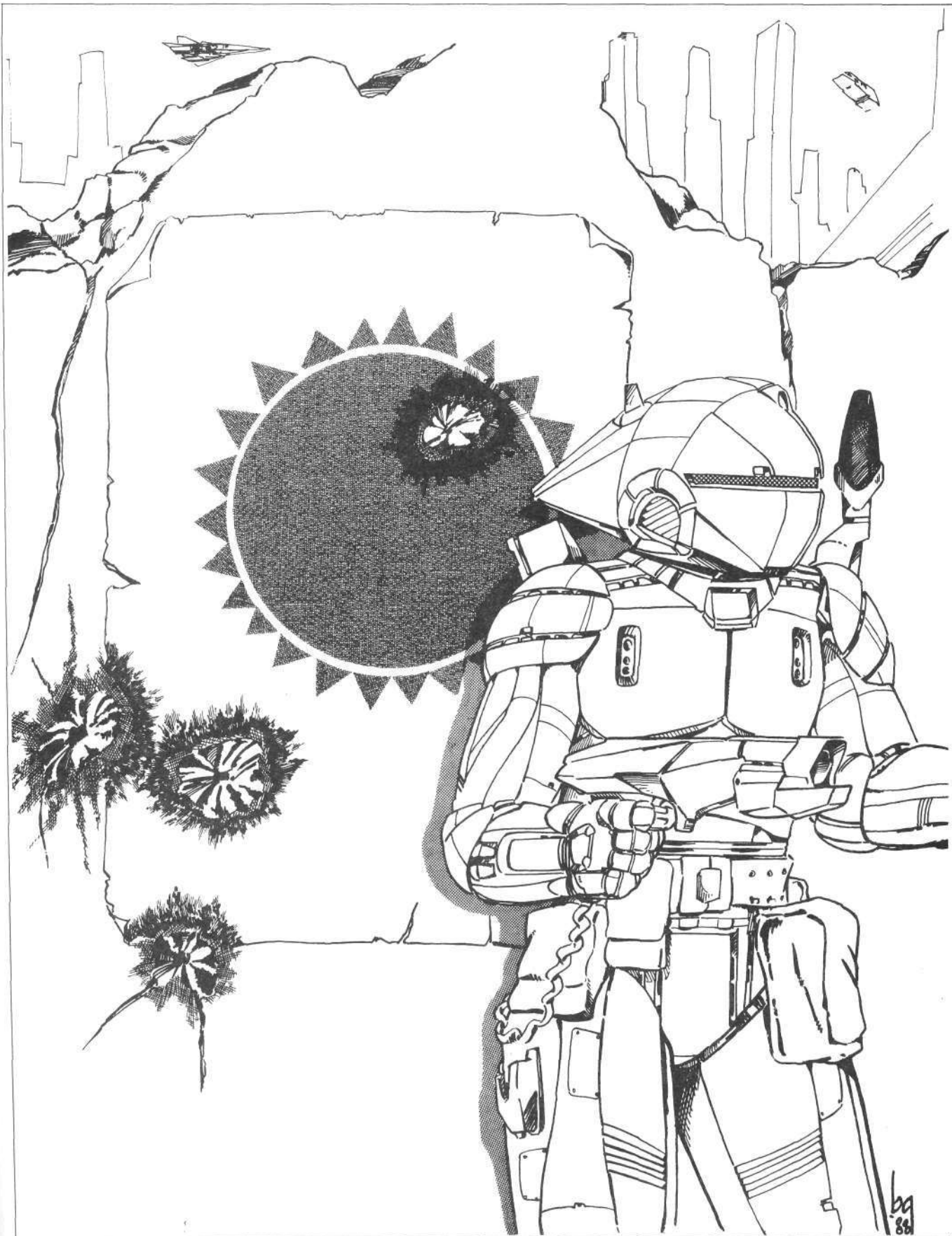



The Armies of the Imperium

Once civilization reaches beyond the bounds of the planetary surface, the nature of armed forces changes. Interstellar navies rise in importance because they can control the means of access to star systems and new worlds. The role of the army changes significantly in the process.

Most armies are defensive in nature. Their purpose is to resist invasion and to keep the peace on a specific world. A select part of an army is given the mission of offensive operations; these special units are the ones that undertake invasions of other worlds.

THE ORGANIZATION OF ARMIES

Armed forces are organized into successive layers of military units. Each layer provides a span of control over a number of subordinate units. Generally, a unit can control several (from three to seven) subordinate units.

Armies: An army is composed of several corps. It is commanded by a general. An army is a command structure which rarely leaves its world.

Corps: A corps is composed of several divisions. It is commanded by a lieutenant general.

Divisions: A division is composed of several brigades or several regiments. It is commanded by a major general.

Brigade: A brigade is composed of several regiments or several battalions. It is commanded by a brigadier general.

Regiment: A regiment is composed of several battalions. It is commanded by a colonel.

Battalions: A battalion is composed of several companies.

It is commanded by a lieutenant commander. A battalion is the basic military unit in the Imperium. It contains approximately 500 men.

Companies: A company is composed of several platoons. It is commanded by a captain.

Platoons: A platoon is composed of several squads. It is commanded by a second lieutenant or a first lieutenant.

Squads: A platoon is composed of several soldiers. It is commanded by a sergeant. The squad is the smallest military unit.

TYPES OF MILITARY UNITS

A wide variety of military units are possible, but most are specialized organizations with specialized missions. For the broad spectrum of military missions, there are only four military unit types: infantry, armor, cavalry, and special units.

Infantry: Infantry units are composed of soldiers who fight with individual weapons. An infantry unit depends on the skills of its soldiers to execute basic tactics in order to achieve its mission. Although the concept of the individual soldier may seem outmoded in a technological society, the most dependable way of seizing and holding territory remains the use of the individual soldier: the infantry.

Originally, infantry units were also called foot units because their transportation was walking. Higher tech level infantry units are provided with transportation so they need not walk to the battle. Tech code Industrial and Pre-Stellar infantry may (about half the time) be motorized (with transportation provided by wheeled trucks). Tech code Early Stellar infantry is generally half-motorized and half-equipped with grav vehicle transportation. Tech code Average Stellar and higher is equipped with grav vehicle transportation.

If the transportation equipment of the infantry is provided with armor, the unit is called armored infantry.

Specialized infantry may be equipped with individual grav belt transportation, with legged vehicles for operations on extremely rugged terrain or in restricted environments, or with individual armored suits for greater protection.

Cavalry: Cavalry units are composed of soldiers who are provided with fast, cross-country vehicles. The name originates with the use of horses to provide mobility, but current usage

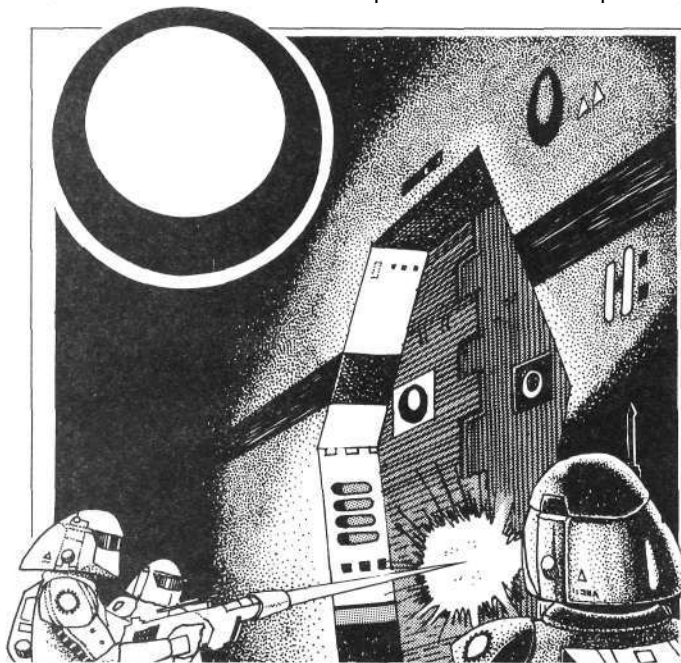

ARMY UNITS OF THE IMPERIUM

TROOP UNITS

Troop units can be uniquely identified by their size, type, mobility, and identification. Combat factor and Tech Level may sometimes be important. The troop unit may be shown in words or in symbols.

Descriptions: A troop unit being described in words should include everything necessary to uniquely identify it. A typical description would be:

4518th Imperial Lift Infantry Regiment.

This description includes identification, mobility, type, and size (the Imperial indicates allegiance and is part of the identification).

Symbols: The Troop Unit Format shows how a troop unit would be described using symbols.

TROOP UNIT FORMAT

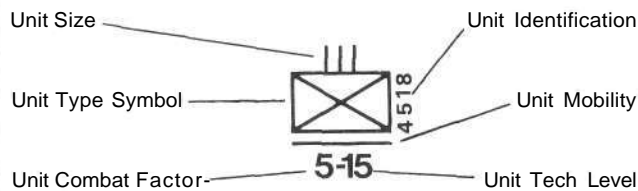

TROOP UNIT SIZES

| Symbol | Unit Size | Relative Strength |
|--------|------------|-------------------|
| II | Battalion | 1 to 2 |
| III | Regiment | 3 to 7 |
| X | Brigade | 10 |
| XX | Division | 20 |
| XXX | Corps | 50 to 100 |
| XXXX | Field Army | 500 |

Troop unit size symbols are placed above the troop unit symbol box and centered.

TROOP TYPES AND MOBILITY

| Symbol | Type | Mobility |
|--------|------------------|------------------|
| | Infantry | |
| | Armored Infantry | |
| | Cavalry | |
| | Armored Cavalry | |
| | Tank or Armor | |
| | Marine | |
| | Jump Troop | |
| | | Lift or Grav |
| | | Motorized |
| | | Foot (no symbol) |

The troop unit symbol is placed within the military symbol box; the troop mobility is usually placed under the box.

EXPECTED TROOP STRENGTHS

ON A SPECIFIC WORLD

This table allows the computation of the specific number of battalions which a world may have as military units. Each battalion has a combat factor of 1; the relative strength factor of larger military units is expressed in terms of battalions, so larger units may be created from those generated by this table. For example, a world with 10 battalions (from this table) could be expected to have them organized into a brigade (strength = 10) of two regiments (strength each = 5) of five battalions each.

In order to use this table, the specific World Population and Tech Level must be known.

| TL | Population | | | | | | | | | | |
|----|------------|---|---|---|---|----|----|-----|-----|-----|------|
| | 0 | 1 | 2 | 3 | 4 | 5 | 6 | 7 | 8 | 9 | A |
| 0 | - | - | - | - | - | - | - | 1 | 10 | 1C | 1K |
| 1 | - | - | - | - | - | - | 1 | 5 | 50 | 5C | 5K |
| 2 | - | - | - | - | - | 1 | 5 | 50 | 5C | 5K | 50K |
| 3 | - | - | - | - | 1 | 10 | 1C | 1K | 10K | 50K | 100K |
| 4 | - | - | - | - | 1 | 10 | 1C | 1K | 2K | 20K | 200K |
| 5 | - | - | - | 1 | 2 | 3 | 30 | 3C | 3K | 30K | 300K |
| 6 | - | - | - | 1 | 2 | 3 | 30 | 3C | 3K | 30K | 300K |
| 7 | - | - | - | - | 1 | 2 | 20 | 2C | 2K | 20K | 200K |
| 8 | - | - | - | - | 1 | 2 | 20 | 2C | 2K | 20K | 200K |
| 9 | - | - | - | - | - | 1 | 15 | 15C | 15K | 15K | 150K |
| 10 | - | - | - | - | - | 1 | 15 | 15C | 15K | 15K | 150K |
| 11 | - | - | - | - | - | 1 | 12 | 12C | 12K | 12K | 120K |
| 12 | - | - | - | - | - | 1 | 12 | 12C | 12K | 12K | 120K |
| 13 | - | - | - | - | - | 1 | 10 | 1C | 1K | 10K | 100K |
| 14 | - | - | - | - | - | - | 7 | 7C | 7K | 70K | 70K |
| 15 | - | - | - | - | - | - | 5 | 5C | 5K | 50K | 50K |
| 16 | - | - | - | - | - | - | 5 | 5C | 5K | 50K | 50K |

Symbols: Letter codes indicate numbers in the following sequence: C = 100; K = 1000. For example, an entry of 1C in the table above means 100; an entry of 100K means 100,000.

Note: If the world has a hostile environment (Atmosphere 0, 1, 2, 3, 4, 7, or 9+) shift the Population column one to the left (effectively reducing the number of battalions present).

UNIT IDENTIFICATIONS

Identifications for troop units are ordinarily numbers which range from single digits to four (or even five) digits. The numbers are assigned arbitrarily by the Imperial bureaucracy as the units are raised; as a result of mixing and transfers, the numbers are scattered throughout the Imperium in no particular order, although lower numbers tend to be closer to the core, and higher (4-digit) numbers tend to be on the borders. Each size unit (battalion, regiment, brigade, division, corps, and field army) has its own sequence of numbers.

When generating or determining military unit identification numbers, randomly generate the number.

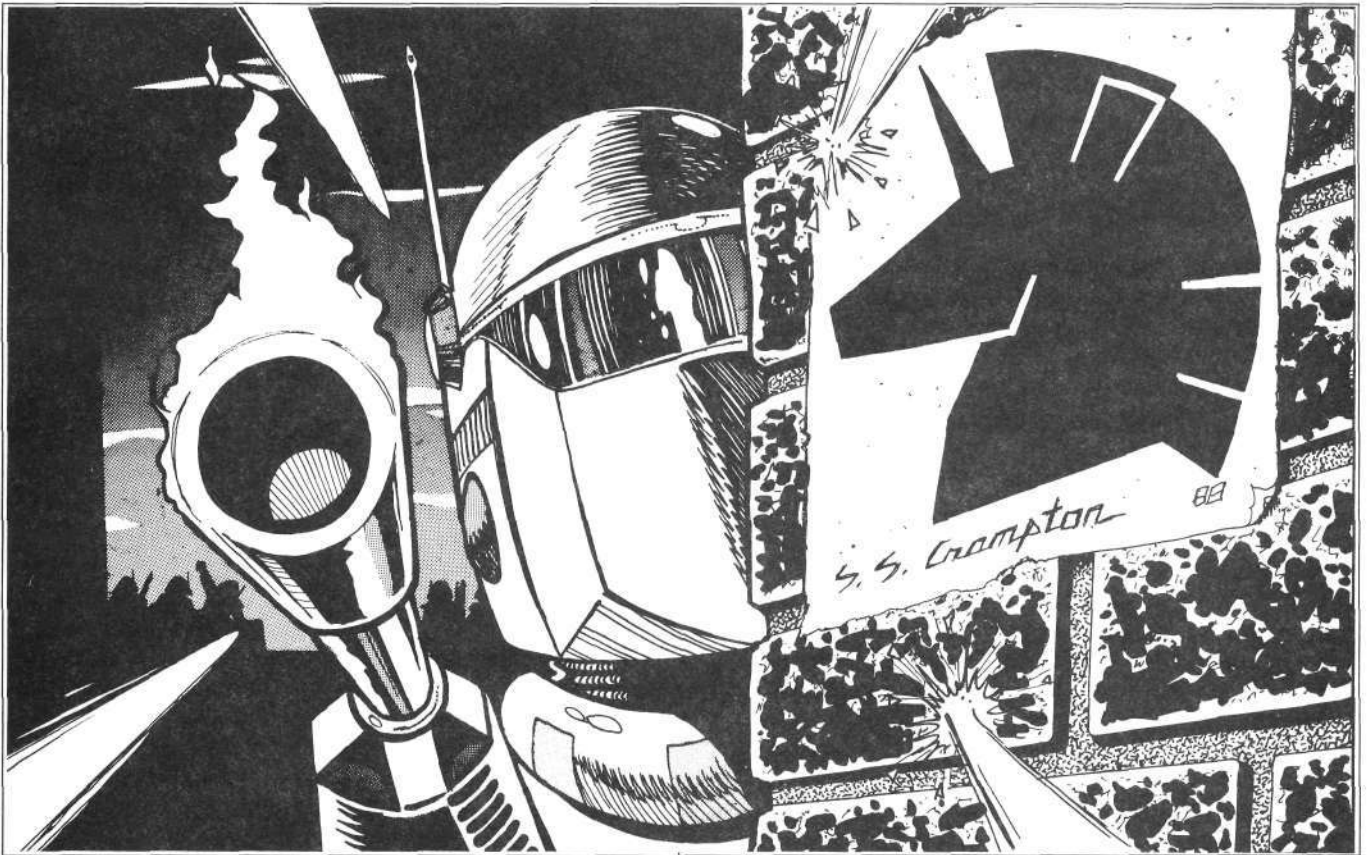

overs any soldiers in fast, cross-country vehicles. Cavalry units are used for scouting and reconnaissance, guarding the flanks of the infantry, and fast reaction forces.

Cavalry units at the lowest tech codes are transported by animals such as horses. As technology advances, horse substitutes become available. At tech code Industrial and Pre-Stellar, cavalry is motorized (with transportation provided by wheeled trucks). Tech code Early Stellar cavalry is generally half motorized and half equipped with grav vehicle transportation. Tech code Average Stellar and higher is equipped with grav vehicle transportation.

If the transportation equipment of the cavalry is provided with armor, the unit is called armored cavalry.

Armor: Armor (or tank) units are composed of soldier crews who operate fighting vehicles. Tanks initially appear at tech code Industrial when they maneuver on treads. About half of tech code Early Stellar tanks are grav vehicles. All tanks at tech code Average Stellar or above are grav vehicles.

Special Units: Specialized units trained for assaults, special operations, or invasions are given a number of different names.

Marines are units normally assigned to squadrons or fleets in order to give them a military reaction capability. They are under navy jurisdiction.

Commandos are specially trained for the conduct of raids. They are under army jurisdiction.

Jump troops are specially trained units assigned to planetary invasions. They are lightly armed infantry, generally equipped with battle dress and whatever support weapons can be man-carried.

Artillery: The task of providing remote firepower support to

units in battle falls to the artillery. Independent artillery units are not normally encountered; their strength is assumed to be part of the units they are assigned to support. For example, an infantry battalion normally has a platoon or a company of artillery fire support assigned as an integral part of it.

IMPERIAL FORCES

The Imperium maintains standing military forces in order to provide security for its bases and governmental offices, and in order to maintain peace and order. Imperial forces range in size from armies to platoons. Higher level units (armies, corps, divisions) coordinate with local popular forces and include them in their span of control. Lower level units make up the reaction forces of the Imperium and are generally mobile units which can respond quickly when trouble flares up.

Imperial Forces in the Rebellion: Technically, the armed forces of the Imperium owe their allegiance to the Emperor. However, because there is a dispute as to who the Emperor is, each Imperial unit commander is forced to decide that unit's ultimate loyalty. That decision is influenced by superior unit commanders' decisions, by the decisions of other Imperial units on the same world, and by the preferences of the members of the unit.

Once an Imperial unit has declared its preference, individual members of the unit may proceed according to the dictates of their own consciences. Some will desert rather than serve a faction they disagree with. Others will serve quietly until an opportunity presents itself, and then they will take some action in support of their preferred factions: sabotage, betrayal, subversion, or espionage.

The result is a distinct lack of dependability in Imperial military units. Commanders are forced to carefully analyze the preferences of their subordinates and carefully assign dependable units to crucial missions. Many Imperial military units become defensive in nature, content to occupy bases until the end of the Rebellion is in sight.

On the other hand, Imperial units which have declared themselves for a specific faction are used as much as possible, precisely because they have declared their loyalty. Factions deploy those units wherever they can in order to achieve the best possible results.

POPULAR FORCES

Popular forces are reserve troop units raised from the local population. Their purpose is clearly the defense of the population and territory of a specific world, and their training is directed toward that mission.

Although all popular forces are provided with basic training in the military sciences, they are given specialized training in areas that are appropriate to their specific world. For example, on a frontier world, some popular force units would be trained in combat engineering and would be able to use that training in the construction of roads, bridges, and other improvements in the world's infrastructure.

On a vacuum world, some popular force units would be trained in vacuum rescue operations; their expertise would be useful in disaster relief.

On a water world, some popular force units would be trained as aquatic marines and others as naval troops; their experience with operations on and under the seas suits them to undersea missions, to control of the seas and transportation choke points, and to sieges.

On a High Population world, some popular force units would be trained for anti-terrorism operations. They are suited to operations against dissident elements which naturally arise in a high population environment.

Popular forces are raised on a specific world and rarely leave that world.

Popular Forces in the Rebellion: Most populations are split in their support of various factions of the Rebellion; popular

forces reflect that same split. If a world is solidly in support of a specific faction, then its popular forces share that allegiance. Where a world is undecided, the popular forces are also split in their loyalties.

MERCENARY FORCES

Military force is often in demand for the protection of merchant corporations, industry, or new colonies. Because of the size of the Imperium, it is not always possible for Imperial forces to respond when trouble strikes, and a specific world may not have enough population to provide popular forces.

To fulfil this need for troops, the mercenary unit has been created. Mercenary units are small military units staffed by military veterans and available for hire to the highest bidder. Because such units are experienced and able to move quickly, they are often hired as an expedient alternative to raising citizen units. Most mercenary units are no larger than companies or battalions. They provide their own basic equipment; however, any special mission needs are supplied by their employers.

Mercenaries in the Rebellion: The chaos of the Rebellion has created a thriving market for military units. In addition, some military units have decided they cannot support the faction they are initially placed under; they have fled their assignment and are now hiring themselves out to causes they support (or at least do not actively dislike).

EXPECTED OPPOSITION

Travellers within the Imperium can expect to encounter armed forces; the Armed Forces of the Rebellion tables show a method of computing the expected size of the military forces a world will have.

Unit Identifications: Because of the large numbers of military units to be encountered within the Imperium, the military hierarchy assigns permanent numbers to each unit in order to better identify it. Generally, low numbers identify older, more elite units; higher numbers identify newer, less experienced units. There is an extensive overlap in assigned unit numbers, and it is not uncommon to encounter distinctly different 100th Tank Battalions on several different worlds.

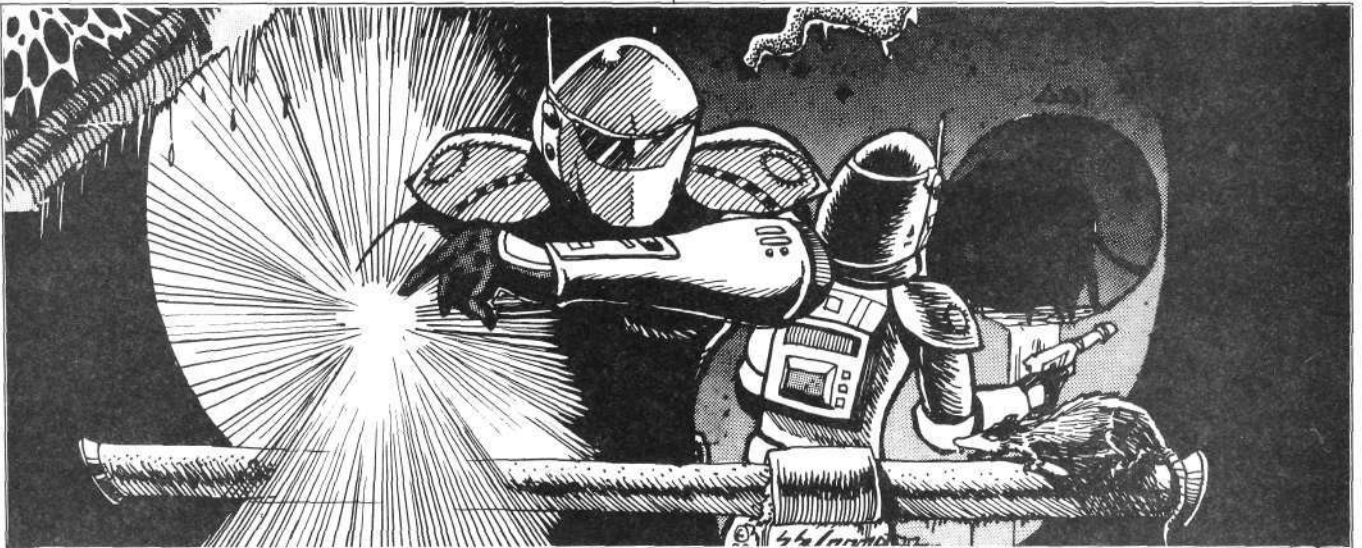



Agencies

Once the nature of the Rebellion becomes clear to the participants, it will also become clear that not all aspects of the conflict can be resolved by navies and armies. Much of the fight for the hearts and the minds of the people will have to be fought with information systems, public relations campaigns, advertising, and dirty tricks. Much of this sort of activity is traditionally the realm of the intelligence agency—the spy network.

But the strategies of the Rebellion call for more than a band of spies capable of digging out specific bits of information, and more than a band of saboteurs who can blow up bridges or factories belonging to the opposition. Instead, they need powerful organizations that can shape public opinion and bring it carefully into a direction and to a degree that will assure support for a specific faction. These agencies must combine the abilities of psychologists, advertising agencies, intelligence networks, censors, and scores of other organizations.

But every faction had to start somewhere. Their usual starting point is the existing intelligence agency.

THE NEW MANHATTAN PROJECTS

When the fate of an interstellar government hangs in the balance, almost any price could be paid for a result that favors your own side. As soon as it becomes clear that navies and armies will not succeed in gaining control of a world, the leader of a faction turns to his intelligence agency and asks, "What will work?"

Their answer determines the next step in the campaign for control of the Imperium. Massive amounts of money can produce answers to almost any problem. Given the circumstances, the present problem is to control the High Population worlds of the Imperium. There are hundreds of ways to achieve that end, but only a few will work on any specific world.

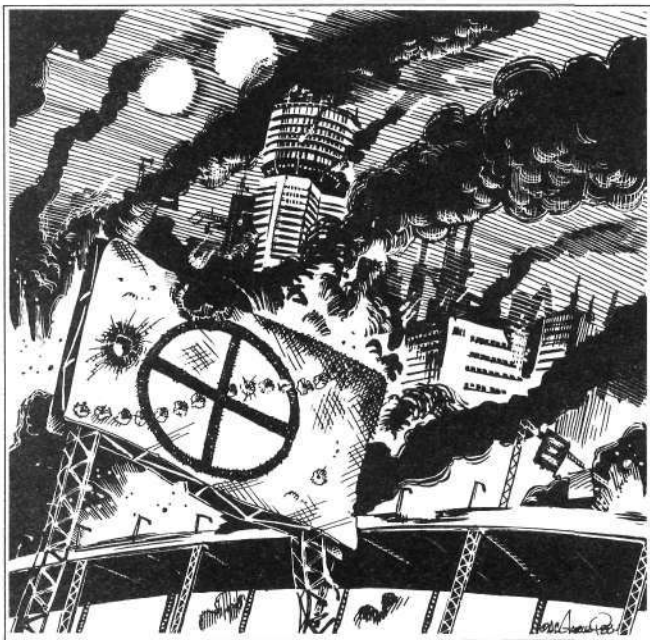

The new Manhattan Project, by whatever name it goes by, is dedicated to finding those specific methods to achieve that end on worlds.

AGENCIES

Each faction has an intelligence agency which serves the purpose of being responsible for its own version of the new Manhattan Project.

Antares: Brzk maintained a minor intelligence network in order to better understand and be able to react to situations within his Domain, but when he declared independence for his Domain, he immediately established a stronger agency capable of providing widespread information, as well as undertaking covert operations. Brzk's Trasilon is a biracial organization which includes both humans and Vargr as full participants. Brzk also has the ability to gain access to the intelligence organizations of each of the confederations within the Julian Protectorate.

Daibei: Daibei began with the least available assets and took two steps to remedy that problem. First, the nobles of the sector joined together and pooled their information in an effort to root out every possible intelligence agency operative they could find. SolSec, INI, and even megacorporation agents were found and compromised, then either forced out of the territory or allowed to participate in a new intelligence network. That new intelligence agency was a sham. The real agency was established by the University of Warinir using the best technology available in the areas of computer and psychological methods.

Using its cover name, the psychology department of the University of Warinir specializes in large scale public relations campaigns designed to change opinions in favor of a specified faction.

Dulinor: Originally, Dulinor's agency was a part of the Imperial Naval Intelligence. When Dulinor began preparations for his assassination, he recruited most of INI within his sector and

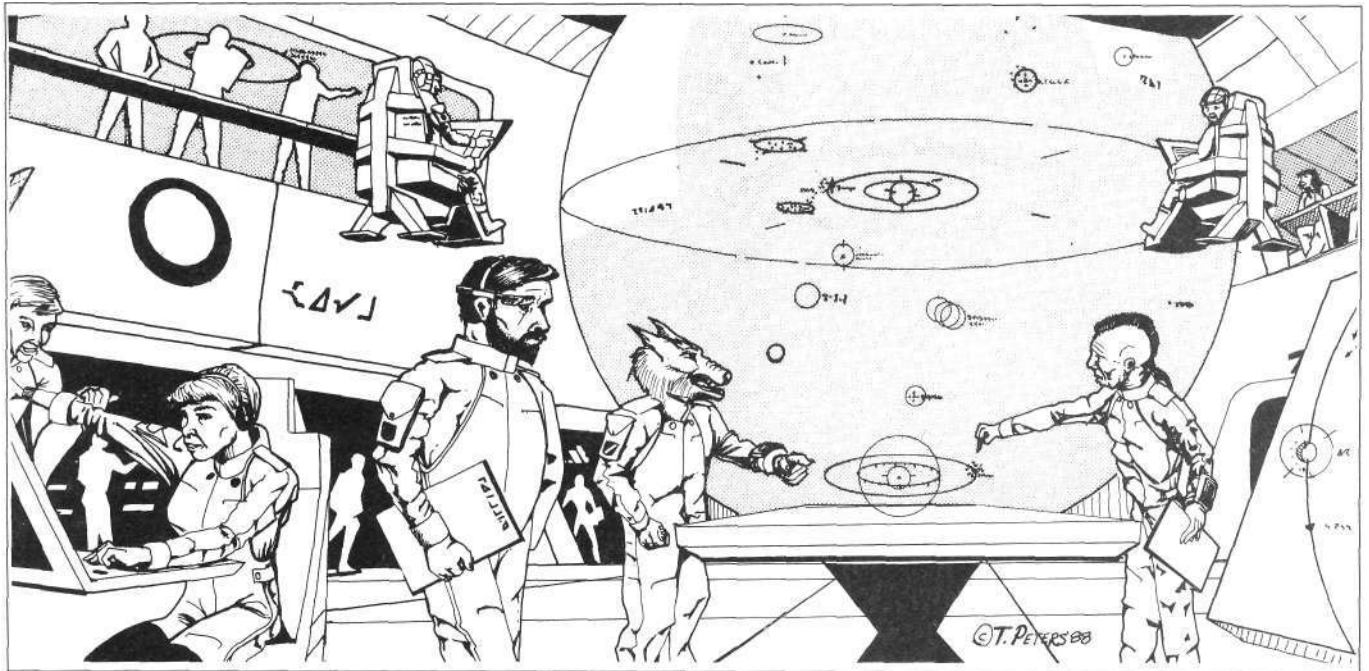

left an ineffective surrogate in its place. That surrogate still exists now, feeding incorrect information to Lucan and his parts of INI.

Dulinor's intelligence network proved especially skilled in manipulating information in order to achieve the required results.

Lucan's Imperium: Lucan retained some of the most powerful intelligence agencies in human space. Indeed, he controls two of them: Imperial Naval Intelligence (INI) and the Imperial Ministry of Justice (MOJ).

The INI can draw on the assets of the entire Imperial Navy and is primarily concerned with military intelligence; it tracks starship and troop operations, and can mount intelligence-gathering activities into all parts of the Imperium.

The MOJ is primarily concerned with Imperial society; it has contacts with the court systems of the worlds of the empire, and it has an intelligence network which concentrates on criminal activity. The MOJ is especially valuable when dealing with the criminal elements of the empire and can offer great rewards (in terms of amnesty or pardon) to those who support Lucan.

Margaret: As a noble, Margaret did not either have or maintain her own intelligence agency. As her faction rose in strength, she was able to attract to her side the Vemene, the covert security agency for Tukera Lines. With operatives located all along Tukera's routes throughout the Imperium, the Vemene provided a perfect, ready-made agency for a newly powerful noble.

Morris: Norris' intelligence agency is the remains of Naval Intelligence in the Domain of Deneb, now called Deneb Imperial Naval Intelligence (DINI). The organization was provided with nearly unlimited assets during the Fifth Frontier War, and it still retains them today. Because of the cosmopolitan nature of the Imperial Navy and the Spinward Marches region, DINI is capable of supplying Aslan and Vargr agents as well as human ones. The major objective of DINI is to strive to predict

operations by Vargr and Aslan located on the borders of the Domain, and to mount operations which will frustrate or prevent those Vargr and Aslan activities.

Solomani: SolSec has always been the Solomani intelligence agency; it has agents in all parts of Solomani society, and in many parts of neighboring Imperial society. Because SolSec monitors have their own independent careers throughout society, SolSec is able to call upon expertise in widely diverse fields.

Strephon's Imperium: Strephon reappeared in Gushemege sector and brought together what he could of the available assets in order to create a new intelligence agency. Existing INI forces had already been pressed into the service of Lucan's Imperium. Instead of using these forces, Strephon turned to the Imperial Interstellar Scout Service assets in the sector. And after winning the allegiance of the Imperial Interstellar Scout Service, Strephon charged them with winning the High Population worlds for him.

Vargr: There is no centralized Vargr intelligence agency in existence.

Larger Vargr governments maintain their own intelligence agencies, and the constantly shifting loyalties of the Vargr make it possible for each agency to keep agents in the employ of most other such Vargr agencies. Some Vargr agents are also in the employ of Imperial agencies.

Viand: The Vilani Empire makes use of three intelligence agencies. Naasirka, Sharurshid, and Makhidkarun maintained a protective security agency, and each megacorporation transformed its agency, turning it into a full-service intelligence agency.

Zhodani: The Zhodani make use of two intelligence agencies: These include the Tavrchedle' and SORAG. Tavrchedle' is primarily an internal attitude and security police; its responsibility is internal order within the Zhodani Consulate. It is charged with locating and removing agents of external powers from the Zhodani Consulate.



Factions of the Rebellion

Faced with no clear choice of action, the hierarchy of the Imperium and the governments of its neighboring empires each chose its own course once the news of Strephon's assassination arrived. At least factions can be recognized as fighting for some territorial or ideological cause.

THE FACTIONS

There are 13 competing factions.

Lucan: Lucan is technically the legitimate heir to the throne of the Imperium. He holds the reins of power and controls the existing Imperial bureaucracy.

Margaret: Questions about Lucan's fitness to hold power caused some nobles within the Moot to look for an alternative. Margaret is an alternative heir to Strephon and is supported by a large fraction of the nobility.

Dulinor: Dulinor claims the throne of the Imperium by right of assassination. He was forced to flee Capital after killing Strephon, but he has created for himself a base of power in Illelish sector.

Antares: Brzk, Archduke of Antares, presented himself as an alternative candidate for Emperor and considered himself a worthy choice. Ultimately, however, he realized that the Moot would not accept a nonhuman on the throne of the Imperium, and declared his Domain independent in order to preserve it.

Daibei: Daibei sector stood fast against mounting Solomani

invasions as news of Strephon's death arrived and ultimately turned them back. When Lucan ordered Daibei's fleets transferred to the fight against Dulinor, Horvath (senior Duke of Daibei sector) assembled a council of nobles and established an independent and neutral region of Daibei.

Viand: Lucan withdrew Imperial fleets from Corridor and Lishun sectors to mount an increasing offensive against Dulinor. Vargr raiders moved into the vacuum, plundering Imperial worlds. When Viand's fleets were ordered withdrawn, Viand balked and declared its independence. The sector is now governed by the Ziru Sirka—the reestablished Vilani Empire.

Strephon: Although reported killed in the assassination of 1116, the man Dulinor killed was actually a double; Strephon survived and was spirited away by loyal Imperial Navy officers. He now continues his rule as well as a campaign to exert it throughout the Imperium from a base of power in Gushemege sector.

Varian: Many people believe Lucan killed Varian (his older brother) in order to become emperor himself. A quiet, determined group of nobles had taken the martyred Varian as their leader, and revenge on Dulinor and Lucan is their cause.

Morris: The recently named Archduke of Deneb has assumed the reins of government of the frontier sectors of the Imperium and holds them in trust for the ultimate winner of the Rebellion. In the interim, he fights a delaying action against the Aslan, Vargr, and Zhodani.

Aslan: Landless Aslan ihatei in search of territory have sensed weakness in the decaying Imperium and are invading Imperial border regions.

Vargr: Vargr governments and corsairs alike were held out of Imperial territory only by continuous fleet patrols. When the fleets were withdrawn by Lucan, the Vargr found it easy to cross the border to plunder and loot.

Zhodani: The Imperium had long been a threat to Zhodani security and territorial integrity. The collapse of the Imperium provides an ideal opportunity for the Imperial threat to be eliminated once and for all.

Solomani: As soon as word of the assassination reached the Solomani Confederation, plans were laid for large-scale fleet movements across the Imperial border in order to reclaim territories lost to the Imperium more than a century before. Of especial importance was the need to retake Terra itself from Imperial hands.

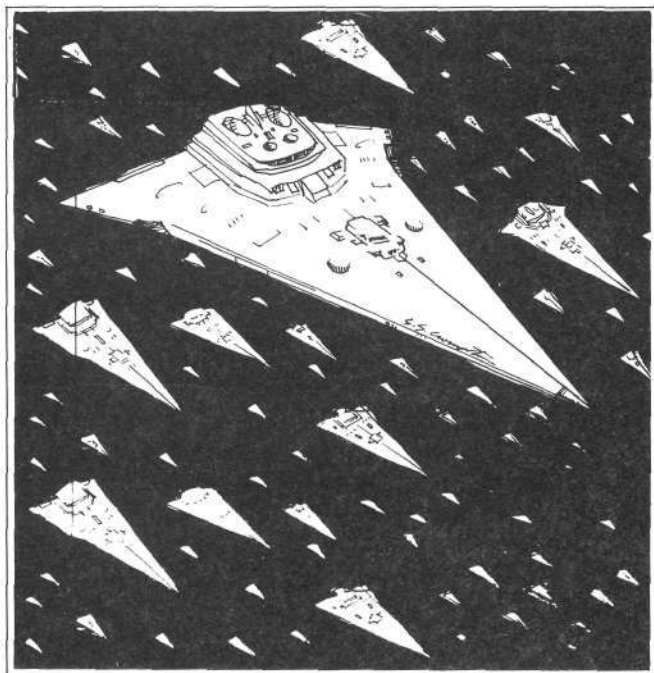

FRIENDS AND ENEMIES

Each faction in the Rebellion has the opportunity (on the basis of goals and ideology) to choose its enemies and to choose its friends. Enemies become a priority for attack and defeat; friends can be depended on for assistance and support.

The stakes of the Rebellion are too high for very many friendships to form. When the leaders of two factions both want to end up as Emperor, it is difficult for either to consider an alliance, no matter how profitable and no matter how temporary. On the other hand, the goals of the factions are contradictory enough so that a great many factions are direct enemies.

The Friends and Enemies table shows the relationships between the factions of the Rebellion. If an enemy symbol is shown, the two factions are in direct enough conflict that they will not form alliances and will not cooperate even temporarily against other factions. If a friend symbol is shown, the two factions consider their goals related enough to permit routine, continuing cooperation against others. If no symbol is shown, the two factions consider their goals diverse enough to allow temporary alliances to pursue results that will benefit both.

CONSEQUENCES OF THE REBELLION

The Rebellion has shattered the Imperium. Its effects are far-reaching and difficult to recover from. Some effects are obvious, but others will become apparent only with time. One thing is known for certain: The stable, safe Imperium that had existed for a 1000 years has now been changed forever.

Polarization of the Imperium: The first three years of the Rebellion saw violent reactions to the death of Strephon. Dulinor's rebellion against the authority of the Imperium, and his claim to be the true Emperor reverberated throughout the empire. Where some proclaimed allegiance to Dulinor, others

sided with Lucan, and still others found it in their best interest to make their own way and proclaimed their independence. The very rise of the factions, however, produced an ongoing conflict within the Imperium: the polarization of the peoples and the worlds of the empire into many independent, rival camps. This polarization will not soon wither away.

Devastated Worlds: The first three years also saw each of the factions attempting to consolidate its hold on the worlds within a reasonable radius of its base of power. Many worlds could be recruited simply because they saw the futility of resisting in the face of massive power; those that did resist were bludgeoned into submission.

On an interstellar scale, the bludgeons were used as small asteroids. The messes they make are cleaned up by armies. The result is a number of devastated worlds within the borders of the Imperium.

Disrupted Trade: The battles fought for worlds and trade lanes make the normal course of business extremely risky and very expensive. Prudent businesses find it profitable to avoid areas in conflict; they stay to safe sidelines. The result is a severe disruption in trade. Even when businesses do operate in the battle zone, they charge higher prices. No matter what happens, the Rebellion will produce disruptions in trade.

Invasions from Outside: The Rebellion shows the ordinary observer that the Imperium is no longer the strong, secure empire that will not tolerate outside interference. The security that the Imperium has worked so long to provide vanishes overnight when there is no longer the dedicated command structure and the caring Emperor to provide it.

Rimward, the Solomani saw the potential for invasion. Coreward, Vargr continued, and they stepped up the plunder campaigns they had always made. Spinward, the Aslan saw potential without rival for acquiring new territories for their landless ihatei.

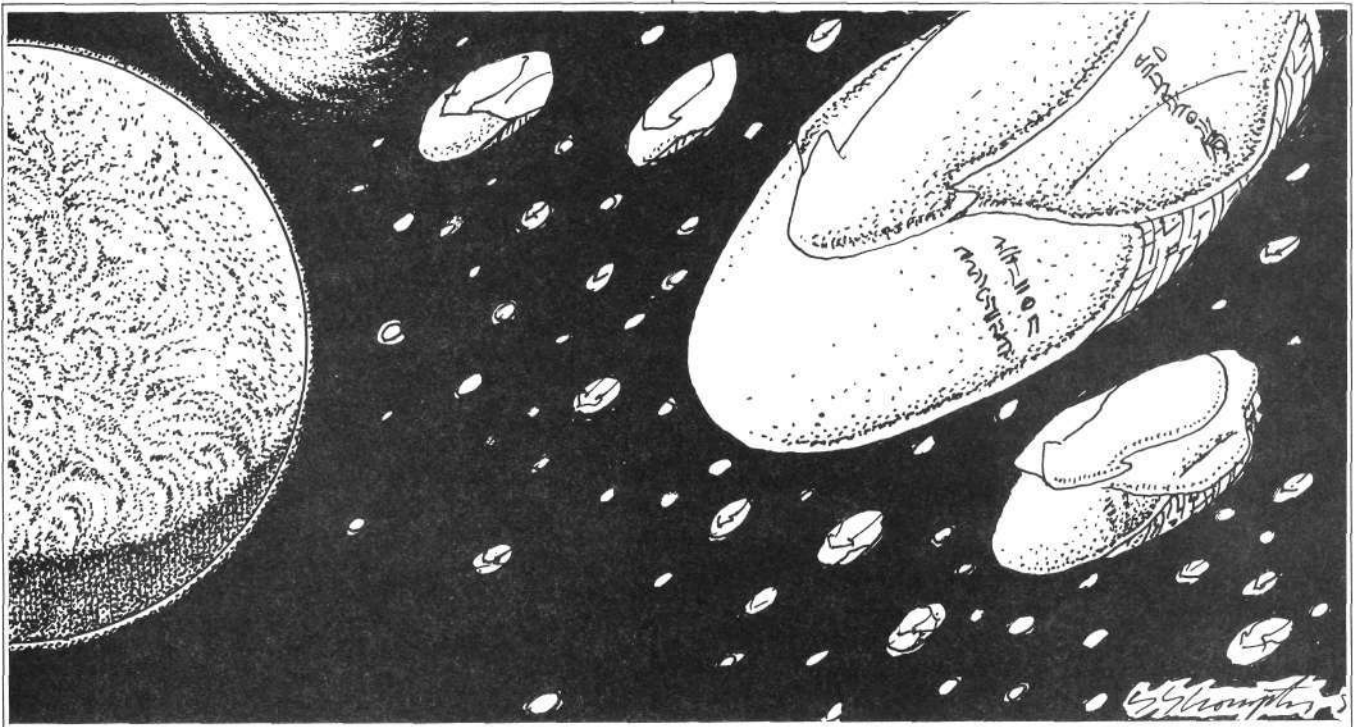



Young Lucan Martin III Alkhalikoi never expected to be Emperor. The branches of the family tree spread too far for the throne to devolve to him. As a result, Lucan was never trained to be an Emperor. He was raised as a noble son—and a younger son at that—to expect comfort and deference; he never learned the responsibilities of command or the accountability of office. He was spoiled as a child, deferred to as an adolescent, and politely ignored as a young adult. When his parents died, the Emperor provided both Lucan and Varian with income and apartments at the Imperial palace; no one, however, provided the firm hand and gentle understanding that would shape the man into a responsible adult.

That spoiled brat now sits on the throne of the Imperium. The ramifications are obvious.

The Emperor is the supreme head of the Imperium. Chains of allegiance and fealty stretch up from the lowliest citizen, the lowest knight, through a network of officials, bureaucrats, and nobles, to the person of the Emperor. The Emperor establishes, by his demeanor, by his actions, and by his tone, how he expects his subjects to act. Tradition has always been that honor is a paramount quality within the Imperium. Individuals are expected to act honorably, with respect even to their adversaries; honor and justice should guide the hand of every person acting for the Emperor.

Lucan changed that concept his second day on the job. The order to stop Dulinor's cruiser as it left the Capital system reached a system defense boat squadron commander just as Dulinor arrived at the system jump point. The commander, unclear about the identity of his target (and well within regulations) held his fire. Dulinor sacked the man, stripped him of his rank, and exiled him to the frontier.

His brief comment established quite clearly to the Imperial Navy what was expected of it. "I don't care what you do. I just want results. If you can't give me results, then get out." Faced with a choice of losing rank they had worked decades for, most of the Emperor's admirals chose to stay. When they addressed their staffs and their subordinates, they conveyed the same philosophy. Within months, every person in the Imperial Navy knew that any means were justified if the end was achieved.

LUCAN

The Third Imperium has not been destroyed by the Rebellion—merely shattered. The largest remaining piece is still the Third Imperium. It needs a strong, powerful leader who can help put the pieces back together. Lucan probably isn't the man to do it.

Name: Technically, Lucan's faction continues to call itself the Third Imperium. Opposing factions call it Lucan's Imperium.

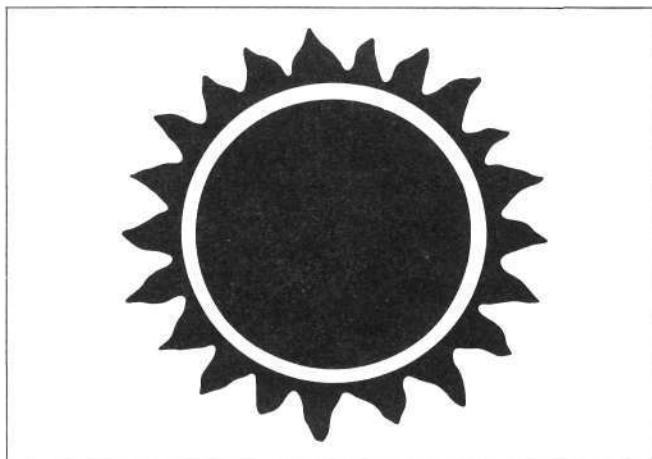

Leader: The Emperor Lucan is titular and actual head of the Third Imperium.

Territory: Although it claims all territory formerly under control of the Third Imperium, Lucan's Imperium actually controls the sectors of Core, Fornast, Ley, and parts of Massilia and Dagudashaag.

Constituents: Lucan's Imperium counts as its supporters all citizens of the Imperium within its territory. It depends on some Imperial citizens in other territories to also provide support.

IDEOLOGY

Any means justify the end.

In one sense, Lucan is the easiest of the many factions to follow. His personal claim to be Emperor is supported by the facts and by tradition. Lucan represents the status quo; he is the standard against which other factions are judged. Lucan also represents the easy choice: Because he is at the head of the government which existed under Strepthon, he is the automatic choice which requires no decision.

Lucan's supporters say that a citizen who uses the facilities of the Imperium becomes a supporter of Lucan. In reality, most Imperial citizens in Lucan's territories use the Imperium because they have always used the Imperium. They accept his rule because they see no available alternative.

The philosophy of Lucan's faction is easily summed up as:

Any means justify the end. Lucan, in his personal behavior, had (probably) killed in order to win the throne. He expects no less a dedication from his supporters in the current struggle to end the Rebellion and to unite the Imperium under his rule.

Lucan's philosophy has several effects on his supporters as his philosophy is absolute: Those who cannot support it also cannot change it. They must do as they are told, or they must get out. In the early months of the Rebellion, as Imperial officers, troops, and bureaucrats learned what was expected of them, many deserted. Those who remain are prepared to use any means to achieve their orders.

Lucan's philosophy is also fickle. It comes directly from the Emperor. When he changes his mind, everyone must follow immediately. Followers are careful to cover themselves, documenting that they are following their commander's lead.

THE IMPERIAL SYMBOL

Emperor Lucan, at the head of the existing Third Imperium, retains the right to make use of the classic Imperial sunburst. The sunburst was adopted as the Imperial symbol when Cleon I established the Third Imperium in the year zero.

IMPERIAL STRENGTHS AND WEAKNESSES

Lucan's Imperium began with the assets of the Imperium; losses and defections have reduced those assets, but the empire remains a strong force.

Strengths: Lucan's Imperium claims three major strengths: the navy, the Imperial bureaucracy, and tradition.

The Imperial Navy under Lucan numbers less than 200 fleets. Of these, he counts 104 numbered fleets (many withdrawn from border sectors), 67 reserve fleets, 18 depot-based fleets, and four Imperial reaction fleets based at Capital.

The Imperial bureaucracy, an efficient support for the empire for more than 1000 years, was already in place when Lucan assumed control. The fact that Lucan's Imperium was a continuation of existing government made the transition easy.

Tradition is a strong force in Lucan's Imperium. Allegiance requires no citizen decision: They are part of the Imperium unless they make an active decision against the empire.

Weaknesses: Lucan faces threats on all sides, and his Imperium is weakened by two conditions: a central position and a widespread rejection of Lucan.

The territory held by Lucan is surrounded by territory under the control of other factions, so Lucan must maintain defenses on all fronts in order to keep other forces from encroaching. His forces are the strongest, but he also has more territory to defend and more adversaries to defend against.

Lucan is also the subject of extensive criticism. The details of his brother's death make him out a murderer, no better than Dulinor, and to many people, worse. Lucan's authoritarian personality and newfound Imperial manner are also poorly received and do not help recruit allies to his cause.

ALLIES

Two major territories within the Imperium have declared unconditional allegiance to Lucan: the Domain of Gateway, and what remains of the Domain of Sol.

Tranian, Archduke of Gateway, rallied early to the side of the new Emperor. Already present at Capital when the

■
Lucan's Imperium
*Lucan, controlling the Imperial
 bureaucracy, has drained border sectors
 of their fleets to crush Dulinor.*
 ■

assassination occurred, Tranian participated in the preliminary search for the appropriate and legitimate heir to Strephon and made the pronouncement himself that Lucan was the proper heir. Apparently motivated by nothing so much as honor and a desire to pursue the legally correct course, he helped install Lucan at a time when the confusion created by Dulinor threatened the peace and order not only of Capital, but of the Imperium itself.

Once Tranian had sworn fealty to Lucan, he felt there was no going back on his word. The loyalty and support of Tranian brings Lucan dozens of fleets, hundreds of worlds, and billions of subjects. Lucan, in turn, has magnificently rewarded this one of only two Archdukes to support the Imperium.

Adair, Archduke of Sol, never even considered not supporting Lucan. The Domain of Sol was threatened by Solomani forces long before the assassination; when word of Strephon's death was made public along the Solomani border, their forces swept across in a concerted action that meant premeditation and planning. With Imperial forces pushed back from Terra and all along the border, it was quite clear that they could never survive without support from the main body of the Imperial Navy. Adair pulled back to the defensible Vegan Autonomous Region, giving ground only when necessary, and making the Solomani pay dearly for it. Within his defensive perimeter, he sent out his appeals to Lucan, asking, begging, demanding more forces, but always acknowledging Lucan as the legitimate Emperor. When every other Archduke but one did not support him, Lucan had to be pleased...annoyed as well, but pleased.

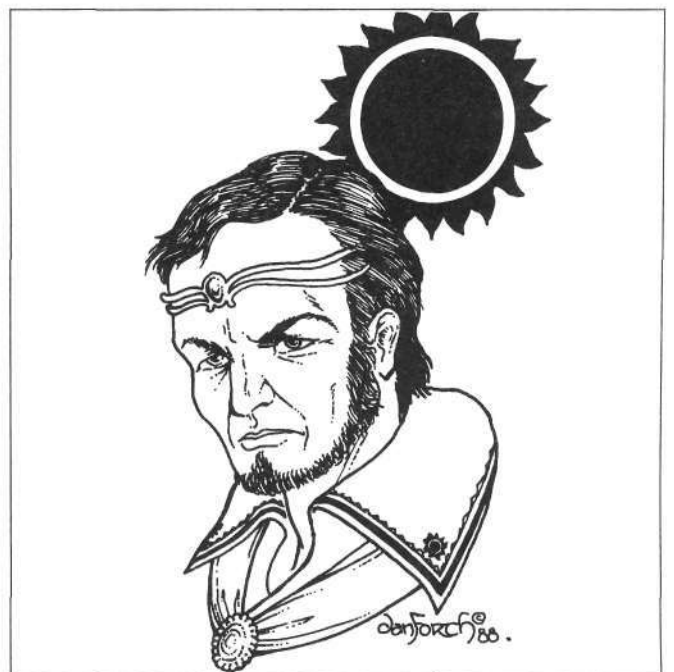



The assassin Dulinor began the Rebellion with his actions in the Imperial Palace on 132-1116.

Faction Name: Dulinor, by announcement in 1116, stated that he was the Emperor and titular head of the Third Imperium. Between 1116 and 1118, he referred to his empire as the Third Imperium or simply the Imperium. In early 1119, he formally named his government the Federation of Illeish. Opposing factions generally call the faction Dulinor's Imperium, or simply refer to Dulinor.

Leader: Archduke Dulinor Astrin Illethian rose to the highest levels of the nobility in the Domain of Illeish with the approval and the support of the Emperor Strephon. As Archduke, he built for himself a strong following in the sectors of Illeish and Zarushagar, and was readily accepted as the leader of the region when he assassinated Strephon and seized the throne for himself.

Territory: Dulinor's Imperium encompasses 36 subsectors centered roughly on Dlan, Dulinor's capital of the Domain of Illeish. The territory includes nearly all of Illeish sector and portions of Gushemege, Verge, and Zarushagar sectors.

Constituents: In addition to solid support within the territory of Dulinor's Imperium, Dulinor claims as his constituents a broad spectrum of Imperial citizens who want a deeper involvement of the Imperium in the affairs of its component worlds.

IDEOLOGY

The Imperium must extend its benefits to its worlds, not merely to the space between worlds.

Unlike many nobles in the Imperium, Dulinor had a deep-seated feeling of responsibility for the masses of the empire. As he rose in noble rank, he developed a strong sense of purpose: to provide the greatest possible benefit for the greatest possible number of Imperial citizens.

Although the Imperium includes more than 8000 worlds, each has its own government. The Imperium rules the space between the stars; its effects are felt on worlds only through the channels of the independent governments on those worlds. Dulinor wants to exert more influence on those governments, charging them with more democratic, responsive policies.

DULINOR'S SYMBOL

The Imperial symbol shows a single star, yet the Imperium

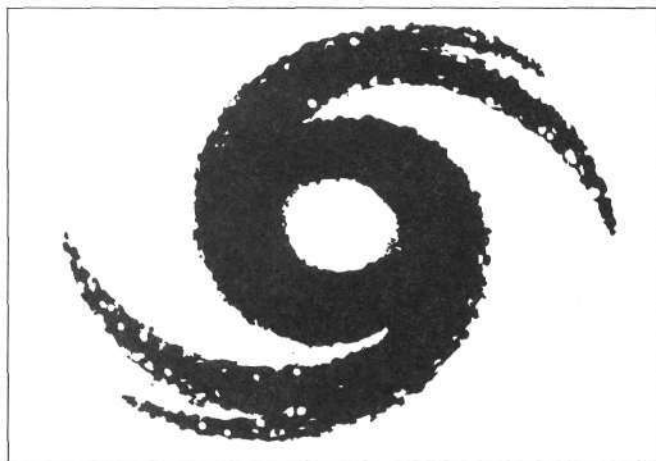

is a unity of many stars. Dulinor selected, as the symbol for his advanced form of the Imperium, the galaxy itself, representing millions of stars considered together as a single unit.

DULINOR'S STRENGTHS AND WEAKNESSES

Dulinor's plan assumed that he would take over the Imperium intact. When that part of the plan was frustrated, the survival of his Imperium hinged on the strength and the weaknesses of his faction.

Strengths: Dulinor claims three basic strengths for his empire: the element of surprise, a moral appeal to individuals who want more involvement of worlds in the empire, and an easily defensible territorial position.

Dulinor's first advantage was the benefit of surprise. He was able to act and then broadcast the first news of his actions before objective accounts could be disseminated. His own accounts, slanted to his best advantage, ensured that citizens within the Domain of Illeish knew and sympathized with Dulinor's principles.

At the same time, Dulinor's principles themselves had a broad appeal. The tradition that the Imperium left world surface affairs to its component world governments meant that there was a broad disparity in citizen rights and privileges. The appeal of consistent and liberalized treatment of citizens within the Imperium was obvious to most, and gained an immediate acceptance. Dulinor's campaign proposed a gradual transformation of the worlds of the Imperium into liberal democracies.

Dulinor also enjoyed a territory that was easily defensible. Backed up against the vast voids of the Great Rift, it effectively shields his territory on two sides, reducing the frontage that must be defended against retaliatory attacks.

Weaknesses: Dulinor crippled the appeal of his faction by his murder of Strephon. Although there were well-documented precedents for his actions, and the dramatic changes he

planned for the Imperium required that there be extensive shifts in the Imperium, a broad public reaction against the murder worked against acceptance of him as a leader.

DULINOR'S HOMEWORLD

Dulonor's homeworld of Dlan/Ileish (A8D1ADE-G) is a religious dictatorship, with its society shaped in great measure by the beliefs of its population. Virasa, the primary religion of Dlan, believes that a knowledge of God is impossible during one's normal life, that discussions of the existence of God or of his attributes is fruitless. Nevertheless, Virasins have extensive beliefs in the afterlife and its nature. They are taught that in the paradise of the afterlife, all knowledge will be theirs. By logical extension, great knowledge is equated with paradise, and Dlan supports a highly technological society patterned in large part on the Virasin concept of heaven.

Virasins believe only they will reach paradise; nonhumans and nonbelievers can only hope to sit outside the entrance to paradise for all eternity. Local custom dictates that nonbelievers on Dlan wear black in recognition of their unfortunate status. Believers and nonbelievers are governed by different laws, but the distinctions apply primarily to allowed occupations and to taxation. Violent death is repugnant to Virasins, so military occupations are restricted to nonbelievers; lower tax rates for nonbelievers make up for the restricted occupations of the military and the police. By extension, Dlani military and police forces wear striking black uniforms.

Dulonor, born on Dlan and holder of a hereditary fief as a noble, is not a Virasin. Because of his background and his participation in Dlani society, he easily and naturally follows its clothing customs, and typically wears black.

THE ILELISH REVOLT

Dulonor's territory of Ileish revolted once before.

Imperial authority met its first great challenge from within when, in 418, the world of Ileish declared its independence from the Imperium and called for its sister worlds within Ileish and Verge sectors to join in the establishment of a new order.

The problem had been a long time coming. The population of the Imperium was concentrated (then, as it is now) on High Population worlds that comprise fewer than a tenth of the available worlds. The focus of the expanding Imperium, however, was on increasing the number of worlds under its authority; because expanding frontiers was first priority, meeting the needs of High Population worlds fell somewhat lower on the list. After decades of neglect, the High Population worlds of Ileish sector (and led by Ileish, then the capital of the sector) began negotiations in 399 with the central Imperial government for the establishment of an autonomous region in Ileish sector. The population centers uniformly felt that greater control over their own interstellar trade was the key to greater profitability.

Emperor Martin III refused. Although the precedent of the League of Antares existed, Martin III and his advisers saw no pressing need to relinquish Imperial authority simply to relieve economic depression within the empire.

In 418, Ileish declared its independence from the Imperium; it was joined by 12 other High Population worlds within a year. By 420, the revolt had spread to six subsectors.

Dulonor

Dulonor, the Emperor's assassin, has retreated to Ileish to rally forces for his own drive for the throne.

In 420, Martin III acted by imposing a blockade around the insurgent territory. Squadrons were mobilized from throughout the Imperium in order to fill out the siege lines. As the noose drew tighter, the density of ships in the line increased. As each world fell to the siege, the inevitability of Imperial victory became stronger.

The Imperium was patient in its campaign. It minimized its own losses by avoiding confrontations. At the same time, its own overwhelming fleet force made confrontations rare. Instead, the revolt was slowly and carefully ground down.

The last world to fall was Ileish itself. When it did, in response to a demand for unconditional surrender in 435, the Imperium mandated the evacuation of all population in the lush equatorial zones, and then scrubbed the zones of their flora and fauna. Seven hundred years later, the equatorial zone of Ileish remains a sterile desert. The capital of the Ileish sector was shifted to Dlan, a High Population world which remained loyal to the Imperium.

The Ileish Revolt challenged the central authority of the Imperium: In the face of the overwhelming assets of the Imperium, no part of the empire has any hope of seceding.

But the revolt also showed how the Imperium could flex its muscles. Squadrons and fleets stationed near the trouble spot would respond first. Where possible, world surface actions were avoided. As time passed, the Imperium mobilized and transferred fleets from more distant regions and used them to reinforce the trouble spots. The Imperium was slow to respond, but it responded inexorably.

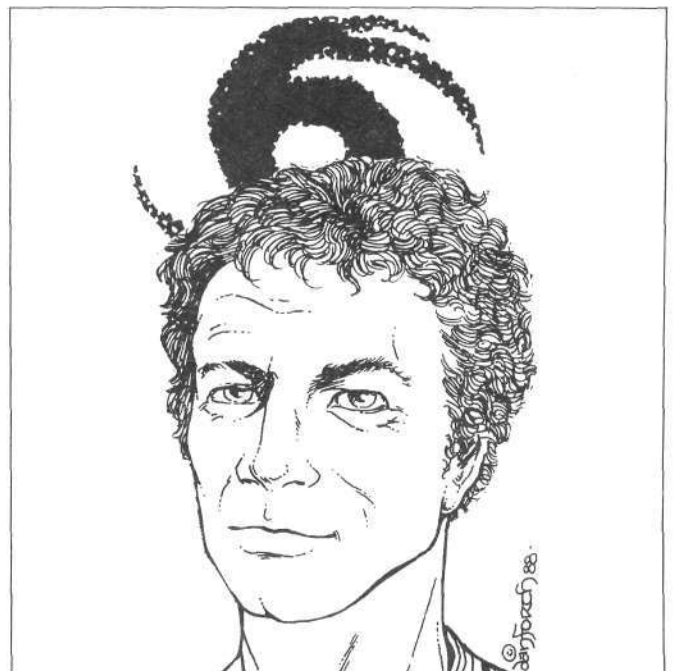



Margaret

Margaret represents the moderate forces of the Imperium. Lucan's ascension to the throne happened too fast, without consultation of the nobles, and without proper analysis of the charges of misconduct levelled against the prince. Many nobles naturally grumbled and talked of supporting an alternative candidate.

Once Lucan was actually on the throne and started giving orders, more nobles rallied to the moderate cause. Lucan's haste in taking the throne was criticized by Duke Simalr of Ushra, who added that under the circumstances, Lucan would require approval by the Moot before becoming Emperor. Lucan issued an order dissolving the Moot for one year. Duke Simalr protested the order as invalid. Lucan placed Simalr under house arrest. Nobles, seeing discretion as the better part of valor, avoided the Moot the next day, and it failed to convene for lack of a quorum. Those nobles who could decided the time had come to return to their fiefs. Lucan was left with control of Capital.

But the moderates gained ground. The search for an alternative heir to the throne turned up Margaret. Many conceded that her claim was subordinate to that of Lucan, but if Lucan should die or be dethroned, Margaret could legitimately succeed him, and the Moot in clear conscience could approve the action.

MARGARET'S FACTION

Lucan issued an order for Margaret's arrest, but she had already left for her estates in Delphi sector. The arrest order produced even more support for Margaret as pretender. By the time Margaret had arrived in Delphi, she had a strong base of power with support from nobles in all parts of the Imperium.

Name: The faction that follows Margaret has adopted her name for their cause. They are referred to as Margaret's forces, as in Margaret's Fleets, Margaret's Faction, or simply Margaret. Alternative designations include the Pretender, and the Empress.

Leader: Margaret is the personal leader of the faction. She has extensive assistance from a staff of nobles and experts who advise her on possible actions and plan out her faction's operations. All policy decisions are decided by her personally, but she leaves their execution to staff and subordinates.

Territory: Margaret's noble fiefs are located in Delphi sec-

tor, and as a Duchess of the Imperium, she already has extensive political power in the region. Her estates, located at Anaxias, deep in the Delphi Rift, are virtually unapproachable to most naval operations, making her base of operations safe and secure. Most of the sector declared itself for Margaret by mid-1117, as had several subsectors in the neighboring Massilia sector.

Constituents: Beyond Margaret's territorial subjects, she claims a sizable proportion of moderate nobles who agree with her philosophy. The fact that Margaret's territory is so close to Capital and its territory provides a steady stream of defectors fed up with Lucan.

IDEOLOGY

A return to the stability of the classic Imperium.

Margaret represents the classic values of the Imperium. The forces which support her fervently wish that the clock could be turned back and the chaos of the Rebellion could be totally avoided.

The Imperium of recent years was an efficient, well-run government that encouraged trade, industry, exploration, and stability. Large corporations were especially prosperous under the empire's protection; they were profitable, and they in turn provided employment to citizens and spread their prosperity throughout the Imperium.

The Rebellion has changed that, shifting the very foundations of profitable business into unstable sand. While each faction demands support from the corporations within its territory, Margaret represents the specific views of most businesses in the Imperium: a return to normalcy.

MARGARET'S SYMBOL

In 1031, Paulo III ascended the throne. One of his first acts was an award of a duchy in Delphi sector to his brother Prince



Asan. Most analysts agree that the move was intended to remove a possibly competitive brother from the intrigue of the Imperial court. When Prince Asan almost married Marian, the daughter of the Delphi's senior duke, he established his family line as the senior one in the sector. To commemorate the marriage and to establish it as distinct from the Imperial family, Asan adopted the bird of prey as the family symbol. Margaret has used the symbol to represent her faction.

TUKERALINES

Margaret is married to Count Elaine Trulla Tukera, one of three sons in the upper reaches of management for the Imperium-spanning Tukera Lines. The marriage provided Margaret with a loving husband and devoted friend before the assassination of Strephon; the fact that much of the power of Tukera could be placed in Margaret's control provided her with additional support when it became apparent that she was a pretender to the throne of the Imperium.

Margaret, seeing the assassinations of Strephon and Varian, understood enough history to realize that a new Long Night was a definite possibility. She also knew that her own personal and family fortunes, her reputation in her home territories, and her experience with economic management could together be applied to delaying or avoiding such a catastrophe. Instead of raising great howling war fleets to conquer territory, Margaret is emphasizing the Imperial infrastructure.

Margaret is a transportation fan; her goal is to keep the ships moving, and as a result, to maintain the status quo. Food shipments from agricultural worlds to high population worlds help to save lives. Machine parts shipments from industrial worlds to less-industrialized worlds save no fewer lives. Without transportation, Imperial territory is a vast domain of isolated worlds, each independent of the other, and each unable to interact with the other in any way.

Military ships are necessary; Margaret's Faction realizes the need and has acted upon it. Someone has to convoy the transport fleets through danger spots and choke points. But war fleets are useless. They destroy more than they ever can save, and Margaret's forces are committed to saving lives and worlds.

Margaret intends to be a threat to no one. She seeks to build an island of stability where the mail still goes through. Her plan is to show the other participants in the Rebellion that a healthy, well-managed economy is a far greater treasure than the throne of the Imperium. She talks a lot about input-output structures and payoff matrices; Dulinor killed Strephon, but what did he really gain? And what did the peoples of the Imperium gain? Margaret is going to manage her territory and show everyone else that nurturing a realm is a greater task with greater rewards than is conquering it.

If Margaret's strategy works optimally, she will be able to remain neutral in the coming succession wars; she'll be able to quietly rejoin the Imperium (on her own terms) once the dust settles. Margaret is not without ambition; she would like to be Empress, but she doesn't want to rule for only a few weeks. Instead, her success (if she can achieve it) would be a testimony to her potential at a higher level. But if her strategy works at a less than optimum level, Margaret understands that she may have to devote the wealth of her region to allying with

Margaret

Margaret, supported by moderates in the Moot, has established a base of power in her own Massilia sector.

and supporting other factions. And if her strategy fails, Margaret knows that she may be forced to cut back, quietly abandoning entire star systems to their fate so that at least a skeleton of civilization can be preserved.

Margaret is naive. Her devotion is to transportation and to its preservation. Trade war she understands, but not true warfare and intrigue. She tends to underutilize (and underfund and underrate) espionage, covert operations, and even normal reconnaissance and scouting in pursuit of her goals. The enemies' plans and operations far beyond her borders are none of her affair. She believes (somewhat lamely) that what she needs to hear will come to her in due time.

Even within her own territory, Margaret underrates and underutilizes the intelligence assets she has. Spying is avoided. Instead, a careful search of public records—births, deaths, arrest and conviction statistics, letters written to district nobles in protest, and so on—is sufficient to find and track trends.

Margaret is unquestionably competent when it comes to managing an economy, but she is also somewhat nearsighted. She sees the trees, but only in economics can she see the forest. If some essentially irrational event creates a disruption (a religious upheaval, a political schism, or a racial or nationalist sweep of unrest), she will be slow or imprecise in reacting.

Margaret is proceeding slowly and diplomatically in absorbing former Imperial assets. She is bringing starports under her control and taking over naval and scout bases. She is working to make her territories survive the Rebellion; if she can do things right, they may even come out on top.





Prince Varian was eligible to ascend the throne at 1517 on 132-1116; he died at 1520 on the same day. Although the prince never formally became Emperor, he did become a martyr. A great many people in the Imperium were shocked that an Archduke would assassinate the Emperor; they were appalled that a Prince would kill his brother in order to win the Imperial Throne.

Varian's death was discussed in detail by a number of nobles in the aftermath of the assassination. It became clear after a few days that Lucan would not tolerate a detailed investigation of the circumstances of Varian's death, and at the same time, that Lucan was indeed involved in his brother's death. Once convinced that a murderer sat on the Imperial Throne, the small circles agreed that honor required measures to avenge the deaths of Varian and of Strephon.

At the same time, direct action was impossible. Security for Lucan and for Dulinor made any retaliatory measures impractical. Instead, the nobles pledged their own honor to a long-term mission to eliminate Lucan and Dulinor, and to restore the Imperium to the honor it deserved.

THE BROTHERS OF VARIAN

Realizing that achieving their goal would require stealth and long-term planning, the group established a system of recognition symbols, made preliminary plans for the future, and dispersed into the Imperium to recruit new adherents and to work against both Lucan and Dulinor.

Name: The band of nobles elected to call themselves the Brothers of Varian. Often the faction is simply called Varian.

Leader: The most visible leader of the Brothers of Varian is Duke Simalr of Ushra. Shortly after being placed under house arrest on his estates in Capital, he fled. No specific leader controls the Varian faction.

Territory: The Brothers of Varian claim no specific territory.

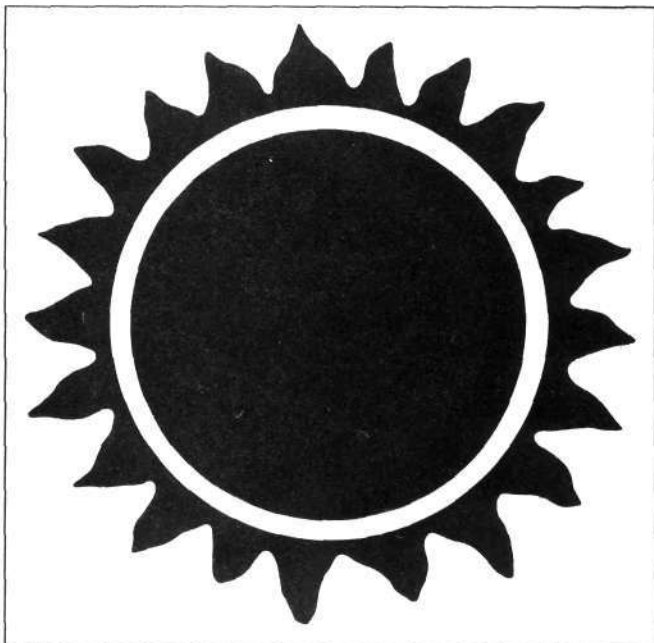

Constituents: The Brothers of Varian appeal to honorable individuals who were shocked by the murders of Strephon and Lucan.

IDEOLOGY

Honor and justice.

For centuries, the nobility of the Imperium has been trained to consider honor the greatest of all human traits. Since communications between worlds and within the government can take weeks, months, or years, the nobles of responsible government must depend on each other's honor to see that jobs are done, orders are carried out, and results are achieved.

The importance of honor is similarly encouraged in non-nobles within the Imperium. The concept pervades Imperial society. Naturally enough, the assassination of Strephon produced a tremendous outcry; honor cried out for justice. Normally, justice would be provided by the Emperor's successor, but many consider Lucan as tainted with dishonor as Dulinor.

In the search for honor and justice, many in the Imperium have rallied behind Varian, selecting the dead prince as a symbolic martyr of honor and justice. They see him as a symbol of the priority confronting the Imperium—justice for Strephon and Varian through apprehension and trial of their assassins.

VARIAN'S SYMBOL

Varian's faction is an invisible, informal one. It has no symbol, and Varian's followers routinely attach themselves to some other faction (depending on expedience and convenience).

AVENGING VARIAN

The Brothers of Varian exist unobtrusively throughout the Imperium. Most claim some other allegiance. When the situation is ripe, each can strike a blow to avenge the fallen Prince—anything from misdirecting a fleet to an empty system when it is vitally needed on the war front to misfiling information essential to winning the allegiance of a High Population world.

Strephon



In mid-1117, the Emperor Strephon stepped out onto the balcony of his vacation palace on Usdiki in Gushemege sector and waved to the crowd. The response was so thunderous that he was unable to deliver his prepared remarks.

News that the Emperor had survived Dulinor's attack was greeted with joy. The Imperial depot in Gushemege, under pressure from both Dulinor and Lucan to declare for them, welcomed the news of Strephon's survival and declared for him. Throughout the sector, fleets were relieved that the real Emperor was alive. Dulinor lost seven fleets, and Lucan lost ten as they crossed the battle lines to join Strephon's forces. Dulinor and Lucan both placed severe restrictions on information passing through their territories, and news about Strephon was generally contained in the Gushemege sector. Both Dulinor and Lucan placed embargoes on Gushemege sector and committed forces to destroy Strephon.

THE PUZZLE

The first question raised was: "How can this be Strephon?" Strephon answered it candidly.

"In the course of handling Imperial affairs, the demands on an Emperor's time are many. Sometimes, they become too great, and it is imperative that the Emperor be allowed a respite. At the same time, citizens and dignitaries expect to see the Emperor, and are not easily persuaded that they cannot. An innocent ruse is necessary at times like these, and I have for years employed a double to take my place at ordinary events.

"On the day of Dulinor's actions against me, I was (fortunately for me, unfortunately for my double) aboard the cruiser *Amedon* en route to the Imperial depot in Core sector. Dulinor killed an innocent actor trained to imitate me at court functions.

"When word of the assassination reached us at Depot/Core, the crew of the *Amedon* rallied to protect me, spiriting me to my vacation palace here.

"I have seen the chaos that Dulinor has caused, and I have seen the foul deeds that my so-called successor Lucan has done in the name of the Imperium. All of this must end. The time has come for all of the Imperium to rally to the banner of Strephon!"

The second question raised was: "Is this really Strephon?" Several answers were forthcoming.

Dulinor privately dismissed the reappearance of Strephon as the work of an impostor.

"The man who routinely impersonated Strephon is now playing the part of his life. Who would believe that a mere actor would have the audacity to think that we would believe that he is the Emperor. Now his claims insult the memory of Strephon. I loved our former Emperor; I was forced to kill him for reasons of state and for the greatest good of the greatest number. For this impostor to claim that he is Strephon is an insult!"

Lucan privately dismissed the reappearance of Strephon.

"We know Strephon sometimes used a robot to impersonate

himself at routine functions. And we know one of them is now missing. Sources tell me this thing that claims to be Strephon is a robot. Heaven help us when his batteries run down!"

IDEOLOGY

Strephon represents the fervent dream of millions of Imperial citizens: that the Rebellion had never happened. After months of disruption and conflict, the man that everyone thought was dead has presented himself as alive. Impossible as that might seem, many are prepared to accept and to believe because Strephon holds out the potential of a return to the old days.

STREPHON'S SYMBOL

Strephon uses the symbol of the Imperium as his own symbol. The confusion is unavoidable; no other symbol would be acceptable to the man who claims to be the true Emperor.

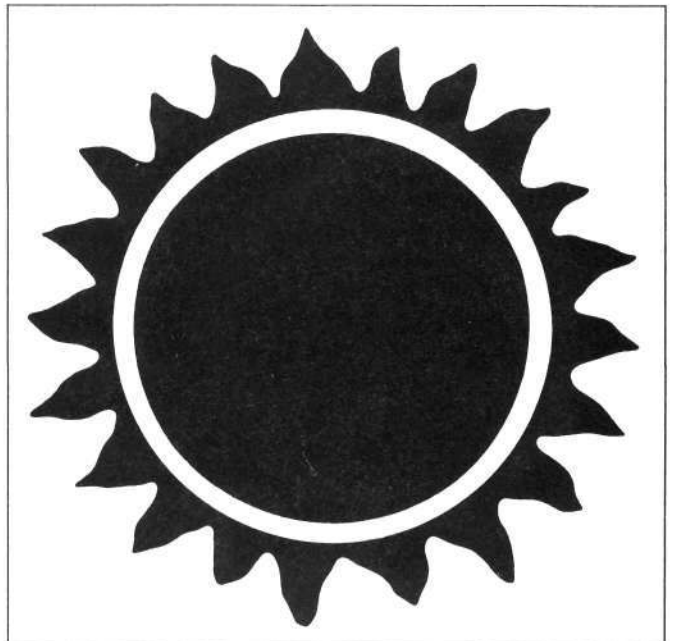



The ancient Imperial capital of the Vilani empire was Viand. When that empire fell, collapsing of its own weight, Viand became a regional capital under the Rule of Man. When the Rule of Man fell, Viand remained a shining center of technology and culture against the darkness of the Long Night. When the Third Imperium was founded and expeditions were sent out to recruit new worlds for its expanding empire, Viand was one of the first to join.

But being a regional capital had always been a blow to Vilani pride. These people were the first human race to discover jump drive and the first to create an interstellar empire. After centuries of being submerged in the Third Imperium, Viand was ripe to revive and regain its lost glory.

The Bureaux: The old Vilani empire divided the duties of government among three bureaux, each charged with responsibility for a specific territory. When the empire fell, the bureaux were transformed into giant corporations which survived to the present as the megacorporations Makhidkarun, Naasirka, and Sharurshid. All three are major economic forces in the Imperium, even as they continue to cherish their ancient heritage.

Lucan's Mistakes: Lucan considered his withdrawal of the fleets from Corridor and Lishun absolutely necessary if he were to defeat Dulinor. The risk to Viand and the sectors bordering on Vargr territory was a calculated one: If Dulinor could be defeated quickly, and if the Vargr could be held at bay, the damage to the Imperium would be minimal.

Dulinor refused to allow a quick defeat; the Vargr quickly found the weaknesses on the border; Lucan needed more and more fleets to fight against Dulinor. When he requisitioned the Viand Fleet, the sector rightly saw it would be left defenseless. It refused.

Refusal of an Imperial order is clearly rebellion, and Viand took up the banner with great energy. The submergence of Vilani pride within the Third Imperium was tolerable when the Imperium worked; when it acted against the Vilani, it became intolerable.

The Vilani Empire Model: It seemed only natural to establish the new government of Viand sector using the Vilani empire as a model. Makhidkarun, Naasirka, and Sharurshid were invited by the Archduke of Viand to reestablish their old territories, which divided the sector equally between them. The megacorporations each elected members of a central ruling council called the Igsiirdi, which in turn elected the Ishimkarun—the Shadow Emperor. They selected Archduke Ishuggi, who then retired to the Vilani Imperial Palace to rule in the ancient manner: by proclamation.

The heads of Makhidkarun, Naasirka, and Sharurshid became the Karunii—the Petit Emperors—each supreme in his own territory.

THE REESTABLISHED VILANI EMPIRE

The new Vilani empire traces its roots back thousands of years to the original interstellar human empire.

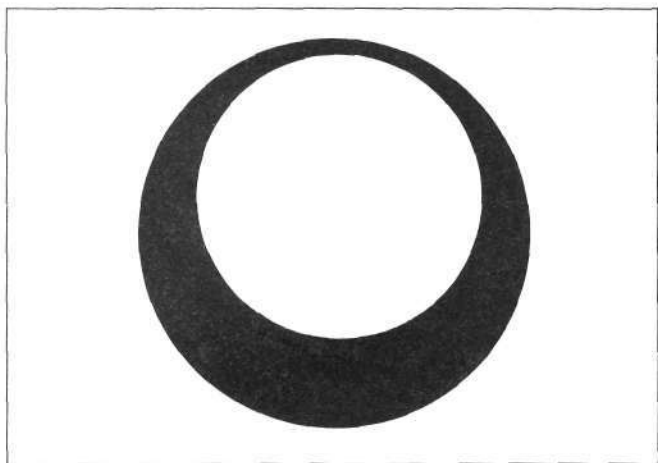

Name: The Vilani name for the Vilani empire is Ziru Sirka, which translates as Grand Empire of Stars. Once it had fallen, to be replaced by the Rule of Man, it was often referred to as the First Imperium. Rather than give their new empire a number, the Vilani prefer to call their government either Ziru Sirka or Vilani empire. Outsiders often call it the Reestablished Vilani empire.

Leader: Ishuggi, Archduke of Viand, was instrumental in leading his sector to independence. The megacorporations responded to his call and elected him Ishimkarun.

Territory: The governed territory of the Vilani empire is Viand sector. Technically, the empire has claims to all territory which was at any time part of the original Vilani empire.

Constituents: In addition to its territorial citizens, the Vilani empire appeals to any humans who were raised in the Vilani culture. Pure Vilani blood means very little; millennia of intermarriage and widespread colonization make pure Vilani blood a rarity and difficult to prove.

In addition, the many employees of Makhidkarun, Naasirka, and Sharurshid have long had a corporate loyalty to their

companies; that loyalty is potentially transferable to the new Vilani empire.

IDEOLOGY

Resurgence of former glory.

After centuries of submergence within the Imperium, the opportunity for the Vilani to regain their lost empire has finally come. As long as the Third Imperium ruled, the Vilani were forced to accept their position within the broad spectrum of Imperial races. Even though they enjoyed prosperity and stability throughout that period, they had no special place in the scheme of things.

Presented with the twofold opportunity of the collapse of the Imperium and the need to defend themselves against aggression from neighboring Vargr, the reestablishment of the Ziru Sirka (the original First Imperium) is an expression of Vilani pride and ambition.

VILANISYMBOL

The ancient symbol of the Vilani empire was an eclipsing star. The two superimposed disks of the symbol are well-known throughout the Imperium as representing the Vilani people and the Domain of Viand. Adoption of the symbol was used to reinforce the concept that the Vilani empire had, at long last, returned.

THE MEGACORPORATIONS

The incorporation of Makhidkarun, Naasirka, and Sharurshid into the Vilani empire had wide-ranging results throughout Imperial territory. Initially, all 13 of the Imperial megacorporations were allowed to continue their operations, subject only to some supervision by local authorities.

When Viand left the Imperium, however, secret announcements were sent to bases and stations belonging to Makhidkarun, Naasirka, and Sharurshid throughout the Imperium, ordering a major and immediate transfer of assets to Viand sector. Liquid assets, starships, trade secrets, and anything immediately moveable were to be sent immediately; employees were to be given the opportunity to transfer as well. Anything that couldn't be moved was to be abandoned or sold at fire sale prices.

By the beginning of 1119, most of the assets of the three megacorporations had been disposed of; fleets of ships (including armed fighting ships commonly used to escort transports) had made their way through one or more enemy territories to safety in Viand. Regions served by these three megacorporations were crippled industrially, or left without service.

Outreach: From its position on the edge of the Imperium, the Vilani empire turned its back on its main body. Instead, using its vast merchant fleets, escorted by any available armed ships, Viand began an extensive trading program with the territories beyond the borders. This outreach served two purposes: It opened new markets and provided an economic bonus to the empire; and it served to reduce tensions with the Vargr raiders across the border. The active trade program changed Viand from a faceless enemy to an active trading partner. Familiarity helped defuse tensions.

The benefits of trade for both sides produced a powerful in-

Vland

Vilani megacorporations have joined forces to reestablish the Ziru Sirka, the Vilani Grand Empire of Stars.

centive to peaceful coexistence. At a time when the Imperium was faltering as a supplier of manufactured goods, the Vilani Empire was able to step into the void and fill the basic trade needs of the Vargr sectors adjacent to Viand. In some ways, Vilani relations with its Vargr neighbors improved as a result of the Rebellion. Previously, the Vargr had directed their raiding indiscriminately against the Imperium, and only coincidentally against the Vilani. At the same time, the Vilani saw the Vargr across the border as a threat to the Imperium and thus a threat to the Vilani themselves.

When the Rebellion divorced the Vilani from the Imperium, it became possible for the Vargr to distinguish between Vilani and Imperial, and at the same time, it was possible for the Vilani to see more than the plundering, lawless Vargr corsairs. With that changed perception, it became possible for the Vargr and the Vilani to develop greater trade links, and in the process reduce tensions across the border.

Viand and the Imperium: The Vilani secession from the Imperium came as a blow to Lucan; it cost him sorely needed fleets, and it also removed a powerful sector from his own control. But Lucan has been able to tolerate the loss of Viand only because Viand has posed no direct threat to his empire. Faced with active contention by Dulinor, Antares, and the Solomani, Lucan is able to tolerate an independent Viand for the moment, biding his time until he has the strength and the security to make a bold stroke to recover the lost territories of Viand.



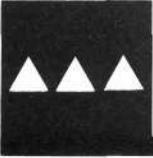

When the Third Imperium first established itself, it expanded to encompass as much former Imperial territory as was possible. Some territories saw the new Imperium as a boon to their economic and technological futures; they welcomed the new government with open arms. Others saw the new empire as a conquerer or an outsider, and they resisted.

Initially, the growing Imperium bypassed areas unwilling to join the empire. As time passed, some worlds saw the benefits they were missing and voluntarily petitioned for inclusion. But several major regions (some approaching a full sector in size) had, 70 years after the establishment of the Imperium, become impediments to the continuing expansion and consolidation of the empire.

Emperor Artemsus (-17 to 166) determined that the Third Imperium would encompass the historical territories of the First and Second Imperia, and he began his Pacification Campaigns to accomplish that end. He created the Domains and their Archdukes, charging each Archduke with the reduction of resistance within his territory. The Archduke of Antares pacified Lishun sector. The Archduke of Viand pacified Dagudashaag sector. The Archduke of Ilelish pacified Zarushagar sector. The Emperor himself took on the pacification of Fornast and Delphi sectors. Between 76 and 120, the empire devoted itself to bringing under its mantle all worlds which lay within the former borders of the First and Second Imperia.

THE JULIAN WAR

Artemsus' Pacification Campaigns had one notable failure: They did not incorporate the coreward sectors of Meshan, Mendan, and Amdukan into the Imperium. His son, Martin I, took upon himself the mission in which his father had failed.

The three sectors of Meshan, Mendan, and Amdukan were, during the First Imperium, the responsibility of a Vilani government bureau, Sharurshid. In the guise of an interstellar megacorporation, Sharurshid still exists, but it long ago lost responsibility for government of the sectors. Under the Second Imperium, the territory was self-governing, presided over by a small bureaucracy imposed by Terra. Large migrations of Vargr passed through the region; many worlds acquired and retained Vargr populations as a result.

When the Second Imperium collapsed, the three sectors survived as a number of confederations, each itself a member

of a larger confederation of confederations. All were dominated by humans and Vargr. The Long Night was less dark in this region than elsewhere; its citizens were reasonably content with the progress and achievements of their culture. Confronted with demands from the Third Imperium that they join the new government of the Third Imperium, they resisted—culturally, diplomatically, and militarily.

Martin I, frustrated after nine years of negotiation, mobilized the Imperial fleets in 175 and attempted to integrate the three sectors by force. In the first three years of the war, the Imperial fleets pushed deep into Mendan sector, capturing the capital world of Lasla and several important industrial worlds but never succeeding in crushing the people's will.

On Asimikigir, the capital of one of many confederations within Amdukan sector, a minor bureaucrat within the naval acquisitions directorate rose to power by increasing naval procurements. Production increased employment, and sparked technological research and development; sales to beleaguered border confederations produced profits and prosperity; the readiness to help produced political power.

By 178, Julian had risen to power within the Asimikigir Confederation and had gathered around him an alliance of neighboring confederations. He then took the bold stroke of establishing a protectorate: a confederation of confederations. Its purpose was to resist the advances of the Third Imperium.

For seven years, the Julian Protectorate fought sporadic battles along the Meshan and Mendan borders, doing its best to push back the Imperial fleets. However, in 185, concentrated and mobilized Protectorate fleets crossed the rift of the Empty Quarter in an end run against Antares, and as a long-range raid against the Imperial naval depots in Antares and Ley sectors. With two major Imperial depots virtually destroyed, the Imperium was forced to rethink its strategies, withdrawing fleets

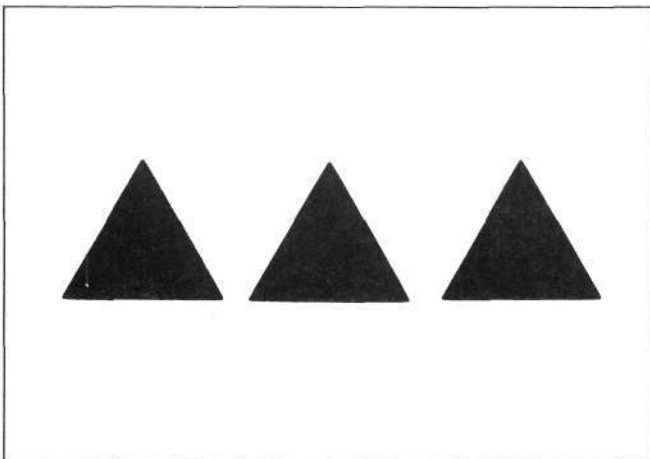

from the frontier to defend interior communications lines.

The Protectorate fleets then turned their attention to the Antares Cluster, 12 worlds lying rimward of Antares. Because the worlds were behind the lines, they were relatively undefended; they fell after only a brief campaign. Using these worlds as a base of operations, the Protectorate fleets carried the war into the Imperium.

The Imperium narrowly lost several battles to regain the Antares Cluster but ultimately proved unable to dislodge the Protectorate. By 190, Emperor Martin I was convinced that the Protectorate worlds could never be forced into the Imperium, and he abandoned the fight.

It took until 191, however, for the war to end. Julian insisted on retaining a hand in the Antares Cluster. By way of compromise, the cluster was established as the League of Antares and given an autonomous status within the Imperium. While the League acknowledged the supremacy of the Imperium, it retained its own rights to negotiate diplomatically and to maintain its own armed forces.

THE ARCHDUKE OF ANTARES

Every Archduke understands how close to the top of the Imperial hierarchy he stands. When Strephon was assassinated, the Archduke of Antares understood that the protocol of hereditary succession meant that one of Strephon's heirs would advance to the Imperial throne. When it became clear to him that Lucan had murdered his own brother to succeed to the throne, Archduke Brzk of Antares came to the conclusion that he himself was a suitable candidate for the throne; he began a quiet campaign within the Moot to line up the necessary support.

Because Lucan was already on the throne and had already dissolved the Moot temporarily, Brzk found himself in a delicate position; he was trying to create support for himself as a successor to Strephon, and that action could be considered treason to Lucan as reigning Emperor. Brzk was forced to work quietly and slowly in order to not offend Lucan (and especially not to tip Lucan off).

But as he worked, Brzk encountered a totally unexpected problem: blatant anti-Vargr prejudice. He found that human nobles, by far the majority in the Moot, would not even consider placing a nonhuman on the throne of the Imperium. The reasons given for their feelings were numerous. Some felt it would be a bad precedent. Others wanted an Emperor who represented the majority race of the empire. Others said they felt Brzk was not the best choice possible. But regardless of the reasons he was given, Brzk soon became convinced that the Moot would never support a Vargr or any other nonhuman on the throne of the Imperium. Faced with the reality of the situation, Brzk elected to take his domain of Antares and chart his own course with it.

In 1117, Emperor Lucan ordered Brzk to mobilize his fleets and transfer at least half of them to central Imperial control in order to fight the usurper Dulinor. Professing obedience, Brzk returned to Antares and began the process of mobilization.

Name: The Domain of Antares declared its independence on 302-1117 and adopted the name League of Antares. By 012-1118, the League of Antares announced that it had joined the Julian Protectorate as one of its member confederations.

Antares

Archduke Brzk of Antares has declared his sectors independent and aligned with the Julian Protectorate.

As a member confederation, it retained its own name as well. The territory is often called Antares.

Leader: The acknowledged leader of the League of Antares is Brzk, Archduke of Antares, a Vargr who traces his ancestry through many generations of Imperial citizenship. He is powerful and committed to justice and treatment of intelligent species.

Territory: The League of Antares encompassed 12 systems in subsector K of Antares sector. When Archduke Brzk declared independence, the League expanded to encompass nearly all of Antares and the Empty Quarter sectors. The Julian Protectorate also encompasses the sectors of Amdukan and Mendan.

Constituents: The citizenry of Antares and Empty Quarter are natural constituents for the League of Antares. In addition, the League is a champion for peace and order in Lishun sector.

IDEOLOGY

Vargr and humans are natural partners.

Archduke Brzk is a champion of human-Vargr partnership. The human dominance of the Imperium has made Vargr along the Imperial border reluctant to accept the concept: Vargr raiding across the border discourages human confidence.

ANTARES' SYMBOL

The traditional symbol for Antares has been in use for more than 5000 years, but interpretations have changed. Classically, the symbol represented a mountain range on Gaakish, the Vilani capital world for the region. As the Vargr population increased, Vargr came to see the triangles as Vargr claws.

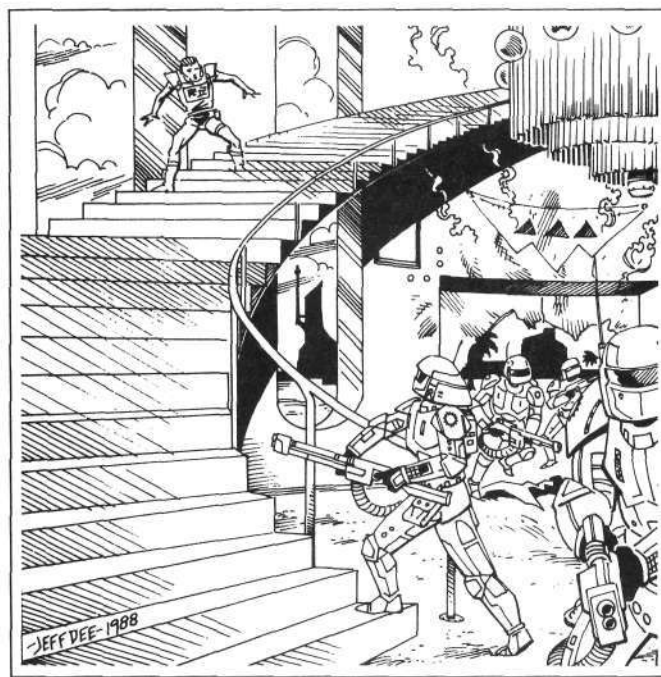



Norris

For centuries, the Spinward Marches have been a vital frontier of the Third Imperium. Settled early in its history, it provided one of the few unpopulated frontiers available to the empire. Despite the fact that the Marches were surrounded by a variety of interstellar governments, they lay relatively empty until the outward thrust of the expanding Third Imperium reached them. In the first centuries of the Imperium, a number of worlds were settled in the Spinward Marches, and the region quickly became an important part of the empire.

During the early years of the empire, the frontier was a peaceful place, relatively secure and stable, while the Imperial interior was wreaked with pacification campaigns and ugly little wars. The emphasis changed as Imperial settlers in the Marches expanded outward into Zhodani space, prompting a succession of Frontier Wars which turned the border with the Zhodani Consulate into an armed camp.

Throughout the history of the Spinward Marches, the narrow access lane through Corridor sector has been a vital link between the Marches and the Imperial core. Passing as it does between two rifts, Corridor is easily blocked, necessitating continuous patrols by the massive Corridor Fleet in order to keep it clear of Vargr raiders. When Lucan withdrew Corridor Fleet in order to reinforce his war against Dulinor, he cut off all commercial access between the Marches and the rest of the Imperium, effectively abandoning all the sectors beyond Corridor until some time after he could defeat Dulinor.

THE ARCHDUKE OF DENEK

Soon after the last Frontier War with the Zhodani, it became apparent that Norris, Duke of Regina, had been a powerful force in the prosecution of the war. Many experts agreed on this, and one of Emperor Strephon's last official acts was to elevate Norris to fill the vacant position of Archduke of Deneb.

Norris' elevation to Archduke automatically positioned him as the most powerful of the Imperial nobles in the four sectors of the Domain of Deneb: Spinward Marches, Deneb, Reft, and Trojan Reach. If the appointment had not been made, there would have been no clear central authority in the region when Strephon was assassinated, and it would have quickly fragmented into small, relatively weak interstellar states.

Name: The Domain of Deneb is technically a part of the Third Imperium. Because it is cut off from the main body of

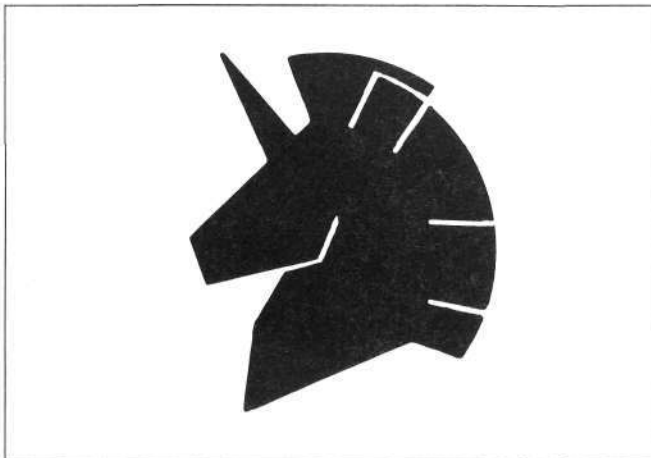

the empire, it has been forced to follow an independent course while waiting until it could be reunited with the Imperium. The region is called Deneb and, less often, the Spinward Marches.

Leader: Norris Aella Aledon is Archduke of Deneb. For most of his life he has been only Duke of Regina, inheriting the title from his father. His full title is Duke Commander Sir Norris, of Regina, Count Aledon, Marquis of Regina, Baron Yori.

Territory: The Domain of Deneb includes all Imperial territory in the Spinward Marches, Deneb, Trojan Reach, and Reft sectors. Curiously, its territory reaches across the Great Rift and includes portions of three subsectors adjacent to Gushemege, Verge, and Illeish sectors. There is no practical way, however, for the Archduke of Deneb to exercise any control over this small portion of his domain.

IDEOLOGY

Loyalty.

Norris knows that the Imperium was the best thing to ever happen to humanity. It provided stability, prosperity, and expansion for humanity, and extended those qualities to the other races who also participated in the Imperium. Faced with making a choice, Norris publicly announced that he remained loyal to the Imperium and its founding principles.

In doing so, Norris committed the government of his Domain of Deneb to a course that supported the Imperium but did not single out the specific leader or faction who represented the Imperium.

Although publicly committed to loyalty to the Imperium, Norris discovered from the very first day that the interests of his own Domain of Deneb were diverging from the interests of the Imperium. Inevitably, Norris was forced to transform his concept of loyalty to the Imperium to loyalty to his subjects. While

he continues to applaud and imitate the Imperium, his government of the Domain of Deneb is committed to the defense and the betterment of the citizens of the Domain of Deneb.

NORRIS' SYMBOL

Although the Domain of Deneb was established in 76, it was not given an Archduke at that time, and the title has lain dormant. When the title was awarded to Norris, it carried with it a variety of prerogatives; one of these was the designation of a symbol for the Domain of Deneb. Norris chose the unicorn.

A constellation in the Spinward Marches is sometimes called the Unicorn, and the symbol has long been used by the Norris family as a symbol for the Spinward Marches territory, which it controls as fiefs. When presented with the opportunity, Norris decided the unicorn would be appropriate as the symbol of the new Domain of Deneb.

WEAKNESS AND STRENGTH

Perhaps Norris's greatest weakness will ultimately prove to be his greatest strength. The Domain of Deneb has always been a distant part of the Imperium, connected by a tenuous link through Corridor sector. That link was essential because of the Zhodani threat to the Domain's security.

With the collapse of the Imperium, it has become obvious that the Zhodani are content to allow the Domain to coexist in peace with them. Once the mighty backing of the Imperium was removed from the Domain, it no longer posed a threat to the Zhodani, and they were able to tolerate its existence.

If Norris can resolve the other problems that face his Domain, he has a genuine chance of keeping it together as a viable interstellar government. Those problems, however, are major ones:

Norris

Norris, recently appointed Archduke of the Domain of Deneb, maintains his loyalty to the Imperium.

Vargr: Vargr, from beyond the Imperial border, think of the Imperium as a land where the streets are paved with gold. Now that the Imperium appears to be weakening, it is natural that the Vargr think in terms of plunder and loot. If the border can be strengthened, or if the Vargr can be persuaded to respect the border, half of the problem is solved. Of course, the Imperium found that the best solution was a massive fleet constantly patrolling at a cost in the billions (and that still did not stop all the raiders).

Aslan: Aslan settlers encroaching from rimward see the Domain of Deneb as ideally suited to their need for new lands. Traditional methods of stopping the Aslan are simply ineffective; the Imperium committed massive amounts for military and naval operations for centuries before the Aslan could be persuaded to accept the Peace of Ftalahr in 380. Norris needs to find a more acceptable solution in a shorter period of time.

THE FUTURE

Although Norris remains loyal to the Imperium, the fate of the Domain of Deneb becomes less and less tied to the fate of the Imperium. Assuming he can solve the Aslan and Vargr problems, any remaining problems are minor. Ultimately, he will need to consider whether the new state that he will lead will be the Empire of Deneb or the Federation of Deneb.

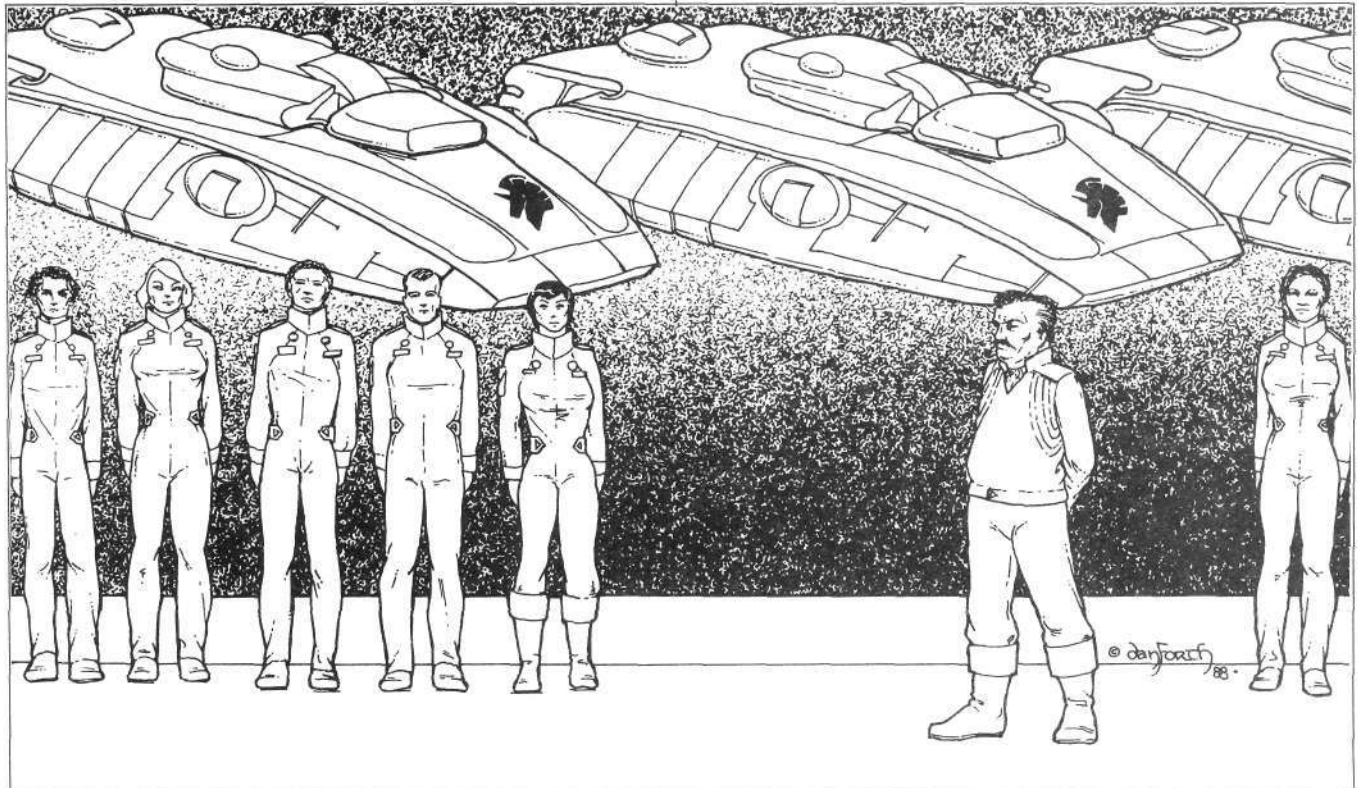



The Fteirle are the youngest of the star-faring major races. After thousands of years confined to their homeworld of Kusyu (A876986-E), located in the Dark Nebula sector, the race discovered the jump drive and had the entire universe opened to them. The territorial instincts of the race drove them to colonize world after world in rapid succession.

Some years after they reached space, they encountered human traders also exploring new territories and, in the process, discovered that the universe was already filled with star-faring races. Initial contacts were peaceful, but conflict eventually developed as both humans and Fteirle competed for worlds and resources. The human traders called the new race they found the Aslan (for reasons which remain unclear).

The Aslan are a race of intelligent carnivorous pouncers at the top of the ecological pyramid on their homeworld. They evolved intelligence as a result of climatic shifts on their world: Forests disappeared, forcing Aslan into the emerging grasslands. The changes of environment were a profound influence on the physical and psychological makeup of this race. Three especially significant characteristics of the Aslan need to be noted.

RACIAL CHARACTERISTICS

Aslan are upright bipeds averaging two meters in height and 100 kilograms in weight. They are divided into two sexes: male and female—the male's increased size and mane are major differences. Females outnumber males three to one.

Aslan males are concerned with military operations, the acquisition of territory, and political affairs; Aslan females are more concerned with technology, industry, trade and commerce, and the accumulation of wealth and knowledge.

Territory: At the root of most Aslan action is a single motivation: the need for territory. Aslan society and Aslan psychology are based on, and Aslan ambition centers on, the basic, instinctual Aslan need for territory. This need, however, expresses itself in different ways in different individuals.

Aslan males have the greatest, most direct territorial drive. The ownership and control of territory for the male is directly associated with concepts of self-worth, with mating instincts,

and with position within the family and clan. Females, however, contribute directly to the importance of territory. Male ownership of territory is attractive to females. Aslan naturally occur in a ratio of about three females to one male; there is a surplus of females in society. Males with more territory attract more females as wives and as servants.

But the Aslan family unit is less a patriarchy than a partnership, because females also value territory. Where Aslan males seek territory almost for its own sake, Aslan females seek territory for what it can be used for. Males are the landowners, often engaging in ritual and real combat to defend their land. Females are the entrepreneurs, finding uses for the land and finding markets for the land's products.

The drive for territory creates a drive for expansion as the population increases and expands into the available territory. Since the firstborn of the family inherits the land, the second sons (*ihatei*) must find other means to acquire territory. Success in warfare, acquisition of successful wives, and a rise in clan power are all ways that can produce territory for an individual. But the star-faring Aslan society has also acknowledged that, for social stability, there must be ways for *ihatei* to acquire territory. The answer is for those without territory to migrate to regions where territory is available.

Migration is an age-old response for the Aslan. Before space travel became available, *ihatei* periodically left the clan to colonize new territory. Once space travel was established, the same procedures were used to produce colonizing expeditions to new worlds. The *ihatei* have always been at the forefront of the thrust outward into new territories for the Aslan.

Every Aslan clan periodically organizes an *ihatei* fleet. *Ihatei* who feel the natural urge to acquire territory volunteer for the expedition. Position in the expedition is allocated based on the individual's skills and financial contributions by the individual and his family. First sons, secure in their territory by inheritance, have a responsibility to help finance the second sons'

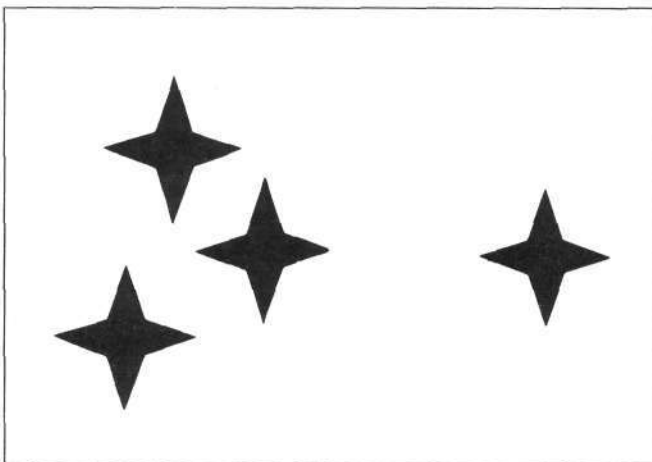

migrations. Fathers and mothers also feel similar responsibilities.

Creation of an ihatei fleet benefits both the economy and society. Spending to equip the fleet helps the economy, and migration of second sons helps relieve population pressure. For those who stay behind, these expeditions produces relief and hope.

The largest single expense that faces an ihatei fleet is the cost of the ships it will need. This expense is met by the clan, which periodically declares older, obsolescent or obsolete star-ships surplus and subsequently allocates them to the ihatei for use.

THE ASLAN HIERATE

The Aslan interstellar civilization is the Aslan Hierate. There is no central Aslan government; the Aslan have no nations in the human sense. Aslan loyalties are channelled along family lines.

Ultimately, every Aslan is a member of a clan. Aslan see their own loyalties in terms of their clan, and its leader, the "ko." Most worlds are inhabited by many different clans, often with their populations intermingled. Differences between clan members within a clan are handled by the family structures; differences between clan members of different clans are handled by negotiations and agreements between the clans themselves.

The 29 strongest clans place their heads (or a representative) on a council called the *Tlauku* (which means 29 in the Aslan language). The Tlauku meets continuously on the Aslan homeworld to arbitrate disputes, settle matters of common interest, and otherwise deal with the problems that must confront an interstellar society.

But clans are independent. An agreement with one clan binds no other clan. A peace treaty with one clan does not assure peace with all other clans.

On the Borders of the Marches: The border between the Imperium and the Aslan Hierate is actually a band of independent worlds and client-states, roughly 10 parsecs wide, that separates Aslan and Imperials from direct contact. Imperial traders venture beyond the Imperial border and into Aslan territory in search of novel products that will sell well in the empire; Aslan traders venture into Imperial territory looking for high-tech goods, as well as markets among the many Aslan who live within the Imperium.

For centuries, the Aslan had looked with envious eyes on the territory of the Imperium. The now ancient Peace of Ftahar (signed in 380) committed the Aslan clans to respect the Imperial territory and borders. For centuries, there was room for expansion within the Hierate's territory; for more centuries, there was expansion room across the Great Rift. In recent years, the ihatei have settled farther and farther from the center of the Hierate. New generations have had to travel greater and greater distances in order to remain able to find worlds to conquer and exploit.

Because of the distances which are involved, many ihatei have been content to travel to closer, previously settled worlds; the poorer quality of the territory they find in these worlds is made up for by the presence of other settlers and established markets.

Aslan Aorlakht

Landless Aslan Aorlakht (New Lords) have invaded in search of developed worlds to conquer.

LAKHT AORLAKHT

Centuries of ihatei settlement throughout the Aslan Hierate have clogged Aslan worlds with a large number of settlers and colonists. Better worlds have experienced wave after wave of settlers, while the less advantaged clans have been forced to settle vacuum worlds in order to find the territory which they need.

In the Trojan Reach sector, few worlds suitable for territorial expansion remained within the defined borders of the Aslan Hierate. A few splinter republics in the sector allowed some settlement, but they too were fast filling up. True frontiers were rapidly being exhausted. And new ihatei fleets arrived in the sector every year. Some moved on to sectors farther away. And some ihatei fleets stayed on, their cargoes of Aslan settlers still in cold sleep, sending out scouts to look for new worlds.

Over the past 20 years, a single Aslan leader has risen to power while administering the otherwise obscure post of Aikoho Earleatrais (Fleet Dispatcher). The accumulation of ihatei fleets in the sector produced confusion and competition; the Tlauku appointed an independent Aikoho Earleatrais and charged him with directing all ihatei fleets, in strict order of arrival, to the best available worlds. The Aikoho Earleatrais enjoyed the support of all existing Aslan settlements in the sector as he helped relieve the pressure of arriving ihatei fleets, and he, in time, assisted every clan in the sector with his direction and information.



In early 1117, the first news of the upheaval in the Imperium filtered across the Great Rift. Conflicting reports about Lucan, Dulinor, and their struggle for the throne of the Imperium were carried by the few ships that were able to traverse the vast, empty expanses of the Rift. By mid-1117, it was clear to the Aikoho Earleatrais that the Imperium was being torn apart. At that time, an ihatei fleet which had originated in Ealiyasiw sector entered Trojan Reach in search of new worlds; it was redirected to Imperial territory and was successful in establishing a settlement within the Imperial border. Several ihatei fleets being organized within the sector realized that the Imperium held tremendous potential, and they also ventured across the border into Imperial space, finding suitable systems for their new settlements as well. Ihatei fleets venturing into Trojan Reach sector during the course of the year heard of the potential for new territory within the Imperium and crossed the border themselves in search of new lands. The confusion of the Rebellion and the commitment of Imperial naval forces elsewhere made resistance only minimal.

The Aikoho Earleatrais at this time saw the tremendous potential of settling in Imperial territory. In his own interpretation of his charge from the Tlaukhu, he mobilized the many ihatei fleets in the sector and commissioned them as Aorlakht (New Lords); he named himself the Lakht Aorlakht (Lord of New Lords) and led them across the Imperial border in search of new worlds. By mid-1118, the Aorlakht fleets had ventured five parsecs into Imperial territory and established settlements on some 20 Imperial worlds.

MORRIS' RESPONSE

When the Aslan ihatei fleets began entering Imperial territory and landing colonization parties on Imperial worlds, Imperial fleets responded in force. They forced off some fleets, which fled to other systems, but Imperial force was simply not sufficient to stop the onslaught of Aorlakht. The Imperial Navy, even as it struggled to contain the invading Aslan, notified its higher headquarters of the problem. Eventually, the matter fell in Archduke Norris' lap.

Norris was caught on the horns of a dilemma. His borders were hard-pressed by Vargr raiders; the threat of Zhodani action was ever-present; even the Sword Worlds required fleet commitments in order to guarantee the Imperial border. Simple military action was not necessarily an available response.

Norris turned the problem over to his chief-of-staff, Imperial Fleet Admiral Tranathiaf, dispatching him to the Aslan front with instructions to eliminate any threat to the Domain.

Tranathiaf began a three-point program of:

- A. Containment of the Aslan invasion to a band within five parsecs of the border.
 - B. Direct negotiation with the Aorlakht to minimize their impact on Imperial worlds.
 - C. A buildup of forces with which to expel the Aslan.
- By 1119, the plan was only just beginning.

THE TECHNIQUE OF ASLAN INVASION

Aslan ihatei fleets constantly search for territory and for

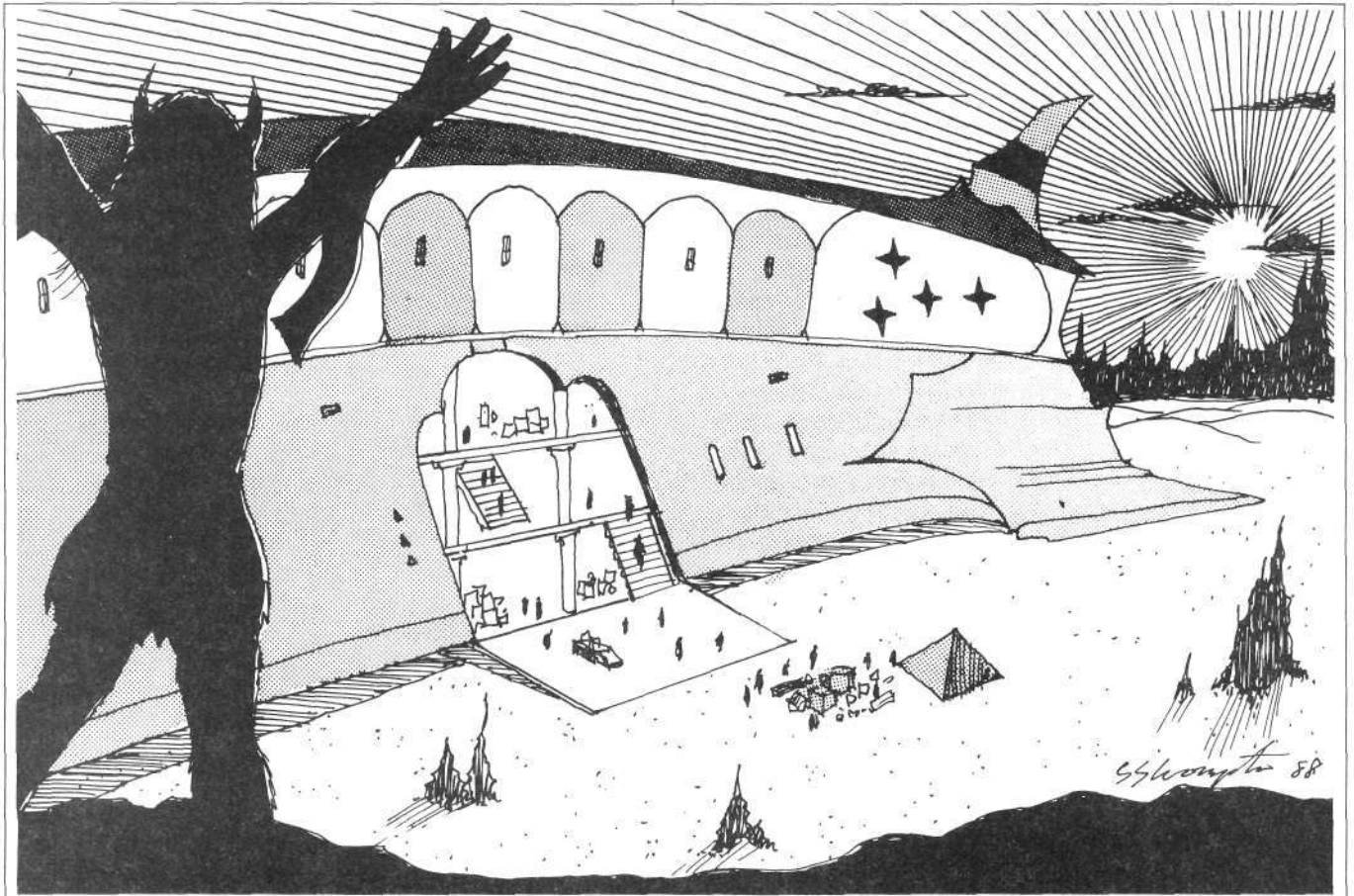

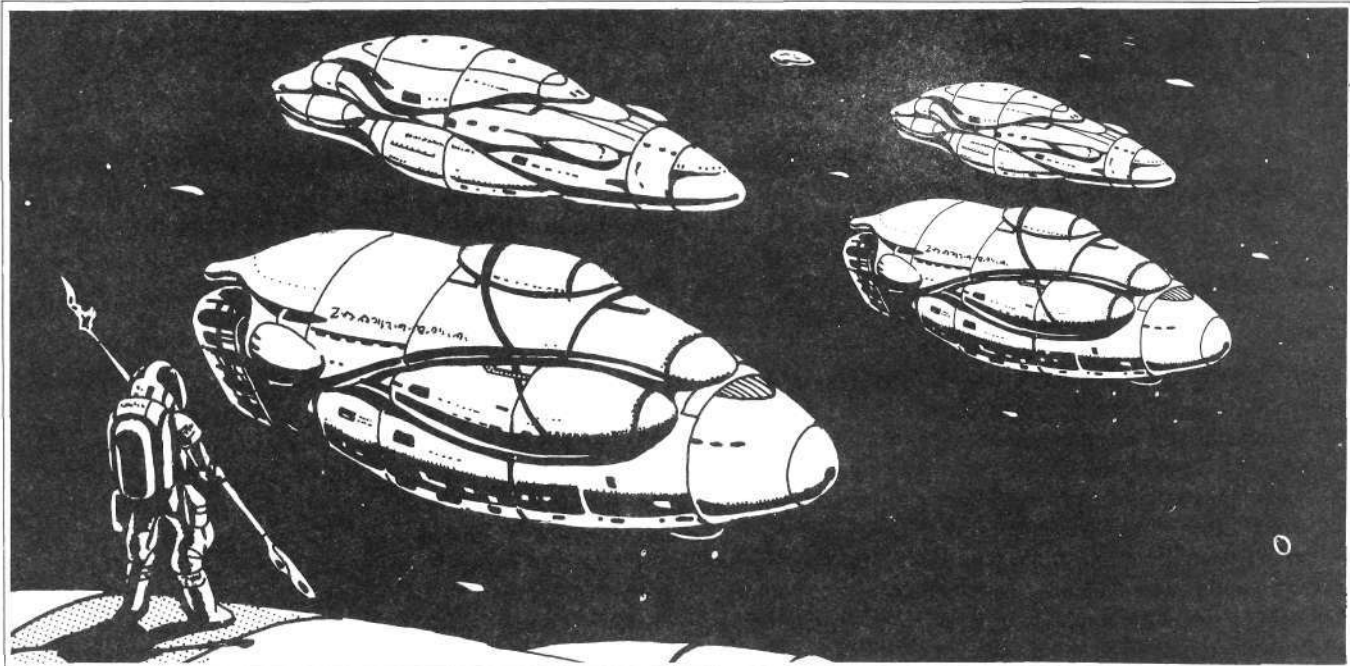

markets. Territory is extremely important to Aslan males, but they bring more practical females who insist on investigating all aspects of the new territory. At their insistence, the ihatei consider the size of territory and practicality of exploitation. Sharing land with previous settlers is considered reasonable if it produces sufficient markets for Aslan business.

Having located a suitable world, the Aslan ihatei fleet moves into orbit while it surveys its surface for likely colony locations. Scouts recon the region more closely. Once the final decision is made, the battle fleet remains in orbit and provides security while the trade fleet carries the colonists and their equipment to the surface. Preliminary quarters are constructed, land cleared, crops planted, resources located, and mines constructed. As the infrastructure is constructed, more colonists are awakened from cold sleep and sent to the surface.

In order to transport the greatest number of ihatei, some of them are carried in cold sleep. Only after the colony is well established can the bulk be revived and transferred to the world's surface.

Invading Uninhabited Worlds: The easiest Aslan invasion takes place on uninhabited worlds. Colonization can proceed at a leisurely pace. No pressing time table exists, and the project is usually easily defended.

Invading Settled Aslan Worlds: Some ihatei fleets select worlds already settled by other Aslan. Although they must be content with territory which not already claimed, there are benefits: People already exist who can be markets for the new settlers' enterprises.

Because trade is as important to female Aslan as is territory to males, many fleets to migrate to settled worlds.

Invading Settled Alien Worlds: The stereotype of alien invasion assumes violence and warfare; the truth of Aslan invasions is quite different. Aslan are not interested in short-term loot and plunder; they do want long-term territory and markets. They need to ensure they will be able to stay in their colony and thrive once it is established.

Wherever possible, Aslan will buy the land they settle. A small population on a world will often sell its rights to unclaimed, unexploited land for very little. Land can be bought with money or with royalties (for a fixed time) against the profit which comes from exploitation, or even with the promise to pay taxes. Aslan owe their own individual loyalty to their clan, but Aslan clans accept the authority of alien governments (for example, in taxation) over clan members, when that authority is evenhanded and just.

Where necessary, Aslan will take the land they need. Some worlds have whole continents which lie vacant; ejecting Aslan squatters is nearly impossible. Eventually, the two-way trade between the Aslan and the locals brings acceptance of the new citizens.

Where required, Aslan will fight for the land they need. Their ability as warriors is undeniable and provides a strong incentive for local citizens not to resist the settlers.

AORLAKHT

The Aslan have discovered new territory at their feet. The urge to exploit it is irresistible.

Name: Aorlakht is an Aslan term for New Lords or New Landholders. The Aslan settlers moving into Imperial territory call themselves Aorlakht. Imperials are content to call them Aslan.

Leader: The most notable leader calls himself Lakht Aorlakht—Lord of the New Lords.

Territory: The invaders come from throughout the Aslan Hierate but typically enter Imperial territory through the border in Trojan Reach sector. Aslan settlement is throughout Trojan Reach and the rimward portions of the Spinward Marches.

IDEOLOGY

New lands!

The racial imperative is the need for territory. The firstborn son inherits land; others must seek their own. Expansion is virtually the only way Aslan can find new territory.



Long ago, shrouded deep in the mists of prehistorical time, the Ancients plucked samples from hundreds of worlds. From Terra, they selected humans and carried them to world after world as slaves, specimens, or companions. They also selected canines from Terra and carried them to one world.

On Lair (A8859B9-F), the Ancient's genetic experiments produced the Vargr: upright, bipedal intelligent carnivores with visible origins as dogs. Over hundreds of thousands of years, Vargr matured and evolved to settle and exploit their world. When, in -3810, they discovered the jump drive, they burst out into the neighboring systems. Over the course of the next 2000 years, Vargr expanded into hundreds of systems, settling virgin worlds and sacking settled ones.

The key to understanding the Vargr is a single aspect of their psychology: They are driven in many aspects by a pack mentality. Vargr are a gregarious people, taking joy in the company of one another and seeking the security and comfort of fellowship with others of their own kind. Yet at the same time, Vargr within a group are engaged in a nearly constant struggle for prestige and dominance; to an outside observer, Vargr often appear quarrelsome and even treacherous. Vargr move from one group or association to another with great regularity.

All of Vargr society is subject to twin forces—a centrifugal force bringing small groups together and makes them more cohesive, and a centripetal force pushing the group apart. All of Vargr society is constantly pushed and pulled by these twin forces.

THE IMPERIAL/VARGR BORDER

Vargr worlds are situated all along the Imperial coreward border. Stretching 200 parsecs across six sectors, the border requires constant monitoring in order to keep Imperial territory secure. Imperial fleets constantly patrol the border systems to deter Vargr corsairs. Punitive raids reinforce the concept that invasions of Imperial territory are unacceptable. Constant vigilance maintains the safety of trade and also of Imperial citizens.

Yet Vargr corsairs continue to cross the border in search of plunder. Successful Vargr raiders also gain an intangible benefit: They find a reputation which enhances their standing with other Vargr.

Long ago, Imperial researchers concluded that the unification of the Vargr under one leader would be a strict impossibili-

ty. There could never be total agreement among Vargr as to a single leader; whenever leaders reach high levels of power, rivals bring them down, and their followers drift away to follow others.

Within the last several decades, however, a new face has appeared among the Vargr, and acceptance of his leadership has grown to unprecedented proportions.

Beginnings: Knouksarrgh Ong (roughly translated as The Electronics Corporation) of Lair built an extensive market for its products throughout Vargr space by importing innovative novelty electronics from high-tech worlds; those products which did well were then copied by the corporation and produced at less cost locally. When the concepts were copied, they were often modified to better conform to the needs of Vargr specifically. Sound systems were more attuned to the Vargr ear; colors for image recorders were more pleasingly presented for the Vargr eye. Over time, Knouksarrgh has expanded its marketing to include the establishment of standards for electronics formats (such as computers, holograph recordings, and broadcast and beamcast transmissions), and even the production of entertainment and educational materials. Knouksarrgh's entertainment subsidiary, Knouks, is widely known to merchants in Vargr space as a quality producer; however, customers themselves rarely pay any attention to the producer, buying instead on the basis of the entertainer.

In 1090, Knouksarrgh introduced *utuvogh* (window-to-the-universe), which was initially perceived by the Imperium as a fancy programmable holoprojector/viewer. The device, through a quick, on-screen survey, determines an array of personality factors about the viewer and tailors the presentation directly to the viewer. For one viewer, the utovogh might tint the background red; for another, the device might insert low



frequency harmonics. When properly set to a viewer's configuration, the utovogh produces a much higher level of entertainment and satisfaction than do ordinary holoviewers, even if the individual cannot verbalize why. The utovogh can incorporate more than one set of personality factors into its presentation and it is still relatively effective while handling four, five, or even six sets of factors. But its greatest effectiveness and satisfaction is achieved when it is used by one viewer at a time.

Utovogh programming was initially divided between entertainment and educational recordings. Entertainment programs were stories, often with alternative endings tailored to a variety of personality types. The utovogh became a widespread phenomenon throughout Vargr space. Humans, however, found the device hollow in its presentation; the nuances of Vargr verbal and body language made the utovogh's presentations opaque to most humans, and the tailored personality factors that appealed to Vargr were totally lost on humans.

In about 1102, Knouksarrgh responded to market research which showed that more and more utovoghs were used for musical entertainment. The tailored personality factors made it possible for a single musical presentation to appeal to a wide variety of musical tastes.

Positive market response to the utovogh prompted Knouksarrgh to research alternative uses for the device. One research project analyzed in detail the personality factors that were input and looked at what customers wanted. Researchers synthesized a musical personality which could easily trigger the greatest number of responses in customers. Actually, they synthesized several—one to appeal to mature individuals, one to appeal to juveniles, one to appeal to young adults—in fact, one to appeal to every major group within Vargr society. Recordings from each hit the market about 1110.

That these new musical stars were synthetic personalities was not a widely known fact. For marketing purposes, a mystique was built around each one, with details and background that created the illusion of reality for the viewer.

The most popular of these synthetic personalities was Oekhsos; he conveyed a very strong charisma which inspired loyalty and allegiance among his viewers. Few realized that he was synthetic; most of his fans were inspired by the way his music touched their emotions and their intellects, and that effectively blinded them to seeing his synthetic nature.

Oekhsos, being synthetic, is manipulated by his manager and a team of electronic scientists. They determine what subject matter his material will deal with. Recently, they found an explosive subject that markets better than any previous one: anti-Imperial tirades. Oekhsos' first tirade reached the top of the market charts immediately and stayed there for months. His second tirade sold even better. Other synthetic personalities joined in and produced their own tirades.

Oekhsos' tirades sparked some attacks on the Imperium. Utovogh provided the primary entertainment on starships, and it was natural to expect that some crews would respond to an anti-Imperial tirade by raiding Imperial territory. Imperial responses were swift and strong, and the Vargr raids were nothing more than a nuisance until the Rebellion.

The Rebellion within the Imperium crippled its ability to resist the Vargr. Fleets withdrawn from the frontier made it possible for Vargr to raid with relative impunity. Oekhsos' (and others')

Vargr

Vargr raiding bands, both private and governmental, have invaded coreward sectors of the Imperial border.

tirades against the Imperium continued to spark raids against Imperial territory.

Oekhsos the Leader: If there is anyone who could be considered a single leader for the Vargr, it has to be Oekhsos. The fact that he is tailored to create favorable responses in individuals makes him a sympathetic, charismatic leader that each individual genuinely feels is worthy of his allegiance and loyalty. In addition, as a recorded presentation, Oekhsos is a remote figure who does not actively interfere in the individual's daily life; each individual Vargr is able to accept and respect Oekhsos as a leader without that leadership interfering with ordinary relationships.

Oekhsos' leadership extends across governmental lines. Governments recognize that he provides no direct competition to their own authority, and so he is no threat to them. Oekhsos is, in reality, the only kind of leader that the Vargr will accept on a broad scale—a rallying point to which they can respond. And, by a curious twist of fate, the chaos in the Imperium has given a focus against which Vargr attention can be pointed.

IDEOLOGY

Plunder.

The Vargr have no real ideology with which to support their actions. Many explanations and justifications can be presented for their actions, but all are fluff to cover the basic pack instincts of the Vargr. Given a leader and a target, the Vargr will seek it out.



Daibei sector is one of many settled long ago by the Vilani as they created their First Imperium. Under the Vilani, it was an undistinguished region far from the Imperial capital. It has been off the major travel routes and treated as an unimportant backwater.

During the Long Night, Daibei suffered as much as any other sector from the loss of trade and collapse of technology. In addition, Daibei sector was located squarely on the frontier with the newly developing culture of the Aslan. Expanding Aslan clans moved into the sector and settled on many of its worlds. When human and other native races in the sector resisted, a series of low level raids known as the Aslan Border Wars (- 1118 to 380) became the norm. Over more than a thousand years, the sector was subject to incessant Aslan raids and settlement, and in return the sector launched incessant raids into Aslan territory.

Finally, in 380, the Third Imperium stabilized the frontier by imposing the Peace of Ftahalr on all of the major Aslan clans. Its provisions established a buffer zone 30 parsecs wide between Imperial and Aslan space and made neighboring Reaver's Deep sector a cosmopolitan interstellar community. Under the provisions of the treaty, the Third Imperium also guaranteed the safety and security of Daibei sector, pledging Imperial forces to ensure the matter.

For 700 years, the peace with the Aslan has continued. Threats to the sector have been greater from the Solomani Confederation than from the Aslan. The Peace of Ftahalr has moldered in the archives of Daibei, forgotten by the Imperial bureaucracy, remembered only slightly better by the government of Daibei sector until recently.

SOLOMANI ADVANCES

Solomani attacks on the Imperium were timed to coincide with arrival of the news of Strephon's death. Solomani fleets crossed the Imperial border with Daibei in early 1117 and probed deep into the sector. Although the Imperial fleets were surprised, they fought a delaying action until reinforcements could be mobilized from the reserve fleets and from the sector's depot. In a surprise turn, the Imperial 285th and 111th Fleets ambushed three Solomani fleets as they entered the Conj system driving toward Depot/Daibei. When the Solomani fleet admiral realized there was a gaping hole in his line, he withdrew, allowing Daibei to regroup and reinforce.

At this early point in the Rebellion, local coordination was still a prime factor in the defense of the Solomani border sectors. Imperial forces in Diaspora sector dispatched several

fleets to assist in the defense of the border, including three to Daibei sector. They were temporarily incorporated into the Daibei Fleet.

Once the initial attacks had taken place, both sides settled into a protracted war of attrition, launching raids against each other's fleets while trying to prevent any deep incursions into their own territory. Because Solomani priorities were higher closer to Terra, the Daibei front was allowed to become stagnant, and it remained static through much of 1117.

The Solomani attacks on Daibei solidified public opinion in favor of the Lucan and the Imperium; although Dulinor launched several public relations campaigns in the sector, it was commonly felt that Dulinor was the ultimate cause of the present crisis, and that loyalty to the Imperium was the preferable choice.

Imperial Demands: In 1118, Emperor Lucan was hard pressed to provide sufficient ships to counter Dulinor. The Navy scoured its fleets in search of ships, and early in the year directed that Daibei provide 12 fleets to a task force being organized in Zarushagar sector for an assault on Dulinor in Illeish. When the order arrived at the sector capital of Warinir, Duke Craig, the ranking sector Duke, was incredulous. He felt totally betrayed by the Emperor who would now strip a loyal sector of its defenses.

The immediate response was to appeal the order, but after the appeal was dispatched, he called a conference of the ranking nobles of the sector. Together they decided that it would be impossible to provide the ships that Lucan required, and that in order to properly defend their own territories, they would refuse if the appeal was not granted. One advisor pointed out that the Peace of Ftahalr guaranteed the security of Daibei from all invaders, not only the Aslan. The fact that the Imperium

proposed to strip Daibei of its defenses was taken as cause for independence.

The appeal was denied.

Independent Action: Daibei, in order to gain time, chose to do nothing overt in response to the denial of the appeal. Provisions were made to reform the sector government as a confederation of subsectors, but no direct action was taken at that time.

In late 1118, Duke Craig was finally forced to act in the face of repeated demands from Lucan. The independent Federation of Daibei was then announced on 289-1118. Declarations of neutrality were dispatched to all neighboring governments, which included the Illelish, Solomani, Imperial, and Aslan governments.

DAIBEI

Daibei has elected to pursue a course of neutrality in the hope that it can survive the Rebellion with relatively little devastation.

Name: The Federation of Daibei is commonly referred to as Daibei.

Leader: The most prominent leader in Daibei sector is Duke Craig of Warinir, the ranking sector duke. When the sector was a backwater, the duties of the sector duke were minimal, and the duke was content to have the bureaucracy handle the details of government. Thrust into a situation which called for action, Craig responded with a talent many had not thought he had.

Territory: Daibei includes parts of Daibei and Reaver's Deep sectors.

Constituents: The inhabitants of Daibei are the natural constituents of the Federation. Beyond the borders of Daibei, many Imperial citizens located in the war-torn Diaspora sector look to Daibei and see an island of stability and peace. Some citizens of the territory captured by the Solomani from Daibei early in the Rebellion look to Daibei to help them in a war of liberation.

IDEOLOGY

"We will survive."

The contention of the Rebellion is concerned with a variety of political and social philosophies. But while these political and social philosophies swirl around and through the systems of the Imperium, they are also remote and theoretical to some regions of the empire.

Daibei sector, when it was faced with a choice of which faction to support in the Rebellion, found that none of the factions could promise Daibei what it needed most—security. Daibei was then forced to go its own way in order to assure its own survival.

DAIBEI'S SYMBOL

Worlds in Daibei sector have traditionally chosen tri-colors as their planetary insignia. One might select a banner of three equally sized panels colored red-white-blue, green-yellow-blue, brown-red-orange, or any other combination of colors. As a representation of solidarity among the many worlds of the Daibei sector, the sector has long used the blank tri-color as its symbol.

Daibei

Daibei sector, ordered by Lucan to commit its fleet against Illelish, has declared its independence.

RELATIONSHIPS

The Federation of Daibei absorbed the Imperial bureaucracy within its borders almost without change. Reporting channels were shifted to a ruling council of nobles headed by Duke Craig. The entire bureaucratic staff was then required to execute an oath of allegiance to the new government. If staff members refused to execute the oath of allegiance to the new government, they were given the option of leaving. The transition to the new government was completed in a matter of only a few months.

Enemies: Daibei is surrounded by enemies—the Solomani rimward and Lucan's Imperium coreward. The Solomani are actively attempting to incorporate Daibei into the Solomani Confederation. Lucan, on the other hand, desperately needs Daibei's fleets, and he would gladly abandon its territory if its fleets could be transferred to the main battle against Dulinor. Active diplomatic efforts are being made by both the Solomani rimward and Lucan's Imperium coreward to coordinate an offensive against Daibei.

Friends: Daibei has found that the enemy of its enemies becomes its friend. Dulinor is resigned to the fact that Daibei will not actively support him with fleets, but he also knows that even a neutral Daibei keeps fleets out of Lucan's hands and protects his flank from the Solomani. Active diplomatic efforts between Dulinor and Daibei are being made to conclude some kind of mutual assistance treaty.





Zhodani

The first contact between the Imperial citizens and the Zhodani took place in the first century of Imperial expansion. The outward thrust of Imperial colonialism carried scouts and settlers into the Spinward Marches sector and beyond, to the edges of the adjacent Foreven sector and into territory long ago settled by the Zhodani. This encroachment was not well-received and was a source of continuing friction between the Imperium and the Zhodani Consulate.

The friction started a fire in 0000 when the Zhodani, in alliance with the Vargr and the Sword Worlders, attacked the Imperium in a bid to expel the Imperials. Five more wars in the next 500 years continued to maintain the uneasy border between the two largest human empires in the galaxy.

THE ZHODANI PURPOSE

In five centuries of conflict with the Imperium, the Zhodani gained a reputation for belligerence, strategic sense, and perfidy. They launched every war with a surprise attack. In every case, they waited until they had the advantage, then used it.

Less obvious is the result of each of the Frontier Wars. No single war was able to gain for the Zhodani more than a subsector of new territory. Imperial histories are self-deluding when they applaud the Imperial ability to mobilize after an attack and to respond in force after a period of build-up. Researchers and commentators dismiss the Zhodani as incompetent at long-term warfare; they failed to note several key factors.

The Zhodani are not expansionist nor are they Imperialistic. They long ago reached the practical size limit for their empire, and they are satisfied with their territory. Moreover, the Zhodani are racial isolationists. They know of the potential problems involved in absorbing non-Zhodani into their culture, and they avoid it whenever possible. They also see little gain in governing conquered worlds.

An analysis of this information gives a clue to the true nature of the Zhodani Frontier Wars. The wars were fought to keep the Imperium out of Zhodani territory. Each one was a forceful

reminder to the Imperium that settlement beyond the accepted border was absolutely not to be tolerated. The reminder was sent not only to the government of the Imperium, but also to the citizens of the empire. For centuries, the reminder served its purpose.

The Zhodani Threat: As the Rebellion begins in the Imperium, it is natural for the Spinward Marches to fear a Zhodani invasion. Indeed, that fear was the purpose of the centuries' Zhodani aggression. When the chaos of the Rebellion struck the Imperium, the last thought that Imperials had was to bother the Zhodani.

The Zhodani Reality: The multi-generation campaign to protect the Zhodani Consulate from the largest human empire in existence has been a success. In the early years of the Imperium there was a real possibility that Imperials would expand out into Zhodani territory. Now, the Imperium is falling apart; no longer is it a threat to the Zhodani.

The most remote of options today would be for Zhodani to invade Imperial territory. Nothing is more acceptable for the Zhodani than to have many small human governments on its borders; each is large enough to be stable, yet small enough to pose no threat.

THE ZHODANI CONSULATE

More than 90 percent of all racial Zhodani live within the borders of the Zhodani Consulate.

Name: The Zhodani homeworld is Zhdant. They call their government Driantia Zhdantia, which is commonly translated as Zhodani Consulate. It means Government of the Zhodani.

Leader: The Zhodani are ruled by the Qlomdlabr—the Supreme Ruling Council. The Qlomdlabr is composed of two regularly elected representatives from each of the eight Zhodani provinces. An advisory council of senior members (all former members of the Qlomdlabr) assists in making decisions.

The senior members of the advisory council of the Qlomdlabr often travel throughout the Zhodani Consulate, and they are respected leaders whose instructions and advice is received and acted upon with appreciation. The most apparent of Zhodani leaders in the region of the Spinward Marches is

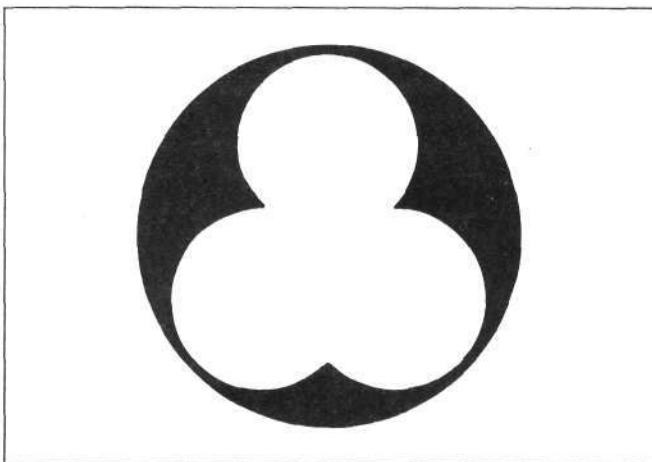

Vlezpriadliashav. As a senior council member, he is aware of the long-term planning of the Qlomdlabr; his presence on the frontier helps advise local authorities of the course they should take.

As the senior official present, it is his advice and instruction maintains a peaceful frontier with the remains of the Imperium.

ZHODANI IDEOLOGY

The preservation and defense of the Zhodani.

The Zhodani Consulate is an insular government; its territory contains the vast majority of all racial Zhodani, while non-Zhodani make up only a small fraction of its citizens. The Consulate has little need or desire to expand beyond its present boundaries, and it recognizes that its neighbors may want to expand into Zhodani territory.

The Zhodani Consulate has long been committed to the defense of its territory with careful, long-range plans that work to constantly inhibit or discourage any offensive action against it, even if that requires disruptive preemptive strikes.

ZHODANI MISSIONS

Virtually unknown to the Imperium, the Zhodani have been engaged for centuries in a consuming passion: the Zhodani Core Expeditions. The Zhodani Consulate has never kept these missions secret, but communications between the Imperium and the Consulate were never good; the information never gained widespread dissemination within the Imperium.

So, virtually unknown to the billions of the Imperium, the Zhodani have sent wave after wave of exploratory missions across thousands of parsecs in a careful exploration of the galaxy between Zhdant and the mysterious core. The Eighth Core Expedition is currently in preparation.

With the Zhodani economy and popular imagination absorbed in this epic undertaking, the onset of the Rebellion within the Imperium is viewed with relief. For as long as the Rebellion continues, the greatly feared threat of Imperial expansion (especially into Zhodani territory) can be discounted. And if the best possible outcome (from the Zhodani standpoint) happens, the greatly fragmented Imperium will pose no threat to the Zhodani ever again.

Consequently, official policy for the Zhodani is to stand back and keep hands off of the Rebellion. It is far better for the Imperials to destroy their own empire than for them to think that an outside enemy did it to them. In addition, an occasional helping hand extended from the Zhodani to a few needy border worlds is considered to be an investment in the future; perhaps such gestures as these would be enough to maintain future friendly relationships and also to help to secure the Zhodani borders.

Unofficial policy, however, is entirely different. While the Consulate maintains neutrality as its policy, higher ranking officials know that the best results are worth pursuing; covert operations which are both untraceable to the Zhodani and which hasten the fall of the Imperium are worth mounting. At times, such operations might even seem contradictory. Zhodani aid and assistance might be given in order to help Morris fend off Vargr invaders under the assumption that a stable Domain of Deneb will help secure the Zhodani border; another mission might also be mounted to help Aslan colonists in their inva-

Zhodane

The Zhodani Consulate has seemed content to let events gradually dismember its only real rival.

sion of the Spinward Marches under the assumption that unrest in the Domain will result in diversion of the region's attention from Zhodane.

THE FUTURE

The Zhodani plan for the long term. Their culture has already achieved what most human societies strive for: general satisfaction and comfort for the majority of the population while retaining a sense of purpose and meaning for everyone. Some might consider such a society stagnant, but the Zhodani emphasis on exploration is enough to keep the Consulate vibrant and progressive.

The Rebellion within the Imperium marks a major turning point in the history of the Zhodani Consulate. For much of the past 1000 or so years, Zhodani government policy has necessarily been directed at protecting the Consulate from expansionist conflict with the Imperium. Just as long-range Zhodani plans to curb and finally end that conflict appear to be bearing fruit, the Imperium is plunged into its all-consuming Rebellion.

If the Rebellion ends with a powerful, aggressive Emperor taking the throne, the Zhodani security and peace will be ultimately threatened. On the other hand, if the Imperium is destroyed by the Rebellion, the lawless chaos that will dominate former Imperial territory may well pose an even greater threat to the Zhodani.

For the immediate future, the Zhodani course remains unclear.

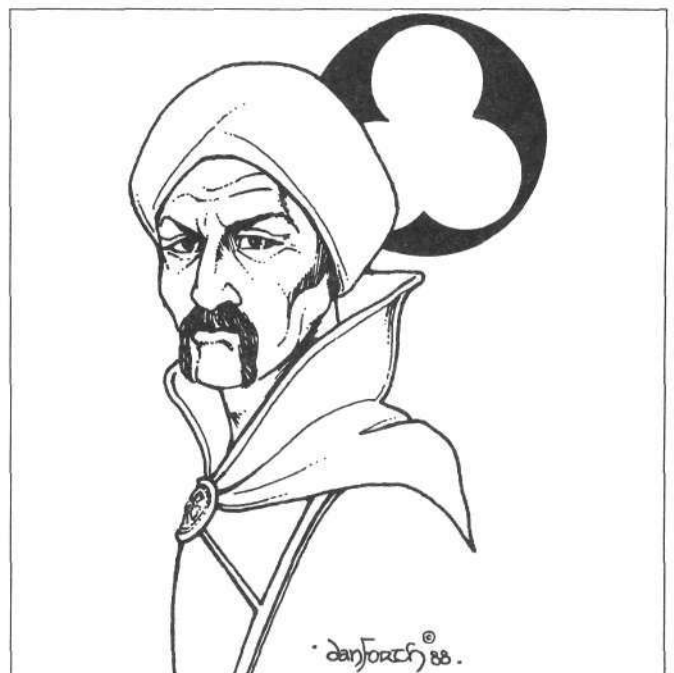



Solomani

The Solomani are the original humans. All other human races, both inside the Imperium and beyond its borders, spring from human samples plucked from Terra more than 300,000 years ago. Naturally enough, the Solomani, as the original human race, has developed a strong philosophy that it is destined to lead—and rule—the human empire of the stars.

The first Solomani empire already had two strikes against it: the Rule of Man taking over the territory and the bureaucracy of the aging and decaying First Imperium. It managed to continue for several hundred years, but the struggle was a losing battle. The Long Night ended its rule of the stars.

The Third Imperium was in many ways a Solomani empire. Solomani settlers were distributed throughout its territory; many families still had their Solomani names and many kept alive their Solomani past. A sizable fraction of the population of the Third Imperium could claim Solomani blood.

But for the growing Solomani political cause based on Terra, participation in the Third Imperium was not enough; it was necessary (as well as proper and inevitable) that Solomani be the leaders and rulers of the empire. Over the years, Solomani were allowed great freedom within the Imperium; they created an autonomous region within the Imperium and expanded its powers. Ultimately, the Solomani went too far, effectively declaring their independence from the Third Imperium. The Imperium was forced to go to war to regain its territories, and in 990 began the Solomani Rim War.

Over the course of the 12-year war, Solomani fortunes changed. The Solomani lost the war; Terra was occupied by Imperial forces and, over the next century, reintegrated into the Imperium. Where as before the Solomani aspired to rule the galaxy, they were instead forced to scheme to regain their homeworld. In the period from the end of the Solomani Rim War (1002) to the present (1119) the Imperium and the Solomani Confederation have lived under an uneasy peace. Neither has the strength or the resolve to attack and destroy the other; both are content to patrol their borders and consolidate their holdings.

SOLOMANI SOCIETY

Solomani society is ruled by a triumvirate of agencies: the Solomani Party, the Solomani Military, and Solomani Security.

The Solomani Party: The Solomani Party is the binding organization under which all political and government activity within the Solomani Confederation is conducted. Every Solomani human is automatically a member of the party, but many individuals do not participate in it due to apathy or disagreement with its principles. Those who do participate find it a hierarchy of committees and ruling councils organized by

order of magnitude: 10 members form a cell; 10 cells form a committee; 10 committees form a supervisory committee. The chain of committees ultimately ends at the High Council, which provides representation for the several trillion Solomani humans throughout the universe.

The Solomani Party is an umbrella organization: Within the party are a great many philosophies and approaches to vital problems. These factions of the party may be moderate, conservative, violent, radical, or have any number of other characteristics, provided only that they do not challenge the basic concept of the Solomani cause—that Solomani, as the original humans from Terra, are best suited to govern all humanity.

The Solomani Military: The Solomani Confederation maintains a strong military in order to defend itself, and to attack its enemies in furtherance of the Solomani cause. It also uses its armed forces for peace enforcement operations within the Confederation; peace enforcement is one of the major functions of the Solomani Army.

The military is divided into two forces: the army and the navy. The army is assigned all activity within the atmosphere of worlds; the navy is assigned all activity outside the atmosphere. As a result, the army is dependent on the navy for transportation between worlds. The navy, however, maintains its own Confederation Marines for military operations in space and on vacuum worlds.

Both the army and the navy maintain reserve units which

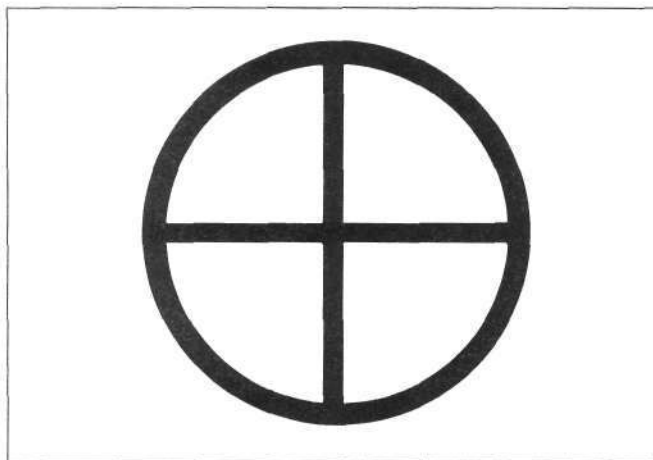

provide individuals with training for the defense of the Solomani Confederation. These Home Guard assignments allow individuals not on permanent military duty to be given military assignments in emergencies or special situations.

Solomani Security: The third arm of Solomani government is SolSec, Solomani Security. This organization is charged with ensuring that the Solomani cause is never ignored or violated. It accomplishes its mission by recruiting agents from the general population. Some become overt agents; others become sleepers waiting to be activated; still others become monitors who observe and report on the actions of others.

The Solomani System: The triumvirate of the Solomani system is structured to ensure that it never strays from its basic purpose. Each of the three arms provides a check on the other two; whenever one gets too powerful, the other two will cooperate to bring it back in line. All three arms work constantly to direct the government as a whole toward the eventual success of the Solomani cause.

THE SOLOMANI CONFEDERATION

Faction: The Solomani Confederation is not a true participant in the Rebellion; it is an interested, interfering onlooker. The correct name for the government is the Solomani Confederation; often, the term Solomani is sufficient.

Leader: The Coordinator of SolSec.

The leadership of the Solomani Party is vested in the High Council which consists of 10 individuals, no one of which is more powerful than the others. The leadership of the Solomani military is vested in a General of the Army and an Admiral of the Navy; the two have staffs that coordinate joint operations involving both forces. The leadership of SolSec is vested in one man—the Coordinator—for the overall security of the Confederation. The Coordinator of SolSec is easily the most powerful person in the Solomani Confederation.

Within the last 10 years, the Coordinator has become a member of the Solomani High Council. This consolidation of the power of a High Council member and the SolSec Coordinator in the hands of one person has made him the most powerful individual in the Solomani Confederation.

Territory: The Solomani Confederation covers six sectors: Magyar, Solomani Rim, Alpha Crucis, Canopus, Aldebaran, and Newworld sectors. The Confederation claims the Solomani Sphere which encompasses everything within a radius of 50 parsecs of Sol. Also, the Confederation aspires to rule all human space.

Initial actions in the Rebellion have transferred control of much of Old Expanses sector and some of Solomani Rim sector to Solomani control.

Constituents: The Solomani claim the allegiance of every human of pure Solomani blood. Most humans within the Solomani sphere qualify under this criteria. Pure-blooded Solomani are also scattered throughout the territory of the Imperium, and many of these individuals support the general principles of the Solomani cause.

IDEOLOGY

Humanity is destined to rule the universe.

For centuries, the Solomani have been a laughingstock. Their grand philosophy stated explicitly that humans of Ter-

Solomani

With the collapse of the Imperium, the Solomani have become the largest human empire in existence.

ran descent were destined, for a variety of reasons, to govern an ever-expanding Imperium that would ultimately extend to encompass all of settled space. When the Imperium rejected this philosophy and reclaimed much of the Solomani Autonomous Region from the Solomani, they delivered a severe setback to Solomani ambitions. They also captured Terra.

Where as before the Solomani claimed a mandate to rule the universe, they were now reduced to plans to recapture just their homeworld.

The Rebellion changed everything. The first Solomani attacks recaptured Terra. Further Solomani advances forced large parts of the Imperium to submit to the Solomani and to join the Solomani Confederation. In the course of three years, the Solomani Confederation transformed from an ineffective joke to the largest human interstellar government in existence.

THE SOLOMANI SYMBOL

When the Solomani Confederation was established, it was decided to adopt, as the government's symbol, the classic astrological symbol for Earth. The circle with a cross signifies Terra as homeworld of mankind and center of human space.

COMPLICATIONS

With the Solomani conquests of the Old Expanses and portions of the Solomani Rim, the Solomani Confederation found itself in control of vast stretches of space conditioned, under Imperial rule, to governing themselves. Under Solomani rule, a greater degree of control by the Solomani government was expected by the Solomani, and just as naturally objected to by the local worlds. As a result, a major portion of Solomani Confederation assets were committed to ruling territories.





Historical Notes on the Rebellion

In order to better understand the process of the Rebellion, the following maps of the Rebellion's progress are provided. Maps for the years 1116, 1117, 1118, and 1119 show the rise of the factions and the boundaries they claim to control. Notations on the maps show specific activities of importance in understanding the individual conflicts.

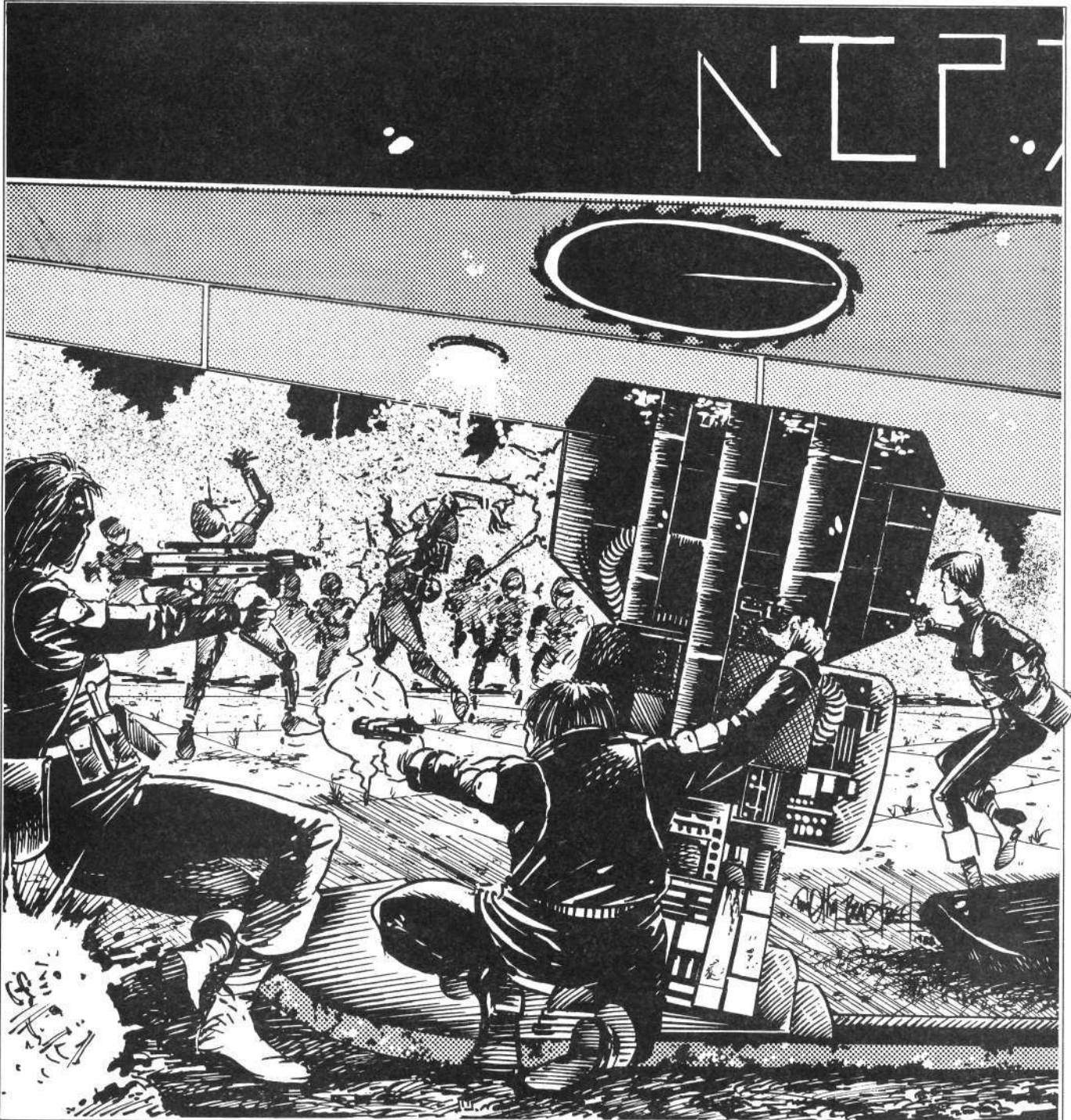

On the Eve of the Rebellion

The sectors of the Imperium as they existed in mid-1116.

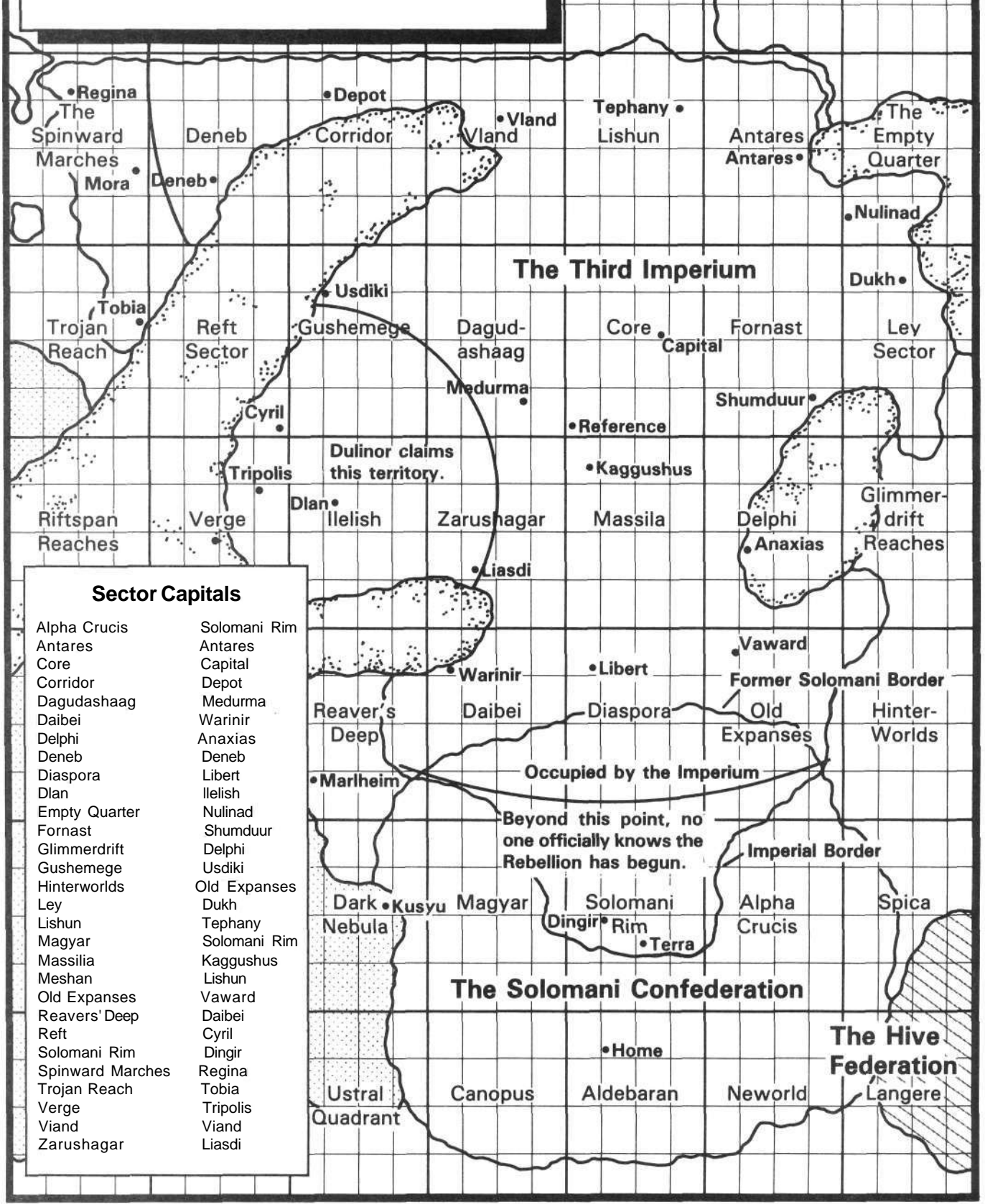

Sector Capitals

| | |
|------------------|--------------|
| Alpha Crucis | Solomani Rim |
| Antares | Antares |
| Core | Capital |
| Corridor | Depot |
| Dagudashaag | Medurma |
| Daibei | Warinir |
| Delphi | Anaxias |
| Deneb | Deneb |
| Diaspora | Libert |
| Dlan | Ilelish |
| Empty Quarter | Nulinad |
| Fornast | Shumduur |
| Glimmerdrift | Delphi |
| Gushemege | Usdiki |
| Hinterworlds | Old Expanses |
| Ley | Dukh |
| Lishun | Tephany |
| Magyar | Solomani Rim |
| Massilia | Kaggushus |
| Meshan | Lishun |
| Old Expanses | Vaward |
| Reavers' Deep | Daibei |
| Reft | Cyrl |
| Solomani Rim | Dingir |
| Spinward Marches | Regina |
| Trojan Reach | Tobia |
| Verge | Tripolis |
| Viand | Viand |
| Zarushagar | Liasdi |

1117

The factions establish themselves.

Borders and boundaries shown are as of 365-1117.

••••• Represents major battles or clashes.

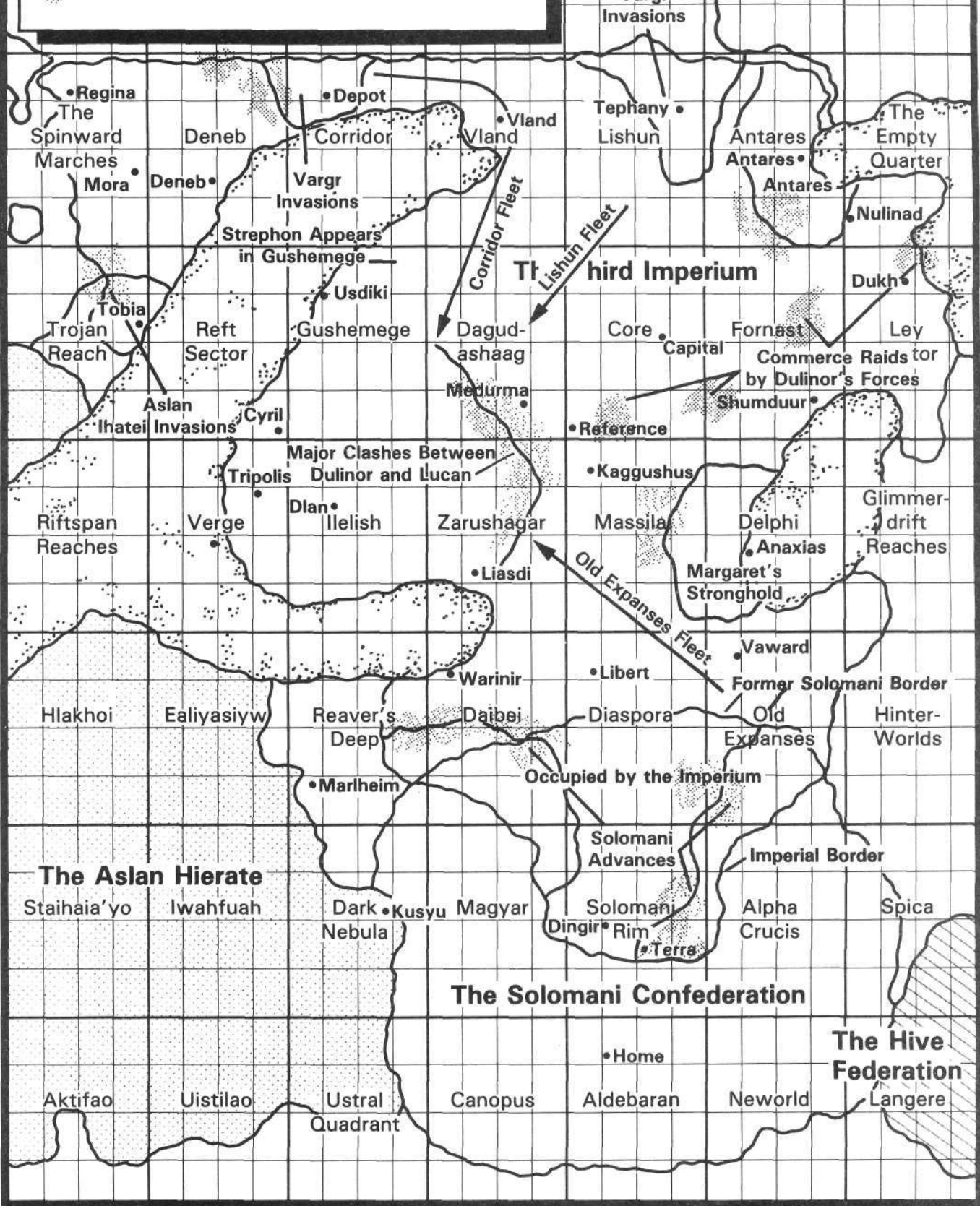

1118

The struggle for strength.

Borders and boundaries shown are as of 365-1118.

 Represents major battles or clashes.

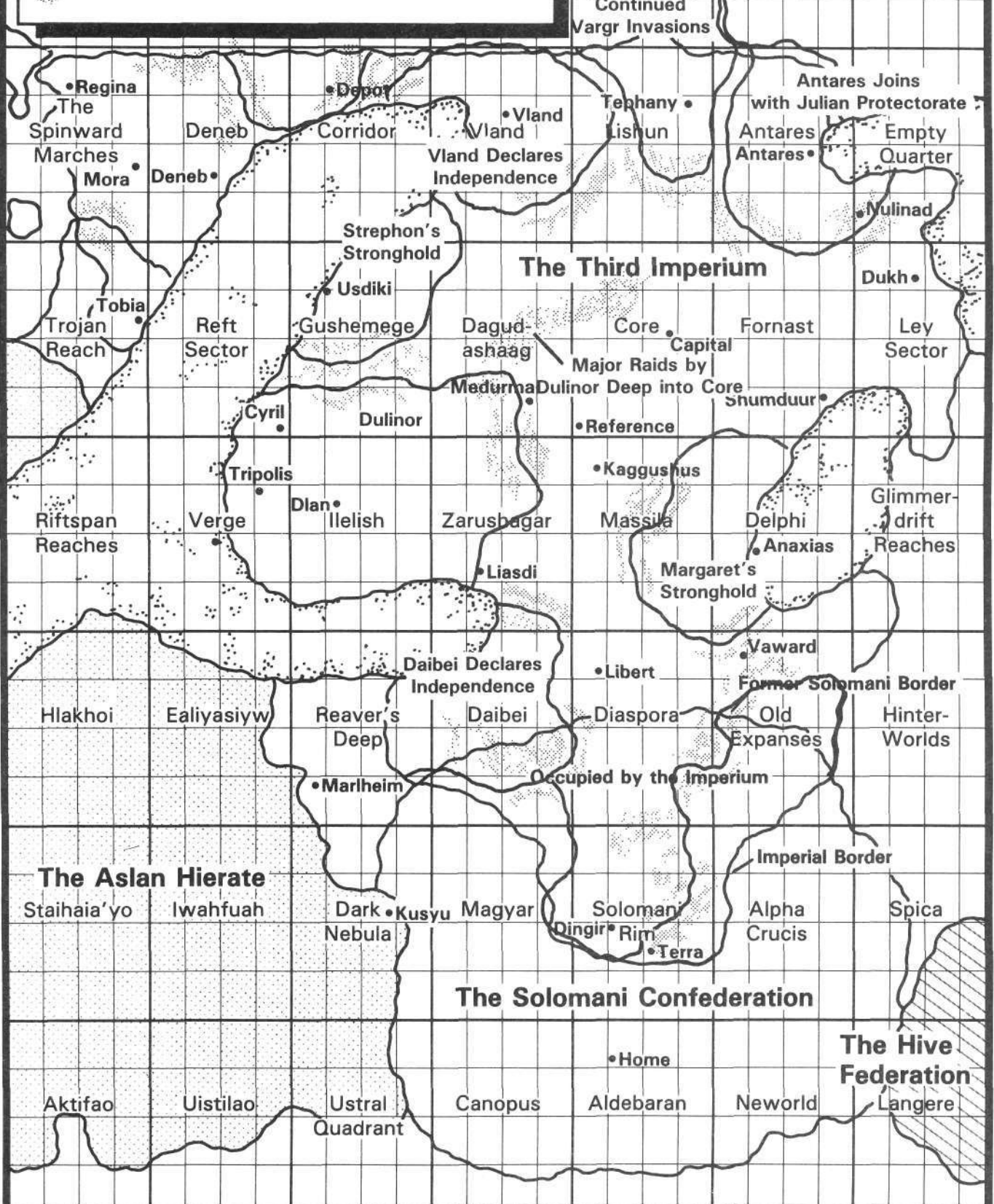

Meshan Mendan Amdukan

Continued Vargr Invasions

Antares Joins with Julian Protectorate

Vland Declares Independence

The Third Imperium

Major Raids by Dulinor Deep into Core

Daibei Declares Independence

Former Solomani Border

The Aslan Hierate

The Solomani Confederation

The Hive Federation

Regina
The Spinward Marches
Mora

Deneb

Depot

Strephon's Stronghold

Vland

Tephany
Lishun

Antares
Antares

Empty Quarter

Nulinad

Dukh

Tobia

Reft Sector

Gushemege

Dagud-ashaag

Core

Fornast

Ley Sector

Riftspan Reaches

Cyriel

Dulinor

Medurma

Reference

Shumduur

Glimmer-drift Reaches

Tripolis

Dlan
Illelish

Zarushagar

Kaggushus

Massila

Delphi
Anaxias

Margaret's Stronghold

Vaward

Hlakhoi

Ealiyasiyw

Reaver's Deep

Daibei

Libert

Diaspora

Old Expanses

Hinter-Worlds

Marlheim

Occupied by the Imperium

Imperial Border

Staihaia'yo

Iwahfuah

Dark Nebula

Kusyu Magyar

Solomani
Dingir
Rim
Terra

Alpha Crucis

Spica

Aktifao

Uistilao

Ustral Quadrant

Canopus

Home
Aldebaran

Newworld

Langere

1119

The first signs of exhaustion appear.
Borders and boundaries shown are as of 365-1120.

• Represents major battles or clashes.

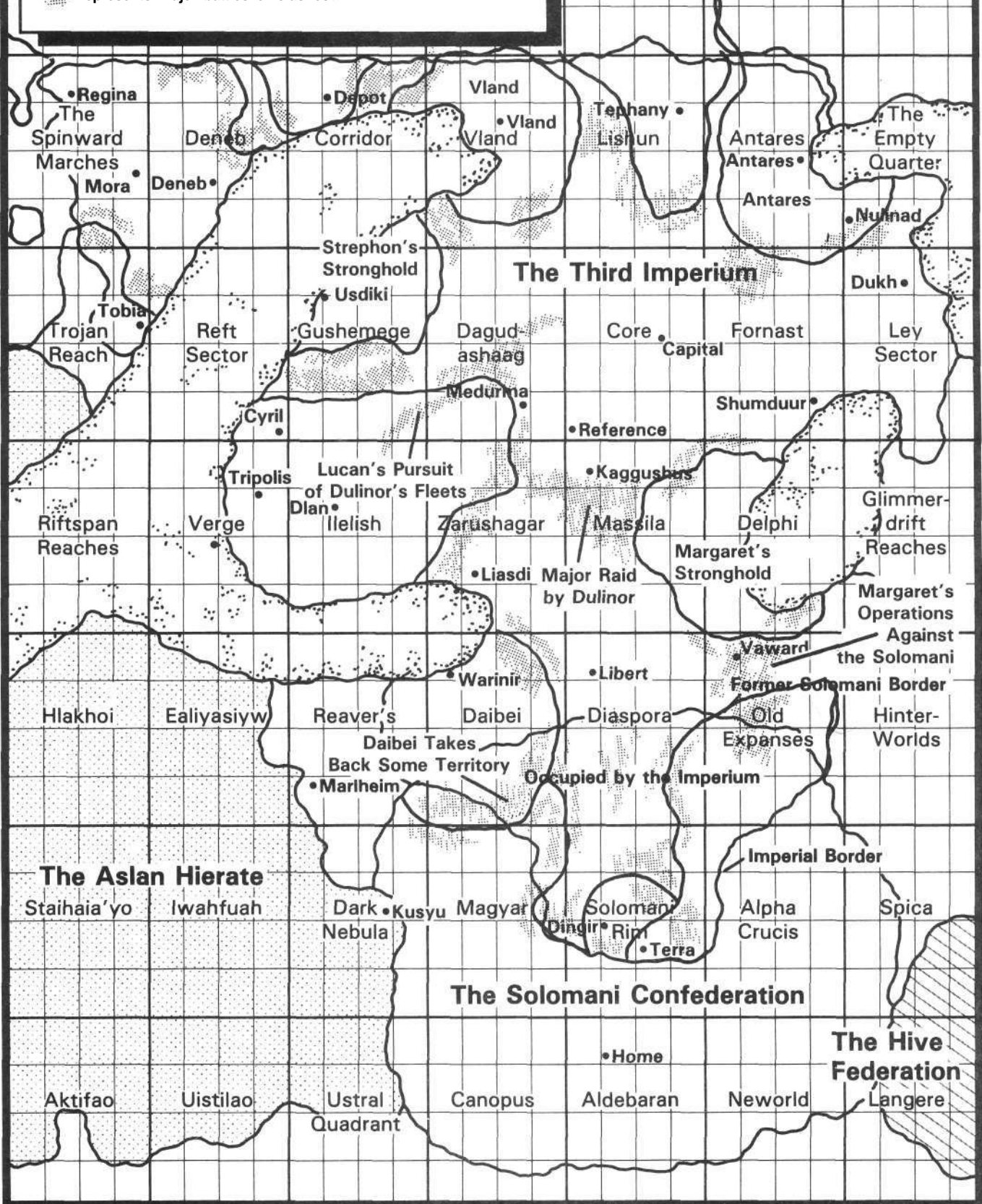

1120

The Rebellion settles into long-term warfare.
Borders and boundaries shown are as of 365-1119.

• Represents major battles or clashes.

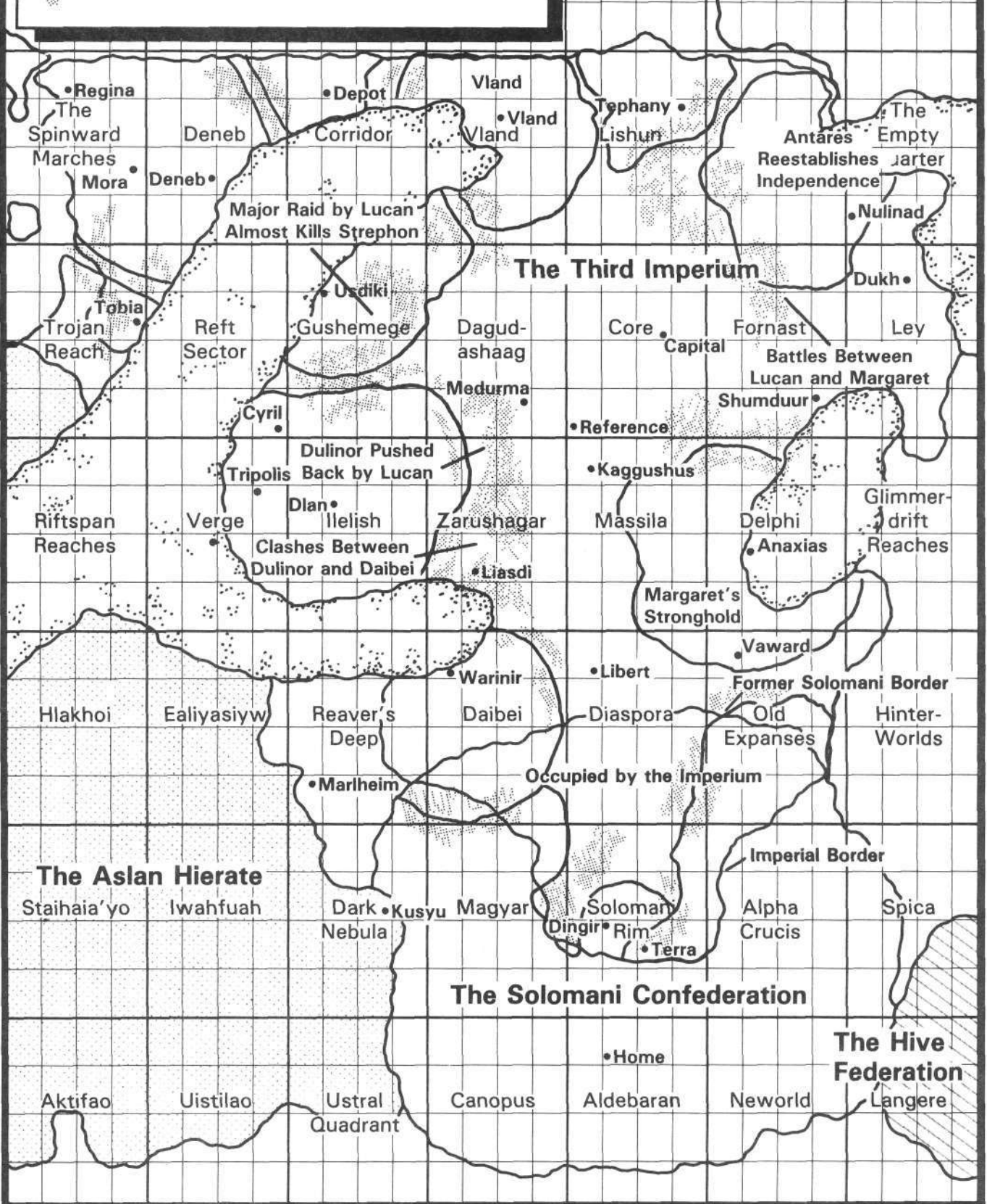



An Equipment Catalog for the Rebellion

Unlike most wars, the Rebellion is fought by several sides which all began as part of the same Imperium. As a result, they all began with essentially the same equipment and the same fighting starships. Except for the fact that two groups are shooting at each other, it would be difficult to tell that they were not from the same side.

Insignia: For the purposes of easy identification, all factions routinely affix their own identification to their equipment and starships. The benefits from efficient control of friendly forces more than makes up for any vulnerability provided by the readily visible identification.

The Catalog: This catalog provides basic information on a variety of equipment that was in the Imperial inventory at the beginning of the Rebellion, and that has since found its way into the hands of various factions of the Rebellion.

Starships: Starship information is provided to allow them to be involved in battles with other starships and spacecraft from the **MegaTraveller** system. In addition, background notes, information on which factions have or use the ships, and other details are included.

Specific ships used by non-Imperial factions are also included.

Vehicles: Fighting and armored vehicles from Imperial inventory are provided to allow encounters with military units in a variety of environments. Background notes, typical numbers of vehicles encountered, and other details are also included.



IMPERIAL RAMPART-CLASS FIGHTER

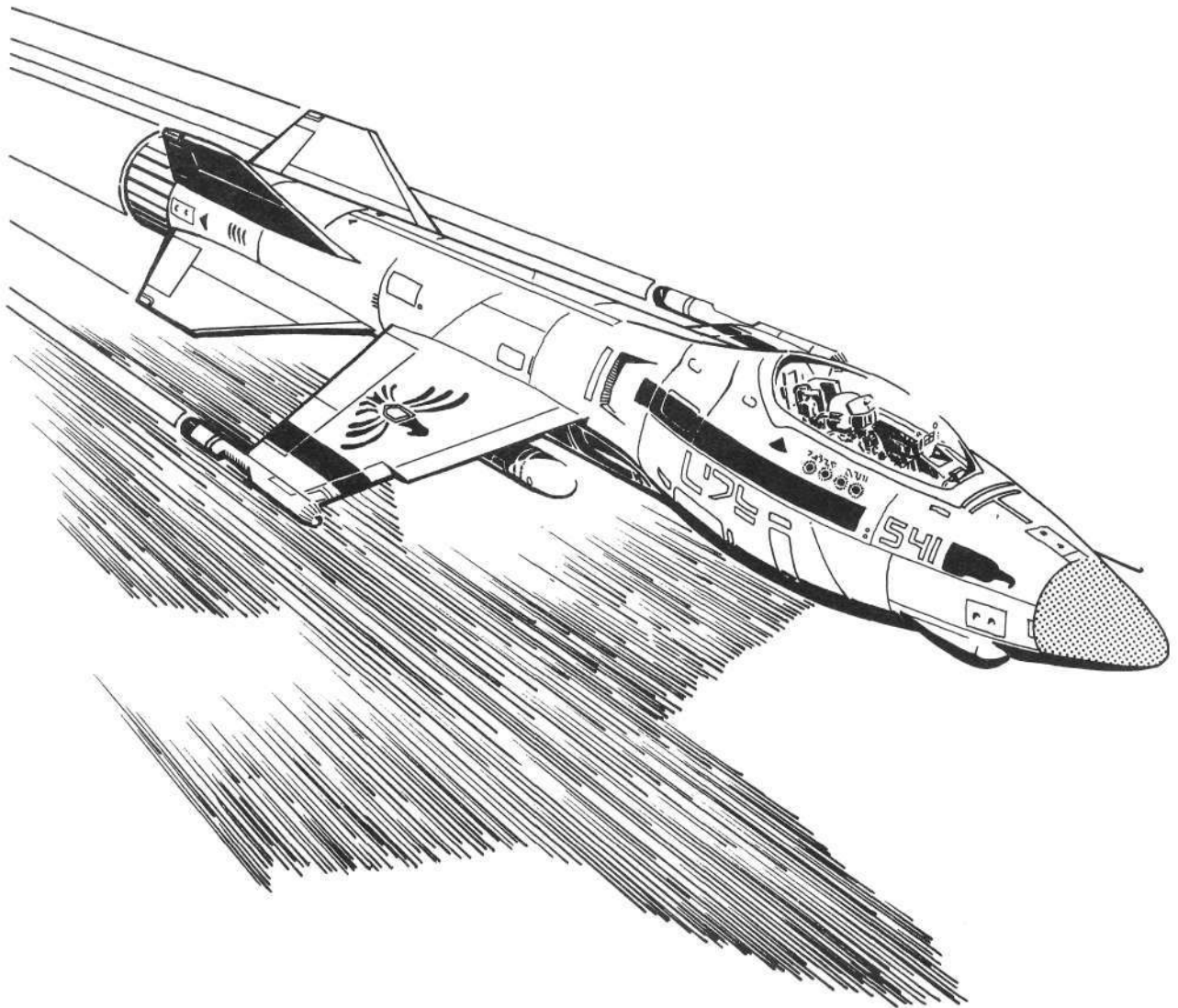

IMPERIAL RAMPART-CLASS FIGHTER

CraftID: Fighter, TL 15, MCr14.23

Hull: 9/22.5, Disp=10, Config = 3AF,
Armor = 40G,

Unloaded = 4.6tons, Loaded = 18.7tons

Power: 1/2, Fusion = 186Mw, Duration = 5/15

Loco: 1/2, StdGravThrust=1173tons,
NOE = 120kph, Cruise = 2835kph, Top = 3780kph
Agility = 6

Commo: Radio = System x 1

Sensors: PassiveEMS= Interplanet x 1,
ActiveEMS = Planet xl,
ActObjScan = Diff, ActObjPin = Diff,
PasEngScan = Rout

Off: BeamLaser = x02
Batt 1
Bear 1

Def: DefDM=+10

Control: Computer = 2x3, Panel = HoloLink x 47,
Special = HeadsUp x 1,
Environ = BasEnv, BasLS, ExtLS, GravPlates,
InertialComp

Accomm: Crew=1
(Operator = 1),
Seats = roomy x 1

Other: Cargo = 6.75kliters, Fuel = 33.6kliters,
ObjSize = small, EMLevel = faint

Comments: The fighter is an armed, grav-powered space vehicle often carried on larger military vessels as a subordinate craft.

VARGR AEK NAZ-CLASS BATTLE CRUISER

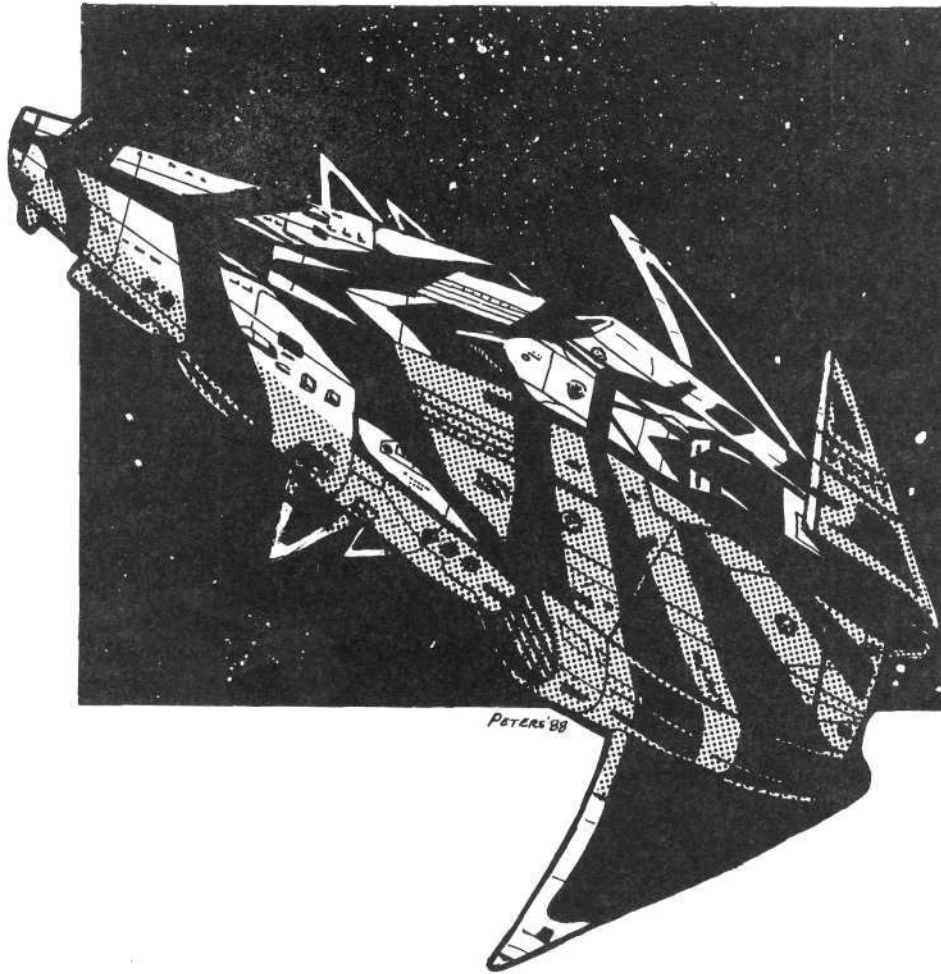

VARGR AEK NAZ-CLASS BATTLE CRUISER

CraftID: Battle Cruiser, Type BC, TL 11, MCr17,189
Hull: 27,000/67,500, Disp = 30,000 tons, Config = 1SL, Armor = 50E,
 Unloaded = 675,297 tons, Loaded = 690,040 tons
Power: 4050/8100, Fusion = 243,000Mw, Duration = 25/75
Loco: 540/1080, Maneuver = 1,
 1350/2700, Jump = 4,
 NOE=1.90kph, Cruise = 750kph, Top=1000kph,
 Agility = 0

Commo: Radio = System x 1
 LaserComm = FarOrbit x 1
 MaserComm = Planet x 1

Sensors: ActiveEMS = FarOrbit x 2,
 PassiveEMS = SubStellar x 2
 Densitometer = HighPen/1m x 1,
 NeutrinoDetect = 1 Gw x 1
 ActivObjScan = Rout, ActivObjPin = Rout
 PasObjScan = Formid, PasObjPin = Formid,
 PasEngScan = Rout, PasEngPin = Formid

Off: Missiles = x03, ParticleAccelerator = D00
 Batt 25 1
 Bear 22 1
 PlasmaGun = x40, BeamLaser = xx4,
 Batt 2 25
 Bear 2 22

Def: DefDM= +4
 SandCaster = xx6, Repulsor = x4x
 Batt 25 5
 Bear 22 5

Control: Computer = 5x3, Panel = DynamicLink x 900,
 Special = HeadsUpDisplay x 1350
 Environ = BasEnv, BasLS, ExtLS, GravPlates

Accomm: Crew = 31x30
 (Bridge=18, Engineer = 134, Maintenance = 13,
 Gunnery = 585, Flight = 2, ShipTroops = 30,
 Command = 130, Medical = 10)
 Staterooms = 487
 SubCraft = cutter x 2, pinnacle2, air/raft x 2

Other: Cargo = 10800kliters, Fuel = 210,600kliters
 PurificationPlant, FuelScoops
 ObjSize = Large, EmLevel = Strong

Comments: No Inertial Compensators.

This Vargr tech level 11 battle cruiser design shows the problems inherent in creating a heavy-firepower starship at the lower levels of technology.

The end result is a series of tradeoffs. In order to fit the required equipment into a 30,000-ton hull, power plant fuel capacity was cut to only 25 days. In order to support jump-4, the maneuver drive was cut to 1G with no excess power to provide agility.

VARGR FOGHOKS—CLASS HEAVY CRUISER

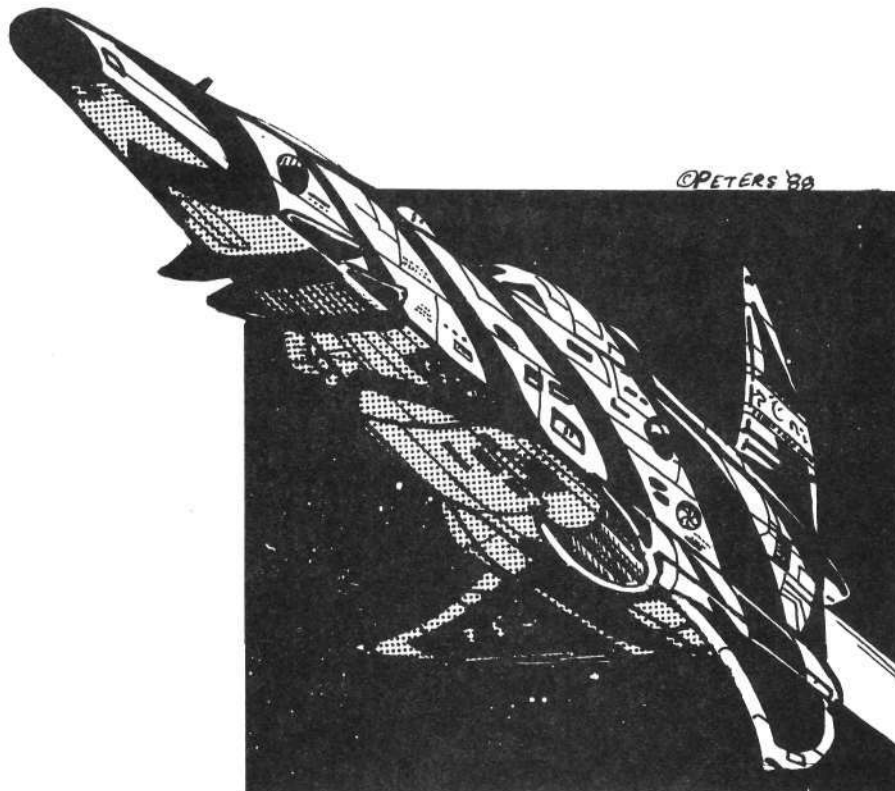

VARGR FOGHOKS-CLASS HEAVY CRUISER

CraftID: Heavy Cruiser, Type CA, TL 11, MCr693

Hull: 9000/22,500, Disp = 10,000 tons, Config = 1SL,
Armor = 45E,
Unloaded = 190,498 tons, Loaded = 195,951 tons

Power: 882/1764, Fusion = 52,920Mw, Duration = 18/54

Loco: 540/1080, Maneuver=1,
810/1620, Jump = 2,
NOE = 190kph, Cruise = 750kph, Top = 1000kph,
Agility = 0

Commo: Radio = System x 1
LaserComm = FarOrbit x 1
MaserComm = Planet x 1

Sensors: ActiveEMS = FarOrbit x 2,
PassiveEMS = SubStellar x 2
Densitometer = LowPen/surface x 1, HighPen/1m
NeutrinoDetect = 1Gw x 1
ActivObjScan = Rout, ActivObjPin = Rout
PasObjScan = Formid, PasObjPin = Imposs,
PasEngScan = Rout, PasEngPin = Formid

Off: Missiles = x70, BeamLaser = xx3
Batt 8 10
Bear 8 10

Def: DefDM=+4
SandCaster = xx4
Batt 10
Bear 10

Control: Computer = 5x3, Panel = DynamicLink x 425,
Special = HeadsUpDisplay x 638
Environ = BasEnv, BasLS, ExtLS, GravPlates

Accomm: Crew = 13x10
(Bridge = 12, Engineer = 45, Maintenance = 6,
Gunnery = 41, Flight = 2, ShipTroops = 10,
Command = 19, Medical = 6)
Staterooms = 71
SubCraft = shuttle x , air/raft x 2

Other: Cargo = 270kliters, Fuel = 77,896kliters
PurificationPlant, FuelScoops
ObjSize = Average, EmLevel = Moderate

Comments: No Inertial Compensators.
This Vargr tech level 11 cruiser design demonstrates the even greater problems (when compared to the larger Vargr Battle Cruiser) of lower levels of technology. This ship sacrifices endurance and armor in order to achieve the jump levels and weaponry it needs.

COMMON IMPERIAL TRANSPORT

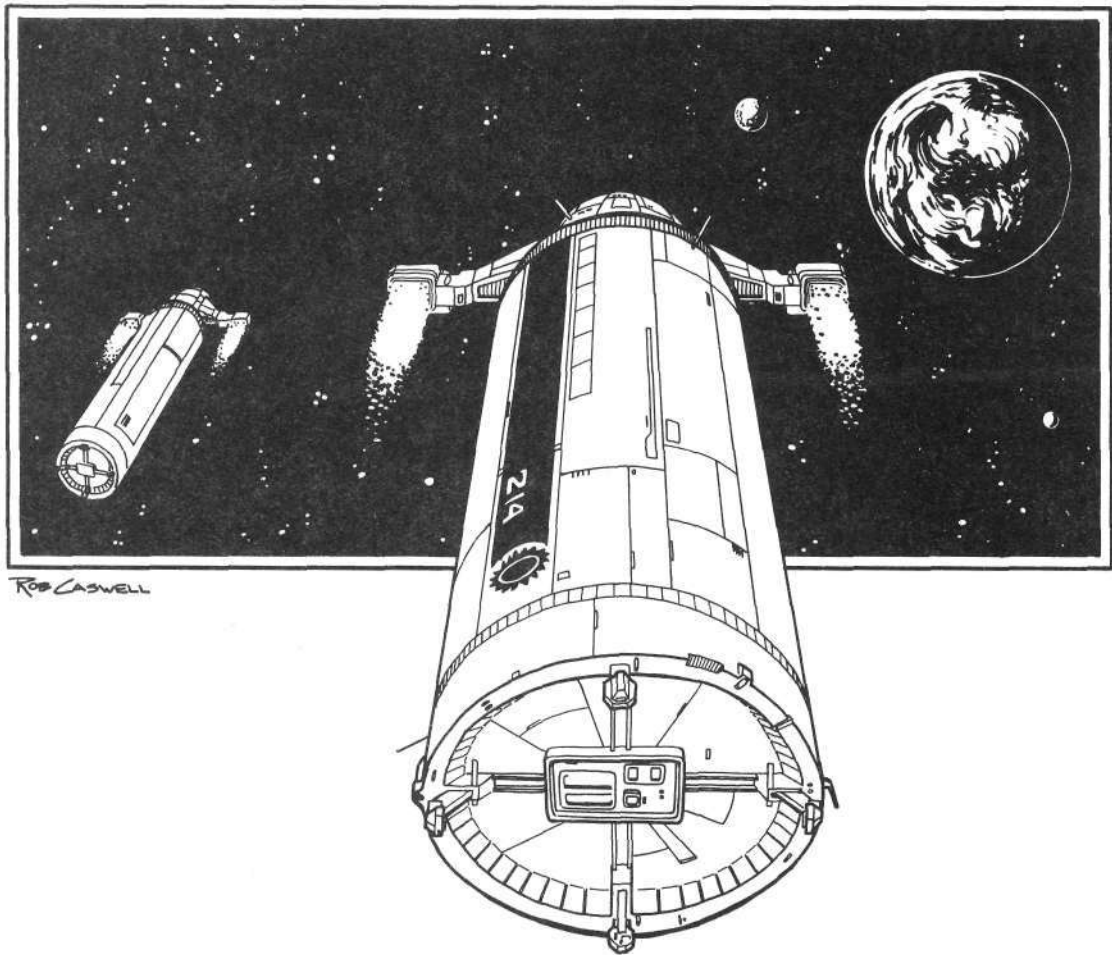

COMMON IMPERIAL TRANSPORT

CraftID: Transport, Type MP, TL 15, MCr3,465
Hull: 18000/45000, Disp = 20,000, Config = 3USL, Armor = 40G, Unloaded = 95,099 tons, Loaded = 100,322 tons
Power: 235/471, Fusion = 63,569Mw, Duration = 27/81
Loco: 360/720, Maneuver = 1, 720/1440, Jump = 3, NOE = 190kph, Cruise = 750kph, Top=1000kph, Agility = 0

Commo: Radio = Planet x 1, System x 1
 LaserComm = FarOrbit x 2,
 MaserComm = Planet x 3

Sensors: ActiveEMS = FarOrbit x 1
 PassiveEMS = InterPlanet x 1,
 ActObjScan = Rout, ActObjPin = Rout
 PasObjScan = Rout
 PasEngScan = Rout,

Off: Missiles = x05, BeamLaser = x07
 Batt 15 12
 Bear 15 12

Def: DefDM=+9, OptimumNucDamper= 1,
 SandCaster=xx5,
 Batt 30
 Bear 29

Control: Computer = 9 x3, Panel = HoloLink x 20,
 Special = LgHoloDisplay x 4
 Environ = BasEnv, BasLS, ExtLS, GravPlates,
 InertialComp

Accomm: Crew = 5x20
 (Bridge = 7, Engineer=11, Gunnery = 49, Flight = 2,
 Command = 14, Steward = 2, Medical = 4)
 Staterooms = 75, HighPassage = 20,
 SubCraft = shuttle, air/raft

Other: Cargo = 145,800kliters, Fuel = 74,596kliters
 PurificationPlant, FuelScoops
 ObjSize = Large, EmLevel = Moderate

IMPERIAL SEH-CLASS LIGHT CRUISER

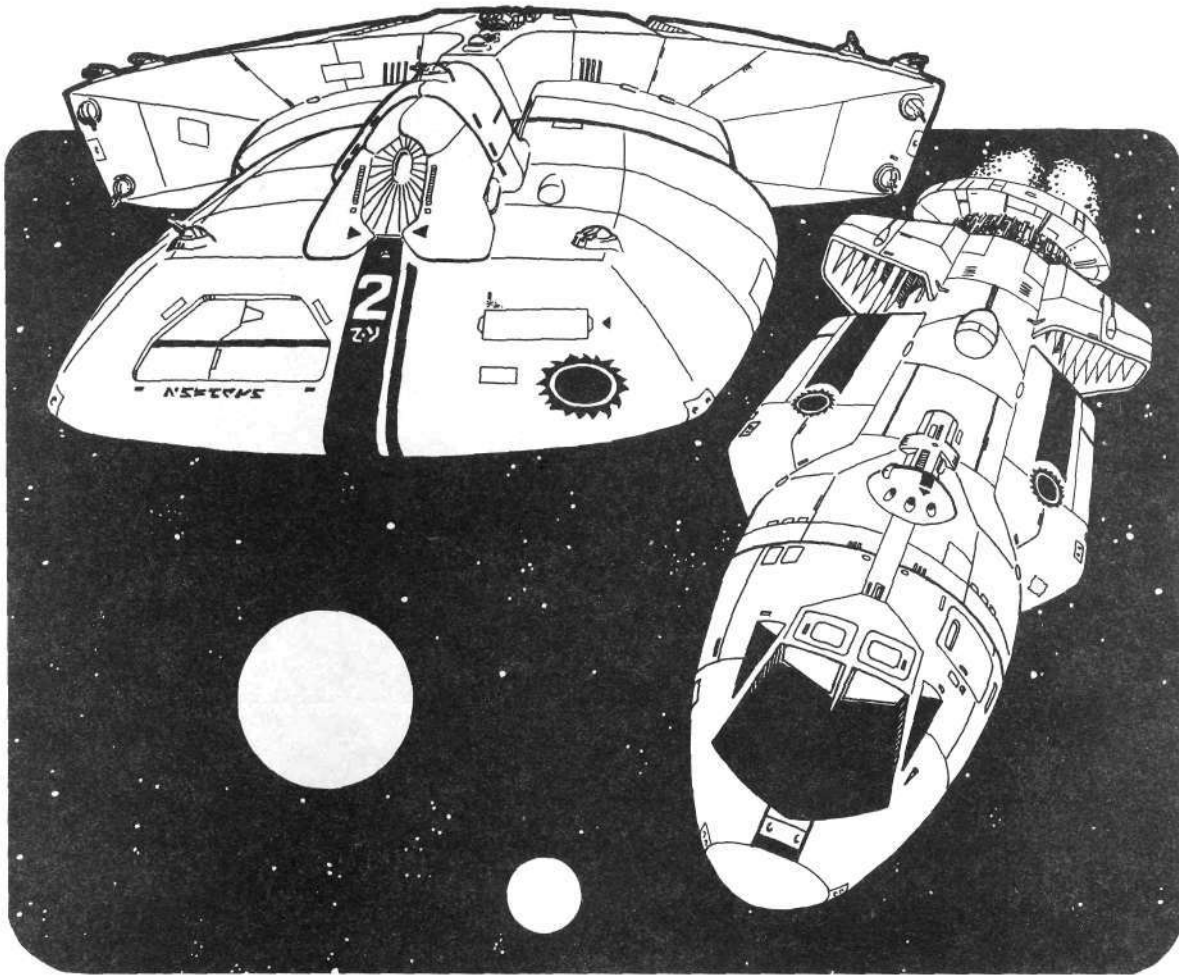

IMPERIAL SEH-CLASS LIGHT CRUISER

- CraftID:** Light Cruiser, Type CL, TL 15, MCr15,732
- Hull:** 27,000/67,500, Disp = 30,000, Config = 1SL,
Armor = 50G,
Unloaded = 334,127 tons, Loaded = 350,800 tons
- Power:** 2800/3733, Fusion = 504,000Mw, Duration = 26/78
- Loco:** 3240/4320, Maneuver = 3,
1620/2160, Jump = 3,
NOE = 190kph, Cruise = 750kph, Top=1000kph,
Agility=1
- Commo:** Radio = System x3
LaserComm = System x 3
- Sensors:** ActiveEMS = FarOrbit x 2
PassiveEMS = Interstellar x 2
Densitometer = HighPen/1km x 1,
NeutrinoDetect = 10kw x 1
ActivObjScan = Rout, ActivObjPin = Rout,
PasObjScan = Rout, PasObjPin = Rout,
PasEngScan = Simp, PasEngPin = Rout
- Off:** Missiles = x06, FusionGun = x03
Batt 20 5
Bear 18 5
Beam Laser = xx6, MesonGun = J0x
Batt 15 1
Bear 14 1
- Def:** DefDM= +9, OptimumNucDamper=1,
SandCaster = xx4, Repulsor = x9x
Batt 10 1
Bear 8 1
- Control:** Computer = 9fib x 3, Panel = HoloLink x 75,
Special = LgHoloDisplay x 13
Environ = BasEnv, BasLS, ExtLS, GravPlates,
InertialComp
- Accomm:** Crew = 20x30
(Bridge=12, Engineer = 35, Gunnery = 434,
Flight = 20, ShipTroops = 30, Command = 85,
Stewards = 2, FrozenW=19, Medical=1)
Staterooms = 319,
LowBerths= 19, EmergencyLowBerths = 159,
SubCraft = cutter x 5, air/raft
- Other:** Cargo = 3375kliters, Fuel = 238,248kliters
PurificationPlant, FuelScoops
ObjSize = Large, EmLevel = Strong
- Comments:** Electronic Circuit Protection.
The SEH-class light cruiser is named for recipients of the Imperial Starburst for Extreme Heroism.

IMPERIAL VOROSHILEF-CLASS BATTLESHIP

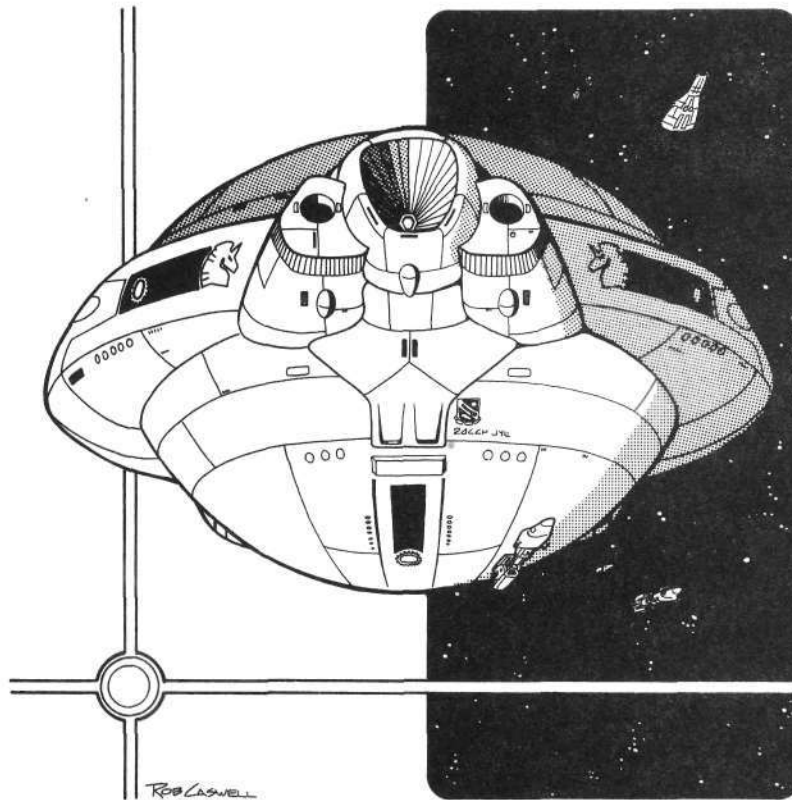

IMPERIAL VOROSHILEF— CLASS BATTLESHIP

- CraftID:** Battleship, Type BB, TL 13, MCr82,577
- Hull:** 180,000/450,000, Disp = 200,000, Config = 4SL,
Armor = 40G,
Unloaded = 3,281,000 tons, Loaded = 3,393,000 tons
- Power:** 14,670/29,340, Fusion = 2,640,600Mw,
Duration = 22/66
- Loco:** 9000/18000, Maneuver = 2,
7200/14400, Jump = 3,
NOE=190kph, Cruise = 750kph, Top= 1000kph,
Agility = 1
- Commo:** Radio = Planet x 1, FarOrbit x 1, System x 1
LaserComm = Planet x 1, FarOrbit x 1, System x 1,
MaserComm = Planet x 1, FarOrbit x 1, System x 1
- Sensors:** ActiveEMS = FarOrbit x 2
PassiveEMS = Interstellar x 2
Densitometer = LowPen/50m x 1, HighPen/100m x 1
NeutrinoDetect = 100kw x 2
ActiveObjScan = Rout, ActiveObjPin = Rout,
PasObjScan = Diff, PasObjPin = Diff,
PasEngScan = Rout, PasEngPin = Diff
- Off:** Missiles = x80, FusionGun = x60
Batt 148 30
Bear 148 30
Beam Laser = xx6, MesonGun = 03x
Batt 12 9
Bear 12 9
Disintegrator = Axx
Batt 1
Bear 1
- Def:** DefDM= +9, NucDamper = 3, MesonScreen = 3
SandCaster = xx5,
Batt 20
Bear 20
- Control:** Computer = 9 x3, Panel = HoloLink x 600,
Special = LgHoloDisplay x 160
Environ = BasEnv, BasLS, ExtLS, GravPlates,
InertialComp
- Accomm:** Crew = 8x200
(Bridge = 37, Engineer = 376, Maintenance= 101,
Gunnery = 679, Flight = 42, ShipTroops = 200,
Command = 232, Stewards = 6, FrozenW = 337,
Medical = 10)
Staterooms = 1231, LowBerths = 410,
EmergencyLowBerths = 615,
SubCraft = shuttle x 5, fighters x 20, air/raft x 4
- Other:** Cargo = 4050kliters, Fuel = 13467kliters
PurificationPlant, FuelScoops
RapidLaunch,
ObjSize = Large, EmLevel = Strong
- Comments:** MCr price is the present cost to build to this configuration.
This present version includes removal of a previous ParticleAccelerator spinal mount and replacement by a Disintegrator-A, and replacement of the TL13 fusion power plant with a TL15 version.

IMPERIAL PLANET-CLASS HEAVY CRUISER

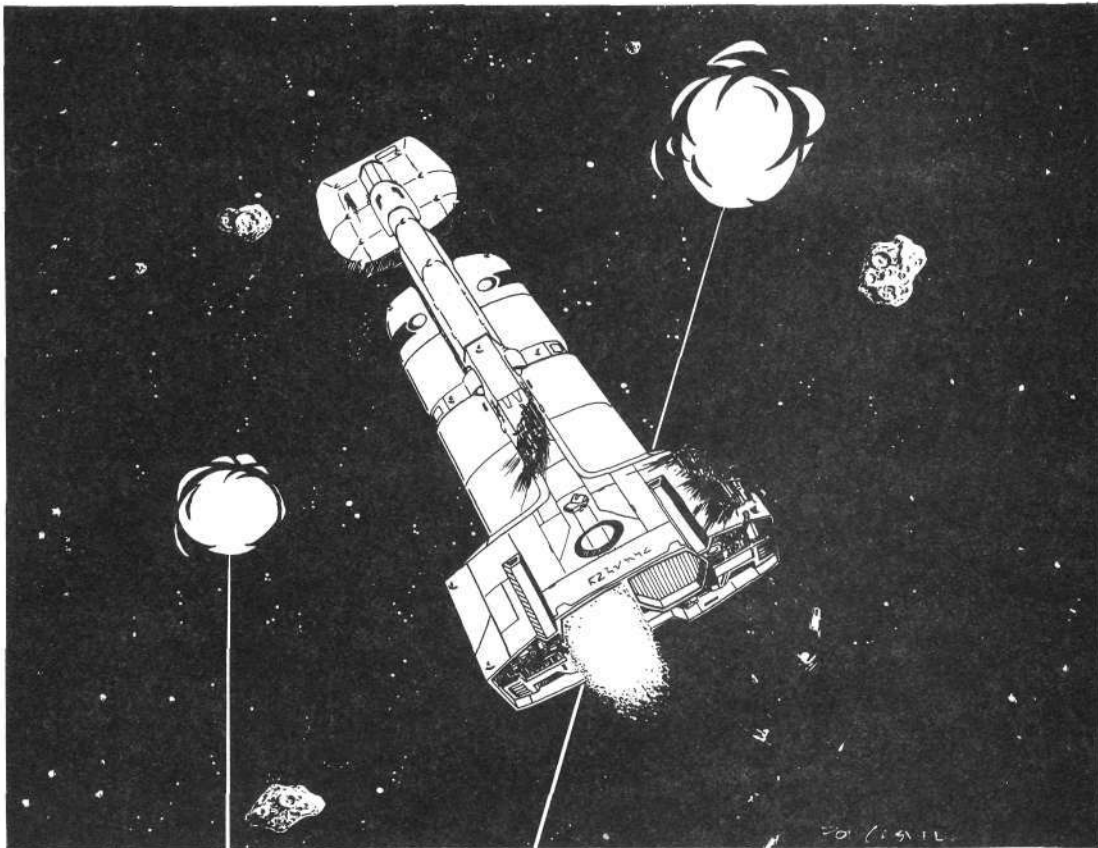

IMPERIAL PLANET-CLASS HEAVY CRUISER

CraftID: Heavy Cruiser, Type CA, TL 15, MCr27,228

Hull: 67,500/168,750, Disp = 75,000 tons, Config = 2SL, Armor = 50G, Unloaded = 944,347 tons, Loaded = 989,443 tons

Power: 3753/7506, Fusion = 1,013,310Mw, Duration = 28/84

Loco: 5063/6750, Maneuver = 2, 6075/8100, Jump = 5, NOE = 190kph, Cruise = 750kph, Top=1000kph, Agility = 2

Commo: Radio = System x 3
LaserComm = System x 3
MaserComm = System x 3

Sensors: ActiveEMS = FarOrbit x3, PassiveEMS = Interstellar x 3, Densitometer = LowPen/250m x 1, HighPen/1 km x 2
NeutrinoDetect = 10kw x 3
ActiveObjScan = Rout, ActiveObjPin = Rout
PasObjScan = Rout, PasObjPin = Rout,
PasEngScan = Rout, PasEngPin = Rout

Off: Missiles = x93, FusionGun = x04

| | | | |
|------|----|----|---|
| Batt | 20 | 10 | 5 |
| Bear | 15 | 8 | 4 |

BeamLaser = xx7, ParticleAccelerator = 090

| | | |
|------|---|---|
| Batt | 3 | 2 |
| Bear | 3 | 2 |

MesonGun = J0x

| | |
|------|---|
| Batt | 1 |
| Bear | 1 |

Def: DefDM= +9, OptimumNucDamper= 1, MesonScreen = 9
SandCaster = xx7, Repulsor = x9x

| | | |
|------|----|----|
| Batt | 15 | 10 |
| Bear | 2 | 8 |

Control: Computer = 9 x3, Panel = HoloLink x 100, Special = LgHoloDisplay x 28
Environ = BasEnv, BasLS, ExtLS, GravPlates

Accomm: Crew= 11x75
(Bridge = 15, Engineer = 86, Gunnery = 542, Flight = 30, ShipTroops = 75, Command = 120, FrozenW = 65, Medical = 4)
Staterooms = 468, LowBerths = 65, EmergencyLowBerths = 233,
SubCraft = shuttle x 3, cutter x 4, air/raft x 4

Other: Cargo = 2700kliters, Fuel = 644,222kliters
PurificationPlant, FuelScoops
ObjSize = Large, Em Level = Moderate

Comments: Electronic Circuit Protection.
No Inertial Compensators.

IMPERIALLINES FRONTIER TRANSPORT TI

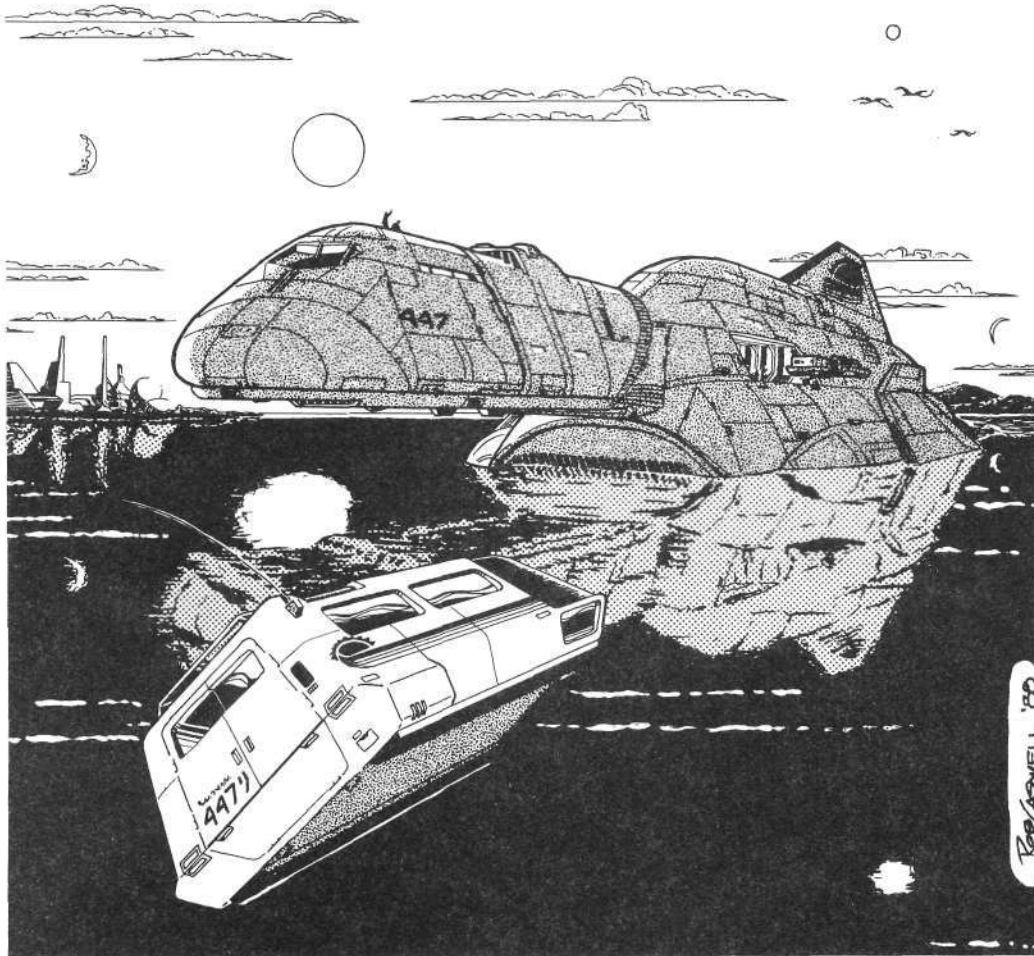

IMPERIALLINES FRONTIER TRANSPORT TYPE TI

- CraftID:** Frontier Transport, Type TI, TL 15, MCr587.9
- Hull:** 1800/4500, Disp = 2,000 tons, Config = 4SL, Armor = 40G, Unloaded = 14,143 tons, Loaded = 14,709 tons
- Power:** 61/83, Fusion = 11,600Mw, Duration = 30/90
- Loco:** 135/180, Maneuver = 2, 81/108, Jump = 2, NOE = 190kph, Cruise = 750kph, Top = 1000kph, Agility = 0
- Commo:** Radio = Planet x 1, System x 2
LaserComm = Planet x 1, System x 2
MaserComm = Planet x 1, System x 2
- Sensors:** PassiveEMS = InterPlanet x 1, Interstellar x 2
Densitometer = LowPen/1 km x 2, NeutrinoDetect = 10kw x 2
PasObjScan = Rout, PasObjPin = Rout, PasEngScan = Simp, PasEngPin = Rout
- Off:** Missiles = x03, FusionGun = x03
Batt 3 1
Bear 3 1
BeamLaser = xx4,
Batt 3
Bear 3
- Def:** DefDM=+9, OptimumNucDamper= 1,
SandCaster = xx4,
Batt 2
Bear 2
- Control:** Computer = 9 x3, Panel = HoloLink x 10, Special = LgHoloDisplay x 1
Environ = BasEnv, BasLS, ExtLS, GravPlates
- Accomm:** Crew = 10x2
(Bridge = 1, Engineer = 2, Gunnery=10, Flight = 2, ShipTroops = 2, Command = 2, Medical = 1)
Staterooms = 12, EmergencyLowBerths = 5, SubCraft = shuttle, air/raft
- Other:** Cargo = 11610kliters, Fuel = 8067kliters
PurificationPlant, FuelScoops
ObjSize = Large, EmLevel = Moderate
- Comments:** Electronic Circuit Protection.
No Active Sensors.
No Inertial Compensators.
- The Imperiallines TI Frontier Transport is a common sight throughout the Imperium, operating on trade and commerce missions to worlds off the main trade routes.

IMPERIALLINES FRONTIER TRANSPORT TJ

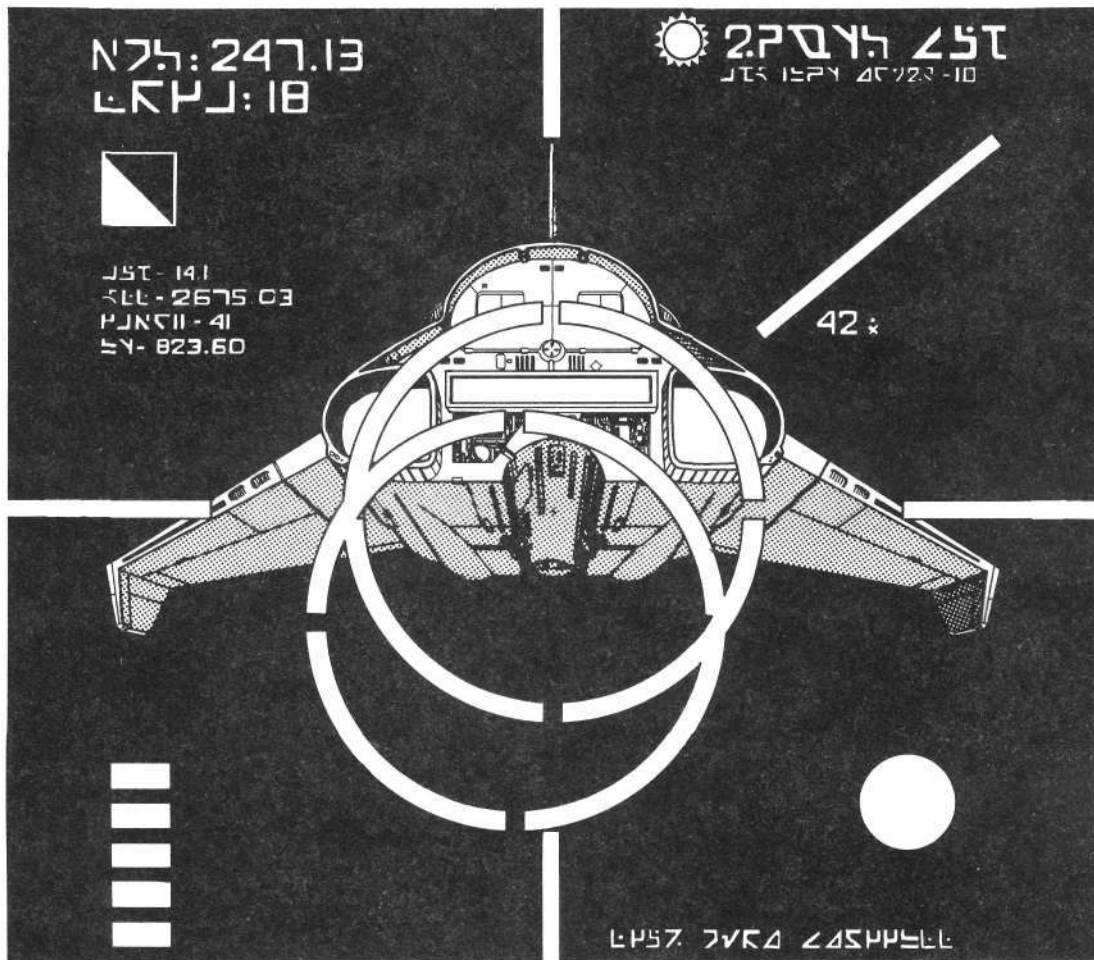

IMPERIALLINES FRONTIER TRANSPORT TYPE TJ

- CraftID:** Frontier Transport, Type TJ, TL 15, MCr975.7
- Hull:** 1800/4500, Disp = 2,000 tons, Config = 4SL, Armor = 40G, Unloaded = 18,463 tons, Loaded = 19,407 tons
- Power:** 62/82, Fusion = 5420Mw, Duration = 30/90
- Loco:** 135/180, Maneuver = 2, 189/252, Jump = 2, NOE = 190kph, Cruise = 750kph, Top = 1000kph, Agility = 0
- Commo:** Radio = Planet x 1, System x 2
LaserComm = Planet x 1, System x 2
MaserComm = Planet x 1, System x 2
- Sensors:** PassiveEMS = InterPlanet x 1, Interstellar x 2
Densitometer=LowPen/1km x2,
NeutrinoDetect = 10kw x 2
PasObjScan = Rout, PasObjPin = Rout,
PasEngScan = Simp, PasEngPin = Rout
- Off:** Missiles = x03, FusionGun = x03
Batt 3 1
Bear 3 1
BeamLaser = xx4,
Batt 3
Bear 3
- Def:** DefDM = + 9, OptimumNucDamper = 1,
SandCaster = xx4,
Batt 2
Bear 2
- Control:** Computer = 9 x3, Panel = HoloLink x 10,
Special = LgHoloDisplay x 1
Environ = BasEnv, BasLS, ExtLS, GravPlates
- Accomm:** Crew=10x2
(Bridge = 2, Engineer = 2, Gunnery=10, Flight = 2,
ShipTroops = 2, Command = 2, Medical = 1)
Staterooms = 12, EmergencyLowBerths = 5,
SubCraft = shuttle, air/raft
- Other:** Cargo = 4050kliters, Fuel = 13,467kliters
PurificationPlant, FuelScoops
ObjSize = Large, EmLevel = Moderate
- Comments:** Electronic Circuit Protection.
No Active Sensors.
No Inertial Compensators.
- The Imperiallines TJ Frontier Transport is externally identical to the Imperiallines TI Frontier Transport; internally, its only difference is the installation of jump-6 drives and a reduced cargo capacity. While Type TI ships routinely cover Imperiallines territory conducting trade and commerce, the Type TJ ships use their immense jump capacity to serve as clandestine Imperial couriers.

IMPERIAL TREPIDA GRAV TANK

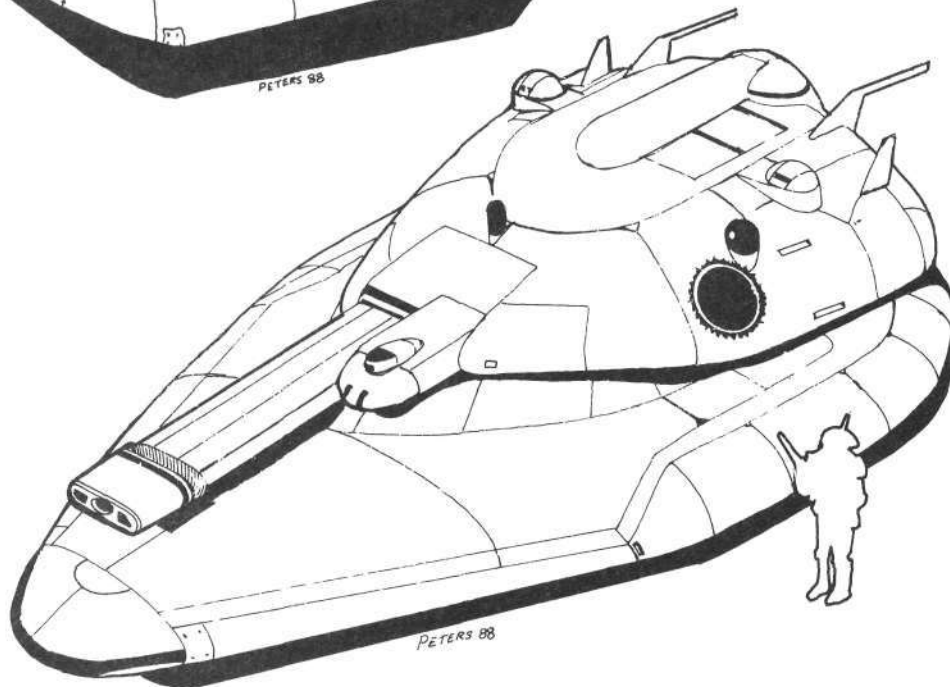
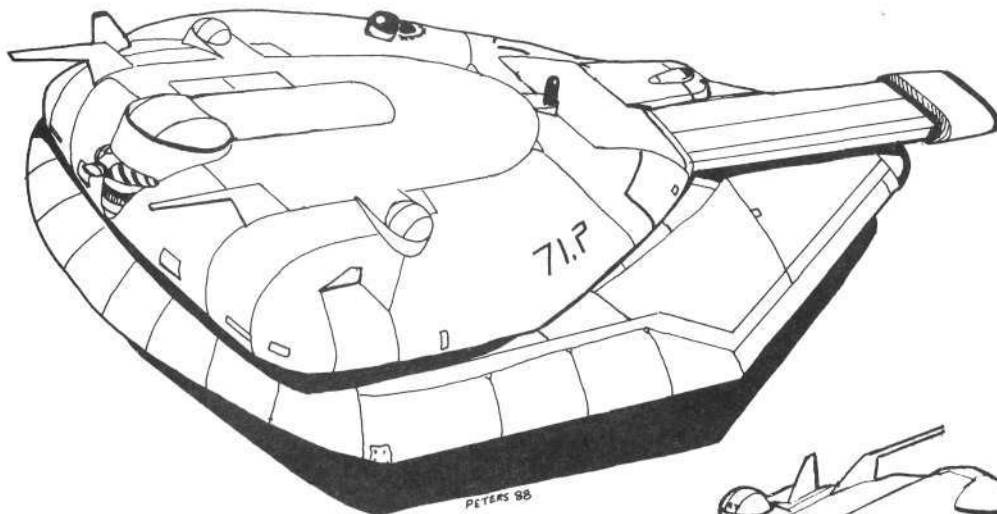

IMPERIAL TREPIDA GRAV TANK

CraftID: Imperial *Trepida* Grav Tank, TL 14, MCr20.06

Hull: 12/29, Disp=10 (+30% turret), Config = 4SL, Armor = 40G,

Unloaded = 110.8 tons, Loaded = 125.9 tons

Power: 2/4, Fusion = 126Mw, Duration = 43/130

Loco: 1/2, Standard Grav Thrust = 400 tons, NOE = 180kph, Cruise = 750kph, Top=1000kph, Vacuum = 1950kph.

Commo: Radio = Continental x 1, MaserComm = Distant x 2

Sensors: EMMask, PassiveEMS = VDistant x 1, Continental x 1, ActiveEMS = Distant x 2, ActivObjScan = Formidable, ActivObjPin = Formidable, PasEngScan = Formidable

Off: Hardpoints= 1.

Control: Computer = 3 x 2 Panel = Dynamic x 1,

Special = HeadsUp x 1

Environ = BasEnv, BasLS, ExtLS, GravPlates, InertialComp

Accomm: Crew = 2

(Operator/Gunner = 1, Commander = 1)

Seats = roomy x 2, Bunks = 2.

Other: Cargo = 10kliters, Fuel = 73kliters

ObjSize = Small, EmLevel = Faint

Comments: The *Trepida* became the standard issue Imperial grav tank (at least at the high end of the technology level scale) in 1109, and is widely distributed within the Imperium.

| | | Pen/ | Auto Dngr | | | | | |
|---------------|------|------|-----------|-----|-----|-----|--------|--|
| | Ammo | Rnd | Attn Dmg | Tgt | Spc | Siq | Recoil | |
| Fusion RFX-14 | 0 | 0 | 67/530 | 2 | 45 | Hi | — | |

(point def targetting)

Def: Prismatic Aerosol x 2, Sandcaster x 2.

IMPERIAL ASTRIN GRAV APC

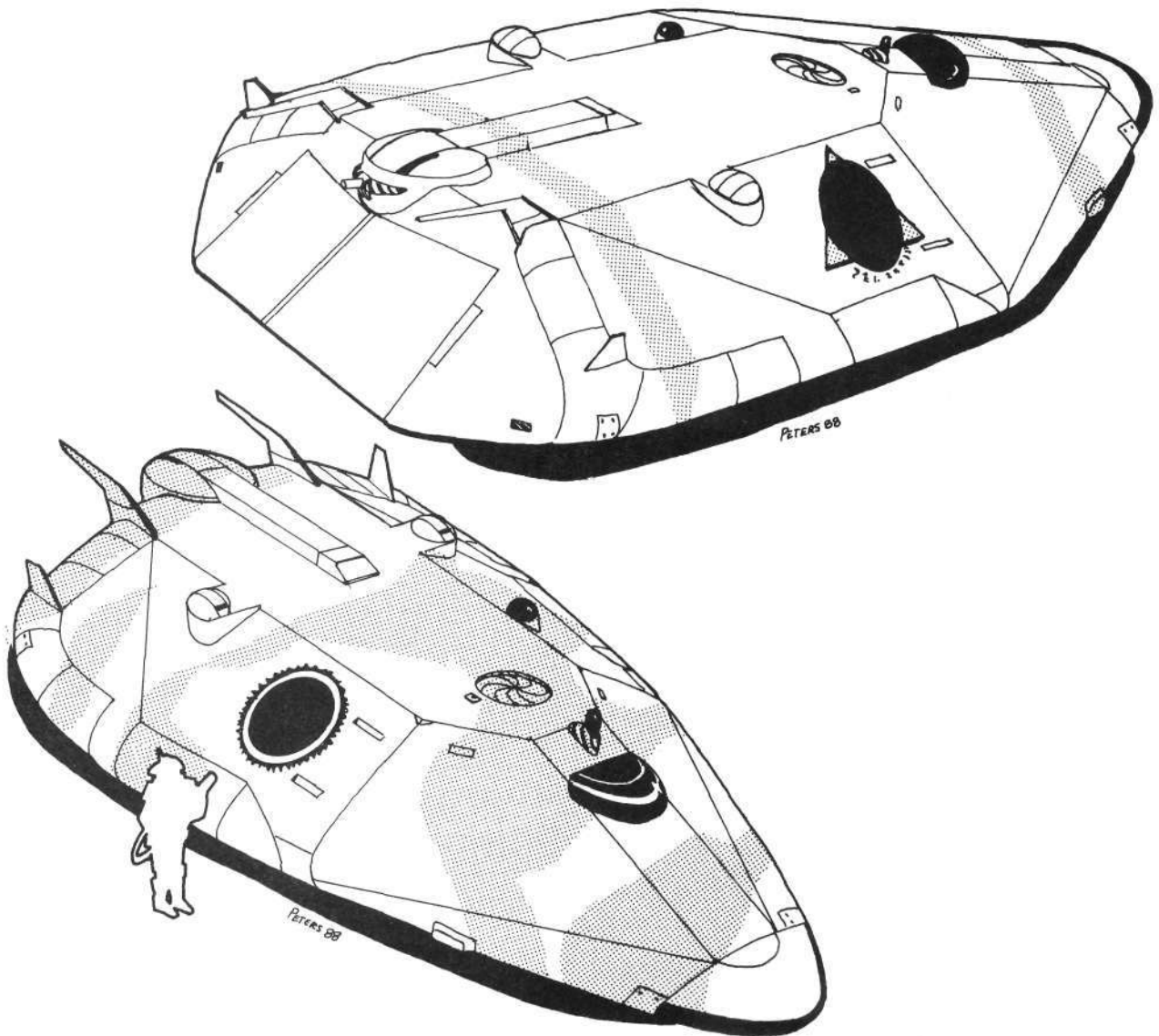

IMPERIAL ASTRIN GRAV ARMORED PERSONNEL CARRIER

CraftID: Imperial *Astrin* Grav Armored Personnel Carrier,
TL 14, MCr18

Hull: 12/29, Disp=10, Config = 4SL,
Armor = 40G,

Unloaded = 100 tons, Loaded = 130 tons

Power: 2/4, Fusion = 120Mw, Duration = 40/120

Loco: 1/2, Standard Grav Thrust = 400 tons,
NOE = 180kph, Cruise = 750kph, Top= 1000kph,
Vacuum = 1950kph.

Commo: Radio = Continental x 1,
MaserComm = Distant x 2

Sensors: EMMask,
PassiveEMS = VDistant x 1, Continental x 1
ActiveEMS = Distant x 2
ActivObjScan = Formidable, ActivObjPin = Formidable,
PasEngScan = Formidable

Off: Hardpoints= 1.

Def: Prismatic Aerosol x 2, Sandcaster x 2.

Control: Computer = 3 x 2 Panel = Dynamic x 1,
Special = HeadsUp x 1
Environ = BasEnv, BasLS, ExtLS, GravPlates,
InertialComp

Accomm: Crew = 2
(Operator/Gunner=1, Commander=1)
Seats = roomy x 2, adequate = 10.

Other: Cargo = 10kliters, Fuel = 73kliters
ObjSize = Small, EmLevel = Faint

Comments: The *Astrin* was developed as a companion to the
Trepida to carry troops into battle. Its deployment has
followed the *Trepida* by about three years.

The *Astrin* carries up to ten combat-equipped
soldiers.

ASLAN IHATEI-CLASS TRANSPORT

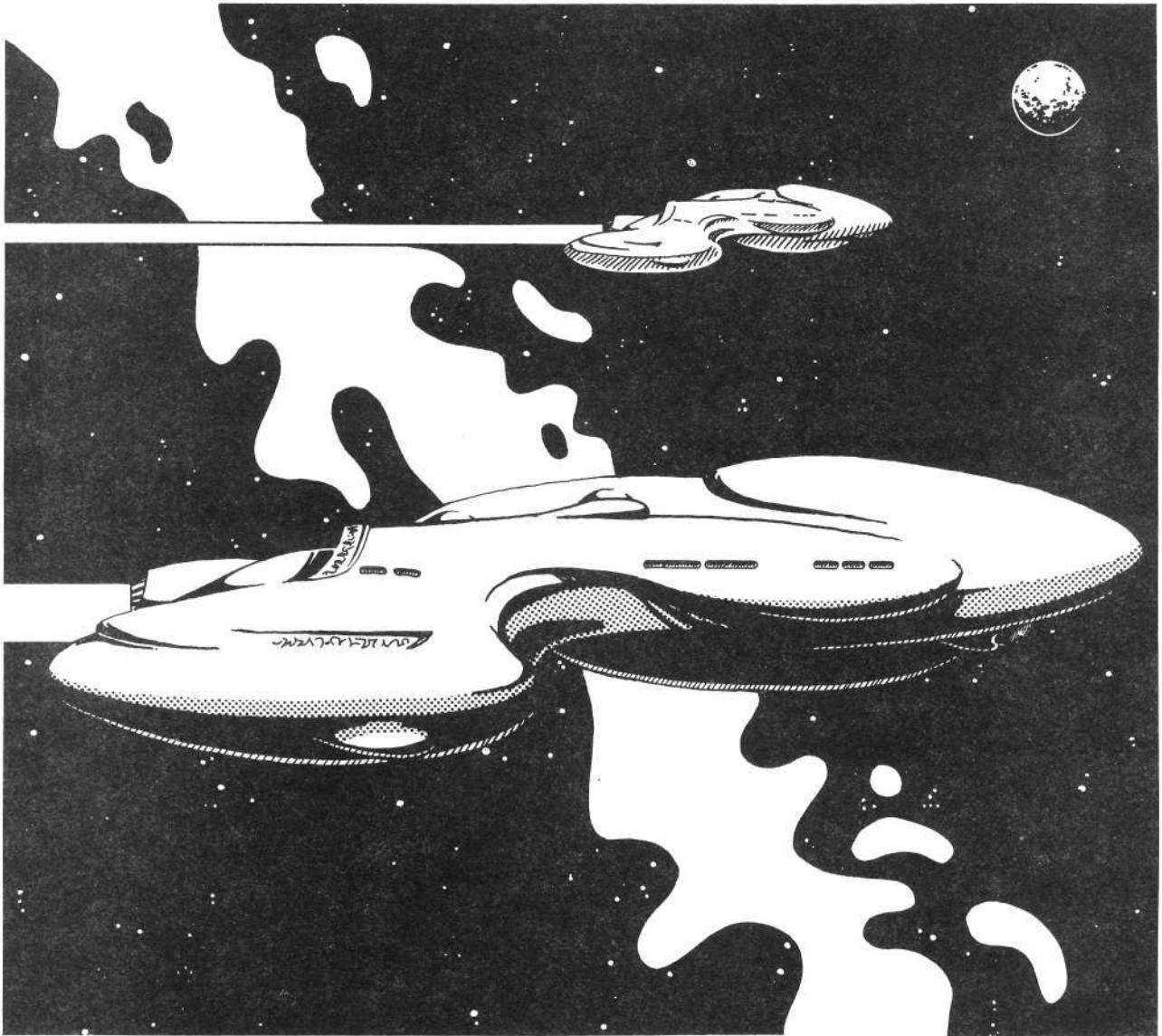

ASLAN IHATEI CLASS TRANSPORT TYPE NP

CraftID: Colonial Transport, Type NP, TL 13, MCr12,474
Hull: 45,000/112,500, Disp = 50,000 tons, Config = 3SL, Armor = 40F, Unloaded = 515,554 tons, Loaded = 529,656 tons
Power: 1202/2403, Fusion = 108,135Mw, Duration = 30/90
Loco: 900/1800, Maneuver = 1, 1800/3600, Jump = 3, NOE=190kph, Cruise = 750kph, Top = 1000kph, Agility = 0
Commo: Radio = Planet x 1, LaserComm = Planet x 1,
Sensors: ActiveEMS = FarOrbit1
 PassiveEMS = InterPlanet x 1,
 Densitometer = HighPen/100mx 1,
 NeutrinoDetect = 100kw x 1
 ActivObjScan = Rout, ActivObjPin = Rout
 PasObjScan = Diff, PasObjPin = Diff,
 PasEngScan = Rout, PasEngPin = Diff
Off: None.
Def: DefDM= +6, NucDamper = 2,

Control: Computer = 7x3, Panel = HoloLink x 200, Special = LgHoloDisplay x 75
 Environ = BasEnv, BasLS, ExtLS, GravPlates
Accomm: Crew = 3x50
 (Bridge=14, Engineer = 52, Maintenance = 19, Gunnery = 8, Flight = 2, ShipTroops = 50, Command = 24, Stewards = 5, Medical = 10)
 Staterooms = 92, LowBerths= 10,000,
 SubCraft = shuttle x 5, cutter x 8, air/raft x 10
Other: Cargo = 202,500kliters, Fuel = 199,881 kliters
 PurificationPlant, FuelScoops
 ObjSize = Large, EmLevel = Strong
Comments: No Inertial Compensators.

The Aslan *Ihatei*-class transport is one of several standard designs encountered in Aslan colonial fleets; like all of them, it provides economical movement of a large number of colonists (in low berths) and their supporting heavy equipment and start-up supplies (about 1.5 tons per colonist).

Aslan *WEAKHTO*-CLASS CRUISER

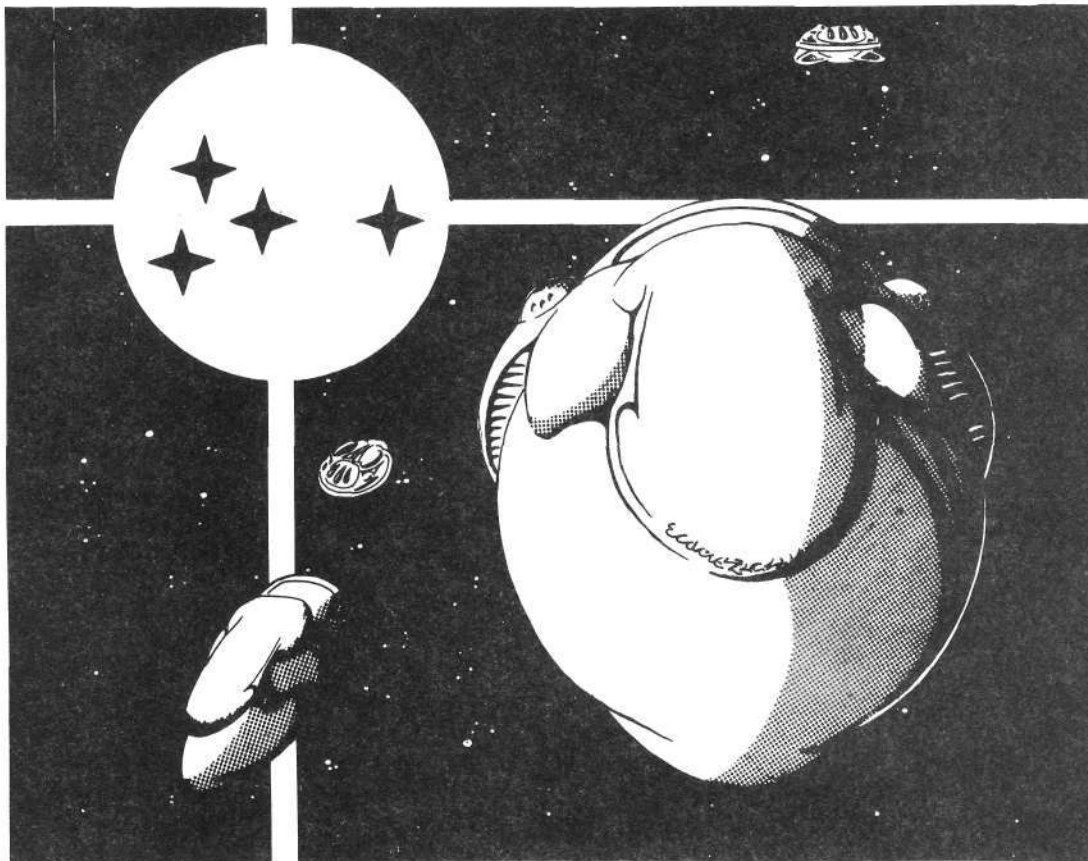

ASLAN *WEAKHTO*-CLASS CRUISER

- CraftID:** Heavy Cruiser, Type CA, TL 13, MCr10,476
- Hull:** 9000/22,500, Disp = 10,000 tons, Config = 2SL, Armor = 50F, Unloaded = 725,807 tons, Loaded = 730,941 tons
- Power:** 990/1980, Fusion = 89,100Mw, Duration = 26/78
- Loco:** 720/1440, Maneuver = 3, 360/720, Jump = 3, NOE = 190kph, Cruise = 750kph, Top = 1000kph, Agility = 0
- Commo:** Radio = Planet x 1, System x 1
LaserComm = Planet x 1
MaserComm = Planet x 1, System x 1
- Sensors:** PassiveEMS = SubStellar x 1, ActiveEMS = FarOrbit x 1, Densitometer = HighPen/100m x 1, NeutrinoDetect = 100kw x 1
ActivObjScan = Rout, ActivObjPin = Rout, PasObjScan = Diff, PasObjPin = Diff, PasEngScan = Rout, PasEngPin = Diff
- Off:** Missiles = x93, FusionGun = x02
Batt 1 10 5
Bear 1 10 5
BeamLaser = xx6, PlasmaGun = x04
Batt 9 5
Bear 9 5
ParticleAccelerator = 030
Batt 1
Bear 1
- Def:** DefDM=+7, NucDamper = 3, SandCaster = xx4,
Batt 10
Bear 10
- Control:** Computer = 7 x3, Panel = HoloLink x80, Special = LgHoloDisplay x 18
Environ = BasEnv, BasLS, ExtLS, GravPlates.
- Accomm:** Crew = 17x10
(Bridge = 13, Engineer = 24, Maintenance = 39, Gunnery = 54, Flight = 2, ShipTroops = 10, Command = 23, Stewards = 5, Medical = 3)
Staterooms = 87, Bunks = 100, SubCraft = shuttle x 2, cutter x 2, air/raft
- Other:** Cargo = 1350kliters, Fuel = 73332kliters
PurificationPlant, FuelScoops
ObjSize = Large, Em Level = Moderate
- Comments:** The Aslan *Weakhto*-class Cruiser is typical of those deployed by the Aslan *ihatei* fleets on colonization missions. Considered obsolescent by contemporary Aslan standards, the ship has enough life left in it to provide effective protection for the colony ships it escorts, and to provide scout and recon services as the fleet seeks out new colony worlds.
Weakhto-class ships are named for famous clan battles; *weakhto* means battle.

IMPERIAL COMBAT ARMOR

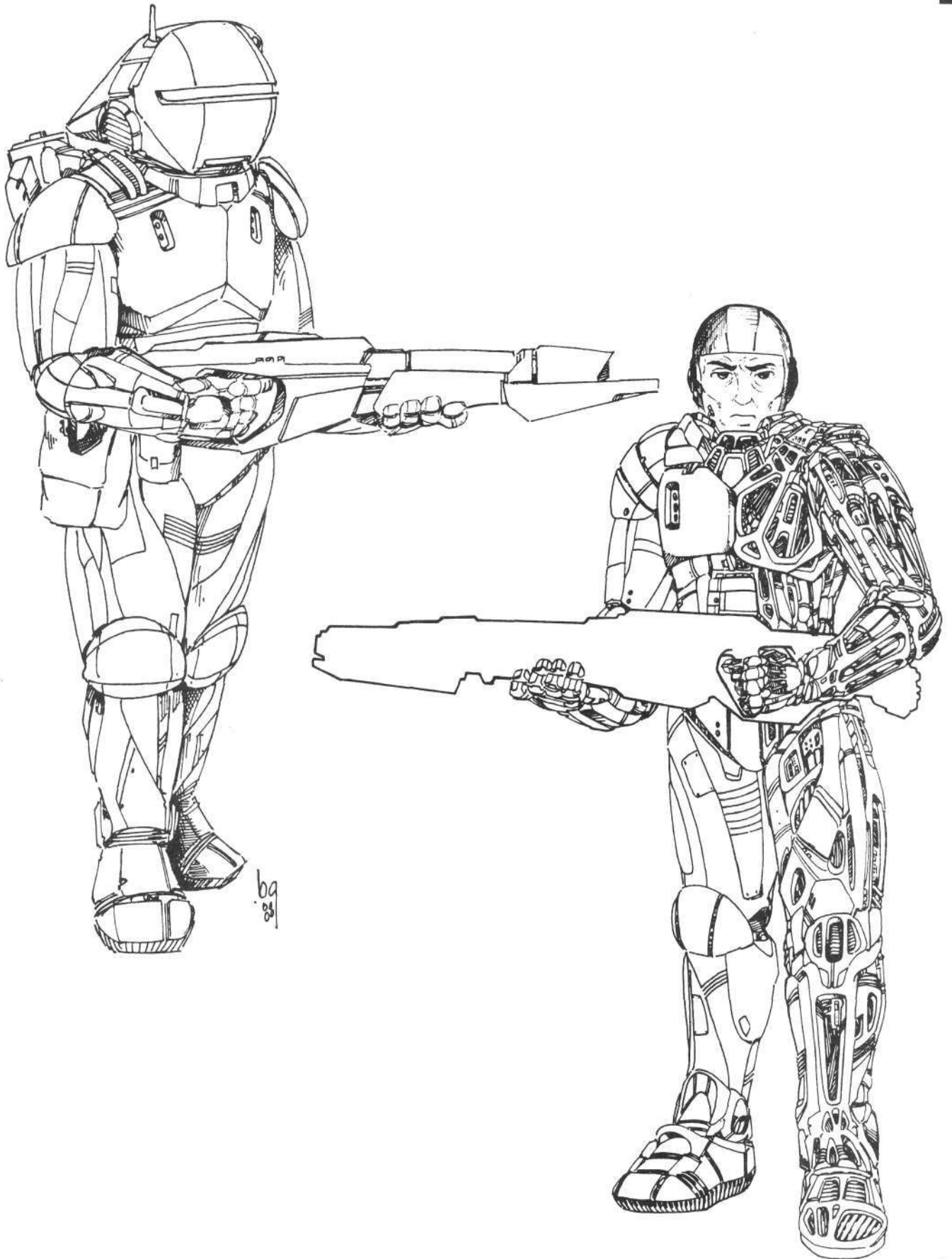

ZHODANI Z-80 GRAY TANK

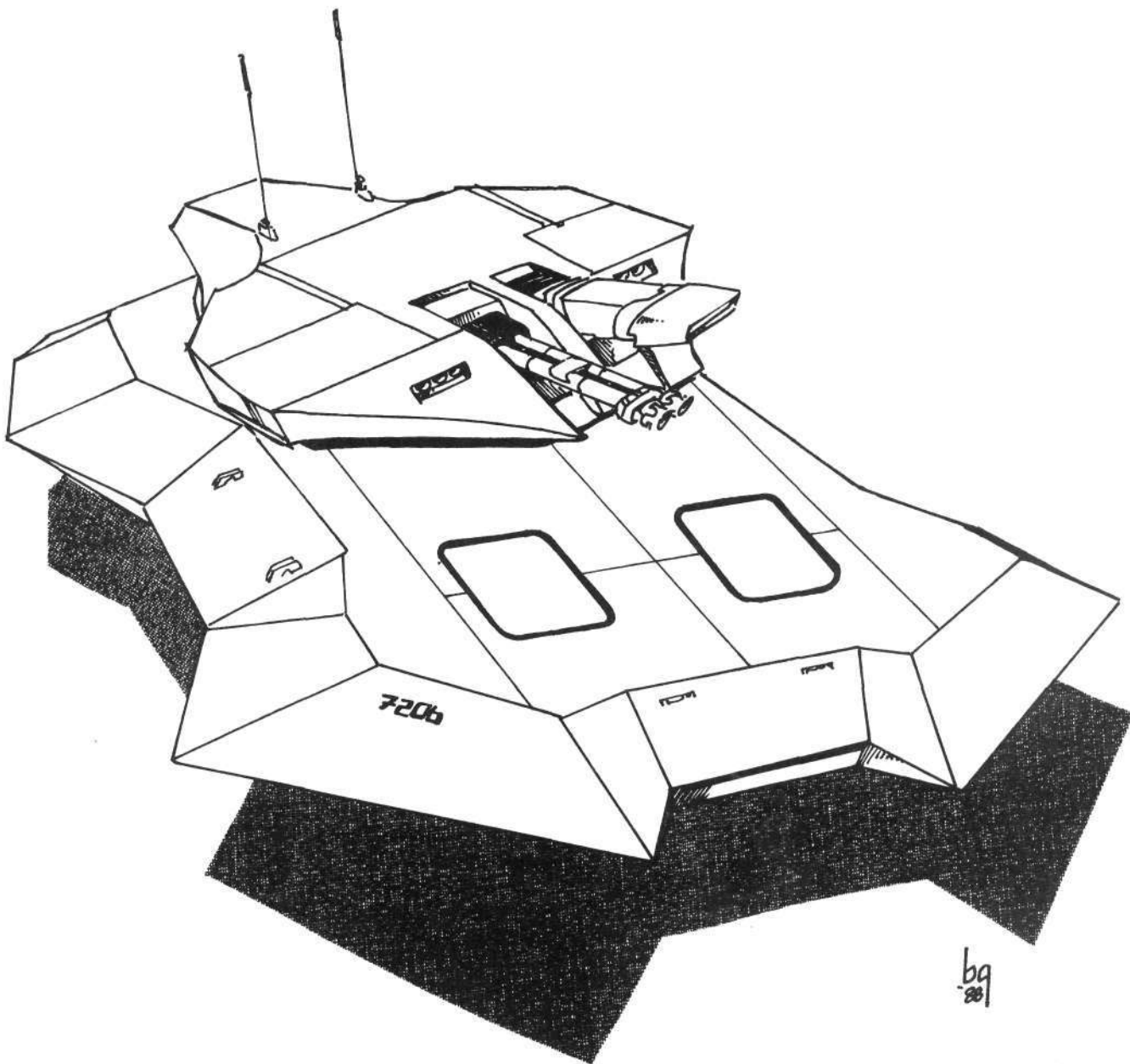

ZHODANI Z-80 GRAV TANK

CraftID: Zhodani Z-80 Grav Tank, TL 14,

Hull: 12/29, Disp=10 (+ 30% turret), Config = 4SL,
Armor = 40G,

Power: 2/4, Fusion = 130Mw, Duration = 38/114

Loco: 1/2, Standard Grav Thrust = 400 tons,
NOE = 180kph, Cruise = 750kph, Top= 1000kph,
Vacuum = 1950kph.

Commo: unknown

Sensors: EMMask, others unknown

Off: Hardpoints= 1.

Def: Prismatic Aerosol x 2

Control: Computer = 3 x2

Panel = Dynamic x 1, Special = HeadsUp x 1
Environ = BasEnv, BasLS, ExtLS, GravPlates,
InertialComp

Accomm: Crew = 2

(Operator/Gunner=1, Commander = 1)
Seats = roomy x 2

Other: Cargo = ?? kliters, Fuel = ?? kliters
ObjSize = Small, EmLevel = Faint

Comments: Imperial intelligence agencies have given the designation Z-80 to the current Zhodani primary issue grav tank. Detailed information about the vehicle has not yet become available.



Nail Mission

The Domain of Deneb has been cut off from the main body of the Imperium ever since Emperor Lucan withdrew Corridor Fleet and allowed the Vargr raiders to move into that sector. All along Imperial coreward border, Vargr corsairs have become bolder and bolder as they find the Imperium unable to resist their plundering expeditions. Meanwhile, the rimward border of the Domain is being steadily nibbled at by Aslan ihatei fleets intent on settling any hospitable world they can find, even ones already settled by Imperials.

Defending at the core of the Spinward Marches is Norris, Archduke of Deneb, using every asset at his command to halt the collapse of his small part of the Imperium, hoping the Rebellion can be ended before the star-spanning might of the empire is completely destroyed.

PROJECT 12

In order to adequately reinforce the defenses of the Domain, every possible starship is being impressed into service. Squadron after squadron of mothballed battleships is being reactivated, refurbished, and pressed into the line to hold back the raiding Vargr.

Long ago, a squadron of *Voroshilef*-class battleships was retired from active service, transferred to the reserve fleet, and ultimately parked in orbit around Mora/Spinward Marches (2924 C367300-8) until they could be scrapped. The ships were always second-class battleships, never intended for use on the main battlefronts, but in the Marches, when used against the Vargr, they promised to be reasonably efficient.

When the naval inspectors looked the hulls over in anticipa-

tion of reactivating them, they bumped up against an undocumented installation in five of the six ships. After a quick check and several cross checks, they confirmed that the battleships Particle Accelerator-R spinal mounts had been replaced (according to the records, at Depot/Gushemege) with a highly experimental Disintegrator-A spinal mount, which conveniently fit into the space left by removing the Particle Accelerator-R.

The reserve fleet commodore immediately saw the potential of several battleships armed with highly effective disintegrators and sent an aide with the news to the Naval High Command at Regina. Only after the aide was on his way was the commodore informed that the Disintegrators didn't work; they were missing a vital component which was obviously not in inventory in anywhere in the Domain.

After several weeks of frantic messages exchanged with Regina, Naval High Command realized that the most straightforward course of action was to send a ship to Depot/Gushemege to get the parts required.

Through a sector filled with Vargr corsairs.

Then through the independent Vilani empire.

To a Depot which could be in the hands of any one of four factions of the Rebellion.

For a part that might not even be there.

And return.

THE MISSION

Sending a fleet on a journey of more than 150 parsecs is a genuine waste of vital naval power. A squadron, on the other hand, might not survive the mission. A single naval cruiser would never survive. The mission absolutely must be undertaken by a ship that can blend into the environment, run fast enough to escape most pursuers, and carry several hundred tons of vital parts back to the Spinward Marches.

Fortunately, there exists such a ship. Several Imperiallines TJ 2000-ton Frontier Transports are stranded in the Marches by the Rebellion. They continue to operate as couriers for the Archduke, mainly because they have little else they can do at



the moment. These ships, capable of jump-6, can easily make the journey to Depot/Gushemege in the fastest possible time.

The TJ has several advantages as well. If any Imperiallines offices remain open, they can serve as a source of assistance and support if needed. Imperiallines offices are present (or were before the Rebellion began) at two out of three type C starports in the Imperium.

Recruiting: Commander Itsan Unuggi, naval aide for the Archduke of Deneb, has been charged with organizing an expedition to Depot/Gushemege using an Imperiallines TJ. Several crews of the TJs have been stranded in the Spinward Marches, and some of their personnel are anxious to return to their homeworlds in the Imperium before all interstellar travel grinds to a halt. From the available crews, a composite crew has been assembled. About half come from subsectors in the interior of the Imperium, and they want to be taken home. The rest are prepared to make the full journey. To round out the crew, Commander Unuggi is now recruiting a multi-skilled band of adventurers who can provide the best possible support to the TJ crew.

The adventurers are the perfect answer. They are recruited.

Preparing for the Mission: The adventurers must prepare themselves for the mission by procuring equipment and supplies that they might feel important. Anything can happen on this mission: It may include world surface actions, encounters with enemy ships, rescue missions, vacuum operations, or any other activity.

The Navy will supply basic small arms weaponry and ammunition. The ship itself is well-stocked with food, some repair parts, and medical supplies. Beyond that, any requirements must be filled by personal purchase.

The Imperiallines TJ included up to 10 tons of cargo space for each crewmember.

Procedures: The TJ is capable of jump-6. It can refuel at any gas giant, at a starport, or with water from a lake or ocean. Costs for life support on the ship are already taken care of.

Theoretically, the ship can make jump after jump after jump without having any appreciable delay on the way to Depot/Gushemege.

The referee must create maps of the sectors through which the TJ will travel. Once these maps are generated, the TJ can proceed under the navigation of one of the player characters (with the advice and assistance of the other player characters, and the non-player characters as administered by the referee).

Mission Orders: As the ship prepares to depart, the specific mission orders are made available to the crew. They read as follows:

You are now ordered to proceed to Depot/Gushemege in Gushemege sector by the fastest possible route. There, you are to locate and procure the attached list of vital starship weaponry components. You will then return to Mora/Spinward Marches to deliver the parts for installation in waiting starships.

Several crewmembers have expressed a desire to be returned to their homeworlds of record. If such action is possible and will not appreciably delay the journey, you are ordered to do so.

Imperiallines Transport offices are commonly encountered at type C starports. You should consider Imperiallines offices a possible resource in the event of problems while enroute. You are ordered to provide Imperiallines Transport offices any possible assistance if it will not appreciably delay your journey.

The attached list of vital starship weaponry components includes parts numbers, descriptions, photographs and drawings to help recognize the equipment. The material weighs 200 tons and has a volume of 400 kiloliters.

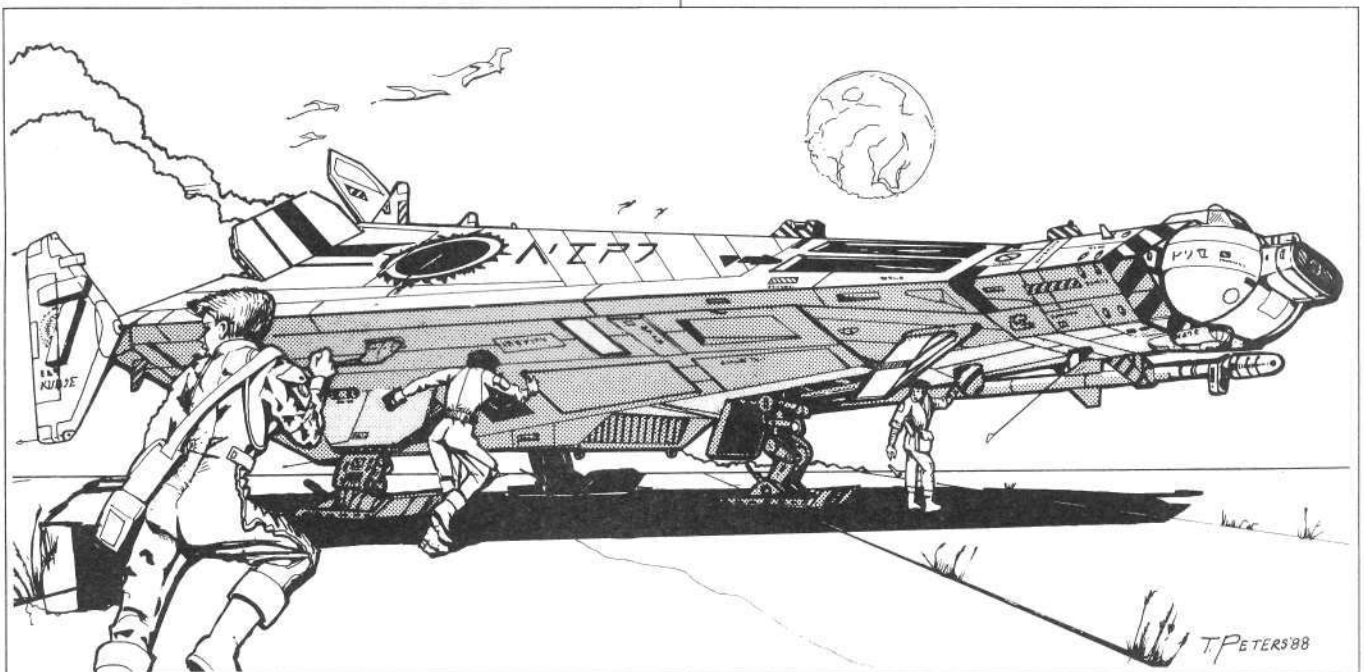

REFEREE'S INSTRUCTIONS

This mission is intended to provide a wide variety of experiences for the player characters as they journey through a wide variety of Rebellion-filled Imperial subsectors. To the casual observer, the mission looks like it will be a simple matter: Go there, get the stuff, and come back. To make it more interesting, the following procedure should be used.

First Steps: After the basic situation has been established, the adventure should concentrate on the details of how the ship travels through unknown or unfriendly territory. Emphasize the details of arrival in system, checking for possible enemy ships, refueling, a reconnaissance of the main world in the system (even if at a distance), and possibly a reconnaissance of other worlds in the system. Only then should the ship proceed to the next world on its itinerary.

Every system should have an encounter. The precise nature of the encounter is left to the referee, and it definitely should not be random. Instead, use each encounter to show some aspect of the Rebellion to the players. Some suggestions include:

A Vargr Corsair: Meeting this enemy allows a pitched space battle. The corsair might be lying in ambush near the gas giant, not to be spotted until too late, or it might lie dormant like a derelict to lure the TJ closer.

An Abandoned World: A world with a type C starport, its city (or cities) in ruins after continued raiding by Vargr. The few survivors on the world need desperately to be taken to a more hospitable place, and the local Imperiallines office pleads for the TJ's help.

Use each encounter to build interest in the adventure. But remember that encounters and game action also helps players better understand not only their own characters but also the character around them. As they become comfortable with the characters of the adventure, they can learn to depend on them. And from that dependence and interaction comes a truly

rewarding role playing experience.

Mid-Game: After the players are comfortable with the procedures and have come to expect an encounter in each system, the adventure can proceed more swiftly. Some systems can now be passed through without encounters, and progress toward the goal of Depot/Gushemege can be more rapid.

First Climax: The obvious goal of the adventure is to arrive at Depot/Gushemege and procure the vital starship weaponry components. There are three alternatives for the events at Depot/Gushemege; which one is used must depend on the referee's evaluation of appropriateness and player enjoyment.

1. The Depot is abandoned. In the early years of the Rebellion, the naval staff maintained the depot as a supply and repair base, but as the war swirled around it, it became apparent that keeping the place in operation was no longer a reasonable option. During 1118, virtually all of the movable, useful supplies and equipment were removed to other naval bases. Left behind were empty starship hulls and parts for which there was no foreseeable use.

The adventurers will have to carefully search the entire depot trying to find the specific components they need. The parts are there; the abandoned computer system (if it can be brought back to life) has the required stock bin locations; the search can be long and tedious or systematic and short, depending on how the adventurers go about it.

Meanwhile, the situation lends itself to various dramatic scenes: huge warehouses stretching for kilometers. Vast landing grounds with a cannibalized starship hull lying collapsed every three or four kilometers. Immense buildings formerly dedicated to naval education, or starship repair, or living quarters, now all abandoned...their windows broken out and their roofs caving in.

2. The Depot remains in operation. Naval security constantly patrols the system and makes it nearly impossible for an unseen penetration. Instead, negotiation and bargaining are necessary to convince the local naval authorities that they should part with the starship weaponry components.

3. The Depot has been destroyed. Destruction can never be complete, but it does make finding specific pieces of equipment a difficult proposition. The search must be systematic, and it is possible that the components were destroyed, in which case the search is hopeless. But perseverance and determination should be rewarded. Eventually, the search should turn up the required equipment.

Once the equipment is found, bargained for, or located, it can be loaded onto the TJ and the journey home begun. Part of the process should include locating some special information about the components: an ordnance repairman who has experience with the parts and who also wants to return to his homeworld in the Spinward Marches; a comprehensive installation manual of very recent date, undoubtedly not available to the Navy in the Marches; an automated installation guide which projects holographic images and uses image recognition to check installation accuracy. This extra bit of help makes the journey to get the parts all the more rewarding.

The Return Journey: The return journey is the time for the excess crewmembers to be dropped off at their homeworlds. Several different homeworlds in Gushemege sector should be selected for this and then each one visited in turn. Each visit

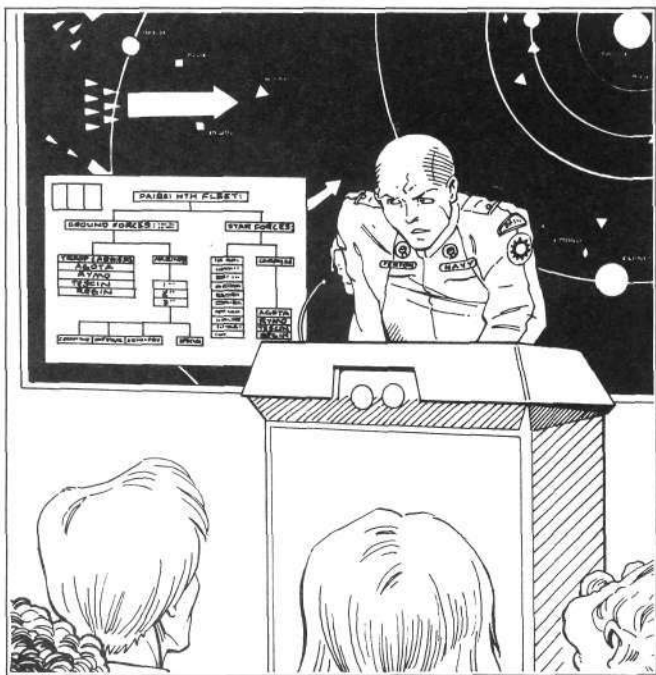

is the pretext for a specific adventure.

On one world, the Rebellion has cut off the flow of provisions and supplies; the world's low population will starve unless it is quickly moved to a nearby, more hospitable world. The several required mercy flights are a reasonable enough return for the able service of the crewman being returned home.

On another world, the crewmember's home village has been destroyed. A momentary delay is necessary to help in the location of his family and possibly the mounting of a short relief effort.

On still another world, the population is suffering from a virulent plague. To just leave the crewmember there would no doubt condemn him to certain death—and to not help his family would condemn them to death as well. A short stopover to help in diagnosing the plague, assisting in synthesizing a treatment for it, and then producing enough treatment and vaccine to help the population is a humanitarian act that few could possibly refuse.

On yet another world, local trade is being raided by a local pirate who exacts tribute to let ships pass. His extortion scheme seems primitive, but the lawless environment of the Rebellion lets this sort of thing happen. The reasonable response is to find some way of stopping the pirate: perhaps a clandestine mission to put a limpet mine on his hull.

The Final Climax: The end of the mission is naturally greeted with great anticipation. With careful preparation on the part of the referee, it can be made memorable and entertaining.

When the TJ returns to Moran/Spinward Marches, the crew finds that the battleships are no longer there. They have been moved to the coreward borders (Aramis/Spinward Marches) closer to the Vargr invaders in order to reinforce the fleets, even though their main weaponry is not functional.

The TJ must move quickly to Aramis, deliver the components, and then stand by while the equipment is installed in the battleships. While the installation process takes place, the base is hit again and again by Vargr raiders, to the point

that it looks like the base will have to be abandoned.

A series of vital (and perhaps lucky) hits cripple the drives of at least two of the battleships, meaning that retreat will allow two potentially well-armed battleships to fall into Vargr hands.

Then, and only then, should the climactic battle between the Vargr raiders and the now-operational battleships be allowed to take place. While three of the battleships move out to use their disintegrators, the two crippled ships remain behind in orbit, maneuvered by the TJ so that they can aim their own disintegrators at any raiders who get past the front lines.

And on that note, the adventure ends.

FINAL REFEREE CONSIDERATIONS

There is a lot of room for adventure in this situation. It is intended to allow the players to see the broad span of situations possible within the Imperium and its ongoing Rebellion. In doing so, it is important for an individual to remember two things, as follows:

First, there is something for everyone in the Imperium. Players in **MegaTraveller** can become involved in naval, military, scientific, exploratory, diplomatic, or merchant activity, all with equal ease. Often all of that activity can be included in the same adventure. Careful planning can make any of it happen.

Second, there are good, sound reasons for nonviolent action in **MegaTraveller**, but there are also good sound reasons for violent responses. Just be careful to realize that each has its place. If every activity is violence or robbery, it soon becomes dull. Instead, a careful mix makes each type of action interesting and exciting.

Third, this adventure can be a lot of fun! Players can enjoy anything that happens to them along the way and at the end, if they do things right, can experience a tremendous feeling of accomplishment. Properly paced, players will look forward to each session. Never let anything get in the way of the players enjoying their adventure, and make sure you enjoy it, too.

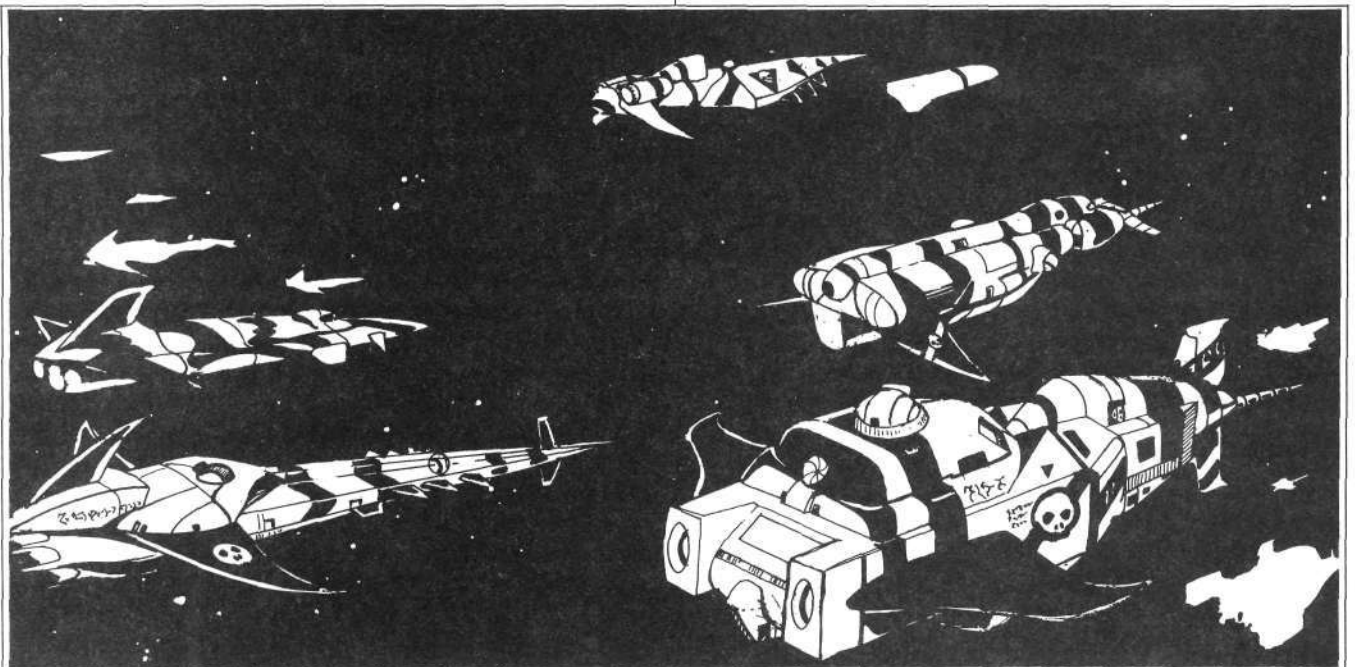



Mapping Sectors

Travel through the vast reaches of the Imperium can be an exciting, intriguing, dangerous activity. Although broad schematic maps of Imperial territory are provided in the **MegaTraveller** rules and in this sourcebook, the details of the individual star systems are not generally available. This chapter provides the basic information necessary to generate star systems as adventurers travel through the Imperium.

The blank sector map shows the 1280 hex locations in which star systems can be placed. The hexagons on the map are numbered with unique, four-digit identifiers. The first two digits show the hex column (01 is the first, or leftmost, column; 32 is the last, or rightmost, column); the second two digits show the staggered hex row. This hex number identifies the location of a hex in a sector.

The blank sector map is also ruled into 16 subsectors for ease in further identifying locations. Since these subsectors are shown on the large-scale maps of the Imperium, they can be used to more precisely locate regions and areas on the map.

MAPPING STAR SYSTEMS

When mapping star systems, a photocopy of the blank sector grid should be made. The simplest procedure uses a photocopy as a rough draft with all markings transferred neatly to a final copy once the computations are completed.

Basic Mainworld Generation: Using Basic Mainworld Generation (pages 24 and 25 in the *Referee's Manual*), consult Step 1, System Presence, for each hex in the sector. Make a small mark to identify when a system is present in a hex.

For each system found then produce Starport Type (Step 3), Scout and Naval Base Presence (Step 11), and Gas Giant Presence (Step 15). Record the information in the format shown for mapping subsectors on page 20 of the *Referee's Manual*.

If more detail is desired, throw for World Size (Step 4), Atmosphere (Step 5), and Hydrographies (Step 6). Using that information, properly show the World Type as a Desert or Vacuum World, an Asteroid Belt, or a Standard World. Also throw for population (Step 7) and give the world a name if it is a High Population world.

ADDING KNOWN INFORMATION

Using appropriate maps from this sourcebook, add additional information to your sector map about allegiances, depots, and capitals. Sketch out the faction allegiance of groups of worlds by noting broad areas dominated by each faction. Note the existence of depots from the depot map and add them to the sector map. Note sector capitals and other named worlds and add them to the sector map as well.

USING THE SECTOR MAP

Producing a sector map for a region within the Imperium allows a **MegaTraveller** referee to administer adventures which can range throughout the length and breadth of the Rebellion-wracked Imperium. When worlds need to be iden-

tified and specified in detail, they can be. Casual travellers, however, need only know the basic information necessary to handle refueling and identifying the probable faction allegiance within the system.

Encounters: A variety of encounters can be dictated by the master sector maps.

Faction Fleets: In a region close to a faction's base of power, it is probable that a casual traveller will encounter fleets loyal to the faction. Since one job a fleet performs is to patrol its territory, these fleets will challenge and inspect ships passing through their territory. Armed vessels will probably be attacked in such situations. It is possible that travellers will encounter elements of a faction's fleet near its controlled territory, although the possibility drops off with distance.

Sieges: High Population worlds which have not declared loyalty to a faction and which are close to its base of power are probably under siege. The besieging fleets use their power to prevent ships from approaching or leaving the besieged world.

Destinations: Analyzing a sector map can provide a variety of important destinations that adventurers can be assigned. The thrill of the journey is what is important, and the preparation during the trip helps make the adventure all the more worthwhile.

High Population worlds are the key to the Rebellion. Although they represent less than 10 percent of the Imperium's worlds, they hold 90 percent of its population. A mission to a High Population world can be the key to an operation by a faction.

Other important destinations include depots, naval bases, and devastated worlds.

Inaccuracies: The information produced when the sector map is generated should be thought of as official information which is available in computer files. The frequently seen shifting of allegiances during the Rebellion makes it all but impossible to know exactly what will actually be encountered within a system.

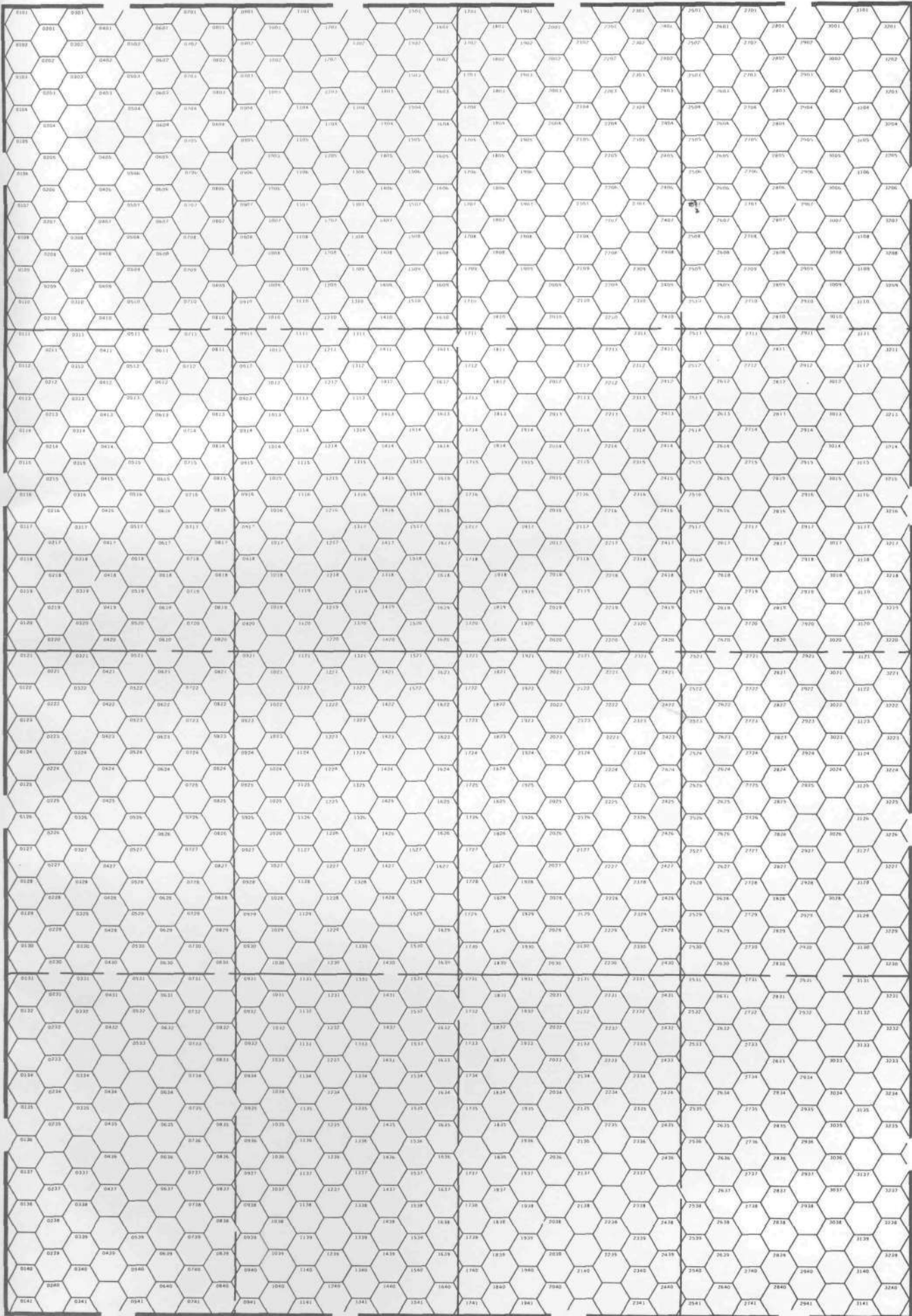

| | | | |
|---|---|---|---|
| A | B | C | D |
| E | F | G | H |
| I | J | K | L |
| M | N | O | P |

SUBSECTORS WITHIN A SECTOR

MAP LEGEND

Starport Type: Gas Giant, Terminus, X-boat Route

World Type: World Name, Asteroid Belt

Travel Zone: No Gas Giant, Asteroid Belt

WORLD CHARACTERISTICS
 ● No Water Present
 ● Water Present
 ○ Asteroid Belt

BASES
 * Imperial Naval Base
 * Imperial Scout Base
 * Zhodani Base
 * Independent Base
 F Research Station
 * Scout Way Station
 R Imperial Reserve
 P Imperial Prison
 X Exile Camp

TRAVEL ZONES
 — Amber Zone
 — Red Zone

POPULATION
 Seconds under one billion
 PRIMUS over one billion
 World names in red are subsector capitals.

REBELLION

S O U R C E B O O K

The Imperium is being torn apart by the star-spanning Rebellion; rival leaders are fighting for the right to sit on the Iridium Throne of the Third Imperium and to rule the greatest interstellar empire that the galaxy has ever seen.

Now, the *Rebellion Sourcebook* provides the details of the Rebellion that allow **MegaTraveller** referees and players to incorporate the sweep and the chaos of the Rebellion into their own role-playing adventures. Maps show the Imperium and its battlegrounds. Diagrams show the organization of the Imperial military, naturally the source of the armed forces for every faction of the Rebellion. Drawings show typical Imperial military hardware—the Imperial standard design grav tanks, grav APCs, and typical ships of the Imperial fleets.

The rival factions of the Rebellion have their own distinct leadership, aims, and backgrounds; the *Rebellion Sourcebook* provides this material.

Lucan—the Emperor's nephew and a legitimate heir but also rumored to have murdered his own brother in order to win the throne.

Dulinor—he sparked the Rebellion by killing the Emperor, and now he claims to be Emperor by right of assassination.

Margaret—the compromise candidate proposed by moderate elements in Imperial society.

Strephon—is he the real Emperor or an impostor?

Brzk—the Archduke of Antares, convinced that the Imperium will never accept him, a non-human, as Emperor.

Norris—claiming allegiance to the Imperium but refusing to support any specific faction.

Vargr—raiders intent on looting the undefended border provinces of the Imperium.

Aslan—driven to colonize new worlds, even if they are inside the Imperial borders.

Vland—intent on reestablishing their own empire.

Solomani—champions of human supremacy, intent on imposing their way on all of humanity.

Also included in this sourcebook is an adventure set against the chaotic sweep of the Rebellion: A starship crew must travel across parsecs of disputed and dangerous territory in a quest for vital starship repair parts. And completion of the trek to an Imperial naval depot is vital

to the survival of the Spinward Marches.

MegaTraveller Rebellion Sourcebook. Intended for **Traveller** referees. Intermediate complexity. Suitable for some solitaire play. Requires the **MegaTraveller** role-playing game system.

Our 15th Year

GDW

