

# ASSIGNMENT: VIGILANTE

Charles  
E.  
Gannon

Science-  
Fiction  
Adventure  
in the  
Shattered  
Imperium



# IMPERIAL LINES 1

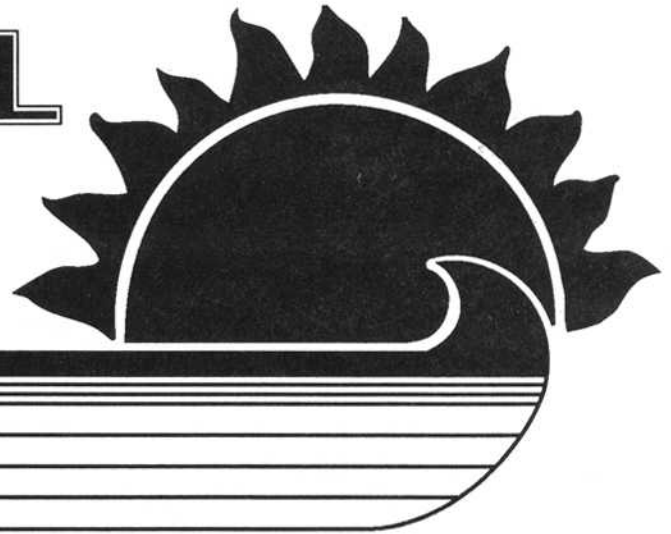

## X-LINK

Mark "Geo" Gelinas

Welcome to the first issue of **Imperial Lines**. We hope it will be the first of many issues.

Because you are reading this newsletter, we believe that either you already love **MegaTraveller** (in any of its various forms), or that you are interested in learning more about **MegaTraveller**. We hope to satisfy both types of readers.

It is not our intention to compete with **Challenge** magazine for coverage of **MegaTraveller**, but to complement it. We fully encourage writers of **MegaTraveller** material to continue submitting to that publication. Although **Challenge** does include a generous quantity of **MegaTraveller** material, additional support is desired. Also, **Challenge** aims for a general science fiction role playing audience. **Imperial Lines**, on the other hand, dedicates itself specifically to the **MegaTraveller** readership, giving it a slightly different nature.

We also do not intend to be a supplement to **Challenge** coverage. While some articles may reference articles found there, we will strive to make each article complete in and of itself. This will tend to reduce your frustration as a reader and increase the usefulness of the newsletter.

Speaking of usefulness, we wish to make this newsletter more than something you simply read and put away somewhere. We hope that every reader will find something they can use as a player or referee in every issue. We intend to include articles on equipment, creatures, deck plans, subsectors, and adventures. Of course we cannot include all of these in every issue, but we will strive for variety.

We at **Imperial Lines** are excited about this newsletter and the possibilities it opens. We hope you will stay with us and watch them unfold.

## Sneak Peek

In this issue you will find an assortment of articles that we think you will find interesting and useful.

First, we look at Foreven Sector. You probably think of it as the sector to the left of The Spinward Marches. A year or so ago, Mike Mikesh sat down with Marc Miller and they came upon the idea of setting aside Foreven as the referee's private reserve. As such, this is the only information that will be published on the sector. Note that it does include what little that has been previously published, but leaves most of the details up to the user. We hope that you'll enjoy the freedom!

Next, a short adventure from Gregory Lee. Some of you long time Travellers may recognize the name from *Lee's Guide to Interstellar Adventure, Volume 1*, published by Gamelords back in 1983. For those unfamiliar with the book, it was a series of 10 adventures connected only by the journal entries of one A.P. Lee, a retired admiral with a taste for travel and adventure. We've tried to maintain the flavor of that book in this adventure.

For those budding naval architects, we have Scott Olson's look at some of the secrets of **MegaTraveller** starship design. Scott has seen fit to shed some light on the process of designing ships and has even provided a few examples.

No **MegaTraveller** fanzine is complete without some artwork. Fortunately, we had room for one piece by Paul Sanders, one of the best artists for **MegaTraveller**, as well as a few pieces of computer generated art. There are also a few other small items to round out this issue. Enjoy!

If you have any comments or contributions please send them to:

**Imperial Lines** c/o GDW  
P.O. Box 1646  
Bloomington, IL 61702-1646

**Foreven Sector**

*Greg Videll and Mike Mikesh*

**Introduction**

Although settled for centuries, the Foreven Sector has had scant attention paid to it by the major states of the region—the Zhodani Consulate and the Third Imperium—except when their interests conflict. The Rebellion has changed all this. The Domain of Deneb finds its attention turning increasingly spinward; a fact not lost on the Zhodani. What the future will bring remains to be seen, but one fact is clear; Foreven will garner greater attention in the years to come.

Marc Miller has officially set Foreven Sector aside for **MegaTraveller** players and referees. All other sectors of charted space are subject to official development, particularly those included in the **Atlas of the Imperium**.

Foreven is the deliberate exception to this. The individual worlds and systems of the sector have an official location within the **MegaTraveller** universe but they will not be named or have a UWP. With only a few exceptions, mentioned below, this is left up to the referee to devise.

This article is intended to help referees integrate their personal version of Foreven into the existing framework of **MegaTraveller's** charted space.

**The Rebellion and Foreven**

The Domain of Deneb has been cut off from the rest of the Imperium. War, as a result of the Rebellion, has fragmented the interior of the Third Imperium and Vargr raiders have severed communications and trade lanes through Corridor. If Deneb is to survive, Archduke Norris must turn his attention from events trailing and focus on what lies spinward.

In the past, the systems spinward have followed their own path and maintained few ties to the Imperium, if any at all. Trade with the human client states has been modest and political interaction limited to the context of the Zhodani threat. The Imperium having been shattered, Norris seeks to change this.

Just as Cleon I did in the early years of the Imperium, Norris is sending his scouts beyond the frontier. Their mission is to assist those friendly to the Domain and develop new friendships.

The megacorporations strongly supported this effort. Cut off from their headquarters and principal markets in the interior, they too have begun to

expand spinward to avoid stagnation and collapse. Working from forward worlds in Foreven, their trade explorers range into the Far Frontiers and occasionally beyond.

Although many welcome the Imperials, others resist their arrival as an unwelcome intrusion. The most disturbed is the Zhodani Consulate. Having fought for centuries to check Imperial expansionism, the Imperium now threatens to sweep across its rimward frontier. Unfortunately, the Consulate's resources are needed elsewhere, so it must rely on its allies, like the Avalor Consulate, and its intelligence and frontier services, to deal with this crisis. The local provincial governor has recognized the need to bring in more capable people than those he has presently. His request for personnel is currently under consideration by higher powers.

**Referee's Notes**

**The Worlds of Foreven**

No official stats will be established for the systems of Foreven Sector. The only exceptions appear below. This gives the referee the freedom to develop the sector without fear of some **MegaTraveller** product will supersede it while at the

<i>Shiva</i>	<i>Lieber</i>	<i>Shial</i>	<i>Massina</i>
<i>Pieplow</i>	<i>Anika</i>	<i>Mowbrey</i>	<i>Fessor</i>
<i>Lassana</i>	<i>Titan</i>	<i>Xenough</i>	<i>Reidan</i>
<i>Rull</i>	<i>Harem</i>	<i>Piah</i>	<i>Urnian</i>

**Foreven: Subsector Key**

same time remaining a part of the official game setting.

In addition, Foreven is adjacent to the Spinward Marches, the principal sector of the **MegaTraveller** universe. A referee can draw upon this vast body of material, yet still have the option to jump next door and run highly personalized adventures and campaigns.

The basic "character" of Foreven is not much different from that of the Spinward Marches. Players will encounter the same alien races, such as the Droyne, Aslan, Vargr, and Chirpers. Many of the sector's corporations and trade lines do business there as well. The Marches provide a good source of inspiration for the referee wishing to flesh out the sector for a campaign.

At the same time, Foreven will be different from what players are used to. No longer are they within an environment they know all too well. This can lead to a host of exploratory adventures whether it be for mercantile, scientific or military purposes. There are also new races to contact and mysteries to solve.

**Existing Information**

The names of Foreven's subsectors are in the

Assigned UWPs					
Alenzar	3229	C000414-9	As Ni	513	Cs G0V
Raschev	3230	C8697C4-6		123	Cs M9V
Avalar	1636	A75599C-C	J Cp	904	Ac M0V
Zdovesil	1212	A65588A-9	Z Cp	103	Zh M9V M1D
Hollis	2523	A370642-C	A De Ni	303	Cs M3V

chart on the previous page. It should be noted that subsector names, as well as some planetary names, will vary depending upon who is referring to them. For example, a subsector or planet may have a local name, a Zhodani name and an Imperial name all at the same time.

Only Imperial designations appear in the chart above.

The Alenzar and Raschev systems of the Reidan Subsector appeared in **Double Adventure 5—Chamax Plague/Horde** (GDW 1981). Background information provided in these adventures can also help a referee new to Foreven to get a feel of things there. Their UWPs appear in the chart above.

Finally, because of their importance in the politics of Foreven, the UWPs for Avalar, the Zhodani provincial capital Zdovesil, and Hollis (a key Imperial client state), are also provided.

**Conclusion**

This article lays the groundwork for the development of adventures in Foreven. From here, it's up to the individual referee to decide the future of an entire sector.

# SUBSCRIPTION FORM

**Imperial Lines** is a Game Designers' Workshop quarterly newsletter. Subscriptions are \$8.00 a year (four issues) in the United States and Canada and \$12.00 overseas. Photocopies of this subscription form are accepted.

Name: \_\_\_\_\_

Address: \_\_\_\_\_

City: \_\_\_\_\_ State \_\_\_\_\_ Country \_\_\_\_\_

ZIP Code Code/Other \_\_\_\_\_

Send check or money order to  
**Imperial Lines** c/o GDW  
 P.O. Box 1646  
 Bloomington, IL  
 61702-1646

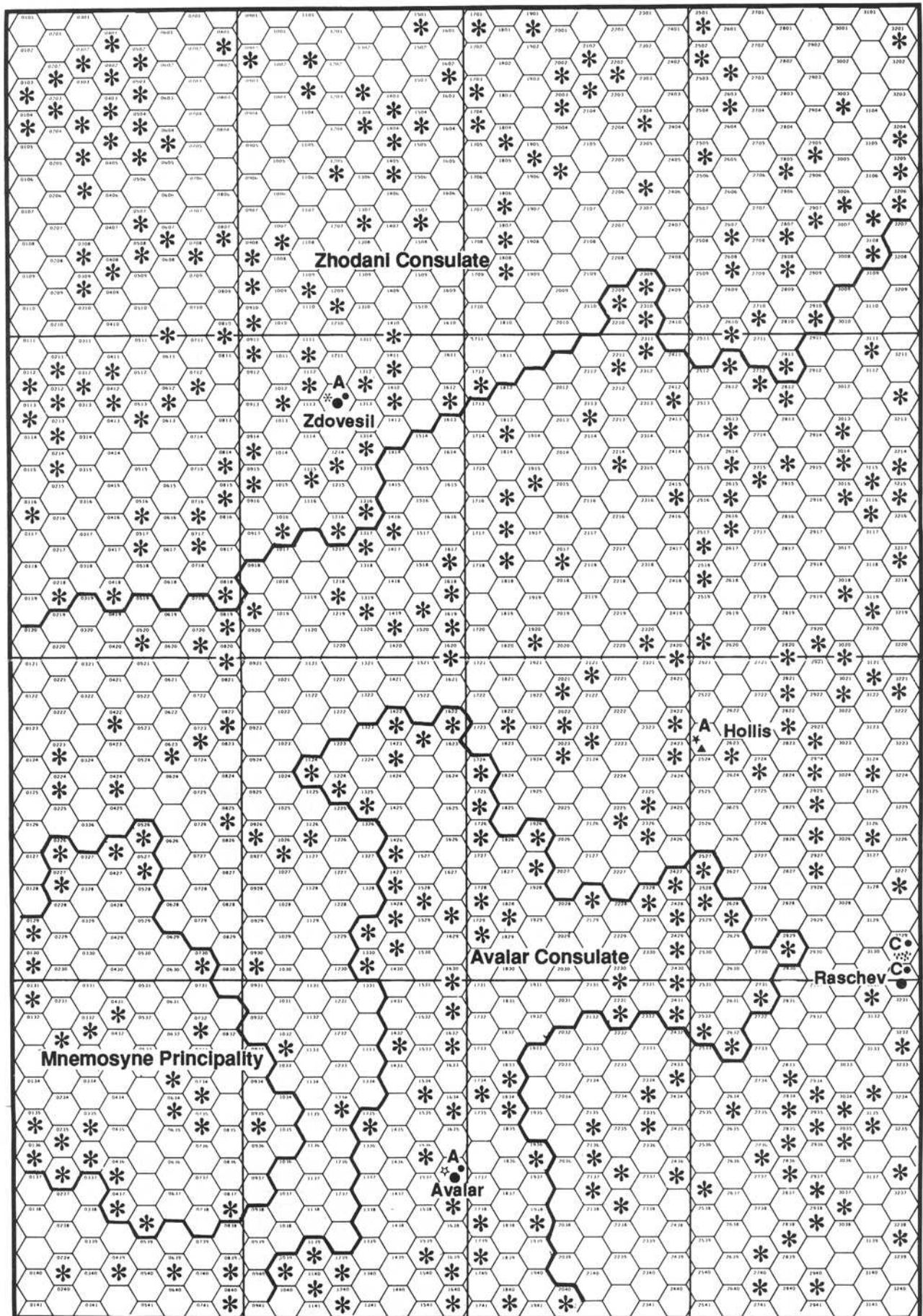

**Lottery Ticket**  
**A Lee's Guide Adventure**

Copyright ©1991 by Gregory P. Lee  
 With Grateful Acknowledgments to Mike Mikesh

**World Statistics: C544826-8**

Appropriate Settings in the Spinward Marches:  
 Riverland (1102), Forine (1533), Louzy (1604), Aki (2035),  
 Treece (2311), Heroni (2521)  
 Appropriate Settings in the Solomani Rim:  
 Porlock (0902), Lyonesse (2732), Cambyses (3108)  
 Acceptable UWP Code Ranges:  
 Port — B-D Atm — Any Pop — 8+ Law — 5-9  
 Size — Any Hyd — Any Gov — 2-6, 8-F Tech — 8-A  
 There are a wide variety of planets meeting the  
 minimal limits in the Imperium.

From the Journals of A.P. Lee—  
 "Lotto's tax system is ingenious. Instead of forcing  
 people to fork over their hard-earned wages, the gov-  
 ernment encourages them to bet. Everyone knows the  
 odds favor the house—that's why it's *gambling*. But  
 everyone wants a big hit, so they tax themselves—  
 sometimes far more heavily than the harshest govern-  
 ment could."

This world's government generates revenue solely  
 through lotteries. No one is required to purchase tickets  
 by *law* (i.e., written law), but every adult is expected to  
 buy at least one ticket per day. Those with higher social  
 standings and/or incomes are morally obligated to give  
 greater support to the state, and so they buy more  
 lottery tickets. Even visitors are expected to play.

**Heroes and Villains**

**Supplement 1—101 Characters** and **Supplement  
 4—Citizens of the Imperium** each included a collection of  
 fictional characters out of science fiction literature expressed  
 in Traveller terms. In that tradition, we included a set of new  
 characters. Their names are on page 6. Hint: the similarities  
 among the three are deliberate.

- 1 Merchant 8DCA63 Age 34 4 terms Cr some  
 Pilot-3, Ship Tactics-3, Laser Wpns-2, Navigation-1,  
 Gambling-1, Engineering-1, Turret Weapons-1,  
 Brawling-1, Grav Vehicle-0, Computer-0
- 2 Scientist 8DCBCA Age 34 4 terms Cr well off  
 History-2, Archaic Weapon-2, Revolver-1, Rifle-1,  
 Survival-1, Linguistics-1, Jack-o-T-1, Carousing-1,  
 Equestrian-0, Wheeled Vehicle-0
- 3 Law Enforcer 8DCAA9 Age 34 4 terms Cr enough  
 Auto Pistol-2, Streetwise-2, Tactics-1, Brawling-1,  
 Forensic-1, Legal-1, Computer-0, Wheeled Vehicle-0,  
 Grav Vehicle-0

Part of the local greeting custom is the friendly  
 display of a current ticket. Business people and govern-  
 ment officials usually carry their tickets in a pocket or a  
 pouch, but pull them out for display. Lower-level workers  
 and people in social situations often wear their tickets  
 clipped to their clothes, hats, or some other secure  
 place. Some even glue tickets to their face or other  
 exposed parts of skin as a form of jewelry.

Failure to somehow display a current ticket on first  
 meeting an associate or joining a social group may lead  
 to suspicion and abuse. Business deals and budding  
 loves have been known to collapse because one party  
 accidentally displayed an outdated ticket.

Basic tickets are made of plastic-coated paper.  
 Season tickets are made of plastic and can be purchased  
 for a minimum of 21 days and a maximum of 1 standard  
 Imperial year. One end of each ticket has a color-and-  
 number code; the other end has a tiny authenticating  
 memory device appropriate to the tech level. For a 1%  
 fee, vanity tickets can be purchased (showing the  
 buyers' name, an advertisement, the logo or name of a  
 favorite sports team, a statement of marital status, etc.).  
 Promoters often purchase these tickets in batches and  
 give them away.

Lottery tickets cost a single credit per day, and  
 drawings are held daily. A season ticket costs Cr 0.99  
 per day, prepaid.

The daily minimum jackpot is Cr 100,000. There is  
 only one winning ticket per jackpot. If no one wins on a  
 given day, the jackpot is carried over to the next. On any  
 given day, the jackpot is awarded on a roll of 12. The  
 government keeps the odds high in order to increase  
 the interest, and therefore the income.

The winning number is selected using a typical  
 mechanical random number generator involving ping-  
 pong balls blown through the air, dice loaded into a  
 machine, or any number of methods. Security is critical.  
 Game officials take precautions such as regularly  
 weighing, measuring, and changing the randomizers.  
 They maintain multiple sets of randomizers, only  
 choosing the set to be used minutes before the drawing.  
 The drawing is shown live on video; the video is re-  
 corded and analyzed for irregularities before the award  
 is certified.

Winners often wear their cancelled ticket as proof  
 of their good fortune. Winning tickets—even season or  
 yearly tickets—are often cast in lucite or similar mate-  
 rials and displayed on the mantel or the desk, both as



a boast and as proof that good citizenship is amply rewarded.

Of course, even benevolent systems of taxation entice some miscreants into tax evasion. Such miscreants often purchase counterfeit season tickets. The counterfeits usually sell for Cr 0.5 per day. Of course, any attempt to cash in using a counterfeit is illegal, and almost certain to be detected.

**Adventure Possibilities**

The players may come to this planet for any number of reasons. Their business should require extensive contact with the local populace, thus forcing the characters to purchase lottery tickets. Trade or an investigation of some type are both good scenarios.

Each player should be encouraged to buy at least one lottery ticket per day. Checking to see if a ticket has won is up to the individual referee.

NPC characters will also be buying tickets, but may be careless. Indeed, a particularly unconcerned NPC may tend to tear each ticket in half and throw it into the garbage at the end of each day.

Several options can be played out.

A. After an extended dry spell (30 + 2D6 days without a winner), a character wins. Unfortunately, the character has torn the ticket and thrown it toward the ship's disposal slot. Half is on the floor, the other half (with the verification stub) is on its way to the central disposal tanks. The characters must locate it in their ship's plumbing, an unpleasant task at best. A local plumbing firm can be engaged; its employees, however, try to cheat the players out of their ticket. The media has a field day if the situation becomes known, and most of the lottery officials at first refuse the ticket when it is presented.

B. A character wins. Near the lottery office (off-port), the players are attacked by appropriately armed

bandits. If the bandits obtain the ticket, the characters are most to likely pursue (no character will roll over for a multi-million credit loss). If the players are unsuccessful in retrieving the ticket, they can waylay anyone who later attempts to present the ticket. Legal action is also possible, but the players face the prejudice of local courts against off-worlders.

C. Either A or B above, but the ticket is, in fact, a clever forgery. This is determined at the lottery office (if the players ever get there with the ticket).

D. As in C, but the players are given the prize money. The forgery is initially convincing because it was prepared by a lottery employee with access to the printing and verification systems. Within seven days, however, the owner of the genuine winning ticket comes forward. The lottery officials discover their mistake, and demand the return of the money. If the players have already left the planet, they are branded thieves, accused of subverting the forging lottery employee, and pursued with appropriate warrants.

E. The players are hired to break the lottery system and defraud it. This is especially feasible if the local TL is below 10, and the players have equipment of TL 14 or above. The players may also choose to attempt such a fraud themselves.

F. The players are hired to investigate a fraud on the lottery system.

If the characters win, they are the targets of pleas and demands for money for so long as they are thought to be the winners. These demands will range from the ludicrous to the pitiable; some (especially the most compelling) could well be confidence jobs. The players face conflict, even physical attack, at any hint that they intend to take their money off-world (bad citizenship).

If they are caught stealing, they will be vilified and pursued. If they are investigating a theft, they will find help in unexpected places.

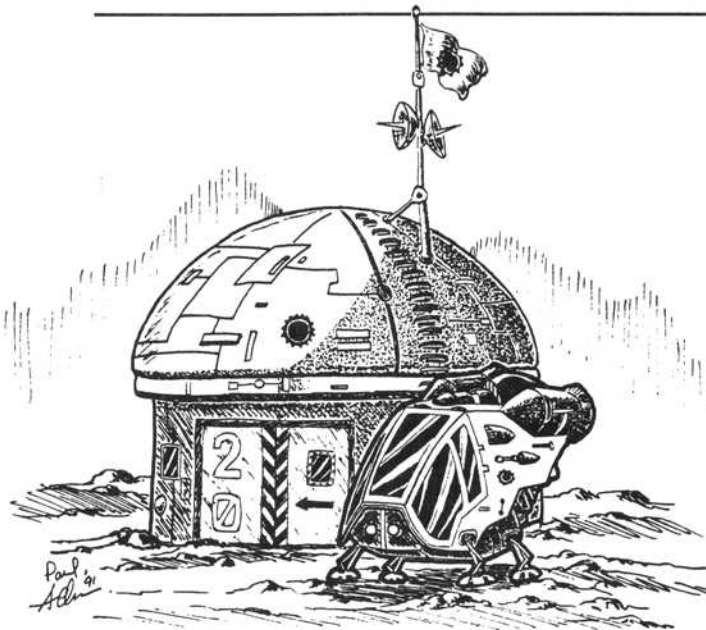

**Heroes and Villains — Answers**

1. Han Solo from *Star Wars*.
2. Indiana Jones from *Raiders of the Lost Ark*.
3. Deckard from *Blade Runner*.

**MegaTraveller Starship Design:  
Tricks of the Trade**

Scott Olson

When designing MT starships, especially warships, something that will become immediately obvious is that power plant fuel requirements can get completely out of control. A design that under **High Guard** would be quite reasonable, with a high-G maneuver drive, agility, and some energy-based weapons, is completely impossible under the rules if the obvious route is taken and the standard 30 days worth of power plant fuel is provided. The effects on designs is graphically illustrated by the ships in **Fighting Ships of the Shattered Imperium**, where there aren't any ships with both a high-G maneuver drive and a high agility, and often the ships have neither. Even on merchant vessels, large amounts of space are consumed by power plant fuel, more so than would be the case under **High Guard**. Power plant fuel

**Test-1 Free Trader**

CraftID: Free Trader, Type AF1, TL13, MCr78.326  
 Hull: 180/450, Disp=200, Config=4SL, Armor=40F, Unloaded=1590 tons, Loaded=2353 tons  
 Power: 8/16, Fusion=990Mw, Duration=30/90  
 Loco: 4/8, Maneuver=1, 6/12, Jump=2, NOE=170kph, Cruise=750kph, Top=1000kph, Agility=0  
 Commo: Radio=Systemx3, Laser=Systemx3  
 Sensors: ActiveEMS=FarOrbit, PassiveEMS=InterStellar, Densitometer=LoPen(50m), Nuetrino=100Kw, ActObjScan=Rout, ActObjPin=Rout, PasObjScan=Diff, PasObjPin=Diff, PasEngScan=Rout, PasEngPin=Rout  
 Off: PulseLaser=xx2, Missiles=x02  

2	2
2	2

36 missiles are carried for each missile launcher  
 Def: DefDM=+4, Sandcaster=xx3  

2
2

 Control: Computer=3x3, Panel=HoloDynamicLinkx82, Special=HeadUp HoloDisplay, Environ=basic env, basic ls, extend ls, grav plates, inertial comp  
 Accom: Crew=2x2 (Pilot, Engineer, Gunner, Steward), Staterooms=12, HighPsg=8, SubCraft= 6 ton vehicle bay  
 Other: Cargo=707Kliters, Fuel=801Kliters, Fuel Scoops, Fuel Refiners (24 hrs), ObjSize=Average, EMLevel=Faint

This is example design #1, built using the standard rules without any special tricks.

is now often the primary space consumer on starship designs, replacing jump fuel.

However, there are ways, that are within the rules, and approved by DGP's Joe Fugate, to fix these problems and to maximize space for more productive purposes (carrying cargo, weapons, troops, craft, etc.).

The first and most important method involves the use of the powering down rule from p. 95 of the **Referee's Manual**. The designer determines how large a power plant is needed to run the ship with all systems active, and its fuel requirements per hour are determined. This power plant is installed. Now, the designer determines how much power is needed for operations during Jump (basically life support functions and control systems),

**Test-2 Free Trader**

CraftID: Free Trader, Type AF2, TL13, MCr78.326  
 Hull: 180/450, Disp=200, Config=4SL, Armor=40F, Unloaded=1605 tons, Loaded=2591 tons  
 Power: 8/16, Fusion=990Mw, Jump Duration=8/24 (no maneuver, weapons, or sensors), Cruise Duration=21/63 (no weapons), Combat Duration=1/3  
 Loco: 4/8, Maneuver=1, 6/12, Jump=2, NOE=170kph, Cruise=750kph, Top=1000kph, Agility=0  
 Commo: Radio=Systemx3, Laser=Systemx3  
 Sensors: ActiveEMS=FarOrbit, PassiveEMS=InterStellar, Densitometer=LoPen(50m), Nuetrino=100Kw, ActObjScan=Rout, ActObjPin=Rout, PasObjScan=Diff, PasObjPin=Diff, PasEngScan=Rout, PasEngPin=Rout  
 Off: PulseLaser=xx2, Missiles=x02  

2	2
2	2

36 missiles are carried for each missile launcher  
 Def: DefDM=+4, Sandcaster=xx3  

2
2

 Control: Computer=3x3, Panel=HoloDynamicLinkx82, Special=HeadUp HoloDisplay, Environ=basic env, basic ls, extend ls, grav plates, inertial comp  
 Accom: Crew=2x2 (Pilot, Engineer, Gunner, Steward), Staterooms=12, HighPsg=8, SubCraft= 6 ton vehicle bay  
 Other: Cargo=947Kliters, Fuel=553Kliters, Fuel Scoops, Fuel Refiners (15 hrs), ObjSize=Average, EMLevel=Faint

This is example design #2, built using the powering down rules to create two booster plants, one for normal maneuvering, and one for combat operations.



and the fuel consumption per hour for this amount of power. Finally, the power and fuel requirements for noncombat operations may be calculated, if applicable. The amount of fuel carried for the power plant is the amount of time the designer wants to be able to operate in each mode. If the design is to be capable of eight days in Jump (a small safety margin is included here), 12 days of normal in-system maneuver, and eight hours of combat, these requirements determine the amount of fuel carried.

Savings from this trick can be very important to a design. For example, it's often the case that the jump fuel allotment (for 7-8 days) is about the same as a single day's operations in a noncombat mode. If true in your case, you have just saved 6-7 days fuel space for some other purpose (or you can carry extra fuel to increase your endurance).

Another trick is to not include fuel tankage in the calculations for life-support systems. After all, your

Test-3 Free Trader

CraftID: Free Trader, Type AF3, TL13, MCr76.7333  
Hull: 180/450, Disp=200, Config=4SL, Armor=40F, Unloaded=1562 tons, Loaded=2360 tons  
Power: 8/16, Fusion=990Mw, Duration=30/90  
Loco: 4/8, Manuever=1, 6/12, Jump=2, NOE=170kph, Cruise=750kph, Top=1000kph, Agility=0  
Commo: Radio=Systemx3, Laser=Systemx3  
Sensors: ActiveEMS=FarOrbit, PassiveEMS=InterStellar, Densitometer=LoPen(50m), Nuetrino=100Kw ActObjScan=Rout, ActObjPin=Rout, PasObjScan=Diff, PasObjPin=Diff, PasEngScan=Rout, PasEngPin=Rout  
Off: PulseLaser=xx2, Missiles=x02  
2 2  
2 2  
36 missiles are carried for each missile launcher  
Def: DefDM=+4, Sandcaster=xx3  
2  
2  
Control: Computer=3x3, Panel=HoloDynamicLinkx82, Special=HeadUp HoloDisplay Environ=basic env, basic ls, extend ls, grav plates, inertial comp  
Accomm: Crew=2x2 (Pilot, Engineer, Gunner, Steward) Staterooms=12 HighPsg=8 SubCraft=6 ton vehicle bay  
Other: Cargo=743Kliters, Fuel=779Kliters Fuel Scoops, Fuel Refiners (24 hrs) ObjSize=Average, EMLevel=Faint

This is example design #3, built with no life support systems in the fuel tanks.

fuel tanks don't need life support. This will save space in two ways: the space normally used by the life support gear and the power plant and fuel that are not needed because this amount of saved life support systems were not installed. Generally, the savings from this method are not extremely large, but they can be useful.

A set of four ships that exemplify the benefits gained by using these tricks appear below. The first is a standard design, the others display the benefits you can gain from each approach and the last uses all of the shortcuts.

Test-4 Free Trader

CraftID: Free Trader, Type AF4, TL13, MCr78.04911  
Hull: 180/450, Disp=200, Config=4SL, Armor=40F, Unloaded=1639 tons, Loaded=2630 tons  
Power: 8/16, Fusion=990Mw, Jump Duration=8/24 (no manuever, weapons or sensors) Cruise Duration=21/63 (no weapons) Combat Duration=1/3  
Loco: 4/8, Manuever=1, 6/12, Jump=2, NOE=170kph, Cruise=750kph, Top=1000kph, Agility=0  
Commo: Radio=Systemx3, Laser=Systemx3  
Sensors: ActiveEMS=FarOrbit, PassiveEMS=InterStellar, Densitometer=LoPen(50m), Nuetrino=100Kw ActObjScan=Rout, ActObjPin=Rout, PasObjScan=Diff, PasObjPin=Diff, PasEngScan=Rout, PasEngPin=Rout  
Off: PulseLaser=xx2, Missiles=x02  
2 2  
2 2  
36 missiles are carried for each missile launcher  
Def: DefDM=+4, Sandcaster=xx3  
2  
2  
Control: Computer=3x3, Panel=HoloDynamicLinkx81, Special=HeadUp HoloDisplay Environ=basic env, basic ls, extend ls, grav plates, inertial comp  
Accomm: Crew=2x2 (Pilot, Engineer, Gunner, Steward) Staterooms=12 HighPsg=8 SubCraft=6 ton vehicle bay  
Other: Cargo=952Kliters, Fuel=541Kliters Fuel Scoops, Fuel Refiners (12 hrs) ObjSize=Average, EMLevel=Faint

This is example design #4, built using the powering down rules to create two booster plants, one for normal maneuvering, and one for combat operations. In addition, the fuel tanks do not have any life support equipment.

# ASSIGNMENT: VIGILANTE™

Charles E. Gannon



*Design:* Charles E. Gannon and Dave Nilsen  
*Development:* Dave Nilsen and Nick Atlas  
*Art Direction:* Steve Bryant and LaMont Fullerton  
*Cover:* Blair Reynolds (pencils and inks), Steve Bryant (colors)  
*Deckplans:* Rick Boquist (design), LaMont Fullerton (colors)  
*Color Illustrations:* LaMont Fullerton, Rick Harris  
*Graphic Production:* Amy Doubet, Rob Lazzaretti  
*Typesetting:* Steve Maggi  
*Proofreading:* Michelle Sturgeon and Steve Maggi  
*Bagpipes:* Royal Scots Dragoon Guards, King's Own Scottish Borderers,  
Gordon Highlanders, Queen's Own Highlanders, The Black Watch



Looking back on it, you can still remember when you changed your mind. Sure they were desperate, but who wasn't anymore? If you let your heart break every time somebody else told you how hard times had become, you'd've been dead a long time ago, trying to save an empire hell-bent on destroying itself.

When you arrived at the Portmasters office the scene was chaos. Outside the panoramic window you could see the wands of smoke still rising from the starport flightline. One of them was from the maintenance van that had been parked right next to your ship. Lucky for you, unlucky for them. Why the raiders had strafed the port was still anyone's guess, but if they had hoped to hit every operable starship in the port, they blew it. They missed yours.

When the Portmaster turned to face you, you could tell that she hadn't slept much lately. She told you about the raids, and about how the merchant traffic was drying up because of the danger, and about what would happen if their trade got completely cut off. Already, she said, their schools and medical facilities had closed as the talented personnel needed to run them fled to safer worlds. You kept your eyes focused on a point a few inches above her head, thinking a few times about how you might finish one of her sentences for her. Somewhere in there she must have asked for your help, but you weren't really paying attention. Suddenly there was a crash as a small boy knocked over a stack of documents to rush to the side of the Portmaster, his mother. He wanted to know if she could come help him fix some thing or another. But that's not what got you. You never were a sucker for domestic scenes.

As she apologized for the interruption she smiled self-consciously. That's when it happened. It was such a small thing, but then so's everything, eventually. When she smiled, you caught a brief glimpse of her teeth and it hit you that there really weren't any doctors or dentists here anymore. Here she was, in charge of a starport, overseeing the maintenance and repair of starships, and her teeth made you think of those people on those tech 1 worlds it used to be quaint to visit. The people that you used to give those trinkets to, and they'd smile those awful little smiles and you'd think how great it was that you never had to worry about living like that. The image you suddenly had of a hollow civilization crumbling in on itself was hard to shake.

You had a knot in your stomach all the long walk back to your ship. You hadn't noticed it before, but now it hit you how shabby the buildings looked. As you walked up the ramp and down the accessway to the bridge you were flipping all the power-up switches, transferring to internal systems. The comforting rising whine that accompanied your actions told you that the repaired fusion core was in good shape. When you stepped through the security hatch to the bridge, you flicked your eyes across the power telltales to see the green columns surging up to standby levels. Your crews' faces were turned toward you.

"We're taking a job."

## Contents

Referee's Introduction .....	3	Once More Unto the Breach, Dear Friends .....	8
Adventure Background .....	4	Further Adventures Aboard <i>Vigilante</i> .....	10
The Sittahr System .....	5	Promise Subsector 001-1129 .....	11
Getting to the Research Station .....	5	Administering UWP Changes .....	11
Entering the Station .....	5	Library Data .....	11
<i>Imperial Research Station Gamma</i> .....	5	Aboard <i>Vigilante</i> .....	12
Research Station and Pirate Base Floorplans ....	6	<i>Vigilante's</i> Crew .....	12
Inside the Station .....	7	<i>Vigilante</i> Systems and Operations .....	12
Arrival: <i>Vigilante</i> .....	8	Ships Used in These Adventures .....	14
Gamble at Gorky .....	8	Promise Subsector 001-1121 .....	16

Assignment : *Vigilante*

Copyright©1992 GDW, Inc.

All rights reserved. Printed in U.S.A. Made in U.S.A.

No part of this book may be reproduced in any form or by any means without permission in writing from the publisher. Permission is hereby granted to photocopy certain portions of the text as indicated in the text for personal use only.

ISBN 1-55878-127-7

**Traveller**® is GDW's registered trademark for its science-fiction roleplaying game system. **MegaTraveller**™ and the **Shattered Imperium**™ are trademarks of GDW.



# ASSIGNMENT: VIGILANTE



**Assignment:** *Vigilante* functions as both a **Mega Traveller** adventure and a minisourcebook for adventuring in the Diaspora Sector during the Hard Times era. Referees can use **Assignment: Vigilante** to start a new campaign set in the Diaspora Sector, continue a campaign begun in the **Hard Times** sourcebook, or continue a campaign that has recently moved to Diaspora.

As a minisourcebook, **A:V** presents further UWP data, both pre- and post-Hard Times, which expands on the subsector data that appears in **Hard Times**. With **Hard Times** and this folio, referees will now have subsector data for three-fourths of the trailing edge of the Diaspora Sector.

Of more interest to campaigns not set in Diaspora is the starship information presented here. Not only is there UCP data for seven new starships, spaceships and fighters, but the deckplans and expanded description of the *Admiral Bertil/Vigilante*-class allow referees to introduce a new ship design that will be of great interest to players. With its ship's troops, fighter and ship-to-ship combat capability, the *Vigilante* design allows a wide variety of PC crew positions. Two ways to fit such a ship into a campaign include allowing the PCs to sign on as crew of a starmerc ship of the *Vigilante*-class, or work to neutralize a viking band using a *Vigilante*-class ship. If the PCs succeed in boarding and capturing the ship, they may be able to press it into service as their own. Referees who own **Hard Times** are encouraged to use the starmerc unit generation rules to create a starmerc unit as a campaign framework, and a *Bertil/Vigilante*-class ship can be substituted for a result of 2, 3, 11 or 12 on the Ship Types Table.

## REFEREE'S INTRODUCTION

**Assignment:** *Vigilante* is set in the Hard Times era, which started at the end of 1124 and runs until the early 1130s. Possession of the **Hard Times** sourcebook is not required for play of this folio, but familiarity with the concepts introduced in that book will certainly enhance play.

The environment of the Imperium has changed forever following the onset of Hard Times. The wholesale destruction of the Rebellion struck at the heart of Imperial society—the trade between its 11,000 worlds. With the gradual destruction of starports and merchant shipping, the ability to move goods from system to system deteriorated. The result was the inability of worlds to maintain their technology levels without specialized imports, and the rapid growth of unemployment as the inability to export goods led to the closing of industries. Worlds that required technological means to maintain livable environments began to find their futures uncertain. Subsectors once familiar to interstellar travellers are now becoming unrecognizable as starports deteriorate, technology recedes, populations decline and, in the face of this, governments and law levels become more insular and draconian.

Such is the state of the Promise Subsector in late 1128 when **Assignment: Vigilante** is set. During play of these adventures or any campaign in this period, players are only allowed to consult the 1121 UWP data presented on page 16. Any information the PCs desire on current conditions must be gained the hard way, by visiting the worlds and finding out for themselves. This reflects the sensation that should characterize this period for the PCs—feeling like strangers in a place that should be familiar.

The first adventure takes the PCs to the derelict Imperial research station in the Sittahr system to salvage urgently needed electronic equipment. There they are set upon by pirates who had been trailing them. But when things look bleak, the tide of battle turns as an unknown force enters the battle on the PCs' side.

In the battle's aftermath, the PCs learn that their beneficiaries are the starmercs of the mercenary starship *Vigilante*, a group of pirate hunters

fairly well-known in the trailing end of the Diaspora Sector. The PCs also learn that the pirates are on the move in a crucial system, and they are asked to join *Vigilante's* crew for the upcoming operation.

The second adventure takes the group to the Gorky system. Here they defend the system's last chance for livelihood against a plot to prevent civilized forces from expanding their protection to undefended worlds. If they win, they will have bought at least a little more time for tens of thousands of people. If they lose, the next Long Night will be that much closer.

## Beginning Play

**Assignment:** *Vigilante* can be played as the opening adventure of a new campaign set in Hard Times-era Diaspora, as a continuation of a campaign conducted with the **Hard Times** sourcebook (either begun there or transferred to that era), or as a continuation of a campaign that has yet to be transferred to the Hard Times era.

**New Campaign:** Players should generate characters using Sittahr as their homeworld. With the referee's permission, another homeworld in the Promise Subsector may be chosen instead. Either way, the 1121 UWP is used for character generation effects.

All careers are open, although the Scout, Merchant, Navy and Pirate careers will require the referee to work more closely with the character generation procedure. In the case of the first three, this results from the loss of positions in these professions over the course of the Hard Times. The gradual reduction in numbers of serviceable ships results in the characters being placed, out of work, on Sittahr. It is strongly recommended that characters mustering out of these three services with four or fewer terms run one additional term in the Army, Marine, Belter, Law Enforcement, Flyer or Sailor careers to simulate their activities after returning to Sittahr.

Pirate careers will require the referee and player to cooperate on establishing how a pirate character ends up involved in an anti-piracy campaign. Perhaps the character was a privateer operating against invading Solomani forces, or was a pirate operating nearby who has turned away from that former life. In the latter case, the referee may rule that the character has some inside or personal knowledge of pirate operations that will come in handy in the coming adventures. However, care should be exercised that this does not unreasonably skew the adventure.

In all cases, the referee should see that all characters receive at least a small number of space skills. The least intrusive way to do this is by counseling in the choice of cascade skills (see **New Gunslingers** on page 8 for useful abilities to suggest).

**Continuing a Hard Times-era Campaign:** This is a simple transition to make. At the end of **Hard Times**, the PCs have just completed the climactic battle against Indro the Lightless at Shareduu (2609/Khavle Subsector). If they have their own ship, the PCs might be encouraged to head down toward Promise by rumors of one of the few remaining good trade routes. If not, perhaps their contacts at Hortalez et Cie might offer them work on an expedition to rimward to see how far Indro's forces have advanced.

**Transplanting a non-Hard Times-era Campaign:** This is the most difficult course, as referees must either finagle their groups across the Imperium to Diaspora and find a way to turn the clock forward to 1128, or else adapt the **Assignment: Vigilante** adventures to their existing campaign locales. Possibilities include the PCs being captured and placed in low berths, to awaken in Promise when their captors' ship is itself captured, being pursued by factional forces due to some real or imagined transgression, or having to go to Promise to settle family business involving the inheritance of money, land, or a ship.

**Local Knowledge:** For either of the two previously existing

campaigns mentioned above, the PCs have access to only the 1121 Promise UWPs (page 16) until they visit those worlds and learn more for themselves. Each character generated on Sittahr will know the Sittahr stats and will also know the current (1129) stats for 1D–2 worlds of the Promise Subsector, chosen randomly.

## ADVENTURE BACKGROUND

The PCs begin on Sittahr (3129/Promise). Sittahr is a fortunate world by most standards. With a diameter of 11,080 km, a standard atmosphere, a base mean surface temperature of 15°C and plenty of water, the world is about as hospitable to human life as any world could be. However, more than the simple lack of active resistance by the environment is necessary to sustain an established society. Sittahr was settled and grew within the context of an interstellar economy. As a nonindustrial world, it could not meet all the manufacturing needs of its society. But as an agricultural world, it could trade its food surplus to nonagricultural worlds to meet its manufacturing shortfalls.

The loss of trade in Hard Times changed all that. Necessary items—from spare parts to keep agricultural equipment running, to educational items for schools, to basic chemicals for medicines—were no longer available, nor was the specialized production know-how readily available on Sittahr. Sittahr began a gradual slide down the technological ladder to its current position at TL8, and it is expected to slide farther unless the situation can be stabilized. Unfortunately, the growth of piracy in the Diaspora Sector in the past few years is aggravating the already bad situation, causing a flight of the most talented professionals to the safer worlds of the independent polities (such as the Unity of Promise three parsecs core-spinward) and away from the exposed worlds that need them the most.

Sittahr's leadership has calculated that interstellar trade has fallen off 30% in the past year alone, down to 18% of pre-Rebellion levels. There are no longer any merchant ships registered out of Sittahr, all having fled to safer worlds or been destroyed. Sittahr was never large enough for a planetary navy; now each additional pirate attack in the system makes Sittahr more of an unacceptable risk to the dwindling number of merchant ships. Healthcare planet-wide is reaching dangerously low levels as the local pathogens once held in check by imported high-tech pharmaceuticals gain the upper hand.

The decision has been made to stabilize, then reestablish Sittahr's trade position by creating an effective antipirate defense around the planet. Since its vast oceans allow cheap electrolytic fuel refining on Sittahr's surface, gas giant refuelling becomes unnecessary, allowing visiting traders to jump from 100 diameters off Sittahr rather than having to venture through the outer system. The first necessary step is an orbital defense and early warning network. As a TL13 agricultural world, Sittahr possessed an extensive system of weather satellites, and most of these are still in repairable condition. The sensors on these satellites can be converted to form the basis of an outward-looking network, using parts scavenged from the former class-C starport. However, what is missing is a sophisticated, high-speed command and control system to rapidly coordinate the sensors, along with a neutrino sensor and a high-penetration densitometer. It is known that just such systems were installed in the Imperial research station formerly located in Sittahr's outer system (see page 5). Due to Sittahr's almost complete lack of hard currency, it cannot hire out for this job, but must find a homegrown way to pull itself up by its bootstraps, as it were.

It is the PCs' job, using the world's last repairable spaceship, to recover that equipment.

## The Job

The PCs are to travel to Imperial Research Station Gamma, located on one of Hamlet's moons. Here they are to explore the station and discover whether the station's neutrino sensor (0.2 kl, 0.095 tons), high-penetration densitometer (7 kl, 1.5 tons), and sensors central control

core (12 kl, 3 tons) are still intact. If this is the case, they are to carefully remove these items and bring them back to Sittahr, where they will be repaired for use there. Electronics, Engineering, Sensors and Computer skills are relevant to these operations.

## Taking the Job

For campaigns beginning with **Assignment: Vigilante**, this part is easy. The PCs already have the job. Since the sensor net project was established six months ago, the population of Sittahr has been canvassed for volunteers, who were then screened and tested for suitability. The PC group is the team that was chosen (this is why space skills were specified on page 3). Their payment for the assignment is free training, plus food and housing for them and their families. They are also rewarded with the status of hero—the public response to the recruiting for this mission was overwhelming, and the PCs are regarded planet-wide as the people's champions. Their folk hero status is confirmed by the fact that wherever they go, they are unable to pay for food, drinks and lodging, as so many citizens compete for this honor. In any case, the motivating force is civic duty, not financial reward.

The PCs' ship is the *Yorick*, part of the Sittahr system's old tourist trade. *Yorick* is a former Type A free trader with its jump drive and jump fuel tankage removed to make room for 2G drives and more passenger and observation lounge space. *Yorick* served as a tour boat that took 52 passengers at a time out on a pleasant, 10-day trip to view Hamlet's surface and take a short tour of the research station. Although lying derelict at the starport for years, she has been refurbished, and the PC group can conduct familiarization "hops" aboard the ship as part of her shakedown, carrying technicians to the former weather satellites to perform the necessary modifications. For purposes of sensors and communications systems, *Yorick* should be treated as a standard *Beowulf*-class Type A free trader. She is, however, unarmed.

**Transplanted PC Groups Owning a Starship:** In the case of a pre-existing campaign, there is no homegrown capability to attempt the salvage mission at the research station. All serviceable ships either have departed to safer areas or have been destroyed in recent pirate raids. Upon arriving at Sittahr, the PCs will be asked to take the job.

Sittahr will not be able to offer payment in hard currency. What the government can offer is free refined fuel, repairs and maintenance for their ship (within the ability of Sittahr's starport) in perpetuity. If the PCs press, Sittahr can additionally offer what is, in effect, the Hard Times equivalent of a subsidized trade route contract. If they agree to operate a trade route between Sittahr and Gorky, Davao, Nysorb and Cosenza, carrying Sittahr's agricultural products and returning with the exchanged goods, the PCs will be allowed to keep, for their own use or for speculative trade, a volume of agricultural goods equal to 5% of their cargo space per trip.

PCs with their own interstellar mobility may not see the value in getting involved with this job and might rather simply jump to another system. This is a danger in the Hard Times era, due to the decreasing level of rewards available in this harsh environment. The prologue on page 2 presents one example of how a PC group might respond sympathetically to the job offer, although some may not wish to. The temptation to use a stick to coerce the PCs to take the job is discussed below, and only referees can make final decisions about the balance of sticks and carrots in their campaigns. However, sticks cannot work indefinitely, and the very nature of the Hard Times framework dictates that PCs will have to get used to accepting less elaborate *material* compensation.

*Moral* compensation, on the other hand, is another issue altogether. The optional bad karma rule in **Hard Times** is one example of a stick that referees can begin using as a carrot, which is to say that player groups that consistently behave in a helpful and sympathetic manner will find that some things begin to get easier for them. This is because surviving governments, merchants and private citizens know the importance of cooperation for mutual

survival. Once the PCs gain a reputation in a subsector for helping out when things are tough, they should gain positive DMs on reaction rolls with the "forces of civilization." For example, they might get discounts on routine maintenance, repairs and refined fuel from local worlds, and starmerc groups and remaining planetary navies will often provide assistance in combat, or in the form of information or emergency repairs.

Player groups with a bent toward empire building will also find this useful, as their counsel or assistance may be sought by planetary governments, and they may be able to gain positions of political or military leadership among the small independent polities.

On occasion, referees may still wish for means to bring PCs to a point where they do not wish to go. One possible solution to this is another of the crucial details of the Hard Times environment, which is the attention to starship systems and maintenance, specifically the new difficulty in obtaining it (See *Hard Times* Chapter 5 or *Imperial Encyclopedia*, page 92). Given the current scarcity of high-quality starports, it is more difficult to obtain refined fuel, and misjumps are therefore more common. A misjump to Sittahr could take place from anywhere in the Promise Subsector. It is also likely that the PCs' ship will be overdue for proper maintenance, and certain systems may be functioning erratically. The failure of a crucial system while in the Sittahr system will allow the Sittahr authorities to exchange the PCs' services for the required repairs. Or the technicians might remove a crucial jump-drive component which will not be returned until the PCs complete the mission. In either case, the residents of Sittahr will fulfill their part of the bargain quickly and fully and, in the latter case, with an apology and perhaps some bonus to compensate for the devious tactic. The PCs should see that the people of Sittahr are not untrustworthy. Rather, they are simply very serious about their need for assistance.

## THE SITTAHR SYSTEM

The Sittahr system consists of a K0 V primary, its companion, an M3 dwarf in the 12th orbit, and six worlds in orbits 0-6 (orbit 1 is vacant). Sittahr occupies orbit 0; orbit 2 contains an airless rock; and 3 through 5 contain gas giants, often used for refuelling by starships passing through the system without paying a call at Sittahr. Hamlet is in orbit 6.

The system retains a slightly higher density of interstellar gas and dust than usual, presumably left over from Hamlet's evolution, but most of this was blasted away during Hamlet's T Tauri stage. It has been suggested that the system was a pre-existing stable system which passed into an interstellar gas and dust cloud—it was this added mass that pushed Hamlet across the boundary into protostar development—but then the process just as abruptly stopped. The "why" is still an open question.

## GETTING TO THE RESEARCH STATION

Sittahr is currently 748 million km from Hamlet, its closest annual approach. One-way travel time at full maneuver (constant acceleration to turn-over at midpoint, followed by constant deceleration) is 152 hours at 1G, 107 at 2G, 88 at 3G, 76 at 4G, 68 at 5G, and 62 at 6G.

Rosencrantz is fairly close to Hamlet and will be easy to locate upon arrival in the area. The PCs have accurate maps which show the station's precise location on the surface.

Rosencrantz is quite tectonically active, and its thin tainted atmosphere carries large quantities of sulfur compounds from the numerous volcanoes that cover the surface. Because of these particulate compounds, which endlessly settle out in heavy layers, Imperial Research Station Gamma was built with a large, enclosed, garage-style landing area for *Yorick* and other visiting vessels. This prevents the accumulation of damaging deposits of the quite corrosive sulfur compounds onto ships during their stay. The PCs have been strongly advised to use this facility to park their vessel, not only to protect it from the fallout, but also because an orbiting vessel will be more readily observable by pirates.

Upon arriving at the station, the PCs will see that quite a lot of sulfurous ash has drifted over the surface features of the station (including the

head of the surface access trunk) and across the entrance to the garage. However, the designers allowed for this eventuality by making the entry tunnel to the garage unusually high and broad, and by placing another entrance within the garage itself. There is ample room for the PCs to maneuver their ship into the shelter. They will note the absence of the base's 50-ton modular cutter, used for maintenance of the orbital sensor arrays (this was taken by the raiders in the 1121 raid; see Inside the Station, page 7).

## ENTERING THE STATION

Entry to the station proper is a short walk down the access corridor (see map, page 6) which ends at a standard airlock once controlled by an electronic panel responding to magnetic ID cards or keyed commands. However, the panel has been damaged by gunfire, with several access panels removed to expose the wiring. PCs with Electronics-1 or greater will immediately recognize that the mechanism had been overridden with an electronic tool kit. Such a kit is available aboard the PCs' ship.

To open an electronic airlock without authorization:  
Formidable, Electronics, Computer, 30 seconds.  
*Referee:* Task is Routine with an electronic tool kit.

Once the PCs have entered the airlock there are no further barriers to entry, although the airlock controls indicate that the atmosphere within the station is at a pressure of only 0.2 standard atmospheres.

## IMPERIAL RESEARCH STATION GAMMA

This is one of the smallest scientific sites ever given the title "Imperial research station." It is more properly thought of as an observation station, as only data collection, rather than basic research, takes place here. The third of Diaspora's four Imperial research stations (Alpha at Quarry/2933, Beta at St. James/1521 and Delta at Moncton/2125), Gamma was tasked with the observation of Hamlet, the anomalous gas giant in orbit 6 of Sittahr's K0 V primary.

Although it had been identified during the time of the First Imperium as a T Tauri protostar, the aptly named body has refused to behave as expected and continue the process of developing into a full-fledged star. The violent outgassing observed by the Vilani scientists which should have immediately preceded fusion ignition is evidenced by the Herbig-Haro objects near the Sittahr system. Yet Hamlet drew back from the threshold of stellar birth to its current over-large brown dwarf state, apparently deciding "not to be." Still massing some 0.08 solar masses, Hamlet appears to have attained at least a temporary equilibrium between its internal heat pressure and its gravitational collapse, previously thought impossible for a body this size. In fact, its diameter fluctuates rather wildly, indicating that this equilibrium may be quite fragile.

Hamlet was once considered one of the wonders of the Diaspora Sector. Aside from its scientific rarity, it was popular as a tourist attraction. Its constantly changing, violent atmosphere glowed with a stunning variety of light and color, and occasionally spewed forth impressive prominences of hot matter, which made quite an unforgettable sight.

Imperial Research Station Gamma was established on Rosencrantz, one of Hamlet's closer moons, to observe this unique phenomenon for stellar evolution research, as well as to provide advance warning to the inhabitants of Sittahr if Hamlet should appear ready to ignite. The station was thought destroyed in 1121 during a clash between Solomani and Imperial forces because it went off the air immediately after the battle and has remained off ever since. And as Hamlet's orbit currently has it on the opposite side of the system from the system's useful gas giants, there has been little reason to go out and check on its status. Now, however, Sittahr's need to rebuild its early warning capability has made it worth sending a crew out to see what might be salvaged.

### Research Station Gamma (Sittahr/3129/Diaspora)

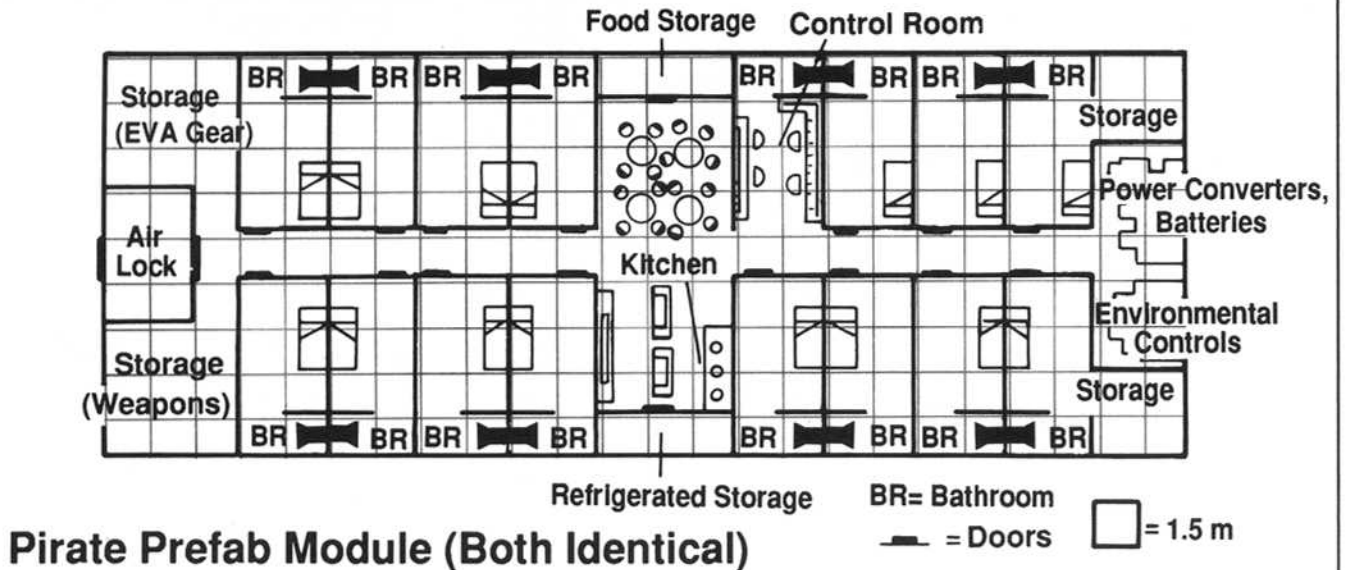
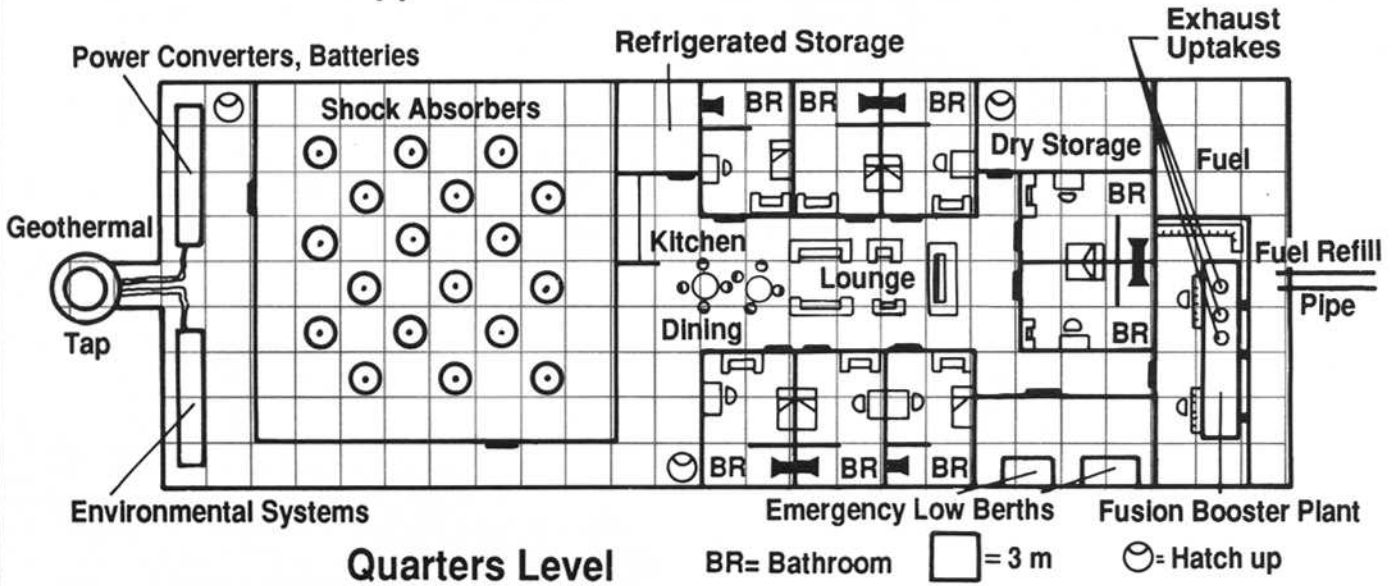
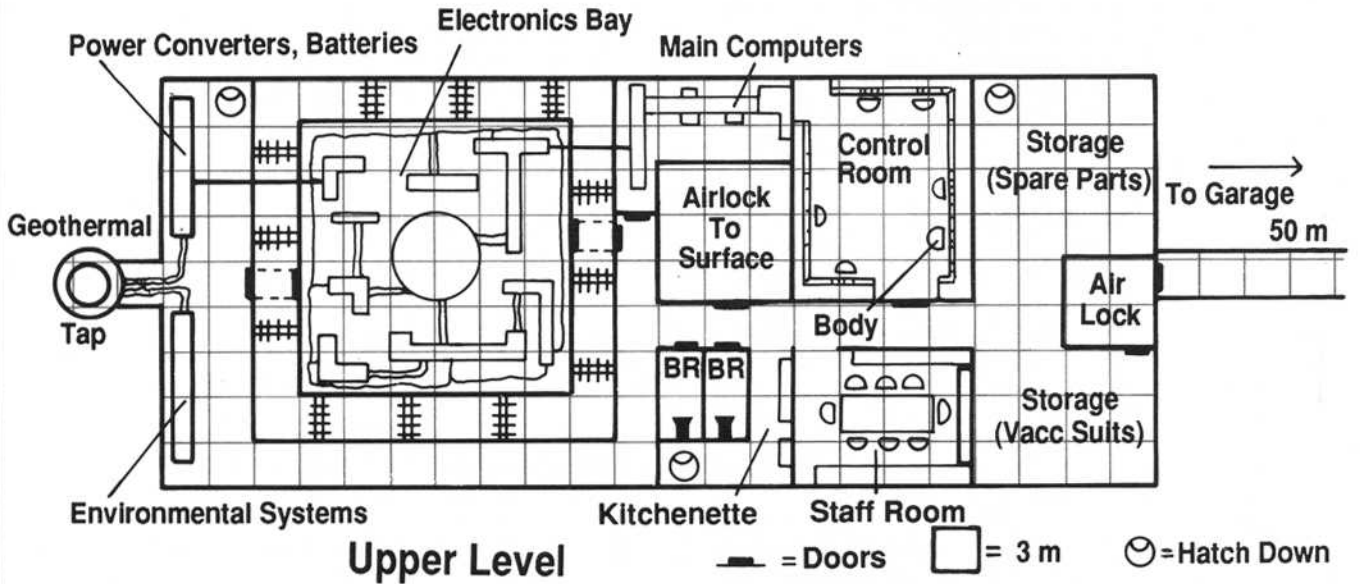

## INSIDE THE STATION

The station's interior temperature is 5°C, not uncomfortable, but the thin atmosphere requires vacc suits to be worn, although the helmets may be cracked open. Any PCs who crack their helmets will be aware of a faint unsettling odor. Gravity is 0.2G.

### Interior Details

Except where covered with electronic equipment, the walls are natural rock sprayed with gray-blue plastic sealant. All electronic equipment and electrical cabling is easily accessible via removable metal plates, or beneath nonskid rugs and metal grates. The PCs will notice damage to the station, mostly in the form of bullet holes or laser burn marks.

**Control Room:** The source of the strange odor will be apparent when the PCs advance into the modest control room and see a man's vacc-suited body slumped over a communications console. Examination reveals bullet holes in the back of the neck and shoulders, and several more holes in the wall consoles, showing that he was killed by a spray of automatic fire from behind. The body has clearly been dead for quite some time, apparent from the desiccated nature of the face, but the thin atmosphere and cold have led to a result closer to mummification than decay.

Although the comms systems are inoperable (tools and parts nearby show that someone has attempted to repair the system), the other systems in the room appear in fine shape, and their power telltales show that the station's geothermal plant is delivering standby power. Any PC can spot the sensor controls, and those with Sensor Ops or Computer skill can pinpoint the location of the sensor equipment and central control core. However, attempts to use the sensors will fail. Many of the antennae are on orbital platforms which are out of alignment, and the downlink transceivers have been damaged by volcanic ash or otherwise failed. Nonetheless, the control equipment the PCs are to retrieve is all in good repair.

**Electronics Bay:** Here is the bulk of the equipment the PCs have been sent for. Although monitored and controlled from the control room, the sensors themselves, including the backup wide-angle densitometer, are shock-mounted in this "room within a room" to prevent vibrations from knocking the instruments out of adjustment. There is no sign of damage here.

**Staff Room:** This room shows considerable damage from weapons fire, and there are signs of a large bloodstain on the floor. If the PCs examine the room, they will see notebooks and schematic diagrams for emergency low berths laid out.

**Geothermal Tap:** The geothermal plant is located a short distance from the station in a nearby hot spot of sufficient temperature to provide power generation for the station's needs. The station was built far enough away from such heat sources to prevent thermal damage to sensitive electronics. The illustrated column contains power cabling from the geothermal plant and distributes it to systems within the station.

**Fusion Booster Plant:** Occasional intensive use of active sensors requires surge capabilities of power generation beyond the geothermal capacity. This plant cannot be run when taking neutrino sensor readings, as its neutrino emissions pollute the data. It draws on LHyd tankage connected to piping in the garage, allowing the tank to be topped off by visiting starships.

There was a firefight in this room, indicated by bullet damage and bloodstains, leading in a trail to the low berths.

**Quarters Level:** This area supports the eight-person staff of the station, including sleeping, lounge, entertainment and food service spaces. This level was reserved for off-duty pursuits; the staff room on the upper level was used for professional purposes.

One of the sleeping quarters has extensive bloodstains on the bed, with a trail in the carpeted floor to the low berths. The dining area is stacked with several weeks' worth of dirty dishes and empty food containers, and several open low berth tech manuals are scattered about.

**Emergency Low Berths:** Both low berths are occupied when the PCs enter the base. One contains three bloody, clearly wounded persons (one in pajamas). The life-monitors on this berth indicate

that one is dead, but the other two are stabilized at low levels. Attempts to revive them without expert medical attention will likely result in their deaths. The other low berth contains one unwounded man, Taseen Gasili, but unless the PCs make it to this area within 15 minutes, he will revive and leave the area, leaving an obviously recently occupied low berth.

These individuals are the remaining staff of the station, caught by a scorched-earth raid in 1121. They resisted long enough to prevent the raiders from destroying the base before being forced to withdraw along with their retreating forces. The last unwounded staff member, Gasili, helped his wounded comrades (including the station medic) into emergency low berths, hid their two snub pistols in the geothermal column, then tried to repair the communications suite, not realizing there was damage to the surface antennae. Failing that, he modified the other low berth for quick, though dangerous, revival procedures and programmed the base computer to revive him when the airlock was next used. He then entered hibernation. (The last three staff members were killed while on the surface, cleaning comms antennae and transceivers. Their bodies are still there, now under several feet of ash fallout.)

### Getting to Work

Removing the equipment is handled with concurrent multiple tasks, one PC per task attempt. Each successful completion indicates that one hour of the appropriate job is completed, against the following totals. The control core requires 20 hours, the densitometer 10 hours and the neutrino sensor five hours.

To remove a component of electronic research equipment:

Routine, Electronics, Computer/Sensor Ops (see below), Absolute.

**Referee:** Computer skill is used for the control core, Sensor Ops for the two sensors. Unskilled attempts allowed only if made as Cautious tasks. Exceptional Success indicates two hours of work are accomplished. Superficial and Minor mishaps have no effect. Major mishap adds one hour *back onto* the work remaining. Destroyed indicates that a portion of the system is ruined.

The PCs may be interrupted by Gasili, who will be stalking them, unsure if they are friends or foe. He is armed, having retrieved his snub pistols, which are loaded with HEAP rounds.

**Taseen Gasili:** 587BC8, age 38, 5 terms. Skills: Sensor Ops-2, Computer-2, Physics-2, Chemistry-1, Electronics-1, Persuasion-1, Admin-1, Vacc Suit-0, Handgun-0.

Gasili is suffering from revival sickness, a result of reprogramming the low berth to revive him too quickly. His stats reflect 1D hits. He is disoriented and suffers from nervous trembling, and his skin is temporarily gray and wrinkled. All this will make him look frightening if glimpsed lurking in the shadows. Although confused and uncertain about how to deal with the PCs, he is lucid and acting judiciously, under the circumstances. He will act to prevent the PCs from reviving his wounded comrades. He is wearing a respirator and will return to his quarters to get warm clothes. He knows the station well and can use ducting systems to sneak past or hide from intruders. He will listen to reason and can be persuaded to join the PCs.

### Rude Interruption

About 20 hours after the PCs' arrival, a pirate-operated *Ramrod*-class missile boat (page 14) lands at the entrance to the garage and disgorges 20 troops. With their ship under cover and the station's sensors out of operation, the PCs will be unaware of this until they hear the clatter of the pirates at the airlock.

There are no weapons in the station (except Gasili's). *Yorick's* ship's locker contains two autoshotguns, two 7mm rifles, one laser carbine, one 7mm autorifle and four 9mm autopistols.

The pirates come in shooting. They are dressed in TL12 vacc suits, armed with autoshotguns and 5mm assault rifles. They fire with a skill level of 2. If the PCs have not met Gasili yet, he will fight with them against the pirates, attacking by surprise, then retreating to cover to reappear elsewhere.



**ARRIVAL: VIGILANTE**

Meanwhile, outside, a *Raptor*-class lander sets down behind a ridge while *Kestrel*-class fighters hold down the grounded pirate ship. With over half its crew away with the assault troops, the *Ramrod* cannot lift off or fight back. Within minutes, troops from the *Raptor* have used shaped charges to blast through a vulnerable hatchway, and their 13 crew against the *Ramrod*'s remaining four, quickly take the pirate vessel.

**The Cavalry**

Moments later, the troops storm into the research station, just as things look bleakest for the PCs. These are *Vigilante*'s squads 1 and 2. As they fall on the pirates' rear, the PCs hear, beyond the gunfire, a strident, wailing sound. Any PC who rolls 3D beneath Education recognizes the sound as bagpipes. The PCs notice that the pirates are distracted by the noise to their rear and begin to panic. (*Referee*: Apply -1 to pirate skills from this point on.)

With the surprise of *Vigilante*'s troops (stats on page 12), the battle should end quickly. Reasoning that the enemies of the pirates are their friends, they will offer to assist the PCs, particularly with medical help to stabilize wounded PCs until they can be brought to *Vigilante*'s surgeon (Medical-4, Dex 9). The PCs cannot return to their ship, as preparations are being made outside for *Vigilante*'s landing.

The troops converse freely with the PCs about "*Viggie*," as they call her; All PCs rolling 8+ on 2D will have heard of *Vigilante*, in favorable terms. *Viggie* had been trailing the pirates, from a distance. The troop-carrying *Raptor*, with its smaller signature, kept a sensor track of the pirates, and maserlinked information back to the mothership. When the *Ramrod* set down and deployed troops, the *Raptor* and its escorting *Kestrel*s went to the attack, while calling in "the big stick."

Once *Vigilante* is down, the PCs will be ushered aboard to be debriefed about the pirate attack.

**Welcome Aboard**

Wounded PCs (plus Gasili) receive immediate medical treatment; the rest are taken to the lower deck mess area to eat. The bulkheads are decorated with photos and unit crests of the crewmembers' former units, and souvenirs from many victories. The focal point of the display is *Vigilante*'s "kill board," sporting red silhouettes of the six pirate ships she has destroyed, and a tally of small skulls—black for pirates killed and white for prisoners. One trooper is painting new skulls onto these tallies, while others argue about the new silhouette to be added. As before, there are many troopers happy to discuss the decor and history.

The PCs cannot leave the area. "Security," they are told.

**Meet the Skipper**

Two hours later, the PCs are taken to the main deck mess area, which has been set up for an interview. They are seated at a table and introduced to Col. Rivera, Lt. Cdr. Marlene and Lt. Kirsidgu, seated at another table facing theirs. Here they are questioned on the events leading to this meeting. Rivera explains that Marlene is psionic and will be checking their thoughts during the questioning to ensure they have no hidden motivations. Marlene will rarely speak during the interview, merely intently watch the PCs, in deep concentration. Armed guards stand behind the PCs.

Marlene is not psionic, but Rivera, Marlene and Kirsidgu have developed an effective interrogation technique by introducing that element of uncertainty into the subjects' minds. Subjects usually respond with visible nervousness if they are hiding something, glance tellingly at each other in attempts to "synchronize their story," or simply break down and tell all. The interrogators have no reason to suspect the PCs other than simple prudence during these times, and they are mostly interested in gaining any scraps of data the PCs can provide on the pirates' operations. When the PCs mention their mission for Sittahr, Rivera orders an officer to contact that planet's government (which takes 42 minutes at this range), to which Rivera and *Vigilante* are well-known, and confirm the PCs' identities. After an 84-minute delay, these will be confirmed. As the interview ends, the *Vigilante* officers' cool reserve eases, and they warmly welcome the PCs aboard, explain-

ing that they are satisfied with their story but that nowadays one must always be "vigilant."

**GAMBLE AT GORKY**

The PCs are told that there are still arrangements to be made before they can leave the moon. They are invited to remain aboard *Vigilante*, but can return to their ship (which remains blocked into the garage) if they prefer.

**New Gunslingers**

A few hours later, the PCs are invited to another meeting with Rivera, Marlene and "Piper" Kirsidgu. The pirate prisoners (actually members of a more organized type of pirate band known to the starmercs as "vikings") have revealed an operation about to take place at Gorky, and a counter-operation must be begun immediately.

While the *Ramrod* was dropped off by jump shuttle to survey Sittahr for a new base, other pirates from the same band moved to Gorky to ambush that world's small fleet of *Roughneck* fuel harvesters (page 14). Gorky, poor in natural resources, has invested its small remaining capital in these "wildcatter rigs" to obtain petrochemicals from its system's gas giants (see *Hard Times*, Chapter 7, for more information), which will permit its industries to keep turning out the precision, highly specialized zero-G manufactured components on which Gorky had built its trade. These parts are almost useless on Gorky itself; this program is a gamble to gain admission to the UP on the strength of its value as a trading partner. Without the protection of the UP, Gorky is doomed to fall to pirates.

The pirates have been hired by a group from Diaspora's rimward end, presumably Solomani, to wreck Gorky's industrial plan by eliminating the wildcatter fleet. This group believes that Gorky's plan might succeed, and it wishes to forestall any further UP expansion into the area. The wildcatter fleet will arrive at the gas giant in a week for the new "season," and it will be a vulnerable target, thought of as not worth a pirate attack.

Rivera needs the PCs to join *Vigilante*'s crew, at least temporarily. They will be paid well (1.5 times the appropriate rate *in cash* as listed in the *Imperial Encyclopedia*, page 93, until they are returned to Rosencrantz, normal rates thereafter). He will see that their cargo is taken to Sittahr and their ship returned to them in perfect working order.

A portion of *Vigilante*'s crew will be left to crew the captured *Ramrod* to greet following pirate forces as a Trojan horse. (See the *Ramrod*'s listing for required crew—these will be drawn from *Vigilante*'s ship's company, ship's troops and flight crews. Base this on the positions the PCs will be able to cover). This leaves *Viggie* shorthanded, and the PCs are needed to fill these holes for *Vigilante*'s urgent mission to Gorky.

The PCs are offered positions (according to their abilities) as gunners (*Viggie*'s laser turret), engineers, fighter pilots and gunners, bridge crew and ship's troops. If several join as ship's troops, the senior PC will be appointed as squad leader of his fellow PCs, and *Vigilante* troopers will be added to bring the squad up to eight. By the same token, if three PCs fill the qualifications for a *Kestrel* or *Raptor* crew, they can be given command of one for the coming operations.

**ONCE MORE UNTO THE BREACH, DEAR FRIENDS**

*Vigilante* procedure calls for refuelling immediately upon arrival in-system. This allows her fuel purifier to start "chewing on" the fuel as quickly as possible (this takes just over 2 1/2 days) in order to be ready for quick departure. She is, therefore, ready to go once the PCs have signed aboard. *Posse*, the re-named *Ramrod* missile boat, has taken orbit around Hamlet, and her crew has established recognition signals with *Vigilante* so that neither will be "reverse trojan horsed" upon *Vigilante*'s return.

*Vigilante*'s 1G drives require 15 hours to reach 100 diameters from Hamlet, and during this time, the planning for the upcoming operation begins. The first decision to be made is the arrival point at the end of the jump. The choices are two: 100 diameters from Bubo to get in quickly, or a point to intercept and join the wildcatter group on its way to the gas giant.

## Gorky System Astrography

Information available to the crew includes the current UWP and the following:

Gorky, in orbit 3 of its G1 V system, is dependent on access to complex hydrocarbons which it obtains from the outer system gas giants in orbits 6 to 8. Once a year, Gorky passes as close as 628 million km to the nearest of these, Bubo, so it has been chosen as the site of the wildcatting operations conducted by Gorky's fleet of six *Roughneck*-class wildcat rigs (page 14) and their mother ship, a converted Type XT express boat tender (see *Hard Times* page 81 for standard configuration UCP).

It is here that the pirates ambush the fleet. They will attempt to capture the *Roughnecks* so that they can profit by converting them to other purposes or selling them, but they will be paid whether they capture or simply destroy them. The pirates have established a base with a handful of prefab modules on Bubo's third moon (airless, with 0.3G) orbiting at 456,000 km. This moon is tidally locked, with one side always facing the gas giant. This is all that *Viggie's* crew knows, although they can calculate that once in geosynchronous orbit, the mother ship, orbiting at 90,400 km, will come within 366,000 km of the moon each time the moon passes overhead.

## The Best-Laid Schemes

Unless the PCs push for another plan (this can be roleplayed or rolled as a difficult confrontation task vs. Rivera and Kirsidgu using Persuasion and Tactics skills), *Vigilante* will jump to intercept the incoming wildcatters and mingle with them. This will conceal *Vigilante's* signature until she gets close to Bubo and hides herself in ambush beneath the cloud deck. The *Raptor* and *Kestrels* can then be launched from the tender's sensor shadow to hit the moon base from only 366,000 km. Such attacks from within the pirates' perimeter should take them by surprise.

The strike on the moon base will be conducted by the *Raptor*, escorted by two *Kestrels*. Their speed and small signatures make detection less likely. The 13 troops aboard the *Raptor* will include those PCs serving as troops, equipped as *Vigilante* troopers with laser rifles (page 12), with the senior PC trooper holding the position of on-scene ground commander. The attack must be a careful room-to-room assault rather than a simple strafing; valuable intelligence must not be lost.

*Vigilante*, holding the other *Kestrels* in reserve (not all of which will be crewed, depending upon decisions made in *New Gunslingers*), will meanwhile lurk beneath the tender while the *Roughnecks* begin their work.

## Gang aft a-gley

The pirate base is on side of the moon that faces the gas giant, necessitated by the prefab modules' power needs. Each is powered by photovoltaic panels, requiring placement on the "bright side" to catch the light reflected off Bubo's swirling surface. There are two identical modules; one is illustrated on page 6. There is also a Type P corsair grounded beside them. If the starmercs approach from Bubo, there is a 9+ chance on 2D to take the pirates by surprise. If they come in from the open space side, this chance increases to 5+. There are 18 pirates, six each in the modules and ship. If surprised, they will not respond until the PCs or starmercs initiate combat. Then roll 1D per pirate for the number of minutes needed to respond. The ship can lift off once the last pirate crewmember has so responded; those in the modules will don TL12 vacc suits and engage with laser rifles.

The PCs have been instructed in the use of shaped charges to blow their way into the modules or starship.

To blow an entry hole in a vacuum module with a shaped charge: Routine, Vacc Suit, Dexterity, 4 seconds, Hazardous.

Referee: Demolition skill may replace Vacc Suit skill, if possessed. Task becomes Formidable if attempting to blow the hole in a starship.

If surprise is not obtained, the corsair will lift off and engage the fighters, while working toward the tender's position.

The crew aboard *Vigilante*, meanwhile, will be waiting for the pirates to arrive. Suddenly, their sensors show an explosion in the tender's cryogenic fuel storage area, and they are asked to come alongside to render assistance. There is a large hole in the tender venting cryogenic fuel, and as *Vigilante* comes in close to get a better look, several objects dart toward her and clanking is heard through her hull.

The pirates have a fail-safe component to their plan. Twenty-five pirates were smuggled onto the tender at Gorky in storage canisters, waiting to arrive at Bubo before taking over the ship. From that position, they could capture each *Roughneck* individually as it came alongside to transfer its load, or strike by surprise in case of emergency as they have here. Isolated in their canisters, they were unaware of *Vigilante's* presence until they took over and were, therefore, unable to warn the moon base. Now, 20 pirates in EVA gear clamber over *Vigilante's* hull planting shaped charges to blow boarding entrances (use skill level 2 and Dex 8 for the task above).

Because they are at battle stations, all crewmembers are fortunately in their vacc suits with sidearms, but there are no more than eight of *Viggie's* troopers aboard to meet the threat.

The pirates will only be able to enter *Vigilante* through holes blown in the top of the jump and main decks or the gooseneck, because other areas have LHyd storage beneath them which spews out to prevent entry and which would freeze any person immersed in it. The PC operating the laser turret will have the opportunity to engage the assaulting pirates, although care must be taken not to hit friendly forces who may decide to counterattack from the gooseneck or jump deck airlocks.

With *Vigilante* busy, the corsair dives into Bubo's atmosphere and begins hunting for the six *Roughnecks*, although the dense atmosphere provides protection by raising all sensor and weapons fire tasks by one level of difficulty. The PCs' *Raptor* and *Kestrel* force should be pacing the corsair, and can pursue the corsair into the cloud deck and maintain sensor contact, or assist *Vigilante*.

## Triumph

*Vigilante* will not emerge unscathed from this encounter. She will presumably require patches to her fuel tanks and probably replacements to her crew. Patching can be done by the crew with materials stored in the hold over a period of several days, but the danger of being attacked while vulnerable will require constant *Kestrel* patrols. On the strength of their recent performance, the PCs will earn offers of permanent crew status from Rivera. Whether they accept or not, the next order of business will be to return to Rosencrantz and Sittahr to deliver the electronic equipment (and perhaps *Yorick*, which is the property of Sittahr) and perhaps return the PCs to their ship. If the PCs offer to join Rivera's *Vigilantes* as operators of their own independent ship, this will have to be worked out with the referee, although Rivera will be favorably inclined to the possibility.

## Variations

Depending on the plans that were agreed upon earlier and the players' decisions, a number of variations on the above events can take place. The following time-distance table will assist the referee in tracking the events.

	Gorky to Gas Giant (628 mil. km)	Moon to Wildcat Tender (366,000 km)	100 Diameters to Moon (13.6 mil. km)	Tender to Cloud Deck (90,400 km)
1	139.2 hr	3.36 hr	20.49 hr	100.22 min
2	98.4 hr	2.38 hr	14.49 hr	70.87 min
3	80.4 hr	1.94 hr	11.83 hr	57.86 min
3.45	75 hr	1.82 hr	11.03 hr	53.96 min
4	69.6 hr	1.68 hr	10.24 hr	50.11 min
5	62.3 hr	1.50 hr	9.16 hr	44.82 min
6	56.8 hr	1.37 hr	8.36 hr	40.92 min

Times reflect arrival at zero net vector. To pass through that point at maximum thrust, multiply listed time by 0.7. Listing for 3.45G is the average of *Raptor* and *Kestrel* performance; the referee may use this one figure for both, for ease of play.

**FURTHER ADVENTURES ABOARD VIGILANTE**

The encounters presented above are only the briefest of introductions to *Vigilante's* missions in Promise Subsector. Below are guidelines for further campaign activities, including day-to-day starmerc operations.

**Starmerc Tickets**

The primary source of income for starmerc units like Rivera's Vigilantes is hiring on as escort for merchant convoys on dangerous trade routes or providing troops for "dirtside" operations on planetary surfaces. This section presents an abbreviated version of the fuller discussion available in **Hard Times**.

The starmerc fee for escorting a merchant convoy for one jump (starport departure to starport arrival) is Cr750 per starmerc crewmember plus Cr 30 per kiloliter of cargo hold of the escorted merchant vessels. Thus *Vigilante's* rate with a full crew of 78 would be Cr 58,500 plus the fee for the escorted cargo capacity. In the example of four Type A free traders, the fee would be  $58,500 + (30 \times [4 \times 1107]) = \text{Cr}191,340$ . Out of this fee come the formidable costs for payroll for *Vigilante's* crew, plus funds for maintenance, supplies, training, and the replacement and repair of equipment (including *Vigilante* herself) placed at constant risk in combat. However, as merchants usually use the 100 tons of starmerc per 400 tons of merchant rule, *Vigilante's* size makes her rather expensive for groups of small ships.

Dirtside missions pay differently, as they are based on the number of troops available, not on the starmerc ship or crew. In the years before the Rebellion, it was considered typical for a merc unit to get at least Cr12,000 per trooper per month. In the **Hard Times** environment, that kind of money doesn't exist anymore. Payment will only be a fraction of that scale, and is often offered in trade, services or salvage rights to the defeated enemy's equipment.

**Recruiting**

Casualties among *Vigilante's* crew or her ship's troops will require the recruiting of replacements. This is an important activity and can be time-consuming, considering the importance of obtaining the right people for the right jobs. It is also quite a promising area for roleplaying, as the PCs will wish to interview some of their prospective employees or shipmates to determine their suitability. This presents numerous opportunities for the referee to play the role of the NPC job applicant who seems to have something to hide or who appears to be too good to be true. The PCs can attempt to check into the background of such individuals, creating more chances for adventure.

When recruiting a new crew, the key factors are the world's UWP population digit and the quality of the personnel being sought. Treat personnel quality as falling into four different classes as indicated in the table below (see **Referee's Companion**, Large-Scale Combat for further discussion of troop quality and morale).

Troop Quality	Number of Dice for Applicants	Terms (Age)
Recruit	UWP Pop Digit -4 (-5 Space)	0-1 terms (18-22)
Regular	UWP Pop Digit -5 (-6 Space)	2-3 terms (23-30)
Veteran	UWP Pop Digit -6 (-7 Space)	4-6 terms (or 3-4 enh gen)
Elite	UWP Pop Digit -7 (-7 Space)	4+ terms enhanced gen

DMs (per die rolled): +2 Gov't 7, +3 Law 0, +2 Law 1-2, +1 Law 3-4, -1 Law 7-8, -2 Law 9-11, -1 TL6-, +2 TL 10-12, +1 TL13+.

(Space only: +1 Starport C, +2 Starport B, +3 Starport A.) DMs also allowed for recruiting; see below.

The Number of Dice for Applicants column indicates the number of six-sided dice thrown for number of applicants per recruiting period. The main number is for ground troops, and the number in parenthesis is for starship crew applicants. Quality classes are rolled separately. Each recruiting period lasts one week, and only one recruiting attempt can be made per month per planet. Recruiting skill allows the PCs to add to each die rolled. For each PC (or *Vigilante* ship's company NPC) with Recruiting-1, add one to the rolls for recruits. For each with Recruiting-2, add one to each die rolled for recruits and regulars. Each with Recruiting-3 adds 1 to each die rolled for all classes, Recruiting-4 adds 2 to each die for all classes, and so on.

The Terms of Service (Age) column is a guide for the referee when generating the applicants responding to the recruiting efforts. The "enhanced generation" notation for Veterans and Elites indicates characters generated by the enhanced mercenary characters procedure (or enhanced Naval, Scout or Merchant Prince characters for space recruits). All others are from the Basic Character Generation Tables for Army, Marine, Law Enforcement and Hunter (or Navy, Scouts, Merchants, Belters, and Pirates for space recruits) characters. In all cases, the referee should allow the PCs to see only the applicants' resumes when interviewing, and *not* their UPPs and skills.

**Pirate Operations in the Promise Subsector**

If intending to conduct a long-term campaign in Promise and the surrounding subsectors of Diaspora, the referee should consider obtaining **Hard Times**. The referee can then use the rules for generating raider bands to populate the campaign area with a balanced "ecosystem" of ripper, corsair and viking bands, each with its own base and "hunting territory." However, the referee can conduct adventures using the guidelines below.

**Trade Routes:** Pirates operate where there is plunder to be had—more specifically, where there is low-risk plunder to be had. Nothing draws pirates like a trade route active enough to offer regular targets but not so well-used as to be heavily defended. For this reason, pirate activity in Promise is lowest among the six worlds of the Unity of Promise, as these are protected by the UP Navy (Library Data, page 11).

Outside the UP, the heaviest (hence, most lucrative, by pirate and therefore, starmerc standards) traffic runs from Tasmania to Ijiwa and Tenmet, from Execute to Exeter and Poznan, between Amoy and the Blight Subsector to spinward, and between Muni and Daaliisa and Lot.

**Pirate Bands:** From his base at Campobello (2714/Pasdaruu, immediately to coreward of Promise), Indro the Lightless (see **Hard Times**) has been attempting to topple the Khavle Accordment. But recent reversals have caused him to look rimward to the Promise Subsector, where he has probed into Seagull, Orsk, Tenmet and Asena. Further expansion is only a matter of time.

However, Promise already has its own ambitious raider band, the viking alliance of ex-Col. (Sir) Cymon Milligan, based at Lekhaana and Sligo. This was the group that *Vigilante* tangled with at Sittahr and Gorky, thwarting initial attempts to expand its influence deeper into Diaspora. This formidable group of two allied bands has two powerful but jump-incapable *Ramrod*-class missile boats (a third was captured by *Vigilante* at Sittahr) which must be ferried from system to system by Milligan's two irreplaceable 600-ton jump shuttles. Additional forces consist of a Type P corsair 9seen at Gorky) and two A2 far traders. Milligan is currently torn between expanding rimward toward Sittahr or spinward to Tasmania. Should he learn of Indro's forays, Milligan will fight ferociously to prevent any intrusions onto "his turf."

Milligan's sponsor for the operations at Gorky will continue to be active, through Milligan's forces or other as yet undiscovered agents.

**Promise Subsector (L/Diaspora Sector) as of 001-1129**

Name	Hex	UWP	Class	PPG	Alg	Str	Zn/Sp
Seagull	2521	E7B13EB-3	Ni FI Lo	603		G2 V	Ou/D
Amoy	2524	E454632-6	Ni Ag	205		G0 V	Ou
Baraduusa	2528	E3422FA-5	Ni Po Lo	215		G3 V	Ou
Ferenira	2724	D1001A5-8	Ni Va Lo	123		M3 V	Ou
Daaliisa	2725	E767600-4	Ag	914		M1.V	Ou/F
Eloji	2728	D846691-9	Ni Ag	302	UP	M0 V	Ou
Exeter	2729	C769891-B		424	UP	K3 V M9 D	Ou
Muni	2825	D3428B8-7	Po	505		K4 VI M6 D	Ou
Promise	2827	B542998-D	Hi In Po	502	UP	M1 V	Ou
Poznan	2830	E232883-6	Po Na	403		M4 V	Ou
Orsk	2922	D535397-9	Ni Lo	912		M4 V M9 D	Ou
Lot	2925	C245690-B	Ni Ag	503	UP	M5 V	Ou
Vahana	2926	E65A595-9	Ni Wa	703	UP	M2 V M5 D	Ou
Udone	2927	D000590-9	Ni As	314	UP	M0 V	Ou
Gorky	2929	D200586-8	Ni Va	911		G1 V	Ou
Execute	2930	X684598-5	Ni Ag	303		M1 V	Ou
Asena	3022	E354832-A		114		M7 II	Ou
Napiresha	3023	X5592B5-5	Ni Lo	623		M6 V M3 D	Ou
530-053	3027	X443200-4	Ni Po Lo	822		M3 V M4 D	Ou/F
Davao	3029	D100696-6	Na Ni Va	113		M3 V	Ou/F
Nysorb	3030	C9B6584-7	Ni FI	733		K2 VI M4 D	Ou/F
Tenmet	3121	C110774-9	Na	203		K2 III	Ou
Tazmania	3123	B456540-A	Ni Ag	104		M1 V M9 D M6 D	Ou
Sligo	3126	X878386-6	Ni Lo	703		K7 V	Ou
Sittahr	3129	D7665A4-8	Ni Ag RsG	405		K0 V M3 D	Ou
Ijiwa	3224	E3008A4-A	Va Na	202		M2 V M6 D	Ou
Lekhaana	3225	X100298-3	Ni Va Lo	124		G6 V	Ou/D
Cosenza	3228	C527464-9	Ni	312		K2 V M2 D	Ou

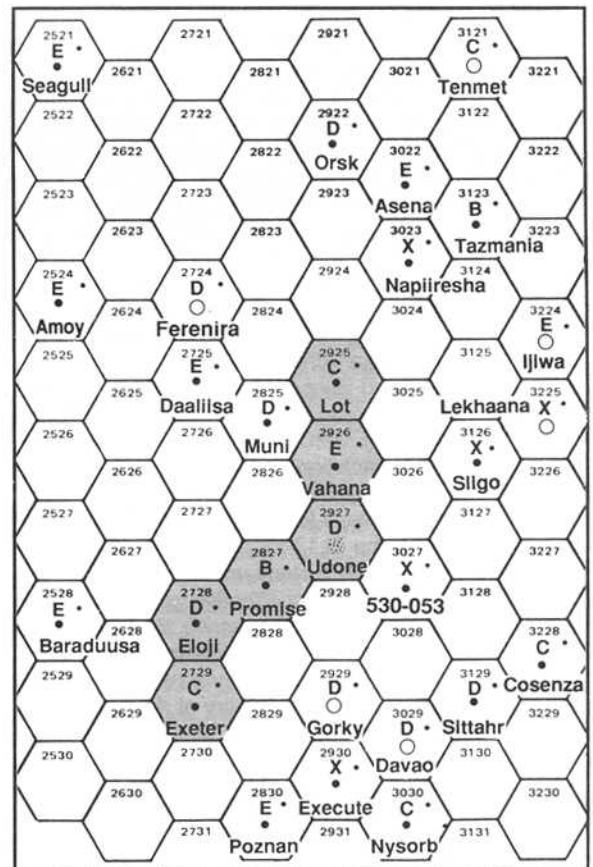

**Alg (Allegiance):** UP: the Unity of Promise.  
**Zn (Zones):** No Indicator: Safe Fr: Frontier Ou: Outland Wi: Wilds.  
**Sp (Special Indicator):** F: Failing world D: Doomed world  
 RsG: Diaspora Sector's Imperial Research Station Gamma.

**ADMINISTERING UWP CHANGES**

The UWP changes seen in the table above have taken place gradually since the 1121 figures found on page 16 and can be administered gradually by the referee who wishes to game through the Hard Times changes reflected in these reductions. Simply compare the 1121 and 1129 values and note changes in UWP digits. Reduction in starport values take place from the latter part of 1124. Reduction in tech levels start in mid-1125; population reductions begin to be seen in early 1128; and government and law level changes start by mid-1128. The **Hard Times** sourcebook provides more in-depth discussion of these issues.

**LIBRARY DATA**

The Promise Subsector was a war zone throughout the duration of the Rebellion. The post-war population of Promise Subsector is approximately 6.63 billion, representing a total decline of 302 million from pre-Rebellion totals. Worlds that experienced noteworthy decreases in population include Seagull, Amoy, Daaliisa, Exeter, Muni and Lekhaana. The highest tech is 13 at Promise.

Two special conditions have been created by the war. On some worlds, special equipment or high technology was needed to support the population in a hostile environment. During the war, a world's technology may have dropped below that which is needed to sustain life. In that case, a Doomed world or Failing world is the result.

**Doomed Worlds:** These are worlds with hostile environments that are on the verge of extinction from loss of technology and supplies—it is only a matter of time until they finally fail. Their people are desperate to get off-world and will pay exorbitant fees for even low passage. They will also resort to hijacking, extortion and bribery. For this reason, Doomed worlds are not safe places to visit.

**Failing Worlds:** These are worlds where a delicate equilibrium has been achieved between the demands of survival and the limited means to maintain it. The people can survive with hard work, but there are few resources for anything else, and anything depends on simple luck.

**Unity of Promise (UP):** This organization was established in 1126 in response to the need for unified authority in the lawless subsector. The six member worlds hope to push back the surrounding tides of anarchy, and to this end they maintain a credible fleet and retain a large number of starmerc units for eventualities. As an island of Outland surrounded by Wilds areas, the UP is quite a powerhouse by subsector standards; in fact, it is one of the more powerful of Diaspora's independent polities. However, being the closest of these to the Solomani Frontier is quite a handicap.

Given its cash-poor circumstances, the UP government pays its starmerc contractors in trade when possible, in the form of starship maintenance and repair at Promise's TL13 yards. Since there are no class-A starports among the UP worlds, new starships in Promise Subsector come mostly from Remington (1820/Diaspora).

The UP fleet consists of six *Gazelle*-class close escorts, *Assurance* (F-11), *Covenant* (F-12), *Oath* (F-13), *Pledge* (F-14), *Warrent* (F-15) and *Bond* (F-16); six *Sentry*-class SDBs (one at each UP member world); four armed Type A2 far traders; three Type T patrol cruisers; one armed Type Y yacht; one Type C mercenary cruiser; and a captured Type P corsair. Small craft include a dozen each of *Termagant*- and *Kestrel*-class fighters, and 30-some pinnaces, ship's boats and cutters used for customs and inspection duties. An additional force of seven starmerc vessels, including *Vigilante*, are kept on reserve status and are frequently hired for missions outside UP territory.

While small, this is a considerable force by post-Rebellion standards.

## ABOARD VIGILANTE

A tour of *Vigilante's* interior is a telling study of the different philosophies of mercantile and military naval architecture. *Vigilante* began as a *Stellar-class* subsidized liner, but was left incomplete at Exeter following the collapse of the commercial shipbuilding market in the early 1120s. Although taken in hand once in 1123 for completion as the warship *Admiral Bertil* for the Promise Planetary Navy, lack of funds curtailed this after the installation of some TL13 systems.

By late 1125, it was clear that additional military vessels were necessary to control the rising incidence of piracy in the Promise Subsector. The Exeter shipyards prepared several studies on the refitting of merchant hulls for military service. Among these were two Type M conversion schemes, the *Admiral Bertil* fighter-carrying commerce protection ship and the *Angkor Wat*, which traded the small craft for greater power and laser armament. These plans were distributed throughout the Diaspora Sector as the Extemporized Mercantile-to-Military Conversion (EMMC) designs. These designs were ideal as templates for the completion of existing incomplete hulls, and *Admiral Bertil* was again taken in hand to be completed as the first EMMC vessel. Although Exeter's locally sustainable tech level was eroding during this period, the TL13 systems installed during 1123 allowed *Bertil's* completion to TL13 standards.

In 1126, the new Unity of Promise government announced that subsidized completion of EMMC vessels would be offered to starmerc units that would agree to accept mobilization duties in the UP fleet. The first unit to take advantage of this program was Col. Robert Rivera's unit Rivera's *Vigilantes*, who took delivery of *Admiral Bertil* on 217-1127, promptly renaming her *Vigilante*.

## VIGILANTE'S CREW

*Vigilante's* crew exhibits several clear traits. One is the prevalence of Solomani names in the Diaspora Sector. The others are a result of Hard Times conditions. First, crewmembers have a more heterogeneous mix of skills than was typical of pre-Rebellion individuals. This is a result of the upheavals of the Rebellion and Hard Times, which forced people to adapt to changing situations instead of becoming experts in the more carefully delineated and separated roles of peaceful times.

Second, there are many family ties among the crew. The uncertain and violent nature of the times require people to travel light and not leave hostages to fortune behind on inadequately defended worlds. When recruiting, Col. Rivera and Lt. Cdr. Marlene take efforts to not split family bonds when work can be found aboard for married couples, siblings, and parents with mature children. At the same time, the intimacies of common cause and shared danger have prompted several marriages among crewmembers, including Rivera and Marlene.

**Colonel Robert R. Rivera:** 7A8BC8, age 40, 5½ terms. *Skills:* Leader-2, Ship's Tactics-1, Fleet Tactics-1, Vacc Suit-1, Grav Belt-1, Tactics-2, Recon-1, Combat Rifleman-3, Recruiting-1, Liaison-2, Linguistics-1, History-1, Forward Observer-2, Persuasion-2, Sensor Ops-0, Engineering-0.

Bob Rivera is the commanding officer of the Rivera's *Vigilantes* starmerc unit, and captain of *Vigilante*, although he retains the traditional colonel rank of merc COs. He is well-liked by his crew and is known for his considered intelligence rather than the "hell for leather" reputation coveted by many starmerc colonels. He prides himself on his crew's low casualty rate. He is a native of Daalissa, and *Vigilante* makes numerous patrols there, providing what help it can to the population of that failing world. He is married to *Vigilante's* navigator, Lisa Marlene.

Rivera maintains close ties to the Unity of Promise government, cemented by *Vigilante's* frequent operations as an auxiliary member of the UP Navy. He uses this position to continuously press home his belief that the UP should work to expand its influence and protection to rimward and trailing to the undefended worlds of the subsector.

**Lieutenant Commander Lisa Marlene:** 886BA9, age 42, 6 terms. *Skills:* Navigation-2, Electronics-2, Pilot-1, Vacc Suit-1, Interrogation-3, Liaison-1, Recruiting-2, Handgun-3, Equestrian-2, History-1, Air/Raft-1, Recon-1.

Lt. Cdr. Marlene is *Vigilante's* navigator and recruiting officer. She has been with the unit since its creation in 1122. She has an interest in antique firearms and Terran "cowboys;" it was she who designed the unit's distinctive patch with its antique revolvers threatening a pirate skull.

Marlene is also the ship's chief interrogator. She is a shrewd judge of human nature, and can usually get the information she wants through questioning and observation. However, if circumstances are sufficiently dire, or her contempt for a pirate prisoner sufficiently strong, she can use physical intimidation and coercion.

Col. Rivera is Marlene's husband.

**Lieutenant Unglnke "Piper" Kirsidgu:** 6A9A95, age 42, 6 terms. *Skills:* Leader-1, Tactics-2, Forward Observer-1, Grav Vehicle-1, Vacc Suit-2, Zero-G Environment-2, Laser Weapons-2, Combat Rifleman-2, Handgun-1, Mass Driver-1, Recruiting-1, Interrogation-1, Gambling-1, Admin-1.

Although of absolutely no Solomani descent, Kirsidgu has decided he wants to be Scottish, at least for the bagpipes. If the PCs ask, he'll explain, "I have a theory, which is my own. The pipes bug people. Bug the daylights out of 'em. But it's a funny thing about the pipes. If they're your pipes, they bug you into doing your job better and tougher. But if they're the other guys' pipes, they bug you into screwing up." Thanks to Kirsidgu's theory, *Vigilante's* troopers often go into battle blaring "Scotland the Brave," "Blue Bonnets O'er the Border" or "The Siege of Delhi" (Kirsidgu's favorite) from portable speakers.

Many times decorated in Imperial service, Kirsidgu is rather old for a lieutenant. For dirtside cadre ops, he uses the rank of Major, a title more appropriate with his age and experience.

## Ship's Troops

All ship's troops are identified on their combat armor by tactical codes ("taccodes"), indicated below. The 43 troops are divided into five squads of eight each plus three command personnel (troop commander and two nonofficer assistants, taccodes 01 to 03). The first section (four troops) of each squad is equipped and trained for zero-G combat with accelerator or laser rifles and snub pistols. The remainder are armed with a mix of ACRs and assault rifles. Currently all troops are equipped with combat armor, although with a wide variety of captured, salvaged and scrounged mix of bits and pieces ranging from TL11-14.

Each squad has a squad leader (SL), whose taccode ends in 1, and an assistant SL, whose taccode ends in 5. The five squads are each identified by a colored pattern painted on their armor and equipment in addition to their taccodes, as follows. *1st:* Black and white checkerboard, taccodes 11-18. *2nd:* Blue and green tartan plaid, taccodes 21-28. *3rd:* Cluster of orange five-pointed stars, taccodes 31-38. *4th:* Blue and yellow "racing stripe," taccodes 41-48. *5th:* Red and white "barber pole" pattern, taccodes 51-58. *Vigilante* is currently operating understrength, without a fifth squad.

Three members of each squad (SL, ASL and one other) should be treated as having a skill level of 3 in their weapon; all others have 2. All troops have at least Vacc Suit-1, Zero-G section members have Vacc Suit-2 and Zero-G Environment-1, (2 if the SL). Each SL additionally has Tactics-1. Two members of each squad have at least Medical-1, though no more than level 2.

## VIGILANTE SYSTEMS AND OPERATIONS

*Vigilante's* streamlined hull allows her to conduct gas giant refuelling. Although she is capable of take-off and landing within planetary atmospheres, the gooseneck that joins the forward disk to the main hull is considered to be a structural weak spot that would be endangered by too much atmospheric maneuvering. Therefore atmospheric operations are avoided when possible, leaving the landing of troops or attacking of surface targets to the fighters and lander.

**Entry Points:** Three airlocks allow routine personnel entry and exit. One is on the dorsal surface of the gooseneck, accessed by an elevator, and the other two are at the forward end of the jump deck on either side.

There are three other specialized entrances. Two, on the dorsal

surface, are the matched flight deck doors, illustrated on the outboard bow view in an opening position. When conducting fighter launch and recovery operations, the door is raised to a fully vertical position. Either or both doors can be used for the launch and recovery of *Kestrel* and *Raptor* craft, requiring that the main deck be depressurized forward to the gooseneck and aft to the forward engineering bulkhead.

The third specialized entrance, on the ventral surface, is the lowered position of the cargo lift; it is here that *Vigilante* is loaded and unloaded when she lands on planetary surfaces. Cargo is normally brought aboard by the *Raptor* and is unloaded to the lift's upper position on the flight deck. The lift can also be extended to its landed position in space, but this requires the depressurization of the cargo hold and flight deck.

### Internal Layout

The main internal difference between *Vigilante* as completed and her *Stellar*-class origins is the rationalization of the *Stellar*'s split-level deck configuration. Rather than having an upper quarters and lower hold deck with an intermediate-level passenger deck wrapped around the two, *Vigilante* has her fuel storage pushed into the outer wrap-around area so that the upper main deck can be extended laterally to house the fighters. The former hold deck has been rebuilt as a quarters deck to house 50 crew. Because of the tremendous space required by the fighter complement, the bridge and additional quarters have been located in the former passenger lounge in the forward disk.

The accompanying deck plans have been color-coded to allow easier use.

**Control Systems (Yellow):** These comprise the four bridge positions and the four diagnostic and monitoring positions in the engineering spaces. Only two crew are required to operate the ship under routine conditions, usually both in the bridge. However, at battle stations, there are personnel sufficient to man each of the eight consoles. In the bridge are the two bridge crew, one gunner and the CO. The engineer, XO and two remaining command personnel man the engineering systems.

**Weapons Systems (Orange):** Although the ship's weapons can be controlled centrally from the bridge by the two gunners, there are five consoles for local turret control (one each, except only one console for both tail stingers together) alongside each turret. Also located contiguously with each missile and sandcaster turret are magazine spaces for additional missiles and sand canisters.

The sandcaster turrets are almost never manned; their placement allows optimal dispersion of sand and chaff by computer. The three missile turrets are usually controlled centrally by one gunner from the starboard console of the bridge, while the other gunner operates the laser turret under local control. While there are safety interlocks to prevent the turrets from hitting other parts of the ship, the interlocks for the laser turret can be overridden. This is an antihijacking contingency, in keeping with the citadel concept of the forward disk. The turret's arc of fire allows it to fire past the shuttered former bridge dome at the two airlocks on either side of the jump deck, and also directly at the gooseneck airlock. The turret can also fire at anything entering or leaving via the flight deck doors. Thus, the only entry to the ship not under the protection of the laser turret is the ventral cargo lift.

**Sensors (Purple):** *Vigilante*'s sensors are located in three main locations. The active and passive EMS arrays are installed in a conformal array around the forward disk and in rear-arc scanners on either side of the stinger turret stack aft. The former bridge dome, retained as a dummy, has been transformed into a sensors and communications turret, housing the high-penetration densitometer, and the laser and maser commo systems.

**Life-Support Systems (Light Blue):** Because of the separation of the forward disk and main hull, and the problems of running too many systems through the cramped and vulnerable gooseneck, *Vigilante* has two independent life-support systems, one each for the disk and main hull. The main hull system operates from ducting behind the outboard bulkheads on either side of the lower

deck, and is controlled from the bridge or, alternately, from the main deck engineering compartment. The portion of the system responsible for depressurizing and repressurizing the flight deck, including air compressors and storage tanks, is located on the starboard side aft, by the machine shop.

The disk's life-support system can only be operated from the bridge, as an antihijack precaution. This allows the disk to function as the citadel where the crew can hold out even if the rest of the ship is taken. The life-support systems there include a small auxiliary fusion generator on the starboard side forward. As the disk contains part of the ship's fuel tankage, it can hold out for quite some time.

**Accommodations (Light Brown):** Staterooms in the disk accommodate 26 crewmembers: two bridge crew, both gunners, four command and the 18 fighter crew. The engineering quarters abaft (aft of) the flight deck house the engineer and the ship's steward. All 28 of these mess in the main deck galley in the disk forward.

The lower deck contains 13 staterooms (one dual and 12 quad occupancy) which house the 43 ship's troops, six fighter maintenance personnel and the ship's medic, who shares the double compartment across from the sickbay. The lower deck has its own galley which serves the 50 personnel berthed here. The sickbay at the aft end contains four beds, each of which doubles as a low berth.

Each stateroom contains one or two (for quad occupancy rooms) bunkbeds and a multipurpose head (bathroom) unit.

**Engineering and Drive Systems (Red):** The aft end of the lower deck contains the fuel purifiers and fuel pumps that supply the fusion power plant directly above. The main deck fusion plant supplies the power needs of every system in the ship save the jump drive and supports the twin maneuver units immediately abaft it. The main fusion plant is also connected by a row of three power columns to the jump drive fusion core immediately overhead. This allows the main fusion plant to draw from the fuel lines that feed directly into the jump fusion core from the dorsal spine in the event of damage to the main fuel pumps.

**Fuel (Green):** Fuel tankage is mostly wrapped around the lateral and ventral portions of the main hull, although there is also some tankage atop and beneath the forward disk. The main hull fuel is fed through the pumps on the lower deck aft, and the disk fuel passes through conduits in the dorsal spine.

**Embarked Fighters (Blue):** In order to fit into the cramped flight deck, the *Kestrel* and *Raptor* craft have folding atmospheric control surfaces. The wings flick out from slots in the fuselage, and the vertical surfaces—the rudder and wing fences—swing up from their flat folded positions.

**Miscellaneous Facilities (Gray):** The aft end of the lower deck provides 352 cubic meters (26 tons) of cargo space, serviced by a lift which runs up to the flight deck and can extend all the way to the ground when the ship is landed. The lift, when in its up position at the flight deck, creates an airtight seal to isolate the flight deck. When at its two lower positions, lower deck and landed, the flight deck and cargo hold become one continuous compartment for purposes of pressurization.

The armory, containing all the weapons used by *Vigilante*'s troop contingent, is just forward of the cargo area, protected by heavy locked doors.

The flight deck, which constitutes most of the main deck, is accessed by two large doors which hinge at the ship's spine. The lift allows cargo to be moved between the cargo hold and the fighters and landers.

The gooseneck between the main hull and the disk houses *Vigilante*'s EVA (extra-vehicular activity) facility, with an elevator that leads to the dorsal airlock and a closet storing a wide selection of vacc suits.

Connecting the main hull to the forward disk is the dorsal spine, running down the centerline, exterior to and above the flight deck. This spine carries power cables and fuel pipes from the engineering spaces aft, across the gooseneck and into the disk forward. The equipment packing the spine has made vision through the former dorsal bridge dome impossible, allowing conversion of the dome into a sensors and commo turret.

## SHIPS USED IN THESE ADVENTURES

Laruusaliin <i>Roughneck</i> -Class Frontier Fuel Harvester	
<b>CraftID:</b>	<i>Roughneck</i> -Class VTOL Frontier Fuel Harvester, Type (Z)TTP, TL6, MCr103.487
<b>Hull:</b>	180/450, Disp=200, Config=5SL/VTOL, Armor=40B, Unloaded=2307.6, Loaded=3485 (Customary take-off Load=2835)
<b>Power:</b>	3/6, ImplntCmbst=18Mw, Duration=2/6
<b>Loco:</b>	12/24, HiPerfRkt=1G/7020Tt, Duration=20min, Top=1000kph, Cruise=750kph, NOE= n/a
<b>Commo:</b>	2xradio=FarOrb
<b>Sensors:</b>	Radar=RegionalAIWthr, ActvIr, PassAud,ActvAud, EnvSnsr, MagSnsr, 2 xRadsnsr, ActvObjScan=Rou, ActvObjPin=Rou
<b>Off:</b>	None (2 hardpoints)
<b>Def:</b>	None
<b>Control:</b>	Computer=2bisx3, CPU=Electronicx1700, Environ=BscEnv, BscLs, ExtLs, 2xAirlock
<b>Accom:</b>	Crew=5x2 (Bridge=1, Eng=1, FuelOps=3), 10 bunks
<b>Other:</b>	Cargo/Fuel Storage Tanks= 650 kl, Cargo=25.6 kl, CryoFuel=1404 kl, HydrocarbFuel=36 kl, scoops

The *Roughneck* is a low-tech spacecraft of unusual design. Its purpose is to collect complex hydrocarbons from the atmospheres of large gas giants.

The *Roughneck* looks like a squashed sphere. It customarily begins its mission with an empty fuel storage cargo hold, reducing takeoff weight to 2835 tons. Therefore, lift-off acceleration is approximately 1.5G, meaning it can lift off even from airless worlds that do not allow it to use a lift-assisted take-off.

Once in space, the *Roughneck* travels out to the desired gas giant. Speed is of the essence, since the power plant burns the same precious hydrocarbons that the ship must gather for resale.

Arriving at the gas giant, the *Roughneck* rendezvous with a support craft or space station, where its cryogenic rocket fuel is replenished and its lift envelope (also called the "air bag") is connected. The lift envelope is an inflatable airfoil of immense volume (over 4 million cubic meters). As the *Roughneck* approaches the gas giant's atmosphere, it begins to collect hydrogen in its scoops to inflate the envelope. The hydrogen is pumped into the envelope through the same conduit that is later used as the run-off collection funnel to help fill the *Roughneck*'s collection tanks.

The lift envelope is useless at these higher altitudes, but becomes increasingly useful as the *Roughneck* descends into the gas giant's cloud layer where the atmosphere is denser. At full inflation, the lift envelope provides 3321 tons of lift—more than enough to keep the *Roughneck* from sinking further. At this point, the ship begins moving toward areas where "propane rain" is anticipated. Run-off vents and folds in the top of the lift envelope gather more of this rain than could be accomplished with the scoops alone, resulting in a rapid ability to fill all 650 kl of fuel storage space.

Tanks full, the *Roughneck* boosts back up to the higher reaches of the atmosphere, where it pumps its collected fuel into three external drop tanks. Small tenders remove these drop tanks, pump cryogenic fuel into the main rocket tanks and emplace new drop tanks. The tenders then take the full tanks back up to orbit.

The primary danger in a wildcatter's occupation is the need to deice the ship, which can be a risky proposition. Another common source of danger are the titanic lightning storms that occur in the atmospheres of large gas giants; a single bolt can disable the ship and ignite its fuel stocks.

The *Roughneck* utilizes a TL7 VTOL hull and TL7 control components. This makes the construction of each craft a painstaking effort for TL6 worlds, which have to fabricate special, purpose-built architectures for each model.

The statistics for the lift envelope are: *Inflated Displacement*: 20000 *Inflated Volume*: 4.05 million kl *Net Lift*: 3321 tons *Wgt*: 2025 tons *Deflated Volume*: 26,730 kl (although not necessary to use, this can fit in a 2000-ton carrier) *Price*: MCr 4.05.

The *Roughneck* incorporates elements of the pre-gravitic spacecraft design supplement (from *Hard Times*) and the aircraft design supplement (presented in *COACC*).

Termagant-Class Fighter	
<b>CraftID:</b>	<i>Termagant</i> -Class Fighter, TL11, MCr 31.33
<b>Hull:</b>	18/45, Disp=20, Conf=4SL, Armor=40E, Loaded=454.7, Unloaded=445.0
<b>Power:</b>	3/6, Fusion=270Mw, Dur=29/87
<b>Loco:</b>	3/6, Maneuver=6, Agility=0, TopSpeed=1000 kph, Cruise=750 kph, NOE=150 kph
<b>Commo:</b>	Radio=System, Laser=System, Maser=System
<b>Sensors:</b>	EMM, EMS(Act)=FarOrbit, EMS(Pass)=Interplanetary, ActObjScan=Rout, ActObjPin=Rout, PassEnScan=Rout
<b>Off:</b>	Hardpoints=1 Missile=x02 Batt 1 Bear 1
<b>Def:</b>	DM+3
<b>Control:</b>	Computer=3x3, HeadsUpDisplayx1, 40xDynLink
<b>Accom:</b>	Crew=1, Small Stateroomsx1, Seat=Roomyx2, Env=BscEnv, BscLs, ExtLs, GrvPlts, InrtlComp
<b>Other:</b>	Fuel=96 kl, BttyRnds=20, ObjSize=Avg, EmLevel=Faint

The *Termagant* is a long-endurance fighter built by a consortium of the independent contractors on Cumber (0532/Diaspora), although the design also sees widespread use in other sectors. It can be operated by a single crewmember, but usually carries two on long-duration patrol missions. This requires double occupancy accommodations and results in a high sociability rating as a requirement for prospective *Termagant* crewpersons.

Ramrod-Class Missile Boat (Corsair)	
<b>CraftID:</b>	Ramrod Missile Boat, TL13, MCr575.5
<b>Hull:</b>	900/2250, Disp=1000, Config=2SL, Armor=40G, Unloaded=15,888, Loaded=16,562
<b>Power:</b>	97/194, Fusion=13050Mw, Dur=34/102
<b>Loco:</b>	153/306, Maneuver=6, Agility=0, NOE=170 kph, Cruise=2835 kph, Max=3780 kph
<b>Comm:</b>	Radio=System, Laser=System, Maser=System
<b>Sensors:</b>	EMS Active(Far Orbit), EMS Jammer(Far Orbit), EMS Passive(Interstellar), High Pen Densitometer(100m), Neutrino Sensor(100kw) ActObjScan=Routine, ActObjPin=Routine, PassObjScan=Diff, PassObjPin=Diff, PassEnScan=Routine, PassEn Pin=Difficult
<b>Off:</b>	Hardpoints=10 Missile=x07 Batt 1 Bear 1
<b>Def:</b>	DM+7
<b>Control:</b>	Computer=7fibx3, LargeHoloDisplayx1
<b>Accom:</b>	Crew=10 (1 Command, 2 Bridge, 3 Engineer, 4 Gunnery), Staterooms=5, Env=BscEnv, BscLs, ExtLs, GrvPlts, InrtlComp
<b>Other:</b>	Fuel=6057 kl, BttyRnds=100, Fuel Scoops, Fuel Purifier (12hr), ObjSize=Large, EmLevel=Moderate

A mainstay of various home defense fleets throughout Solomani space and Imperial frontier regions, these cheap, mass-produced, single-purpose craft are often carried into combat by larger vessels.

Pirates, needing greater flexibility, often reduce the missile storage to 300 kl (BttyRnds=60) and convert the remaining space to accommodations where seven ship's troops are carried (or as many as 14 by "hot bunking").

Sentry-Class System Defense Boat	
<b>CraftID:</b>	<i>Sentry</i> -Class SDB, TL11, MCr426
<b>Hull:</b>	360/900, Disp=400, Config=4SL, Armor=52E, Loaded=11763, Unloaded=11520
<b>Power:</b>	83/166, Fusion=7428Mw, Duration=29/87
<b>Loco:</b>	62/134, Maneuver=6, Cruise=750kph, Max=1000 kph, NOE=150kph, Agility=0
<b>Comm:</b>	Radio=Systemx3, Laser=Systemx3, Maser=Systemx3

<b>Sensors:</b>	EMS Active(FarOrbit)x3, EMS Passive(Interstellar)x3, Neutrino Sensor(1GW)x3, HighPenDensitometer(1m), ActObjScan=Rout, ActObjPin=Rout, PassObjScan=Form, PassObjPin=Form, PassEnScan=Rout, PassEnScan=Form
<b>Off:</b>	Hardpoints=4 BLaser=x03 Batt 3 Bear 3
<b>Def:</b>	DM+9 SandCaster=x04 Batt 1 Bear 1
<b>Control:</b>	Computer=5fibx3, 9xHeadsUpDisplay, 740xDynLink
<b>Accom:</b>	Crew=10 (2 Bridge, 3 Engineer, 3 Gunners, 1 Command, 1 Medical), Staterooms=10, Env=BscEnv, BscLs, ExtLs, GrvPlts, IntrlComp
<b>Other:</b>	Fuel=2585 kl, Cargo=62 kl, Fuel Scoops, ObjSize=Large, EmLevel=Moderate

The *Sentry*-class SDBs were first built by a technical consortium on Dingir, prior to its reabsorption into the Third Imperium. The laser-only weapons package reflects an emphasis on reduced logistical requirements; missile resupply problems cannot affect the *Sentry's* offensive punch. An official IDP (Imperial data package) design since 434, vessels of this class may be found in planetary navies of this tech level throughout the Imperium and beyond.

#### Admiral Bertil-Class Modified Type M (Starmerc)

<b>CraftID:</b>	<i>Vigilante</i> , TL13, MCr606.8
<b>Hull:</b>	540/1350, Disp=600, Config=4SL, Armor=40F, Loaded=10625, Unloaded=3912
<b>Power:</b>	14/28, Fusion=1800Mw, Duration=30/90
<b>Loco:</b>	11/22, Maneuver=1, 22/44, Jump=3, NOE=40 kph, Cruise=750, kph, Max=1000 kph, Agility=0
<b>Comm:</b>	Radio=System, Laser=System, Maser=System
<b>Sensors:</b>	EMS Active(Planetary), EMS Passive(Substellar), Neutrino Sensor (100kw), HighPenDensitometer (100m), ActObjScan=Rout, ActObjPin=Rout, PassObjScan=Diff, PassObjPin=Diff, PassEnScan=Rout, PassEnPin=Diff
<b>Off:</b>	Hardpoints=6 Missile=x03 BLaser=x04 Batt 3 1 Bear 3 1
<b>Def:</b>	DM+8 SandCaster=x04 Batt 2 Bear 2
<b>Control:</b>	Computer=7x3, 2xHeadsUpHoloDisplay
<b>Accom:</b>	Crew=78 (2 Bridge, 1 Medic, 1 Engineer, 24 Flight, 43 Troops including troop command, 4 Command including CO and XO, 2 Gunner, 1 Steward), Staterooms=39, Env=BscEnv, BscLs, ExtLs, GrvPlts, IntrlComp
<b>Other:</b>	Fuel=2340 kl, Fuel Purifier=80 kl, Cargo=337kl (25t), BttyRnds=90, Fuel Scoops, ObjSize=Average, EmLevel=Moderate Subcraft=6x20 ton craft

The *Vigilante* (originally *Admiral Bertil*) is a specially modified Type M liner. Although *Vigilante's* internal arrangement is unique, the *Admiral Bertil* name has been given to a number of Type M conversions that have been made throughout the Diaspora Sector. As all of these vessels were made individually to the same overall plans, they conform closely to the figures above, but all have variations in internal layout and equipment due to local availability and conditions.

The upgrade to a Model 7 computer reduces the required operating crew to two. The small TL13 fuel purifier indicated is unique to *Vigilante*, and purifies 229 kl of fuel per hour, or 61.4 hours for the full load. Power allocation is such that the lasers cannot be operated at the same time as the grav plates and the inertial compensators.

The cost given includes the price of the six landers, although *Vigilante* is equipped with five *Kestrel*-class fighters and one *Raptor*-class lander.

#### Kestrel-Class Interface Fighter (Starmerc Subcraft)

<b>CraftID:</b>	<i>Kestrel</i> -Class Fighter, TL13, MCr88														
<b>Hull:</b>	9/23, Disp=10, Conf=1AF, Armor=40F, Loaded=153.6, Unloaded=150.2														
<b>Power:</b>	1/2, Fusion=135Mw, Dur=15/45														
<b>Loco:</b>	1/2, StdGrav=700 kph, Max=3150 kph, Cruise=2363 kph, NOE=170 kph, MaxAccel=3.5G, Agility=0														
<b>Comm:</b>	Radio=System, Laser=FarOrbit, Maser=Planetary														
<b>Sensors:</b>	EMSActive(FarOrbit), EMSPassive(Interstellar), Neutrino Sensor (100kw), LowPenDensitometer (50m), ActObjScan=Rout, ActObjPin=Rout, PassObjScan=Diff, PassObjPin=Diff, PassEnScan=Rout, PassEnPin=Diff														
<b>Off:</b>	Hardpoints=1 Missile=x03 Batt 1 Bear 1 Antipersonnel Beam Laser														
	<table border="1"> <thead> <tr> <th>TL</th> <th>Pwr</th> <th>Vol</th> <th>Weight</th> <th>Pen</th> <th>Dmg</th> <th>Range</th> </tr> </thead> <tbody> <tr> <td>8</td> <td>50.0</td> <td>3.30</td> <td>3.30</td> <td>55/4</td> <td>100</td> <td>Regional (250)</td> </tr> </tbody> </table>	TL	Pwr	Vol	Weight	Pen	Dmg	Range	8	50.0	3.30	3.30	55/4	100	Regional (250)
TL	Pwr	Vol	Weight	Pen	Dmg	Range									
8	50.0	3.30	3.30	55/4	100	Regional (250)									
<b>Def:</b>	DM+4, Point Defense Targeting for Laser														
<b>Control:</b>	Comp=3x3, HoloLinkx40														
<b>Accom:</b>	Crew=3 (Commander, Gunner, Pilot), Seats=Roomy x3, Bunks=2, Env=BscEnv, BscLs, ExtLs, GrvPlts, IntrlComp														
<b>Other:</b>	Fuel=27 kl, ObjSize=Avg, EmLevel=Moderate														

The *Kestrel* is an IDP design produced (under license) by Ling Standard Products. It is manufactured throughout the Imperium. The *Kestrel* is a compromise design. Some capability for space combat was considered to be essential, but the vehicle's primary role is atmospheric combat. Accordingly, the computer installation was limited to a Model 3, which still accounts for 50% of the vehicle cost. However, for starmerc units which require a great deal of versatility in their subcraft, the *Kestrel* is an excellent, and frequent, choice.

#### Raptor-Class Combat Lander (Starmerc Subcraft)

<b>CraftID:</b>	<i>Raptor</i> Combat Lander, TL13, MCr 57.5														
<b>Hull:</b>	19/48, Disp=20, Config=1AF+turret, Armor=60F, Loaded=1018.4, Unloaded=1014.4														
<b>Power:</b>	5/10, Fusion=576Mw, Dur=36hrs														
<b>Loco:</b>	7/14, StdGrav=4500 kph, Max Speed=3090 kph, Cruise=2317 kph, NOE=170 kph, MaxAccel=3.4G, Agility=0														
<b>Comm:</b>	Radio=System, Laser=System, Maser=System														
<b>Sensors:</b>	EMM, EMS Active(Planetary), EMS Jammer(Planetary), EMS Passive(Substellar), LowPen Densitometer(50m), Neutrino Sensor(100kw), ActObjScan=Diff, ActObjPin=Diff, PassObjScan=Diff, PassObjPin=Diff, PassEnScan=Routine, PassEnPin=Diff														
<b>Off:</b>	Hardpoints=1 Missile=x03 Batt 1 Bear 1 Antipersonnel Pulse Laser														
	<table border="1"> <thead> <tr> <th>TL</th> <th>Pwr</th> <th>Vol</th> <th>Weight</th> <th>Pen</th> <th>Dmg</th> <th>Range</th> </tr> </thead> <tbody> <tr> <td>8</td> <td>100.0</td> <td>3.30</td> <td>3.30</td> <td>57/4</td> <td>100</td> <td>Regional (250)</td> </tr> </tbody> </table>	TL	Pwr	Vol	Weight	Pen	Dmg	Range	8	100.0	3.30	3.30	57/4	100	Regional (250)
TL	Pwr	Vol	Weight	Pen	Dmg	Range									
8	100.0	3.30	3.30	57/4	100	Regional (250)									
<b>Def:</b>	Point Defense Targeting for Laser, DM+3														
<b>Control:</b>	Computer=3x4, HeadsUpHoloDisplayx1, HoloLinkx26														
<b>Accom:</b>	Seats=Roomy x16 (Commander, Pilot, Gunner, 13 Passengers), Env=BscEnv, BscLs, GrvPlts, IntrlComp														
<b>Other:</b>	Fuel=11.52 kl, Cargo=3.2 kl, BttyRnds=10, ObjSize=Avg, EmLevel=None														

The *Raptor* is another IDP design, essentially an enlarged *Kestrel*, which serves as a multifunction vehicle. Capable of performing as a space or atmospheric fighter, it is also equipped to land a squad of 12 infantrymen. Endurance was sacrificed to provide the other desired operating features. The *Raptor* carries a space-rated triple missile turret, as well as a remote-operated, 100Mw pulse laser in a belly turret.



**Promise Subsector (L/Diaspora Sector) as of 001-1121**

Name	Hex	UWP	Class	PPG	Alg	Str	Zv/Sp
Seagull	2521	D7B1430-9	Ni FI	103	U	G2 V	
Amoy	2524	D454634-8	Ni Ag	305	U	G0 V	
Baraduusa	2528	C342231-D	Ni Po Lo	215	U	G3 V	
Ferenira	2724	B100165-F	Ni Va Lo	123	U	M3 V	Muni
Daallisa	2725	D7677B8-7	Ag	A114	U	M1 V	
Eloji	2728	B846647-C	Ni Ag	302	U	M0 V	
Exeter	2729	A769895-F	Ri	524	U	K3 V M9 D	
Muni	2825	B3428C9-C	Po	A605	U	K4 VI M6 D	
Promise	2827	A542999-F	Hi In Po Cp	502	U	M1 V	
Poznan	2830	C232888-A	Po Na	403	So	M4 V	
Orsk	2922	B535321-F	N Ni Lo	A912	U	M4 V M9 D	
Lot	2925	A245666-F	Ni Ag	A503	U	M5 V	Muni
Vahana	2926	B65A577-F	Ni Wa	703	U	M2 V M5 D	
Udone	2927	A000599-F	Ni As	314	U	M0 V	
Gorky	2929	A200442-F	N Ni Va	911	U	G1 V	
Execute	2930	C684588-A	Ni Ag	303	So	M1 V	
Asena	3022	C354855-C		114	U	M7 II	
Napiresha	3023	B559230-D	Ni Lo	623	U	M6 V M3 D	
530-053	3027	X443201-7	Ni Po Lo	R822	U	M3 V M4 D	
Davao	3029	D100677-D	Na Ni Va	113	So	M3 V	
Nysorb	3030	C9B6525-C	Ni FI	733	So	K2 VI M4 D	
Tenmet	3121	B110725-F	Na	203	U	K2 III	
Tazmania	3123	A456527-F	Ni Ag	104	U	M1 V M9 D M6 D	
Sligo	3126	B878322-D	Ni Lo	703	U	K7 V	
Sittahr	3129	C766530-D	Ni Ag RsG	405	So	K0 V M3 D	
Ijiwa	3224	B300864-F	Va Na	202	U	M2 V M6 D	Prom
Lekhaana	3225	E100223-B	Ni Va Lo	424	U	G6 V	
Cosenza	3228	B527485-F	Ni	312	So	K2 V M2 D	

**Alg (Allegiance):** *Li*: Lucan's Imperium *So*: Solomani Confederation.  
**Sp (Special Indicator):** *RsG*: Diaspora Sector's Imperial Research Station  
*Gamma Muni*: Muni owns this world *Prom*: Promise owns this world.

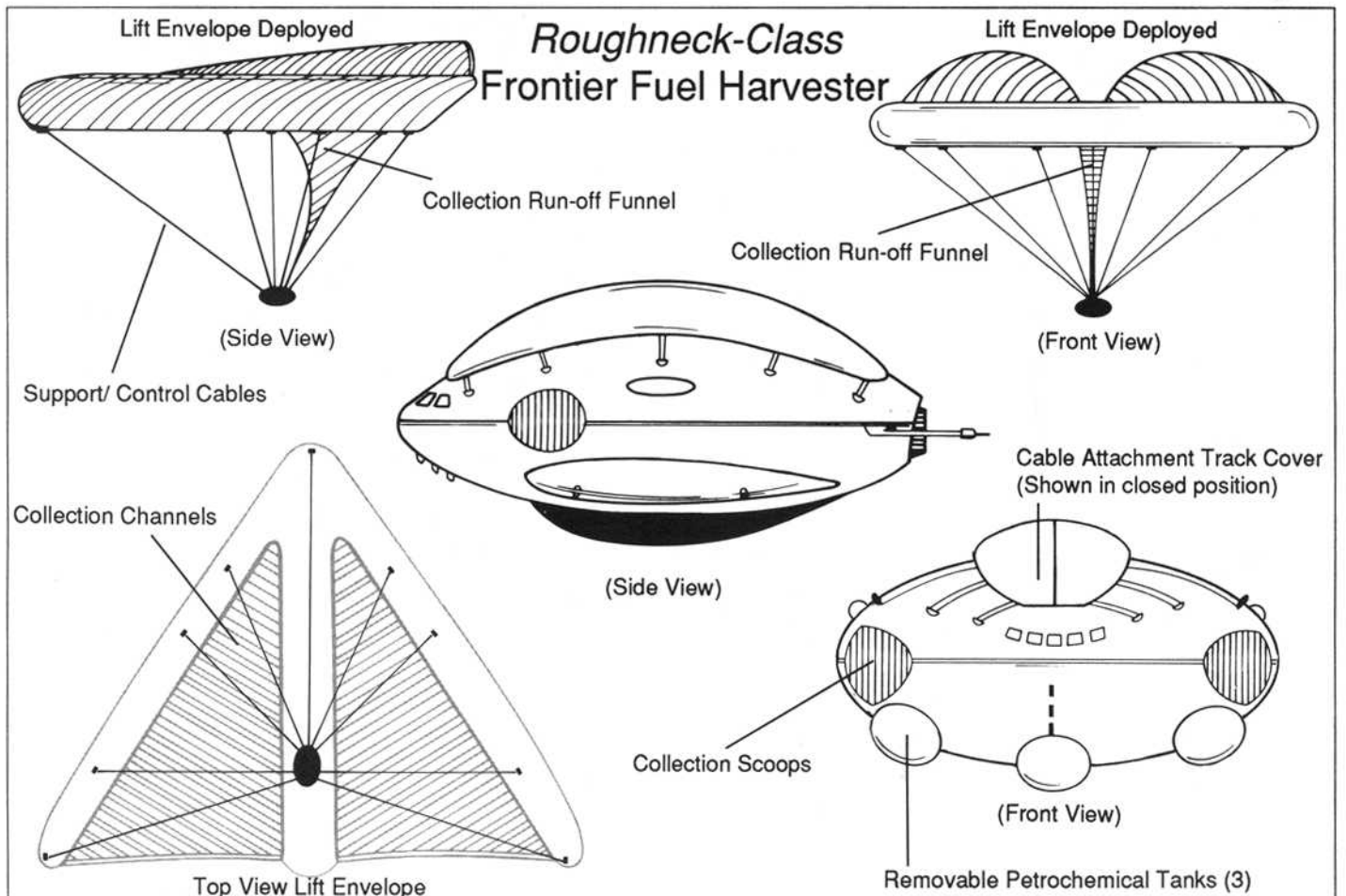
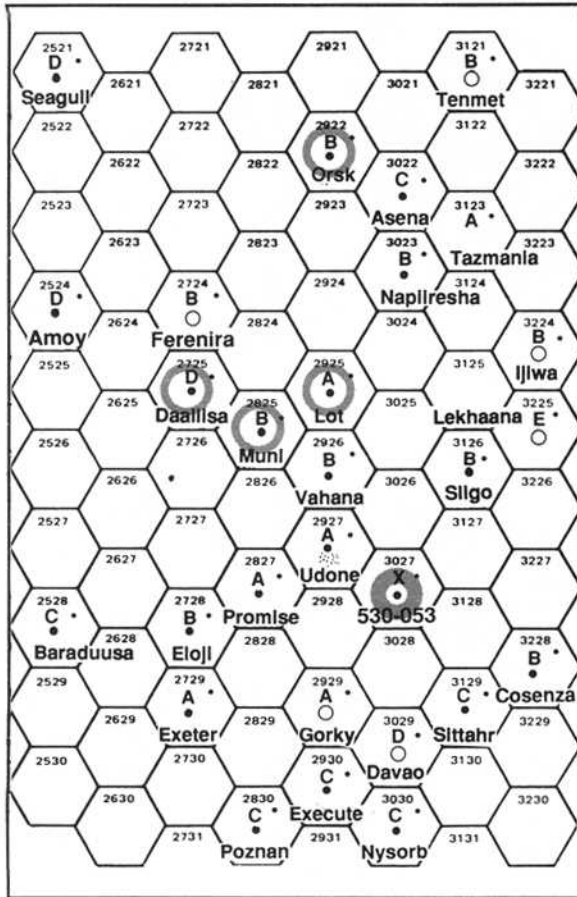

# STAR MERC: VIGILANTE

This trooper can be identified as an elite zero-gee trooper by his 6mm Instellarms TL 13 accelerator rifle. Specifically designed for zero-gee combat, it fires 5 gram bullets at low velocity, hence low recoil; the bullets then accelerate to 800 mps with internal rocket charges.

His combat armor is assembled from parts of at least two suits, as the arms and torso armor are of a different design from the leg armor. On his right hip he carries a reaction pistol attached by a hose to propellant tanks on his waist. This pistol allows him to maneuver across open areas in zero-gee conditions. On his other hip he carries a snub pistol, another standard low-recoil weapon. The orientation of the pistol butt shows that he is right handed, and that he gets more use out of the reaction pistol. Note that he has had to improvise holsters with buckled straps, as his thigh armor strangely has no holster attachment points.

In his bandolier he is carrying extra accelerator rifle clips and snub pistol cylinders.

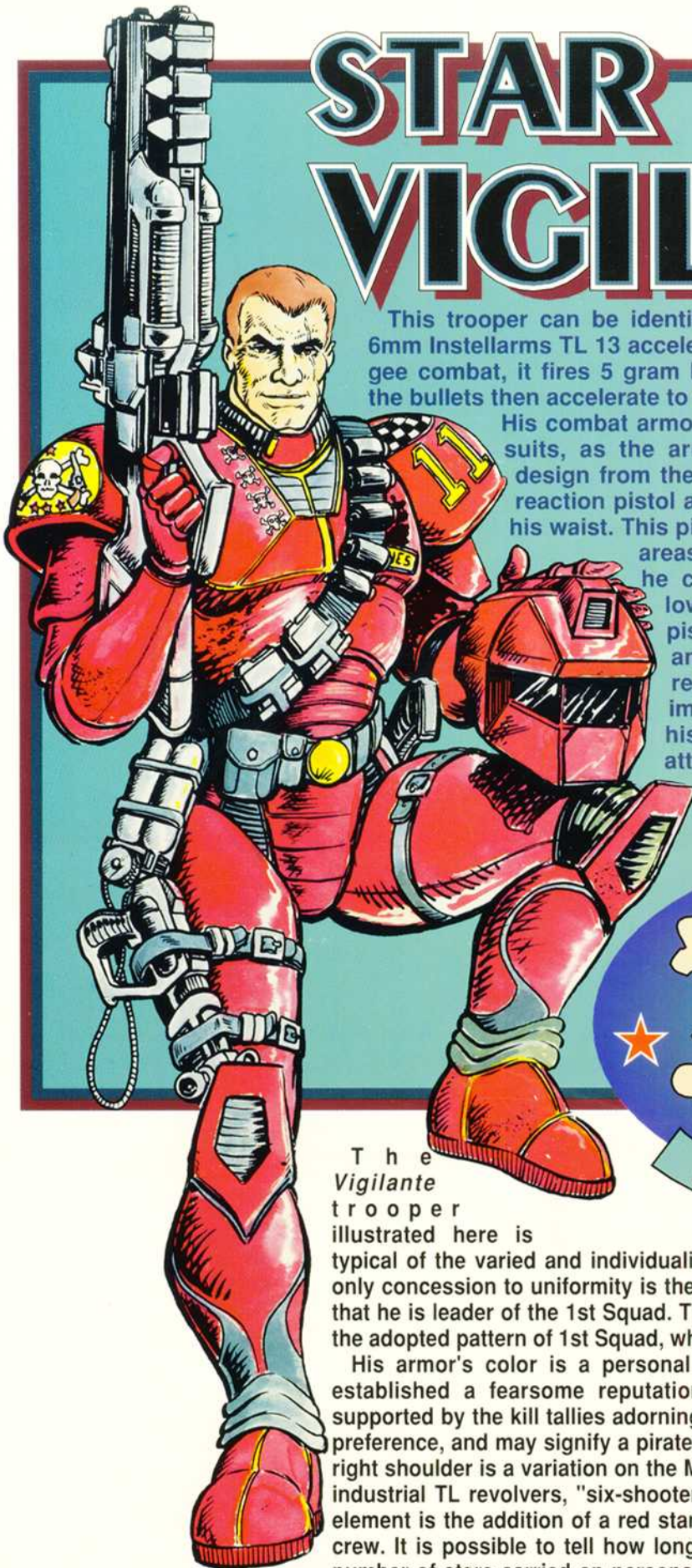

The Vigilante trooper illustrated here is

typical of the varied and individualistic appearance of starmerc ship's troops. The only concession to uniformity is the tactical ID code on his left shoulder, indicating that he is leader of the 1st Squad. The checkerboard pattern above the "taccode" is the adopted pattern of 1st Squad, which adorns much of their equipment.

His armor's color is a personal choice; this trooper clearly believes he has established a fearsome reputation, which the color enhances. This belief is supported by the kill tallies adorning his breastplate. These marks vary by personal preference, and may signify a pirate kill or a successful mission. The symbol on his right shoulder is a variation on the MSS *Vigilante* insignia. All of these involve early-industrial TL revolvers, "six-shooters", threatening a pirate "Jolly Roger." Another element is the addition of a red star for each pirate vessel destroyed by Vigilante's crew. It is possible to tell how long a crewmember has been with the ship by the number of stars carried on personal insignia. The trooper illustrated has been with "Viggie" for at least two pirate ship kills.

# STARSHIPS

of the Promise Subsector

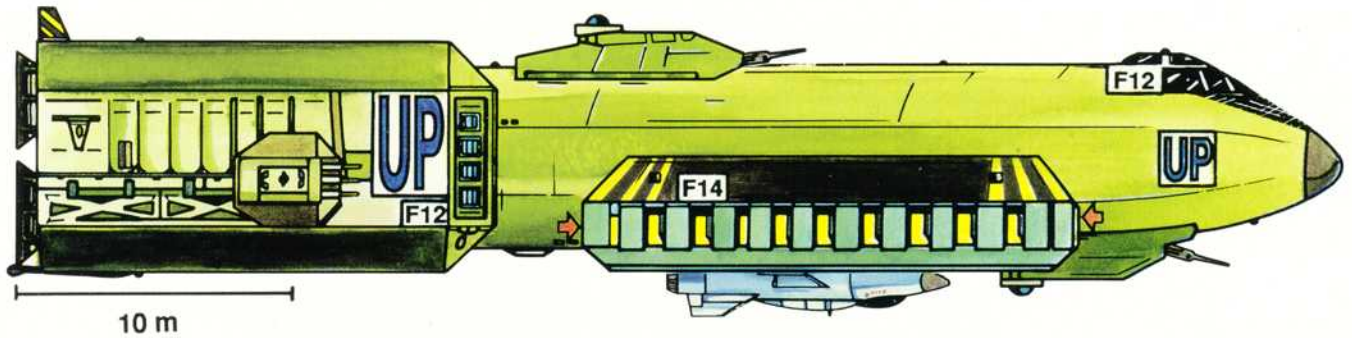

This *Gazelle*-class Close Escort, UPS *Covenant*, is one of six operated by the Unity of Promise for commerce protection. Styled as "frigates," they are numbered and marked F-11 through F-16. She is an early production model which has been retrofitted with the nose and high-visibility bridge of later production variants. She is finished in the green scheme of the former Promise planetary navy, with several large white and blue UP recognition panels added.

The markings on her drop tanks indicate that she is actually carrying the tanks of her sister *Pledge* (F-14). Another notable feature is that she has given up her standard equipment 30-ton gig in order to operate the sole remaining RF-128-1C *Rampart* fighter owned by the UP forces.

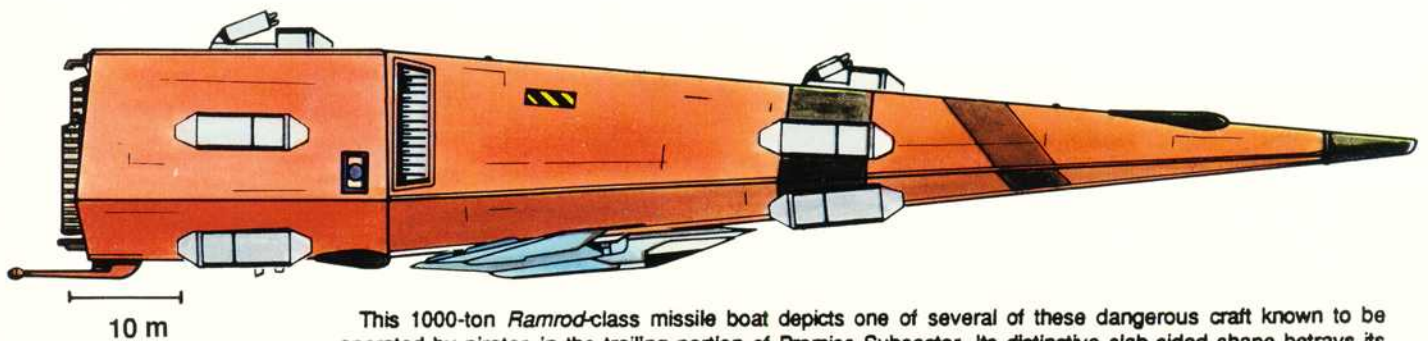

This 1000-ton *Ramrod*-class missile boat depicts one of several of these dangerous craft known to be operated by pirates in the trailing portion of Promise Subsector. Its distinctive slab-sided shape betrays its common heritage with the more familiar 400-ton SDB designs. Both of these types have traded interstellar mobility for enhanced combat characteristics, typically heavy armor. This choice can clearly be seen in the *Ramrod*'s hull lines: the thick armor plating cannot be easily formed into exotic curves, nor can it be too frequently pierced for hatches or cabling without compromising its purpose.

She is shown with a *Termagant*-class fighter, also known to be operated in some numbers by Promise's corsairs, in a belly-to-belly dock. The crimson paint scheme is typical of the ostentatious "fierce face" schemes popular among pirates in these lawless times.

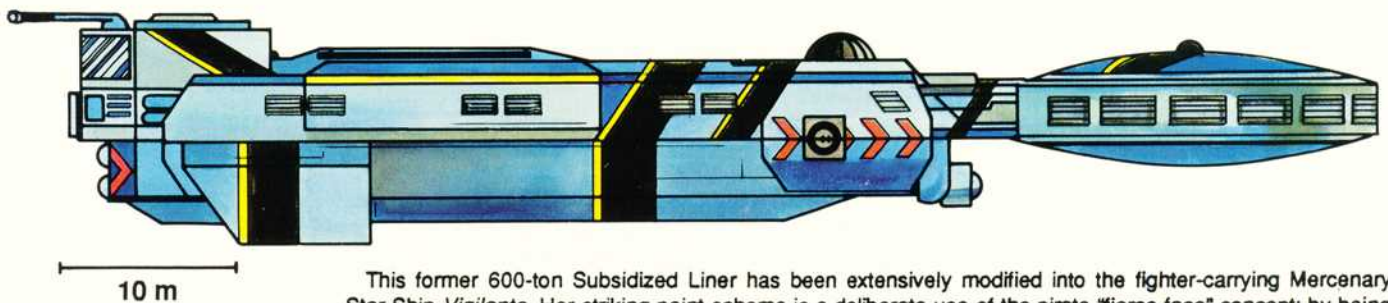

This former 600-ton Subsidized Liner has been extensively modified into the fighter-carrying Mercenary Star Ship *Vigilante*. Her striking paint scheme is a deliberate use of the pirate "fierce face" concept: by being clearly recognizable, a ship with a fearsome reputation can bolster its allies' morale and undermine its enemies'. And *Vigilante*'s reputation has grown to the point where that is a valid capability. The pattern does, however, destroy her formerly useful resemblance to a harmless liner.

The scheme also has tactical value. By differentiating the dorsal and ventral surfaces and marking turret arcs of fire with colored bands and chevrons, visual station-keeping by *Vigilante*'s fighters is made easier, even in the heat of combat.

She is shown with her latest field modification, a static discharge probe for use while skimming fuel.

Wings Swing Out

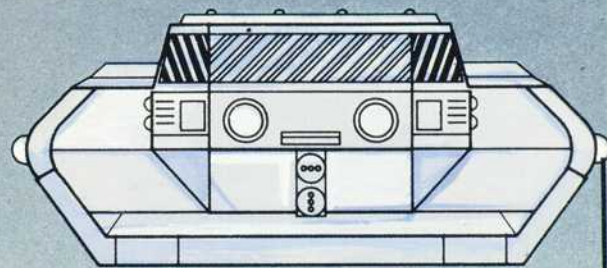
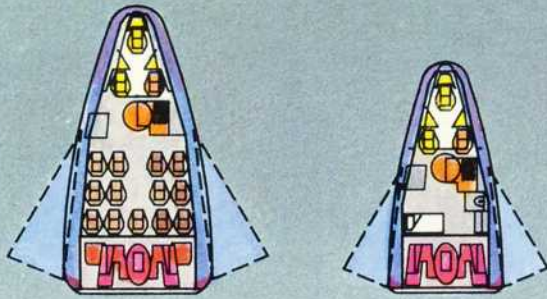

**OUTBOARD STERN**

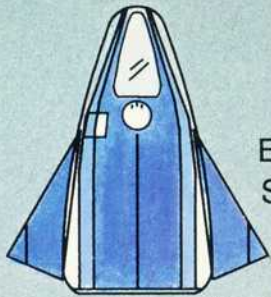

Environmental Systems

Vertical Surfaces Swing Up



Laser



Missile

**RAPTOR-CLASS COMBAT LANDER**

Port Missile Turret



Laser



Missile

**KESTREL-CLASS INTERFACE FIGHTER**

Laser

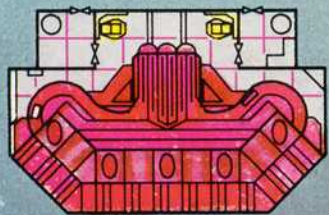

**JUMP DECK**

Storage Bridge

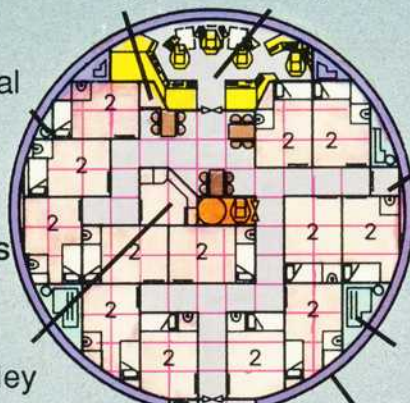

Storage

Environmental Systems

Galley

EVA Equipment

Sensor Array

Lift

Starboard Missile Turret

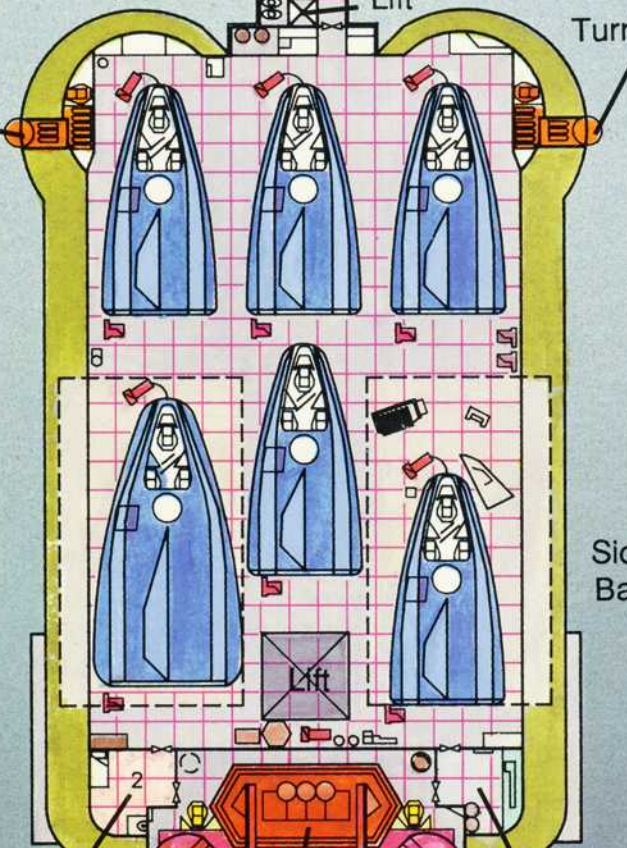

Engineering Quarters

Fusion Plant

Maneuver Drive

Machine Shop

Sick Bay

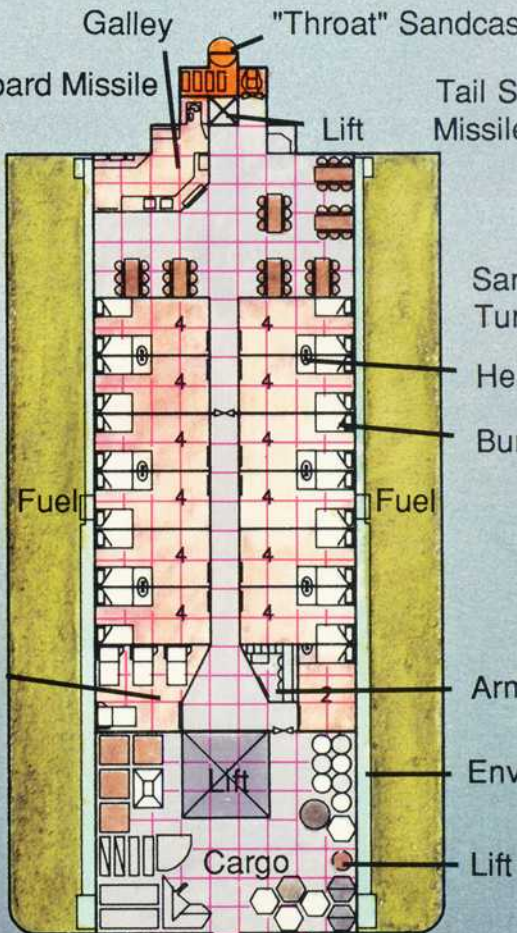

Fuel

Fuel

Sick Bay

Lift

Lift

Cargo

Lift

Fuel Pump

Fuel Pump

Sandcaster Turrets

**MAIN DECK PLAN**

**LOWER DECK PLAN**

Missile Turret

**OUTBOARD BOW**

Door

Missile Turret

"Throat" Sandcaster

Tail Sandcaster

Missile

Sandcaster

Turret

Head

Bulkhead

Bulkhead

Bulkhead

Bulkhead

Bulkhead

Bulkhead

Bulkhead

Bulkhead

Bulkhead

Bulkhead

Bulkhead

Bulkhead

Bulkhead

Bulkhead

Bulkhead

# The VIGILANTE

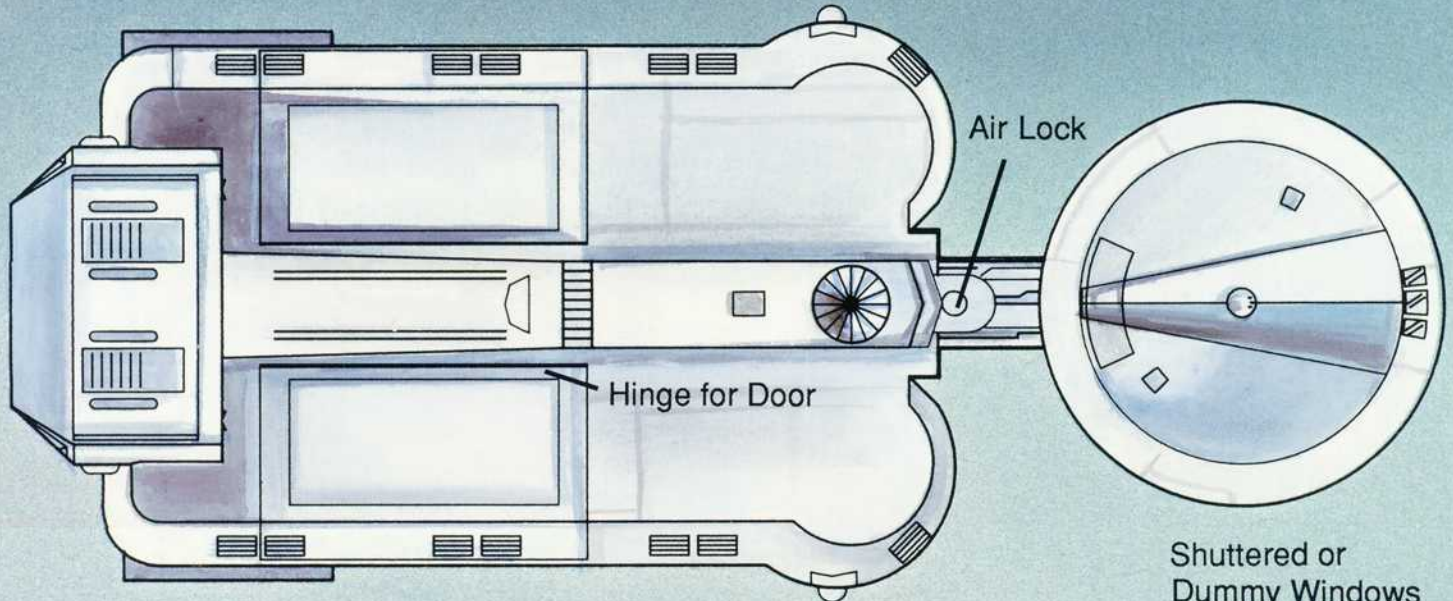

**OUTBOARD DORSAL PLAN**

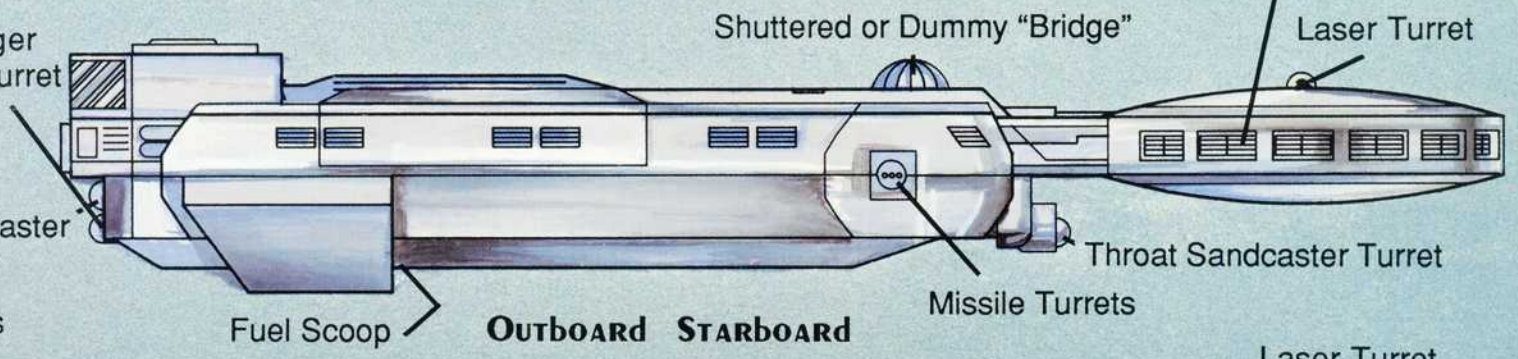

**OUTBOARD STARBOARD**

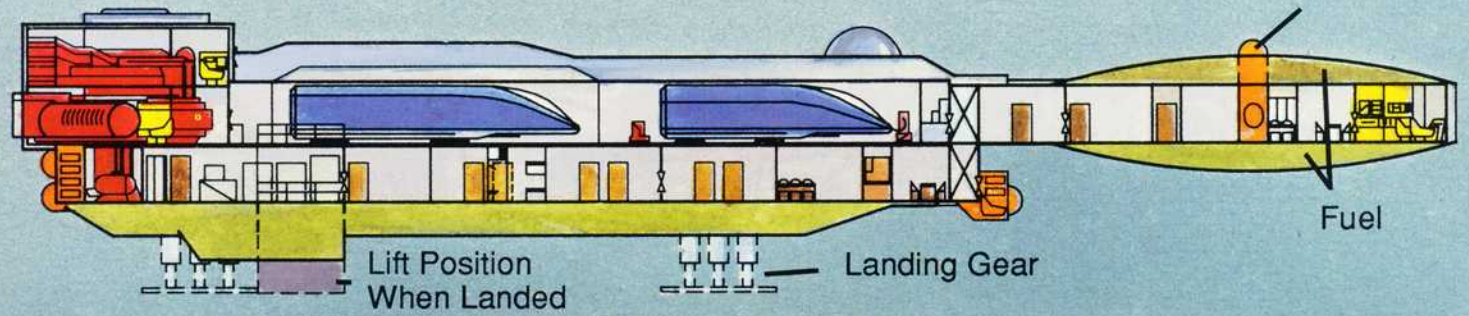

**STARBOARD CUTAWAY**

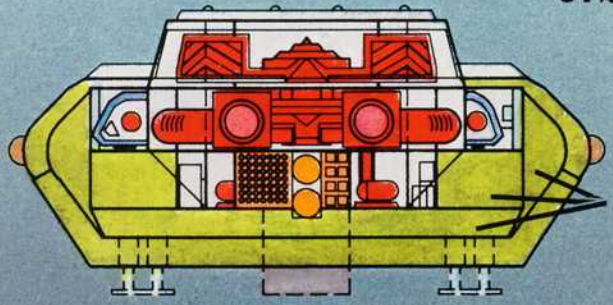

**STERN CUTAWAY**

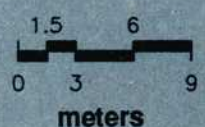

KEY	
Control Chair	Hatch Down
Bunk	Hatch Up
Iris Valve	Hatch Up & Down
Door	Heads

# FIGHT THE GOOD FIGHT



**IN THE WAKE** of the Rebellion, chaos rules over the once proud Imperium. Bands of corsairs stalk the spaceways, crippling the trade that had linked over 11,000 worlds. Without some force to permit the safe passage of trade, interstellar society cannot help but collapse.

Even in these dark times, people can still be found to shoulder the burdens of civilization. Among these are the crew of the starship *Vigilante*. A fighter-carrying mercenary ship, its dedicated crew of starmercs specializes in the eradication of pirate forces wherever they may be found.

Live the excitement of life aboard the *Vigilante*, battling pirates around the threatened worlds of the Diaspora Sector, infiltrating the ranks of deadly raiders, or fighting to the death inside a massive gas giant.

## ASSIGNMENT: VIGILANTE

Two tense scenarios pull the players into the struggle for the spacelanes of Promise Subsector. First, a search-and-retrieval job turns deadly, then the future of a small world requires an inside job to thwart an elaborate pirate plot.

**Included in the Assignment: *Vigilante* Campaign Folio are:**

- Full-color two-page deck plans of the starship *Vigilante*
- Detailed color diagram of Starmerc trooper equipment
- Full-color starship recognition chart
- 16-page campaign booklet containing background information to join the adventures into a full campaign set in the Promise Subsector of Diaspora. Features seven new MegaTraveller ship designs and up-to-date UWP information for Promise Subsector.

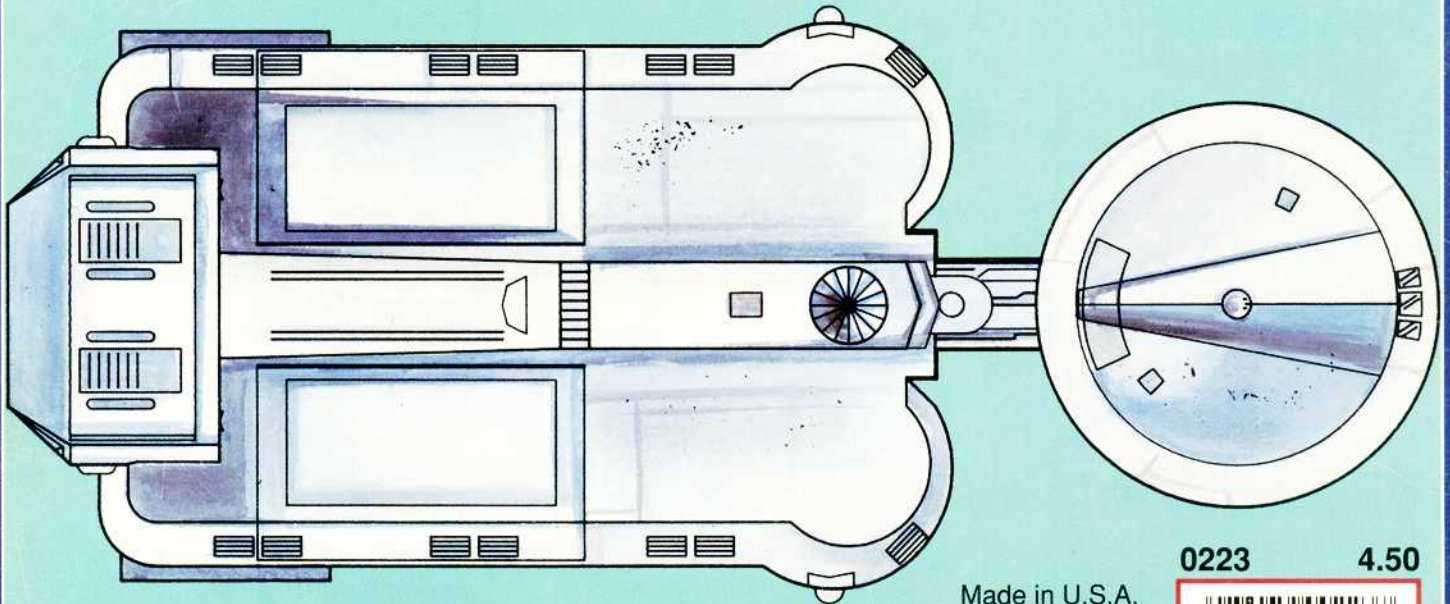

P.O. Box 1646  
Bloomington, IL 61702-1646

Made in U.S.A.  
Printed in U.S.A.  
All rights reserved.  
Copyright©1992 GDW, Inc.  
MegaTraveller™ is a  
trademark of GDW, Inc.

0223

4.50



ISBN 1-55878-127-7