

# T4 EMPEROR'S ARSENAL™

MARC MILLER'S TRAVELLER®





# **T4** **EMPEROR'S ARSENAL™**

MARC MILLER'S TRAVELLER®

## **Science-Fiction Adventure in the Far Future**

Armament procurement procedures of the Imperium on page 4.

Every weapon from a wooden spear to advanced battle dress starting on page 16.

Learn about the prohibitions against terrible chemical weapons on page 59.

Examine the thinking behind use of nuclear weapons on page 72

Calculate the cost of all types of ammunition using the rules presented on page 86.

Go beyond normal tech to weapons only dreamed of in Imperial arsenals on page 105.

The Master Weapons Table, with every weapon from every tech level, on page 107.

## **The Future is Around the Corner**

©1997 by Imperium Games, Inc. All rights reserved. This material is protected by the copyright laws of the United States of America. Any reproduction or unauthorized use of the material or artwork contained herein is prohibited without the express written consent of Imperium Games, Inc.

TRAVELLER is a registered trademark of FarFuture Enterprises. Used under license by Imperium Games, Inc.

The references to any companies or products in these pages is not a challenge to the trademarks of copyrights concerned.

## TABLE OF CONTENTS

<b>INTRODUCTION</b> .....	3
<b>IMPERIAL PROCUREMENT PRACTICES</b> .....	4-6
Quality Standards .....	4
Official Nomenclature .....	4
Sample Procurement .....	6
<b>NEW WEAPON RULES</b> .....	7-11
Malfunctions .....	7
Environmental Hazards.....	7
Special Weapon Effects .....	8
<b>TECH LEVEL 0</b> .....	12-13
<b>TECH LEVEL 1</b> .....	14-17
<b>TECH LEVEL 2</b> .....	18-20
<b>WEAPON TECHNOLOGIES</b> .....	21-22
<b>TECH LEVEL 3</b> .....	23-25
<b>TECH LEVEL 4</b> .....	25-28
<b>SIGHTING AIDS</b> .....	29-30
<b>TECH LEVEL 5</b> .....	31-37
<b>TECH LEVEL 6</b> .....	38-42
<b>TACTICAL ROLES OF WEAPONS</b> .....	43-44
<b>TECH LEVEL 7</b> .....	45-50
<b>TECH LEVEL 8</b> .....	51-57
<b>CHEMICAL WEAPONS</b> .....	58
<b>TECH LEVEL 9</b> .....	59-63
<b>TECH LEVEL 10</b> .....	64-70
<b>NO NUKES</b> .....	71
<b>TECH LEVEL 11</b> .....	72-77
<b>TECH LEVEL 12</b> .....	78-84
<b>AMMUNITION COSTS</b> .....	85
<b>TECH LEVEL 13</b> .....	86-91
<b>TECH LEVEL 14</b> .....	92-97
<b>LAW LEVELS</b> .....	98-99
<b>TECH LEVEL 15</b> .....	100-103
<b>TECH LEVEL 16</b> .....	104-105
<b>MASTER WEAPONS TABLE</b> .....	106-110

## CREDITS

**Design & Writing**  
Greg Porter

**Editing**  
Tony Lee

**Assistance**  
Timothy Brown  
Cathy DeMott

**Interior Art**  
Bryan Gibson  
*Assisted by*  
Ashe Marler  
Steve Bryant

# INTRODUCTION

---

Welcome to the Inaugural Edition of *Carnak's Surface Weapons*. This is the first of several known space databases, which are the definitive yearly reference to Sylean, Imperium and non-Imperium hardware of all kinds, including *Carnak's Jump and System Ships*, *Carnak's Surface Transports*, *Carnak's Sensors and Communications* and *Carnak's Ship Support Systems*.

Year 59 sees continuing expansion of the Imperium under the rule of Emperor Cleon I, with exploration and trading vessels leaving and arriving at Sylea on a daily basis. The Dynari and Mioza civilian shipyards are still running at 100% capacity, and while Navy construction tonnage figures are classified, Navy recruiters are still paying large signing bonuses to experienced zero-G industrial workers and naval architects. At least two firms have subcontracts with other worlds to provide unfinished hulls, which are brought to Sylean space on huge dispersed frame cargo ships, to be fitted with locally produced thruster plates, drives and sensors. Supply is beginning to approach demand, and inflation of subsystem prices is expected to decline as normal market forces take their course.

The continued expansion of Imperium space has brought contact with worlds that have been out of touch for centuries. Records often exist of occasional visits by scout ships from worlds still maintaining an interstellar presence, but regular trade and communication is being re-opened with many long-silent worlds. Sometimes these worlds are not open to outside trade or exploration, or are engaged in intra- or inter-planetary conflict and see any outside influence as potentially hostile. On the other hand, many newly visited worlds are eager to join the Imperium, trade and

upgrade their arsenals, and the astute trader can acquire local weapons at a discount and resell them to a more primitive world looking to upgrade as well, but with less goods or currency to use as payment.

The *Carnak's Surface Weapons* database provides the constantly updated information you need to make tactical, diplomatic or mercantile decisions when dealing with the potential threat or profit to be found in the military hardware of newly contacted cultures. Last, arms traders dealing in Imperium-standard weaponry will find our Imperial Procurement policies section an invaluable resource and sales tool when providing weaponry to skeptical clients or those with special tactical or environmental needs.

The publishers of *Carnak's Surface Weapons* would like to express their thanks to Viscount Lec Marlmir for access to his database and collection of Vilani Empire weaponry, the crew of the merchantman *Dwbetag* for their interviews and personal notes following their ill-fated expedition to Gak, and the countless others whose efforts have made it possible to compile this database and make it accessible to everyone under one title.

Major G.G.Troerpre (ISN, Retired), Editor  
132-0059

## WEAPON CHRONOLOGY

For reference, most casual students of weapon history classify developments, weapon types and manufacturing types into a system of tech levels, as is commonly used for other incrementally improved technologies. Note that statistics are provided for weapons only. For heavy weapons, side items like carriage, tripods, and so forth are not counted unless explicitly mentioned. If a mounted weapon is capable of being dismounted and used in a man-portable or mobile

application, a reasonable assumption is a 20% mass penalty to any mobile part (including ammunition storage) to take the required accessories into account. *Carnak's Surface Weapons* will use the commonly accepted technological breakpoints. The information below has been compiled from historical data and preliminary scouting reports from over 183 worlds, and the weapon performances listed are representative of the tech level specified.



# IMPERIAL PROCUREMENT PRACTICES

---

## Quality Standards

Imperium procurement procedures are extremely strict, and designed to allow only weapons with long-term compatibility with the current and anticipated needs of Imperium military forces. Second-line or reserve equipment may not meet all of these qualifications, since the standards were not in force when they were produced, but all front line and current Imperium-issue weapons will have the following characteristics:

**Environment Tolerance:** At a minimum, all Imperium-issue weapons can operate without penalty in vacuum and high atmospheric pressure environments (atmospheres 0 through A), wet or dry, in temperatures ranging from -50°C to +50°C. They are expected to perform with little modification at 50°C beyond either extreme. This necessitates the use of high quality materials and rigorous testing by any potential Imperium contractor. Most weapons are not expected to perform in liquid environments, but should not be adversely affected by extended exposure to same. In addition, all Imperium-issue weapons will be designed for corrosion and insidious environment resistance, but survival to long-term exposure is not mandatory.

That is, if it has the Imperium sunburst on it, you can dump it in a bucket of muddy salt water, store it overnight in the freezer, dump it in a vat of boiling water to melt the ice, rinse it off and it damn well better work flawlessly or "Uncle Cleon" will come down on the manufacturer like a ton of plascrete. They are designed to accept protective coatings with little modification if required for protection against a specific environment, or to be easily decontaminated with few or no tiny cracks/crevasses for chemicals, debris or micro-organisms to lodge in.

**User Tolerance:** All Imperium-issue weapons must be able to be fired, reloaded, readied and unreadied by a person in any Imperium-issue protective gear, including hazard suits, pressure suits, EVA suits and regular and augmented battle dress. This can be through weapon adjustment, but all such parts must be stored on or in the weapon.

Normally, Imperium-issue weapons will have larger than normal trigger guards, and have a "space suit" trigger guard stored in a hollow grip or mounted flush with some other weapon part. The space suit trigger guard is usually big enough to get the entire hand inside it. Weapons may also have extended or enlarged controls for gauntleted use. Since Imperium-issue weapons are not meant for concealed carry, this is seldom a problem.

**Forward/Backward Compatibility:** All Imperium-issue hardware and software will be physically and technologically compatible with similar hardware and software currently in second-line service.

Basically, Imperium-issue weapons will have compatible hardware and software for one tech level in either direction. Your TL12 weapon sight will integrate with a TL11-13 rifle. It will mount on the weapon without modification, and the power supply and computers will talk to each other with no alterations needed. This often makes such hardware and software a little more expensive due to circuitry and data paths that would not be needed if it weren't for this compati-

bility requirement. While it is more likely that Imperium-issue weapons will be compatible for more than one tech level in either direction, it is not guaranteed. For Imperium standard weapons at a two tech level difference, the chance of partial compatibility is a 2D roll of 5-. So, while your TL12 ACR will work with TL11-TL13 accessories, the chance that the TL11 ACR will work with TL13 accessories is only a 5-. It is unlikely that any technological weapon accessories will work over more than a range of two tech levels.

Weapons and accessories made by non-Imperium contractors will often be slightly cheaper, but may only be partially compatible with Imperium-issue equipment. There is an extensive aftermarket in add-ons for Imperial-issue weapons. Planets desiring compatibility may acquire stripped-down Imperium-standard weapons, and save money by purchasing non-standard sighting aids and other add-ons. These will work with the weapon in question, but may not work with newer or older models, or have some other compatibility problem.

**Parts Integration:** Any Imperium-issue weapon using a technology identical to one in Imperium service will use the exact same part design whenever possible.

Any two Imperium-issue weapons using the same general technology will have a 2D chance of 9- of having compatible parts for repair purposes. So, if your 7mm machinegun breaks down, there is a 9- chance that you can scrap a 7mm assault rifle to get the parts you need. Apply a DM-2 for each TL of difference between weapons.

## Official Nomenclature

By Imperial fiat, all new military hardware will have a alpha-numeric nomenclature for database and tracking purposes, and all second-line hardware is being reclassified according to this system. For infantry weapons, the encoding is in the form x[Y]Y000z, where "x" is the technology the weapon is based on, "[Y]" is an optional function designator in single digit numeric format, "Y" is the type of weapon, "000" is the Imperial Year the weapon was first manufactured in, and "z" is an optional suffix not currently used. The format allow easy interpretation by technicians and supply personnel. The "x" parameter is mostly of interest to technicians, while "[Y]Y" is more of interested to logistics and tacticians. All Imperium-issue weapons are usable by humans unless otherwise specified.

Index x[Y]Y000z

- c Cartridge. Uses conventional propellants to fire a projectile of some kind.
- e Explosive. Some type of munitions that destroys itself when used.
- l Laser. Uses a laser beam as the primary form of energy delivery. No infantry weapons currently use this designator.
- g Gauss. Uses magnetic acceleration to fire a projectile of some kind.
- f Plasma. Uses acceleration of a magnetically contained plasma as the primary form of energy delivery.

- r Rocket. Uses a reaction engine of some type to deliver either a kinetic energy or other payload.
- a Antigrav. Uses a reactionless engine of some type to deliver either a kinetic energy or other payload.

Note: Civilian manufacturers eager to export weapons have co-opted this nomenclature scheme, and produce a number of weapons bearing other letter combinations. Use of the above letters is restricted by Imperium law to Imperium-issue weapons, and other letters do not imply Imperium approval or adoption of the weapon. The popular pR903 is an example. While it is a modified, license-built copy of the cR898, it is not approved for Imperium issue, and has not undergone the rigorous testing and inspection procedures the cR898 has. However, many buyers assume the similar type designation carries with it some implied quality standard, which is not the actual case.

#### Index x[Y]Y000z

Currently this is used as a personnel designator. If it is absent, the weapon can be fully utilized by a single individual. Otherwise:

- 1 Weapon may be fired by a single individual, but requires one support person for full tactical flexibility. A dismountable weapon that requires two people to carry it is an example.
- 2,3 Weapon requires two, three or the listed number of dedicated operators.
- 0 Weapon is autonomous and requires no operator in current tactical deployment.

#### Index x[Y]Y000z

- P Pistol. A weapon which can be fired from one manipulative appendage of most known sentient species.
- R Rifle. A weapon which is normally fired from two manipulative appendages of most known sentient species.
- V Vehicular. A weapon which is exclusively used in a vehicle armament or emplaced role.
- S Support. A weapon which may either serve as tertiary vehicle armament, a transportable asset or as armament for battle dress or augmented battle dress units.
- E Emplaced. Some type of stationary weapon not suitable for mobile use.

#### Index x[Y]Y000z

000 Imperial Year of introduction. Existing weapon stocks have been reclassified according to this scheme. For instance, the Multon KC11A3 battle rifle has been redesignated the cR898.

#### Index x[Y]Y000z

In the event that minor changes are made to a weapon that do not warrant a new designation, an "a", "b" or other sequentially allocated letter will be used to identify the altered design. The next revision of the cR898 will be the cR898a, for example. By Imperium standards, such a revised weapon system must be 100% forward and backwards compatible with all previous weapons of the same designation. Letters u-z are reserved for alien compatibility variants, while n-t are reserved for platform variants such as towed weapons or environment-specific versions.

## Sample Procurement

If a branch of the Imperium Armed Forces decides it needs a new weapon design, a specification sheet is produced by the branch of the military requesting the weapon (Navy, Army, Marines, or a specialized branch of one of these services). This is then forwarded to the procurement bureaus of the other military branches, and to the government of any Imperium world requesting it. After a suitable comment period (several months to a year), requests for changes or additions to the specifications are acted on, and forwarded back for further comment. After a shorter comment period, final changes to the specifications are made, and the results compiled. This is known as a "request for bids", or RFB.

The specification process is time consuming, and filled with more squabbling and intrigue than is usually ever publicly known. For instance, a world just gaining the industrial capacity to build the weapon might try to delay its changes or additions to give itself more time. A world or noble with a friend in high places might try to skew the specifications to give a particular manufacturer an edge in the bidding. For instance, making the specifications require a particular protective coating that, coincidentally, only one company has the manufacturing rights to. The end result is up to the procurement office to thin down to a weapon that is actually usable. They do a pretty good job most of the time, since all weapons must pass certain requirements, but there is almost always a little something that gets by them, which ends up as big profits for the company that finally gets the contract. Industrial espionage is common, expected, and guarded against. Professional freelancers are often involved to protect company reputation and provide plausible deniability.

The RFB goes out to a select group of manufacturers, but is also publicly available, and can be bid on by anyone. The bid documentation is a painfully dense process, requiring masses of data on everything from employee security clearance to subcontractors used, location, manufacturing equipment, suppliers of raw materials and literally thousands of other bits of minutia. For a sophisticated weapon system, this is a rating (weapon TL-6) computer task, provided the computer has the specialized "Imperial Bid Assistant" software (only Cr5000, plus Cr1000 per quarter for updates based on bid process changes).

The three lowest bidders are notified within a week of the bid submission deadline. Then the mayhem begins. These three manufacturers must produce a sufficient quantity of weapon prototypes to allow competitive testing. For small arms, this is usually 100 units and 100,000 units of ammunition if a new ammunition is required or needed. For larger items, 10 units are required.

These prototypes are usually made to the highest standards, and cost anywhere upwards of 10-100 times the normal cost when R&D is taken into account. The mass-produced winner of the process is expected to perform equally well as these finely-tuned prototypes. More than one contractor has been burned by not being able to mass produce in the same quality as the Imperium was led to expect. If characters are arms magnates, assume the cost of these prototypes is 10x the "retail" cost of the item. If they are submitting a Cr1000 battle rifle, then they need to deliver 100 of them at a cost to the company of Cr10,000 each, or a MCr1 investment that may never pay off. If the contract is



approved, most of the time it will include a clause where the Imperium pays for the production cost of these prototypes, which are used for destructive testing or farmed out to military bases as museum pieces or non-functional displays. Sometimes, the Imperium will pay the production cost of weapons it *doesn't* decide to acquire, simply to keep possession so that the prototypes stay off the gray market.

Approximately half the prototypes are used and used up in controlled testing, while the remainder are shipped to line units for supervised field tests. Manufacturer representatives are often on hand for both parts of testing, to train, advise and put a positive spin on their particular product.

A little sabotage has been known to occur as well. At this point, the successful bidders haven't received a single Cr from the Imperium. All the R&D, manufacturing, shipping and training has been done solely at their expense, and if they don't get the final contract, they go home with nothing but what is left of their prototypes after the testing process is over. So, manufacturers have a lot of incentive to see that they win that contract. Collectors will pay premium prices (5-10x "retail" price) for prototypes of important weapon developments, and a few prototypes almost always leak into the gray market economy unless they use classified or restricted forms of technology. For instance, a prototype might be a "personal evaluation copy" (i.e. gift) to an officer. This officer

might retire later, and sell the weapon on the private market. This is frowned upon, but legal most of the time. Or, a soldier assigned to field test a weapon might "lose" it, and then try to sell it to a collector. This is severely frowned upon, and definitely illegal. Last, damaged prototypes might make it into lots of scrap material sold for recycling, and snagged by a dealer with a keen eye. These units are often in poor shape, but can be made serviceable with some work.

By the time final testing is over, approximately 3-5 years have passed since the initial decision to acquire a new weapon. Sometimes the company that would be the winner has ended up out of business for other reasons (more intrigue), and the second in line gets the deal. Sometimes *none* of the tested weapons performed satisfactorily, everyone goes home unhappy, and the process starts again from square one. If there is a winner, they begin production as soon as possible to meet the demands of the contract, and given the nature of the Imperium, will probably be able to keep the item in production for upwards of a century before it is superseded by a slightly improved model.

Over several centuries, this process eventually ends up creating an item of a higher TL, as incremental improvement and overlapping discoveries in different fields combine to create a markedly superior system.

# NEW WEAPON RULES

When dealing with the amazing variety of possible weapons in the Imperium, the basic combat rules in **Traveller** need to be expanded. If necessary without slowing down play, the following optional rules are suggested for certain contingencies.

## Malfunctions

Under normal conditions, weapons will fail somehow at GM option on a spectacular failure roll. Optionally, "unreliable" weapons *will* count half dice when looking for sixes, and "very unreliable" weapons will roll a *separate* die solely to see if a "6" comes up. If a failure roll results from this die getting a "6", it is automatically a weapon malfunction of some type. If something is adversely affected by conditions, but is not normally subject to failure rolls, assume an "unreliable" component gets a permanent DM-1, and "very unreliable" ones get a DM-2.

Example: A weapon that is normally reliable in cold conditions may have an electronic sight that is unreliable. While the weapon might function flawlessly, the electronic sight might take a DM-1 in cold conditions, which will affect the user's chance to hit.

## Environmental Hazards

The nature of the universe is such that entropy tends to make your weapons break down at the least opportune moments. Being aware of the nature of environmental hazards may not let you do anything about them, but at least you will know why your weapon gums up when it does.

Most of the environments described below will be classified as "normal" and "extreme". All Imperium-issue weapons are fairly immune to "normal" environmental changes, and "extreme" environments have the same effect as "normal" environments on regular weapons (e.g. an Imperium-issue rifle would count extreme cold as having the game effects as normal cold. Simultaneous exposure to more than one hazard has all the effects of each, and reliability is counted as for the harshest environment.

**Cold:** Very low temperatures can cause lubricants to gel, parts to contract, seize or become brittle. Normal cold is any temperature from 0°C to -50°C, while extreme cold is anything from -50°C to -100°C. Outer space areas shaded from direct or reflected sunlight count as extreme cold. Conventional weapons become unreliable in normal cold, and very unreliable in extreme cold. Energy weapons generally function better in cold conditions, as their normal heat dissipation problems are reduced, and electronic components function more efficiently. Do not subject cold energy weapons to rapid temperature shifts, or key parts may be thermally overstressed (don't use autofire until you fire a few regular shots). Chemical energy storage such as batteries is at reduced efficiency, and all capacity or duration is halved in extreme cold. Low tech batteries (<TL9) may lose all function in extreme cold.

**Corrosive:** Normal corrosive environments are those which can be tolerated with special skin creams and wearing of a filter mask. These can slowly eat into or etch components, causing eventual parts failure. Conventional weapons become unreliable on 2D roll of their TL or higher per month of exposure, and if they become unreliable, the same roll on subsequent months to become very unreliable. Any failure after that results in a broken weapon. Energy or energy-powered weapons must roll 3D of TL+ instead. Extreme corrosive environments cannot be survived for more than a few min-

utes without protective gear, and is effectively an acid bath for weapons. The rolls for becoming unreliable are the same, but are rolled each *day* rather than each *month*, and any result of 10+ counts as failure, regardless of weapon TL (exceptions can be made for TL16+ weapons). Any weapon enhancements are treated separately for failure purposes, and failing the roll generally means failure of the device in question. So, your TL13 Imperium rifle could survive for years in the mildly acidic swamps, but its electronic night sight probably won't.

**Heat:** Very high temperatures can cause moving parts to seize, electronics to overheat and chemicals to degrade. Normal heat is any temperature from 50°C to 100°C and extreme heat is anything from 100°C to 150°C. Outer space areas in direct sunlight are normal heat within the habitable zone and extreme heat in the inner zone of a star system. Most weapons become unreliable in normal heat, in addition to being too hot to actually handle with unprotected body parts. Weapons in autofire mode become very unreliable, and may easily suffer permanent damage. Long-term exposure of batteries or chemical propellants may cause eventual degradation of capacity or power (2D roll with TL as target number per month to avoid 50% loss). Most weapons become very unreliable in extreme heat, and weapon failures can be catastrophic, with exploding ammunition, discharging energy banks and hot pieces of metal or composite flying everywhere. Treat such a catastrophic failure as a fragmentation explosion using the weapon's normal damage against the firer, and halved for everyone else (round down). Batteries or propellants will degrade as in normal high temperatures, but on a 3D roll of TL+ per month.

**Insidious:** Normal insidious environments are those with a higher than normal concentration of hydrogen or helium. These extremely small atoms can migrate through the atomic structure of plastics, metals and ceramics and act as impurities in most electronic circuits. Conventional weapons are completely unaffected, as the propellant contains its own oxidizer, and diluting the small air space inside a shell with either more flammable or inert gas will not significantly affect performance. Any weapon relying on electronic components has a 2.5D roll of TL+ each month to become unreliable in a normally insidious environment. This can be cured by a month's exposure to a low pressure environment to leach the insidious components back out, or delayed by using a low-pressure weapon locker to store weapons after each duty shift. Extremely insidious environments are those whose concentrations of hydrogen or helium are greater than Sylean normal atmospheric pressure, so that components are at a relative pressure difference, pulling these elements into weapon components. Normal weapons are still unaffected, but any weapon relying on electronic components needs to roll a 3D roll of TL+ each month to become unreliable in a normally insidious environment. Already unreliable weapons roll to become very unreliable ones, and very unreliable ones break down and require parts replacement.

**Liquid:** Normal liquid environments are those composed of liquefied gases such as ammonia or methane (both usually extremely cold as well). In addition to visibility problems, the density of the atmosphere will drastically reduce weapon



ranges and visibility is usually a maximum of Short range. All conventional firearms and gauss rifles will become unreliable, and will lose an amount of damage equal to the range band of the target. For instance, a Short range target is range band 2, so a conventional rifle would lose 2 dice from its damage at Short range. Lasers are unaffected in terms of reliability, but unless the laser frequency is adjusted to match the spectral windows of the liquid atmosphere, range is limited to Contact, and will usually be pretty spectacular as the entire laser beam loses its energy in cloud of expanding gas bubbles within a meter of the muzzle. This, by the way, will generate an intense sonic blast that will be audible for kilometers and will probably damage any sensitive listening gear. Particle or plasma weapons cannot be used at all in this type of environment without damaging the weapon and possibly the user. Extreme liquid environments are those composed of water or other similarly dense fluids. All conventional firearms and gauss rifles become very unreliable in these environments, and primitive weapons relying on sparks or flame are obviously impossible to use. Possible problems include barrel failure due to having to push a barrel full of water out with each shot, or a projectile failing to clear the barrel and causing a weapon failure when the next shot has nowhere to go. In addition, these weapons lose dice of damage equal to twice the range band of the target. Lasers and any other weapon using electrical components will become unreliable unless the weapon is designed expressly for liquid environment use, and notes regarding laser frequency still apply. Particle beam and plasma weapons cannot be used.

**Particulates:** Normal particulate environments are somewhat harsher than average combat conditions, and consist of quantities of windblown dust, grid or organic debris that tends to lodge in the moving parts of any weapon. Any desert planet would probably qualify. Any conventional weapon or gauss rifle that is not cleaned weekly or stored in a dust-tight container will become unreliable. Extreme particulate environments are worse, and may include static buildup that attracts dust, micro-organisms that breed in weapon lubricants, or even alien squirrels that make nests in the barrel of your plasma cannon and leave ugly residues when you fire it. Conventional weapons or gauss weapons that are not cleaned weekly or stored properly will become very unreliable, and other weapon types will simply become unreliable.

**Vacuum:** Normal vacuum can cause out-gassing of volatiles from plastics and composites, rendering them less structurally sound, or leaving residues that can jam moving parts. Unless special lubrication is used, normal lubricants will sublimate, leaving parts without protection, with overheating or vacuum welding a likely result. Most weapons will become unreliable in normal vacuum. For environmental purposes, there is no "extreme vacuum".

**Visibility:** Normal poor visibility environments are those in which atmospheric composition or impurities restrict clear visibility to Medium range (out to 150m), with a DM-3 to targeting rolls for each band past Medium. This could be fog, dust or smoke. Weapon reliability is unaffected, but TL13-lasers will lose dice of damage equal to half the range band, rounding down. Extremely poor visibility environments are those with near-zero visibility, with a DM-3 for targeting at each range band past Contact. Weapon reliability is unaffected, but TL13-lasers will lose damage equal to the range band, with a minimum loss of 1 point for firing through a small area of zero visibility, like a smoke screen. Note that special anti-laser smokes or aerosols will have greater effect, and TL14+ lasers take half effect, rounding down.

## Special Weapon Effects

Some weapon effects are not covered in the basic **Traveller** rules, or are only lightly touched upon because they don't normally come up in play. Use the following only as you see appropriate. Note that many of these options are more appropriate to open warfare than character adventures, and involve weapons and weapon systems that can quickly unbalance or completely ruin a campaign if used by or against the characters. The main use of these rules is as a GM tool to add background to an adventure, figure the chances of bad things happening to NPC's accompanying the characters or how likely a large vehicle the characters are on is to be hit or take damage. For instance, is the ocean-going passenger liner hit by a homing torpedo? The weapon is certainly big enough to ruin an entire party's day, but as long as they are not sitting behind the piece of the hull that is hit, they will not be *directly* affected.

**Area Effect Weapons:** Some weapons will not act like explosives, but rather saturate an area with a fairly even effect. An example might be a flamethrower or fuel-air explosive. Area effect weapons generally fill a certain number of outdoor squares, and anyone in one of those squares will take full effect. If the effect is explosive in nature, it drops off like a normal explosion once you get past the edge of the area. If it is a continuing effect like flames or gas, characters take effect each turn they remain in the area. If the central or detonation point of an area effect weapon is a character or vehicle, they take double effect, plus any special effect of the weapon. A flamethrower blast might cover a vehicle in flaming fuel, while a fuel-air mixture might strip off sensors, communication antennae, special surface coatings and so on.

**Armor Piercing:** Most modern military ammunition will be armor piercing or semi-armor piercing, and modern armor will generally be designed to resist this effect, so there is no bonus in game terms. Sporting or non-military weapons will generally not be armor-piercing, or at best, not equal to military ammunition in armor piercing effect. There won't be any real difference against flexible armors. In conventional firearms, ammunition will commonly be **Armor Piercing Discarding Sabot** (APDS) or a variant, where a lightweight sleeve surrounds a denser core. The sleeve falls away after firing, leaving the narrow penetrator carrying most of the muzzle energy for better penetrating power. Armor-piercing ammunition tends to develop ahead of armor advances. As an optional rule, if the TL of an armor piercing ammunition is *greater* than that of the armor, then reduce the armor rating by a quarter (round armor down) before comparing to the penetration of the weapon. Shaped charge or HEAP rounds are considered to be a TL6 development, though more advanced tech levels refine and improve the concept.

**Backblast:** Weapons like rockets and recoilless rifles will have a cone of backblast behind the weapon. Anyone in the area immediately behind the weapon will take damage like an explosion, with a blast effect equal to a quarter the damage rating (round down) of the weapon. This blast can pick up loose material on the ground and produce damaging fragments, and often reveals the position of the firer due to the plume of dust created. Disposable or one-shot weapons may have means of containing or reducing the blast by keeping it partially inside the weapon. This is more common at TL8+ and would halve (round down) the normal blast effect.

Example: A TL8 shoulder fired rocket launcher with a damage rating of 20 will have a backblast like a 5 point explosion. If this were a disposable launcher with a reduced signature, the backblast would only be treated as a 2 point explosion.

Plasma cannons have a similar effect along the length of the beam. This is caused by the sun-bright heat of the plasma as it passes by, followed by the expansion of superheated air a fraction of a second later. This is counted as half effect backblast (round down). The easiest way to figure this is to use half (round down) the explosive value of the plasma burst.

Example: A plasma cannon with a penetration of 36 (9 explosive) would have a sideways backblast of 4, which would cause flash burns, ignite easily flammable materials, shatter windows and melt composites along its path. Infantry makes a point of being extremely aware of the position of friendly plasma units and staying out of the way if at all possible.

**Beam Riders:** This is a form of remote guidance where instead of guiding the weapon, the user "paints" the target with a specific frequency of light or radar waves. A sensor in the weapon is designed to home in only on that specific type of signal and is much less susceptible to countermeasures. However, the homing ability is only as good as the person using the designator. The user must make a normal to hit roll for themselves on the turn the beam riding weapon will hit. This will have any modifiers that would normally apply, such as range, aiming bonuses, size modifiers and so on. If this roll is successful, then the missile can make its own success roll. If the user fails, the missile will *automatically* miss. To reflect the benefit of keeping the missile on course, apply a DM+1 to the missile for each full turn the user successfully painted the target, and a DM-2 for each turn they failed to. Any spectacular failure means the beam intersected a nearby obstacle or the ground and the missile hits that instead, while a spectacular success means the user can pick the vehicle hit location.

**Burst Fire:** This is a limited case of autofire, and most autofire weapons of TL8+ have the capability. Burst fire has the same effect on a *single* target as autofire, but does not affect secondary targets. The negative DM for burst fire is equal to half the range band (round up), and burst fire *may be aimed*. Only one burst fire action is allowed per turn.

Example: A burst fire combat rifle at Short range (range number 2) would take a DM-1 to burst fire, which could be aimed, and which would do doubled wounds after penetrating armor if it hit.

**Directed Fragmentation:** Some fragmentation attacks are directed only in one direction. Treat these as having both a blast rating and a fragmentation rating. The blast rating drops off normally in all directions. The fragmentation rating drops at one-quarter the normal rate, in a 45° arc.

**Explosives:** Explosives act as a crushing or concussive force in all directions, and tend to propagate in the direction of least resistance. This is why a tamped explosive charge is more effective than an untamped one, as there is no "easy path" for the blast to go along. Not all of a blast is lethal in nature to humans or other life forms. In general, half (round up) the damage that penetrates applicable armor is non-lethal. If you want to be nice to characters, you can simply say that the maximum lethal dice that get through armor is 3D, and the rest is non-lethal, thus giving them a chance to survive blasts that would otherwise certainly be fatal. Since blast is transmitted through air like sound is, being behind cover sufficient to stop a blast will also halve the effect, as the refracted blast wave is not as powerful. So, ducking behind a low wall might not save your hearing, but it could save your life. Against vehicles or other solid barriers, explosive force is halved (round down) before comparing it to armor unless it is tamped down or otherwise confined, like running over a land mine.

Example: A high-explosive shell with a blast rating of 25 hits a vehicle with an armor of 10. While all soft targets adja-

cent to the blast suffer normal effects, the vehicle is treated as having taken 12 hit, so 2 points gets through armor and may damage a vehicle system. Of course, the armor will have been breached over the entire area that took the Penetration 12 effect (an area of one indoor square), leaving a gaping hole in the armor.

**Fire Control Systems:** As described in the *Central Supply Catalog*, fire control systems are available for mounted weapons of TL5+. These include advanced optical sights, gyro or grav stabilized weapons, inertial compensation, crosswind sensors and so on. They provide an additional aimed fire DM of half the TL (round down), *or* allow aimed fire while moving in conditions that would otherwise disrupt aim, provided these disruptions are equal or less than the fire control DM. TL5 fire control systems only work while a vehicle is stationary.

Example: A TL9 fire control system will provide a DM+4 to aimed fire in addition to the normal weapon bonus, or it will allow use of the normal weapon bonus when the vehicle is moving and taking penalty DMs of -4 or less.

**Guided Weapons:** Normally, most guided weapons will reach their target in a single 6 second turn, and simply provide a +DM to the firer. Weapons that are expected to make course corrections on their own over several turns are counted as having a Dexterity equal to half their TL (round down), plus their guidance DM. A guidance task is rolled against this skill each time the range changes (usually once per turn) using the current range and all applicable DM's. As long as the roll is made, lock-on is maintained. If the roll is failed, lock-on is lost. Depending on the weapon type, different things may happen. The weapon may self-destruct to prevent it from accidentally picking up a friendly target. It may continue on course and scan for the old target or any new ones. This is rolled for whenever DMs on the original target improve or a new target shows up on the weapon's sensors, with a cumulative DM-1 to re-acquire lock-on. Or, it may engage a pre-programmed search pattern to look for *any* new targets, with similar game effect. A guided weapon fired from a vehicle with sensors of its own may use the vehicle sensors to initially acquire the target (use the DM of the vehicle sensors instead of the weapon's sensors), and the weapon will not have to make its own roll to keep acquisition until the range band it crosses after launch. A weapon designed to accept remote guidance may continue to use the vehicle's sensor DM so long as communications aren't jammed. If they are, the weapon reverts to its own on-board sensors.

Example: A guided TL6 torpedo with an inherent DM+2 is fired at the same target as in the previous example. A 3km range is a 4.5D direct task, and the torpedo has a skill of 5 (half its TL, DM+2). Since it is *not* indirect fire, there is no -DM for range, just a DM+5 for the Agility of the target. Presumably the torpedo wouldn't be fired until it had a lock-on (with help of the sub's fire control system), so the first roll is at Very Long range (1.5km), an Impossible (4D) task vs. a total of 10 (skill of 5 plus target agility DM+5). If it makes the roll, it would continue tracking and reroll on any turn in which it changes range brackets.

If a weapon is guided remotely by a person, its DM reflects the quality of the guidance and data links, and it also rolls to maintain lock on target each time the range band changes, but the DM applies to the skill of the user, not the inherent (tech level/2) skill of a self-guided weapon. A wire-guided anti-tank missile would be an example. The maximum skill DM that the user of a remotely guided weapon can apply is the DM of the weapon. So, A DM+1 weapon would be fired using the Dexterity + skill of the user, but the maximum skill contribution is another DM+1. That is, a person



with a skill of 3 firing a DM+1 weapon is treated as though they only had a skill of 1. This reflects the limitations of the equipment overcoming user skill.

**Limited Blunt Trauma:** Rigid armor normally stops all effects if the armor is equal to more than the damage rating of the weapon. If the effects of this do not suit your game style, we suggest that any hit on rigid armor that is within 1 point of damage rating it does 1 point of non-lethal damage to the wearer. On highly padded armors such as battle dress and augmented battle dress, say that each point that *exactly* equals the armor does 1 point of non-lethal damage. This rule also allows a person in primitive plate-2 armor (armor rating 2) to be bludgeoned into submission by someone with a sword-2 (damage rating 2), since each hit will do a point of non-lethal damage instead of completely bouncing.

**Long Range KE Attacks:** The effectiveness of most attacks decreases with range. This is most noticeable with small arms at long range. Reduce the damage rating of all weapons that don't rely on a payload by 1 at Long range and each range past Long. This includes guns, lasers, gauss weapons and plasma cannon, but not high explosive, HEAP, chemical agents or submunitions. Damage rating of 0 do 1/2D wounds to unarmored targets, and damage rating of less than 0 do no damage.

Example: A damage rating 2 pistol fired at a target at Long range would only hit with a damage rating of 1.

**Maximum Useful Range:** The maximum useful range of a direct fire weapon is usually two range numbers past its Range stat. An indirect fire weapon usually has a maximum range listed with the weapon. The weapon can still do damage well past this range, but it is nearly impossible to aim the weapon to deliberately hit something that far away. You can ignore this rule if it makes for better dramatic situations or a weapon has a targeting aid that allows accurate fire at long ranges. Without advanced targeting aids, most handheld projectile or beam weapons have a maximum useful range of Extremely Long (3km), regardless of tech level, because of the limits of the human using the weapon. In addition, called shots for special game effects are generally impossible past medium range (150m) without some sort of targeting aid like a telescopic sight.

Example: A pistol with Very Short range can only be fired at targets out to Medium range. A Medium range ACR can only be fired at targets out to Very Long range.

**Minefields:** A "minefield" is an area of mines at least an outdoor square in size, and generally requires 100 antipersonnel mines or 10 anti-vehicle mines to get the detonation roll listed above. Count the chance of a mine being triggered as for proximity fused weapons (i.e. the TL of the minefield on 2D). Doubling the number of mines is a DM+1 to the chance of triggering one, and halving it is a DM-1 (a vehicle driving over a proper antipersonnel minefield would have a DM+3 to hit at least one). To roll for a group passing over a minefield, apply a DM+1 for each doubling of targets past 1 and roll once for each outdoor square traversed. If the roll is made, a random member of the group is hit. The larger the group, the sooner this happens, alerting the rest of the group.

Example: A group of 4 characters walks blindly into a properly laid TL9 anti-personnel minefield. The chance of *someone* getting hit is a 2D roll of 11-, 9- for the TL, and DM+2 for the number of people walking across it.

Remember that even very low mine densities will *eventually* get someone, and tie up medical staff, force mine clearing or marking operations, or restrict the movement of people through the area.

**Proximity Fuses:** A weapon with a proximity fuse has an extremely short range sensor or a particular type, set to trig-

ger if a target gets within a certain range, usually a range which the area effect of the weapon would work in. These are generally possible at TL6+. Proximity fuses will trigger on a 2D roll of equal or less than the weapon's TL, plus any size DM for vehicular targets. Contact fuses or useful time delays are possible at TL3+ and trigger the same way. Contact fuses like on many types of mines will get a DM+4, while artillery gets a DM+6. Both rolls take into account partial blockage of sensors due to wind-blown debris, badly laid mines, etc. If conditions are extremely good or bad, further +/-DM's may apply.

Example: A proximity-fused TL7 land mine would detonate on a 2D roll of 7- if someone walked within range. A contact-fused TL7 mine would detonate on a 2D roll of 11- and TL7 contact-fused artillery would automatically would (2D roll of 13-).

**Saturation Bombing:** When a large number of identical attacks are targeted on an area, such as an artillery barrage, massed rocket fire or bombing runs, rolling for each shot is tedious and detracts from game play. What is needed is a general indication of the effectiveness of the barrage. Roll three indirect fire tasks based on the average skill used in the bombardment, with a general DM-3, a DM+1 for each doubling of number of attacks, whether from units participating or shots fired, and DM's for the lowest fire control in the unit. Throw out the best and worst rolls, and apply the remaining roll with a DM of the target size you want to determine effect on:

Target Size	DM
Medium vehicle (tank)	+2
One outdoor square	+3
Nine outdoor squares	+4
Sixteen outdoor squares	+5

Assume one hit in the target area for each point the roll was made by, with an exact success meaning one hit at the edge of the area. A miss means the nearest hit was in the outdoor square the miss amount from the edge of the target. For determining if a smaller area took a hit, reroll for the smaller area, noting that the smaller area will never take a total number of hits more than is proportional for the size of the area.

Example: A sixteen tube artillery unit would give a DM+4, and if each one fired 8 rounds, that would be another DM+3 and a general DM-3 for resolving saturation bombing. If this was fired at an enemy base camp (DM+5) at a range of 10km (range number 7, DM-7), the end result would be a Difficult (2.5D) task with a DM+2. Each point the roll is made by would be one hit inside the base camp (a 60m x 60m area), and the GM could adjudicate game results based on the number of hits. For determining if a *particular* area in the base camp took a hit (like the character's bunker), reroll the task with the DM of the smaller target, and if this is successful, that area a number of hits up to an amount proportional to its area. So, if the base camp got hit with 4 rounds, and you want to see if one landed in the character's encampment, you would use a DM+3 for one outdoor square, for a total DM+0 and a maximum of one hit in that area.

**Smart Guns:** This is some form of targeting aid attached to a handheld weapon, and operates much the same as a fire control system on a vehicle. It provides a further bonus to aimed fire, and in some cases to unaimed fire. If a weapon has these, its effects and limitations will be noted. If a weapon has varying +DMs at different ranges, this usually reflects the velocity of the weapon effect. A gun firing a slow grenade will keep a +DM for a shorter distance than one firing a fast bullet.

**Torpedoes:** Torpedoes and other very slow weapons are a special case of indirect fire where the spotter is the firer as well. Normally, indirect fire is called onto a specific location, which is a stationary patch of land. Torpedoes are effectively an indirect fire attack against a moving target. A large target, but a moving target nonetheless. Normal indirect fire rules are used, with the following additions. The success roll is made only when the torpedo reaches the target. Apply any fire control system DM's if applicable. Apply the agility of the target to the skill roll. This is the USP size code, minus 4, minus the maximum G's (round nearest) of acceleration of the vehicle. If more than one torpedo is fired in a salvo, apply DM+1 per doubling of torpedoes, but only make one roll for the group. If the target is unaware of the attack possibility, apply a further DM+3. If the target detects the incoming attack and has the capability to evade, use its Agility as a -DM for *each* turn it can evade before the torpedo arrives, with a minimum DM-1 per turn.

Example: A TL6 submarine fires a salvo of two torpedoes at a destroyer 3km away. The base indirect fire task is Difficult (2.5D), with a DM-6 for range, and DM+3 for fire control and for sake of the example, a DM+0 for perfect ocean conditions. The destroyer has a displacement of 1000 ship tons (14000 cubic meters), which is a USP size of 9, and has less than .5g acceleration, for a DM+5. There is a DM+1 for the two shot salvo. The cruiser is not evading, but neither is unaware of the submarine threat. It is making wide zig-zags to make itself slightly harder to hit, so it has no surprise or extra evading DM. The final roll is a 2.5D Artillery task with a DM of +3. If the torpedoes move 100 meters per turn, and an alert helmsman spots them 5 turns out, there would be an extra DM-5 on the roll. If a random crewman spotted them, the DM would be based on how long it would take to communicate the threat to the bridge and begin evasive maneuvers.

**Tracer Fire:** Any form of autofire projectile that enables the user to see the path the supersonic projectile has taken. Usually this is a small chemical flare in the base of the projectile, ignited by the heat of firing. Normally every 5th or 10th round has this quality in a weapon designed to benefit from tracers. The advantage is a DM+1 for any autofire or suppression fire task if the total burst is at least 20 rounds long (more than the normal 5 rounds may be expended per autofire target if the shooter so desires). This bonus may be in addition to RF or VRF bonuses. The downside is that the firer's position is immediately known by virtually everyone within sight. For various tactical uses, tracers may be designed to ignite after a certain minimum delay. They do not pinpoint the firer as much, but provide no benefit within this minimum range.

**USP Ratings:** While all of the *Emperor's Arsenal* weapons are below the class of starship weapons, some *are* large enough to damage starships, and characters could be placed in situations where the two combat scales overlap. If a weapon has a range of subregional (range number 7), it can engage targets at Very Short starship combat ranges, which would typically be ground to low orbit. This would be a 5D task on the personal combat scale, with DMs as appropriate for maneuvering, size, etc. On the starship combat scale, most small vehicle sensors capable of targeting a starship in low orbit would be counted as a sensor rating of 1-2, for a DM-2 to hit. The comparison between personal scale and USP scale damage is below:

Damage Rating	USP Rating	Damage Rating	USP Rating
0-16	0-0-0-0	45-47	9-0-0-0
17-20	1-0-0-0	48-54	10-0-0-0
21-25	2-0-0-0	55-60	11-0-0-0
26-29	3-0-0-0	61-64	12-0-0-0
30-32	4-0-0-0	65-68	13-0-0-0
33-35	5-0-0-0	69-72	14-0-0-0
36-37	6-0-0-0	73-75	15-0-0-0
38-40	7-0-0-0	76-81	16-0-0-0
41-44	8-0-0-0	82-86	17-0-0-0

All personal scale weapons that can be powered on a continuous basis (1 shot per turn) have a +1 to the USP rating for their rate of fire (100 shots per ship combat turn), but only if their base USP rating is at least 1. Sustained autofire weapons get up to +4 to the rating, but not more than their base USP rating. Non-starship weapons do not need or use the advanced techniques applicable to starship weapons, so they do not keep sufficient focus to be used outside of Very Short starship ranges. However, within this range they are probably more mass and energy efficient than starship equivalents. Note that for special game effects it is not unreasonable to roll for a surface explosion hit on an armor 0 ship hit by a large number of USP damage rating 0 weapons.

Example: A heavy plasma cannon-13 has a damage rating of 81 and a USP rating of 16-0-0-0, 17-0-0-0 if it can be fired continuously. A TL8 heavy anti-tank missile has a damage rating of 33, and while it can't target anything at ship combat ranges, it would have a USP rating of 5-0-0-0 if firing at one on the ground nearby.

Note: These same USP values can be used to get the starship equivalent armor rating of ground vehicles, which if nothing else is a fast way to figure out combat results. Structure points would be figured as for starships, the G-rating of acceleration (minimum of 1) times 1/14th the mass in metric tons (its ship ton displacement), compared to the USP table in *Starships*, with a minimum of 1 structure point. For instance, a 50 metric ton archaic tank with a top armor of 30 would have a USP armor rating of 4 and USP structure rating of 1 vs. fire from orbit. A 60,000 ton battleship with an armor of 50 would have a USP armor rating of 10 and USP structure rating of 20.

**Zero-G Recoil:** Firing any sort of recoiling weapon in zero gravity requires training. If you are braced against an object there is normally no penalty, but otherwise you always use the lower of adverse environment combat or the skill with the weapon to reflect the difficulty. In addition, an Average Environment Combat task roll is required to avoid being knocked off balance, with a -DM of half the damage rating of the weapon (round down). Only one roll is needed per turn, but the DM is cumulative in that turn with the number of shots fired with a maximum of DM-6. Failing this roll means you lose directional control or facing and take this -DM on all subsequent shots until you spend an action and successfully make an Average Environment Combat roll to reorient yourself. If the first roll is failed, subsequent rolls are made with no negative DM unless the character continues to fire.

Example: Firing a damage rating 2 pistol in free fall would require an Average (2D) Environment Combat roll with a DM-1. If three shots or a three-shot autoburst were fired, the total would be DM-3.

# TECH LEVEL 0

Primitive, non-industrial, hunter-gatherer levels of weapon development. Seldom seen in known sentient species, but common among pre-sentient or near-sentient species like Weem's Beast (Daaraam, Antares subsector C, 2009). Warfare is disorganized at best, and limited to poorly organized groups gathered for a single specific task. Weapons are made exclusively by hand, using only naturally occurring materials such as stone, plant fibers, or animal parts such as leather, bone, teeth or connective tissue. Such weapons are capable of bringing down animals of substantial size, and capable of doing serious injury to unarmored personnel, especially as physical prowess is usually a pre-requisite for long-term successful use of such weapons.

The other type of TL0 weapon are the ones based on high levels of skill rather than skill plus force. These include simple devices like slings and blowguns, the latter almost exclusively used with drugged darts made from locally occurring plant or animal sources. While the exact biological mechanism of a drug may be unknown to the people using it, the means of preparing it with the simplest of tools is highly refined, and the pharmaceutical compounds that result can be extremely potent. This class of weapon is seldom used by pre-sentient species. The simple appearance and easy concealability of these weapons may be a concern if the user has or develops hostile intent towards explorers.

## Common Weapons

### Ax-0

A heavy stone blade attached to a handle of wood or animal bone by leather cord or plant fibers. Is not as sharp as a knife or sword, but has a large moment arm and significant crushing power. The heaviness of the blade also makes it more durable if used against hard surfaces or as a blocking tool. This heaviness and size of this two-handed weapon makes it somewhat unwieldy in combat or in enclosed spaces (DM-1 for each). Large or very strong individuals may be able to wield a version of this weapon with greater penetrating ability.

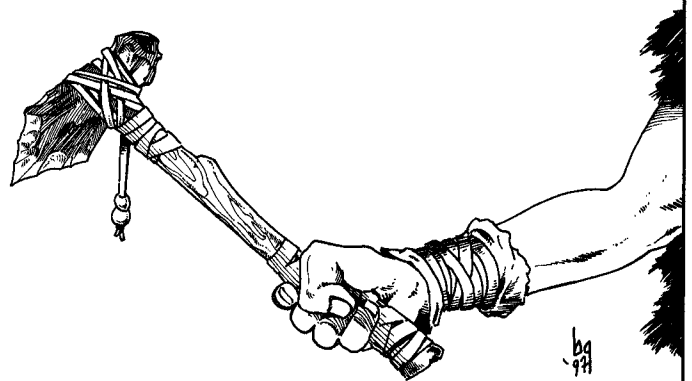

Damage	TL	Range	Shots	Mass	Reloads	Cost
2	0	Contact	-	2.2kg	-	Cr70

### Blowgun-0

A hollow tube, usually made of some type of hollow plant fiber, firing darts made of plant thorns or sharpened slivers of wood or bone. Has no penetrating power

and does negligible damage, but is capable of delivering a dose of toxin through normal clothing.

Damage	TL	Range	Shots	Mass	Reloads	Cost
0	0	Contact	1	.2kg	-	Cr20

### Club-0

A simple one-handed crushing tool, usually made from the long bones of a large animal or an appropriate sized piece of wood or similar plant matter. Its broad striking surface is inefficient at transferring energy through rigid

armor, but good at delivering blows through flexible protection (double rating of rigid armor, halve rating of flexible armor, round armor down). The most common weapon among pre-sentient species.

Damage	TL	Range	Shots	Mass	Reloads	Cost
2	0	Contact	-	1.5kg	-	Cr60

### Knife-0

A knife-shaped piece of stone, flaked to a sharp but brittle edge, with a wrap of leather around the hilt area. Alternately, a shaped piece of animal bone, horn or claw,

usually with a point and no cutting edge. Capable of normal knife damage, but will break if forced to strike a hard surface or block a rigid weapon.

Damage	TL	Range	Shots	Mass	Reloads	Cost
1	0	Contact	-	.2kg	-	Cr20

### Bow-0

The most basic form of this weapon, made from wood and animal sinew or similar materials. It lacks the increased efficiency of composite construction, and its accuracy is unremarkable, but it is still lethal. The stone or bone-tipped arrows tend to damage their tips on hitting any hard object, but otherwise are as useful as modern ones of similar power.



Damage	TL	Range	Shots	Mass	Reloads	Cost
1	0	Contact	1	1.8kg	.2kg	Cr60



### Sling-0

A simple strand of plant fiber or leather, with a pouch for holding a round or ovoid projectile, usually a smooth stone, but metal projectiles are not unknown. It is whirled rapidly until maximum angular velocity is reached, at which point one of the strands is released, allowing the projectile to speed towards its target. It requires a high level of skill to use effectively, but is capable of shattering bones and delivering significant blunt trauma. The large personal space required to use the sling precludes indoor or close-quarter use.

Damage	TL	Range	Shots	Mass	Reloads	Cost
1	0	Contact	1	.1kg	.1kg	Cr20

### Spear-0

A wooden shaft with a sharpened stone or bone tip, suitable as a two-handed thrusting weapon or short range thrown weapon. Equal in effectiveness to later weapons, but suffers the limitations of other stone-tipped tools. May be used with a spear-thrower, a means of effectively increasing throwing arm length for higher velocity and better range.

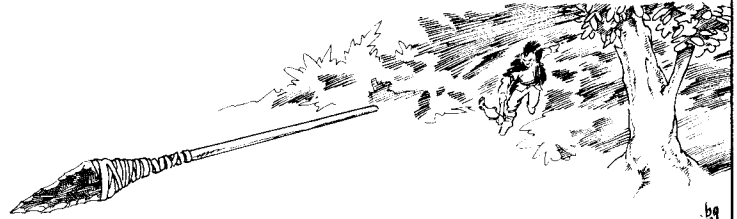

Damage	TL	Range	Shots	Mass	Reloads	Cost
2/1	0	Contact/Cont.	1	1.0kg	-	Cr60

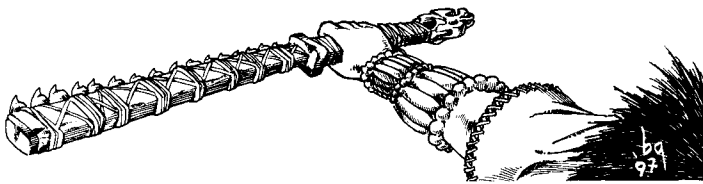

### Sword-0

A wooden or bone blade, studded with sharp objects, typically animal teeth or spikes, or flakes of volcanic glass. Does significant damage, but suffers from the same limitations on durability as TL0 knife. However, the individual items used as the weapon edge are easily replaced when they break.

Damage	TL	Range	Shots	Mass	Reloads	Cost
2	0	Contact	-	1.5kg	-	Cr40

Name	Dam. Rating	TL	Range	Shots	Mass	Reloads	Cost*
Ax-0	2	0	Contact	-	2.2kg	-	Cr70
Blowgun-0	0	0	Contact	1	.2kg	-	Cr20
Bow-0	1	0	Contact	1	1.8kg	.2kg	Cr60
Club-0	2	0	Contact	-	1.5kg	-	Cr60
Knife-0	1	0	Contact	-	.2kg	-	Cr20
Sling-0	1	0	Contact	1	.1kg	.1kg	Cr20
Spear-0	2/1	0	Contact/Cont.	1	1.0kg	-	Cr60
Sword-0	2	0	Contact	-	1.5kg	-	Cr40

\*Cost for these primitive weapons is reflection of the manual labor required to produce them. Tech level 0 cultures do not have currency as such for transactions, and acquisition would be through barter, salvage or theft.



# TECH LEVEL 1

Pre-industrial civilization. This level of technology is usually allowed to cover the broad region from the earliest metal tools to just before the invention of gunpowder or other weapons based on chemical rather than mechanical energy storage. Archaeologists will often divide this and other broad tech levels into subcategories such as 1a or 2b. For instance, TL1a usually indicates a pre-Iron Age level of development, possibly sophisticated cultures, but still limited to bronze or other low-temperature alloys, while TL1b would have iron weapons and later TL1 developments. However, these distinctions are not needed for the most part.

Tech Level 1 cultures have formalized warfare and conflict, with rank structures, standard tactics and so on, though these are not usually sophisticated. Normal conflicts involved throwing masses of armed men at each other until one side became demoralized and retreated. Battlefield communications were negligible and allowed only the simplest of changes to a battle plan once the fighting started. Naval combat involves primitive sail or man-powered vessels, using small siege engines, rams and boarding actions as the means of capturing or destroying enemy vessels.

All weapons at tech level 1 are still made by hand, though culture specific tools and skills usually are developed and the weapon-making art falls to a limited subset of tradesmen for simple weapons and craftsmen for more complex or technically challenging ones. The tools required for weapon-making are usually made by the weaponsmith themselves, during or as part of a training period under an existing weaponsmith. Common tools include a combustion-heated forge for the heating and working of low-temperature metals or alloys, hammering, shaping and cutting tools suitable for the same, plus possibly a number of finer tools such as scales and punches, plus limited protective gear like gloves or heat-resistant outerwear to protect from sparks or heated metal particles. Craftsmen for more complex weapons will

have tools for the shaping of smaller parts, plus engraving or other etching tools for artistic decoration.

Items may be constructed to a standard pattern, size or mass, but all are hand-created and unique. Weapons with moving parts will seldom have those parts be perfectly compatible with similar weapons, even if made by the same craftsman. Hand-fitting and adjustment is always required.

Tech level 1 civilizations are capable of producing crude chemical propellants, but seldom create an effective means of employing them. Crude rockets are possible, and may be useful to create distractions, frighten animals or create smoke or fire, but are seldom used as actual weapons.

The last category of tech level 1 weapons is artillery. Aside from use of rockets, torsion or counterweight engines are often used to hurl rocks or other objects at fortified positions. Historically this is a time consuming process, sometimes requiring months of sustained fire to breach or weaken a well-fortified position. Just as often, these set pieces are used to hurl diseased or decaying animal parts into a besieged structure in hopes of weakening resistance, or using flaming projectiles to destroy wooden structures and the supplies they might contain. Tech Level 1 artillery can also be used in a battlefield support role, to clear a swath through enemy forces with their massive projectiles.

## Common Weapons

### Ax-1

A heavy bladed weapon relying on cutting and crushing damage. Usually with a metal-reinforced or metal haft. Not very well suited for defensive use (DM-1 to use

against opponent's chance). May be used one or two-handed, and some designs can be used as a thrown weapon.

Damage	TL	Range	Shots	Mass	Reloads	Cost
2	1	Contact	1	1.8kg	-	Cr220

### Bow-1

A painstakingly constructed device, usually made from wood and a combination of organic materials with appropriate compression and tension characteristics. The result is a powerful composite bow, which is usually highly

prized by the owner, who is often also its maker and loath to part with it for any price. Access to remnants of modern steels or adequate metallurgical knowledge may also produce powerful steel bows at this Tech level.

Damage	TL	Range	Shots	Mass	Reloads	Cost
2	1	Short	1	1.9kg	.1kg	Cr200

### Knife-1

A simple but effective metal knife. Capable of any task a modern knife is, but not quite as sharp and unable to hold an edge in use without frequent sharpening.

Usually larger and broader than a modern knife to reflect the lower strength of the metals used.

Damage	TL	Range	Shots	Mass	Reloads	Cost
1	1	Contact	1	.6kg	-	Cr60

## Crossbow-1

A stored energy bolt shooter, much like a bow laid sideways with a rifle stock attached. Using mechanical force multipliers, it can hold more energy than possible for a bowman to draw and hold, and is easier to use and train people in its use. It is however, more mechanically complex and will permanently lose strength if left strung or cocked for extended periods (days), necessitating "downtime" while its molecular structure resets from temporary overstress. Crossbows range in power from bow-like strength, to extremely heavy versions designed to injure a soldier in the heaviest TL1 armor. All except the least powerful crossbows require extended reloading times.

The light crossbow can be reloaded in one turn, and the heavy crossbow in four turns, provided the user is not interrupted in this interval. Crossbows have the advantage that they can be aimed and held ready for extended periods, unlike bows which costs 1 fatigue point per round of aiming after the first.

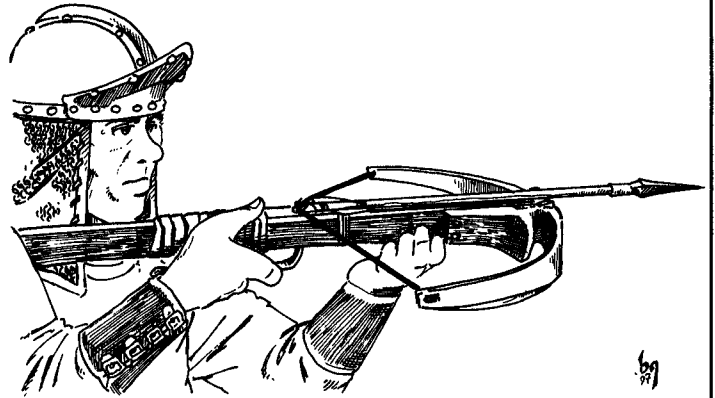

	Damage	TL	Range	Shots	Mass	Reloads	Cost
Heavy-1	3	1	Short	1	8.9kg	.1kg	Cr340
Light-1	2	1	Short	1	2.8kg	.1kg	Cr200

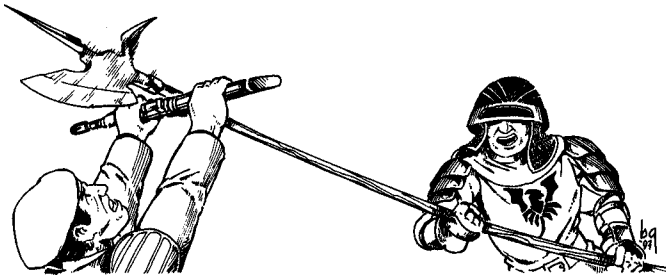

## Polearm-1

Normally used in mass combats, a polearm is a heavy blade and point attached to a shaft ranging from 2-4 meters long. In quantity, this provides a formidable barrier, and sufficient weapon length to easily engage soldiers mounted on riding animals. In addition, one end can be braced on the ground to counter overrun attacks. Outside these limited circumstances, the weapons are unwieldy, but their long moment arm allows them to do significant damage if unopposed (-2DM each to use defensively or in close quarters).

Damage	TL	Range	Shots	Mass	Reloads	Cost
3	1	Contact	-	3.5kg	-	Cr160

## Shield-1

Normally a disk or oblong construction of wood, with possible leather or metal facing or reinforcement. Designed to be used in the off-hand as a blocking tool.

Treat it as a DM+1 to DM+3 to appropriate skill for defensive purposes. If a melee hit misses by the amount of shield bonus, the attack lands on the shield, which has an armor of 1 and can absorb 5 points of damage per +1 bonus before disintegrating. Penetrating hits like arrows do 1 point of damage to the shield on the way through.

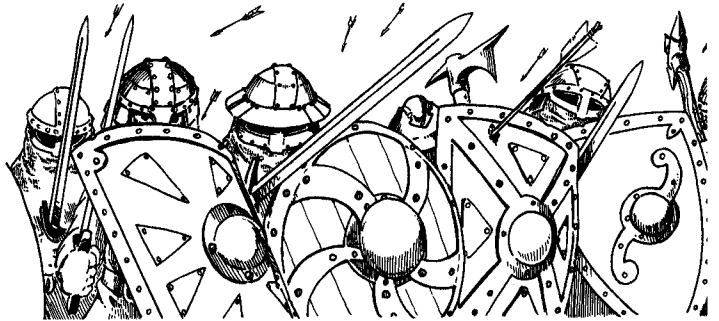

	Damage	TL	Range	Shots	Mass	Reloads	Cost
(+1)	-	1	-	-	1.0kg	-	Cr30
(+2)	-	1	-	-	2.5kg	-	Cr50
(+3)	-	1	-	-	4.0kg	-	Cr100

### Spear-1

Typically a wooden haft with a metal thrusting and cutting point. Requires little training and material cost to produce, and thus favored for use with expendable or

poorly trained soldiers. May be thrown with limited effectiveness.

Damage	TL	Range	Shots	Mass	Reloads	Cost
2/1	1	Contact/Cont.	1	1.0kg	-	Cr60

### Sword-1

Tech level 1 is the period in which large bladed weapons were the primary tool of warfare, and developed into a variety of styles, usually complementing the types of armor used in a particular geographic region. One area might specialize in thrusting blades or picks in areas where cut-resistant armor is prevalent, while heavy, crushing blades might work to counter flexible armor.

In game terms, a TL1+ sword or other large melee weapon can be a generic weapon, or specialized to be counted as armor piercing vs. a particular type of armor, which effectively reduces the rating of that armor by 1 point. These armor-piercing melee weapons commonly do reduced damage and have a maximum damage of 1D.

Damage	TL	Range	Shots	Mass	Reloads	Cost
2	1	Contact	-	2.0kg	-	Cr200

### Ballista-1

This is an archaic artillery piece relying on the torsion of rope, hair or similar material to propel a heavy shaft into masses of opposing soldiers. Its presence may have demoralizing effect, but by itself does no more individual casualties than other missile weapons. It has a significant reload time, and is not normally moved from its emplaced position during a conflict (*10 turns to reload*).

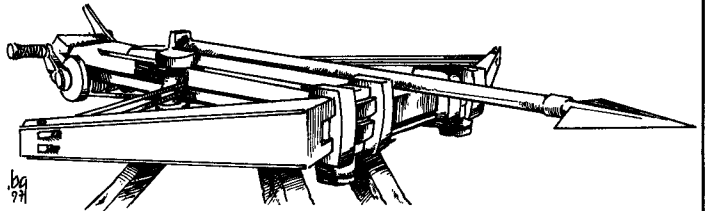

Damage	TL	Range	Shots	Mass	Reloads	Cost
4	1	Short	1	120kg	6.0kg	Cr380

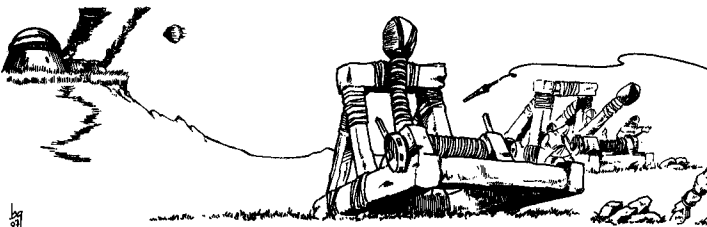

### Onager-1

A torsion weapon designed to throw rocks. These are capable of bouncing along the ground at high velocity, breaking legs and injuring several individuals before coming to rest. They may also be used against light fortifications, or to deliver small payloads of flammable chemicals. Like the ballista, the onager takes significant time to reload (*20 turns to reload*).

Damage	TL	Range	Shots	Mass	Reloads	Cost
5	1	V.Short	1	150kg	1.5kg	Cr490

### Trebuchet-1

This is the heaviest of TL1 artillery pieces, and uses a long lever arm, a heavy counterweight and gravity to hurl heavy stones a great distance. It is strictly an indirect fire weapon, but its payload is capable of damaging fortifications and killing or injuring several armored soldiers should it land among them. It may also be used to hurl moderate-sized payloads. Due to the mass of the counterweight, it takes several people to reload and prepare the weapon (*60 person-turns to reload, split between up to 6 people*).

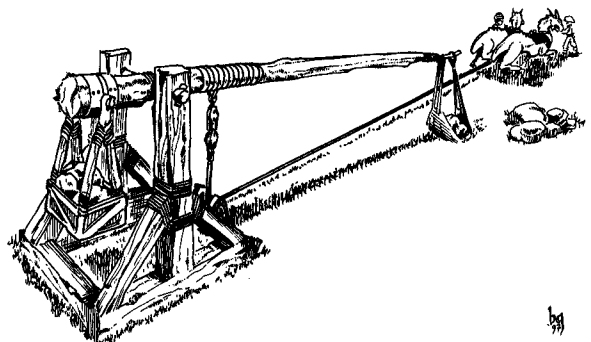

Damage	TL	Range	Shots	Mass	Reloads	Cost
6	1	V.Short	1	2300kg	5.4kg	Cr1100

## Rocket-1

The simplest form of reaction engine weapon, this is typically a crude deflagrating mixture in a tube of wood, plant fiber or other lightweight material, stabilized by either fins or a counterbalance shaft. Extremely inaccurate and suitable for indirect fire use only. It may rely on either its inherent stink to affect riding animals (Difficult Endurance task for animal to avoid leaving the area, modified by rider skill), or have an explosive warhead capable of killing someone immediately adjacent to where it lands

A rocket-1 has a warhead ignited by a powder train linked to its engine. On any given turn after launch it will detonate on a 2D roll of 7-. A catastrophic failure will result in detonation upon launch, but the launch fuse has a 1 turn delay to allow the firer to get clear. A Rocket-1 has a maximum range of Medium (150 meters), and will reach that range the turn it is launched.

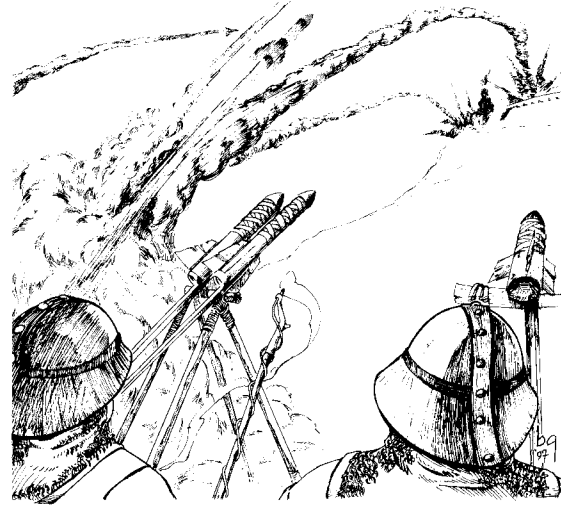

Damage	TL	Range	Shots	Mass	Reloads	Cost
7 explosive	1	V.Short	1	4.2kg	-	Cr50

Name	Dam. Rating	TL	Range	Shots	Mass	Reloads	Cost
Ax-1	2	1	Contact	-	1.8kg	-	Cr220
Bow-1	2	1	Short	1	1.9kg	.1kg	Cr200
Crossbow, Heavy-1	3	1	Short	1	8.9kg	.1kg	Cr340
Crossbow, Light-1	2	1	Short	1	2.8kg	.1kg	Cr200
Knife-1	1	1	Contact	-	.6kg	-	Cr60
Polearm-1	3	1	Contact	-	3.5kg	-	Cr160
Shield-1 (+1)	-	1	-	-	1.0kg	-	Cr30
Shield-1 (+2)	-	1	-	-	2.5kg	-	Cr50
Shield-1 (+3)	-	1	-	-	4.0kg	-	Cr100
Spear-1	2/1	1	Contact/Cont.	1	1.0kg	-	Cr60
Sword-1	2	1	Contact	-	2.0kg	-	Cr200
Ballista-1	4	1	Short	1	120kg	6.0kg	Cr380
Onager-1	5	1	V.Short	1	150kg	1.5kg	Cr490
Rocket-1	7 explosive	1	V.Short	1	4.2kg	-	Cr50
Trebuchet-1	6	1	V.Short	1	2300kg	5.4kg	Cr1100



# TECH LEVEL 2

Early industrial civilization weapons. Basic scientific principles, systematic experimentation and widespread communication of knowledge help spread the techniques of making crude gunpowder weapons, and begin to make an impact on culture and the battlefield. Warfare has developed into an art or serious lifetime profession, with scholars and useful treatises on tactics and strategy. Combat usually involves poor to average trained men on foot and elites riding on some form of animal to provide greater mobility, height advantage or armor carrying capacity. Typically, the latter forces are restricted to wealthy or high-status individuals due to the expense of equipment and support staff. Until large gunpowder weapons become available, stone fortifications can withstand these forces until the besieged run out of food or water, fall afoul of disease from overcrowding or succumb to treachery from within. Naval combat involves large wooden sailing vessels carrying crude gunpowder artillery. Ships are fired upon until they are so full of holes that they sink, or until the enemy crew complement is reduced enough to make boarding practical. Pirate ships may specialize in boarding actions to plunder cargoes.

Cultures reaching this level for the first time tend to have a number of unfruitful side branches of weapon design, but usually develop single shot weapons of reasonable potency, and the technology to create crude artillery pieces capable of destroying (with time) any contemporary fortifications. Severely regressed cultures reaching this level will often have records allowing them to bypass technological dead ends, and may be able to produce or work higher quality materials. In such cultures, this Tech Level is usually a transitory stage on the way to true industrial capability. Almost all TL2 weapons are "muzzle-loaders", where the weapon is sealed at one end, and a measured quantity of propellant is manually loaded, followed by a projectile rammed down the length of the barrel. This is a time-consuming proposition (10 turns for rifles, 5 turns for pistols), and for military use these

weapons are usually fired in a volley, with defensive weapons like polearms or bayonets employed to prevent a group from being overwhelmed during the reloading process. The weapons detailed for tech levels 2-4 generally represent the high end of the spectrum encountered to date. Many of these devices were built by trial and error, and are heavily over-engineered, sometimes massing 2-3x the described amount for artillery pieces, either as a safety margin or as the only means of reducing recoil. Until synthetic propellants are developed at late TL4 or early TL5, most cultures use volatile organic mixtures as propellant, with the frequent side effect of producing large clouds of semi-opaque smoke when fired. In mass quantities, it can rapidly reduce normal visibility enough to affect accurate targeting of the weapons.

## Common Weapons

### Blunderbuss-2

A crude form of shotgun, designed to fire any form of projectiles that could be loaded into its wide, flared barrel, including small rocks, nails, bullets and so forth. Has very little penetrating power, but is capable of hitting multiple targets at close range.

Treat as damage rating 1 autofire attack, so it is capable of doing 2D wounds to its primary target, and 1D wounds to adjacent targets.

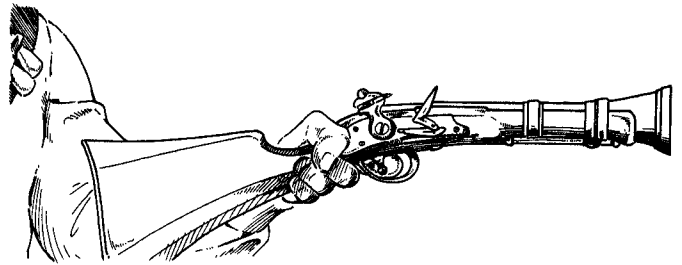

Damage	TL	Range	Shots	Mass	Reloads	Cost
1*	2	Contact	1	3.4kg	.2kg	Cr90

### Pistol, Heavy-2

Not concealable except under voluminous clothing, the heavy pistol usually fired a larger ball with more energy, capable of causing severe injury and penetrating many forms of contemporary armor. Soldiers using riding animals like horses would commonly have a pair of these as secondary armament. Rigidly stratified cultures may place legal restrictions on who may own these weapons because their concealability and ability to penetrate armor makes them a powerful tool for overturning the social order.

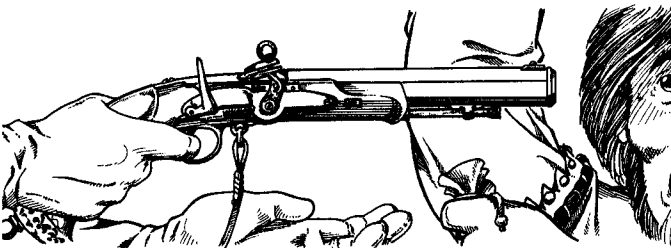

Damage	TL	Range	Shots	Mass	Reloads	Cost
2	2	V.Short	1	1.0kg	-	Cr140

## Pistol, Light-2

A personal defense weapon, easily concealable but not very powerful or accurate. Typically used as a threat in cultures where the result of wound sepsis can make even a minor organ penetration a life-threatening event. Both light and heavy pistols are usually encountered in pairs, to allow for a continuing threat if the first weapon is forced into use.



Damage	TL	Range	Shots	Mass	Reloads	Cost
1	2	Contact	1	.5kg	-	Cr120

## Black Powder-2

A combination of easily refined organic ingredients that functions as a propellant or crude explosive mixture.

A 1 kilogram charge has a concussive damage rating of 6. Proper use of Demolitions skill is required to get this level of effect. Each time the quantity is quadrupled, the damage rating is doubled. Black powder-2 does not

actually detonate, but just burns at an extremely rapid rate. Certain explosive side effects such as HEAP warheads are impossible to create with black powder-2. Black powder-2 can be mixed with other ingredients to reduce the burning rate and produce copious quantities of thick smoke.

Damage	TL	Range	Shots	Mass	Reloads	Cost
6 expl.	2	Contact	1	1.0kg	-	Cr20

## Crossbow, Medium-2

Improvements in armor and the rise of gunpowder weapons force crossbow developments to consolidate at a median suitable for most uses. TL2 military crossbows tend to fire solid metal shafts which are less likely to be deflected by incidental cover or rigid armors. Heavier

models are less cost effective than firearms, and lighter models are relegated to sporting use by those with the time and money to engage in such pastimes. A medium crossbow takes two uninterrupted turns to reload.

Damage	TL	Range	Shots	Mass	Reloads	Cost
3	2	Short	1	6.5kg	.1kg	Cr350

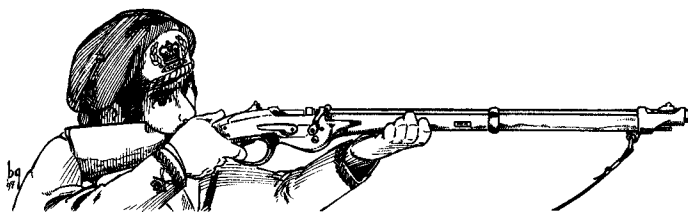

## Musket-2

An archetypal longarm from cultures at the TL2 level of development. Configuration may vary, but in operation most are the same. Usually a smoothbore barrel, with an ignition system based on spark, flame or other outside heat source. Most commonly fires a round lead projectile, though variations based on local metal availability are common.

Damage	TL	Range	Shots	Mass	Reloads	Cost
3	2	V.Short	1	3.6kg	.1kg	Cr120

## Stiletto-2

A heavy-bladed puncturing knife, usually with no edge to speak of. Designed to penetrate lightweight armor and do internal damage with a minimum of force. It or similar size weapons are sometimes used in a two-hand fencing style, allowing an extra tool to parry or attack with.

A stiletto counts as armor-piercing vs. most flexible armor of any tech level. Use in a fencing context gives the user DM+1 for decreasing an opponent's chance to hit, but this particular aspect of the skill is not normally taught in cultures where fencing is a sport rather than combat form.

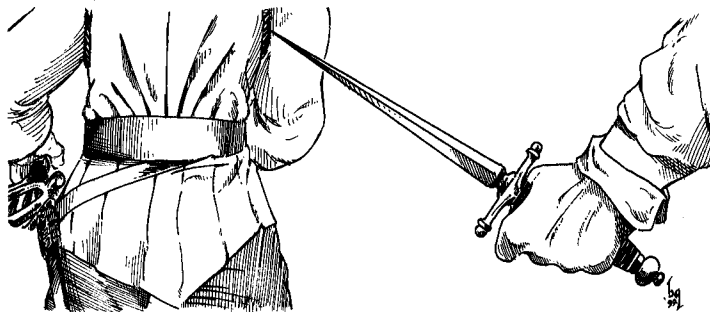

Damage	TL	Range	Shots	Mass	Reloads	Cost
0(1/2D wnds)	2	Contact	-	.2kg	-	Cr25

## Cannon, Light-2

A light artillery piece, capable of being moved by several men or a small number of draft animals. Normally used in a battlefield support, fortification defense or as light armament on a water vehicle. Easily capable of severely injuring or killing an individual in the best contemporary armor. May also be used as an area antipersonnel

weapon by loading a large number of small shot pellets. If used in this fashion, halve the damage rating, rounding down, but count it as an autofire attack to reflect the ability to hit multiple targets, with the exception that it can be aimed.

Damage	TL	Range	Shots	Mass	Reloads	Cost
6	2	V.Short	1	60kg	2.0kg	Cr1100

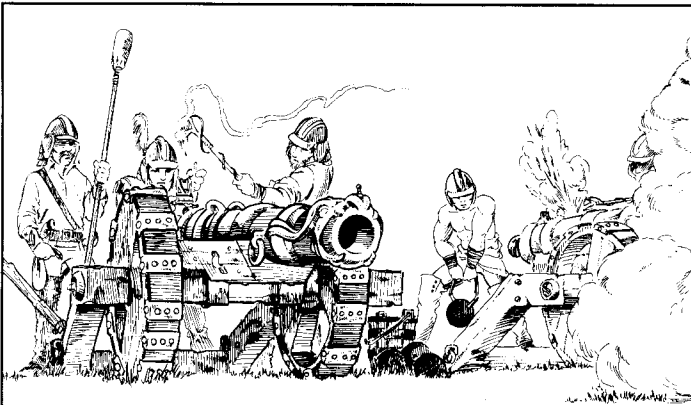

## Cannon, Medium-2

Average size artillery piece, typically the largest battlefield support weapon, drawn by several draft animals, with a separate unit for support and supplies. May also be used on fortifications or as medium armament on naval vessels.

Damage	TL	Range	Shots	Mass	Reloads	Cost
8	2	V.Short	1	160kg	4.4kg	Cr1500

## Cannon, Heavy-2

Large artillery piece, firing iron balls up to 50kg in mass. Used only in fortified emplacements or large naval ves-

sels. Capable of demolishing any contemporary armor or armored structure with repeated fire.

Damage	TL	Range	Shots	Mass	Reloads	Cost
10	2	V.Short	1	490kg	60kg	Cr3600

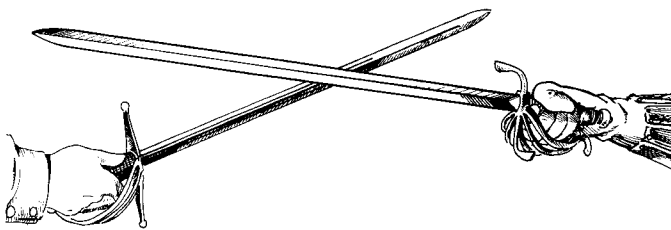

## Rapier-2

One of many fencing weapons that develop in this transitional period between melee weapons and full firearm usage. Most cultures develop their own specific weapons and styles of using them, but they share the common characteristics of light weight, fast response, low damage and using the parry as a defensive maneuver rather than a block which might break the weapon.

Damage	TL	Range	Shots	Mass	Reloads	Cost
1	2	Contact	-	.8kg	-	Cr150

Name	Dam. Rating	TL	Range	Shots	Mass	Reloads	Cost
Black powder-2	6 expl.	2	Contact	1	1.0kg	-	Cr20
Blunderbuss-2	1*	2	Contact	1	3.4kg	.2kg	Cr90
Crossbow, Medium-2	3	2	Short	1	6.5kg	.1kg	Cr350
Musket-2	3	2	V.Short	1	3.6kg	.1kg	Cr120
Pistol, Heavy-2	2	2	V.Short	1	1.0kg	-	Cr140
Pistol, Light-2	1	2	Contact	1	.5kg	-	Cr120
Rapier-2	1	2	Contact	-	.8kg	-	Cr150
Stiletto-2	0(1/2D wnds)	2	Contact	-	.2kg	-	Cr25
Cannon, Heavy-2	10	2	V.Short	1	490kg	60kg	Cr3600
Cannon, Light-2	6	2	V.Short	1	60kg	2.0kg	Cr1100
Cannon, Medium-2	8	2	V.Short	1	160kg	4.4kg	Cr1500

# WEAPON TECHNOLOGIES

---

**Conventional Weapons:** These date from around tech level 2, and see use in some form or the other all the way through tech level 15 and possibly beyond. They use a chemical propellant mixture or some other means to generate a large volume of gas behind a projectile. The pressure difference between this volume and the outside atmosphere accelerates the projectile, which then continues unpowered towards its target. The means of generating the gas pressure vary with culture and technology, but have included rapidly burning compounds like black powder (TL2), steam generators (TL4), compressed air cylinders (TL4), nitrogen compound propellants (TL5), fuel-air mixtures (TL6), metered liquid propellants (TL7) and others.

For convenience in handling, most weapons at Tech Level 5+ will have the propellant and projectile packaged together, allowing for automated loading of each shot. Typically, a number of shots are packaged together in a "clip" or "magazine", and the empty clip is ejected from the weapon and replaced as necessary. Some weapons only hold a single shot and must be manually loaded for each shot (1 turn to reload). Most Tech Level 4- weapons are this type, and in addition the propellant and projectile are loaded separately, a cumbersome procedure at best (10 uninterrupted turns of work per shot for rifles, 5 turns for pistols). Other weapons must reload each shot individually, but hold several shots. These are usually multiple-barrel weapons. Each shot is fired from a separate barrel, or revolvers, where a rotating magazine holds anywhere from 4-9 shots, depending on the size of the weapon and its power. Most revolvers have fixed magazines that must be reloaded one shot at a time, but a few have removable ones for faster reloading.

**Advantages:** Conventional weapons are electronically inert, and have no signature other than the reflectivity of their metal parts and at tech level 7+, the possibility of detecting their propellants by chemical sniffers or use of nuclear resonance techniques (not a portal scanner technology!). They can be created at any level of technology with metalworking, and are fairly forgiving of manufacturing errors and tolerances. They require only a minimum level of skill to use, and a large force can be inexpensively equipped with them. With appropriate lubricants, they work equally well in atmosphere and vacuum, and the projectiles can be designed to carry special purpose payloads such as explosives.

**Disadvantages:** Conventional weapons rely mainly on the energy of the projectile to penetrate armor, and since the recoil of the weapon is proportional to this energy, it limits the size of a weapon that can be safely fired. In general, the recoil from a damage rating of 6 (a modern .50 cal sniper rifle) is the most you would ever want to take. Higher tech weapons can get this penetration with APDS ammo, but a damage rating of 7 from a recoiling weapon will probably do at least a point of damage to your character (wear a shoulder pad!). Conventional weapons are also extremely noisy and draw attention to the firer. The projectiles are slow by most standards (usually <1km/sec), and accuracy is affected by wind, gravity and target movement, all of which must be compensated for, requiring either advanced targeting equipment or a level of skill suitable to compensate for these factors, which vary from weapon to weapon.

**Lasers:** These are invented at tech level 7, but are not developed in a practical weapon sense until at least tech level 9 and are not used as personal weapons until at least tech level 11-12. Lasers rely on a cascading buildup of ener-

gy, reflected back upon itself through an amplifying medium. An initial energy pulse creates photons of the desired wavelength. Many of these scatter through the sides of the lasing medium and are lost as heat. However, some travel down the length of the lasing medium, encounter a reflecting mirror, and bounce back the way they came. This process continues as the properly aligned photons reflect back and forth, until eventually the energy level is sufficient to breach one of the mirrors, and the beam emerges as a coherent pulse of light. This is a simplistic explanation, but sufficient for most purposes. Since the beam is coherent, it does not scatter like a flashlight beam, and retains its intensity for a long distance. A side effect of this is that unless there is something in the path of the beam to scatter it, laser beams are invisible.

In their early development, it was thought that laser energy was difficult to produce, and almost all early lasers relied on expensively produced synthetic crystals. Later it was discovered that the only real requirements for a laser are a transparent lasing medium and a large enough input energy. Lasers have been made from such oddities as children's plastic rulers, or suitably dyed gelatin mix ("It's a dessert! No, it's an energy weapon! Wait, it's both!"). Presumably then, since living creatures have been encountered who store large quantities of electricity, and lasers can be made from organic materials, humanity may eventually meet creatures with natural laser armament . . .

Typical low-tech lasers (TL9-10) will rely on either energy generated from combusting gases (a gas dynamic laser), or from electrically excited gases (typically a carbon dioxide mixture). Higher tech lasers may use tunable free-electron systems, or banks of frequency-agile semiconductor junction lasers feeding a common output. At tech level 13+, starship lasers are typically x-ray lasers, and at tech level 14+, x-ray lasers can be made small enough for hand-held weapons. (The author has no idea how this would be done, but that's because he's stuck at tech level 9...)

**Advantages:** Lasers are speed-of-light weapons, which for most purposes means that gravity, wind and target motion are irrelevant (a Mach 6 fighter at 50km will move 30 centimeters in the time it takes a laser to reach it). In vacuum environments, lasers are virtually invisible, but ship sensors will often be able to pick out the ionization of individual dust particles and gas molecules to backtrack extremely high energy lasers to their source.

**Disadvantages:** Lasers will drop their energy into anything opaque to the laser beam, and the resulting gas cloud is usually opaque to the laser as well, so lasers cannot penetrate long distances through light cover like a conventional weapon might. A person behind a wooden wall could be hit by a bullet passing through, but a laser beam would blow a



hole in the wall and go no further. At short range however, the heat and debris generated by the exploding cover can cause significant secondary damage. Most lasers can also be blocked or diminished by fog, dust or smoke. Tech level 14+ lasers operating at x-ray frequencies are not affected by these problems as much as lasers operating in the visible and near-visible spectrum. While a laser beam is normally invisible, electrically pumped lasers have significant energy signatures that are easily pinpointed with passive sensors.

Even at high tech levels, lasers are not 100% efficient, and generate waste heat just like other weapons. Unlike conventional guns where much of this waste heat escapes the weapon with the muzzle blast, lasers have to dissipate it all, and show up on thermal scans quite readily after they have been fired.

**Plasma Weapons:** Plasma weapons use an extremely large energy discharge to generate a self-confining plasma ball, which is propelled to the target by a series of magnetic acceleration coils. Upon hitting any solid object, the magnetic confinement ruptures, and the small quantity of superheated plasma explosively melts the target, usually resulting in secondary blast effects from molten debris. More powerful weapons will generate a longer plasma stream which is "pinched" into stable configurations on the way out of the accelerator. These will cascade into the target one after the other in a matter of milliseconds, with proportionately greater damage potential.

Plasma weapons were conceptualized as far back as tech level 8, but the technology to develop them in a practical sense was not invented until tech level 11, and not fully accepted in a military sense until tech level 12. The typical light plasma weapon is a crew-served affair, composed of a magnetic accelerator and plasma containment vessel, blast shield, portable fusion reactor and deployable heat sink. Normally this would be a four-man load, three men carrying the reactor, accelerator, blast shield and heat sink, with the last man carrying a 20 liter water container to refill the heat sink when it boils off its normal load of chilled water. At higher tech levels, this can be condensed into a man-portable setup suitable for augmented armor units.

**Advantages:** Plasma weapons can generate long-term firepower more efficiently than conventional weapons, with less recoil, allowing them to be used on lightweight vehicles. While they are accelerated much like gauss projectiles, the

plasma has very little mass, and travels significantly faster. Plasma weapons can also penetrate light cover and atmospheric obscurement much better than lasers.

**Disadvantages:** Plasma weapons have the highest signature of any weapon, and are visible, audible, and detectable by both radio-frequency and radiation detectors. They are expensive, do not have a high rate of fire, and are extreme energy hogs. They are extremely unfriendly to the surrounding terrain, and will ignite any flammable object the plasma passes close to. Use without a blast shield or heavy armor will cause flash and light radiation burns, and all plasma weapons eventually have to be decommissioned due to secondary radiation effects such as metal fatigue and generation of radioactive isotopes. While plasma weapons void a lot of their heat through the plasma ball, they require more energy to begin with and some parts get extremely hot after extended operation.

**Gauss Weapons:** These rely on an intense magnetic field to accelerate a ferromagnetic or conductive projectile. These projectiles are usually very small in diameter, and have a high length-to-width ratio for weapons designed for atmospheric use. Weapons designed solely for vacuum use have spherical projectiles, which is more efficient in terms of mass and final velocity.

Magnetically accelerated projectiles were considered as far back as tech level 7, but the first practical applications were in late tech level 8, and were not adopted by Terran forces as vehicle armament until tech level 9, and they fell out of favor when tech level 11 plasma weapons became available. Power consumption makes them impractical as hand-held weapons until approximately tech level 12 levels of power storage are available.

**Advantages:** Gauss weapons probably have the most efficient means of using electricity to deliver energy to a distant target. They can also fire specialty projectiles, have an extremely high potential rate of fire, penetrate visual cover and be used without concern for weapon side effects.

**Disadvantages:** The use of projectiles means that there is a greater logistics burden in keeping troops supplied, and the mechanical parts are prone to wear and malfunction from foreign material getting in the weapon. Gauss weapons are unsuitable for long range space combat due to their low velocity (compared to light-speed weapons like lasers), though they might be used in a point defense role.

# TECH LEVEL 3

Industrial era civilizations. Introduction of external combustion engines and large-scale metal refining provides the tools and impetus for standardization, and the ability to mass-produce simple mechanical parts. Warfare has evolved to take into account gunpowder weapons. Personal armor is largely discarded as ineffective vs. contemporary weapons and will remain so until tech level 6 synthetic materials or lightweight alloys are developed. Warfare in this interval is extremely gruesome, with no effective armor against military weapons and only the most primitive of medical techniques for repairing the damage. Tactics generally involve massed formations of infantry using sequential volleys of inaccurate fire against similar formations, followed by mounted or infantry charges using melee weapons until one side retreats from the field. Use the "Saturation Fire" rules to resolve massed infantry fire. Artillery is used against enemy artillery and against massed infantry formations.

Weapon developments are largely refinements of TL2 designs, including such features as rifled barrels and elongated projectiles for accuracy and ballistic performance, early experimentation with impact-sensitive compounds as propellant igniters, very crude telescopic sights, and repeating weapons such as revolvers. By the latter half of this period, almost every soldier would have a rifled single shot muzzle-loading weapon, with a detachable bayonet for melee use if there was insufficient time to reload. Artillery science is slightly more advanced, and crude exploding projectiles are in use by the end of tech level 3, as are primitive breech-loading weapons. Rockets as a form of artillery

are occasionally seen, but are generally inaccurate. They have the advantage of being able to carry a long range explosive payload without the recoil and mass of a regular cannon.

If you want to quickly approximate low-tech medical care, assume the maximum skill level that can be applied is equal to half the TL of the knowledge or equipment used, whichever is lower, rounding down. Spectacular failures mean no healing for that interval and a permanent DM-1 to future healing rolls for that injury. Of course, this penalty could be removed if amputation was a viable option... Until about TL5, an injury equal to a Serious Wound in *Traveller* would almost always end up killing the victim from complications.

## Common Weapons

### Shotgun-3

A smooth-bore weapon designed to fire either a large round projectile or a number of standardized smaller ones, used typically as a hunting weapon vs. small or hard to hit game animals. Many of these shotguns have two barrels allowing for a quick follow-up shot in case of an initial miss. Does 2D wounds per point of damage penetrating armor.

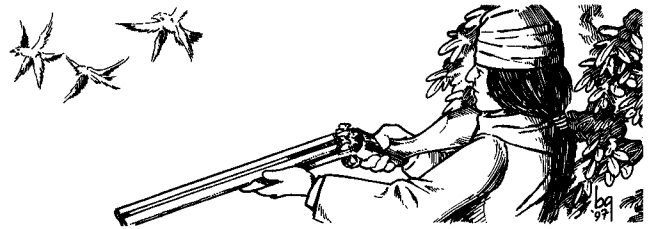

Damage	TL	Range	Shots	Mass	Reloads	Cost
2*	3	V.Short	2	4.7kg	.1kg	Cr200

### Rifle, Air-3

Some cultures lacking in the resources to make conventional propellants have constructed reasonably effective compressed air weapons, the technology to generate and contain these pressures becoming available at tech level 3. Typically, these are highly sophisticated for their period, requiring some basic mechanical talent to keep in good working order. Also, without any form of temperature compensation, they lose power in extremely cold conditions, and may burst from overpressure in hot conditions (count as **very** unreliable in normal cold or hot conditions). They are effective in the right hands, as they can fire a number of shots in quick succession before needing to exchange air reservoirs. A hand operated air pump is typically issued with each weapon (.5kg), which allows recharging of air reservoirs over a half-hour period.



Damage	TL	Range	Shots	Mass	Reloads	Cost
2	3	Short	20	2.2kg	.3kg	Cr220

### Pistol, Heavy-3

A more reliable and slightly lighter version of the heavy pistol-2.

### Pistol, Light-3

Similar to the light pistol-2, but a little more reliable, with two barrels instead of one, allowing for two quick shots from one weapon before reloading.

	Damage	TL	Range	Shots	Mass	Reloads	Cost
Heavy 3	2	3	V.Short	1	.9kg	-	Cr150
Light 3	1	3	Contact	2	.7kg	-	Cr170

### Revolver-3

First available in late TL3. The modern magnum revolver has many of the same mechanical characteristics as this early model. The reloading time on this weapon is multiplied by 6, since it has six separate chambers to reload.

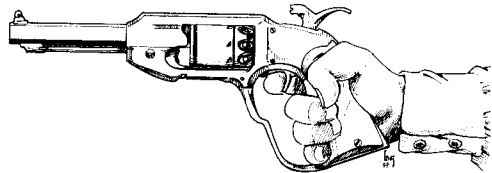

Damage	TL	Range	Shots	Mass	Reloads	Cost
2	3	V.Short	6	1.4kg	.1kg	Cr150

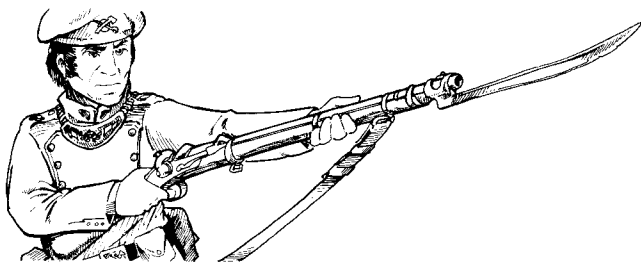

### Rifle-3

Operates much the same as a Musket-2, but has a smaller, rifled bore, and a significantly higher projectile velocity. Fine examples of these weapons are capable of surprising accuracy. Military versions issued in bulk will cost less, but are less reliable and may vary greatly in accuracy.

Damage	TL	Range	Shots	Mass	Reloads	Cost
3	3	Short	1	2.7kg	-	Cr370

### Cannon, Light-3

Early rifled artillery piece. Some improvement over the tech level 2 version, but not significant. Capable of firing low efficiency explosive shells. These have a higher explosive damage, but only detonate on a 2D roll of 9-, otherwise they are treated as damage rating 4.

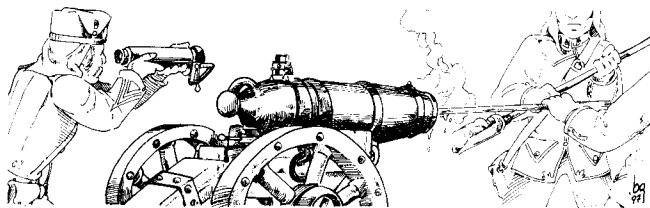

Damage	TL	Range	Shots	Mass	Reloads	Cost
6 (10 explosive)	3	V.Short	1	60kg	5.0kg	Cr1900

### Cannon, Medium-3

A similar improvement on the Medium cannon-2. Capable of firing low efficiency explosive shells. These have a

higher explosive damage, but only detonate on a 2D roll of 9-, otherwise they are treated as damage rating 5.

Damage	TL	Range	Shots	Mass	Reloads	Cost
8 (13 explosive)	3	V.Short	1	100kg	9.5kg	Cr2600

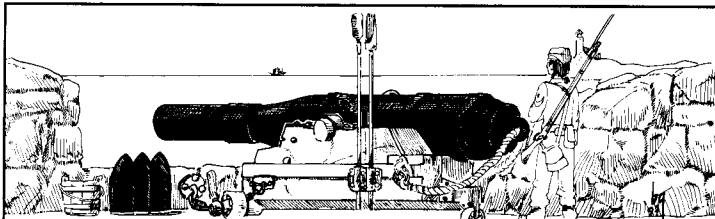

### Cannon, Heavy-3

A significant improvement on the Heavy cannon-2, usually firing streamlined soft iron penetrators, sometimes with a large explosive charge. These have a higher explosive damage, but only detonate on a 2D roll of 9-, otherwise they are treated as damage rating 8.

Damage	TL	Range	Shots	Mass	Reloads	Cost
12 (21 explosive)	3	V.Short	1	880kg	80kg	KCr18.7

Name	Dam. Rating	TL	Range	Shots	Mass	Reloads	Cost
Pistol, Heavy-3	2	3	V.Short	1	.9kg	-	Cr150
Pistol, Light-3	1	3	Contact	2	.7kg	-	Cr170
Revolver-3	2	3	V.Short	6	1.4kg	.1kg	Cr150
Rifle-3	3	3	Short	1	2.7kg	-	Cr370
Rifle, Air-3	2	3	Short	20	2.2kg	.3kg	Cr220
Shotgun-3	2*	3	V.Short	2	4.7kg	.1kg	Cr200
Cannon, Heavy-3	12 (21 explosive)	3	V.Short	1	880kg	80kg	KCr18.7
Cannon, Light-3	6 (10 explosive)	3	V.Short	1	60kg	5.0kg	Cr1900
Cannon, Medium-3	8 (13 explosive)	3	V.Short	1	100kg	9.5kg	Cr2600

# TECH LEVEL 4

Median industrial culture. Standardization, mass production, heavy industry and other factors allow myriad competing weapon designs to flourish.

Warfare is conducted mostly in tech level 3 terms, but with more efficient and accurate weapons. By the latter half of this period, experiments with heavier-than-air flight are taking place, and lighter-than-air vehicles are used in a reconnaissance role. Naval combat sees the introduction of metal-hulled vessels, very crude submersibles, and vessels powered exclusively by steam engines. Naval boarding actions generally cease to exist as a viable tactic, but use of ships for large-scale amphibious invasions is more practical.

Most of the technological developments in firearms through tech level 9 are conceived of and possibly experimented with during tech level 4. Recoil and gas-operated repeating weapons, autofire, modern propellants, multiple barrel rapid-fire weapons, liquid cooling, mechanically fused payloads and mathematically calculated indirect fire are tech level 4 developments. Other notable developments include self-powered naval torpedoes.

## Common Weapons

### Dynamite-4

One of any number of high energy nitrogen compounds developed at this tech level. These are more powerful than previous explosives, but not as stable as modern blasting compounds.

A 1 kilogram charge has a concussive damage rating of 7. Proper use of Demolitions skill is required to get

this level of effect. Each time the quantity is quadrupled, the damage rating is doubled. Dynamite and other TL4 explosives will detonate on a 1D roll of the penetration or less of any attack striking them, with DM+2 if the attack is itself explosive.

Damage	TL	Range	Shots	Mass	Reloads	Cost
7 explosive	4	Contact	1	1.0kg	-	Cr40

### Grenade-4

Simple hand-held explosive device with little or no fragmentation effect. Once activated, it must be used within a few seconds, and is almost always thrown at the target area. Cultural differences in commonly thrown objects

result in a variety of shapes, but effect is generally the same. Fusing is primitive and not exceptionally reliable or accurate in its time delay. Count as an unreliable weapon.

Damage	TL	Range	Shots	Mass	Reloads	Cost
7 explosive	4	Contact	1	.5kg	-	Cr30

### Machinegun-4

A simple, inefficient but fairly reliable application of self-powered repeating firearms technology. Normally, ammunition is fed into the weapon by a gravity fed hopper or by means of a chain, belt or other continuous loop which is preloaded with ammunition before use. Count as an unreliable weapon unless there is a dedicated crew member maintaining a proper ammunition feed.

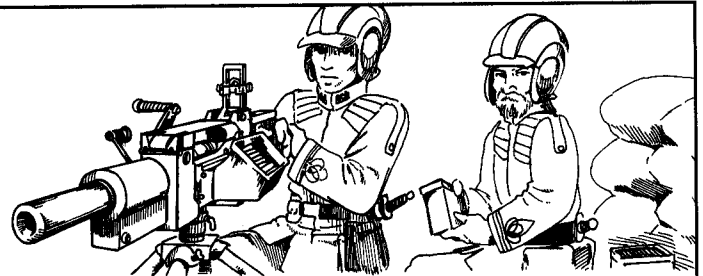

Damage	TL	Range	Shots	Mass	Reloads	Cost
4	4	Medium	200	17.5kg	6.1kg	Cr360

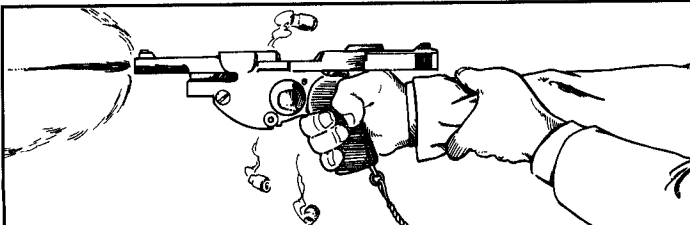

### Pistol-4

A low-capacity semi-automatic pistol or medium power revolver. Performance of the two is nearly identical, and they differ only in their means of operation, the revolver being more reliable in adverse conditions and the semi-automatic faster to reload when empty.

Damage	TL	Range	Shots	Mass	Reloads	Cost
1	4	V.Short	6	.8kg	.1kg	Cr260



### Machinegun, RF-4

Not all cultures develop rapid-fire weapon technology, but those that do usually acquire it at tech level 4 through tech level 6. At the lowest level of feasibility, it is a basic multi-barrel weapon fed from a single ammunition source, with all mechanical activity handled by a turn crank, pedal, or simple linkage to a contemporary power source like a steam engine. While the overall penetration of the weapon is marginal, the ability to lay down a large volume of fire is extremely important in an era when most soldiers are completely unarmored against the threat of firearms. Many of these early weapons suffer from progressive unreliability caused by residues of the primitive propellants used. Count as an unreliable weapon.

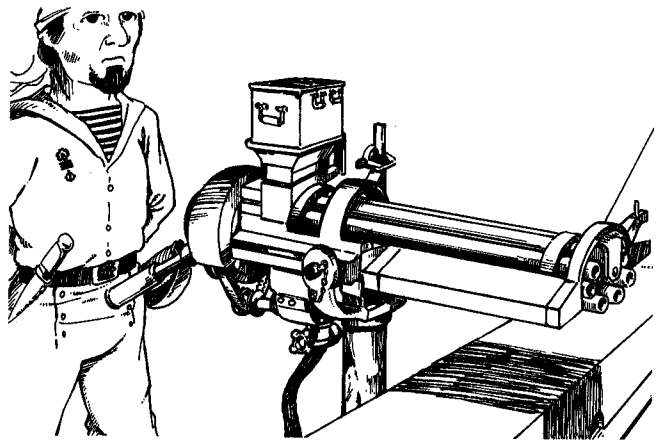

Damage	TL	Range	Shots	Mass	Reloads	Cost
4	4	Medium	200	48kg	6.1kg	Cr820

### Pistol, Body-4

An easily concealable self-defense weapon using self-contained cartridges instead of the ball and powder of previous models. Normally has two barrels, one over the other, which fire with consecutive trigger pulls. The low power cartridges allow for simple weapon designs to be

incorporated into everyday items so that they do not attract undue attention as ranged weapons, including known examples in small utility knives, lighters, writing implements, umbrellas and so forth, and would qualify under most definitions as a "body pistol".

Damage	TL	Range	Shots	Mass	Reloads	Cost
1	4	Contact	4	.3kg		Cr120

### Pistol, Light-4

An easily concealable self-defense weapon using self-contained cartridges instead of the ball and powder of previous models. The light pistol normally has two barrels, one over the other, that fire with consecutive trigger pulls. The low-power cartridges allow for simple weapon

designs to be incorporated into everyday items so that they do not attract undue attention as ranged weapons, including known examples in small utility knives, lighters, writing implements, umbrellas and so forth, and would qualify under most definitions as a body pistol.

Damage	TL	Range	Shots	Mass	Reloads	Cost
1	4	Contact	2	.3kg		Cr50

### Revolver, Heavy-4

A long-barrel revolving action pistol firing a cartridge with more energy than a semi-automatic pistol of the

time could normally handle. Not very concealable. May see use as a military sidearm or heavy police sidearm.

Damage	TL	Range	Shots	Mass	Reloads	Cost
2	4	V.Short	6	1.0kg		Cr150

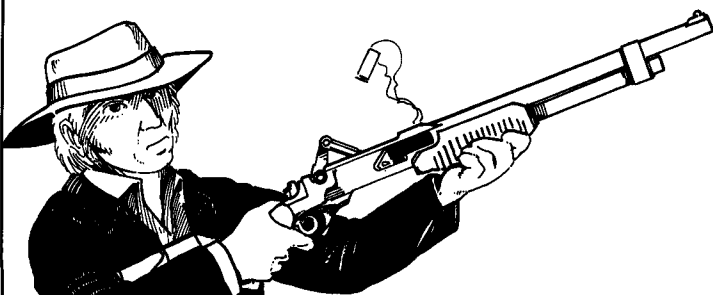

### Shotgun-4

First use of magazine-fed shotguns. Because of the size of shotgun shells, they are usually kept in a non-removable tubular magazine under and parallel to the barrel of the weapon. They are cycled into firing position manually, by means of a lever or slide. This is a typical shotgun, but larger or smaller examples are frequently seen. Does 2D wounds per point of damage penetrating armor.

Damage	TL	Range	Shots	Mass	Reloads	Cost
2*	4	V.Short	6	3.8kg	.2kg	Cr200

### Rifle-4

Medium power military or civilian rifle, differing mainly in that the civilian model is usually of better quality. Usually reloaded by a manually operated bolt and a non-removable internal magazine.

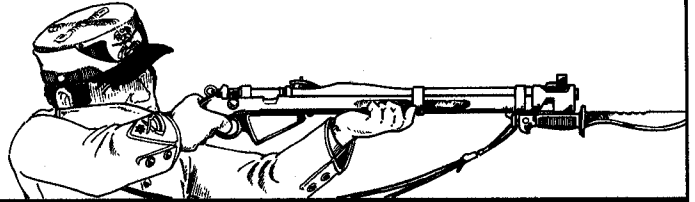

Damage	TL	Range	Shots	Mass	Reloads	Cost
4	4	Medium	5	5.7kg	.1kg	Cr350

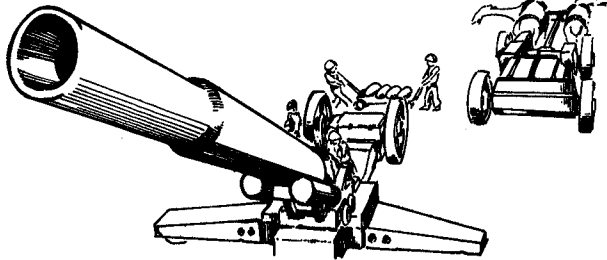

### Cannon, Heavy-4

The largest land mobile artillery of the period, requiring an extensive support crew and usually only portable on hard-surface roads, rails or other improved surfaces. Fires high explosive shells out to subregional range (10km) exclusively through indirect fire to designated map coordinates.

The high explosive rounds only detonate on a 2D roll of 10-, otherwise they are treated as damage rating 10.

Damage	TL	Range	Shots	Mass	Reloads	Cost
22 explosive	4	Long	1	1150kg	55kg	KCr60.0

### Cannon, Light-4

First example of the modern field piece, using hydro-pneumatic recoil compensators to allow more accurate consecutive shots. Normally fires small explosive rounds, but if armored vehicles or structures are typical for the culture at this TL, steel penetrating rounds will also be used. Light cannon and other artillery with a direct fire role will often have "gun shields" to protect the crew from fragmentation and low-power projectiles.

Anyone manning an artillery piece with a gun shield is considered to be behind an armor with a rating of 3. The high explosive rounds only detonate on a 2D roll of 10-, otherwise they are treated as damage rating 5.

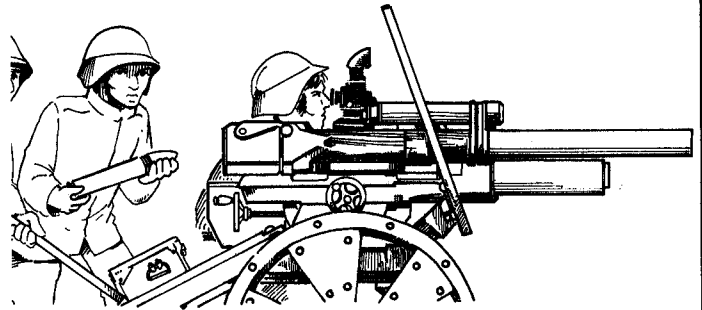

Damage	TL	Range	Shots	Mass	Reloads	Cost
8 (7 explosive)	4	Long	1	105kg	1.6kg	Cr4200

### Cannon, Medium-4

Typical field piece for the period, averaging 70-80mm in bore, firing high explosive shells for area denial, suppression fire or destruction of fortifications. May be used in an indirect fire role, and is typically moved by teams

of draft animals or early powered vehicles.

The high explosive rounds only detonate on a 2D roll of 10-, otherwise they are treated as damage rating 7.

Damage	TL	Range	Shots	Mass	Reloads	Cost
12 (13 explosive)	4	Long	1	420kg	13.9kg	KCr14.0

### Rocket, Artillery-4

An archaic mass bombardment weapon, these are black powder rockets, stabilized by canted nozzles, and fired from ramps or wooden tubes. Carrying a black powder warhead with an impact or time-delay fuse, they are woefully inaccurate, but can be fired from vessels too light to carry cannon, or carried by hand to positions inaccessible to artillery. They are very unreliable weapons, but fortunately most malfunctions are just wildly inaccurate, misfires or failures to launch.

These rockets are considered very unreliable weapons, and their explosive warheads only detonate on a 2D roll of 8-. Otherwise, they are treated as a damage rating 2 attack. They can only be fired in an indirect fire mode, and cannot take advantage of aiming to target subsequent volleys closer to the target. An artillery rocket-4 has a maximum range of Very Long (1.5km), and will reach that range in 3 turns.

Damage	TL	Range	Shots	Mass	Reloads	Cost
15 explosive	4	V.Short	1	10.0kg		Cr25

## Cannon, Very Heavy-4

Weapons of this size are only possible with the large scale industry which usually occurs at the TL4 stage of development. Without accurate missiles, these cultures rely exclusively on heavy, indirect fire projectiles capable of punching holes in armor through terminal velocity alone, with the natural result of large weapons firing large projectiles. These would typically be used as coastal defense weapons to protect areas against hostile ships, or as weaponry aboard very large naval vessels. The accuracy and power of the extremely heavy projectiles should not be underestimated. Typically, these weapons fire either soft steel projectiles for penetrating armor, or impact-fused high explosive rounds, timed to go off *after* penetrating armor of half or less what it would go through (in this case, apply all explosive damage **inside** a vehicular target). These have a higher explosive damage, but only detonate on a 2D roll of 10-, otherwise they are treated as damage rating 13. Weapons larger than this are possible at this level of technology, and examples in the historical record show individual cannon massing more than 50 metric tons, sometimes even mounted in batteries of three or four for salvo fire.

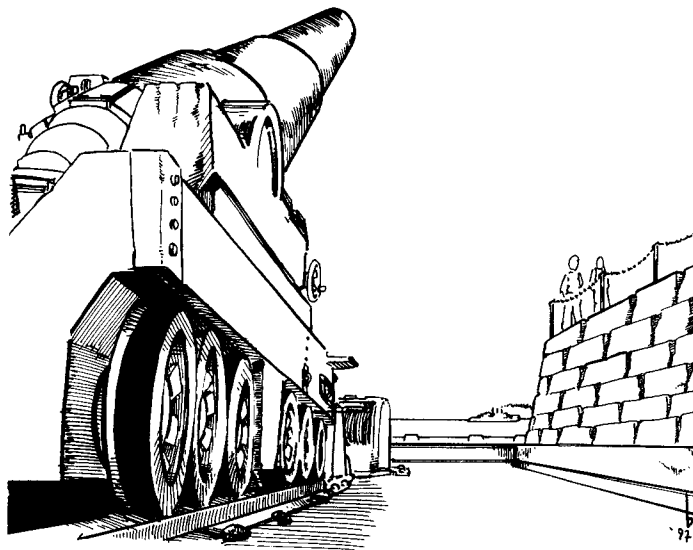

Damage	TL	Range	Shots	Mass	Reloads	Cost
20 (29 explosive)	4	Medium	1	8900kg	270kg	KCr500

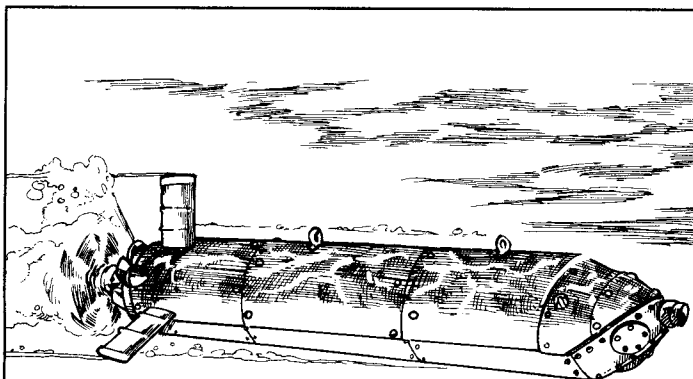

## Torpedo-4

This tech level usually sees the introduction of the unguided naval torpedo. Typically powered by compressed air, crude batteries or chemical reactions producing hot gases to turn a small turbine. Not exceptionally accurate, but few if any countermeasures exist at the time of its development.

Treat a TL4 naval torpedo as an indirect fire weapon that moves 50 meters per turn (30kph) with a maximum range of Extremely Long (3km), and apply DM+1 per doubling of torpedoes in the salvo to reflect the ability to bracket a target. Use the optional torpedo rules presented earlier. All torpedo hits will be below the waterline, and will cause internal flooding. In addition, the incompressible nature of water means that the explosive effect is counted as tamped, i.e. do **not** halve before comparing to armor.)

Damage	TL	Range	Shots	Mass	Reloads	Cost
52 explosive	4	Contact	1	990kg	-	Cr2200

Name	Dam. Rating	TL	Range	Shots	Mass	Reloads	Cost
Dynamite-4	7 explosive	4	Contact	1	1.0kg	-	Cr40
Grenade-4	7 explosive	4	Contact	1	.5kg	-	Cr30
Machinegun-4	4	4	Medium	200	17.5kg	6.1kg	Cr360
Machinegun, RF-4	4	4	Medium	200	48kg	6.1kg	Cr820
Pistol-4	1	4	V.Short	6	.8kg	.1kg	Cr260
Pistol, Body-4	1	4	Contact	4	.3kg	-	Cr120
Pistol, Light-4	1	4	Contact	2	.3kg	-	Cr50
Revolver, Heavy-4	2	4	V.Short	6	1.0kg	-	Cr150
Rifle-4	4	4	Medium	5	5.7kg	.1kg	Cr350
Shotgun-4	2*	4	V.Short	6	3.8kg	.2kg	Cr200
Cannon, Heavy-4	22 explosive	4	Long	1	1150kg	55kg	KCr60.0
Cannon, Light-4	8 (7 explosive)	4	Long	1	105kg	1.6kg	Cr4200
Cannon, Medium-4	12 (13 explosive)	4	Long	1	420kg	13.9kg	KCr14.0
Cannon, Very Heavy-4	20 (29 explosive)	4	Medium	1	8900kg	270kg	KCr500
Rocket, Artillery-4	15 explosive	4	V.Short	1	10.0kg	-	Cr25
Torpedo-4	52 explosive	4	Contact	1	990kg	-	Cr2200

# SIGHTING AIDS

Basic **Traveller** only includes the simplest descriptions of advanced sighting aids available and few rules for their use. In general, a sighting aid for adverse conditions will remove all but DM-2 for a condition at the tech level of its introduction, all but DM-1 at the tech level after that, and all negative DMs at the tech level after that. Also, for devices of limited resolution, the ability to pick out fine detail at range continually improves with TL. So, while TL9 and TL12 night vision devices both negate all darkness DMs, the TL12 sight will provide a more detailed image than the TL9 model. This is largely subjective and left to GM interpretation.

For instance, complete darkness is a DM-6 to visually spot things. If the first night vision scopes become available at TL6, these crude devices reduce the penalty to DM-2. The improved TL7 night vision scope only gives a DM-1, while TL8+ night vision is no -DM to spot things.

Normal penalties to spot/target/acquire things are:

Condition	Penalty
Darkness	DM-6
Partial Darkness	DM-3
Medium Fog	Maximum visibility is Medium (150m) and DM-3 per band past this
Heavy Fog	Maximum visibility is Contact (3m), and DM-3 per band past this
Airborne Dust/Sand	As for fog
Camouflage	DM-3 to naked eye or sensors of below its TL, DM+0 to sensors of TL or better
Spectrum Masking	DM-3 if appropriate to the sensor in question, DM+0 otherwise

Common weapon sights are below. Note that a weapon sight has to be ruggedized and keep a fixed point of aim shot after shot, so these devices will almost always be more expensive and heavier than non-military applications of the same technology. For instance, you can use your night vision sunglasses to fire a weapon without penalty, but it won't provide you any magnification, and the resolution might not let you see the crosshairs if trying to look through a telescopic sight. Multi-spectrum binoculars have a wider range than a thermal conversion scope, but the binoculars would probably be damaged by recoil if you tried to mount them on an automatic rifle, while the scope is designed to take that kind of punishment for years of use. Most of these sights can be combined. Price will be as for all the sights combined, but mass is that of the heaviest sight and half the other sights. While not explicitly stated, assume all forms of vision enhancement sights at TL6+ incorporate telescopic sights and may be used as such in most conditions, so .2kg and Cr500 of the cost of the other types of sight is the telescopic sight.

**Telescopic Sights (TL3+):** These allow more accurate aimed fire at longer ranges. They require an aim action to use, and provide a +DM of the weapon's Range number, with a maximum DM+4. Normally a target has to be at a range of at least Short to use the sights effectively. DMs for an *evading* target are doubled if trying to aim at them with a telescopic sight (in effect, evading negates the telescopic sight bonus). Moving targets simply don't get the DM+3 for being stationary, while evading targets are even harder to hit.

Telescopic sights can be knocked out of alignment by

rough handling or damage, and this may not be immediately apparent until the weapon is fired again. Rough handling is an Easy task (1.5D) on the sight's TL or less to avoid this, and any form of weapon damage is a Formidable task (3D) to avoid this. Mis-aligned sights are a -DM of the range number to aimed fire rather than a +DM, since aiming at a particular spot is more likely to generate a miss at long range than at short range. Called shots of any kind are impossible outside Medium range without some form of magnified sights.

A good quality telescopic sight is about .4kg and Cr500, regardless of tech level. Higher TL's provide features like anti-glare or flare coatings, variable magnification, and better weather resistance and durability. Telescopic sights of TL7+ are usually weather- and water-proof.

**Light Amplification/Conversion Sights (TL6+):** These either convert an invisible portion of the light spectrum into visible frequencies, or amplify invisibly small amounts of existing light into visible quantities. The net effect is to negate darkness penalties. The technology is usually a classified military item at TL6 because of its tactical advantage over forces that lack this capability.

At TL6, these devices are approximately 5kg and Cr1000, with a heavy power draw and only a few hours use between recharges. They use a non-visible light source easily detected by higher TL sights of this type. At TL7, they are 1kg and Cr4000, and TL8+ models are .5kg and Cr2000. TL7+ models have extended battery life measured in the hundreds of hours.

**Tactical Heads-Up Display (HUD) (TL9+):** This is a portable sensor and target analysis suite mounted on the weapon. By means of a thumb switch, the user can designate a target, and the HUD will highlight it as long as it stays in the general sights of the weapon. The HUD takes into account range and target movement, and projects a crosshair on the sight where the user should aim for best chance to hit. The maximum +DM provided on any shot is only enough to offset the movement of the target and in this way it complements a normal telescopic sight. The telescopic sight only gets a +DM vs. stationary or non-evading targets, and the HUD only gets its +DM vs. evading ones. The maximum +DM also depends on the weapon and TL. An advantage of the HUD is that the firer gets some of the +DM when using snapfire actions. They do not get the full bonus if they move, but they do get half (round down) the +DM the heads up display provides.

Example: A rifle with Medium range and a DM+3 HUD would have a maximum DM+6 on aimed fire vs. any target (DM+3 for aiming and either DM+3 for the inherent telescopic sight and a Medium range weapon, or DM+3 for the HUD). Versus a stationary target they would also get the normal

DM+3 bonus. If the shooter were moving, the HUD would give a DM+1 for snapfire shots, and avoid the DM+3 opponents would get for shooting at a stationary target.

Note that this qualifies as a sensor, and would take penalties to "lock on" to a camouflaged or masked target, especially one of higher TL than the HUD itself. Abilities of HUDs vary, but a TL12 model can provide a DM+3 in a package about .8kg and Cr1200. A DM+2 unit would be about .1kg and Cr200 and is a popular accessory for police pistols and submachineguns. The bulk does make the weapon slightly harder to conceal. Both types are normally restricted to qualified personnel, but are not actually illegal to own, making the "street price" significantly higher.

**EMF Scope (TL11+):** While technically possible at lower TL's, an electromagnetic field sensor scope is sometimes available once the battlefield becomes fully electronically integrated. The scope is a directional array of magnetic and electric field sensors. It is wide and flat at the front to provide good parallax for distance estimation, and has a small hooded output screen where the eyepiece of a normal scope would be. What it provides is a false color picture of all sources of electromagnetic radiation superimposed on the visual scene in front of the user, coded for distance, intensity and probable type. A typical view might have pixels representing the small shielded output of infantry electronics, pulsing lines where underground power lines run, bright flashes from a distant airplane radar, and the heavy blur of a grav tank's power plant. The advantage is that output from

visually hidden sources is easily spotted. The airplane radar could be behind clouds, and the tank in a warehouse building, but both would still show up. The disadvantage is that such power emanations are easily faked, and most military forces will have a variety of countermeasure packages designed to fool this type of sensor.

An EMF scope will mass about 1.5kg at TL11, and cost around Cr2000. At TL12+ they mass about .8kg and cost Cr1500.

Note: At TL14+ these sensors can start to incorporate functions of the Neural Activity Sensor, allowing them to discriminate the electrical emanations of a lifeforms' nervous system, and eventually this technology would allow weapons tailored to target a specific species, or possibly even a particular individual.

**Densitometer Sights (TL16+):** This is an advanced densitometer array with computer enhanced output. It lets the user specify a range band and density gradient, and provides a medium resolution picture of all density contours within that range. It would for instance, let you see a person behind a solid obstacle. The level of detail is reduced by nearby extremely dense objects, so while the sight might resolve a person leaning against a stone wall, it might not resolve a person leaning against a superdense wall.

Since this is a device outside the scope of most campaigns, cost and mass are left to the GM. Note that such a sight would almost certainly include the functions of an advanced tactical HUD.



# TECH LEVEL 5

Pre-atomic industrial. More refinements of tech level 4 weapons, usually the introduction of autofire weapons into warfare in a larger scale, including the issuance of personal autofire weapons.

Warfare begins using weapons and tactics easily recognizable to modern readers, including aircraft, armored ground vehicles, chemical warfare, radio communications and remote sensing devices like radar and primitive counter-measures against the same. Early in this period, warfare will use some of the tech level 5 advances with tech level 3-4 tactics, resulting in horrific casualty rates, while later TL5 conflicts will develop the new tactics required for effective use of these weapons.

Advanced materials like aluminum, primitive composites and heavy element penetrators are experimented with, but not in widespread use. Development of heavier-than-air flight brings the use of unguided bombs and manual sighting systems to fire on rapidly moving targets. The first primitive fire control systems using purely mechanical and passive optical elements are introduced. The first electronically enhanced night vision devices appear in late tech level 5, using an active source of non-visible wavelengths for target illumination.

## Common Weapons

### Demolition Charge-5

A pre-packaged explosive charge with adjustable chemical timer. Used to demolish barricades, light fortifications, structures and is sometimes used in a desperation

role against armored vehicles, either in the propulsion system to immobilize it, or near a weapon system to destroy it.

Damage	TL	Range	Shots	Mass	Reloads	Cost
22 explosive	5	Contact	1	5kg		Cr50

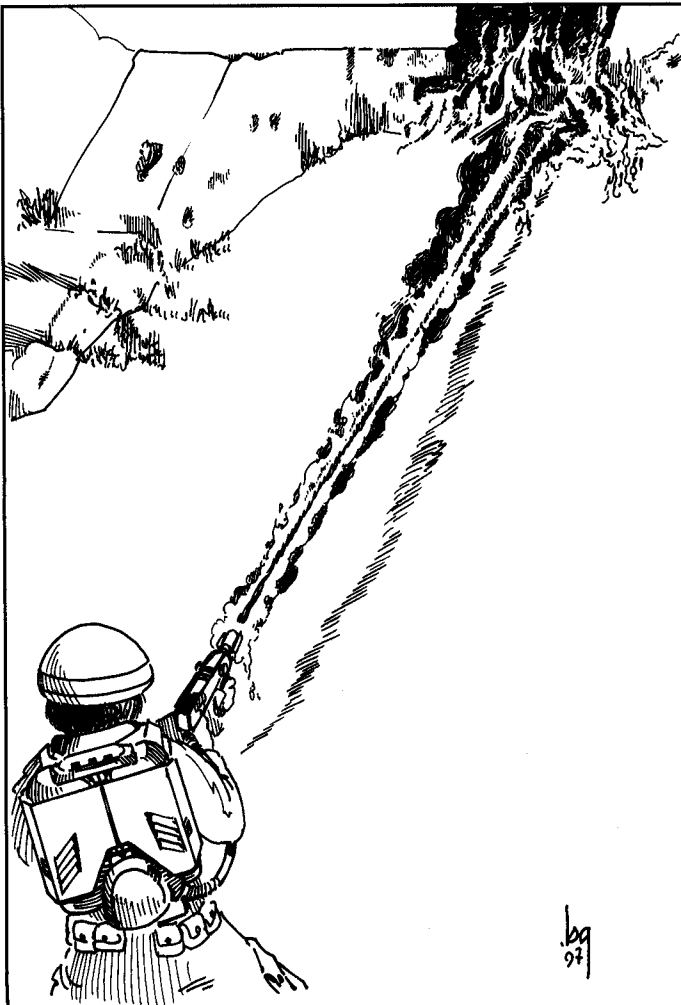

### Flamethrower-5

The concept of a flammable liquid projector dates back to TL3 in some cases, but is not developed to a practical stage until TL5. It normally consists of a canister of pressured inert gas, a canister of flammable liquid such as refined petroleum, often with additives, and a hose and projector assembly with some form of igniter at the end. The range is not significant, but in an era where all vehicles consumed outside oxygen and no combatants had environmentally sealed suits, the havoc such a weapon could cause is barely imaginable. The closest modern comparison would be to a PCMP-series weapon. The flamethrower was heavy and bulky, and its storage units were completely unarmored, making the wearer vulnerable to a fiery death should a bullet passing through the unit generate any sparks.

A flamethrower shot will fill an outdoor square with burning fuel, which ignores any unsealed armor for damage purposes. Assume there is a DM+3 for targeting an outdoor square. An aimed shot can splatter flaming material through vision slots and other unsealed apertures, and will cause internal combustion engines to immediately shut down on a propulsion system hit, regardless of armor rating. Anything in the targeted area takes damage each turn it remains in the area. Any object directly targeted is covered in burning fuel and continues to take damage even if it leaves the targeted area. A person carrying a flamethrower should be targeted using vehicle hit locations. If the result is "device" (or "weapon" or "ammunition" on advanced hit locations), the flamethrower is hit, and will explode (target its own outdoor square) if it fails catastrophically. This is normally on a 2D roll of (14-damage rating of weapon hit) or more.

Damage	TL	Range	Shots	Mass	Reloads	Cost
1*	5	Contact	10	20.0kg	15.0kg	Cr500

### ACR-5

The first TL at which the term advanced combat rifle is applicable. At previous tech levels, there was very little distinction between an inexpensive civilian firearm and a normal military one. At TL5, purpose-built military long-garms start to show distinctions between non-military weapons firing similar ammunition. Typically, the weapon will be a repeating weapon with a detachable clip, with an unregulated autofire mode available if required. While it uses less advanced materials, many concepts of modern ACRs are experimented with at this stage.



Damage	TL	Range	Shots	Mass	Reloads	Cost
4	5	Medium	20	6.8kg	.5kg	Cr640

### Grenade, AT-5

Earliest development of the shaped charge concept. An aerodynamically stabilized thrown grenade with an impact fuse or timer. In the case of a timer, may be equipped with magnets or adhesives to ensure continued

contact with soft or hard steel targets until detonation. Requires considerable courage to use, as the attacker must get within throwing distance of an armored vehicle typically equipped with cannon and automatic weapons.

Damage	TL	Range	Shots	Mass	Reloads	Cost
21 (13 expl.)	5	Contact	1	.8kg	-	Cr50

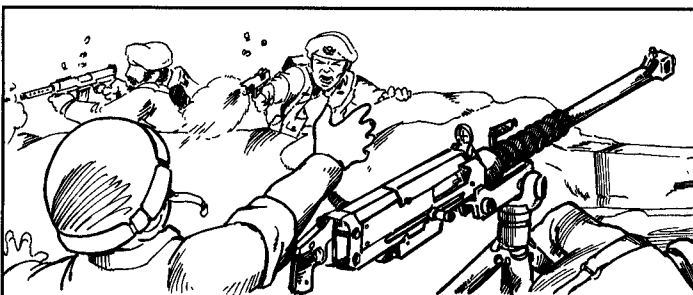

### Machinegun, Heavy-5

An autofire weapon capable of engaging targets at longer ranges than the ACR, with light anti-vehicle and anti-aircraft capability with the addition of special sights. May be secondary armament on armored vehicles, or primary armament of TL5 combat aircraft. May be broken down into 3 man-portable loads, with any extra individuals carrying weapon reloads.

Damage	TL	Range	Shots	Mass	Reloads	Cost
6	5	Long	200	50.5kg	23.2kg	Cr2600

### Machinegun, Medium-5

Light support weapon for military use, typically firing the same ammunition as the ACR-5, but from a hopper or feed bin holding several hundred rounds, allowing for sustained autofire use. In addition, it will have more mass for heat absorption and dissipation. May be mounted on light vehicles as a self-defense weapon, or broken down into 2-3 man-portable loads (weapon and multiple ammunition loads) for placement in strategic locations.

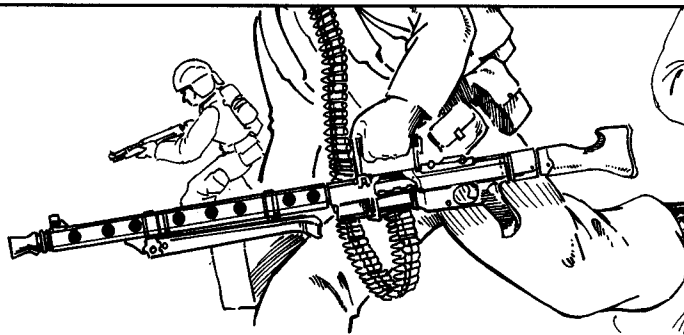

Damage	TL	Range	Shots	Mass	Reloads	Cost
4	5	Medium	200	15.6kg	5.9kg	Cr950

### Pistol-5

A minor mechanical improvement on the Pistol-4, but similar in overall performance.

Damage	TL	Range	Shots	Mass	Reloads	Cost
2	5	V.Short	10	1.0kg	.1kg	Cr300

## Rifle, Anti-Tank-5

The development of light armored vehicles early in this period is often followed by attempts to create a man-portable anti-tank gun. Typically this is a robust manual-action firing a heavy machinegun or light cannon round. It may be of some use against early vehicles, but rapid development of more efficient power plants and propulsion systems soon allows vehicles to carry enough armor to negate this threat. These weapons may still be used in a long-range antipersonnel or anti-materiel role after their anti-vehicle usefulness has ended.

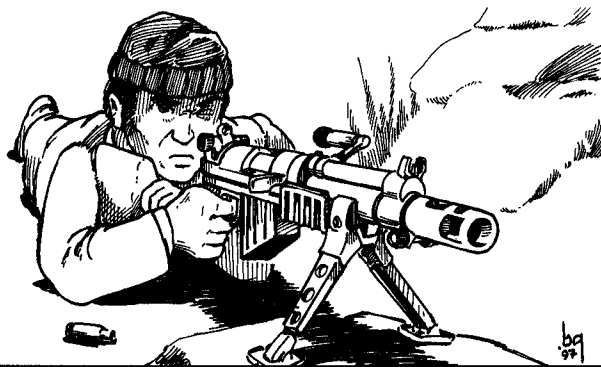

Damage	TL	Range	Shots	Mass	Reloads	Cost
7	5	Medium	5	32.8kg	1.9kg	Cr2400



## Rifle, Hunting-5

A generic longarm used for sporting purposes, often designed with aesthetic considerations and sometimes with significant off-world collector value as art pieces due to engravings, carvings or other artistic additions. May be tailored for a specific type of game animal, but an usual representative of models suitable for game up to 1000kg in mass is often equipped with a passive optical telescopic sight and in wartime may be pressed into use as a sniper weapon. Higher quality models may have a longer effective range.

Damage	TL	Range	Shots	Mass	Reloads	Cost
5	5	Medium	4	6.4kg	.1kg	Cr480

## Submachinegun-5

A heavy autofire weapon firing a pistol cartridge, typically used for short range or urban combat. Shorter range than a rifle, but longer tactical range than a pistol, with the capability of laying down suppressive fire for tactical advantage or area denial. Lighter ammunition mass means a greater quantity can be carried, allowing more frequent use of the autofire capability. It almost always requires use of both hands because of weight, ergonomic or recoil considerations. Often mass produced in marginal quality (unreliable weapon) for used by poorly trained troops. Many varieties of this type of weapon exist, from those firing lightweight pistol cartridges to ones firing full-power rifle rounds.

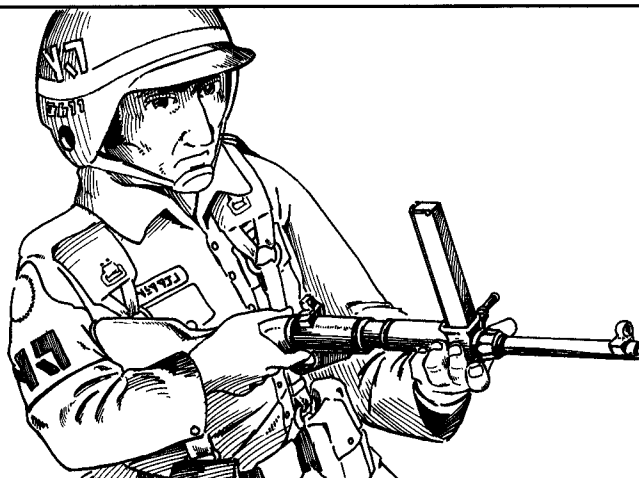

Damage	TL	Range	Shots	Mass	Reloads	Cost
2	5	V.Short	30	2.0kg	.4kg	Cr220

## Bomb-5

A simple unguided explosive device, dropped from aircraft and aimed by indirect fire sights. Normal use is to drop them in great quantity in the hopes that one or more will hit near the target. They are available in an unlimited variety of sizes, often tied to round units of

local weight measurement (such as the kilogram), or the lifting capacity of existing aircraft.

The high explosive rounds only detonate on a 2D roll of 11-, otherwise they are treated as damage rating 20.

	Damage	TL	Range	Shots	Mass	Reloads	Cost
Heavy-5	72 explosive	5	Contact	1	1000kg		Cr1000
Medium-5	53 explosive	5	Contact	1	250kg		Cr500
Light-5	37 explosive	5	Contact	1	50kg		Cr100

### Cannon, Heavy-5

Improved version of the heavy cannon-4, representing light naval weaponry, heavy artillery or extremely heavy land vehicle armament. These weapons commonly use bagged propellant charges, the number of which varies with the indirect fire range needed. In vehicle use, these separate propellant charges also ease the loading process of the heavy projectiles into two or three smaller loads.

The high explosive rounds only detonate on a 2D roll of 11-, otherwise they are treated as damage rating 11.

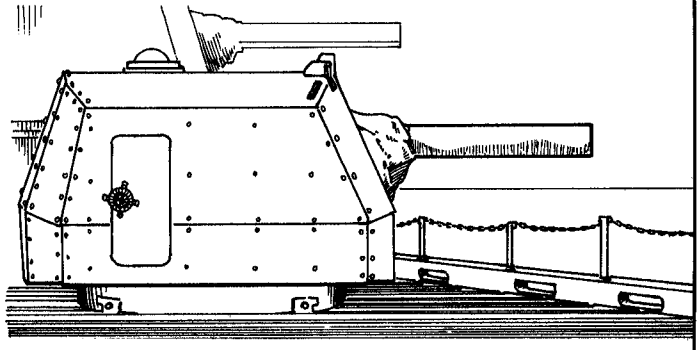

Damage	TL	Range	Shots	Mass	Reloads	Cost
18 (23 explosive)	5	Long	1	1460kg	64.8kg	KCr101

### Cannon, Light-5

Typical of light armament on combat vehicles or light anti-armor towed weapons, usually with a bore of 30-

40mm. Normally only fires hard steel armor piercing rounds.

Damage	TL	Range	Shots	Mass	Reloads	Cost
10	5	Long	1	200kg	1.5kg	Cr8500

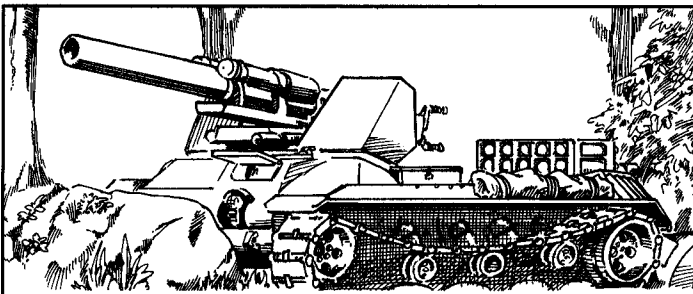

### Cannon, Medium-5

Improved version of the medium cannon-4, representative of medium artillery pieces or heavy land vehicle armament. Limited use of these heavier weapons has been documented in aircraft as an airborne anti-tank weapon, but these are limited to large aircraft due to mass, recoil and volume needed.

The high explosive rounds only detonate on a 2D roll of 11-, otherwise they are treated as damage rating 8.

Damage	TL	Range	Shots	Mass	Reloads	Cost
14 (14 explosive)	5	Long	1	600kg	18.1kg	KCr30.3

### Cannon, Very Heavy-5

This is usually the maximum development of the direct or indirect fire projectile weapon. The sheer size and difficulty in manufacturing prevents rapid development in the field of very heavy cannon, and unless destroyed in combat, these behemoths are usually durable enough to survive well into the rapidly developing curve of TL6-9, during which they rapidly become obsolescent or suitable only for very specialized uses. Normal ammunition is a hard steel penetrator with small explosive charge, or a normal explosive round. Both are loaded separately from the propellant for ease of handling.

The high explosive rounds only detonate on a 2D roll of 11-, otherwise they are treated as damage rating 14.

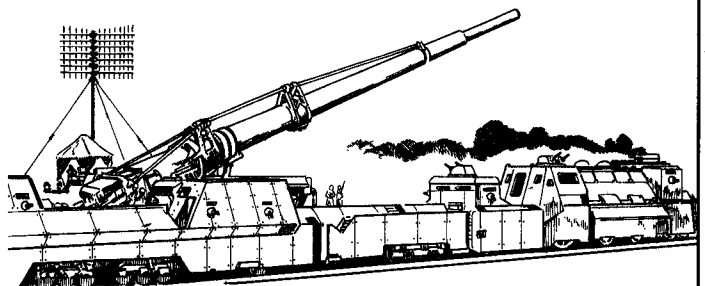

Damage	TL	Range	Shots	Mass	Reloads	Cost
23 (14 expl.) (36 explosive)	5	Long	1	5300kg	420kg	MCr1.3

## LAAW-5

**Light Anti-Armor Weapon.** Another early development of the shaped charge concept. Normally a simple solid rocket booster with a HEAP warhead on the front, fired from a thin-walled metal tube equipped with simple sights and possibly a backblast shield. Accuracy is poor and performance barely adequate for use against contemporary heavy tanks, but is the only portable ranged weapon of this period capable of the role.

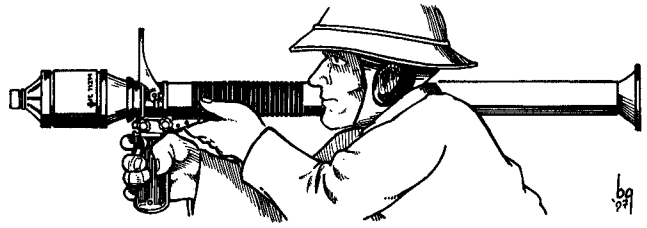

Damage	TL	Range	Shots	Mass	Reloads	Cost
19 (15 expl.)	5	V.Short	1	6.3kg	4.1kg	Cr400

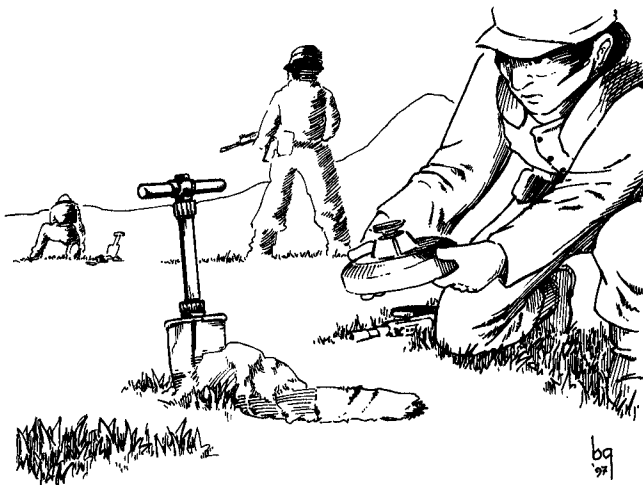

## Mine, AP-5

A simple mechanical pressure switch and very small explosive charge. It may be designed to injure a combatant, depriving an enemy of medical resources, or kill them outright. More sophisticated models have a fragmentation effect, to injure or kill anyone else near the person who triggered it. AP mines will also go off if run over by a vehicle, and may immobilize unarmored or lightly armored vehicles.

Since they are buried on one side and facing a foot on the other, AP mines are considered tamped explosives and are not halved vs. enclosed or rigidly suited individuals. A person or vehicle passing over an area that is mined will set them off if they are placed properly (as per the Minefield rules). Explosive damage from mines is always assumed to hit the feet or legs of the victim and is treated as a half-damage called shot for injury purposes.

Damage	TL	Range	Shots	Mass	Reloads	Cost
4 explos. or 4 frag.	5		1	.2kg		Cr10

## Mine, AT-5

A simple mechanical pressure switch and large explosive charge, designed to disable or destroy vehicular targets. Often equipped with anti-tamper devices to prevent them from being moved. Their size and metallic construction makes them simple to detect with modern equipment.

Since they are buried on one side and facing a vehicle on the other, AT mines are considered tamped explosives and are not halved vs. vehicle targets. A vehicle passing over an area that is mined will set them off if they are placed properly (as per the Minefield rules). Damage from TL5 mines is always assumed to hit the propulsion system of the vehicle first. Higher TL mines may have proximity sensors that can trigger under the hull of the vehicle and target virtually any vehicle system.

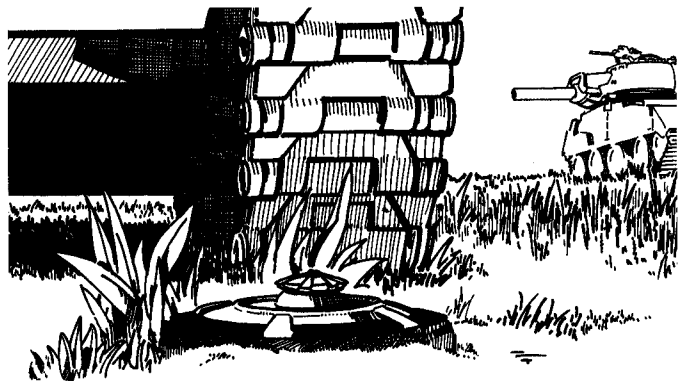

Damage	TL	Range	Shots	Mass	Reloads	Cost
24 explosive	5		1	7.0kg		Cr50

## Mortar-5

A short range, man-portable indirect fire weapon. A combination of varying propellant charges and barrel angle allows the user to lob explosive projectiles to various ranges. Typically a spotter will provide indirect fire directions and the barrel will be adjusted after each shot to incrementally get closer to the target. This TL lacks any precise counter-battery technology, so this crude target acquisition is often effective, given enough time and ammunition. The mortar-5 can be broken down into two man-portable loads, with extra individuals carrying ammunition or a bulky TL5 radio transceiver for receiving targeting directions.

A mortar-5 has a minimum range of Long (150m) and a maximum range of Extremely Long (3km). Projectiles require about 6 turns to reach maximum range, so this is the minimum time between spotting corrections at this distance. The high explosive rounds only detonate on a 2D roll of 11-, otherwise they are treated as damage rating 4.

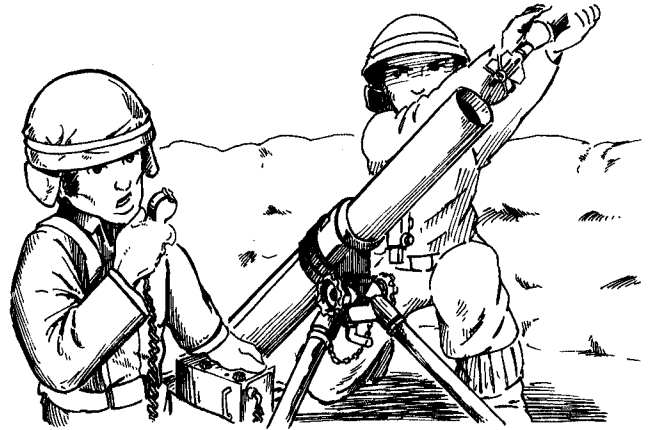

Damage	TL	Range	Shots	Mass	Reloads	Cost
15 explosive	5	Contact	1	17.5kg	4.6kg	Cr250

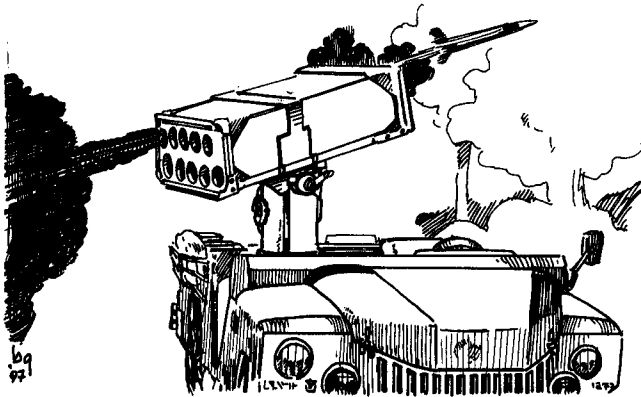

## Organ Rocket-5

This is an easily produced means of delivering a large artillery barrage without the need for conventional artillery pieces. It is a network of lightweight launch rails for a cluster of 20-50 unguided rockets with HE warheads. Aimed solely by a simple traverse and elevation system, the entire group of rockets is fired over the course of several seconds, after which it is rapidly redeployed to prevent counter-battery fire. These rockets are invariably less accurate than tube artillery, and are usually deployed in large numbers to compensate.

Rocket artillery cannot effectively use spotting rounds to zero-in on a target and usually uses Saturation Fire rules. Any given rocket only detonates on a 2D roll of 11-, otherwise they are treated as damage rating 5.

Damage	TL	Range	Shots	Mass	Reloads	Cost
25 explosive	5	V.Short	50	1800kg	-	Cr6400

## Torpedo-5

A great improvement over the torpedo-4, made possible by improvements in gas generators, batteries and other power sources. Capable of being fired from underwater tubes, running at a certain depth or very limited pre-launch course programmability. Late TL5 versions may

have primitive homing circuits based on the loud acoustic signatures of a moving ship. The torpedo-5 has a maximum velocity of 75 meters per turn (45kph), a maximum range of Subregional (10km), and is fired using Indirect Fire rules.

Damage	TL	Range	Shots	Mass	Reloads	Cost
49 explosive	5	Contact	1	1200kg	-	Cr1900



Name	Dam. Rating	TL	Range	Shots	Mass	Reloads	Cost
ACR-5	4	5	Medium	20	6.8kg	.5kg	Cr640
Demolition Charge-5	22 explosive	5	Contact	1	5kg	-	Cr50
Flamethrower-5	1*	5	Contact	10	20.0kg	15.0kg	Cr500
Grenade, AT-5	21 (13 expl.)	5	Contact	1	.8kg	-	Cr50
Machinegun, Heavy-5	6	5	Long	200	50.5kg	23.2kg	Cr2600
Machinegun, Medium-5	4	5	Medium	200	15.6kg	5.9kg	Cr950
Pistol-5	2	5	V.Short	10	1.0kg	.1kg	Cr300
Rifle, Anti-Tank-5	7	5	Medium	5	32.8kg	1.9kg	Cr2400
Rifle, Hunting-5	5	5	Medium	4	6.4kg	.1kg	Cr480
Submachinegun-5	2	5	V.Short	30	2.0kg	.4kg	Cr220
Bomb, Heavy-5	72 explosive	5	Contact	1	1000kg	-	Cr1000
Bomb, Light-5	37 explosive	5	Contact	1	50kg	-	Cr100
Bomb, Medium-5	53 explosive	5	Contact	1	250kg	-	Cr500
Cannon, Heavy-5	18 (23 explosive)	5	Long	1	1460kg	64.8kg	KCr101
Cannon, Light-5	10	5	Long	1	200kg	1.5kg	Cr8500
Cannon, Medium-5	14 (14 explosive)	5	Long	1	600kg	18.1kg	KCr30.3
Cannon, V. Hvy-5	23 (14 expl.) (36 explosive)	5	Long	1	5300kg	420kg	MCr1.3
LAAW-5	19 (15 expl.)	5	V.Short	1	6.3kg	4.1kg	Cr400
Mine, AP-5	4 explos. or 4 frag.	5	-	1	.2kg	-	Cr10
Mine, AT-5	24 explosive	5	-	1	7.0kg	-	Cr50
Mortar-5	15 explosive	5	Contact	1	17.5kg	4.6kg	Cr250
Organ Rocket-5	25 explosive	5	V.Short	50	1800kg	-	Cr6400
Torpedo-5	49 explosive	5	Contact	1	1200kg	-	Cr1900

# TECH LEVEL 6

Early atomic era. Weapon developments are mainly improvements in materials, with the addition of rudimentary electronics to large weapons, including simple gyrostabilized fire control systems and very basic targeting computers.

Warfare continues along tech level 5 lines, with new tactics involving the deployment, use and defenses against atomic weapons among those cultures that develop them. Marginally effective body armor vs. high velocity fragments and small bullets becomes available, but is not in widespread use.

Propulsion technology allows for reaction engine missiles with intercontinental range and atomic warheads. It is

conceivable that a starship without either point defense or nuclear dampers could be targeted by ground launched weapons at this tech level, but no instances of this have been recorded. Civilian and many personal weapon technologies are more or less the same as TL5 weapons. Personal night vision devices of some effectiveness are available, but often a "secret" military technology.

## Common Weapons

### ACR-6

First major ACR use of lightweight alloys or plastics. The ACR of this period fluctuates between a lighter model that allows more ammunition to be carried, and a heavier model that has more penetrating power and range. Which one is used depends on the logistics and terrain the purchaser is expecting to fight in.

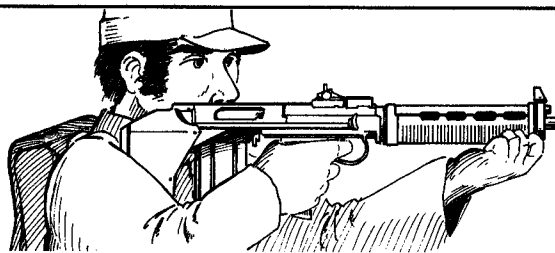

	Damage	TL	Range	Shots	Mass	Reloads	Cost
Heavy-6	5	6	Medium	20	5.9kg	.5kg	Cr1900
Light-6	4	6	Medium	40	4.0kg	.4kg	Cr500

### Grenade-6

Much improved version of the grenade-4, with a scientifically designed fragmentation effect for maximum tactical advantage in the typical conflicts among the user's culture. The ACR-6 may have a special attachment for

launching grenades as an indirect fire weapon (out to a maximum of Long range (450m)).

Preparing a grenade for rifle launch takes at least a turn, plus one turn to reach its destination.

Damage	TL	Range	Shots	Mass	Reloads	Cost
Grenade-6	6 fragment	6	Contact	1	.2kg	-

### Machinegun, Heavy-6

Refinement of the heavy machinegun-5, with slightly better performance, but no longer suitable as anti-vehicle armament except vs. the lightest armored vehicles.

Often found used as a heavy anti-infantry weapon for its ability to penetrate light cover and maintain significant damage at extreme range.

Damage	TL	Range	Shots	Mass	Reloads	Cost
6	6	6	Long	200	39.9kg	19.0kg

### Rifle, Recoilless-6

A lightweight zero-recoil weapon that uses a counter mass like metal or plastic pellets to counter the launch force of the projectile. Much of the propellant energy is wasted, but the mass of the weapon is much less since the stress placed on it is much smaller. The lower projectile velocity is offset by exclusive use of HE or HEAP rounds. This weapon is usually carried, with larger versions towed behind or mounted on light or unarmored vehicles. Both are used in a support or anti-tank role. The backblast of the weapon immediately gives away the firer's position, and normal doctrine is to move immediately after firing. May be vehicle mounted in groups for salvo fire to offset its poor accuracy.

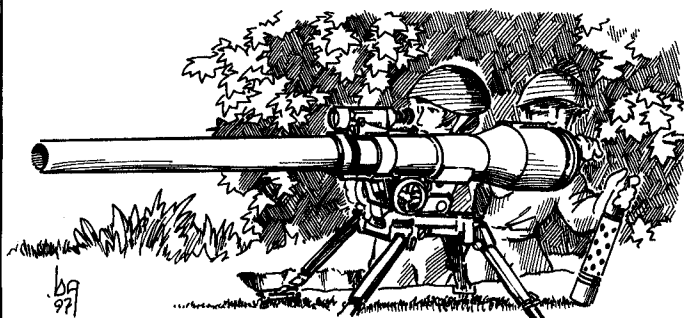

Damage	TL	Range	Shots	Mass	Reloads	Cost
21 (16 expl.)	6	V.Short	1	13.4kg	5.2kg	Cr860

### Machinegun, Medium-6

Light to medium sustained autofire weapon. In cultures using the light ACR, it typically is a carried support weapon firing slightly heavier ammunition, while in heavy ACR areas it is more likely to be a static weapon served by a crew of 2-3 people, who carry extra ammunition and spare barrels for the weapon.

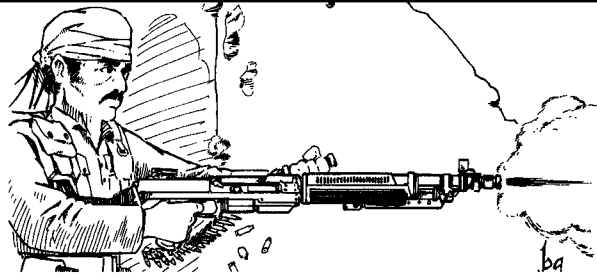

Damage	TL	Range	Shots	Mass	Reloads	Cost
6	5	6	Medium	200	14.0kg	5.4kg

### Submachinegun-6

Refinement of the submachinegun-5 with minimal performance changes.

Damage	TL	Range	Shots	Mass	Reloads	Cost
2	6	V.Short	30	1.8kg	.4kg	Cr230

### Autocannon, Light-6

Autofire version of the cannon-5, typically used in an anti-aircraft or light anti-vehicle role. Dedicated anti-air-

craft vehicles will normally mount a radar-based fire control system.

Damage	TL	Range	Shots	Mass	Reloads	Cost
10	6	Long	100	307kg	176kg	KCr19.2

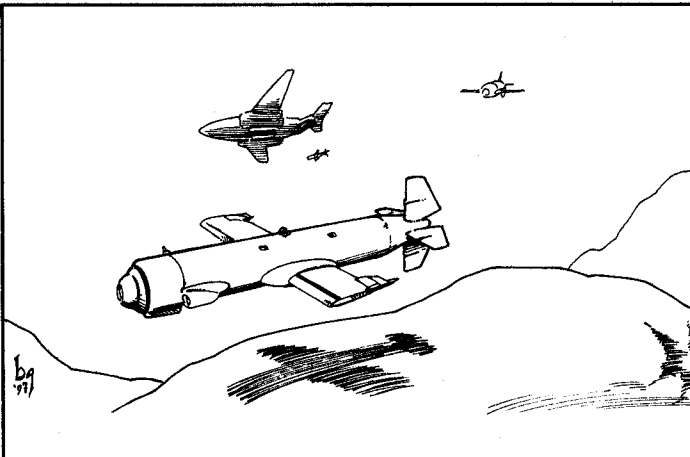

### Bomb, Glide-6

Unlike the extremely wasteful and inefficient use of unguided bombs at TL5, many TL6 cultures develop basic remote guidance systems for bombs. These are usually a primitive video transmission system of low resolution and marginal encryption, and is easily jammed, even by TL6 standards. However, in instances where it is unopposed, the user can visually guide the bomb directly to its intended target. Limitations of the technology are its short range and the need for one targeting crewman per bomb dropped.

Glide bombs are treated like a guided weapon, but use their inherent DM+3 as a bonus to the firer's skill, which is rolled for after each range increment, like other guided weapons.

Damage	TL	Range	Shots	Mass	Reloads	Cost
56 explosive	6	Contact	1	250kg	-	Cr1500

### Cannon, Medium-6

Typical armament of tracked or wheeled armored vehicles of the period. Can fire either HEAP, HE or heavy alloy armor-piercing rounds. Combined with early stabilized fire control systems, it can pose a threat to lightly armored exploration vehicles. This weapon system may also be used in an indirect fire role, and can be linked to early radar-based counter-battery systems. Some cultures have developed the equivalent of shotgun rounds for these cannon to allow the weapon to be used in an anti-personnel or possibly anti-aircraft role (treat as grapeshot, see Light cannon-2).

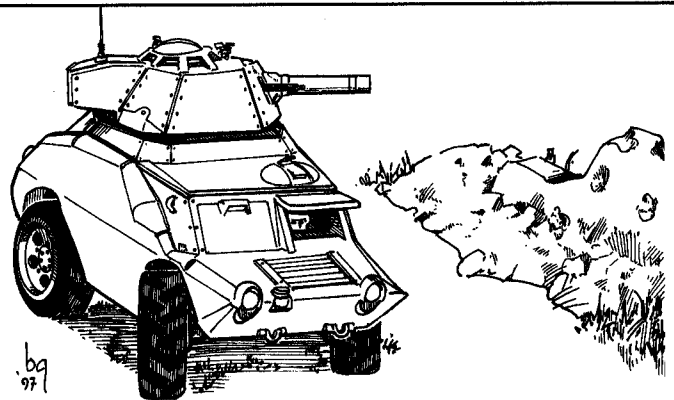

Damage	TL	Range	Shots	Mass	Reloads	Cost
17/21 (16 expl.)	6	V.Long/Long	1	815kg	20.5kg	KCr49.4

## Cannon, Heavy-6

Typical very heavy direct fire, heavy artillery or medium naval armament. In the former cases, usually it is in a self-mobile configuration, or towed behind a heavy wheeled or tracked vehicle which also carries the crew and ammunition supply.

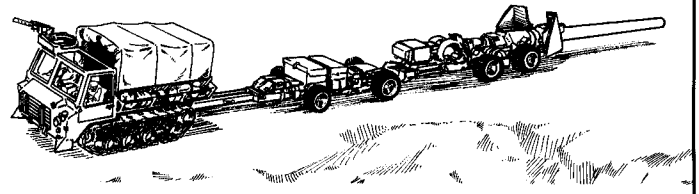

Damage	TL	Range	Shots	Mass	Reloads	Cost
20/25 HEAP	6	V.Long/Long	1	1410kg	50.7kg/45.0kg	KCr133

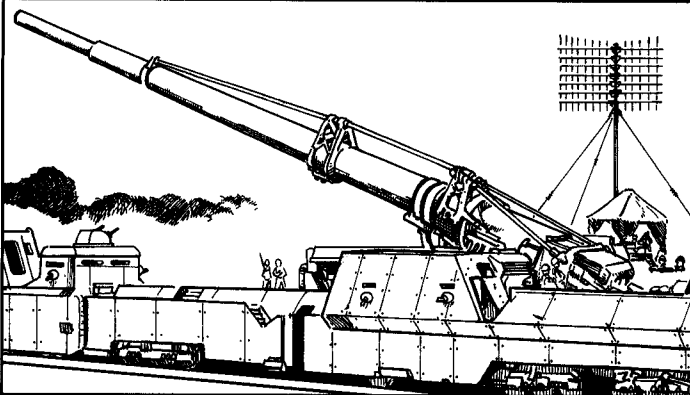

## Cannon, Very Heavy-6

The normal final development of the superheavy direct fire weapon, which by TL6 is being superseded by long range missiles. Similarly, the large, slow naval platforms these weapons are mounted on are extremely vulnerable to the threat of atomic weapons, whereas an extremely mobile, easily concealed and dispersed group of small missile carriers is less likely to be considered worth the expenditure of expensive atomic munitions. It is worth noting that the very heavy cannon is usually able to fire small nuclear payloads, and may be deployed on land as a short range delivery system for battlefield use.

Damage	TL	Range	Shots	Mass	Reloads	Cost
25 (14 expl.)/37 expl.	6	Long	1	5400kg	430kg	MCr1.3

## LAAW-6

A slightly improved version of the LAAW-5, meant to handle the threat of heavier armored vehicles, mostly by being able to engage them at longer ranges. Otherwise it is still an unguided rocket with a HEAP warhead.

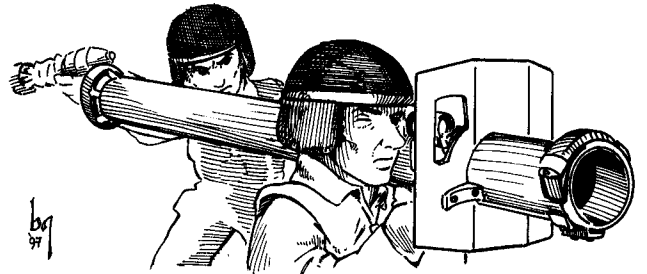

Damage	TL	Range	Shots	Mass	Reloads	Cost
20 (16 expl.)	6	Short	1	8.0kg	5.2kg	Cr420

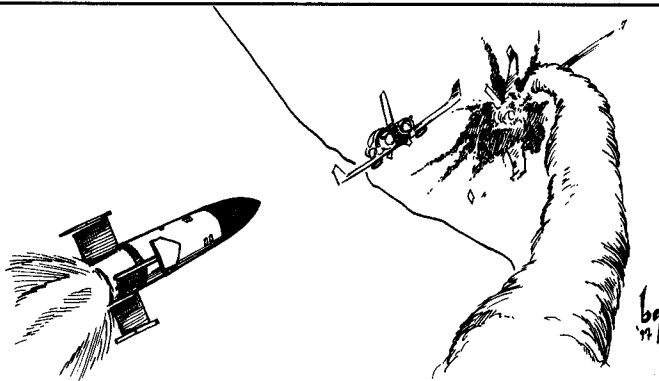

## Missile, AA-6

First incorporation of self-guidance technology into anti-aircraft weapons. Normally it homes in on the hot exhaust plume of turbine engines, but may also use radar reflections, either from an on-board radar or reflected radar from a ground or airborne source. Not exceptionally reliable and prone to being jammed or fooled by countermeasures.

Has a skill of 5 for self-guided lock-on and tracking purposes (DM+2 on user skill at ranges of 3.5km or less), with a speed of 3.5km per turn (2000kph) and a maximum range of subregional (10km).

Damage	TL	Range	Shots	Mass	Reloads	Cost
14 fragment	6	Long	1	42.5kg	-	Cr3500

## Missile, AS-6

**Anti-Shiping missile.** This is for all practical purposes an aerial torpedo. Using radar or other TL6 vehicle sensors for initial target acquisition, it will fly a short distance over the surface of the water and impact above instead of below the waterline. While significantly faster than its underwater counterpart (1250 meters per turn/750kph) it is still slow enough to be visually tracked and intercepted by conventional machineguns, or confused by simple electronic countermeasures.

The AS Missile-6 has an inherent skill of 6 for lock-on purposes and a maximum range of Regional (30km). Wire-guided models exist (DM+4) but only have a maximum range of 10km.

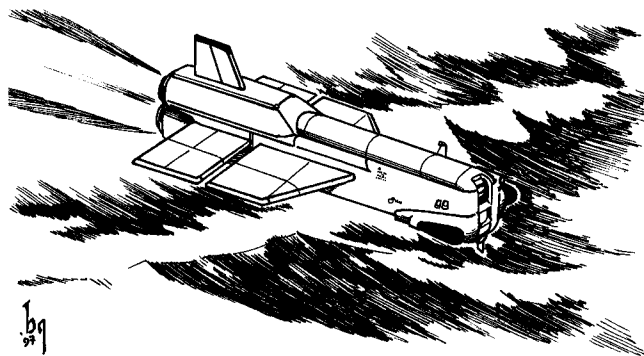

Damage	TL	Range	Shots	Mass	Reloads	Cost
50 explosive	6	Short	1	670kg	-	KCr26.5



## Missile, AT-6

The more cluttered environment of ground combat is usually beyond TL6 sensors, and TL6 guided AT missiles usually rely on active control by a remote operator. This control is usually by thin wires spooled out of the missile trailing back to a command console, or by radio or other wireless means. Advantages are that it is usually difficult to jam, but has the disadvantage that any distraction or disruption to the operator usually results in the missile crashing into the ground.

These user-guided missiles have an inherent DM+1, a velocity of 750 meters per turn (450kph) and a maximum range of Very Long (1500m).

Damage	TL	Range	Shots	Mass	Reloads	Cost
22 (14 expl.)	6	V.short	1	11.6kg	9.1kg	Cr750

## Torpedo-6

Almost all torpedoes at a TL6 level of sophistication have homing systems based on sonar returns or hydrodynamic signature of the target. The relatively slow speed of both the torpedo and the target allows for numerous course changes, but as long as the torpedo is faster than the target, they have a good probability of hitting.

The Torpedo-6 has a maximum velocity of 90 meters per turn (63kph), a maximum range of Subregional (10km) and has a skill of 6. Unguided TL6 torpedoes have significantly larger warheads.

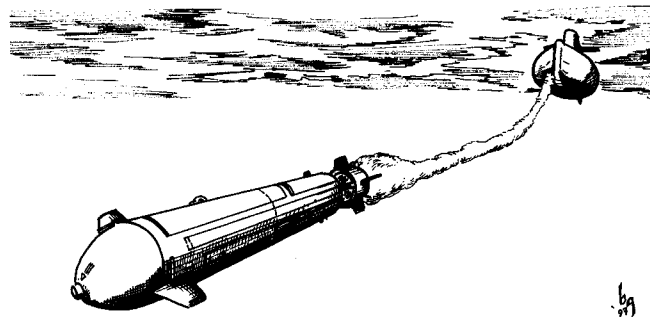

Damage	TL	Range	Shots	Mass	Reloads	Cost
36 explosive	6	Contact	1	1230kg	-	Cr9500

Name	Dam. Rating	TL	Range	Shots	Mass	Reloads	Cost
ACR, Heavy-6	5	6	Medium	20	5.9kg	.5kg	Cr1900
ACR, Light-6	4	6	Medium	40	4.0kg	.4kg	Cr500
Grenade-6	6 fragment	6	Contact	1	.2kg	-	Cr20
Machinegun, Heavy-6	6	6	Long	200	39.9kg	19.0kg	Cr2700
Machinegun, Medium-6	5	6	Medium	200	14.0kg	5.4kg	Cr1200
Rifle, Recoilless-6	21 (16 expl.)	6	V.Short	1	13.4kg	5.2kg	Cr860
Submachinegun-6	2	6	V.Short	30	1.8kg	.4kg	Cr230
Autocannon, Light-6	10	6	Long	100	307kg	176kg	KCr19.2
Bomb, Glide-6	56 explosive	6	Contact	1	250kg	-	Cr1500
Cannon, Heavy-6	20/25 HEAP	6	V.Long/Long	1	1410kg	50.7kg/45.0kg	KCr133
Cannon, Medium-6	17/21 (16 expl.)	6	V.Long/Long	1	815kg	20.5kg	KCr49.4
Cannon, V. Hvy-6	25 (14 expl.)/37 expl.	6	Long	1	5400kg	430kg	MCr1.3
LAAW-6	20 (16 expl.)	6	Short	1	8.0kg	5.2kg	Cr420
Missile, AA-6	14 fragment	6	Long	1	42.5kg	-	Cr3500
Missile, AS-6	50 explosive	6	Short	1	670kg	-	KCr26.5
Missile, AT-6	22 (14 expl.)	6	V.short	1	11.6kg	9.1kg	Cr750
Torpedo-6	36 explosive	6	Contact	1	1230kg	-	Cr9500



# TACTICAL ROLES OF MODERN WEAPONS

---

The editors of *Carnak's Surface Weapons* realize many readers of this file will be engaging in interstellar travel for the first time, and trying to figure out how to equip themselves or others. Our advice to you is:

Leave these matters to professionals. If you have not contracted qualified security personnel for the type of exploration you are considering, please do so. Most travel to civilized planets does not require personal weaponry, and unless you are qualified to use these weapons, you are more of a danger to yourself than any imagined threat.

That disclaimer aside, what follows is a short section on the appropriate use and likely deployment of various types of weapons.

**Pistols:** Pistols have mediocre accuracy, short range, and unless specialized projectiles are used, relatively low penetrating ability. What they do have is light weight and concealability. Modern weapons are also relatively easy to acquire familiarity with, ergonomics and reliability making it a simple "point and shoot" proposition. Pistols are used as personal defense weapons by personnel that either do not need more themselves, or are surrounded by people who are better armed. Some cultures may use them as status symbols as well. Given this, the likely legal users are military officers, non-combat military personnel like transport drivers, law enforcement, diplomats and bodyguards. There is also the criminal element to consider, where the concealability is probably the most important factor.

*Recommendation:* If you are concerned for your own safety, pistols are suitable for most environments. They have sufficient stopping power to incapacitate most humanoid races and wild animals, and if used only in defense, the lack of range is seldom a major concern. Concealability may provide an element of surprise against intelligent attackers, but if the weapon is too difficult to access, it is useless. Most modern semi-automatic pistols serve adequately. "Hand cannon" may be more powerful, but if you have to carry the extra mass a long way or on a daily basis, the extra power is probably not worth the trouble unless you know it is necessary. Since these larger pistols are not concealable anyway, find an external holster that is both easily accessible, comfortable and does not get in the way of your normal lifestyle. For instance, large hip holsters are uncomfortable in most vehicle seats, and large shoulder holsters may interfere with seat belts. An upper thigh arrangement may be more practical in this case.

**Submachineguns:** These have slightly better range and power than pistols, but are always significantly heavier. The "machine pistol" is not a submachinegun either in appearance or construction, but rather just a heavy pistol with autofire capability and a larger magazine. Submachineguns were probably developed at TL5 to give cramped vehicle crews a compact self-defense weapon when dismounted, or to provide low-tech infantry units with short range suppression fire capability in an area when battle rifles were semi-automatic at best, and bolt-action at worst. Gradually they became the weapon of choice for urban warfare. Their compact nature allowed easier maneuvering in tight environments, the high rate of fire allowed good suppression of

enemy movement and increased hit probability, and the smaller pistol bullets used allowed carrying enough ammunition for regular use of this rate of fire. The weapon has stayed in this role more or less until the present day. Specialized law enforcement and commando units will probably have them for assault purposes, vehicle crews have them for secondary armament, and elite bodyguards may have concealable compact submachineguns to defend their clients. To counter the defenses of modern armor, many submachineguns fire high-powered versions of a pistol cartridge, use specialized ammunition for better penetrating ability, or both. High velocity discarding sabot rounds are the most common, but some newer designs are meant to use snub gun ammunition. The latter are almost exclusively for tactical law enforcement or commando use, as the ammunition expense is prohibitive for general military deployment. It is expected that some variant of the snub submachinegun will eventually be used as an anti-boarding weapon on starships, as it has sufficient penetrating power to defeat many armors, but low recoil and less collateral damage that plasma or large shaped charge weapons.

*Recommendation:* Submachineguns have a limited tactical role, and unless you have tactical training with automatic weapons, you would be better served with a pistol or rifle.

**Rifles:** Rifles are the first "guns" developed in most cultures. Among handheld weapons, they have the best accuracy and range, and only launchers are capable of delivering more energy to a target. This is offset by being heavier and bulkier, both in the weapon itself and its ammunition. Rifles will serve as the main military weapon in most forces, and the long-range or high-power weapon used by law enforcement, and all personnel in both forces will have some basic familiarity with their operation.

*Recommendation:* Don't carry a rifle-sized weapon unless you seriously believe you will have the opportunity or need to use it. There are numerous situations where they are warranted, but leave the weapon in storage until you feel the extra mass and encumbrance is worth it. In any area where other firearms are the primary danger, a rifle may provide a deterrent measure, but good body armor is also a must. Avoiding potential firefights is the best option, and is often viewed more favorably by a group that isn't armed to the teeth and itching for an opportunity to retaliate. If you are going to be equipped with a rifle and have the luxury of a selection, pick the right tool for the job. Hunting rifles are more accurate and lighter than many military weapons, but lack the magazine capacity and rate of fire military weapons have. If extremely long range or armored targets are not a problem, a smaller rifle with a larger magazine gives more tactical options than the heavier varieties of assault rifle. Laser and gauss weapons have their advantages and disadvantages. It is popular opinion at the time of this printing that the complexity and cost of these weapons makes them impractical for all but the most specialized of situations.

Advances that are sure to come will eventually make them a practical weapon as the Vilani Empire conclusively demonstrated, but that time is not here yet.

**Shotguns:** Large bore projectile weapons firing a cluster of smaller projectiles. Originally developed as a sporting weapon, they have seen limited military and tactical use. Civilian weapons usually fire short range spherical projectiles, while military weapons fire a cluster of darts, flechettes or a small shaped charge or tranquilizing round. The advantage of the weapon is the firing of many projectiles at once both increases the chance to hit and may give multiple hits for a cumulative trauma effect. Deployment of tactical shotguns is very limited, however, large numbers of shotguns may be in civilian hands among populations allowed to own firearms. While civilian shotguns are limited in rate of fire or magazine capacity, some are still able to fire specialized military rounds should they be available.

*Recommendation:* While underpowered as a military weapon, modern shotguns are an excellent sporting weapon. Many survival kits would be better off with a shotgun than the current small rifle, since the average person using one could use the increased chance to hit small or moving targets if hunting for food. Tactical shotguns are fairly heavy and are not recommended for long duration carry, but the ability to fire a wide variety of ammunition and small payloads may give an advantage over submachineguns in a short range combat environment.

**Support Weapons:** This category generally includes heavy autofire or crew-served weapons, such as bipod or tripod mounted machineguns. These provide a sustained autofire capability, and are designed for heavy use at high rates of fire. The lighter varieties can be carried or even fired while on the move, but the user will have little room for anything except the weapon and ammunition. Support weapons are capable of suppressing large areas or damaging light vehicle targets or equipment, and are exclusively a military tool. Modern support weapons are capable of neutralizing any infantry threat, and if you happen to be infantry, you should keep this in mind. A new development in support weapons is the portable plasma cannon, which promises to have a

prominent role in tactical planning for the foreseeable future. Side effects of the weapon are substantial and require special training by units equipped with them. However, the penetration and secondary explosive power, combined with the logistical flexibility of energy weapons, make these devices worth considering for any force needing support weapons.

*Recommendation:* If you need a support weapon, you are either engaged in a paramilitary operation and don't need our advice, or you are in over your head and should not have been there in the first place.

**Launchers:** Such as grenade and rocket launchers, including unguided, user-guided and fire-and-forget types. These are exclusively for military use and have no civilian application. Normal use is to destroy or damage a specific type of target, usually land vehicle/fortification, air vehicle, or water vehicle. Most primitive hand-held launchers are incapable of penetrating even light starship armor, but may damage sensor arrays and cause minor hull buckling. The best defense is to simply get out of their limited range.

*Recommendation:* There is no task an average traveller will need a launcher type weapon for, and notes for support weapons apply. Any mundane task launchers can perform can be more reliably performed by regular explosives, cutting tools or starship weaponry.

**Heavy Weapons:** Vehicle weaponry, including heavy missiles, cannon, laser, gauss and plasma cannon. With the exception of tools like vehicle-mounted mining lasers and plasma cutters, heavy weapons are exclusively a military tool designed to take out targets too tough for other weapons. These weapons are capable of penetrating the armor of most civilian starships and some military vessels, and should not be under-rated. As with launchers, the best defense is to get out of their limited range. Even light starship weaponry should be sufficient to destroy the vehicles mounting these weapons from a safe orbital range.

*Recommendation:* Civilians should avoid all environments that require these weapons for safety or defense. In the event a planet has hostile wildlife that requires weapons of this nature to incapacitate, be sure to hire a local expert rather than just trusting in possession of the "big gun."

# TECH LEVEL 7

Middle atomic era. A transitory period of rapid development and experimentation, with computers of usable power turned towards analysis and development of weapons.

Warfare is a continuation and refinement of tech level 5-6 tactics using better and more effective weapons. Few cultures can handle the casualties that would be caused by a protracted period of warfare at this level.

Most advances in TL7 and TL8 are in the form of elec-

tronics, and adoption of more advanced materials in weapon design, for incremental decreases in mass and minor increases in accuracy. Laser pointers and designators are sometimes seen during this period, and electronic vision and targeting aids are bulky but man-portable.

## Common Weapons

### ACR-7

Continued marginal improvement in weapon and materials technology, usually firing the same ammunition as its

TL6 counterparts.

	Damage	TL	Range	Shots	Mass	Reloads	Cost
Heavy-7	5	7	Medium	30	5.2kg	.7kg	Cr1900
Light-7	4	7	Medium	50	3.6kg	.5kg	Cr500

### Assault Grenade-7

A heavy rifle-launched grenade with limited range. Designed to clear obstacles and destroy fortifications too strong to assault or expose troops to direct fire. Has a maximum range of Long (450 meters) and is fired as an indirect fire weapon.



Damage	TL	Range	Shots	Mass	Reloads	Cost
17 explosive	7	Contact	1	1.2kg	—	Cr100

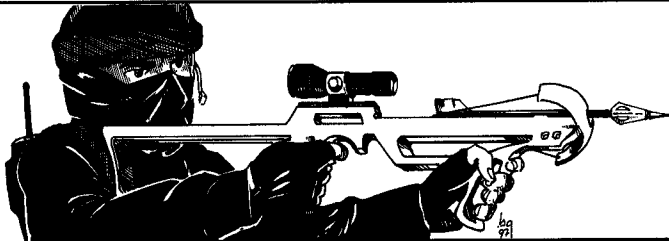

### Crossbow-7

An updated, accurate version of the ancient weapon, normally used for hunting small to medium game animals or as a competitive sport.

Takes a Strength of 6+ and 1 full uninterrupted turn to reload.

Damage	TL	Range	Shots	Mass	Reloads	Cost
3	7	Medium	1	3.8kg	.1kg	Cr350

### Flame Rocket-7

Successor to the Flamethrower-5, this is a multi-barrel disposable rocket launcher that fires explosive incendiary rockets. These have a similar burst radius to a flamethrower attack, but with a large number of intensely hot fragments rather than flaming liquid.

Treat a flame rocket as similar in effect to a flamethrower, but anyone in the area when it goes off takes 2D of wounds if not in sealed armor with a rating of at least 1, and 2D per turn if they were the actual target. The flaming fragments will burn through any non-metallic armor within a turn. This type of rocket will detonate with similar effect if intercepted by a point defense system.

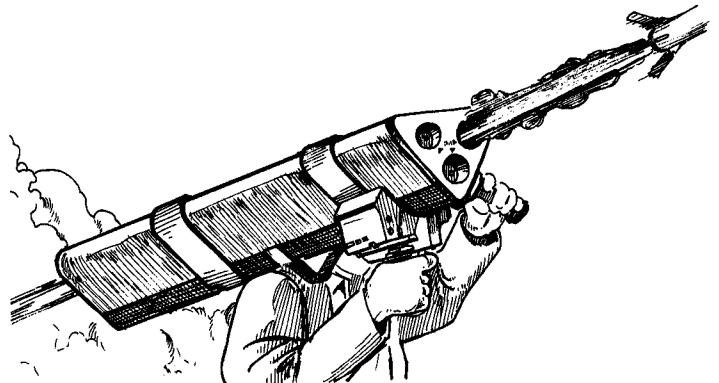

Damage	TL	Range	Shots	Mass	Reloads	Cost
special	7	Short	4	36kg	—	Cr980

### Explosive, Plastic-7

A moldable explosive compound similar in function and power to modern explosives. Stable over a broad temperature and pressure range, and difficult to detonate without proper initiators.

A 1 kilogram charge has a concussive damage rating of 8. Proper use of Demolitions skill is required to get

this level of effect. Each time the quantity is quadrupled, the damage rating is doubled. Plastic explosive-7 and other TL7+ industrial or military explosives only detonate if triggered by sudden extreme heat or blast effects. A 2D roll of the damage rating or less from other explosives or plasma cannon will work.

Damage	TL	Range	Shots	Mass	Reloads	Cost
8 explosive	7	Contact	1	1.0kg	—	Cr70

### Machinegun, VRF-7

A multiple barrel machinegun with an action driven by outside force, like an electric or hydraulic motor. Very reliable, and capable of extremely high rates of fire, limited mainly by the mass of the conventional ammunition.



Damage	TL	Range	Shots	Mass	Reloads	Cost
5	7	Medium	2000	70.0kg	43.6kg	Cr1800



### Pepper-7

A more barbaric weapon along the same lines as Blur, a chemical incapacitation agent. However, while Blur has its effects by numbing the assailant to the point where they cannot continue an attack, Pepper-7 is sprayed at the face and causes searing eye and lung pain to get the same effect. While completely non-toxic and non-lethal except for rare cases of allergic reaction, the technology is largely dropped when Blur-equivalents become available.

Pepper-7 is treated as a ranged weapon with a maximum range of Very Short (15m). It does 1D of non-lethal damage if a face hit is scored (DM-3 called shot). The victim is unable to act in a given turn unless they make an Average Endurance task. The effects wear off in an hour if untreated, or in several minutes if the affected area is flushed with water. Larger Pepper-7 canisters fill an area with spray, do not require a called shot to have effect, and will affect anyone in a line of ten indoor hexes who does not have eye covering and air filtering capability.

Damage	TL	Range	Shots	Mass	Reloads	Cost
0	7	Contact	10	.1kg	—	Cr10

### Pistol, Tranq-7

Normally used in animal control and capture operations, tranq pistols use compressed air to fire a large syringe filled with an incapacitating agent, the dosage being set for the size of the animal being targeted. Doses too small will have insufficient effect, while doses too large can be lethal.

The normal game effect of a tranq round is to non-lethally drop all physical characteristics by 1 per turn for a number of turns based on the dosage (10 turns for humans), and after this they will start to recover at the rate of 1 per 10 turns until back to full. If any characteristic drops to a negative amount equal to its normal value (5 going to -5 for instance), the result is an overdose and any extra amount is counted as lethal damage to that characteristic.

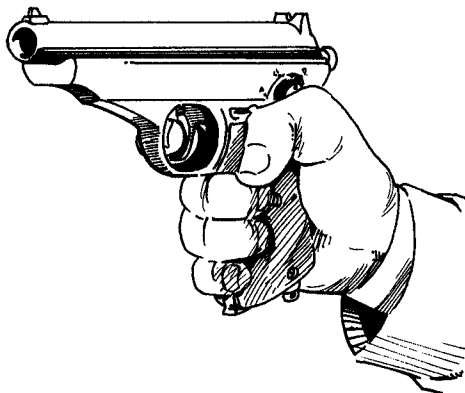

Damage	TL	Range	Shots	Mass	Reloads	Cost
0	7	Contact	1	.2kg	.1kg	Cr120

### Pistol-7

Incremental improvements in conventional hand weapons, including lighter materials and larger clip

capacity. Typical of military sidearms.

Damage	TL	Range	Shots	Mass	Reloads	Cost
2	7	V.Short	15	1.0kg	.2kg	Cr360

### Pistol, Heavy-7

A larger version of the Pistol-7, designed to fire cartridges normally reserved for magnum revolvers. Heavy and not readily concealable. Often owned as a status symbol or threat gesture, and manufactured to higher quality standards than less powerful pistols.

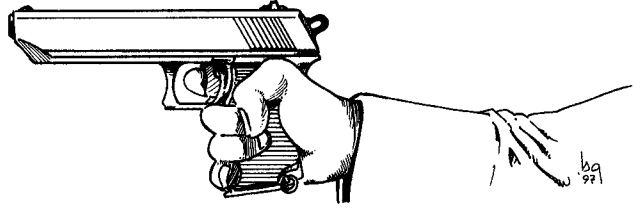

Damage	TL	Range	Shots	Mass	Reloads	Cost
3	7	V.Short	10	1.6kg	.2kg	Cr980

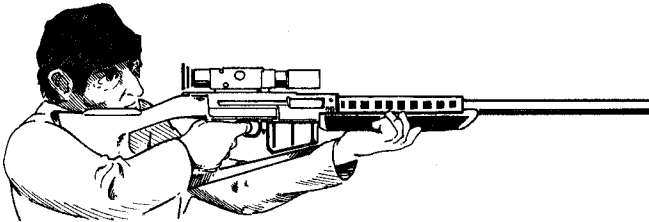

### Rifle, Sniper-7

A heavy, extremely accurate firearm for long-range anti-personnel use. May be used by military forces or police forces intervening in hostage or terrorist situations. Almost always equipped with a telescopic sight and only issued to highly trained personnel.

Damage	TL	Range	Shots	Mass	Reloads	Cost
6	7	V.Long	5	12.2kg	.3kg	Cr8300

### Rifle, Tranq-7

Basically the same in operation as the tranq pistol, but with greater accuracy.

Damage	TL	Range	Shots	Mass	Reloads	Cost
0	7	V.Short	1	.5kg	.1kg	Cr170

### Riot Shield-7

An updated version of the primitive melee shield, designed for use in quelling civil disturbances with the aid of truncheons or shock batons. Usually made of a composite or plastic variant with moderate ballistic resistance (armor of 2 vs. all weapons), with a transparent window or viewing slit. tech level 8 variants may have electrodes on the outer surface allowing use of hand stunner technology.

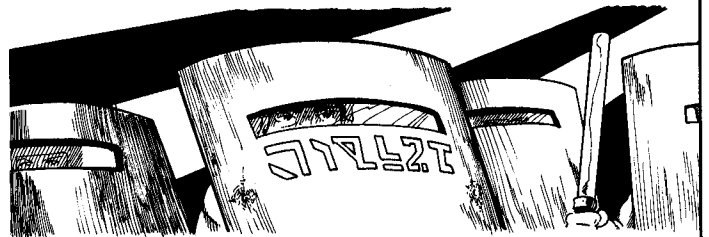

Damage	TL	Range	Shots	Mass	Reloads	Cost
(+3)	7			3.5kg		Cr100

### Mine, AP-7

A very small shaped charge attached to a simple pressure fuse, it is designed to simply incapacitate the victim, thus absorbing personnel to get them to safety and treat

the injury. Will also damage the propulsion system of many light vehicles.

Damage	TL	Range	Shots	Mass	Reloads	Cost
(3 expl.)	7		1	.1kg		Cr20

### Cannon, VRF-7

A scaled-up version of the VRF machinegun-7, often used in an anti-aircraft role. May be mounted in larger aircraft and used against air or ground targets, typically the less armored top facing of TL6-7 armored vehicles. May also be deployed in combination with TL7 sensors and fire control systems as an automated point defense weapon vs. anti-ship missiles.

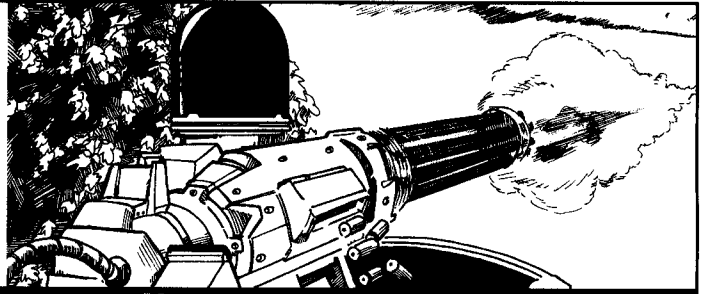

<b>Damage</b> 10	<b>TL</b> 7	<b>Range</b> Long	<b>Shots</b> 1000	<b>Mass</b> 1870kg	<b>Reloads</b> 570kg	<b>Cost</b> KCr27.9
---------------------	----------------	----------------------	----------------------	-----------------------	-------------------------	------------------------

### LAAW-7

Incrementally improved version of the man-portable anti-tank rocket. Often issued as a single shot disposable launcher.

<b>Damage</b> 21 (13 expl.)	<b>TL</b> 7	<b>Range</b> Short	<b>Shots</b> 1	<b>Mass</b> 5.0kg	<b>Reloads</b> -	<b>Cost</b> Cr420
--------------------------------	----------------	-----------------------	-------------------	----------------------	---------------------	----------------------

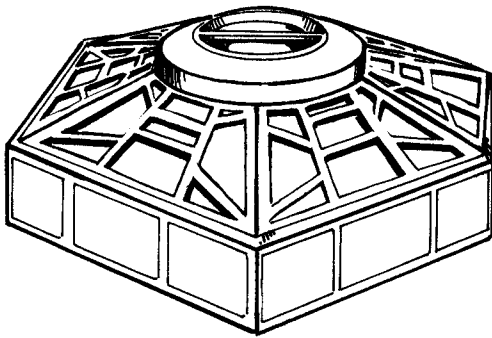

### Mine, AT-7

A large shaped charge warhead designed to blast through the propulsion system or hull of a land vehicle. Activated by a passive magnetic proximity fuse, it is made with a minimum of metal parts to minimize detection chances with contemporary sensors, and is usually equipped with a self-destruct switch to delay moving it if it is detected.

The effects of the shaped charge are reduced by the earth covering it. To reflect this, drop the damage rating of the HEAP warhead by 2D to reflect random variance. Moving a booby-trapped mine is an Average Demolitions task, with a DM+3 if you know the proper method for a particular type of mine, and a -DM of any TL difference between the mine and the skill of the poor sod trying to ease it out of the ground.

<b>Damage</b> 31 (20 expl.)	<b>TL</b> 7	<b>Range</b> Contact	<b>Shots</b> 1	<b>Mass</b> 5.0kg	<b>Reloads</b> -	<b>Cost</b> Cr140
--------------------------------	----------------	-------------------------	-------------------	----------------------	---------------------	----------------------

### Mine, Scattermine-7

Scattermines are broad-area antipersonnel weapons made from a flat explosive charge layered on one side with thousands of small fragments. Remotely detonated by a trip wire, pressure, sonic or heat sensor, the blast directs a broad swath of fragments in one direction, mowing down all in its path. The low-level body armor typical of this period is capable of stopping most of the fragment energy, but the quantity fired usually allows unarmored locations to be hit, incapacitating or killing the target as a result.

Treat a scattermine as having a fragmentation rating which drops each four indoor squares instead of one, and affects all targets in a 45 degree cone. Anyone in complete armor coverage takes half damage from this attack. The scattermine also has normal blast effects which drop off as for any other explosive charge. The remote detonation device has a default chance of 7+size DM on 2D each time a target passes the sensor.

<b>Damage</b> 3 (15 expl.)	<b>TL</b> 7	<b>Range</b> Contact	<b>Shots</b> 1	<b>Mass</b> 1.6kg	<b>Reloads</b> -	<b>Cost</b> Cr220
-------------------------------	----------------	-------------------------	-------------------	----------------------	---------------------	----------------------

### Missile, AA-7

Basically the same as the AA Missile-6, but with improved sensor capability.

Has a skill of 6 for self-guided lock-on and tracking

purposes (DM+3 on user skill at ranges of 3.5km or less), with a speed of 3.5km per turn (2000kph) and a maximum range of subregional (10km).

<b>Damage</b> 20 explosive	<b>TL</b> 7	<b>Range</b> Long	<b>Shots</b> 1	<b>Mass</b> 49.3kg	<b>Reloads</b> -	<b>Cost</b> KCr17.5
-------------------------------	----------------	----------------------	-------------------	-----------------------	---------------------	------------------------



### Missile, Light AA-7

A marginally useful man-portable AA missile system, which may either be shoulder fired or mounted on vehicles too small for a more powerful AA system. Almost always works on the infrared signature of the target.

Gives a DM+2 on user skill anywhere in its useful range, with a speed of 3.0km per turn (1800kph) and a maximum range of Extremely Long (3km).

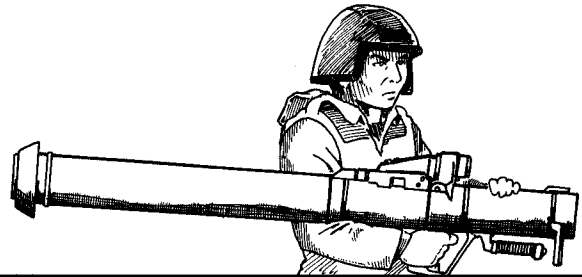

Damage	TL	Range	Shots	Mass	Reloads	Cost
14 explosive	7	Short	1	31.5kg	21.9kg	Cr2300

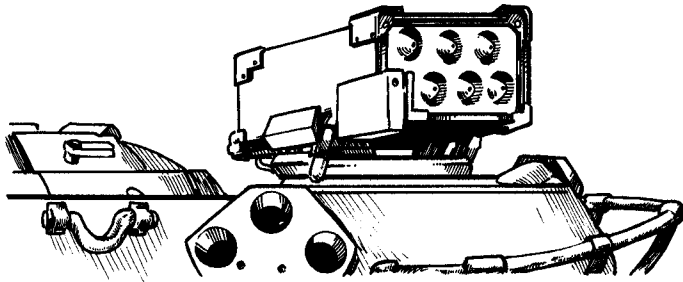

### Missile, AM-7

Anti-Missile Missile. A small multi-shot missile launcher. The missiles have a very small warhead, and are designed solely for intercepting incoming missiles. Almost always linked to a vehicle-based fire control system and sensor suite.

On its own the missile has a negligible chance of intercepting a target (skill of 4 for self-guidance and lock-on), but provides a DM+1 to any vehicle fire control system directing it, and is capable of using the RF bonus by firing all the missiles at once. The missiles have a velocity of 3,000m/turn and a maximum effective range of Extremely Long (3km). A full set of missile reloads costs about KCr17.

Damage	TL	Range	Shots	Mass	Reloads	Cost
10 expl.	7	Medium	20	1100kg	820kg	KCr40

### Missile, AT-7

Mostly the same as the AT Missile-6, but with better guidance and longer range. Heavy AT missiles are also often developed, with warheads capable of penetrating any contemporary armor. The heavy AT missiles may also be fired indirectly after the target is illuminated with a laser or maser pointing device. Both missiles are capable being launched from land vehicles or low speed aircraft. Listed mass and cost does not include an TL7

sighting aids that may be associated with the weapon, such as light amplification devices.

The user-guided light AT missile has an inherent DM+2, a velocity of 750 meters per turn (450kph) and a maximum range of Very Long (1500m). The user-guided heavy AT missile has an inherent DM+3, a velocity of 1500 meters per turn (900kph) and a maximum range of Extremely Long (3km). If beam riding, treat as having an inherent skill of 6.

	Damage	TL	Range	Shots	Mass	Reloads	Cost
Light	26 (16 expl.)	7	V.Short	1	12.5kg	9.5kg	Cr2300
Heavy	30 (20 expl.)	7	Short	1	69.2kg	55kg	Cr7900

Name	Dam. Rating	TL	Range	Shots	Mass	Reloads	Cost
ACR, Heavy-7	5	7	Medium	30	5.2kg	.7kg	Cr1900
ACR, Light-7	4	7	Medium	50	3.6kg	.5kg	Cr500
Assault Grenade-7	17 explosive	7	Contact	1	1.2kg	-	Cr100
Crossbow-7	3	7	Medium	1	3.8kg	.1kg	Cr350
Explosive, Plastic-7	8 explosive	7	Contact	1	1.0kg	-	Cr70
Flame Rocket-7	special	7	Short	4	36kg	-	Cr980
Machinegun, VRF-7	5	7	Medium	2000	70.0kg	48.6kg	Cr1800
Pepper-7	0	7	Contact	10	.1kg	-	Cr10
Pistol-7	2	7	V.Short	15	1.0kg	.2kg	Cr360
Pistol, Heavy-7	3	7	V.Short	10	1.6kg	.2kg	Cr980
Pistol, Tranq-7	0	7	Contact	1	.2kg	.1kg	Cr120
Rifle, Sniper-7	6	7	V.Long	5	12.2kg	.3kg	Cr8300
Rifle, Tranq-7	0	7	V.Short	1	.5kg	.1kg	Cr170
Riot Shield-7 (+3)	-	7	-	-	3.5kg	-	Cr100
Cannon, VRF-7	10	7	Long	1000	1870kg	570kg	KCr27.9
LAAW-7	21 (13 expl.)	7	Short	1	5.0kg	-	Cr420
Mine, AP-7	4 (3 expl.)	7	-	1	.1kg	-	Cr20
Mine, AT-7	31 (20 expl.)	7	Contact	1	5.0kg	-	Cr140
Mine, Scattermine-7	3 (15 expl.)	7	Contact	1	1.6kg	-	Cr220
Missile, Light AA-7	14 explosive	7	Short	1	31.5kg	21.9kg	Cr2300
Missile, AA-7	20 explosive	7	Long	1	49.3kg	-	KCr17.5
Missile, Light AT-7	26 (16 expl.)	7	V.Short	1	12.5kg	9.5kg	Cr2300
Missile, Heavy AT-7	30 (20 expl.)	7	Short	1	69.2kg	55kg	Cr7900
Missile, AM-7	10 expl.	7	Medium	20	1100kg	820kg	KCr40

# TECH LEVEL 8

Late atomic era. Much the same as TL7, with further advances and miniaturization of electronics. Laser designators and pointers drop in mass, the latter to insignificant levels (less than 50 grams). Processing power and sensors advance to where remotely programmable self-guided weapons are possible, but these are still of very large size, relying on aerodynamic lift, reaction engines or both to achieve any reasonable range.

When personnel are deployed, warfare and tactics are still along the lines of previous tech levels, but very long range and remotely guided munitions mean that the early stages of a battle may take place without either side ever see-

ing the enemy. Minor differences in sensing technology may make major differences if they allow one side to detect or target an opposing force without being detected or targeted.

## Common Weapons

### Grenade-8

A highly efficient fragmentation device designed to kill or incapacitate lightly armored infantry. Dangerous to soldiers without full armor, but otherwise only a minor tactical problem. Variants include versions with a removable fragmentation sleeve for use where only blast effect is required. Many late tech level 8 and tech level 9+ grenades are electrically fused and have built-in provisions for use with trip wires and other remote sensors.

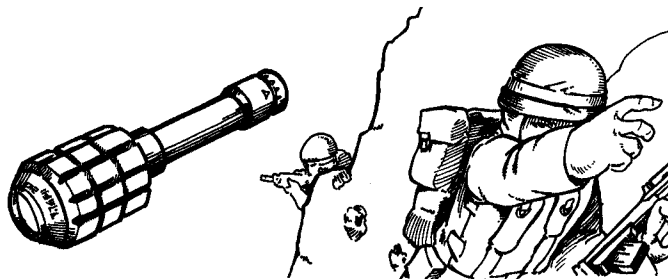

Damage	TL	Range	Shots	Mass	Reloads	Cost
7 fragment	8	Contact	1	2kg		Cr50

### Hand Stunner-8

First available at tech level 7 and perfected at tech level 8+, a hand stunner is a simple box with protruding electrodes. It arcs a precisely tailored high voltage current between the electrodes, which deactivates any muscle tissue it comes in contact with. The effect is unpleasant and temporary, but totally non-lethal. Limitations of the technology are the inability to penetrate any form of armor, including heavy clothing. Police or military variants may have longer and sharper electrodes to mitigate this problem, but the weapon still lacks fast incapacitation ability.

A hand stunner does 1D non-lethal damage on a successful melee or unarmed combat attack, and cannot be used to block or parry with. It does not do blunt trauma damage through flexible armors. Due to nervous system differences, hand stunners will be of limited effect against species other than the one it is designed for. For races with similar biology, damage is halved, and for ones with completely different nervous system types (human vs. hresh, for instance), hand stunners do no damage at all. This would apply also to most weapons that rely on electrical disruption of the nervous system.

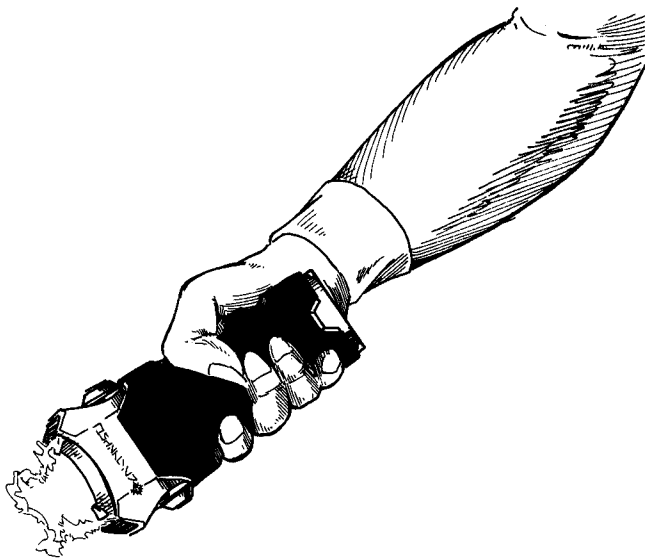

Damage	TL	Range	Shots	Mass	Reloads	Cost
1	8	Contact		.3kg		Cr50

## Machinegun, Heavy-8

Use of advanced ammunition allows the heavy machinegun to engage light armor or armored aircraft with some chance of success. The heavy machinegun-8 may also be used as light aircraft armament. The default ammunition is a standard armor piercing round, but the second magazine may be loaded with more effective (and more expensive) discarding sabot heavy alloy penetrators, and switched as needed. This weapon is usually vehicle mounted and may be slaved to fire control systems, but is also seen in a detached role as a positional defense, sometimes with attached night vision equipment.

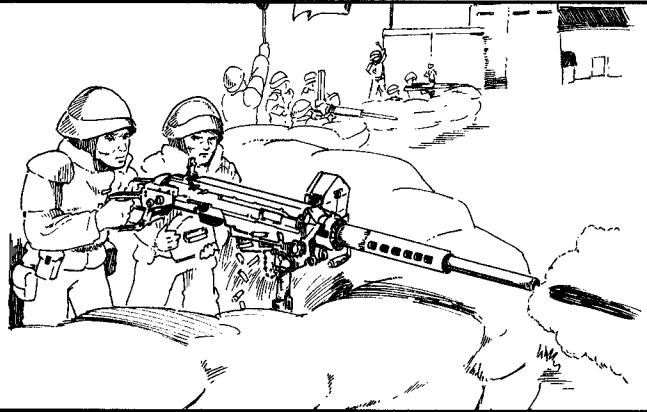

Damage	TL	Range	Shots	Mass	Reloads	Cost
8	8	Long	100	76kg	30kg	Cr8700

## Net Gun-8

A bulky device designed for non-damaging capture of animals or people. It fires a self-expanding net of cut-resistant fibers out to a maximum range of Very Short (15m). Optionally, the net can have microbarbs or adhesive to make it cling to clothing or fur for enhanced effect.

A net gun will fill an area the size of 9 indoor squares. The large area filled is offset by the low speed of the net. However, anyone surprised or unable to dodge will give the firer the normal DM+3 to hit. A hit is an immediate 2D penalty to Dexterity, cumulative with any damage from injuries, and anyone trailing a net cannot move more than one outdoor square per turn. Note that the net does no damage, just reduces Dexterity for purposes of skill use and characteristic rolls. Disentangling oneself can be done at the rate of 1 point of penalty per uninterrupted turn of work. A Strength of 10+ will increase the removal rate by 1 point per turn, as will a cutting implement or other net damaging effect. At tech level 10+, nets are commonly coated with the same material used in tranq rounds, in a skin-permeable carrier. Each round of work struggling against the net will result in tranq effects unless the victim is in a sealed suit. Replacement nets are Cr100, doubled if coated or equipped with some other special effect.



Damage	TL	Range	Shots	Mass	Reloads	Cost
special	8	Contact	1	2.5kg	1.0kg	Cr400

## Pistol, Body-8

Intelligence operatives and anti-government extremists sometimes use weapons invisible to contemporary sensors, and the common use of portal sensors by TL8 makes these weapons more common. Constructed of plastics, composites and ceramics, they are not designed for extended use, but for emergency use only. Modern sensors will typically key on the shape after detecting the density difference, and may recognize the resonance signature of the propellants as well.

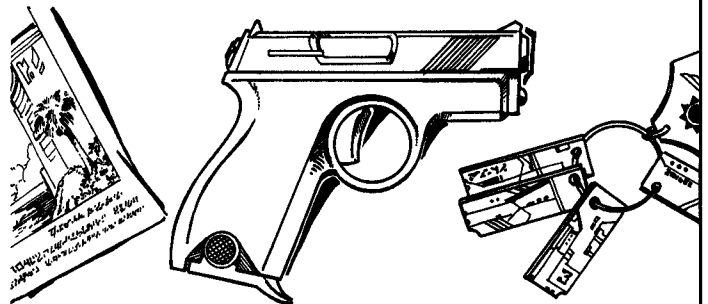

Damage	TL	Range	Shots	Mass	Reloads	Cost
2	8	V.Short	4	.5kg		Cr1500

## Shock Baton-8

A heavy-duty version of the hand stunner-8, the shock baton has longer electrodes on its tip, smooth electrodes down its sides, and can be used as a small club (damage rating of 1) without much risk of damaging it. It is not readily concealable and serves a deterrent better when prominently displayed.

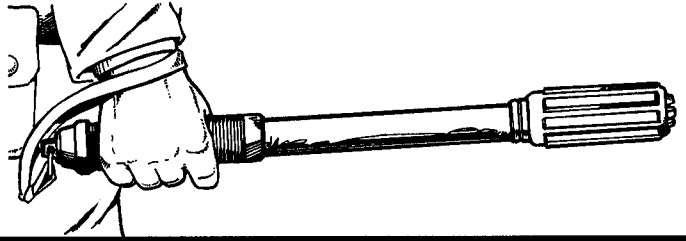

Damage	TL	Range	Shots	Mass	Reloads	Cost
1	8	Contact		.8kg		Cr150



## Thud Gun-8

A largely ineffective application of non-lethal force, adopted by a very small number of people who felt the need for self-defense, but were unwilling to either undergo either self-defense training to use hand stunners, carry the painful chemical deterrents available or use conventional firearms. A small compressed gas cartridge fired a heavy, flexible projectile, which if it hit would cause significant blunt trauma and hopefully allow the potential victim time to escape. It was limited by a single shot capacity, inaccuracy and marginal effectiveness. Many manufacturers included features like indelible skin dyes and micro-tagants to aid identification of the assailant if captured later, which really only underscored the likelihood of it not actually incapacitating them.

The one advantage that a thud gun like this has is that flexible armor provides little protection, much like a bulletproof vest might stop a bullet but wouldn't do much against a boot to the solar plexus. Thud guns or other impact weapons count as armor piercing vs. any flexible armor.

Damage	TL	Range	Shots	Mass	Reloads	Cost
2	8	Contact	1	1.4kg	.1kg	Cr160

## Autocannon, Light-8

The use of the heavy machinegun-8 to fill the role formerly held by both machinegun and light cannon meant that the next upgrade of firepower would be a significant increase in the power of light autocannon. These are typically in the 30-35mm range, where at tech level 7 they would have been in the 20-30mm range. These autocannon are used in a variety of roles, from helicopter and fighter armament, to APC armament and anti-aircraft guns. Normally they will fire armor-piercing ammunition, but are capable of firing light HE or fragmentation rounds as well.

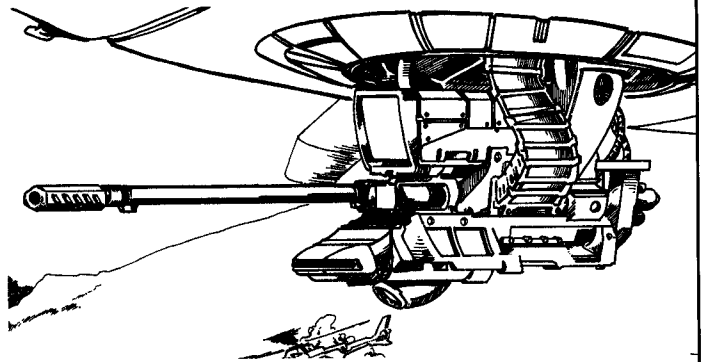

Damage	TL	Range	Shots	Mass	Reloads	Cost
10 (7 expl.)	8	Long	100	270kg	42kg	KCr23.1

## Bomb, Fuel Air-8

This is a special area effect weapon that disperses a cloud of explosive vapors over a large area, followed by detonation of the cloud. The resulting blast is relatively even over the entire area, unlike a conventional blast, and is extremely destructive, comparable to a low-yield tactical nuclear weapon in its effects on soft targets. They can be used against most targets, but are especially effective in clearing an area of mines or unprotected personnel. They have also been used to good effect by survey crews to clear landing zones in areas of dense vegetation.

Fuel-air munitions detonate one turn after impact, to give the gas cloud time to expand out to maximum radius. Fuel-air munitions only work in atmospheres containing breathable amounts of oxygen (usually types 4 through 9). Using a fuel-air weapon against a minefield will detonate almost all TL7- mines (DM+6 to detonate mines), and reduced amounts of TL8+ mines, which have overpressure limiters on their pressure switches (DM-2 per TL past 7). The bomb listed will fill a circular area about 1.5 outdoor squares in diameter (central square and surrounding squares) with a damage rating 8 blast, which is counted at full effect vs. vehicle and structural targets. Against heavily armored vehicles that can stop the blast, apply the damage rating vs. any vehicle subsystem that is less protected, such as sensors and other external fixtures like pintle-mounted weapons. Use in a ground-clearing mode will level all vegetation in the blast area and create an instant landing zone about 45 meters in diameter. It is extremely discouraged to let characters use this type of weapon, or to use it against them due to their completely indiscriminate nature and the possibility of killing any innocent bystanders who happen to be in the area of effect.



Damage	TL	Range	Shots	Mass	Reloads	Cost
8	8	Contact	1	250kg	-	Cr2000

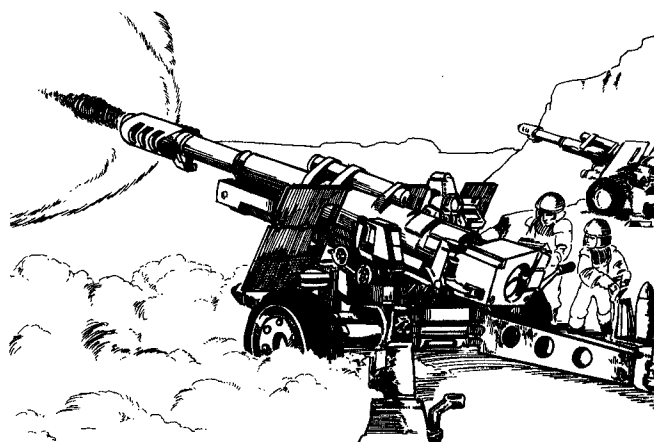

## Cannon, Heavy-8

Heavy vehicle armament or artillery piece. For anti-vehicle use, normally fires heavy alloy APFSDS rounds or HEAP warheads as appropriate, and is almost always slaved to a fire control system. For artillery use, may be loaded with high explosive, or with dispersed submunitions such as anti-tank self-guided warheads or anti-personnel mines, and may be linked to radar-based counter-battery sensors.

Submunitions automatically deploy, whether or not the indirect fire task hits the right area. If the indirect fire task puts the warhead over the correct area, it will drop 4 guided HEAP or 32 regular anti-personnel mines over an area of 4 x 4 outdoor squares. The small guided munitions have a Formidable task per target of half the TL with a DM of the vehicle's size and DM+1 per 2 points the indirect fire task was made by. Note that the quantity of mines in the area is not large and several shots would be required to get a useful minefield density. Note that these mines are not buried, and while they may be camouflaged, they are easier to spot than buried mines.

Damage	TL	Range	Shots	Mass	Reloads	Cost
Heavy-8 21 22 expl. 27 HEAP	8	E.Long V.Long V.Long	1	1120kg	26kg 33kg 33kg	KCr256

## Cannon, Medium-8

Medium armament for armored vehicles. The example shown details some of the advances common to this weapon, including automatic loading, and dual magazines for either increased endurance or multiple ammunition types. As a firing action, the user can switch from one magazine to the other, either because one is empty, or to use a different type of ammunition. Normal loads are APFSDS, HEAP and HE.

While the cannon is self-loading, reloading magazines is done at the rate of one shot per turn.

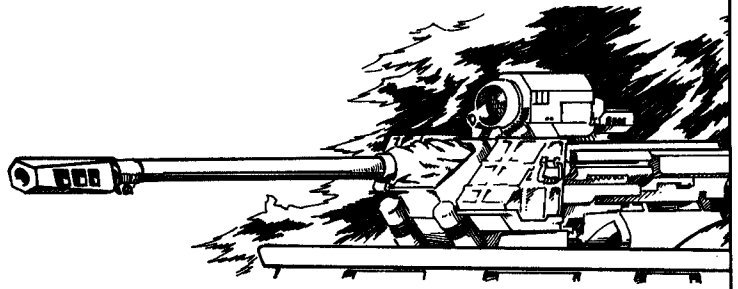

Damage	TL	Range	Shots	Mass	Reloads	Cost
13	8	E.Long	20 x 2	550kg	230kg	KCr54.5
14 expl.		V.Long			370kg	
19 HEAP		V.Long			370kg	

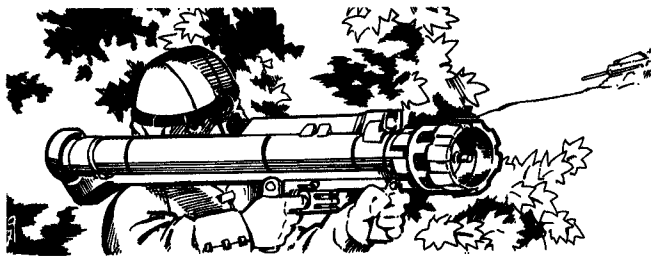

## LAAW-8

A moderately powerful weapon with anti-personnel, anti-vehicle and anti-fortification capabilities. It uses a HEAP warhead with a fragmentation sleeve and secondary HE charge. Some versions may be disposable and slightly lighter, or have a reusable sighting package that is attached to a disposable weapon.

The LAAW-8 has a fragmentation damage of 8.

Damage	TL	Range	Shots	Mass	Reloads	Cost
23 (16 expl.)	8	Short	1	9.1kg	6.5kg	Cr1100

## Mine, Multi-8

A moderately expensive multipurpose mine. Normally it will be partially buried or concealed under light cover like leaves, with only a small antenna array protruding. Using a very low power radar, the mine determines when a land vehicle, very low flying vehicle or personnel target comes within its limited range, at which point it either fires a small shaped charge or fragmentation warhead. May be programmed to activate and deactivate its sensors at certain times and to self-destruct or deactivate after a fixed period of up to a month.

The multimine-8 has an effective skill of 6, and will fire at any appropriate target that comes within Very Short range (50 meters). It has 2 shots of each type of grenade (HEAP and fragmentation).

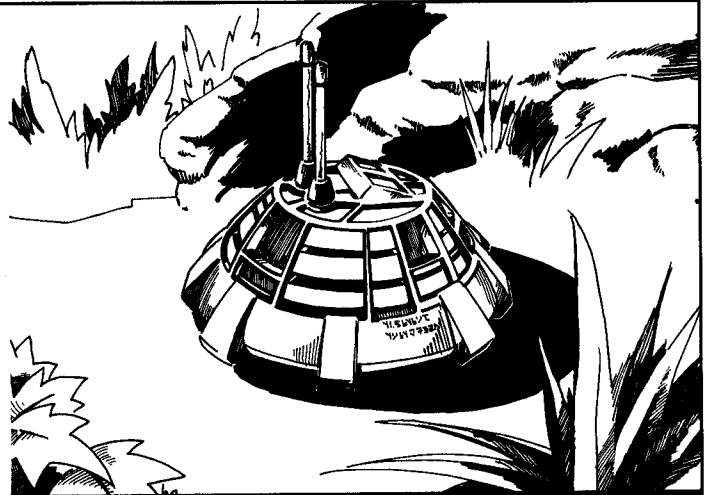

Damage	TL	Range	Shots	Mass	Reloads	Cost
18 or 7 frag.	8	Contact	2	6.0kg		Cr1100

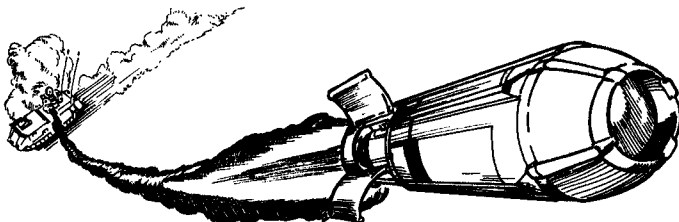

## Missile, AA-8

Vehicle mounted anti-aircraft missile. Most variants operate on a heat-seeking or radar sensor, with shorter range versions usually heat-seekers and long-range versions are radar based. Uses a large fragmentation charge to enhance its blast effect. This missile will travel 3.6km/turn and has a maximum range of Regional (30km). If fired within one turn's distance of target, provides a DM+3 to the firer, otherwise it acts with an inherent skill of 7.

Damage	TL	Range	Shots	Mass	Reloads	Cost
22 expl.	8	Long	1	68.0kg		KCr23.6



## Mine, Remote-8

A small sensor package attached to a LAAW-8. It is placed out of casual sight of the target area, aimed and armed. When a land vehicle passes through the narrow arc of a fixed target area, the sensor automatically fires the LAAW-8. The system is programmable with some limits. For instance, it can be programmed to turn on and off at certain times, ignore a certain number of targets before firing, or fire only at targets within a certain range band.

The remote mine-8 fires a LAAW-8 with an effective skill of 6 within 100m and 5 within 200m, and does not get or use any bonuses except for target size. Setting up the LAAW-8 is an Average Heavy Weapons task and takes about a minute. Failing the roll applies a -DM to the mine equal to the amount failed by. Mass and cost listed is for the sensor/LAAW pair.

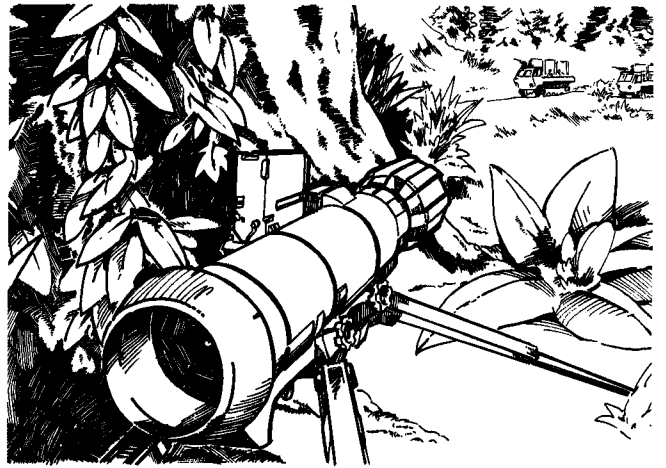

Damage	TL	Range	Shots	Mass	Reloads	Cost
23 (16 expl.)	8	Short	1	10.3kg		Cr1500

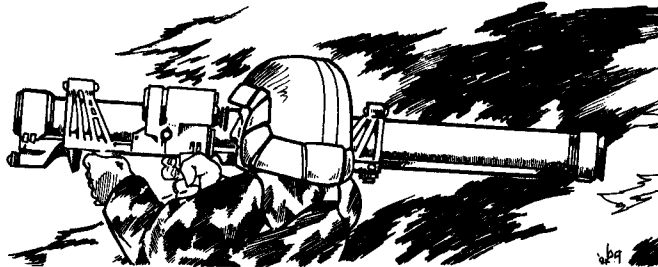

## Missile, Light AA-8

A man-portable heat-seeking missile designed for battlefield use. The relatively small explosive charge is often enhanced by the addition of a fragmentation sleeve to cause secondary damage outside the normal blast radius. Basically the same as the AA Missile-7, but with improved abilities.

Has a skill of 7 for self-guided lock-on and tracking purposes (DM+3 on user skill at ranges of 4.0km or less), with a speed of 4.0km per turn (2500kph) and a maximum range of subregional (10km).

Damage	TL	Range	Shots	Mass	Reloads	Cost
14 expl.	8	Short	1	33kg	23kg	Cr7900

## Missile, AT-8

Vehicle mounted anti-tank weapon. Normally deployed on lightly armored platforms unable to mount comparable direct fire weaponry, such as on helicopters, reconnaissance vehicles and armored personnel carriers.

This missile will travel 750m/turn and has a maximum range of regional (30km). If fired within one turn's distance of target, provides a DM+3 to the firer, otherwise it

acts with an inherent skill of 7. If user-directed, it follows short range maser reflections to the target, and seeks targets based on millimeter-wave radar reflections and target discrimination software. Advantages include better penetration of smoke, fog and dust, but any designator is more easily spotted by contemporary technologies. It can be targeted at any vehicle the designator can be aimed at.

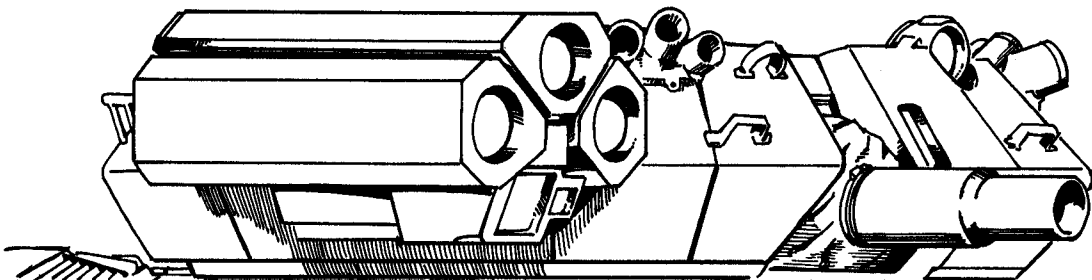

Damage	TL	Range	Shots	Mass	Reloads	Cost
33 (21 expl.)	8	Short	1	82.9kg	67.2kg	KCr10.3

## Mortar-8

Very similar in operation to the mortar-5, but with more advanced ammunition, including terminally guided munitions.

A mortar-8 has a minimum range of Long (150m) and a maximum range of Extremely Long (3km). Projectiles require about 6 turns to reach maximum range, so this is the minimum time between spotting corrections at this distance. Typically someone in a multiple mortar setup would have a fire control computer,

possibly linked to remote sensors. Available ammunition includes high explosive (as listed), one with a fragmentation rating of 10, and a skill 5 guided HEAP warhead with a damage rating of 20 and blast effect of 13. The latter gets DM's for target size and agility, and only rolls vs. ground vehicle targets if the normal indirect fire task is successful. Remember that this warhead would automatically target the top armor of the vehicle.

Damage	TL	Range	Shots	Mass	Reloads	Cost
17 explosive	8	Contact	1	13.5kg	4.0kg	Cr250

Name	Dam. Rating	TL	Range	Shots	Mass	Reloads	Cost
Grenade-8	7 fragment	8	Contact	1	.2kg	-	Cr50
Hand Stunner-8	1	8	Contact	-	.3kg	-	Cr50
Machinegun, Heavy-8	8	8	Long	100	76kg	30kg	Cr8700
Net Gun-8	special	8	Contact	1	2.5kg	1.0kg	Cr400
Pistol, Body-8	2	8	V.Short	4	.5kg	-	Cr1500
Shock Baton-8	1	8	Contact	-	.8kg	-	Cr150
Thud Gun-8	2	8	Contact	1	1.4kg	.1kg	Cr160
Autocannon, Light-8	10 (7 expl.)	8	Long	100	270kg	42kg	KCr23.1
Bomb, Fuel Air-8	8	8	Contact	1	250kg	-	Cr2000
Cannon, Heavy-8	21	8	E.Long	1	1120kg	26kg	KCr256
Cannon, H. cont.	22 expl.		V.Long			33kg	
Cannon, H. cont.	27 HEAP		V.Long			33kg	
Cannon, Medium-8	13	8	E.Long	20 x 2	550kg	230kg	KCr54.5
Cannon, M. cont.	14 expl.		V.Long			370kg	
Cannon, M. cont.	19 HEAP		V.Long			370kg	
LAAW-8	23 (16 expl.)	8	Short	1	9.1kg	6.5kg	Cr1100
Mine, Remote-8	23 (16 expl.)	8	Short	1	10.3kg	-	Cr1500
Mine, Multi-8	18 or 7 frag.	8	Contact	2	6.0kg	-	Cr1100
Missile, Light AA-8	14 expl.	8	Short	1	33kg	23kg	Cr7900
Missile, Medium AA-8	22 expl.	8	Long	1	68.0kg	-	KCr23.6
Missile, Heavy AT-8	33 (21 expl.)	8	Short	1	82.9kg	67.2kg	KCr10.3
Mortar-8	17 explosive	8	Contact	1	13.5kg	4.0kg	Cr250

# CHEMICAL WEAPONS

---

Most warring societies in the tech level 5-8 range develop, deploy and sometimes use airborne chemical agents. Most recorded incidents of actual use are caused by desperation when no other weapon system will work, by surprise to gain a temporary tactical advantage, or when a clear technological advantage prevents one side from developing their own agents. The relative inability to protect a military force from airborne agents at these low levels of technology, combined with the ease of producing these weapons in quantity means that all combatants are likely to have them available, but do not use them for fear of retaliation in kind against military or civilian targets. Inexpensive reliable protective gear and artificial immunity to most of these agents is routinely developed in tech level 9+ societies, greatly reducing their military effectiveness. The exact agent used by a planet depends on its historical path and local biology, but agents usually fall into one of several broad categories.

**Blood Toxins:** These act similarly on all species with the same overall biology and are usually developed at tech level 5-6. The chemical agent interferes with the molecular transport of oxygen or other vital compounds by blocking or mimicking the necessary compound. These agents must be inhaled to have effect, and can be removed from the air by a filter mask with the proper cartridge. Antidotes destroy or deactivate the agent in the bloodstream, and unless the patient is extremely near death, will usually make a full recovery.

Blood toxins do 1D damage split between physical characteristics the turn after they are inhaled, and 1D each minute of exposure after that. Any leftover amount of damage is applied to Endurance. Accumulation of damage will stop 1 minute after exposure ceases, and damage is recovered as minor wounds. If an anti-toxin is available, damage is recovered as superficial wounds. Some blood toxins have effect by irreversibly latching onto blood cells. Damage from these is recovered normally, and anti-toxins only prevent more accumulation of damage. Preventive use of anti-toxins may have side effects, but will last for about a day, and is common in troops at risk at TL6-8.

**Corrosives:** The agent is some type of gas that reacts with moisture, organic material or both to form a compound which dissolves cell walls and causes chemical burns on exposed tissues. These are capable of producing surface burns, blindness and permanent lung damage. These are developed at TL5 and may consist of large quantities of natural elements like chlorine or smaller quantities of other compounds. They react quickly, disperse and usually lose all effectiveness in the course of several hours. They may linger for some time in enclosed areas or on exposed surfaces, however. Antidotes neutralize the corrosive chemical, but do not undo any damage caused.

Corrosive agents do 1 point of damage to Dexterity if a character is exposed to them, and 1D damage to Endurance if inhaled. Continued exposure causes more damage each minute a character is in the toxic environment. All damage taken is repeated a day later, as secondary effects on skin and lung tissue take effect, and are often fatal at TL8-. Half of all Endurance damage is permanent unless regenerative medicine is available, and scarring from skin damage may be permanently disfiguring. Being in the vicinity of many types

of toxic chemical spills would have much the same effect.

**Neurotoxins:** These act specifically against the nerve cells of the target, causing nervous system failure of some type. This may be through hyperactive nerve action, causing convulsions and fibrillation of the heart, or by reducing nerve activity to the point where the breathing becomes impossible or the heart stops beating. They are *extremely* toxic and can infiltrate the body through inhaling them or be absorbed through skin contact. These are developed at tech levels 6-8, with the tech level 6 compounds markedly less effective than later ones. Protection against these agents is in the form of specialized filter masks and whole body protective suits. The compounds are relatively stable and can remain active on surfaces for weeks after delivery. Decontamination is mandatory to guarantee safety in recently exposed areas. Antidotes are available, but must be injected, and have severe side effects. Preventative antidotes are available, but of limited effectiveness.

Neurotoxins do 1D damage a turn after exposure, to a random physical characteristic. This damage is repeated each minute until the victim either dies, receives an antidote or takes only 1 damage or less twice in a row. Application of an antidote stops the accumulation of damage, but drops any physical characteristic that wasn't at zero to 1. If a preventive antidote is available, all damage is 1D-1 instead of 1D.

**Delivery of Chemical Agents:** Any weapon with an explosive warhead can have it replaced with a chemical warhead. The base area effected is measured in outdoor squares, and is equal to square of the smaller of the explosive or fragment rating of the weapon. Divide this by 50 for corrosive agents, by 20 for blood agents and by 2 for neurotoxins. One square kilometer is about 4,400 outdoor squares.

Example: A heavy cannon-6 fires a shell with an explosive effect of 23. The base area for a chemical warhead is  $23 \times 23 = 529$  outdoor squares. If loaded with a blood agent, this would be divided by 20 to  $529/5 = 26$  outdoor squares, or roughly a  $5 \times 5$  area.

Corrosive and blood toxins will usually disperse to safe levels in 1D hours, *much* less if windy or raining, and more if still or in enclosed areas. Neurotoxins will stay at unsafe levels for 1D hours to 1D weeks, depending on whether they were designed to dissipate or linger. In enclosed areas they remain dangerous for a nearly indefinite period.

# TECH LEVEL 9

Early fusion era. Advances in electronics begin to level off, but increased space exploration and development of early jump drive spurs interest in energy weapons. Impractical for most surface vehicles due to power and size limitations, but potentially used in surface-based planetary defense arrays. Few new developments except for marginal advances in fire control systems.

Most warring cultures either finally embrace peace or bomb themselves back a few tech levels and try again. The extremely expensive and hard to defend infrastructure needed to develop jump capability makes it nearly impossible in a wartime environment. Military forces may be called upon to

quell local hot spots or otherwise act in a policing role, and may take a strong interest in interstellar ships if it is known that there are other civilizations nearby that have or may soon gain that capability.

## Common Weapons

### ACR-9

The first genuine advances in ACR technology since they were invented at tech level 5 often occur at tech level 9. Integral laser pointers, small but functional telescopic sights, caseless ammunition and discarding sabot ammunition begin to see use among forces able to afford the increased weapon cost.

The ACR-9 is capable of autofire or autoburst in addition to single shots, and the light ACR-9 can get the RF bonus if it expends an entire clip in one turn. The ACR-9 includes a minimal telescopic sight (DM+1 to aimed fire in addition to normal aiming bonus). Either ACR-9 may be considered an unreliable weapon when first introduced.

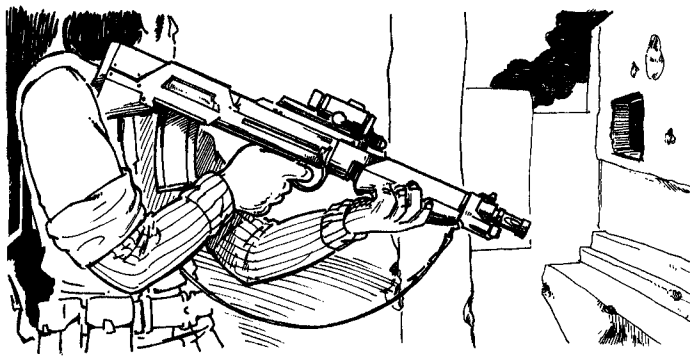

	Damage	TL	Range	Shots	Mass	Reloads	Cost
Heavy-9	5	9	Medium	40	4.9kg	.5kg	Cr2500
Light-9	4	9	Medium	60	4.2kg	.3kg	Cr920

### Bullpup-9

Any one of hundreds of designs matching a broad set of characteristics. Compact, lightweight, reliable in most environments and easy to use. It does not mount any advanced sighting aids, and is basically a stripped civilian version of a light ACR-8.

This is the Milieu 0 equivalent of an AK-47 and would be considered as reliable as any Imperium-issue weapon is, making it popular among people who don't have the budget to get weapons optimized for different environments.

Damage	TL	Range	Shots	Mass	Reloads	Cost
4	9	Short	50	3.5kg	.5kg	Cr300

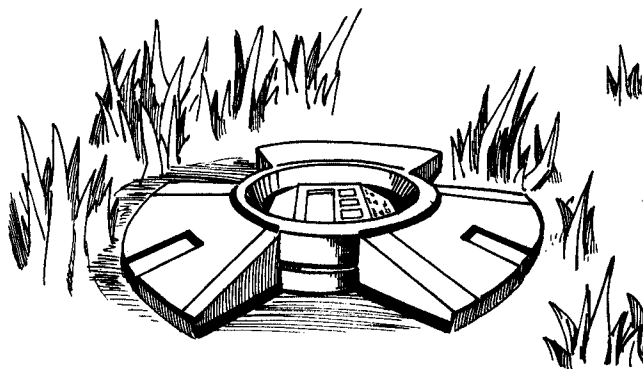

### Mine, AP-9

Incremental advances in technology allow more flexible deployment of anti-personnel mines, but performance is largely the same as for tech level 7 anti-personnel mines. Typical advances include a number of programmable settings, allowing for use against any combination of light, medium or heavy targets, instant detonation, detonation after a fixed number of triggering incidents, detonation after a random number of triggering incidents (2D roll of 5- to go off on any given trigger event) and detonation after a given tactical delay (usually one month). They are also harder to detect, and may be deployed quickly by specialized vehicles or as artillery barrages of submunitions.

Damage	TL	Range	Shots	Mass	Reloads	Cost
4 (3 expl.)	9	-	1	.1kg	-	Cr20

## Mine, AT-9

The larger body of the anti-vehicle mine allows for more advanced electronics than the AT mine-7. Depending on tactical radio security, these mines may be remotely reprogrammable, allowing use by friendly forces but denying the area to enemy units. They are normally equipped with multi-impulse magnetic sensors to reduce the likelihood of being effected by mine clearing charges, and which allow the mine to target hovercraft and other vehicles with no actual ground contact. Like other mines at this tech level, they can be set for varying activation, deactivation or self-destruct parameters, and are equipped with self-destruct triggers to prevent manual removal.

The AT mine-9 has a small clearing charge to remove covering earth or debris a fraction of a second before the main charge detonates, so the mine has full effect without the reductions listed on the AT mine-7.

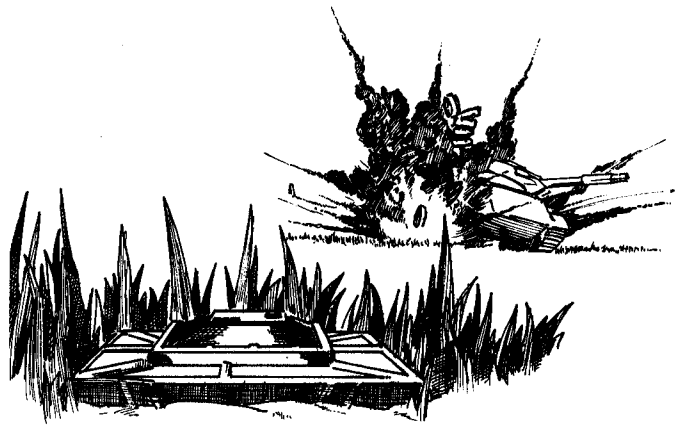

Damage	TL	Range	Shots	Mass	Reloads	Cost
32 (21 expl.)	9	—	1	5.0kg	—	Cr420

## Sentry Gun-9

A sentry gun is not so much a weapon as a targeting system for one. It is usually a pulse frequency encoded visible wavelength laser with a power in the 2-5 milliwatt range. It is used within the scanning range of a compatible fire control system attached to a heavier weapon, such as a linked ACR-9. The idea is that the user has limited control over a weapon system, without actually having possession of it. This control can be modified or revoked at any time. One common use of the sentry gun in TL9-12 societies is among penal guards who need to move about open areas such as exercise yards. The laser pointer allows any of several remotely mounted weapons to be used against a prisoner. If the laser pointer is taken, it is but a flick of a switch or remote command to deactivate the pointer, so no actual weapons

are ever available to be used against the guards.

A fire control system that only works while stationary and does not have all the advanced functions of a military system (crosswind sensors, temperature, humidity, air pressure compensation, etc.) would be about half cost, and provide a total skill of TL/2 (round down), with a bonus if aiming of TL/2 (round down). The rapid elevation and traverse hardware would probably be about half the weapon mass, excluding accessories that might be needed like recoil-stabilized tripods. This system would be counted as a beam-riding weapon, so the user of the laser pointer has to hit, and then the sentry gun itself rolls to hit. Remember that the sentry gun gets any appropriate bonuses, such as rapid fire or DMs from fire control aiming.

	Damage	TL	Range	Shots	Mass	Reloads	Cost
Pistol-9	—	9	V.Short	—	.3kg	—	Cr200
Rifle-9	—	9	Medium	—	1.5kg	—	Cr400

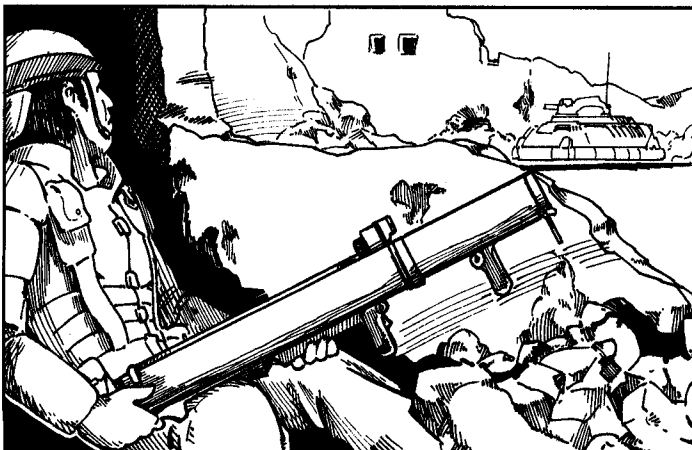

## LAAW-9

Advances in electronics allow an optical target recognition or millimeter-wave radar sensor to fit inside the small LAAW missile. Unlike the tech level 8 remote mine, the tech level 9 LAAW needs no extra sensor package to act in this role and only requires a firm attachment to a solid surface to avoid shifting under the firing impulse.

It provides a DM+2 to user skill for land vehicle targets within 150m and DM+1 for targets within 300m, and if used in an autonomous mode will fire with a skill of 6 within 150m and 5 within 300m. The LAAW-9 does not use a fragmentation sleeve and only has explosive secondary effects.

Damage	TL	Range	Shots	Mass	Reloads	Cost
24 (16 expl.)	9	Short	1	10.9kg	—	Cr1800

## Submachinegun-9

A significant improvement in this class of weapon, usually the result of rethinking the weapon concept and mission from the ground up. Militarily these weapons are most often used in an autofire mode at close range, with an emphasis on reliability, controllability and a stopping power sufficient to take down a threat in one firing action. Logistically, the weapon will often use a hot-loaded pistol cartridge, with an increased barrel length for extra muzzle energy. Recoil and rate of fire will be tailored for controllability, magazine size will be increased to reduce downtime in reloading, and parts will be heavily overengineered for reliability in extreme conditions. The resulting weapon is usually heavy for its power, but is not carried by troops burdened down with other equipment. The submachinegun-9 usually has a laser sight and folding stock, and can be equipped with a sound suppressor as needed.

A submachinegun-9 has single shot, autofire and burst fire modes. It is capable of the RF bonus if it has a full clip. This action will empty the clip. Variants with Very Short range and a 20 round clip may be concealable beneath properly tailored clothing, and are often used by high-profile bodyguards.



	Damage	TL	Range	Shots	Mass	Reloads	Cost
SMG-9	3	9	Short	100	3.0kg	1.4kg	Cr780
SMG, Compact-9	3	9	V.Short	20	1.8kg	.3kg	Cr750

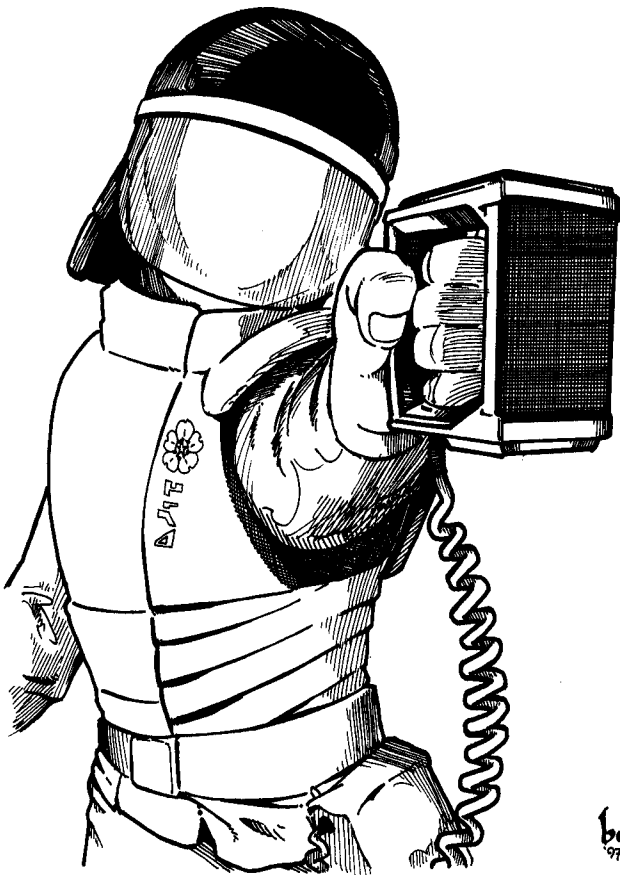

## Hazer-9

Hazers are sonic disruption weapons, broadcasting an especially annoying frequency combination at extraordinarily high volume. They do no damage *per se*, but just make it extremely uncomfortable to linger in an area, more so than a typical siren or fire alarm. The sound projection is largely directional, but the user of the weapon must wear ear protection or suffer much the same effect as the targets. At point blank range, a hazer is capable of shattering crystal, breaking glass and damaging delicate mechanical parts.

Hazers have a cone of effect that is half an outdoor square wide per outdoor square of range. A hazer simply forces all targets in that area to make an average Endurance check, DM-1 for each doubling of the number of hazers, and DM+1 for each range band past Contact, with a maximum effect range of Medium. Failing the check means that no matter how annoyed you are at the user of the hazer, you have to move away from him if possible or cover your ears to block out the noise. Anyone with full hearing protection or a sealed suit has a DM+3 on this check. Normally, users will purchase a Cr200 electronic filter to allow somewhat normal hearing while filtering out the hazer frequencies. The belt-mounted battery pack is good for 5 minutes continuous use (50 turns) and can be recharged from any contemporary vehicle or domestic power source. Hazers mounted on riot control vehicles will work in any or all arcs around the vehicle, and have an inherent DM+1 due to the extra power available. A vehicle-mounted hazer assembly has 10 times the mass and cost of a hand-held unit, and consumes about .03Mw of power at maximum output.

Damage	TL	Range	Shots	Mass	Reloads	Cost
special	9	Contact	—	3.5kg	—	Cr700

## Flasher-9

Flashers are a largely discontinued technology that exploited the hardwired nerve pathways in some genetic groups of humanity. A high intensity flash lamp was pulsed in a computer-generated rhythm, and focused by a small parabolic mirror. Many people looking in the direction of the weapon would be overcome by dizziness or nausea, which would pass almost immediately once the exposure stopped. Common use of the weapon was to deploy them in large numbers for crowd control. Certain segments of any population would be tolerant of the effect, but certain ethnic gene pools could be targeted with a specific frequency that affected them more, with numerous recorded uses by repressive governments against ethnic minorities. Expansion of the human gene pool through interstellar travel during the Second Imperium homogenized most populations to the point that flashers can no longer have the severely debilitating effects on select populations that have been historically recorded. Reports of current use on some Vilani worlds are unconfirmed.

Flashers have a cone of effect that is half an outdoor square wide per outdoor square of range. A flasher does 1D non-lethal damage to a randomly chosen single physical characteristic (dizziness, nausea, weakness) as long as you are looking in its general direction, with -1 to the effect for each range step outside Contact, +1 to the effect each time the number of flashers is doubled, and a maximum effect range of Medium. The effect ceases the turn after you look away from the weapon, but a person rendered unconscious will stay that way for at least 10 minutes. A person who rolls a 1 for their 1D damage on first exposure is tolerant of the effect and always takes an extra -1 effect, while a person who rolls a 6 for their first exposure is vulnerable and always takes an extra +1 effect. The built-in battery pack is good for about 30 minutes of continuous use (150 turns) and can be recharged from any contemporary vehicle or domestic power source. Hazers mounted on riot control vehicles will work in any or all arcs around the vehicle, and have an inherent +1 effect due to the extra power available. A vehicle-mounted hazer assembly has 10 times the mass and cost of a hand-held unit, and consumes about .01Mw of power at maximum output.

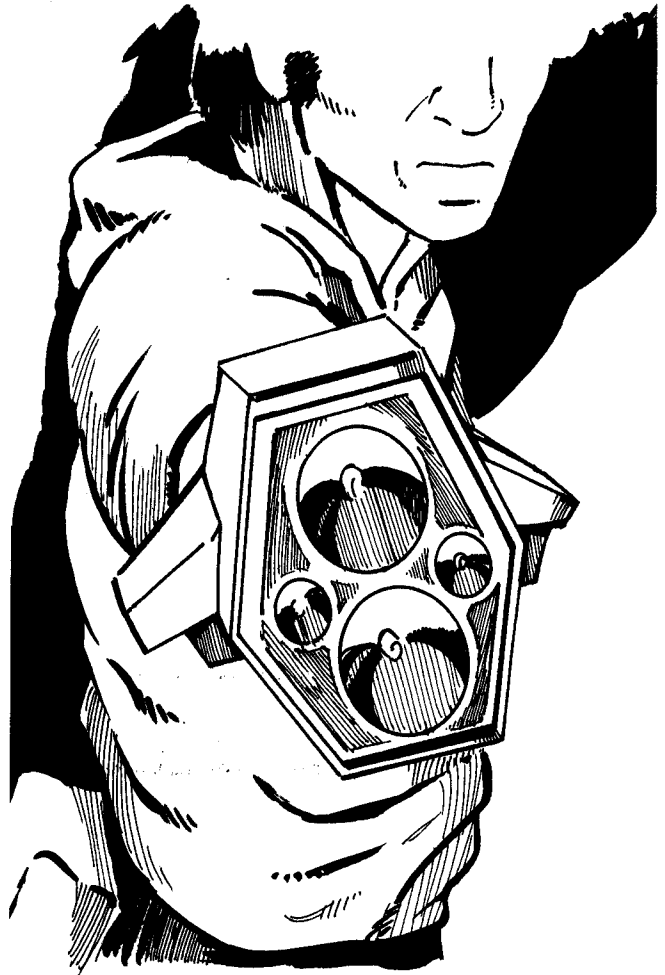

Damage	TL	Range	Shots	Mass	Reloads	Cost
1 (special)	9	Contact	-	3.0kg	-	Cr800



## Battle Dress-9

The first fully armored and protected infantry normally occurs at tech level 9 or late tech level 8. While the augmented armor concept is being experimented with, it has not been perfected nor is there a truly suitable power plant capable of running such a suit for extended periods. Battle dress-9 is often called "assault armor", and is for specific missions where the heavy mass is less of a liability. Battle dress-9 consists of a full-body suit of overlapping plates of ceramic-aluminum composites in a harness of ballistic fabrics. A small, battery operated "cool pack" and fan keeps the head and torso from overheating in the semi-sealed suit. A rigid helmet with bulletproof faceplate, air filter, integral thermal vision subsystem and scrambled subregional range communicator completes the suit. The elite soldier is equipped with whatever weapons are appropriate to the mission at hand, usually a knife, grenades of various types and a heavy ACR-9.

Battle dress-9 has a rigid armor rating of 5 over the entire body (TL8 composite laminate), and a rating of 3 on the extremities. In game terms, the double and triple damage called shot locations have the rating of 5, and half damage locations have a rating of 3. The various electronic subsystems have a battery life of about 4 hours. The mass of battle armor-9 is offset by being cus-

tom fitted to each particular user, reducing the total penalty DM for the armor by 1 point. A series of adjustment straps and pads allows any given suit to be fitted to an individual in about half an hour. Even so, battle dress-9 can only be used to best effect by people with a Strength and Dexterity of 9+ due to the total load they have to carry in armor and weapons.

Note that battle dress, combat environment suits or any armor expressly made for military use is not normally going to be available to civilians. While such armors that do not include weapons or classified hardware may not be illegal to own, there are no normal channels that have them available for sale. Once something is two TL's behind current technology, it will have been retired from second-line service and used examples may be found as surplus in varying condition. However, remember that TL's in **Traveller** cover a much longer period of time than the 20-30 year gap we see here in the 20th century. Milieu 0 **Traveller** is just going into TL12, and was probably at TL11 for centuries. This means that only the most recently manufactured TL10 equipment is going to be in anything close to good condition. But, with the total quantity made, there will be some available for those who look hard enough.

**Mass** 22kg      **Volume** .2 cubic meters      **Cost** KCr10

Name	Dam. Rating	TL	Range	Shots	Mass	Reloads	Cost
ACR, Heavy-9	5	9	Medium	40	4.9kg	.5kg	Cr2500
ACR, Light-9	4	9	Medium	60	4.2kg	.3kg	Cr920
Bullpup-9	4	9	Short	50	3.5kg	.5kg	Cr300
Flasher-9	1 (special)	9	Contact	-	3.0kg	-	Cr800
Hazer-9	special	9	Contact	-	3.5kg	-	Cr700
Sentry Pistol-9	-	9	V.Short	-	.3kg	-	Cr200
Sentry Rifle-9	-	9	Medium	-	1.5kg	-	Cr400
Submachinegun-9	3	9	Short	100	3.0kg	1.4kg	Cr780
SMG, Compact-9	3	9	V.Short	20	1.8kg	.3kg	Cr750
LAAW-9	24 (16 expl.)	9	Short	1	10.9kg	-	Cr1800
Mine, AP-9	4 (3 expl.)	9	-	1	.1kg	-	Cr20
Mine, AT-9	32 (21 expl.)	9	-	1	5.0kg	-	Cr420

# TECH LEVEL 10

Early interstellar era. Typically a long period of slow growth, with increased interest in vehicular energy weapons, development of new materials through use of fusion power and zero-gravity manufacturing and incorporation of minor electronic aids into previously unadorned military weapons. A typical example of this would be holographic target reticles and "low clip" warning lights on ACRs. Most weapons of this period will be easily recognizable to modern cultures. This period includes most of the early augmented battle armor concepts, of limited efficiency due to power constraints.

Warfare becomes more oriented towards in-stellar deployment and logistical support, with fleet tactics and boarding actions commonly taught. Much effort is made in securing the orbital "high ground". The tech level 7 maxim "no air force has ever captured territory" is found to still be true. While starship weapons can alter the outcome of almost any ground battle, commanders find that they still need troops to actually occupy the ground.

## Common Weapons

### ACR, RF-10

Most military forces strive to make most efficient use of their firepower, but the rate of rounds fired per casualty may still be several thousand to one in modern armies. Lower tech armies are even worse, and this rate of consumption has always been a logistical problem. Technically, it has usually been solved by incorporating weapon improvements that increase the chance to hit, hopefully resulting in less ammo consumption, or decreasing ammunition mass, allowing the soldier to carry more. For an unknown reason, around tech level 10 many militaries adopt light ACRs that use very lightweight ammunition at an extremely high rate of fire. This presumably increases the chance to hit groups of enemy infantry or in squad or platoon use, suppress extremely large areas or even shoot down low flying aircraft or drones. The experiment is usually a failure and these weapons are almost always dropped from service by tech level 11.

This is just a minimum power ACR with the rate of fire and magazine capacity to get the DM+2 for rapid fire twice before reloading, or a large number of regular auto-fire attacks. Ammunition is provided in disposable 250 round "bricks" (peel the wrapper off the top and pop it in), every 5th round of which is usually tracer.



Damage	TL	Range	Shots	Mass	Reloads	Cost
4	10	Short	250	3.4kg	1.1kg	Cr640

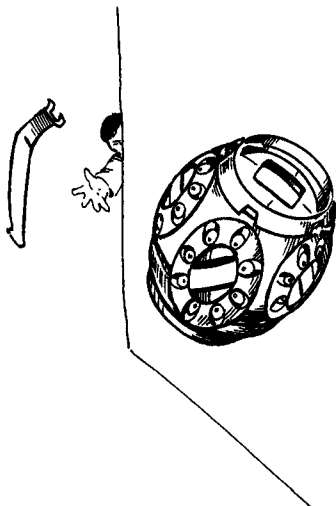

### Grenade, Sticky-10

These are one-shot sticky foam dispensers designed to cover an area with strands of sticky foam. The chemicals are mixed when the priming lever is released, and forced out through dozens of small nozzles by a chemical gas generator similar to the ones used to deploy crash bags in most land vehicles. Threat response law enforcement teams often have grenade launchers to fire these through windows or into vehicles if no other safe immobilization options are available.

A sticky grenade will fill a 3 x 3 area of indoor squares with strands of sticky foam. Anyone in the area when it goes off is counted as having been hit by a sticky gun. It cures fast enough that travel through the area is largely unimpeded by the turn after it goes off. These grenades usually have an impact fuse with a fractional second delay, so that they can penetrate light cover like windows or bounce around a corner before going off.

Damage	TL	Range	Shots	Mass	Reloads	Cost
(special)	10	Contact	1	.5kg	--	Cr80

## ACR-10

Those forces not adopting the RF ACR concept below usually retain the light ACR, which is improved by the use of better caseless ammunition and lightweight materials wherever possible. These weapons are fairly durable, and used examples may be available in quantity

from worlds upgrading to tech level 11+ weapons. A typical example is the cR776 Imperium rifle, the general design and function of which was used for the cR898 model that is still in front-line Imperium service.

Damage	TL	Range	Shots	Mass	Reloads	Cost
4	10	Medium	100	5.2kg	1.2kg	Cr1090

## Grenade-10

Gradual improvements in the power of explosives and computer designed fragmentation patterns make these TL10 devices slightly more efficient than previous designs. They can usually be set for time delay or impact detonation and are almost completely immune to premature detonation. A feature sometimes seen, especially on dual-purpose grenades with HEAP capability, is the extrusion of a small quantity of sticky foam when the priming lever is released. These grenades do not bounce, but tend to stick firmly to the first surface they hit. This has certain advantages, but some accidents

have been reported where the foam has been an contributing factor.

The time delay can be set at 0 (same turn), 1 or 2 turns delay, with the fourth position on the rotary selector being "impact". The selector knob has clearly marked settings, and can't be switched by accident. Sticky grenades will **not** accidentally stick to the thrower on a spectacular failure roll, but might stick to something inconveniently close to them. Yanking one free of a surface is an Average Strength task, but getting it loose from your hand after doing so is a Difficult one.

Damage	TL	Range	Shots	Mass	Reloads	Cost
8 fragment	10	Contact	1	.2kg	-	Cr50

## Knife-10

A much ignored but still ubiquitous weapon and tool. The knife-10 is representative of most that follow, with a strong steel blade and well designed grip. Commando forces are still taught its use, implying that even in an interstellar era, the most primitive weapons can still be effective.

Knives do not change much except in the material of

construction. TL9 knives may be ceramalloy, TL10 knives may have crystaliron cores, and TL12 knives may have a thin strip of superdense that holds its edge virtually forever. But just because the knife is strong enough to pound up to the hilt in a block of steel doesn't mean you'll ever have the strength to do so, and the damage rating of all these knives will stay at a 1.

Damage	TL	Range	Shots	Mass	Reloads	Cost
1	10	Contact	-	.4kg	-	Cr50

## Machinegun, Heavy-10

General-purpose medium vehicle armament. Reconnaissance vehicles might have one in a stabilized turret, while APCs would typically have either a dual mount or a single mount combined with an anti-tank rocket. Dedicated anti-aircraft vehicles might have a quad mount, and light air vehicles might have a built-in

mount, or a hardpoint gun pod linked to vehicle fire control systems. They are sometimes seen in multiple barrel rotary variants. Normal ammunition load is solid heavy alloy penetrators carried in a pair of 150 round belts, but discarding sabot rounds are used if the military budget can afford it.

Damage	TL	Range	Shots	Mass	Reloads	Cost
9	10	Long	300	190kg	75kg	Cr5500

## Pistol-10

Many of the technological advances in the ACR-9 are usually scaled down and incorporated into civilian sidearms by tech level 10. With the exception of the ceramalloy barrel, almost all parts are made of plastics or composites. The weapon fires caseless ammunition, and in cultures that allow these weapons only with restriction

or regulation, the propellant usually contains micro-tagged particles to identify the original purchaser of ammunition should the weapon be fired in commission of a crime. Military or paramilitary versions of the Pistol-10 will have larger clip capacity and are capable of autofire or autoburst modes.

Damage	TL	Range	Shots	Mass	Reloads	Cost
3	10	V.Short	30	1.0kg	.2kg	Cr490

## Machinegun, VRF Gauss-10

An early and largely successful energy weapon, limited to vehicle or electrically supplied emplacements by its extraordinary power requirements. A four-barrel gauss machinegun firing from twin magazines, either concurrently or consecutively, reducing the danger of a feed problem disrupting the weapon entirely. The normal ammunition load is 5mm hardened steel penetrators. Preferred deployment was usually either a stationary point-defense role, or on light attack aircraft fitted with an auxiliary power plant. Few of these early weapons are still in working condition due to the intense stress and

wear place on virtually all of the moving parts.

The normal tactical application of the weapon is wide-area suppression fire or VRF autofire. It is capable of firing over 300 rounds in the course of a normal turn. It requires .02Mw/hr of battery power per turn of use, or a power plant with a surplus output of 8.3Mw. This weapon does not have any internal power supply and will not work at all if disconnected, unlike the energy weapons in the *Central Supply Catalog* which usually have a 1 shot or turn energy reserve.

Damage	TL	Range	Shots	Mass	Reloads	Cost
10	10	Long	3000	75kg	25kg	KCr24.3

## Pistol, Tranq-10

The tech level 10 tranq pistol is usually used in a police role in societies with a non-lethal ethos or extreme restrictions on possession of lethal weapons, even by law enforcement agents. It fires much smaller darts with a pre-set human dose of incapacitating agent, and has a multiple shot capacity. If needed, the firing power can be adjusted to penetrate light cover or armor, but this is usually only done if absolutely necessary. Burst fire carbines and autofire pistols are common variants for crowd control at more repressive law levels.

Tech level 10+ tranq rounds have an effect similar to Blur. While they do no lethal damage, they will penetrate normal heavy clothing, and cause a 1D non-lethal wound

effect, normally a numbing sensation that affects the ability to move or use objects. Targeted rolls will have full "damage" effect, but the attacker can choose a body part and which characteristic is affected. For instance, a called shot could target a weapon arm and Dexterity to force an opponent to drop a weapon. Like the tech level 7 tranq weapons, dropping a characteristic to past its negative value counts as lethal damage from drug overdose. In addition, the TL10+ tranq weapons can be boosted up to a normal damage rating of 1, sufficient to give them extra distance or penetrate extremely heavy clothing or light cover, or do regular lethal damage to an unarmored target.

Damage	TL	Range	Shots	Mass	Reloads	Cost
0 (special)	10	Contact	10	.5kg	.2kg	Cr250

## Revolver, Magnum-10

This type of pistol seems to be unique to Sylea and worlds closely associated with it during the Long Night and rise of the Third Imperium. It is an archaic revolving cylinder design, so outdated that a person unfamiliar with their operation would have trouble figuring out how to properly use and reload it. It is for some reason the sidearm of choice among many nobles, both for wilderness and formal dress use. While archaic in functioning, they are still quite deadly and unusually accurate firearms, and capable of taking down heavy game at close range. It is typical of these weapons that they have no electronics whatsoever, relying solely on the skill and instincts of the shooter.

While a pistol with a better penetration is certainly possible with advanced technology, keeping the archaic weapon design means that a more powerful pistol would have far too much recoil to handle. These large bore pistols can easily handle discarding sabot armor piercing rounds with a damage rating of 4, and the practice is fairly common among those who actually care enough to be proficient with the weapon. Magnum revolvers are only available from a handful of companies on Sylea and elsewhere, and are usually made to order with the final "fitting" of the weapon requiring the purchasers presence. As with some of the other "status" weapons, it is as much a statement of refined taste as it is an expression of big-bore firepower.

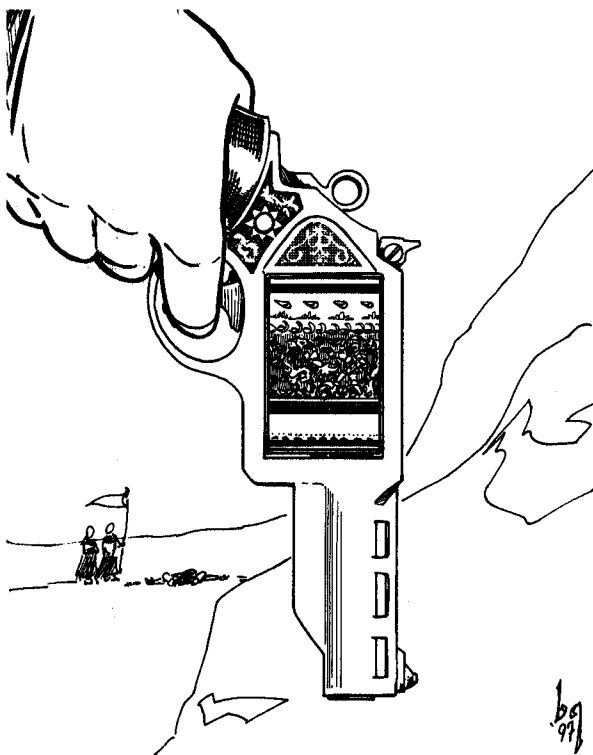

Damage	TL	Range	Shots	Mass	Reloads	Cost
3	10	Short	6	1.4kg	—	Cr2300

## Shotgun-10

Sporting shotguns are a specialized tool for the taking of small or very fast game. The wider spread of shot and multiple projectiles will often succeed where even the best hunting rifle fails. The traditional form is a double-barreled weapon, the barrels firing alternately on consecutive trigger pulls, or by two separate triggers, so that either or both barrels can be fired. Like hunting rifles, the best sporting shotguns are works of art as well as weapons, and antique or especially aesthetic designs can be sold for extremely high prices if you can find a discerning buyer.

The basic shotgun rules in **Traveller** assume a small number of large pellets, which does not normally give an

inherent +DM. However, in either an autofire mode or if using very small projectiles, the total quantity can give a bonus to hit. If you assume a spread of large shot is around 10 pellets, then an autofire burst of 10 shots throws out enough steel to give the DM+2 for rapid fire weapons. This does normal shotgun damage, which is technically a pair of damage rating 2 hits. A spread of small shot is at least 100 tiny pellets, also enough to give the DM+2 for rapid fire, but in this case it is just one or two shots, and the DM+2 helps offset the -DM for a small or fast moving target. Small shot is a pair of damage rating 1 hits, doing a total damage of 2D.

Damage	TL	Range	Shots	Mass	Reloads	Cost
2 (special)	10	Short	2	3.7kg	.1kg	Cr1100

## Rifle, Hunting-10

Sporting weapons have a long tradition of acceptable appearance which has defied the practicalities required of military weapons. They are larger than necessary, have useless ornamentation, are not made to a particular common standard ammunition and use materials that are neither necessary or optimal for outdoor use. However, none of this keeps them from being powerful, accurate weapons, and their users often collect them like others would collect works of art. The basic tech level 10 hunting rifle has most of these characteristics. Aside from use of ceramic-metal alloys in the high-stress parts, the weapon is finished in polished wood, often hand-selected by the buyer and fitted to their measurements. If money permits, exposed metal parts will be engraved, etched or inlaid with precious metals, and the weapon topped with an unaugmented variable power, ballistically compensated telescopic sight. The more restricted weapons are in a

culture, the more the ownership of one becomes a status symbol and the more likely they will be adorned and displayed as such. Since they see little use compared to a military rifle, these hunting weapons are often in good condition even after several generations of being handed down within a family or cultural sub-unit.

For a noble going on safari, such a weapon is a must. Having to borrow a host's weapon is poor state of affairs for anyone with a title to maintain. Having a custom-made weapon available, and knowing its history and characteristics shows your well-rounded character and general savoir-faire. A properly fitted TL10 hunting rifle is generally a DM+2 for negating penalties for that individual only, using the **Central Supply Catalog** guidelines for having the best quality tools. Price includes a velvet-lined wooden carrying case, often with a fitted composite outer case for shipping purposes.

Damage	TL	Range	Shots	Mass	Reloads	Cost
5	10	Long	5	4.7kg	.1kg	Cr4000

## Shotgun, Assault-10

The high rate of fire variant for short range combat, sometimes supplanting the submachinegun in this role. A bulky but devastatingly effective weapon in the right circumstances, TL10 assault shotguns usually fire from one of two 15 round box magazines, allowing for tactical use of different ammunition types. When one magazine is emptied, the weapon automatically switches to the other. Assault shotguns almost always use special ammunition that does not fit in civilian weapons, but civilian ammunition can be used in the assault shotgun if necessary.

An assault shotgun does normal shotgun damage, but can get a +DM as described above. It can also fire damage rating 5 discarding sabot slugs, penetration 7 shaped charges or small chemical rounds, but without the +DM for rapid fire.

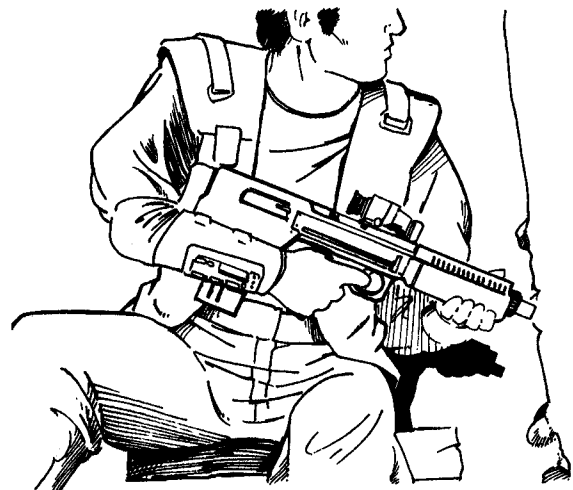

Damage	TL	Range	Shots	Mass	Reloads	Cost
2 (special)	10	V.Short	30	5.7kg	1.8kg	Cr600

## Rifle, Sniper-10

Many of the characteristics that make a good hunting rifle also apply to the highly precise sniper rifle. The main differences are that the sniper rifle is designed to accept specialized or military targeting equipment like passive thermal sights, and is designed purely from a functional standpoint, with no concern for aesthetics. The sniper rifle also fires a heavy alloy sub-caliber penetrator, while the hunting rifle fires a soft alloy tissue disruption round.

The sniper rifle is a very specialized tool, and the best are usually hand-made to fit a specific individual, who uses the same weapon throughout their service career, and may keep it after leaving military service in case they are called back to active duty. The listed price does not take customization or sensory aids into account. While a sniper rifle would serve perfectly well as a heavy hunting weapon, it would be a *faux pas* to do so in the company of others.

Damage	TL	Range	Shots	Mass	Reloads	Cost
6	10	Long	10	5.2kg	.2kg	Cr4200

## Cannon, Heavy-10

The material science technologies at tech level 10 are more than sufficient to create extremely powerful direct fire weapons, but the abilities of fire-and-forget munitions, armed drones and artillery-deployed submunitions make traditional tanks extremely vulnerable, and this period on most worlds tends to be more concerned with mobility and stealth rather than armor and firepower. This phase lasts until the introduction of the first heavy grav tanks. The heavy cannon-10 is a marvelous if bulky beast, firing either extremely high velocity heavy alloy

penetrators, or some form of high explosive munitions. This is usually a dedicated HEAP or multiple-stage HEAP warhead. It uses a dual feed autoloader for speed and flexibility, the relatively small magazines being manually replenished by the crew from protected storage elsewhere in the vehicle. This cannon may also be used in a conventional artillery role, firing until magazines are empty and then rapidly switching location to avoid counter-battery fire. In both roles it is always equipped with fire control systems appropriate to its mission.

Damage	TL	Range	Shots	Mass	Reloads	Cost
24	10	E.Long	10	3100kg	205kg	MCr1.1
25 expl.		V.Long			280kg	
30 HEAP		V.Long			280kg	

## Waterknife-10

This is a military application of a TL7 industrial technology. An extremely high pressure stream of abrasive-loaded water is pumped through a very small diamond nozzle, and the resulting pinpoint jet is capable of cutting through any material up to diamond hardness. As the possibility of boarding actions on starships became a reality, the waterknife became the melee weapon of choice for selective disabling of systems and opponents without undue damage to the boarded ship in general. Normal application would be a small high pressure tank on the back, with armored hose leading to a nozzle on top of one wrist. This could be used as a cutting tool, or a melee weapon capable of cutting through virtually any space suit without too much effort. It is "fired" with a hand-mounted trigger, tied either to a particular hand motion or by nerve impulses fed through a port on the suit.

A waterknife has a damage rating of 12 per turn if used in a controlled sense against a target like a lock, door, etc., and a full pressure charge will last for 10 turns of continuous use. They can bore a deep hole like a drill bit, to provide a small access hole for an observation device, introduction of incapacitating agents, and so on. As a melee weapon, its cutting ability varies widely with the actual range when the jet intersects something. Even a few cm of distance can significantly drop the cutting ability. On a successful melee attack, a waterknife has a damage rating of 2D. Higher tech waterknives have +10 turns duration per tech level past 10. Weapon implementations are not available for civilian use, but less elegant portable waterknives are available through industrial channels. These usually have a backpack and pistol-grip cutting nozzle. Using one as an improvised melee weapon is a DM-3 to hit.

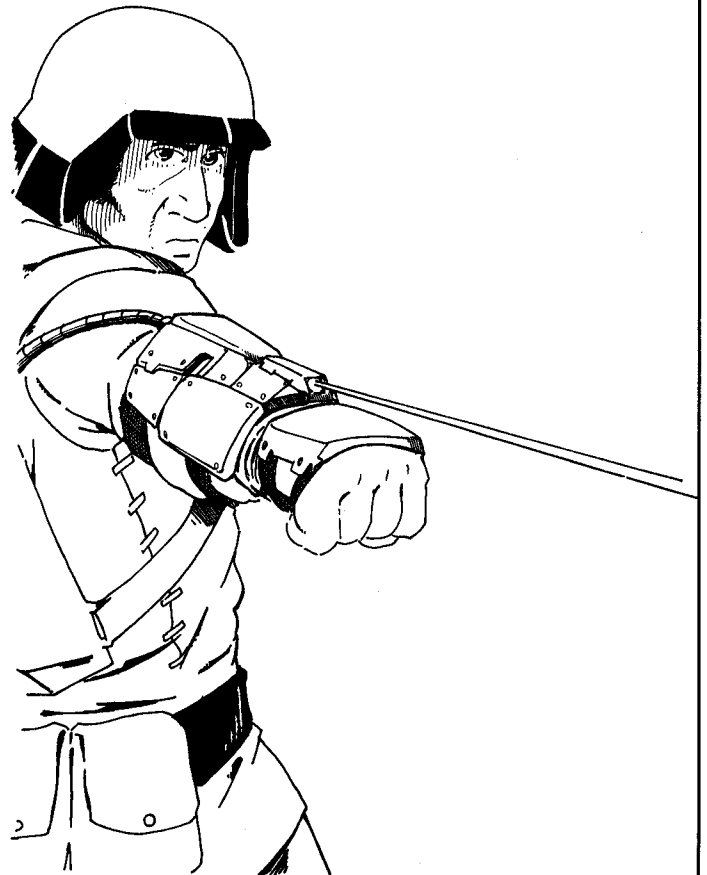

	Damage	TL	Range	Shots	Mass	Reloads	Cost
Civilian	2D (special)	10	Contact	10	9.0kg	4.0kg	Cr2000
Military	2D (special)	10	Contact	10	7.0kg	4.0kg	Cr3500

## Sticky Gun-10

The so-called "sticky gun" is one of the more useful Vilani developments that has come down to us. It is a short range weapon firing a continuous stream of fast-setting flexible epoxy. This hits the victim and adheres, usually binding one or more body parts together, immobilizing them with no actual damage. The weapon fires from integral or backpack mounted clips, each containing two chemicals which are mixed the instant of firing. The epoxy can be neutralized and softened by application of a special solvent spray, but the process usually takes at least a minute, and still leaves a sticky mess.

A sticky gun has a maximum effective range of Very Short, and may be used as an autofire weapon. The effect of a single hit is to do 1D "wounds" to Dexterity. This is not actual damage, but represents the external immobilizing effects of the ropy strands of epoxy binding body parts together. A DM-3 called shot will have double effect or do normal effect and the immobilizing special effect of choice, such as binding legs together, sticking as person to a wall, etc. a DM-6 called shot will have triple effect, or normal effect and a very specific special effect. This has been known to be lethal, as a face hit will completely cut off visibility and breathing. It is an Average roll of half the victim's Strength (round down) or less to break a set of sticky strands, with a DM-1 per hit after the first. Defenses against sticky guns include the "slick suit" and the "tear suit". The first is a thin outer garment made from a tetrapolyethylene or other low-friction polymer film. The sticky glop hits, solidifies and then usually falls off. The latter is a thin outer garment made not from regular cloth, but a very thin or weak fabric. The sticky glop hits, solidifies and then the user simply rips off the glop, taking pieces of the outer garment with it. Both suits allow the 2D task to be made on Strength rather than half Strength. Riot troops issued sticky guns usually wear slick suits, just so they can fire at very short range without endangering their friends.

Sticky guns have a number of other uses. A single hit will fill holes, clog gun ports, blind cameras, jam locks, cover access plates, anchor ropes or do anything else you could do with a handful of instant-set epoxy. An autofire blast is capable of creating a web across a doorway to delay passage, generate a "rope" up to 15 meters long to climb up or across an obstacle or completely encase a small object in a protective armored coating.

The sticky gun spray is a two part mixture that is combined in the nozzle of the weapon. Normally, each time the trigger is released, a blast of solvent-laced compressed air clears the nozzles of the quickly congealing mixture. Most spectacular failure rolls are a result of incomplete clearing after a long spray, which jams the nozzles with goo and requires weapon disassembly to clear.

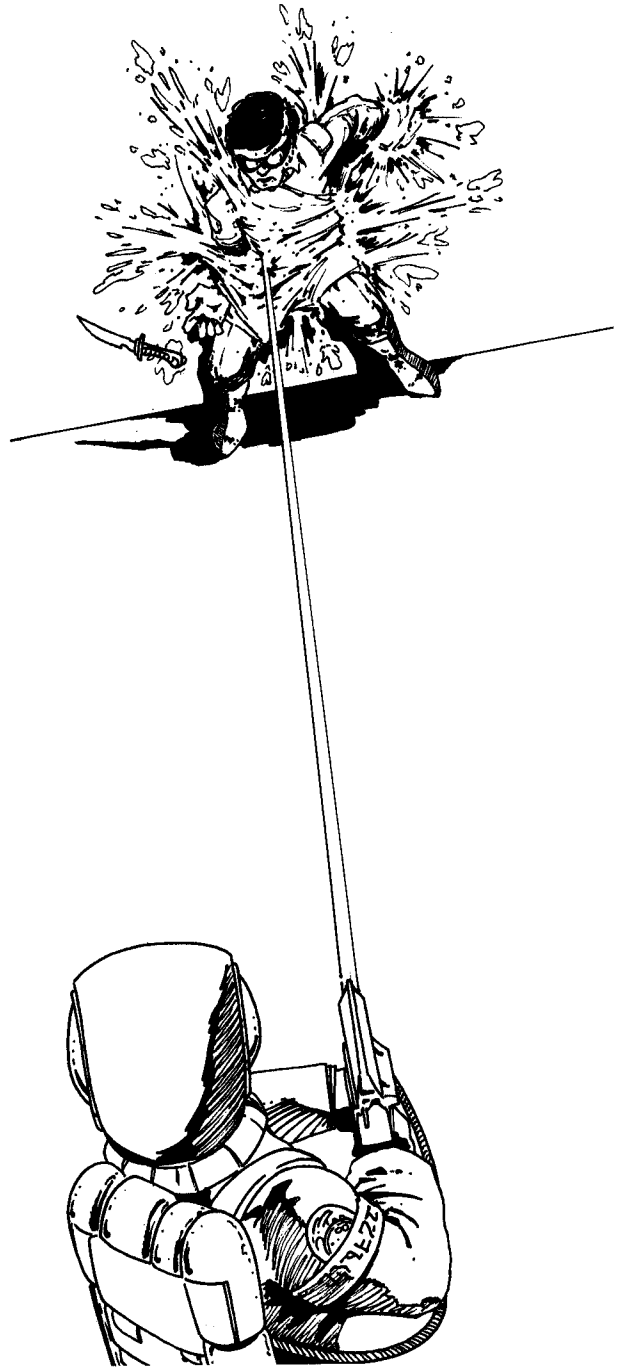

Damage	TL	Range	Shots	Mass	Reloads	Cost
(special)	10	Contact	40	7.0kg	5.0kg	Cr2000

## Battle Dress-10

With the separation into augmented and unaugmented battle dress at TL10, battle dress becomes less specialized. Instead of having many integrated functions, it becomes just an armored framework which the end user customizes to fit their needs. It will include power and data paths, but not have any standard equipment. Environment sealing

would be provided by a separate underlayer if needed.

Battle dress-10 provides a rigid armor rating of 4 on the arms and legs and 6 on the torso and head (crystal-iron). It comes with no options, but can handle up to .1m<sup>3</sup> of internal gear and .1m<sup>3</sup> of external fixtures. If properly fitted, penalty DMs for its encumbrance are reduced by 1.

Damage	TL	Range	Shots	Mass	Reloads	Cost
Battle Dress-10	23kg	.3 cubic meters	Cr2000			



## Battle Dress, Augmented-10

This is an intermediate step towards full augmented battle dress. It affords more mobility than an unencumbered person, and allows this mobility while carrying a significant load of weapons and armor. Power augmentation is not provided for the torso and arms, which must rely on natural strength, and the operational range of the unit is not more than 2 hours from a given resupply point. Most ABD-10 units are designed around a vac suit concept, and are usable without modification on the ground or in space.

Augmented Battle Dress-10 provides power augmentation to the legs only, enough to give a leg strength of 10 and move at up to 45 meters per turn (27kph). The high density battery power supply (.08Mw/hr) will last for 5 hours at full load, or perhaps a few days in a resting state using only life support and limited sensors. ABD-10 units have life support, satellite navigation systems, inertial navigation systems, subregional military-grade communicators, subregional passive optical sensors and an overall rigid armor of 7 (crystaliron). Normal weapon load would be some combination of TL10 weapons, with a waterknife and HEAP-loaded assault shotgun for space combat, grenades and rapid fire ACR for assaults on lightly armored positions, with a LAAW-9 or two carried in case heavier armor is encountered.

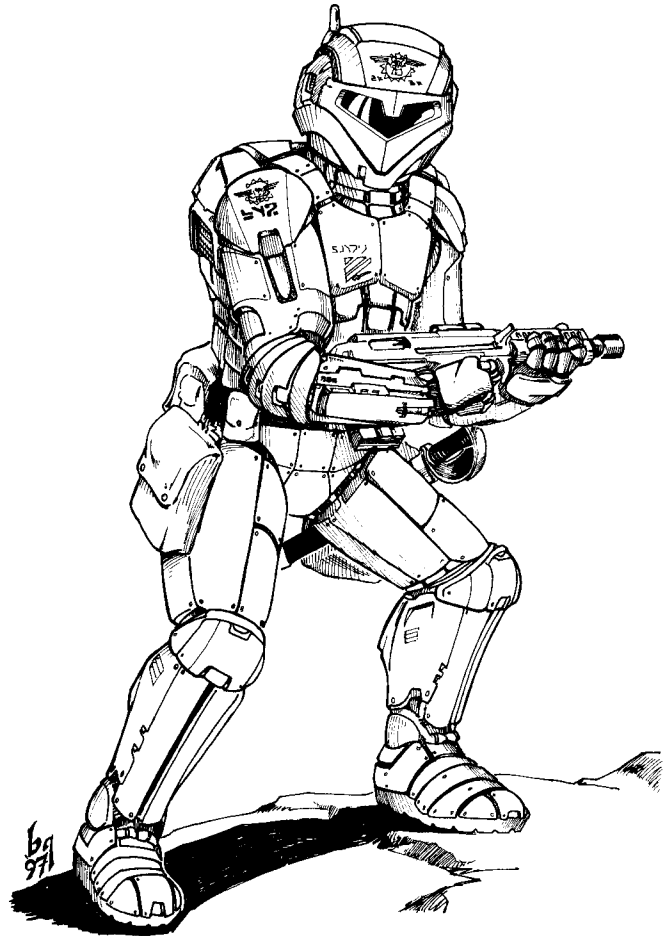

**Mass**  
270kg

**Volume**  
.3 cubic meters

**Cost**  
KCr15.2

Name	Dam. Rating	TL	Range	Shots	Mass	Reloads	Cost
ACR-10	4	10	Medium	100	5.2kg	1.2kg	Cr1090
ACR, RF-10	4	10	Short	250	3.4kg	1.1kg	Cr640
Carbine, Tranq-10	0 (special)	10	V.Short	30	1.1kg	.5kg	Cr190
Grenade-10	8 fragment	10	Contact	1	.2kg	-	Cr50
Grenade, Sticky-10	(special)	10	Contact	1	.5kg	-	Cr80
Knife-10	1	10	Contact	-	.4kg	-	Cr50
MG, Heavy-10	9	10	Long	300	190kg	75kg	Cr5500
MG, VRF Gauss-10	10	10	Long	3000	75kg	25kg	KCr24.3
Pistol-10	3	10	V.Short	30	1.0kg	.2kg	Cr490
Pistol, Tranq-10	0 (special)	10	Contact	10	.5kg	.2kg	Cr250
Revolver, Magnum-10	3	10	Short	6	1.4kg	-	Cr2300
Rifle, Hunting-10	5	10	Long	5	4.7kg	.1kg	Cr4000
Rifle, Sniper-10	6	10	Long	10	5.2kg	.2kg	Cr4200
Shotgun-10	2 (special)	10	Short	2	3.7kg	.1kg	Cr1100
Shotgun, Assault-10	2 (special)	10	V.Short	30	5.7kg	1.8kg	Cr600
Sticky Gun-10	(special)	10	Contact	40	7.0kg	5.0kg	Cr2000
Waterknife-10 (civ.)	2D (special)	10	Contact	10	9.0kg	4.0kg	Cr2000
Waterknife-10 (mil.)	2D (special)	10	Contact	10	7.0kg	4.0kg	Cr3500
Cannon, Heavy-10	24	10	E.Long	10	3100kg	205kg	MCr1.1
Cannon, H.-10, cont.	25 expl.		V.Long			280kg	
Cannon, H.-10, cont.	30 HEAP		V.Long			280kg	

# No NUKES!

While atomic weapons and portable delivery systems are available at TL6+, *Emperor's Arsenal* isn't going to go into them in detail. *Emperor's Arsenal* isn't a miniatures system or board game that requires tables for the effects of nuclear battlefield weapons. If you use them against characters, well, characters die. If characters use them, they either succeed in their goal and the eventual price they pay is worth it, or they don't succeed and are hunted down and shot like rabid dogs. The only reason you need to worry about nuclear-scale weapons is as a backdrop for some other aspect of an adventure.

No government in its right mind is going to let civilian ships of any kind carry atomic munitions. It's bad enough that they have to worry about starship-grade particle weapons in the hands of grizzled old traders who may have come out of jump in a bad mood and don't care who they take it out on. Those are at least point-target weapons, and conventional missiles can usually be shot down. But fission, fusion, transuranic and antimatter warheads? Don't even think about it. Even with nuclear dampers, people don't care to take the risk, and dampers do nothing to stop the spread of radioactive debris that a fizzled detonation brings. In any milieu that isn't openly at war with someone else, possession of such warheads is grounds for imprisonment and ship confiscation at the very least, as well as bringing to bear the full brunt of technological interrogation to find out where you got them and if you know of anyone else who has them. During times of war, civilian ships may have letters of marque and reprisal allowing them to legally prey on enemy shipping, but even then, nuclear munitions are still highly regulated, with full documentation required every time one is used (in the form of complete and unedited ship sensor logs).

These figures are derived from US Government research and converted into **Traveller** terms as best we could. "Wounds" is the number a person in the open without a pressure sealed suit would take. A hardened structure would be a steel reinforced masonry building, while a light structure would be equivalent to a wood frame house. Approximate penetration value of the blast is double the number of wounds listed.

## A Note on Damage Rating

As you compare weapons of one TL to another, you may see that some weapons at a higher TL seem on the surface to be less effective or only marginally more effective than those that went before. For instance, a PCMP-13 (Plasma Cannon,

Man-Portable) has a damage rating of 21, while a LAAW-8 has a damage rating of 23. However, technologically the PCMP has a longer range, greater accuracy and has 20 shots worth of energy in a package massing less than three LAAW-8's. In addition, the LAAW-8 would almost certainly be shot down by point defense systems at TL13, while the shot from the plasma cannon would not. There are tradeoffs and matters of technological efficiency at work behind the scenes. For instance, does the chemical warhead of a TL8 HEAP round have the same penetration ability against TL13 armor as a TL13 plasma cannon? Is the military buying these things looking for a well-rounded weapon system or a logistics-heavy one-shot device? You could make a one shot PCMP-13 with a damage rating of 28 instead of 21 for the same total mass, but is that the role envisioned for the PCMP series? If you assume the PCMP series is meant to take out heavy infantry and light vehicles, then a damage rating of 21 is sufficient. If you expect to be engaging heavy grav armor, a damage rating of 21 is not going to do the trick, but a damage rating of 28 is not going to be a sure kill either.

If you have the vehicle design rules from *Central Supply Catalog*, you can see how the armor rating of materials goes up with their thickness. If not, then just consider that a damage rating 6 weapon will go through almost 240% more hard steel than a damage rating 4 weapon, or that a damage rating 23 plasma cannon will go through 30% more superdense than a damage rating 21 plasma cannon. Getting these extra points of damage is *expensive* in terms of energy, and that energy has mass in the form of weapons able to handle it and the advanced materials used to store it. Unfortunately, the unaugmented TL13 grunt still has the same carrying capacity as their distant TL8 ancestors. In addition to these weapons, he or she also has to carry armor, communications gear and other things unimagined to their LAAW-8 lugging counterparts.

Warhead	Pen/USP	Groundburst crater	Hardened structures severely damaged (6D wounds)	Light structures severely damaged (2D wounds)
1 kiloton	360/52	~75m diameter	out to ~180m	out to ~750m
10 kiloton	600/65	~150m diameter	out to ~420m	out to ~1700m
100 kiloton	1000/79	~300m diameter	out to ~950m	out to ~3800m
1 megaton	1600/91	~600m diameter	out to ~2200m	out to ~8700m
10 megaton	2600/103	~1200m diameter	out to ~5000m	out to ~19500m

# TECH LEVEL 11

Average Imperial era. The technology in this period's weapon development is currently the same as that in Imperium reserve units, some of which is still classified in exact capabilities. However, most of the tech level 11 developments are refinements or modification of tech level 10 designs, with few actual breakthroughs of note. Weapons at this level of sophistication were common during both the Vilani Era and many areas during the Rule of Man. Any starfaring culture encountered may have some weapon developments at this level.

Warfare is uncommon on an interstellar scale unless both sides control the resources of several star systems. While resource bases can be destroyed with relative ease, many conflicts involve control and capture of these resources, requiring invasions with ground forces and atmosphere craft rather than strategic bombardment with

starship weaponry. Individual planets may have civil wars or rebellions, which often result in mutual destruction of nearly all high-tech weapons and defense systems and degenerate into protracted guerrilla actions using lower tech equipment that can be built with the reduced industrial base.

## Common Weapons

### ACR-11

The current state of ACR technology is typified in the Imperial cR898 battle rifle. This embodies the "heavy ACR" concept, combining adequate range and penetrating power with an extended magazine capacity. Mass is kept down through use of advanced materials and APDS caseless ammunition, and it meets all the recent Imperium standards for reliability and multiple environment use. A slightly less advanced model (cR776) is available for export, and civilian versions without the hardware and data paths are already made under license on several worlds. Quality has been found to be irregular, and the

manufacturers are not required to meet Imperium military standards on reliability and environment tolerance.

The ACR-11 is capable of single shot or burst-fire modes, but is not normally capable of full autofire. Multiple bursts can be used for suppression fire, however. The Rifle-11 is single shot only, and fires lead-core caseless ammunition through a longer barrel to get the same penetrating power. While it is capable of firing the more advanced ammunition issued with the ACR-11, it does not significantly affect damage (while better than the ACR-11, it is still not high enough to be a 6 instead of 5).

Damage	TL	Range	Shots	Mass	Reloads	Cost
5	11	Medium	100	4.3kg	.6kg	Cr1050

### Staple Gun-11

The term "staple gun" has stuck to the cP859u pistol since its introduction, so much so that official Imperium databases automatically cross-reference the term. The cP859u through x variants are designed as sidearms for non-human Imperium troops who are unable to comfortably handle standard Imperium designs. These species are usually assigned to secondary roles that do not require front-line armament. The cP859 series is designed to allow field modification so that any known species can adapt it to their special manipulative members. Features of note are the extremely large and adjustable handguard, a trigger assembly that is electrical and can be placed anywhere on the weapon, and a low recoil force so that even smaller or more fragile species can use it without harm.

In game terms, Hivers, Asym, Denaar, Graytch and Hresh would take -DMs to use humanocentric weapon designs, and those species in different branches of the Imperium military would probably use this weapon. This would not keep them from using better native designs of their own while in their home territory. The staple gun is capable of being adjusted for single shot, burst fire or autofire, or having any of these modes locked out to take species preferences into account.

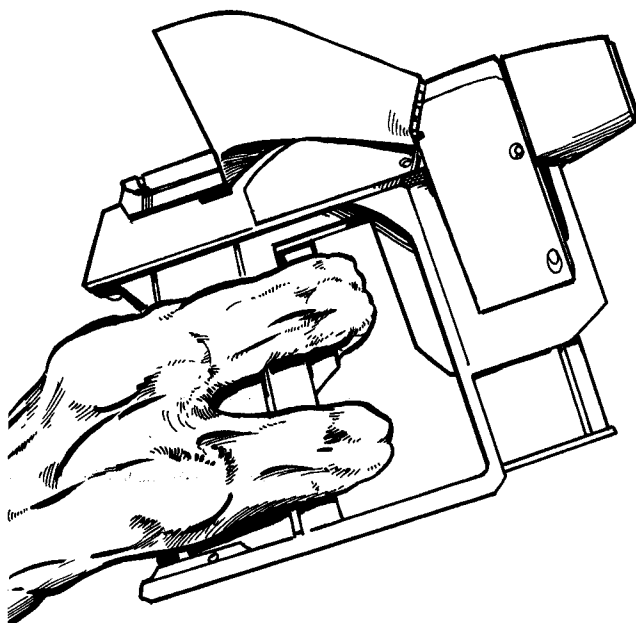

Damage	TL	Range	Shots	Mass	Reloads	Cost
2	11	V.Short	25	.9kg	.1kg	Cr550

## Pistol-11

A high-capacity pistol using proven materials and technologies. It serves in a number of roles, such as personal defense, police or military sidearm, and in some variants, competition shooting. It incorporates a muzzle

brake and laser sight as standard features.

This is just the generic TL11 pistol, with about the same stopping power as today's Desert Eagle semi-auto pistols, but with less mass and a better clip capacity.

	Damage	TL	Range	Shots	Mass	Reloads	Cost
	3	11	V.Short	20	1.1kg	.2kg	Cr500
Target-11	3	11	Short	20	1.5kg	.2kg	Cr2100

## Crossbow-11

A modification of the archaic weapon designed for heavy hunting use. The stored energy in the bow is augmented by the addition of shape-change alloys and high-density energy banks. When the weapon is fired, much of the force is actually generated by the shape-change alloy, propelling a hard steel bolt at supersonic velocity. The string and bow tips have a distinctive "crack" when fired, but the bolt arrives at the target before this is heard. After firing, the current is reversed and the shape change alloys bend the opposite direction, allowing the

heavy composite bow to be recocked by hand.

Without the extra energy, the crossbow-11 only has a damage rating of 3, and cannot be cocked by anyone with Strength of less than 9. The energy pack holds enough power for 10 fire/recock cycles, and is rechargeable in a matter of minutes from any household or vehicle power source. In some areas, the crossbow-11 may be the "sporting" weapon of choice, and is used only with open sights to increase the challenge.

Damage	TL	Range	Shots	Mass	Reloads	Cost
4	11	Medium	1	3.8kg	.1kg	Cr550

## Snub gun-11

The weapon given the general title "snub gun" refers to a large bore, low velocity pistol firing small shaped charges instead of solid projectiles. These have greatly increased penetrating power with the penalty of reduced clip capacity and increased cost. They are extremely effective against light body armor, and while most military body armor incorporates ceramic or ablative fibers to slow down a snub gun's HEAP effect, the transmitted concussion is still enough to cause serious injury. In the few areas where the ammunition is available to civilians, the weapons are seen in a number of concealable sizes. In areas where the ammunition is only available through illegal channels, unreliable or improvised weapons using the ammunition may sometimes be encountered. Current military snub gun technology is represented by the Imperial cP003 pistol and cP007 submachinegun, both of which have hardware mounting and data paths compatible with most Imperium equipment.

Most snub guns also have an explosive effect of 1, which can cause light concussion to unprotected individuals in the same indoor square as the target. Police forces using snub guns can often stun a holed-up individual by massed fire into the area, even if they can't hit the actual target. Non-lethal snub gun rounds are available and usually treated like a slightly less effective thud gun. The snub submachinegun-11 is capable of burst fire or autofire, and is designed to be fired from both hands, though it is light and balanced enough to fire one-handed if necessary (DM-1). In general, snub guns are low-velocity weapons and are impractical to use past Medium range (no aimed fire past Medium range).

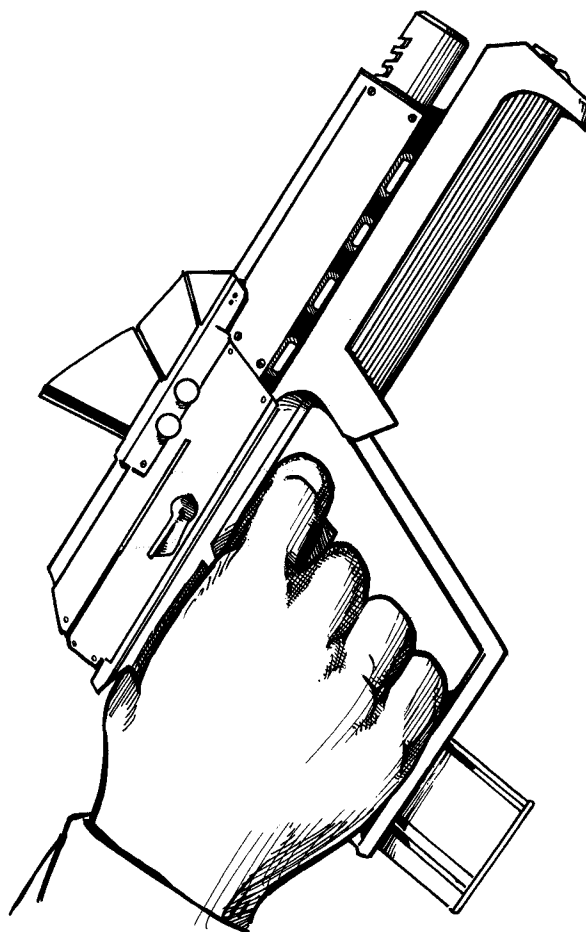

	Damage	TL	Range	Shots	Mass	Reloads	Cost
	5	11	V.Short	10/20	.6kg	.1kg	Cr610
Pocket-11	5	11	Contact	3	.2kg	-	Cr210
SMG-11	5	11	Short	60	1.6kg	.3kg	Cr960

## Stay-Put-11

In areas open to the public, or where capture is the preferred option, some buildings have equipped fire extinguisher vents with a secondary Stay-put nozzle and have security forces with a backup Stay-put sprayer. Stay-put is a mildly volatile and non-toxic superlubricant. Anything coated with Stay-put is nearly frictionless, especially smooth surfaces like floors and walls. Without special hand and footgear, it is nearly impossible to tightly grip an object or run, walk or even stand on the stuff. It has been likened to walking on ice with greased shoes. While it inconveniences everyone in the area, it has the beneficial side of effect of getting civilians on the floor and out of the line of fire. Security forces can move around in Stay-put coated areas by using electrically heated gloves and boots, which vaporize the Stay-put on contact, leaving them with solid grip and footing wherever they go. Evaporating Stay-put fumes will give you a headache and prolonged exposure is not recommended, but no fatalities have been reported from its use.

A Stay-put sprayer resembles some of the medium-size pressurized squirt guns you see in toy stores. While a building system will reliably drench everything in its area, the sprayer will only douse a person and the indoor square they are standing in, with a maximum effective range of Very Short (15m). A solid hit is a 1D penalty to Dexterity and any action requires an Average Dexterity roll to avoid fumbling somehow. Any amount the Dexterity task is failed by is a -DM to that task. You could slip and throw off your aim, squeeze the trigger too hard and have the gun fly out of your hand like a wet bar of soap, and so on. Multiple hits cannot have the effect of dropping Dexterity to less than 2.

Stay-put is not commercially used as a lubricant, as its volatility is not desirable in most applications. However, it can be synthesized without too much trouble, and authorities have implicated its use in several murders and attempted murders. Typically, the victim will fail to make a turn due to a Stay-put lubricated roadway, or fall from a height due to poor footing. Microscopic residues of Stay-put remain even after the bulk has evaporated, allowing forensic experts to eliminate the possibility of these murders being mistakenly labeled as accidents.



Damage	TL	Range	Shots	Mass	Reloads	Cost
special	11	Contact	5	2.0kg	1.5kg	Cr400

## LAAW-11

The prevalence of countermeasures on modern armored vehicles, combined with advances in armor technology means that hand-held weapons must be extremely sophisticated to have both a good chance of success and to keep the operator of the weapon alive. The LAAW-11 uses a high-velocity unguided rocket, with all targeting computations handled by an optical target recognition sensor array that is dismounted from the launch tube and reused. This makes the rocket itself immune to ECM and any distractions on the firer. The Imperium rS965 launcher uses tandem HEAP warheads for better penetration, and the entire composite rocket body is chromium plated to provide a degree of resistance to point defense lasers, giving it the nickname "Silver Bullet". While the sensor package only provides "shoot/don't shoot" indicators, the full output can be integrated into TFAC systems and

monitored remotely. By the addition of an ICOM link, the weapon can be fired remotely from any station in the ICOM network with the right authorization code.

In **Traveller** terms, the LAAW-11 provides a DM+2 to hit any vehicular target within 300m, and DM+1 for targets within 600m, in addition to normal aiming bonuses. A miss by 1 point triggers the proximity fuse at a range of 2 meters for normal blast effects. The detachable sensor array masses 1.5kg and costs Cr1600, and rocket reloads cost Cr3000 each and have a mass of 11.5kg. If left in autonomous mode, it will fire with a total skill of 8 vs. the first vehicle that passes through the area it is targeted on within 300m, and a skill of 6 within 600m. The reflective coating on the missile provides a DM-1 on point defense rolls for TL13- point defense lasers.

Damage	TL	Range	Shots	Mass	Reloads	Cost
29 (17 expl.)	11	Short	1	13.0kg	11.5kg	Cr4600

## Thud Gun-11

The name preferred by Sylean manufacturers is "ranged impact weapon", but the name "thud gun" has irrevocably stuck to this class of weapon. Detractors say it represents the "thud" your body makes after the person you shot comes over and knocks your lights out. A technically non-lethal projectile weapon firing elastic balls at high subsonic velocity. The elastomer compound used is designed for maximum energy transfer and minimal penetration, but hits to fragile body areas can cause serious internal damage. The elastic balls may be impregnated with an indelible skin dye that is released on impact. Some repressive societies have used projectiles laced with a custom molecule detectable by portal scanners, so to track escaped trouble makers or at least confine them to a limited area until they think the compound has degraded and it is safe to move about again. Thud guns are also a relatively easy way to collect specimens of small animals where serious tissue damage or drug residues would hinder later analysis, and are capable of discouraging curious larger animals without causing lethal harm. The examples described in the analysis section is typical Sylean manufacture, and the heavier model includes a laser sight, small electronic camera and is exceptionally accurate for a weapon of this type.

It is a Difficult Electronics or Armory task to tinker with the gun to increase its non-lethal damage rating to 2. To make it adjustable is a Formidable task, and to tinker with it and still have it appear normal to a detailed examination is an Impossible task. Substituting a rigid projectile for the elastic ball will convert the damage to lethal damage. Both types of modification are usually quite illegal. Weapon cameras usually are sealed units with non-volatile memory, and record what was aimed at every time the weapon is fired with live ammunition. For practice use, the gun can be fired with blanks and the camera linked to an external recorder or computer to see if you "hit" what you were aiming at.

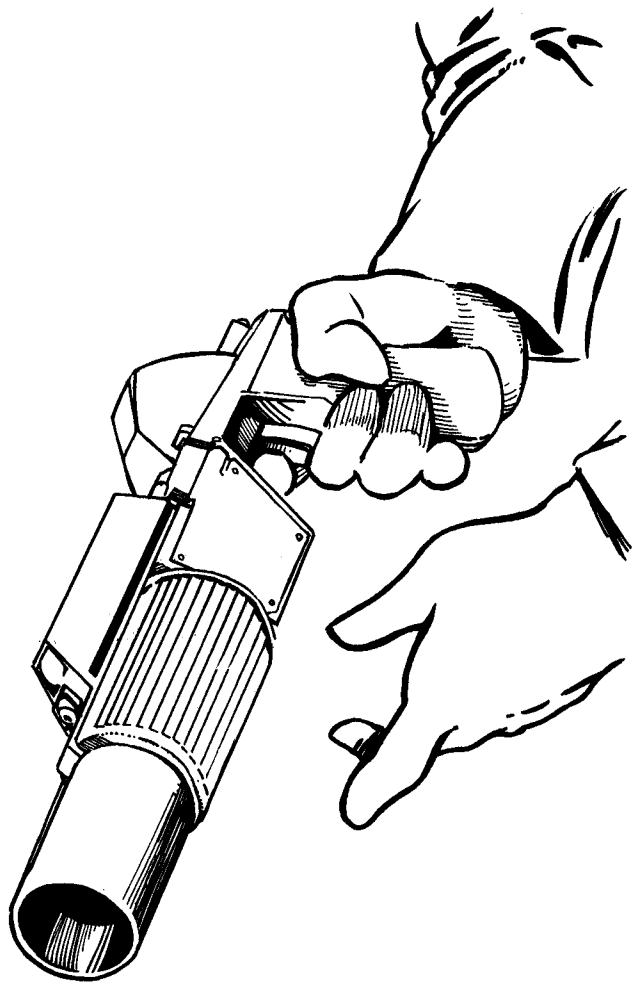

	Damage	TL	Range	Shots	Mass	Reloads	Cost
	1	11	V. Short	10	.7kg	1kg	Cr580
Pocket-11	1	11	Contact	2	.3kg	-	Cr160

## Mine, AP-11

Simple improvement of the basic anti-personnel mine. The possibility of heavily armored or augmented infantry means that most small mines past TL11 will be designed to get some penetration vs. any type of infantry likely to be deployed during their operational lifetime. The

Imperium eE965 mine is typical, incorporating a small shaped charge, a remotely programmable timing cycle, adjustable self-destruct time and anti-tamper measures in a package that fits in the palm of your hand.

	Damage	TL	Range	Shots	Mass	Reloads	Cost
	5 (3 expl.)	11	-	1	.1kg	-	Cr25

## Mine, AT-11

Improved electronics and explosives are the main features that differentiate the tech level 11 mine from its predecessors. Use of ground effect or contragrav vehicles requires a much faster sense-detonate cycle, plus the ability to detect the approximate height above ground the sensed vehicle is at. Most tech level 11 anti-vehicle mines include a directional bounding charge to

drive the main warhead up to a height of several meters before the proximity-fused main charge goes off.

If a low-flying vehicle is targeted and there is some question as to its altitude, an AT mine-11 can probably target it if it is below treetop level. Making a to hit roll exactly might indicate the vehicle only takes blast effects instead of the HEAP damage.

	Damage	TL	Range	Shots	Mass	Reloads	Cost
	34 (22 expl.)	11	Contact	1	5.0kg	-	Cr550

## Point Defense Laser, RF-11

Most Imperium heavy vehicles now mount this system or a variant of it (Imperium reference I0V926a through I0V926d). It consists of three vertical lasers reflected onto a single path, which is then reflected off a cooled adaptive mirror array in a 30cm microturret with armored shutters. Manual control of the weapon can be slaved to any weapon station, but it is normally linked to the vehicle's fire control system and programmed to automatically engage certain classes of targets. This is usually missiles, but it can be adjusted to fire on human-sized thermal targets, thrown objects, or any other parameter the vehicle's sensors are capable of discriminating.

The RF point defense laser-11 gets the skill of the vehicle fire control system used, and the DM+2 for a rapid fire weapon. Penalties are as appropriate for the situation, and vehicle combat is more fully covered in the *Central Supply Catalog*. The turret consumes either .0001Mw/hr of battery storage per use or soaks up .5Mw from a vehicle power plant. It has internal power storage for one RF burst to compensate for momentary lapses in vehicle power. Note that the mass listed includes the basic hardware, but neither the sensors or armored turret, which are subsumed in the mass of the vehicle it is mounted on. Any form of visual obscurement like smoke will block the laser's effectiveness, and result in a -DM as described for that type of obscurement.

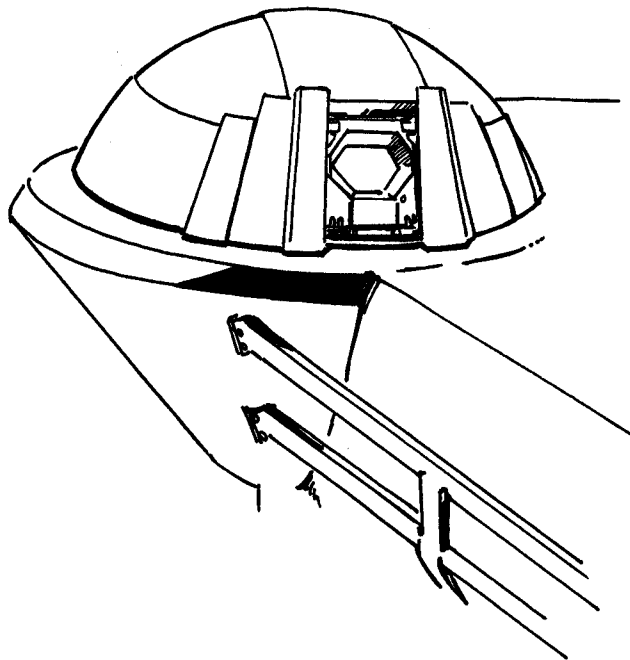

Damage	TL	Range	Shots	Mass	Reloads	Cost
5	11	Medium	—	13.3kg	—	Cr7000

## Battle Dress-11

With the separation into augmented and unaugmented battle dress at TL10, battle dress becomes less specialized. Instead of having many integrated functions, it becomes just an armored framework for the end user to customize to fit their needs. It will include power and data paths, but not have any standard equipment. The suit is semi-sealed, enough to protect against sudden changes in pressure like explosions, but is not vacuum capable on its own. Body heat is transferred out of the suit by a limited PLSM unit and a small network of cooling tubes, much less than a space suit would require. This is powered by a small integral battery that lasts about 10 hours of constant use and is easily recharged from any domestic or vehicle power source. Environment sealing would be provided by a separate underlayer if needed. Unlike early tech level 11 battle dress, later models have complete overlapping coverage

at all the joints. While this increases mass significantly, it does eliminate most potential weak spots at the joints — a problem with earlier units.

There is a technological lull in the Traveller universe around TL11. Sensors and electronics have not gotten appreciably smaller, and no new armor material fills the gap between TL10 crystaliron and TL12 superdense. Battle dress-11 uses extremely limited amounts of superdense in its construction as an experimental (and classified) technology which would be illegal to own or sell at TL11. Battle dress-11 provides a rigid armor rating of 5 on the entire body, plus internal cushioning on vital areas. It comes with no options, but can handle up to .1m<sup>3</sup> of internal gear and .1m<sup>3</sup> of external fixtures. If properly fitted, penalty DMs for its encumbrance are reduced by 1. Differences between this battle dress-11 and other battle dress-11 units are noted above.

Damage	TL	Range	Shots	Mass	Reloads	Cost
Battle Dress-11	17kg	.3 cubic meters	Cr5400			



## Battle Dress, Augmented-11

This is similar to the ABD-10 units, but with limited amounts of superdense and better storage cells for longer range.

Augmented Battle Dress-11 provides full power augmentation, enough to give a strength of 10 and move at up to 30 meters per turn (18kph). Unlike ABD-10 units, the ABD-11 is equipped with a small contra-grav "jump pack" with 1 ton of thrust, capable of accelerating at about 2g, with a top atmospheric speed of around 90 meters per turn (54kph). The grav unit cannot be tuned down to less than a ton of thrust, so fine maneuvering, hovering and indoor use are all but impossible for early models of this unit. The user is specially trained in using short on/off pulses to land safely, which is an Average task, failure indicating a graceless but usually harmless tumble to the ground. Later models incorporate a dedicated computer for managing the thrust, allowing a stable hover and controlled ascent and descent modes. The high density batteries (.1Mw/hr) have enough power to last for 6 hours at full load, or perhaps several days in a resting state using only life support and limited sensors. ABD-11 units have life support, satellite navigation systems, inertial navigation systems, subregional military-grade communicators, subregional passive optical sensors and an overall rigid armor of 7 (crystaliron/superdense). Normal weapon load would be some combination of TL10-11 weapons, with a waterknife-10 and HEAP-loaded assault shotgun-10 for space combat, grenades and an ACR-11 for assaults on lightly armored positions, with a LAAW-11 or two carried in case heavier armor is encountered.

Note: On both the ABD-10 and ABD-11 units the batteries are most of the mass and internal volume, up to 1/3rd the total volume under armor. This means they are inserted anywhere they will fit and it would be difficult to knock out the power supply as it is so widely distributed. It also makes Milieu 0 ABD-10 and ABD-11 units almost impossible to retrofit with Fusion+ units, as there really is no single space large enough to fit one. The only way to do it would be as a "backpack", making it impossible to sit in normal vehicle seats. Second-line vehicle units may be equipped with normal ABD-11 units, which are kept "topped off" by vehicle power, but surplus ABD-10 units will be sold in bulk, for discounted prices, usually for export use only.

If you design your own augmented armor using *Central Supply Catalog*, the reason we chose batteries instead of the more powerful fuel cells is the huge volume that would be taken up by the fuel (fuel cells use liquid hydrogen fuel, which has x20 fuel volume). Volume is more at a premium in armor than mass, so we chose the next best technology for quiet, all environment operation.



Mass  
360kg

Volume  
.3 cubic meters

Cost  
KCr31

Name	Dam. Rating	TL	Range	Shots	Mass	Reloads	Cost
ACR-11	5	11	Medium	100	4.3kg	.6kg	Cr1050
Crossbow-11	4	11	Medium	1	3.8kg	.1kg	Cr550
Pistol-11	3	11	V.Short	20	1.1kg	.2kg	Cr500
Pistol, Target-11	3	11	Short	20	1.5kg	.2kg	Cr2100
Rifle-11	5	11	Medium	50	4.9kg	.6kg	Cr970
Snub Gun-11	5	11	V.Short	10/20	.6kg	.1kg	Cr610
Snub Gun, Pocket-11	5	11	Contact	3	.2kg	-	Cr210
Snub SMG-11	5	11	Short	60	1.6kg	.3kg	Cr960
Staple Gun-11	2	11	V.Short	25	.9kg	.1kg	Cr550
Stay-Put-11	special	11	Contact	5	2.0kg	1.5kg	Cr400
Thud Gun-11	1	11	V.Short	10	.7kg	.1kg	Cr580
Thud Gun, Pocket-11	1	11	Contact	2	.3kg	-	Cr160
LAAW-11	29 (17 expl.)	11	Short	1	13.0kg	11.5kg	Cr4600
Mine, AP-11	5 (3 expl.)	11	-	1	.1kg	-	Cr25
Mine, AT-11	34 (22 expl.)	11	Contact	1	5.0kg	-	Cr550
PD Laser, RF-11	5	11	Medium	-	13.3kg	-	Cr7000

# TECH LEVEL 12

Average Imperial era. Non-imperial cultures will have incremental advances over TL11, while Third Imperium cultures will have access to Fusion+, and will likely use this development for portable energy weapons and increased mobility through use of small contragrav vehicles. These two developments make man-portable intercontinental missiles possible, and most Third Imperium heavy vehicles and installations are known to use point defense lasers or other point defense weapons to protect against such threats. The first plasma cannon and single-person laser weapons become available during this period. Concurrently, magnetic vehicle shielding is developed as a partial counter to plasma weapons.

**Referee note:** The Imperial weapon designation system becomes standard early in the Milieu 0 period, and lasts for approximately a thousand years before being phased out by a future Emperor.

## Common Weapons

### ACR-12

While there are no announced plans to replace the cR898 battle rifle and variants, continued material advances will soon make it possible to make the basic weapon lighter, allowing for more advanced concepts to be integrated into it. Critics complain that the increasing cost of weapons will eventually make it possible for an army to be defeated just by breaking so many of its weapons that they can't afford to replace them, but defenders argue that the increase in combat effectiveness is worth the cost, and do the critics want the task of explaining to bereaved families why troops weren't equipped with the best tools available to do their job?

The ACR described below is taken from the "Force 1100" White File, which attempts to predict what the Third Imperium will need to maintain its current rate of expansion in the next century. It is similar to the cR898 in basic capabilities, but is somewhat lighter, and includes a fully integrated EMF/HUD/thermal conversion scope.

While not politically correct, it recognizes the tendency of current troops to use advanced sights in combination with ICOM and TFAC units to fire over obstacles and around corners without exposing themselves. The weapon is short, blocky and is fired from high on the shoulder, with the barrel about even with the top of the average helmet. The soldier can use just the HUD for moving fire, or use aimed fire over obstacles at no penalty without exposing anything but the weapon. How many of these concepts are eventually adopted is anyone's guess, but it does provide goals that need to be met and addresses the reality of modern combat situations.

The basic ACR-12 is 3.0kg loaded and has a cost of Cr710. All the remainder of the mass and cost is the electronics on and in the weapon. The ACR-12 has single shot, burst fire and normal autofire modes, and the HUD provides a DM+3 on aimed fire to offset evading targets.

Damage	TL	Range	Shots	Mass	Reloads	Cost
5	12	Medium	100	4.1kg	.5kg	Cr2900

### Grenade-12

Aside from minor improvements in fusing technology, the grenade has really changed little since the early days of the Second Imperium. Modern body armor is capable of reducing the lethality of fragments at all but the closest ranges, but until sealed system armor becomes standard equipment, the blast effects will continue to be the major source of casualties. The only new design to surface in recent years has been the **Adjustable Range Munition** or ARM grenade. In addition to the normal impact and 3.5 second delay settings, it has a rotary positive detonate switch calibrated for range. When activated, an accelerometer and timer gauge when the desired distance has been reached and detonate the grenade. The manufacturer claims redundant safety measures to prevent premature or false detonation conditions such as bounces off intermediate objects. Numerous tactical uses are suggested, but to date no Imperium or

Imperium-affiliated force is using them. Small quantities are known to be exported, presumably enough to keep the manufacturer in business. No field reports are available as to its effectiveness.

Most Imperium forces use the Grenade-10, and little improvement in the basic concept is expected except perhaps a moderate increase in fragment lethality. The ARM grenade has a certain flexibility, but also a number of possible drawbacks on an electronically noisy battlefield. One good side effect of an ARM-fused grenade is that it doesn't go off if you drop it after arming, as it knows it hasn't gone far enough yet. On the other hand, they have been used as booby traps by "pulling the pin", arming the grenade for 10 meters distance and then carefully making the grenade look like it hasn't been armed. It then sits and waits for someone to pick it up, stick it on their belt and then walk 10 meters...

Damage	TL	Range	Shots	Mass	Reloads	Cost
8 fragment	12	Contact	1	.2kg	-	Cr50

## Machinegun, RF Gauss-12

This support weapon was designed especially for augmented battle dress units and has undergone several variations before the final gR057c and gR2057c units were accepted. The gR057c unit is designed for battle dress use, and while completely compatible with the gR2057c it does not include the tripod or pintle mount attachments. The gR2057 is a two-man support weapon, one man carrying the battery and weapon, with the second carrying the accumulator banks and ammunition.

The RF gauss MG-12 holds enough on-board energy storage for 100 shots. This is constantly replenished by a battery pack (.02Mw/hr to recharge) that replenishes this storage at the rate of twenty shots per turn up to the full weapon load of 500 shots. For vehicle use, the battery can be left behind, which saves 28kg of mass but requires a power plant output of .50Mw to recharge twenty shots per turn. In game terms it is not a coincidence that this weapon is barely able to penetrate TL12 augmented battle dress. Imperium planners don't make it unless they can also break it.

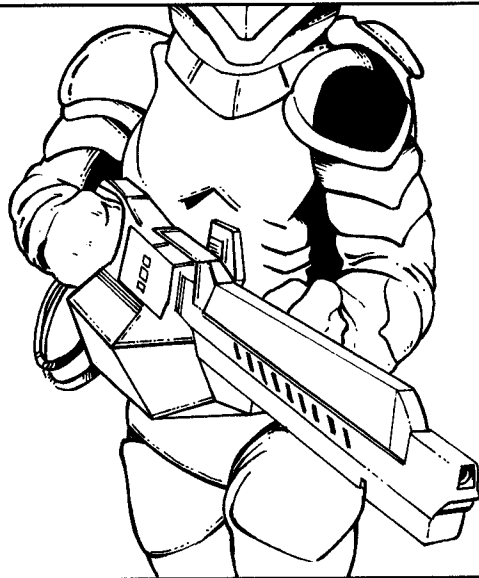

Damage	TL	Range	Shots	Mass	Reloads	Cost
--------	----	-------	-------	------	---------	------

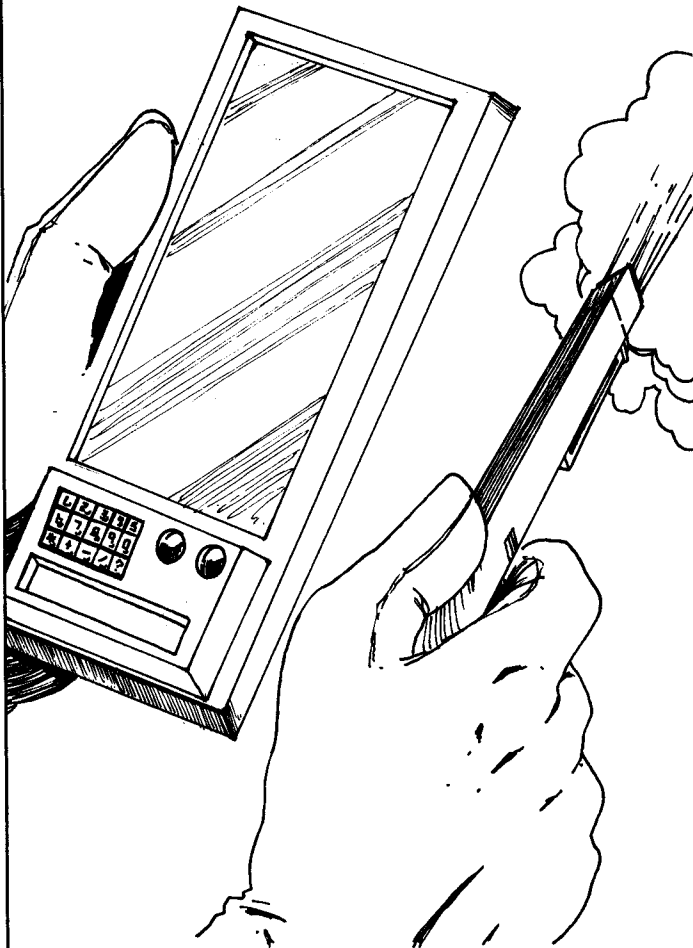

## Pistol, Body-12

An extremely concealable backup weapon, usually disguised as an innocuous device. To visual inspection, it is what it appears to be, and functions normally, like a Comm unit, writing stylus, belt buckle or other routinely worn or carried device. It also appears as this to any portal scanner or routine sensor scan made by equipment of its own tech level or less. However, by a simple physical manipulation it will fire a small number of very high velocity projectiles, capable of incapacitating or killing an unarmored individual. The steps needed to activate the weapon are unlikely to happen either accidentally or in routine use of the item. While well known to the general public through entertainment dramas, body pistols are almost universally illegal to own, and are normally only available to well connected criminals or intelligence operatives. The examples listed are representative of those confiscated from illegal users and generally have some minor flaw which allowed detection under special circumstances. Imperial Intelligence denies the use or deployment of these weapons, so no statistics are available for these "non-existent" weapons.

In general, a properly disguised device does not trigger portal sensors of less than their tech level. At the start of the Third Imperium (Milieu 0), most sensitive military facilities are using TL12-13 sensors, while important civilian facilities and off-world transit hubs are TL11-12 and run of the mill places like government offices, on-world transit hubs and the like are TL10-11.

Acquiring a body pistol through illegal channels would be some combination of Bribery, Broker, Streetwise, Carousing and Investigation tasks, depending on how the character goes about it, and the difficulty of the task is based on the penalties for owning, selling or manufacturing illegal weapons. Making one would require having the proper tools and materials, plus Difficult Electronics, Armory and Intrusion tasks. Failure means the design may work, but is detectable. It can be retried with a DM+1 on the failed skill when a new example is made. Normally, one would also want actual examples of the sensors to be evaded. With these, the character gets to see their rolls and know if they succeeded. Without them, the GM makes the rolls in secret.

Damage	TL	Range	Shots	Mass	Reloads	Cost
2	12	Contact	1	.1kg	-	Cr540
2	12	Contact	5	.2kg	-	Cr1100

## Pistol, Laser-12

The first practical laser pistols in the Third Imperium are entirely civilian developments. The high damage available is offset by the extraordinarily high cost and bulk of the weapon, and lighter models do not have sufficient advantage to replace sidearms in their already limited military role. So far no branch of the Sylean armed forces has shown interest in adopting the existing laser pistol designs, but individual security agencies are known to have purchased small quantities for evaluation and possible use, and sales to individuals are sufficient to keep several small companies in business.

Remember that while lasers may have a high penetration, they do not do much trauma through armor. If the damage rating is exactly equal to armor, the target will take 1 point of damage from minor burns, but otherwise there is no damage from non-penetrating hits on any type of armor. The heavy laser pistol-12 mounts a heads-up display which provides target lock-on and predictive software for a DM+2 on most shots. Both models described use a length of superconducting cable hooked to a belt-mounted power supply which can be recharged from most vehicle or household power sources.

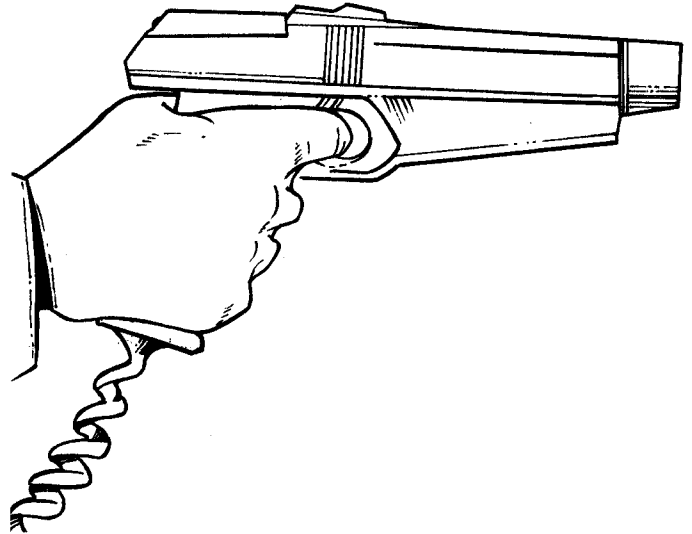

	Damage	TL	Range	Shots	Mass	Reloads	Cost
Hvy Laser-12	5	12	Short	30	2.9kg	1.3kg	Cr7500
Lt Laser-12	4	12	Short	30	2.0kg	.7kg	Cr2000

## Rifle, Gauss Sniper-12

Recent political considerations within the Imperium have led to this weapon technically being called an "anti-material" rifle, with a stated use of destroying soft targets like sensor arrays and light vehicles at long range. In fact, this is the taught tactical doctrine, but it is not publicly mentioned that among the "anti-material" capabilities taught are also "anti-helmet" and "anti-body armor" strategies. That aside, the weapon serves the same role as in the past, a limited issue extremely accurate weapon for use by highly trained individuals. The Imperium model is the recently adopted gR034, which is usually equipped with a variable power thermal imaging sight with integral optical processors and automatic ballistic compensation based on range, humidity and temperature.

When equipped with its targeting scope, the gauss sniper rifle-12 gets a DM+3 to all aimed fire within its

useful range, as well as the ability to operate at night with no penalty. The targeting scope by itself is 1.5kg and Cr2500 and while designed expressly for this weapon, its software can be adjusted for most other Imperium-standard small arms. A character with Stealth 0+, Recon 0+ and Gun Combat (Rifle) 3+ who gets a weapon as a mustering out benefit can choose this weapon if they are a military sniper or commando. The rifle is technically still Imperium property, but practice, repair and resupply expenses are free at any Imperium facility with the tools to manufacture the ammunition or parts. Actual specifications for manufacture of the gauss projectiles and spare parts is password encoded into the rifle's onboard computer and can be downloaded to any portable manufacturing unit once the unique authorization code for that weapon is entered.

Damage	TL	Range	Shots	Mass	Reloads	Cost
8	12	Long	10	10.4kg	2.1kg	KCr31.3

## Plasma Cannon, Light-12

Vehicular mounts are more satisfactory platforms for plasma cannon, and two models are currently under consideration for the role. The first is a lighter model intended for defensive armament on armored personnel carriers or combat engineer vehicles. It is compact, with an excellent punch for its size, but like all plasma weapons developed to date, has severe shortcomings in recharge time, making it unsuited for protracted engagements. It is still expected to be adopted and tactical doctrine adjusted, if only because its reliance on energy instead of munitions makes interstellar logistics much simpler.

It takes .35Mw/hr of battery storage to recharge the 10 on-board storage banks, or a power plant capable of providing 210Mw for a turn or a lesser amount for a greater period of time. The compact accelerator is a squat affair only a few meters long, and due to the backblast side effects, is never mounted on any vehicle without full armor and environment sealing. Treat the weapon as creating a damage rating 4 explosion everywhere along the path of the shot and this somewhat limits its use where collateral damage is unacceptable.

Damage	TL	Range	Shots	Mass	Reloads	Cost
44 (11 expl.)	12	E.Long	10	1360kg	-	KCr500

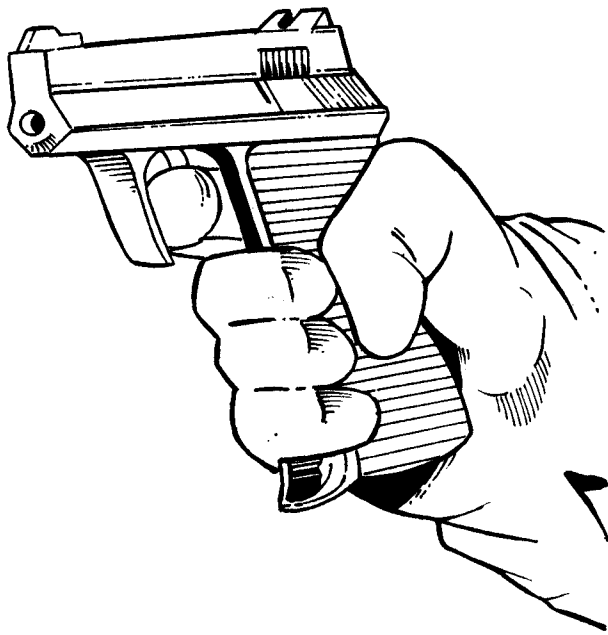

### Spurt Gun-12

This is an illegal and disturbing weapon that has been seen on some parts of Sylea and is known to have been exported elsewhere. It is a very small disposable autofire pistol, firing ceramic beads through a superdense-lined barrel. Recovered units show that once triggered, the weapon automatically cycles through a tightly coiled 200 round microbelt of ammunition, becoming red-hot in the process. While the bullets have a relatively low penetrating power and shatter on impact, the quantity fired almost guarantees collateral damage. Even though it is manufactured to very fine tolerances, it is not expected to be reliable in use. Imperial Intelligence is known to be looking into the "spurt gun menace" but will not comment to the media on any details of their investigation.

The spurt gun-12 is a very small VRF pistol. As described above, once you pull the trigger, that's it. It fires its entire clip in one turn with the full DM+4. Aside from leaving incriminating DNA and fingerprints, anyone not wearing gloves when they fire it will take 1 point of lethal burn damage to their hand and probably another if they don't drop it immediately after firing. Spurt guns are unreliable weapons at best, and adverse conditions will make them more so. Any spectacular failure usually results in weapon disintegration like a 2 point fragmentation attack.

Damage	TL	Range	Shots	Mass	Reloads	Cost
2	12	Contact	200	.2kg	—	Cr2000

### Plasma Cannon, Medium-12

The second model under consideration is intended as main armament for grav tanks, near-space interceptors and other front-line vehicles. It has about triple the delivered energy of the light plasma cannon-12 and greater accuracy, but no means of fast recharging is practical. While its short term rate of fire is excellent, most vehicles mounting it require several minutes of inactivity or heavy battery reserves to fully recharge the weapon's internal storage.

The medium plasma cannon-12 requires 1.05Mw/hr of battery storage to recharge its 10 internal storage banks, or a power plant capable of providing 625Mw for a turn or a lesser amount for a greater period of time. It is approximately 4 meters long, and looks like a scaled-up version of the light plasma cannon, a bulky central section, with a thick barrel about 3 meters long that contains electrostatic accelerators, electron strippers, superconducting coils and cryogenic cooling conduits inside an armored housing. All the warnings that apply to the light plasma cannon apply to the heavy one. The muzzle flash alone is enough to kill unprotected personnel. Treat the weapon as creating a penetration 6 explosion everywhere along the path of the shot. For use against orbiting ships, this weapon has a base USP rating of 10-0-0-0.

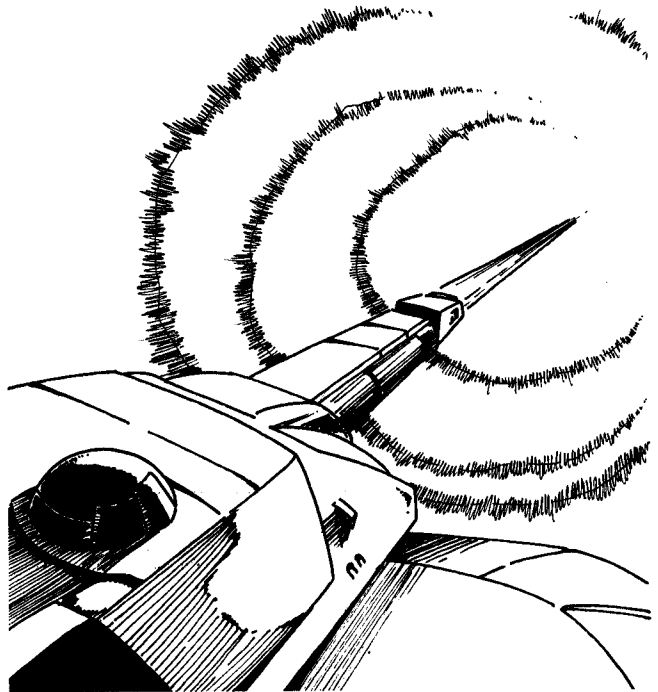

Damage	TL	Range	Shots	Mass	Reloads	Cost
50 (12 expl.)	12	Subregional	10	3900kg	—	KCr880

## Cannon, Heavy Gauss-12

While gauss cannon have been conceptually possible since Tech Level 8 levels, gauss weapons were largely seen by the military as experimental, fragile, and even "toys". Not until the reliability of gauss weapons in other applications (notably VRF machineguns) was proven were they considered for main armament roles. The heavy gauss below is representative of the species. A very long barrel, autoloading, extremely accurate high velocity cannon, firing long rod 20mm superdense-tipped penetrators at over 4 kilometers per second. Combined with a state-of-the-art fire control computer, the gun is capable of engaging most types of targets with a high probability to hit. The significant mass savings in projectiles is somewhat offset by the enormous power requirements of the weapon, but the introduction of newer, high capacity batteries and compact Fusion-units means that even light vehicles would be able to use such a weapon in a limited role. However, it is expected that most military forces would adopt plasma cannon technology for heavy weapons if it is available, as plasma weapons have a greater destructive potential.

The heavy gauss cannon-12 is actually an autocannon and can fire 5 rounds as a burst fire action at vehicular targets. It stores enough on-board energy to fire 5 shots, and each clip contains only 20 of the long rod penetrators. Depending on vehicle configuration, this is either done automatically or by a crew member. The gauss cannon-12 is over 9 meters long, which places some restrictions on vehicle shape to carry it. Normally it is spine-mounted in aircraft or in an elliptical turret with a few meters sticking out the back, part of the weapon (including the reloading station) in the turret and approximately 5 meters of weapon sticking out the front. Recharging the internal energy banks requires .18Mw/hr of battery capacity or 105Mw of power plant output for a turn, or some lesser power plant output for a greater period of time. This weapon has sufficient range to target ships in low orbit and has a base USP rating of 3-0-0-0.

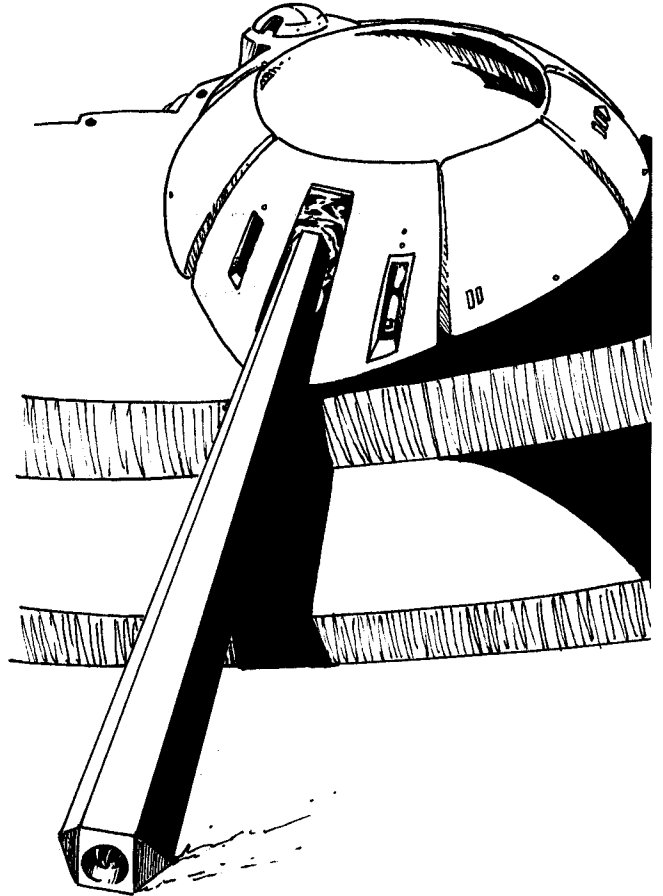

Damage	TL	Range	Shots	Mass	Reloads	Cost
27	12	Subregional	5	1400kg	32kg	MCr3.58



## Rifle, Laser-12

Like the laser pistols, current laser rifles are civilian developments. A representative model comprises a 75cm rifle assembly attached by superconducting cable to a heavy power supply harness/belt, and equipped with a variable power filtered telescopic sight and optical processors for easier target acquisition in most conditions. Few have expressed interest in these weapons except for experimental and evaluation purposes, though one company makes a "traditional" design that has found some favor among some well-heeled hunters. This model looks much like a standard rifle, and aside from anti-laser coatings on its simple telescopic sight, it has no extra enhancements.

The laser rifle-12 gets a DM+2 on most aimed fire due to its electronically enhanced sights, in addition to the normal bonus for telescopic sights. The laser hunting rifle gets only the normal telescopic sight bonus to aimed fire.

	Damage	TL	Range	Shots	Mass	Reloads	Cost
	7	12	Long	50	15.6kg	7.8kg	KCr10.4
Hunting Lsr-12	6	12	Long	5	3.9kg	.5kg	Cr7500
RF Gauss-12	9	12	Long	500	68kg	58kg	Cr9100

## PCMP-12

**Plasma Cannon, Man Portable.** Uses the Imperial designation FS1055, but common military slang is to use the Second Imperium abbreviation style. Exact details are unavailable from the manufacturer for security reasons, but unclassified historical records and photographs of the units allow reasonable estimates of the technology involved. The PCMP-12 is a two-piece unit, with the power supply separated from the weapon itself by an approximately 1m length of high density superconductor cable. High energy storage banks, presumably recharged by a Fusion+ unit, use electrical resistance to create a super-hot plasma. This is fed into the weapon and stored for several milliseconds within a metastable magnetic containment field. This field and the plasma within is then accelerated much like a railgun projectile. When it strikes an object, the field dissipates and the velocity-based kinetic energy of the few grams of plasma combines with its extremely high temperature to blast a hole in the target, and incidentally spray super-hot plasma and fragments of the target in all directions. Current technologies allow for an energy density sufficient to realize near-fusion temperatures. Expected side effects of the weapon are extreme recoil force, secondary radiation and flash burns from millisecond exposure to the plasma on launch, and possible environmental contamination. While the PCMP-12 is not expected to supplant all man-portable anti-vehicle weapons, it is being seriously considered for urban warfare and portable AA applications.

The PCMP-12 is a fearsome weapon to fire. Anyone without electronic flash compensation or heavily tinted lenses will be temporarily blinded (D6 hours) on failing an average Endurance task. Flash burns will do one point of physical damage if there are any exposed body areas. It will also ignite flammable clothing, and melt synthetic clothing. Recoil taken against anything except rigid armor will break the firer's shoulder (D6 wounds), and recoil taken by anyone without a computer-linked contra-grav harness will knock them over. This said, it is still an extremely effective can-opener, and would certainly be an option for augmented battle dress units, and possibly for tripod use by a three-man unit of normal battle dress. Usually the weapon will be fired in combination with a heads up display or TFAC link to other sensors for a +DM to hit. If this weapon were mounted in a vehicle with fusion or Fusion+ power, much of the reload mass would be unnecessary. Recharging the power pack takes .004Mw/hr of battery storage or about 2.7Mw of power plant output for a turn. The mass of the PCMP-12 does not include any sighting aids, and is expected to be integrated into the sensors of an augmented armor system.

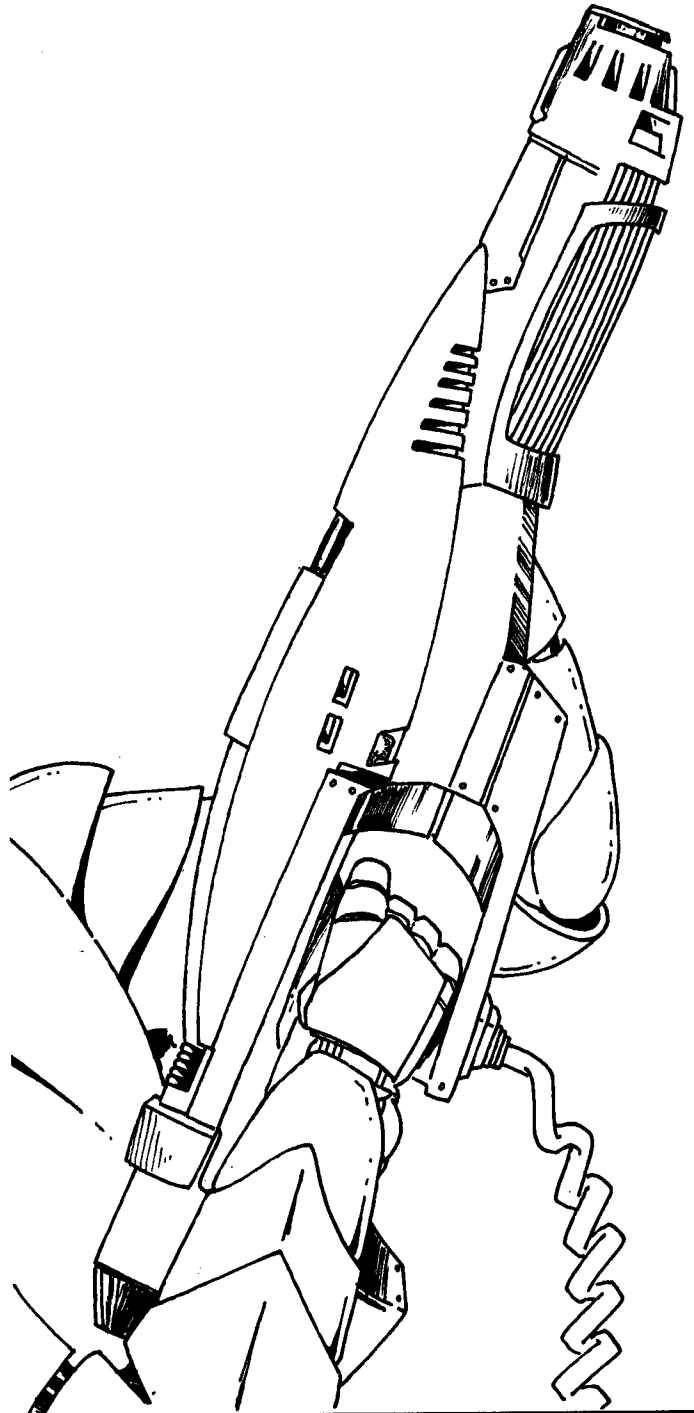

Damage	TL	Range	Shots	Mass	Reloads	Cost
19 (4 expl.)	12	Medium	20	28.9kg	16.6kg	KCr24.5

## Point Defense Laser, VRF-12

Exact details are unavailable for security reasons, but the VRF point defense laser-12 is simply expected to be a more compact version of the RF point defense laser-11, taking advantage of recent superconductor developments. Combined with rumored fire control improvements it should allow virtually any vehicle a reliable anti-missile capability. Heavy vehicles will likely use it as tertiary anti-personnel armament in relatively missile-free environments.

The mass of the VRF PD laser-12 includes internal energy storage for one burst of VRF fire or two bursts of RF fire. To use the weapon constantly requires .003Mw/hr of battery storage per turn or a power plant with a surplus output of 1.8Mw. Note that this is not the same system as described in *Central Supply Catalog*, which was meant for augmented armor use, but is a heavier vehicle-mounted version.

Damage	TL	Range	Shots	Mass	Reloads	Cost
5	12	Medium		16.8kg		Cr7000

## Battle Dress, Augmented-12

While exact specifications on current augmented armor are unavailable for security reasons, analysis of the projected missions and defense needs allows some reasonable assumptions to be made. Augmented armor is expected to be resistant to almost all infantry threats and most light support weapons, while being able to engage and neutralize any normal infantry, battle dress or light vehicle targets. While vulnerable to heavy weapons, tactics and deployment by the elite augmented armor units are designed to minimize this threat.

ABD-12 units have an overall rigid armor of 8, full sealing and life support. They are equipped with a DM+3 fire control system for both the carried weapon and their RF point defense laser array (damage rating 3, .0002Mw/hr power per turn used). Power is provided by a small Fusion+ unit providing up to .05Mw for up to 200 hours of operation, and a rapid discharge battery that holds .02Mw/hr of power for weapons and backup purposes. When not firing weapons, maximum load on the power plant is about 90%, which includes movement, life support, use of computer and fire control systems (DM+3), subcontinental range radio, subregional range radar and optical sensors, inertial and satellite nav systems, and the Tactical Force Analysis Computer-12 (TFAC-12). The user has an effective Strength of 14, can run at up to 68m per turn (41kph) or use a contragrav unit to fly up to 78m per turn (48kph). All suit systems can be integrated with Imperium-standard hardware and software. Normal weapon load would be a support weapon like a PCMP-12 or RF gauss MG-12, plus grenades, remote sensors and other mission-specific hardware.

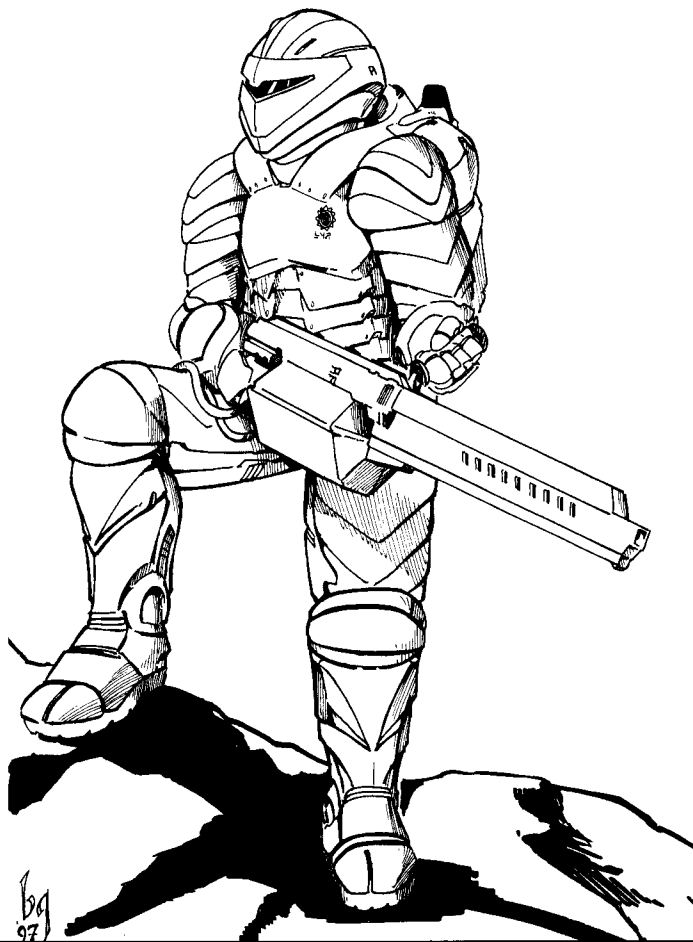

Mass  
455kg

Volume  
.3 cubic meters

Cost  
KCr257

Name	Dam. Rating	TL	Range	Shots	Mass	Reloads	Cost
ACR-12	5	12	Medium	100	4.1kg	.5kg	Cr2900
Grenade-12	8 fragment	12	Contact	1	.2kg	-	Cr50
Pistol, Body-12	2	12	Contact	1	.1kg	-	Cr540
Pistol, Body-12	2	12	Contact	5	.2kg	-	Cr1100
Pistol, Hvy Laser-12	5	12	Short	30	2.9kg	1.3kg	Cr7500
Pistol, Lt Laser-12	4	12	Short	30	2.0kg	.7kg	Cr2000
Rifle, Gauss Snpr-12	8	12	Long	10	10.4kg	2.1kg	KCr31.3
Rifle, Hunting Lsr-12	6	12	Long	5	3.9kg	.5kg	Cr7500
Rifle, Laser-12	7	12	Long	50	15.6kg	7.8kg	KCr10.4
Rifle, RF Gauss-12	9	12	Long	500	68kg	58kg	Cr9100
Spurt Gun-12	2	12	Contact	200	.2kg	-	Cr2000
Cannon, Hvy Gauss-12	27	12	Subregional	5	1400kg	32kg	MCr3.58
PCMP-12	19 (4 expl.)	12	Medium	20	28.9kg	16.6kg	KCr24.5
Plasma Cannon, Lt-12	44 (11 expl.)	12	E.Long	10	1360kg	-	KCr500
Plasma Cannon, Md-12	50 (12 expl.)	12	Subregional	10	3900kg	-	KCr880
PD Laser, VRF-12	5	12	Medium	-	16.8kg	-	Cr7000



# AMMUNITION COSTS

Ammunition is usually listed and sold in 50 round quantities. The mass for one round is generally  $((\text{Damage Rating} + 1)/(13 - \text{Damage Rating}-8))^4$  kilograms with a base minimum of  $(\text{Damage rating}/200)$ kg per round.

Because we don't actually expect you to figure this out every time, see the following table. Figures are rounded to the nearest 2 digits or .1kg:

Dam. Rate	Mass (50 rd.)	Dam. Rate	Mass (10 rd.)	Dam. Rate	Mass (1 rd.)
1	.3kg	9	4.8kg	17	26kg
2	.5kg	10	10kg	18	32kg
3	.8kg	11	21kg	19	39kg
4	1.0kg	12	44kg	20	47kg
5	1.3kg	13	94kg	21	57kg
6	2.4kg	14	124kg	22	68kg
7	5.3kg	15	160kg	23	81kg
8	11kg	16	200kg	24	95kg

## Modifiers

APDS Ammunition: x.5 mass; TL9+ Ammunition (Caseless): x.5 mass; Rockets: x1 mass (do not use caseless modifier on rockets); HE Ammunition: x.5 mass; HEAP or HEDP Ammunition: x.25 mass (use only one of HEAP or HE); Multiple Proj. (Shotgun): x2 mass; Guided Weapon: x2 mass.

Example: Lets say you want 50 rounds of TL12 APDS ammunition with a damage rating of 5. The base mass is 1.3kg, times .5 for APDS, and times .5 again for TL9+ ammunition, for a total of .325kg, rounding to .3kg.

Example: You need to know how much each HEAP reload for a damage rating 27 TL8 cannon is. This is off the table so you have to figure it out. The base mass is 150kg, times .25 for HEAP ammunition is 37.5kg, rounding to 38kg.

Now, these don't exactly match the figures given for reloads for each weapon in *Emperor's Arsenal* or *Central Supply Catalog* but are close enough for most purposes. For most applications, just use the mass of a listed weapon reload, since when you are on the move, what you can transport is the important part. On the other hand, if you are buying in bulk and want to ship or store the stuff in a limited amount of volume, use the figures from this table. Bulk ammunition has a mass of 3 metric tons per cubic meter for shipping purposes.

**Cost:** Now this is more near and dear to most character's credit accounts. The basic cost per round for most ammunition is  $((\text{Damage Rating} + 2)/10)^3$  Cr per round. As for mass, you don't have to figure this out:

Dam. Rate	Cost (50 rd.)	Dam. Rate	Cost (10 rd.)	Dam. Rate	Cost (1 rd.)
1	Cr1.4	9	Cr13	17	Cr6.9
2	Cr3.2	10	Cr17	18	Cr8.0
3	Cr6.3	11	Cr22	19	Cr9.3
4	Cr11	12	Cr27	20	Cr11
5	Cr17	13	Cr34	21	Cr12
6	Cr26	14	Cr41	22	Cr14
7	Cr36	15	Cr49	23	Cr16
8	Cr50	16	Cr58	24	Cr18

## Modifiers

Previous TL Surplus Ammo: x.25 cost (but makes weapon automatically unreliable); APDS Ammunition, TL8-: x6 cost; APDS Ammunition, TL9+: x3 cost; TL9+ Ammunition (case-

less): x2 cost; Rockets: x4 cost (do not use caseless modifier on rockets); HE Ammunition: x3 cost; HEAP or HEDP Ammunition: x5 cost (use only one of HE or HEAP); Multiple Proj. (Shotgun): x2 cost; Guided Weapon: x4 cost per DM+1, minimum base cost of Cr5; Proximity Fused Only: x2 cost or +Cr5, whichever is more; Buying in lots of 1000+: x.8 cost; Buying in lots of 10000+: x.6 cost; Availability/Legality: x what the market will bear.

Example: You need some APDS reloads for a TL8 damage rating 21 cannon. The base cost is Cr21, times 6 for APDS ammunition is Cr126 each.

Example: You need reloads for a TL7 damage rating 19 shoulder fired HEAP rocket launcher. The base cost is Cr9.3, times 4 for a rocket, times 5 for HEAP is Cr186 each.

Example: You have a TL13 cannon firing caseless guided HEAP rounds with a DM+3 and a damage rating of 28. The base cost is Cr27, times 2 for caseless ammunition, times 5 for HEAP, times 4 three times for the guided bonus is Cr17,280 per shot. Make them count...

As with most goods, manufacturing and sale cost will vary with the local political climate. If APDS is the normal type of ammunition used, competition will drive the price down. If it is brand new and there are limited manufacturing facilities, the price will be higher. Availability of ammunition depends on three levels: Tech level, law level and population level. The base 2D roll for *easy* availability at a *major* population center is the planetary population level+2, levels A and above needing a roll of 12-. Each tech level the ammunition is higher than the planetary tech level is a DM-3 to this roll, and each tech level lower is a DM-1. If there is a source, but the law level is past the "legal to own on planetary surface" level for the weapon firing this ammunition, it requires a Difficult (2.5D) Streetwise task to find said source, with a DM-2 for each law level the weapon is illegal by. A spectacular failure means you get in trouble of some kind. This could be immediate, like being present during a police raid or having the supplier think you are an informant or spy, or delayed, like buying from a sting operation, where the character will be busted at some later date for the recorded and witnessed illegal transaction.

Example: Characters touch down on a TL10 world with a population level of 9 and a law level of 4. Wisely, they leave their heavy weapons on the ship, but someone decides they need extra ammunition for a TL11 vehicle autocannon. The 2D availability roll is 8- because of the DM-3 for tech level difference. If there is some to be found here, it is a Difficult Streetwise roll with a DM-2 for the illegal nature of the ammunition to get an appointment with someone who can provide it. The haggling over the price is left to the GM and player to work out.

# TECH LEVEL 13

Pre-Third Imperium technology. Few Second Imperium weapons from this period survive, and the requisite infrastructure and investment to redevelop this level of technology is not anticipated in the foreseeable future. However, records have been retained on what material was available at the time. These consist mainly of increased power storage for portable energy weapons, and related to this, introduction of smaller energy-based weapons like gauss rifles and gauss pistols. Conventional weapon technologies generally fall into disfavor and are either discontinued or stagnate at TL12 levels, with the exception of sighting aids which continue to either decrease in size or increase in capability. All heavy energy weapons are in larger installations than would be expected, since the previous minimum fusion plant size was markedly larger during the Second Imperium. Increased jump capability opens trade and strategic starlanes that were effectively impassable with earlier jump drives. It is worth noting that extremely few examples of tech level 13+ weapon technology remain in existence, either in working or non-functional condition, and many descriptions are based on archaeological finds and historical accounts, some of which may have been written and heavily slanted by the weapon manufacturer. Most period pieces are of Vilani origin, simply because of the much greater quantity originally available.

## Known Weapons

### ACR, Gauss-13

While gauss weapons were superseded almost immediately in the heavy weapon role, they continued to be useful in the small arms role. Until the X-ray laser technologies become available, it is likely that gauss rifles will supplant conventional weapons because of their ability to penetrate obscuring cover and atmospheric particulates. The gauss ACR-13 fires the same 3mm projectiles as the gauss pistol, but with significantly higher velocity. The weapon can integrate a number of advanced sighting aids, but is normally only equipped with a small telescopic sight and predictive HUD.

The gauss ACR-13 is capable of using the single shot, burst fire, autofire and RF autofire modes. The HUD provides a DM+2 vs. applicable targets. The clips are reloadable and can be recharged from most household or vehicle sources. The projectiles for the gauss ACR-13 and gauss pistol-13 are interchangeable, but the clips are not. Loose gauss needles for these two weapons mass about .25kg per hundred, the rest of the clip mass being energy storage. The gauss ACR-13 clip holds about .00025Mw/hr of energy, for reference.

Damage	TL	Range	Shots	Mass	Reloads	Cost
6	13	Medium	100	5.5kg	3.0kg	Cr6700

### ACR, Laser-13

Second Imperium laser rifles followed the same development curve as pistols. Unlike the pistols, the rifles had a detachable magazine, but included a spring-loaded cable spool almost identical to the Vilani model. Unlike the Vilani weapons, Second Imperium laser rifles were designed exclusively for vacuum use and did not make use of frequency agile lasers, sacrificing flexibility for penetrating power. No definite records remain on exactly what sighting aids were used, but they were probably optimized for long range vacuum use.

The laser ACR-13 is capable of single shot and burst fire modes, and like all laser weapons has no recoil to throw off aim on consecutive shots or unbalance a character in freefall. The power output can be adjusted to fire either the normal number of penetration 6 shots or four times as many penetration 4 shots.

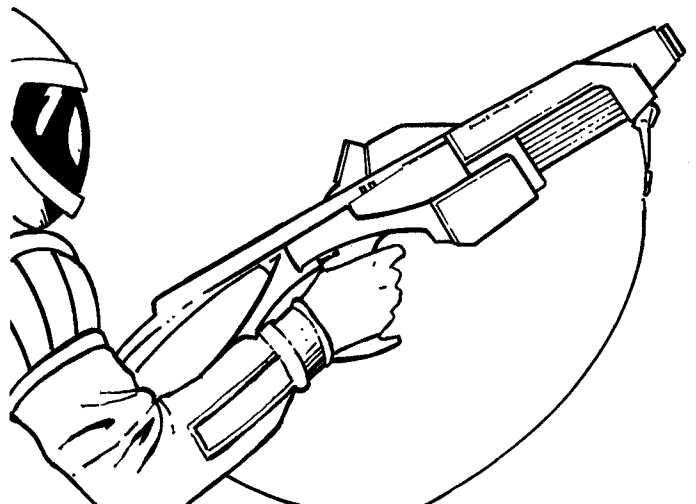

Damage	TL	Range	Shots	Mass	Reloads	Cost
6	13	Long	50	5.5kg	2.8kg	KCr11.3

## Machinegun, VRF Gauss-13

References are made to this type of weapon as a "battlefield broom", and probably for good reason. A multiple feed, multiple accelerator weapon, it was expressly designed as secondary vehicle armament and light grav vehicle armament, and probably did more than any other weapon to spur the 100% battle armor infantry doctrine proposed during the last days of the Second Imperium. The VRF gauss MG-13 is compact enough to be deployed on augmented battle dress units when integrated into the contragrav harness for recoil compensation.

The VRF gauss MG-13 fires over 500 of its 3mm nee-

dles in a turn, and can lay VRF suppressive fire over an extremely large area. It can turn plascrete buildings into confetti, shred light vehicles and strip all external fixtures from heavier ones. Crews of this weapon were very seldom taken prisoner, and most were shot "while trying to escape". Repeatedly. The VRF gauss MG-13 requires .01Mw/hr of battery storage or 7.5Mw of vehicle power per turn, and only has enough onboard power storage for a single VRF burst. It has no inherent sighting aids and is normally attached to a vehicle fire control system or vision enhancement system.

Damage	TL	Range	Shots	Mass	Reloads	Cost
8	13	Medium	10000	65kg	32kg	KCr16

## Pistol, Gauss-13

Usually referred to as a gauss pistol, but illustrations indicate that while it could be fired from one hand, it was meant to be fired from two. It used a helical storage drum slung below the barrel to store both energy and heavy alloy penetrator darts. This drum also served as the forward handgrip and had a datapath to the weapon to update a small status board on the back of the weapon. It was normally equipped with a multimode

laser sight and a minimal target-predicting HUD.

The gauss pistol-13 is capable of using the single shot, burst fire, autofire and RF autofire modes, but use of autofire or RF autofire usually requires use of both hands to avoid losing aim due to recoil (Difficult Strength task or take DM-3). The HUD provides a DM+2 vs. applicable targets. The clips are reloadable and can be recharged from most household or vehicle sources.

Damage	TL	Range	Shots	Mass	Reloads	Cost
4	13	Short	100	2.4kg	1.0kg	Cr2600

## Pistol, Laser-13

Laser sidearms and ACRs were proposed during the late Second Imperium after full analysis of Vilani weaponry from that era. Second Imperium models were not as refined as Vilani ones, but the Terran willingness to experiment with new technologies and ideas made Second Imperium weapons better in different ways. The laser pistol-13 is an example. Never issued in any significant number, they were still in the field testing stage when production stopped. To save mass, the pistol did not have a replaceable clip, but was instead either recharged by holstering it or connected to the holster by a breakaway cable. The Terran deployment was with vac suited units, who either had their own on-board power supplies or would be

connected to a vehicle power supply, so as long as the spacesuit had power, so would the weapon. Terran models also were not frequency agile, but did have a slightly better overall penetration and could be used as low power laser cutters when connected by cable to a power source.

The laser pistol-13 is capable of single shot and burst fire modes, and can be used as a laser cutter with a power consumption of about 3,000 watts from a vehicle power plant. It can make a 1 meter linear cut 1 centimeter deep per minute in soft steel. For tougher materials, adjust the time proportionately, but note that it does not have sufficient cutting power to disassociate atomically compressed matter like superdense.

Damage	TL	Range	Shots	Mass	Reloads	Cost
4	13	Short	40	1.6kg	-	Cr2150

## Snub SMG, Heavy-13

While this weapon is typically deployed in the submachinegun role, it is more accurate to call it an autofire grenade launcher. It fires oversized snub gun projectiles and was designed as an inexpensive weapon to use against starship boarding parties or heavy infantry. It has a very short range and poor accuracy, but so far is the only lightweight weapon capable of meeting this need.

The heavy snub SMG-13 looks like a plastic sawed-off semi-auto shotgun with a big clip, and that's about what it is. It fires 25mm HEAP rounds in either single shot or burst fire modes and would be a common tool for starship security personnel. Normally the HEAP rounds are kept under lock and key and for less violent disturbances gel rounds with a non-lethal damage rating of 2 are used.

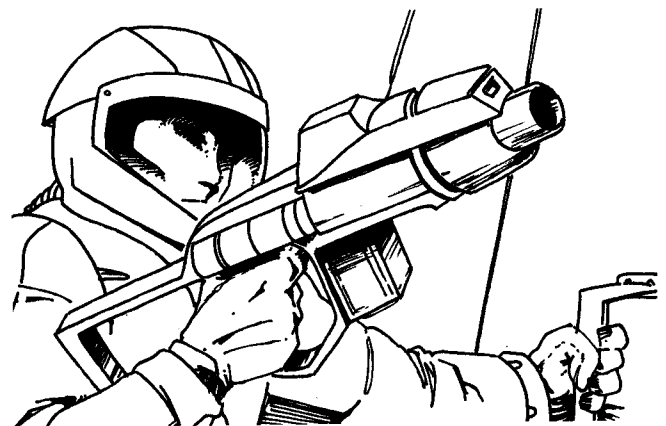

Damage	TL	Range	Shots	Mass	Reloads	Cost
9 (4 expl.)	13	V.Short	12	1.1kg	.4kg	Cr200

## Rifle, Heavy Laser-13

In addition to the lighter lasers previously mentioned, heavier models were experimented with to overcome the anti-laser coatings and heavy armor commonly worn by vacuum capable troops. Using laser rangefinders and adaptive optics for precise beam focus, it turned out to be too expensive for general use, not counting the advanced sensor package and suit integration electronics it undoubtedly was equipped with. This model had an extremely limited on board power supply, but had sufficient power to damage most personal armor enough to cause pressure leaks or system malfunctions.

The heavy laser-13 is too powerful for normal atmospheric use and has to be downpowered to a damage rating of 9 in these conditions. The weapon is capable of single shot and burst fire modes, and the small magazine is normally plugged directly to a suit or vehicle power source to avoid frequent reloading. One magazine's worth of energy takes .0004Mw/hr of battery power or vehicle output of .31Mw to recharge it in a turn. The power can be adjusted to fire either five penetration 10 shots, ten damage rating 8 shots or forty damage rating 6 shots.



Damage	TL	Range	Shots	Mass	Reloads	Cost
10	13	Long	5	10.7kg	2.0kg	KCr54.5

## Shotgun, Gauss-13

The gauss shotgun-13 was designed to fill the submachinegun role for close-in combat situations. It is a large-bore gauss weapon, firing either a large or small cluster of 3mm gauss needles with each shot or a small tactical grenade. It fires from a dual-chamber drum mounted at the back of the weapon, and the user can quickly switch from one ammunition type to the other, or carry a double load of a single projectile type. It is a heavy weapon, and records do not show its tactical effectiveness in this role, but it was usually equipped with a small predictive HUD for better "first hit" capability.

The gauss shotgun-13 has a number of ways it can be used. First, it has a DM+2 HUD unit which works in the normal fashion. A single shot can fire a cluster of 50+ darts, counting as an RF attack with a damage rating of 2. The second load is a smaller cluster of darts which counts as burst fire with a damage rating of 4, and the last is a 23mm shaped charge with a damage rating of 8 and a blast effect of 4. The dual-chamber clip can be switched from one side to the other by a grip switch, or by software command if the weapon is integrated into other systems.

Damage	TL	Range	Shots	Mass	Reloads	Cost
(special)	13	V.Short	20	7.0kg	2.9kg	Cr2300

## PCMP-13

Foreseeable improvements in the PCMP concept include reduced side effects from firing, increased magazine capacity and possibly a lighter weight, all borne out from existing records of experimental Second Imperium weapons.

The PCMP-13 has most of the side effects of the PCMP-12, but at reduced levels. Flash burns from exposure are now non-lethal damage, and recoil to other than rigid armor only does 1/2D damage. A Third Imperium model would have a minimum size Fusion+ unit and 10 hours of fuel(≈25kg) and a second person to carry it, or a Fusion+ powered grav recon vehicle. This would recharge the weapon at the rate of 1 shot per 3 turns. Or, you could use .004Mw/hr of battery storage or about 2.6Mw of power plant output for a turn. The PCMP-13 is equipped with a full-spectrum set of sensors, along with a DM+3 targeting system for aimed fire. It would be issued to both augmented and non-augmented battle dress units in limited numbers, the former saving weight by using their on-board fire control systems instead of a vulnerable external mount.

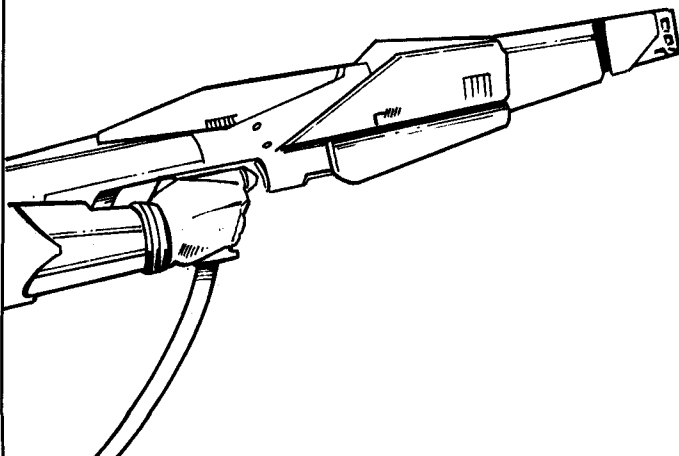

Damage	TL	Range	Shots	Mass	Reloads	Cost
21 (5 expl.)	13	Long	20	28.6kg	13.3kg	KCr45.0

### Cannon, VRF Gauss-13

Filling a role between point defense lasers and plasma cannon is the VRF gauss cannon-13. Sufficiently powerful to take down lightly armored targets at extended ranges, or in a dedicated anti-aircraft role, these are usually mounted on high power platforms able to take the recoil and supply the energy needed for extended use. They are especially common on naval vessels where fog sometimes presents a problem for laser point defense systems.

The VRF gauss cannon-13 fires 6mm steel needles at velocities of over 4 kilometers per second, at the rate of over 50 per second. It consumes .05Mw/hr of battery power per turn, or 38Mw from a power plant for continuous operation. It holds enough on-board power for one turn's use at the full VRF rate. It is normally mounted in a rapid traverse turret and connected to vehicle sensors and fire control systems.

Damage	TL	Range	Shots	Mass	Reloads	Cost
11	13	Long	10000	370kg	150kg	KCr71

### Plasma Cannon, Heavy-13

The heavy plasma cannon-13 was the main armament of the *Monitor* series of specialized SDBs. These 1.5g craft were designed for long-term underwater use rather than deep space, and had a number of passive countermeasure systems and communication links to orbital or ground-based sensor arrays. The combination of atmosphere, water and passive stealth design allowed these ships to remain undetected until hostile ships were in orbit. The Monitor would then surface, let loose a punishing barrage of plasma fire, and then submerge and run to a pre-designated subsurface hiding place. A limit-

ed role, but the ships were relatively inexpensive and could also be used in peacetime as commerce monitoring vessels.

The heavy plasma cannon-13 has sufficient range to target ships in low orbit and has a base USP rating of 16-0-0-0. It holds enough energy for one shot, consumes 3.6Mw/hr of battery power per shot, and requires power plant output of 2500Mw to fire once per turn. This is the same cannon as listed in *Central Supply Catalog*. Simply being in an outdoor square the bolt passes through is usually fatal to unprotected personnel.

Damage	TL	Range	Shots	Mass	Reloads	Cost
81 (20 expl.)	13	Subregional	1	11.4 tons	-	MCr16.2

### Plasma Cannon, Light-13

The light plasma cannon is suitable for lightly armored vehicles and is sometimes seen as a pod-mounted hard-point weapon with an integral battery and small MHD turbine or other power source. It has roughly the same performance as previous TL models, with reduced mass and power consumption. It has good penetration for its size and is capable of causing serious damage to lightly armored starships. Contemporary illustrations also show a five-tube array used as a static point defense against heavy missiles.

The light plasma cannon-13 consumes .22Mw/hr of battery power to recharge the 10 on-board storage banks, or a power plant capable of providing 133Mw for a turn or a lesser amount for a greater period of time. The plasma PD cannon-13 is basically a linked group of five of these firing a ripple burst of six shots, once per turn, consuming .11Mw/hr of battery power per shot or 67Mw from a power plant to fire one burst per turn. The plasma PD cannon does not get any rate of fire bonus but does count as an autoburst weapon for most purposes. It has sufficient range to target ships in low orbit and has a base USP rating of 8-0-0-0.

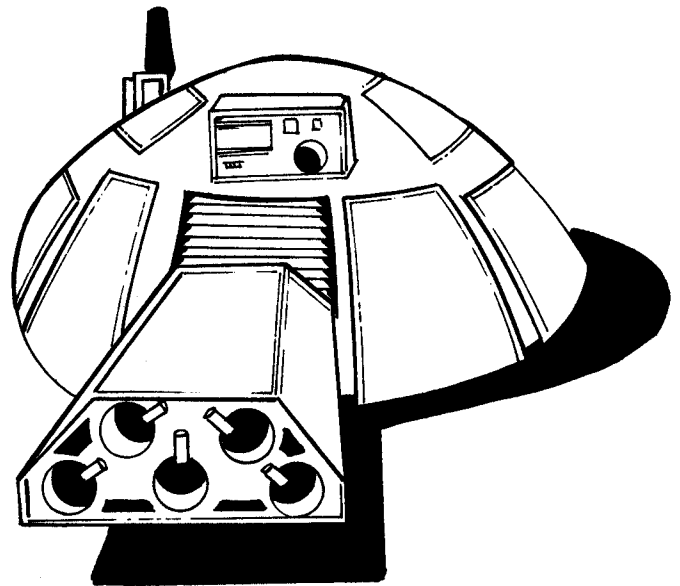

Damage	TL	Range	Shots	Mass	Reloads	Cost
44 (11 expl.)	13	E.Long	10	880kg	-	KCr550

### Plasma Cannon, Medium-13

This weapon is the typical armament of tech level 13 heavy grav armor. The heavier plasma cannons are more powerful, but consume more power than most medium vehicles can supply.

The medium plasma cannon-13 has enough on-board storage for 10 shots. It requires .86Mw/hr of battery power or a power plant capable of providing 620Mw for a turn or a lesser amount for a greater period of time. A Third Imperium TL13 heavy grav tank will typically mount one of

these, a very light plasma cannon for soft target use, and a pair of VRF point defense lasers, all running off a pair of high discharge batteries and recharged by a pair of large Fusion+ units that also power the contragrav, nuclear damper and magnetic shielding units. These vehicles don't really have to worry about running out of ammunition, but intense fighting can deplete the battery reserve and force a unit out of combat to recharge. This weapon has sufficient range to target ships in low orbit and has a USP rating of 10-0-0-0.

Damage	TL	Range	Shots	Mass	Reloads	Cost
52 (13 expl.)	13	Subregional	10	3000kg	-	MCr1.1

### Plasma Cannon, Very Light-13

This is one of the few plasma weapons designed with their intrinsic power consumption in mind. It was built to operate off not more than 5% of the output of a typical armored personnel carrier of its time, and can maintain a sustained rate of fire of 10 shots per minute as long as the power plant has fuel.

The very light plasma cannon has 10 storage banks for on-board power, and requires a power plant output of .07Mw to recharge one of them per turn.

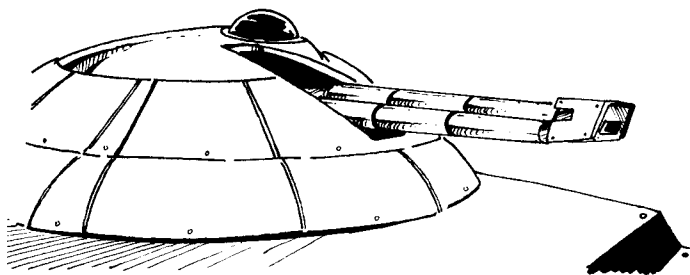

Damage	TL	Range	Shots	Mass	Reloads	Cost
24 (6 expl.)	13	V.long	10	32kg	-	KCr82

### Point Defense Laser, VRF-13

Further improvement in anti-missile laser technology. The best technique usable against point defense lasers is to obscure the target in smoke before launching missiles. While this seems simple enough in concept, in practice most of the means of delivering this smoke can also be shot down before reaching the vehicle. Most turreted vehicle illustration show two small point defense barbettes on the top of the turret, providing overlapping coverage and good multiple shoot-down capability.

The VRF point defense laser-13 consumes .002Mw/hr of power per VRF burst, or requires a power plant output of 1.8Mw for continuous operation. It holds enough on-board energy for one turn of VRF or two turns of RF fire. This is a multiple frequency laser, and would normally be adjusted automatically by the vehicle sensors for best penetration of any visual obscurement.

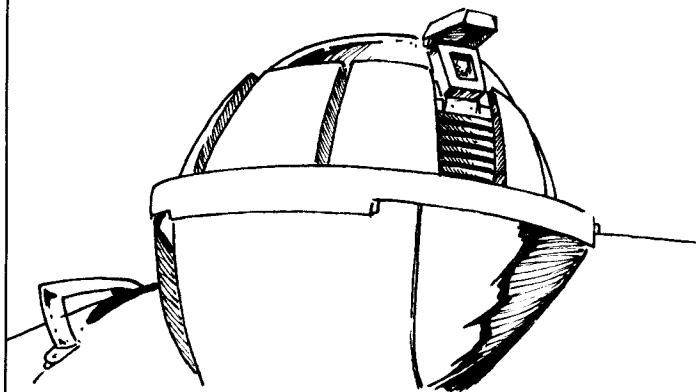

Damage	TL	Range	Shots	Mass	Reloads	Cost
6	13	Long	-	26.4kg	-	KCr12.6

Name	Dam. Rating	TL	Range	Shots	Mass	Reloads	Cost
ACR, Gauss-13	6	13	Medium	100	5.5kg	3.0kg	Cr6700
ACR, Laser-13	6	13	Long	50	5.5kg	2.8kg	KCr11.3
MG, VRF Gauss-13	8	13	Medium	10000	65kg	32kg	KCr16
Pistol, Gauss-13	4	13	Short	100	2.4kg	1.0kg	Cr2600
Pistol, Laser-13	4	13	Short	40	1.6kg	-	Cr2150
Rifle, Hvy Laser-13	10	13	Long	5	10.7kg	2.0kg	KCr54.5
Shotgun, Gauss-13	(special)	13	V.Short	20	7.0kg	2.9kg	Cr2300
Snub SMG, Heavy-13	9 (4 expl.)	13	V.Short	12	1.1kg	.4kg	Cr200
Cannon, VRF Gauss-13	11	13	Long	10000	370kg	150kg	KCr71
PCMP-13	21 (5 expl.)	13	Long	20	28.6kg	13.3kg	KCr45.0
Plasma Cannon, Hvy-13	81 (20 expl.)	13	Subregional	1	11.4 tons	-	MCr16.2
Plasma Cannon, Lt-13	44 (11 expl.)	13	E.Long	10	880kg	-	KCr550
Plasma Cannon, Md-13	52 (13 expl.)	13	Subregional	10	3000kg	-	MCr1.1
Plasma Cannon V Lt-13	24 (6 expl.)	13	V.long	10	32kg	-	KCr82
Plasma PD Cannon-13	44 (11 expl.)	13	Subregional	10	2000kg	-	MCr18.8
PD Laser, VRF-13	6	13	Long	-	26.4kg	-	KCr12.6

## Battle Dress, Augmented-13

The allure of anthropomorphic augmented armor systems persisted for centuries, despite the mechanical complexity of legged movement systems and their inefficient use of armor. By tech level 13, small contragrav units and power systems began to make that type of design non-competitive with the idea of a grav-driven sphere with retractable manipulator arms and under-armor weapons. These are extremely expensive weapon systems, and as such would be deployed in limited numbers for special purposes. They are usually called "battle pods".

Oddly, while exact statistics on ABD-12 units are classified, records on Second Imperium ABD-13 units are not. While they suffered operation shortcomings for lack of a long-term power supply like Fusion+ units, they were still a viable tactical option. What they lacked in long-term efficiency, they made up in short term firepower and survivability. ABD-13 units were of two radically different types. The first was the current route of a very anthropomorphic suit of armor with a chest or backpack, allowing seating in most military and some civilian vehicles. The other route was more spiderlike, with the user in a semi-fetal position, operating all systems with hands, voice and eye movements from within a spherical shell. These had roughly the same volume as the other ABD units, but the configuration made it impossible to fit one into most vehicles.

Performance-wise, the units were almost identical, except the cost of armor fabrication on the spider units was different due to the simpler shape and because that shape allowed the use of magnetic shielding. If the designers had abandoned the leg concept altogether, the latter type would probably have been able to carry more armor and power, and emerged as clearly superior. But it did not, and a system with the same performance from a more expensive package hindered the development of the battle pod concept for quite some time.

Unofficial reports suggest the magnetic shielding was largely useless since the armor already stopped most threats, and that the shielding plus armor was of insufficient power to deflect plasma cannon, and just made the armor easier to spot and harder to maneuver.

Both units ran off small battery packs, and some used very small internal combustion engines to recharge the batteries in any oxygen atmosphere, allowing for an extended range. They were equipped with a full suite of sensor and communication gear, and were usually armed with a PCMP-13 or heavy laser rifle equivalent, along with a VRF point defense laser. The spider form would have any weapons mounted under armor, while the human form would have only the point defense system protected. Both types used high efficiency contragrav and were capable of very fine maneuvering and hovering under computer or manual control. This was substantially more efficient than walking, and was the preferred means of movement whenever there was a gravity well strong enough to use it in.

A spherical armor unit for a person would be designed as a displacement .05 vehicle, a claustrophobic 1.1 meter sphere with a volume of .7m<sup>3</sup> and an area of about 3.88m<sup>2</sup>. A legged "spider" vehicle would be designed as a displacement .1 vehicle, a 1.4 meter sphere with a volume of 1.4m<sup>3</sup> and an area of 6.1m<sup>2</sup>. Both would have "womb" style cockpits taking up .2m<sup>3</sup> of volume leaving just about enough room to scratch your nose and push the hatch release button. Definitely not for the claustrophobic. Any clothing bulkier than leotards is verboten, and you might be able to find room for a pocket snub pistol and a pack of gum if you really try. Access to these tiny little coffins is through a hatch in the top, which in emergencies can be blown off if you need to get out *fast*.

The ABD-13 units have an effective Strength of 12 for lifting purposes, and can run at speeds of up to 60 meters per turn (36kph) and fly at up to 90 meters per turn (54kph). They have an overall rigid armor of 9, with anti-laser coatings bumping this up to 11 vs. laser attacks. The on board battery (.03Mw/hr) can power the legs for about an hour, or the contragrav for up to four hours. A power bay contains either a small internal combustion engine driving a generator capable of fully powering the contragrav and life support systems for 15 hours, or extended battery with an extra .06Mw/hr capacity. The ABD-13 has fully usable hands, while the spider unit does not, and uses the spare volume for an internally mounted PCMP-13 unit (.004Mw/hr to fully recharge). Both types have a VRF point defense laser (penetration 4) that uses .0004Mw/hr per VRF burst, a pair of DM+3 fire control computers, a rating 3 computer, autopilot, life support, inertial navigation, satellite navigation, subcontinental range military laser and radio communicators, direction finders, subregional range (10km) optical sensors and regional range (30km) active and passive radar sensors linked to the fire control systems.

The battle pod-13 unit has an armor rating of 9 with +2 from anti laser coatings, like the ABD-13 unit, but also is equipped with magnetic shielding that provides +4 armor when activated, with the normal DM-1 penalty on vehicle operation. It takes a meager .00017Mw/hr of battery capacity to fully charge the magnetic shielding unit. The battle pod-13 has a .5Mw/hr battery reserve, over five times that of the ABD unit. However, it is heavier and goes through this power fairly fast. The contragrav unit consumes .035Mw at full power, enough to give the battle pod-13 a top flight speed of 150 meters per turn (90kph) with 3g acceleration, but its legs only provide a top running speed of 30 meters per turn (18kph) and consume .04Mw of power. They do allow for movement in environments where use of contragrav is impractical, but really aren't worth the mass. While they can grip, the legs do not have manipulator hands. The legs can be used for pushing and bracing with an effective strength of 15. Since it is treated as a vehicle rather than a person, it has an agility of DM-2 to be hit when evading.

Note: Third Imperium ABD-13 and Battle Pod-13 units will be built using Fusion+ power in the power bay, providing .10Mw for vehicle systems and weapon charging for up to 500 hours of full power operation.

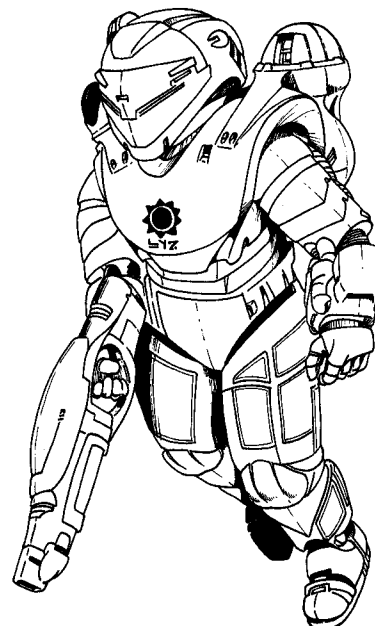

	Mass	Volume	Cost
Battle Dress, Augmented-13	310kg	.3 cubic meters	KCr304
Battle Pod-13	1200kg	.7 cubic meters	KCr390

# TECH LEVEL 14

Pre-Third Imperium technology. Characterized by further advances in material science, such as bonded superdense, and further increases in power storage and energy efficiency. The few records from this period describing tech level 14 research show a virtual abandonment of conventional explosive payloads, due to the efficiency of point defense systems, counter-battery targeting and other measures. Think tanks make the assumption that by this time, virtually all weapons will be line of sight. Portable lasers will appear in x-ray or far ultraviolet wavelengths, thus eliminating previous problems of visual obscurement. Use of exotic isotopes to create self-configuring nuclear impact warheads is noted by an increase in the number of non-starships carrying nuclear damping fields.

X-ray lasers are standard at TL14+, and have the game effect of halving the rating of any armor (round down) that is not made from or faced with superdense or other atomically compressed matter. This also means that Reflec and other

optical means of reducing penetration also fail to work. The interaction of high-energy x-rays with living tissue will result in normal injury, but healing is at half normal rate if TL14+ medical treatment is unavailable.

## Postulated Weapons

### ACR, Gauss-14

With the introduction of hand-held lasers in the x-ray portion of the electromagnetic spectrum, it is likely that gauss rifles will fall out of favor at TL14+. However, not all cultures can be expected to make the breakthroughs needed, or deploy large numbers of laser weapons for other reasons. The gauss ACR-14 is functionally identical to the gauss ACR-13, but with more advanced power storage technology and increased efficiency. It fires the same 3mm projectiles as the heavy gauss pistol-14, but with significantly higher velocity. The weapon can integrate a number of advanced sighting aids, but is normally only equipped with a small telescopic sight and predictive HUD.

The gauss ACR-14 is capable of using the single shot, burst fire, autofire and RF autofire modes. The HUD provides a DM+3 vs. applicable targets. The clips are reloadable and can be recharged from most household or vehicle sources. The projectiles for the gauss ACR-14 and heavy gauss pistol-14 are interchangeable, but the clips are not. Loose gauss needles for these two weapons mass about .25kg per hundred, the rest of the clip mass being energy storage. The gauss ACR-14 clip holds about .00025Mw/hr of energy, for reference.

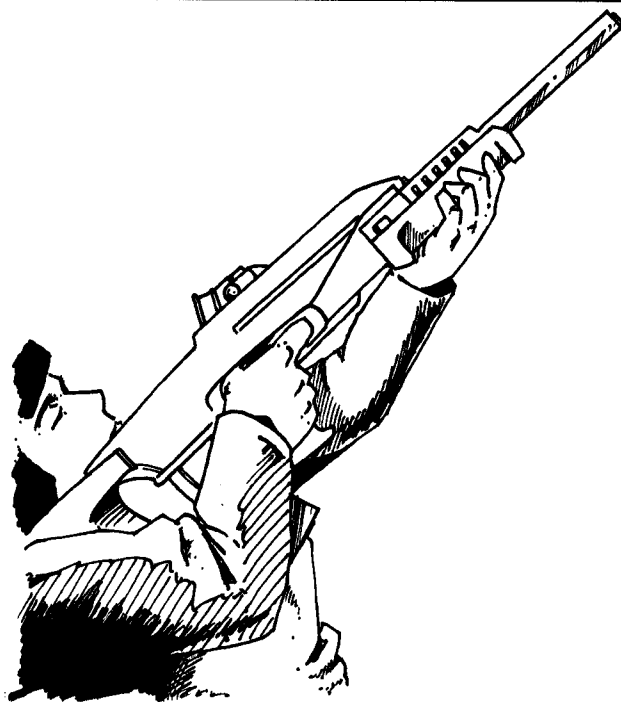

Damage	TL	Range	Shots	Mass	Reloads	Cost
6	14	Medium	100	5.2kg	2.0kg	Cr4900

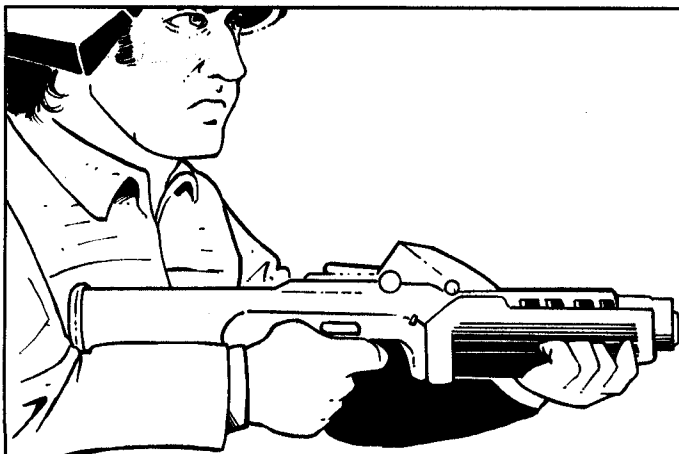

### ACR, Laser-14

The laser ACR at tech level 14 would provide no inherent bonus over the tech level 13 model, but against targets armored with less advanced materials the extra penetrating power would be a significant advantage. The TL14 laser ACR is capable of normal use in atmosphere or vacuum and could be integrated with any contemporary sighting aid.

The laser ACR-14 is capable of single shot and burst fire modes and has an adjustable power feature that allows either 50 shots at a penetration of 6, 100 shots at a penetration of 5 or 200 shots at a damage rating of 4.

Damage	TL	Range	Shots	Mass	Reloads	Cost
6	14	Long	50	4.5kg	1.7kg	Cr5200



### Grenade-14

The grenade-14 includes new safety features to prevent accidental detonation or disarming on an electronically sophisticated battlefield, but otherwise is much the same as its predecessors, an effective tool for clearing an area of unsealed or lightly armored infantry.

#### Grenade, Plasma-14

In effect, this is a small, single use plasma cannon. It can be used for penetrating barriers or deactivating hardened equipment, but has less blast effect than conventional grenades.

A plasma grenade has the same effect on whatever it is touching as a small plasma cannon blast would. If untamped, the hole is not much bigger than the grenade, but if tamped the confined plasma will leave a glowing hole big enough to crawl through, if it penetrates. The plasma grenade-14 has the "sticky" option allowing it to be placed on virtually any surface. Plasma grenades are energy weapons, and are typically shipped uncharged for safety reasons.

	Damage	TL	Range	Shots	Mass	Reloads	Cost
	10 expl.	14	Contact	-	.2kg	-	Cr50
Plasma-14	17 (4 expl.)	14	Contact	-	.5kg	-	Cr150

### Machinegun, Laser-14

A heavy-duty support weapon for engaging light vehicle or heavy infantry targets. Normally fired via TFAC link from a covered position. May be used as light vehicle armament.

This weapon is normally a 3 person load, one to carry the 12kg laser, another to handle the 24kg accumulator bank and a third to carry a power plant of some kind. The laser MG-14 holds enough energy in its accumulator bank to fire 50 shots at normal autofire rates. This bank requires .007Mw/hr of battery capacity to recharge (6.7kg of TL14 batteries) or a power plant with

an output of about 1Mw to recharge a 10 shot burst per turn. In Third Imperium terms, the last man would be lugging a 50kg Fusion+ unit with an output of about .2Mw about a hundred hours fuel, and its own contra-grav unit to negate the weight while on the move. In Second Imperium terms this weapon would probably have a dedicated carrier vehicle (aka Jeep) powered by a TL14 fuel cell and this would be used to recharge the weapon via up to 50 meters of superconductor cable.

	Damage	TL	Range	Shots	Mass	Reloads	Cost
	10	14	Long	-	36.8kg	24.4	KCr45.5

### Machinegun, VRF Gauss-14

Basic increases in efficiency in the VRF gauss MG-13 concept, with largely the same tactical role. The VRF gauss MG-14 is compact enough to be deployed on augmented battle dress units when integrated into the contra-grav harness for recoil compensation.

All notes applicable to the VRF gauss MG-13 apply

for this model as well. The VRF gauss MG-14 requires .01Mw/hr of battery storage or 7.5Mw of vehicle power per turn, and only has enough onboard power storage for a single VRF burst. It has no inherent sighting aids and is normally attached to a vehicle fire control system or vision enhancement system.

	Damage	TL	Range	Shots	Mass	Reloads	Cost
	9	14	Long	10000	70kg	29kg	KCr33

### Pistol, Heavy Gauss-14

An advanced gauss sidearm. Gauss sidearms are not expected to achieve better penetration without a breakthrough in accelerator technology. While the weight is acceptable for a one-hand weapon, it is near the maximum length for convenient holstering. While there may be a certain *machismo* in a pistol that extends from the

hip to the knee, it is not the major reason most people carry sidearms and less powerful weapons will adequately serve this need.

The heavy gauss pistol-14 is capable of single shot and autoburst fire, and the listed mass and cost does not include any advanced sighting aids.

	Damage	TL	Range	Shots	Mass	Reloads	Cost
	5	14	Short	30	1.6kg	.3kg	Cr8200

### Pistol, Laser-14

The laser pistol-14 is an improvement on earlier models in that it has enhanced performance against some types of armor and all types of atmospheric obscurement. It has mounting points and data paths for targeting equipment, but does not incorporate them in the version listed here.

The laser pistol-14 is capable of single shot and burst fire modes. Unlike the laser pistol-14 it is not equipped to be used as a cutting tool because of the radiation back scatter that would occur.

Damage	TL	Range	Shots	Mass	Reloads	Cost
4	14	Short	50	1.4kg	.3kg	Cr2930

### Pistol, VRF Gauss-14

The light gauss pistol-14 has an unknown tactical role. It is, like most military sidearms, supposedly for personal defense, but only has a damage rating comparable to modern pistols, certain insufficient to threaten TL14 body armor. However, against unarmored or lightly armored personnel it would be an absolutely devastating weapon due to its tremendous rate of fire.

The light gauss pistol-14 fires in either single shot or VRF autofire modes. It uses up 2.4mm steel pellets at the rate of 50 per second, and it has sufficient clip capacity to use the VRF bonus of DM+4 for two turns before reloading. Every fifth pellet has a magnesium component which is ignited by the magnetic flux induced heat on its steel coating, providing a tracer stream to aid aiming and also igniting easily flammable targets. Practically, this is a terror weapon, used either by guerrillas to wreak havoc or by repressive governments to keep unarmored populaces in line.

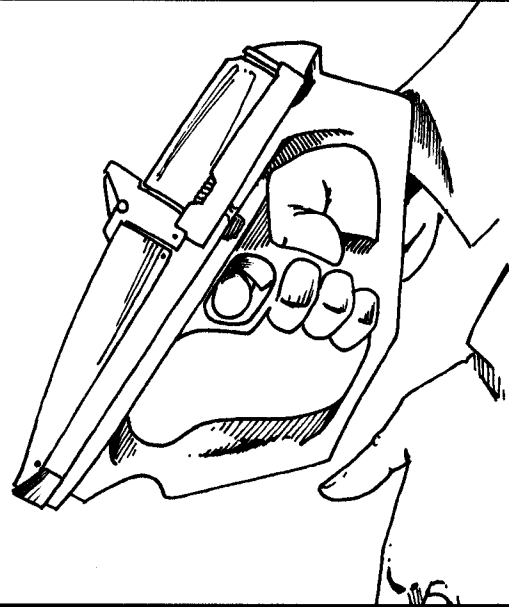

Damage	TL	Range	Shots	Mass	Reloads	Cost
3	14	V.Short	400	1.3kg	.6kg	Cr2600

### Shotgun, Gauss-14

The gauss shotgun-14 is basically an improvement on the gauss shotgun-13 concept, with slightly better performance and largely the same tactical role.

The gauss shotgun-14 has a number of ways it can be used. First, it has a DM+3 HUD unit which works in the normal fashion. A single shot can fire a cluster of 50+ darts, counting as an RF attack with a damage rating of 2. The second load is a smaller cluster of darts which counts as burst fire with a damage rating of 4, and the last is a 25mm shaped charge with a damage rating of 9 and a blast effect of 4. The dual-chamber clip can be switched from one side to the other by a grip switch, or by software command if the weapon is integrated into other systems. Ammunition between the gauss shotgun-13 and gauss shotgun-14 is similar but not compatible.

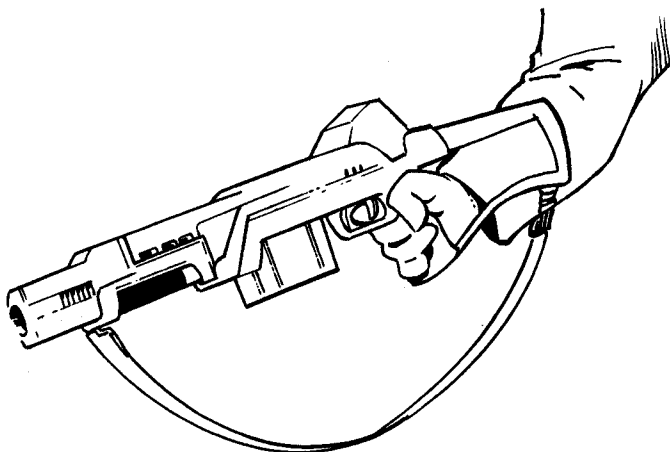

Damage (special)	TL	Range	Shots	Mass	Reloads	Cost
	13	V.Short	20	6.3kg	1.8kg	Cr2000

### Plasma Cannon, Light-14

An upgraded version of this light vehicle armament, with increased performance and better energy efficiency.

The light plasma cannon-14 holds 10 shots worth of

energy in on-board accumulators. Recharging these requires .2Mw/hr from batteries or requires 15Mw of power plant output to recharge one shot per turn.

Damage	TL	Range	Shots	Mass	Reloads	Cost
46 (11 expl.)	14	E.Long	10	820kg	-	KCr660

## Cannon, VRF Laser-14

The VRF laser cannon-14 normally supplants the VRF gauss cannon-13 because of advances in laser technology. They are used in the same role and are often designed to fit the same weapon sockets as their predecessor. It is a multiple amplifier system focused into a common beam path by a cooled low-angle reflector of bonded superdense. The entire amplifier array is housed within a thin superdense shell to minimize radiation leakage.

The VRF laser cannon-14 uses .07Mw/hr of battery storage per turn of use, or requires power plant output of 49Mw for continuous fire. It has on-board energy sufficient for one turn of fire at the VRF rate. Exposure to the amplifying medium of this or any other operating TL14+ laser is likely to cause some degree of radiation exposure, light for hand-held weapons, but serious to fatal for high-power or high rate of fire weapons.

Damage	TL	Range	Shots	Mass	Reloads	Cost
11	14	Long	-	400kg	-	KCr330

## PCMP-14

No examples are currently known of a PCMP weapon at postulated TL14 developments. Increases in power storage technology combined with known advances in material science and increased efficiency contra-grav would allow a self-contained weapon with its own recoil compensation, motion stabilizers and side-blast reduction, possibly allowing use by unaugmented troops.

A PCMP-14 has no weight when activated, but does have inertia, and contributes to any Dexterity penalties its actual mass would cause. However, it does not add to carried load for purposes of getting tired. In this "weight-

less" mode, it consumes 400 watts of power on a constant basis. A pre-Third Imperium model would supply this power from a 3200 watt-hour battery (3.2kg), while a model made with Third Imperium technology would use a 10kg Fusion+ unit instead, which would supply .046Mw and recharge the weapon's accumulators at the rate of 1 shot per 3 turns and last for about 200 hours of constant use before refueling. Add 7kg to the mass listed for a Third Imperium unit. A full recharge of the external power pack requires .004Mw/hr of battery power or a power plant providing 3.1Mw for a turn.

Damage	TL	Range	Shots	Mass	Reloads	Cost
23 (5 expl.)	14	Long	20	38.6kg	13.0kg	KCr66.1

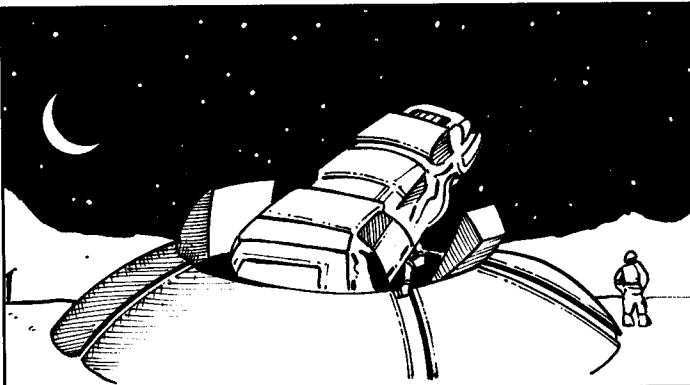

## Plasma Cannon, Heavy-14

Like the heavy plasma cannon-13, this weapon system is suited only for the largest vehicles or fixed emplacements with large power reserves. It is quite capable of forcing destroyer-class starships to keep their distance.

The heavy plasma cannon-14 holds 1 shot worth of energy in on-board accumulators. Recharging these requires 3.3Mw/hr from batteries or requires 2400Mw of power plant output to recharge one shot per turn. If used against starships it has a USP rating of 17-0-0-0, 18-0-0-0 if it can be fired continuously.

Damage	TL	Range	Shots	Mass	Reloads	Cost
84 (21 expl.)	14	Subregional	1	11.3 tons	-	MCr21.3

## Point Defense Laser, VRF-14

A short wavelength version of the TL13 model, more powerful and better able to penetrate atmospheric obscurement. Combined with improved fire control systems, it is able to reliably shoot down multiple incoming missiles or submunitions.

A TL14 fire control system gives a skill of 7 for snap shots, and with the DM+4 for VRF weapons and any +DM from extra computer power, it is almost certain that sever-

al missiles or munitions have to be targeted to arrive in the same turn to get one of them through. In addition, the VRF point defense laser-14 is even better at suppressing poorly armored or lower TL infantry and makes like extremely difficult for reconnaissance drones. The VRF point defense laser-14 has enough on-board energy for one VRF burst of 50 shots. Recharging this takes either .0008Mw/hr of battery power or a power plant providing .60Mw for a turn.

Damage	TL	Range	Shots	Mass	Reloads	Cost
7	14	Long	-	32.6kg	-	KCr31.1

## Plasma Cannon, Medium-14

Like the medium plasma cannon-13, the preferred armament of heavy grav armor. More capable than the tech level 13 models and near identical mass, allowing for retrofit in older vehicles.

The medium plasma cannon-14 holds 10 shots

worth of energy in on-board accumulators. Recharging these requires .9Mw/hr from batteries or requires 67Mw of power plant output to recharge one shot per turn. If used against starships it has a USP rating of 11-0-0-0, 12-0-0-0 if it can be fired continuously.

Damage	TL	Range	Shots	Mass	Reloads	Cost
55 (13 expl.)	14	Subregional	10	3000kg	-	MCr1.5

## Thor-14

Named after a Terran myth figure with an unerring ranged attack of great power. The Thor-14 is a railgun with suborbital velocity firing a cluster of terminally guided californium atomic munitions and/or bonded superdense penetrators. These can be fired from anywhere on most planetary surfaces to impact at any other location in 30 minutes or less. Final target programming is accomplished by satellite or other reconnaissance. The long rod penetrators are capable of extremely high penetration vs. vehicle armor, having a terminal velocity of over 10km/sec in normal atmosphere and gravity, and the nuclear projectiles can destroy any area unprotected by nuclear dampers. Both types are extremely difficult to shoot down as the narrow, laser shielded sensor window is the only portion vulnerable to most low-power point defense lasers. Normal mounting of a Thor system is on a dedicated contragrav or thruster plate vehicle, which often retreats underwater after firing. If orbit is uncontested, the system can be used by starships as well.

The Thor-14 system can do indirect fire to anywhere on the surface of a 1G Terra-size planet. The 70 meter long gauss cannon fires a 250kg cluster of terminally guided submunitions with a total muzzle energy of 20,000 megajoules. The long rod penetrators have a damage rating of 53 vs. the top armor of anything they

hit, while the nuclear submunitions count as 1 kiloton warheads. The system has a skill of 7 + DM's for size and movement to hit any target matching its criteria within 10km of the designated impact point, and each shot is capable of targeting up to 40 separate objects. The round can be programmed to engage all targets in an area, or directed by satellite reconnaissance during re-entry to target specific structures or vehicles. Normal use is to fire several shots and then retreat the vehicle to a protected position. Limitations are that most TL14 battlefields will detect the incoming projectiles and hasten to be out of the target zone when they hit, which is also a valid area denial use of the system. Point defense systems with a damage rating of less than 15 will have no effect vs. the armored submunitions. The Thor-14 system has enough on-board energy for one shot, and requires 28Mw/hr of battery power to recharge each shot or a power plant with an output of 20,000Mw to power it on a continuous basis (1 shot per turn). Firing it once a minute requires about 400 metric tons of TL14 Fusion+ or 1000 metric tons of normal TL14 fusion power. Note that while this weapon technically has a USP rating of 10-0-0-0, even a crippled ship with only maneuvering thrusters could get out of the way of the unpowered projectiles before they hit.

Damage	TL	Range	Shots	Mass	Reloads	Cost
special	14	Subregional	1	605 tons	250kg	MCr184

## Battle Pod-14

Personal augmented armor at tech level 14 bears no resemblance to the concepts originally imagined at lower tech levels. TL14+ uses the battle pod concept as a more efficient means of protecting the individual and providing maximum battlefield firepower in the smallest possible package.

A battle pod-14 unit is the .05 displacement ton type of armor, a minimum volume vehicle with a single very cramped operator completely surrounded by high-tech equipment. The only reason for a human operator at all is there are still some places where human intuition, flexibility and just "being there" is a significant tactical edge you can't get from expert systems and remote consoles.

The battle pod-14 unit is entirely contragrav powered, with a pair of Strength 6 waldos for doing things that require the use of hands. If deployed outside a gravity well where contragrav does not operate effectively, an armored TL14 thruster pack would be used, using electric resistance to heat a working fluid like water for thrust. Armament includes a PCMP-14 unit (sans contragrav) and VRF point defense laser-14, though other weapons could be configured to fit in the .015m<sup>3</sup> volume each of these systems take. Defenses include an armor rating 14 bonded superdense shell and 7 points of magnetic shielding. No anti-laser coating is used as few regular lasers can penetrate the normal armor, and the coating would be useless against TL14+ lasers anyway. The battle pod-14 unit is capable of contragrav flight at up to 100 meters per turn through most atmospheres, and can accelerate to this speed in one turn (3g maximum thrust). Since it is treated as a vehicle rather than a person, it has an agility of DM-2 to be hit when evading. It has DM+4 fire control systems for all weapons, magnetic shielding, multiple communication systems, optical, thermal and nuclear sensors, a rating 3 computer, and is capable of unassisted re-entry on planets of atmosphere type 0 through A. Power comes from a high discharge battery holding up to .7Mw/hr of power. All non-weapon systems running at full is a load of about .07Mw, of which movement is half the load and the rest is sensors, communicators and life support. Going dormant to life support only drops the load to about .001Mw. Each recharge of the magnetic shielding takes .0005Mw/hr, the point defense laser takes .0008Mw/hr, and a full 20 shot recharge of the PCMP-14 is .004Mw/hr. A Third Imperium unit would replace half the battery capacity with a .1m<sup>3</sup> Fusion+ unit producing .77Mw, a few hundred hours of fuel and room for a water bottle and a sandwich.

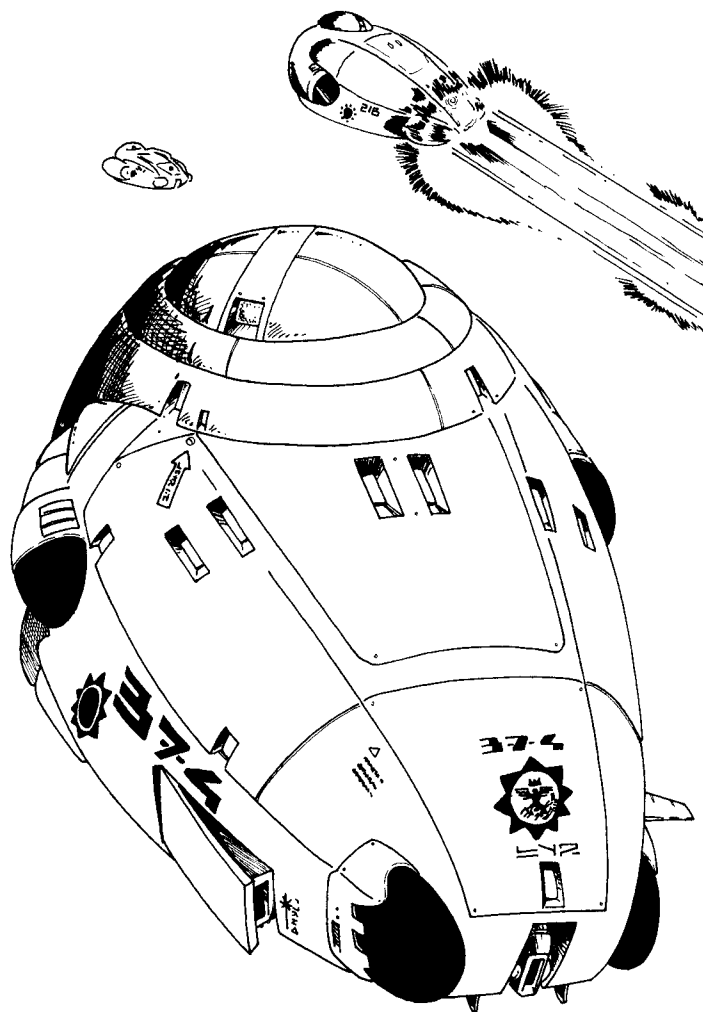

**Mass** 1560kg  
**Volume** .7 cubic meters  
**Cost** KCr500

Name	Dam. Rating	TL	Range	Shots	Mass	Reloads	Cost
ACR, Gauss-14	6	14	Medium	100	5.2kg	2.0kg	Cr4900
ACR, Laser-14	6	14	Long	50	4.5kg	1.7kg	Cr5200
Grenade-14	10 expl.	14	Contact	-	.2kg	-	Cr50
Grenade, Plasma-14	17 (4 expl.)	14	Contact	-	.5kg	-	Cr150
Pistol, Hvy Gauss-14	5	14	Short	30	1.6kg	.3kg	Cr8200
Pistol, Laser-14	4	14	Short	50	1.4kg	.3kg	Cr2930
Pistol, VRF Gauss-14	3	14	V.Short	400	1.3kg	.6kg	Cr2600
MG, Laser-14	10	14	Long	-	36.8kg	24.4	KCr45.5
MG, VRF Gauss-14	9	14	Long	10000	70kg	29kg	KCr33
Shotgun, Gauss-14	(special)	13	V.Short	20	6.3kg	1.8kg	Cr2000
Cannon, VRF Laser-14	11	14	Long	-	400kg	-	KCr330
PCMP-14	23 (5 expl.)	14	Long	20	38.6kg	13.0kg	KCr66.1
Plasma Cannon, Hv-14	84 (21 expl.)	14	Subregional	1	11.3 tons	-	MCr21.3
Plasma Cannon, Lt-14	46 (11 expl.)	14	E.Long	10	820kg	-	KCr660
Plasma Cannon, Md-14	55 (13 expl.)	14	Subregional	10	3000kg	-	MCr1.5
PD Laser, VRF-14	7	14	Long	-	32.6kg	-	KCr31.1
Thor-14	special	14	Subregional	1	605 tons	250kg	MCr184

# LAW LEVELS

---

Traveller has a number of law levels that societies are rated by (page 134 of basic rules, first and second printings), ranging from 0 (total anarchy) to A (no weapons of any type permitted). Not all of these will apply to all cultures, but probably have equivalents. For instance, a tech level 7 world has no use for law level 2 (portable energy weapons prohibited), but they would probably substitute weapons of light cannon size and up. Different law levels are more predominate with certain government types, but there is no hard and fast correlation. For instance, a militant Religious Dictatorship (Government Type D) might have a low law level, while one concerned with internal dissent might have a high one. Or, the official reports from government travel ministries may provide the impression of LL5, but naturally does not mention that rampant corruption means that the effective law level is only 2. Travellers are advised to read any recent reports before touchdown on any world for which full information is lacking, especially on worlds with multiple governmental units. While obvious, it is worth repeating that individuals of high status usually have either less legal strictures on their ownership of weapons, or they are more easily able to maneuver the legal formalities required. This also applies somewhat to their immediate circle of employees. It should not come as a surprise to find that a noble on a law level 5 world has bodyguards with concealed pistols.

Enforcement *ability* depends on tech level, but enforcement *aggressiveness* depends on law level. At tech levels of 5-, detection is almost always by manual or visual searches, while at tech level 7+, portal sensors become available and are used both on a personal level, and by TL8+ on a bulk cargo level if necessary. At TL9+, short range sensors allow some ranged detection ability through light cover like clothing, but range and detection ability only slowly increase, and only for specific types of weapons.

**Law Level 0** No enforcement, since nothing is illegal. However, private dwellings and businesses may set their own weapons code inside their controlled area. Enforcement is usually as appropriate for a culture that would not place restrictions on personal atomic munitions.

**Law Level 1** Only weapons of mass destruction are prohibited. Usually seen in "honor" cultures, where concealed or indiscriminate weapons are considered dishonorable to use. Detection ability may be fairly high, but uncommon, as social stigma is the major means of discouraging use. Use of prohibited weapons may reduce honor strictures on opponents, allowing forms of retaliation normally discouraged.

**Law Level 2** The only normal prohibitions are on portable energy weapons, but in less developed cultures this may apply to any extremely powerful man-portable weapon, such as rocket launchers. Uncommon in stable cultures except during a state of war or protracted civil unrest where any region may be subject to violent encounters. The ability to detect prohibited weapons may be very high, and used extensively near important persons or places, with increased law levels inside these restricted access zones.

**Law Level 3** Lowest law level usually seen in stable, technologically improving cultures. Only weapons with a strict military nature are prohibited to civilians. At law level 3+ there is usually formal documentation and registration of ownership and transfer of weapons at or near the maximum permitted level. Weapon detection is not usually pervasive, but an accepted part of society in limited circumstances or in certain locations. (Late 20th century Israel.)

**Law Level 4**

In general, this law level and weapons for the next 2 higher levels require either approval of local authority and/or registration and documentation of transfer. In addition, non-citizens and ex-criminal citizens are usually prohibited from possession of weapons at the "citizen" level, and require full documentation for allowed weapons of the higher law levels. For instance, at LL3, citizens might be able to own submachine-guns, but visiting aliens would be treated as being at LL4 or 5, and would require documentation for weapons at this level.

Automatic weapons of all types and most military technologies are prohibited to citizens. Typical for societies moving from a history of violent conflict into a long-term peace. The independence provided by personal firearms is still given lip service, but the need for the weapons is actually minimal. Enforcement is typically the same as for law level 3. Long-term social factors will tend towards a higher Law Level if the peaceful conditions remain stable. Rapid social or technological change may tend to delay or prevent increases in law level beyond this point. (Late 20th century United States; Milieu 0 Sylea.)

**Law Level 5**

Personal concealable firearms are prohibited. Usually the maximum law level for any society which thinks of itself as "free". Normally, there is little perceived need for lethal ranged weapons and the restrictions on them are seen as a social good by the majority of the population. Hunting and sporting firearms are still allowed, with restrictions on ownership, transfer, storage and transport. In addition to portal scanners on all government buildings, most transport hubs will also have them, and law enforcement will have broad but limited powers of search and seizure. Strictures on weapons usually apply to body armor as well. The usual justification is that law abiding citizens do not have to worry about being shot at, and therefore ownership of body armor is *prima facie* evidence that you engage in or are conspiring to engage in illegal activities. In game terms, any TL5+ body armor heavier than heavy clothing is prohibited

and subject to seizure. TL4- armor is allowed as antiques, but not as personal protection.

Law Level 6

Almost all firearms are prohibited, with only a strictly defined set of sporting or competition firearms permitted, and only with heavy restrictions. Any firearm possession or open display outside permitted areas is grounds for immediate arrest and permanent weapon confiscation. Non-lethal ranged weapons may be allowed with permits and registration. Law enforcement and military powers often overlap in matters of search and seizure, with less limitations than at law level 5. (Late 20th century England.)

Law Level 7

All lethal ranged weapons are prohibited. At TL5-, this usually also covers the prohibitions of law level 8, and some feel the distinction is unnecessary, law level 8 simply being a lower tech version of law level 7. Open weapon possession of any kind is either illegal or socially frowned upon, and use of weapons in self-defense still requires legal justification. This is usually justifiable fear for one's life or defense against an attacker using a similar weapon. Defense of property with lethal force is prohibited to civilians under any circumstances. Even law enforcement officials may be prohibited from owning off-duty weapons. Law enforcement may be a branch of the military, with little accountability and near-immunity to public criticism.

Law Level 8

Long bladed weapons are restricted if not prohibited. Concealed blades longer than needed for tools or household use are illegal. Societies that cannot change such systems usually develop alternate weapon technologies. Canes, scraping implements, and other everyday items may be manufactured with the durability and balance of melee weapons, allowing ownership of a useful weapon without it legally being a

weapon. Unarmed combat techniques may also be highly refined among certain segments of the population, with emphasis on disarming and incapacitating blows.

Law Level 9

Possession of any weapon outside one's residence is prohibited. This is just an extension of law level 8, generally accompanied by stricter enforcement and more pervasive enforcement technology. At low tech levels, this could be body searches by any law enforcement official at any time, while at higher tech levels portal sensors at major transport intersections will be common.

Law Level A

All ownership of weapons is prohibited. This is very difficult to achieve in practice, and would typically only be seen in penal colonies or extremely repressive dictatorships. The ability to use any blunt or pointed household item as a weapon makes it almost impossible to remove the potential from the population. Enforcement is typically extremely strict and thorough.

Characters can run afoul of local laws in any number of ways, but they could also carry illegal weapons for years and not have any problem. Imagine you were carrying a concealed pistol right now. If no one knows, the crime is invisible. However, if you bent over and a pistol fell out of your belt in sight of the local police, you would be in trouble. Also, possession of a prohibited weapon while committing a crime is usually a more serious offense in many legal systems, and crimes that might normally allow release on bail or payment of a fine might require incarceration and formal trial if a prohibited weapon is involved (i.e. you are a danger to the community...). Players should remember that their characters are subject to *local* law, not Imperial law. Of course, the reverse applies as well. Characters cannot usually be extradited back to a planet where they committed a crime, should they manage to escape or be bailed out by friends. It is unlikely that they will ever be able to return without an identity change that can fool the technology base of that world, though. And while there might not be *formal* extradition treaties, there are always "deals", especially if each planet has fugitives wanted on the other planet.

# TECH LEVEL 15

Maximum known Second Imperium technology. Includes maximum known refinement of weapons technology based on known or extrapolated principles. Many descriptions are theoretical, based on personal journals, fragmentary data logs and known theoretical work at the time when experimental tech level 15 research was taking place.

## Postulated Weapons

### ACR, Gauss-15

This is actually a heavy gauss rifle that is downrated to meet the load carrying capacity of the average soldier. It has three modes. The first fires gauss needles normally, the second fires them at low power, while the third mode uses the accelerator at full potential for a much greater muzzle energy. This depletes the clip's energy pack at a higher rate, but gives an extra punch that sometimes makes all the difference.

Normal mode fires damage rating 6 gauss needles. Low power mode allows the clip to be reloaded with loose needles up to three times, but only hits with a damage of 4. The last mode fires these same needles at three times the energy, giving a damage of 8, but at the cost of only getting 16 shots per clip. The gauss ACR-15 can fire in single shot or burst fire modes.

Damage	TL	Range	Shots	Mass	Reloads	Cost
6(8)	15	Long	50	4.6kg	.8kg	KCr11.6

### ACR, Laser-15

A medium-power assault rifle with heavy duty amplifier banks. At the cost of decreased clip life, power can be boosted to burn through obscuring cover or compensate for long range diffusion of the beam.

The amplifier assembly on the laser ACR-15 is rated at a damage rating of 7, but normally set at a damage rating of 6. Damage rating 6 shots provide 100 shots per clip, but damage rating 7 shots only give 50 shots per clip. The weapon is capable of single shot and burst fire modes. As listed, it does not include any advanced sighting aids.

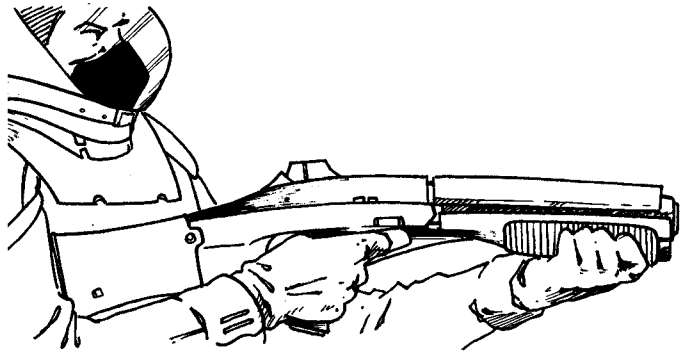

Damage	TL	Range	Shots	Mass	Reloads	Cost
6(7)	15	Long	100	4.5kg	2.1kg	KCr14.6

### Pistol, Laser-15

A general purpose self-defense weapon, not optimized for any particular need. Easily concealable under loose clothing, but readily detectable by portal scanners. Capable of single shot and burst fire modes.

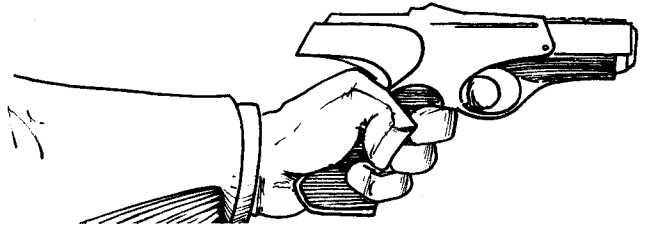

Damage	TL	Range	Shots	Mass	Reloads	Cost
4	15	Short	30	1.0kg	.2kg	Cr2900

### Cannon, VRF Laser-15

Like the VRF laser cannon-14, this is a multiple amplifier system focused into a common beam path. Increased laser efficiency allows more power in a package of similar size, and the weapon's most common use is as an extended range point defense system and anti-aircraft weapon on large vehicles. The high rate of fire combined with tech level 15 fire control systems means that the

system can engage ultra-agile targets with some chance of success. The entire amplifier array is housed within a thin superdense shell to minimize radiation leakage.

The VRF laser cannon-15 uses .08MW/hr of battery storage per turn of use, or requires power plant output of 60Mw for continuous fire. It has on-board energy sufficient for one turn of fire at the VRF rate.

Damage	TL	Range	Shots	Mass	Reloads	Cost
12	15	Long	-	460kg	-	KCr410



## Pistol, Body-15

An extremely concealable and virtually undetectable conventional firearm. Normally implanted in the body and fired by manual pressure to avoid detectable electronic traces. All parts are made from organic materials synthesized from the body of the eventual recipient for maximum compatibility.

It is almost impossible to find one of these unless you know what you are looking for and where to look for it. Typically it would be mounted in the long bone of the index or middle finger. It isn't meant to be accurate, but just a short range means of incapacitating a person when they aren't expecting it. It can be used in either single shot mode or as a single burst fire action.

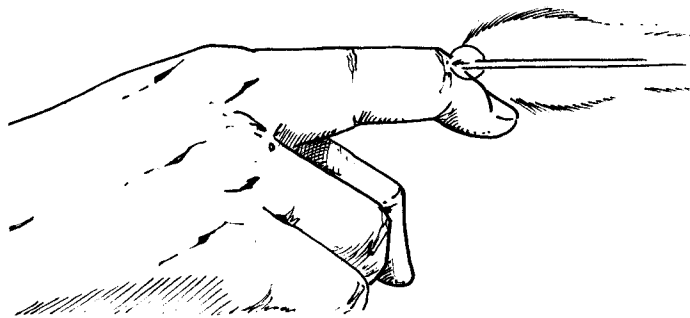

Damage	TL	Range	Shots	Mass	Reloads	Cost
2	15	Contact	3	.1kg	-	Cr5500

## PCMP-15

The PCMP-15 is the maximum refinement of the concept, using technology currently unavailable to the Third Imperium. Gravitic recoil compensation and an integral contragrav harness allow use by lightly armored troops. Artist's impressions of such futuristic weapons often depict a high "over-the-shoulder" configuration, presumably to allow fire from behind cover without exposing the firer, while sighting through a helmet-mounted holographic display.

While not included here, the PCMP-15 would normally have a DM+4 sensor suite including thermal, nuclear and EM scans, along with a computer-assisted threat analysis program that highlights targets by their appraised level of lethality. The PCMP-15 does include contragrav recoil compensation and weight negation, the latter taking 400 watts of power from its 3600 watt-hour auxiliary battery. A model made with Third Imperium technology would use a 10kg Fusion+ unit instead, which would supply .088Mw and recharge the weapon's accumulators at the rate of 1 shot per 2 turns and last for about 200 hours of constant use before refueling. Add 7kg to the mass listed for a Third Imperium unit. A full recharge of the external power pack requires .005Mw/hr of battery power or a power plant providing 3.6Mw for a turn.

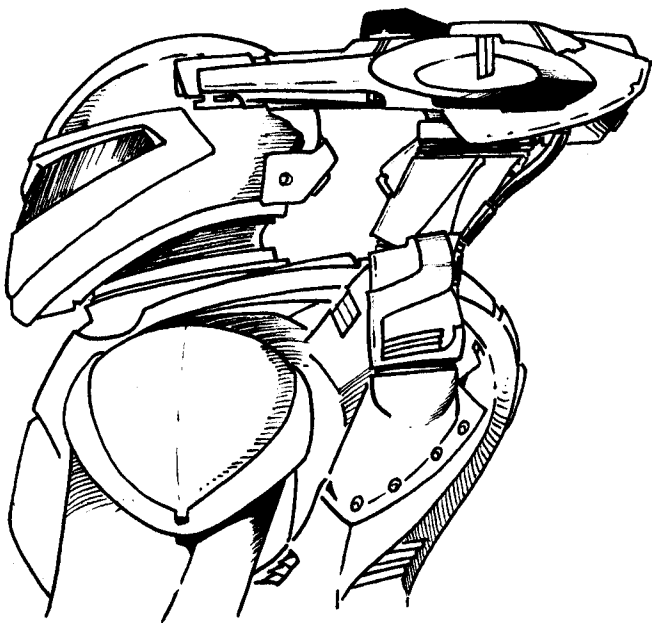

Damage	TL	Range	Shots	Mass	Reloads	Cost
25 (6 expl.)	15	Long	20	38.6kg	12.5kg	KCr91.1

## Plasma Blunderbuss-15

This is a jury-rigged and homemade plasma cannon, using modified over-the-counter hardware available at any tech level that has had plasma cannon technology for a long time. It is not especially effective in tech level 15 terms, but is still a powerful weapon.

The plasma blunderbuss-15 is made from regular power storage cells, a modified plasma cutting torch and some accelerator coils from a plasma thruster unit. In terms of side effects, count it as a PCMP-12 that is treated as an unreliable weapon.

Damage	TL	Range	Shots	Mass	Reloads	Cost
17 (4 expl.)	15	Medium	5	7.4kg	-	Cr7800

## Plasma Cannon, Heavy-15

The largest non-starship weapon design found in any existing records, and then only as a theoretical system requiring technology unavailable at that time. An extraordinarily complex and bulky weapon, even by tech level 15 standards, it requires a fusion reactor with an output of 230 megawatts to reach a sustained rate of fire of 1 shot per minute. No conventional material known would be capable of resisting the quantity of superheated plasma thrown, and even atomically compressed matter would only stop the energy by being disassociated into superheated gas, leaving deep craters in the surface of the material. With suitable targeting systems, a heavy plasma cannon is easily capable of massive damage to targets in low planetary orbit. Dissipation of 3,000+ megajoules of waste heat per firing is a postulated problem, handled in the design either by injection of cryogenic gases or use of massive radiating areas. The first is a supply problem in vacuum environ-

ments, and the latter makes concealment of the weapon from sensors an even more impossible task than normal.

The only real difference between this and the other heavy plasma cannon is that the computing power and precision is available to put a "spin" on the plasma as it exits the weapon. Combined with real-time geomagnetic data from ground and satellite stations, the plasma ball can hit over the horizon targets by interacting with a planetary magnetic field. Range is substantially better than previous models, but is still short by starship standards, with a USP equivalent of 18-0-0-0. The waste heat from this weapon is sufficient to bring 32 tons of ice water to an instant boil, and even slight malfunctions involve tremendous amounts of energy. You should be very careful around any weapon capable of punching through two and a half meters of bonded superdense or thirty-two meters of armor steel...

Damage	TL	Range	Shots	Mass	Reloads	Cost
89 (22 expl.)	15	Subregional	1	12.1 tons	-	MCr27.1

## Plasma Cannon, Light-15

Sufficient precision in timing and acceleration exists at tech level 15 to use dual mode plasma cannon, firing either a single superheated bolt or a series of smaller bolts with milliseconds of separation. The latter is useful against lightly armed but highly agile targets.

The light plasma cannon-15 can fire either a single damage rating 48 bolt, or an autoburst of five damage rating 33 bolts that can be spread across several targets if needed. It is conceivable that the technology would exist

to spread the bolt energy across enough shots to get a DM+2 rapid fire bonus, and in this case the damage rating of each one would be about 20. Approximately the same damage ratios would hold if you decided to try this with other plasma weapons. The light plasma cannon-15 holds enough on-board energy for 10 shots, and recharging the full energy bank takes either .23Mw/hr of battery power or a power plant providing 163Mw for a turn.

Damage	TL	Range	Shots	Mass	Reloads	Cost
48 (12 expl.)	15	E.Long	10	820kg	-	KCr802

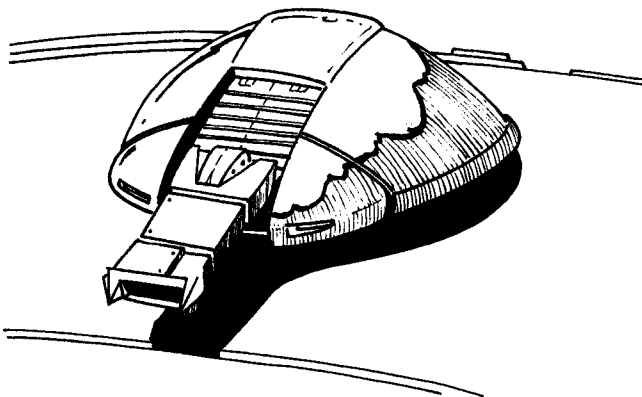

## Plasma Cannon, Medium-15

An extremely powerful weapon in a package that can be fitted to almost any tech level 15 armored vehicle, so long as rapid recharging is not required. Like all plasma cannon, the signature of the weapon is unmistakable, and the medium plasma cannon-15 bolt is bright enough to light up everything within a kilometer as bright as daylight.

The medium plasma cannon-15 holds 10 shots worth of energy in on-board accumulators. Recharging these requires 1.0Mw/hr from batteries or requires 69Mw of power plant output to recharge one shot per turn. If used against starships it has a USP rating of 11-0-0-0, 12-0-0-0 if it can be fired continuously.

Damage	TL	Range	Shots	Mass	Reloads	Cost
57 (14 expl.)	15	Subregional	10	2970kg	-	MCr1.8

## Battle Pod-15

The theoretical pinnacle of the armorer's art, the battle pod-15 is supposed to be the "future of warfare", a weapon system invulnerable to conventional infantry and designed to accompany heavy grav armor in a combined force doctrine. Special "pod tender" vehicles were to be developed, the tech level 15 equivalent of an armored personnel carrier, giving battle pod crews a place to rest, recharge or maintain their units. These looked like turretless grav tanks with up to half a dozen eggs embedded in its sides and provided bunks and minimal amenities for the pilot and up to half a dozen pod pilots.

The battle pod-15 has a PCMP-15 and point defense laser-14, bonded superdense armor with a rating of 16 and +8 magnetic shielding. It has a top speed in atmosphere of 260 meters per turn (156kph) and can accelerate up 5g, giving it an agility of DM-4 to be hit when evading. What the battle pod-15 has in firepower and armor is paid for by a smaller range than the battle pod-14. Its total battery reserve is only .3Mw/hr. Full power contra-grav uses .056Mw, recharging the shields is .0007Mw/hr, the point defense laser uses .0008Mw/hr per use, the PCMP-15 takes .005Mw/hr for a full recharge and all sensors and communicators running at full is about .15Mw/hr, though most of this is the continental range laser system which is normally only used for short data bursts and passive receiving. The battle pod-15 has a rating 4 computer, a pair of DM+4 fire control systems, a pair of strength 6 manipulator arms with data links, inertial and satellite navigation equipment, autopilot, subcontinental range radio and radio jammer, direction finders, continental range laser communicator, regional range optical sensors and subcontinental range radar system. A Third Imperium model would have a .15Mw/hr battery and a 1.2Mw Fusion+ unit with 300 hours of fuel and a .01m<sup>3</sup> storage compartment/accessory bay (enough room for a few kg of "stuff").

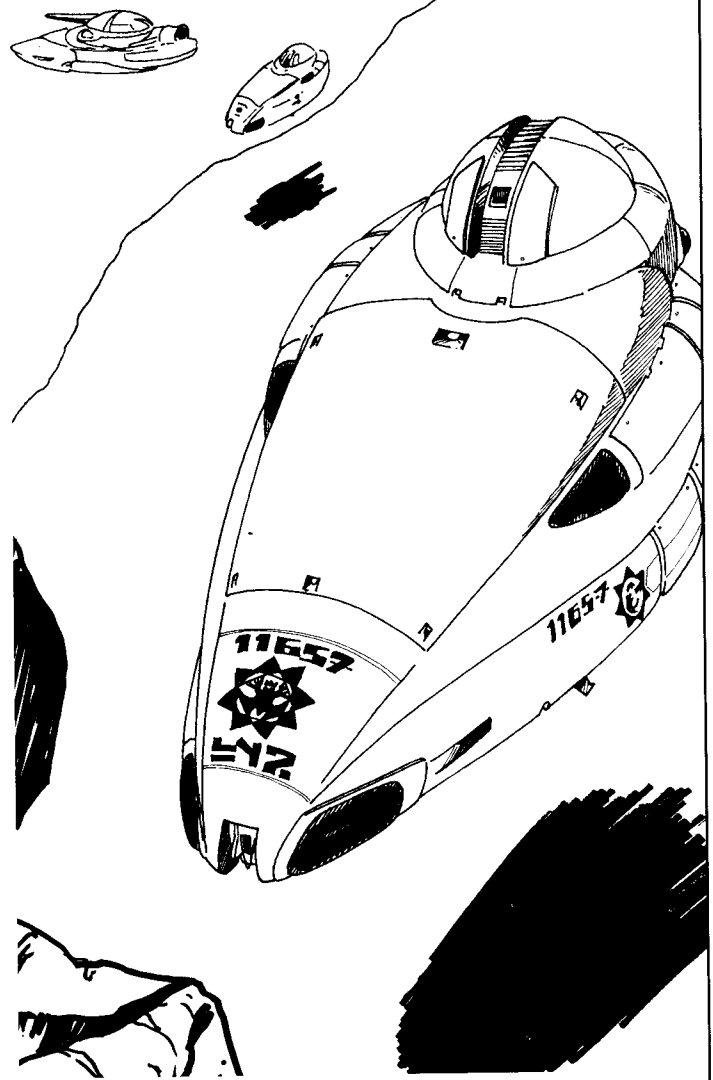

**Mass**  
1500kg

**Volume**  
.7 cubic meters

**Cost**  
KCr635

Name	Dam. Rating	TL	Range	Shots	Mass	Reloads	Cost
ACR, Gauss-15	6(8)	15	Long	50	4.6kg	.8kg	KCr11.6
ACR, Laser-15	6(7)	15	Long	100	4.5kg	2.1kg	KCr14.6
Pistol, Body-15	2	15	Contact	3	.1kg	-	Cr5500
Pistol, Laser-15	4	15	Short	30	1.0kg	.2kg	Cr2900
Cannon, VRF Laser-15	12	15	Long	-	460kg	-	KCr410
PCMP-15	25 (6 expl.)	15	Long	20	38.6kg	12.5kg	KCr91.1
Plasma Blunderbuss-15	17 (4 expl.)	15	Medium	5	7.4kg	-	Cr7800
Plasma Cannon, Hv-15	89 (22 expl.)	15	Subregional	1	12.1 tons	-	MCr27.1
Plasma Cannon, Lt-15	48 (12 expl.)	15	E.Long	10	820kg	-	KCr802
Plasma Cannon, Md-15	57 (14 expl.)	15	Subregional	10	2970kg	-	MCr1.8

# TECH LEVEL 16+

---

Fragmentary knowledge exists on tech level 16+ developments, either as rare archaeological finds from long-dead cultures, partially reverse-engineered Ancient devices or as scraps of knowledge on products in research or prototype stage in either the Vilani Empire or during the final days of the Second Imperium. No examples of these weapons are known to exist within the current boundaries of the Third Imperium, and illustrations are artist's conceptions only.

## Postulated Weapons

### Pistol, Laser-167

By all accounts, a pistol-sized x-ray laser with a number of advanced sighting aids, using some unspecified but highly advanced power source.

(This pistol is capable of single shot and burst fire modes, and can adjust its power to fire fifty damage rating 5 shots or a hundred penetration 4 shots.)

### Rifle, AM Gauss-167

A commonly discussed variant on the gauss rifle concept, in which the normal projectile is replaced with an antimatter projectile, either in a magnetic bottle, antimatter stored inside a crystal lattice or sometimes created by an onboard reactor of unspecified design. Most serious researchers discount the concept as it would indicate issuance to an average soldier enough energy to destroy a city, and anyone who has ever seen Imperial Marines on a drunken leave would think twice about it as well.

(For gearhead reference, this weapon fires 2mm gauss needles with an antimatter component of .001g, which is converted to energy with .1% efficiency. The nature of the explosion tends to irradiate the target, if it survives, and consecutive shots can eventually gouge holes in even the thickest material. The weapon would normally have a DM+4 HUD with the ability to target through most forms of obscurement. The weapon is just extremely high-tech. The reloads are the expensive part...)

(Also, antimatter is *not* your friend! If the author's physics are right, 1 gram of antimatter is a potential ninety million megajoules of energy, or about the same as twenty-odd kilotons of TNT. If this book were made of antimatter, and you stuffed it in a gun barrel and rammed a battleship down on top of it, you could shoot a really scary bullet at a velocity of around a kilometer per second. Special effects-driven movies aside, a quantity of the stuff would probably *not* catastrophically explode if it touched matter. The surface of the antimatter chunk would constantly ablate a white-hot hail of subatomic particles and slight differences in the reactions would make it jet about like a drunken comet. It would be unlikely to explode unless hit by a high intensity particle stream, like a **Traveller** particle accelerator or meson gun, and nuclear damper screens probably would not stop this from happening.)

(Antimatter is discovered at TL5-6; we proved its existence in 1932. Tech level 8 cultures can make and temporarily store antimatter — we can do it right now!. Tech level 9 cultures can make dangerous amounts of it, albeit at great expense, and Tech level 10+ cultures can actually store it for extended periods of time. It's extremely useful stuff for any number of purposes, so it probably exists somewhere in any TL10+ culture. The smart cultures do their antimatter research in far orbit, and don't allow inebriated oil tanker captains to pilot ships powered by it. It's a safe bet that both the Vilani and Second Imperium had a devastating accident or two with the stuff, and humans have generally learned to live without it or keep it under a *very* tight leash ever since.)

### Rifle, CG-167

The reactionless nature of contragrav is well known, and is at the heart of this weapon. Each projectile is a contragrav or thruster unit, powered by a minuscule quantity of antimatter. The tiny contragrav generator is burned out in a fraction of a second, but not before accelerating itself to impossibly high velocities with virtually no recoil force. It is assumed that the inside of the launch barrel is maintained at near vacuum by electrostatic fields, and that the projectile itself is both highly streamlined and made from some advanced superdense variant to avoid instantly vaporizing from friction. It seems doubtful this technology would only be known as a rifle, and if it is not mythical, it would also likely exist in vehicle mounted form.

(The CG rifle-16 is virtually unpowered and relatively inexpensive. All the "oomph!" comes from a tiny particle of antimatter inside each projectile, which burns out the projectile's tiny contragrav unit in 1.1 microseconds. This accelerates the projectile at roughly 1.8 **billion** g's to a muzzle velocity of almost 200 kilometers per second. With the proper sights, targets in low orbit can be successfully engaged. The side effects of the projectile in an atmosphere include a lightning-like flash along the projectile's path, and a large thunderclap a fraction of a second later. The CG rifle is capable of single shot fire only, and holds 20 shots in a detachable clip. Each projectile has a cost of around Cr3000 in any TL16+ culture able to manufacture them. In USP terms this weapon has a rating of 13-0-0-0.)

### Rifle, Plasma-167

Variously described as a plasma flamethrower, particle cannon or plasma cannon, most sources agree it is probably an extremely efficient version of the PCMP concept, presumably with damping fields for radiation and recoil control. Power is presumed to be from some advanced accumulator technology and an integral fusion, very small antimatter or possibly quantum vacuum power source.

(The plasma rifle-16 contains a small onboard fusion reactor good for several months of constant use, capable of recharging the weapon at the rate of 1 shot per turn and it holds up to 10 shots worth of energy, allowing the reactor to be turned off when the weapon is stored. The plasma rifle-16 requires flash-protective eyewear, but can otherwise be used by unarmored individuals.)

### AMPCMP-167

A variant on the man-portable plasma cannon, in which the plasma is composed of antimatter instead of superheated matter. This is seen as somewhat more possible than the AM gauss rifle, since plasma cannon require extensive training to use properly, and are issued in very limited numbers. The potential side effects of the user taking a weapon hit would seem to indicate these weapons would not be used in close proximity to populated areas.

(This weapon has stable onboard storage of .2 grams of

antimatter, enough for 100 shots. In the event of a containment breach, it is ejected in several individually secure packets that release the antimatter in a violent but controlled fashion. If the ejection mechanism were to fail and the antimatter converted at full efficiency, the resulting explosion would have a blast effect of about 640 (about 4.5 kilotons TNT, but the **Traveller** explosive rules aren't really meant for this scale). The weapon has an onboard fusion reactor that recharges the accelerator banks at the rate of 1 per 2 turns, but it holds enough high discharge storage to fire 10 shots without recharging. It includes integral gravity compensation, recoil compensation and sighting aids of at least DM+4. The antimatter component is selectable, and without it the penetration is 24 (6 explosive). In USP terms this weapon has a rating of 13-0-0-0, or 2-0-0-0 without the antimatter component.)

## Known Weapons

This is where myth and fact get a little closer together. Over the Vilani Era and the Rule of Man, exploration uncovered a number of Ancient artifacts, some of which were weapons. While many of the artifacts were unfathomable pieces, some of the near-indestructible Ancient devices were still in working order. In all the cases described below, they eventually fell into possession of a government, and exact disposition and whereabouts were usually extremely secret, lost during the Long Night, or both.

### Artifact Ganiir 4132

Little is known of the origin of this item save that it came from Ganiir (Vland, subsector J, 0921), an uninhabited, thin-aired world that was apparently a minor casualty of the war between Grandfather and the Ancients (minor in that the planet is still there, unlike the *major* casualties). Designed to fit a Droyne-like hand, it created at variable range a spherical energy absorbing field of variable size, within which most or all molecular activity stopped — in effect, a stasis field. Items on the field boundary were severed cleanly at the boundary, though no mention is made of what materials this was tested on. The duration of the field was random and while presumed to be adjustable, no means of doing so was ever found.

*Source:* Excerpts from the posthumously published diaries of William Mann (2402-2510), professor emeritus, Deraan University, Vland B subsector, 1403. Sections of the diaries relating to this artifact were censored within days of publication and all electronic records of it purged.

It is a good bet that this planet still sees regular archaeological or treasure hunter visits, unless it has been Red

Zoned for some reason. Badly blasted ruins are still visible, the near-vacuum atmosphere preventing erosion and weathering. Heavy inclusions in the crust of the planet have still not been conclusively analyzed and there are measurable but unpredictable variations in certain quantum phenomena across the surface of the planet. These do not typically have a major effect on "primitive" TL12 equipment, but there are occasional exceptions...

### The Big Gun

This artifact was discovered on Ildurk (Massilia, subsector F, 1514) where it fell to ground 79 years ago, and was originally thought to be a meteor. After it was dug up from the 200m diameter crater it left, it was immediately obvious that it was some sort of large Ancient artifact, which also might explain why it did not show up on any planetary defense sensors until seconds before impact. Analysis of debris it had accreted and its apparent trajectory indicate its origin at a point in interstellar space between 170 to 230 thousand years ago. In appearance it is a mottled cylinder approximately 12.3 meters long and varying in diameter from .73 to 1.45 meters, with numerous ridges and semi-regular depressions in its surface. At the far end it is attached to a gently curving plate of irregularly blasted material between .63 and .74 meters thick. It is presumed to be a weapon mount and a portion of starship hull. The total mass is 498.9 metric tons and indicates an average material density of 40.3 metric tons per cubic meter. There are no moving parts, only two holes on the inside of the "hull" opposite the cylinder. Analysis was unable to determine the type of matter the artifact was made of, nor much more than the density varied within it in a regular pattern. Experimentation eventually found that raw fusion plasma directed into the holes produced a measurable emission of muons and mesons from the end of the cylinder, and the device is assumed to be some advanced form of meson weapon. Experimentation on it slowed to near nothing after a few decades of further fruitless tests, and it is currently on public display at the Trentan Federation Museum of Science and Technology in startown Granger on Dupleen (Massilia, subsector F, 1515). No new research grants have been funded by the Trentan Federation for the past 13 years, nor have they allowed off-planet researchers more than casual access to it for the same period.

*Source:* Carnak News Databases.

(The Big Gun is whatever the referee want it to be. Too big to casually walk off with, but small enough to steal if you are *really* determined about it. Any Ancient device of this size has got the capability to funnel a lot of energy, but exactly what it does with that energy is up to you.)

Name	Dam. Rating	TL	Range	Shots	Mass	Reloads	Cost
Pistol, Laser-16	6	16	Short	25	1.8kg	.4kg	KCr16.9
Rifle, AM Gauss-16	8 (44 expl.)	16	Medium	100	4.8kg	1.9kg	KCr40
Rifle, CG-16	66	16	V.Long	20	3.8kg	1.4kg	Cr2100
Rifle, Plasma-16	15 (4 expl.)	16	Long	10	7.0kg	-	KCr20
AMPCMP-16	68 (52 expl.)	16	Long	10	25kg	-	KCr660

## Tech Level 0

Name	Dam. Rating	TL	Range	Shots	Mass	Reloads	Cost*
Ax-0	2	0	Contact	–	2.2kg	–	Cr70
Blowgun-0	0	0	Contact	1	.2kg	–	Cr20
Bow-0	1	0	Contact	1	1.8kg	.2kg	Cr60
Club-0	2	0	Contact	–	1.5kg	–	Cr60
Knife-0	1	0	Contact	–	.2kg	–	Cr20
Sling-0	1	0	Contact	1	.1kg	.1kg	Cr20
Spear-0	2/1	0	Contact/Cont.	1	1.0kg	–	Cr60
Sword-0	2	0	Contact	–	1.5kg	–	Cr40

\*Cost for these primitive weapons is reflection of the manual labor required to produce them. Tech level 0 cultures do not have currency as such for transactions, and acquisition would be through barter, salvage or theft.

## Tech Level 1

Name	Dam. Rating	TL	Range	Shots	Mass	Reloads	Cost
Ax-1	2	1	Contact	–	1.8kg	–	Cr220
Bow-1	2	1	Short	1	1.9kg	.1kg	Cr200
Crossbow, Heavy-1	3	1	Short	1	8.9kg	.1kg	Cr340
Crossbow, Light-1	2	1	Short	1	2.8kg	.1kg	Cr200
Knife-1	1	1	Contact	–	.6kg	–	Cr60
Polearm-1	3	1	Contact	–	3.5kg	–	Cr160
Shield-1 (+1)	–	1	–	–	1.0kg	–	Cr30
Shield-1 (+2)	–	1	–	–	2.5kg	–	Cr50
Shield-1 (+3)	–	1	–	–	4.0kg	–	Cr100
Spear-1	2/1	1	Contact/Cont.	1	1.0kg	–	Cr60
Sword-1	2	1	Contact	–	2.0kg	–	Cr200
Ballista-1	4	1	Short	1	120kg	6.0kg	Cr380
Onager-1	5	1	V.Short	1	150kg	1.5kg	Cr490
Rocket-1	7 explosive	1	V.Short	1	4.2kg	–	Cr50
Trebuchet-1	6	1	V.Short	1	2300kg	5.4kg	Cr1100

## Tech Level 2

Name	Dam. Rating	TL	Range	Shots	Mass	Reloads	Cost
Black powder-2	6 expl.	2	Contact	1	1.0kg	–	Cr20
Blunderbuss-2	1*	2	Contact	1	3.4kg	.2kg	Cr90
Crossbow, Medium-2	3	2	Short	1	6.5kg	.1kg	Cr350
Musket-2	3	2	V.Short	1	3.6kg	.1kg	Cr120
Pistol, Heavy-2	2	2	V.Short	1	1.0kg	–	Cr140
Pistol, Light-2	1	2	Contact	1	.5kg	–	Cr120
Rapier-2	1	2	Contact	–	.8kg	–	Cr150
Stiletto-2	0(1/2D wnds)	2	Contact	–	.2kg	–	Cr25
Cannon, Heavy-2	10	2	V.Short	1	490kg	60kg	Cr3600
Cannon, Light-2	6	2	V.Short	1	60kg	2.0kg	Cr1100
Cannon, Medium-2	8	2	V.Short	1	160kg	4.4kg	Cr1500

## Tech Level 3

Name	Dam. Rating	TL	Range	Shots	Mass	Reloads	Cost
Pistol, Heavy-3	2	3	V.Short	1	.9kg	–	Cr150
Pistol, Light-3	1	3	Contact	2	.7kg	–	Cr170
Revolver-3	2	3	V.Short	6	1.4kg	.1kg	Cr150
Rifle-3	3	3	Short	1	2.7kg	–	Cr370
Rifle, Air-3	2	3	Short	20	2.2kg	.3kg	Cr220
Shotgun-3	2*	3	V.Short	2	4.7kg	.1kg	Cr200
Cannon, Heavy-3	12 (21 explosive)	3	V.Short	1	880kg	80kg	KCr18.7
Cannon, Light-3	6 (10 explosive)	3	V.Short	1	60kg	5.0kg	Cr1900
Cannon, Medium-3	8 (13 explosive)	3	V.Short	1	100kg	9.5kg	Cr2600

## Tech Level 4

Name	Dam. Rating	TL	Range	Shots	Mass	Reloads	Cost
Dynamite-4	7 explosive	4	Contact	1	1.0kg	-	Cr40
Grenade-4	7 explosive	4	Contact	1	.5kg	-	Cr30
Machinegun-4	4	4	Medium	200	17.5kg	6.1kg	Cr360
Machinegun, RF-4	4	4	Medium	200	48kg	6.1kg	Cr820
Pistol-4	1	4	V.Short	6	.8kg	.1kg	Cr260
Pistol, Body-4	1	4	Contact	4	.3kg	-	Cr120
Pistol, Light-4	1	4	Contact	2	.3kg	-	Cr50
Revolver, Heavy-4	2	4	V.Short	6	1.0kg	-	Cr150
Rifle-4	4	4	Medium	5	5.7kg	.1kg	Cr350
Shotgun-4	2*	4	V.Short	6	3.8kg	.2kg	Cr200
Cannon, Heavy-4	22 explosive	4	Long	1	1150kg	55kg	KCr60.0
Cannon, Light-4	8 (7 explosive)	4	Long	1	105kg	1.6kg	Cr4200
Cannon, Medium-4	12 (13 explosive)	4	Long	1	420kg	13.9kg	KCr14.0
Cannon, Very Heavy-4	20 (29 explosive)	4	Medium	1	8900kg	270kg	KCr500
Rocket, Artillery-4	15 explosive	4	V.Short	1	10.0kg	-	Cr25
Torpedo-4	52 explosive	4	Contact	1	990kg	-	Cr2200

## Tech Level 5

Name	Dam. Rating	TL	Range	Shots	Mass	Reloads	Cost
ACR-5	4	5	Medium	20	6.8kg	.5kg	Cr640
Demolition Charge-5	22 explosive	5	Contact	1	5kg	-	Cr50
Flamethrower-5	1*	5	Contact	10	20.0kg	15.0kg	Cr500
Grenade, AT-5	21 (13 expl.)	5	Contact	1	.8kg	-	Cr50
Machinegun, Heavy-5	6	5	Long	200	50.5kg	23.2kg	Cr2600
Machinegun, Medium-5	4	5	Medium	200	15.6kg	5.9kg	Cr950
Pistol-5	2	5	V.Short	10	1.0kg	.1kg	Cr300
Rifle, Anti-Tank-5	7	5	Medium	5	32.8kg	1.9kg	Cr2400
Rifle, Hunting-5	5	5	Medium	4	6.4kg	.1kg	Cr480
Submachinegun-5	2	5	V.Short	30	2.0kg	.4kg	Cr220
Bomb, Heavy-5	72 explosive	5	Contact	1	1000kg	-	Cr1000
Bomb, Light-5	37 explosive	5	Contact	1	50kg	-	Cr100
Bomb, Medium-5	53 explosive	5	Contact	1	250kg	-	Cr500
Cannon, Heavy-5	18 (23 explosive)	5	Long	1	1460kg	64.8kg	KCr101
Cannon, Light-5	10	5	Long	1	200kg	1.5kg	Cr8500
Cannon, Medium-5	14 (14 explosive)	5	Long	1	600kg	18.1kg	KCr30.3
Cannon, V. Hvy-5	23 (14 expl.) (36 explosive)	5	Long	1	5300kg	420kg	MCr1.3
LAAW-5	19 (15 expl.)	5	V.Short	1	6.3kg	4.1kg	Cr400
Mine, AP-5	4 explos. or 4 frag.	5	-	1	.2kg	-	Cr10
Mine, AT-5	24 explosive	5	-	1	7.0kg	-	Cr50
Mortar-5	15 explosive	5	Contact	1	17.5kg	4.6kg	Cr250
Organ Rocket-5	25 explosive	5	V.Short	50	1800kg	-	Cr6400
Torpedo-5	49 explosive	5	Contact	1	1200kg	-	Cr1900

## Tech Level 6

Name	Dam. Rating	TL	Range	Shots	Mass	Reloads	Cost
ACR, Heavy-6	5	6	Medium	20	5.9kg	.5kg	Cr1900
ACR, Light-6	4	6	Medium	40	4.0kg	.4kg	Cr500
Grenade-6	6 fragment	6	Contact	1	.2kg	-	Cr20
Machinegun, Heavy-6	6	6	Long	200	39.9kg	19.0kg	Cr2700
Machinegun, Medium-6	5	6	Medium	200	14.0kg	5.4kg	Cr1200
Rifle, Recoilless-6	21 (16 expl.)	6	V.Short	1	13.4kg	5.2kg	Cr860
Submachinegun-6	2	6	V.Short	30	1.8kg	.4kg	Cr230
Autocannon, Light-6	10	6	Long	100	307kg	176kg	KCr19.2
Bomb, Glide-6	56 explosive	6	Contact	1	250kg	-	Cr1500
Cannon, Heavy-6	20/25 HEAP	6	V.Long/Long	1	1410kg	50.7kg/45.0kg	KCr133
Cannon, Medium-6	17/21 (16 expl.)	6	V.Long/Long	1	815kg	20.5kg	KCr49.4
Cannon, V. Hvy-6	25 (14 expl.)/37 expl.	6	Long	1	5400kg	430kg	MCr1.3
LAAW-6	20 (16 expl.)	6	Short	1	8.0kg	5.2kg	Cr420
Missile, AA-6	14 fragment	6	Long	1	42.5kg	-	Cr3500
Missile, AS-6	50 explosive	6	Short	1	670kg	-	KCr26.5
Missile, AT-6	22 (14 expl.)	6	V.short	1	11.6kg	9.1kg	Cr750
Torpedo-6	36 explosive	6	Contact	1	1230kg	-	Cr9500



## Tech Level 7

Name	Dam. Rating	TL	Range	Shots	Mass	Reloads	Cost
ACR, Heavy-7	5	7	Medium	30	5.2kg	.7kg	Cr1900
ACR, Light-7	4	7	Medium	50	3.6kg	.5kg	Cr500
Assault Grenade-7	17 explosive	7	Contact	1	1.2kg	-	Cr100
Crossbow-7	3	7	Medium	1	3.8kg	.1kg	Cr350
Explosive, Plastic-7	8 explosive	7	Contact	1	1.0kg	-	Cr70
Flame Rocket-7	special	7	Short	4	36kg	-	Cr980
Machinegun, VRF-7	5	7	Medium	2000	70.0kg	48.6kg	Cr1800
Pepper-7	0	7	Contact	10	.1kg	-	Cr10
Pistol-7	2	7	V.Short	15	1.0kg	.2kg	Cr360
Pistol, Heavy-7	3	7	V.Short	10	1.6kg	.2kg	Cr980
Pistol, Tranq-7	0	7	Contact	1	.2kg	.1kg	Cr120
Rifle, Sniper-7	6	7	V.Long	5	12.2kg	.3kg	Cr8300
Rifle, Tranq-7	0	7	V.Short	1	.5kg	.1kg	Cr170
Riot Shield-7 (+3)	-	7	-	-	3.5kg	-	Cr100
Cannon, VRF-7	10	7	Long	1000	1870kg	570kg	KCr27.9
LAAW-7	21 (13 expl.)	7	Short	1	5.0kg	-	Cr420
Mine, AP-7	4 (3 expl.)	7	-	1	.1kg	-	Cr20
Mine, AT-7	31 (20 expl.)	7	Contact	1	5.0kg	-	Cr140
Mine, Scattermine-7	3 (15 expl.)	7	Contact	1	1.6kg	-	Cr220
Missile, Light AA-7	14 explosive	7	Short	1	31.5kg	21.9kg	Cr2300
Missile, AA-7	20 explosive	7	Long	1	49.3kg	-	KCr17.5
Missile, Light AT-7	26 (16 expl.)	7	V.Short	1	12.5kg	9.5kg	Cr2300
Missile, Heavy AT-7	30 (20 expl.)	7	Short	1	69.2kg	55kg	Cr7900
Missile, AM-7	10 expl.	7	Medium	20	1100kg	820kg	KCr40

## Tech Level 8

Name	Dam. Rating	TL	Range	Shots	Mass	Reloads	Cost
Grenade-8	7 fragment	8	Contact	1	.2kg	-	Cr50
Hand Stunner-8	1	8	Contact	-	.3kg	-	Cr50
Machinegun, Heavy-8	8	8	Long	100	76kg	30kg	Cr8700
Net Gun-8	special	8	Contact	1	2.5kg	1.0kg	Cr400
Pistol, Body-8	2	8	V.Short	4	.5kg	-	Cr1500
Shock Baton-8	1	8	Contact	-	.8kg	-	Cr150
Thud Gun-8	2	8	Contact	1	1.4kg	.1kg	Cr160
Autocannon, Light-8	10 (7 expl.)	8	Long	100	270kg	42kg	KCr23.1
Bomb, Fuel Air-8	8	8	Contact	1	250kg	-	Cr2000
Cannon, Heavy-8	21	8	E.Long	1	1120kg	26kg	KCr256
Cannon, H. cont.	22 expl.		V.Long			33kg	
Cannon, H. cont.	27 HEAP		V.Long			33kg	
Cannon, Medium-8	13	8	E.Long	20 x 2	550kg	230kg	KCr54.5
Cannon, M. cont.	14 expl.		V.Long			370kg	
Cannon, M. cont.	19 HEAP		V.Long			370kg	
LAAW-8	23 (16 expl.)	8	Short	1	9.1kg	6.5kg	Cr1100
Mine, Remote-8	23 (16 expl.)	8	Short	1	10.3kg	-	Cr1500
Mine, Multi-8	18 or 7 frag.	8	Contact	2	6.0kg	-	Cr1100
Missile, Light AA-8	14 expl.	8	Short	1	33kg	23kg	Cr7900
Missile, Medium AA-8	22 expl.	8	Long	1	68.0kg	-	KCr23.6
Missile, Heavy AT-8	33 (21 expl.)	8	Short	1	82.9kg	67.2kg	KCr10.3
Mortar-8	17 explosive	8	Contact	1	13.5kg	4.0kg	Cr250

## Tech Level 9

Name	Dam. Rating	TL	Range	Shots	Mass	Reloads	Cost
ACR, Heavy-9	5	9	Medium	40	4.9kg	.5kg	Cr2500
ACR, Light-9	4	9	Medium	60	4.2kg	.3kg	Cr920
Bullpup-9	4	9	Short	50	3.5kg	.5kg	Cr300
Flasher-9	1 (special)	9	Contact	-	3.0kg	-	Cr800
Hazer-9	special	9	Contact	-	3.5kg	-	Cr700
Sentry Pistol-9	-	9	V.Short	-	.3kg	-	Cr200
Sentry Rifle-9	-	9	Medium	-	1.5kg	-	Cr400
Submachinegun-9	3	9	Short	100	3.0kg	1.4kg	Cr780
SMG, Compact-9	3	9	V.Short	20	1.8kg	.3kg	Cr750
LAAW-9	24 (16 expl.)	9	Short	1	10.9kg	-	Cr1800
Mine, AP-9	4 (3 expl.)	9	-	1	.1kg	-	Cr20
Mine, AT-9	32 (21 expl.)	9	-	1	5.0kg	-	Cr420



## Tech Level 10

Name	Dam. Rating	TL	Range	Shots	Mass	Reloads	Cost
ACR-10	4	10	Medium	100	5.2kg	1.2kg	Cr1090
ACR, RF-10	4	10	Short	250	3.4kg	1.1kg	Cr640
Carbine, Tranq-10	0 (special)	10	V.Short	30	1.1kg	.5kg	Cr190
Grenade-10	8 fragment	10	Contact	1	.2kg	-	Cr50
Grenade, Sticky-10	(special)	10	Contact	1	.5kg	-	Cr80
Knife-10	1	10	Contact	-	.4kg	-	Cr50
MG, Heavy-10	9	10	Long	300	190kg	75kg	Cr5500
MG, VRF Gauss-10	10	10	Long	3000	75kg	25kg	KCr24.3
Pistol-10	3	10	V.Short	30	1.0kg	.2kg	Cr490
Pistol, Tranq-10	0 (special)	10	Contact	10	.5kg	.2kg	Cr250
Revolver, Magnum-10	3	10	Short	6	1.4kg	-	Cr2300
Rifle, Hunting-10	5	10	Long	5	4.7kg	.1kg	Cr4000
Rifle, Sniper-10	6	10	Long	10	5.2kg	.2kg	Cr4200
Shotgun-10	2 (special)	10	Short	2	3.7kg	.1kg	Cr1100
Shotgun, Assault-10	2 (special)	10	V.Short	30	5.7kg	1.8kg	Cr600
Sticky Gun-10	(special)	10	Contact	40	7.0kg	5.0kg	Cr2000
Waterknife-10 (civ.)	2D (special)	10	Contact	10	9.0kg	4.0kg	Cr2000
Waterknife-10 (mil.)	2D (special)	10	Contact	10	7.0kg	4.0kg	Cr3500
Cannon, Heavy-10	24	10	E.Long	10	3100kg	205kg	MCr1.1
Cannon, H.-10, cont.	25 expl.		V.Long			280kg	
Cannon, H.-10, cont.	30 HEAP		V.Long			280kg	

## Tech Level 11

Name	Dam. Rating	TL	Range	Shots	Mass	Reloads	Cost
ACR-11	5	11	Medium	100	4.3kg	.6kg	Cr1050
Crossbow-11	4	11	Medium	1	3.8kg	.1kg	Cr550
Pistol-11	3	11	V.Short	20	1.1kg	.2kg	Cr500
Pistol, Target-11	3	11	Short	20	1.5kg	.2kg	Cr2100
Rifle-11	5	11	Medium	50	4.9kg	.6kg	Cr970
Snub Gun-11	5	11	V.Short	10/20	.6kg	.1kg	Cr610
Snub Gun, Pocket-11	5	11	Contact	3	.2kg	-	Cr210
Snub SMG-11	5	11	Short	60	1.6kg	.3kg	Cr960
Staple Gun-11	2	11	V.Short	25	.9kg	.1kg	Cr550
Stay-Put-11	special	11	Contact	5	2.0kg	1.5kg	Cr400
Thud Gun-11	1	11	V.Short	10	.7kg	.1kg	Cr580
Thud Gun, Pocket-11	1	11	Contact	2	.3kg	-	Cr160
LAAW-11	29 (17 expl.)	11	Short	1	13.0kg	11.5kg	Cr4600
Mine, AP-11	5 (3 expl.)	11	-	1	.1kg	-	Cr25
Mine, AT-11	34 (22 expl.)	11	Contact	1	5.0kg	-	Cr550
PD Laser, RF-11	5	11	Medium	-	13.3kg	-	Cr7000

## Tech Level 12

Name	Dam. Rating	TL	Range	Shots	Mass	Reloads	Cost
ACR-12	5	12	Medium	100	4.1kg	.5kg	Cr2900
Grenade-12	8 fragment	12	Contact	1	.2kg	-	Cr50
Pistol, Body-12	2	12	Contact	1	.1kg	-	Cr540
Pistol, Body-12	2	12	Contact	5	.2kg	-	Cr1100
Pistol, Hvy Laser-12	5	12	Short	30	2.9kg	1.3kg	Cr7500
Pistol, Lt Laser-12	4	12	Short	30	2.0kg	.7kg	Cr2000
Rifle, Gauss Snpr-12	8	12	Long	10	10.4kg	2.1kg	KCr31.3
Rifle, Hunting Lsr-12	6	12	Long	5	3.9kg	.5kg	Cr7500
Rifle, Laser-12	7	12	Long	50	15.6kg	7.8kg	KCr10.4
Rifle, RF Gauss-12	9	12	Long	500	68kg	58kg	Cr9100
Spurt Gun-12	2	12	Contact	200	.2kg	-	Cr2000
Cannon, Hvy Gauss-12	27	12	Subregional	5	1400kg	32kg	MCr3.58
PCMP-12	19 (4 expl.)	12	Medium	20	28.9kg	16.6kg	KCr24.5
Plasma Cannon, Lt-12	44 (11 expl.)	12	E.Long	10	1360kg	-	KCr500
Plasma Cannon, Md-12	50 (12 expl.)	12	Subregional	10	3900kg	-	KCr880
PD Laser, VRF-12	5	12	Medium	-	16.8kg	-	Cr7000

## Tech Level 13

Name	Dam. Rating	TL	Range	Shots	Mass	Reloads	Cost
ACR, Gauss-13	6	13	Medium	100	5.5kg	3.0kg	Cr6700
ACR, Laser-13	6	13	Long	50	5.5kg	2.8kg	KCr11.3
MG, VRF Gauss-13	8	13	Medium	10000	65kg	32kg	KCr16
Pistol, Gauss-13	4	13	Short	100	2.4kg	1.0kg	Cr2600
Pistol, Laser-13	4	13	Short	40	1.6kg	-	Cr2150
Rifle, Hvy Laser-13	10	13	Long	5	10.7kg	2.0kg	KCr54.5
Shotgun, Gauss-13	(special)	13	V.Short	20	7.0kg	2.9kg	Cr2300
Snub SMG, Heavy-13	9 (4 expl.)	13	V.Short	12	1.1kg	.4kg	Cr200
Cannon, VRF Gauss-13	11	13	Long	10000	370kg	150kg	KCr71
PCMP-13	21 (5 expl.)	13	Long	20	28.6kg	13.3kg	KCr45.0
Plasma Cannon, Hvy-13	81 (20 expl.)	13	Subregional	1	11.4 tons	-	MCr16.2
Plasma Cannon, Lt-13	44 (11 expl.)	13	E.Long	10	880kg	-	KCr550
Plasma Cannon, Md-13	52 (13 expl.)	13	Subregional	10	3000kg	-	MCr1.1
Plasma Cannon V Lt-13	24 (6 expl.)	13	V.long	10	32kg	-	KCr82
Plasma PD Cannon-13	44 (11 expl.)	13	Subregional	10	2000kg	-	MCr18.8
PD Laser, VRF-13	6	13	Long	-	26.4kg	-	KCr12.6

## Tech Level 14

Name	Dam. Rating	TL	Range	Shots	Mass	Reloads	Cost
ACR, Gauss-14	6	14	Medium	100	5.2kg	2.0kg	Cr4900
ACR, Laser-14	6	14	Long	50	4.5kg	1.7kg	Cr5200
Grenade-14	10 expl.	14	Contact	-	.2kg	-	Cr50
Grenade, Plasma-14	17 (4 expl.)	14	Contact	-	.5kg	-	Cr150
Pistol, Hvy Gauss-14	5	14	Short	30	1.6kg	.3kg	Cr8200
Pistol, Laser-14	4	14	Short	50	1.4kg	.3kg	Cr2930
Pistol, VRF Gauss-14	3	14	V.Short	400	1.3kg	.6kg	Cr2600
MG, Laser-14	10	14	Long	-	36.8kg	24.4	KCr45.5
MG, VRF Gauss-14	9	14	Long	10000	70kg	29kg	KCr33
Shotgun, Gauss-14	(special)	13	V.Short	20	6.3kg	1.8kg	Cr2000
Cannon, VRF Laser-14	11	14	Long	-	400kg	-	KCr330
PCMP-14	23 (5 expl.)	14	Long	20	38.6kg	13.0kg	KCr66.1
Plasma Cannon, Hv-14	84 (21 expl.)	14	Subregional	1	11.3 tons	-	MCr21.3
Plasma Cannon, Lt-14	46 (11 expl.)	14	E.Long	10	820kg	-	KCr660
Plasma Cannon, Md-14	55 (13 expl.)	14	Subregional	10	3000kg	-	MCr1.5
PD Laser, VRF-14	7	14	Long	-	32.6kg	-	KCr31.1
Thor-14	special	14	Subregional	1	605 tons	250kg	MCr184

## Tech Level 15

Name	Dam. Rating	TL	Range	Shots	Mass	Reloads	Cost
ACR, Gauss-15	6(8)	15	Long	50	4.6kg	.8kg	KCr11.6
ACR, Laser-15	6(7)	15	Long	100	4.5kg	2.1kg	KCr14.6
Pistol, Body-15	2	15	Contact	3	.1kg	-	Cr5500
Pistol, Laser-15	4	15	Short	30	1.0kg	.2kg	Cr2900
Cannon, VRF Laser-15	12	15	Long	-	460kg	-	KCr410
PCMP-15	25 (6 expl.)	15	Long	20	38.6kg	12.5kg	KCr91.1
Plasma Blunderbuss-15	17 (4 expl)	15	Medium	5	7.4kg	-	Cr7800
Plasma Cannon, Hv-15	89 (22 expl.)	15	Subregional	1	12.1 tons	-	MCr27.1
Plasma Cannon, Lt-15	48 (12 expl.)	15	E.Long	10	820kg	-	KCr802
Plasma Cannon, Md-15	57 (14 expl.)	15	Subregional	10	2970kg	-	MCr1.8

## Tech Level 16

Name	Dam. Rating	TL	Range	Shots	Mass	Reloads	Cost
Pistol, Laser-16	6	16	Short	25	1.8kg	.4kg	KCr16.9
Rifle, AM Gauss-16	8 (44 expl.)	16	Medium	100	4.8kg	1.9kg	KCr40
Rifle, CG-16	66	16	V.Long	20	3.8kg	1.4kg	Cr2100
Rifle, Plasma-16	15 (4 expl.)	16	Long	10	7.0kg	-	KCr20
AMPCMP-16	68 (52 expl.)	16	Long	10	25kg	-	KCr660

# Imperium Games Web Site

has a **WHOLE** new look **AND** feel for the fans of the **GAMES** and **MORE!**

## '<http://www.imperiumgames.com>'

### Convention Listings!

Find out where your favorite Traveller creators will be appearing this season!

### Chat Groups!

Talk to other fans of the Traveller universe!

### Back Issues!

Missed out on Traveller expansions? Here's where to complete your arsenal!



### Special Offers!

Exclusive Traveller offers available only via the web site!

### Suggestion Forums!

Got an itch for a Traveller expansion that isn't out yet? Here's your chance to voice your opinion!

### Upcoming Products!

Don't lose out to your friends! Get the scoop on all the new Traveller news!

# NEW!

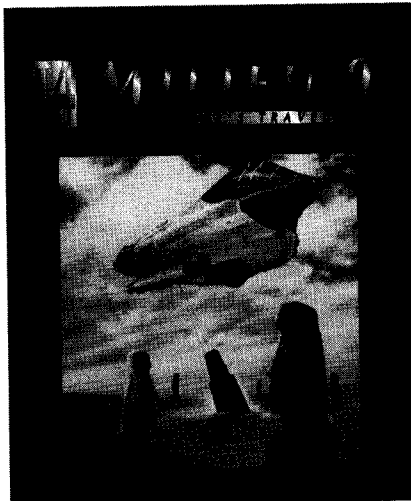

# AVAILABLE NOW!

Get the latest **Traveller** expansion without leaving your home!

# JTAS

## Journal of the Travellers' Aid Society

The source for the newest Traveller information, from exciting scenarios that take adventuring to new heights to the latest development within Third Imperium.

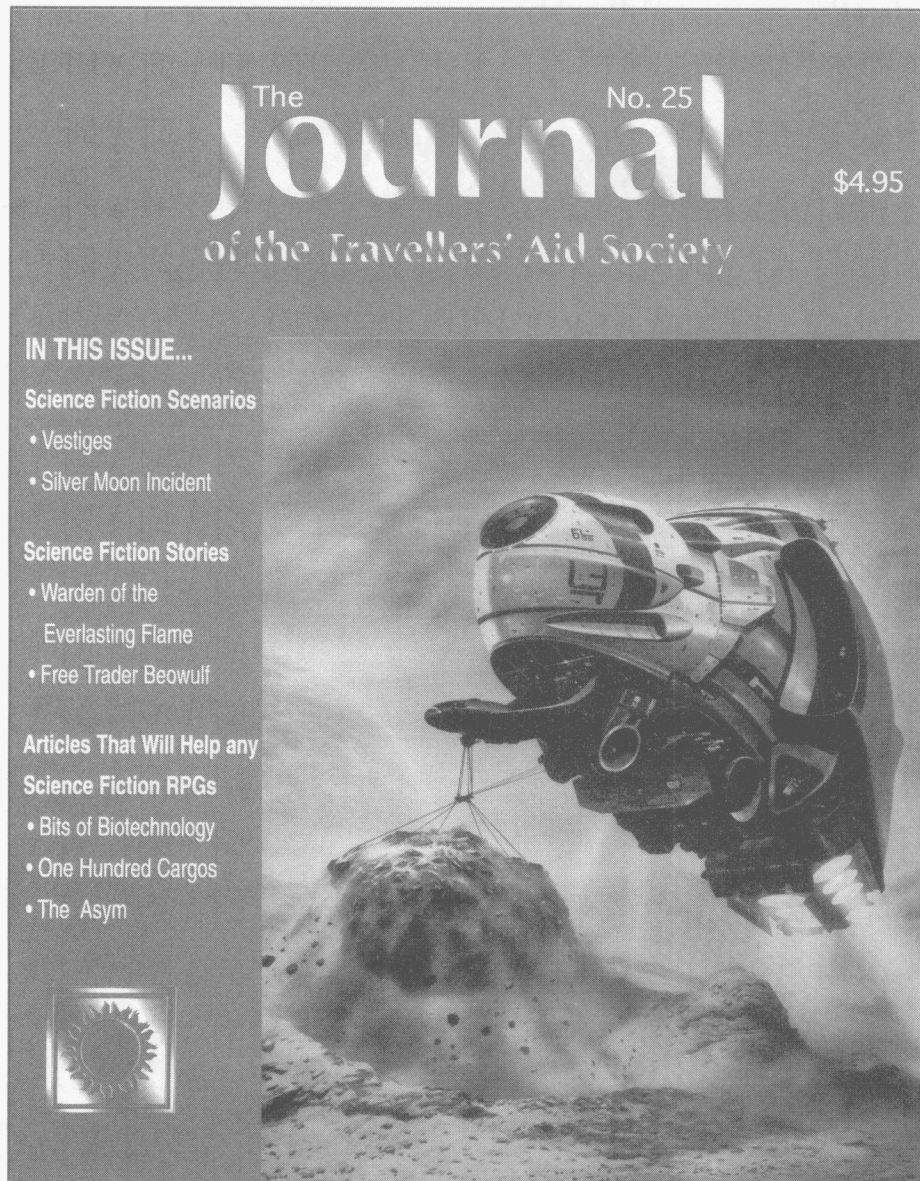

No serious Traveller fan should miss an issue!  
If you don't have it...you don't get it!

Pick it up at your local game store, order it directly via the Imperium web site at <http://www.imperiumgames.com>, or send a check or money order for \$30.00 for a one year subscription to Imperium Games, 9461 Charleville Blvd. #307, Beverly Hills, CA 90212





**IMPERIUM GAMES, INC.**  
9461 Charleville Blvd. #307  
Beverly Hills, CA 90212



ISBN 1-57828-350-7 \$22.95 IGI-1500



Marc Miller's  
**TRAVELLER 4TH EDITION**

Traveller is a registered Trademark of FarFuture Enterprises. Copyright © 1997 Imperium Games, Inc. All rights reserved. Printed in the U.S.A.