

# PROJECT PHOENIX

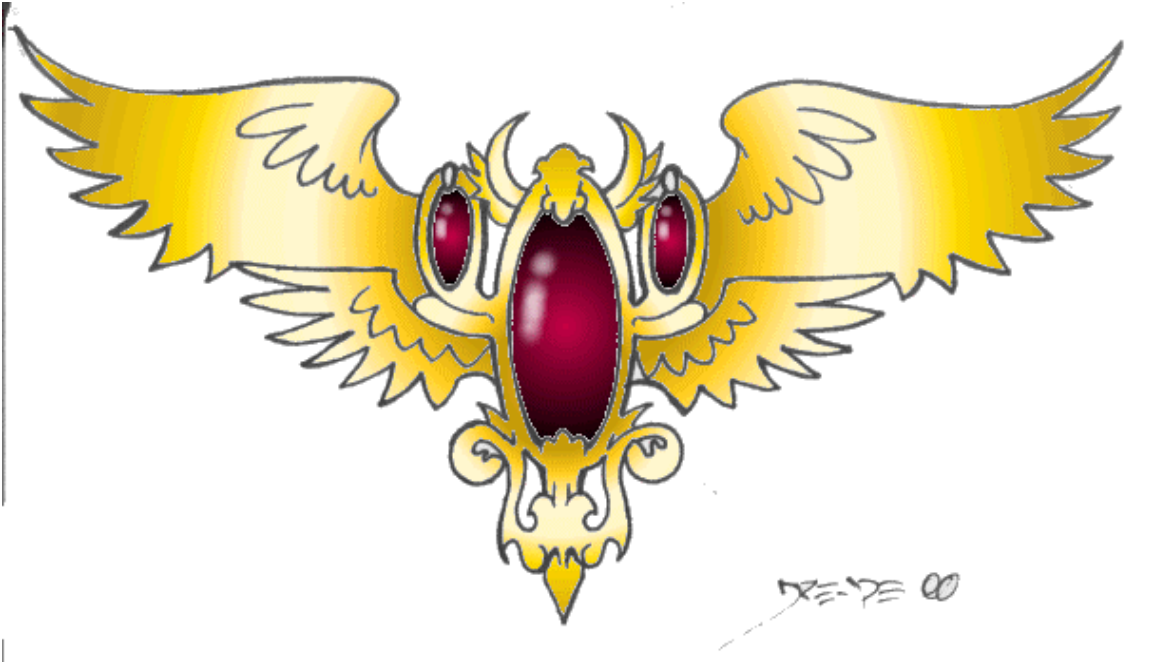

The World As We Know It has ended.

But a small group of scientists knew it was coming - and had the resources to put teams in protected bases, scattered around the world. While they could not stop the Fall, they could at least make sure Humanity got its foot back on the ladder.

<b><u>ABOUT THIS BOOK :</u></b> .....	<b>5</b>
<b>BACKERS</b> .....	<b>7</b>
<b><u>PROJECT TECHNOLOGY</u></b> .....	<b>8</b>
<b>WHAT WENT WRONG</b> .....	<b>8</b>
<b><u>CHARACTER GENERATION</u></b> .....	<b>9</b>
<b>PRIMARY ATTRIBUTES</b> .....	<b>9</b>
<b>SECONDARY ATTRIBUTES</b> .....	<b>9</b>
<b>SKILLS</b> .....	<b>9</b>
<b><u>TEAM CONSTRUCTION</u></b> .....	<b>14</b>
<b>EAGLE TEAMS</b> .....	<b>14</b>
LIGHT EAGLE TEAM: .....	14
MEDIUM EAGLE TEAM: .....	14
HEAVY EAGLE TEAM.....	14
<b>OWL TEAMS</b> .....	<b>15</b>
LIGHT OWL TEAM:.....	15
MEDIUM OWL TEAM:.....	15
HEAVY OWL TEAM:.....	15
<b>HAWK TEAMS</b> .....	<b>15</b>
LIGHT HAWK TEAM: .....	15
MEDIUM HAWK TEAM: .....	16
HEAVY HAWK TEAM: .....	16
<b><u>EQUIPMENT</u></b> .....	<b>16</b>
<b>BASIC LOADS</b> .....	<b>16</b>
GENERAL ISSUE GEAR .....	16
JOB ISSUE GEAR .....	18
DEFENSIVE GEAR .....	18
<b><u>WEAPONS</u></b> .....	<b>18</b>
<b>HANDGUNS</b> .....	<b>18</b>
GLOCK MODELS 17, 19, 26. 9MM.....	18
HK SOCOM, .45 ACP (11.43X23MM).....	19
<b>SUB MACHINE GUNS</b> .....	<b>19</b>
HK MP5 N:.....	19

HK UMP .45.....	19
M16A2 COMMANDO 5.56MM .....	19
<b>RIFLES .....</b>	<b>20</b>
M16 A2 .....	20
HK G3A3 RIFLE, 7.62X51MM .....	20
HK G3A4 CARBINE, 7.62X51MM .....	20
SPRINGFIELD ARMORY M6 SCOUT.....	21
<b>MACHINEGUNS.....</b>	<b>21</b>
SHRIKE LMG 5.56MM .....	21
M60E3 AND M60D LIGHT MACHINE GUNS .....	21
M2HB "MA DEUCE" .50 CAL MACHINE GUN .....	22
<b>SHOTGUN .....</b>	<b>22</b>
MOSSBERG 9201 SHOTGUN .....	22
<b>HEAVY WEAPONS : GRENADE LAUNCHERS, ROCKETS AND MISSILES.....</b>	<b>23</b>
M203 GRENADE LAUNCHER .....	23
40MM AMMO FOR THE M203 GRENADE LAUNCHER.....	23
MK19 MACHINE GRENADE LAUNCHER.....	24
40MM AMMO FOR THE MK 19 MACHINE GUN .....	24
M383 / M384 40MM HE (HIGH-EXPLOSIVE) CARTRIDGES .....	24
M430 HEDP (HIGH-EXPLOSIVE, DUAL-PURPOSE).....	24
M72A3 LAW ROCKET .....	25
M47 DRAGON MISSILE LAUNCHER.....	25
M151 TOW MISSILE LAUNCHER .....	25
FIM-92A STINGER MISSILE .....	26
M252 MORTAR .....	26
<b>COMMUNICATIONS EQUIPMENT.....</b>	<b>27</b>
GMRS PERSONAL RADIO .....	27
KENWOOD TH-G71A HANDHELD COMM.....	27
KENWOOD VC-H1 VIDEO COMM -HANDHELD.....	28
KENWOOD TM-742AD MOBILE (VEHICLE) RADIO.....	28
PROJECT PERSONAL COMPUTER - TERRALOGIC DISCOVERY .....	29
<b>MEDICAL GEAR .....</b>	<b>29</b>
DRUG KIT:.....	29
<b>OPTICS AND SENSORS.....</b>	<b>30</b>
<b>NBC KIT - NUCLEAR, BIOLOGICAL AND CHEMICAL WARFARE KIT .....</b>	<b>30</b>
M17A1 GAS MASK AND HOOD .....	30
MINI MULTI-COMBAT-ANYLIZER-430 .....	30
<b>FOOD KIT .....</b>	<b>31</b>
<b>TRADE KIT.....</b>	<b>31</b>
<b>VEHICLES .....</b>	<b>31</b>
M1109 HMMWV WEAPONS CARRIER .....	31
LAV-300 ARMORED PERSONNEL CARRIER.....	32
M977 HEMTT CARGO TRUCK WITH MATERIAL HANDLING CRANE .....	33
<b><u>TASK RESOLUTION.....</u></b>	<b><u>35</u></b>
<b>BASIC IDEA .....</b>	<b>35</b>
<b>OPPOSING TASKS:.....</b>	<b>35</b>
<b>RANGED COMBAT MODIFIERS .....</b>	<b>36</b>
<b>MELEE COMBAT MODIFIERS .....</b>	<b>36</b>

<b><u>DAMAGE RESOLUTION</u></b> .....	<b>37</b>
<b>DAMAGING ORGANICS</b> .....	<b>37</b>
<b>HEALING:</b> .....	<b>37</b>
<b>DAMAGING IN-ORGANICS</b> .....	<b>37</b>
<b>REPAIR MODIFIERS</b> .....	<b>38</b>
REPAIRING PEOPLE .....	38
REPAIRING STUFF.....	38
<b><u>BIOLOGICAL WARFARE</u></b> .....	<b>38</b>
<b>CATCHING THE BUG</b> .....	<b>38</b>
<b>TREATMENT:</b> .....	<b>38</b>
<b>BIOLOGICAL WARFARE CONSTRUCTION KIT</b> .....	<b>38</b>
<b><u>CHEMICAL WARFARE</u></b> .....	<b>40</b>
SAMPLE CHEMICAL AGENTS: .....	41
<b>CHEMICAL WARFARE AGENTS</b> .....	<b>42</b>
<b><u>RADIATION</u></b> .....	<b>43</b>
<b>RAD HAZARDS:</b> .....	<b>43</b>
<b>INITIAL RADIATION EXPOSURE:</b> .....	<b>43</b>
<b>ONGOING RADIATION EXPOSURE</b> .....	<b>44</b>
<b><u>ANIMAL ENCOUNTERS</u></b> .....	<b>45</b>
<b><u>PEOPLE</u></b> .....	<b>47</b>
<b><u>NON-PROJECT WEAPONS</u></b> .....	<b>52</b>
<b><u>THE FALL</u></b> .....	<b>70</b>
<b>OPTION 1 : GLOBAL THERMONUCLEAR WAR</b> .....	<b>70</b>
RUSSIAN NUCLEAR DOCTRINE.....	70
RUSSIAN NUCLEAR MISSILE DATA.....	77
US TARGETS.....	78
<b>OPTION 2: CLIMATE CHANGE</b> .....	<b>81</b>
<b>OPTION 3: 'DINO KILLER' IMPACT</b> .....	<b>81</b>
OPTION 4: ORWELLIAN CHANGE .....	83

**About this book :**

This font is used for section headings.

This font is used for background information about the Project.

*This font is used when game information is placed within background or story-lines.*

This font is used for general game rules.

*This font is used for notes of advice to the GM or Players*

**Things in blue** are hyperlinks on the CD version - these allow you to flip instantly to another page, or in many cases, a whole manual on the topic.

If you're interested in acquiring the CD Version, send email to [schwartz@bitstorm.net](mailto:schwartz@bitstorm.net) or send \$20 (includes postage and handling) to :

Jeff Schwartz  
43 Floridana Road  
DeBary , FL, 32713

## Background Information

*IN the Garden of Paradise, beneath the Tree of Knowledge, bloomed a rose bush. Here, in the first rose, a bird was born. His flight was like the flashing of light, his plumage was beauteous, and his song ravishing. But when Eve plucked the fruit of the tree of knowledge of good and evil, when she and Adam were driven from Paradise, there fell from the flaming sword of the cherub a spark into the nest of the bird, which blazed up forthwith. The bird perished in the flames; but from the red egg in the nest there fluttered aloft a new one- the one solitary Phoenix bird. -- FAIRY TALES OF HANS CHRISTIAN ANDERSEN, 1872*

On Thursday, November 18, 1989, a research group operating in the Los Alamos lab in New Mexico made a breakthrough. They were following a line of inquiry based on a unproved relationship between electromagnetism and gravity, in the hopes of producing anti gravity technology. What they found destroyed the lab, but the records survived.

They managed to construct a "tame" micro-sized black hole that would collapse when they stopped providing power to it. Stephen Hawking was brought in to try to figure out exactly what they had. During the course of that research, they discovered that by inserting probes at just the right angle and velocity, the probe would pass close enough to the event horizon to be propelled out of the "light cone" - and as it completed its orbit, it would fall back into our own space.

Attaching radio receivers and recorders to the probes was easy, and the research crews found that they were getting radio news stories from between 1 and 100 years in the future. They monitored it for 3 years, making quite a bit of money in the stock market in the process, when suddenly, they stopped getting any stories more than 50 years out. As time progressed, it became 49 years, then 48...

Obviously something would happen in 47 years that would take every radio station in the world off the air. Maybe it was a technological breakthrough that made radio obsolete - or maybe it was something very, very bad. No one knew and it was too big a risk to just ignore.

A small group of scientist put forth a proposal to their superiors, and it went through channels. FEMA became involved, as well as other government agencies. Project Phoenix was born.

During the intervening 5 years of research, still trying to develop anti-gravity, the scientists taught their tame black hole a new trick - they could distort the flow of time in a given area, by a factor of about 700 to 1. While about two years would pass outside the field, only a day would pass inside.

Project Phoenix designed and constructed a number of bunkers across the world, and put time distorters in each one. They equipped these bunkers lavishly, and trained the crews. If the loss of signal was because of a world wide natural disaster, war, astride strike, or something worse, at least there would be something there to "jump start" humans back toward an advanced society.

**Standing Orders** for the Project were:

- 1) Assist those in need.
- 2) Promote a democratic "American Way" society during the course of rebuilding
- 3) Act as repositories of knowledge, and share that knowledge with those who can best use it.

This is, of course, rather idealistic. On the other hand, if the teams had to fall back to making decisions based on a "high level mission statement", they were pretty much free of a chain of command at that point anyway.

Teams were issued large amounts of weapons based on the chance that there was still a war in progress when they came out of Flicker. It was anticipated that the level of weaponry issued would be sufficient slow an incoming Aggressor Force until the normal US Military got back on its feet. The Project rules of engagement are to fire only to prevent loss of life or grievous bodily harm. The Project Code of Justice includes provisions for a Court Martial Tribunal and the penalties are much more draconian than the current US Army. For example, willful and needless execution of a civilian is punishable by hanging. The members of the Project were expected to either set a high example for the rest of society to follow or die trying - one way or the other.

*Even when there is no Project Military Tribunal watching over your shoulder, the Universe seems to have its own way of setting things straight. Players each have a number of Karma points. These may be used in desperate situations to bail the character out of trouble by changing the odds on a given task roll. Players gain Karma points through 'good deeds' - living up to the image and expectations of the Project. Alternately, actions which are totally against the morals of the Project (killing civilians, etc) will reduce the Karma*

of the character. Negative Karma influences the die rolls the other way, and is allocated by the GM (Game Master). At any given time, the player will know only how much Karma the character started with, and how much they've used. The GM is not obligated to tell them when they've gained or lost points. It is recommended that Karma awards be, at most, one point per adventure. Karma penalties will happen as often as the player commits horrible wrongs.

*The whole idea behind the Karma awards comes from two items that came up during various games over the years. The first is that modern weapons are very lethal, and the players do need some kind of edge to allow them to survive. The second is that some people tend to be ... shall we say, "a bit too jumpy". This tends to lead to a "shoot first, worry about it later" mentality. Karma points are an attempt to avoid that.*

### **Backers**

The Project was backed by a number of US Government agencies - FEMA was the foremost among them but others knew. The Joint Chiefs willingly fudged papers to make equipment 'disappear', and they apparently did it with the knowledge of a number of members of Congress.

Seven scientists (Dr. Colvin, Dr. Edwards, Dr. Maxis, Prof. Wall, Prof. Studenberg, and Dr. Milleit) provided cash for the Project from their considerable fortunes, gained during the aftermath of Project Icarus, and its unexpected future information.

The Overall Project Leader was a 'retired' one-star general named Martin 'Marty' Serpico. A big man, six foot seven and 260 pounds of pure muscle, he had come up through Marine Force Recon, and kept his military bearing.

General Serpico decided to have his people trained in four different training programs, each focussing on a different overall task in the Project.

The HAWK leader was Capt. Sam Randall, formerly commanding the US Navy's SEAL 9. At 5'3", and a mere 120 pounds, he was physically the smallest person in the whole HAWK section of the Project. However, he was reputed to be "120 pounds of sheer determination". No matter what he was faced with, he would not give up. He'd try approach after approach until he succeeded.

HAWK's were meant to protect the other teams from harm and to act as "heavily armed MP's" to stop local brush-wars. HAWK team recruiters prowled military bases, looking for "the best of the best of the best, with honors, sir!" The ideal HAWK candidate was either a West Pointer who had actually led troops in combat, or an enlisted man that had seen the elephant, then gone to OCS. The minimum rank for HAWK teams was O-2, and once in the teams, rank didn't matter much at all. Everyone was treated the same - just like "dirt".

OWL trained individuals were to act as engineers, scientists and living repositories of the "old knowledge". Doctor Sarah Colvin headed up the OWL training. She was a physicist from the early Project Icarus anti-grav experiments, and one of the people who understood Hawking Technology best. At age 41, she was a 5'4" bundle of energy. She competed in local triathlons, never winning but always finishing in the top half of the pack. A thin, 90 pound brunette, she often invited pudgy OWL trainees to go for a run with her. Soon, they were no longer pudgy, but many developed an aversion to running. OWL recruiters wanted people who knew their stuff. In spite of the large proportion of college degrees found in OWLs, a degree wasn't required if the candidate had demonstrated knowledge and talent in their field. Most of the tech/engineering OWLs were independent contractors before being brought in. Medical OWLs tended to be ER doctors and paramedics who were beginning to burn out - six months of training and at least another month of 'Flicker' would be enough of a break to let them recover.

The eyes and ears of the Project were the EAGLES. Many were recruited from Army Light Infantry units, or from hunting guides in areas where the hunting preserves were being closed. Others were ex-CIA, and in some cases ex-police. The desired traits were excellent woodcraft and survival skills, along with the ability to interact with people well when they did run into civilization. EAGLE training was headed up by Lt Phil Davis. "The LT" was a former Army Ranger who had gone into the Army Reserves after his first hitch. He then started working as a consultant for "A Civilian Company Based In Langley, Virginia". He spent four years working as a 'field researcher' for that company in a variety of environments. At 5'6", 155 pounds, brown hair, brown eyes, he was the epitome of 'non-descript'.

All of the above would need supplies, as would the people they were helping. The Project put together a fourth section which would handle these tasks - people who had the 'hands-on' skills and background to get the world functioning again. VULTURE teams were made up of wildcat oil rig crews, coal miners, loggers, Army Corp of Engineers members, steel workers and other such people who did things with their hands. These people were also picked for the ability to act as a foreman; it was anticipated that they would act as a cadre of skilled workers who could straw boss refugees into productive labor. The

VULTURE's were a strong, independent lot. Several different people ran this side of the house during the course of the Project.

### **Project Technology**

The Project developed a variety of special technologies during its set-up. These were, in order of invention:

**Future Viewer:** Only two were built; one at the research facility that spawned the Project, and another at Project HQ. Since Project HQ was buried in much the same way NORAD was (just in case), it had a huge 'gravitic slope' upon which the time distorter built momentum. Someday this device will be available to the Project again.

**Time Distorter:** This device generates a field in which time flows 700 times slower inside the field than outside. If used for more than three years (outside time), it begins picking up 'momentum' which causes the field to remain in place even after power is removed. The duration of the field depends on local micro-gravity differences. Typically, more matter around the field, the more momentum. While inside the distorter field, you can look out, but everything outside seems to flicker and twitch. There is also a Doppler distortion that twists the colors. This visual effect led to the slang term 'Flicker' for being inside the field. From the outside, the field looks like a red sphere - it would be black, but light being twisted around the event horizon is Doppler distorted before reaching the viewer.

**Zero Point Reactor:** If you take six small gravity generators, and arrange so that the fields intersect in just the right way, two things happen. First, the gravity fields cancel each other out before leaving the outside of the box you've put them in, and thus, the box seems inert from the outside. Second, a small "cold point" forms in the center of the configuration. This cold point is a place where all matter and energy have been removed by "dragging" it toward a gravity generator, resulting in a small zone of absolute, perfect, energyless vacuum. The universe does not like this. 'Nature abhors a vacuum', and this kind of perfect vacuum just drives it totally nuts. As a result, in order to balance the normal chaos of the universe, a 'little bang' occurs in the center of the zone of space. A pulse of electrons spontaneously accumulate, then look for something to ground to. By careful placement of an anode grid, those electrons are captured and routed to capacitors where high energy pulses are stored and slowly drained to charge batteries, thus powering the device and providing a steady stream of power output.

The smallest Zero Point Reactor (ZPR or 'Zipper') is about the size of a GM V6 engine, with similar power output. This is used in Project vehicles. The next step up is a Zipper 2m x 4m x 1m used to power bases. Neither are particularly portable. Both have warnings about "No User Serviceable Parts Inside"

Breaching the outside of one while its running will cause it to suck air in from the outside. The air will fall in toward the gravity generators, compressing in on itself as it does. At some point, the heat of compression will convert the air to plasma. Milliseconds later, the interior of the Zipper will incinerate, along with anything else within about 50 meters. Zippers have a "fail safe" that is supposed to shut them down when the outer casing is cracked and before the inner casing is opened. The failsafe works about 75% of the time.

The rest of the equipment that the Project relied on was either US Military or commercial/civilian production. Because they had independent funding (Wall Street Journal from 2 years in the future), it was easy to buy some things 'off the street' rather than waiting for 'lowest bidder'. When it came to weapons and other hardware that couldn't be picked up easily, they used the US Military as their supplier.

### **What went wrong**

The time distortion equipment was designed to shut down when the BBC was not received for 2 weeks straight, or when the crew inside shut it down manually.

On the whole, it did.

But no one (for obvious reasons) had ever tested the shut down cycle of a time distorter that had run for more than 3 years. In actuality, there is a approximately 5 year "threshold" for these devices. After running that long, there is a kind of "momentum" built up, that allows the time distorter to "coast" once power has been removed. This "coast time" depends on a kind of "gravitic friction" based on the elevation (and thus local microgravity change) of the generator at the time of start up, and the coast time can be up to three times the run time of the generator.

The crews were supposed to "flicker" over 40 years in 20 days of local time. In some cases, they flickered an additional 120 years, in 60 days of local time. Since each base



had consumables for 120 days, they could survive the extra time, but since the coast time was random it meant that rather than a unified return, with multiple teams being able to work together, the teams were strewn over a 120 year period. Teams "In Flicker" could receive radio signals, but couldn't send through "the horizon". Requests for aid went unanswered, and more and more teams realized they were on their own.

**Character Generation**

**Primary Attributes**

Phoenix uses the "classic six" char attributes, using a percentage scale. 50 is a normal human. Rolling is a little unusual: Roll d10. If its even, you're above normal, odd below. Since there are certain minima for being in the Project, if you're "below", subtract 2d10. If you're "above", add 5d10.  
 Strength : Multiply Strength by 0.75, round up. This is max encumbrance in kilos. Double strength is max liftable (again, in kilos)  
 Dexterity : Overall body coordination.  
 Constitution: General physical shape  
 Intelligence : Overall thinking ability. 50 is equal to and IQ of 100.  
 Willpower: Ability to keep going even after your Intelligence tells you its hopeless.  
 Charisma: Overall physical and social attractiveness.

**Secondary Attributes**

Accuracy: This is a base attribute for hand-eye coordination. It is equal to DEX/10.  
 Dodge: This is the ability to perceive, identify, and figure the best course of action to evade a threat, then implement the dodge. (DEX+INT)/20.  
 Damage Resistance: (CON+WILL)/20. This is used to determine how well the char can handle taking hits. Also used for "stamina" points.  
 Disease/Radiation Resistance : CON/10  
 Age: determined by player, but Project standards are 21 to 50. For year past 30, subtract 1 from CON, and 1 from either STR or DEX.  
 Karma : "What goes around, comes around" Subtract your lowest stat from 100, then divide by 10. For example, if your low stat is a Dex of 30, then your Karma is (100-30)/10 = 7.  
 Blood Type : (used when transfusing blood from one to another)  
 Roll D10 twice:

1-3	O
5-8	A
9	B
0	AB

8	Rh Positive
9-0	Rh Negative

**Skills**

Chars get a number of skill points to invest based on (INT/30) x Age. Skills are rated from 1-5, with 1 being "exposure" and 5 being "PhD" or "Seasoned Professional Guru". Skill points may be placed into the Category (ie, Animal skills), in which case they count as 1/2 (round up) for all skills in the category. The sub-skills can be bought up as well. For example, someone who's parents owned a farm might have "Animal Skills 2", which gives Horseback 1, and spend another point to buy Horseback up to "2".  
 In cases of multiple indentations, the skill level is halved at each indentation up or down from where the player purchased the skill. Thus Animal Skills 2 also gives Agriculture 1 (the char remembers the farm he learned to ride on). This halving always rounds up, so there is always a 1 point skill there.  
 Buying a skill requires paying for all levels below of that skill. Skill level 3 costs 1+2+3 = 6 points. Maximum level is 5. Purchase of Animal Skills 2 costs 1+2 = 3 points. Skills involving the use of a given article of technology may be bought at one level to the right on the chart, but only for one item. For example, you could buy "Combat Arts 1", "Firearms 1" "Handgun 1" and "Glock 17 : 1" for a total skill with the Glock 17 of 4 and a cost of only 4. On the other hand, you could spend 1+2+3+4 = 9 points and get level 4 in "Firearms", or "Combat Arts 2", "Firearms 3" for a total of 9 points for the same effect but have other skills too.  
 Skills can be used to substitute, within reason - for example, someone with Human Medicine could guess about working on a horse. Skills drop to 1/2 in this case.  
 Skills listed with a "\*" get only 1:6 ratio for buying via the category, since they're only slightly related.  
 Some skills show up in more than one category, for just the above reason.  
 (Many skills are in this table for non-Project chars)

Depending on training, your character will get other skill bonuses:

HAWK: Athletics: 3, Combat Arts : 4, Medicine : 1

OWLs get 1 bonus skill point for every 8 points of INT. They can place this in any skill they wish. They also get 3 skill points for their job skill - Medicine, Geology, Computer Science, etc.

EAGLES : Ecology - 3,Combat Arts: 2,Engineering : 1, Liberal Arts : 1 (Pick a language, too)

VULTURES: Forestry: 2,Unarmed Combat : 1,Engineering: 2,Civil Engineering : 1,Repair Electrical : 1,Repair Mechanical : 2,Geology: 1

<b>Athletics</b>					
	Animal Riding*				
	Swimming				
	Climbing				
	Jumping				
	Muscle Powered Ranged Weapons*				
	Move Silently				
	Melee Weapons *				
	<a href="#">Tracking*</a>				
	<a href="#">Camouflage*</a>				
	Hide				
	Listen				
<b>Biology</b>					
	<i>Botany</i>				
		Agriculture			
			Animal Skills		
				Animal riding	
				<a href="#">Veterinary Medicine*</a>	
			Planting techniques		
			Harvesting techniques		
			Field Preparation		
			Disease treatment		
		*Pharmacy			
		Forestry			
			Disease treatment		
			Resource management		
			<a href="#">Logging</a>		
	<i>Zoology</i>				
		<a href="#">Veterinary Medicine</a>			
		First Aid			
		Treat Disease			
		Animal Skills			
			Animal riding		
		Treat Poison			
	<i>Humans</i>				
		Medicine			
			<a href="#">First Aid</a>		
			Treat Disease		
			Treat Poison		
		Dentistry			
		Nursing			
			<a href="#">First Aid</a>		
		Pharmacy			
			Treat Disease		
			Treat Poison		
		Sociology			
		Psychology			

	<i>Ecology</i>			
		Botany*		
		Zoology*		
		Humans*		
		Chemistry*		
		Sociology*		
<b>Chemistry</b>				
	Lab Procedures			
	Organic Chemistry			
		Explosives		
		*Pharmacy		
	Pharmacy			
		Treat Disease		
		Treat Poison		
	Inorganic Chemistry			
	Primitive/Survival chemistry			
		Explosives		
		Batteries		
		*Pharmacy		
<b>Combat Arts</b>				
	<a href="#">Tracking</a>			
	<a href="#">Camouflage</a>			
	Hide			
	Listen			
	<a href="#">Find Cover</a>			
	<a href="#">Make Combat Position</a>			
	<a href="#">Move Under Fire</a>			
	<a href="#">Unarmed Combat</a>			
		Dodge		
		<a href="#">Falls</a>		
		<a href="#">Punch/Strike</a>		
		<a href="#">Kick</a>		
		<a href="#">Throw</a>		
		Block		
		Joint Locks		
		<a href="#">Improvised Weapons</a>		
	<a href="#">Firearms</a>			
		<a href="#">Hand Gun</a>		
			<a href="#">Glock 17 9mm</a>	
			<a href="#">Glock 19 9mm</a>	
			<a href="#">Glock 26 9mm</a>	
			<a href="#">HK SOCOM Mark 23 .45ACP</a>	
		Shotgun	<a href="#">Mossberg 9201</a>	
		SMG		
			<a href="#">M16/9mm SMG</a>	
			<a href="#">HK MP5N 9mm</a>	
			<a href="#">HK UMP .45ACP</a>	
			<a href="#">M16A2 Commando</a>	
		Rifle		
			<a href="#">M16A2 5.56mm</a>	
			<a href="#">Springfield M-6 Scout</a>	

			<a href="#">HK G3A4 Carbine</a>		
			<a href="#">HK G3A3 Rifle</a>		
			<a href="#">Barrett M95 .50cal Rifle</a>		
		Crew Served Weapons			
			<a href="#">Ares Shrike M16 Upper</a>		
			<a href="#">M-60 LMG</a>		
			<a href="#">M2HB</a>		
		Special Weapons			
			<a href="#">M203 Grenade Launcher</a>		
			<a href="#">Mk19 Machine Grenade Launcher</a>		
			<a href="#">M72 LAW</a>		
			<a href="#">M47Dragon</a>		
			<a href="#">M151E2 TOW</a>		
			<a href="#">FIM-92A Stinger</a>		
			<a href="#">M252 81mm Mortar</a>		
			<a href="#">Demolitions</a>		
			<a href="#">Mines</a>		
	<i>Muscle Powered Ranged Weapons</i>				
		Thrown Weapons			
			Dart		
			<a href="#">Grenade</a>		
			Knife		
		Personal Projectile			
			Shortbow		
			Longbow		
			Crossbow		
		Siege			
			Catapult		
	<i>Melee Weapons</i>				
		Pole Arms			
			<a href="#">Bayonet</a>		
			Spear		
			Pike		
		Blades			
			<a href="#">Knife</a>		
			Light Sword		
				Rapier	
				Katana	
			Heavy Sword		
				Broadsword	
Communications					
	<a href="#">Radio</a>				
		<a href="#">Usage</a>			
		Repair			
	Landline				
		Usage (phone phreaking)			
		Repair			
<a href="#">Computer Science</a>					
	Software usage				
	Software design				

	Software implementation				
	Hardware design				
	Hardware construction				
	Microcoding				
Engineering					
	<a href="#">Carpentry</a>				
	<a href="#">Civil</a>				
	<a href="#">Combat Engineer</a>	<a href="#">Combat positions</a>			
		<a href="#">Demolitions</a>			
		<a href="#">Mines</a>			
	<a href="#">Computer</a>				
		Hardware design			
		Hardware construction			
		Microcoding			
	<a href="#">Electrical</a>				
	<a href="#">Masonry</a>				
	Hawking Technology				
	Hydraulics				
		<a href="#">Plumbing &amp; Pipes</a>			
		<a href="#">Hydraulic Equipment</a>			
	Gunsmith				
	<a href="#">Vehicular</a>				
	Repair Electrical				
	Repair Mechanical				
Geology					
	Identification				
	Mining				
	*Inorganic Chemistry				
Liberal Arts					
	History				
	Linguistics				
		Language (pick one)			
	Philosophy				
	Political Science				
	Sociology				
Mathematics					
	Calculus				
	Topography				
	Advanced/Hawking				
Physics					
	Newtonian				
	Nuclear				
	Hawking				
	Hawking Technology Theory				
Transport					
	Boating				
	<a href="#">Diving</a>				

	Drive Wheeled				
	Drive Tracked				
	Fixed Wing				
	Rotary Wing				

**Task Resolution Note:**

(Secondary Attribute or Attribute/10) + (Skill) gives "chance"

Tasks are scored with a difficulty of 1-10, with 10 being dirt-easy and 1 being very difficult.

Multiply "Chance" by "Difficulty", and you get the percentage chance of success. Roll this number or under on d% to find out if you succeed.

**Team Construction**

Most teams consist of people trained in more than one training program. The majority of the people on the team will be of one program, with only a few of the others. This allows an OWL team to have a couple of HAWKS acting as 'hired guns' to provide security, or an EAGLE team to have an OWL around to help interpret the info that they've gathered.

*This was intended to give some diversity to the players skills, so that at least someone in the team would have skill "X" when "X" was needed. The Light teams are the ones most likely to be played, since they have about 4 people. Medium teams were meant for larger gaming groups, up to a dozen or so. If you've got more than 4 players, I'd recommend running a Medium team, and making the extra people "faceless NPCs". This gives players a method to get a new character should they get their first one killed. The NPCs can guard the base until needed. Heavy teams are listed primarily as story background - a Heavy HAWK team has over 200 people in it, which is a bit much for most GMs to run.*

**EAGLE Teams**

In the original mission plan, the EAGLE teams were to scout out the areas and help make "triage" decisions. Once aid arrived, the Eagles would help the arriving OWL or VULTURE units, until they were in place and on their feet, then move on to other areas that needed help.

**Light EAGLE team:**

This kind of team is used to recon an area, and call back to bring in OWL or VULTURE teams depending on what they find. This is the most common kind of team in the game, and the Project had a tendency to fiddle with it depending on exactly where they were placing them.

Team Scout: EAGLE trained, issued scout gear

Team Commo Spec: EAGLE trained, issued Signals gear, operates as a second scout

Team Medic Spec: OWL with Biology background

Team Security Officer: HAWK Rifleman

Vehicle: [M1109 Hummer](#) armed with whatever weapon the team agrees on, or a [M1097A1 HMMWV Cargo Carrier](#) with extra starting gear, or a [Bell UH-1 Huey](#)

**Medium EAGLE team:**

This team is used to recon either a wider or potentially more dangerous area.

1 Scout: EAGLE trained, issued scout gear

1 Assistant Scouts: EAGLE trained, issued normal gear

Team Commo Spec: EAGLE trained, issued Signals gear, operates as a second scout

Team Medic Spec: OWL with Biology background

Team Intel Officer: OWL with Engineering or Science training and kit

Team Security Officer: HAWK Rifleman

Vehicle: [LAV-300](#)

1 Scout: EAGLE trained, issued scout gear

1 Assistant Scouts: EAGLE trained, issued normal gear

Vehicle: [M1097A1 HMMWV Cargo Carrier](#)

**Heavy EAGLE Team**

This kind of team was used to recon 'time sensitive' places. For example, Kennedy Space Center, nuclear power plants, etc. These are locations where the Project wanted to be able to step in immediately after the Fall, and make sure the reactor was shut down or the shuttle mothballed for later use.

1 Light EAGLE Team

1 Medium EAGLE team

1 HAWK Security Specialist and 1 VULTURE logistics Spec in [M977 HEMTT Cargo Truck with Material Handling Crane](#) loaded with spare supplies

### **OWL Teams**

OWL teams were intended for areas where some level of "white collar" specialized skills were needed.

#### Light OWL team:

This kind of team was meant for locations where the Project was pretty sure a small amount of skilled help would do a lot of good. For example, small towns where a doctor would be helpful.

Mission Specialist : OWL trained, issued gear based on mission

Team Commo Spec: EAGLE trained , issued Signals gear, operates as scout

Team Medic Spec: OWL with Biology background

Team Security Officer: HAWK Rifleman

Vehicle: [M1109 Hummer](#) armed with whatever weapon the team agrees on, or a [M1097A1 HMMWV Cargo Carrier](#) with extra starting gear.

#### Medium OWL team:

This team is used when more engineering or scientific knowledge was indicated. Note that this team is larger than a heavy EAGLE team - they're not there to look around and report, they're there to take care of business.

1 Scout: EAGLE trained, issued scout gear

1 Assistant Scout: EAGLE trained, issued normal gear

Team Commo Spec: EAGLE trained , issued Signals gear, operates as a second scout

Team Medic Spec: OWL with Biology background

Mission Specialist Officer: OWL with Engineering or Science training and kit

Team Security Officer: HAWK Rifleman

Vehicle: [LAV-300](#) with additional cargo

1 HAWK Security Specialist and 1 VULTURE logistics Spec in [M977 HEMTT Cargo Truck with Material Handling Crane](#) loaded with spare supplies

Mission Specialist : OWL trained, issued gear based on mission

Team Commo Spec: EAGLE trained , issued Signals gear, operates as scout

Team Medic Spec: OWL with Biology background

Team Security Officer: HAWK Rifleman

Vehicle: [M1109 Hummer](#) armed with whatever weapon the team agrees on, or a [M1097A1 HMMWV Cargo Carrier](#) with extra starting gear.

#### Heavy OWL team:

This team is used when large amounts of engineering or scientific knowledge was indicated. This is the size team you deploy for things like rebuilding the levees on the Mississippi, dealing with a cholera outbreak in a mid-sized city, or getting GPS and Comm satellites launched.

Light EAGLE team

2x Light OWL team

Medium OWL team

Light HAWK team

### **HAWK Teams**

These were the "Bad Boyz" of the Project. They were scattered across the country, for the most part, but the scattering was intended to put them in communication range for the other teams. When called in, they would 'take care of business'. Until then, they acted as a recon team for more dangerous areas.

#### Light HAWK team:

This team was intended to act as a protective unit for other teams. They were Flickered in a 1:3 ratio to EAGLE teams, and a 1:10 ratio for other teams. This put enough out that a call for help by another team *should* be picked up by two or three light HAWK teams, who would respond 'police style'

Team Scout: HAWK trained, issued scout gear

Team Commo Spec: HAWK trained , issued Signals gear, operates as a second scout

Team Medic Spec: OWL with Biology background

Team Security Officer: HAWK Rifleman

Vehicle: [M1109 Hummer](#) with agreed on weapon and M47 Dragon missile launcher with 3 missiles as cargo, or a Bell [UH-1 Huey](#)

Team Commander : HAWK trained, issued Signals gear

Team Gunner : HAWK trained, issued grenadier gear (M203, M72 LAW, etc)

Team Driver: HAWK trained, with medical gear

Vehicle: [LAV-AG with 90mm gun](#)

Medium HAWK team:

This team was intended to act as a protective unit for light HAWK teams . They were Flickered in a 1:3 ratio to light HAWKs

2 Light HAWK teams

Artil section of 3 [LAV-M's](#) , each with: Vehicle CO: HAWK grenadier, Vehicle Driver/Medic: OWL medic,3 HAWK riflemen as mortar crew

Light HAWK team in an [Avenger Anti Aircraft vehicle](#)

1 HAWK Security Specialist and 1 VULTURE logistics Spec in [M977 HEMTT Cargo Truck with Material Handling Crane](#) loaded with spare supplies

Heavy HAWK team:

This team was intended to be the big hammer in military engagements. They were Flickered in a 1:3 ratio to medium HAWKs

4 Light EAGLE teams to act as scouts and screen. One is equipped with a UH-1 rather than a Hummer.

6 Light HAWK teams to act as screen and security escorts. Two or three of these are equipped with UH1's .

Three Artil sections, each having 3 [LAV-M's](#)

4 x Light HAWK teams in [Avenger Anti Aircraft vehicles](#)

2x Armor Platoons of 4 [LAV-AG's](#) , crewed as above

2x Anti-armor teams , each consisting of 2 [LAV-TOW's](#) and two light HAWK teams as escorts

4 [M977 HEMTT Cargo Truck with Material Handling Crane](#) loaded with spare supplies, each crewed as above

4 Infantry units, each consisting of two [LAV-300's](#) carrying driver, CO, gunner , two four-man fire teams and a section leader (for the fire teams) (total of 18 infantry per Infantry Unit

## Equipment

### Basic Loads

Each Project member is issued a certain amount of basic gear. This breaks into three categories: General Issue, Job Issue, Defensive Issue.

### General Issue Gear

This is gear such as clothing, Load Bearing Equipment (LBE), basic survival, and basic medical.

Standard Uniform: The project uses US Military style BDUs. These include boots, a field cap, sock, skivvies, etc. Each Project member is issued 3 sets of BDUs. They are also issued three sets of "PT's" - T-shirt, shorts, sweats, sneakers, etc- for lounging around the base during 'Flicker'.

**LBE:** The Project uses ALICE gear consisting of a pistol belt and H-suspenders. The belt has room for 7 standard sized "Objects" to be clipped on. The H-Suspenders can support two "objects". "Object" is a game term (related to encumbrance). In this case, it is a magazine pouch, pistol, canteen, entrenching tool, etc. The Project also issues an "ALICE Vest" which allows up to 16 objects to be clipped on

General issue gear also includes a [personal medical kit](#), and a [NBC kit](#)

### Load Bearing Equipment

Alice Vest: Has room for four "objects" on each side of the front of the vest, plus 8 more on the back. If a backpack is to be worn, the 8 on the back must be removed.

Alice Belt: Has room for 7 "objects"

Alice Suspenders: Has room for 2 "objects"

Alice Pouches: Number in brackets is the number issued as part of the basic gear

[4] 1st Aid/Compass pouch: 5" x 4" . Will hold compass, field dressing, hand radio, etc

[3] Shotgun pouches: - hold 6 shells each

[3] Pistol Magazine Pouches - holds 2 pistol magazines

[3] J75: large pouch 6"x6"x1.75"

[3] 30 Round Mag: holds 3 M16 mags, 6 M16/9 mags, or 2 HK 7.62 mags. Also has loops for 2 grenades.

[1] Shovel Carrier : holds a 3-fold entrenching shovel securely. Shovel included in issue.

[3] SAW AMMO GENERAL PURPOSE CARRY POUCH

Heavy-duty 7w x 9h x 3d pouch holds belted ammo for the Shrike Squad Automatic Weapon, but it makes a super handy general-purpose carrying bag for first aid supplies, rappelling equipment or other small articles. Generous size: 7" w x 9" h x 3" d (17.8 x 22.9 x 7.6 cm). Features Velcro® and snap closure, 2 ALICE clips, big 3" (7.6cm) belt loop and drain hole. NSN 8465-01-157-4834. [12 oz/341 gm]

### Canteens

[1] LC-2 GI 2 QUART FLEECE LINED CANTEEN COVER AND Canteen This rugged fleece-lined cover features ALICE Belt Clips, removable shoulder sling and small pocket for purification tablet bottle.

[1] TABS® GI CANTEEN STRAW ADAPTER KIT Simple refit kit allows you to use any size GI plastic canteen to get the benefits of bite-and-suck drinking without interrupting your activities.

[1] ONE QUART CANTEEN Not insulated Features water tablet accessory pocket with Velcro® closure. Extended web "ears" on each snap closure make it easy to open and extract canteen.



[1] GI 5 QT COLLAPSIBLE BLADDER JUNGLE CANTEEN & COVER SET Excellent for survival needs, "packing-in" water supply, flotation use, or a comfy camp pillow. The popular Vietnam era collapsible 5 quart bladder canteen was reproduced by Korean craftsmen for a replica so authentic you'd never guess. Five-quart plastic bladder removes from the durable and well constructed packcloth carrier. Top forms a "funnel" to help fill from mountain streams. Canteen neck also has the screen wire to keep out debris. Excellent for survival needs, "packing-in" water supply, emergency flotation use, or a comfy camp pillow. Strings allow securing to pack. Collapsed/folded size: 7" x 4" x 1-3/4" (17.8 x 10.2 x 4.5cm).

[1] EAGLE TIGER STRIPE BECKER RANGER PATROL PACK

Six outer pouches, 2 on sides and 4 on the front Packsack and pouches are constructed of Cordura® nylon. Belt and back of pack are packcloth lined with moisture-wicking Cool Max® fabric for greater comfort. Four interior pouches allow compartmentalization of load • Six outside pouches with Fastex® buckles (Side pouches are perfect for cross country skis, machete, antenna or other long items) • Front, top and sides have 2 1/4" (57mm) webbing triple-stitched for attaching gear using ALICE clips • Sleeping bag strap (28" (71cm)) and cargo strap (16" (41cm)) • Main compartment capacity 1110 cu. in. (18 1/2" x 10" x 6" (47 x 25.4 x 15.2cm)) • Side Pouches 8 1/2" x 5" x 3" (21.6 x 12.7 x 7.6cm) • Back Pouches 6 x 4 x 2 1/2 (15.2 x 10.2 x 6.3cm) • Flap Pouches 7" x 3" x 1 3/4" (17.8 x 7.6 x 4.4cm) • Empty Weight- 4 lb 15oz/2.22 kg • Water Resistant • Works well with H-Harness. Tiger Stripe Camo.

[1] GI ANGLE FLASHLIGHT BELT POUCH & Light Special design protects your angle light and assists in keeping it secured to your gear. Enc .25

Survival Kit: consists of two sealed pouches that are issued as a single Kit and can be separated after issue. Each half fits easily in a cargo pocket.

Side A: Shelter and Food Gathering Side:

- |                            |                           |
|----------------------------|---------------------------|
| (a) Fishing Kit, Emergency | (d) Plastic Bag, Zip-Lock |
| (b) Saw, Finger Ring       | (e) Candle, Votive        |
| (c) Survival Blanket       | (f) Snare Wire            |

Side B: Escape and Evasion (E and E) Side:

- |                             |                           |
|-----------------------------|---------------------------|
| (a) Fire Starter, Magnesium | (e) Plastic Bag, Zip-Lock |
| (b) Knife, Pocket           | (f) Whistle, Extreme Cold |
| (c) Signaling Mirror        | (g) Water Bag, Drinking   |
| (d) Compass, Smoke Chaser   | (h) Matches, Waterproof   |

Physical Characteristics : 13" x 6" by 2". Encumbrance 1

GMRS Radio with 3 battery packs, earbud and throat mic. (See radios for more details)



LC-2 PARATROOPERS BELT FIRST AID KIT COMPLETE

Current issue individual first aid kit. Plastic Olive Drab insert box is packed with essentials for proper first aid.

Items include: Band-aids®, Povidone-Iodine antiseptic, gauze dressing, compress bandage, field dressing with safety pins, eye dressing, pill vials (8 treatments each Antibiotics, Pain killers, sedative, stimulant), burn salve, sunburn cream. Box is stored in the LC-2 nylon pouch with ALICE attaching clips and Lift-o-Dot snaps. Plenty of extra room to pack personal medical items.. [1 lb/454gm

### Job Issue Gear

This is gear specific for the individual's job in the team. For example, the team medic has a much larger medical kit. The team RTO (Radiotelephone Operator) has extra commo gear.

Medical Issue: [Large Medical Kit with field surgery kit](#)

Commo/Signals Issue: [2 each of signal flares](#), [TH-G71A Radio](#), [VC-H1 Video Unit](#)

Scout/Recon Issue: binoculars, [2 each of signal flares](#), [TH-G71A Radio](#)

OWL Engineer: Ruggedized Toshiba laptop computer with solar panel, CD-Rom's containing Engineering Library

OWL Scientist: Ruggedized Toshiba laptop computer with solar panel, CD-Rom's containing relevant science library.

HAWK Rifleman: Extra ammo, personally selected weapons

HAWK Machine Gunner: Extra Ammo, personally selected weapons

HAWK Grenadier: Extra Ammo, Personally selected weapons

### Defensive Gear

This is equipment designed to protect the team member. For the most part, this means weapons and body armor. All Project members get a "police style" body armor vest to be worn under the BDU (this counts as 'light armor'). HAWK teams also get SWAT style body armor (this counts as 'heavy armor')

Following are some weapon combinations that may be of use to players. In most cases, the grenades are up to the carrier to pick. You may trade 3 grenades for a ScatMine.

- (1) M16/9 w/15 mags, Glock 17 w/3 mags, 5xM67 grenades, 3xM15 WP grenades, 2xM72A2 LAWs
- (2) M16/M203 w/36 rounds 40mm & 12 mags, Glock 17 w/3 mags, 1xM67, 1xM15 WP, 1xM7 CS, 1xM18 Smoke
- (3) HK G3A4 Carbine w/12 mags, HK SOCOM w/3 mags, 2xM67, 2xM15 WP, 2x M25 CS, 1xMk3A2, 1xM126A1
- (4) M47 Dragon w/3 rounds, HK MP5N w/6 mags, Glock 26 w/3 mags, 1x M67 grenade, 1x M15 WP, 1x AN-M14 Thermite
- (5) Shrike LMG with 3 belts & 6 mags, Glock 19 w/3 mags, 10 grenades of choice
- (6) Mossberg shotgun, Glock 17, 10 grenades
- (7) HK MP5N, Glock 26, 3 grenades, 1 M18A1 Claymore, room for extra equipment (Medkit, demolitions gear, radios, etc)
- (8) M-60, Glock 19, 3 grenades
- (9) HK UMP, HK SOCOM, 6 grenades, 2 M72 LAWs
- (10) M16/9, Glock 17, 16 grenades, M18 Claymore
- (11) M16A2 Commando, Glock 17, 16 grenades, M72 LAW
- (12) Shrike w/4 belts, Glock 26, 8 grenades
- (13) Barret .50 Sniper rifle, Glock 17, 7 grenades
- (14) M60 w/3 belts, HK SOCOM, 6 grenades
- (15) M16/9 w/M203, 16 40mm rounds, 13 magazines., Glock 17 w/3 mags, 4 M72 LAW rockets, 4 grenades
- (16) Stinger w/3 missiles, Glock 26, 3 grenades
- (17) M47 Dragon w/2 missiles, M16/9, Glock 17, 4 grenades (\*\*\*) expect Dragon to be in vehicle most of the time, or spare round carried by teammate (\*\*\*)
- (18) M16 Commando w/m203, 20 rounds 40mm, HK SOCOM, 4 grenades, M18 Claymore
- (19) HK G3A3 Rifle, Glock 17, 6 grenades, 1 M72 LAW
- (20) HK G3A3 Rifle w/Modified M203, 20 rounds 40mm, HK SOCOM, 1 M72 LAW, 1 M18 Claymore, 4 grenades

### Weapons

Note on issued Magazines: Each pistol is issued with 5 magazines : one in the weapon, two on the belt, and two spares in case of losses. Long guns are issued 15 magazines, nominally: one in weapon, 6 on belt, rest are spares. In the case of the Colt 9mm SMG, 12 magazines will fit inside two belt pouches, thus giving one in weapon, 12 in mags, and two spares. Magazines are a "Class IX" inventory item, and as such a Project Member may requisition an entire replacement magazine set to be kept as a spare.

### Handguns



Glock Models 17, 19, 26. 9mm.

Damage 9 Penetration 40, Effective Range: 20 meters

Encumbrance: 1, .8, .6 with 2 spare mags. Additional mags .1 each.

Mag Capacity: 19, 17, 10, plus 1 in chamber

Any larger mag may be used in a smaller Glock. Glock 17 mags may be used in the M16/9 due to a special adapter. M16/9 mags may be used in any Glock.

Each Glock is also issued with a .22 cal conversion kit. This kit contains 3 replacement barrels and a replacement magazine. When installed in a Glock 17,19 or

26, it converts the weapon to .22LR cartridge with a magazine size of 10. The barrels also extend past the end of the slide, and have a threaded muzzle for attachment of a suppressor (included).

The primary purpose of these kits is to allow hunting of small game with a lower noise signature than 9mm. Damage: 6 Penetration: 4 Encumbrance: The whole kit with 50 rounds of ammo has an encumbrance of .1

**HK SOCOM, .45 ACP (11.43x23mm)**

Effective Range in meters : 20  
Damage 14 Penetration: 46  
Magazine Capacity: 10 + 1 .  
Encumbrance: 1.2 with 2 spare mags. Additional mags are encumbrance 0.1 each.  
Alternate Ammo notes: .45 Tracer is Damage 15.  
Glaser is Pen 5 / Damage 25. Shotshell is Pen 1/ Damage 14/ +3 to hit.  
Additional Equipment in kit: Flashlight , Laser, Suppressor. Either the flashlight \_or\_ the laser may be mounted.  
Changing mounted device is a 15 minute job.



**Sub Machine Guns**



M16/9: A standard M16 lower with a Colt 9mm upper. A special insert in the magazine well allows 33 round Glock 9mm magazines to be used. Glock 17 (19 round) mags can also be used) Removal of the insert and changing the upper receiver will allow the weapon to be converted to a regular M16A2 - assuming another upper receiver, bolt carrier, etc are available. The weapon can mount a grenade launcher.  
Cartridge used: 9x19mm Effective  
Range in meters : 100 Penetration:  
Damage factor: 10

44 Magazine Capacity: 33  
Encumbrance: 3 with 2 spare mags. Add'l mags @ 0.1

**HK MP5 N:**

This weapon was designed by HK for use by US Navy SEAL teams. It is a high reliability 9mm Subgun used in the Project as a "heavy sidearm" by Project members who have other things as a primary job - radiomen, Medics, etc. Cartridge used: 9x19mm  
Effective Range in meters : 100  
Damage factor: 10 Penetration: 44  
Magazine Capacity: 30  
Encumbrance: 3 with 2 spare mags. Additional mags are encumbrance 0.1 each



**HK UMP .45**

From the HK Website and Sales Brochure:" For tactical team use as the ultimate CQB weapon, for issue as a squad car carbine, for a pistol caliber companion weapon to HKs new .223 G36 rifle or carbine, or as a pistol caliber long gun to supplement HK .45 or .40 caliber handguns, the UMP is the world's most advanced submachine gun for the uncompromising user. For the new millennium, the UMP reigns supreme."

It's all that, and a box of ammo. This is the SMG preferred by HAWK teams, coupled with the HK SOCOM as a sidearm. It comes with a telescopic sight, laser, and flashlight. All three are mounted.

Effective Range in meters : 100 Damage factor: 14 Penetration: 46  
Magazine Capacity: 25 Encumbrance: 3 with 2 spare mags. Additional mags are 0.1 each.



**M16A2 Commando 5.56mm**

This is the top end of the SMG group. The 5.56x45 cartridge is a rifle round. This weapon produces a 4' muzzle flare when fired. Typically it's picked when the rest of the team has M16s, and the radioman or medic wants to shave a couple points on encumbrance.

Effective Range in meters : 500



Damage factor: 33  
 Penetration: 237  
 Magazine Capacity: 30 round M16 mag  
 Encumbrance: 4 . Additional mags are encumbrance 0.5 each.  
 Interchangeability Notes: will not accept an under barrel grenade launcher.  
 Issued with a Ceiner .22LR conversion kit. The conversion kit has an encumbrance of 0.5. When installed (3 minutes), the rifle fires .22LR cartridges. The kit includes a box of 50 rounds of .22LR (Damage 6, Pen 4) and is intended as a survival aid. [Operators Manual](#)

**Rifles**

**M16 A2**



Cartridge used: 5.56x45mm NATO  
 Effective Range in meters : 700  
 Damage factor: 33  
 Penetration: 237  
 Magazine: 30 round M16 mag  
 Encumbrance: 4 . Additional mags are encumbrance 0.5 each.

Interchangeability Notes: will accept an under barrel grenade launcher. M16 Mag also used by M16 Commando, Shrike.  
 Accepts M234 Non-Lethal adapter.  
 Alternate Ammo notes: Issued with a Ceiner .22LR conversion kit. The conversion kit has an encumbrance of 0.5. When installed (3 minutes), the rifle fires .22LR cartridges. The kit includes a box of 50 rounds of .22LR (Damage 6, Pen 4) and is intended as a survival aid. Normally issued with M234 [Operators Manual](#)

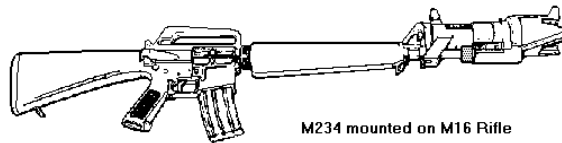

This is intended for quelling rioting individuals.  
 The M234 Launcher is Enc .25, and comes with a box of 10 blanks, and 5 each M734 and M742 projectiles. A pair of 5 round M16

magazines are included. Both of these magazines are painted bright yellow.  
 The M734 projectile is made of rubber, and has Pen 0 / Dam 60.  
 The M742 round is Pen 0 /Dam 40 on impact, but releases a 10 foot diameter cloud of CS powder on impact. This is treated like normal CS gas for 15 seconds until the powder settles.

**HK G3A3 Rifle, 7.62x51mm**



Damage factor: 64  
 Penetration: 340  
 Magazine Capacity: 20  
 Encumbrance: 4.5 . Additional mags are encumbrance .5 each.  
 Interchangeability Notes: Can swap magazines with G3A4 Carbine. Can mount M203PIGrenade launcher through use of adapter bracket.

Cartridge used: 7.62x51 NATO  
 Effective Range in meters : 1000

**HK G3A4 Carbine, 7.62x51mm**



Cartridge used: 7.62x51 NATO  
 Effective Range in meters : 900  
 Damage factor: 63  
 Penetration: 334  
 Magazine Capacity: 20  
 Encumbrance: 4.5 . Additional mags are encumbrance .5 each.  
 Interchangeability Notes: Can swap magazines with G3A3

Rifle.  
 Alternate Ammo notes:  
 Note :Overall length drops to 28" with stock closed.  
 Barrett M95 .50 cal rifle

Cartridge used: 12.7x99 NATO

Effective Range in meters : 1600+



Damage factor: 331  
Penetration: 980  
Magazine Capacity: 5  
Encumbrance: 11.5 . Additional mags are encumbrance 1 each.

Interchangeability Notes:  
Alternate Ammo notes: [.50 SLAP](#) may be used for  
Damage 200, Pen 2900

### Springfield Armory M6 Scout

Cartridge used: .22LR and .410 shotgun  
Effective Range in meters : 100  
Damage factor: (.22LR =6) (.410 birdshot:3) (.410 slug: 12)  
Penetration: (.22LR =4) (.410 Birdshot: 1) (.410 slug: 5)  
Magazine Capacity: over and under two barrels. The stock has a storage area for 10x.22LR cartridges and 6x shells.  
Encumbrance: 2  
Interchangeability Notes:  
Alternate Ammo notes:  
Cartridges and shells are conveniently stored in the butt stock. Each M6 is drilled and tapped to accommodate a Weaver base scope mount. The M6 Scout features a folding stock which is easily detached quick-release pivot pin. An M6 breaks down in less than 5 seconds to a very compact overall length of 18 inches, providing easy storage on a boat, small plane, tractor or recreational vehicle. A specially designed trigger guard allows conventional finger firing, or full hand firing while wearing mittens or heavy gloves. Stainless Steel construction resists sand and saltwater, and performs flawlessly in foul weather conditions



### Machineguns

#### Shrike LMG 5.56mm



Cartridge used: 5.56x45mm NATO  
Effective Range in meters : 700  
Damage factor: 33  
Penetration: 237  
Magazine Capacity: 30 round M16 mag or 200 round belt  
Encumbrance: 4 . Additional mags are encumbrance 0.5 each. Belts are Encumbrance 3  
Interchangeability Notes: Can use M16 magazines or feed M249 belts. All lower and bolt parts are standard M16 for spares compatibility. Comes with integral bipod and 1 spare barrel. Barrel can be hot-swapped in 5 seconds. An oven mitt is included in the kit for handling the hot barrel.  
Alternate Ammo notes: One round in 5 in belts is tracer. Damage 32.

#### M60E3 and M60D Light Machine Guns



Length: 42.4 inches (107.70 centimeters)  
Weight: 18.75 pounds (8.51 kilograms)  
Bore diameter: 7.62mm (.308 inches)  
Maximum effective range: 3609.1 feet (1100 meters)  
Maximum range: 2.3 miles (3725 meters)  
Muzzle velocity: 2800 feet (853 meters) per second  
Rates of fire:

Cyclic: 550 rounds per minute  
Rapid: 100 rounds per minute\*

Sustained: 100 rounds per minute\*  
(\* with barrel changes at each 100 rounds)

Cartridge used: 7.62x51mm NATO  
Damage factor: 64  
Penetration: 340

Magazine Capacity: 100 round belt  
Encumbrance: 8.5, empty .Belts are encumbrance 2

Interchangeability Notes: M60E3 comes with integral bipod and 1 spare barrel. Barrel can be hot-swapped in 5 seconds. An oven mitt is included in the kit for handling the hot barrel. M60D is pretty much the same, except used on vehicles and has spade grips

[Operator's Manual for M60E and D](#)

M2HB "Ma Deuce" .50 cal Machine Gun



**Gun:** 84 pounds (38 kilograms)  
**M3 Tripod (Complete):** 44 pounds (19.98 kilograms)  
**Total:** 128 pounds (58 kilograms)  
**Bore diameter:** .50 inches (12.7mm)  
**Maximum effective range:** 2000 meters with tripod mount  
**Maximum range:** 4.22 miles (6.8 kilometers)  
**Maximum effective range:** is 1,830 meters

**Length:** 61.42 inches (156 centimeters)  
**Weight:**

**Cyclic rate of fire:** 550 rounds per minute

Cartridge used: 12.7x99 NATO (.50 Cal)  
Effective Range in meters : 2000  
Damage factor: 331  
Penetration: 980  
Alternate Ammo notes: [.50 SLAP](#) may be used for Damage 200, Pen 2900  
[Load M2HB](#) [Shoot M2HB](#)

Magazine Capacity: 105 round belts. Each belt has an encumbrance of 5  
Encumbrance: vehicle mount or tripod needed for firing.

## Shotgun

Mossberg 9201 Shotgun



Cartridge used: 12 gauge shotgun shell, 2.75 or 3 inch  
Effective Range in meters : 40  
Damage factor: 12 pellets at Damage 8 for 2.75

inch, or damage 10 for 3" . (00 Buckshot)

Penetration: 20

Magazine Capacity: 4 + 1 or 3+1 with 3" shot

Encumbrance: 3 , 0.6 per round

Interchangeability Notes:

Alternate Ammo notes: Large variety of birdshot, flares, birdbombs, dragonsbreath, #4 shot, etc.

Issued with a sling that holds 15 rounds, and an elastic "butt sock" that holds 5 rounds. LBE also allows carry of additional ammo.

The Project Issue firearm includes a fiber-optic "bead sight" that collects available light for easier shooting.

Damage note: Quick resolution for shotguns: if the shot hits, roll d12 for number of hits. If penetration occurs, multiply damage by the *square* of the number of hits. This accounts for multiple temporary wound cavities and the widespread nature of the damage.

*Shotguns are bad, bad medicine. An average roll for buckshot is 6 pellets, which makes (6x6)x8=288 points of damage - enough to take a human being out of combat immediately. Shotguns also allow a wider variety of ammo types to be used. The only drawback to a shotgun is the low penetration - with PCs wearing body*

armor, they'll likely be able to take a hit. Also, you can hide behind things. But this is probably the most deadly, single shot small arm in the game. On the other hand, multiple hits from automatic weapons fire are resolved the same way...

**Heavy Weapons : Grenade Launchers, Rockets and Missiles**

**M203 Grenade Launcher**

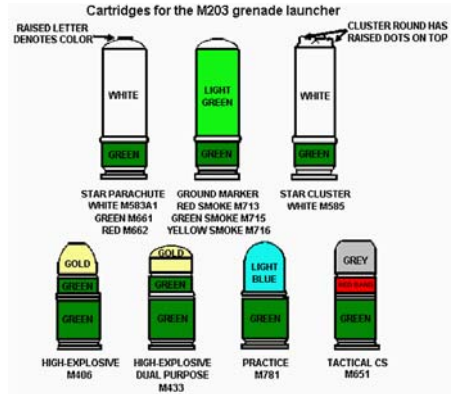

The M203 Grenade launcher is intended to provide additional, short range, support fire for Project teams. It can be attached to any member of the M16 family The Project has fabricated an adapter that will allow fitting of the M203 to the HK G3 rifles and carbines, as well as the HK MP5N. This weapon fires a variety of [40mm grenades](#), with differing damages and penetrations.

Encumbrance: Adds 1.5 to "parent" weapon

- Bore diameter: 40mm
- Maximum effective range: 1312.4 feet (400 meters)
- Area target: 1148.35 feet (350 meters)
- Point target: 492.15 feet (150 meters)
- Minimum safe range: 426.53 feet (130 meters)
- Training: 101.71 feet (31 meters)
- Combat: 101.71 feet (31 meters)

- [FM23-31 : M203](#)
- [Operation and Function of M203 from Army Correspondence course on M203](#)
- [Description and Maintenance of M203](#)
- [Using M203 on Battlefield](#)

40mm ammo for the M203 Grenade Launcher

Encumbrance : .2 per grenade carried

Grenade	Damage	Radius	Penetration
M406 HE	4xd20	5m	20
M433 HEDP	4xd20/300	5m/.5m	20/1200
M651 CS Gas	CS Gas	2.5x4.5x2m	gas
M576E2 MultiProjectile (not shown)	4xd20	Shotgun	20

Damage note: When inside the radius of these grenades, roll d20 for number of hits. If penetration occurs, multiply damage by the square of the number of hits. This accounts for multiple temporary wound cavities and the widespread nature of the damage. This also makes the military view of "5m Guaranteed Kill" pretty accurate. Penetration on the M433 is to the primary target of the shot, which is also hit with an Armor Piercing Shaped Charge for damage 120. Penetration on the frag sleeve is 20.

## Mk19 Machine Grenade Launcher



The MK19 Mod3 40mm Grenade Machine Gun was first developed by the Navy in the early 1960's. TACOM-ARDEC has since suggested modifications to this system which has enabled the deployment of the MK19 in the harsh environments. The MK19 firing rate is over 350 grenades per minute and it is effective to ranges of over 2200 meters. This weapon is fired only from vehicle mounts or the tripod.

**Manufacturer:** Saco Defense Industries  
**Length:** 43.1 inches (109.47 centimeters)  
**Weight:**  
**Gun:** 72.5 pounds (32.92 kilograms)  
**Cradle (MK64 Mod 5):** 21.0 pounds (9.53 kilograms)  
**Tripod:** 44.0 pounds (19.98 kilograms)  
**Total:** 137.5 pounds (62.43 kilograms)  
**Muzzle velocity:** 790 feet (240.69 meters) per second

**Bore diameter:** 40mm  
**Maximum range:** 2200 meters  
**Maximum effective range:** 1600 meters  
**Rates of fire:**  
**Cyclic:** 325-375 rounds per minute  
**Rapid:** 60 rounds per minute  
**Sustained:** 40 rounds per minute

### AMMUNITION

The MK 19 fires six types of cartridges: M430I / M430A1 high-explosive dual-purpose grenades, M383 high-explosive grenade, M385I / M918 training practice, and M922/M922A1 dummy rounds.

[Mounting on a vehicle](#) [Mounting on a tripod](#)

[Loading a Mk 19 GL](#) [Firing a Mk 19 GL](#)

40mm ammo for the Mk 19 Machine gun

M383 / M384 40mm HE (high-explosive) cartridges

The two HE (high-explosive) cartridges inflict personnel casualties in the target area with ground burst effects. Their fillers and body materials differ although performance traits are the same. Neither has the armor penetrating ability of the HEDP M430 round. They are both in wooden boxes, 50 rounds to a box.

M430 HEDP (high-explosive, dual-purpose)

The HEDP (high-explosive, dual-purpose) M430 cartridge, joined with M16A2 links, is the standard round for the MK 19. The impact-type round penetrates 2 inches of steel armor and inflicts personnel casualties in the target area. This round is 48 rounds, linked, in each container. It is olive drab with a yellow ogive and yellow markings. It arms between 18 to 30 meters and has a casualty radius of 15 meters.

### **40mm Canister Cartridge**

The 40mm canister cartridge provides a short range anti-personnel capability from muzzle to a maximum effective range of 100 meters for the MK-. The cartridge is used as a force multiplier against ground troops in exposed positions, in



rugged terrain, vegetation, urban terrain, and other tactical scenarios where the rest of the MK-19 family of 40mm ammunition is limited.

Encumbrance : .2 per grenade in belt

Grenade	Damage	Radius	Penetration
M383/384 HE	4xd20	15m	20
M430 HEDP	4xd20/300	15m/.5m	20/1200
M385 Training Round			
Canister	8xd20	Shotgun	40

Damage note: When inside the radius of these grenades, roll d20 for number of hits. If penetration occurs, multiply damage by the square of the number of hits. This accounts for multiple temporary wound cavities and the widespread nature of the damage. This also makes the military view of "5m Guaranteed Kill" pretty accurate.

Penetration on the M430 is to the primary target of the shot, which is also hit with an Armor Piercing Shaped Charge for damage 120. Penetration on the frag sleeve is 20.

### M72A3 Law Rocket

Enc: 2.5 Pen: 3000 Damage: 500  
 Length (Extended) ..... Less than 1 meter (34.67 inches)  
 Length (Closed) ..... 0.67 meters (24.8 inches)  
 Weight (Complete M72A3) .. 2.5 kg (5.5 pounds)  
 Caliber ..... 66 mm  
 Minimum Range (Combat).... 10 meters (33 feet)  
 Minimum Arming Range..... 10 meters (33 feet)  
 Maximum Range..... 1,000 meters (3,300 feet)

### Maximum Effective Ranges

-Stationary Target ..... 200 meters (660 feet)  
 -Moving Target..... 165 meters (541 feet)  
 (Beyond these ranges, reduce chance to hit by half) [Operators Manual for LAW Rocket](#)

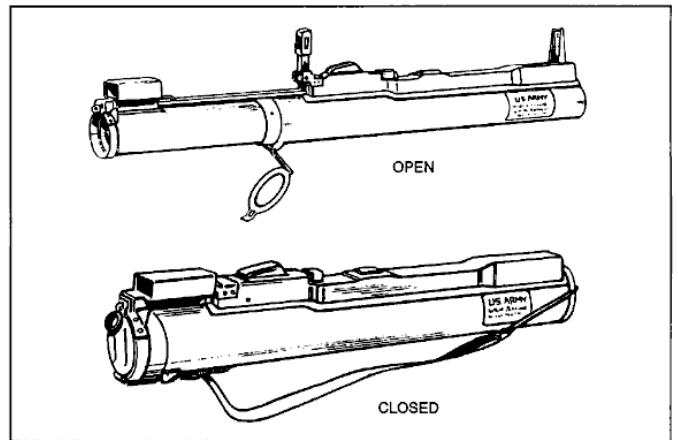

Figure 2-1. The M72A2 or M72A3 LAW.

### M47 Dragon Missile Launcher



Encumbrance: 16  
 Penetration : 5000  
 Damage: 2500  
 Guidance: Semi-automatic, wire  
 Warhead High Explosive Anti-tank  
 Warhead diameter: ca 140 mm  
 Launch unit weight: 6.9 kg  
 Launching Platforms Man pack (crew of 2)  
 Missile weight: 10.07 kg  
 Warhead weight 5.4 kg  
 Missile length: 852 mm  
 Max. effective range: 1000-1500 meters  
 Range 75 meters (minimum)  
 Max. velocity: ca 200 m/sec

[Operator's Manual FM23-24](#)

### M151 TOW Missile Launcher



Encumbrance: 92 for launcher, 24 for Guidance module, 22 per missile, 20 for tripod.  
 Penetration : 10000 Damage: 5000

This is a powerful anti-tank guided missile. CD version has users manual, for more details.

FIM-92A Stinger Missile

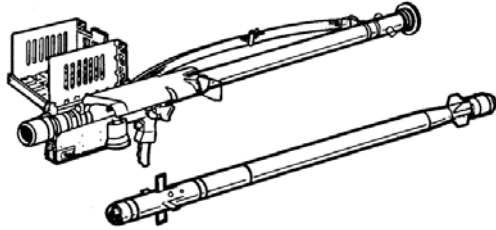

Encumbrance: 15 loaded. Additional missiles: 6 each  
 Penetration : 100  
 Damage: 1000

The Stinger missile is the Project's system for short-range air defense that provides the protection against low-altitude airborne targets such as fixed-wing aircraft, helicopters, unmanned aerial vehicles, and cruise missiles. The Stinger is launched from the Avenger (HMMWV) as well as Man Portable Air Defense (MANPADS).

The Stinger is a man-portable, shoulder-fired guided missile system which enables the firer to effectively engage low-altitude jet, propeller-driven and helicopter aircraft. The system is a "fire-and-forget" weapon employing a passive infrared seeker and proportional navigation system. Stinger also is designed for the threat beyond the 1990s, with an all-aspect engagement capability, and IFF (Identification-Friend-or-Foe), improved range and maneuverability, and significant countermeasures immunity. The missile, packaged within its disposable launch tube, is delivered as a certified round, requiring no field testing or direct support maintenance. A separable, reusable gripstock is attached to the round prior to use and may be used again. [Usage Manual](#)

**Specifications**

<b>Primary function</b>	To provide close-in, surface-to-air weapons for the defense of forward combat areas, vital areas and installations against low altitude air attacks.
<b>Propulsion</b>	Dual thrust solid fuel rocket motor
<b>Length</b>	5 feet (1.5 meters)
<b>Width</b>	5.5 inches (13.96 centimeters)
<b>Weight</b>	12.5 pounds (5.68 kilograms)
<b>Weight fully armed</b>	34.5 pounds (15.66 kg)
<b>Range</b>	1 to 8 kilometers
<b>Guidance system</b>	Fire-and-forget passive infrared seeker
<b>Warheads</b>	High explosive
<b>Rate of fire</b>	1 missile every 3 to 7 seconds
<b>Type of fire</b>	"Fire-and-Forget"
<b>Sensors</b>	Passive infrared

M252 Mortar



Cartridge used: <a href="#">81mm Mortar Shell</a>	Magazine Capacity:1 shot
Damage factor: varies	Encumbrance: 40, empty.
Penetration: varies	Minimum range: 80 meters, Max range 5700 meters
	Maximum Rate of Fire.....30 rounds/min (2 minutes)
	Sustained Rate of Fire.....15 rounds/min

81mm Mortar Ammo

For simplicity, all mortar rounds are considered to weigh 4.5 kg

### M889 81mm HE Mortar Cartridge

The M889A1 High Explosive Cartridges is designed for use with the M252 81mm Mortar against personnel, bunker and light materiel targets. The M889A1 is equipped with the M935 Point Detonating Fuze which functions in the Impact mode. Each M889A1 is packed in a fiber container and three packed rounds are assembled into a PA156 container. Burst Radius is 35 meters, doing damage 6/pen 20 and d20 pellets per target. Against bunkers and buildings, it will blast through 1 meter of concrete or rock. Against vehicles, it is Pen 400/damage 100/ burst radius 2 meters.

### M853A1 81mm Illuminating Cartridge

The M853A1 for use with the M252 81mm Mortar for illuminating areas. The projectile is loaded with a parachute flare. The M853A1 contains an illuminant which provides about 525,000 The M853A1 is equipped with the M772 Mechanical Time Fuze which functions after a user-specified time after launch. The flare burns for 50-60 seconds, providing illumination over a 1,200 meter radius. If the fuze is set to function after impact, the round will act as ignite whatever it lands on.

### M819 81mm Smoke Cartridge

The M819 Smoke is designed to produce an obscuring smoke screen. The projectile is loaded with red phosphorus pellets which are ejected from the projectile body. The smoke covers a 30 meter radius.



### Communications Equipment

*There's an old saying that "If you ain't got comm, you don't have nothin." Communications is a powerful force multiplier, and working, powered radio comm is a big advantage over people who don't have it. The Project decided on using civilian radios when it rapidly became apparent that they were smaller, had longer range and were built to military specs with regards to environmental resistance. The only thing they don't have are scramblers. In the case of the GMRS radios, they are designed to be used as tactical radios, so scrambling would be gilding the lily. For secure communications, the solution was to put a laptop computer in each vehicle, patched into the vehicle computer. The TH-G71A handheld radio's keypad is used to generate tones which allow you to record a .wav file on the computer. At the end of your message, press the 'E' key, followed by the 'D' of the destination station. The computer will then convert the .wav to .mp3. PGP encrypt the message using the destination's public key, and use the data link to the vehicle radio to send it out. At the other end, the process is automatically reversed.*

### GMRS Personal Radio

Operates on the UHF/GMRS  
CH1 - 7, A,B,C 462.5625 to  
462.6750 MHz.

Specifications: Power: 2 watts (range is subject to terrain conditions, but typically 3-5 miles)  
Channels -10 parallel • 38 Interference Eliminator Codes •  
Voice assisted programming  
Enhanced Scan Capability  
Audible call alert  
Carrier squelch  
Side PTT

Transmit light  
Time out timer  
Audible low battery alert  
Backlit LCD channel display  
Audio accessory jack - issued with earbud and PTT throat mike.  
Operates up to 16 hours (10% talk time, 90% standby) on the included rechargeable NiMh battery pack •  
Height, 6.5" (8.75" w/antenna x 2.5" wide x 1.25" thick  
• Weight, 11.1 oz with battery  
Issued with two spare battery packs.

### Kenwood TH-G71A Handheld Comm

Encumbrance: 1

Issued with 3 sets of NiMh batteries and charger, plus a "shoulder patch" speaker/mic.

Note that these can receive a GMRS signal, but can't send on that band. They work very well with VC-H1 and TM-742AD Vehicle units. Range for this unit is over 40km.

From the Kenwood Website:

"Just hold the TH-G71A in your hand and it's immediately clear how well our new handheld transceiver is engineered. The ergonomic design, illuminated keys and backlit display all combine to make operation a breeze. As does the menu mode, which allows you to customize the TH-G71A by adjusting all major settings to your choice. Besides being easy to use, it also boasts extraordinary power - up to 6 watts (VHF) or 5.5 (UHF) of RF output (selectable) with its high-performance antenna. The speaker provides powerful, refreshing clear audio. The TH-G71A is even built with a polycarbonate casing for rock solid performance outside as well as inside".

[Owner's Manual](#)

6W (VHF), 5.5W (UHF) at 13.8V DC  
 PC programmable FTP download  
 200 memory ch. with alphanumeric display  
 MIL-STD 810E (rain & shock)  
 CTCSS tone scan  
 Wide-range coverage (incl. Aircraft receive)\*

DTMF memory (10 ch. Up to 16 digits)  
 Multiple scan modes  
 Key illumination  
 High-performance antenna  
 TM-V7A remote control (DTMF remote)



**Kenwood VC-H1 Video Comm -Handheld**

Encumbrance: 1  
 Issued with 3 sets of AA NiMh batteries and charger.  
 An adapter cable allows it to be plugged into a Kenwood Handheld TH-G71A. From there it can send to other units, or it can use a vehicle radio to retransmit the signal longer distances. This is a slow scan camera; it sends one image per 10 seconds or so. It is not real-time video communications, but is useful for showing another team terrain features for planning purposes.  
 AA alkaline or 110 volt AC adapter operation  
 Operates all Slow Scan modes  
 Callsign superimpose  
 10 picture memory  
 Auto Power Off  
 1.8 inch color display  
 Built-in speaker and microphone  
 Transmits to another radio and PC (w/ special software)

Removable head  
 Accepts input from other camera or video devices  
 Dimensions [WxHxD]  
 (projections not included) 2-5/8 x 1-3/8 x 6-3/4 in (62 x 30 x 160 mm)  
 Monitor 1.8" TFT color LCD  
 Terminals Data I/O (for transceiver), Video in, Video out,  
 COM (for computer), DC 1N (6.0V)  
[Operators Manual](#)

**Kenwood TM-742AD Mobile (vehicle) Radio**



This unit communicates with GMRS, THG-71A, and VC-H1 devices. It has a 'global' range using a vehicle whip antenna.  
 101 memory channels & memory banks system  
 Flexible scan and scan stop modes. The tone alert system can be activated independently for each band. Automatic band change. Sub-band muting circuit. Cross band repeater function. Duplexer included 144 MHz/440MHz/Open Band (Open Band used for 462MHz to link to GMRS radios)

[Owner's Manual](#) Power Requirement 13.8 V DC ±15% Weight (approx.) 3.3 lb (1.5 kg)

*All of the above is rather confusing, unless you're a radio head. This radio is really a "three in one" set up, with each band being in a different frequency range. The radio will take its orders either from the front panel, or from a computer, and will pass what it hears to the computer. The "Cross band repeater function" means it will link two bands together - whatever it gets on one band, it sends out on the linked band. One use for this is to patch GMRS to Kenwood handheld communications. The GMRS's have a range of about 8 km. If you've got your vehicle patched for GMRS to TH-G71, then if the GMRS is within 8km of the vehicle and the gent with the TH is within 40km, everybody can talk. Another fun thing is to patch GMRS to another vehicle, which is also set for GMRS. In this case, anything either vehicle crew says on the GMRS goes over the vehicle radio to the other vehicle, where its patched back to GMRS and the other crew can hear it, so long as they're within 8km of the vehicle. One magazine article reviewing this equipment had a man in the US using a VC-H1 patched to a TH, patched to a TM, sending to Singapore, where it went through the same patch in reverse.*

## Project Personal Computer - Terralogic Discovery



Recognizing the need to have a handy reference of data, plus the ability to use PGP software to handle encryption, push video using the VC-H1 and all the other things a computer is handy for, the Project decided on the Terralogic Discovery computers. These computers meet or exceed environmental standards such as IEC-68-2 and MIL-STD-810E, IP54 and IP65. The computer is Enc:4  
Terralogic also offers (and one is included with each PC) a Solar panel, sufficient to allow usage of the computer for up to 8 hours per day. The solar panel is 2"x7" folded, and weights 4lbs (Enc: 2). It has a nominal output of 30 watts.  
A ruggedized inkjet printer is included as well. The printer, in its case, is Enc: 3  
Multiple RS-232 ports on the back allow the computer to be patched into vehicle radios, VC-H1 units, the Kenwood handheld radios and other devices. One of these computers is included in each vehicle, with software to allow DES-encrypted communications between Project vehicles.

Mobile CPU Pentium- 266 Mhz, 256MB RAM, 12.1" TFT Color Display, 20Gb Hard drive, 20x CD-ROM, 1.44" floppy, 2xPCMCIA II/III slots, RS232 x 3 + RS422, Parallel, CRT, RJ-11, IrDA, 16 bit sound card, Audio ports, 56k modem, 10-base-T LAN, 1 PCI card slot, adapter to run and charge off of 12VDC, 24VDC, 110VAC. Backlit keyboard for use at night, touch screen

## Medical Gear

Note: Antibiotics and some other drugs are listed in "treatments". This is a small blister pack of tablets that are to be taken once every 8 hours until the entire blister pack is used.

Handy Books:

[FM21-11 First Aid for Soldiers](#)

### MEDIC'S INSTRUMENT SHOULDER BAG

This bag is normally carried by Project Medics. It contains:

- \* Sterile eye wash
- \* 3 Large cold packs (disposable)
- \* 1 space blanket
- \* Bandages - stored in Zip Lock bags
  - 2 4-inch wide roller bandages (Bulk non-sterile)
  - 2 4-inch wide Kerlix rolls (bulky roller bandages)
  - 6 4X4 12 ply gauze dressings
  - 1 Blood Stopper (a VERY multi-use telfa compress dressing)
  - 1 multi-trauma dressing (10X30 heavy duty dressing)
  - Several packages of Vaseline gauze (for sealing sucking chest wounds)
  - Adaptic dressings (fine mesh dressings for burns and abrasions)
  - 2 triangular bandages
  - Band-aids (can of 100 in assorted sizes)
- \* Betadine - 8oz squeeze bottle
- \* Hydrogen peroxide 8 oz bottle
- \* Hibicleanse antiseptic soap
- \* 6 Safety pins
- \* Pad and pen
- o 2 Squirt bulbs (for irrigating wounds)
- o 1 unit instant glucose
- o 1 wire splint
- o 4 "treatments" of antibiotics and 4 of pain killers
- o Field Surgery Kit (see below)
- o Stethoscope
- o BP cuff w/ pediatric adapter
- o 8 pairs Latex exam gloves (disposable)
- o CPR rescue mask (a mask you place on a victim to perform rescue breathing)
- o Tape
- o Steri Strips- Large open wounds are only to be covered with a sterile dressing and left to heal/close by themselves. This way, drainage takes place as the dressing is replaced daily.
- o 1 set of 5 oral airways- meant to be used primarily in conjunction with ventilation equipment, rescue masks, bag valve masks etc.
- o 1 oxygen equipment tubing (connect my mask to supplemental O<sub>2</sub>, VERY important)
- o 8 Surgical scrub brushes packaged in betadine or hebicleanse
- o Trauma Shears
- o 'Extractor' venom pump kit

### FIELD SURGICAL IMPLEMENT KIT

Military medical kit is packed for the advanced medic, normally only issued as part of a larger medical pack. Top quality surgical stainless steel instruments last forever. Packed in an Olive Drab pouch, kit includes: Suture kit (6 pre-made sutures), prep pads, suture scissors, bandage scissors, scalpel blade and handle, 2 Kelly forceps, tweezers, and light. Closed size: 3 1/2" x 8" (8.9 x 24.3 cm).

### Drug Kit:

Encumbrance 15. This kit is a large aluminum suitcase box. In one corner is a full reload for a Medic's Shoulder Bag. The rest of the box contains

100 treatments of wide-spectrum antibiotics

100 treatments of wide-spectrum vaccines for children's diseases

100 treatments of wide spread vaccines for "Third World Country" visiting (smallpox, diphtheria, tetanus, etc)

100 treatments of vitamins for pregnant women or people suffering from vitamin deficiencies  
 100 treatments of anti-diarrhea medicine

**Optics and Sensors**

8x35 Binoes. Weight .5 kilos. Rubber armored for protection. Nitrogen sealed to prevent internal condensation.

NVS -40 weapon starlight scope. Adds 1 kilo to weapon. Battery life of 60 hours. [Tech Info](#) [Employment info](#)



**PVS-7B NIGHT VISION GOGGLES.** .5 kilos, battery life 100 hours. These are light intensifiers, not thermal imaging.

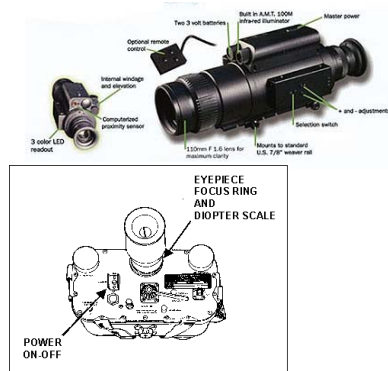

**AN/PAS-7** Passive Infrared Viewer: 5kg, 48 hours battery life. These are Thermal Imagers.

**NBC Kit - Nuclear, Biological and Chemical Warfare kit**

[Info on usage of gear and administering drugs](#)

Tablets to be taken one per 8 hours before exposure to chemicals - is done, gives +2 to effectiveness of antidote kit (ie, -5 difficulty)

Encumbrance: 0.1 per 3 packages Unit of issue : 3 packages

Mark I Antidote kit - allows a second roll at -3 difficulty to survive a chemical exposure

Enc: 0.1 per package Unit of issue: 3 per kit

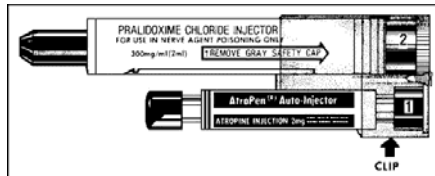

M258A1 Decon kit : used to wipe down skin, clothing and equipment exposed to toxins  
 Enc: 0.1 per package Unit of issue : 3 per kit

M17A1 Gas Mask and Hood

Enc: 1.3 Unit of issue : 1 per kit

(Also protects from radioactive dust and some biological weapons.)

Issued with this is a plastic full-body suit. It is Enc: 5, and all skills take a +3 difficulty while worn.

mini Multi-Combat-Analyzer-430

COMMUNICATIONS: RS-232, 9600bps; Windows™ based software

DIMENSIONS: 9.5" h × 4.75" w × 4" d (24 × 12 × 10cm)

WEIGHT: Rechargeable: 5 lb (2.3kg) including battery --- ENC: 2.3

Functions: Will report radiation levels, chemicals detected and the probability of bio-threats. Can be linked to computer for storage and increased processing of data



### Food Kit

Encumbrance: 15

This pack contains:

12 MRE's - 4 each breakfast, lunch and dinner menus.

24 Food Bars in assorted flavors. Each has about 1/3 the food needs for an adult for a day. These are a lot like "sports energy bars"

2 plastic jars, each with 14 days survival food tablets. These tablets allegedly are chocolate flavored. 12 tabs per day are supposed to be enough to keep an adult alive. Most Project Personnel figure a person would have to be pretty desperate to eat more than 4 a day.

3 packages of Datrex Bars. Each package contains 9 bars. These are yummy - somewhere between vanilla wafers and cake. 3 bars per day is enough to (barely) live on.

A plastic jar of "Civil Defense Candy" - hard, fruit flavored lumps that are 90% sugar. Mmmm..

Two 5qt Canteens

24 envelopes of water treatment powder. Each envelope will treat 5 quarts.

24 envelopes of various flavored drink mix, with sugar. Each will make 5 quarts.

*The food kit provides a total of just over 45 man days of food, and 30 man-days of water treatment if you eat light. To be perfectly honest, 28 days of the food are survival tablets, and trust me, those will encourage you to find something else to eat.*

### Trade Kit

Encumbrance: 15

This pack contains:

50 : Twenty Dollar bills

10: 1 oz gold coins

20: 1/4 oz gold coins

20: 1 oz silver coins

10: "Airline Size" bottles of booze, various flavors

10: Food bars

20: Packs of Gum

10: pre-packaged salt&pepper shakers

10: plastic bottles with 5 each beef, chicken and pork bullion cubes

20: small sewing kits

5: pocket size first aid kits with 1 dose of antibiotics in each

2: 50 round boxes of .22LR

25 individually wrapped toothbrushes

5 travel-size tubes of toothpaste

10 "hotel size" bars of soap

*The Trade Kit is intended to give team members something in their hands when they go to negotiate with the locals - other than large firearms. The items in the kit are things that would be useful to people who have lost their homes and are mainly "comfort items" keeping with the original Project plan of showing up within a week or so of the Fall. This item is potentially the most powerful man-portable device in the game, if used wisely.*

### Vehicles

*In the interest of space, only the most 3 commonly used vehicles are listed in the "paper version" of Project Phoenix.*

M1109 HMMWV Weapons Carrier



The M1109 HMMWV is an Up-Armored Armament Carrier configuration of the HMMWV family. This vehicle has additional armor both on the sides and underneath to protect the crew from small arms ammunition and mines. The weapon mount, located on the roof of the vehicle, is adaptable to mount either the M60, 7.62mm machine gun; M2 .50 caliber machine gun; or the MK 19 Grenade Launcher. The weapons platform can be traversed 360 degrees. This configuration of the HMMWV is equipped with the self-recovery winch.

Armor Rating: 150  
Damage Rating : 10

Length: 15 feet (4.57 meters)

Width: 7.08 feet (2.16 meters)

Weight: 5,200 pounds (2359 kilograms)

Height: 6.00 feet (1.83 meters) reducible to 4.5 feet (1.37 meters)

Engine: Hawking Technology Zeropoint plant powering a 150hp electric motor

Horsepower: 150 at 3,600 RPM

Transmission: 3 speed, automatic

Transfer case: 2 speed, locking, chain driven

Electrical system: 24 volt, negative ground, 60 amps  
Brakes: Hydraulic, 4-wheeled disc  
Fording depth:  
without preparation: 2.5 feet (76.2 centimeters)  
with deep water fording kit: 5 feet (1.5 meters)

[Driving the HMMWV](#)

[IDENTIFY INSTRUMENTS, CONTROLS, INDICATORS, AND EQUIPMENT](#)

[DRIVE AN M998 SERIES HMMWV OFF ROAD OVER ROUGH OR UNUSUAL TERRAIN](#)

[DEEP WATER FORD AN M998 SERIES HMMWV](#)

*The Hummer is the workhorse of the Project, and the vehicle players are most likely to be driving. With a M619 GL on top, this thing is well suited for any task, but very ammo-dependant. The M2 AB gives a much longer duration on the ammo.*



## LAV-300 Armored Personnel Carrier

The LAV-300 is an all-terrain, all-weather vehicle with night capabilities. It carries infantry and equipment and provides direct support to units in combat. The body is constructed of ballistic steel plate that defeats multiple hits by 7.62-mm ammunition. It accelerates from zero to 20 mph (32 km/hr) in less than 10 seconds, making it a "sports car" among armored vehicles.

Armor Rating: 400  
Damage Rating : 20

### Specifications

#### ARMAMENT:

Main Weapon: Cockrill Mk 3 90mm /36 cal rifled gun with 39 rounds

Secondary Weapon: 7.62mm coaxial machine gun with 400 rounds, 7.62mm anti-aircraft machine gun with 200 rounds

Armor: CADLOY ballistic steel plate, proof against 7.62mm ball ammunition (vision blocks and periscopes hardened to same level)

#### POWER TRAIN & SUSPENSION

Transmission Allison MT653 (5 speeds forward - 1 reverse)

ZPR driving 275 HP electric motor

Transfer case (1)

Differentials (4) automotive, (1) water drive

Suspension (8) wheel independent.

Full time 4 wheel (rear)

Selective 8 wheel drive

Power steering

Power brakes

Selective water drive

Water drive: (2) propellers , (4) rudders

#### PERSONNEL:

(1) driver

(1) vehicle commander

(1) gunner

(9) Infantry

#### SIZE/WEIGHT

Length 251.60 in.

Width 98.4 in.

Height 78 in.

Gross weight (max.) 32,000 lb.

#### ELECTRICAL SYSTEM

24 volts negative ground, 12V Neg ground, 110VAC

Waterproof

Radio suppressed system

Wiring, connectors, breakers, harnesses IAW MIL-STD's

(4) batteries per MS 35000 (500 amp slave receptacle)

#### EQUIPMENT:

Laser range finder AN/GVS-5 (hand-held)

#### PERFORMANCE @ GVW

Maximum speed 92 mph

Swim speed 6.5 mph

Minimum turn diameter 51 ft.

Maximum trench crossing 81 in.

Maximum grade 60%

Maximum side slope 30%

*This is the second most likely vehicle issued. It has a crew of three, and can carry up to nine more, making ideal for mid-sized groups of players. The extra space inside allows carry of additional equipment and ammo if a full crew isn't loaded.*



# M977 HEMTT Cargo Truck with Material Handling Crane

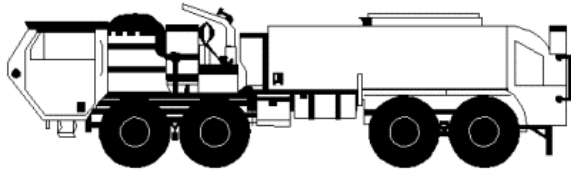

The Heavy Expanded Mobility Tactical Truck (HEMTT) provides transport capabilities for re-supply of combat vehicles and weapons systems. This vehicle is used by the



project to carry large amounts of stores in-team, thus reducing the logistics tail - important when the basis of the Project mandates that they don't really know where the 'next meal' is coming from.

Armor Rating: 100

Damage Rating : 15

[LESSON OUTLINES FOR DRIVING OPERATIONS](#)

[LESSON OUTLINES FOR MATERIAL HANDLING CRANE AND SELF RECOVERY WINCH OPERATIONS](#)

---

## Vehicle Specifications

**Vehicle Manufacturer:** Oshkosh Truck Corporation

**Dimensions:**

Length: 401"H

Height: Operational 112", Transport 102"

Width: 96" -

Wheel base: 210"; M983 - 181"; M984 - 191"

Turning Circle: M977 / M978 / M985 - 100'; M983 - 91'; M984 - 95'

Vehicle Curb Weight: M977 With Winch - 38,800 lb., Without Winch - 37,900 lb.; M978 With Winch - 38,200 lb., Without Winch - 37,300 lb.; M983 With Crane - 39,200 lb., Without Crane - 32,200 lb.; M984 - 50,900 lb.; M985 With Winch - 39,600 lb., Without Winch - 38,700 lb.

Ground Clearance: 24" - All

**Performance:**

- Maximum Speed: 57 mph Governed - All  
Cruising Range: 300 mi. @ Gross Vehicle Weight Rating - All  
Maximum Grade: 60% - All  
Approach Angle: 41 deg. - All  
Departure Angle: 45 deg. - All  
Side Slope: 30% - All  
Maximum Fording Depth: 48" - All

**Equipment Specifications:**

- **Cab:** Crew Seating: 2 Man  
Seat Design: Fore/Aft Adjustable  
Steering Type: Dual Gear With Integrated Hydraulic Power Assist

**Engine:** Hawking Tech zero point reactor driving a 450hp electric motor  
Rating: 450 hp, @ 2100 rpm

**Transmission:** Manufacturer: Allison, Automatic  
Model: HT740D  
Speeds: 4 Speeds Forward/ 1 Reverse  
Oil: 38 qt. With Filter

**Transfer:** Manufacture: Oshkosh Truck Corporation, 55000  
Type: Air Operated, Front Tandem Disconnect  
Oil: 6.5 qt.

**Axles:** Manufacturer: Front Tandem - Oshkosh Truck Corporation/Eaton; Rear Tandem - Eaton  
Models:  
No. 1 - RS480  
No. 2 - DS480-P - All  
No. 3 - M977 / M978 / M983 / M985 - DS480-P; M984 - DS650-P  
No. 4 - M977 / M978 / M983 / M985 - RS480; M984 - RS650  
Front Axle Steering Angle: 32 deg. - All  
Oil: Front Tandem - 17.5 qt.; Rear Tandem - 21.5 qt. - All

**Wheels:** Type: Disk  
Quantity: 8 ea.  
Spare Tire: 1 ea.  
Rim Size: 20x10  
Stud Quantity: 10 per Wheel

**Tires:** Radial With Tube  
Quantity: 8 ea.  
Spare: 1 ea.  
Tread Type: Radial Traction, Non-directional  
Size: 16:00x20"

**Brakes:** Air-activated, Internal Expansion - All

**Electrical System:** Alternator: Engine Driven: EMI/RFI Suppressed, Waterproof  
Rating Standard: M977 / M978 / M984 / M985 - 65 Amp, Optional: M983 - 100 Amp  
Batteries: 4 ea., 12v Connected in Series Parallel  
Voltage: 24v

**Self-Recovery Winch:** Manufacturer: DP Manufacturing  
Model: 20K-HEMTT  
Wire Rope Diameter: 9/16"  
Wire Rope Length: 200'  
Line Pull - 1st Layer (With 5 Wraps Minimum): 20,000 lb.  
Line Pull - 2nd Layer: 18,173 lb.  
Line Pull - 3rd Layer: 16,663 lb.  
Line Pull - 4th Layer: 15,361 lb.  
Line Pull - 5th Layer: 14,254 lb.

**Recovery Winch:** M984 Manufacturer: DP Manufacturing  
Model: 51022 60K  
Type: Automatic, Two Speed  
Wire Rope Diameter: 1"  
Wire Rope Length: 220'  
Line Pull - 1st Layer: (With 5 Wraps): 60,000 lb.  
Line Pull - 3rd Layer: 45,000 lb.

**Material Handling Crane:** Manufacturer: M977 / M984 / M985- Grove; M983 Hiab  
Maximum Capacity:  
M977 at Boom Length of 19': 2,500 lb.

## Task Resolution

Task Resolution is used to resolve things the players try to do, events that occur, or things NPC try to do to the PCs. The basic task resolution methods are used to generate a number from 1 to 100. d% is then rolled, and if the rolled number is lower than the computed TR number, the event succeeds.

\*NOTE\* die rolls from 95 to 00 are automatic failures. Die rolls from 01 to 05 are automatic success.

### **Basic Idea**

**(Secondary Attribute or Attribute/10) + (Skill) gives a number from 2 to 10. This number is called "chance"**

**Tasks are scored with a difficulty of 1-10 , with 10 being dirt-easy and 1 being very difficult.**

**Multiply "Chance" by "Difficulty", and you get a number from 2 to 100. This is the percentage chance of success for the player.**

Bob is attempting to repair an old generator. It's been sitting outside for 50 years, so the GM decides this is not an easy task at all - on a scale of 1-10 where 10 is amazingly easy, he decides a "2" is appropriate.

Bob has an INT of 60, divided by 10 is 6. He has a 3 skill in "repair mechanical". Adding those together is 9. Multiply by the Difficulty is  $2 \times 9 = 18$ . Bob needs to roll 01-18 to succeed.

### **Opposing Tasks:**

When two people compete against each other, both make TR rolls. The one who makes their roll *and* exceeds the other persons roll wins.

For Example : When shooting at a non-moving target, one need merely make an roll of Accuracy + (weapon skill). If the roll is made, the shot hits. However, most creatures dislike being shot, and thus attempt to evade (if aware of the shooter). In this case, the defender makes a "Dodge" roll. If they have the Unarmed Combat subskill of "dodge" they may add this in as well. The GM assigns a difficulty based on the terrain (10 being plenty of cover, 1 being standing in the open) and the defender makes a skill roll.

To make the example more concrete:

Shooter and Victim are in the woods. Shooter decides he's going to attack Victim via his HK SOCOM pistol.

Shooter has DEX 60 ->Accuracy 6, and skill 3 with the weapon. The GM decides this is a "typical" shot, and gives a difficulty of 5, for a  $(6+3) \times 5 = 45\%$  chance to hit.

Victim decides to dodge and hide. He has Dex 50->Dodge 5, and a Unarmed Combat/Dodge skill of 1. The GM decides the trees make for level 6 cover/concealment, so his chance is  $(5+1) \times 6 = 36\%$

The table below shows possible results

Shooters Roll	Victims Roll	Effect
45 or less	less than 36, more than shooter	Shot hits tree
More than 45	doesn't matter	Shot misses everything
45 or less	more than 36	Victim is shot
45 or less	less than shooter	Victim is shot

**Karma:** a player may use a Karma point to modify a roll before it's processed. Only one Karma point may be used, and it must be declared before dice are rolled. The effect of a Karma point is to move the Difficulty one point in the player's favor. The player may push the Karma total below zero, but in this case he's just handing the GM negative Karma points to play with at some future date.

**Negative Karma:** If a character's Karma is below zero, then the GM may, at will, move the Difficulty of rolls one point against the player. Upon doing so, he adds a point to the character's Karma. For example: Fred has a -2 Karma. The party is climbing a tree to escape a pack of wolves. The normal difficulty for the climb is 5, but the GM decides to use one of Fred's negative Karma points, and bump the difficulty to 4. Fred now has -1 Karma. Sooner or later, he'll either shape up, or be eaten by wolves ☺

### **Ranged Combat Modifiers**

The basic difficulty for a shot against a normally moving target while within the effective range of a weapon is 5, on a scale where 1 is very unlikely to succeed, and 10 is very likely to succeed.

If the range is less than half the effective range, add 1.

If the target is not moving, add 1

If the target is actively evading, subtract 1

If the target can take cover, subtract from 1 to 3 depending on how much cover the target has available.

If vision is obscured (low light, smoke, etc) subtract 1 per obscurement (smoke at night = -2)

The effective ranges for some weapons include modifications for the included scopes. If the scope is not available, or not accurate, and the shot is over 600 meters, subtract 2. If the scope is not accurate and the firer doesn't know that, subtract 4.

If the total modifier is negative or zero, the firer will know even before pulling the trigger it's a hopeless shot, and may either abort the action, or hope for the 'lucky' 01-05 die roll.

### **Melee Combat Modifiers**

The basic difficulty to hit a normally fighting target is 5, on a scale where 1 is very unlikely to succeed, and 10 is very likely to succeed.

If the target is fighting aggressively, then add 2 to attacks against him.

If the target is fighting defensively, subtract 2 from attacks against him

If the target has room to retreat and is willing to use it, subtract 1

If the target is tightly hemmed in or has his "back to the wall", add 1

If the attacker is fighting aggressively, add 1

If the attacker is fighting defensively, subtract 1, unless the move is a throw or joint lock (Aikido style 'attacks')

Melee weapons do a base damage of  $(\text{Users Strength}/10) + (\text{Skill}) + (1 \text{ per } 1/2 \text{ meter of length})$

Unarmed combat is a special case of Melee weapons, in which weapon length = 0.

## Damage Resolution

### Damaging Organics

When a creature takes damage, there is the possibility the damage it takes will remove it from combat. As the creature takes more damage, the chances of future hits taking it out of combat improve.

In Project Phoenix, this is resolved as follows:

- (1) The current CON score is reduced by the amount of damage taken
- (2) The controller of the creature (Player or GM) rolls d%. If the roll is less than (CON+Damage Resistance), the creature is wounded, but can remain in combat. SPECIAL RULE: on a roll of 95 or higher, the creature is removed from combat no matter the CON+DamageResist.
- (3) If the wound is such that the creature is bleeding, they lose an additional point of CON due to blood loss each time they perform an action other than sitting still and trying to stop the bleeding. On a successful "First Aid" roll, this will stop. Each turn they are still bleeding, a CON+DamageResist roll needs to be made.
- (4) If the roll in (2) if failed, the creature may make one Willpower roll to perform a last action. Otherwise, they collapse.
- (5) Once a creature collapses, make a roll vs DamageResist on d%. If passed, the creature will awaken in d10 minutes. If failed, they will die in d10 minutes without medical help.
- (6) If medical help arrives during the d10 minutes, then a successful First Aid roll will result in the creature surviving. Add up lost CON points - every point lost is 10 minutes before the creature awakens.

### Healing:

Creatures recover (CON/20) points per day when given bed rest and plenty to eat. If anti-infection measures are taken, there is no chance of infection occurring. If the situation is septic, there is a chance each day (usually 10%, may be adjusted by GM) that an infection occurs. This will reduce current CON by (d10/3) points per day until the infection is dealt with.

Blood transfusions from one person to another can repair up to 1/2 of the blood loss damage (see item 3 above) , but does a point of damage to the donor . The blood types must be compatible. The following table may help. The left most column lists the donor's type, the headings on the top the recipient.

	O+	O-	A+	A-	B+	B-	AB+	AB-
O+	OK	1	OK	1	OK	1	OK	1
O-	OK	OK	OK	OK	OK	OK	OK	OK
A+	NO	NO	OK	1	NO	NO	OK	1
A-	NO	NO	OK	OK	NO	NO	OK	OK
B+	NO	NO	NO	NO	OK	1	OK	1
B-	NO	NO	NO	NO	OK	OK	OK	OK
AB+	NO	NO	NO	NO	NO	NO	OK	1
AB-	NO	NO	NO	NO	NO	No	OK	OK

NO Don't do it , OK = OK to transfuse, 1 = 1 time only

### Damaging In-Organics

This is mostly for shooting at vehicles.

Divide the Penetration of the weapon by the Armor Rating of the target. This will give the chance to penetrate armor. Then make a to-hit roll to see if the projectile hits anyone inside. Example : a .50BMG round with Pen 980 hits an AR 10 pickup truck. It has a 98% chance of blowing through the door into the passenger space. Surprise, it does. The GM now decides since there's no where

to dodge, this is a difficulty 5 shot, and has the shooter roll to hit again to see if he hits an occupant.

If shooting to disable the vehicle, as opposed to hitting the folks inside, check for penetration. If made, divide Damage by the vehicles Damage Resistance. This will give the chance of disabling the vehicle. Example; Our shooter from the last example puts his second round into the hood of the pickup truck. The round has a damage of 331, divided by the engine Damage Resist of 10, giving a 33% chance of cracking the engine block and stopping the truck.

## ***Repair Modifiers***

### **Repairing People**

The base difficulty is 10 x (current CON/Normal CON) round down. Thus, if your current CON is 25, and you are normally at 50, the difficulty number is 5.

If the form of injury is a burn or multiple hits (shrapnel, grenade, shotgun), subtract 1.

If the injury is blunt trauma, add 1.

If the injury is from "fist fighting", add 2.

If working with a good medical kit, add 1

If working with makeshift equipment, subtract 1

### **Repairing Stuff**

Use the same ratio above - 10 x (current damage rating / normal damage rating) as the target number.

If working with a good tool kit, add 1

If working with makeshift equipment, subtract 1

## **Biological Warfare**

### ***Catching the Bug***

When exposed, roll a task of (Disease Resist) x (Virulence of the bug). If the player fails the roll, they catch the bug - and will find out about it at the end of the incubation time + onset of first symptom. After onset of symptoms, every four hours, the player makes a roll of (Disease Resist) x (Lethality). If they fail the roll, they take d10 points of damage to CON... which may give them a new, lower Disease Resist. They then make a CON check as if this were any other kind of damage to see if they're incapacitated by the disease. If CON drops to zero, they die. If 4 Lethality rolls in a row are made, the disease is fought off and the infection ends.

### ***Treatment:***

If it is a bacteria and appropriate anti-biotics are available, add 3 to Disease Resist for Lethality rolls.

If treating the symptoms, then add 1 to Disease Resist for Lethality rolls. In this case, we're talking about a cold cloth on the forehead for fever, drink plenty of fluids for vomiting, etc.

If treating symptoms and Over-The-Counter medications (Asprin, etc) are used in conjunction with the above, then add 1 more to Disease Resist. (total of 2)

### ***Biological Warfare Construction Kit***

Roll the dice to generate the bug.

Roll d10 to determine bug type : 1-4 : Bacteria 5-8 :Virus 9: Parasite 0: Something Really Sick

**Bacteria:**

Roll d10 to determine gram-strain : 1-5=Gram +, 6-10 = Gram -. The Project uses a wide-spectrum antibiotic, so this doesn't matter as long as you're using Project medkits. However, if using homebrew or pre-Fall medicine, then using an antibiotic that doesn't match will give *no* results. Otherwise, roll as normal below.

**Viruses :**

Antibiotics have zero effect on viruses.

**Parasites:**

Tapeworm, ringworm, etc. None are fun. Roll as above, but give +3 on Lethality (less lethal). Antibiotics don't work. On d10:1-7, the parasite can be found on the surface and dosed there with alcohol or other antiseptics, thus getting the bonus to disease resist that antibiotics would normally give

**Something Really Sick:**

These are gene engineered critters that are neither fish nor fowl, and don't fit into any of the above categories. Subtract 1 from incubation time rolls, add 1 to Symptom rolls (which will increase Lethality), add 1 to Virulence, and add 1 to Lethality.

**Incubation Time:** d10: 1-3 = d10 hours, 4-6=d10 days 7-9=d6 weeks , 0 = d% minutes

**Symptoms:** roll d10 for each one. If in the range, this symptom will be present. They will occur in order of die rolls - ie, if you roll 2 for fever and 4 for vomiting, fever will happen first. Divide the incubation time by 10, and multiply by the number you rolled to get onset time for the symptom. For example, if incubation was 2 days, then each point on your symptom die roll would be (.2 x 24 hours) = 4.8 hours. Rolling a 2 for fever means about 10 hours after the onset of symptoms, fever starts, and 4 for vomiting means 20 hours after onset vomiting begins. This becomes important for the really nasty symptoms.

1-8 : Fever
2-7: Runny nose, watery eyes
3-7: Vomiting
3-8: Diarrhea
2-5: Body rash
3-6: Body Sores
4-7: Swollen glands
8-0: Internal Tissue Necrosis - internal bleeding, organs shutting down. (Once this symptom begins, all CON losses are <i>permanent</i> )
8-0 : Disease impacts other stats in addition to CON - roll at random. Nerve degeneration impacts DEX or INT, skin scarring impacts CHR , etc.

**Virulence:** Again, roll d10. Times are from time of exposure, and are computed as above:

3-7 spreads by aerosol (coughing, sneezing)
2-4 spreads by bodily fluids (blood, excrement, etc)
2-0 spreads by physical contact (bug stays on skin)

Add up the three die rolls made above and divide by 3. Subtract this number from 10. This is the difficulty to avoid 'catching' the bug if exposed. Example: rolls are 4, 5, 6 . Total is 15, divide by 3 is 5. Subtract 5 from 10 gives a difficulty of 5. This is used in computing the chance of body defenses stopping the bug before it gets started - a lower Virulence number is a more dangerous bug.

**Duration:**

Roll d10, and add the number of symptoms rolled. (EX: roll of 5 + Fever, Runny nose = 7). This is the number of symptom time intervals *after the first one shows* that the disease will take to run its course. Round up to the next convenient time interval. Using the above example of 4.8 hours, times (5+fever+runny nose) = 33.6 rounds to 36 hours.

**Lethality:**

Average the numbers you rolled while generating symptoms. Subtract this average from 10.

[FM 8-9 Overview on Biowar Agents](#)

Table A-1. Potential Biological Agents

Agent	Disease
Bacterial	Anthrax Brucellosis Cholera Meliodosis Plague (pneumonic) Shigella Tularemia Typhoid fever
Rickettsial	Epidemic typhus Q fever Rocky Mountain spotted fever Scrub typhus
Chlamydial	Psittacosis
Fungal	Coccidioidomycosis Histoplasmosis
Viral	Argentine hemorrhagic fever Bolivian hemorrhagic fever Chikungunya fever Crimean-Congo hemorrhagic fever Dengue fever Ebola Eastern equine encephalitis Influenza Korean hemorrhagic fever (Hantaan) Lassa Omsk hemorrhagic fever Rift Valley fever

Table A-1. Potential Biological Agents (continued)

Agent	Disease
	Russian spring-summer encephalitis Smallpox Venezuelan equine encephalitis Yellow fever
Toxins	Botulinum toxins Clostridium perfringens toxins Mycotoxins of trichothecene group Palytoxin Ricin Saxitoxin Staphylococcal enterotoxins Tetrodotoxin

## Chemical Warfare

After exposure, every minute, the victim makes a roll of (Disease Resist/2) x (Lethality). If they fail the roll, they take d10+ (# of symptoms) points of damage to CON... which may give them a new, lower Disease Resist. They then make a CON check as if this were any other kind of damage to see if they're incapacitated by the agent. If CON drops to zero, they die.

Chemical Agents will continue to inflict damage until the victim is decontaminated (if a persistent agent) or moves out of the agent (if non-persistent). Note that slapping an antidote into a contaminated victim is pretty pointless... Clean them up first!

Unprotected contact with contaminated equipment has 1/2 the normal chance of exposure if the contactee is aware its contaminated and can take improvised measures to protect themselves.

CS Gas is a non-persistent agent with a "Lethality" of 5, symptoms of Runny nose, watery eyes, affects INT (perception rolls, ability to plan next move) and DEX (Harder to do things).



**Treatment:**

Injection of an antidote kit gives a single roll at -3 on the Virulence of the agent to see if the agent is stopped. If Nerve agent tablets are in the system when the antidote is taken, subtract a total of 5 from the Virulence.

If treating the symptoms , then add 1 to Disease Resist for Lethality rolls. In this case, we're talking about a cold cloth on the forehead for fever, drink plenty of fluids for vomiting, etc.

If treating symptoms and Over-The-Counter medications (Aspirin, etc) are used in conjunction with the above , then add 1 more to Disease Resist. (total of 2)

**Chemical Agent Construction Kit**

Symptoms: roll d10 for each one.

1-8 : Fever
1-9: Runny nose, watery eyes
3-7: Vomiting
3-8: Diarrhea
1-5: Body rash
1-6: Body Sores
4-7: Swollen glands
8-0: Internal Tissue Necrosis - internal bleeding, organs shutting down. (Once this symptom begins, all CON losses are <i>permanent</i> )
8-0 : Impacts other stats in addition to CON - roll at random. Nerve degeneration impacts DEX or INT, skin scarring impacts CHR , etc.
3-6: Jitters, irritability, nervousness
1-4 : Blinding

Lethality : 8 - ( number of symptoms. )

## Sample Chemical Agents:

[Federation of American Scientist's webpage on chemical agents](#)

**Nerve Agents:** Only VX is persistent, and thus a threat to players. Death occurs within 15 minutes of absorbing a fatal dosage, unless antidote is effective. The gas is distributed as a vapor, but if the players are working in a contaminated area, it will be liquid droplets. LD-50 at this point is 10mg/70kg of body weight. (10mg is a single drop). If the area is a warm, sunny day, the droplets on the ground may rise as a vapor. In this case, LD50 is <0.09 mg-min for inhalation. Note that for game purposes, the VX is assumed to have been sitting around in the open, being diluted for quite a while. If you're looking at 'fresh' VX, Lethality is 1.

VX Liquid: Symptoms: Jitters, watery eyes, Impacts INT, Impacts DEX. Lethality 4

VX Vapor: Symptoms: watery eyes, blinding, jitters, Impacts DEX, Impacts INT, Lethality 2

**Blister Agents:** These will cause blistering and sores on any body part they contact... including the insides of the lungs, if inhaled. This issue of "any body part" requires as much skin as possible be covered, which means the defense against it hampers military operations almost as much as the agent does. The earliest one developed is Mustard Gas . Lewisite is an 'improved' version. These agents are very persistent, and with the use of thickening additives are even more so. The numbers below are for "stale" agents. Move down by 1 for 'fresh'.

Mustard Gas: Symptoms: Body rash, body sores, Impacts DEX (can't fight effectively due to pain), blinding. Lethality 5

Lewiston: Symptoms: Body rash, body sores, Impacts DEX (can't fight effectively due to pain), blinding. Lethality 2

[FM 8-9 Introduction to Chemical Agents](#)

[FM 8-9 On Nerve Agents](#)  
[FM 8-9 On Blister Agents](#)  
[FM 8-9 on Riot Control Agents](#)

Chemical Warfare Agents

NAME	C O D E	TYPE	PERSISTENCE 70-90 deg F (HRS)	PERSISTENCE 40- 60 deg F (HRS)	ACTION	STATE (20 DEG C)	ODOR	REMARKS
PHOSGENE	C G	CHOKI NG	0.5	1	RAPID	COLORLESS GAS	GREEN CORN OR NEW MOWN HAY	MAY BE KNOWN AS COLLONGITE
DIPHOSGENE	D P	CHOKI NG	.5 - 3	1 - 4	RAPID	COLORLESS LIQUID	GREEN CORN OR NEW MOWN HAY	MAY BE KNOWN AS SUPERPALITE
TABUN	G A	NERVE	24 -48	48 - 96	VERY RAPID	COLORLESS TO BROWN LIQUID	FRUITY TO NONE	
SARIN	G B	NERVE	.5 - 24	24 - 36	VERY RAPID	COLORLESS LIQUID	NEAR ODORLESS	
SOMAN	G D	NERVE	24 - 48	48 - 96	VERY RAPID	COLORLESS LIQUID	CAMPHOR TO FRUITY	
VX	V X	NERVE	240 -720	720 - 2160	RAPID	COLORLESS LIQUID	ODORLESS	
HYDROGEN CYANIDE	A C	BLOOD	.25 - .5	.5 - 1	VERY RAPID	COLORLESS GAS OR LIQUID	BITTER ALMONDS	DEGRADES FILTERS
CYANOGEN CHLORIDE	C K	BLOOD	.25 - .5	.5 - 1	RAPID	COLORLESS GAS	WEAKLY LIKE BITTER ALMONDS	DEGRADES FILTERS
ARSINE	S A	BLOOD	.08 - .25	.25 - .5	DELAYED	COLORLESS GAS	MILD GARLIC	
DISTILLED MUSTARD	H D	BLIST ER	24 -48	48 - 96	DELAYED	COLORLESS TO PALE YELLOW LIQUID	GARLIC	LESS CONCENTRATED MIX MAY BE KNOWN AS "HS" OR YPERITE
NITROGEN MUSTARD	H N - 1	BLIST ER	24 -48	48 - 96	DELAYED	DARK LIQUID	FISHY OR MUSTY	
NITROGEN MUSTARD	H N - 2	BLIST ER	24 -36	48 -72	DELAYED	DARK LIQUID	SOAPY TO FRUITY	
NITROGEN MUSTARD	H N - 3	BLIST ER	48 - 72	96 - 144	DELAYED	DARK LIQUID	NEAR ODORLESS	
PHOSGENE OXIME	C X	BLIST ER	2 TO 4	3 TO 6	IMMEDI ATE	COLORLESS SOLID OR LIQUID	SHARP AND PENETRATI NG	
LEWISITE	L	BLIST ER	18 - 36	48 - 72	RAPID	DARK BROWN OR YELLOW OIL/LIQUID	MAY RESEMBLE GERANIUMS	
MUSTARD LEWISITE	H L	BLIST ER	24 -36	48 - 72	DELAYED	DARK BROWN OR YELLOW OIL/LIQUID	GARLIC	
ETHYLDICHLOROARSIN E	E D	BLIST ER	1 TO 2	2 TO 3	IMMEDI ATE	COLORLESS LIQUID	FRUITY AND BITING	VERY WATER SOLUBLE; BECOMES VERY NON- PERSISTENT IN RAIN,

								ETC.
METHYLDICHLOROARSI NE	M D	BLIST ER	2 TO 4	4 TO 8	RAPID	COLORLESS LIQUID	ODORLESS	
DIPHENYL- DICHLOROARSINE	D A	VOMIT ING	1 TO 2	2 TO 4	VERY RAPID	WHITE TO BROWN SOLID	ODORLESS	ALWAYS SPREAD AS AN AEROSOL
ADAMSITE	D M	VOMIT ING	1 TO 2	2 TO 4	VERY RAPID	YELLOW TO GREEN SOLID	ODORLESS	
DIPHENYLCYANOARSIN E	D C	VOMIT ING	1 TO 2	2 TO 4	VERY RAPID	WHITE TO PALE SOLID	BITTER ALMOND- GARLIC MIX	OFTEN USED IN CONJUNCTION WITH GB ; MAY BE KNOWN AS STERNITE
CHLOROACETOPHENOME	C N	RIOT	1 TO 2	2 TO 3	INSTANT	SOLID	APPLE BLOSSOMS	
CHLOROACETOPHENOME IN CHLOROFORM	C N C	RIOT	1 TO 2	2 TO 3	INSTANT	LIQUID	CHLOROFORM	ALWAYS SPREAD AS AN AEROSOL
CHLOROACETOPHENOME AND CHLOROPICRIN IN CHLOROFORM	C N S	RIOT	1 TO 2	2 TO 3	INSTANT	LIQUID	FLYPAPER	ALWAYS SPREAD AS AN AEROSOL
CHLOROACETOPHENOME IN BENZENE AND CARBON TETRACHLORIDE	C N B	RIOT	1 TO 2	2 TO 3	INSTANT	LIQUID	BENZENE	
BROMOBENZYL CYANIDE	C A	RIOT	24 - 48	48 - 96	INSTANT	LIQUID	SOURED FRUIT	MAY BE KNOWN AS CAMITE
O-CHLORO- BENZYL MALONITRIL E	C S	RIOT	168 - 336	168 - 336	INSTANT	COLORLESS TO WHITE SOLID	PEPPER	
BZ	B Z	INCAP ACITA TING	240 - 480	720 -1440	DELAYED	DUST ?		NO LONGER IN ACTIVE SERVICE; EFFECTS WILDLY UNPREDICTABLE

## Radiation

### Rad Hazards:

These should be listed in the game as radiating "x rads per hour". This allows computation of how long the victim is exposed, and by multiplying the two, the number of rads the victim picks up. This number should be added to the total exposure to radiation the victim has taken.

### Initial Radiation Exposure:

LD -50 dosages for a creature are considered to be level "10" radiation. For each additional 10% of the LD-50 amount, subtract 1 from the Radiation Difficulty level. Thus, for humans, 440Rads is level "9", 600 rads is level "5", and 760rads is "1". 800 rads is a "0".

Make a roll of (Radiation Resist) x (Radiation Level). If this roll is made, the victim does not begin dying over the next few hours, but instead moves to the "Ongoing Radiation Exposure" table below. If they have had prior exposure, this dose may put them over the edge.

LD-50 (lethal dose for 50% of exposed population) EXPOSURE DOSES FOR VARIOUS ORGANISMS

Dogs, pigs 300	Goats 350	MAN 400
Mice, monkeys 450	Sheep 540	Fish/shellfish 550 to 100,000

Cattle,rats,horses 630	Rabbits 800	Chickens 1000
Insects 5000+	Turtles 15000	Bacteria/viruses 100000

### ***Ongoing Radiation Exposure***

Cross reference the total number of Rads the victim has taken, and read off the effects. (This table is for humans only)

Total Rads	% sickness	% Death	Notes
0-25	0	0	No short term effects
25-100	25%	0	7 days of nausea and general body pains
100-200	25+(rads-100) %	25%, takes 30-60 days of being sick to die	Definite identifiable changes in blood cells. Highest dose causes hair loss, livid skin spots, nausea, vomiting, diarrhea, fevers, hemorrhages, and great fatigue. Heart failure in some./ Rest reassurance, blood cell count, light diet, antibiotics.
200-400	100%	25-50% in 30-60 days	Symptoms as above, but more severe. Blood transfusion may help.
400-600	100%	50-75% in 20-35 days	Bone Marrow transplant, if possible.
600-800	100%	75-99% in days	Circulatory and nervous system malfunction rapidly. Maintain electrolytes may assist victim
800+	100%	100%	Vomiting, Falling blood count, internal bleeding. No Recovery.

[NATO HANDBOOK ON THE MEDICAL ASPECTS OF NBC DEFENSIVE OPERATIONS PART I - NUCLEAR](#)

## Animal Encounters

Animals have a reduced set of stats: INT (1-20) , CON (1-100+) , and ACC at 1-10. These function pretty much like the stats for people. There is also a PEN/Damage pair. These work like the weapon stats work. Some animals also have a Damage Resistance rating. Weapons doing less damage than the creatures DR will merely annoy it with little real harm unless the 'to hit roll' is 01-05, in which case they hit a critical spot and do normal damage.

Note: the animals are primarily for Option 1, 2 or 3 games, where the chance for mutation and survival pressures are much higher.



**Ants, Carpenter :** These are throwbacks to the Mesozoic era. At about 11" long , they're able to more effectively manipulate their environment. They consume cellulose, so they're not out to eat the players. But they are after wood, paper, some plastics....

which means the wooden cases ammo is packed in, or the cloth bag your medical supplies are in are fair game. These guys are \_individually\_ easy to kill (INT 1, CON 4) and have no effective attack against humans (ACC3, Pen 1, Damage 2). On the other hand, they work in groups of d10 dozen.

**Ants, Giant Fire:** These are throwbacks to the Mesozoic era. At about 9" long , they're hefty. They mutated off the "red, fire ants" hated by so many people. They are meat-eaters, and will view the party as a large snack. Again, individually they are easy to kill, (INT 1, CON 4, ACC3, Pen 2, Dam 2) but carry a toxic bite. If they manage to bite flesh, the toxin does 5 points of damage per minute for 10 minutes. It is an acidic toxin, and can be neutralized with application of a base.

### BEARS

**Bear, White:** After escaping from the local zoos, some polar bears managed to adapt to warmer climates. These animals are short tempered and have a high capacity for violence. They enjoy swimming, and usually lair near a spring, lake or stream. INT: 10, CON 130, Damage Resist 5. Pen 20, Damage 10

**Bear, Normal :** INT 8, CON 90, DR 3, PEN 15, Damage 8

### Cats:

**Simbas :** Tiger/Lion/Tigron mutations. At 900lbs pre-rad, they had enough body mass that critical body organs didn't get as much of a jolt. Now, 2 meters at the shoulder when walking. Need about 50-60kg meat a day. Grumpy. Solitary, territorial. INT 5, CON 100, ACC 7, Pen 10 (massive impact), Damage 20

**Quickly:** Cheetah mutations from the Zoo. They survive by eating skeeters, bats, etc. Since the new prey can fly, the cheetahs became even quicker, but the respiratory and kidney systems can't keep up. After a "sprint", they get muscle cramps and sit still for a while until the lactic acid is cleaned up. They'll do 90mph for a block or so, and the faster metabolism affects the nervous system as well, making them amazingly dexterous. They are rather fragile creatures as well, with thin, hollow bones like a bird. Also, since due to the inbreeding, they all consider each other litter-mates, and thus the normal cat territoriality and competition isn't there. They hunt in groups, like a pride of lions. They attack with a sudden spring at the prey's throat, then clamp down with their powerful jaws. INT 8, CON 40, ACC 10, Pen: 11, Dam 15.

### Cows

Cow, "Milk Bar" : These are dairy cows that have managed to survive. In the course of successive generations of only keeping the cows that gave the most milk and eating the others, the remaining "Milk Bar" cows are now producing up to 200 pounds (28+ gallons) of milk per day. These cows are also highly domesticated, almost like dogs. They know they can't fight, so they stay as close to their humans as possible. INT: 10, CON 60, Pen2, Dam4

"Cow, Beefy" : pretty much the same as a MilkBar, but the evolutionary pressure was to produce huge amounts of meat. They are not as smart as a MilkBar, but much bigger. INT 5, CON 150, Pen 2, Dam 4



**Dog, Wild:** Dogs have interbred enough that they've moved back to a generic, wolf-type creature. At the same time, they have been heavily pressured for "smarts" and have learned to work in larger and larger packs. In some areas, packs of over 300 have been sighted. These animals have some respect for but no fear of man. The pack does associate humans with firearms, and the pack typically knows how to herd and hunt humans without revealing clean shots until right on top of the victims. Some like humans, but most have a racial memory of them as "A creature that won't hurt us, and when dead is yummy". INT: 16 CON25, PEN 9, Damage 6

**Dragon:** These are alligators that have grown in size. Most also have larger legs, allowing them to move better on land. On the plus side, if you leave them alone, they'll usually leave you alone. On the minus side, during nesting season (spring), anyone in their territory is considered a threat to the nest. They have a very thick hide with will turn 9mm shots. INT: 3, CON: 140, DR 9, ACC 5, Pen 30, Damage 15

Elephant : The elephant herds made a comeback after escaping from zoos and circuses. The moved far enough into the outback that they were unnoticed until the herd had built up enough to be worth hunting, and now they are treated much like the Native Americans treated buffalo: hunted only as needed. A single kill can feed a village for weeks, and the amount of leather produced is astounding. These animals are large enough to hold off Wild Dog attacks, just because the dogs usually have trouble reaching high enough to find a vital organ or being able to bite deep enough to hamstring them. They operate in herds of 20-50 elephants. The herd protects its young and elderly very strongly, with adult males charging the threat head- on. INT: 9, CON: 150, DR: 20, ACC: 6 Pen: (CLUBS/Stomps), Damage: 40



**Skeeter:** Mutated Mosquito or other annoying insect. Basically an airborne ant, about 11" long with a wingspan of 16". They live in the same 'niche' as scavenger birds. INT 1, CON 4, ACC3, Pen 2, Dam 2

#### Snakes:

**Vipers :** Pit Viper, Cottonmouth, Rattlesnake. Typically, they've grown larger without having humans persecute them - adults are 7-10' long. They eat small game (squirrels, rabbits, etc) . The Hyperlink has symptoms of poisoning. INT: 3, CON: 20, ACC 6, Pen 3, Damage 25

**Elapids :** Coral, Mamba and Cobras (escaped from zoos). Again, bigger, meaner. They aren't as "meaty" as the vipers, but are smarter and more deadly. INT 5, CON 12, ACC 8, PEN 4, Damage 40

## People

These are notes on different social groups that may be encountered.  
The format is:

**Group Name** [option numbers] : Origin  
Goals/Description  
Resources

---

**Coppers (1,2,3)** : Hereditary police force or people who have joined the force.

Much like fictional Old West Texas Rangers, they operate with a code of honor, and try "To Serve and To Protect".

Horses, Modern weapons, some radios.

---

**Pigs (1,2,3)** : Hereditary police force or people who have joined the force

Much like Coppers, but the role model is the corrupt police force of Al Capone's Chicago.

Whatever they can take

---

**SecPol (4)** : Federal Security Police

Picture the KGB with no leash, total deniability and an expense account that would blow your mind.

Whatever they want - see [Option 4](#)

---

**Airish (1,2,3)** : Descendants of people who lived in small fly-in communities.

At the tail end of the 20<sup>th</sup> century and beginning of the 21<sup>st</sup>, many private pilots moved to fly-in communities - a group of 20-50 houses built around a small runway. The people who lived in a typical community consisted of engineers, mechanics, retired doctors, paramedics, ex-Military. These communities were usually well off the beaten path, and thus had enough farmland nearby to permit farming. The name of the group is a corruption of "Amish" - they are basically Amish communities insofar as food production and "community spirit", but maintain their aircraft the way Amish do horse-and-buggy.

Resources include aircraft , ranging from balloons and ultra-lights running on vegetable oil on one end of the scale, to Mig-21's on the other end of the scale. Most aircraft are four seater single engine prop planes. Some have Bell UH-1 Hueys. Their ancestors were members of the Viet Nam Helicopter Pilots Assoc.

---



**Vampires (1,2,3,4) :** People who played certain Live-Action Role Playing games way too much, then raised children while in-charter. To remain in char, operating under the deeply seated belief they are a vampire, werewolf or other supernatural creature. This remaining in-char may demand that they say very strange things and on occasion attack for reasons that are very hard for anyone outside the clique to understand. Disdain "normal" weapons (guns etc), but most use a homebrew PCP derivative which allows them to ignore wounds - they make no CON

rolls and do not fall until all CON points have been used up. Most have very high martial arts scores.

---

**Medicos (1,2,3,4) :** Doctors, or the next best thing

People who feel a higher calling to heal. In Option 4, they have the same training and background current doctors do. In 1,2,3 they may be anything from herbalists and reakie practitioners to people who have studied old texts or have been to one of the few remaining medical schools.

Usually have bodyguards with good weapons (respected and needed member of the community). Medical equipment apropos to the scenario and style of healing.

---



**Drivers** (1,2,3,4) : people who drive professionally; truckers, couriers, teamsters. The term harkens to late 20<sup>th</sup> /early 21<sup>st</sup> century CB radio slang.

Goals: These people just want to show a profit at the end of the day and be able to drive tomorrow. They also will support other drivers who are in trouble, since there's a "Prisoner's Game" principle involved - a Driver with a reputation for helping others will be helped when he needs it. A Driver who doesn't help will be blackballed. Depending on the route and the infrastructure of the towns they visit, they'll be driving everything from diesel semi's converted to run on vegetable oil to alcohol fed pick up trucks to an ox-cart. Most carry side arms of some sort since they're often out of the range of police support. Some aren't all that particular about what goods they carry. Most have some sort of CB radio set up.

---

**Nobles** (1,2,3, very rare 4) : These are people who live up to the high standards of chivalry and *nobless oblige*. They come from all walks of life. The man who stands his ground against thirty foes to defend a widow and her children from the tax collector, the thief who robs from the rich slavers to give to the poor. These are the people who formed the nucleus of new towns. In Option 4, these are the people who still believe in Freedom and Equality, and who start Resistance Cells. All members of the Phoenix Project *should* fall into this category.

Goals: Do what is morally right. Always keep their word. Defend the innocent, Might for Right.

Resources: Often (but not always) are in the top 1/4 of the social structure. Will usually be well armed for the culture they're in, and because of a strong reputation of trading honestly will usually be fairly well off. Some Nobles decide to "wander the Earth - you know, like Caine in Kung Fu". Those that do so operate either solo or in bands of less than 20, operating much like Nomads but not leaving an area in which injustice is occurring. Once things are settled, they move on.

---

**Zulu** (1,2,3) : These folks decided to give up technology, either for moral reasons or because they couldn't maintain it. They now live with almost nothing in the way of tech, but usually have large tribes - making up with sheer manpower what they lack in tools. They look toward Shaka Zulu, the most famous tactician and strategist of pre-

industrial Africa as a fount of wisdom. Considering that Shaka managed a number of victories against a much higher technology opponent, he's not a bad role model for them.

Goals: Protect their land. Get more food. Survive

Resources: Spears, usually with fire hardened wood points. Wicker shields. In cold climates, animal furs and leather boots. And sheer numbers and determination. The determination is legendary; these people will not give up or quit no matter what the odds.

---

**Squids** (1,2,3) : The wet equivalent of Drivers. Merchant Marine, Navy, Coast Guard personnel that decided to remain aboard ship and raise their children there too.

Goals: These people just want to show a profit at the end of the day and be able to sail on another voyage later. There is a loose confederacy amongst them, although sometimes up to 8 ships may form an alliance for some goal. Few are adverse to a little piracy to help the bottom line.

Many ships are sailing vessels of various sizes. Some older hulls have been converted to coal burning instead of oil bunkering. In scenarios 2 and 3, some nuclear submarines and carriers may have survived. In this case, they may send shore parties to old nuclear reactor sites to get fuel. In scenario 2, a very few ships have ZPRs provided by the US Gov't during the Fall.

---

**Slavers** (1,2,3,4) : Any culture which has more work to do than the economic system will support at fair wages will eventually turn to slave labor. In Option 4, this is the resurrection of the "CCC" and "WPA". In scenarios 1,2,3, these are people who have decided they'd rather provide the labor than do it.

Goals: Make a buck. Make another buck. Repeat until rich enough to retire.

Resources: Socially, only one step above their product. They usually make pretty good money, but it goes to equipping more expeditions and their retirement account. They will be well armed, especially with non-lethal weapons. Most have Driver or Squid contacts to move the merchandise to a more salable location.

---

**Mercs (1,2,3)** : In any culture where the economic system won't support a standing army, but occasional use of professional soldiers is needed, a professional soldier without the strings of patriotism will arise. Often, these groups form around a Noble with a cause.



Goals: Keep breathing. Don't bleed. Make a buck. Repeat until retired or dead.

Resources: Best weapons for the area. Best training for the area. Man-for-man they are 3+ times as good as locally raised non-Merc troops, and have tactical training that lets them get away with fighting at 5 to 1 odds - but they never fight more than 2.5:1 so as to limit the number of casualties and lost profits.

---

**Nomads (1,2,3, very rare 4)** : these folks "follow the herd" or a circuit of arable lands. They are hunter-gatherers, picking up a little here and there, never settling down. In Option 4, they live out of motor homes and work odd jobs for cash, keeping as little paper-trail as possible.

Goals: Very few. They'll fight to defend the herd, or to escape persecution and that's about it. In most cases, they move on before they upset people enough to attack them.

Resources: Transport of some sort - usually renewable resources such as ox carts or horse drawn wagons (1,2,3) or old but well maintained motor homes and travel trailers. Some nomad tribes operate as circuses or traveling shows in order to make ends meet. All are very protective of their privacy.

---

**Monasteries (1,2,3)** : These are either real monasteries or universities that have gone into seclusion but managed to make ends meet. They maintain the old knowledge no matter what. Most focus more on the maintenance of the information without considering dissemination or utilization of it past immediate needs. For example,

a cloistered university may pull books on agriculture and organic chemistry/fertilizers from the library, and have what's left of the chemistry department whip up a batch of high tech fertilizer, but wouldn't host a seminar for the local farmers on the same topics or train people to build a fertilizer factory in exchange for part of the take.

Goals: all the books in the library must stay safe. "Oral Knowledge" must be passed onto the next generation.

Resources: Huge knowledge base. Campus Police and ROTC weapons in the case of universities, plus whatever the mechanical engineering, chemistry and ROTC instructors could cook up. Past that, not much.

---

## Non-Project Weapons

1. Small arms. Small arms are heavy and reliable. Their simple design allows easy training, handling, and maintenance. Automatic small arms are generally short for use from inside armored personnel carriers.

a. Semiautomatic pistols.

(1) Makarov 9-mm semiautomatic pistol ([Figure 1](#)). Characteristics are as follows:

- Ammunition, 9 x 18 mm.
- Length of weapon, 194 mm (7.5 inches).
- Magazine, 8 round.
- Range, effective, 50 meters.
- Weight, loaded, 1.33 kg (3 pounds).
- Weight, unloaded, 0.78 kg (1.5 pounds).

Damage 8, Pen 30, Enc 1.5 , mag enc = .75

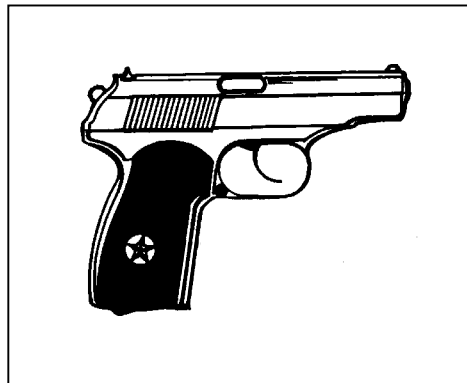
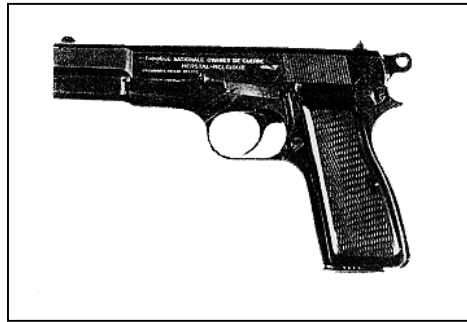

Figure 1. Makarov 9-mm semiautomatic pistol.

(2) Browning 9-mm “High-Power” pistol ([Figure 2](#)). Characteristics are as follows:

- Ammunition, 9 x 19 mm.
- Length of weapon, 203 mm (about 8 inches).
- Magazine, 13 round.
- Range, effective, 50 meters.
- Weight, loaded, 1.50 kg (3.3 pounds).
- Weight, unloaded, 0.86 kg (1.9 pounds).

Damage 9, Pen 40, Enc 1.5, Mag enc 1ea



**Figure 2. Browning 9-mm “High-Power” pistol.**

b. Automatic rifles. Automatic rifles cannot sustain automatic fire because they do not have a quick-change barrel. These rifles are best used in two-shot bursts against point targets. Firing the automatic rifle stimulates other riflemen to fire.

(1) AK 47 7.62-mm assault rifles ([Figure 3](#)). The AK 47, 7.62-mm, comes with either a folding stock or standard stock. Characteristics of this weapon are as follows:

- Ammunition, 7.62 x 39 mm, ball or tracer.
- Magazine, 30 round, box type, detachable.
- Maximum effective ranges.
  - Automatic fire, 200 meters.
  - Semiautomatic fire, 300 meters.
- Rates of fire.
  - Cyclic, 640 rounds per minute.
  - Practical.
    - Automatic, 100 rounds per minute.
    - Semiautomatic, 40 rounds per minute.

Damage 37, Pen 194, Enc 8 Mag 1

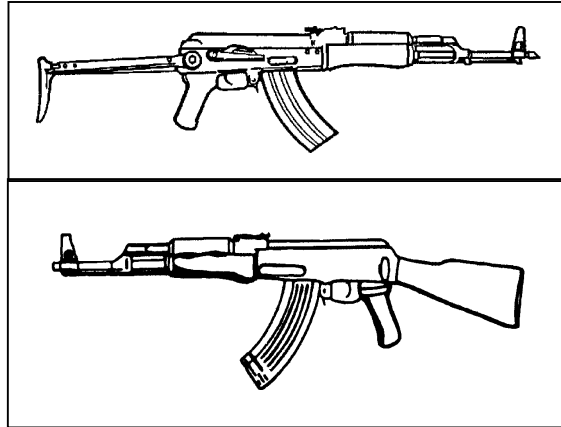
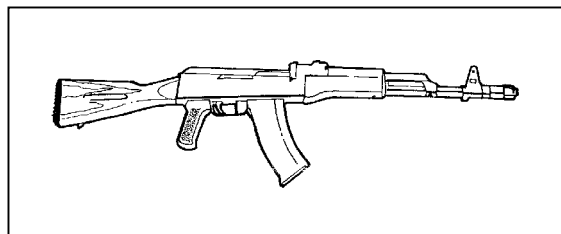

**Figure 3. AK 47 assault rifle.**

(2) AK 74 5.45-mm assault rifle ([Figure 4](#)). The AK 74 may have either a wooden or skeleton stock and looks like an AKM with a muzzle brake. You may find more information about this weapon on the Internet at <http://www.prairienet.org/guns/arms/ak47.htm>. Characteristics of this weapon are as follows:

- Ammunition, 5.45 x 39 mm.
- Length (wooden stock model), 930 mm (36.6 inches).
- Length (folding stock model with stock folded), 690 mm (27.2 inches).
- Magazine, curved plastic, 30 round.
- Muzzle velocity, 900 mps (1,984 fps).
- Operation, gas, selective fire.
- Rate of fire, cyclic, 650 rounds per minute.
- Range, effective, 400 meters.
- Recognizable feature, “Ak-ak” sound when fired.
- Weight, unloaded, 3.6 kg (7.9 pounds).

Damage 12, Pen 90, Enc 8, mag 1



**Figure 4. AK 74 5.45-mm assault rifle.**

(3) SKS 7.62-mm x 39-mm semiautomatic carbine ([Figure 5](#)).

- Ammunition, 7.62-mm M43 cartridge.
- Length, 1.02 meters (40.2 inches).
- Magazine, integral, 10 round, triangular.
- Operation, gas, semiautomatic.
- Range, effective, 400 meters.
- Sights, day.
  - Front, hooded sight post.
  - Rear, adjustable from 100 to 1,000 meters.
- Weight, unloaded, 3.8 kg (8.4 pounds).

- Recognizable features.
  - Integral triangular magazine.
  - Gas port cylinder above the barrel.
  - Knife-type bayonet.
  - Hooded front sight post.

Damage 37, Pen 194, Enc 6 Mag .3

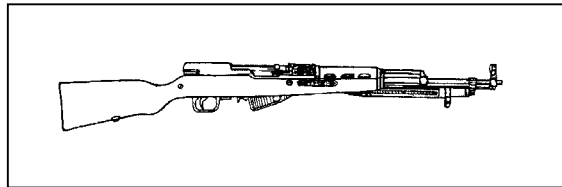
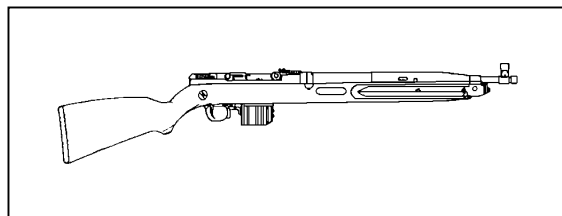

**Figure 5. SKS 7.62-mm x 39-mm semiautomatic carbine.**

(4) M-52/57 7.62-mm semiautomatic rifle ([Figure 6](#)). Characteristics of the M52/57 are as follows:

- Ammunition, 7.62-mm M43 cartridge.
- Length, 1 meter.
- Magazine, integral, 10 round, box type.
- Operation, gas, semiautomatic.
- Range, effective, 400 meters.
- Sights, day.
  - Front hooded sight post.
  - Rear, adjustable from 100 to 900 meters.
- Weight, unloaded, 4.45 kg (9.8 pounds).
- Recognizable features.
  - Gas port cylinder above the barrel.
  - Folding, knife-type bayonet.
  - Hooded front sight post.

Damage 37, Pen 194, Enc 6 Mag .3

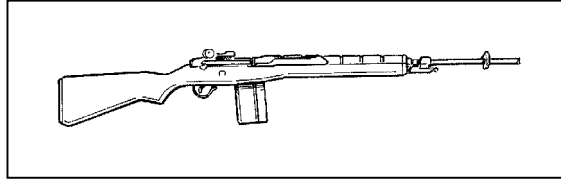

**Figure 6. M-52/57 7.62-mm semiautomatic rifle.**

(5) M14A2 .30 caliber automatic rifle ([Figure 7](#)). Characteristics of the M14A2 are as follows:

- Ammunition, 7.62 x 51 mm.
- Magazine, 20 round, box type.
- Rate of fire, 700 to 750 rounds per minute.
- Sight, day, 10X scope, adjustable focus.

DAM 64, Pen 340, Enc 8, Mag 1

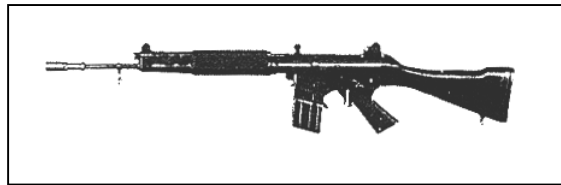

**Figure 7. M14A2 .30 caliber automatic rifle.**

(6) FN FAL 7.62-mm assault rifle ([Figure 8](#)). Characteristics of the FN FAL are as follows:

- Ammunition, 7.62-mm.
- Length, 1,054 mm (41.5 inches).
- Magazine, 20 round, box type.
- Muzzle velocity, 2,800 fps (853 mps).
- Operation, gas, semiautomatic or automatic.
- Range, effective, 600 meters.
- Sight, day, rear, adjustable, 600-meter (656-yard).
- Weight, unloaded, 4.31 kg (9.5 pounds).
- Recognizable features.
  - Folding carrying handle forward of receiver.
  - Solid or folding stock.
  - Bipod and heavier barrel on automatic version.

DAM 64, Pen 340, Enc 8, Mag 1



**Figure 8. FN FAL 7.62-mm assault rifle.**

c. Sniper rifles.

(1) SVD 7.62-mm sniper rifle Dragonou ([Figure 9](#)). Characteristics of the SVD 7.62-mm sniper rifle Dragonou are as follows:

- Ammunition, 7.62 x 54-mm M-08 cartridge.
- Sight, day, rear, adjustable, 1,300-meter; or 4X scope.
- Length of weapon, 1.225 meters.
- Magazine, 10 round, box type, detachable.
- Maximum effective range, 1,300 meters.
- Operation, gas, semiautomatic.
- Weight, unloaded, 4.3 kg (9.5 pounds).

DAM 64, Pen 340, Enc 8, Mag 1



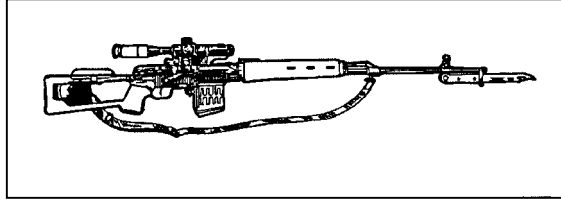
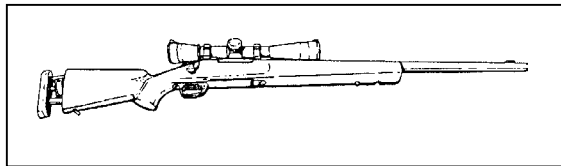

**Figure 9. SVD 7.62-mm sniper rifle Dragonou.**

(2) M24 7.62-mm sniper weapon system ([Figure 10](#)). Characteristics of the M24 7.62-mm sniper weapon system are as follows:

- Ammunition.
  - 7.62 mm.
  - .308 Winchester.
  - M118 special ball.
- Bipod, optional.
- Length (butt to muzzle), 1.08 meters (43 inches).
- Magazine, 7.62 mm, 5 round, integral.
- Muzzle velocity, 793 mps (2,600 fps).
- Maximum Effective Range, 1,000 meters.
- Sights, day, front and rear, iron, detachable.
- Weights.
  - Completely loaded, 6.47 kg (14.25 pounds).
  - System, sniper, complete, 29 kg (64 pounds).

DAM 64, Pen 340, Enc 8, Mag 1



**Figure 10. M24 7.62-mm sniper weapon system.**

d. Machine guns.

(1) RPK 7.62-mm light machine gun ([Figure 11](#)). The RPK is a larger, heavier variant of the AKM assault rifle. The RPK has a chrome-plated barrel, chamber, and gas piston. A cyclic rate reducer is built into the trigger mechanism. Luminous night sights may be installed on the front and rear sights. Most of the RPK's moving parts are interchangeable with those of the AK or AKM assault rifles. The RPKS is a folding stock version used by airborne soldiers. Characteristics of the 7.62-mm RPK are as follows:

- Barrel, longer, heavier, and larger in diameter than the AKM's barrel; chrome plated.
- Bipod, stamped metal.
- Buttstock, wooden; heavier than that of the AKM.
- Magazine.
  - 40 round, curved box type.
  - 75 round, spring-loaded, drum type.
  - 30 round, curved, box type (AKM magazine).
- Nightsight, infrared, compatible with some RPKs, but not all.
- Receiver, modified from the AKM receiver to fit the larger-diameter barrel.

Damage 37, Pen 194, Enc 9, mag 1 (30), 1.1 (40), 3 (75)

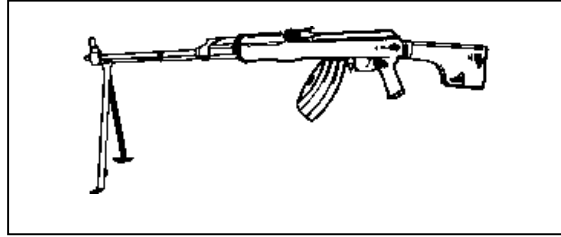

**Figure 11. RPK 7.62-mm light machine gun.**

(2) RPK-74 5.45-mm light machine gun ([Figure 12](#)). Characteristics of the 5.45-mm RPK LMG are as follows:

- Ammunition, 5.45 x 39-mm, ball or tracer.
- Magazine, 30 or 40 round, box type, detachable.
- Maximum effective range, 800 meters.
- Rates of fire.
  - Cyclic, 800 rounds per minute.
  - Practical.
    - Automatic, 150 rounds per minute.
    - Semiautomatic, 50 rounds per minute.
- Nightsight, optional image-intensifying sight.

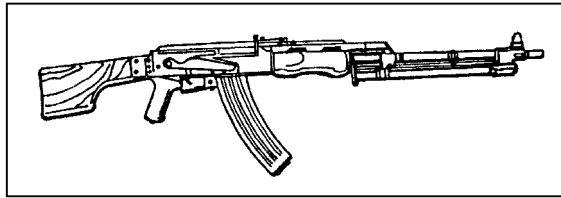
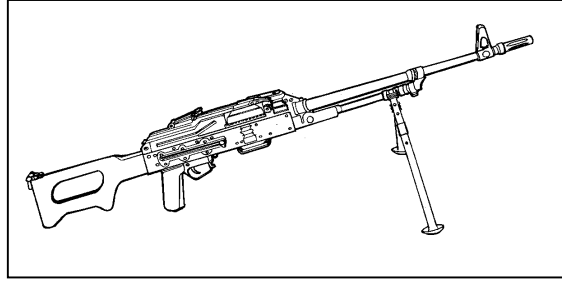

**Figure 12. RPK 5.45-mm light machine gun.**

(3) PKM 7.62-mm general-purpose machine gun ([Figure 13](#)). Characteristics of the PKM are as follows:

- Ammunition, 7.62 x 54 mm.
  - Ball.
  - Tracer.
  - AP.
  - API.
- Crew, two.
- Feed mechanism, 100-, 200-, or 300-round belt.
- Maximum effective range, 1,000 meters.
- Maximum range, 3,800 meters.
- Nightsight, image intensifier.
- Rates of fire.
  - Cyclic, 650 rd/min.
  - Effective, 250rd/min
- Unit of fire, 2,500.

Damage 12, Pen 90, Enc 8, mag 1

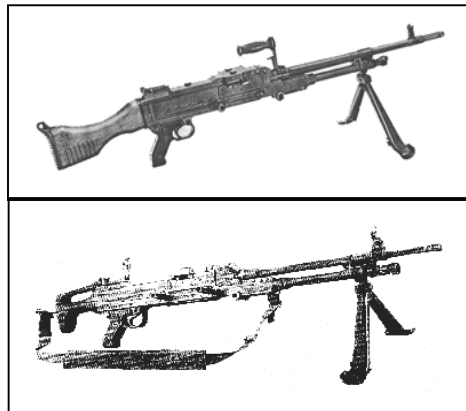

**Figure 13. PKM general-purpose machine gun.**

(4) FN MAG 58 general purpose 7.62-mm machine gun ([Figure 14](#)). Characteristics of the FN MAG 58 general purpose 7.62-mm machine gun are as follows:

- Action, air-cooled, gas-operated.
- Ammunition, 7.62 x 51 mm.
- Barrel, quick-change.
- Bipod, built-in (weapon may be fired from tripod also).
- Feeding mechanism, belt.
- Operation, gas, air-cooled.
- Range, effective, 1,500 meters.
- Rate of fire, cyclic, 650 to 1,500 rounds per minute.
- Weights.
  - Loaded, 13.92 kg (30.69 pounds).
  - Unloaded, 10.98 kg (24.21 pounds).
- Recognizable features.
  - Gas regulator above bipod.
  - Numerous rounded rivet heads along the receiver body.

DAM 64, Pen 340, Enc 9, Mag 3 per 100



**Figure 14. FN MAG general purpose machine gun.**

2. Antitank weapons.

a. Grenade launchers.

(1) RPGs (rocket-propelled grenades) ([Figure 15](#)). Characteristics of RPGs are as follows:

- Action, smooth-bore, muzzle-loading, recoilless shoulder weapon.
- Ammunition, 40 to 73 mm.
- Fin-stabilized.
- Shaped-charge.
- Antitank and antipersonnel HEAT grenades.

- Caliber, warhead is at least 80-mm (3.15 inches) in diameter.
- Diameter, launch tube, 40 mm (1.6 inches).
- Length, 950 mm (37.4 inches).
- Penetration, 175 to 320 mm (6.9 to 12.6 inches).
- Range, maximum effective, 150 meters (moving target) to 300 meters (static target).
- Rate of fire, four to six rounds per minute.
- Sights.
  - Night, infrared sight.
  - Day, front, fixed sight post.
  - Day, rear, adjustable folding leaf type.
- Recognizable features.
  - Large cone-tipped round.
  - Muzzle-loader.
  - Pistol grip trigger assembly.
  - Possible aluminum blast deflector at rear of weapon.
  - Steel barrel open at both ends.
  - Sight, rear, top-mounted, adjustable leaf.
  - Sight, front, top-mounted, fixed.
  - Two-piece plywood heat shield at midsection.

Dam 500, Pen 3000, Enc 2.5 each round, 2 for launcher

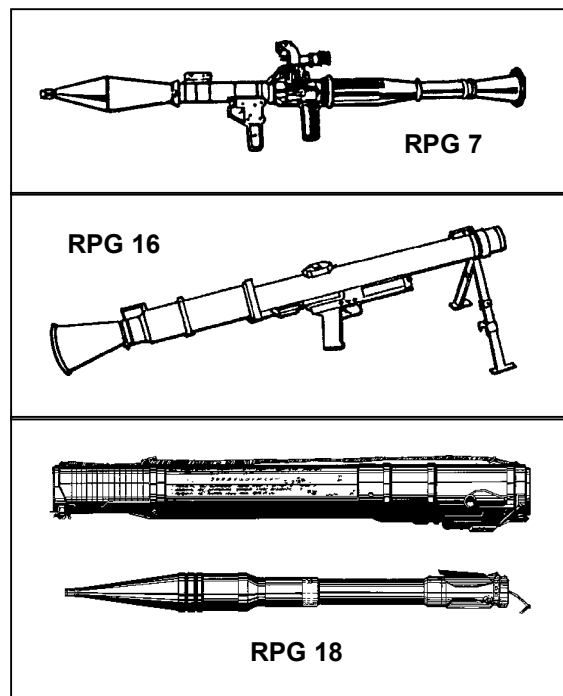

**Figure 15. RPG.**

- (2) M203 grenade launcher ([Figure 16](#)). Characteristics of the M203 are as follows:
- Action, single shot, breech loading, pump action (sliding barrel).
  - Ammunition, 40-mm grenades (HE, HEDP, CS, TP, smoke, and illumination).
  - Chamber pressure, 210 kg/cm.
  - Combat load, minimum, 36 HE rounds.
  - Sights, day.
    - Front sight post.
    - Rear leaf sight.

- Length of rifle and grenade launcher, overall—9 cm (39 inches).
- Muzzle velocity, 76 mps (250 fps).
- Ranges.
  - Effective, about 400 meters (1,312 feet or 437.3 yards).
  - Maximum effective, fire-team-sized target, 350 meters (1,148 feet).
  - Maximum effective, vehicle or weapon point target, 150 meters (492 feet).
  - Minimum arming, about 14 to 38 meters (46 to 125 feet).
  - Minimum safe, HE, combat, 31 meters (102 feet or 34 yards).
  - Minimum safe, HE, training, 80 meters (262.4 feet or 87.5 yards).
- Weights.
  - Unloaded, unmounted grenade launcher, 1.4 kg (3.1 pounds).
  - Loaded rifle and grenade launcher, 5.0 kg (11 pounds).
- Round, about 227 grams (8 ounces).
- Rate of fire, 5 to 7 rounds per minute.
- Recognizable features.
  - Breech loading.
  - Mounts beneath M16A1 or M16A2 rifle.
  - Pump action.

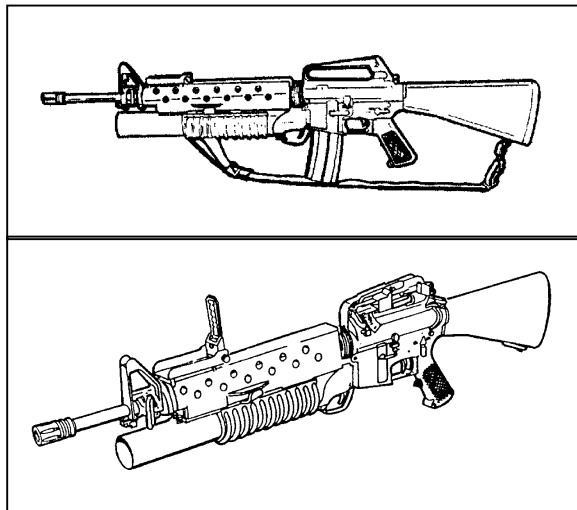
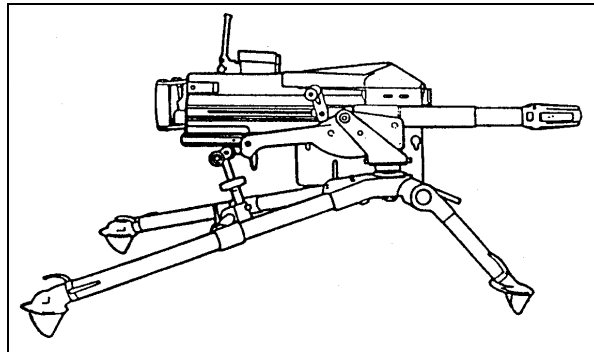

**Figure 16. M203 grenade launcher.**

(3) MK 19 grenade launcher ([Figure 17](#)). Characteristics of the MK 19 grenade launcher are as follows:

- Action, Air-cooled, blowback, with an electrical or manual firing mechanism.
- Indirect fire, single fire, or automatic.
- Fires from open bolt.
- Ammunition, Various belted 40-mm rounds; links eject with cartridge case.
- Feeds during recoil much like the M2 .50 caliber machine gun.
- Feeding mechanism, belt fed.
- Length, launcher, overall, 1,095 mm (40.5 inches or 1.125 yard).
- Muzzle velocity, 241 mps (790 fps).
- Ranges.
  - Maximum, 2,200 meters.
  - Maximum effective, point target, 1,500 to 1,600 meters.
- Rate of fire, 320 to 375 rounds per minute.
- Sights, day.
  - Rear, folding leaf.
  - Front, iron blade.

- Weights.
  - Launcher, unloaded, 34.3 kg (75.6 pounds).
  - M3 tripod, 20 kg (44.1 pounds).
  - Lightweight tripod, 9.1 kg (20.1 pounds).
  - Round, 227 grams (8 ounces).
- Recognizable features.
  - Sight, rear adjustable.
  - Tripod, mounts forward under the receiver.
  - Short, boxy receiver.
  - Heavy barrel with flash suppressor.



**Figure 17. MK 19 grenade launcher.**

(4) M79 grenade launcher ([Figure 18](#)). Characteristics of the M79 grenade launcher are as follows:

- Action, break open, single shot, shoulder fired.
- Ammunition, 40 mm.
- Sights, day.
  - Rear, folding leaf.
  - Front, iron blade.
- Length, launcher, overall, 73.7 cm (29 inches).
- Muzzle velocity, 76 mps (250 fps).
- Ranges.
  - Maximum, 400 meters (1,312 feet or 437.3 yards).
  - Maximum effective, fire-team sized area target, 350 meters (1,148 feet).
  - Maximum effective, vehicle or weapon point target, 150 meters (492 feet).
  - Minimum safe firing, HE, combat , 31 meters (102 feet or 34 yards).
  - Minimum safe firing, HE, training, 130 meters (426 feet or 142 yards).
- Recognizable features.
  - Adjustable rear sight located in center of barrel.
  - Short, wide-bore barrel.
- Weights.
  - Round, 227 grams (8 ounces).
  - Weapon, unloaded, 2.72 kg (6 pounds).
  - Weapon, loaded, 2.95 kg (6.5 pounds).

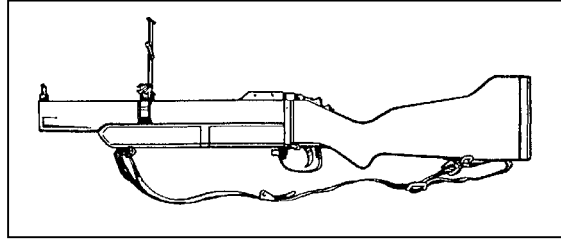
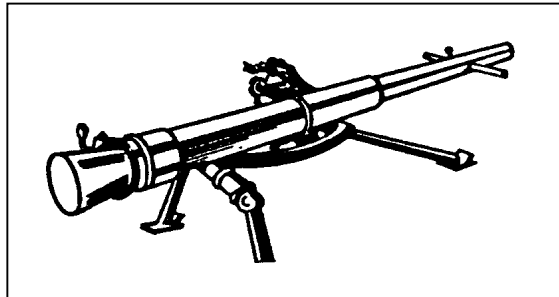

**Figure 18. M79 grenade launcher.**

b. Recoilless weapons.

(1) SPG-9 73-mm antitank recoilless gun ([Figure 19](#)). Characteristics of the SPG-9 73-mm antitank recoilless gun are as follows:

- Action, recoilless.
- Ammunition.
  - 73-mm fin-stabilized, rocket-assisted HEAT projectile.
  - 4-kilogram rocket-assisted HE round.
- Man-portable, but usually carried on a truck or APC.
- Ground mount, tripod.
- Muzzle velocity, high; increases to 700 meter per second with rocket assist.
- Range, effective, HEAT projectile, 1,000 meters.
- Penetrates 400 mm of armor.
- Sights.
  - Infrared sight available.
  - Passive night sight available.
- Weights.
  - HEAT projectile, 3.5 kilograms.
- Recognizable features.
  - Tripod.
  - Man-portable.



**Figure 19. SPG-9 73-mm antitank recoilless gun.**

(2) Carl Gustaf 84-mm recoilless rifle ([Figure 20](#)). Characteristics of the Carl Gustaf 84-mm recoilless rifle are as follows:

- Versatile, powerful weapon system.
- Effective against heavy armor, APCs, landing craft, or entrenched troops.

Enc 2.5 each round, 8 for launcher

- Ammunition.
  - HEAT 751 penetrates tiles without setting them off, then blasts through armor into interior. **Dam 500, Pen 3500**
  - HEAT 551 is effective against armor vehicles and other hard targets to 700 meters. **Dam 300, pen4000**

- TP 552 is an inert warhead for training and practice; it is ballistically matched to HEAT 551 round.
- HEDP 502 is an dual-purpose HE and HEAT round for urban combat. Effective against light armored vehicles, concrete and brick walls, field fortifications, and ground forces. In the HEAT role, the round has a devastating behind-armor effect. **Dam 400, Pen 3300**
- HE 441B can be set to impact detonation or air burst; used to combat troops in the open or behind cover, soft-skinned vehicles, and other soft targets. **Dam 100, Shrapnel 6xd20, Pen 40**
- Illumination 545 rapidly illuminates target areas.
- Smoke 469B develops a smoke screen instantly on impact.

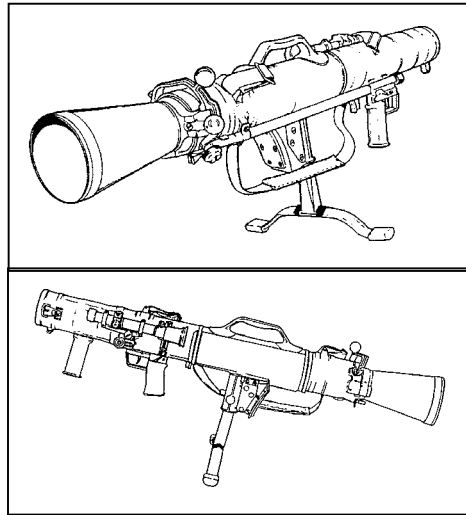

**Figure 20. Carl Gustav 84-mm recoilless rifle.**

- c. Guided missiles.
  - (1) Sagger or Swatter with carrying case and mount ([Figure 21](#)).
  - (a) Characteristics common to the Sagger and Swatter.

**Pen 8000, Damage 4000**

- Sights. Optical viewer for tracking target and missile (day only).
- Employment. Employed on the ground while the crew is “buttoned up” or mounted on a BMP, BMD, BRDM-2, or helicopter.
- Target. Can defeat most known armor.
- Gunners. Must be highly trained, because they must track the target and the missile through an optical viewer at the same time they fly the missile with a joystick.
- Missile speed. Sagger and Swatter missiles are slower than the TOW.
- Night use. Neither the Sagger nor the Swatter may be used at night; they have no night vision capability.
- Vulnerabilities.
  - Wire breakage. Bushes and other obstacles may break wires.
  - Early detonation of warhead. Trees or heavy brush can detonate the ATGM warhead.
- (b) Distinguishing characteristics of the Sagger.
  - Tracking, optical (same as Swatter).
  - Wire guided.
  - Minimum tracking range, 500 meters (same as Swatter).
  - Maximum effective range, 3,000 meters (slightly more accurate at this range than the Sagger).
  - Invulnerable to electronic countermeasures.



- Highly mobile.
  - Weight, 11.3 kg.
  - Dimensions.
    - Length, 864 mm.
    - Diameter, 120-mm.
- (c) Distinguishing characteristics of the Swatter.
- Tracking, optical (same as Sagger).
  - Radio guided.
  - Minimum tracking range, 500 meters (same as Sagger).
  - Maximum effective range, 3,000 meters (slightly less accurate at this range than the Sagger).
  - Vulnerable to electronic countermeasures.
  - Slightly less mobile than the Sagger.
  - Dimensions unknown.
  - Weight unknown.

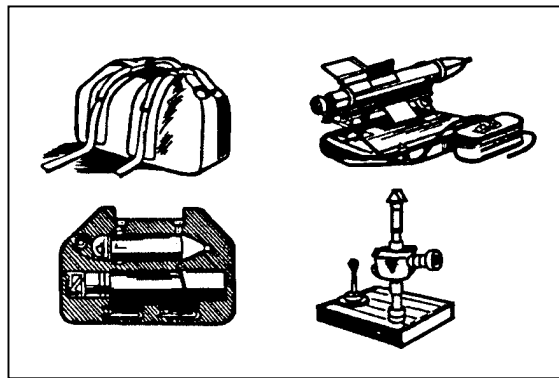

**Figure 21. Sagger or Swatter with carrying case and mount.**

(2) TOW 2 (BGM-71D) heavy antitank weapon ([Figure 22](#)). Characteristics of the TOW 2 (BGM-71D) heavy antitank weapon are as follows:

- Employment by ground or vehicle mount.
- Range, 3,750 feet (0.71 mile).
- Ammunition, four configurations.
- Weight, 190.5 lb, complete.

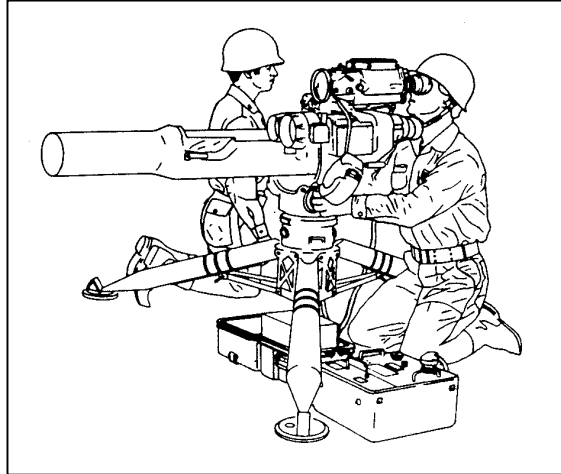

**Figure 22. TOW 2 (BGM-71D) heavy antitank weapon.**

(3) M136 AT4 light antiarmor weapon ([Figure 23](#)). Characteristics of the M136 AT4 are as follows:

- Ammunition, integral, rocket-type 84-mm cartridge.
- Caliber, 84 mm.
- Length of launcher, 1.02 meters (40 inches).
- Length of rocket, 460 mm (18 inches or 0.5 yard).
- Penetration, more than 14 inches of armor.
- Ranges.
  - Maximum, 2,100 meters (1.3 mile).
  - Maximum effective, 300 meters.
- Weights.
  - Loaded, 8.5 kg (18.8 pounds).
  - Unloaded, 6.7 kg (14.8 pounds).

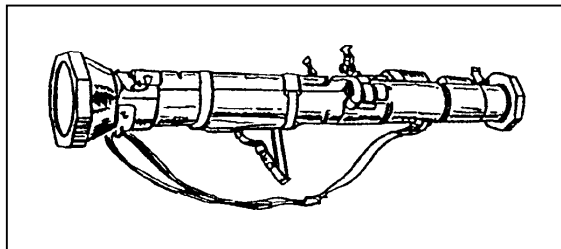
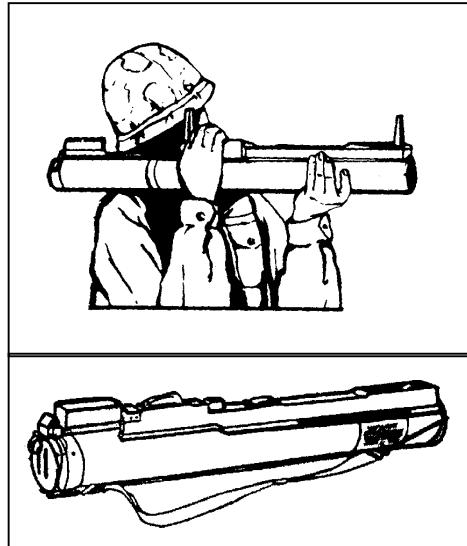

**Figure 23. M136 AT4 light antiarmor weapon.**

(4) M72-series light antitank weapon (LAW) ([Figure 24](#)). Characteristics of the M72-series LAW are as follows:

- Caliber, 66 mm.
- Firing mechanism, percussion.
- Muzzle velocity, 144.8 mps (475 fps).
- Lengths.
  - Closed, 0.67 meter (26.38 inches).
  - Extended, less than 1 meter.

- Ranges.
  - Maximum, 1,000 meters (1 km) (1,094 yards or 0.621 mile).
  - Maximum effective, moving target, 165 meters (541 feet).
  - Maximum effective, stationary target, 200 meters (60 feet).
- Sight, night, AN/PVS-4.
- Weight, 2.3 to 2.5 kg (5.1 to 5.5 pounds).



**Figure 24. M72-series LAW.**

(5) M47 Dragon medium antitank weapon ([Figure 25](#)). Characteristics of the M47 Dragon are as follows:

- Ground employed, direct line-of-sight.
- SACLOS/wire guidance system.
- Night vision equipment, thermal imaging device.
- Range, 1,000 meters in 12 seconds.

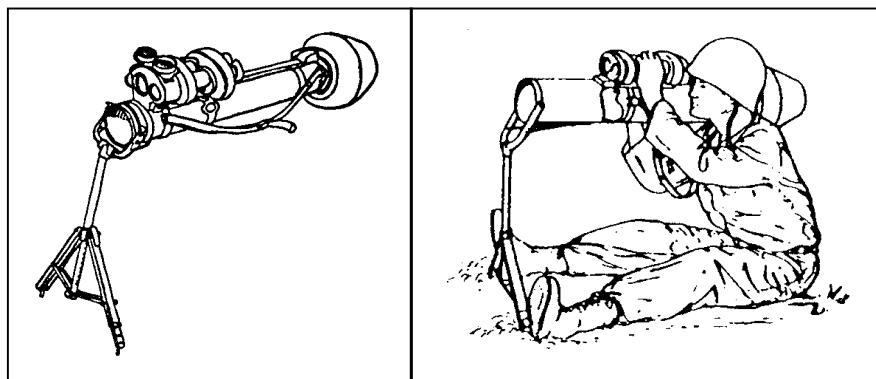

**Figure 25. M47 Dragon medium antitank weapon.**

d. Grenade launchers. The only weapon included in this category for purposes of this task is the AGS-17 automatic 30-mm grenade launcher ([Figure 26](#)). Characteristics of the AGS-17 automatic 30-mm grenade launcher are as follows:

- Action, selective-fire mode.
- Ammunition includes 30 x 28.5-mm fragmentary, HE, and possibly HEAT also.
  - Bursting radius, 7 meters.
  - Crew, three.
  - Length of weapon, 0.80 meter.
- Magazine, 29 round, belt fed.
- Ranges, effective.
  - Direct, 1,200 meters.
  - Indirect, 1,730 meters.
- Rate of fire.
  - Cyclic, 300 to 350 rds/min.
  - Effective, 40 to 60 rds/min.
- Unit of fire, eighty-seven.
- Weight of weapon.
  - Loaded, 43 kg.
  - Unloaded, 17.75 kg.

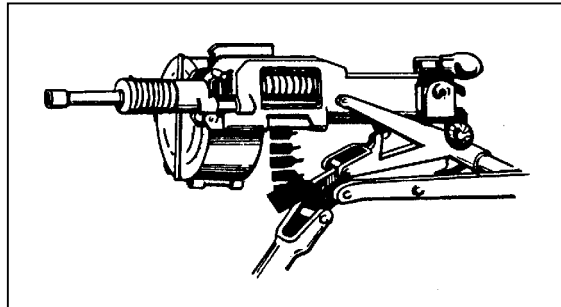

**Figure 26. AGS-17 automatic 30-mm grenade launcher.**

e. Artillery.

(1) D-20 152-mm gun/howitzer ([Figure 27](#)). The D-20's range compensates for its cumbersome nature—it is large, and it is too heavy for a simple towed carriage. Other characteristics of the D-20 are as follows:

(a) Ammunition. The D-20 uses case-type, variable-charge, separate-loading ammunition.

- Frag-HE. ***Shrapnel, Damage 9xd20, Pen 30, 15m radius***
- CP.
- AP-T. ***Pen 3000, Damage 500***
- HE/RAP. ***Damage 100, Pen 10, 15m radius***
- HEAT. ***Pen 3500, Damage 750***
- HEAT-SS (spin stabilized). ***Pen 2500, Damage 800***
- Flechette. ***Cone/Shotgun, 15xd20, Pen 40***
- Scatterable mines (AT and AP).
- Semi-active laser. ***+20 to hit, Pen 3500, Damage 750***
- Chemical (CW agent dispersed by a TNT bursting charge).
  - The 40-kg round has 2.8 kg of the Sarin CW agent.
  - The 42.5-kg round has a 152-mm viscous Lewisite projectile and includes 5.4 kg CW agent.
- Smoke (D-540).
- Illuminating (S-540).
- Tactical nuclear (0.2 kiloton). ***Don't worry about it***

- (b) Ranges.
- Semi-active laser, 18 kilometers.
  - HE/RAP, 24 kilometers.

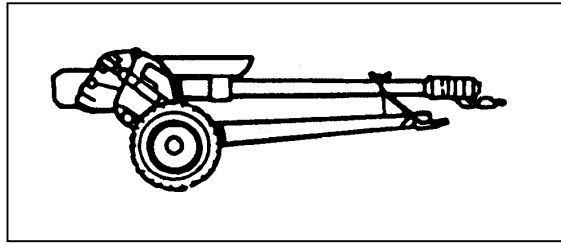

**Figure 27. D-20 152-mm gun/howitzer.**

- (2) D-30. 122-mm howitzer ([Figure 28](#)). Characteristics of the D-30 are as follows:
- Ammunition, variable charge, case type, separate loading.
    - Chemical, CW agent is dispersed by a TNT bursting charge.
    - 1.3 kg of Sarin CW in a 22.5 kg round.
    - 3.3 kg of viscous Lewisite CW in a 23.1 kg round (122-mm projectile).
    - Flechette.
    - Fragmentary-HE.
    - HEAT-FS.
    - Illuminating, S-462, weighs 22.4 kg.
    - Incendiary.
    - Leaflet.
    - RAP (maximum range 21,900 meters).
    - Smoke, D-462, weighs 22.3 kg.
  - Angle of fire, high to low.
  - Crew, eight.
  - Sights.
    - Infrared sight available.
    - Passive night vision sight available.
  - Tactical employment, antitank defense.
  - Traverse, 360 degrees.
  - Vulnerabilities include minimum crew protection.

**NOTE:** Aligning the D-30 directly over the support rails reduces the weapon's maximum effective range significantly (to 7,000 meters).

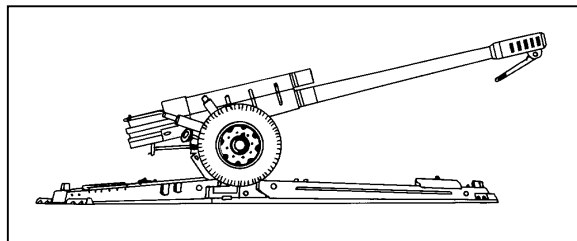

**Figure 28. D-30 122-mm howitzer.**

# The Fall

## **Option 1 : Global Thermonuclear War**

### **"Nuclear War Construction Kit"**

This game predicated on a Russian launched nuclear attack. I've checked the numbers, and the Chinese just don't have enough missiles to make the party worthwhile, so to speak. Right now (May 28, 2000) it looks like the Russians and Chinese are edging toward a partnership anyway, which means the Russian Strategic Arm is still the thing to worry about.

The information below is intended for GM's to use in the course of planning their own (gamed) nuclear attack on the US. All info is public domain, so I'm not giving out any secrets

## Russian Nuclear Doctrine

### **RUSSIAN MILITARY DOCTRINE AND STRATEGIC NUCLEAR FORCES TO THE YEAR 2000 AND BEYOND.**

Alexei Arbatov

(This paper was prepared for the conference Russian Defense Policy Towards the Year 2000, Naval Postgraduate School, Monterey, California, March 26-27, 1997.)

Present Russian military doctrine is based on a document approved at a Security Council session on 2 November, 1993. On that same day, the document, "Principle Guidance on the Military Doctrine of the Russian Federation" ( PGMD) was officially legalized by Presidential decree No. 1833 (1). Whatever the outcome of continuing work on its revised version, there is reason to expect its main points will remain the same.

#### 1. THE DOCTRINE

In the document of November 1993, alongside pledges of allegiance to international law and disarmament agreements, the substantive part had a number of peculiar points. The main points were: an emphasis on rapid deployment of interventionist forces, to be used on post-Soviet territory; a renewal of the traditional accent on offensive conventional operations; legalization of stationing Russian forces abroad (in the CIS) and - what was most striking - of their potential employment in domestic situations. Not a single word mentioned civilian or Parliamentary control over the armed forces and military policy (the President is the sole chief), military reform or further reductions of force levels(2).

The nuclear part included several notable innovations. First, the document states unequivocally: "The goal of Russian Federation policy regarding nuclear weapons is to remove the threat of nuclear war by deterring its initiation against the Russian Federation and its allies."(3) After several years of utopian concepts about substituting deterrence with something different, this was a positive and realistic point, clearing the issue and theoretically allowing a focus on real problems without confusion or wishful thinking. Nonetheless, the concrete formula of deterrence was much more dubious and controversial.

In particular, and this was the second point, the 1982 non-first-use (NFU) pledge was officially revoked. The PGMD elaborately states that the Russian Federation would not employ nuclear weapons against any other state-party to the Treaty on the Non-Proliferation of Nuclear Weapons (NPT) which (1) is not a nuclear power, (2) is not an ally of a nuclear power, (3) is not engaged in joint operations together with a nuclear power in aggression against the Russian Federation, its territory, its allies or its forces. To put it in a different way, Russia would feel free to use nuclear weapons against any nuclear power; any non-nuclear ally of a nuclear power; any non-nuclear non-aligned state, acting militarily together with a nuclear power; and any non-nuclear, non-aligned state, not acting together with a nuclear power, if that state is not a party to the NPT Treaty of 1968.

Third, there was more confusion, because from the text of the PGMD it did not follow whether this highly permissive formula meant first use/strike or second/retaliatory strike. However, further elaborations from the highest officials of the Ministry of Defense and Security Council made it clear that it was exactly a first strike (not first use), that was the subject of this doctrinal part.(4)

Fourth, the strategic requirements were interpreted as "maintaining the structure and state of strategic nuclear forces at a level that will assure inflicting the designated damage on an aggressor under any circumstances." Compared to traditional notions of "massive", "crashing", or "maximum" retaliation, the new goal sounds more limited and selective, which might indicate a recognition of previously overstated damage requirements and of the prospects of deep force reduction (under START-2, or even without it, because of weapons obsolescence and curtailment of modernization programs).

Fifth, the technical requirements were stated as "maintaining the entire complex of strategic weapons at a level that ensures the security of the Russian Federation and its allies, deters nuclear and conventional war, and maintains strategic stability as well as

nuclear safety." (5) This was yet another clear statement, assigning the strategic forces the task of deterring conventional war, which implied first use/strike strategy. The main arguments in favor of rejecting the 1982 Soviet commitment, presented afterwards by military and civilian officials, as well as by private experts, were as follows:

- The declaration of 1982 was purely propagandistic, and its revocation means a realistic adaptation of declared doctrine and strategy to practical strategy and force capabilities.

- Other "civilized" states (i.e. NATO states, which impolitely implied that China was not quite "civilized") had not followed the Soviet example and had not assumed a no-first-use posture.

- Russia's strategic forces and C3I (for economic reasons and as a result of deep reductions either unilaterally or under START-2) would be more vulnerable to counterforce nuclear strikes, making second strike or launch-on-warning (LOW) less reliable for deterrence.

- Moscow's strategic forces would also become more vulnerable to conventional precision-guided weapons, because of the latter's further development in conjunction with strategic forces reduction and restructuring.

- Russian conventional forces are too weak, as a result of the USSR's disintegration, Russia's economic crisis and the transitional nature of current military reforms. They have to be enhanced by higher reliance on nuclear weapons, much like NATO had been doing during the Cold War to counter Soviet and Warsaw Treaty Organization (WTO) conventional superiority.

## 2. FIRST STRIKE CONCEPT.

The argument about degradation of Russia's conventional forces is the most serious, and requires a detailed analysis. The principle of making up for the lack of conventional forces by greater reliance on nuclear weapons in deterrence strategy and operational planning alike, is as old as the Dulles "Massive Retaliation" strategy of 1954. After 1967 and during the next quarter century, despite the shift to "flexible response" and its various consecutive versions, NATO retained the first-use option for its forward-based tactical nuclear forces in Western Europe, trying to outweigh the almost triple aggregate numerical superiority of the WTO in offensive conventional ground and air forces on the continent (6).

Disintegration of the WTO, break up of the Soviet Union, deep economic crises and high inflation in Russia, failure of conversion and military reform in 1991-1993, political and administrative turmoil - all these have greatly degraded the conventional forces, which were historically the strongest Soviet/Russian point. However, the accepted notion of making up for this unaccustomed weakness by increased reliance on nuclear weapons, which was officially recognized in the new Russian military doctrine, is quite dubious for at least two reasons.

The first is the strategic logic of a conventional-nuclear trade-off, the second is the operational logic of a first strike/use concept.

In order for the nuclear first strike concept to work as a reinforcement for inadequate conventional deterrence, several conditions have to be met. First, there has to be a need for such reinforcement, i.e. an opponent or opponents superior in conventional capabilities and capable of threatening one's own interests by implementing successful conventional offensive operations. Second, nuclear force employment should be credible as a threat - that is, the subject's interests must be really vital to justify nuclear warfare, and this act should not be purely suicidal for the initiating party. Hence, the initiator should possess clear advantages in nuclear capabilities in order to achieve military objectives, dominate escalation and prevent an opponent's nuclear counteractions, which may deny these gains or inflict overwhelming damage on one's own state.

Looking at potential military threats, which might face Russia before and during the first decade after the year 2000 (when its conventional forces may remain relatively weak), it is hard to find opponents and contingencies corresponding to the two above conditions. All other former Soviet republics have negligible armed forces compared to Russia, since the factors affecting Russia have undercut them to an even greater degree. Even Ukraine, without massive outside support, would not be able to challenge Russia militarily.

Leaving aside any moral and ethical aspects of a nuclear strike against Ukraine or the other neighboring republics (that have, incidentally, 25 million ethnic Russians on their territories), from a purely military point of view a nuclear option would be absurd. These states would not under any circumstances be capable of mobilizing victorious offensive conventional operations against Russia, that might justify nuclear a response. On the other hand, if Russia attacks them with conventional forces, it would be senseless to use nuclear weapons against the territory and population, which Russia hypothetically might want to occupy. In most cases if military conflict occurs Moscow may face only guerrilla-type warfare, for which nuclear force is neither required, nor effective. Beyond the "near abroad," Russia will be facing a number of states or alliances with considerable and growing armed forces. In the West after the late 1990s, NATO will be at least three times superior to Russia in the same categories of conventional forces in which WTO had triple superiority till the late 1980s. But this overwhelming military power will be separated from Russian borders by a double belt of East European states and the Baltics, Belarus, Ukraine, Moldova and the Transcaucasus. Preserving this "buffer

zone" and developing good relations with the West (7) would remove the danger of Russia's confronting a much superior conventional power.

However, for a conservative military planner it is conceivable that NATO will confront Russia, after accepting into its membership some or all of the present "buffer states" and extending its forces to the east; or that both NATO and Russia will tear this zone apart and meet at some new watershed of military confrontation. Nonetheless, in this hypothetical case the second condition of effective nuclear first-strike deterrence still would not be satisfied. In addition to conventional superiority, NATO will possess a clear-cut nuclear superiority over Russia both in tactical and strategic nuclear forces. US tactical nuclear forces could be brought back to Europe in mass and forward deployed in Eastern Europe, in the Baltics and other neighboring states, thus densely covering targets deep in Russia's heartland.

US strategic forces, together with the British and French, may be as much as 50-70% larger (by warhead number) than Russian forces under START-2 terms, and would be twice as large without START-2 after the year 2003-2005. Without any limitations, the US alone would be capable of achieving triple strategic superiority over Russia by the year 2003, due to its economic and geostrategic advantages.

Hence, nuclear use would be suicidal for Russia. It would not be able to achieve any military advantage by initiating nuclear warfare, either to dominate in escalation or inflict larger damage than incurred by itself. Moreover, in a crisis situation, Russia's first use posture might provoke a preemptive strike by NATO, which could be quite effective due to its conventional, tactical nuclear and strategic nuclear counterforce superiority. Contemplating this possibility, Russia might decide to launch its weapons first, with catastrophic consequences for itself as well as for others.

This is different from past NATO first-use policies because, at least theoretically, the US had the advantage of being immune to attacks by tactical or theater nuclear weapons, in contrast to the USSR (as well as Western and Central European states). Hence, the US theoretically could credibly threaten nuclear first use, having an inherent geostrategic advantage and escalation dominance at all levels, except the highest stage of massive global counter-urban strike exchange.

In future, these dire scenarios are much less conceivable than in the past. But the declared Russian first strike option is not designed for friendly and routine situations. Within its own frame of reference this strategy looks self-defeating and prone to catastrophic consequences for Russia's own survival. If nuclear weapons are perceived, as was stated by Moscow's political and military leaders, to be a means of policy, rather than weapons of war (8), such policy should not be absurd, illogical or dangerous for Russian security. If the threat of nuclear war is considered purely hypothetical and absolutely remote, then the reasons for this conspicuous doctrinal shift are all the more inconceivable.

In fact the change of doctrine in 1993 did not affect force levels and structure, weapon programs, employment concepts and command-control systems and procedures. First use was and now is still more (in view of NATO's expansion plan) a political message to the West, lacking any material substance or logical framework. It is perceived more like a "doomsday machine" factor, rather than a credible deterrence strategy, even if very few people in Moscow would be able to recognize the difference.

At the southern rim of instability Turkey, Iran, Pakistan and Afghanistan may individually or in some combination present a security problem for Russia. This threat, however, would not be direct, but would come through their support of anti-Russian regimes in the Transcaucasus and Central Asia. Another possibility is for these states to support guerrilla fighting against the federal forces in Russia, or against Russia's client regimes, as is now happening in Tajikistan.

However, even from a purely military point of view nuclear weapons would hardly be useful there either, because of the character of warfare. Russia will retain a clear-cut conventional superiority over all such opponents. If this superiority is not capable of achieving Russian goals, then nuclear weapons would be even less effective, to say nothing of the international political consequences of such a hypothetical action.

Besides, states like Iran and Afghanistan fit under Russian doctrinal definitions as the few states "exempt" from nuclear strike: they are not nuclear powers, neither allies of nuclear powers, and they are parties to the NPT. As for Turkey, if it acts independently from NATO, it will not be a serious challenge to Russia (especially taking into account the geography of the Transcaucasus). If on the other hand, it is supported by NATO, then all arguments relevant for NATO-Russian scenarios are applicable here.

In the Far East two powers, Japan and China, may present a threat to Russia. In the case of Japan, the logic of Russia's hypothetical confrontation with NATO is relevant with only one reservation: Japan's conventional offensive capabilities against Russia will be quite limited at least during the next 10 years. An attempt to take the Kurile Islands or Sakhalin by force is not conceivable, and initiating nuclear weapons use in this case would not be a viable strategy.

China is a special matter. Its current crash military build-up, geostrategic situation, and long history of territorial disputes with Russia and the USSR might, in future, encourage Beijing's expansionist policies towards Russia's Siberia and the Far East, or against Kazakstan and other Central Asian allies of Moscow.

At the same time, China would fit the conditions for Russia's first-use strategy to be effective. In time it may achieve conventional offensive superiority along the



Transbaikal and Maritime borders, and have serious reinforcement advantages and the capability to interdict Russian reinforcements from its western territory. On the other hand, China will remain inferior to Russia in tactical nuclear weapons and strategic nuclear capabilities, giving Moscow a credible first-strike threat and escalation dominance.

Still, there are some considerations against such a strategy. First, China's conventional build-up greatly depends on massive imports of weapons and technology from Russia. Thus, besides the nuclear first-use threat, Moscow has an effective means of undercutting or at least seriously slowing down the emergence of this hypothetical threat. Second, China is now the only nuclear power which has officially adopted and is maintaining a nuclear non-first-use commitment. A Russian nuclear threat might encourage China to do the same and revoke its pledge, all the more so since its strategic nuclear forces and C3I system will remain vulnerable to counterforce strikes for a long time yet. In that case, the Russian-Chinese nuclear balance in the Far East would become highly unstable, and nuclear war would become more possible. This cannot be a desired goal of any nuclear strategy. At a minimum to effectively deter China's conventional offensive superiority in those theaters, Russia might rely on the option of employing a few tactical nuclear weapons in the border areas to thwart its enemy's offensive operations, while deterring China's nuclear response at the strategic level with superior (counterforce and countervalue) strategic retaliatory capabilities. Then Russia's deterrence would be credible: its nuclear capabilities would be sufficient to deny China's alleged military gains in the theater, but would not threaten China's national survival, and thus would not provoke strategic nuclear preemption. At the same time, China's preemption would be deterred by Russia's superior strategic retaliatory potential. This would be very similar to NATO's deterrence strategy towards the WTO from the 1960s to the 1980s.

The problem is that Russia's highest military command and strategists do not think in these seemingly rational terms. The former head of the General Staff, General M. Kolesnikov, put it with a rare clarity: "The questions of nuclear (operational) planning and strategic forces employment are not affected at all by the state of other arms and armed services. As for tactical nuclear weapons use plans, they are essentially non-existent. The General Staff is not doing any planning for tactical nuclear weapons employment at all. That's why these weapons are called tactical, aren't they? We cannot foresee all the nuances of conceivable offensive or defensive operations. As soon as a situation occurs, we'll start the planning process. As for the new military doctrine, it refers only to circumstances for the particular potential use of strategic nuclear forces." (9)

The above statement raises many questions about the attitude of the Russian military towards nuclear-conventional trade-offs, and centralized control over and preparations for tactical nuclear weapons employment. It is also quite revealing as to the peculiarities of Soviet/Russian strategic nuclear thinking. In particular, nuclear weapons employment strategy (i.e., first/second strike, counterforce/countervalue targeting, retaliation/damage limitation missions etc.) is not seen as closely related to force levels, structure, posture and systems characteristics. Force employment plans are not perceived as affecting the probability of war, encouraging or provoking first nuclear strike/use from one or the other opponent. Any declaration on the need to compensate Russian conventional weakness with nuclear strength is predominantly a general political argument, not a reflection of a consistent strategic analysis, assessment of contingencies or planning of defense policy options.

Moreover, the problem of nuclear weapons employment is addressed in terms of operational convenience, not strategic goals or a rationale of particular options (10). Hence, arms control agreements, the philosophy of strategic stability, force development planning, and force employment strategies are only remotely and in a very general way associated with the state of political and military, particularly nuclear, relationships between Russia and the US, as well as other nuclear powers. These deficiencies have always plagued and still are undercutting Moscow's strategic policy efficiency. They are most vividly demonstrated in designing a first strike doctrine to deter NATO, but they are also undermining Russia's deterrence strategy towards China, where there is a clear case for such a strategy and where it may be badly needed in the not so distant future.

### 3. FORCE PROJECTIONS - NINE SCENARIOS.

The shift in Soviet/Russian nuclear doctrine has not changed anything regarding operational planning or weapons programs. As before, declaratory doctrine lives quite independently from practical strategy and forces. And as before, several principle strike plans are operational without much attention to their validity at the level of "grand strategy" or national survival.

All projections of Russian strategic force evolution are affected by (1) the disintegration of the Soviet Union and its nuclear arms development/production complex; (2) the deep economic and financial crisis in Russia, as a result of the failed "reforms" of 1992-1996; and (3) disarray in Moscow's decision-making system on strategic programs and arms control talks, which has led to confused priorities in defense policy and a wide divergence between force planning, budgeting and arms control agreements.

It is convenient to use the December, 1995, START-1 memorandum on data exchange as a baseline. The Russian forces then consisted of 180 SS-18s (called in Russian R-36 and R-36UTTH), 167 SS-19s (UR-100 and UR-100UTTH), 46 SS-24s (RT-23UTTH), including 10 in silos and 36 on railroad launchers, and 351 SS-25s (RT-2PM) ICBMs. Also there were 89 Tu-95s

(including 20 Tu-95Ms, 28 Tu-95Ms6s and 35 Tu-95Ms16s), and 6 Tu-160 heavy bombers. The submarine forces comprised 7 Delta-4s (Project 667BDRM), 6 Typhoons (Project 941), 13 Delta-3s (Project 667BDR), 4 Delta-2s (Project 667BD), 12 Delta-1s (Project 667B), and 1 Yankee-1 (Project 667A) submarines, altogether 43 SSBNs, 664 missiles and 2492 warheads. Thus, by 1996 Russia's overall baseline force consisted of 1497 launchers and 6949 warheads.

All of the following projections should not be construed as representing actual Russian force planning. They are more just an illustration of the logic of major hypothetical options, based on open information on existing forces and weapon programs, as well as on simplified financial data and commonly known patterns of weapons deployment and withdrawal.

**First scenario:** By the year 2003 (deadline of START-2 implementation) the natural decommissioning of technically obsolete weapons would probably bring these forces down to 40 SS-18s, 120 SS-19s, 46 SS-24s and 220 SS-25 ICBMs. Submarine force, for lack of maintenance and overhaul, would probably be drawn down to 3 Typhoon, 7 Delta-4 and 3 Delta-3 SSBNs. The bomber force may be expected to comprise no more than 20 airplanes (of which 8 are Tu-160s). Thus, the present level of funding, insufficient for adequate maintenance, timely overhaul or life-extension measures would bring the baseline force to 666 launchers and 3216 warheads.

By the year 2010 the baseline force under the same conditions would go down to 50 SS-25 ICBMs, 1 Typhoon SSBN, 3 Delta-4 boats and zero bombers. Altogether, 118 launchers and 442 warheads.

**Second scenario:** Continuation of the present rate for procurement and deployment of SS-25s and in a few years of their follow-on SS-26 ICBMs (RT-2UTTH Topol-M) would add to the baseline force about 70 missiles and warheads by the year 2003 and 150 by the year 2010, correspondingly up to totals of 3286 and 592 warheads.

**Third scenario:** Better maintenance, overhaul and service life-extension programs with increased funding (by about 50% for strategic forces yearly) by the year 2003 might add to the above baseline-plus-new-deployment force (BPNDF) 50 SS-25 ICBMs, 2 Typhoon SSBNs and 15 Tu-95 bombers: up to 3906 warheads.

By the year 2010, with the same maintenance measures, BPNDF could have 70 more SS-25 missiles, 2 additional Typhoon and 4 Delta-4 boats, plus 8 Tu-160 bombers. These would add up to 1446 warheads.

However, the projection may be different if strategic forces are given much higher political priority in the years to come, increasing their yearly share even within the same defense budget by 100%. Another possibility is increasing the whole defense budget from the present 3.8% to 5-6% of GNP (i.e. from 20% to 30% of the federal budget), as proposed by the Ministry of Defense and its partisans in the State Duma. Finally, it is conceivable that the Russian economy could start to grow in 1998-1999 and budget revenues go up, which would permit higher spending on defense without increasing its share of the federal budget or GNP.

**Fourth scenario:** One of these alternatives or some combination of them might lead to a higher procurement rate for SS-26 ICBMs and to the introduction of a new SSBN class (which may be called Delta-5) starting in the year 2000, at a rate of 2 boats every three years (like Typhoon deployment rate in the 1980s). This would add to the year 2003 force about 100 SS-25/26 missiles, and about 240 SS-26 ICBMs by the year 2010. Deployment of Delta-5 SSBNs would add 240 SLBM warheads in the year 2003 and 840 in the year 2010, bringing the total warhead numbers correspondingly to 4246 and 2526 warheads.

**Fifth scenario:** If, for whatever reason (like the US deciding to deploy a nation-wide ABM system), the decision is taken to equip SS-26s with MRVed warheads, then by the year 2010 the total Russian enhanced force may comprise around 4100 warheads.

As may be seen, the array of five alternatives, defined by various assumptions about funding and technical strategy, spans a 25% difference in aggregate warhead numbers by the year 2003 (from 3200 to 4250), and an order of magnitude by the year 2010 (ranging from 442 to 4100 warheads). Overimposing an arms control framework on the above projections complicates the picture still more and multiplies the number of feasible alternatives.

Assuming that the START-1 Treaty is observed by both sides, the greatest difference will be made by the presence or absence of START-2 and its follow-on START-3. If the START-2 treaty is not ratified by Russia and nothing is created as a substitute, Russian strategic force would most probably evolve along the third scenario. Since US forces in this case would most probably stay at START-1 levels, Russian forces, while naturally degrading, would be turning more and more vulnerable each year. This vulnerability would transform the first strike emphasis of Moscow's new military doctrine from a purely political posture into the real and only available employment option, which would be highly detrimental to strategic stability. This is all the more so when further degradation of Russia's command-control, early warning and monitoring systems are taken into account.

At some point the US may opt for nation-wide strategic ABM deployment. Then, Russia's response could follow the fifth scenario (revival of a MRVed ICBM system and crash modernization effort). All this would imply quite dire consequences for strategic stability, arms control and political relations between Russia and the West.

**Sixth scenario:** Matching START-2 to a quite probable, but highly inefficient, policy which is a direct extrapolation of the course of the last five years (i.e. the second

scenario), would bring Russian strategic forces down to 1806 warheads, since 1475 warheads would have to be removed through dismantling and downloading MRVed ICBMs several years ahead of the end of their service lifetime. The US at this same time would easily maintain about 3500 warheads, i.e. acquiring a double superiority just through implementation of the START-2 treaty.

Besides this, implementing the treaty in five years (1998-2002) instead of ten - which was initially planned when it was signed in January 1993 - would overtax limited Russian financial resources and technical capabilities. Even with greater maintenance efforts (third scenario), which would be seriously hampered by a crash reduction program Russian force levels would be as high as 2431 warheads - 30% lower than American levels. To reach at least the lower bracket of START-2's warhead ceiling (3000-3500), Russia would need to deploy 570 additional warheads. Under the circumstances, the only way to do that would be by deploying more SS-25/26 ICBMs at a rate of 110 missiles per year. This is about eight-ten times greater than the current rate and totally infeasible.

Political factors aside (like NATO expansion), this may explain why there exists such strong opposition to START-2 in Russia. Even the treaty's supporters predicate their position on extending its implementation schedule by 3-5 years. This would be much less expensive and technically complicated for Russia and besides, it would bring dismantling more in line with the weapons' natural service lifetime expiration.

Thus, assuming a 5-year extension agreement (**seventh scenario**), which would provide for better maintenance, a smooth dismantling schedule and easy current deployment rate, by the year 2008 Russian strategic force could consist of 300 SS-25/26 ICBMs, 3 Typhoon and 7 Delta-4 SSBNs and about 20 Tu-95/160 bombers. In total this would come to 1668 warheads. A relaxed Delta-5 construction schedule may provide 480 additional warheads to the aggregate level of 2148 warheads.

This would still fall 30% short of the START-2 lower bracket and 40% short of the US force level, if it is maintained at the permitted maximum of 3500 warheads. If Russian doctrine insists on closer parity with US forces, which is quite plausible, there are two ways of closing this gap. One would be to go for higher ICBM and SSBN deployment rates, and reach the year 2008 with a force of about 2500 warheads (**eighth scenario**).

The other option (**ninth scenario**) would be to reach a START-3 treaty instead, to save resources for both the US and Russia, and reduce the aggregate ceiling to 1500-2000 warheads. This would relieve Russia from larger expenditures on higher deployment rates and undercut the arguments of those in Moscow who call for the revival of MRVed ICBMs, as the only feasible way to match US force levels. The US could easily fit under the 1500 ceiling with 8 Trident SSBNs, 200 Minuteman-3 ICBMs and 300 bomber weapons or any other chosen forces mix.

#### 4. FORCE PROJECTION - TENTH SCENARIO.

Interestingly enough, for Russia the peculiarity of START-3, in contrast to START-2 and all other preceding strategic arms control treaties, is that it will be not about any force reduction, but almost exclusively about the scale of maintenance efforts, as well as the rate and system types of new deployment programs. For the US it would be mostly a matter of maintaining a larger or smaller portion of its existing force.

Provided a benign political environment, Russia and the US could agree on much more radical force reductions under START-3 or START-4 treaties. To achieve much greater Russian savings on maintenance and modernization and US savings on maintenance, after the year 2010 the parties could go down to a level as low as 1000 or even 500 nuclear warheads. Actually, for Russia, decommissioning forces to a level of 500 warheads would altogether remove the need for greater maintenance or even the current low deployment rate, virtually matching arms control prospects to the first scenario of natural force degradation.

If only the US would agree to go along with Russia to 500 warheads after the year 2010, both sides might then agree to de-alert and de-activate the remaining forces. This would be as close to a general and comprehensive nuclear disarmament as may be imagined without departing completely from technical and strategic reality.

However, going in this direction would require reaching a US-Russian agreement on its desirability and feasibility within the next two-three years. This is due to the fact that within this time-span Moscow will have to make important long-term decisions on its future nuclear doctrine and strategy, funding level, and maintenance and modernization directions and rates. Also, resolution of the START-2 deadlock would be of utmost long-term importance for arms control and force projections.

Finally, radical further strategic arms reductions would imply addressing many other issues of mind-boggling complexity. Among them are: third nuclear weapon states' forces; strategic and theater defenses; tactical nuclear weapons; conventional force balances and capabilities, including the counterforce potential of precision-guided systems; nuclear, chemical and missile proliferation in the world at large. All of that would finally boil down to devising a qualitatively new organization of nations for dealing with world security problems. These concerns go far beyond the scope of this paper or the ability of its author to imagine.

TABLE I. Ten scenarios of Russian strategic force evolution.

Scenarios	Warheads year 2003	Warheads year 2010
1. Natural degradation:	3216	442

2. Plus current deployment rate:	3286	592
3. Plus adequate maintenance:	3906	1446
4. Plus higher deployment rate:	4246	2526
5. Plus new MRVed ICBM	4336	4086
6. Second plus START-2:	1806	592
7. Third plus START-2 extended:	3906	2148
8. Fourth plus START-2 extended:	4246	2526
9. Third plus START-3 (1500-2000)	3906	1446-2000
10. Radical reduction START-3/4:	1806	442-529

## Russian Nuclear Missile Data

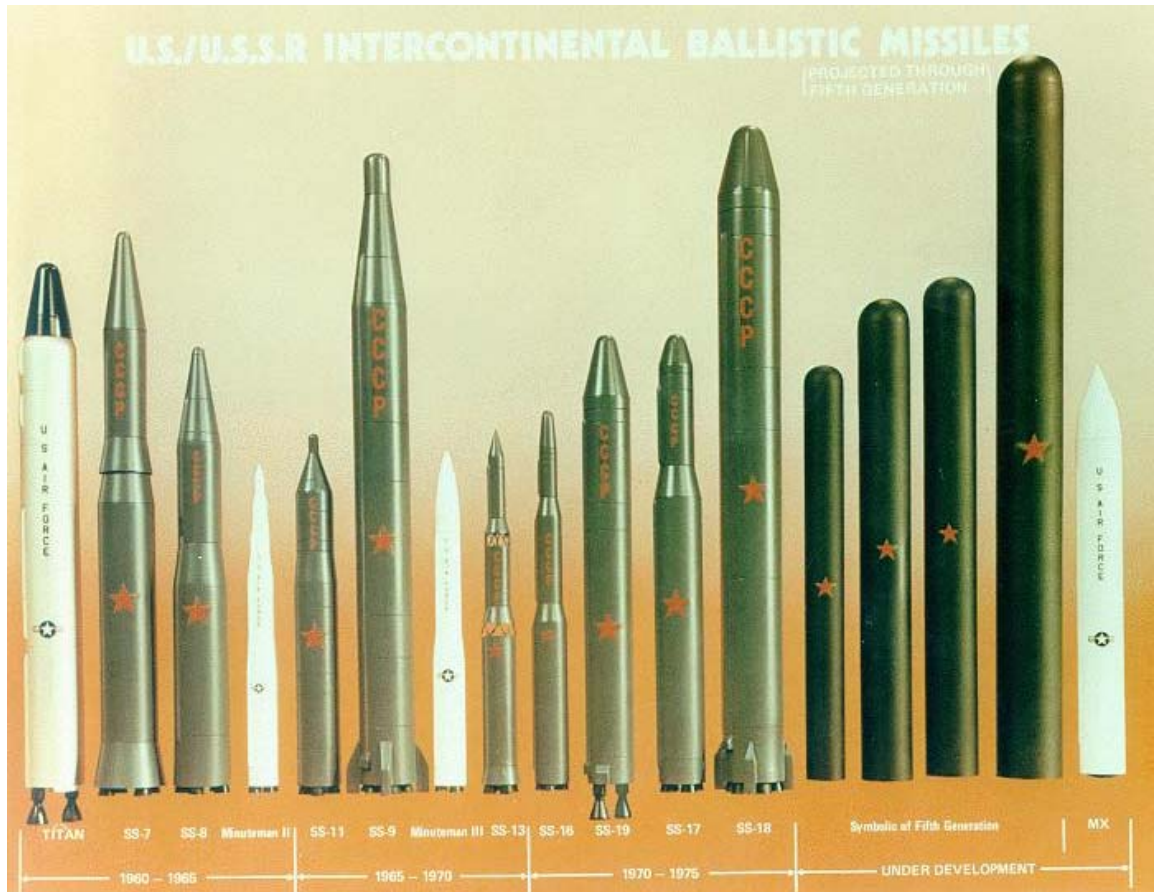

### RT-21 / SS-16 SINNER

The RT-21/SS-16 intercontinental ballistic missile is a three-stage, tandem, solid-propellant missile with a post-boost vehicle (PBV) operating after third-stage burnout. The missile is assessed to be capable of delivering a throw-weight of about 2100 lb to a range- of 5000 nm, with the PBV providing the capability for an additional range increment of about 500 nm for the 1000-lb class reentry vehicle known to have been tested. The missile uses an inertial guidance system and has a CEP of about 0.4 nm. The SS-16 was first detected on March 14, 1972.

### UR-100MR / SS-17 SPANKER

The UR-100MR / SS-17 intercontinental ballistic missile is a two-stage, tandem, storable liquid-propellant missile capable of delivering a throw-weight of 6000 lb to a range of 5500 nm. The throw-weight consists of a post-boost vehicle and four reentry vehicles which weigh about 900 lbs each. The missile has an inertial guidance system with an estimated CEP of 0.34 nm for 1975 and a potential CEP of 0.28 nm in 1980. The SS-17 uses a sabot "cold launch" or pop-up launch system that would facilitate modifying existing SS-11 facilities. Flight testing was first detected on September 15, 1972.

### UR-100N / SS-19 STILLETTO

Once regarded by some as the "backbone" of the Soviet ICBM force, the UR-100N / SS-19 intercontinental ballistic missile is a two-stage, tandem, storable liquid-propellant missile with a post-boost vehicle (PBV) and six MIRV reentry vehicles. The SS-19 is approximately 80 feet long and 8 1/2 feet in diameter. The SS-19 has been deployed in two configurations. Mod 1 carries six independently targeted one- to two-megaton reentry vehicles. The booster alone is limited to a range of 4900 nm but the total system, booster plus PBV, is capable of delivering all six RVs to a maximum range of 5200 nm. Mod 2 carries a single warhead that is in excess of 5 megatons. The missile employs an inertial guidance system, and is estimated to

have an operational CEP of 0.3 nm in 1975 with a potential CEP of 0.25 nm in 1980. The SS-19 is probably not launched from reconfigured SS-11 silos.

The fourth generation SS-19 was developed to partially replace the SS-11 force. Both of the SS-19 Mods have been attributed "hard target kill" capabilities. The first flight test occurred on April 9, 1973 and it was deployed in 1974. The silo-based version of the SS-24 replaced some SS-19s.

In accordance with the START-II Treaty Russia has the right to preserve 105 SS-19 ICBMs, having left one warhead each on them (instead of six)

## RT-23 / SS-24 SCALPEL

Comparable in size to the US PEACEKEEPER, the SS-24 is cold-launched with 10 warheads. The missile is deployed both as rail-mobile and silo-based. The silo-based SS-24 was intended to replace the SS-19 Stiletto in the Russian strategic inventory. The SS-24 rail missile systems with 10 warheads is subject to elimination under the provisions of the START-II Treaty.

It has been suggested that these rail-mobile land-based missiles, which have been parked in their garrisons, may be placed back on patrol in response to American missile defense and associated arms control initiatives.

## R-29 / SS-N-8 SAWFLY

The SS-N-8 submarine-launched ballistic missile is a two-stage, storable liquid-propellant missile capable of delivering a 1400-lb reentry vehicle with a 0.6-1.5 MT warhead a distance of 4200 nm. The missile uses a stellar-inertial guidance system and has a CEP of approximately 0.5 nm.

The Delta Class nuclear submarine carries 12 SS-N-8 SLBMs and can launch missiles at approximately 7-second intervals while fully submerged. Normal reaction time is 15 minutes; reaction time under conditions of peak alert is about one minute. The allowable hold time under peak alert conditions is one hour.

First land-launched flight test occurred on June 21, 1969. First sea-launched flight test occurred on December 25, 1971. Initial operational capability was reached in 1973.

## R-36M / SS-18 SATAN

The R-36m / SS-18 intercontinental ballistic missile is a large, two-stage, tandem, storable liquid-propellant missile developed to replace the SS-9 ICBM. The missile uses an inertial guidance system with a CEP of approximately 0.25 nm. This 2-stage missile, using dinitrogen tetroxide (N<sub>2</sub>O<sub>4</sub>) and heptyl (a UDMH [unsymmetrical dimethyl hydrazine] compound) has a first stage powered by a 460-ton-thrust motor with four combustion chambers, and the second by a single-chamber 77-ton-thrust motor.

Designed by the M. K. Yangel OKB Yuzhnoye at Dnepropetrovsk (Ukraine) during 1966-1972, this third-generation ICBM was tested beginning in November 1972, deployed in January 1975, then integrated with the weapons arsenal in December 1975.

There are five variants: the single-warhead, 24Mt Mod-1; the 550Kt, 8-warhead MIRVed Mod-2; the single-warhead, 20Mt Mod-3; the 500Kt, 10-warhead MIRVed Mod-4; and the 500Kt or 750Kt, 10-warhead MIRVed Mod-5.

- **Mod 1** The SS-18 Mod 1 carried a single large reentry vehicle, with a warhead yield of 18 to 25 MT, a distance of about 6000 nm. testing began in October, 1972, with initial operational capability reached in early 1975.
- **Mod 2** The SS-18 Mod 2 included a post-boost vehicle and up to eight reentry vehicles, each with a warhead yield of 0.6 to 1.5 MT, with a range capability of about 5500 nm. The initial flight test of the Mod 2 MIRV version occurred in August, 1973, with IOC in 1975.
- **Mod 3** The SS-18 Mod 3 carried a single large reentry vehicle, with a warhead yield of 18 to 25 MT.
- **Mod 4** The SS-18 Mod 4 carries at least 10 MIRVs and was probably designed to attack and destroy ICBMs and other hardened targets in the US. The SS-18 Mod 4 force has the estimated capability to destroy 65 to 80 percent of US ICBM silos using two nuclear warheads against each. Even after this type of attack, it is estimated that more than 1,000 SS-18 warheads would be available for further strikes against targets in the US.
- **Mod 5** The newer, more accurate version (the SS-18 Mod 5) placed in converted silos allowed the SS-18 to remain the bulwark of the SRF's hard-target-kill capability. The increase in the Mod 5's warhead yield, along with improved accuracy, would, under the START treaty, help allow the Russians to maintain their hard-target-kill wartime requirements even with the 50 percent cut in heavy ICBMs START requires

## US Targets

### US Targets

Table 22. Population of the 100 Largest Urban Places: 1990

Source: U.S. Bureau of the Census  
 Internet Release date: June 15, 1998

Rank	Place	Population	Land area (sq. miles)	Density (average population per sq. mile)
1	New York city, NY *.....	7,322,564	308.9	23,705
2	Los Angeles city, CA.....	3,485,398	469.3	7,427
3	Chicago city, IL.....	2,783,726	227.2	12,252
4	Houston city, TX.....	1,630,553	539.9	3,020
5	Philadelphia city, PA....	1,585,577	135.1	11,736
6	San Diego city, CA *.....	1,110,549	324.0	3,428
7	Detroit city, MI.....	1,027,974	138.7	7,411
8	Dallas city, TX.....	1,006,877	342.4	2,941
9	Phoenix city, AZ *.....	983,403	419.9	2,342
10	San Antonio city, TX.....	935,933	333.0	2,811
11	San Jose city, CA.....	782,248	171.3	4,567
12	Baltimore city, MD.....	736,014	80.8	9,109
13	Indianapolis city, IN *..	731,327	361.7	2,022
14	San Francisco city, CA...	723,959	46.7	15,502
15	Jacksonville city, FL *..	635,230	758.7	837
16	Columbus city, OH.....	632,910	190.9	3,315
17	Milwaukee city, WI.....	628,088	96.1	6,536
18	Memphis city, TN *.....	610,337	256.0	2,384
19	Washington city, DC.....	606,900	61.4	9,884
20	Boston city, MA.....	574,283	48.4	11,865
21	Seattle city, WA.....	516,259	83.9	6,153
22	El Paso city, TX *.....	515,342	245.4	2,100
23	Cleveland city, OH.....	505,616	77.0	6,566
24	New Orleans city, LA *..	496,938	180.6	2,752
25	Nashville-Davidson, TN *	488,374	473.3	1,032
26	Denver city, CO *.....	467,610	153.3	3,050
27	Austin city, TX.....	465,622	217.8	2,138
28	Fort Worth city, TX *....	447,619	281.1	1,592
29	Oklahoma City city, OK *	444,719	608.2	731
30	Portland city, OR.....	437,319	124.7	3,507
31	Kansas City city, MO *..	435,146	311.5	1,397
32	Long Beach city, CA.....	429,433	50.0	8,589
33	Tucson city, AZ *.....	405,390	156.3	2,594
34	St. Louis city, MO.....	396,685	61.9	6,408
35	Charlotte city, NC.....	395,934	174.3	2,272
36	Atlanta city, GA.....	394,017	131.8	2,990
37	Virginia Beach city, VA *	393,069	248.3	1,583
38	Albuquerque city, NM.....	384,736	132.2	2,910
39	Oakland city, CA.....	372,242	56.1	6,635
40	Pittsburgh city, PA.....	369,879	55.6	6,653
41	Sacramento city, CA.....	369,365	96.3	3,836
42	Minneapolis city, MN.....	368,383	54.9	6,710
43	Tulsa city, OK.....	367,302	183.5	2,002
44	Honolulu CDP, HI *.....	365,272	82.8	4,411
45	Cincinnati city, OH.....	364,040	77.2	4,716
46	Miami city, FL.....	358,548	35.6	10,072
47	Fresno city, CA.....	354,202	99.1	3,574
48	Omaha city, NE.....	335,795	100.6	3,338
49	Toledo city, OH.....	332,943	80.6	4,131
50	Buffalo city, NY.....	328,123	40.6	8,082
51	Wichita city, KS.....	304,011	115.1	2,641
52	Santa Ana city, CA.....	293,742	27.1	10,839
53	Mesa city, AZ.....	288,091	108.6	2,653

54	Colorado Springs city, CO	281,140	183.2	1,535
55	Tampa city, FL.....	280,015	108.7	2,576
56	Newark city, NJ.....	275,221	23.8	11,564
57	St. Paul city, MN.....	272,235	52.8	5,156
58	Louisville city, KY.....	269,063	62.1	4,333
59	Anaheim city, CA.....	266,406	44.3	6,014
60	Birmingham city, AL *....	265,968	148.5	1,791
61	Arlington city, TX.....	261,721	93.0	2,814
62	Norfolk city, VA.....	261,229	53.8	4,856
63	Las Vegas city, NV *....	258,295	83.3	3,101
64	Corpus Christi city, TX..	257,453	135.0	1,907
65	St. Petersburg city, FL..	238,629	59.2	4,031
66	Rochester city, NY.....	231,636	35.8	6,470
67	Jersey City city, NJ.....	228,537	14.9	15,338
68	Riverside city, CA.....	226,505	77.7	2,915
69	Anchorage city, AK *....	226,338	1,697.6	133
70	Lexington-Fayette, KY *..	225,366	284.5	792
71	Akron city, OH.....	223,019	62.2	3,586
72	Aurora city, CO *.....	222,103	132.5	1,676
73	Baton Rouge city, LA.....	219,531	73.9	2,971
74	Stockton city, CA.....	210,943	52.6	4,010
75	Raleigh city, NC.....	207,951	88.1	2,360
76	Richmond city, VA.....	203,056	60.1	3,379
77	Shreveport city, LA.....	198,525	98.6	2,013
78	Jackson city, MS.....	196,637	109.0	1,804
79	Mobile city, AL.....	196,278	118.0	1,663
80	Des Moines city, IA.....	193,187	75.3	2,566
81	Lincoln city, NE.....	191,972	63.3	3,033
82	Madison city, WI.....	191,262	57.8	3,309
83	Grand Rapids city, MI....	189,126	44.3	4,269
84	Yonkers city, NY.....	188,082	18.1	10,391
85	Hialeah city, FL.....	188,004	19.2	9,792
86	Montgomery city, AL.....	187,106	135.0	1,386
87	Lubbock city, TX.....	186,206	104.1	1,789
88	Greensboro city, NC.....	183,521	79.8	2,300
89	Dayton city, OH.....	182,044	55.0	3,310
90	Huntington Beach city, CA	181,519	26.4	6,876
91	Garland city, TX.....	180,650	57.3	3,153
92	Glendale city, CA.....	180,038	30.6	5,884
93	Columbus city, GA *....	178,681	216.1	827
94	Spokane city, WA.....	177,196	55.9	3,170
95	Tacoma city, WA.....	176,664	48.0	3,681
96	Little Rock city, AR.....	175,795	102.9	1,708
97	Bakersfield city, CA *...	174,820	91.8	1,904
98	Fremont city, CA *.....	173,339	77.0	2,251
99	Fort Wayne city, IN.....	173,072	62.7	2,760
100	Arlington CDP, VA *.....	170,936	25.9	6,600

-----  
 -Prudhoe Bay, Alaska, has 25% of U.S. oil reserves

Hoover Dam, which provides agriculture and drinking water supplies in the Southwest

Chemical weapons depots in Oregon and Washington, which could release deadly toxins if struck

-Port Valdez, Alaska , main delivery point of Alaskan oil

You can safely add to this any Air Force Bases or Army bases in the area, as well as any Naval bases. Included on the CD version are:

**State Maps** - Pulled from National Atlas , these have airports, railways, metropolitan areas (pink) , and nuclear sites color coded (various, by type of installation).

**Air Force Bases** Compiled by Joseph McCusker

**Army Bases** - with a brief blurb about each, and the state & zip code.

**Marine Bases** - by state, provided from the US Marine Corp web page. With links to the bases

**Navy Bases and Air Stations**, provided by the US Navy website. With map



## **Option 2: Climate Change**

This scenario postulates a continuance in the current trend of global temperature increase, drought and increasingly powerful storms. It breaks into several sub-scenarios. The simplest would be that the nations of the world end up fighting for remaining resources, leading back to Option 1.

The second possibility is widespread rioting and a collapse of the world-as-we-know-it through planetary famine. In this scenario, most animals would be eaten, and the ones that are left highly prized. Humanity would break into several groups, such as:

Farmers, who tend small farming communities in the few remaining areas of arable land  
Nobles, who reprise the role of feudalism and protect the farmers in exchange for a cut of the food

Ravagers, who raid the farms and take what they need.

Technology for the various groups would be fairly high, since there is plenty of equipment 'per capita' after two-thirds of the world population starves off. On the other hand, heat and humidity (see below) contribute to rust, so objects which are sensitive to such things would have to be scavenged and stored early for the locals to have them later.

Assuming the fall occurred fairly quickly and bloodlessly, the players won't need to worry about radiation, chemical contamination, etc. However, for most areas, it suddenly becomes a continuing quest for desert survival. And pity the poor teams stationed in Alaska and Canada, with plenty of cold weather gear and winter temperatures in the 80s.

Under this scenario, the minimum consumption of water goes from 4 liters per person per day to 10 liters per day. Ground water (such as small ponds and lakes) is non-existent. Icecap melting balances the amount of sea-water evaporated and trapped in the atmosphere.

During the day, it is hot (80-110F) and muggy (90+% humidity). At night, it is cooler, but still humid. There is a 1% chance per day that a storm will visit the players. When this happens, they'll get about one-third of the normal annual (present day) average rainfall for that area over the course of 8 hours, along with 50-70 mile per hour winds, and huge amounts of thunder and lightning. Average annual rainfall for Central Florida is about 53 inches. This would work out to about 2.5" of rain per hour for an 8 hour storm. If the players do not immediately move to the high ground, they will get to enjoy a flash flood.

<http://www.worldclimate.com/> is a good spot for getting the data for the area you're playing.

Driving during such a storm would be difficulty 3 at the beginning and end, with a 1 at the peak of the storm. Many roads would be washed out during the storm, so if you factor in the storms that occurred during flicker, you have a recipe for difficult travel.

Non-human contacts would primarily be insects and desert-style animals that have adapted to the heat.

## **Option 3: 'Dino Killer' Impact**

[Sandina National Lab news release](#)

The effect is a single, 300 gigaton detonation in the Pacific. The tidal wave washes over coastal areas world wide, doing massive destruction, then recedes. 300 to 500 cubic kilometers of ocean vaporize, and some water is knocked into orbit or even "splashed" at escape velocity and leaves Earth entirely.

The game postulates that between an "orbital water cloud" and the huge amounts of water vapor and debris blown into the atmosphere, global temperatures drop 10-15 degrees for 50-75 years. There is also a 1-2 year long "deluge" of triple normal rainfall. The net result is the loss of most

arable land, either through it being too cold to effectively crop there or from having the deluge wash out the topsoil.

This scenario combines Options 1 and 2 above : massive devastation in some areas, but most deaths due to famine.

For added fun, you may want to acquire a "relief map" of the area your players are enjoying and decide that anything with less than "X" elevation is now a lake. By using <http://www.ncdc.noaa.gov/ol/climate/stationlocator.html> you can get info on the elevations of different cities.

## Option 4: Orwellian Change

This scenario is based on there being no disaster, but the government & UN just *know* one's going to occur.... and they try to prepare by getting the populace under tighter and tighter control, so that when things go sour, they can minimize the loss of life. This one becomes extremely nasty for PCs, as the World Gov't forgets about them... until they wake up, at which point they are considered 'dangerous' because they have the old thought patterns about "Truth, Justice and the American Way" as opposed to "Big Brother doubleplusgoodful, selfthink bad!" In a way, this is the "self-fulfilling prophecy" scenario - what happens when you know your doom is coming and try to evade it?

There is no conspiracy, per se, but the actions of separate individuals "in the know" mix together, producing the effects of one. Call it Chaos Theory in action, with the information from Project Icarus being the strange attractor.

- (1) Small group "A" (the Proto-Project) finds out the future is bad
- (2) "A" sells a larger group (Congress, FEMA, the President) on the need to do something
- (3) The "do something" ends up with "A" becoming "The Project"
- (4) As new congresscritters move into the oversight committee, they make deals along the lines of, "Yes, we'll get you funding, if you get me into a safe spot". Consider the number and positions of the Senators and Congressmen that have flown on the Space Shuttle.
- (5) After doing a term on the "Project Subcommittee", they now know that their continued survival hinges upon being in office when "the bad thing" happens. As a result, they do whatever is necessary to get re-elected to more and more powerful committees, where they can have more weight to nudge lower-ranking Congress critters out of the "safe seats". At the same time, they try to remain closed mouthed about the issue, since it would increase competition for the "Senate Junket Survival Seats"
- (6) Eventually, more and more government decisions are based on #5 above. People who figure they can't get a Senate Junket Seat turn toward controlling the public, reducing the number of guns etc so that when "the bad thing" happens and they retreat to their safe-houses, there are fewer armed people that their bodyguards will have to deal with. In a way, since they can't get in on the super-equipped Phoenix Teams, they figure they'll de-equip everyone else until they have the same level of advantages that being on the Project would bring.
- (7) #5 and #6 produce a heterodyne effect, resulting in a very paranoid, self-centered government doing its best to tax and regulate the common person into a highly controlled state.

The net result is 45 years of military build up, and a slow incremental return to the kind of centrally planned and controlled economy and civil defense system the US had back during WWII. Numerous advanced weapon systems are fielded, because they might be handy when "X" happens - especially if it turns out to be an alien invasion. Who knows ?

There are two recommended scenarios to play under this option.

In scenario one, the players find out about a "safe haven" - a section of badlands somewhere that the world turns a blind eye on, and the campaign becomes a race to see if the good guys make it to safety before BigBro catches them.

Scenario Two is more bloody, and more difficult. The players decide to change the world, and must use what tools and skills they have to manipulate WorldGov into a kinder, gentler, not so paranoid state.

WorldGov has a number of toys that are currently in the developmental stages. GM's are encouraged to generate their own stats for these toys, modified for just how small they want the chunks of the PC's to be after they've been shot.

[Artillery](#)

[Tanks](#) (Download the links to the ARMOR articles at the end of this page - this thing is scary.

Multiple 25mm and 35mm railguns, laser cannon... supposed to deploy in 2015.)

[APC and General Purpose](#)

[Personal Electronics & Gear](#)

[Personal Weapons](#)

[Crew Served Weapons](#)

(Note: all info on post-2020 military hardware is on the CD version, due to space considerations.)