

M A R C M I L L E R ' S  
**TRAVELLER**<sup>®</sup>

**ANOMALIES**



# MARC MILLER'S TRAVELLER®

## The Future is Just Around the Corner!

Nine exciting products that bring the Traveller universe to life!

### TRAVELLER

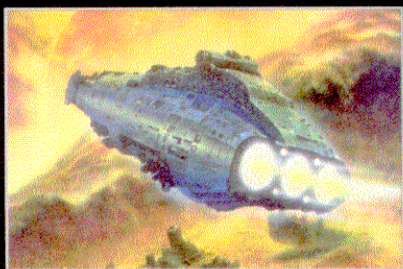

The soft cover rules for Traveller, science-fiction adventure in the far future! All the rules for characters, worlds, star travel, psionics, and more!

IGI-1000 \$25.00

### STARSHIPS



Dozens of starship deck plans: scout, free trader, liner, corsair, merchants, and other vessels. Complete rules to build ships for your campaign.

IGI-1100 \$20.00

### CENTRAL SUPPLY CATALOG



Weapons and equipment for Traveller adventurers. Equip your characters with gear for deep space and other exotic environments.

IGI-1200 \$22.95

### ALIENS ARCHIVE

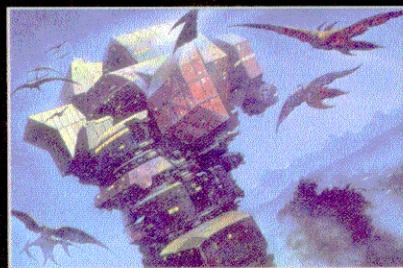

Ten new minor alien races for the Traveller campaign. Cultural and biological backgrounds, psychological profiles, and rules for use as characters.

IGI-1300 \$22.95

### MILIEU 0

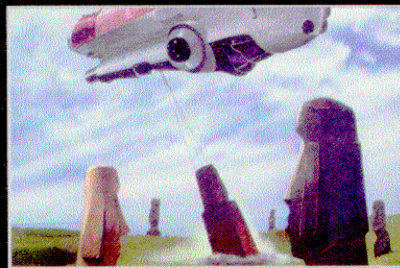

The first Traveller campaign setting, right-at the end of the Long Night and the dawn of the new Imperium. Background and options for play.

IGI-1400 \$22.95

### FIRST SURVEY



Maps and data for the sectors of the new Imperium. World data is presented complete for the referee and incomplete for would-be Traveller explorers!

IGI-1410 \$22.95

### EMPEROR'S ARSENAL

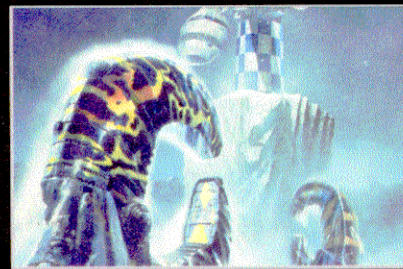

The complete guide to weapons for the Traveller universe. Weapons are presented by tech level, from spear to fusion gun, with terrific illustrations!

IGI-1500 \$22.95

### REFEREE'S SCREEN

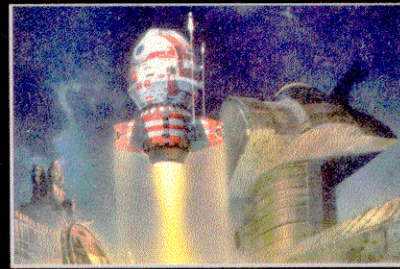

Charts and diagrams for Traveller play, referee's on one side, players' on the other. Includes the Memory Alpha adventure written by Marc Miller.

IGI-1510 \$12.95

### POCKET EMPIRES

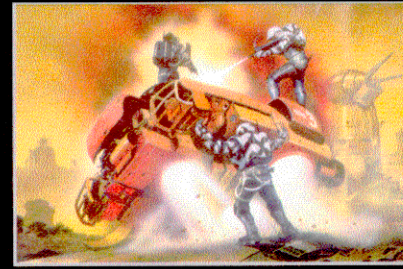

As the new Imperium grows, Pocket Empires emerge around it. Complete rules for owning and managing worlds and groups of worlds.

IGI-1600 \$22.95

TRAVELLER products are available at fine game stores everywhere, or visit us on the web at [www.imperiumgames.com](http://www.imperiumgames.com). Find out about special deals, Journal of the Travellers' Aid Society, new game information, Citizens of the Imperium, and more!

Imperium Games, Inc., 9461 Charleville Blvd., #307, Beverly Hills, CA 90212

Traveller is a registered trademark of FarFuture Enterprises. ©1997 by Imperium Games, Inc. All rights reserved.

# MARC MILLER'S TRAVELLER®

---

# ANOMALIES

## Science-Fiction Adventure in the Far Future

Deliver dispatches to an Imperial Marshall on page 7.

See what lies beneath the pyramids of the Ancients on page 17.

Visit a treasure trove from the Rule of Man on page 33.

Discover a vast cryogenics facility, still functional from before the Long Night on page 59.

Help a Trakii on a mission to save its accursed race on page 71.

Help escort the daughter of a noble family, a girl of great psionic talent on page 81.

Deliver cargo to a doomed Imperial research station on page 101.

## The Future is Just Around the Corner

# TABLE OF CONTENTS

---

---

<b>1: THE RAPTOR</b> .....	5
Sample Crew Roster .....	6
<b>2: AKIRA DOWNED!</b> .....	7
The Setup .....	9
Help! .....	9
The Search .....	12
Further Adventures .....	14
<b>3: LONE WHISPER</b> .....	17
The Setup .....	17
“There They Are!” .....	20
A Mysterious Whisper .....	22
Further Adventures .....	23
<b>4: DOUBLE DEAL</b> .....	25
The Setup .....	25
Quick Start .....	27
Welcome to Alterra! .....	28
Détente .....	29
Double Deal .....	33
<b>5: LOCK AND LOOT</b> .....	34
The Setup .....	38
Arriving at the Base .....	51
Neff and the Natives .....	55
Further Adventures .....	59
<b>6: THE SLEEPERS</b> .....	59
The Setup .....	63
The Lurker in the Cave .....	64
The Silver Guardians .....	67
The Sleepers .....	71
<b>7: EASY CREDITS</b> .....	71
A Simple Assignment .....	72
Stowaway .....	74
The Flight to Trakiini .....	75
On Trakiini .....	78
Conclusion .....	80
<b>8: PSILENT ESCORT</b> .....	81
The Setup .....	81
The Journey .....	84
Dirtside .....	85
Looking for Tess .....	87
The Local Law .....	89
Rescue .....	90
Conclusion .....	92
<b>9: THE GIFT</b> .....	93
The Setup .....	93
First Contact .....	95
Trouble! .....	97
Negotiations .....	98
Conclusion .....	99
Further Adventures .....	99
<b>10: DEAD SPACE</b> .....	101
The Setup .....	101
Arrival .....	103
The Research Station .....	103
Station EDX17-T .....	105
Further Adventures .....	106

# CREDITS

---

## Design & Writing

Duane Maxwell ("The Raptor", "Akira Downed!", "Psilent Escort", "The Gift")  
Steve Miller ("Lone Whisper", "Lock And Loot", "The Sleepers", "Dead Space")  
David Wise ("Double Deal", "Easy Credits")

## Editing

Tony Lee

## Production Manager

Timothy Brown

## Cover Art

Chris Foss

## Interior Art

Steve Bryant  
Bryan Gibson

***Traveller<sup>®</sup>,***

***Science-Fiction Adventure in the Far Future***

by Marc Miller

Copyright ©1997 by Imperium Games, Inc.

All rights reserved. Printed in the United States of America.

No part of this book may be reproduced in any form or by any means without permission in writing from the publisher.

Edition 4.1

1 2 3 4 5 6 7 8 9

Traveller is Far Future Enterprises' registered trademark for its science-fiction game system.

The game and universe presented in this book envisions a referee or game master as the ultimate supervisor of game play. The publisher is prepared to answer questions about Traveller provided a stamped, self-addressed envelope accompanies the request.



Imperium Games, Inc.



169  
1971

# 1: THE *RAPTOR*

---

---

In the event that player characters do not have access to a ship, you may wish to make available the use of the *Raptor*. Its armament, armor, and cargo space are sufficient to allow characters to engage in a variety of different small-ship missions, from trade to exploration/survey to small-unit military or security operations. Because of the special capture-and-refit program that makes these ships available, the cost is no greater than that of a smaller freighter. Not everyone is eligible to offer bids on these refitted ships. The owner (or owners) are not eligible if they have a known or suspected criminal background, nor are they eligible if they are not Imperial citizens. Practically speaking, the Imperium rarely sells such vessels to those who have not had at least two terms of voluntary Imperial service, whether through the military, law enforcement agencies, or scout service. Free traders *may* be eligible to own such a ship if their service can be documented as exemplary and if they have a history of accepting and fulfilling Imperial transport contracts.

In the early years of the Third Imperium, the threat of piracy from those who opposed the rule of law was so great that the Emperor continued and stepped up the policies he enacted while he was the leader of the Sylean Federation. He expanded upon the development of a group of armed vessels designed to patrol the spacelanes seeking out pirates and corsairs, as well as their bases of operation, and bring them to justice or destroy them. As a result, many of the ships used by the corsair groups were captured by the patrol forces of the Imperial Navy. Rather than destroy them, the Navy refitted them with updated technology and sold them as armed merchants. In addition to raising capital for a young political institution, it reduced the necessity for the Imperial Navy to patrol a great number of systems to protect merchant shipping lanes. The only drawback to the program was that some of the refitted vessels found their way back into the hands of the very pirates the Imperium sought to dispossess. Despite these setbacks, the policy yielded great benefits, and it contributed substantially in the early expansion of trade in the Third Imperium.

These ships are sold only to persons who have no record of any felony convictions or arrests. The ships are sold at an invitation-only auction, usually at a cost far below their actual value. The *Raptor* is one of the ships captured and refitted by Cleon's Imperial Navy. Sold at auction for a price well below its actual value, the Navy still made a healthy profit over what it paid in refitting costs. The captain (Harco Esher or a player character) got her for the equivalent cost of a Far Trader. The payments have not been easy to make all the time, but one of the arrangements the Imperial government has with captains of these refitted vessels is that they accept an Imperial shipping contract if they are unable to meet a quarterly payment. The *Raptor* has managed to stay ahead enough to make ends meet and to afford not only her annual maintenance requirements, but a few minor modifications to suit her captain and crew as well.

The crew complement of the *Raptor* consists of a captain/pilot, a co-pilot, a navigator/sensor operator, two engineers/maintenance techs, and four gunners. In addition, there is space for a medical officer if need be. In addition to her crew, the *Raptor* can carry up to ten passengers (5 high passengers or 10 middle passengers) and eight additional persons in low berths. In the event that the crew of the *Raptor* captures someone or needs to keep a critically injured person in stasis, the

number of low berths available for passengers may decline.

The *Raptor* can hold up to 100 tons of cargo in her spacious holds. The huge clamshell doors that allowed her to bring ships of up to 100 tons into her hold were permanently sealed by the Imperial Navy, but the cargo accesses they replaced them with enable her to carry smaller vessels of up to 30 tons displacement. This requires cargo space in the holds equal to 133% of the displacement of the small craft (i.e. 40 tons of cargo space for a 30 ton craft).

The variable transponder of the original corsair vessel has been replaced with one that bears only one transponder code. This transponder is very difficult to alter, as the Imperial Navy does not want these refitted ships to fall into the hands of pirates and other criminals. It requires success at an impossible Computer task and a formidable Forgery task to make any alterations to the transponder code. In addition, it is so inaccessible that a successful staggering Engineering task is necessary even to reach the transponder itself.

## **The *Raptor***

Tons: 400  
Volume: 5600 cubic meters  
Crew: 9  
Staterooms: 10 (5 crew/5 pass.)  
Cargo: 100 tons  
Low Berths: 8  
Tech Level: 12  
Controls: Exploration/Survey  
Cost in Mcr: 225.3

8 Size Rating  
3 Fire Control Rating  
4 x L Battery 3, 0, 0, 0  
2 Jump Rating  
3 G Maneuver Rating  
4 Power Plant Rating  
127 Fuel Rating/S/R  
10A 4P 4J Sensor Rating  
(Masking)  
40 Armor  
16 Structure

# Sample Crew Roster

Name <b>Captain Harco Esher</b>		UPP <b>7B9AA7</b>
Service		Rank <b>Captain/Pilot</b>
Birthdate	Birthworld	
Skills <b>Administration-2, Astrogation-2, Athletics-1, Brawling-2, Bribery-1, Broker-1, Carousing-1, Communications-1, Computer-1, Engineering-2, Forward Observer-1, Grav Craft-1, Gunnery-1, Leadership-2, Pilot-3, Pistol-2, Sensors-1, Stealth-1, Streetwise-2, Survey-1, Survival-1, Stealth-1, Tactics-2, Trader-3, Vac Suit-2.</b>		
Possessions		Money
Comments		

UPP Card 001-000

Name <b>Girush Uulum</b>		UPP <b>A7A885</b>
Service		Rank <b>Engineer</b>
Birthdate	Birthworld	
Skills <b>Brawling-2, Computer-1, Electronics-3, Engineering-4, Environment Combat-3, Grav Craft-2, Gravitics-3, Gunnery-1, Mechanics-2, Pistol-2, Sensors-1, Streetwise-1, Vac Suit-2.</b>		
Possessions		Money
Comments		

UPP Card 001-000

Name <b>Eslin</b>		UPP <b>598CB6</b>
Service		Rank <b>Navigator/Co-pilot</b>
Birthdate	Birthworld	
Skills <b>Astrogation-6, Communications-3, Computer-4, Electronics-2, Geology-1, Grav Craft-1, Jack-of-All-Trades-1, Physics-1, Pilot-1, Pistol-1, Recon-1, Sensors-4, Survey-3, Survival-1, Vac Suit-1</b>		
Possessions		Money
Comments		

UPP Card 001-000

Name <b>Sir Spencer Hyland</b>		UPP <b>798B8B</b>
Service		Rank <b>Supernumerary</b>
Birthdate	Birthworld	
Skills <b>Pistol-3, Athletics-2, Brawling-3, Camouflage-1, Computer-1, Demolitions-1, Forensics-1, Ground Craft-1, Gunnery-1, Interrogation-1, Investigation-1, Jack-of-All-Trades-1, Law-1, Leadership-1, Long Blade-1, Medical-1, Navigation-2, Perception-2, Pilot-1, Recon-2, Rifle-1, Stealth-2, Streetwise-2, Survival-1, Tactics-1.</b>		
Possessions		Money
Comments <b>Also serves as a gunner if need be</b>		

UPP Card 001-000

Name <b>Liam Fitzgerald</b>		UPP <b>7979B7</b>
Service		Rank <b>Ship's Doctor</b>
Birthdate	Birthworld	
Skills <b>Administration-2, Athletics-1, Biology-2, Brawling-1, Carousing-3, Chemistry-1, Computer-1, Diplomacy-1, First Aid-4, Forensics-1, Grav Craft-1, Ground Craft-1, History-1, Medical-4, Carousing-3, Perception-2, Philosophy-1, Pistol-1, Psychology-2, Research-2, Rifle-1, Survival-1, Writing-2.</b>		
Possessions		Money
Comments		

UPP Card 001-000

Name <b>Mikal Herens</b>		UPP <b>678975</b>
Service		Rank <b>Gunner</b>
Birthdate	Birthworld	
Skills <b>Brawling-1, Computer-1, Electronics-1, Engineering-1, Grav Craft-1, Gunnery-3, Jack-of-All-Trades-1, Mechanics-1, Perception-1, Psionics-1, Psionics-1, Sensors-1, Short Blade-1, Streetwise-1, Vac Suit-1. Psionics: Awareness-2, Telekinesis-2, Telepathy-2.</b>		
Possessions		Money
Comments <b>Also serves as Cargo Handler and Maintenance Technician</b>		

UPP Card 001-000



# 2: AKIRA DOWNED!

The characters are in system to deliver dispatches to an Imperial Marshal and to explore the possibility of a little bit of trade with local miners and ranchers. The system is also enroute to their first expected trade world, and has both water on the main world and a gas giant in the system, either of which the characters can use to refuel their ship.

## The Setting

For referees and players using *Milieu 0* and *First Survey* supplements, the following system near the Sylean Federation worlds will work reasonably well for the location of this world:

1921 Medishvlaas C245377-7 LoPop 724 G4 V

For those who wish to use an alternate setting, here are some ranges for the Universal World Profile of the world:

UWP Ranges	
Starport:	D-C
Size:	3-A
Atmosphere:	4-9
Hydrographics:	3-A
Population:	2-6
Government:	0, 3, 5, 7, C
Law:	2-5
Tech Level:	7-A
Bases:	None

The system is as yet undeveloped; few travel here, other than a handful of miners trying their luck. The trade station is run by Claremont Davis, a miner who turned a bit of luck into a more reliable future. The station itself has a population of no more than 600 people, most of the rest of the population out working their claims. The starbase could handle more traffic easily enough, but for now there are only a few ships in port: a 600 ton ore carrier (currently being loaded with cargo), an Imperial Scout Service scout ship, another scout ship bearing Imperial Ministry of Justice markings, and a couple of beaten-up tramp freighters. There is no Imperial presence here other than a single Marshal of the Office (or Ministry) of Justice, a woman named Maggie Young. The Marshal acts both as the representative of Imperial law and the principal claims adjuster and trade contact for the world. Young has been here for only a year, and has managed so far to hold the peace between the various mining groups, but she realizes that her influence more or less ends at the outskirts of the trade station. The seven principal mining combines enforce their own laws in their territories, and they resent any outside intrusion into their affairs. So far, Young has not found it necessary to challenge their claims to their territorial jurisdiction, but knows that it will come someday.

## The Imperial Marshal

Maggie Young has been Marshal on Medishvlaas for just over a year. She started her career as a Marine, and she served eight years with distinction as a recon

team leader before a Reduction-In-Force caused her to muster out. She spent a tour in the Scouts, but it wasn't what she thought it would be, mainly just survey team work on uninhabited worlds. Not of a scientific bent, she decided to leave the Scouts when she heard that the Imperial Ministry of Justice was accepting applications for agents-in-training. Although she was somewhat older than most of the other recruits, her eight years spent in the Marines served her well in the difficult training that followed, and she finished at the top of her class. She spent four years as a junior agent in the Zuarkri office before being recalled to Sylea for a special undercover assignment. Her years as a Marine and those investigating the low-lives that often make Zuarkri an night life so "interesting" served to hone her talents well for the harrowing assignment that took two years to bring to trial. A retired Imperial admiral and several other senior officers, including three still on active duty, were found guilty of selling high-tech armaments and spare parts to the Mushaad Consortium, a wealthy and well-connected criminal family. Young's identity as the undercover officer was never made public, and only the Deputy Minister for Intelligence and the Minister himself were privy to her involvement. Nevertheless, when offered her choice of any assignment she wanted, she chose to take the recently-vacated post of Imperial Marshal on Medishvlaas. She will not speak of her undercover assignment to anyone; she follows a careful cover story that was given to her by her superiors.

Although the assignment on Medishvlaas is not as intense an assignment as she had gotten used to, that suits Young just fine. She has gotten to know several of the locals, and for a rowdy bunch, they're not all that bad. She does what she has to do to keep the peace and enforce Imperial law as it applies. Her involvement in local matters comes only as a result of being officially requested to do so by the Miner's Council, which is more or less the government on Medishvlaas. She has a quiet post, and she intends to keep it that way.

Name <b>Margaret ("Maggie") Young</b>		UPP <b>79AB86</b>
Service		Rank Imperial Marshal
Birthdate	Birthworld	
Skills Administration-1, Astrogation-1, Athletics-2, Brawling-3, Computer-1, Forensics-1, Grav Craft-1, Ground Craft-1, Interrogation-2, Intimidation-2, Investigation-2, Law-1, Long Blade-1, Navigation-1, Perception-2, Pilot-1, Pistol-4, Psychology-1, Recon-3, Stealth-2, Streetwise-2, Survival-1		
Possessions		Money
Comments		

UPP Card

001-000



## The Setup

When the characters arrive at Marshal Young's office to deliver their dispatches, she will invite them to lunch over at the station's only eatery, a little establishment called The Belle Star. It is actually a ship, an old 400 ton freighter of unknown design, that has been gutted of its components and refurbished as a restaurant. Locals claim that it has been a part of the landscape here for centuries. Most believe that it was forced to land during the interminable wars that heralded the Long Night, and the crew was either killed or simply decided to take root here. The Marshal tells the characters that one old guy claims that it belonged to a merchant family from Old Earth named Chantilly; the last of them died nearly a century ago. The Belle Star has housed the offices of the original trade station itself, acted as a defense platform for the town when the Miner's Council came up with the notion that pirates and other undesirables might threaten their world, and finally was won in a card game by Fiona Ngomo, the proprietor of the restaurant. During the storm season, Fiona opens it up as a shelter from the terrible winds that lash the planet. It retains enough of its original streamlining and is anchored solidly into the bedrock that it escapes the ravages of the worst of the storms.

The kitchen is in what was the engineering section, the bridge serves as Fiona's office. When the Marshal and the characters come in, Fiona waves a greeting. The Marshal sits at a table that has a good view of the door and the rest of the room. She nods a greeting to a few of the patrons, who nod back. When the waiter, a youngish man named Khamu, brings lunch, the Marshal asks after news from the core worlds. The characters and she sit for a while and exchange gossip, and when the bill comes, she picks up the tab. She then tells the characters that if they have any trading business to do, to see the station manager, Claremont Davis. She thanks them for delivering the dispatches and for the news, and leaves the restaurant.

If the characters have any trading business they wish to transact, they can see Davis. If they need his broker services, he charges 11% of the final sale price (his skill level in Broker is 2). Characters who wish to do their own brokering may do so, but he still charges them 1% of the final sale price as a transaction fee. If the characters complain about this, he tells them that the fee goes to maintaining the station. If they get belligerent about it, he will calmly inform them that they pay the price or he will see to it that no one on planet trades with them. The station cannot exist on air, and he doesn't work for free.

The characters will not likely be able to unload an entire cargo here, but they should be able to move some of their goods. They can sell up to five tons of food and other agricultural products (some to Fiona at the Belle Star, the rest to agents of the mining stations scattered around the area) at a base price of Cr 6,000 per ton. The station is home to a hospice, which acts as a small medical facility as well. The man who runs it, a guy named Doc Kusek, could probably use up to half a ton of pharmaceuticals and other medical supplies. The hospice hasn't much money, but Doc Kusek is too proud to ask for any sort of discount. If the char-

acters learn about this from talking with the station manager or perhaps the Marshal, and they offer a reduced price for the medical supplies, they will have made a friend in the Doc. The mining concerns together will buy another half ton of pharmaceuticals and medical supplies (paying full price of Cr 6,500 per ton—or Cr 3250 for the half-ton). They are also interested in replacement parts and electronic components which can be altered to serve their needs. The characters can sell up to seven tons of these durable goods at a base price of Cr 6,000 per ton. Education and technical media will also interest the local population; the characters will be able to sell up to a ton of such material, at a base price of Cr 7,000. Finally, novelty and entertainment items will sell; the characters can sell up to a ton at a base price of Cr 7,000. The final prices are determined by consulting the Actual Value Table on page 171 of the **Traveller** rulebook. The only goods the world has to offer are their ores (raw and rare materials). Basic ores (raw materials) sell for a base cost of Cr 6,700 per ton; there are 25 tons available. Because characters may balk at such prices, the station manager will tell them that other ships have managed to make a reasonable profit on the next world on the trade route. The locals there need the material for construction. The rare ores sell for the same amount as do the basic ores (Cr 6,700 per ton), but there are only three tons available. The station manager can tell the characters that these ores have generally sold well in several of the surrounding systems, but he cannot guarantee that any particular world will need them at the moment.

## Help!

As the characters are leaving the system, they pick up a faint signal GK (a distress signal). The message is too filled with static to understand clearly. A character may attempt an Average Communications task to amplify and clarify the signal. If the characters do not succeed at the task on their first attempt, they may try again after the ship has moved from the position where they first attempted the task. When the characters succeed at the task, they hear the following message:

"Any station this net, any station this net, this is the Independent Merchant Ship *Akira*. We have been attacked by a vessel of unknown origin and are adrift near the gas giant Gem. Our maneuver systems are out, and our jump capacitors have been badly damaged. We have managed to restore minimal power, but current course projections make it likely that we will be drawn into the gravity well of Gem within ten days of the originating date-time group of this message. Repeated attempts at restoring our main maneuver systems have failed so far. If there is anyone out there who picks up this message, please help us. I say again...Any station this net, any station this net..."(the message repeats itself).

The originating date-time group of the message was 93 hours ago.

The characters can open up a channel and attempt to hail the *Akira* if they succeed at a Difficult Communications task. They can attempt this multiple times if they are unable to establish contact immediately, as long as their ship has moved from its original position.

When contact is established, they get an almost immediate response, delayed only by the lag that usually occurs in communications over such vast distances. The relief in the voice of the person at the other end of the communication is evident, and the characters can hear cheering and shouts of relief from those clustered around whatever part of the ship the radio is located in. After a moment of this, the person at the other end gets them to quiet down and identifies himself as Third Officer William Gant. He answers whatever questions the characters have to the best of his ability. The First Officer, Nim Gaareki, will also speak to the characters. They will identify their ship as a 400 ton Subsidized Merchant, operating out of the Third Imperium. Their principal duties are carrying industrial parts and technological information to several outlying systems. They bear documentation to that effect if the characters choose to review it. They were coming to this system both to refuel and to deliver some vehicle parts to the Eckhart Combine, a small mining company operating on the main world.

The ship was attacked some four days ago by an unidentified vessel. She wasn't emitting any transponder code, and she attacked from behind an ice asteroid in the first ring that surrounds the gas giant. Her first pass opened up the hull around the cargo bay, but no real damage occurred to any systems until her next pass, when she fired some powerful weapon and hit Engineering. They lost helm controls immediately, as the blast from the weapon put a hole clean through Engineering. The engineer and his assistant were both killed, and the captain (Floyd LaGrange), who was on his way back to Engineering, was injured. The attacker's third pass was the one they thought would kill them, but there was some kind of explosion near the weapon that had holed Engineering, and the attacking ship broke off the assault and fled. The *Akira's* weapons were having little effect on the attacker, so they assume that she was fairly well armored. They are uncertain of the exact sort of weapon that was used, but they believe that it was some sort of fusion or plasma weapon. The *Akira* is a thin-skinned freighter, so there was little difficulty in the attacker blasting a hole clean through her hull.

Since sending the message, they have managed to improve their repairs on the power plant, so their power is okay. They have also managed to jury-rig some repairs to the jump capacitors, but they are afraid to jump so near the gravity well of Gem. Their maneuver drives remain completely shot. Their one laser turret still has power, and all other systems are operational. The only casualties are the injured captain and two engineers who were killed in the attack. They have no ship's boats, so they have not been able to evacuate the crew or send for help.

If the characters attempt to get a line-of-bearing on the message, they will be able to do so if they succeed at a Difficult Communications or Sensors task. The signal emanates from a source that is approaching the gas giant Gem. The characters can plot an intercept course if they succeed at an Average Astrogation task; they can arrive at the damaged ship's projected location in approximately 76 hours. If this information is passed along to the *Akira*, they will be obviously

happy to hear the news, and they will ask the characters if there are any special preparations they need to make. Any character succeeding at an Average Intelligence task will realize that the starport in-system should be notified as well, so that they can send out whatever rescue aid they can muster. Any such aid will not be able to arrive onsite before the characters can, so they will have to attempt the initial rescue. The starport authorities ask that they remain in contact both with the *Akira* and with them, keeping them apprised of any new information. They will be sending out Marshal Young in a scout ship and a slower tug to tow the *Akira* and unload the crew.

The flight to intercept point is uneventful. Ship's scanners pick up no hostile craft, and communication with the *Akira* reveals no changes in their status. At one point, the captain speaks to the characters, but it is clear that he is in pain, so the conversation is short. The usual communication occurs with Third Officer Gant, who seems never to leave the radio, or with the First Officer. It is obvious that they are anxious, and the wait is not easy on them. If any of the characters talk to them once in a while (just chatting), their morale stays pretty high. If the characters do not contact them on the radio once in a while, however, they will try to raise the characters' ship, just to check on their progress, or to talk.

Two hours before the estimated rendezvous time, the characters can try a Sensors task to sweep the area where the *Akira* should be; a success at an Easy difficulty will locate her. If this task is successful, the characters can then attempt a lock, which requires success at a Difficult Sensors task. As the characters' ship closes the distance between the two vessels, the sensors operator must maintain the sensor lock on the *Akira*; this requires success at an Average Sensors task. Approximately twenty minutes from the estimated rendezvous, the sensors will have enough data to display a visual image of the *Akira*. As reported by her crew, she has sustained serious damage to her Engineering section and cargo area. There is a single laser turret visible, mounted dorsally aft of the bridge. Currently, it is pointed in the direction of the characters' ship, but no sensor lock has been established. Any of the characters who are viewing the sensor data can attempt an Average Intelligence task. If they succeed, they realize that the *Akira* is simply taking routine precautions.

It is entirely possible that the characters will suspect a trap of some sort. This is fine; they can prepare themselves and their ship as they choose. If they decide to ignore the distress signal, referees should remind them that it is a very strong custom, now backed by Imperial law, that any vessel capable of rendering assistance to a ship in distress must make every attempt to do so unless it directly endangers their own ship. If this does not convince them, referees should remind them that it could as easily be them in need of help.

The *Akira* is headed toward the gas giant Gem. She had built up a fair amount of speed before her engines were shot up, and she hasn't been able to shed any of her velocity. Success at an Average Astrogation task will confirm that indeed she will enter the atmosphere of Gem and break up in a day or so. The characters might be able to help the *Akira* shed some of the

momentum she has built up. If a character succeeds at a Difficult Astrogation task, he can determine an approach that will enable the characters' ship to maneuver nose-to-nose with the *Akira* and use her engines to slow the *Akira* down. The actual maneuver requires that the characters succeed at a Formidable Pilot task. Up to three characters can work together to increase their chances of success. Two of them can be on the characters' ship (a pilot and a co-pilot, who calls out the tiny course corrections necessary for the delicate maneuver). The *Akira's* pilot can help as well by observing the approach from her bridge and informing the pilot on the characters' ship of any needed course adjustments. If the characters take their time, they can add a +1 to the final target number they need for success. A simple failure may result in damage either to the *Akira* or to the characters' ship. This should amount to little more than damaging sensor or communication arrays, or perhaps a weapon emplacement (if one is located near enough to the bow of the ship). A catastrophic failure could indicate a hull breach (especially on the *Akira*, for she has little or no armor) or that the maneuver has caused the *Akira* to begin tumbling. If the characters have not yet unloaded the crew and passengers of the *Akira*, this will make any such attempts very difficult (they will require success at a Formidable Pilot task). It is unlikely that any other method will have as much chance of succeeding. Using sling-load cables, for example, will make the task even more difficult, and in case of a failure, may make the consequences devastating to both ships. The momentum of the *Akira* is great enough that any alteration in her flight stability may cause her to yaw out of control. If the characters' ship is attached by cable to her, the two ships may very likely collide.

If the characters succeed in shedding the *Akira's* velocity, they can attempt to maneuver her into a stationary orbit around Gem. They can accomplish this by a similar maneuver they used to slow her down, or they can use cables if they have them (the *Akira* does not). As long as they maneuver very slowly, they should not encounter any particular danger. If the pilot of the characters' ship succeeds at a Difficult Pilot task, he can move the *Akira* to a stable orbit around Gem. The characters can determine the orbit by succeeding at an Average Astrogation task.

If the characters succeed at these tasks, the *Akira* will be out of danger of breaking up in Gem's atmosphere. If the crew of the *Akira* is already aboard the characters' ship, the characters can simply wait for assistance or intercept the scout ship and tug enroute from the main world. If the characters ask the crew of the *Akira*, the First Officer will ask if they would be willing to remain nearby since he does not want to leave her unguarded, especially not with a corsair in-system. The estimated time of arrival of the scout ship is about 42 hours. In the mean time, the characters can do several things. First, they can attempt to determine the damage to the drive section of the *Akira*. If a character makes an Average Engineering check, he can determine that the damage to the engines is severe, but he might be able to restore some maneuver, at least temporarily. This will require a series of three successes at an Engineering task: two against Formidable difficulty,

and the last requires a Difficult success. The characters can be assisted by Nim Gaareki (the *Akira's* First Officer), who has a skill level of one in Engineering. The base time for accomplishing these tasks is twelve hours. The characters can attempt to succeed at these tasks multiple times, each time requiring another twelve hours and a successful Endurance check (the first check at Average, the second at Difficult, the third at Formidable, etc.). If the characters are successful at these three Engineering tests, they have managed to jury-rig the maneuver drives to provide 1G acceleration for a while. These repairs will last only for a short time (4d6 hours) before breaking down again and requiring a new set of repairs. By no means can the characters and the crew of the *Akira* make permanent repairs to the ship; she needs extensive work at a starport (with a rating of C or better).

After nearly two days, the characters pick up an approaching ship on their sensors, which they can identify as the Imperial Ship Varig, a 100 ton scout ship converted to use as a system patrol vessel. In the Varig are Marshal Young, who is piloting her, and Doc Kusek, here to render medical assistance to any who might need it. They link up with the characters' ship and ask to come aboard. Doc brings along his medical gear and sees to the crew of the *Akira* while the Marshal chats with the characters about what they might have seen. If the characters have already rendered what medical assistance they could to the crew, Doc's work is short. He says that although Captain LaGrange's injuries do not seem too serious, he will need hospital care as soon as possible. While the Marshal is interviewing the crew of the *Akira*, he asks for help from one of the characters in moving him to the Varig. It takes about three hours for Young to interview the crew. If the characters listen to the questions, they will hear her ask about what they saw, when the attack occurred, what they were doing, if they got any identification from the ship, if they saw where it seemed to be heading, etc. She does not seem to be grilling them so much as trying to put as clear a picture together as possible about the attack. If characters want to ask questions of their own, she will let them to do so. After she talks with the crew, Young approaches the characters.

"I hate to have to ask this of you, but I'm afraid I have little choice. I need someone to mount a search for the ship that attacked the *Akira*. I need to know if it was the act of a wandering corsair, using this system's gas giant to refuel, or if I have a pirate problem in-system. The data that the crew of the *Akira* gave me suggests the latter, but I can't be sure. I would gladly do it myself, but I will have to return to port, not only to bring the captain of the *Akira* to medical facilities, but also to use my authority to coerce the mining concerns to provide ships and manpower for a general search of the system. That may take days. Now, I know that you probably have places to be, but I'm in a jam here. I probably can't pay you what you'd make elsewhere, but I can give you a promissory letter of credit that you can redeem at any office of the Imperial Ministry of Justice. I've got a little discretionary fund here, too, and I'll see to it that you get at least a little something up front, say... 200 credits per day for each of you. And I'll see to it that your ship is refueled with refined fuel

and that your stores are replaced free of charge before you leave system. And since you are on Imperial business, any damage to your ship will be repaired at an Imperial base without cost to you. What do you say?"

Young is willing to offer a voucher for 500 credits per day per person, but she cannot redeem it here. She is genuine in her offer of 200 credits per day for anyone who helps her out, and she will see to it that they receive that pay and the fuel and stores free of charge before they leave the system. She won't haggle about the 200 credits per day; that's all she can afford out of her small operating budget. If the characters try to negotiate for more, she will explain this politely, saying that she understands they also have to make ends meet, but that's all she's got available. Should they start to become insistent about getting more money from her, she will start to become a bit irritated after a while. She says that she is paying them with a voucher that's worth more than twice what she makes in a day to each one of them, and throwing in an extra 200 out of her own budget. By law, she isn't required to pay more than a quarter of what she's offering. If the characters become belligerent or simply refuse to cooperate, she will sigh, and then she will arrest them under suspicion of smuggling contraband. They might be innocent, she argues, but the inspection of the ship takes at least a week or so, and what with the possibility of corsairs operating somewhere in-system, the organization of a patrol effort, plus the actual search through the system, she has no idea when she will be able to get to the inspection. Until then, they can be her guests at the small containment facility she has, and their ship will be impounded until the inspection is over. If they suggest that she has no right to do that, she will admit they might be right, but the worse that will happen to her is a letter of reprimand from her superiors, while they will likely be trapped here for well over a month. Wouldn't it be simpler for them to help her out for a week or so?

There is a possibility, however unlikely, that the characters might become violent toward Young or even kill her. If they do this, they will be hunted down by Imperial authorities and captured or killed. Assaulting an Imperial officer in the lawful commission of his duties is a serious crime, and killing one considerably worse. The referee is free to make the characters' lives sheer torture. They will be fugitives from justice. Their assets will be seized and a bounty will be placed upon their heads. There is nowhere in Imperial space they can go without the law seeking them out or even catching up with them. If they are caught, they will be sentenced to a long prison term of hard labor, or they might be killed by Imperial authorities or bounty hunters (in either case, they can tear up their character sheets). This will almost certainly not be necessary, but some characters might get into their heads that they can do what they please without consequence.

## The Search

If the characters agree to assist the Marshal, she will get them the logs, sensor readouts, astrogation data, and recordings of her interviews of the crew before she leaves for the main world. The characters can review these to get an idea where to begin their

search. She will also swear them in as her deputies "pursuant to the duties herein agreed, etc." In effect, their authority extends to the mission of seeking out the ship that attacked the *Akira*, assuming it is still in-system. She will issue them identifications that make their status clear. This whole process will take about an hour.

When the new deputies examine the data, a Difficult Astrogation check will show that it is possible that the corsair did not leave the system after the explosion on board that caused it to break off the attack. If a character chooses to pursue this line of reasoning, he can attempt a Formidable Astrogation task (or he can suggest it to a character who has the skill). If he succeeds, he can determine that the bearing they were on when they fled the location where they attacked the *Akira* put them on an intercept route for one of two moons orbiting Gem. The calculations necessary to this check take about three hours, and if the characters fail at the first attempt, they can continue trying as long as they succeed at an Average (or harder) Endurance check (the next retry is a Difficult Endurance task, the third a Formidable, etc.). Characters can assist one another, and using the ship's computer and navigation software can make the task one level easier (i.e. it becomes Difficult instead of Formidable). The first moon is called Pearl, so named for its cloudy atmosphere. The second, a reddish planet, is called Garnet. Existing survey data stored in the ship's computer drives show that Pearl is the larger of the two, and that Garnet has a breathable standard atmosphere, but that neither show any record of ever having been settled.

### Players' Data

Pearl ?8A7???-?  
Garnet ?264???-?

### Referee's Data

Pearl E8A7000-0  
Garnet X264000-0

If the characters decide to choose these two moons as a starting place for their search, they can plot a course to either of them by succeeding at an Average Astrogation task. Pearl currently is the nearest of the two; it will take about 81 hours (estimated) to make the journey (assuming 1G acceleration). To get to Garnet will take an additional 86 hours from the ship's present location, or 111 hours from Pearl.

### Pearl

The ship that the characters are chasing is on Pearl, hiding in a canyon while her crew tries to repair her hull around where the weapon exploded.

When the characters arrive at Pearl, they can use sensors to get a better idea of what the planet is like. Success at an Average Sensors or Survey task will both confirm the physical data about the planet outlined above under Players' Data and give a more accurate reading of secondary data, such as surface temperature, atmospheric composition, and meteorological information. Around the equator, the temperature is unbearable for humans, but nearer the poles are relatively wide bands which could allow human habitation. The atmospheric mix requires respirators or air tanks that contain the proper combination of oxygen and nitrogen, for the air on Pearl is too thin and contains too high a percentage of inert elements for humans to

breath it unassisted. The weather on Pearl is usually stormy, so it is difficult to get any accurate sensor readings without entering the atmosphere. Piloting tasks within the atmosphere are also more difficult (by one difficulty level), depending on whether or not the characters' ship is caught in a storm. Referees should roll a single six-sided die to determine the existence of a storm. If the referee rolls a 1-3, then there is a storm currently over whatever area the characters are searching or flying. Referees should check every hour or so if the characters remain in a specific area, or when they move to a new location 500 or more kilometers away.

If the characters enter the atmosphere to begin searching the planet for any signs of the damaged corsair, they will need to decide which part of the planet they wish to search. Effectively, anywhere between approximately 60 degrees North latitude and 50 degrees South latitude is so hot that humans could not safely exist. That still leaves a considerable portion of the planet to explore, however. The corsair is hidden in a canyon in the northern polar region. For the characters to find the area in which the ship is hiding, however, requires that they succeed at an Average Sensors (or Difficult Survey) test; remember that if there is currently a storm over the area, the difficulty increases by one level. Using passive sensors only increases the difficulty by one level, but if the characters are using active sensors, there is a chance that the crew of the corsair will notice. There is a 50% chance (a 1-3 on a six-sided die) that someone is on the bridge doing security watch. If this is the case, he might notice that the ship is being scanned (8- on 2d6). If so, the corsair crew will be prepared for the characters should they come looking.

### The Pirates

The crew of the corsair are not actually typical vicious pirates. They are a motley gang of "freedom fighters" from a nearby world with an oppressive political environment. They call themselves The New Dawn, and they fight against the complacency of a population ingrained to follow the authority of the repressive government of their home world. Their ship was sent out to acquire other ships so that their revolutionary leaders could prosecute their rebellion against the tyrants that rule their planet.

There are essentially three ways the characters can deal with the corsair crew: shooting, sneaking, or talking. Of course, they can easily enough combine any two of them or even all three. The following paragraphs will outline some of the basic capabilities the corsair crew has in dealing with each of these approaches.

If the characters choose violence as the means to deal with the pirates, they will be facing nearly twenty people. The corsair carries its normal crew complement of ten and an additional ten crew members who act as prize crew for any vessel they might capture. These extra crew are trained not only in boarding actions but also in the skills necessary to operate nearly any ship of up to around 600 tons displacement. The corsair is currently short two crew members who were caught in the explosion of the main gun. On Pearl, where they are attempting to repair the fusion gun and the other sys-

tems damaged by the explosion, the crew members are wearing a mixture of armor protection. Referees should roll a single six-sided die: on a 1-3, the crewman is wearing the equivalent of diplo armor (although it is fashioned more as a ship's coverall or jacket and trousers than as formal or business wear); on a 4-5, the individual is wearing flex armor; and on a 6, roll again (re-roll if a 6 comes up again) to determine the sort of armor listed above and add reflex armor to the protection worn. Nearly all of the pirates carry pistols (primarily slughtrowers), but some carry other weapons as well. Of the eighteen crewmembers who are on Pearl, four carry submachineguns, three have rifles, and three carry short-barreled shotguns. Due to the exotic atmospheric mix, any pirate outside the ship will be wearing a respirator. Vacuum suits are not necessary.

The pirates are not psychotic, but they are desperate. They will not give themselves up without a fight, for although there is little to look forward to in returning home, there is even less to look forward to in an Imperial prison. Their principal concern is to effect whatever repairs they can to their ship while on Pearl and get off planet and out of the system. If left alone, they will have accomplished enough of a repair to their hull that they can exit the system within 24-36 hours from the time that the characters first spot them.

There will be six pirates outside the ship when the characters approach. One will be on top of the ship, serving as a lookout. He is armed with a rifle, and he has a communications link with the bridge. Two will be patrolling the perimeter, about one hundred meters from the ship. One is armed either with a submachinegun or a shotgun, and the other has just a pistol. They, too, have radio communications with the ship. The other three are trying to seal the breach in the hull of the ship near where the weapon exploded. The other twelve pirates are in the ship, either resting, conducting other maintenance, or on bridge watch (two people will be doing the latter).

Combat should be handled as outlined in Chapter 5 of the rulebook. Note that if a character loses his respirator during the fight, he will begin to asphyxiate. This will begin almost immediately, but no damage accrues to the character until after five rounds without a mask. At that point, the character will take one die of damage every round until he dies. After one physical characteristic has reached zero, the character passes out from lack of air. When two reach zero, his internal organs (principally the cardiovascular system) begin to become damaged. When all three reach zero, the character is dead. This process can be halted at any time by the character (before he goes unconscious) or someone else (before the affected character is dead) re-affixing the respirator mask over the character's face. The pirates will surrender if twelve of their number are down (six if the leader is among the downed pirates).

If the characters attempt to sneak up on the pirates' ship, they will have to be especially careful. The pirates inside the ship are running passive sensors to give them a warning if any other ship approaches. Although their chances of spotting ships are very low (due to the inherent weakness of passive systems and the atmospheric distortion), these sensors are able to pick up persons or vehicles approaching from the

ground. Characters must succeed at an opposed skill test (see page 50 of the rulebook), comparing their Stealth skill (added to Intelligence in this case) to the Sensors skill (added to Intelligence) of whatever pirate crew member happens to be monitoring the sensors when the characters approach. The referee can either have each character roll separately, or he can have the player whose character has the best total roll for the entire team, applying his relative success to the entire group. The individual method will be more realistic, but a sufficiently skilled character can enable his entire team to approach undetected. Referees can use a similar test to determine if any of the sentries spot their approach, using either their Perception or Recon skill as the appropriate skill. If the characters elect to approach by day, their chances of being spotted by the sensors decreases somewhat (subtract 1 from the sensor operator's roll), but they are more likely to be spotted by one of the pirates on sentry duty (add 1 to their Perception or Recon total). If they approach at night, the sensor operator adds a one to his roll, but the sentries are less likely to see the characters (subtract 2 from their Perception or Recon total).

They can also try to talk the pirates into surrendering, but because the pirates know that they are dead if they turn themselves over to the Imperial authorities, this method will be the most difficult one to bring off. The pirates must be convinced that their chances of survival are greater if they surrender peacefully. The number of variables is too great to list here, but some general guidelines apply. Psychology or Fast Talk skill requires success at a Difficult task check, Diplomacy or Intimidation a Formidable task check, and Bribery or Leadership a Staggering task check. These are modified by other factors as well. If the pirate leader, Jurgen Haas, is still conscious, add two levels of difficulty to any of the tasks listed above. If any task goes beyond the Impossible level of difficulty, it simply will not succeed. If all of the pirates are safely inside the ship in defensive positions, add two levels to the difficulty. If one-third of the pirates have been rendered unconscious or dead, reduce the difficulty by one level (two levels if two-thirds of the pirated have been neutralized). If the characters are in a superior tactical position, reduce the difficulty by one level. Other modifiers may affect the difficulty of dealing with the pirates in this manner; such modifiers are up to the referee. Although the negotiated solution is the most difficult, it is the one which will gain the characters the most distinction. Referees should reward characters who manage to accomplish the capture of the pirates with minimal bloodshed. The higher the number of pirates brought to justice uninjured, the better the reward. This reward can take many forms: a favorable die modifier for negotiations with law-abiding patrons, a couple of lucrative Imperial transport contracts, an offer of membership in the Travellers' Aid Society, etc. These effects can last for however long the referee chooses (six months seems appropriate, except for those benefits like TAS membership).

If the characters have not managed to achieve a solution within 24 hours of their first communication with the pirates, the pirates will be able to finish enough repairs (from inside the ship) to attempt to

depart from Pearl. These repairs will be temporary in nature, but they will give the corsair a chance to escape.

Name <b>Jurgen Haas</b>		UPP <b>99BA97</b>
Service		Rank Pirate Leader
Birthdate	Birthworld	
Skills <b>Brawling-2, Environment Combat-2, Intrusion-1, Leadership-4, Perception-1, Pilot-2, Pistol-2, Recon-1, Short Blade-1, Stealth-1, Streetwise-1, Submachinegun-2, Tactics-2, Vac Suit-2</b>		
Possessions		Money
Comments		

UPP Card

001-000

### Pirates

Age: Varied

UPP: 777775

Skills: Each has one ranged weapon skill level of 2; those who carry two weapons know how to use the second weapon at a skill level of 1. In addition, each has two close combat skills (i.e. Brawling, Melee Combat, Short Blade): one at a skill level of 2, the other at a skill level of 1. Finally, each knows his job aboard the ship (astrogator, pilot, gunner, boarding crew, etc.) at a skill level of 2, and each crew member has been trained in Vac Suit at a skill level of 1. Half the pirates will have either a Recon or Perception skill level of 1-2 (referee's choice). Referees may add to this list of skills any he feels appropriate to such a crew, and he may modify the skill levels to provide the appropriate challenge to his particular group of players. Remember that the pirates will likely outnumber the characters by a considerable margin.

The pirates are on a 400 ton corsair (see page 50 of the *Starships* supplement). In addition to the weapons listed, the corsair had a TL14 plasma gun, capable of punching through most TL12 armor. When it exploded, it killed two crewmembers and put a hole in the hull along the ventral spine of the ship.

### Further Adventures

If the characters are successful in saving the *Akira* and bringing the pirates to justice, they will be local heroes of a sort. The local mining and rancher outfits will offer them one-time preferred business deals for purchase of cargo. Traders and merchants who put in at the main world will hear of their exploits, and the word will spread out into adjoining systems. The characters will also make a friend in Marshal Maggie Young.

If the characters manage to bring back both the pirates and their ship, they can take a look at their computer and navigation logs. They will find evidence of an uncharted world called Delugon II where the ship had stayed for a few weeks. If the characters seek to explore this world, see the adventure "Lone Whisper."

There are other possibilities for future adventures in this system. Some of the mining combines may erupt in a brushfire war over mining rights, bringing



about just the thing Marshal Young has been dreading. The characters could hear about a confidential survey which shows evidence of a previously unknown ore deposit. The characters could become aware of a corrupt safari company that has set up on the world — when some of its customers go missing, the characters

are hired to search for them. Perhaps the world becomes a safe haven for the characters when they get involved in a dangerous intrigue not of their choosing. These are but a few of the adventures that characters could discover awaiting them on this world.





# 3: LONE WHISPER

---

This adventure can serve as a link between “Akira Downed!” and “Double Deal.” The characters run into yet another band of the jumped-up TL6, New Dawn raiders on their continuing quest for “alien technology” at the location of a ruined Second Imperium naval base that was constructed inside one of the massive pyramids of the Ancients. Here, they may discover the location of the hidden base, and be set on the path between ending the threat of the raiders once and for all. Additionally, psionically active characters or those with strong psionic potential will be drawn to a mysterious chamber deep under the Ancient site. Here, they may restore to their dimension one of the Ancients who fled this reality in order to escape the wrath of the Grandfather.

## The Setting

The primary backdrop for this scenario, Khiinra Ash (Core/2916/CAE6133-6), is a system with eighteen planets, two of which are gas giants. Although an intensive survey of the system reveals that at one time this system was heavily developed — there are remnants of bases on the surface of or dead satellites in orbit around virtually every planet — sentient life currently exists only on the system’s primary planet, those who were supported by technology on the other worlds having long since passed on. It does not contain an asteroid belt, which makes navigation extremely simple.

The only sentient inhabitants in the system now are the pirates, who have made their base inside an Ancients structure. 60% of the world’s surface is covered with water, and its countless islands are teeming with both flora and fauna. The world has been uninhabited by humans for over 1,000 years, and nature has reclaimed most of the ruined Vilani settlements, although they are still visible from orbit.

The pirates have constructed a starport outside their base that permits basic ship repairs. Likewise, they have stolen enough equipment to be able to affect such repairs, but do not have the technical know-how yet to actually use the tools to their fullest extent. The only refueling capability that exists are the gas giants in the system.

## The Setup

“Lone Whisper” grows out of the events of “Akira Downed!” In that adventure, the characters should have discovered the coordinates for Delugon II, a system which is known as Khiinra Ash by the Imperium’s stellar cartographers. This planet is a source of the “alien artifacts” that the raiders haven’t gained by attacking merchant vessels from Imperial worlds.

If the characters did not board the raiders’ ship in “Akira Downed!” or did not think to check for astrographic data so that they might locate their base of operations, there are a variety of ways in which the player characters may be drawn into this adventure.

**By Assignment:** The activities of the raiders have become an annoyance to a patron of the characters. Another of the ships he uses barely escaped an attack staged by the raiders in the Khiinra Ash system. Sensor data gathered indicated that the raiders had some manner of base on the primary planet of that system. The patron wants the player characters to travel to that world and capture the leader of the band. If the leader is not in the Khiinra Ash system, the patron wants them to locate him, and capture him if possible.

**By Accident:** The characters are either looking for new trading opportunities, or partaking in the early stages of the First Survey for the Imperium. As they are to begin their survey of the Khiinra Ash system, they observe a ship with markings similar to the one used by the pirates they faced in “Akira Downed!” emerge from jump space. The ship doesn’t appear to notice them, and it heads straight for the system’s primary planet. A scan of that world reveals a primitive spaceport near one of the long-abandoned Ancient structures.

**By Design:** The characters could take it upon themselves to track down the pirates. The referee can set up a situation where a ship owned by a close acquaintance of the player characters was attacked but managed to fight off the pirates. However, it was not without cost. Their friend’s ship was severely damaged, and due to losses among his crew and severe injuries on to himself is unable to affect repairs cheaply, nor can he work on other ships to earn the money he needs for months to come. He asks the characters to destroy the pirates before they ruin the lives of any more unfortunate travellers who happen to cross their path.

In this example, the characters need to conduct a concerted search for the pirates. The friend’s ship was attacked while processing fuel in system at Muugkha (Core/2814/D223133-6). The characters’ search should begin with systems for which full data does not exist that are within Jump 2 of Muugkha, and expand their effort from there. At worst, the characters will have to visit seven systems before encountering the pirates, perhaps affording the referee the opportunity to run them through the “Lock And Loot” scenario. (If that adventure is used in this way, Archibald Neff and the crew of *Liberty* have no connection with the pirates, nor do they have any knowledge of them. It’s a vast galaxy, after all.)

When the characters finally find the pirates in the Khiinra Ash system, they catch them unawares. Once the characters are in orbit around the system’s primary world, an Easy Sensors task reveals that the raiders’ ship is sitting on the tarmac of a primitive, no-frills starport.

## “There They Are!”

As the characters track the pirate ship, a successful Difficult Sensor task reveals that some sort of installation has been constructed in the cavernous interior of the long-deserted temple. There is no power in the installation, but readings indicate that it contains hundreds of power cells for lasers, as well as nuclear missiles, a

deadly type of weapon that most civilized cultures of the Imperium have not used for many centuries. It is clear that the characters have discovered a major pirate base, and if they move fast, they might be able to destroy their ship on the ground, and prevent the pirates from launching any of their barbaric and deadly atomic missiles. Further, as soon as the pirate ship landed, repair crews went to work on its hull, so the pirates do not even have any aircraft to send after the characters.

### **The Attack**

Whether the characters strafe the pirate ship and landing field while it is on the ground, or if they land their ship some distance away (a successful Average Pilot task means the characters have found a spot three kilometers away from the pyramid, behind a series of hills that allows them to land completely undetected) and then attack on the ground in a commando-style raid, the pirates will be caught completely by surprise. They know they are the only sentient beings on the continent, and thus did not expect any difficulties from spacefarers.

The pirates present at this base are not intended to be full-fledged characters, although the referee can certainly expand any of them as such, or he can insert any pirate character that might have been developed in the course of other adventures the characters have had. The statistics given are just for the purposes of the combat when the characters attack.

An aerial attack will result in a complete slaughter. The pirates' grounded ship is destroyed, and 3d6 pirates die as well. A ground attack will likewise result in many casualties on the pirate side as the characters will take them almost completely by surprise. The pirates do have the perimeter of their base patrolled by sentries — and the referee should make appropriate Camouflage, Recon, and Stealth task checks as the characters get into position for their attack — but they are watching more for dangerous predators than a group of travellers out for blood. It will take the pirates 1d6 rounds to start firing back at the characters, during which time the NPCs will be seeking cover or readying their weapons. Once the pirates get themselves somewhat organized, however, they fight back with everything they've got, apparently intending once again to fight to the death.

### **Pirates (six for each player character present)**

Age: Varied

UPP: 777775

Skills: Brawling-2, Melee Combat-1, Perception-1, Recon-1, Submachinegun-2.

Possessions: dagger, machinegun, three hand grenades.

### **The Surrender**

Unlike their comrades in the previous adventure, these pirates surrender quickly to the characters. If the characters attack from the air, the pirates contact their ship via the radio, and the desperate voice of a woman shouts in heavily accented Galanglic, "We surrender! We surrender! Please, stop the attack!"

If the characters launch a ground attack, the pirates fight for 2d6 rounds before a cry issues from inside the

pyramid: "Cease fire! Put down your weapons! Surrender! We surrender! Cease fire, I say!"

Once the shooting stops or once the characters land and leave their ship, or address the pirates through whatever PA system their ship might have, a woman, who is of middle years and whose face is furrowed by a lifetime of hard living, steps forward and asks in heavily-accented Galanglic, "May I speak a few words? We are more than the pirates and killers you must think us. We are, in fact, freedom fighters, struggling to free our world from oppression." If the characters are interested in hearing what she has to say, the referee should turn to "The Plea", below.

If the characters order her to be quiet, the woman makes no argument. She and her people allow themselves to be herded into whatever containment area the characters prepare onboard either their own ship or the pirate vessel.

Searching the pirate base uncovers a variety of personal belongings, most of which are articles of a TL6 or TL7 world. An item of greater interest is found in what appears to be a make-shift command center, which has been established in what was once the base's mess hall. A star chart with names and coordinates that are unfamiliar to any of the player characters is found on a table along with a set of badly decayed Vilani technical manuals for a variety of weapons, grav vehicles, and military-grade starships and ground craft. If a Difficult Astrogation task is successfully performed while studying the star chart, the character discovers it to be an incomplete map of Core Subsectors C, D, G, H, K, and L, with a coordinate system originating in Kiikagaiir (Core/2111). Elsewhere in the installation, the characters find 24 missiles equipped with nuclear warheads. The search also makes it clear that this installation has been ransacked and thoroughly stripped of all valuable equipment. Unless the referee wants to introduce some new piece of technology into the campaign, the characters find nothing of interest in the installation aside from the items mentioned above.

Since there is nothing of interest to find in the installation and no encounters are scripted here, no map has been provided. If the referee finds himself in need of a floor plan, he can use the lunar base provided in "Lock And Loot" as a model. The only difference is that all underground levels on that map are built up into the pyramid.

Before the characters leave the planet, the events of "A Mysterious Whisper" begin to unfold. As soon as the characters have either refused to listen to the woman and the captives have been secured, or the characters are ready to leave Khiinra Ash, the referee should continue the adventure as instructed in that section.

When those events are complete, the characters may either change their minds and give the woman a chance to speak, or they may leave Khiinra Ash and turn the pirates over to Imperial authorities. The nearest major world is Argash (Core/2416/B755400-6), which is three weeks travel away at Jump 2. The characters can also return the pirates and their leader to the world where it all started in "Akira Downed!" That system is 11 weeks travel away by Jump 2. Regardless, once that

trip has started, the prisoners become incaltrant in the extreme, and none will attempt to engage the characters in conversation, or answer any questions.

Once the pirates have been handed over, the characters receive any standing bounty the referee thinks may have been placed on them, and the law enforcement officials dismiss them with warm congratulations for a job well done. However, before they can leave the world, they receive a summons to return to the headquarters of the law enforcement agency they handed the pirates over to.

The official asks the characters if they interrogated the prisoners at all, or whether the issue of problems on their homeworld ever came up in conversation. At this point, the characters have to answer in the negative to at least one of those questions, and the law enforcement official will have Elana brought in. He asks her to repeat what she has already told him. She looks very tired and despondent, but she relates the information in "The Plea."

Name <b>Elana Gestain</b>		UPP <b>537998</b>
Service		Rank <b>Pirate Leader</b>
Birthdate	Birthworld	
Skills <b>Brawling-2, Carousing-1, Charisma-1, Communications-1, Computer-1, Fast talk-1, First aid-1, Ground craft-2, Gun combat-1, Linguistics-1, Mechanics-1, Performance-7, Recon-1</b>		
Possessions		Money
Comments		

women, and children of our world.

"The trouble started when a few decades ago, when my people shot one of your ships out of the sky with some of our missiles. The government was able to retrieve the weapons and technology, and the superior fighter planes and spaceships they were able to build by reverse-engineering your spaceship soon made them masters of our world.

"If we were to have a hope of fighting them, we had to get spaceships and alien weapons of our own — resisting the government with the weapons of our people would have led to our eventual destruction. So, members of my movement managed to steal one of their ships and head for the stars in search of our own alien technology.

"You probably can't imagine our surprise, and the fear, we felt when we discovered that we were actually surrounded by a vast Empire. There are legends on our world that it was once under the domination of iron-fisted tyrants who came from the stars, but no one believes them to be true, not even after we discovered your society exists when one of your ships was shot down over our world. After all, iron-fisted tyrants who are super-beings to boot don't just up and leave the way they are described as doing in our legends. But, when we became aware of your Empire, after visiting the wondrous asteroid world of Kimvle, it was clear to us that you are vastly superior to us, and that your Empire may very well be the ancient tyrants who legends tell of.

"For this reason, we were fearful of asking you or any of your people for help. Our goal is to liberate our world, not deliver it from one tyrant to another. That's why we hi-jacked your vessels, and otherwise did what we did. But, now that you have captured us, I have little choice but to throw myself upon your mercy, and ask for your assistance.

"The truth of the matter is that we have been less than successful in securing the technology we wanted. We've been able to continue to steal weapons and technology from the planetary government, and have established several bases like the one on Delugon II, but we have the same problem I'm sure our government must be facing. We are having a hard time keeping your technology operational. The only headway we've made toward keeping it in working order was some manuals that we're able to make sense of in your abandoned depot on Delugon II. There was no technology left there — we found the planet because we trailed scouts from our world there, who cleaned out the various devices there before we could stop them — but we found some technical manuals. Still, they are not enough. They are outdated in regards to the ships we have been stealing from your people, and so are of limited use. They do probably work for whatever ships, weapons, and other devices the scouts secured from the depot.

"Now, what I'm hoping is this: with your help, we might be able to put a stop to both the attacks of my people on your shipping lanes, and the oppression suffered by the people on my world at the hands of the government. You can show my people how to properly maintain the technology we have stolen, and you can show us how to properly build our own such

### The Plea

It is important that Elana be taken alive, even if the player characters stage a major attack on the pirate base from the air. As mentioned previously, she surrenders immediately when it becomes clear that her force has been taken by surprise.

Elana Gestain is an intense woman with deep red hair and dark chocolate brown eyes. One can see that she was extraordinarily beautiful when she was young, but now her face is scarred and drawn with cares. She is a skilled actress, which serves her well in negotiations and general interaction. A bit of a flirt, she knows how to manipulate an unwary man's mind and emotions.

Elana wastes no time putting her charms to work in dealing with the PCs. She asks to speak with them, and whether they listen to her on Khiinra Ash, or on whatever world they turn her and the rest of her band over to authorities, she relates the following in a tired voice:

"You've defeated us. We knew it might happen, because you and your people are so much more technologically advanced than we are. Your spaceships showed us that, as did this base. Before you punish us with your justice system, though, may I at least explain our actions? You may think us murderers and thieves, but the fact is that we had no choice. We are fighting against an evil regime who has turned the advanced technology of your people to oppressing the men,

devices. Better yet, perhaps there are diplomats among your people who will be willing to negotiate an alliance with the rebels, and assist us in overthrowing those who would oppress us.

"Like I said, you've defeated us. I have no doubt that you will be able to use any number of interrogation techniques to extract the locations of our bases from myself and my men. Nevertheless, I want to see freedom for my world, so now all I can do is ask for your aid, and hope that your Empire isn't evil as it was so many centuries ago."

Whichever Imperial official is involved in this discussion has already contacted the local representative of the BIA. That representative is in the process of drawing up diplomatic credentials for the player characters, should they choose to become involved with the efforts to do a little reconnaissance work on this until-now uncontacted and mysterious planet. The BIA hopes they will first simply take a quiet look around and then report back. The diplomatic credentials are being provided in case the situation develops in such a way that it becomes impossible for them to report back to the Imperium so a genuine first contact team can be sent out. (The local BIA representative is hoping, in part, that sending the characters immediately will reduce the number of pirate attacks in the area.)

Elana is from a world she called Alterra (known in the Third Imperium as Kiikagair/Core/2111/C446455-9), the same place that is the center of the coordinate system on the star chart the characters found at the pirate base. Alterra is described in the "Double Deal" adventure, wherein the nature of the government against which Elana is struggling is revealed as are her ulterior motives for asking that the characters return with her to her world to help enter negotiations with her government. She does not reveal these motives at this time, although the referee should read that adventure in its entirety so he understands Elana's motivation while she interacts with the player characters here. He should also keep in mind that she firmly devoted to her cause, and will use whatever means she can to get the characters to travel to her world.

Once the characters resolve to travel with Elana to her homeworld, the events of Double Deal can unfold.

## A Mysterious Whisper

This portion of the adventure only happens if the group includes psionically active characters, or a character with latent psionic abilities of 5 or better. As the characters are dealing with their prisoners, the referee should roll a Difficult task against the character's psionic rating. If it is successful, the character hears a faint telepathic whisper in his mind: "Help. I am trapped here. Please, you must free me." The character also receives a flash of great pain and sorrow. (For skilled psionics, both feel like being on the receiving end of the Telepathic disciplines of Telepathy and Send Thoughts.) It should seem clear to the psionist that the pirates are keeping prisoners somewhere within the ancient ruins, something Elana and all of her people vehemently deny.

The psionic character who has been contacted continues to receive waves of pain and misery. The psychic broadcasts get stronger when he moves in some

directions and weaker when he moves in others. The mental link guides the character to the back of the Vilani installation where he can sense that the imprisoned person is being held below ground, beyond what appears to be a wall at the end of a corridor, with long-empty laboratories to the left and right — whoever that has established a link with the character is somewhere within the building of the Ancients.

Difficult Perception actions, or Average Intelligence tasks if the characters have a multiscanner at hand, reveal that the wall is a removable panel, beyond which is a sturdy security door. It features an electronic lock which has been shorted out, either intentionally or as the result of a severely fumbled attempt to bypass it. Elana and her people deny any knowledge of the door, or of whatever is being held imprisoned beyond it. Fear begins to set in among the NPCs, and they ask the characters not to open it.

## Leaving Well Enough Alone

Should the characters decide to heed the wishes of the pirates, and start to leave the installation, the psionic character who has been contacted by the imprisoned being is suddenly subjected to hallucinations. They need to be tailor-made to the character in question — and they need to be visions that keep him from leaving, all of which may seem like they take minute or hours to unfold, but in reality barely take a second. (It is suggested that the referee take the psionic character away from the rest of the gaming group while putting him through the visions. The other characters don't know why their comrade is suddenly vehement about seeing what's beyond the door, so neither should their players. Their decisions in this matter should be based purely on their intuitions — unless the affected character shares his visions with them.)

- His companions vanish suddenly, and the hallway away from the security door suddenly seems to stretch on for miles. No matter how fast he tries to run, he can never move away from the door. Once he resolves to convince other characters to open the door, the hallway returns to normal, and the other characters reappear.

- The character finds himself on the bridge of the party's starship. A battle is unfolding around them, a battle they are losing. As the bridge takes a direct hit and the character is sucked into space, a voice whispers in his mind: "This is the future you see. Help me, and I will prevent this from happening."

A similar vision might involve the death of loved ones while the character watches helplessly because he is too far away to affect the unfolding events.

- The character is suddenly in his sixties, and is surrounded by wealth and opulence. Servants wait upon him, and beautiful women (or men, depending on the character's sex) fawn over him. Advisors come before him with news from the worlds of his Grand Duchy, and offer suggestions as to how to deal with droughts, famine, uprisings, and the many honors that the peoples of the worlds want to bestow upon him for being a wise and benevolent ruler.

Suddenly, the scene shifts, and the character tumbles into a snowbank. He is still old, but rather than

being a leader of worlds, he appears to be a much-hated, homeless bum. Two men in uniforms beat him with night sticks and kick him with steel-toed boots. Any attempt to fight back on the character's part is feeble and ineffectual. Soon, he is beaten into painful unconsciousness. As the world fades to darkness, a voice whispers: "There are two futures possible for you. You stand at the crossroads of your life. Don't make the wrong choice. Free me."

Another option for a character whose goals include to someday settle down might be for the first part of the vision to portray him with a loving wife and adoring children, while the second half gives the family to another member of the player character group, who now has nothing but disdain for the character having the vision.

Should the party remain firm in their desire to not open the door, the character with the mental link loses control of his actions. He draws a gun, or snatches one from another character if he typically goes unarmed, and demands they free the trapped being. He is willing to shoot anyone who gives him an argument. The referee can let the player roll dice for his character if he chooses, but should make it clear that the character is not in control of his own actions.

If the party successfully subdues their suddenly violent colleague, they can leave Khiinra Ash without further incident. However, they need to keep him sedated for a number of days equal to his base Psionics characteristic. Whenever he regains consciousness during this period, he shrieks, "The spiders! The spiders! They're eating my brain! Make them stop! Go back, so they will stop eating my brain!"

Eventually, the psionic character recovers from this state. However, whenever he uses his psionic abilities in the future, he gets the feeling that someone — or something — is watching him and waiting for a chance to destroy him. The character may eventually decide that he needs to return to the Khiinra Ash and deal once and for all with whatever is trapped inside the Ancients' pyramid so he no longer needs to live in its shadow.

### **Beyond the Door**

Should the characters decide to investigate beyond the security door in the Vilani installation, either while dealing with the pirates or upon a return visit at some future date, they must first successfully perform a Formidable Intelligence-based Intrusion task (to disengage the electronic lock), or a Difficult Demolitions task to blast the door open with explosives.

If the rolls are successful, the characters find stairs that lead steeply into the ground. A failed Intrusion task means the lock cannot be opened. A failed Demolitions task means that too much explosives were used and that the characters collapse some of the hallway. It takes 2d6 hours to clear the rubble. If a spectacular failure is rolled, the explosion is so severe that the entire Vilani structure collapses. Characters with Demolitions skills will know from the severe trembling of the building that they have five rounds to get out of the structure. Those who don't flee to the outside immediately will be crushed under tons of rock. It takes 2d6 weeks to dig away enough rubble to once again gain access to the stairs.

As the character who has the mental link with whoever or whatever is imprisoned beneath the pyramid descends the stairs, he is filled with excitement and joy. He must make a successful Average Intelligence test to keep from running full speed down the corridor at the bottom of the stairs, at the end of which the characters can see a faint, pulsating, greenish glow.

At the end of the hallway is a ceilingless room, and the characters can look up toward the soaring peak of the stepped pyramid hundreds of meters above. One wall of the chamber is glowing with a soft, pulsing green light, but other than this, the room is featureless. Scans do not detect anything special about the glowing wall. The mentally linked character, however, can sense that the prisoner is beyond it. Further, he feels a strong urge to touch the wall. In order to resist, he must make a successful Difficult Intelligence check. Resisting this urge, however, triggers a vision similar to the ones described above, and if the character continues to resist, or if he restrains, he starts suffering a severe headache, and horrifying images of tiny spiders consuming his brain. He knows that the only way to save himself is to touch the wall.

If the travellers leave Khiinra Ash without allowing the character with the mindlink to touch the wall, the character first gets violent, then falls into fits like those described in the previous section.

If another character touches the wall, nothing happens. If the character with the link touches the wall, he feels a jolt of energy. Onlookers see the glow from the wall surge forward and seemingly coalesce around the character into an immense shape that vaguely looks like a winged humanoid. The character with the mindlink must endure a Formidable Psionics task or fall unconscious. Whether he successfully makes the check or not, he once again hears the whisper in his mind: "Thank you. You have served your purpose well. Enjoy my final gift to your kind." (The character has gained a permanent increase of 1 in his base Psionics rating. The referee can announce this immediately, or tell the player this fact the next time he attempts to use his psionic abilities.)

The green glow then vanishes, and the characters are left standing in the dark, both literally and figuratively. The only evidence they have that anything happened here is whatever havoc the travellers wrecked to access the bottom of the Ancient structure.

### **The Prisoner in the Pyramid**

Untold millennia ago, the **Traveller** universe was ruled by a race of superbeings known now only as the Ancients. They called themselves the Droyne, and the Chirper race that is found on many worlds scattered throughout the Imperium are degenerate remnants of their race.

The Droyne were ultimately destroyed in a centuries-long conflict by their very creator. This being is referred to as "Grandfather" in what legends that remain of those ancient times. Upon seeing the impact the actions of thoughtless Droyne were having on the universe — spawning of new races, the scattering of species across the galaxy where they had no reason for being, random mutations forced upon entire species for the amusement of Droyne children — he

reportedly hunted down and destroyed every powerful Droyne that existed. When he was done with his task, he retreated into a pocket universe, never to interact with the universe that spawned him and thus leaving it and its many species to develop naturally.

But even the Grandfather is not infallible. One of the wiser Droyne realized early in the conflict that the Grandfather was an entity that could not be defeated. He knew that the only chance for survival was to flee his wrath, but he also knew that there was no place in the universe that one could hide from the Grandfather.

The Droyne came up with a plan, however. He introduced one final mutation in many different species, the mutation that led to the development of psionic potential in many of the galaxy's beings. He then built the pyramid in the system that eventually became known as Khiinra Ash to the Vilani Empire and ultimately by the Third Imperium. Deep underneath the structure, he created a gate to a pocket universe, which was only one way unless two circumstances were true: The Grandfather was no longer in the primary universe, and a being with the gift of psionics was on the world.

Although Grandfather has been absent from the universe for over two hundred millennia, it wasn't until roughly 3,500 years prior to the founding of the Third Imperium that the Vilani first colonized Khiinra Ash. And, unfortunately for the Droyne awaiting freedom in his pocket universe, the colonists were of a Vilani sect who hated and feared psionics, and who had been granted titles by the Emperor to settle their own solar system so as to ease the ongoing strife they were causing in Vilani society. Hence, the population of the system did not include any psionics, and through the force of chance, the player character in this adventure was the first psionically active being to set foot on the world since the Droyne fled the Grandfather.

What impact the unleashing of a genuine Droyne into the galaxy will have is up to the referee. It is more than likely that nothing will come of it in the lifetimes

of the player characters — after all, there is much for the Droyne to explore as he has been released into what is essentially a brand new universe. The Droyne are an exceptionally powerful race. The only thing that would be able to defeat this released Droyne would be the entire Imperial fleet or the Grandfather himself. Unless the referee wants to send the characters looking for a way to find and contact that mysterious and ancient being, it is probably best if the events in the pyramid remain a mystery to them.

## **Further Adventures**

If the characters choose to travel with Elana to her homeworld, this may lead directly to the "Double Deal" adventure. The referee can, of course, insert whatever other adventures he chooses along the way to Alterra/Kiikagair, where "Double Deal" takes place.

If they choose not to get involved with the internal politics of Elana's world, the referee can still spin adventures off from this scenario. Several of the systems noted on the star chart recovered on Khiinra Ash contain pirate bases. One or two planets may even contain outposts of the government the pirates are fighting against. After enough interaction with the pirates and warriors working for the government, the characters may find themselves on the world from which the problems are emanating after all, permitting the referee to run Double Deal with some minor modification.

Another possibility is for the referee to create further adventures in the Khiinra Ash system. As mentioned, the system was heavily developed during the time of the Second Imperium, and virtually any type of long-abandoned base can be found somewhere in the system. It might even be possible that when the scouts surveyed the system, they missed a small native population on one of Khiinra Ash's many islands. If the referee chooses to add a native population that has slipped into savagery, Khiinra Ash may be the perfect world on which to stage "The Sleepers" adventure, or the perfect system for "Lock And Loot" scenario to unfold in.



# 4: DOUBLE DEAL

---

---

In “Lone Whisper” adventure, the player characters traced a group of pirates — an outfit calling themselves the New Dawn — to the planet they call Delugon II, where they discovered an abandoned site containing old tech and psionic devices — perhaps alien, perhaps lost technology from the Second Imperium. When they arrived, they found Delugon protected by a band of the New Dawn pirates, from whom the characters learned the location of the pirates’ home world, Alterra (Kiikagaiir, see “The Setting” below). In fact, Delugon was originally the finding of an Alterran government expedition, and several pieces of technology had already been shipped back to Alterra for examination. The pirates had recently raided and captured Delugon, killing the government scientific team sifting through the area for more tech. A key find in the raid was a set of old-fashioned, printed operations manuals, written in an obscure language which they could not translate. However, the pirates had examined the diagrams and schematics in one of the manuals and determined that one of the pieces of technology taken back to Alterra was an “incredible discovery” of great technological value: a device capable of food production for perhaps millions of people.

Recognizing the characters’ superior technology, the pirates begged them to help them negotiate with their government for shared use of the tech, using the operations manuals as bait. This adventure hinges upon the characters’ interest in investigating Alterra and the strange technology taken there from Delugon.

## The Setting

Alterra is known to the Imperium (and is listed in *First Survey*) as Kiikagaiir/Core/2111/C446415-9. Alterra is a world that had forgotten the rest of humanity during the course of the Long Night, until the Third Imperium awakened the Core Sector and visited it. The planet had become isolationist in the extreme, and popular belief held that there was no other intelligent life in the universe — at least none capable of reaching Alterra. They were a self-proclaimed highest life form in the cosmos, further advanced than any other living thing in existence.

The first Imperium spaceships to investigate the planet found an extremely paranoid world, entrenched in war over rapidly dwindling natural resources. Several of its nation-states were already considering the option to go nuclear, but when visitors from the stars appeared, everybody panicked and hit the red button. Hundreds of ballistic missiles exploded over the planet, and hundreds of millions of people died overnight. In the midst of the destruction, the Imperium representatives briefly surveyed the planet, quickly learning to avoid its hostile natives, and discovered there were not enough resources on the planet to sustain the remaining population for long — Alterra was not worth conquering, let alone trading with. So the Imperium moved on, leaving the inhabitants to the mess they made of their planet.

Ironically, the brief appearance of the Imperium gave the people of Alterra something to unite them: fear of aliens and alien invasions. Leaders of surviving nations quickly came together and formed a tyrannical coalition to manage global resources so they could turn their collective defense efforts to the stars, preparing against an Imperium invasion that would never come. The masses, devastated by war and in terror of “green men,” accepted martial law without discernible resistance. Today, several years later, the government controls all resources for the entire planet. What began as

an aristocracy turned into communism: All goods and services produced by the population belong to the state by law, to be collected and then distributed fairly evenly, with some adjustments according to guidelines for relative difficulty, prestige of a given job, and for comparative performance within that field. (Certainly, corruption on all levels results in unequal distribution, but hard-line communism dominates the system, nevertheless.)

Meanwhile, spaceships that chanced upon Alterra since the holocaust were not invaders but spacefaring traders and explorers, several of whom were shot out of the skies without warning. Anxious to protect itself, the government recovered every ship it could salvage and began to cobble together a few working crafts, studying the technology. Through trial and error, they learned how to pilot the ships, then began exploring nearby systems, pillaging wherever they found weakness and fleeing wherever they found strength. Thus, the government helped to postpone the final demise of its culture while consolidating its power over the people.

Still essentially a tech level 9 system, the government constantly struggles with its desire to return to the days when Alterra was “the only planet with intelligent life in the universe,” along with the ambition to acquire the power and technology that lie beyond its world. There are opposition groups, however, who wish to keep the fruits of their labor for themselves instead of giving it to the government. They have been persecuted and prosecuted for years, until all that are left are secret and dangerously militant groups who are every bit as avaricious as the government, every bit as ruthless in the pursuit of their goals. The New Dawn is one such group. In the last few years, this group has grown bolder in its talk and actions. The member-pirates have even captured a few spaceships from the government and are now pillaging the space around them for themselves, hoping to acquire enough wealth to open trade with the Imperium and leave Alterra behind. That path led them to Delugon II and the PCs.

Before the nuclear holocaust, there were nearly 400 million people living on Alterra. Afterward, only a few hundred thousand survivors crawled from shelters and emerged from relatively isolated areas, far enough from the war zones to escape the explosives or subsequent death by radiation. There are just two major land masses on the planet — one of them north of the equator.



tor and one south—and the southern continent was by far the most heavily populated and highly developed before the holocaust. Today, some two decades later, only the northern continent is inhabited, while the southern continent has been forsaken and reclaimed by nature. A Difficult Sensors task reveals a few scattered, tiny settlements across the southern hemisphere, but no trace of industrialization or civilization remains there. The government has decreed that 50 years shall pass before resettlement efforts may begin, and in the meantime there is much to do simply sustaining the remaining population on the northern continent.

## The Setup

The characters, with the pirate leader Elana Gestain aboard, fly to Alterra and are immediately fired upon with missiles from points across the planet's surface. With persistence, they contact the government and inform them that they can provide the manuals needed to operate some of the technology taken from Delugon II. A meeting is proposed.

The characters listen to the political perspectives of both the government and the New Dawn and find that neither side is completely right or wrong. The government representative, Colonel Randol Traber, "enlightens" them as to Alterra's behavior and policies, with a genuine attempt to convince them of the government's right to guide its planet through its resource crisis with stern measures. By contrast, the pirates have repeatedly raided shipping lanes with deadly force (including attacking the characters), and their cries of freedom, noble as they sound, would pitch Alterra into chaos and extinction. Meanwhile, Elana Gestain defends her own way of life to the characters, talking of freedom and other noble beliefs. The New Dawn deplores Alterra's isolationism and wants to make the planet attractive to the Imperium by creating a free-market economy.

The subject turns to the recovered tech from Delugon II. The food-production device is discussed, and a deal for shared use is proposed. A neutral meeting place is appointed, where the machine and manuals can come together. At the meeting, the characters confirm the tech machine as a crop-growth enhancement device. Abruptly a fight breaks out, with each side begging the characters to help them. The characters' decisions will have a lasting impact on Alterra's future.

## Quick Start

This section is provided for referees who decide not to run the first or second parts of the adventure which culminates in this scenario; by running this encounter, "Double Deal" may be run independently. If the previous adventures have been run, skip directly to "Welcome to Alterra!" Another option is to play through the previous adventures and then simply introduce this encounter after they leave Delugon II, adjusting for knowledge the player characters have already acquired.

### Pirates Attack!

Begin this encounter as the player characters are traveling through space. Ideally, they should be in Core Subsector B, C, D, F, G, or H (especially G or H). If

active sensors are running, the PC scanning them detects a small ship on an intercept course. The ship can't be much larger than a scout-class vessel, but its configuration is a bit odd. Deciphering the ship's actual configuration is a Difficult Sensors task — it's a modified Yacht, fitted with engines from a Free Trader. In visual range, the ship appears to have been cobbled together with spot welds, a few staples, and a prayer. For purposes of adjudication, treat the ship as a Yacht (see the **Traveller** rule book). It belongs to the New Dawn, stolen from their world government. However, it is fitted with a strange piece of technology: a TL14 plasma cannon, discovered at Delugon II (known to the Imperium as Khiinra Ash/Core/2916/CAE6133-6).

Attempts to communicate with the ship are met with static. A few broken words crackle through the speaker, as though the mystery ship's comm system is marginally functional. The words "antenna," "electrical," and "help" are barely discernible. If a character decides to scan the ship's systems for causes of the communications trouble, it's an Easy task to see that nothing seems to be wrong with ship's systems, other than various anomalies that probably stem from its unconventional configuration. Otherwise, a Formidable Sensors task may be spontaneously called for by the referee in order to reveal the information.

As soon as the ship is in range, it opens fire with the plasma cannon: There is a bright flash in the ship's forward weapons array, and a large, brilliant sphere of churning miasma bursts forth tumbling through space, toward the characters' ship. Avoiding the plasma burst is a Staggering Piloting task, and the pirates continue to fire it each round. When a burst hits their ship, the plasma surrounds the entire hull in a glowing layer of gel-like energy and rocks it violently—inertia dampeners are knocked off line, and all screens and armor are instantly destroyed! A second hit disables their ship's weapons and deprives the hull of half its structure points. Then, as the pirates come around for another shot, the weapon flashes, but the plasma burst detonates immediately, upon the pirate ship, effectively rendering it dead in space. The pirates immediately broadcast a surrender and beg for assistance, but they also send out a coded signal (calling for aid from a sister ship, somewhere in space).

If the character are able to avoid the plasma weapon and begin to get the best of the battle, the explosion occurs on the pirate ship before it can be destroyed, and it surrenders, sending out the various messages as described above. In any case, it is assumed that they will board the pirate vessel or bring prisoners aboard their ship. If they destroy the vessel, a similar sister ship enters the area but sues for peace as soon as it approaches.

### A Plea For Help

Upon whichever ship the characters deal with, there are a dozen pirates with average skills, including Pistol-2 and Blade Combat-1. However, the leader of the New Dawn, Elana Gestain, greets them and seeks to avoid battle if possible, calming both sides. (See page 19 for Elana's statistics.) Gestain is an intense, ideological woman of 37 years, with deep red hair and dark chocolate brown eyes. She wears a dark blue

jump suit with a magnum revolver holstered in a belt that hangs low on her hips. One can see that she was extraordinarily beautiful when she was younger, but now her face is scarred and drawn with care. Raised in a relatively well-to-do family, she went to a college of the arts in order to become an actress, and she was inducted into the Alterran performance guild. Her acting talents were and are excellent, which she uses to her advantage in negotiations and general interaction. A bit of a flirt, she knows how to manipulate an unwary man's mind and emotions. Seven years ago, she fell in with anti-government protesters who objected to the pay scales for performers, whereupon she was ejected from the guild by the bureaucratic order. Shortly thereafter, she joined the New Dawn and eventually became one of its leaders, thanks to her abilities to move people and trumpet her cause.

Gestain wastes no time putting her charms to work in dealing with the characters. The referee should roll against her performance skill each time a character differs with her agenda or point of view, or anytime she is suspected of lying; the relative difficulty of the task must be determined by the referee, based upon the situation. For example, if caught in a lie, talking her way out of it would be a Formidable or even Staggering task, depending upon the depth of the deception and the characters' knowledge of the truth. Apply a +1 DM for every point of the character's Int less than Gestain's, or a -1 DM for each point more. If Gestain's task is successful, assure the character that he is convinced of Gestain's truth or sincerity in the matter.

The following subjects are pertinent to this encounter. The characters should be allowed to introduce topics by questioning her, but Gestain can broach subjects that need to be discussed, especially the proposal.

**Who are the Pirates:** They are "freedom fighters" from Alterra. (Gestain can identify Kiikagair on a star chart, if the PCs show her one.) They attacked the characters' ship because they believed it was part of the government fleet, with whom they have been at open war for the last two years. (This is a lie; they are simply pirates.) Their ship is one they stole from the government, and they are using it to explore space and seek friends in their efforts to free Alterra from the yoke of tyranny. Gestain will be happy to talk more about her world and her cause, but her present priority is to put forth her proposal. (See "Gestain's Views" below.)

**The Plasma Weapon:** The plasma weapon came from a planet Gestain calls Delugon II, which is listed in *First Survey* as Khiinra Ash/Core/2916, and which she can also identify on the star charts if the characters oblige. Delugon is a long-abandoned site of some mysterious and ancient culture of unknown origin. The pirates managed to get the plasma cannon working and installed on their ship, but it overloaded and blew up in their faces during their attack on the characters.

**Delugon II:** The ancient site contained many interesting mysteries, but the government found it first and carried many of them away — the pirates only "liberated" the site a few weeks ago. However, they did manage to capture the plasma weapon as well as a set of old-fashioned, printed operations manuals, apparently undiscovered by the government scientists. The manu-

als helped them to get the plasma weapon working, and they seem to describe a lot of other interesting devices as well. Gestain won't elaborate on these devices, truthfully claim that she does not understand the artifacts' technology.

**Gestain's Proposal:** The pirate leader believes that the manuals are key to making the found technology in the government's hands work, as most of the devices they have found are well beyond her culture's capacity to understand. The government will probably have no luck without them, which gives Gestain an idea: According to one of the manuals, one piece of machinery taken back to Alterra apparently is a remarkable piece of technology, "perhaps capable of producing food for millions of people." If the freedom fighters had that machine, they could feed the masses and free themselves from the government's yoke of tyranny. Alterra is a planet of relatively primitive technology in comparison to the characters' (TL9). Perhaps they, with their superior technology, could negotiate with the government without fear of being captured.

Gestain wishes to offer the operations manuals for the rest of the technology in exchange for the feeder device. She believes the government will deal in good faith if a superior force is present. She offers to go with the PCs, to show her good faith and to represent the New Dawn's interests in the negotiations. She also wants the characters to help repair her ship or at least let it go. The manuals, themselves, have been already returned to Alterra in another ship, where they have been hidden with the New Dawn underground. The only manual present on Gestain's ship is the one for the plasma cannon. She'll willingly let them look at it, but she wants them to accept her proposal first. Obviously, the pirates are in little position to bargain if the characters threaten force, so Gestain uses her wiles to the best of her ability. The manual is written in an archaic language, requiring a Formidable Linguistics or a Staggering Research task to decipher; a complete translation matrix will require a great deal of time and a computer library system at a TL12 facility. The pirates have only studied the schematics and figured out how to hook the weapon to a ship's power source, and they learned how to aim and fire it through trial and error.

**What's in the Deal for the Characters?:** First, the opportunity to free a planet from the bonds of a cruel government. If that's not enough, the freedom fighters report that they have mined and booby trapped the entire ancient site at Delugon II; they would be willing to part with a map of their work, and forfeit their salvage rights to the characters, in exchange for the service. Gestain and her fellow pirates are unwilling to offer much information about themselves, Alterra, or its government unless the characters agree to help.

If the characters are unwilling to help them, they become completely uncooperative. They curtly say that they're used to persecution from superior forces and are prepared to die rather than cooperate. If the characters agree, Gestain suggests both parties combine efforts to repair both ships, using the pirates' store of parts if necessary, but they need to be thoroughly supervised: They aren't used to the characters' level of technology, and they're likely to steal anything they can get away with.

## Welcome to Alterra!

This encounter assumes that Gestain has joined the characters and they are all headed for Alterra, and that they are aware of the manuals-for-technology deal. If necessary, Gestain can relate any pertinent information from the preceding encounter during the flight to Alterra. Gestain is thoroughly impressed with the their ship and asks to see how everything works. She certainly will flirt with some of the men if it will loosen their tongues, but her main intent is to win their political sympathies. She is willing to discuss her planet and its politics, now, and she grows particularly animated as she discusses her fight for freedom.

### Gestain's Views

If the referee is not using Delugon II and Alterra (Khiinra Ash and Kiikagair), as mapped in *First Survey*, the flight to Alterra requires two jumps, so the characters have plenty of time to interact with Gestain. Most of the subjects below lead naturally into one another, along multiple lines of discussion, so the referee can take them in any order they come up. If the characters don't care to discuss much with her, she makes sure to at least tell them about the first two bolded points below. Otherwise, Gestain is happy to pass the time learning what she can about their technology, entering into drinking contests (Average Carousing task with each drink beyond the fifth, to avoid passing out; factor positive or negative DMs into the challenged character's roll for each point of difference between Gestain's and the character's End scores), and frequently preaching about her "politics of freedom" to whoever will listen.

**The New Dawn:** Alterra is ruled by a communistic consortium of the most powerful nations' leaders. In fear of subjugation by the Imperium or other aliens, they combined their powers for the common defense after a world-wide nuclear holocaust, 21 years ago. At that time, planet-wide martial law was declared, allowing the government to take control of all goods and services for purposes of rationing. Slowly and steadily, they expanded their jurisdiction and made all citizens employees of the government. As time passed, the threat of invasion mellowed, but the government hung on to and expanded its powers. Now, the Alterran government is a massive bureaucracy that owns all goods and services produced by the people, redistributing them according to its own standards of need and deserving.

Over the decade, freedom fighters have emerged, believing that people deserve to keep the fruits of their labors and use them for trade in a system of free enterprise; the New Dawn is one such entity. The government has responded ruthlessly to this movement, but it will not die. Personal freedom is on the line, and even the most downtrodden are willing to fight for it.

**How the Characters Will be Greeted by the Government:** Gestain is reluctant to reveal the following fact, lest the characters abort the mission, but the government has made a practice of shooting down spaceships and then salvaging them and stealing what technology it can grasp. She prefers to warn them that the government is quite afraid of aliens and may fire upon them if they don't quickly make clear that they have the operations manuals and want to negotiate. Even

then they should be prepared for a hostile reaction, as Gestain believes the government is bull-headed enough to not care about technology that could feed a starving planet.

**The Pirates' Ship(s):** They have stolen several ships from the government, who stole them from innocent space travellers. The New Dawn had to steal the ships because the government is using them to plunder nearby planets and innocent travellers, adding to the resources of Alterra and increasing its technology, and therefore its grip on the people. The freedom fighters must have spaceships to acquire technology and resources, too, else the government will have too much power and will eventually crush all freedom movements.

**Alterra:** The planet is slowly dying. There was a protracted world war several decades ago, quickly escalating toward nuclear deployment. Twenty-one years ago, in the midst of the crisis, Imperium ships visited and caused a global panic. All nations felt vulnerable to the superior technology of the visitors, accused each other of joining with alien forces, and in the atmosphere of hostility, hundreds of nuclear missiles were launched, devastating the planet. Natural resources were already bottoming out, which was one of the causes for the world war, but after the holocaust there was even less to go around. That was when the strongest powers took over, to control the remaining resources and defend Alterra against an invasion.

The Alterra government remains isolationist in the extreme. There are stories of dealings with aliens and other human cultures in the distant past, but the people of Alterra believed themselves to be the most advanced culture in the universe. The arrival of the Imperium shattered that belief and engendered terror in the masses. The newly formed world government took advantage of that paranoia to consolidate its power over all resources, "for the good of all Alterra." The people acquiesced under the threat of alien invasion. Freedom fighters have been struggling against the ensuing tyranny ever since.

### Rockets' Red Glare

If the characters hail Alterra as they approach, they receive silence for their efforts, which should provide some warning of the reception they are about to receive. As soon as they enter the atmosphere, the planet's defensive systems are activated and multiple land-to-air missiles are launched at the ship from several points across the globe, coming upon their ship at a rate of two per round. Hitting the ship is a Staggering task against a computer-targeting skill equal to 9, and each hit inflicts 1 point of damage. After five rounds, the number of missiles fired increases to three per round, and if the characters choose to run the gauntlet and attempt to land, requiring a total of 10+1d rounds, the number of missiles per round increases to five for the last three rounds.

The safest approach is to return to orbit and attempt to establish communications with the government with an open hail. However, before there is any answer, three ships, which are similar to Gestain's in that they are cobbled together from parts of various others, blast off from the surface and move to inter-

cept and destroy the characters' ship. For purposes of adjudication, treat them as free traders (see the **Traveler** rule book).

The only way to elicit a response is to defeat or elude the Alterran ships and repeatedly broadcast the fact that the characters possess the operations manuals required to operate the various technologies discovered at Delugon II . . . unless they are capable of and willing to engage in planetary bombardment. (Gestain will do her best to dissuade them from that strategy.) If the players don't think of this solution, wait until they either flee or are suffering internal ship damage before Gestain suggests that course of action.

The voice which finally speaks to them through the comm channel is extremely hostile, warning them to surrender, leave, or be destroyed. He is not easily convinced of any peaceful overtures, especially if the characters have returned fire upon any hostile forces arrayed against them. Convincing the defense grid to cease its aggressions is a Formidable Diplomacy or Fast Talk task, and a Staggering Intimidation task. Gestain cannot help, as any knowledge of the presence of a New Dawn operative will exacerbate the problem. If the effort is successful, the attacks cease and the characters are ordered to stand by while the proper authorities are informed of the situation.

Otherwise, they will have to defeat all three Alterran vessels, sending them back to the surface in flames, before ground control grudgingly contacts them and demands to know their business. The Alterrans continually assure the characters that any invasion force will be met with nuclear resistance, that Alterra will *never* be taken until every last citizen is dead, and so forth, even if the characters insist that their intentions are peaceful. Before they ever speak to anyone with real authority, they should know without a doubt that they have come upon a chronically paranoid society.

Should the characters choose to flee, the Alterran vessels give chase until they make jump space. Gestain apologizes on behalf of her people (but not her government!) and uses the incident to stress her planet's need. Contacting the Imperium and recommending action on its part isn't the answer; the Imperium has seen Alterra go nuclear when a simple trade delegation visited, and Gestain insists that a similar reaction would take place now. She recommends that they keep at it, take measures to avoid capture or destruction, and eventually the government will treat with them, given no other choice.

Should they actually fight their way to the surface, they are surrounded by ground troops and arrested (or killed if they resist). In this case, the following encounter, "Détente," takes place in a detention center, and regaining their ship and equipment becomes a part of the negotiations.

## Détente

When at last the characters are recognized and make known the fact that they can trade operations manuals in exchange for one piece of the technology, they are told to stand by until proper authorities are notified. They are instructed in no uncertain terms to remain in orbit, and not to attempt a landing, lest they be attacked with any means required to destroy them.

Several hours later, they are hailed by Colonel Randol Traber. The 43-year-old career Army man has conducted several interrogations of captured aliens and has been instrumental in convicting them of conspiracy to overthrow the government of Alterra, condemning them all to execution. However, he secretly understands that most space travelers are not hostile, and that his persecution of outworlders is strictly political. This does not deter him from his duties, but it allows him to interact with aliens without the hysteria typical of most Alterran politicians. Traber is also a veteran of counter-insurrection, with a great deal of knowledge concerning The New Dawn and many of its members. He knows Gestain, has memorized a fully detailed record of her offenses against the government, and he understands her charismatic abilities. He respects her as an adversary, while others in the Army tend to underestimate both her and her movement.

## First Contact

Colonel Traber begins by explaining that he has contacted them on a secured channel, so they can speak freely with him. He makes no apologies for his people's actions toward the characters, but assures them that he is prepared to listen to them. He also sternly warns them that any attempts at subterfuge will be interpreted as hostility and will be met with harsh reaction. Traber wants to know how they came by the operations manuals and the nature of their alliance with the New Dawn. Even if no reference has been made to the rebel organization or Gestain, Traber knows that the characters must be involved with them because Delugon II was the site of an Alterran expedition which was raided by New Dawn pirates. Therefore, they would do well not to deny it.

Traber also wants to know what devices the characters possess operations manuals for, since the government has yet to figure out what most of them do, although he doesn't admit to that ignorance. Any reference to the fact that they don't actually have the manuals generates new suspicions. The Colonel asks how he can be assured that they can get the manuals, if they are sure the manuals even exist, and further questions their involvement in the whole affair. If it hasn't been revealed that Gestain is with the party yet, it should come out now. Gestain, herself, grows impatient with the man and speaks out, revealing her presence. She tells him that the manuals are already on Alterra, but they are well hidden among the members of the New Dawn underground. They can be produced with very little notice, provided the government deals with them. Otherwise, they can figure out what the ancient technology is and how it works by themselves. (More likely, it will blow up in their faces like the plasma cannon.)

If the characters make a sincere effort to convince Traber that they are acting as a neutral party, he eventually admits that there are a number of curious devices in Alterran research labs, brought home from Delugon II. If any character succeeds at a Formidable Diplomacy task, Traber goes so far as to tell them that several of the devices have been ruined beyond recovery by attempts to understand and make them work. The government wants very much to recover the tech-

nology. He cannot tell them much of anything about the devices, as he has not seen them himself.

Gestain describes the particular device in which she and the New Dawn are interested: There is little remarkable about its appearance. It seems to be a large console from which three pipes extend on one side. If the device is placed on the ground such that the pipes extend upward, the underside is rounded inward, and a series of brackets run along the edges. In fact, the brackets are designed to mount the device on the underside of an airplane or similar flying machine, and the pipes extend downward so as to release gasses as the plane flies over fields. It is, in essence, a crop-dusting machine, and the real secret to making it work lies in the chemicals it distributes rather than the machinery itself. However, no one knows that, including the characters, and no one should be told at this point. Without the manual, they have only Gestain's rough description of it.

Reluctantly, Gestain reveals that the device seems to be designed for crop enhancement, and she proposes the exchange of all other manuals recovered from Delugon II in exchange for that one device. Traber quickly points out that Gestain and the New Dawn have no right to ownership of anything, let alone the device in question, and an argument over politics ensues (see below). The characters must use their negotiating skills to keep the two parties from wasting time in ideological debates. Role-playing works best for resolving these issues, but Diplomacy and Fast-talk task rolls can also accomplish the job.

### Political Perspectives

Gestain is free with her political opinions in response to Traber's official stand on ownership of property. If the characters indicate sympathy with her point of view, Traber responds with a rebuttal. He points out that the natural resources of Alterra have been dwindling steadily for years. Even with the severe reduction of the population after the holocaust 20 years ago, Alterra is dying. The only hope for survival is to control and conserve resources while developing new technology to extend the possibilities of long-term survival. Without strict governmental supervision of production and distribution, Alterra would be a dead planet by now.

Traber points out that the New Dawn has a noble cry of "freedom," but Alterra cannot survive their selfish philosophy. A small, elite group might flourish, but only upon the misery of many more. There simply aren't enough resources available to support "free enterprise," and Alterra is not prepared to turn to the Imperium for help. Besides, Gestain is not as altruistic as she claims to be. She is wanted on multiple counts of murder, theft, and treason. Her faction has stolen spaceships from the government and used them to commit acts of piracy, which not only involves violence against others but threatens to bring retribution upon Alterra.

The referee is encourage to balance the points of view between the two factions, allowing neither to claim the white or black hat. If the characters show more sympathy for one or the other, the referee should attempt to support the other view in order to

bring it into balance. Ideally, they should debate amongst themselves over the pros and cons of each side's beliefs.

### A Deal is Struck

When the political debate and negotiations have played themselves out, Traber informs the characters that he will have to confer with his superiors regarding the proposed exchange. He asks them to hold their position and he will get back to them as soon as possible. If the referee wishes, a second attempt to attack their ship and capture it may be attempted. Otherwise, Traber gets back to them in about five hours, at which time he says that the government is willing to make the exchange. He proposes that the two sides meet somewhere in the *wasteland*—a southern continent which was once home to hundreds of millions of people, before the holocaust. He suggests coordinates that would put the meeting place in the middle of a wide, flat, desert area, difficult to approach unseen. Gestain agrees to the meeting area, and Traber tells the characters they may land at that site, and that site alone, without fear of government hostilities.

Traber proposes that the government send one aircraft, with the device, the New Dawn send one aircraft, with the manuals, and the PCs act as a neutral party, overseeing the exchange, confirming that each party has brought what it promised, and monitoring sensors for signs of approaching reinforcements on either side. The characters can remain in orbit until they confirm that only the two aircraft are approaching the meeting point, then come in for the exchange. The time is set for one standard day from when the agreement is made. Each side is send three representatives and no more.

Neither side brings up the issue of whether weapons are permitted, as both sides plan to arm themselves for their own protection, so it will be up to the characters to insist upon this condition, if desired. From orbit, they can easily use sensors to see if either side is sending more than one ship; the site is a thousand miles from civilization, so it would be very difficult to approach the area undetected. If they wish to add conditions to the agreement, they may do so, as long as neither side is compromised by the deal.

### Double Deal

Gestain uses the comm station to contact the New Dawn and inform them of the deal as soon as Traber signs off. She leans over the console, loudly proclaiming a minor victory, then explaining the details and issuing instructions in a quieter voice. The referee should roll dice for Gestain as she attempts a Difficult Fast Talk task of subtly ordering, through code phrases, her comrades to send an attack force along with the manuals, hoping to steal away with the crop-enhancement technology without turning over the manuals. If any character indicates suspicion about her conversation, apply a -1 DM to the target number. If she fails at her task, it is an Average Streetwise task for anybody within earshot to deduce what she is up to. If caught, she attempts to enlist the characters' aid in the scam, returning to her cries of freedom and government oppression. If they remain adamant that the New Dawn abide by the terms of the agreement, she reluc-

tantly acquiesces and instructs her comrades to disregard her earlier instructions. (They will send an attack force anyway.)

In any event, Gestain is elated by the success of the mission thus far, not only because the technology is important but also because the government has actually agreed to negotiate for the operations manuals. This is the first time they have ever acknowledged, even unofficially, the New Dawn, and Gestain credits the characters' efforts in gaining this success. She continues to express her appreciation and admiration for them, partly because she sincerely feels that way, partly because she wants them on her side when her associates attempt to make off with the goods.

### The Approach

An Easy Sensors task reveals the two aircraft approaching the wasteland from the northern continent, each requiring over ten hours to reach the meeting area. Any attempt to scan the ships for number of occupants or other information is inconclusive. The characters can time their descent to arrive at the meeting point at the same time, monitoring the situation from orbit before descending. As they enter the atmosphere, they may be wary of further attacks, but none are forthcoming. No spaceships are in orbit or in the process of taking off, as far as sensors can see, and an Average Astrogation task confirms that no spaceship could blast off, set course for the site, and attack before the characters detected it—all seems to be relatively safe. They may wish to leave someone at the sensor station to watch for signs of treachery, once the ship has landed, but no other ship appears on the screen during the course of the meeting.

The actual meeting site is indeed a barren salt flat, several hundred miles wide. It would be impossible to approach the area unseen from any direction, making it a perfect place to stage an exchange. As the characters' ship approaches within a mile of either aircraft, all communications go dead. Unless they are monitoring general communications or using sensors to scan for comm signals, there is no reason why they should notice this. However, if they do notice, an Average Sensors or Communications task reveals that *both* aircraft are sending out jamming signals, each intent upon preventing the other from contacting allies. Gestain displays no surprise or real concern if confronted with this information, as she can understand why neither side wants to allow the other to send signals during the course of the exchange.

After each of the Alterran crafts has landed, a party of three emerges from each and waits for the characters to emerge from their ship. The government party carries a large crate, approximately four feet square in dimension, while the New Dawn party carries a large brief case. They then proceed to meet at a point between all three ships, approximately 100 feet from any craft. Remember that only three player characters should be allowed to attend the exchange as well.

Colonel Traber is a large man, well over six feet tall, with black hair shot through with silver and a thick mustache. He wears a gray uniform, decorated with insignia indicating his rank and various areas of expertise. As he leads two male soldiers (commandos with

Pistol-2 skills and 8 Dex), who carry the crate, his hand rests lightly on his pistol (.44 caliber, treat as a magnum revolver), if weapons haven't been prohibited from the meeting, and he eyes the characters with distrust. If they carry weapons (or other equipment) more advanced than TL10, he tries not to stare, but it's obvious he would like to inspect them very closely.

The New Dawn contingent consists of a man and a woman, both dressed in civilian clothing, but they also wear scarves over their faces to hide their identities. Their attentions are divided between their government enemies and the mysterious characters. If permitted, they both shoulder a bullpup rifle. (They have Rifle-1 skills and 7 Dex.) They greet Gestain with restrained enthusiasm but keep their attentions on the commandos.

Name <b>Randol Traber</b>		UPP <b>A68B94</b>
Service		Rank Colonel
Birthdate	Birthworld	
Skills Aircraft-3, Artillery-1, Brawling-1, Bureaucracy-3, Computer-1, First Aid-2, Forward Observer-2, Grav Craft-3, Ground Craft-4, Heavy Weapons-2, Interrogation-2, Intimidation-1, Language (Galanglic)-1, Long Blade-2, Melee Combat-1, Perception-1, Recon-2, Rifle-2, Streetwise-2, Tactics-1		
Possessions		Money
Comments		

UPP Card

001-000

### The Exchange

This should be a particularly intense encounter. The New Dawn contingent is defiant toward the government, and Traber is haughty and incredulous toward both the characters and the rebels. The referee can heighten the suspicions and tension with references to covertly exchanged glances between members of each side, and roll dice behind the screen from time to time, without indicating the meaning of such actions. Pepper the conversation with politically charged sniping, with threats of eventual justice from Traber and sneers at authority from Gestain. The characters should be made to feel like they are maintaining peace by a thread.

"Before we proceed any further," says Traber, "open the case and show us the manuals." Gestain replies, "Open the crate and show us the tech." Both sides cautiously comply. Gestain suggests that, as neutral observers, the characters should examine everything and confirm that both sides have lived up to their agreement. Traber questions the neutrality of the characters but agrees to let them inspect the cargo and display it to both sides.

Because they expect to keep the crop-enhancement device, the New Dawn pirates have not brought along the manual for it. Therefore, the characters can only inspect the strange piece of technology and make educated guesses about it. As Gestain described it earlier, the device seems to be a large console from which three pipes extend on one side. If the device is placed on the ground such that the pipes extend upward, the underside is rounded inward, and a series of brackets



run along the edges. An Average Engineering or Mechanics task is required to determine that the brackets are designed to mount the device on a vehicle — most likely one that can fly— and pipes most likely extend downward so as to release gasses. An inspection of the workings is a Formidable Engineering task without the manual, but if successfully completed the character can tell that the device is not much more than a TL10 device. Furthermore, the chemicals it distributes are more important than the hardware, and without the manual, it's impossible to say what they are.

The manuals are written in an unknown language, but diagrams and schematics reveal the general nature of the devices they describe, provided a character successfully performs a Difficult Mechanics, Engineering, or Physics task. Roll separately for each of four manuals, with a successful task indicating a jump drive diagnostics console, a power pack recharger for laser weapons, a meson screen generator, and a psionic dampener field generator. There are several more books, but they contain no graphic elements by which they may be interpreted without extensive research and translation. Overall, though, there is nothing of an advanced nature; in fact, more advanced and efficient machinery could be purchased at any large starport.

### Turning Point

As soon as the characters finish identifying the manuals and the crop duster, Gestain's accomplices point their weapons at Traber and his soldiers, and Gestain declares that the New Dawn will not surrender the manuals. Five more armed rebels emerge from their aircraft and charge the group. Almost as quickly, three more commandos emerge from the government craft and also charge toward battle. A brief standoff ensues while the reinforcements approach.

Gestain begs the characters to help. With their weapons, they should easily overcome Traber's soldiers. Traber quickly responds that if they help the New Dawn, they will confirm government suspicions about outworlders, and no one will be allowed to get away with this crime. Shots are fired from both sides as the additional fighters shoot from long range. The characters have only moments to make a decision.

If they side with Gestain and the rebels, Traber and his men go down fighting. There is no cover anywhere, and it will be a simple contest of fire power until everyone on one side is dead or routed. Assuming that they are victorious and Gestain survives, she thanks them profusely for their aid. (Otherwise, any surviving rebel does the job.) She apologizes for forcing a decision upon them, but she has been fighting an uphill battle for seven years, and she has grown used to audacious plans and calculated risks. Unless they try to stop her, she orders her comrades to load the crop duster into their craft. Finally, she proposes an

alliance with the characters. With high-tech supplies, they can overthrow the government either by force or by sedition. By giving the people of Alterra the means to improve their lives and extend the future of the planet, the government will lose its grip and fall.

Unfortunately, Gestain is incorrect. Even if the characters decline to join their cause, the rebels will make large advances against the government. However, all New Dawn will accomplish is civil war, which Alterra cannot survive. The government will turn its planetary defenses against its own people, and there will not be enough people left to sustain the world.

The characters should immediately return to their ship and blast off. Gestain tells them to contact her or her comrades at Delugon II, then hurries to join her ship and flee before the government can catch up with them. If the referee desires, a contingent of Alterran ships may attempt to intercept and shoot them down as they leave.

On the other hand, if they help Traber, Gestain and her cohorts fall quickly. Traber is grateful for their "intelligent" decision, but he adds that Alterra will not embrace outworlders, even in the light of this action. All he can promise them is that they can leave peacefully (although he will not promise to respect them if they come back). He collects the manuals and instructs his men to load the crop duster back into their craft.

Sadly, with this solution Alterra remains isolationist and destined to fade away, although food supplies may not be as significant a problem. The New Dawn will continue its resistance but will eventually fade as the planet slides toward oblivion.

Once again, if the referee desires, a contingent of Alterran ships may attempt to intercept and capture or shoot the characters' ship down as they achieve orbit.

If the characters simply withdraw, the fight continues between the people of Alterra, and neither side wins. In this case, several Alterran ships move to intercept them.

Another solution will be for the characters to take control of the battle and defeat both sides, then attempt to broker peace. If this happens, Traber is impressed enough by their true neutrality, now very apparent, that he agrees to plead with his superiors for a discussion of opening relations with the Imperium. It won't be easy, but it may save the planet.

The characters may choose to accept a role as diplomats, but they may also simply notify the Imperium of Alterra's tentative willingness to talk. Either way, the government eventually agrees to open trade with other planets and the pirates agree to give up their renegade activities, allowing economics to change and save Alterra instead. The planet will then rise from its own ashes, and the characters will become friends and heroes of the Alterran people, receiving special deals and privileges whenever they visit.



69

# 5: LOCK AND LOOT

---

In this adventure, the characters find a world where primitive humans live among the ruins of a Second Imperium civilization. The planet's moon in particular is a treasure trove of Second Imperium technology. However, should the player characters investigate the lunar installation, they discover a far trader crew has already claimed the base. This crew makes their living by locating and looting long-abandoned Second Imperium bases, and this base is a treasure of a magnitude unlike any they have found up to this point. Their leader — Archibald Neff, a self-centered noble who was drummed out of the diplomatic corps for negotiating treaties that benefited himself and his family more than they benefited the Imperium — is on the planet below, negotiating with the leaders of several native tribes for legal dominion over their moon. He is preparing for the worst-case scenario in which an Imperium survey ship or first contact team arrives in system before he and his crew have at least covered their expenses. He hopes to stall long enough through legal wrangling for his crew to recover their gear and for all of them to make good their escape. The fellow's best case scenario involves forming a firm alliance with a few of the tribes, and then turning them on the others and starting either a slave trading ring out of this system.

The nonplayer characters are an unsavory bunch, and it is in the best interest of the native population and the Imperium for the player characters to snatch away the advantage they seek to gain. There are a number of ways the player characters can go about this, and if they're smart about it, they can make a lot of credits in the process. If they aren't, they may end up dead.

## The Setting

This adventure can be set in any star system that is not located near a main shipping lane or a major inhabited Sylean Federation or Imperium controlled world. Data available to the player characters should indicate that the system contains a gas giant, and that the primary world was host to either an A or B class starport, had a standard atmosphere, and a hydrographics in the 40% range.

The moon where the first part of this adventure takes place orbits the system's fourth world. It is a planet with no axial tilt, and the temperatures on the world range from -5 degrees Celsius in the polar regions to 30 degrees Celsius at the equator year-round. The planet has an orbital cycle of 387 days, each of which is 27 hours long. The gravity is standard. 40% of the planet's surface is covered in water. Land masses consist of three large continents and several dozen islands of varying sizes. Mountains are low and ancient, reflecting the world's long geological stability. Most of the land is covered with forests, although scans and simple observation of the world from orbit or atmospheric flights show that once hundreds of cities and thousands of towns were scattered across this garden world's surface. Each of these ruined cities show evidence of having been subjected to heavy bombardment or shelling, and they have mostly been reclaimed by the forests. Scans reveal no evidence of power sources, or other hallmarks of currently active high-tech societies.

Available data on this system indicates that at the fall of the Second Imperium, this system was plagued by civil unrest or possibly even full-scale civil war. Since the intensity and nature of that conflict is not known, the Third Imperium has not yet wanted to devote its limited resources to investigating the system. There are many other star systems that are far more likely to still be

home to habitable planets or civilizations with whom the Imperium can establish trade relations.

The forests and ruined cities are teeming with life, though. Any travellers exploring this world can expect an encounter with some form of animal life once per hour, not counting the constant tittering of avians and rustlings in the undergrowth of small mammals and reptiles. The animal encounters should be generated using the tables in the **Traveller** rulebook. If the "Event" result is rolled, the travellers encounter a party of native humans numbering between 1 and 6. They are dressed in skins and home-spun cloth and carry weapons TL1 weapons such as spears, axes, bows, and iron swords. This party is typically a group of hunters, and the referee should use the Reaction table on page 150 of the rulebook to determine the natives' reaction to the characters. As expounded upon below, however, only hunting parties will behave in an aggressive fashion, and never if they actually witness the characters land in and exit a starship; the men and women of this world are expecting visitors from the stars to one day arrive on their world. Hunting parties witnessing such an arrival are likely to address the characters with reverence and ask that they return to their village with them. (All natives of this world speak corrupted forms of Galanglic; player characters must make successful Language skill tests whenever they interact with a new group of natives in order to fully understand the particular dialect.)

As the Long Night fell, the people of the world were embroiled in civil war. Eventually, the cities were shattered and rendered uninhabitable. The survivors fled into the countryside where they soon slipped into barbarism. 1,700 years later, they continue to live in small hunter/gatherer societies of TL1-2, each sharing three things in common: Superstitious fear of the ruined cities, a dislike of technology, and a deep hatred for citizens of other villages. The civil war that robbed these people of their Second Imperium society continues to this very day, with the horrors of bombing, shelling, and the unleashing of chemical weapons being passed down from generation to generation in stories and legend. Each village blames their neighbors for ending the "Golden Age" and for causing the cities to be populated by demons and the spirits of the evil dead.

Villages are typically allied with each other against clusters of villages a bit further away. They consider

themselves nations, even though each village is ruled supremely by their Chief or Witchdoctor. The ties between villages are primarily based on intermarriages, with warriors helping other villages should threats from nearby enemies become apparent.

Although primitive, the people of this world have no fear of travellers, nor is the existence of space travel a surprise to them. Their myths are filled with tales of men and women from stars, and that some day, someone will return from the stars and spark a rebirth of the Golden Age. Travellers, unless they try to disguise themselves as natives, are likely to be treated like kings and possibly even gods, should they happen upon a village. The leaders look to the travellers for insight and guidance, and eventually for them to restore the "magic" that they believe destroyed by their evil neighbors. The natives fail to recognize that the magic they wish restored is the same technology their legends cause them to revile. Reintegration of this world into intergalactic society will be a slow and arduous process, something that will take many decades and much effort on the part of the Imperium's finest first contact specialists and sociologists.

## The Setup

This adventure can be played any time the characters are refueling their ship from a gas giant in a system that has not yet been explored by the Sylean Federation. The information available to the characters on this system can be found in "The Setting", above, for this adventure. As their fuel is being refined, their commo systems pick up a broadcast on several frequencies. Initially, the broadcast is mostly static, with only a few scattered words coming through. Characters capable of operating the ship's communications system can perform Difficult task to retune them to properly receive the message; it is being broadcast on several frequencies that have not been in use for centuries, including Designated Emergency Channels that have not been active since the early days of Sylean Confederation. The characters were receiving bleeds from the transmission.

Once the characters can hear the message clearly, they discover it is a voice-only transmission. The broadcaster is a woman who is using an archaic form of Galanglic. She says, "This is FPK Lunar Installation 23AB-17. Our reactors and secondary power systems have failed and there are 37 hours of power left of our emergency power supply. Once they fail, we shall only be able to survive another 15 hours before carbon dioxide poisoning and lack of environmental controls kill us. If there are any starships in the system, private or imperial, we urge you to assist in the evacuation of personnel from the moon around the world in the third orbit. To those of you on planet, we thank you for your prayers. May God smile upon us all, for if he doesn't, we fear a long night is about to descend upon us all."

A second, toneless, metallic voice cuts in, "This is an automated broadcast. Base personnel have retreated to the emergency shelters. Rescuers should use DEC band 43.1 to communicate with them."

The message repeats every five minutes for two hours, then abruptly stops. If the characters try band 43.1, they receive no reply. The characters operating the

communications systems know that the message is being received, but still no one replies. The message is transmitted again 13 hours later, and once again repeats every five minutes for two hours before stopping.

The characters can verify the source of the transmission if they wish. For each transmission, characters can attempt to use the ship's communication direction finder to pinpoint the transmission's point of origin (this is an Easy Communications task). If the ship does not have a direction finder, skilled communications operators and sensor operators can work together to try to discover where the broadcast is coming from. They can make one attempt each time the message is broadcast. The difficulty of this task starts at Impossible, but for each additional attempt the characters make, the task becomes one step easier.

The broadcast is coming from a moon in orbit around the system's fourth planet. Successful scans reveal the moon has no atmosphere, but that the planet itself has an environment that is ideal for human habitation. Navigational information available to the characters (see "The Setting") indicate that in the days of the Second Imperium, this system was home to both civilian and military ports. Aside from the automated distress signal, however, the characters do not pick up any other transmissions in the system. Nor are there any starships within sensor range. Perhaps the inhabitants of this system did eradicate each other during the death throes of the Ramshackle Empire, or perhaps the civilization that remains simply has limited resources.

If the characters choose to investigate, the travel time to the moon is roughly four hours. After three hours, they are close enough to scan the moon's surface, which is pocked and cratered by millennia of meteor strikes. On a successful Average Sensors skill roll, the characters find the base on the surface. The base consists of a central structure from which wings radiate in each of the cardinal compass points; one of these wings has been destroyed by an explosion or a meteor strike, while a second wing, slightly longer than the others, stretches to a landing platform, which has also been damaged by a meteor impacts. They can also detect that much of the base is without power. However, the areas that appear to be the base's main control center still has power, as does one of the wings. On a successful Formidable Sensors task or if the characters conduct a scan while orbiting directly above the base, they realize the power in the base is being supplied by a far trader that is docked with the installation. Most of the installation appears to be without power. (See "The Lunar Installation" for details.)

If the characters scan the planet, they see countless ruined cities that have been reclaimed by nature. Unless an Impossible Sensors task is achieved, the characters do not detect any power sources or transmission of any kind on the planet. Should a success occur, the characters detect a minute power reading on the outskirts of one of the ruins. This is the looter's launch that has traveled to the surface, where their captain and one of his men are negotiating with the natives in an attempt to gain a tenuous legal claim to the moon and the valuable technology contained in the base.

If the player characters choose to bypass the moon

and head straight for the planet, the adventure continues on page 51 with "Neff and the Natives."

The characters receive no response if they hail the lunar base, the ship docked with it, or the launch on the surface. (Hailing the ship, however, alerts the looters within the base. This will have consequences should the characters try to board the ship or enter the base itself. The detailed descriptions of the ship and base will highlight the differences in actions of the nonplayer characters should they be aware of the player characters' presence in-system.

### On the Moon

There are no suitable landing spots near the lunar space. Although the landing pad appears to once have been able to handle three or four 200 ton ships, or possibly even a ship as large as a patrol cruiser, the meteor impacts have made it so that even landing a single far trader there something of a feat on the pilot's part.

By working together, the ship's pilot and a scan operator can try to find a place on the moon's surface where they can land their ship. The outcome depends on the task level at which they are successful: If they succeed at the Formidable level, a landing spot is found one hour's walk away from the base; at Difficult, the characters land two hours away from the base; and at Average or worse level, the closest suitable landing spot is three hours away.

The moon has no atmosphere, and the characters are going to have to use vac suits to reach the lunar base. The gravity on the moon is .1G. The surface is covered with rocks and fine red dust, and is marred by craters ranging from half a kilometer to three kilometers in diameter. Each step the characters take sends twisting plumes of dust into the air. For each hour the characters travel to or from the lunar base across the surface, the referee should roll two dice for each hour of travel and check the following table.

### Moon Encounters

2D6	Result
2	No event or encounter
3	No event or encounter
4	No event or encounter
5	Dust bowl
6	No event or encounter
7	No event or encounter
8	No event or encounter
9	No event or encounter
10	No event or encounter
11	Land crawler
12	Roaming looter

**Dust Bowl:** The characters come upon a crater that has filled completely with the fine dust that covers the lunar surface. The character at the front of the group suddenly feels the ground drop out from under him. Unless the player rolls a successful Difficult Dexterity or Athletics task, the character tumbles down into the depths. If the second character in the group is following the leader closely, he needs to perform an Average Dexterity or Athletics task or plunge into the pit as well.

When the character hits bottom, the player should roll to see if the suit is damaged by the impact. The

character takes 1D of damage on impact. If the damage roll is less than the vac suit's armor rating (typical vac suits in **Traveller** have armor ratings of 2), the character merely takes stun damage. If the roll exceeds the vac suit's armor rating, the character still takes the rolled value as stun damage, but the suit has also been damaged and punctured by the fall. The ensuing exposure to vacuum inflicts 1 point of damage per turn to all the victim's characteristics except Education and Social standing. If the suit is self-sealing, the damage is only taken for one round.

If the character is carrying equipment (a vac suit patch kit) that might be used to seal the hole in the vac suit, the damage is taken for two rounds, or until he succeeds at a Difficult Dexterity task and manages to plug the leak. If another character leaps into the sea of dust to help the unfortunate victim, he must first perform an Average Dexterity or Athletics to not take damage from the decent, followed by a Difficult Perception task to locate his unfortunate comrade. Once the character with damaged suit has been located, the second character can patch the suit in a single turn.

There is another danger in the crater, however. The fine dust in the dust bowl may contaminate the vac suits of characters who spend time in it. On a roll of 4–, the suit begins to malfunction. The character finds it increasingly difficult to breathe, and within an hour, the oxygen feed ceases completely. Until that point, the character must successfully perform an Average Endurance task for every 15 minutes of travel to remain unfatigued. For each failed task roll, the character receives one Fatigue point. Once the suit fails completely, the character takes 1D of stun damage for every half hour he remains in the suit. The suit must undergo major repairs before it is operational again.

**Land Crawler:** As the characters come over a rise, they spot a long vehicle on treads. It consists of an enclosed cockpit for the driver, and an open payload in the back. It is not moving. The tracks left by the land crawler clearly show it came from the direction of the moon base. As they approach the land crawler, the characters notice that a thin coat of the red dust covers the vehicle. Inside, sits a long-dead man in a TL14 EVA/vac suit. (See page 16 of the *Central Supply Catalog* for details.) The characters recognize it as a vac suit, but the corpse inside is withered and mummified. The oxygen supply in the suit has long since been depleted, as has its internal power supply.

The vehicle is powered by photoelectric batteries, and the characters can drive it back to the base if they choose. The trip takes 15 minutes for each hour they had left on their journey (with a minimum of 15 minutes for the characters to come within sight of the base). The vehicle's cockpit seats one person, although the rest of the characters can ride in the payload.

Although the product of a TL14 culture, a cursory inspection of the craft might lead technologically adept characters to identify it as an artifact of a TL6 or TL7 people. Its sides and roof sport solar panels that charge the photoelectric batteries that rest under the cab's floor. It relies on treads for its locomotion rather than anti-grav technology. Further, the cab does not seal tightly and has no life support systems. The primitive appearance of the craft comes from the desire of

the designers to create a vehicle that was nearly maintenance free. It was created to haul valuable minerals and crystals that were being extracted from small mining installations scattered across the moon, and the designers wanted the vehicles running mostly non-stop. The electronic components are advanced, but little else on the land crawler is.

There is only room for one passenger inside the land crawler's cab, the driver himself. The cab is enclosed, but it has windows made from micro-thin, impact- and scratch-resistant diamond sheets that gives the pilot the opportunity to get a good overview of his surroundings. It has three floodlights — two on the cab's front, mounted directly above the treads, and one on its roof. The one on the roof can be manipulated by the pilot with a lever on the dashboard. As soon as the vehicle is activated, the powerful lights come on. The can only be deactivated if appropriate fuses are removed from under the dashboard. This is an Easy Electronics task for characters familiar with land crawlers, but an Average task for those aren't. Of course, trial and error efforts involving pulling random fuses until the floodlights go out will eventually turn out the lights. Such an approach risks wiping all the information that is programmed into the vehicle's onboard navigational systems. (The referee should ask the players to roll 2D should their characters begin to pull random fuses out of the land crawler. If the result is 2, they cut power to the navigational systems and render them useless.)

The land crawler, as mentioned, is built to haul ore and other goods and equipment. To this end, it is equipped with a powerful engine that is capable of pulling as much as two displacement tons of cargo up grades as steep as 30%. The vehicle itself has an acceleration rating of 0.5G and a maximum speed of 130 kph. For each .5 tons of hauled cargo (which is carried in treaded carts that are hooked to the back of the cab and each other) the acceleration is reduced by 0.1G, and the maximum speed is reduced by 20 kph, while each 10% of incline on a grade reduces the top speed possible by 10 kph.

The land crawler sports a TL14 autopilot with 12 pre-programmed destinations. The driver can switch the auto pilot on and off at will, as well as cycle through any of the preprogrammed routes and change them even in mid-execution. This is an Easy Navigation task for characters who have been trained in the use of this system, but Difficult for those who have not.

The autopilot system is linked to a TL14 sensor system that continuously scans the area surrounding the land crawler. The sensor system has a range of 300 yards. A display panel on the dashboard shows the driver the course the autopilot has plotted, and should something appear on the sensors that is unexpected or potentially dangerous to the vehicle (such as a new crevice, other vehicles in its path, or nearby mining activity, for example), the autopilot immediately slows the vehicle while the computer flashes a warning to the pilot, slows the craft, and offers to switch the controls to manual. Piloting the land crawler is an Easy Ground Craft task, assuming the driver maintains a safe speed. If the pilot chooses not to take control of the craft, he can at least confirm the sensors estimated

threat visually, using the spotlights if it is dark.

The land crawler is equipped with a TL14 comm unit. It is capable of tuning to over 100 frequencies, most of them not presently used by the current Imperium. The radio can be adjusted to modern frequencies through the successful completion of a Difficult Communications task. It has a range of 500 km, and several of the frequencies it uses in its original configuration resist inference from sunspots and magnetic distortions.

The land crawler has no armaments and no armor. It is strictly a civilian craft. It is no longer in production anywhere within the known Imperium, but would probably sell for Cr6,000 if it was. If the characters try to strip the land crawlers electronic components (such as the autopilot, the sensor suite, and the radio), they need to perform Difficult Electronic tasks for each component in order to extract it intact and operational. The referee can decide the value of each, should the characters attempt to sell them either to Imperial or megacorp R&D people.

**Roaming Looter:** While most of the looters are occupied at the lunar base, a single one of them has decided to take a TL14 vac suit for a "test drive."

Clem Valenz is a former prospector who joined with the looters after a dispute with newly arrived Imperial claims adjusters lost him everything he owned, including the small scout ship in which he had travelled the stars for almost two decades. When he joined Archibald Neff's crew, he shared the noble's bitterness toward Cleon's empire. Destroying and looting derelict ships and bases, and selling looted materials to corporations rather than the empire, seemed like the perfect way to make the uppity puppets of Cleon pay for robbing him of his livelihood. That bitterness has faded, however, and now the old prospector wants nothing more than to stake another claim and once again live in solitude. He is wandering the lunar surface, using a TL15 densitometer (see *Central Supply Catalog*, page 24) he found in the base to search for mineral deposits. Should he find anything, he plans to ask Neff to stay behind on the moon, ostensibly to guard the treasures of the base while the rest of the crew goes off to sell the loot.

The encounter with Clem can be used in two ways. Either the characters on their way to the lunar base can spot him scanning a steep slope, or Clem can accidentally find their ship. The second option is recommended if any characters remained behind. An encounter with Clem may ensure that those players get to do some role-playing as well.

If the characters encounter Clem while travelling toward the base, they spot him walking along a steep ridge, sweeping it with his scanner. He is wearing a vac suit identical to the one worn by the dead body in the land crawler. He turned off the comm unit in the suit, because he doesn't want to be bothered by the people back at the base while he is exploring. The characters will have to get close to Clem before he notices them. The referee should roll 1D+4 and compare it to the Encounter Range chart on page 61 of the **Traveller** rulebook.

Once Clem spots them — after catching a hint of movement out of the corner of his eye — the referee should roll to see the prospector is surprised. If so, the

referee should roll an Average Dexterity test for Clem. On a failure, he loses his balance and tumbles down the hill. He is knocked unconscious by the fall, and the densitometer is shattered beyond repair. Fortunately for him, his suit remains undamaged. The characters now have to decide what to do with their unconscious prisoner. (Clem regains consciousness after 1D minutes.)

If Clem is not surprised, the referee should call for an initiative roll. Clem is taking two actions that round — drawing a TL14 laser pistol (see below) and activating the comm unit in his vac suit. The looters' comms expert has already retuned it so it broadcasts on modern-day frequencies. Assuming the player characters don't open fire on him, Clem shouts, "Where in Sylea did *you* 'pounders come from?! Keep your hands in front of you. I don't want to have to shoot you with this here laser!"

If the characters claim any kind Imperial authority while speaking with Clem, the prospector's voice takes on a snarl. "It's getting to the point where a person can't make a living anymore. You buggers are spreading like a plague." Clem insists they drop whatever weapons they are carrying, and marches them to the lunar base where he turns them over to Mara Arnaarmash, Archibald Neff's Vilani lover who is overseeing the activities on the moon while he negotiates on the planet below. The adventure then continues from "Arriving at the Base."

If any character draws their weapons or otherwise attack Clem at any time while speaking with him or being escorted to the base, combat should be played as detailed in the **Traveller** rulebook.

If the referee chooses to use Clem as an encounter for characters who remained behind in the ship, he should first determine what each character onboard is doing. If anyone is pulling monitor or watch duty on the bridge, a Difficult Perception test should be rolled for that character. If the test is successful, the character notices a faint transmission registering on the ship's comms system. Upon successfully completing an Average Communications task, the character can hear the message clearly:

Male voice (Clem, anxious): No, it's a ship, I'm telling you! A Sylean ship! Looks like some kind of transport vessel. It's operational, and it's sitting right here on the surface of the moon!

Female voice (Mara, cold as ice): Okay, okay. I'll send Ruud and Marty out to give you a hand. Do they have any sentries posted?

Male voice: Not that I've seen so far.

Female voice: See if you can spot any. Don't take make any move against them, just keep an eye out. Wait for the pro's to get there.

Male voice: Okay. When they get here, I'll be by the cliff that looks like a K'Kree's butt."

Female voice: Sigh. Base out.

There are no further transmissions.

The characters left on the ship can take several actions in response to this transmission. The referee should let the characters come up with a course of action on their own. Likely steps to take include going outside and trying to capture Clem, if there are any additional vac suits on board — an action that leads to a fire fight, unless the characters manage to catch Clem completely by surprise, in which case the prospector

surrenders. Whether or not they try to capture or eliminate Clem, the characters can try to ambush the arriving "professionals," a move that leads to a certain fire fight. The characters can wait inside the ship and fight Clem and the "professionals" on their own turf, or they can lift off and take their ship into orbit, temporarily stranding their comrades on the surface. (Should the characters wish to contact other characters on their way to the lunar base, the referee should allow characters who either have the Tactics or Communication skills to make an Average task roll. If the roll is successful, he should tell them that if *they* coincidentally picked up a transmission from the surface to the base, couldn't someone at the base accidentally intercept any transmission they might make as well? In truth, however, there is no one on permanent monitor duty at the base, and the characters can safely tell their comrades that the ship has been discovered, although they have no way of knowing this for sure.)

There are two outcomes of using an encounter with Clem in this fashion (aside from giving characters who remained behind something to do during the game session), one of which is good, the other is bad: A pair of the most effective combatants at the base are drawn away from there, but those who remain behind are at a heightened state of alert.

#### TL14 Laser Pistol

At first glance, this weapon appears to be a large caliber, semi-automatic slugthrower. On closer inspection, however, it becomes clear that the weapon's bulk is caused by a built-in power pack.

Like the TL12 laser pistol described in the **Traveller** rulebook, the TL14 pistol fires energy beams powered by a power pack, has a range of Long in ground combat, and a damage rating of 6. Unlike the TL12 version, the wielder of this more advanced model does not have to worry about a separate power pack, as it is built into the weapon itself. The weapon is capable of firing 20 shots before the power pack must either be replaced or recharged, which requires special equipment. Recharging takes five hours. Changing the power pack is an Easy Dexterity task for characters who are familiar with this make of weapon, but Formidable for all others. (Familiarity can be gained through experimenting with the weapon.)

This weapon would be of great interest to Imperial weapons developers. More can be found in the lunar base.

Name <b>Clem Valenz</b>		UPP <b>563897</b>
Service <b>Crusty Prospector</b>		Rank
Birthdate	Birthworld	
Skills <b>Athletics-2, Astrogation-3, Blade Combat: Short-2, Brawling-3, Communications-3, Engineering-2, Fast Talk-1, Electronics-1, First Aid-1, Ground Vehicles-1, Jack-Of-All-Trades-2, Mechanics-1, Melee Combat-2, Navigation-2, Perception-2, Pilot-4, Pistol-4, Sensors-3, Short Blade-2, Survey-2, Vac Suit-3</b>		
Possessions <b>TL14 laser pistol, TL14 vac suit, TL15 densitometer</b>		Money
Comments		

UPP Card

001-000

Name <b>Ruud</b>		UPP <b>A86654</b>
Service <b>Lowbrow Thug</b>		Rank
Birthdate	Birthworld	
Skills <b>Brawling-2, Computer-1, Grav Craft-1, Ground Craft-1, Grav Craft-1, Intimidation-1, Melee Combat-2, Pistol-2, Recon-1, Short Blade-1, Vac Suit-1</b>		
Possessions <b>TL14 laser pistol</b>		Money
Comments		

UPP Card 001-000

Name <b>Marty</b>		UPP <b>798963</b>
Service <b>Arrogant Thug</b>		Rank
Birthdate	Birthworld	
Skills <b>Brawling-1, Computer-1, Grav Craft-1, Grav Craft-1, Ground Craft-1, Intimidation-2, Jack-of-All-Trades-2, Melee Combat-2, Pistol-2, Short blade-2, Vac suit-1</b>		
Possessions <b>TL14 laser pistol</b>		Money
Comments		

UPP Card 001-000

Ruud and Marty are a simple pair of characters. They are simpleminded bullies who grew up together on the mean streets of a major Sylean city. Together, they cut their teeth on muggings and protection rackets. They are both crude and ill-mannered, although Marty's arrogance lends him a certain amount of clumsy charm. The fact that he believes himself the galaxy's greatest lady's man, and that he doesn't take well to rejection causes that charm to quickly wear thin for most female characters, however. Ruud is the muscle of the team, but both men are brutal, unfeeling killers.

### Arriving at the Base

Characters trekking to the base eventually climb a final rise and find themselves gazing down onto the lunar base. Situated at the center of a crater that is a kilometer wide, the base is a brilliant white cross shape that contrasts brightly with the dull red surface of the moon. In places, the red dust has settled on the base, and in others, meteor impacts have caused black blemishes to appear. One of the base's arms has all but been destroyed by a meteor impact or an explosion.

As the characters' scans may have indicated, there is a 200 ton ship parked on the meteor-battered landing platform by the base. Its docking sleeve has been extended to form a seal with the airlock leading into the base. Light shines brightly in the base's central dome, and the wing that connects with the ship.

Characters with mercantile or naval backgrounds recognize the ship as a far trader, although an extensively modified one. It appears as though the ship's

cargo area has been completely sacrificed in order to outfit the ship with a docking bay for a smaller vessel, either a gig or launch. The doors to the docking bay are presently open, and the smaller vessel is not present. The modified far trader is described below.

At this point, the characters must decide if they want to investigate the ship, or simply infiltrate the base. From their vantage point, they can see that at least one other of the wings — although apparently without power at present — has an airlock through which to enter. If they choose to investigate the ship, the adventure continues in following section. If the characters choose to head straight for the base, the adventure continues with "The Lunar Installation."

### The Far Trader

The *Liberty* is all Archibald Neff has to show for his status as a scion of a Sylean noble house. His self-centered, greedy nature dishonored both himself and his family when it was revealed that he was abusing his position as a Sylean Federation diplomat to secure personal wealth and status rather than forwarding — and occasionally even at the expense of — the goals of the Imperium. His father stripped Neff of his status of heir, giving that honor instead to his younger sister, and drove his son from their home. The father gave Neff *Liberty*, a 200 ton ship and the advice that his son use the vessel to become an honest man, and that he never show himself near any of the Neff holdings. His likeness is known to all of the family's security people, and they have instructions to shoot him on sight.

Neff's harsh ejection from his family could have been a fresh start, a dawn of a new, honest life for him. Although *Liberty* is not fit for hauling large cargoes, the ship would make the perfect transport for wealthy patrons interested in low-key travel, a suitable conveyance for diplomats or first contract teams interested in traveling unobtrusively, and even as a source of transporting small cargoes needing direct tending or delicate handling. Although *Liberty's* hull is that of a 200 ton far trader as detailed in the *Starships* supplement, it has been heavily modified from the stock ship in that volume.

Most of *Liberty's* cargo space has been sacrificed in favor of a launching/docking bay for a 20 ton launch, allowing the vessel to ferry passengers and small cargoes to and from planets without attracting the attention that of a larger vessel. The modifications have left *Liberty* with 4 tons of cargo space, and no low berth facilities.

Although Neff's noble background would have made him the perfect man to captain a ship dedicated to staging cruises for celebrities and others interested in travelling quietly, the dishonored noble had neither the intention nor the inclination toward using *Liberty* as a means of making an honest living. Together with Willard Nelsen, a cargo broker and merchant who is as lacking in moral character as Neff himself, he formulated a plan in which they would pool their skills to use *Liberty* to loot lost colonies and forgotten Second Imperium bases of their technological and artistic wonders in order to sell them to the highest bidders. Neff's highly charismatic nature and the promise of great wealth attracted a crew of men and women who were



# FOR TRADER LIBERTY

**DECK 1**

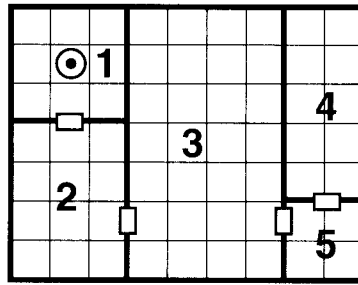

**DECK 2**

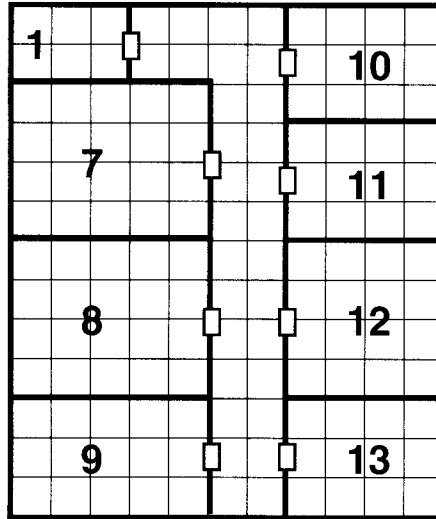

**DECK 4**

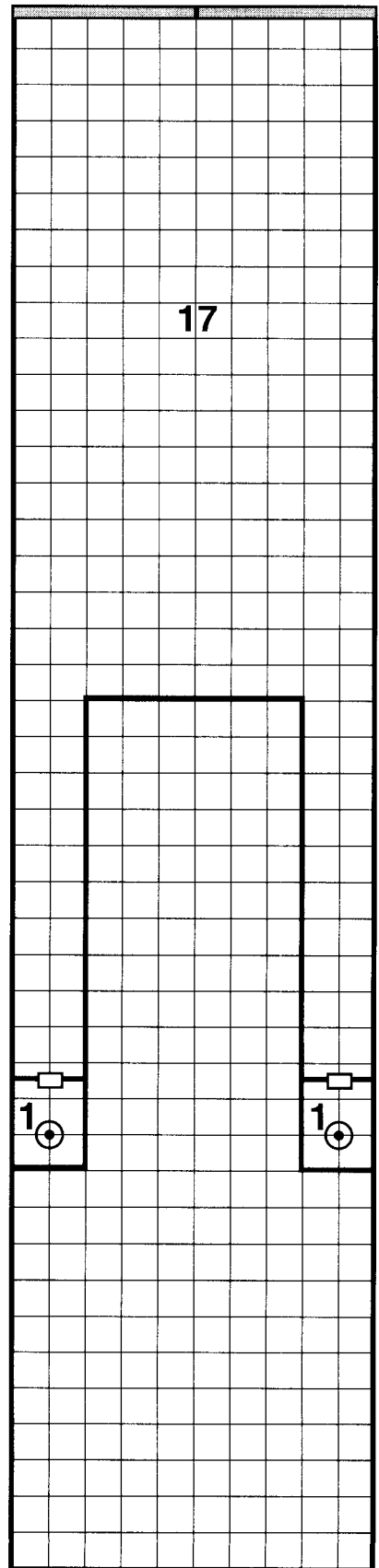

**DECK 3**

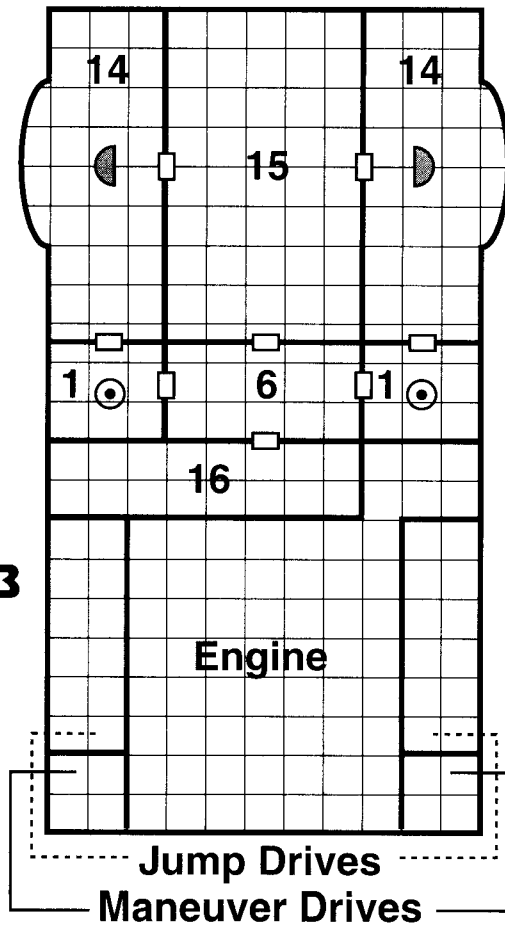

**MAP LEGEND**

⊙ Airlock

□ Door

◐ Gunnery Positions

▬ Bay Doors

⊞ = 2 Meters

either as crooked as Neff himself or simply disaffected with the Imperium, and they set out to loot the wonders of the galaxy before the Imperium found them.

When the player characters first come upon *Liberty*, it is docked with the moon base. Bay doors at the front of the ship are wide open, revealing the docking bay for the ship's launch, and the characters can easily enter the vessel through the airlocks on this deck. (See the map of *Liberty*, page 39.) Only two members of its crew are onboard, Lori DuPont and Sarlam Arnaarnesh. Should the characters choose to not investigate the ship immediately, Sarlam leaves the ship and enters the base, leaving Lori alone.

### The Liberty: Modified 200 ton Far Trader

Tons: 200

Volume: 2,800

Cost in Mcr: Not for sale (custom vessel)

Crew: 5

Passengers High/Medium: 7

Cargo: 4

Controls: Civilian with bridge

Tech Level: 11

8 Size Rating

+1 Fire Control Rating (with newly installed TL14 targeting systems)

2xL Batteries - 2, 0, 0, 0

2 Jump Rating

1G Rating/HEPIaR

5 Power Plant Rating

50 Fuel Rating

0A 2P 0J Sensor Rating

0 Armor, 6 Structure

### Deck One

**1. Airlocks:** The ship is constructed in such a fashion that a hull breach on one deck does not mean that atmosphere is lost to the entire ship. All doors seal tightly when closed, and one can only pass from deck to deck through airlocks. Further, the airlocks on Deck One and Deck Four can also be used to exit the ship.

**2. EVA Preparation Area:** Three TL12 EVA suits hang in this area. A locker contains welders and a variety of diagnostic and repair tools, enough so that a ship's crew might effect temporary repairs in order to get a damaged ship to a port with a real repair facility. The door leading to area 3, the ship's bridge, is heavily reinforced. It is equipped with high quality magnetic locks which can only be engaged and disengaged on the bridge.

**3. The Bridge:** This area is dimly lit, so as to allow crew members to more clearly see the readouts on the many screens that monitor various ships systems, help keep track of its course, and relay sensor data to the crew. All ship systems mechanical and electrical can be monitored from here, and all electrical systems, including the doors to the staterooms and various sections of the ship, can be activated and deactivated from one of the workstations. There are seats here for the pilot, co-pilot/astrogator, and the captain. A fourth seat stands in front of the workstation that is used to assist in the launching and retrieval of *Liberty's* launch.

A large viewport looks out into space and the front of the ship.

**4. Weapons Locker:** The door from the bridge to this room is equipped with an electronic lock and keypad. All crew members except Lori DuPont (see area 12) know the code, however. The coded lock is an artifact of a paranoid captain who ran the ship for Neff's father years ago. Only the captain and his first officer knew the code to access the weapons locker and ready room beyond it in those days. The captain wanted to have an area that would provide extra protection from boarders, and keep weapons out of the hands of mutineers or hijackers.

The weapons locker contains five thud pistols, five submachine guns, and five TL12 laser pistols. There are ten ammunition clips for each weapon. In addition, five soft suits are stored here.

**5. Storage Area:** This area was at one time the captain's ready room. Now it serves as a storage area, although the room still does contain a couch and a small desk and chair. Characters can find two multiscanners (with mass spectrometer, atmosphere analysis, and text analysis/interpretation programs), a survival still, and whatever other equipment the Referee chooses to add. (For example, if the Referee wishes to introduce new items of technology into the campaign, this might be a place to do so. *Liberty's* crew has visited many lost settlements, and they could easily have decided to retain several pieces of hi-tech for their own uses.)

### Deck Two

**6. Hallway:** The hallways on *Liberty* are all 4 meters wide, and lit by glow panels set into the walls.

**7. Shorty, Ruud, and Marty's Stateroom:** This stateroom is shared by *Liberty's* muscle, Shorty, the bodyguard of Willard Nelsen (the ship's trade specialist), and a team of Sylean leg-breakers named Ruud and Marty. The place is a shambles. A three-level bunkbed stands here, with only one of the bunks showing that its owner has made even the slightest attempt to make it when he left the stateroom. The walls are covered with printed images of women in varying states of undress — many of them incongruously so, like the picture of a woman wearing nothing but a toolbelt and the boots of an EVA suit — and items of clothing lay strewn about, mixed with a wide selection of men's magazines and weapons. The head in this stateroom is a disgusting mess that clearly hasn't been cleaned in many weeks.

Searching this room reveals little of interest, unless the characters are interested in collecting girlie magazines. They can, however, retrieve two auto pistols, one revolver, and three daggers from the mess. All the firearms are fully loaded.

**8. Mara and Neff's Stateroom:** Mara Arnaarnesh, a former Naval officer and the astrogator for the looters, and Archibald Neff, the dishonored nobleman who owns the ship and serves as their leader have been a couple for almost three months now, and they share this stateroom and its sole double-bed. The bed is carefully made and everything in the room appears neat and tidy. This is a result of Mara's military-bred neatness, and a little cleaning assistance from Lori DuPont, a teenager who recently joined the crew at the behest of Mara's brother Sarlam.

A search of this stateroom shows that the closet and dresser contains carefully folded or hung clothes for a man and a woman, and in the bathroom, the characters find toiletries and personal hygiene items for two persons of different sexes as well. There is a small night stand with a drawer on either side of the bed. On one, they find a variety of star charts and a selection of books detailing the final days of the Second Imperium. Several systems on the charts have been circled while others have question marks by them. These marks identify systems that Mara believes to contain Second Imperium research stations or military bases that are likely to be abandoned, while the question marks indicate systems that might contain such installations or might still hold active high-tech societies that have yet to be contacted by the Imperium. On the other are more books about the Second Imperium, and a couple of gossip magazines centering on the noble families of the Imperium. In the drawer of this night stand is a body pistol, kept here because Neff doesn't fully trust anyone.

**9. Willard's Stateroom:** Willard Nelsen lives in this stateroom. He is a wheeling and dealing con artist who likes bending the law and using the trust of honest people to increase his profits. He keeps his stateroom obsessively neat — in fact, Willard can't abide disorder or dirty people and places, and gets flustered and irritated from simply glancing into the staterooms of the ship's three hoodlums and Lori DuPont. Willard is the only inhabitant of this room, and even if *Liberty* were to take on more crew members, no one else would be assigned to bunk with Willard. Chances are, the unfortunate person would either lose their minds or kill Willard within a week of signing on.

Willard is a rather colorless individual when he's not obsessed with order and cleanliness or trying to sell sand to the inhabitants of desert worlds, and his stateroom reflects this fact. Aside from the toiletries in the head, and the plain clothing in the closet and dresser, one cannot tell that this stateroom is inhabited. There isn't a single personal effect or item of diversion in the room. Willard lives for turning a dishonest credit, and turning dishonest credits is his entire life. His other role on *Liberty* is that of pilot, and while he is quite skilled at flying spacecraft, a replacement could easily be found. He is a master wheeler-and-dealer, but he is also a pathetic little man whose passing will barely be noticed by anyone.

**10. Sarlam's Stateroom:** This room belongs to Sarlam Arnaarnesh, brother to Mara Arnaarnesh and *Liberty's* chief engineer. The room contains a single bed which has been carefully made. A bookshelf stands on one wall, holding manuals on maintaining starship systems, ranging from jump engines and maneuver drives of all types to a wide spectrum of navigational, life support, and electrical systems. Some of the books are quite ancient, dealing with the installation and maintenance of targeting and piloting systems that are keyed to the synaptic functions of crew members, allowing a gunner to take aim on a target, or a pilot to take an evasive action with the ship literally with the speed of thought. These manuals for this wonder technology were discovered in one of the sites looted by the crew, but no examples of the technology itself has

been uncovered yet. Other ancient manuals describe the procedures for installing and maintaining the TL14 targeting system that *Liberty* has recently been outfitted with. (See area 14.)

The decorations in the cabin are sparse, but on the small writing desk next to the bookshelf is a framed photo of a young man and a young woman. They bear a distinct family resemblance. The young woman is dressed in a Naval cadet uniform. The pair in the photo are Sarlam and his sister, Mara. If the characters search the dresser and closet, they find a variety of male clothing, all in the same size, and a large number of tools and diagnostic equipment used by a ship's engineer both in his every day activities and in all repair situations.

**11. Delaware's Stateroom:** Jonathan Delaware is the crew's primary expert on the Second Imperium, and his stateroom shows it. Though orderly and clean, it is crammed with books on the Rule of Man, old star maps and astrogation charts, and a wide variety of Second Imperium pop cultural artifacts. Where Mara attempts to locate sites containing potential plunder by referencing current shipping lanes with historical texts, Delaware does it almost purely based on his information about the old Imperium. He scours the texts for references to out-of-the-way settlements and bases, almost always assuming correctly that such locations are even less likely to be active settlements in the vastly reduced Third Imperium.

If the characters compare the star charts in this stateroom with the ones they found in the one shared by Mara and Neff, they find that three systems that are currently a Jump 2 away from any shipping lanes, and a Jump 3 or higher away from any currently inhabited systems. One of these systems is where Neff intends to take his crew next, although observant characters may be able to claim whatever treasures may be waiting there for themselves. Mixed in with the other books are more engineering texts, although the majority of them relate to environmental control systems of the Second Imperium. Aside from being a historian and archeologist, Delaware is also an accomplished engineer. His efforts to get the power generators and environmental systems in the bases and starships the looters search back in working order make activities far easier.

Searching the dresser and closet reveals a range of practical clothing. The head has toiletries for a lone male.

**12. Lori's Stateroom:** Lori DuPont's stateroom is clearly the domicile of a teenage girl. The walls are covered with pin-ups of current holo-vid heart-throbs, while the floor is strewn with a variety of publications devoted to young women and gossip about the stars who adorn her walls. There are two bunks in this room, but the top one is strewn with tools and magazines, clearly not in use by anyone for sleeping purposes. The closet and dresser contain clothes for a petite female as well as a Naval lieutenant's uniform for a female of bigger build than the person the rest of the clothes are for. (The uniform belongs to Mara, who shared this cabin with Lori until she and Neff became a couple.) The bathroom holds a variety of feminine personal hygiene items.

Lori is the only member of the *Liberty* crew who is in her stateroom when the player characters first search the ship. She is curled up on her bunk, sleeping soundly, an open copy of *Sylean Superstars* next to her on the bed. She is a slender, delicately built young woman with long dark hair, olive skin, and an attractive face. The characters can quietly search the room without waking her if they wish. If they do wake her, she is groggy at first, but then grows terrified — she begs the characters not to hurt her, and promises to tell them everything she knows.

Lori is a Solomani teenager who ran away from an abusive home roughly a year ago. She was begging near the spaceport when Sarlam, the ship's engineer struck up a conversation with her and decided she was too bright a girl to be swallowed up by the underbelly of Sylean society. Neff agreed to let her to travel on the ship for a time, as long as she made herself useful. She keeps the common areas of the ship clean, sees that Neff and Mara's stateroom is kept spic and span, and helps load and unload the launch whenever Neff or other crew members take it on missions. She is also learning the basics of being an engineer from Sarlam, and has rudimentary skills in electronics and engineering.

Lori doesn't have much information for the characters. All she knows is that the majority of the crew is exploring the abandoned moonbase while the captain took the launch to the planet. Why he went there, she doesn't know. She also tells the characters that her friend Sarlam is in the engineering section, and asks them not to hurt him. "He'll do whatever you ask him to," she says. "Please don't shoot him."

As long as she doesn't see immediate evidence that the characters intend to harm her or Sarlam, Lori cooperates with them peacefully. However, if it becomes apparent they are about to brutalize her or Sarlam, she attacks the nearest character with a shriek and wild abandon, clawing at his face and eyes with her fingers. (The referee should roll for initiative as normal, but Lori's attack is likely to be ineffectual against most characters as she is not at all experienced with any form of combat, and thus must make an Average test with a 0-level Brawling skill in order to successfully attack.)

If this adventure is being used as part of an ongoing **Traveller** campaign, the referee may consider modifying the character of Lori slightly. It might lead to some interesting role-playing situations if Lori is the younger sister of one of the player characters, or perhaps even the daughter of an older character, if it can be fit into a character's background. (For example, the player character may wish to see that Lori is returned safely home, but the young woman grows angry and indignant, as she considers herself an adult now and does not need to take orders from the character or her parents. Eventually, Lori may admit that there are serious troubles on the homeworld in general, and with the family in particular, which is why she ran away from home in the first place. What these troubles are, and what adventures the characters might have while bringing Lori home, is up to the referee.)

Name <b>Lori DuPont</b>		UPP <b>597943</b>
Service		Rank
Birthdate	Birthworld	
Skills Athletics-1, Computer-1, Electronics-1, Engineering-1, Grav Craft-1, Ground Craft-1, Perception-1		
Possessions		Money
Comments Teenage Runaway		

UPP Card

001-000

**13. Clem's Stateroom:** Clem Valenz's stateroom is unkempt and messy. The bed is unmade, clothes are strewn about, and a variety of battered survey equipment is stacked against one wall. Clem has precious few personal belongings, and only three sets of clothes. However, two fully loaded submachine guns and a fully loaded auto-pistol are stored in the closet.

### Deck Three

**14. Gunner Positions.** At first glance, these are typical gunnery positions for a far trader. However, should a character activate the weapons systems and examine the targeting scopes, he discovers that they are somewhat unusual.

*Liberty* is equipped with a TL14 targeting system that was scavenged from a derelict space craft a couple of months ago. It provides any gunner with a functional +1 skill level in Gunnery. Further, if a character uses the targeting system to track a target for two combat rounds, he receives an additional +2 effective Gunnery skill levels, for a total of +3. This includes characters who have no skill in Gunnery, or Jack-of-All-Trades, although such characters must make a successful Average Intelligence task roll in order to initially figure out what the various instrument panels and screens are used for before they can even begin to use the weapons.

This new system is something Neff and other crew members were very happy to find. *Liberty's* crew does not include any members who are good ship's gunners.

**15. Cargo Hold/Common Area:** Due to the conversion of the cargo bay into an internal hanger for a launch, cargo space on *Liberty* is at a premium. Therefore, the portion of the ship that normally serves as the common area — where crew and passengers would take their meals and otherwise engage in social activities while in jump space — has been fitted with bay doors so it can double as a cargo bay.

When filled with cargo containers or large ill-gotten items scavenged from ruins across the galaxy, the common area consists of a small dining area with a table large enough to seat four people. When the ship is not carrying anything in particular, a variety of diversions are set up in here, including various exercise machines, and a high-quality A/V system with a large selection of popular holo-vids and musical recordings. A portion of the floor is kept clear for dancing or physical and combat training. A second table for four is also

set up, enlarging the dining area and allowing all crewmembers to take their meals together.

At present, this area contains six crates. Three of them hold the exercise machines, the fourth the A/V machine, and the fifth the second set of tables and chairs. The sixth crate contains a shipment of Second Imperium magazines, books, entertainment tapes, and personal mail. The looters found it in area 2A of the base, and Neff ordered it carried onboard the *Liberty* immediately, as he knows historians are willing to pay good money for such material. The dining area is spotless, with the microwave and food dispenser here kept clean and in top condition by Lori DuPont as part of her normal duties. Twelve sets of plates and cutlery are in the cabinet under the microwave.

**16. Engineering Section:** *Liberty's* engineering compartment is typical for a far trader, with the exception that rudimentary navigation and pilot stations have been installed in a relatively cramped corner of the area. Even if the bridge is heavily damaged or perhaps seized by boarders or mutineers, every important ship's system can be controlled from here.

When the characters enter this area, they find Sarlam Arnaarnesh, the ship's engineer, in the process of putting the final touches on the power re-routes needed for the new weapons systems to function fully. He has removed one of the wall panels, and is laying on his back on the floor with his entire upper body inside the ship's systems. The player characters can hear the whine of a powered screwdriver as Sarlam says, "Lori, you rested up already? That was quick! Grab that Power Meter next to my left leg and take up to the starboard gunnery placement. I think I got that power fluctuation beat."

As soon as Sarlam realizes that it isn't Lori who has entered the engineering section, the sound of the screwdriver ceases. "I am unarmed," the engineer says. "I'm coming out slowly. Don't shoot. I'm not going to cause any trouble."

Sarlam is a tall, muscular man with dark hair, into which the first strands of gray are beginning to insinuate themselves. He is dressed in overalls and wearing a toolbelt around his waist. He carefully removes it and hands it to a character, showing his complete surrender.

Sarlam is the son of Vilani middle managers on Sylea who were more concerned with their careers than with raising their children, Sarlam and his older sister Mara. The two siblings looked after each other as they grew into adulthood, and even after they settled into their careers — Mara as a naval officer and Sarlam as an engineer on a passenger liner — the two kept in touch and shared each other's good times and bad times.

A couple of years ago, Mara was drummed out of the service following an incident during which she stabbed a fellow officer in self-defense. The loss of the career she had made her entire life threatened to send Mara into a deep depression, so Sarlam gave up his own job so he could be on hand to give his sister emotional support and help her rebuild her life.

It didn't take long for Sarlam to discover new potential careers for both of them. Friends at the Sylean Port Authority told him that a nobleman was interviewing skilled pilots, astrologers, and engineers

for duty on what was being referred to as "an exploration vessel." Sarlam convinced Mara to go to meet with the ship's owner, Archibald Neff, and soon a new chapter in both their lives began.

Sarlam has no moral qualms about being the engineer on a ship whose captain is devoted to looting technological and archeological treasures and selling them to the highest bidder. The engineer saw some of the worst sides of the so-called "intellectuals" and "nobles" of the Imperium both as a child and during his years on the passenger liner. Further, he shares his sister's bitterness over what they both consider her unfair treatment by the Navy.

However, Sarlam is not entirely comfortable with the leadership of Archibald Neff. Although the other members of the crew are sold as much on their present activities through the money they make as Neff's stirring speeches against the Imperium's attempt to dominate every aspect of its citizens' lives, and that in their activities as looters they are striking their personal blow against the oppressors, Sarlam doesn't fully trust Neff. He doesn't believe the speeches, and thinks that when it comes right down to it, Neff is interested only in the well-being and advancement of Neff himself.

This, in and of itself would not be a bad thing from Sarlam's point of view — but then Neff's charming ways caused his sister to fall in love with him. As Mara grew increasingly enamored with Neff, Sarlam grew increasingly concerned that she would eventually get hurt or even killed as a result of a man he suspects is completely self-centered.

Sarlam's suspicions of Neff's motivations has also caused him to take Lori under his wing. He knows that Mara can, ultimately, take care of herself, but is fearful that Lori is too naive to ever even suspect Neff of any wrong-doing, and since the young woman has virtually no practical skills, he fears she will soon fall prey to abuse by one of the less moral members of the crew, particularly Ruud or Shorty. Sarlam hopes that if Lori is a valuable addition to the crew, Neff will see to it that no harm comes to her. To that end, he is teaching Lori the ins and outs of being a ship's engineer. She is a fast learner, and she has become a valuable assistant to him. Together, they installed *Liberty's* TL14 targeting systems in roughly one-third the time Sarlam expected it would take. Secretly, he hopes he can convince Lori to take a job on a ship that engages in less shady activities, with a captain and crew that are more honorable than the ones on the *Liberty*.

Sarlam's desire to protect both Lori and his sister is what causes him to surrender immediately to the characters when they invade the engineering section of the ship. He knows Lori is taking a nap in her stateroom, and he doesn't want to give the characters a reason to harm her.

Sarlam volunteers that the looter crew consists of ten members, the majority of which are in the base's command center, stripping computer components while a single crew member has made his way to the base's power plant and is attempting to restore power to the rest of the base in order to make their looting efforts easier. He adds that other crew members may have ventured to other parts of the base, but he can't say for sure. Finally, he explains that the band's leader

has taken the ship's launch to the planet's surface with the intent to conduct some business with the natives. Sarlam doesn't know what that business is, but guesses that Neff is trying to secure some form of "legal right" to the *Liberty* crew's presence on the moon. He says that if the characters want to stop the looters or horn in on their activities, their best bet is to confront Neff while he is on the planet, along with his business partner, Willard, and Willard's bodyguard, Shorty. Sarlam isn't certain exactly where Neff has landed, but offers to help the characters scan the planet's surface for power-readings from the launch.

If it becomes clear that the player characters intend to enter the base and confront the other looters, Sarlam offers himself as a hostage. He explains that although several crew members are armed and have some skills with weapons, the only really dangerous one is his sister, Mara. She is a former Naval officer, and is not likely to surrender to the characters without a fight — unless she believes resistance means he will be harmed. If the characters get suspicious due to Sarlam's helpfulness, he explains that he is merely trying to protect his sister. He has no desire to see her gunned down by them. He feels the same way about Lori.

Similarly, if Sarlam becomes aware that Lori is related to one of the player characters (assuming this option was suitable for individual referees' campaigns), he tries to quietly speak with that character. He encourages the relative to take Lori with him when they leave. Sarlam believes she is far too intelligent to spend her life as a "scavenger and interstellar scoundrel." He also tells the character that he suspects she was having serious problems at home, but that she won't talk about them. Generally, he shows an almost paternal concern for Lori, and it should be clear to the character that he is trying to look out for Lori's best interests.

Name <b>Sarlam Arnaarnesh</b>		UPP <b>8A9866</b>
Service <b>Engineer</b>		Rank
Birthdate	Birthworld	
Skills <b>Brawling-1, Computer-1, Electronics-2, Engineering-4, First Aid-2, Grav Craft-1, Ground Craft-1, Instructor-1, Jack-of-All-Trades-1, Melee Combat-1, Pistol-1, Sensors-1, Short Blade-1</b>		
Possessions		Money
Comments		

UPP Card 001-000

## Deck Four

**17. Docking Bay:** The cargo area of the stock far trader has been rebuilt into a docking bay for a small launch. When the launch is in the docking bay, it is held in place by clamps, then bay doors close, and the entire area is pressurized, allowing for easy embarkation, de-embarkation, and loading of cargo. Presently, the launch is on the planet with Neff, and the bay doors are open. Entering through them are the easiest way for the characters to gain access to the ship.

## The Lunar Installation

The lunar installation was originally built as part mining facility, part research facility, and part communications relay station. It housed 40 miners, 20 researchers, 10 communications specialists, 15 administrators, 5 security officers, and 10 general repair and maintenance personnel. Centuries ago, as the Long Night was taking hold on this system, the moon was hit by a meteor shower. An experimental communications relay that was attempting to send messages through jump space was struck by meteorites. A power overload surged through the rest of the base, burning out key circuits and fuses in the power plant and related control systems, causing both it and the emergency back-up systems to irrevocably shut down. At this point, it became apparent to the inhabitants of the base that they did not have parts on hand to fix the power plant or fuses, as what had just occurred was "impossible." After exploring all options of potentially jury-rigging a repair job, and failing, the chief administrator ordered all personnel to the Emergency Shelter. Using a solar powered emergency broadcast system, she sent out the automated distress call the player characters (as well as the looters) intercepted. She then settled in to wait along with her doomed staff and workers. Almost 1,700 years later, someone finally arrived. First the looters, now the characters.

The installation consists of a large central domed structure, with four wings radiating from it at each of the cardinal compass points. From the air, it appears like a cross. The central dome has one level on the surface, and four below ground. Each of the four wings consist only of the ground levels. The primary living quarters, administration facilities, and some labs and medical facilities were in the central dome. The outlying buildings were where mining vehicles were stored and repaired, the communications relay stood, and a couple of labs dedicated to more dangerous research could be found. The facility is still mostly intact, except that the communications wing was destroyed by the meteor impact.

Most of the members of the far trader crew who are in the base are located in the central area. Only a single crew member will be encountered outside of the central dome, and he is exploring the dangerous research labs, trying to determine what the scientists were investigating in the days before the Long Night.

The hallways are spacious and lit by panels every meter or so where power has been restored. Where power has yet to be restored, the only light is that which comes through the windows. All doors are electrically powered, but can be cranked open in case of emergencies. The doors to all interior rooms and offices slide into the wall when opened, while the interior and exterior airlocks are similar to iris valves. Working the cranks on all interior doors takes an Average Strength task while opening airlocks requires a Difficult test. Once an airlock has been cranked open, it must be cranked shut as well.

A map of the base can be found on page 108. The following paragraphs describe the base in more detail, as well as the various encounters the characters will have as they explore it. If they are brought to the lunar base as prisoners by Clem, they are taken straight to the Command Center (area 4). Here they meet with

Mara Arnaarnesh, a former Naval officer who is the lover of the leader of the gang of looters.

**1A-B. External Airlocks:** Only the airlock labeled 1A has power restored to it. All others must be opened and closed manually, using nearby cranks that are clearly labeled "Emergency Use Only."

**2A. Security Checkpoint:** Power and life support systems have been restored to this part of the base. The air and temperature are within comfortable ranges for humans.

This dome was a multi-purpose area. It served as a checkpoint for incoming base personnel and visitors, as a isolation area for those suspected of carrying disease, and as a way to verify those disembarking arriving ships were who they claimed to be. Several obvious cameras and sensor devices are mounted on the ceilings and walls of general de-embarking area.

To the right, the characters can see a long glass window. Behind it is the security station. To the right, the characters can see four doors which lead to quarantine areas.

At the end of a straight corridor directly ahead, the characters can see another airlock leading into the base (labeled 3A on the map). Mounted directly above it are two very nasty-looking anti-personnel flechette guns — the kind of weapons one typically expects to see mounted on spaceships or ground assault vehicles. There is no question in the minds of any characters with any combat skills whatsoever that if those cannons were fired in the relatively close quarters of the corridor they are standing in, they would either be killed or maimed to the point they wished they had died.

To the right of the de-embarkation area, the characters can see a long glass window, behind which instrument panels, screens, and half a dozen chairs can be seen. This is the security station from which the doors to the quarantine areas can be remotely opened and shut, the sensors and video footage of arriving personnel can be analyzed both by human and computerized observers, and the flechette weapons above the airlock can be fired. Both airlocks leading from this area can be electronically sealed from within the booth, but doing so triggers a general alarm in the Command Center (area 4). A podium-like device stands directly in front of the window. An adjustable microphone stands on it, along with a button labeled "Speak." This permitted those outside the booth to communicate with those inside.

Up to six members of the base's security or administrative staff would man this security station to observe those disembarking from incoming vessels. The only access to the security station is the airlock labeled 3B. It features an electronic lock, and the access code died with the base personnel. The looters have not yet tried to gain access to the security station, but if the characters wish to make an attempt, the electronic lock can be overridden with a successful Difficult Intrusion task roll (based on Int, as there are no tumblers or other moving parts involved.) If no character has Intrusion skill, a Formidable Electronics test can also be used to override the lock. (This lock is sturdier than the ones on the quarantine areas. Physical force to this door, short of using explosives, will only result in making it inaccessible.)

Once inside, characters can make Average Intelligence tasks to identify the various systems on the control stations. Among the interesting features here is a direct intercom channel to the Command Center, and switches to disengage the locks on the doors to the quarantine areas. Low on the far wall, in a location hidden from view from outside the window, is a small, unlocked compartment. Inside are three TL14 laser pistols, and six combination masks. (Combination masks are described fully on page 11 of the *Central Supply Catalog*. They permit characters to breathe in very thin or tainted atmospheres. The masks found in this adventure are intended only for emergency use, and are good for two hours.)

On the wall opposite the security station, the characters can see three doors equipped with electronic locks that are openable with a keycard. These were the base's quarantine areas. Any arriving travellers who might be carrying diseases would be confined here until the medical staff cleared them. The rooms were also frequently used as "waiting areas" for spacers making cargo deliveries, and who thus had no need to enter the rest of the base, or until cargo had been offloaded from their ship and they were ready to depart again. Occasionally, they also served as the base's jails.

The lock has been disabled — it appears someone took a sledgehammer to it and the door itself — on one of the doors, but the others are locked tight. Without access cards, or the ability to unlock the doors from within the security booth (see below), the characters will need successful Average Intrusion (Int) task rolls. If no character has Intrusion skills, a Formidable Electronics test can be used to override the locks.

Beyond each door are three small rooms. Each area is identical. The first room contains a medical examining bed and a small desk. In the desk drawer are standard medical examining devices such as tongue depressors and cotton swabs. The second room is a small sitting area that contains a table, four chairs, and a cabinet that contains an entertainment center consisting of an audio/visual player, a dozen films and musical recordings, and a variety of books and magazines. (These materials will be of great interest to historians, as they are genuine examples of pop culture entertainment as it existed in the final days of the Second Imperium.) There is a small cooking area in the corner that contains a sink, a microwave, and a cabinet contained freeze-dried meals, cutlery and plates. The third room contains two two-bed bunks, and a bathroom area that can be curtained off from the rest of the room. Each of these rooms is on their own, isolated environmental systems, which are monitored and controlled from the security station.

**2B. Vehicle Storage Bay:** The atmosphere here is stale and high in carbon dioxide content. The temperature is well below freezing, and a fine layer of frost covers everything. Any oxygen breathing being could not survive in the chamber for any period of time without an environmental suit, or severe cold-weather clothing and a combination mask.

Three dozen large crates (roughly ten tons of cargo) stand scattered around the bay. Most of them have been opened, and it appears someone has rum-

maged through the once-neatly packed content. They, like everything else in there, are covered with frost, indicating they were searched in this hasty fashion while the base was still active. In fact, several miners and technicians searched the crates hoping to find components they could use to repair the power systems. They were unsuccessful. Most of the crates contain a variety of spare parts and electronic components for the land crawlers, but if the characters spend 2D6 minutes searching, they find one of the crates contain 30 engineering demolition kits.

Ten land crawlers are also parked here, along with 29 of the modular payload carts. Looking over the area, the player characters can see that one payload cart and one land crawler appears to be missing. If the characters encountered the dead miner in the land crawler, this should not be a cause for alarm. Even if they didn't find him, they should quickly realize that the bay door can't be opened without power.

Along one wall stand a dozen low-gravity jackhammers, which characters with the appropriate background or skills can identify and potentially use as weapons, if the characters have been disarmed. Using the jackhammers in this fashion requires a Difficult Strength test, or the referee may wish to make it an opposed action with the target's Dexterity as the opposing value. They are considered melee weapons when used in this fashion, and have a damage rating of 4.)

Along the opposite wall is a rack containing TL14 vac suits. The rack is constructed in such a way so characters can just step into the suit and seal it without any additional assistance. The rack is capable of holding 40 suits, but two are missing. On the wall behind the rack is brace that at one time held ten TL14 laser pistols in holsters. One of the weapons and holsters are missing. (Clem has both the pistol and one of the suits; the other suit is worn by the dead man in the land crawler.)

The only other object of interest in the vehicle storage bay is the exoskeleton that hangs in one corner. It has been built to handle cargo and other heavy equipment, and its battery has power for six hours of operation remaining in it. An additional 1D6 minutes of checking crates turns up a crate containing 200 kilograms of plastic explosives. The explosives are identical to the ones described on page 67 of the **Traveller** rulebook.

In addition to the airlock, a large bay door leads to the lunar surface. If the characters wish to drive a land crawler out of the base, they will need to open the door, which cannot be done unless power is restored to this part of the base. The door can be blown open using the explosives or torn open with the exoskeleton should the characters wish. (The door has an armor rating of 5.)

### **TL14 Engineering Demolition Kit**

Contained in dull-gray metal boxes with hinged lids, these kits consist of an assortment of items that let characters rig explosive charges and fuse them for detonation. These kits are primarily used by miners and construction or demolition crews, but they also see some military use. Primitive versions of such kits are available at TL5. The TL14 kits found by the characters in this adventure are primarily geared for use in vacuum. While such kits would typically contain a vari-

ety of non-electrical fuses and ignition devices, these kits do not.

Some items in the kit are intended for reuse. Others, such as the blasting caps are not. Each kit weighs 25 kg when fully packaged, and typically sells for 400+1D60 credits. Wholesale value is 150+1D60 credits. Actual explosives must be acquired separately. A single charge uses one blasting cap, as well as whatever fuse and detonators the character chooses to use. Wires, tools, timers, and blasting machines can all be recovered after the explosion, but all other items are used up. Each kit contains the following components:

Tools. Pliers, knife, tape, and other items needed to prepare explosive charges.

50 Electrical Blasting Caps. At least one is required to set off an explosion.

50 Nonelectrical Blasting Caps. At least one is required to set off an explosion.

3x100 Meter Spools of Electrical Wire. For use with electrical blasting caps. Not typically reused.

1x500 Meter Spool of Trip Wire. This thin wire is used in booby traps and the like. Tripwires can be of any reasonable length, but are typically not longer than the blast radius.

1 Blasting Machine. This is a hand-cranked electrical igniter that can fire up to electrical 12 blasting caps at a time. It never needs recharging and does not use batteries.

5 Timers. These detonators have digital timers that can be set at any time ranging from 30 seconds to 72 hours, in 30 second increments. It will fire up to electrical 20 blasting caps.

5 Manual Igniters. These pull/release detonators can be used as part of sophisticated booby traps. It detonates when pressure is placed on it, or when pressure is placed on an attached trip wire, or when tension is released from an attached trip wire, all depending on the configuration of the igniter. Up to six trip wires may be attached to the detonator, or it can be used under a single pressure plate. (Trip wires may also be used in conjunction with pressure plates.)

### **TL14 Exoskeleton**

A variety of different types of exoskeletons may be found on worlds of TL11 or better. Some are designed for combat purposes, others for rescue operations, but the most common ones are built to handle cargo in confined spaces, or where other types of forklifts or transportation might not be available.

The exoskeleton stands close 3 meters tall, and is about 1.5 meters wide. It is an open, tubular framework, into which the user climbs, straps himself into a harness, and manipulates the exoskeleton through body movement and levers. Unlike the TL11 exoskeletons, operators of TL14 exoskeleton do not need wear Battle Dress in order to work the equipment. The exoskeleton provides no armor protection for the user, and it is considered to have an armor of 2 for purposes of resisting damage to itself. It has battery power that permits 12 hours of uninterrupted use.

An exoskeleton has an amazing Strength. It is capable of lifting and carrying objects of two metric tons or less, or crush objects with an armor rating of 5 or less (2D damage per round), but it has low agility



and specialized skill requirements. The exoskeleton has an effective basic Strength of 15, and the user suffers a -2 Dexterity penalty and cannot use it for fine precision work at all. The operator can increase the Strength of the exoskeleton with an additional penalty of -1 Dexterity per point of Strength increase.

**2C. Research Facilities:** Two laboratories occupy this dome. Power has not been restored to this area. The atmosphere in each is high in carbon dioxide content. The temperature is well below freezing, and a fine layer of frost covers everything. An oxygen breathing or human character could not survive in the chamber for any period of time without an environmental suit, or severe cold-weather clothing and a combination mask.

Although this base was primarily devoted to mining, the local Vilani government maintained these labs in order to conduct sensitive, top secret, and potentially dangerous research.

The lab on the right of the hall was dedicated to weapons research. The door to this lab is locked. Behind it, four TL14 lasers have been rigged to equipment designed to manipulate the output of the weapons. Without power, none of these experiments are functioning. The objective, however, was to create laser weapons that fired invisible and highly radioactive beams. The hope was that firing these at ships and other vehicles would irradiate them, making them easier to track should they escape destruction. Details on these experiments (which were still in their early stages and had been largely unsuccessful) are contained in the computer banks also inside this lab. Still, should the characters manage to get the data from these experiments, as well as the actual experimental devices, they will be able to sell them to Imperial or corporate researchers for a fair amount (5,000 credits and up, depending on how effective their bargaining efforts are).

The lab on the left was dedicated to researching chemical weapons. It is packed with a bewildering array of computers, atmosphere analyzers, incubators, DNA analysis machines, and racks containing hundreds of sealed jars and vials.

Characters may or may not find any useful chemical compounds while searching this room — that is left to the whim of the referee. However, there are analysis and initial experiments on chemical weapons that speed the onset of rust in metals, make a wide variety of atmospheres unbreathable, and cause chemical reactions that will ignite the hydrogen in any substance or compound. Although none of these weapons are fully developed, the characters can make thousands of credits by selling these initial findings to corporations or the Imperium. (The referee should make clear how monstrous the weapons that were being developed here were. Perhaps the social conscience of the characters will win out over their greed.)

**2D. Communications Facility:** This dome has almost been completely destroyed by a meteor impact, the same meteor impact that spelled doom for the inhabitants of the base. The entire area is exposed to the cold vacuum of space.

The characters can easily make their way through the twisted wreckage, much of which has been blackened by an explosion, to the airlock leading into the

base. The airlock and emergency crank were damaged in the explosion, and attempts to open this door without the use of an Iris Valve Opener (see *Central Supply Catalog*, page 25) or similar piece of equipment are made through Formidable Strength tasks.

If characters spend time searching the wreckage, they find the remains of several different military grade communication devices, several maser broadcasting stations, as well as the remnants of equipment they can't identify. (These are the fragments of the experimental jump-space communications device. These odd bits of technology may, nonetheless, be of interest to researchers should the characters attempt to gather them all. Such an effort requires a dedicated search of the ruins, which will take 3D6 hours in order to find all the pieces of strange tech.)

If the characters do indeed take the time to recover all the pieces, they can sell them to Imperial researchers. Up front payment equals 1,000 credits, with additional payment promised once the researchers have decided the actual value the fragments have to their work. (The referee can determine this. The payment might be an additional small cash payment, fuel for the ship, and a mission, for example.)

**3A-D. Internal Airlocks and Access Tubes:** Only the airlocks labeled 3A and 3B have power restored to them. All others must be opened and closed manually, using nearby cranks that are clearly labeled "Emergency Use Only." The four wings of the base are connected by these access tubes. They have walls made from two-inch thick, transparent, impact-resistant curved diamond sheets. Each end of the tubes features airlocks. The only airlocks to which power has been restored are the ones where the far trader is docked, and the ones leading into the central structure (1A and 3A).

**4. Command Center:** This was the heart of base operations. Power and life support systems have been restored to this part of the base. The air and temperature are within comfortable ranges for normal humans.

The command center is accessed through the internal airlocks, labeled 3A, and 3C-E. Two elevator shafts lead from hereto the sub-surface levels of the installation. An armory (labeled 5 on the map) is situated between the elevator shafts. It is virtually impossible for the characters to gain surprise on the looters in the control center, as they must open an airlock to enter, which results in a -3DM to the player characters' surprise and initiative rolls in the first round of combat.

This circular chamber is crowded with elaborate banks of screens and computer terminals. Part of the floor has been sunken, and five steps lead down to a large table with a shiny black top. Thirteen chairs stand around it, and small monitors rise from the table surface before them. At one time, this served as the base's conference area. Smaller meetings were held in the private offices on the lower levels.

Elsewhere in the room, four half-circles radiate around a central console island. Each half-circle has two work-stations, each capable of monitoring a specific base function when the command center is functioning. Presently, only the central console island remains operational, as the looters have already begun to disassemble the computer components in the command center. (Characters who examined the content of

the *Liberty's* cargo hold recognize the computers here are of similar make to the parts they found.) However, the entire station can be monitored from the central console, and any doors to which power has been restored can be opened or locked from there as well.

Depending on how the adventure has progressed up to this point, there may be as many as four looters in here, or there may only be one. If the characters are captured by Clem, he brings them here, so that Mara Arnaarnesh, the looter in command on the moon, can decide their fate.

Mara is a tall, dark-haired woman in her early thirties. She moves with the fluid grace of a cat. She is dressed in a black jumpsuit and wears a tool harness from which a variety of electronic, and mechanical tools hang. She also carries two daggers and is very efficient in their use, and has picked up one of the TL14 lasers from the armory in the command center. For the current stage of the operation in the base, she is also using a powerful portable computer.

Mara is a former lieutenant in the Imperial Fleet. She was a talented astrogator and by all appearances had a promising career ahead of her, but then she stabbed a fellow officer. A hearing concluded that she had acted in self-defense — the drunken man was trying to force himself upon her — but unfortunately for Mara, he was the son of a powerful Sylean noble. The Admiralty needed to put the incident behind them, and the easiest way to do so was to court martial Mara and give her a dishonorable discharge.

The fleet had been Mara's life, and it was only through the support of her brother, Sarlam, that kept her from being lost in a downward spiral of depression. It was also Sarlam who first introduced her Archibald Neff, the man with a plan that would lead to a new phase in both their lives.

Mara initially held Neff in contempt, classifying him with the noble who cost her career, but when she came to understand that Neff too had been abused by Sylean nobility, she warmed to him. This warmth gradually grew into love, spurred by a combination of Neff's charm and Mara's subconscious desire to put the bad times behind her for good. What this emotionally wounded soldier does not understand, however, is that her devotion to Neff is almost entirely a one way state of affairs; Neff merely finds her skills useful, and doesn't like sleeping alone.

Under most circumstances, Mara is seated at a terminal in the central console island, while Ruud and Marty dismantle consoles. While they do the basic grunt-work, Mara is working on establishing a link with the base's main computer, so the looters can download as much information from it as Mara's portable computer will hold. Should Ruud and Marty have been sent to take the player characters' ship, Mara might be in the control center alone, but she is still seated at the console island. If she is alone, and if she knows the characters are on the moon, she has a TL14 laser pistol within reach. As soon as she becomes aware of the player characters' presence, the referee should call for initiative rolls, as she ducks for cover and starts shooting immediately. (The only exception to this the unlikely eventuality that the characters show up with Sarlam as a hostage. Mara will negotiate for

her brother's safety, as the siblings are very devoted to each other's safety and well-being. She will even give up the location of Archibald Neff if she thinks it will save her brother.)

If the characters didn't board the ship, there is a 1-in-6 chance that Mara's brother Sarlam has come to the command center to help strip computer components. In this case, Mara and he will be ribbing each other — Mara implying that Sarlam's tutelage of Lori is him "robbing the cradle," and Sarlam retorting that if his sister could get a real man, she wouldn't be having a relationship with a Solomani. If the characters eavesdrop for a couple of minutes (upon opening one of the airlocks just a crack, for example), they hear Marty (if he is present) pipe up with a crude remark of his own, something which makes the Vilani siblings fall silent. (If the characters can see one or both of them, they see that Mara and Sarlam are giving Marty poisonous stares.) Marty murmurs an apology and goes back to his work. Mara and Sarlam do not resume their banter, but continue their work quietly. Characters who act quickly might get the drop on the group during this exchange, although Mara will still attempt to put up a fight unless it is clear that Sarlam is in immediate danger. Ruud and Marty follow her lead. (Descriptions of and game statistics for Ruud and Marty are on page 38.)

If Clem brings the player characters to the base as prisoners, Mara conducts a brief interrogation, consisting basically of "What are your names?," "Who sent you?," and "Give me one reason why I shouldn't kill you where you stand." She then orders the characters to remove their vac suits, and then instructs Marty and Ruud to search them, take all their equipment, and lock them in one of the quarantine areas in 2A. Neff will decide their fate, she says. (If it comes to this, the referee should proceed to "Continuing the Adventure" and "Neff's Offers" in "Neff and the Natives.")

There is a chance that Mara may recognize a character who is a former officer in the Sylean Navy, and visa versa. (Roll an Average Intelligence test. The character who succeeds recognizes the other.) If the character mustered out under negative circumstances, and if the player characters have not harmed Sarlam, or killed any members of the looter crew, Mara might extend an invitation to him to join the looters. She portrays Neff as a righteous man who is struggling against the oppressive forces of the Imperium. She claims that Neff gave her and her brother a second start, and that perhaps he can give a similar new start to the character, too. The invitation may be extended to other characters if the former officer puts in a good word for the rest of them. Mara is particularly interested in recruiting the character if he can add a second ship to the looters' lineup — seeing a fellow former Naval officer has put her in mind that perhaps there is a chance of building a small fleet that will increase everyone's chance at getting wealthy and getting back at the Imperium in a small way.

Mara's offer to the character is genuine, as is her plan. She may be embittered, but deep down she is a good and generous person who wants to share her good fortune with someone she perceives as being in a situation similar to hers. She also believes that with

two ships, they will be able to make twice the money.

Should she convince the character to join them, and if he in turn convinces the other characters to join, Mara suggests that they take the characters' ship to the planet, where she can introduce them to Neff. Mara leaves Sarlam in charge of the moon operation and travels to the planet below with the characters.

Name <b>Mara Arnaarnesh</b>		UPP <b>7B8C76</b>
Service <b>Astrogator</b>		Rank
Birthdate	Birthworld	
Skills <b>Astrogation-5, Athletics-1, Brawling-1, Computer-3, Electronics-1, Grav Craft-1, Ground Craft-1, Intimidation-1, Leadership-1, Long Blade-1, Mechanics-1, Pistol-2, Sensors-2, Short Blade-2, Tactics-1, Vac suit-1</b>		
Possessions <b>Two daggers, repair tools, portable computer, TL14 laser pistol</b>		Money
Comments <b>Former Naval Officer</b>		

UPP Card 001-000

**5. Armories:** There is an armory on each level of the central dome, near the elevators. The doors on the compartments are lined by red and are labeled "Authorized Personnel Only." The doors are not secured in any fashion, but opening them triggers alarms in the Commander Center.

Each armory holds four thud guns and two fully charged TL14 laser pistols. Six combination breath masks and a medkit are also stored in each of these lockers. The exception to this is the weapons locker in the command center.

**6A-B. Elevator Shafts and Emergency Ladders:** The elevators are locked in position on the third underground level. The looters have not yet bothered to reactivate them, choosing instead to use the ladders that run along the inside of each shaft.

**7. Administrative Offices:** Power and life support systems have been restored in these rooms, which are linked to the same life support and power systems as the rest of the central part of the base. The air and temperatures are within comfortable ranges for humans. Each of these areas contains 1-2 desks with computer terminals, several filing cabinets, and an "operations board" on one of the walls, containing maps of the moon, star charts, or other materials relevant to the work those who kept this office were devoted to.

The offices are personalized to varying degrees. Some are so spotless as to appear as if they had been vacant, until the characters discover the filing cabinet is full with fragile paper documents and old computer disks. The walls of others sport pictures of families and friends, or media idols from the last days of the Second Imperium. A rare few of the offices are awash in a papers, disks, and half-eaten donuts. The worker in such an office probably claimed he had a "creative filing system," but everyone else would just call it "disorganized." Each office bears some small evidence that the workers left in a hurry, even if the messy offices may appear as though some sort of fight took place in them.

All computers in the offices are linked to the central computer, and the looters have yet to begin to disassemble them or the links. However, due to the systems architecture, most offices can only access certain parts of the central system — such as personnel records, mining data, laboratory information, or financial records, to name a few examples — and only on a roll of 1 of on a six-sided die does the terminal grant full access to all data. (As mentioned in the description of area 4, the computer data can be used to plant leads to adventures of the referee's own devising, or to other adventures in this anthology.)

**8. Living Quarters:** Power and life support systems have been restored to these rooms, which are linked to the same life support and power systems as the rest of the central part of the base. Each of these rooms holds the personal belongings of individuals long dead, ranging from clothes and personal hygiene items, to love letters and pictures of family. Most rooms housed a single individual, although if the referee rolls a 1 on 1D when the characters enter it, a couple shared the room. Two different sizes of clothes are in the closets, and the room holds a double bed. All rooms show evidence that a few items of clothing, toiletry, and possibly a book or picture or two were quickly grabbed from them. (Closets and medicine cabinets stand ajar, or there is a bare spot between two pictures on the wall where something evidently once hung.)

There is nothing of value in any of the chambers, beyond artifacts of the final days of the Ramshackle Empire. Even the money that is stored in some of the rooms is now worthless to anyone except historians, as the planetary government that issued it is long gone.

**9. Kitchen:** Power and life support systems have been restored to this room, which is linked to the same life support and power systems as the rest of the central part of the base. The air and temperatures are within comfortable ranges for humans. Food storage bins line the walls. Most of the food is freeze-dried and still edible, although the many centuries have left it somewhat tasteless. Food preparation areas, sinks, washing machines, and microwave ovens are other features of the room. Characters in search of weapons can find five electric knives here. They have damage ratings of two, and are only usable in melee combat.

**10. Messhall:** This was the dining area of miners and low-ranking staff members. There are six tables, each flanked by benches, and several half-eaten meals. It is clear that the messhall was vacated in a hurry. The messhall could only handle 36 people at a time, which was more than adequate as life in the base happened in three shifts. Power and life support systems have been restored to this room, which is linked to the same life support and power systems as the rest of the central part of the base. The air and temperatures are within comfortable ranges for humans.

**11. Dining Room:** This was where chief administrators and important visitors would take their meals. The room is smaller and more elegant than the spartan, utilitarian messhall. Power and life support systems have been restored to this rooms, which are linked to the same life support and power systems as the rest of the central part of the base. The air and temperatures are within comfortable ranges for humans.

**12. Workshops:** Power and life support systems have been restored to these rooms, which are linked to the same life support and power systems as the rest of the central part of the base. The air and temperatures are within comfortable ranges for humans. A variety of tools, diagnostic computers, vehicle parts, and disassembled mining equipment or communications gear can be found on long tables in these rooms. Virtually any tool the characters might need can be found in one of these workshops. (The exception to this might be highly specialized devices used in starship maintenance.)

**13. Laboratories:** Power and life support systems have been restored to some of these rooms. Most of the labs (on rolls of 1–5 while the characters are exploring them) are linked to the general environmental systems of the central building. Within these labs, the oxygen levels and temperatures are within comfortable ranges for humans. Some of these labs are devoted to a variety of chemical research relating to more efficient extraction of ore, data which might be of great value to both the Imperium and the mining corporations. A couple of the labs are medical facilities, from which the characters can recover automated medical facilities, portable medical scanners, and a variety of smaller items of medical technology. On rolls of 6, the lab is isolated on its own environmental systems. These facilities are ancillary to the main weapons research lab in Area 2C.

**14. Recreational Facilities:** This is where miners and base personnel would blow off steam after a hard week of work. The large room contains a variety of diversions, ranging from workout machines to virtual-reality video games. Four vending machines and two drink dispensers (one with alcoholic beverages, the other with non-alcoholic beverages) flank the games. Several tables and chairs stand around what appears to be a dance floor, and a hi-tech juke box stands against the far wall.

Each of the machines and the jukebox in this room are of potential interest to historians, social scientists, archeologists, and corporations alike. Each weighs several hundred pounds and takes up .1 displacement ton in a cargo hold. Should the characters acquire them, they will be able to sell them at auction for 2D600 a piece, with additional modifiers based on good bargaining rolls at referee's discretion.

Power and life support systems have been restored this area. The air and temperatures are within comfortable ranges for humans.

**15. Power Plant and Environmental Control:** When the meteor struck the communications center it caused a powerful surge that burned out key components in the base's power plant. Power to all systems failed, including life support. The surge even shut down life support systems that operated independently of the general environmental control system, as they were all governed by the computer in this room. The parts needed to repair the power plant were not available in the base, so the personnel were unable to affect repairs. No ships were in the system to come to the aide of the base, so the inhabitants died.

One of the looters is here, trying to restore power and environmental control systems to the entire facility. He is Jonathan Delaware, a Solomani archeologist

and engineer who lost his tenure at the university on Urish in the Core sector. He is a slender man with graying blond hair, narrow eyes, and a weak chin. He is dressed in a utility suit, and is unarmed. When the characters come upon him, he is deeply absorbed in his work, and does not notice them until they are literally standing over him.

Delaware likes to claim (and does so frequently and loudly when around what he believes to be sympathetic ears) that he was removed from his position for no reason other than his Solomani ethnicity. He claims that he is living proof that the Imperial bureaucracy, with the help of the AAB and the Traveller's Aid Society, is trying to wipe out all Solomani cultural identity within the Imperium.

The truth of the matter is that Delaware was drummed off the faculty after it was discovered that he had been selling artifacts from digs at Ancient sites to private collectors rather than bringing them back to the university for further studies. Delaware joined Archibald Neff's crew during a recent stop-over on Urish. The disgraced professor had been stranded there since he could not afford passage off the world as most of his ill-gotten gain had been claimed by authorities. His combination of technical skills and vast book learning has made him a valuable member of the crew. Delaware is loyal to Neff more because of the opportunities he has to continue his exploration of ancient sites while continuing to make money doing so.

Delaware is not a brave man. He immediately surrenders if challenged. Additional threats must be leveled against him before he betrays his shipmates, however. Still, the information he can provide is scant, and probably not anything beyond what the characters have already learned: That he is part of a crew of interstellar scavengers and looters, and that their leader, Archibald Neff is on the planet below negotiating formal ties with some of the savage tribes, hoping to use the relationship to either delay the efforts of Imperium first contact teams long enough for them to make good their escape, or to start building a small slave ring in the system. Delaware does not know exactly where Neff is meeting with the natives.

If the characters clearly have the upper-hand when they encounter Delaware, he attempts to join their crew. He claims that he was forced into working with Neff and his crew (which is a lie). To show his good will, he shows the characters that from the computer in this room, they can monitor and control all of the base's systems, including the atmospheric pressure, composition, and circulation in all areas. (The characters can determine as much themselves, or verify Delaware's claim with a successful Easy Engineering task and 2D6 minutes of time spent examining the consoles.) If the characters have not yet defeated the looters, they can attempt to do so by making them pass out through oxygen deprivation.

Delaware, however, is far from a loyal friend to the player characters. If they trust him and allow him to join their crew, he betrays them at the first sign of trouble as he did with his companions during this adventure. Delaware is only interested only in his own future well-being.

Name <b>Jonathan Delaware</b>		UPP <b>575AB8</b>
Service Engineer/Scholar		Rank
Birthdate	Birthworld	
Skills Archaeology-3, Carousing-1, Computer-2, Engineering-2, Forgery-1, Grav Craft-1, Ground Craft-1, History-3, Instructor-1, Jack-of-All-Trades-2, Linguistics-1, Pistol-1, Survival-1		
Possessions TL12 portable repair kit		Money
Comments		

UPP Card

001-000

**16. Emergency Shelter:** An underground access tube some 75 meters long leads to an complex which in some ways resembles a smaller version of the central building. It has a small command center, a communications room, a medical facility, recreational facilities, a common room that doubled as a messhall, and sleeping facilities for 110 people.

Like the rest of the base areas without power, the temperature in the shelter is well below freezing. The carbon dioxide in the air here is well into the dangerous levels. The reason for this is clear as soon as the characters start exploring the area: 89 men and women lay dead, covered by a fine layer of frost. Most of the bodies are in the bunks, but some are slumped in chairs in the common room. A single female lays on the floor in front of the communications equipment in the comm room. It was her voice that brought the characters to this place of death, and it is a voice that was silenced by death over 1,700 years ago.

If the characters explore this grizzly, makeshift tomb, they find many more artifacts of every day life at the end of the Second Imperium. They also see sights that should tug at their heart-strings, such as a couple locked in a final, eternal embrace, or a parent holding a photo of the children they never got to see again in his or her frost-coated hand.

### Continuing the Adventure

If the characters are captured and locked away in area 2A, they have 1D6+10 hours to escape. If they take no action, they become little more than lambs waiting for the slaughter. Neff returns to the moon and orders the characters executed. Ruud and Marty, if still alive, happily follow the order. If Ruud and Marty are dead or otherwise incapacitated, Neff and Mara conduct the executions. A kind referee may give the player characters one last chance by letting them get the drop on the NPCs that come to kill them — although Neff and Mara are both smart enough to kill the characters by cutting off the oxygen to their prison and sending Ruud and Marty to shoot them as little more than an extra precaution. Another option is to make a second check to see if Mara recognizes any former Naval officers among the characters. If she does, she may extend her invitation to them in front of Neff, prompting the noble to attempt to deal with the characters in the fashion outlined in "Neff's Offers", below.

If Mara invites the characters to join the looters, or

if they somehow force her to reveal Neff's location on the planet, she returns with them to their ship. She gives them coordinates that takes them toward a valley some 30 km from one of the planet's many shattered, overgrown cities. Here, they encounter Archibald Neff, the charismatic leader of the looters.

### Neff and the Natives

The leader of the looters have taken the launch to the planets surface. Here, Archibald Neff, *Liberty's* broker/trader Willard Nelsen, Willard's bodyguard, Shorty, took the ship's launch to one of the many villages on the planet and entered into negotiations with the leader of the settlement.

When the characters disembark their ship, they are met by dozens of friendly, excited natives. If a member of *Liberty's* crew is with them, he/she explains that Neff radioed the ship several hours earlier and reported that he had learned the primitive natives were actually waiting for someone to visit from the stars one day. Further, that the various villages were in a constant state of war with each other. Neff said he was hoping to use these facts to greatly increase the profits that could be made in this system.

Unless the characters resist, the natives escort them to the village, chattering at them in a degenerate form of Galanglic (Average Linguistics tasks to understand) about how the characters are the companions of the Bringers of the New Golden Age. Questions are answered with eager assurances that will be shown all the honor they are, and that the chief is the one who can answer their questions.

When the player characters arrive in the village, twilight is settling over the land. The village, which is a curious collection of ancient, weather-beaten structures built by a hi-tech society and simple huts with mud brick walls and thatched roofs, is alive with activity. By the light of dozens of flickering torches, the natives are gaily beating drums and playing flutes while others are preparing a great feast. The characters are escorted to a group of musicians, one of whom puts aside his flute and leaps up and embraces them and any non-player character companions they have in turn. He is dressed in simple clothing like the other natives, with the exception of a large, corroded loose metal collar around his neck. It is clearly the remains of some hi-tech artifact, and curious characters can identify it as the neck seal from an EVA suit upon making a successful Average Vac Suit task. As he embraces them, the native identifies himself as Chief Bran, and says that he is delighted that even more visitors from the stars could join them for the festival in honor of the "Bringers of the New Golden Age."

Bran is a tall, powerfully built man. His skin is tanned from a lifetime spent close to nature. Although Bran may come across as an excited child in his initial dealings with the characters, he is an intelligent man with a well-developed eye for body language and a keen sense of sarcasm — he is, in fact, what his people consider a highly skilled diplomat. Sights and put-downs from the characters are initially met with slight confusion, but if they continue to treat him like a fool, his patience eventually wears thin. Characters who alienate Bran during this first encounter may come to

regret it when events heat up later in this section of the adventure.

While the chief is fawning over the People from the Stars, he can manage to answer basic questions about his village and people: There are roughly 600 men, women, and children in the village, which is known as Soobub. Soobub is allied with three surrounding villages, but is at war with all other known settlements. Bran is particularly excited because Spaceman Neff has not only promised them powerful weapons with which they can defeat their enemies, but has also promised to take any captured enemies to the stars so they will never trouble Soobub and its allies ever again.

When someone eventually asks him to take the travellers to see Neff, Bran leads them to a building that is part concrete and part mud bricks. Spaceman Neff, Spaceman Willard, and Spaceman Shorty are within, he explains. Then he returns to the preparations for the feast, and to his musical activities.

It is possible that one or more characters — particularly those with a scholarly bent — will be more interested in observing the natives than speaking with Neff. These characters will find that their very presence is disruptive to the native activities, unless they make an effort to remain undetected (such as an Average Stealth task). Characters will be swarmed by natives wanting to know what it is like to live among the stars, what the purpose of the strange devices they carry are, and whether they can travel with characters to see the stars up close. The only place characters will be able to participate in or witness undisturbed native activity is if they get involved with the small orchestra Bran is currently part of. Offers will be extended to the characters to play either the drums (an Average Music task) or the flute (a Difficult Music task), with unskilled attempts defaulting to Dexterity. The characters need not know anything specific about the musical works of this people, as everything they perform is strictly improvisational. The other musicians will adjust their performances to incorporate the efforts of the characters, and after they have played for awhile, Bran interrupts the music and loudly announces that, “the Spacemen have within them the hearts of Soobubs! They are now part of the tribe, as well as valued allies!” Then the music resumes.

For characters who go to see Neff, they step into a room that is decorated with animal hides, ornate, primitive weapons, and a variety of relics from the hi-tech society the natives once possessed, all of which have long since ceased to function. Neff (a dark haired, fit man in fine clothing of Solomani styling with a sword at this side), Willard (a balding, pudgy man in a Vilani business suit), and Shorty (a short, thick-necked and broad-shouldered man with a blond crewcut, who is wearing an ubiquitous ship’s utility suit) are seated cross-legged in the center of the room, a low table between them. On the table are a variety of gourds, cups containing liquids, a crude map of the surrounding area, and a star chart.

As soon as the characters enter, Shorty immediately grabs his nearby shotgun and aims it at them, clearly intending to use it. Either quick words or quick action on the part of the characters or any NPCs accompanying them will prevent Shorty from unload-

ing on them — after all, Neff and his crew are the only known travellers in the system, and any newcomers can only be viewed as threats. And Willard Nelsen pays Shorty to eliminate problems in a permanent fashion.

If the player characters react by either drawing or firing their own weapons, a combat has started. Willard starts shrieking hysterically and draws his thud pistol to support Shorty against what is probably overwhelming odds, while Neff simply dives for cover in an adjacent room, all the while shouting, “Cease fire, you clods! Cease fire!”

Once the shooting starts, it doesn’t stop until the characters or Shorty and Willard are disabled or dead. One of Neff’s crewmembers who escorted the characters to the surface may take the chance to jump one of the PCs, trying to wrestle their gun out of his hand. This character is likely to fall victim to gunshots from one side or the other.

Should battle erupt at this point, the referee should continue the adventure with “Wrapping Things Up.”

If the characters don’t open fire on Shorty, both Neff and whichever *Liberty* crewmember brought them to the surface start yelling at Shorty to put his gun down, and for the player characters to remain calm. Shorty obeys, and once the immediate danger of a gun-battle has been averted, Neff politely asks who the characters are, and what they are doing in this system.

Any answer given is augmented by comments from some *Liberty* crewmember who joined the characters on the trip to the planet (if any). For example, if Mara formulated the idea of the two ships joining forces, she brings that up at this point. He/she also brings up any deaths the characters may be responsible for, but will typically try to explain the deaths away as the fault of victims if he or she has become favorably disposed toward the characters.

After exchanging introductions with the characters, and inquiring as to the status of his ship — he wants to know that it is unharmed and to ensure that it will be returned to him in the condition in which it was seized. He is also willing to lay out the plans he had for the lunar base and the natives on the planet. (The base was simply going to be stripped over a period of time, while the savages of the planet were to be used as a stock in a slave ring that Neff and Willard intend to start building. Soobub and its allies will be supplied with pistols, rifles, and other hi-tech weapons, and they will round up the population of other villages, their enemies, and hold them for pick-up by slave transport ships.) As he converses with the characters, he also mentions that he believes the window of opportunity in this system is limited, as it is close enough to the shipping lanes that a First Contact Team from the Imperium will arrive here sooner rather than later. For this reason, Neff and his crew are moving as fast as they can.)

Neff is happy to deal with the characters in a reasonable, non-violent fashion. If it appears they can be talked to or negotiated with, he happily does so. “I’m a business man,” he says. “You’re businessmen. Let’s work out a deal.”

The truth of the matter is that Neff has no interest in dealing with the characters. If he can’t buy them off

Name <b>Chief Bran</b>		UPP <b>98783F</b>
Service		Rank
Birthdate	Birthworld	
Skills -2, Bow Combat-3, Brawling-1, Carousing-1, Diplomacy-2, Equestrian-1, Law-2 (his own culture only), Leadership-3, Long Blade-2, Music-1, Recon-2, Short Blade-2, Survival-1, Throwing-1		
Possessions Bone dagger, wooden flute		Money
Comments (Social Standing is for his homeworld only, and his title is "chief.")		

UPP Card 001-000

Name <b>Shorty</b>		UPP <b>B76655</b>
Service Bodyguard		Rank
Birthdate	Birthworld	
Skills Brawling-2, Computer-1, Ground craft-1, Intimidation-2, Jack-of-All-Trades-2, Melee Combat-2, Shotgun-2, Stealth-2, Vac suit-1		
Possessions Metal club, shotgun		Money
Comments		

UPP Card 001-000

Name <b>Willard Nelsen</b>		UPP <b>764997</b>
Service Pilot/Crooked Trader		Rank
Birthdate	Birthworld	
Skills Administration-3, Broker-4, Communications-4, Computer-1, Fast talk-3, Forgery-2, Grav Craft-1, Ground Craft-1, Law-2, Melee Combat-2, Piloting-4, Pistol-1, Trader-5		
Possessions Small selection of drugs, thud pistol		Money
Comments		

UPP Card 001-000

Name <b>Archibald Neff</b>		UPP <b>87789D</b>
Service Disgraced Noble		Rank
Birthdate	Birthworld	
Skills Archaeology-1, Carousing-2, Computer-2, Diplomacy-3, Equestrian-1, Fencing-2, Fast talk-2, Grav Craft-2, Ground Craft-2, History-1, Jack-of-All-Trades-2, Law-3, Leadership-3, Navigation-1, Ship's Boat-2, Tactics-1, Vac Suit-2		
Possessions Agreement signed by Chief Bran, sword		Money
Comments		

UPP Card 001-000

with some cash and an offer to share the findings on the moon, he will eventually take steps to remove them from the picture on a permanent basis.

### Neff's Offers

Neff has the following solutions to resolve the differences between his crew and the player characters:

- "I'll pay you 100,000 credits in cash, and I'll share the findings from the base on the moon with you, if you get lost and never bother us again."

This is the only option in which Neff won't try to betray the player characters at some point. He is willing to go as high as 500,000 credits (which is all the cash he has with him, stashed aboard the launch), and is even willing to give the characters first pick of base equipment — although it will be clear that he is highly annoyed if forced into such a lopsided deal, particularly if the characters boarded *Liberty* and now have the same information on potential salvage sites that his experts had located through painstaking research.

If the characters do have access to that information, Neff and his crew will not bother with those sites. If the characters accept the payoff, Neff intends to immediately return to the moon and prepare for departure. He will shift his operations to a different sector of space, chalking the events of this adventure up to a learning experience: From now on, they're going to stick to small operations that are measured in the space of hours or days, not the weeks or months it would have taken to fully exploit this system. Neff hopes to never cross paths with the player characters again.

- "Eventually, we're going to get a lucrative slave trade going here, and the natives are going to do all the work for us. With a ship your size, we won't even

need to hire transports. I'm willing to give you 60% of the take on slaves, if you supervise the operation."

Neff suggests this if the characters want more than simply sharing the moon base with him. He is willing to go as high 80% of the cash take, but insists that the characters must do all the dirty work involved with the transportation of the slaves to the various markets on the fringe worlds of the Imperium. Connections will be set up by Willard, he promises, and Lori DuPont will be transferred to the characters' ship to serve as Neff's "eyes on the scene." He wants to meet with the characters on Sylea every six months so he and the crew of *Liberty* can receive their cut.

Characters who choose to become slavers will be betrayed by Neff almost instantly. While it is virtually impossible for the Imperium to prevent slavery even on worlds within its sphere of influence, the interstellar government can (and has) made the transportation of slaves between worlds and star systems an offense punishable by death for the slave ship's captain and the imprisonment of the crew. Neff intends to make the Imperium aware of any slavery activity the characters might engage in at the earliest possible moment, so sooner or later, they will jump into a waiting Naval ambush. If they manage to escape the Imperial law at that time, law enforcement at all of the Imperium's ports will be on the look-out for the characters and their ship. He made Lori his representative in the matter because to his mind, she is the most expendable member of his crew.

Before the characters commit to this option, the referee should let those who are knowledgeable in the areas of Administration or Law to try to roll Average tests in whichever of these skills they have the highest

rating. If the tests are successful, they are aware that transporting slaves is illegal in the Imperium, and they are aware of the punishments leveled against the violators. The referee should just point out these facts to the players. They (and their characters) must figure out that they are opening themselves to a sure-fire set-up. Once they figure this out, they may consider turning the tables on Neff by turning *him* into the Imperium for slavery. This idea will not work, however, for Neff was resolved to abandon the "bonus" aspect of his plans for this system until the player characters are completely neutralized — and then he needs a "cooling off" period to be sure the Imperium isn't watching the system and the space lanes around it. (Further, once the danger to the population of the planet becomes clear, the Imperium is likely to make establishing contact with the natives a higher priority.)

Still, such cross and double-cross efforts might lead to some interesting encounters and side-adventures if the referee is inclined to develop them.

- "There's more than enough wealth in the galaxy to go around. Why don't we combine our efforts?"

Neff makes this offer if Mara vouches for one or more of the characters, under circumstances outlined earlier in the adventure, or if they show up on the planet with Mara or other crewmembers as their captives. His offer starts with him paying for maintenance and fuel for the characters' ship, as well as arranging to take over whatever payments remain on the purchase cost, all to be paid for out of a general fund created from the income of sales of the technology and artifacts recovered. On top of this, the opening bid includes 10% of the takes to be divided among the player characters in cash. Neff is willing to go as high as 20%, but explains that he can't guarantee always being able to pay for fuel with those terms, requiring the characters to occasionally scoop and refine their own fuel at gas giants. Neff is more apt to go higher if the characters' crew includes historians and highly skilled astrogators as his does.

This partnership only lasts for one or two expeditions, however. As soon as he can maneuver the characters into a position where they are carrying cargo that is illegal, or if he can concoct a situation wherein the characters' ship will be impounded or otherwise delayed for a significant length of time. Neff will use this period to relocate *Liberty's* activities to a different sector of space, relying on his smooth tongue to convince what friends the characters may have made among Neff's crew that they'll hook up with the characters later on, when their legal troubles have died down. Neff even puts a little money toward lawyer fees, or to paying whatever monstrous fines the characters are faced with — but nowhere near enough to be any real help to them. And then he carefully covers his tracks and *Liberty* vanishes into the depths of space. As before, it is Neff's intention to never cross paths with the player characters again.

The adventures surrounding Neff's double-crosses of the characters are once again left to the referee to design, should he feel inclined to incorporate them into an ongoing campaign. If choosing this route, the Referee should make the more sympathetic members of Neff's crew (Sarlam, Mara, and Lori in particular)

into central characters in the campaign. If at all possible, they should befriend one or more of the player characters, making the betrayal by Neff something that comes as a surprise to the players as well as their characters.

### Willard's Plan

Willard Nelsen, however, is going to become the monkey-wrench in Neff's careful attempts to pacify the characters.

Dealing with the savages is quite stressful for Willard. The filthy barbarians simply mill around to his mind, without organization or reason. Further, constantly catching sight of their unwashed children out of the corner of his eye — children who are playing when they should be in a school somewhere — is pushing him to the limits of his tolerance. The characters' interference pushes him past that limit.

While the characters speak with Neff, Willard excuses himself, and heads toward the edge of the forest. His bodyguard picks up the shotgun and follows. If a character attempts to follow him, he must perform a Difficult Stealth task in order to remain undetected by the highly strung and paranoid trader. (This is one case where the referee should definitely not let the player know what the target number is; even if the character fails to reach the Difficult requirement, the devious Willard pretends as though he hasn't seen the character.)

On the outskirts of the village, Willard tells Shorty that he wants the player characters dead — and Neff, too, should the "pompous windbag get in the way." If Mara is with the characters, he tells Shorty to be careful not to kill her, as they're going to need an astrogorator to get them away from this filthy planet once this is over and done with. Willard gives Shorty five doses of a combat drug, and urges him to round up some of the savage warriors to help with the "extermination process." Shorty vanishes into the forest, and Neff takes a circuitous route back to the hut where Neff and the characters are meeting.

If the character failed his Stealth roll while following Willard, the trader leans close to Shorty and whispers something in his ear, after which Shorty heads into the woods, vanishing out of sight. Shortly quickly doubles back toward the village, and attempts to use his Stealth skill to ambush the character and beat him into unconsciousness and death with the metal club he carries. (The club has a damage rating of 2.) Shorty intends to fight either to his death or to the death of the character.

If a character eavesdropped undetected on the conversation, and if the report of the impending danger is shared with Neff, the disgraced noble is incredulous. "Willard could never conceive of such a brutal and foolish act," Neff says. "What is it you are trying to do here? Drive a wedge between us?" If Mara is present, she urges Neff to consider the character's warning; she says that she has had a funny sense about Willard ever since arriving at the village. At this, Neff agrees to confront Willard when he returns, but first wants to make sure that his business with the characters is finished and whatever details that remains are discussed (either for them to join his crew, or to determine what



is required to buy them off so they will leave him and his crew alone).

Willard soon returns to the hut. His demeanor is unchanged, and if no character spied on him when he excused himself, he remains quiet for the rest of the discussion, saying only, "I still think this is a mistake, Mr. Neff. I don't think we can trust these people."

If a character spied on Willard, and informed Neff and the others of Willard's planned attack, the nobleman says, "I disagree, Willard. I'm the one in charge here, you do remember that, don't you? Or perhaps you have conceived of some better option than the one I've arrived at with our fellow travellers?"

The high-strung trader decides at this point that the gig is up, and starts screaming for Shorty to protect him, even as he attempts to flee through the exit. If Shorty is still alive, he arrives on the scene within two rounds. He has three native warriors with him, all of which have taken a dose of combat drugs. The warriors each attack a random person in the room while Shorty blasts at a concentration of characters with his shotgun. (There is even a chance that the warriors might attack Willard; the drugs are wrecking havoc with their bodies as well as minds, as they are not accustomed to the various chemicals that are a fact of life from birth for the citizens of the Imperium. Each warrior is armed with an ax, and the statistics that follow have already been modified to reflect the use of the combat drug. (See page 70 of the **Traveller** rulebook for details about the combat drug.)

The combat continues until one or the other side is victorious. Willard also joins in on the fight, and Neff ignores all other targets to reach the man who betrayed him. "You're going to regret the day you were born, Nelsen," Neff threatens as he draws his sword. Unless a character engages Shorty, the bodyguard blasts the noble with his shotgun, cutting Neff down before he can run Willard through. If Shorty is too busy to protect Willard, Neff makes short work of his treacherous partner, nimbly evading a shot fired by the shrieking man and impaling him with a lethal thrust.

### **Drug-Crazed Warriors**

Age: 22

UPP: 987835

Skills: Bow Combat-2, Brawling-1, Carousing-1, Long Blade-2, Melee Combat-2, Short Blade-2, Survival-1, Throwing-1.

Possessions: Stone axes (damage rating 2).

### **Wrapping Things Up**

The sounds of battle and Willard's screams brings the chief and other natives to the scene. They are confused and horrified that any of their number have attacked the visitors from the stars, and the chief promises it won't happen again. If the warriors are still alive, he orders them put to death. . . but then he asks for an explanation either from Neff or the characters about what happened.

The characters can offer any explanation they like, and Bran will accept it. He just needs to hear something, so he can understand why violence unfolded among the visitors. Among his people, it his highly unusual for members of a tribe to fight with other

members of that tribe — there are too many enemies to worry about to allow such things to happen.

If the characters don't speak up, Neff (if still alive) says that it became apparent that Spaceman Willard was not acting in the best interests of Soobub, so Neff and the other Spacemen had to destroy him. This completely pacifies the chieftain, who returns to the banquet preparations.

If Neff survived, he suggests to the characters that they should be ready to leave immediately after the banquet. He certainly intends to, as he doesn't know if friends and loved ones of the dead tribesmen will try to avenge their deaths. He explains that he fully intends to return and provide the chief with the promised weapons, and set up the slave-ring, but wants to get some distance between him and the primitives so that things can calm down for a while.

Of course, if Neff didn't survive, the characters may try to take his plans as their own. The characters may also wish to claim the launch from *Liberty*. This vessel conforms in every way to the ship's launch detailed in the *Starships* supplement. Of course, if the characters have completely defeated Neff, Mara, and the other looters, and have made no friendships or alliances among them, and if *Liberty* happens to be a better ship than what the characters are currently using, they may choose to simply take both it and the launch and make it their new base of operations.

There are several items in the launch that may be of interest to the characters. First, there is the money that Neff offered them. Second, the ship's cargo hold contains six "Impress the Natives" kits, three of which are complete (as detailed in *Central Supply Catalog*, and are essentially collections of trinkets and toys with which explorers may dazzle natives of societies with tech levels of 4 or less). Additionally, the characters can find any kind of strange alien trinket or remnant technology that the referee wishes to introduce into the campaign in the launch's small cargo hold. Such an item could have been gifted to Neff and his crew by the Soobub villagers, indicating that there might be a mysterious alien settlement somewhere on the planet, or that Neff's crew perhaps discovered an Ancient site during their travels.

### **Further Adventures**

An easy continuation of this adventure is to play through "The Sleepers", elsewhere in this anthology. The adventure involves the discovery and of an ancient cryogenics storage facility. It is usable whether the characters have joined Neff's group or have defeated it.

Interaction with the Soobub tribe might also give rise to adventures. Perhaps the characters can be drawn into an attempt to stop the conflict between the tribes due to a tragedy on a personal level, if they spend an extended period of time on the world: One of the characters is befriended by a sensitive, insightful, intelligent native — perhaps a romance even starts to develop between the two characters. However, the native is killed during a raid staged by one of the other tribes — just another senseless death in the never-ending war. For that character, it is personal now, and aside from giving rise to some potentially interesting role-playing, it might spur deeper involvement with

the problems of this world. The characters may try to end the battles through diplomacy or they might choose to force a peace by using their superior firepower to scare all the tribes into submission rather than giving weapons to one tribe. This is a very flexible setup, and how it is executed will vary greatly from game group to game group.

Another obvious continuation is if the characters decide to adopt Archibald Neff's scheme as their own — gradually strip the base of all components and sell them to the highest bidder. They might even conclude Neff's negotiations by simply taking the "contract" off his dead body, or in exchange for his freedom. However the characters choose to approach this, Neff's fear of Imperium first contact teams arriving in this system becomes reality nine weeks after "Lock And Loot" concludes. The referee should adjudicate how the Imperium deals with the characters based on how they have treated the natives, and how greedy they get should the first contact teams and other diplomats try to negotiate with them for salvage rights to the moon base. Of course, if they take over Neff's schemes to create a slavery ring, they will eventually find themselves incarcerated.

Of course, they may also be somewhat smarter about it. If they were careful in their search of *Liberty*, they know of at least three worlds likely to contain ruins from the Second Imperium — in the systems that were identified on both Mara and Delaware's star maps. They might decide to leave this system to Neff and his band, while rushing ahead of them to investigate and possibly loot installations in the other systems. This can lead to many adventures of the referee's own devising, or he can choose to place "Lone Whisper" adventure in one of the systems that Delaware notes as "Top Secret or Quarantined" on his map. (Referees should be aware that "Lone Whisper" actually ties in with the "Akira Downed!" adventure. Linking it to "Lone Whisper" might be a good idea if the characters missed the opportunity to learn of the abandoned naval base during that adventure — perhaps by destroying the pirate ship rather than boarding it.)

Should Neff escape the adventure alive, the referee might create an adventure that brings the characters into contact with Neff's family. Perhaps they can become regular employees of one of the family's many businesses. At one point, a noble character becomes romantically involved with Neff's sister, Melanee Neff, a gorgeous, intelligent young woman in her early twenties. Soon thereafter, Neff reappears on the stage, finally having decided it is time to take revenge for being denied his birthright. (Such an adventure would only be effective in a long-running campaign, as the referee needs to take the time to not only establish a in-character connection with Neff's family, but also to ensure that Melanee is a fully developed character in whom the characters and players alike have some emotional investment. Anything less, the menace of Neff's quest for revenge against his sister and player characters alike will be mute at best, and empty melodrama at worst.)

Neff can also become an ongoing nemesis for the characters if they attempt to join him in his ventures. As mentioned above, Neff betrays them at the earliest

opportunity, resulting in the impoundment of their ship, their imprisonment, or, at the very least, their becoming fugitives from the law. Eventually, they learn that Neff is the source of their troubles — either through a friend in law enforcement who is willing to look the other way for them, or from a shadier contact who might have overheard one of Neff's less intelligent associates bragging about how the characters were set up — and then launch efforts to get back at the crooked noble and his crew.

The reverse can also be true if the characters attempt to turn the tables on Neff by betraying him before he can betray them. In this case, Neff engages the characters in a battle of reputations, trying to destroy them slowly from the shadows of the Imperium's underworld.

If Mara or Sarlam die in a confrontation with the characters, they may have made themselves one or more mortal enemies. Mara and Sarlam were very close. Their parents were abusive, and the siblings helped each other survive childhood. They remain very protective of each other, and the survivor of the pair will dedicate the rest of his or her life to destroying the PCs. Mara will be the most direct about it — the characters will find themselves stalked by bounty hunters and snipers, and Mara will show up at the most inopportune moments, ready to blow the head off a wounded character, or to prevent them from fleeing a group of heavily armed NPCs they may have offended. Sarlam, on the other hand, will be more subtle and dangerous. He will bribe maintenance personnel to sabotage their ship, use his computer skills to ruin their credit ratings and issue false arrest orders and fines against them, and take out phony loans against which their ship is used as collateral. Ultimately, he will try to set the characters up in such a way that they are either killed by criminal or law enforcement elements at a location where he can witness it.

If Mara dies, the characters may also have to deal with a vengeful Archibald Neff. The noble will not stalk them the way Sarlam will — after all, Mara was just a woman, and there are plenty of other women in the galaxy — but will certainly attempt to make their lives miserable should their paths ever cross again. If the reverse is the case (Archibald dies and Mara lives), she will be almost as obsessed with revenge as if the characters had killed her brother. (The difference here will be that she won't hunt them personally, but will send assassins and bounty hunters after them.)

A less violent but perhaps even more interesting development that may grow out of this adventure is the potential relationship with Lori DuPont. If the referee chose to make her the runaway younger sister or daughter of one of the player characters, she may well be travelling with the group for a time. The referee will have the opportunity to create many fascinating role-playing challenges as the young woman attempts to prove that she is no longer a kid, while the player character tries to come to grips with this fact. The act of bringing Lori home may also give rise to interesting situations. Why did Lori *really* run away from home? How do the parents view this act? Do they blame the player character, thinking that if he had settled down, he would have been a good example for her rather

than a bad one? Lori will most likely not be the center of many combat situations (unless she fled the home-world after flirting with the psychotic leader of a violent street gang or something similar), but she might be a vehicle for many other different types of role-playing encounters... particularly if a player character adopts the role of protective older brother or father.

There is also a slim possibility that Clem may become a friend of the characters. As mentioned, he had no particular love for the rest of his shipmates. If the characters took him prisoner and treated him fairly

— and didn't turn him over to the law at the first opportunity — any future encounters with him will be friendly ones. Clem will have gotten his hands on a small ship again, and will once again be travelling the space lanes. He is a magnet for gossip, and will happily share it with the player characters whenever they cross paths. The rumors he picks up will be as varied as the ones presented in *Milieu 0*, and will only be accurate once in a blue moon. However, each and every one can lead to new adventures.

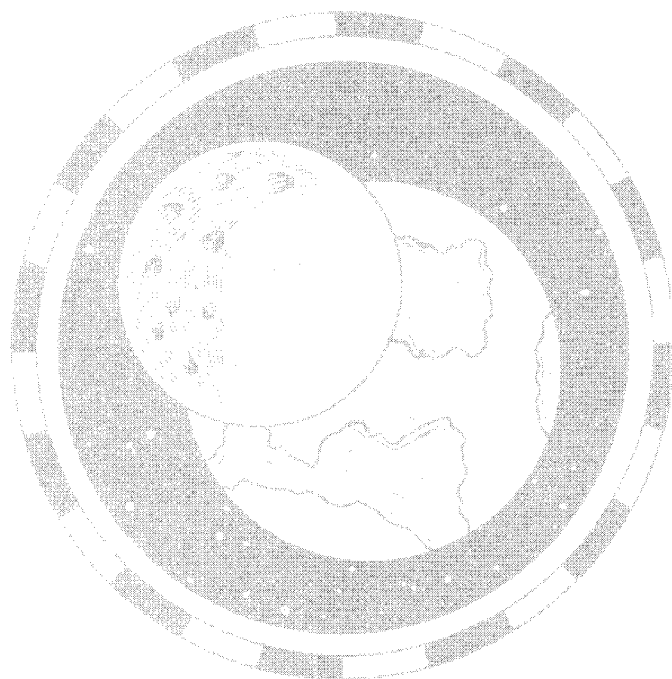

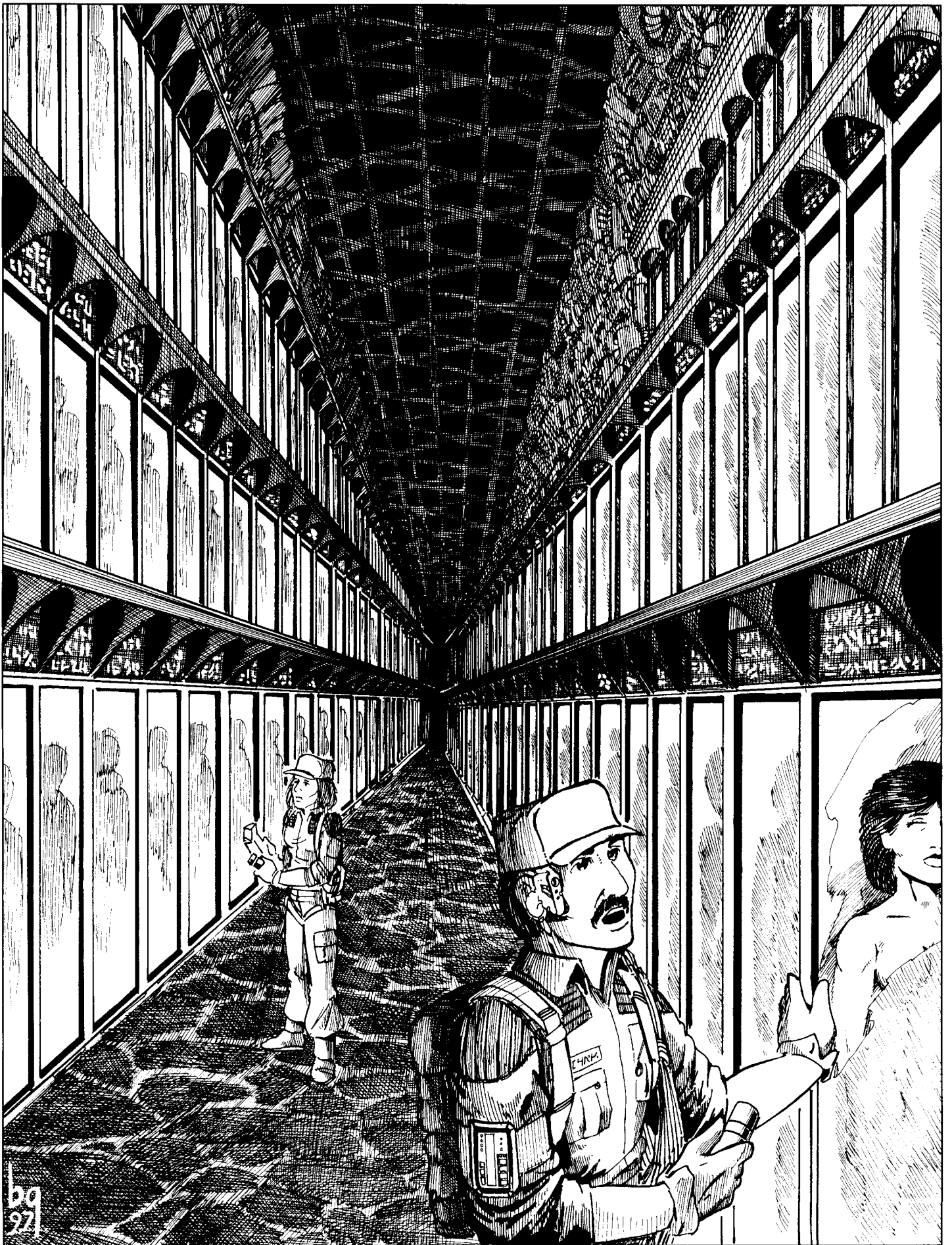

69  
971

# 6: THE SLEEPERS

---

This adventure can be played independently during a “one-night stand” type of game, incorporated into an ongoing campaign, or serve as a virtual buffet of springboards into other scenarios of the referee’s own design. In it, the player characters discover a long-forgotten facility containing thousands of pre-Long Night men and women in suspended animation. After facing primitive tribesmen who consider the vast cryogenics facility a holy site, defeating a pouncer beast that lairs in the outer areas of the facility, and destroying malfunctioning robots that have served as the facility’s guardians, the characters must stabilize the facility’s failing power supply in order to save the many sleepers.

If the referee chooses, the characters may awaken one or more of the sleepers, some of whom may not be who they immediately seem to be.

## The Setting

This adventure takes place planetside, and the referee is free to choose the world. The world should have an atmosphere and hydrosphere capable of supporting even low-tech human settlements, as the planet is currently inhabited by humans who descended into primitive savagery during the Long Night. (The planet outlined in “Lock And Loot” on page 33 is a suitable world. This adventure can serve as a sequel to that adventure, if the characters conduct any exploration of the planet after that adventure.)

## The Setup

There are a number of ways to set the player characters on the path leading to this adventure. Here are some suggestions:

- A patron approaches the player characters with AAB references to a company named “A Better Tomorrow.” This company promised to place clients in cryogenic storage for up to 2,500 years. The selling point was that the wealthy could be kept here safely until some point in the future when the Rule of Man was firmly established and the utopia that many expected would grow out of that establishment. The location on which “A Better Tomorrow” was located is detailed in the entry, and the remarks indicate that the facility was built to withstand a Ground Zero nuclear detonation and contained a power plant capable of operating independently of all other facilities on the planet for at least 3,000 years. Although the populace of the world are reported to have destroyed each other in a bloody civil war as the Long Night fell, the patron believes there might be a chance that “A Better Tomorrow” might still be intact and operational. The men and women kept there are a storehouse of knowledge that is currently lost to most others — and he wants the characters to investigate if it is possible for those men and women to be awakened into the Third Imperium.

The patron is willing to loan the characters whatever equipment they think they might need for this operation. He does not expect them to awaken the “sleepers,” but merely wants them to find out whether “A Better Tomorrow” and its charges are still intact. He plans to send a medical frigate with doctors specializing in retrieving people from long-term cryogenic storage, and psychologists capable of helping the people stored there adjust to their new world.

When the characters arrive on the world where “A

Better Tomorrow” was located, they find a world covered with shattered, long-dead cities. Humans still survive here in a state of barbarism. Their sensors help them lock in on the location of the facility. A suitable landing site is located a couple of kilometers from the power source. The power source is fluctuating, and characters who possess Engineering skill know that such fluctuations indicate the facility’s power plant will probably burn out within the next few weeks.

- While visiting a world that is home to the primitive remnants of a human society shattered during the Long Night, something or someone tells the characters that beyond the City of the Ancients is a cave where hundreds of Ancients sleep an eternal sleep, alive, yet never waking or stirring. The characters are warned about a twisted tribe of violent men and women who worship the sleeping ancients, and the hideous metal monsters that serve as the guardians of the sleepers.

- While exploring ruins dating from the Second Imperium, the characters find a faint power source while using a multiscanner. On a hill overlooking the shattered city is a collapsed structure. The power source is fluctuating widely.

The adventure begins as the characters draw near to the location of the fluctuating power source. Parties equipped with grav belts will easily bypass this first situation, but they will encounter problems of a different sort in “The Cult of the Ancient Sleepers.”

The scans (or information from friendly natives) show that the power source is somewhere in a cave that is clearly visible halfway up a steep foothill, beyond which gray stone mountains stretch toward the blue sky. The cave is surrounded by scattered remnants of buildings, and to reach the base of the hill, the travellers must pass through a treacherous collection of rubble — the rest of the buildings that once stood near the cave, buildings that slid down the hillside centuries ago. This barrier is many kilometers long, and it is more practical to traverse it than to go around it. It requires some climbing, but it appears safe enough, as long as the characters are careful, and stay clear of concrete slabs and beams that appear to be balanced on others.

Still, accidents do happen. As the characters pass through this area, the referee should call for Athletics skill checks (to represent the efforts of climbing through the shattered ruins) for all characters, assuring the players that a single check is all that is needed to get through the most hazardous area. The character with the highest die roll grabs what appears to be a solid handhold, but instead finds that it breaks off which sends him tumbling down a weather-beaten concrete incline. He falls through a until-that-moment unnoticed opening and eventually hits the ground hard enough to

be winded. He finds himself at the bottom of what is essentially a shaft in the concrete slabs, standing in a shaft of light as dust particles dance around him. He is unhurt (except perhaps for a bruise on his pride), but cannot climb out on his own. Other characters need to lower a rope, or he can try to make his way through the rubble by crawling through the maze that has formed under the twisted metal and broken concrete walls.

However, while the unfortunate character is either waiting for his companions to lower a line, or weighing his options for his way out of his predicament, he notices that he is standing on a large sign. If the character takes a few minutes to clear away the dirt and rocks, he finds that it reads, in Galanglic and Vilani, "A Better Tomorrow." For characters who actually came in search of time-lost citizens of the Second Imperium, this discovery might be slightly discouraging, and might cause them to question whether the company hype their patron had uncovered was just so much false advertising. For a character stuck at the bottom of a steep shaft — particularly one who has never heard of "A Better Tomorrow" — might consider this sign an example of fate playing a cruel joke.

It is a simple matter for the character to climb out of the hole once a rope has been lowered to him (an Easy Athletics task). A character who needs to find his way through the accidental maze formed by the rubble makes his way to the other side in 2D6 hours. The player must roll 2D6 and compare the result to his character's Intelligence score. If the roll exceeds the character's Intelligence, the character emerges 100 meters times the excess from where the rest of the party is waiting for him, assuming the rest of the group didn't just push on toward the cave.

After passing through the wreckage of buildings, climbing the hill will be a simple matter. However, there may be a sight that gives the characters reason to pause: At the edge of the rubble, posts have been erected every 20 or so meters. A human skull or head in an advanced state of decay has been mounted on each post.

If the travellers hadn't already been warned about the violent tribe that lives in the area, they have just encountered their territorial markers. More than likely, the characters will not be scared off by such primitive displays. After all, what could simple-minded savages do against a team of fully equipped Third Imperium explorers?

### **The Cult of the Ancient Sleepers**

As the characters begin their climb toward the cave, ask them to make an Average Recon task check, with a 3 point modifier. Successful rolls mean they spot several primitive tribesmen hiding among the ruins and behind false vegetation on the hillside. If the characters immediately open fire on the natives, they receive automatic initiative. If they hail them, the primitives leap from their hiding spots with their arrows knocked in their bows and attack. Depending on which situation is true, either the characters or the natives get automatic initiative in the first round of combat. If the characters attempt to conceal themselves upon spotting the natives, have each player roll a Difficult Camouflage or Stealth task, depending on whether the character is simply going to hide, or attempt to sneak up on the natives.

The natives are firing arrows whose tips have been coated with a paralyzing poison made from plants that grow on this world. Their arrows have damage ratings of 2, and if a character is injured by one, a Difficult Endurance task must be rolled for the character. If successful, the character suffers a temporary 1 point reduction in Strength, Endurance, and Dexterity characteristics once the poison takes effect, but if the test fails, the character starts losing 1 point of Strength, Endurance, and Dexterity per round until one characteristic is reduced to 0 and he loses control over all his muscles and collapses. A separate roll must be made for each arrow that injures the character, and the effects of the poison is cumulative. (If the character is injured by two arrows and fails the Endurance roll each time, he loses two points in his physical characteristics per round, for example.) The poison takes effect 2D6 rounds after the character is injured by an arrow, and renders the character paralyzed for 1D6 hours. Once the poison begins to wear off, the character regains 1 point in each of his reduced characteristics every minute until they are restored to their original levels, minus actual wounds inflicted by arrows which must be treated with First Aid or other medical skills.

Characters who are flying across the landscape using grav belts or rocket packs to fly over the collapsed buildings expose themselves to two rounds of free attacks by the natives before they can draw a bead on them and return fire. (All the natives focus their fire on flying characters, assuming them to be some form of evil spirit.) Flying characters are effected by the poison like characters on the ground were. Those who aren't wise enough to land once the poison begins to sap their strength eventually crash to the ground, suffering 2D6 points of damage.

The primitive warriors are willing to give up their lives in their attempt to kill or capture the characters, but, barring extreme bad luck on the part of their opponents, the savages are both out-gunned and out-classed. Once the battle is over, the characters can continue to the cave, or they can interrogate any survivors among the enemy. In the unlikely event that they were defeated, the adventure continues below with "The Lurker in the Cave."

The tribesmen speak a degenerate form of Galanglic, and characters who make successful Average Linguistics tasks are able to understand and communicate with them. The warriors answer questions to the best of their ability, but are not very knowledgeable about their world or the universe around them. Basically, most of their replies boil down to, "We guard the Ancient Sleepers, so the ignorant and foolish can't bring doom to our world."

The tribe to which these warriors belong are led by shamans whom they believe to be the highest mortal authority. All members of the tribe follow the commands of the shamans, who fervently believe that the Powers of the Universe speak to them through the stars in the night sky. At the center of the tribe's mythology are the Ancient Sleepers, powerful spirits that rest deep in the cave in cases of crystal and ice, watched over by the silver-skinned Guardians. The shamans believe that when the Ancient Sleepers awaken, their world will end, so they (and thus the tribe) are somewhat touchy about

### Further Adventures: Against the Natives

The village where the Cult of the Ancient Sleepers live with their families is located in a hidden valley over five miles from the party's current location, and the characters will have to make it through many hidden guard positions such as the one they encountered here, each manned by a war party consisting of a leader and 2D6 warriors. For simplicity's sake, Referees can consider them statistically identical to the ones encountered in this section. However, as the characters draw closer to the village, the warriors begin to retreat when it becomes apparent that the characters are too powerful for them to defeat. Should any of the retreating warriors manage to beat the characters to the village, a quick evacuation is staged, and when the characters arrive, they are must combat 20 of the tribe's greatest warriors (all with Leader statistics), who are hiding in various points in the abandoned village, turning it into what is essentially a deadly maze with a creepy ghost town-like atmosphere. The warriors fight to the death, and have no intention of allowing any characters to survive.

Any warriors who are captured refuse reveal the location of the villagers, but persistent characters with psionic disciplines can once again extract the information from their very minds. Continuing their pursuit, the characters eventually face the rest of the tribe's warriors (27 young men with statistics like the standard warriors featured previously in this adventure, plus whichever warriors retreated from the advancing characters earlier) and the shaman and his three assistants. For the shaman and his men, use the statistics for Chief Bran from "Lock And Loot" adventure, while his assistants conform to the warrior statistics presented on page 55 of that same adventure.

When it becomes apparent that the warriors are being slaughtered, the shaman commands them to lay down their arms. He offers the whole tribe — including the crying women and children — as victims to the player characters' mighty weapons. He states that it is clear to him that the strangers are intent on the tribe's destruction, and that there is no point in resisting. He asks whether the player characters are awakened Sleepers, or just harbingers of the world's destruction.

At this point, the carnage may give way to role-playing. The shaman will do virtually all the talking among the primitives, and he has enough grasp of Diplomacy to attempt to enter negotiations with the player characters. He is more interested in saving the

tribe — and the entire world — than in destroying the strangers with powerful magic.

Assuming the characters still have an interest in the Sleepers, the shaman can't tell them much more than the warriors already did. The only detail he can add is that the Guardian told his great-great-great grandfather that the Sleepers must not be disturbed, for if they waken "the world as we know it will end, a completely different reality will take its place and we will not be part of it."

This may sound like superstitious nonsense to the player characters but the shaman (and his entire tribe) believe firmly in the truth of this dire prophesy. They are adamant in their desire not to allow strangers — and the player characters are *definitely* strangers — to wander their tribal lands due to the threat of disturbing the Sleepers, but the shaman will grant the characters the right to freely wander the lands if they promise to stay clear of the Sleepers, and promise never to threaten their village again. (The poor man has little choice, but is trying to retain some dignity.) If they make this promise to the tribe, and swiftly return to the hillside where they detected the power source, they will be able to enter the cave without difficulty. Upon exiting the cave, however, they will encounter tribal guards, and hostilities with the tribe resumes — and their desire to outright slaying the player characters will triple due to the losses they suffered in their first encounter.

The perfect way to pacify the tribe without butchering the lot of them is for the characters to show the shaman their spaceship and possibly to give him a short ride in it. The tribe's folklore is rich with tales of visitors from the stars (which is one reason why the shamans think the stars speak to them — even if the only voices they hear are created by intoxicants they consume before "meditating"), and if they prove themselves to be such visitors, they will have an easy time convincing the shaman that they, and others like them, have come to take the Sleepers away, so they will no longer threaten the world or reality.

If the characters have been hired to investigate whether pre-Long Night men and women still survive in cryogenic storage, successfully pacifying the tribe in a permanent fashion is very important for the long-term goals of their employer. Naturally, using their superstitions to calm them is better than killing all of them. Further, once the Imperium establishes a presence on the world, sociologists and first contact specialists will want to begin the process of restoring civilization and technology to the savages.

### Further Adventures: The Dead Scout

Those who decide to search the remains of the pouncer's meals realize that one of the older victims was a traveller like themselves — a rusty revolver, a shattered multiscanner, and the tattered remains of a uniform belonging to the Sylean Federation Scout Service (a pre-cursor to the modern-day Imperial Interstellar Scout Service). The presence of this long-dead individual indicates that there might be an abandoned Scout ship nearby. Should the characters attempt to find this ship, in hopes of receiving salvage pay, or perhaps to check its computer systems for discoveries made by the scout but never reported back to Sylea, the referee has a number of adventure spin-off possibilities at his disposal. If the scout ship is still on-planet (doubtful, as its compliment could have consisted of as many as four scouts, any of whom could have piloted the ship off-planet), the referee can use its computers to give the characters tantalizing hints of future adventures, including leads to another adventure (such as "Lone Whisper").

Another possibility presented by the deceased scout is an attempt to identify who he was and return what personal belongings the characters can find to his living relatives. Such an effort is a perfect opportunity for characters who possess Investigation skill to shine. Further, it might see the characters embroiled in an adventure of intrigue: What if this scout's capture by the natives was no accident, and what if his crewmates didn't come to his aide since they *wanted* him to die, because of some dark secret they were covering up? If such a conspiracy exists, those involved in it may feel they need to silence the characters once they begin to pry into things.

If the scout's death was caused by a conspiracy as suggested above, the characters will not find his ship, as those set him up to be killed have already departed in it. They can still start their investigation by inspecting the seven skulls located here in order to identify the one with all of its teeth and artificial fillings. Then they must perform DNA or dental record comparisons against the SFSS service records to discover his identity.

Once the DNA or dental record have been examined and a match has been made, the characters can track down the scout's surviving relatives. But if there is a conspiracy surrounding the death of this scout, the conspirators know the characters are on to something the moment they complete their scan of the old SFSS records. The nature of the conspiracy, the identity of the scout, his family, and who is responsible for his death is left up to the devious mind of the referee.

strangers walking their lands. After all, strangers do not understand the Sleepers, and they might awaken them.

The shamans are very concerned that strangers wandering their land, because they believe strangers don't understand the danger posed by the Sleepers. Rather than avoid the Home of the Ancient Sleepers, strangers are likely to explore it and possibly disturb the rest of those fearsome beings. All of the tribe's warriors are members of the Cult of the Ancient Sleepers, and are sworn to help the shamans in ensuring the Sleepers aren't disturbed.

Warriors guarding the cave are under strict orders to capture or kill all strangers that they encounter, particularly if they approach the guard posts near the Sleepers. Those who are captured are bound hand-and-foot and placed immediately inside the Sleepers' cave by the warriors, making them offerings to the Guardians. If the captives are still there when the warriors return 24 hours later, they assume the Guardians have rejected the offering, and the warriors then kill the unfortunates. Their heads are then put on a post at the edge of the tribe's land as a warning to others. None of the warriors have ever seen the Guardians or the Sleepers, but the fact that they have all at one time or another left prisoners in the cave that have been gone the following day — sometimes leaving behind blood or bits of torn flesh, but more often than not vanishing without a trace.

The warriors refuse to take the characters to their village, and no degree of interrogation or torture will get them to reveal its location. Characters with the appropriate psionic disciplines can, of course, force the location out of the warriors. The village is not detailed in this adventure, so referees faced with players who are insistent about sending their characters to visit (or conquer) the village will have to create their own side adventures. The immediate adventure continues beyond the mouth of a dark cave that overlooks the shattered remains of a Second Imperium city.

Name <b>Leader of the Primitive Human War Party</b>		UPP <b>98783F</b>
Service		Rank
Birthdate	Birthworld	
Skills <b>Bow Combat-3, Brawling-2, Camouflage-3, Law-2 (his own culture only), Leadership-3, Recon-3, Short Blade-2, Survival-1, Throwing-1</b>		
Possessions	<b>Bone dagger, bow and eight poison-tipped arrows</b>	Money
Comments		

UPP Card

001-000

### Primitive Human Warriors (two for each player character)

Age: 22

UPP: 787835

Skills: Bow Combat-2, Brawling-1, Camouflage-2, Recon-1, Short Blade-2.

Equipment: Bone daggers, Bow and six poison-tipped arrows each.



## The Lurker in the Cave

As the characters draw near to the cave, it becomes apparent that it's not a cave at all, but the mouth of a broad hallway that leads into the side of the hill. By looking at the overgrown rubble and concrete fragments jutting from the ground and hillside, it is clear to them that a sizable complex once stood here — the complex that scaled to reach the hill in the first place. A portion of the tunnel wall has collapsed, and the mouth is heavily vegetated, making it appear like a naturally occurring cave from a distance. But, once the characters are as little as 5 meters in, the evidence that they are in a man-made structure is incontrovertible: Although the walls and floors are streaked with mineral deposits and dirt, marble tiles are still clearly visible under foot and the walls and ceilings join at a perfect right angle.

The above information can be gleaned by those who were defeated by the natives, and left here as sacrifices for the Guardians by just visually surveying their surroundings once the poison wears off. Such characters will be unaware as to the reasons why they were tied up with crude hemp ropes and left here. All they know is that they were, and that the natives didn't take any of their equipment. (Even weapons and scanners dropped during the battle have been thrown into the cave with the characters.)

They probably assume that if they don't escape, something bad will happen — and they will be assuming correctly. In all likelihood, the characters will try to escape. If any of them are carrying knives, they can attempt Formidable Dexterity tasks to reach them. Should these attempts succeed, the characters may cut their bonds with ease. Barring this, characters may attempt either Average Strength or Dexterity tasks to either snap the bonds with brute force, or to wriggle free of them. (Characters who have Athletic abilities can try Difficult Athletics tasks drawing upon Strength or Dexterity.) Characters can make as many attempts to snap the bonds as they wish, but if one of them suffers a Spectacular Failure, he is considered to have injured himself in some way. That character must succeed a Difficult Endurance task before he can attempt to free himself again; he must first overcome the pain suffered from the pulled muscle or dislocated joint.

If the characters make no attempt to free themselves, they're going to wish they had. As explained above, the natives leave regular sacrifices to the Guardians in this cave. One of the world's indigenous, highly intelligent predatory life forms, which bears a strong resemblance to the Terran tiger except its fur has chameleon qualities that permits it to blend into any surrounding environment, discovered the cave was an easy source of food and has chosen to lair here. 2D6 minutes after the first character begins to recover from the effects of the poison, this beast awakens from its slumber, smells the presence of the morsels that have been left for it, and lets out a joyous howl. The beast appears five rounds later, its coming preceded first by a meaty thud as it leaps out of the tunnel that leads to its lair, then by the clicking of its claws on the marble tiles.

When the pouncer first comes into view, the only thing the characters can see initially is the light from the cave opening reflecting off of its eyes, causing them to appear to glow in the dark. As it draws closer,

the characters can see a sleek, furred creature with four legs and viciously clawed paws. It licks its black nose as it approaches, revealing knife-sharp canines. Its narrow eyes appear to glitter malevolently.

If any character has managed to free himself, he can snatch up one of the firearms and attack the creature. Any moving characters become instant targets for the creature.

If no character has managed to free himself, the cat seizes the nearest character by a pants leg or boot heel and drags him off into the darkness. Unless the victim manages to free himself, or another character comes to his rescue, the remaining characters hear his death shrieks, intermingled with growls and the sound of tearing flesh and snapping bones 2D6 minutes later.

If an attempt is made to rescue the character before he becomes dinner, the cat has merely dragged him 20 meters down the hallway, into the shadows where he is out of view. There is ample evidence that the cat has enjoyed many other such meals here, which will probably convince the characters once and for all that the Silver Guardians are not the ones accepting the sacrifices offered by the tribal warriors.

Even if none of the characters were captured by the natives, the group encounters the pouncer. However, they will in all probability be prepared for its attack, for as soon as they move beyond the cave opening, they will need to use flashlights, glow rods, or low-light goggles to see in the hallway. The first sign that a potential threat may be lurking somewhere within are bloody paw prints on the dirty marble floor which are spotted with an Easy Perception task. Upon seeing the tracks, the characters look nervously toward the 2m X 2m square openings that are found every 15 meters near the ceilings on both walls of the corridor. Such openings are familiar to any character who has experience with Vilani architecture: They were undoubtedly covered with vents at one time, and served as part of the structure's environmental control system. Now they might serve as the openings to lairs of dangerous creatures, and in this case they do.

The chameleon cat lurks in the second opening on the characters' right, as they move down the hallway. (The bloody paw prints do not give this away, nor do the human and animal remains scattered across the floor.) The only way they will spot the pouncer is if one of them is boosted up to gaze into the opening — which either causes the cat to flee or immediately attack that character, as dictated by the dice. Otherwise, the cat waits patiently until the majority of the group has passed its hiding place, and then pounces on the last character in the marching order, and then moves to attack the rest of the group the following round. The cat's first attack is a surprise attack, unless the character is specifically observing the vent opening on the right. Otherwise, the combat is run according to the initiative system preferred by the referee.

Once the chameleon cat is defeated or driven off, the characters can continue along the hallway. By consulting their scanning equipment, they can see that the power source they have been tracking is located deeper inside the hill.

## Chameleon Cat, Wild Pouncer

A: 9, F: 8, S: 4, Weight 100 kg, Hits 16/9, Armor Nil, Wounds/Weapons Claws/Teeth (2D damage each attack, two attacks per round when in Very short/Contact range).

## The Silver Guardians

The hallway continues beyond the pouncer meal site for another 34 meters, and then makes a sharp a sharp 90-degree angle to the left. Looking around the corner, the characters can see that the tunnel continues onward in complete darkness. Their scanning equipment tells them that the power source they seek is still deeper inside the hill, so following the corridor is their only option. Once they round the corner, low-light goggles no longer suffice, and the characters will need to use glow rods or flashlights to see.

The hallway stretches for 30 meters, then ends. About halfway to the end, the characters catch sight of a dimly flashing red light on the left wall. As they draw nearer, they see a large iris valve door that appears to be jammed halfway open. The flashing red light is a status indicator on a palm scanning device of the type used to restrict access to authorized personnel only, warning those approaching that the door is closing. It is an Easy Intrusion task to disable the mechanism so that the door either opens or closes fully, if the characters have the proper tools to deal with electronic security devices and locks with them. If not, a Difficult Electronics task can achieve the same objective. These efforts take 1D6 minutes, although the characters will be approached by a Guardian as soon as they begin to tamper with the lock, or when one of them goes through the door.

If the characters merely tamper with the lock but don't check the room inside, a shiny, silvery humanoid robot with a pair of soft, glowingly green visual sensors emerges stiffly from the opening and says in a soft, melodic voice, "Are you from the maintenance department?" If the characters think quickly and answer in the affirmative, the robot withdraws into the room again, saying, "There is a more important task to attend to. Please follow me."

The characters should have no problem identifying this robot as one of the "Guardians" they have been told about. It is actually one of two robots that have been maintaining this facility throughout the Long Night. Both, much like the facility's power plant are malfunctioning, although this robot is the more harmless of the two.

Beyond the door is a room in which the order and cleanliness is sharply contrasted with the filth and decay of the hall outside. Here, a dimly lit reception area (clearly operating on emergency power only, as the light in the room emanates from glow strips along the walls that point toward the half-opened iris valve) is found, complete with rich red carpet, a sofa and two armchairs arranged around a low table, and a shiny black desk upon which a computer terminal stands. If the robot didn't meet the characters at the door, it is seated behind the desk. It focuses its glowing visual sensors on them and says, "I'm sorry, but the sales staff have all gone home. Please come back at some other time." On the wall behind the robot at the desk,

the player characters see a sign that reads in Galanglic and Vilani, "A Better Tomorrow," three glass doors that lead to other offices, and a second iris valve that is completely closed. The indicator light on the palm reader next to it is yellow. If the robot has mistaken the characters for the repair crew it sent for, it takes them straight to this door, interfaces briefly with the security systems, and the iris door unfolds, allowing access to the room beyond.

If the robot has not mistaken them for workmen, they will either need to convince the robot to admit them, or fight it and the second robot that is located beyond the second iris valve door. Here are some of the basic questions the characters might ask of the robots as they attempt to gain more information about the facility, or to pass beyond the second valve — for their scans tell them that the power source of the facility is somewhere beyond it.

- **What is this place?** "It is 'A Better Tomorrow,' where we promise a brighter future for citizens who are unhappy with today."

- **What is your function?** "I am to assist the sales staff with menial duties, and to attend to the needs of prospective clients waiting to be served."

- **What is beyond the iris valve door?** "Our clients sleep there in suspended animation induced by the latest in cryogenic technology. When the conditions of their contract require them to be awakened, our skilled staff of doctors — who will remain on the cutting edge of medical technology as our civilization continues to advance — will bring them out of their suspended animation. Our highly trained sociologists and psychologists will then assist the client in reintegration into the brave new world they have awakened into, while the financial consultants check on the status of the investments we have made for them."

- **Can we gain access to the 'clients'?** "Only next-of-kin, descendants, and client-authorized executors are permitted into the cryogenics facility. Further, access is granted by appointment only, and then only if escorted by a member of the sales or medical staff. The staff have gone home for the day. Are you next-of-kin, descendants, or authorized executors of any of our clients? Would you care to make an appointment for tomorrow?" (Characters who answer in the affirmative to this question are asked to provide their names, the name of the client they are related to or represent, and that client's personal identification number. The robot accesses the computer terminal on the desk and prepares to check their replies against the database. Those who continue with their bluff attempt must roll a spectacular success on an Impossible Fast Talk task in order to pull it off. Basically, the character — through pure luck — pulls a correct answer off the top of his head. The referee should write down whatever name the character provided, because it is possible that the characters look that client up in the computer system once they gain access to it. Any result other than a spectacular success is an automatic failure.)

- **How long has it been since any members of the staff have been to work?** "1,628 years and 194 days. It is an extended weekend." (The fact the robot makes this assumption is a sure sign its logic circuits are failing.)

- **The staff isn't coming back. Will you admit us?**

“‘A Better Tomorrow’ remains open and active. I do not recognize you as members of the ‘A Better Tomorrow’ staff. I cannot admit you unless you are next-of-kin, descendants, and client-authorized executors. Come back and speak with a sales representative or a manager tomorrow. Would you care to make an appointment?” (The characters have a second opportunity to attempt to bluff their way past the robot. The same guidelines as mentioned above apply — only a spectacular success on an Impossible Fast Talk task will gain access.)

• **The clients are in danger. The power plant is on the verge of failing. Doesn’t that matter?** “I am aware of that fact. I have put in a call to maintenance department. They will be here shortly.” (For characters who have not yet tried to pass themselves off as maintenance staff, this is the perfect opportunity for them to do just that. The robot doesn’t question them or ask for identification, but instead simply walks over to the palm reader, accesses the security system and opens the door. “Speak with the robot inside. It will assist you in your repair efforts,” it says.)

There is a chance the characters lose patience with the robot and decide to simply destroy it. This is easily done, as the robot does not defend itself. It does, however, transmit a request for assistance and a warning to its counterpart in the area beyond the iris valve opening. This robot comes to support its less-aggressive companion, attacking the characters with a built-in laser pistol that has a damage rating of 4. (The laser pops out of the robot’s chest when combat begins.)

Even if the characters do not attack Robot #1, Robot #2 eventually becomes dangerous. Its logic circuits are far more deteriorated than the first. It had been programmed as a multi-purpose robot, intended mostly to assist technicians with routine maintenance tasks but also including a few security protocols, and some public relations programming, but over the years its various programming modes have become jumbled as its computer brain has become old, and now it is as close to insane as a robot can come.

The public relations and sales data stored within him corrupted the security protocols and visa versa, and now he has come to think that the men and women in cryogenic storage must be kept in this state at all costs, for if they are released the universe will be irrevocably changed, and everything that currently exists will cease to be. In other words, rather than knowing that “A Better Tomorrow” stores clients who hope to someday awaken in a universe that has changed for the better, the robot has come to believe that interrupting their cryogenically induced slumber will *cause* the universe to change. Therefore, the Sleepers can never be permitted to wake, and the robot will kill to prevent this from happening.

Robot #2 is apparently as harmless as Robot #1 as it escorts the player characters beyond the iris valve door, causing it to slide shut behind them. This is a glass-walled control center crammed with dozens of computer terminals, beyond which the characters can see a vast hall containing thousands of cryogenic storage units. Robot #2 shows them to a bank of panels and monitoring screens while saying, “This indicates a problem with the power regulators that is beyond my

capabilities to fix. It is good that the maintenance department finally sent you. I fear the reactor would either have overloaded or shut down within two or three more weeks. That would have been disastrous.”

The problem with the installation can be diagnosed as well as repaired by characters with Engineering skill from the workstation indicated by the robot. The problem has arisen from a need to adjust settings that slipped over the centuries, and it can be corrected by a successful Difficult Engineering task. The repairs take .5D hours to complete and take effect.

In the meantime, other characters can freely investigate the other computer terminals and system monitoring stations in the control center, or even walk out into the cavernous room containing the cryogenics units. Those who access the computer system (possible for those who successfully perform an Average Computer task) gain the information listed in the “‘A Better Tomorrow’ In Brief” sidebar. Further, the characters learn that 11,375 men, women, and children rest here in cryogenic hibernation — or at least rested here. At the monitoring stations, the characters learn (once again, upon successfully completing Average Computer tasks) that almost half of the active capsules have malfunctioned during the centuries since the facility was abandoned. Still, despite all the lost lives, the remaining individuals have the potential to help speed both the growth and technological development of the Third Imperium, as many of them remember the Rule of Man and many of that period’s time-lost secrets as though it was yesterday... because for them, it *was* yesterday.

The monitoring systems do present an obvious mystery, however. Despite the fact the facility has been abandoned by humans for well over a millennia and a half, 23 cryo-units have been engaged within the last three centuries. The 23 men and women within the pods are in perfect hibernation, yet they are not listed in the directory of the facility’s clients. According to the directory, those 23 pods are no presently in use. If asked about these discrepancies, Robot #2 denies having any answers and suggests that the characters run a diagnostic on the computer systems, as they may be malfunctioning as well.

While Robot #2 genuinely doesn’t know where those 23 extra individuals have come from due to its malfunctioning computer brain, they were actually placed there by the robot. Occasionally, the cries for mercy from those left as sacrifices by the tribal warriors attracted the attention of the robot during periods of serious malfunctioning. In his electronic “daze,” he believed these unfortunates to be clients that had been prepared for the cryogenics process and then forgotten by the staff when they left. Robot #2 then placed them in pods and activated them. When the “daze” lifted, the robot had no recollection of the action, and will, in fact, never have it again; his memory program does not recognize the periods when Robot #2 enters the “daze” and automatically begins to overwrite those sections as soon as the robot enters its normal mode of operation again.

Visual inspection of the cryo-pods reveals that unlike those who were placed into suspended animation millennia ago, who are dressed in gray jumpsuits, the recent additions are dressed in simple homespun or rawhide clothing similar to that worn by the natives

### **"A Better Tomorrow" In Brief**

Third Imperium historians note that interstellar civilization as it had existed during the Vilani Empire (also called the Great Empire of the Stars or "First Imperium") was doomed when the Empire fell to the advancing Solomani forces from Terra. Although the fresh viewpoints and technological innovations brought by the Solomani when they assumed dominion of the empire in -2219 provided the stagnated Vilani culture with a brief spurt of vitality, it was too little and too late to reverse the spread of entropy that had infected interstellar culture. In fact, the Rule of Man sped the process in the long run.

The people of the time were not blind to the ever-spreading chaos and decay that was poisoning the spacelanes and the millions of worlds that made up the Empire. Many feared that things would get far worse before they got better. These attitudes gave rise to many utopian movements in the latter decades of the Rule of Man, but they also gave rise to secessionist movements. Many saw the end approaching, but no one was organized, charismatic, or militarily powerful enough to unite the planets firmly under one interstellar government.

It was in this atmosphere that Vilani scientist Relenar Tevellaenes and Solomani businessman Garret Werdnung conceived "A Better Tomorrow." Tevellaenes had invented a process to safely placing living beings in long-term cryogenic storage, without the risk of tissue deterioration, a factor that had previously limited the length of time during which a person could be kept in any form of suspended animation.

When Werdnung heard of this secret process, he approached the scientist with a plan that would make both of them fabulously wealthy. By using Tevellaenes' improved cryogenic storage techniques, they could start a company to serve people who feared for the future. It would promise those who were willing to pay the price that they could sleep through all the hard times, eventually waking up to a better tomorrow. Werdnung's plan included having financial managers who would take care of clients' personal fortunes while they slept, as well as a promise of supplying psychologists to ease the client's re-entry into the unknown world they would awaken in.

Tevellaenes had originally intended to sell his jealously guarded process to the galactic government for use as a lower-cost, low-space alternative to conventional prisons, but Werdnung's promise of untold megacredits made him revise that plan. The two opened the first "A Better Tomorrow" facility, the one the characters locate in this adventure, in -1789, and their success exceeded even their wildest expectations. Some of the galaxy's richest and most famous people chose to avail themselves of "A Better Tomorrow's" services. The operation was so popular that smaller facilities were opened on two other worlds.

In the long run, however, "A Better Tomorrow's" own future was anything but bright. The world upon which it was headquartered erupted in civil war soon after the collapse of the Rule of Man in -1776. The civil war was fueled, in part, by the fact that the planet's political and industrial leaders were abandoning

the world's common people for an escape beyond the galaxy's current crisis.

"A Better Tomorrow's" well-equipped mercenaries defended the facility against looters and rebels, keeping the structure safe until the civil war had raged itself out — by exterminating 80 percent of the planet's population and leaving the cities disease-ridden pits choked with dead bodies. The remaining populace soon slipped into a state of savage barbarism and superstition, abandoning the cities and living from the land as their primitive ancestors had done on Vlan or Terra millennia ago.

The sleepers in the now-abandoned facility would have joined the dead in short order if Tevellaenes hadn't been insistent that all their technology live up to their advertised promises, as special long-lasting low maintenance power plants would probably not have been developed, nor would extra expenditure to construct the cryo-pods in such a way that they would continue to function for many centuries.

Still, even "A Better Tomorrow's" biggest supporters could not in their wildest dreams have conceived of the situation where those who went to sleep hoping to wake up to a brighter future would still be alive and in cryogenic hibernation almost 2,000 years later. But for Third Imperium historians, and those who are once again hoping to reunite the galaxy under one banner, such individuals with first-hand knowledge of the final years of the Rule of Man might be serious blessing: They know exactly where the spacelanes were, which important hub worlds might contain now-forgotten societies that still maintain their advanced technology, and reintroducing many of the bright minds slumbering in storage will speed technological development of the new empire while hopefully giving them the insights needed to keep from repeating the mistakes of the past.

The main "A Better Tomorrow" facility features computers that not only contain complete biographical data on the thousands of individuals who were placed in suspended animation there, but also the locations of three "branch" locations in out-of-the-way systems. These were brought on-line after the Rule of Man began to collapse, and, according to promotional materials stored in the computer systems of the main facility, some of the era's greatest artists and scholars were offered free opportunities to preserve their lives and minds for a future where the waves of chaos sweeping the galaxy had subsided and the could emerge safely and continue their contributions to human culture. How many of the cream of the Rule of Man's intellectual and artistic communities accepted this offer is impossible to tell from the files at the headquarters. Still, searching out the facilities to see whether they are still intact, and what legendary minds might be found there — perhaps even Relenar Tevellaenes, the inventor of the superior cryogenic technique that has made the facilities possible — can lead to numerous adventures for the player characters. Additionally, exploring and securing such facilities will bring the characters much fame among scholarly and artistic communities, and lead to other lucrative contracts involving the location of ancient sites.

who attacked the characters on the hillside. Further, they are still tied hand and foot like the characters had been. Clearly, *someone* placed them in suspended animation. The question is who?

As the characters ponder this mystery, the first thought that is likely to present itself is to revive the tribesmen and ask who placed them in suspended animation. As they begin looking into reviving the primitives, either by consulting the monitoring systems or by asking Robot #2 how to do it. Before they have a chance to begin the revival, however, the monitoring system alerts them to the fact that two more of the ancient cryo-pods are on the verge of failing. The characters must take immediate action if they are to save the lives of those within. Robot #2 supports them in the attempts to restore correct functions to the pod, but Easy Medical or Electronics tests (or Average if the robot isn't assisting) reveal that the only way to save the people in the pods is to start the process of bringing them out of suspended animation.

At this moment, the cooperation of Robot #2 ceases. "I cannot allow you to awaken the sleepers," the robot says in its gentle voice. "If the sleepers awaken, the world as we know it will cease to exist. I cannot allow that to happen."

The robot attacks any characters who are near the monitoring stations, the weapon hidden in its chest cavity popping into view and combat starts immediately. Although it may seem that Robot #2 is acting out of fear for his own safety, this is in fact due to the part of its programming that compels it to protect "A Better Tomorrow" equipment and personnel. After all, if the present world ceases to be, that means that the complex within which the robot exists will cease to be also — and it can't permit such mass-destruction of company property to occur.

If the battle between the characters and Robot #2 breaks out in the control center, the referee should roll to see if stray bullets or laser beams damage any of the terminals and sensitive systems located in the room. For each failed Gun Combat task, the referee should roll 1D6. If the result is 6, one of the computer terminals erupts in a shower of sparks, and between 2D6 x 10 of the cryo-units malfunction, killing those within. When the battle is over, the characters are free to attempt to rescue the two sleepers in the failing pods — which, ironically, are still on the verge of failing even if a number of control stations have been reduced to smoking slag heaps. If the fight with Robot #2 occurred before the characters even gained access to the command center, they can now investigate the computer systems as described above, and rescue the two sleepers in the failing pods.

#### **TL14 Robot #1: Receptionist**

UPP: 769700

Skills: Administration-3, Carousing-3, Communications-2, Computer-4.

#### **TL14 Robot #2: All-purpose Assistant/Security-bot**

UPP: 86B700

Skills: Carousing-1, Computer-2, Jack-of-All-Trades-2, Medicine-2, Pistol-2, Robotics-2.

Combat against these humanoid-shaped robots is treated as combat against any character, except damage is applied across to Strength, Dexterity, Endurance, and Intelligence since all four of these are considered physical characteristics for the robot. (Its Intelligence reflects the flexibility of its programming.) When the robot is damaged in combat, the referee can either assign the damage as he sees fit, or he can roll 1D6 and assign the damage randomly — 1-2: Strength, 3: Dexterity, 4-5: Endurance, 6: Intelligence.

The skills listed reflects each robot's programmed functions, with the Carousing skill reflecting the fact that they have been programmed to be friendly toward prospective clients and to answer questions about "A Better Tomorrow," and the Robotics skill representing Robot #2's built-in self-repair program that activates on a successful Average task roll when the robot's Strength or Dexterity characteristics are reduced to 0. Unlike the normal Robotics skill, which is based off Education, the self-repair program of these robots is tied to Intelligence. The self-repair program operates for 2D6 minutes, restoring the effected characteristic to half of its original value, after which the robot returns to activity and attacks the characters again. After it has been defeated, the self-repair program activates again, repairing the effected characteristic to one-quarter of its original value, and so on. The repair program always repairs the characteristic to a minimum value of 2, if it successfully activates. The robot only becomes truly inert if its Endurance or Intelligence scores are reduced to 0 (reflecting that its metal body or electronic brain have been shattered) or if the self-repair program fails to activate.

## **The Sleepers**

The two people who are brought out of suspended animation are Wenarl Ehrtesshab, a brilliant psychologist, and Laura Stone, an actress and singer. Returning to their patron with these two individuals will prove the worthwhileness of getting teams to the various "A Better Tomorrow" installations to return as many of these time-lost individuals to the current world as possible.

This section describes the pair in some detail. They are as different as night and day, and each of them can serve as vehicles for role-playing situations and future adventures.

### **Wenarl Ehrtesshab**

Wenarl Ehrtesshab is one of those rare individuals who was born sick and twisted. He believes he is operating with the highest moral and that he has been chosen by the powers of Fate to punish those who cause hurt and anguish in others through the violation of friendships and the bonds of family.

Wenarl had a typical Vilani childhood, with the loving extended family that all Vilani have, yet even as a child, he loved "punishing" those who "hurt others." At age ten, he murdered his first victim, a schoolmate who had excluded another child from a game of tag. Even as a child, he was smart enough to see to it he wasn't caught. During his service in the military, Wenarl murdered three fellow soldiers who cheated on their wives by hiring prostitutes. As he grew older, Wenarl became

increasingly fixated on what causes men, women, and children to hurt and betray others, and he became increasingly convinced that it was his duty to make those who hurt others pay for their "crimes."

His quest for insights caused him to become a military psychiatrist, and once he ended his military career to start a practice as a "family therapist." Those went to him in search of guidance or a cure for their mental pains, however, were either signing their own death warrants, or putting him on the trail of his next victim.

Upon hearing of a particularly grievous slight against a friend, violation of a marital vow, or of an abusive parent, Wenarl would start observing the supposed wrong-doer in order to decide whether the person deserved to die. More often than not, he decided the person deserved to die. Rarely did Wenarl ever kill his actual patients, but instead went after those they spoke of during their sessions. Sometimes, Wenarl's victims were only remotely connected to the patient's problem, but to Wenarl, killing them was removing a blight upon the galaxy.

This perhaps goes without saying, but Wenarl is dangerously psychotic, and was the much-feared "Family Slasher" who for a period of 11 years killed without rhyme, reason, or any discernible pattern except for the presence of the Vilani word for "Family" carved nearby.

As his list of victims mounted, law enforcement began to close in on the serial-killing psychologist. Wenarl knew it was only a matter of time before he was caught, and he could not allow that to happen. There was still many evil men and women to be punished in the galaxy, and he could not allow the ignorant and misguided to interfere.

When he heard of "A Better Tomorrow," Wenarl immediately recognized his path to escape the tightening grasp of the law. If he entered suspended animation for 200 years, his efforts to curb pain and suffering in the galaxy would be all but forgotten amidst the never-ending march of time. If he indeed found himself awakened into a better tomorrow, where the sentient races of the galaxy didn't heap abuse on each other for little more than personal gain and pleasure, he would not need to punish the wicked anymore and could instead help the people of the brave new world reach new spiritual heights. And if the beings of the Imperium had not improved, then Wenarl would resume his activities with a fresh, blank slate.

Wenarl got more than he bargained for. Not only are his crimes forgotten, but the institutions that were hunting him are long gone as well. For Wenarl, the Third Imperium is truly a better tomorrow. While he will look upon the masses and find them wanting — and thus in need of his "punishment" — he will be doing so without any suspicion whatsoever for many months or even years.

The characters and their families will be Wenarl's first targets in his resumed killing spree. During the return trip to the characters' patron, Wenarl does his best to get to know the new world he finds himself in. In doing so, he attempts to get information on the characters personally. Once he is acclimated to life in the Third Imperium (which involves using his great knowledge of psychology to fool the experts who evaluate his mental

state into thinking he is sane), he begins to do in-depth research on the characters, their families, former love interests — whatever he can find. It will take months, but sooner or later, the characters find themselves stalked by an unknown, murderous assailant. Wenarl may fail at his attempts to "punish" a player character, but he might successfully kill someone who is near and dear to him. The characters must then try to discover who is behind it, a difficult proposition since they may have forgotten all about Wenarl, or may consider him a good friend, if they have kept in touch with him.

Adventures involving Wenarl can be of two types. First, he can be used as a simple monster of terror, the bloodthirsty killer who seems to be able to get at the characters and those they love with impunity, but who remains completely unknown. Second, he can be the object of an investigation scenario, in which the characters hunt the hunter before he kills again. The two approaches can also be merged into one, casting the characters in the role of hi-tech detectives on the trail of a vicious killer.

### **Wenarl Ehrtesshab, Vilani Psychologist**

678997, 40 years old, Administration-2, Brawling-2, Computer-2, Gambling-1, Forward observer-1, Grav craft-1, Ground craft-2, Gun combat-1, Medical-4, Melee combat-1, Psychology-5, Research-2, Short blade-3, Survival-1, Tactics-2.

### **Laura Stone**

Laura grew up in the dimly lit corridors of a mining colony in an obscure asteroid belt. Few of her contemporaries ever escaped to better lives, particularly if they were beautiful girls like Laura — most were married with children before they were out of their teens.

But Laura had an indefatigable spirit, a strong will, and a dream that she kept in mind at all times: Laura wanted to be a pop star of galaxy wide fame. Fortunately, Laura also had talent, and the combination of all of these assets, along with the most important ingredient — a strong streak of common sense — she worked her way from smoky bars and audiences of a dozen drunken miners to system-wide pay-per-view broadcasts. Laura Stone went from the bottom of society to the top of the entertainment industry in the space of a few short years, producing a string of acclaimed best-selling musical recordings and starring in two movies that were popular with the public even if they were despised by the critics.

Then Joenelaren Verkelnaleer entered her life. This dashing handsome Vilani author entered the scene just as Laura started to contemplate achieving the final goal that would make her life complete — finding a man who loved her, and with whom she could start a family. For almost a year, Joenelaren appeared to be that man. With her career continuing to soar, and a man in her life whom she thought she would be together with forever, Laura was as happy as could be. However, on the day she decided she was going to propose to Joenelaren, having grown tired of waiting for him to propose to her, she got a call from her manager. Joenelaren had just signed a contract with a major publisher for a tell-all expose about the life, hopes, and dreams of Laura Stone.

At that moment, Laura's world collapsed around her. The man she had given her heart to had never truly loved her... all he was trying to do was to get information for a book he was writing. Laura sank into depression, and when the book came out and became a best-seller, her depression only got worse. At her lowest, hounded by reporters who wanted more tidbits about her early life, and afraid to face fans who now seemed more concerned with her personal secrets instead of her music, Laura got a mailing from "A Better Tomorrow." The company was just starting up, and their offer of providing a place to hide away from the world until the present was dead forever was very attractive to her. Although he protested vehemently that she was making a mistake, Laura's manager arranged for her to enter cryogenic sleep. She was to be reawakened three years after the death of Joenelaren Verkelnaleer.

When reawakened, Laura is at first stunned. Eighteen centuries is far longer than she had intended to sleep. Her initial confusion and shock quickly passes, however, and, although the future is not the harmonious place that "A Better Tomorrow" in its commercially oriented optimism had led her to hope it would be, she takes steps to begin a new career in a new world as soon as possible. She befriends the characters during her first few weeks out of hibernation, if only during the trip back to the characters' patron. She is a friendly, outgoing, charming woman . . . the ideal NPC for a romantic subplot, should the referee choose to introduce such an element into his campaign. However, Laura has recently been burned by a romantic relationship — to her, the incident with Joenelaren only happened a few months ago — and she will be very cautious about getting involved with someone while rebuilding her life. Still, a heroic and brave character who is her friend first might find the relationship growing into something more.

Laura's attempted return to fame can be a vehicle for several different types of adventures, perhaps even an entire campaign. It can start with the characters assisting her in getting acclimated to the Third Imperium while helping her track down what remains of the investments that were made on her behalf long ago. When Laura begins using this money to reestablish herself as a pop artist — she quickly takes to what is considered pop in the Third Imperium, fusing it with the style she per-

formed with and creating an entirely new sound that quickly starts to earn the favor of common fans and critics alike — she might offer to hire the characters and their ship as her managers, bodyguards, and personal transport for her and the back-up band she assembles. Of course, they will be far more to her than just an entourage of hirelings: She considers them friends, and will always treat them as such, first and foremost. She shares as much of her success with the characters as possible, allowing them both access to her wealth and the spotlight. Characters with musical talents in particular can find themselves on the road to fame as pop stars, as she attempts to get them to join her band.

While lives as the companions of a woman who is slowly coming into Imperium-wide fame carries with it the excitement of hobnobbing with increasingly powerful individuals in the various entertainment corporations, more action-oriented adventures can also grow out of the never-ending tour Laura embarks upon. She (or even one or more of the characters, since Laura tries to bring them fame as well) may be stalked by a deranged fan; a member of the band may be on the run from interstellar loan sharks or drug dealers intent on taking the money he owes them out of all his associates' hides; or terrorists seizing the studios of a planetary broadcast network may end up with Laura as one of their hostages. If a relationship develops between Laura and a player character, she might even be threatened by the murderous lunacy of Wenarl Ehrteessab.

Name <b>Laura Stone</b>		UPP <b>7B9743</b>
Service <b>Solomani Singer/Actress</b>		Rank
Birthdate	Birthworld	
Skills <b>Acting-2, Athletics-2, Carousing-1, Computer-1, Dancing-2, Grav Craft-1, Ground Craft-1, Jack-of-All-Trades-1, Music-3, Streetwise-1, Vac Suit-2</b>		
Possessions		Money
Comments (Social Standing of A, during the height of her fame.)		

UPP Card

001-000



69  
97



# 7: EASY CREDITS

---

In this non-linked adventure an unusual Trakii named Zebbachnoccookander secures passage aboard the player characters' ship. Unlike the rest of his people, he is unwilling to complacently let their 200,000-year history come to an end, as they are supplanted by the degenerate, cannibalistic *abominations* — mutated offspring of low intelligence and violent bent. (See the *Aliens Archive* supplement for a description of Trakii and the decline of their civilization.) Zebbachnoccookander has a serum that will reverse the genetic defect which created the degenerate Trakii, and he wishes to introduce it into his world's atmosphere.

The mutation agent responsible for the development of the abominations did not come from native pollutants of Trakiini, as commonly thought, but from the Solomani PERFORMAC Pharmaceuticals conglomerate. Based on Imkhasham (Core/1124/A8AA677-C) for the last six centuries, PERFORMAC is one of the most powerful companies in the Imperium. It produces as much as one third of all pharmaceuticals used in medical facilities across the Imperium, and many popular over-the-counter drugs are also packaged by the conglomerate or one of its subsidiaries. PERFORMAC rose to power mainly due to its development of numerous anagathic drugs which reverse aging effects, increase stamina and sexual potency, and otherwise enhance the physical performance of the user.

To create those popular pharmaceuticals, PERFORMAC sometimes engaged in questionable research practices, amoral at best and quite often criminal. However, the immense wealth and subsequent political power of its directors were always more than sufficient to bury any accusations against the company (and frequently those who made them). Thus, PERFORMAC clandestinely introduced into the atmosphere of Trakiini, some 500 years ago, a dysgenic quantum virus designed to destroy specific strands of DNA connected with the aging process. Laboratory experiments produced venerable rats, but they also viciously slaughtered each and every litter they bore, if not prevented from doing so. Nevertheless, PERFORMAC geneticists were anxious to introduce the synthetic virus to an extremely long-lived race and then harvest the genes of its offspring, advancing their research. The Trakiini were covertly exposed to the quantum virus, and about 100 years later, the first of the abominations appeared. Now, the mutated genotype appears to be taking over the species.

About a year ago, records of the experiment were uncovered during a raid on PERFORMAC's research facilities (on Imkhasham), staged by a Vilani eco-terrorist group. The company's well-oiled, TL13 intelligence network quickly caught the raiders and recovered the documents, but rumors of "some heinous and highly illegal experiment on a planetary scale" still managed to leak out. The exact nature of the experiment and the identity of the victims were successfully covered up, but the Vilani grew relentless in their efforts to discover the details. If nothing else, they roused enough suspicion across the Imperium to create a call for investigations into the allegations. Groups and organizations opposed to genetic manipulation began to search the Imperium for signs of such illegal operations. Only the fact that the experiment was 500 years old prevented everyone from considering Trakiini immediately, but it would not be long before some

scholar thought of the Trakii abominations.

PERFORMAC decided to cover its tracks, by neutralizing the quantum virus in Trakiini's atmosphere. They had already created a serum, but they needed to find a quiet way to release it because they knew they were being closely watched by several parties, official and unofficial. Therefore, they sent a covert-operations specialist (codename: Mandrew) to contact Zebbachnoccookander and lure him to a busy spaceport (which is where the characters will begin this adventure), with a promise of a cure to the "disease" that creates abominations. PERFORMAC learned of the Trakii's uncommon (for his race) desire to restore the purity of his genotype, so they decided to simply give the serum to him anonymously and let him take care of the matter for them.

Meanwhile, the Vilani eco-terrorists, who want more than anything to embarrass PERFORMAC, will do whatever they can to catch the company red-handed. They have diligently monitored the conglomerate's activities with their own network of spies, and they have tailed the PERFORMAC operative with the serum to his rendezvous with the Trakii. Mandrew is aware of them, however, and thinking fast, he comes up with a plan to use a neutral party to help finish the job. . .

The enmity that exists between the two factions and their operatives is a key element in this adventure. Whenever agents of each side are present, battle is almost inevitable and the characters are caught in the middle of it. Ironically, both factions want them to complete the assignment they receive in this scenario, yet both will see the mission fail unless it happens under *their* terms.

## The Setup

Agent "Mandrew" will contact the characters, claiming to represent Zebbachnoccookander, and ask them to "quietly" transport his client to his home planet for an extremely generous fee. The characters will most likely accept the job, whereupon they'll be attacked by Vilani eco-terrorists who believe they are employees of PERFORMAC. Assuming they win the battle, they will head to their ship (or one that Mandrew gives them for the job, if need be) and discover that Zebbachnoccookander is already aboard. The Vilani will attack again, in larger numbers, but the characters should be able to evade capture and leave the area, en route to Trakiini.

They can take advantage of the space flight to learn about Zebbachnoccookander and the slow demise of his race, but they can also learn how to deploy the serum into Trakiini's ecosystem, which might be handy later. They will find a Vilani force of

spacecrafts waiting for them at Trakiini. Particularly clever parties may devise a way to run the blockade, but they are likely to find themselves overwhelmed. If necessary, an unknown squadron of state-of-the-art spacecrafts (PERFORMAC ships) will come to their rescue just in time, allowing them to reach the surface of the planet.

On Trakiini, they will find Zebbachnoccookander's mate, Ikutheranimus (see "Native Trakii Encounter," in the Trakii section of *Aliens Archive*), under attack by abominations. In the midst of the fight, Zebbachnoccookander will be killed, and the odds may yet again seem overwhelming, especially when the Vilani show up in the midst of the fray. However, the Vilani will help to defeat the abominations, as their primary interest is to document the mission and implicate PERFORMAC's illicit operations, so they must help to fend off the abominations lest the evidence be lost.

They should release the serum into the atmosphere, whereupon agents of PERFORMAC will appear and attempt to eliminate all evidence. The outcome of the adventure, and adventures to come, will depend upon the characters' actions.

## A Simple Assignment

The referee can introduce "Easy Credits" in the midst of a larger adventure, treating it as a side trek, or wait until the characters are looking for work or action. They should be at a type A or B spaceport, where aliens and humans mingle freely. If the characters are at or near a suitable location, begin this adventure there. Otherwise, steer them toward the starport *Stonehenge* (UWP: B000414-C), nestled against the asteroid belt of the nearest system. Despite its complete facilities, Stonehenge is a zero-atmosphere environment. All large-scale operations, including shipbuilding, are performed in orbit around the 500-mile-diameter rock in space, which drags behind the denser sectors of the asteroid field. The relatively extreme density of Stonehenge's core provides for a fairly stable orbit, and the nearby asteroid field is riddled with ore mines, which is why a fully equipped starport was built there. Stonehenge is owned by Sternmetal, LIC (see "Megacorporations" in the *Millieu 0* supplement).

On the surface, it's a small-but-bustling city that never sleeps under the constant illumination of solar lamps. Stonehenge looks very much like an airport, with long malls containing various establishments interspersed between wide viewing ports, overlooking the tarmac and stars beyond. Outside, there are expansive landing bays for ships up to 200 tons, but vac suits are required to walk from the tarmac to the airlocks that access the station. Of course, the spaceport is spread out over several square miles, branching out in all directions, containing residential areas and industrial arms as well as shops, restaurants, entertainment centers, and so forth.

Mandrew has been looking for the right party to finish his assignment for him, and the PCs comprise the sort he's been looking for. He studies the group for a while before approaching them; each time they make a stop, or overlook the crowd around them, he attempts to blend into the background. Hiding from the characters is an Easy task if they are not wary of

spies, and a Difficult Stealth task one if they're watchful. If and when he fails his task, any character with Perception skill may attempt a Difficult task of spotting him. Add a cumulative +1 DM for each check performed until Mandrew is sighted. A PC who sees Mandrew realizes that the stranger has been lurking in the background almost everywhere that the party has been that day.

Allow the characters to react to the realization that they're being followed. Let them to initiate contact if they're so inclined. If they attempt to lose Mandrew, they're only temporarily successful — with additional subsequent Perception tasks, he shows up again. If they make no attempt to contact him, he eventually approaches them, at a point where he can talk to them either privately or without appearing obvious:

"Pardon me, please, but might I have a word with you? I'm looking for someone who might be interested in a little quick work for good pay, someone like you."

If possible, lead the characters to a quiet location, like a dimly lit club or restaurant, or an alleyway, as Mandrew is extremely concerned that *he* might have been followed. He introduces himself as a "freelancer" who hires himself out to very-wealthy private parties, to take care of various assignments in a "discreet and effective manner." His work is sometimes dangerous, but the compensation is excellent. Sometimes he hires strangers with necessary and appropriate skills to help finish the job. He needs help now, and he thinks the characters are right for the job.

## The Job

Mandrew does *not* reveal the true agenda of himself, PERFORMAC, or the Trakii! His story is as follows: The client is a political exile who desperately wishes to return to his home planet and see his mate. The client has been in hiding for decades, as he has many enemies who want to assassinate him, and now that he has emerged, they are hunting him again. Mandrew has helped the client elude his pursuers over several parsecs, but they are hot on their trail, and Mandrew wants to draw them off while the characters take the client the rest of the way home.

Depending upon how smart they play it, and how smart the client's enemies are, the characters may encounter some resistance along the way. Things might get tough, but Mandrew will make it worth their while. The ideal situation is for the whole job to go off without anyone knowing about it. Mandrew has been watching them for some time, making sure they're the type to keep their heads in a dangerous situation. If they have demonstrated their adventurous personalities at any earlier point that day, Mandrew cites the incident(s) as the event(s) that helped him choose them. Otherwise, he claims that investigators like him have a natural ability to judge peoples' characters, and he thinks he can trust them to get the job done.

Mandrew refuses to identify his client or the destination until they have agreed to take the job ("client confidentiality"). He assures them that knowing those facts should have little or no bearing on the case because they don't affect the situation as he has just described it. If they refuse to take the job unless they're immediately and fully briefed, he strenuously

demands a pledge of absolute confidentiality, and he insists that they agree to accept the job if the information doesn't present a specific and real problem.

Once any restrictions are overcome, Mandrew tells them Zebbachnoccookander's name and his destination planet. He doesn't offer much information about the Trakii or Trakiini unless it's pertinent to the job. For any character with the History skill, a successful Average task enables him to recall the introductory remarks (only) under the "Trakii" entry in *Aliens Archive*. Checking a database is an Easy Computer task, allowing the characters to learn the above information, plus everything in the "Racial Origins" and "Trakii Physiology" sections. A character with the Research skill can perform a Difficult task to access all information up to (not including) "Trakii Character Generation," with a spectacular success indicating that he learns the information about Ikutheranimus, under "Native Trakii Encounter."

If the characters accept the job, Mandrew tells them to be ready for departure in exactly four hours. He asks where their ship is docked so he can send the client. In the unlikely event they don't have a ship (and can't secure one themselves), Mandrew provides them with the *Raptor*, presented earlier in this adventure anthology (page 5), which they must return to this spaceport when the job is finished. The ship will be reported as stolen if they don't return it within a week.

Mandrew offers them 150,000 credits apiece. As an employee of PERFORMAC, he has access to immense wealth and the authority to dispense it. He wants to pay half up front, the balance to be paid by the client upon reaching the destination. He uses a wrist-comm to electronically transfer the credits into their account upon acceptance.

If they refuse the job, Proceed to "The Vilani Attack," below. Even now, Zebbachnoccookander is aboard their ship with his cargo. They will have little choice but to accept the assignment, at least for the time being. (See "Stowaway," below.) By refusing the job, they will only succeed in getting no pay for it.

Name <b>Mandrew</b>		UPP	6B8A79
Service PERFORMAC Agent		Rank	
Birthdate	Birthworld		
Skills Brawling-2, Bureaucracy-1, Computer-1, Forward Observer-1, Grav Craft-1, Perception-1, Pistol-2, Rifle-2, Recon-1, Stealth-2, Survival-1, Tactics-1, Vac Suit-1			
Possessions Laser pistol		Money	
Comments			

UPP Card

001-000

### The Vilani Attack

No sooner is the bargain concluded (or rejected) when a group of Vilani eco-terrorists attack. They are all rogue types, armed with blades and wearing normal street clothes rather than any uniforms. Use as many as are needed for a short battle, lasting only a few rounds. The Vilani attack from the closest range possible for

them to attempt a surprise (+1 DM for NPCs). Mandrew curses, draws his pistol, and fires upon them immediately.

If the characters fight, the dice can determine the outcome. The Vilani tend to concentrate their attacks on Mandrew until the characters attack them, at which point they attack everyone with equal likelihood. If and when the Vilani morale breaks, Mandrew warns that the attackers must not escape to warn others and seek reinforcements. Let dice and role-playing determine if anyone escapes.

If Mandrew is killed or knocked unconscious but the Vilani are driven off or defeated, the characters can do as they choose; the adventure is now in motion, proceed to "Stowaway" below when the actions have played out. Assuming Mandrew is conscious, he tells the characters to make themselves scarce, before the local authorities show up, and get to the ship quickly and quietly. He'll get the client to them in four hours, as scheduled, one way or another. He disappears as quickly as he can. Should they develop cold feet after the fight, Mandrew will increase his payment offer to as much as twice the original agreement, but he will first try to convince them that they're knee-deep in the assignment already.

If the party is overrun, Mandrew attempts to slip away. Go to "Talking With the Vilani," below.

If the characters abandon Mandrew and attempt to escape, Mandrew tries to escape as well. The Vilani try to chase the characters down and capture them. If they are caught, go to "Talking With the Vilani;" if they escape, go to "Stowaway."

### Vilani Eco-Terrorists

Age: Varied

UPP: 885674

Skills: Brawling-1, Computer-1, Melee Combat-1, Recon-1, Short Blade-1, Stealth-1, Vac Suit-1

Possessions: clubs, daggers.

### Talking With the Vilani

If the whole party is rendered unconscious in combat, the Vilani administer sufficient first aid to revive the least-hurt character and they question that character. If the party surrenders, then the Vilani simply speak with those who remain conscious. They want to know who the characters are, whom they work for, and what business they have with "that man" (Mandrew — the Vilani don't know his name). They refuse to identify themselves or their cause unless the characters first tell them everything they know about Mandrew and his mission. The chief Vilani who questions the characters is named Aileena. She's a tough, no-nonsense, articulate woman who is very serious about nailing PERFORMAC. The referee should play her like a calculating freedom fighter, passionate about her cause without sounding crazy.

Aileena interrogates them and tries to trick them into revealing that they know more than they claim. For instance, Aileena asks them several straightforward questions, then asks if they've ever worked for PERFORMAC before, to see if they slip up and admit to knowing more than they claim.

The Vilani themselves know the agent (Mandrew) works for PERFORMAC Pharmaceuticals (a company that virtually everyone has heard of), that PERFORMAC

has conducted illegal genetic research on some planet in the Imperium, and it now seeks to cover up any evidence to that effect (Aileena reveals this with great moral indignation). They also know Mandrew has or had something designed to destroy the evidence, though they do not know what PERFORMAC is up to, that Mandrew is contacting a Trakii, and that there is a serum involved.

If the characters play the innocents well, the Vilani grudgingly accept their story and eventually let them go, telling them to stay clear of Mandrew or anyone working with him "or else." Aileena offers a modest bribe to them, telling them to contact her at a local drinking establishment should Mandrew or anyone associated with him approach them again.

The referee should encourage the party to take care of any outstanding business at the spaceport immediately so they can get to the ship.

If the characters choose to tell the truth, Aileena carefully determine the length and extent of their involvement with Mandrew. She then reveals that Mandrew is a PERFORMAC operative and explains her suspicions about the company and its illegal activities. Mentioning the word "Trakii" will be a major revelation among the Vilani, and Aileena will quickly send off one of her men, instructing him to "contact Headquarters and tell them that Trakiini is 'ground zero.'"

The Vilani decide that they want the characters to finish the job and restore Trakiini to its natural genetic state. Furthermore, she wants the characters to act as though they are carrying out Mandrew's assignment, just in case PERFORMAC has already been informed of their involvement. In order for the Vilani to document the existence of the dysgenic virus in Trakiini's ecosystem, as well as the introduction of the serum to it, they may have to "play dumb" and follow the mission from a discreet distance, lest PERFORMAC change its plans. This is an opportunity she has awaited for years, so she'll offer them a modest bribe to cooperate, and she emphatically asserts that they will be aiding a heroic cause.

If they want nothing to do with any of it, The Vilani label them "cowards" and leave. Go to "Stowaway."

If they join forces with the Vilani, Aileena and her band go off to find the Trakii, promising to bring him to the characters so that they can complete the assignment. If all goes well, they will rendezvous with the party within two hours. (A Trakii can't be that hard to locate, they figure.) In any event, they'll be in touch soon.

The characters should be encouraged to take care of any outstanding business quickly so they can get to the ship. If they have errands to run, a Vilani agent tails them, to make sure they don't try anything. (Use the same mechanic as listed above, for Mandrew.) If they want to catch the spy, make it difficult even though it proves a waste of time. If they capture him, he merely tells them that he's watching their back, as PERFORMAC is a dangerous operation who deals ruthlessly with its adversaries.

If the characters change sides at any point in the scenario, the referee should bear in mind that both PERFORMAC and the Vilani want Trakiini's natural genetic pool restored, but the former wants no evidence to remain and the latter wants to document the whole thing for posterity. If the characters ally with PERFORMAC, the Vilani dog them all the way to the resolution.

If they ally with the Vilani, PERFORMAC attempts to abort the mission (and either kill the witnesses or fully wipe their computer banks of all relevant entries) unless it reaches Trakiini, at which time they allow the serum to be administered and *then* move in. With minor adjustments, most of the following encounters can be adapted such that either faction is the enemy.

## Stowaway

The characters should arrive back at the spaceship expecting either Mandrew or the Vilani to bring a Trakii to them. Instead, they discover that Zebbachnocookander is already aboard, with his cargo of serum, waiting for them. Mandrew knew that the Vilani were following him, so he avoided contacting Zebbachnocookander personally and led the Vilani on a wild goose chase. Along the way, he managed to send a message to the Trakii, instructing him to quietly slip aboard the characters' ship and get out of sight (if possible). While he negotiated with them for their cooperation, Mandrew was already foisting the job upon them. Even if they refused the job, the move would still buy him time to make other arrangements.

The serum itself is highly concentrated. The entire supply required to neutralize the quantum virus fits into a dense polymer container that occupies just 3 cubic feet of space. Zebbachnocookander keeps the serum behind him and will not tolerate anyone going near it. (See "Talking With Zebbachnocookander," below.)

If a character or hireling has remained aboard the ship during the party's negotiation with Mandrew, or if the ship is equipped with anti-intruder technology, the docking officials call for a random safety inspection of the ship, requiring those on board to disembark, enter the station, and sign paperwork. Let them try to avoid the inspection if they like. The officials can be comical, intimidating, or dull and officious with the characters. While they all argue around the paperwork, Zebbachnocookander steals aboard.

If the ship is protected, Mandrew has given Zebbachnocookander a hand-held computer override appropriate to penetrate the defenses. PERFORMAC is wealthy, TL 13, and more than willing to equip its operatives with devices that enable the user to perpetrate criminal acts.

If the characters are working for Mandrew, they find a message in their ship's comm station recorder from Mandrew, instructing them to leave immediately. They can do so without incident if they take off within five minutes. This essentially means they must go straight to their stations and depart, whether or not they discover Zebbachnocookander, without asking questions of him, or pausing for any other activities.

After five minutes, the Vilani appear on the scene. If the characters are still present, the Vilani attempt to board the ship or otherwise stop it from leaving. They charge the ship, weapons drawn, in open hostility, believing the characters are PERFORMAC operatives. The object of this encounter is to force them to flee the scene under duress. If a full-fledged battle breaks out, allow the characters to break for the ship while steadily increasing the odds against them on the other side. For example, after several combat rounds, another group of Vilani might arrive with a tripod-mounted heavy laser rifle, capable of destroying the ship with a direct hit, but it will take another round or

two to set it up, out of range of the melee. If the ship is boarded, allow the characters to force back the attack just long enough to seal the hatches and blast off, and so forth. Of course, some groups refuse to leave a battle; they should require a little luck to get out alive.

Zebbachnoccookander stays in the ship and fights only if the battle comes aboard. His main concern is to protect the serum.

If the referee desires, a Vilani scout/courier waits beyond the spaceport and moves to intercept as soon as they clear the gravity well. The ship is only a small scout ship, and no match for the characters. It makes a valiant attempt to disable their vessel, but cannot stop it from punching through to jump space.

Should the characters have re-aligned with the Vilani, they still find both Zebbachnoccookander and the same message from Mandrew, instructing them to leave immediately. They can do so if they wish, but that will convince the Vilani that they are traitors to everyone, not to be trusted. The Vilani ship mentioned above will be the only resistance they encounter until they reach Trakiini.

Otherwise, they can wait for two hours, at which time Aileena shows up to tell them that she has been unable to locate Zebbachnoccookander. If they know about the Vilani spy who's watching them, they can approach him and tell him to call Aileena, and she'll come immediately. She shows up with two bodyguards, and she wants to talk to Zebbachnoccookander very badly, but she's too fiery to wait for the translator to work between them. She asks a torrent of questions all at once, then grows exasperated at the Trakii's blank stares. Before she can get any answers, PERFORMAC agents move in to attack. The characters-Vilani alliance jeopardizes the mission, so they want to kill all witnesses and recapture the serum. They are well-equipped fighters, with weapons and armor of obviously premium make. Fortunately for the characters, they hate the attention that a battle draws, and they run at the first sign of the local authorities, who appear on the scene within three rounds of the first shot. The fight should be short and sweet—just long enough for the characters to see they're up against a powerful enemy.

If the characters don't want the Trakii aboard, it will take quite a while to make Zebbachnoccookander understand that he's not welcome. As far as he knows, they were always a part of the effort to get the serum to Trakiini. In the midst of the debate, the Vilani attack. The characters may surrender Zebbachnoccookander to them, which ends the adventure and puts the entire party on PERFORMAC's hit list.

### **PERFORMAC Agents**

Age: Varies

UPP 967758

Skills: Brawling-2, Rifle-1, Tactics-1

Possessions: Laser rifles, cloth and reflex armor.)

### **When Zebbachnoccookander Speaks**

The Trakii language is complex in the extreme, grammatically, phonetically, and linguistically. To a human, the speech of a Trakii is reminiscent of Gregorian chanting. Translators can overcome the language barrier, but the Trakii will drone for some five minutes before a simple, single sentence issues from the speak-

er. Conversely, when a human speaks into the translator, the device hums for several minutes, essentially constructing a crude sentence in the Trakii drone. The Trakii will then require a few minutes to develop the snippet of information into a concept it can process — one might compare the experience to a parent hearing a string of baby babble, picking up a key word, and extrapolating the baby's full desires and intents from it.

Zebbachnoccookander carries a small, hand-held translator of Trakii design, but if a character is capable of speaking Trakii, he or she can make a fairly literal translation from Trakii into other languages. The following paragraph represents a literal translation of the sentence, "I am hungry."

*Long the day when first all creatures grew from the dust. Long the day when first all creatures walked the land. Long the day when first the Trakii rose above the rest. Long the day when first the plants grew over the land. Long the day when first Relloutommea sired my line. Long the day when Spiddethalus begot him Ornerreerratum. Long the day . . .* (At this point, the referee can pause and say that the lineage continues for several minutes, and the Trakii is being brief for the sake of his audience.) *Thus do I look ever forward as I look back. Thus do I know my duty to my ancestors and my descendants. Thus do I name my future as I name my past. Thus do I seek to beget . . .* (At this point, pause to say that several future generations are named, but the Trakii only gives a few of them, to save time). *Thus do I seek to perpetuate myself, my family, my people, my honor, my everything. Thus do I seek to unite myself with longer life, thus do I refurbish what is lost, thus do I sustain, for myself and those yesterday and tomorrow.*

The characters will probably only have to hear this single, literal sample of Trakii before they ask the referee to skip to the final translation and adjust for the necessary passage of time!

### **The Flight to Trakiini**

Trakiini is known to the Vilani as Emirkushguur (Dagudashaag/0924/BAE7633-B). If desired, the referee can interject delays and side-trips into the adventure, but the characters should run into agents of their adversary at each stop — people all over the sector are looking for them. Zebbachnoccookander might become a temporary member of the party—he's in a hurry to get home, but hurrying to a Trakii is like procrastinating for a lifetime to others.

Once per jump, a character may attempt an Average Sensor task. If successful, the player notices, during routine sensor sweeps, a blip on the screen that fades away before he can even draw others' attention to it. Only a spectacular success enables the character to scan the blip again, but then it disappears. A spectacular success also indicates *several* blips. These are state-of-the-art PERFORMAC fighter ships, designed for stealth and fitted with TL 13 electromagnetic scanning and jamming equipment.

### **Talking With Zebbachnoccookander**

In any event, the characters should take advantage of the opportunity to talk to Zebbachnoccookander. There's good opportunity for role-playing here: The translation matrix is maddening, and an hour is

required to absorb each piece of information listed below. As such, there is over 30 hours of interrogation needed to absorb all that Zebbachnoccookander has to relate (but it is the *interrogators* who are most likely to suffer). Attempting to talk with Zebbachnoccookander is a Formidable Int or End (whichever is higher) roll; if a character has the Linguistic skill, add the number of skill levels to the target number. Failure indicates that the Trakii has grown so abstract that his translations make no sense, and a spectacular failure indicates a migraine headache that lasts until he rests for 1D+2 hours. A spectacular success indicates that the character absorbs two pieces of information that hour. If a character abandons a conversation with Zebbachnoccookander and then approaches him later, the Trakii picks up the conversation right where he left off, and attempts to get him to repeat information are nearly impossible. The Trakii has keyed into one phrase, which he can speak without need of the translation device: "Take me to Trakiini." Anything else must be handled through his translator, or through a character who speaks Trakii.

*Note that Zebbachnoccookander knows nothing about the politics of this affair, nor does he care about them.* Attempts to discuss such matters result in a lecture of the philosophy of determinism (a favorite among Trakii) at first, and sullen refusal to talk with the "hasty, quick-tongued, flighty humanoids" at last. If approached peacefully, Zebbachnoccookander's demeanor seems a bit haughty, but he agrees to discuss the subjects below one at a time. Given the opportunity, he simple relates each point in a subject, one by one, as long as the characters are willing to sit and listen to him. In fact, he relays information in the actual order presented below. In other words, a character can elect to just get him talking and listen until he's done, and the referee can simply relay each piece of information below, one by one.

However, if a character asks for a change of subject, Zebbachnoccookander abandons the subject at hand and does not return to it unless specifically asked about points he never brought up. For example, if Zebbachnoccookander says, "They should make for the home of Ikutheranimus, my mate" (see below), and a character replies, "Tell me about your cargo," then Zebbachnoccookander says, "The serum will heal my people." His remarks continue in order from there. Thus, the amount of information Zebbachnoccookander reveals depends upon their willingness to work for it.

The Trakii does not raise any of the following subjects himself; he must be asked. Depending upon shallow, short-lived creatures like humanoids is distasteful to Zebbachnoccookander. He would prefer to assume that the characters know their duties and don't try to talk to him. (After all, they'll just gabber for a moment, then walk away without listening, so what's the use?)

**Who are you?:** A literal translation of this proves to be a finely detailed lineage, including all relatives to the third cousin, and all his mate's relatives to the first cousin. The process requires two hours. If the players indicate politeness on the part of the characters during the process, Zebbachnoccookander continues for another hour, adding names of future generations to come. If the player indicate boredom or rudeness, he

stops after two hours, and waits for their questions. The translator, after the hours have passed, merely defaults to "Zebbachnoccookander."

- I am a Trakii.
- I must go home.
- I must go to my mate, Ikutheranimus. (This name also requires two hours to relate, but the characters may interrupt any time, as the translator defaults to "Ikutheranimus.")

**Where to?:** Other than "Take me to Trakiini," Zebbachnoccookander can relate the following:

- They should make for the home of Ikutheranimus, his mate.
  - Ikutheranimus lives in a mountainous city.
  - The city lies on the 45th latitudinal parallel of the southern hemisphere.
  - The city lies between two active volcanoes, 50 miles apart.
  - The volcanoes are both over five miles tall.
  - Zebbachnoccookander can identify the topography from orbit.
  - Ikutheranimus will offer refuge from the abominations.

**The Abominations:** A great sadness pervades even the translations of this subject. Telepathic psionic skills employed during this time relate overwhelming sadness, possibly resulting in emotional damage to the psionist.

- They are our hatchlings.
- They are terrible creatures.
- They are sick. (This carries with it a feeling of revolting and dread for all who listen. Telepaths receive shocking images of cannibalism, instantly reducing their psi scores to 0.)
- They appeared 400 years ago.
- Sometimes a normal Trakii hatches, other times an abomination hatches.
- You can't tell which is which until they've matured.
- Their frequency is increasing.

**The Serum:** Zebbachnoccookander will not allow anyone to touch the serum. He merely says the word "no!" if someone tries, and the tone of his voice is deadly and clear.

- The serum was a gift.
- The serum will heal his people.
- The serum will destroy the abominations.
- The serum must be superheated and released into the atmosphere to work.
- The serum's container must be suspended in an environment with temperatures exceeding 2000° F (1100° C) for several minutes to release the serum.

**Trakii Culture:** Characters are better off accessing a computer and reading the available literature on Trakii (i.e., the *Aliens Archive*), but Zebbachnoccookander makes the following remarks about his people.

- We are too deep for you to understand.
- The abominations are destroying us, but most Trakii don't care.
- Most Trakii have simply accepted the existence of the abominations.
- Only Ikutheranimus and I want to make the abominations go away.
- Trakii used to be social and civilized.

- Now, Trakii are solitary and grim.
- Additional nuggets of facts can be drawn at a glance from the *Aliens Archive*.

Name <b>Zebbachnoccookander</b>		UPP <b>A4BCCA</b>
Service <b>Trakii</b>		Rank
Birthdate	Birthworld	
Skills <b>Biology-1, Brawling-1, Chemistry-2, Instruction-3, Philosophy-1, Research-2</b>		
Possessions		Money
Comments		

UPP Card

001-000

### Blockade!

If the characters have joined with the Vilani, skip this encounter and move on to "On Trakiini," below. In the most likely scenario, they have had several run-ins with the Vilani, met Zebbachnoccookander, and made their way to Trakiini. Smart characters will run active sensors as they approach the system. There are six ship's boats circling the planet in an evenly distributed pattern, creating a sensor net, attempting to ensure that no one reaches the surface unnoticed. Trakiini is an extremely large planet, so the power required to set up the net substantially inhibits the effectiveness of long-range scanners, giving the characters the ability to see the Vilani well before the Vilani see them — a sensor check at Average task difficulty reveals this vulnerability — if they have active sensors running. If so, they automatically detect the Vilani ships in orbit. If only passive sensors are operating, then the Vilani ships are detected, but so is the characters' ship. If no sensors are operating, the Vilani attempt a surprise attack.

There are three programmed methods of running the Vilani blockade, if they have detected the ships without themselves being detected. Creative players are likely to dream up other possibilities, and the referee should give reasonably well-planned schemes a good chance of succeeding. The Vilani are not professional soldiers or mercenaries, so they're liable to fall for most ploys.

**Blind Spot:** Trakiini is so large that there are small holes in the Vilani net, through which the characters' ship can fly undetected. This involves timing the movement of the ships and approaching inside a narrow window — to successfully do so is a Formidable Pilot task. Once the ship enters the atmosphere, the Vilani detect them, but it will be too late to intercept.

**Meteor Field:** The solar system is relatively young, and therefore littered with large asteroid and meteor fields. The metallic, electromagnetic stone interferes with sensor readings, especially where it enters Trakiini's atmosphere and picks up friction. Presently, a wide field of fairly small meteors are raining over the south pole. In order to tighten up the net elsewhere, the Vilani are not scanning the southern polar area, figuring that no one would try to fly through an asteroid field.

Reaching the area and remaining undetected is an

Average Pilot task. However, maneuvering through the field is more difficult. As soon as they draw near, the hull of the ship begins to resound with a sound like sand and stones blowing over it. Pings and bangs ring out here and there, and every round there are several alarmingly loud crashes against the ship, which sound like they may blow right through the hull. The referee should describe an escalating hail storm, where the stones keep getting bigger and bigger. By the time the ship is clear of the storm, it will have sustained 1 point of incidental damage, but there is much more to fear than that: Five Formidable Pilot task rolls are required to move through the meteor storm and then fly free of the area, no matter how or where the ship enters. If they think of it, a Formidable Sensors task can be attempted with each Pilot check, with success adding a +2 DM to the latter. For each failed Pilot task, the ship is struck by a fragment which inflicts 1 point of damage.

**Crash Landing:** Desperate parties might try to simply fly past the blockade, seeking to reach the surface before the Vilani can get to them. An Easy Navigation or Pilot task reveals that the maneuver is possible, but the ship will have to make a controlled crash landing. Have the pilot perform three Difficult Pilot tasks. For every failed task, the ship bounces roughly, inflicting a point of damage to the hull and everyone aboard.

### Battle Over Trakiini

If the characters don't come up with a way to run the blockade, they are intercepted as they approach the planet. Two of the ship's boats block their path, and another ship's boat arrives each round until all six are on the scene. The Vilani send out a hail: "Surrender and prepare to be boarded." They only send the message once, and they open fire if they don't receive an immediate response. This battle should prove overwhelming. Unless they surrender, the Vilani ships begin to blast them to the brink of destruction.

**If the Characters Surrender:** The Vilani board the ship and gather the characters and Zebbachnoccookander together for questioning. Aileena is in command, but she's openly hostile at this point. Between the Vilani, Zebbachnoccookander, and the characters, most of the truth should come out. Remember that Zebbachnoccookander will not allow anyone to touch the serum. He merely says the word "no!" if someone tries, and the tone of his voice is deadly and clear. He will report upon questioning that the serum will heal his people and destroy the abominations. It came from an altruistic humanoid scientist, and must be released into the atmosphere to work.

The Vilani decide that they want the characters to finish the job and restore Trakiini to its natural genetic state. They only wish to collect samples of the virus, then document the introduction of the serum. If the characters wish, they can hand Zebbachnoccookander and the serum over to the Vilani and be on their way; this ends the adventure. However, Aileena point out that they will have made a powerful enemy in PERFORMAC, and only going on record with their involvement in the whole affair will provide any assurance against corporate revenge. PERFORMAC may put a bounty on their heads.

**If the Characters Fight It Out:** As mentioned above,

they are severely overmatched in this battle. The referee should allow the fight to reach desperate proportions. Suddenly, a dozen black-painted fighter ships swoop in, from out of nowhere, and attack the Vilani ships with deadly force. They remain long enough to blow all Vilani craft out the sky, then disappear back into the darkness without a word. These are the PERFORMAC fighters, mentioned earlier. They have been monitoring the characters' progress, instructed not to engage anyone unless absolutely necessary. The characters may consider this action *deus ex machina*, but they'll realize why the fighters were there all along when the PERFORMAC forces move in to eliminate evidence, at the end of this scenario.

## On Trakiini

Zebbachnoccookander's home is briefly described in the "Trakii" entry of the *Aliens Archive* (listed in *First Survey* as Emirkushguur/Dagudashaag/0924/BAE7633-B). It is a large planet, exerting a force of gravity roughly equal to twice the normal at sea level. Vac suits aren't imperative, but most people will tire quickly. (Average tasks against both Str and End can be called for each hour, with failure indicating the loss of 1 point. Lost points are regained 1 per hour, once the character returns to a less-oppressive atmosphere.) However, one of Trakiini's most remarkable features is its incredibly high mountain reaches, due to massive tectonic movement and a metallic, multi-layered crust — two mountains actually top the ten-mile mark! A full 300 peaks, fairly evenly scattered over the planet, rise well above the 8-mile-thick atmosphere, which flows around them like milky water. The humanoid altitude-comfort zone lies between 58,000 feet and six miles up. Above that level, the air quickly thins.

Another feature of Trakiini is its proximity to several asteroid fields, scattered throughout the system. Meteor storms occur on a regular basis. Most of what reaches the surface breaks up into small bits, but larger pieces fall, too. There referee can introduce a meteor shower at will, which should last 1D+1 rounds. (Multiple showers can occur, 1D rounds apart.) As the first few strikes come streaking in, Zebbachnoccookander calmly moves under the nearest overhang of rock or other likely shelter and waits for it to pass. As long as they remain exposed to the skies, avoiding a meteorite is a Difficult task against Dex each round. If a character is hit, roll 1D to determine how many dice of damage are inflicted by that particular meteor, and re-roll results of 6, adding subsequent numbers to the total. The ship, unless protected, suffers 1D damage in every storm.

There are serviceable landing sites at virtually every altitude. If the characters have failed to ask Zebbachnoccookander where to drop him off, he says nothing. If they land anywhere but Ikutheranimus's city, he merely stares at them when they expect him to disembark. They must request his exact destination from him, as he simply assumes they know their job and are getting it done in their own good time. (Remember, Trakii are never in a hurry.) Of course, they can always kick him off the ship and let him fly home, but he warns that he is subject to attack by abominations, which would prevent him from accomplishing his mission. Besides, the adventure would be over, and they

would be marked for death by PERFORMAC, preventing them from ever revealing the conglomerate's illegal industrial practices (see "Conclusion").

An Easy Sensors sweep is required to locate Ikutheranimus's city, which lies in a ring mountains that circles the southern hemisphere at the 45th parallel. Another Easy Sensors task reveals that the entire planet is riddled with active volcanoes, but most of them are hundreds of miles apart. There is only one pair of volcanoes that are just 50 miles apart, and Ikutheranimus's city lies between them. The city itself actually lies within a cluster of peaks that rise several thousand feet above both volcanoes, so the location is safer than it sounds. A character with Geology skills can interpret Sensor readings as an Average task, learning that the entire range is laden with heavy metals and is latticed with lava networks. Even at its altitude of just over six miles, the city is geothermally heated and almost humid. Clouds of mist and steam float along the surface and then rapidly evaporate into the thin air.

## Ikutheranimus's City

The name of this city is so long and unpronounceable that even the translator labels it, simply, "Ikutheranimus's City." The ancient home to thousands of Trakii is now little more than a sprawling network of broken walls and foundations, overgrown with tough, sinewy vines, thrusting from the rocky slopes of the mountain tops. The stone and artwork suggest a highly civilized culture once thrived there, but centuries have passed since then. Planetary earthquakes and constant meteor showers have destroyed most structures. There are large caverns that sink into near-vertical grades, their mouths adorned with crumbling architecture that created the facade of stately manors and places of meeting, where the residents contemplated and talked for days at a stretch. A lot of steam issues from the caverns, as well as from fissures in the mountainside—there's obviously a lot of geothermal heat below the city. The referee should stress the fact that there are fissures and deep caves of all sizes, all around the area, making it difficult to walk or climb in a straight line anywhere.

There is ample landing area for the characters' ship (and several more, shortly), at the base of the city. Because of the surrounding peaks, however, a smooth landing requires an Average Pilot task. As soon as the ship comes to rest, Ikutheranimus flies out of a cavern and swoops down to the ship, where she waits for Zebbachnoccookander to appear.

Oxygen deprivation is a factor at this altitude. Any activity more strenuous than walking and talking is an Average task against End each round, and failure reduces a character's End by 1. When a character's End reaches 3, he becomes so winded that all tasks become two levels more difficult. By standing still or sitting down, all points of End lost to failed task checks return at the rate of 1 per round (unless the strenuous activity resumes). Food and water are an issue as well: they require twice normal rations to function normally.



Name <b>Iktheranimus</b>		UPP <b>B5697A</b>
Service <b>Trakii</b>		Rank
Birthdate	Birthworld	
Skills <b>Biology-1, Brawling, Chemistry-1, Philosophy-1, Research-1</b>		
Possessions		Money
Comments <b>Zebbachnoccookander's Mate</b>		

UPP Card 001-000

### Abominations Attack

Zebbachnoccookander and Iktheranimus meet and simultaneously begin droning without any indication of a greeting. The translator begins to yield extremely abstract comments, about subjects completely unrelated to the task at hand. A character who succeeds a Difficult Int task realizes that they are picking up a conversation where they left off, whenever they last saw one another.

In the midst of the Trakiis' talk, and the likely prodding of the characters, abominations swoop in from the surrounding peaks, roaring ravenously. Zebbachnoccookander and Iktheranimus hiss and take flight to battle with the abominations, but there should be more than enough to make for a good fight with the characters. Zebbachnoccookander dies in this battle, either at its end or when the action of battle creates an appropriate moment. Iktheranimus may live or die as the dice dictate. The abominations tend to concentrate their attacks on the Trakii, but everyone looks edible to them. If the characters begin to get the best of the battle, introduce another swarm, larger than the first. When the tide turns against them, several Vilani ships arrive on the scene and circle. The characters will probably assume that new enemies have arrived, but the Vilani will actually come to their aid.

If the Vilani have joined the mission, the abominations should be fairly easily eliminated, but Zebbachnoccookander still dies.

### Trakii Abominations

Age: Varied

UPP: A46332

Skills: Brawling-3 (hand-to-hand attacks inflict 2D dam.)

### Deploying the Serum

Once the abominations have been defeated, the serum can be deployed. The Vilani produce a portable camera and begin to document the whole procedure. They interview the characters on camera (if permitted), asking for the whole story that led to this point. They will protect the identities of the characters if asked, but they are willing to take the serum by force and deploy it themselves if that's what's required to document PERFORMAC's cover-up.

If the characters never learned from Zebbachnoccookander how to deploy it, an examination of the container and an Average Engineering task reveals that the serum is suspended in a high-density polymer. The container has been heat sealed and will require immense heat, over a period of at least several minutes, to open.

There are two likely means of releasing the serum.

**Into the Volcano:** It's possible to deliver the serum directly into the caldera of any volcano on Trakiini. However, temperatures near and above the rim average 3000° — more than hot enough to melt a ship. Armor may be sufficient to maintain hull integrity, but its conductive properties will superheat this ship for several minutes, which would instantly kill most life forms aboard.

The best method for using a ship to deploy the serum is to put the container into a missile payload carrier and fire the missile into the volcano. Anyone with Gunnery, Heavy Weapons or Demolition skill can automatically accomplish this average task.

**Into the Crust:** There are many rifts inside the caverns, and in deep fissures that crease the city. By accomplishing a Difficult Dex task, a character can work his way down to a shaft that leads directly to subterranean lava flows. Simply casting the container down the shaft will deliver it into a suitable medium for release.

Shortly after putting the serum into the lava, a yellowish gas begins to billow up from the volcano. The serum is harmless to anyone who breathes it, but it is deadly to the quantum virus that lives in the bodies of the Trakii. Within a few weeks, the gas will permeate the entire atmosphere and all traces of the virus will be wiped clean.

### Eliminating the Evidence

As soon as the gas is released, PERFORMAC commandos, led by Mandrew (if he hasn't been killed), swoop in to capture and destroy all incriminating evidence. They begin by strafing the characters and Vilani, but land and attack on foot when all have taken cover. The commandos and Mandrew want to interrogate prisoners, to learn the extent of the information leak, so they seek to wear down the resistance, rather than wipe out every breathing thing. Their strategy is to carefully establish a perimeter around the party and then close it. Realistically, the characters and Vilani can't beat PERFORMAC commandos in a straight-up fight. They'll be captured, by force if necessary, if they don't come up with an escape plan. Given the situation, they have time, while the commandos land, to formulate a plan.

The Vilani want to flee and sneer at any suggestion that they tough it out. They know what they're up against! Their only objective is to escape with the evidence, and they will accept a few casualties if a plan involves a guaranteed window of opportunity. If the characters' first thought is to fight it out, Aileena (or another Vilani, if she's not there) suggests that the characters protect a corridor to the Vilani ship with suppression fire so they can make their break. She believes the commandos will follow the Vilani, leaving the characters alone or with a contingent small enough to handle. (The Vilani will have to hope they can make jump space before the commandos catch up.)

If they agree to this, they are in for a beating, but the commandos immediately break off the attack and run for their ships the moment the Vilani are aboard. The Vilani will take off immediately, and the PERFORMAC fighters will follow closely behind. One crew will remain behind to finish with the characters. Truly heroic fighting at this point might drive off the commandos. Otherwise, they are captured and interrogated to find

out if they have any physical evidence of the events on Trakiini. Their computer logs are checked and stripped of any records pertaining to the mission, and they are released, no longer posing a threat to PERFORMAC.

It's also possible to evade the commandos by running into any nearby fissure or cave. This tactic leads the party into a labyrinth of caves. The commandos play cat-and-mouse with the party as long as they attempt to remain in the immediate area, then move back outside and post guards around their ships. They figure that the Vilani and characters can't go anywhere without their ships. They will also board the ships and strip the computer files, as described above.

If Ikutheranimus is still present, she can lead the party through the caves, to an exit out of sight of the commandos. If asked, she agrees to lead the party to a place where they can summon a transport ship. The referee can create a whole adventure out of reaching the ship and escaping Trakiini, if desired. Otherwise, they reach the departure point without incident.

## Conclusion

If the characters escape the commandos, they must go public with their involvement; otherwise, PERFORMAC will attempt to kill them before they can talk. Both PERFORMAC and the Vilani will attempt to find them first. In the meantime, PERFORMAC will claim that a rogue scientist stole the quantum virus from its labs, 500 years ago, but the company only recently learned the virus had been used on Trakiini. They'll claim they were merely trying to fix a problem that they had only inadvertently caused, through no fault of their own. They were trying to do it quietly because "eco-terrorists wanted to prevent them from helping the poor, accidental victims of Trakiini."

Conglomerates don't see much profit in revenge, so the characters may be free of trouble, once they go public. However, the referee may choose to make a lasting enemy of Mandrew and/or PERFORMAC, as they're perfect bad guys — wealthy, high-tech, seemingly undefeatable.



# 8: PSILENT ESCORT

In this adventure, the characters are hired by a noble family to take their young daughter and some retainers to a world on which the family has a country estate. The girl is a very powerful untrained psionic, and some of her dreams and subconscious thoughts have unleashed bizarre manifestations of those powers that have unsettled the predominantly backward and superstitious locals on the world where her parents govern. At the suggestion of their retainers, they have decided to send her to their hunting lodge on a garden world reserved for nobles and other wealthy families. There, the family retainers can protect her and see to it that she begins her training in the proper and responsible use of her psionic abilities. Privately, they are somewhat nervous about their daughter's talent, for although psionic ability is a part of their genetic heritage, they have never known one of their members to manifest so strong a talent. They do not know what to make of this situation, but they are hoping that time away from superstitious locals will give them time to consider the way they will approach her training.

Enroute to the estate world are two adventures concerning the young girl. In the first of these (this adventure), she is kidnapped while she and the characters are at the first of their refueling stops. Terrorists (or freedom fighters) from the world on which her parents work take her in an effort to pressure their own government to reduce its ties to the Imperium. They learned of the characters' route (either by sneaking aboard and downloading their computer or by bribing a starport official for the information) and sent a team to the characters' first stop in order to capture the girl.

## The Setting

The location for the beginning of this adventure should be on a world that is somewhat off the beaten path, yet is economically or politically important enough to warrant a representative of the Imperial government. Suggested ranges for the characteristics of the Universal World Profile are:

Starport:	C-B
Size:	2-A
Atmosphere:	5, 6, or 8
Hydrographics:	1-A
Population:	3-8
Government:	Any
Law:	4-A
Tech:	5-9

The world has a relatively diverse economy, so trade goods of many types are available here, especially high-quality electronic components of moderate technological level, art objects and other novelties, and processed alloys. Nearly any sort of trade product will sell here, with the best prices going for unprocessed high-grade ores, light machinery, personal vehicles, and information and education materials.

## The Setup

The characters are on this world conducting their routine business, be it trading, looking for passengers, delivering courier packages, seeking mercenary or security contracts, or simply getting a little rest and relaxation. They have been on world for a day or so when a local courier delivers to their ship the following note:

To the Captain, Officers, and Crew of the (name of characters' ship),

I wish to invite you to dine with my family and I this evening and to discuss with you a potentially profitable business venture. I can assure you that this is no trick; I discovered your ship listed in the starport traffic log, and I am sending this simple inquiry as a request for a few hours of your time. If you are willing to meet with me, please tell my courier so that I can arrange the dinner with my household. We normally dine at 7:30 pm, local time, but if this is unacceptable, we are willing to adjust that schedule accordingly. Thank you for your consideration.

Sincerely,  
Sir Kaplin Harbouss

Success at an Average Intelligence task will identify Sir Kaplin Harbouss as the Imperial representative on this world. He holds the office of Consul-General, and he runs the small contingent of Imperial offices that conduct the Emperor's business with the local government. If the characters choose to accept Sir Kaplin's invitation, the courier will gladly take their response to him. Furthermore, he will inform the characters that he will return at 7:00 pm (or one half hour before whatever dinnertime they prefer) and drive them to Sir Kaplin's residence. If the characters ask about why he is to drive them, he will tell them that Sir Kaplin wishes this meeting to be discreet. If they insist on driving themselves, he will agree to their requirement, and ask them to use the side vehicle entrance to the compound. He thanks them for their time and bids them good day.

If the characters choose to find a little information about Sir Kaplin, they must succeed at an information gathering task. Success at an Average Streetwise test, a Difficult Administration or Research test, or a Formidable Carousing test (Sir Kaplin's social peers and local government employees are less likely to provide information about him than are members of the local street culture) will yield the characters some or all of the following information:

- Sir Kaplin has been in his post for the last six years.
- His family consists of his wife Claire and a five-year-old daughter named Tess.
- Since arriving at his post, Sir Kaplin has become well-integrated into local society, donating time and resources to local charities and civic programs.

If the characters exceed the required roll by two or more, give them the following information:

- Sir Kaplin has a reputation as an insightful admin-



istrator, and these insights have helped smooth over some rough issues between the local and Imperial governments.

- Three months ago, Sir Kaplin and his family were visiting a factory when some machinery broke loose and severely injured a worker; immediately before the accident, Kaplin's daughter pointed to the machine and said, "Look, Mommy, it's broken." Several people standing nearby heard what she said and have wondered if there is any connection between her comment and the accident. Investigators discovered that the machine had been sabotaged, but local popular opinion still suggests that there may have been a connection between the injury to the worker and Tess's odd observation.

If the characters exceed the required roll by four or more, give them the following additional information:

- Psionic talents are not at all uncommon in Sir Kaplin's family. Several members of his family are known psionics, as were several of his ancestors. Sir Kaplin has not claimed that he, too, possesses such talent, but he has not denied it either.

- At the school she attends, Sir Kaplin's daughter Tess reputedly knocked down another child without even touching him. The child and she had gotten into a dispute during recess, and she became annoyed and yelled at the child to get away from her. As she did this, the child was hit by a great enough force that he was knocked off his feet. Tess was several feet away when it happened.

- An anti-Imperial political action group called the Independence Front has recently made propaganda use of Tess's strange foreknowledge of the events at the factory. They claim that the Imperial government uses psionic talents and its huge military to persuade and coerce individual systems to become part of the Imperium. Such methods deny independent systems the basic freedom to choose that the Imperium claims to support.

### **Dinner with Sir Kaplin**

At the appointed time later in the day, the courier returns with the ground transportation to take the characters to their dinner appointment (or if the characters chose to provide their own transportation, they can leave at the appropriate time).

When the characters arrive, they are greeted by Sir Kaplin at the door. He appears in his late thirties and has sandy hair, green eyes, and a florid complexion. He wears casual garb.

"Ah, you must be the crew of the (name of characters' ship). Welcome. Please, come in."

Sir Kaplin holds the door open and nods a greeting to each character as they enter the house. He invites them out onto a patio screened by a hedge, where his wife, Claire, and daughter, Tess, are sitting. The Harbouses chat with the characters for a while, and an hour or so after the characters arrive, Sir Kaplin leads them into the house and to the dinner table. The dinner itself is quite good, without being very fancy. During this time, characters can ask Sir Kaplin and Lady Claire any questions they have about the world they live on and other such general questions. If the characters bring up any of the rumors and stories they uncovered, Sir Kaplin will forestall them until after dinner. After dessert, a middle-aged woman comes into the dining

### **The Imperial Marine Sylean Guard Regiment**

In Holiday Year, Emperor Cleon I resurrected one of the traditions of earlier Imperiums by designating one of his Sylean Federation Marine regiments as his personal Imperial Guard regiment. The personnel of the Sylean Guard were taken from the ranks of those Federation regiments that aided in the formation of the Third Imperium. The first members were all decorated combat veterans from several of these regiments. Placed under the command of the brilliant and demanding Colonel Devan Eshabi, the Regiment established traditions that ended up standing for until the death of the Third Imperium.

For a Marine to be invited into the Regiment, he or she must first have served at least two terms with distinction in another of the Imperial Marine regiments in service. Although decorations for valor in combat are not necessary for entry, many Marines who enter the Guard have distinguished themselves in combat. All members of the Guard, regardless of their specialty, are considered commandos.

The Regiment is made up of a support company and four battalions: one cavalry and three infantry battalions. All of these are provided with grav vehicles, enabling the Regiment to act as a full-lift infantry regiment. Usually, though, it is not deployed as such, and the different battalions are often given individual assignments. One battalion is always on guard duty in the Imperial palace, one is used to guard other installations and persons important to the Emperor, and the other two are attached to other regiments engaged in military operations across the Imperium.

The Sylean Guard are not a parade unit. Their requirements for entry, the extremely high standards they demand of their officers, sergeants, and troops, and their deployment into hot combat zones either as a unit or attached to other Imperial units make them one of the truly elite combat regiments of the Third Imperium.

room, still dressed in an overcoat. Lady Claire introduces her as Donata Terin, Tess's governess. She removes her coat, flashes the characters a smile, and greets each of them. She appropriates Tess, who clearly seems to dote on her governess, and takes her up to get her ready for bed. Later, when she comes back downstairs, she joins Sir Kaplin, Lady Claire, and the characters in a sitting room. Here, Sir Kaplin and his wife come to the point of their request to see the characters.

"We have asked you here to request of you a favor, for which you will be well compensated. In recent months, my daughter has been manifesting indications that she possesses latent psionic talents that have caused quite a stir in the local community. This really is a charming world, and we have enjoyed our service here, but I must admit—in confidence—that the people here are more superstitious than are those of other worlds. They seem to fear that which they do not understand. In my family, there has been a strong tradition of psionic talents. I myself possess such talents, but not in such a degree that I can accomplish anything other than gain insights into the emotional needs of others, a talent which has aided me in maintaining a sense of affinity between the local government and the Imperium I represent. Others in my family also have these skills, but never have I heard of any such talent as the locals suggest my daughter has. They call her "witch," and we cannot take her anywhere for fear of upsetting the local population or even endangering her. They claim that she is responsible for the injury sustained by a local worker at a factory we visited some months ago, but such a claim is preposterous. She is only five, so she is hardly articulate enough to make it apparent to those around her that she was trying to warn of the impending danger. Nevertheless, the story that is circulating suggests that she caused the accident. Her school refuses to allow her to return after a similar so-called "witch" incident. We have received comm calls that threaten us with retribution for bringing this evil to this world, but these are likely no different from threats we have received from time to time from an anti-Imperial faction who wants to rid their world of our "evil influence," or some such nonsense. Still, we love our daughter very much and wish to see her protected at any cost. What we would like to ask of you is transportation for her and a number of my staff to our estate. The distance is too great for us to take her ourselves, for we have our duties to our posts here, and we fear what may happen if we send her on one of the regular passenger vessels who put into port here. If we can get her there safely, I believe this situation will blow over and we can continue our duties as we have before. Will you help us?"

Sir Kaplin will offer the characters fifty thousand credits for taking their daughter and some staff to the world on which they have a small estate, some six parsecs away. He is willing to bargain, but despite his noble status, he is not made of money, and cannot afford any more than seventy thousand. He is not completely aware of the economics of running a starship, so if the characters take the bargaining approach of informing him that such an amount will barely cover their expenses, he will gladly pay the extra amount. If, however, they suggest to him that they have him over

a barrel, he will be more resistant to negotiations. Characters who have Carousing or Administration skill (or simple common sense and good manners) will realize that taking the latter approach after they have enjoyed his hospitality is very bad form, and could earn them a bad reputation among clients who can pay. Furthermore, successfully completing this contract might open doors for other such contracts in the future. His only additional request is that the characters do not take on any other passengers from this world, in order to ensure his daughter's safety. In addition to the money offered, he will see to it that berthing charges and cargo transaction fees for the characters' ship are waived at the starport, and the ship itself is fueled with refined fuel and its consumable supplies are replenished.

Sir Kaplin will give them as much time in private as they need to discuss the matter. If necessary, he will give them time to think about it overnight. Lady Claire will add her plea for their help if they seem reluctant.

If the characters agree to accept the contract, for whatever price was agreed to, it will be clear that Sir Kaplin and Lady Claire are relieved to hear it. Sir Kaplin will ask of the characters the rules of their ship so that he can explain it to his staff members who will accompany Tess. Furthermore, he will see to it that the characters are introduced to those who will be making the trip.

First among them is the governess, Donata Terin. An attractive woman with a ready smile, Donata spends a great deal of her time with Tess, and acts as a tutor in addition to her duties as a governess. Also accompanying their daughter are Harlik Terhune, a compact man in his late forties, and Averi Colaán, a tall slender young man with a look of laziness to him, both of whom are responsible for Tess's safety and security. Terhune, the elder of the two, asks the characters only that he and his assistant have access to Tess's cabin for the entire length of the trip.

## The Journey

The trip will likely take at least four weeks to complete. A ship capable of Jump-2 can complete the journey in this time, while one capable of no more than Jump-1 will require six weeks to arrive at its destination. The characters may conduct trade and seek passengers throughout the trip if they wish, or they can try to make as good a speed possible to their destination and simply refuel at each world and press on. Even refueling will require at least a day in each system, plus travel time from the jump point to the refueling point (and the return). No matter which approach the characters take, however, they will need to land on the first world in their route, for there is no gas giant in the system to use for wilderness refueling. This world will also be important for the continuation of this adventure.

During the trip, the characters notice several small glitches in their ship's systems. None of these are serious, but they do take some time to fix. The referee should introduce little odd "hiccups" along the way. There does not seem to be an immediate pattern to these very minor mishaps. By themselves, they are no danger to the ship, but if they are not taken care of, the strain on other systems could cause more serious

problems. If the characters are in the middle of a jump, these oddities will not be anything that will bring them back into real space. Some suggested glitches include:

- The ship's clock seems to stop every once in a while (when the characters check the computer, it shows the correct time on terminal displays, but the clock displays on the bridge and in the lounge are off by a few seconds).

- The lights in the corridor between the bridge and engineering go out.

- Number two fuel pump shows it's malfunctioning. When the characters check it, they discover that a faulty valve on a coolant tank has frozen it solid. Thawing it is all that is necessary to fix it, and the coolant valve can be replaced easily enough.

- The drink dispenser in the galley/lounge makes hot tea. No one is around in the galley when this happens, and no one claims to have made some and left it there accidentally.

These odd glitches should seem nothing more than the usual sort of complications encountered when operating a high-tech complex piece of machinery like a starship. While this is true with some of them, others are caused by Tess. She is completely unaware that she is doing anything. When she is asleep and dreaming, or when she is playing, some of her dreams manifest themselves as odd technological quirks on the ship. The tea dispensing in the galley with no one around could happen when she is having a "tea party" with her dolls. One of Tess's psionic talents is the ability to connect her mind with computers and other high-tech devices. She has not yet been trained, but the sheer power of her raw talent manifests itself subconsciously. None of her dreams or games offer any real risk to the ship. If, however, she becomes angry or frightened, that situation could easily change. Referees are encouraged to keep these odd occurrences a mystery, letting the characters build up information over a period of time.

## Dirtside

The characters' best route places the first stop in their journey on a world whose principal products are agricultural. Referees may use whatever world they choose, but the parameters of the world should match with the requirements for an agricultural or rich world, with sufficient water for refueling operations for mercantile and other ship traffic. In the case where referees cannot find such a system that does not also have a gas giant, they can make wilderness refueling dangerous at the gas giant (perhaps from pirate activity, violent storms in the gas giant's upper atmosphere, or unpredictable gravitational fluctuations).

The principal spaceport in this system has both a dirtside and orbital station. Refueling at the orbital station is faster but more expensive; for those who have the time, the downside port is a preferable place to refuel. Furthermore, cargo transfer fees are less expensive.

Trade goods that sell well on this world include manufactured items that aid in agriculture, novelty items, personal weapons and light armor (smuggled in if the world's law level is high), and processed ores. The world sells primarily agricultural goods and their by-products (including an especially delicious ale), as well as some unprocessed ores from a small mining concern.

The second day the characters are on the world arranging for refueling, conducting routine systems checks, and transacting cargo sales and purchases, Donata takes Tess out to see some of the town nearby, accompanied by the two bodyguards. So far, they have limited themselves to the starport facilities, but Donata learned of an open market not far from the port which she would like to see, and it will give Tess some relief from being cooped up on the ship (which has not made Donata's job easy in the last week). They expect to be back in around four hours.

Around four hours later, Averi Colaán, the lanky bodyguard, comes back to the ship. It is obvious that he has been in a fight. His face is bruised, and his jacket is bloody near the waist. He appears to have been shot or stabbed. By the time he reaches the ship, he is stumbling around and out of breath, fatigued with blood loss.

"They got her, they got the little girl, Tess. You've got to help her, get her away from them!"

Colaán's injury, a knife puncture wound, looks bad, but is probably not life-threatening if he gets medical attention. If the characters signify that they are going to call an ambulance or take him to a local hospital, he asks them not to involve the locals, for he does not know whom to trust. He says that Terhune was taken down by three assailants who jumped him, and the local police have him in a custody ward in a nearby hospital. He says he saw Donata and Tess hustled into a ground car by three men and a woman and could not get to them in time to prevent it. He did see a license plate, but got only a partial number: ANR 8 (the plate had two other numbers or letters after the 8). The vehicle itself was a dark brown four-door wheeled sedan, but as Colaán is unfamiliar with local ground vehicles, he does not know what type it is. Both he and Terhune were assaulted at the same time as Donata and Tess were hustled into the car; someone obviously knew where they were and planned a professional strike in a very short time. Its execution leaves Colaán no doubt that they were dealing with professionals.

Within minutes of Colaán's arrival back at the ship, characters who succeed at an Average Perception task notice that the local police arrive at the starport office. Ten or so minutes later, in a general communication to all ships in port, the Port Authority informs the ships in port that they are grounded until further notice. They should expect to remain in port for at least another forty-eight hours. If the characters comment to Colaán about this, he will explain that the local police fear that the assailants might try to remove their victims off world before authorities can determine their identity and whereabouts. Colaán is actually moderately impressed by the quick action of the local cops; at least someone there seems to know what they are doing.

If the characters ask about the two security men's assailants, Colaán will tell them that they attacked without weapons at first. It was only when he and Terhune drew weapons that they attacked them with knives and took them down. Terhune managed to take down all three of the ones attacking him, but collapsed shortly thereafter from wounds he had sustained, and Colaán got only one of his before the sounds of approaching local police vehicles caused the other two

to flee. Terhune told him to get to the ship and get the help of the characters; he would deal with the police. Colaán got here as quickly as he could; he estimates it has been no more than thirty minutes since the attack.

### Options

The characters were not paid to protect and rescue the little girl, but only a completely cold-hearted mercenary would turn his back on helping her. If the characters need prompting, Colaán will tell them that he will see to it that they are given a substantial bonus by Sir Kaplin, and if he cannot pay it, Colaán will. He is not wealthy, but he will pay them whatever he can for their help. Colaán will also inform them that he and Terhune are actually members of the Sylean Guard (the elite Marine Imperial Guard Regiment). Terhune is a Master Sergeant and Colaán is a Sergeant. They were assigned as part of the security detail for Sir Kaplin's Imperial Consulate office. If characters ask why members of the Sylean Guard are guarding an Imperial Consul-General on a relatively minor world, he will explain to them that he is not allowed to answer that question. He does not believe his detachment's assignment to Sir Kaplin is connected to this, but he will want to hear whatever evidence they might uncover.

Colaán will also insist on aiding them, but is probably not mobile enough to participate directly in the investigation itself. Any character who successfully achieves an Average Medical or First Aid task will see that the only help he will be capable of providing would be advice, for he is too sorely wounded to be moving around much. He will accept that if he believes the characters are willing to help find Tess and Donata.

Sergeant Colaán's primary objective is to locate and free Tess and her governess from their captors. This must be done as quickly as possible, for he does not know the capabilities of the local authorities and fears they may attempt a violent recovery without concern for the hostages, which will endanger Tess and Donata. In addition to freeing Tess and Donata, Colaán wants to get Sergeant Terhune out of the secured hospital ward where he was taken. As difficult as it may be, he asks that none of the locals be killed or seriously injured, especially not police! The repercussions could bring about all kinds of difficulties for the Imperial government, not to mention causing the characters, Tess, Donata, and he and Terhune serious problems. As there is no Imperial presence on this planet, characters will have to be circumspect in their dealings with the locals.

### The Sergeants' Mission

The Emperor has placed a detachment (two squads) of his Sylean Guard at the disposal of Sir Kaplin. The Imperium is interested in expanding relations with the government of the world on which Sir Kaplin serves, for not only do they possess significant deposits of a strategic mineral which the Imperium needs (such as lanthanum), but they sit at the entry point of a Jump-1 route to a fairly sizable cluster of worlds. As such, the world is important to the long-term goals of the Imperium. Unfortunately, the inhabitants of the world are not yet ready to join with the Imperium, for they harbor suspicions as to the Imperium's long-term goals.

Sir Kaplin, an experienced diplomat, was sent there to build the economic and political bridges that will eventually lead to the fulfillment of the Imperium's goals. Unfortunately, there is a small but increasingly vocal opposition to any strong relations with the Imperium. The locals managed on their own to pull themselves out of the ravages of the Long Night, and they do not want to bring about a repeat of those difficulties for future generations. Furthermore, they are very uncomfortable with psionics. In their own history during what others refer to as the Long Night, they were under the influence of a psionic dictatorship that used its powers to keep the populace in line. When Tess began to manifest talents they could not understand, they began to fear her and her family. By default, they began to see the Imperium in a negative light, which the insurgents of the Independence Front have capitalized on. The Emperor decided to increase the security around Sir Kaplin and his family, sending two squads of his Guards to aid him. Their mission is to defend Sir Kaplin and his family. In this case, that includes Tess and her governess on their trip to Sir Kaplin's estate.

Name <b>Averi Colaán</b>		UPP <b>9CAA87</b>
Service		Rank
Birthdate	Birthworld	
Skills Athletics-3, Battle Dress-2, Brawling-4, Camouflage-2, Computer-1, Demolitions-2, Environment Combat-2, Forward Observer-2, Grav Craft-1, Intrusion-2, Long Blade-1, Navigation-3, Philosophy-1, Psionics-1, Recon-3, Stealth-3, Survival-2. Psionics: Awareness-1, Telepathy-1		
Possessions	cP-003 combat pistol, diplo armor	Money
Comments		

UPP Card

001-000

A member of the Imperium's elite Sylean Guard Marine Infantry Regiment, Sergeant Colaán is a formidable fighter. Partnered with Master Sergeant Harlik Terhune for this mission, the younger Sergeant Colaán looks more like a scholar just out of university than a commando. His pals in the regiment give him no end of grief about his youthful looks, but they have aided him on numerous occasions in the past, especially in infiltrations and similar assignments.

Sergeant Colaán comes from a community of psionics who follow a philosophy of community service as the highest good a being can do. Located on a secondary world of the Sylea system, they learn in their youth what disciplines they are able to absorb, and as adults, use that knowledge for the good of others. As a young man, Sergeant Colaán discovered that he possessed considerable talents in both Awareness and Telepathy. After his initial training, he chose to serve in the fledgling Imperium as a soldier. His service to the Imperium has been exemplary, and after his second term, he was invited to join the Sylean Guard Regiment, the elite guard unit that serves Emperor Cleon directly. His service in the military has made it difficult for him to improve his psionic skills, so he



relies on them only in the rarest of circumstances.

Colaán takes very seriously his role as one of Tess's protectors. He is aware that she is manifesting signs of strong psionic potential. He also knows that if those abilities are not honed by the proper training, her power will become increasingly erratic and possibly dangerous, either to her or to others. If he and his partner, along with the assistance of the characters, can get her to her parents' estate, teachers there can begin to train her and help her focus her skills. Sergeant Colaán will do whatever it takes to help her get there, but his injury makes it difficult for him to become directly involved. He has put his trust in the characters to find her and get her off this world.

## Looking for Tess

The characters have at least a couple of different means by which they can try to locate Tess and Donata. The principal clue that the characters have is the partial license number that Colaán saw on the sedan that rushed off with the two captives. The trick is to do this without alerting the local authorities. Characters can try either gaining it directly from the police by breaking into a police station or hacking into the police computer system, or they can get someone else to get it for them (bribing a cop or contacting someone who could bribe one).

## Information Gathering

Of these, perhaps the easiest is engaging in hacking the police systems or contacting a street source who can gain the information from the police. If the characters try hacking the police computers, they will first have to find a means of accessing them. The world has the equivalent of a communications and data transfer grid spanning the distances between urban areas and remote agricultural facilities, so it is possible that they could access the police computers through the grid if they know where to look. If a character with both Computer and Streetwise skills (or two characters each with one of these skills) succeeds at an Average task roll at either of these two skills, he can locate (either online or otherwise) a place where local hackers hang out. There, with a bit of cash (say a few rounds of drinks or so) and another Average Streetwise skill test, the character can get the grid address of the node that leads into the police computer systems. This is not a back door into their system; rather, it is a means by which files from the local Department of Motor Vehicles can be accessed. If the characters want anything more sophisticated than that, they will have to succeed at a Difficult Streetwise task and actually pay out Cr 500.

If characters do not possess the requisite computer skills to access the police net, they can attempt to contact the local underworld for assistance. This option is likely to be more expensive than doing it themselves, but no less reliable. If all the characters want is the identity of the owner of the brown sedan that drove away with Donata and Tess, the fee will be Cr 750. If they want anything more than that, adjust the fee accordingly. For example, if they wish to find the status of Sergeant Terhune (he has suffered three puncture wounds—one serious enough to threaten his life—and numerous minor lacerations and is in serious but stable

condition), it will cost an additional Cr 250. If they also wish to discover what he is charged with (nothing yet, but he is being investigated in connection with kidnapping, assault with a deadly weapon, and reckless endangerment), that will cost yet another Cr 250.

The search through the Department of Motor Vehicles records actually shows two dark brown four-door sedans with ANR-8 as the first four digits of the license plate. One belongs to a Mr. Renni Daniels and the other belongs to a local rental agency. The one belonging to the rental agency was reported stolen this morning; police assume it was stolen sometime last night.

If the characters seek out information concerning the stolen vehicle, they can discover that its whereabouts are not yet known. Success at an Average Streetwise task allows a character to realize that it may already have been stripped for parts at a local chopshop. The location of this vehicle is not important, however, for it is a blind trap. The kidnappers stole it to leave a false trail, so that any investigation would likely follow its whereabouts, a process which would take long enough for the kidnappers to get off this world. The vehicle that was used in the kidnapping is the one belonging to Mr. Daniels. If the characters harry down the trail of the missing stolen car without considering the possibility of the other car being involved, referees might wish to allow the characters to attempt a Difficult Investigation task (without telling them what it is for) to realize that they should be thorough and check out both vehicles. A generous referee might allow a reroll of this task every twelve hours. Note that if a player thinks of this on his own, referees may want to grant his character an extra experience point at the end of the adventure, since the red herring of the stolen rental car is the more likely clue.

## Contacting Renni Daniels

If the characters attempt to find Mr. Daniels, they will need to be diligent. The address listed in the local comm directory is an old one. Characters who investigate it find a rundown hotel. The grouchy old man behind the counter says that he has not seen Daniels for over two months. He also tells the characters that the little jerk owes him Cr 720 in back rent, so if they see him, bring him back here so he can get it out of the little weasel's hide. The only place he ever heard that Daniels hung out was a bar called the Pink Pennard (a local small animal).

At the Pink Pennard, the characters encounter a number of local toughs who want to know why the characters are looking for Daniels. They don't like strangers from off world coming into their hangout and nosing around. There will be one thug (to a minimum of two) for every character who shows up at the bar. Although they start out talking, they really have no intention of helping the characters at all, and it won't take long for them to get nasty. Referees should use the standard rules for combat to resolve this encounter. The thugs will use only fists or brass knuckles in their fight with the characters. None of them will draw any other sort of weapon. If the characters draw any sort of firearm or energy weapon, the toughs will immediately break off the fight and back away. If the characters actually shoot one of them, they will run.

They are occasionally used as knee-breakers for a local loan shark (to whom, surprisingly, Renni owes no money), so the next time they see the characters, they will be armed and looking to collect for the shooting of their friend. If the characters manage to defeat the thugs in a fist fight, they can attempt to coerce out of them the whereabouts of Daniels. A successful Easy Intimidation or Average Interrogation task will give the characters the name and location of the current flop-house they believe Daniels is staying in.

If the characters seek out Daniels at the address they got from the thugs, they will find him attempting to clean out his stuff in a big hurry. One of the thugs knows Daniels, and actually thinks the guy is okay (Daniels set him up with his current squeeze in exchange for his not beating Daniels up). He gave him a call after the encounter with the characters to warn him that someone is looking for him. Note that if the characters somehow managed to prevent the leg-breakers from being able to contact anyone (rendering them unconscious, taking their money or portable phones, or —yikes!— killing them), Daniels will not be in such a state of panic — until he sees the characters. He will assume they are cops, or worse, someone sent to collect money he owes. He will immediately launch into a fawning diatribe.

"I'm clean, I haven't done anything wrong, man! What do you guys want? You bill collectors? Cause you tell Mr. Zoman I was just comin' over to pay down on what I owe him, see? I mean, it's funny how you guys show up just as I was gettin' ready to pay him a visit 'n' all."

When the characters let him know they aren't debt collectors or cops, he stops his whining for a moment and asks who they are and what they want. If they ask him about his car, he gets very nervous and says that he sold it. Any character who succeeds at an Average Psychology or Interrogation task can see that he is scared to death. If they ask him to whom the car was sold, he responds, "I don't know, some guy. Hey, it's none of your business anyway. Who are you guys?"

For the characters to get any more out of Daniels, they will have to attempt a Difficult Interrogation or a Formidable Intimidation test to get him to break (referees may substitute other skills like Streetwise or Bribery if appropriate). Even so, Daniels will want to get something out of it, preferably passage off world or a sum of money that will enable him to book passage on another ship. He knows where the car is, but he will not claim to unless the characters succeed at another Difficult Interrogation or Formidable Intimidation test. If they succeed, he will demand access to their ship or the escape money well in hand before telling them where the car was left. Once he gets his money, he will demand to be let go. Under no circumstances will he go anywhere near the place he left the car, for he is fairly sure that the people he sold it to are holed up relatively nearby. If forced to describe them (he will not volunteer this information — the characters must scare it out of him), he shouts, "Hey, man, easy! You don't have to be so nasty about things, you know? You guys are gonna get me outta here, right? Okay, cool. Look, all I saw were two guys. One was a short, husky guy with black curly hair, and the other was a slender blond

guy with a messed up face. The short guy did all the talking, and the blond guy didn't say a thing until the deal was done and they were ready to leave. He looks at me with this sick kinda grin on his face and told me that if I mention anything about the sale of the car to anyone, he was gonna pay me a "visit" and give me a "stern talking-to." I think the guy was lookin' forward to that visit, 'cuz I don't think he was plannin' on doin' much talking, know what I mean? Man, that guy creeps me out! But now that you and me are pals, there's nothin' to worry about, right? Right?"

After he has either the cash or an entry voucher for their ship, Daniels gives them the address and says he's got to take care of some things before he leaves. If the characters let him go, he will be killed within a few hours of his departure from the flop-house (the kidnapers are aware that he is likely to turn on them and will seek to silence him before the local authorities can catch up to him). If instead they keep him near them, he will attempt to disappear from them for a few hours to go pick up the money he got for the car. Any character who succeeds at an Average Perception test notices Daniels trying to slip away (the task will be Difficult if there are suitable distractions preventing the characters from keeping an eye on him).

Name <b>Renni Daniels</b>		UPP 698653
Service		Rank
Birthdate	Birthworld	
Skills Administration-1, Brawling-1, Fast Talk-2, Gambling-1, Grav Craft-1, Ground Craft-1, Intrusion-1, Mechanics-1, Perception-1, Small Blade-1, Stealth-1, Streetwise-2, Survival-1		
Possessions	Money	
Cr 100,000; knife; lockpicks (not very good quality)		
Comments		

UPP Card

001-000

Renni started out a low-life and will likely end up as one. He is a rat. Few people like him, and almost no one wants him around. He's always borrowing money (or just stealing it), and to date, nobody has ever known him to pay it back. He would have been okay if he hadn't gotten on a lucky streak at the gambling tables one night. He was on fire, raking in piles of money. Renni would have made out with a pretty healthy sum of money if he had quit while he had the chance. But he started losing — big. As he started sinking lower and lower, he began to lose what little sense he has. He borrowed from the house, and then he put it all on one grand bet. Naturally, he lost. Unfortunately, he had no way of covering his marker, so when the illegal casino owner — a Mr. Zoman — sent some of his assistants to bring Renni to him, Renni ran. And ran. And ran. He has spent the last seven months dodging Mr. Zoman's "collectors" and has attempted twice to stow away on outbound transports off world. His luck was nearly gone until a couple of days ago, when a stranger found him and offered him a sum of money for his car. He would have told the guy off, but when

the man said that he would pay him Cr 100,000 for it, Renni hesitated. For him, that kind of money would pay off his debts and get him free of this world. Still, he hesitated. He thought maybe he could squeeze some more out of this chump. He demanded twice that. When the man suggested that he could approach a Mr. Zoman for the purchase of a car, Renni gave in. He was paid the money, and he has been living high for the past day or two. Now, he needs to get out of here, and he's home free. Of course, since he won't be coming back here, he really doesn't need to repay Mr. Zoman what he owes.

### Witnesses at the Scene

Another possible source of information the characters may try to pursue is what witnesses at the open air market saw. Throughout the rest of the day of the kidnapping, there are enough local police there to make it difficult for characters to approach any of the possible witnesses (attempts to do so are one level more difficult than normal; failures cause one of the police on the scene to detain the character **who** failed and ask what his interest in the matter is). However, at night, or during the next day, characters can attempt such actions with relatively little risk of discovery by local authorities. Talking to potential witnesses will take a total of eight person-hours (eight hours for one person, four hours each for two people, etc.). If characters succeed at a Difficult Streetwise (or Formidable Interrogation) task, they will be able to glean the following information (note that if the characters can convince the witnesses they are just trying to find Tess and her governess, these tasks will be one level easier—the small-time merchants who conduct their business in the market have no love for cops):

- There were three people in the car: a driver (male of indeterminate description — the driver's side window was dirty and smeared), a gunman in the front passenger seat (male with dark brown unkempt hair and a rough beard and mustache — a three day growth sort of beard), and another gunman (slender female with shoulder-length brown hair and an almost creamy complexion) who got out of the back seat of the car and ushered the woman and the child into the car and climbed in after them.

- Two witnesses claim also to have seen a slender, craggy-faced, blond-haired man with a scar on his left cheek watching from an outdoor cafe across the plaza. As soon as the woman and child were in the car, he got up and left, walking quickly to a pay phone, where he made a call, hung up quickly, and walked away. The guy didn't even pay his tab at the cafe.

- One of the witnesses hit redial and recorded the tones. If the characters run it through a computer, and they succeed at an Average Computer test, they can get the number. The number the man called was 573299 (a local area number). The witness was not around when the police came to take statements yesterday, so they do not yet have it. If characters choose to determine the associated address, see "Rescue" below.

## The Local Law

At some point after the characters have sought out the information on the vehicle used in the kidnapping and after they have interviewed witnesses who were in the market, they get a visit by a police detective. He is a slender man of medium height, has short dirty blond hair, blue eyes, and sallow skin. He introduces himself as Inspector Alyn Venn. He speaks with a lazy drawl.

Venn shows the characters his badge. He does not have a weapon out, but one is visible beneath his overcoat in a holster on his belt.

"So, friends, you want to tell me why you're snoopin' around town, askin' folks questions about the kidnappin' that happened yesterday?" —he pauses— "Don't answer all at once, now." He smiles at that.

If the characters give him any backtalk or if they feign innocence, he'll remind them that accessing police records is at least a misdemeanor, maybe even a felony — he doesn't remember exactly which. He doesn't really want to arrest them, since he thinks that he and they are all working on the same side, but he would like to compare notes with them, if they're willing to spare him a few moments of their time. If the characters get hostile or try to threaten him, he doesn't bat an eye. He'll say that he's sure to keep his hands well away from his weapon, for fear of provoking a fierce fight. Besides, he's not sure if he remembers how to use the thing.

If the characters agree to talk with Venn, they will find him quite reasonable. He has no intention of harassing them about accessing the police computers. From his point of view, the cops need all the help they can get. They found the rental vehicle being taken apart in a chop-shop. While they managed to arrest some of the people there on charges of receiving stolen property, they found no evidence that suggests it was the car involved in the kidnapping. He was following up on the other vehicle when he saw some of the characters talking with Daniels, so he followed them here.

Venn will also tell the characters that the bodyguard in the hospital is in serious but stable condition (see "Information Gathering", above, regarding Terhune). He's wondering what became of his partner, and asks the characters if they might know. He admits to being curious why a member of the Imperium's Sylean Guard Regiment is on such a backwater *independent* little world as this one. He'll say that he assumes that the little girl is not here to foment insurrection against the popularly elected government, so he is curious who she is and why she is so special that at least one and possibly two members of the Imperium's most famous Marine regiment are keeping an eye on her. It is particularly perplexing to him because so far, no one has sent any ransom demand. He must conclude, therefore, that someone has brought their problems to his backyard, something the local government is sure not to like. If the characters can shed any light on the situation, he would certainly appreciate it.

If Daniels is with the characters, Venn nods to him and says, "'Lo, Renni, long time no see. So how's the two-bit crime business goin'? Still owe Zoman all that money, I suspect. He's going to be sorta put out, you tryin' to skip town and all."

Daniels glares at Venn, but doesn't respond.

If Venn does not gain any information about the

kidnapping from the characters, he won't press. Before he leaves, however, he reminds them that the case is official police business, and some of his colleagues are not so forgiving as he. He bids them all a good day, and says, "I'll be keepin' an eye on you, so don't go doin' anything foolish or anything. And you, Renni, if I was you, I'd be growin' an eye on the back of my head, 'cuz' if Zoman catches wind of your vacation plans, he's likely to want to cut them short."

Daniels tells Venn to get lost, and Venn chuckles and leaves.

Name <b>Alyn Venn</b>		UPP <b>78AB86</b>
Service Inspector		Rank
Birthdate	Birthworld	
Skills Administration-2, Bowling-2, Forensics-2, Ground Vehicle-2, Interrogation-3, Intrusion-2, Investigation-3, Law-1, Melee Combat-1, Perception-3, Pistol-3, Psychology-2, Streetwise-3		
Possessions Forensics kit, pistol, taser, two pairs of handcuffs, ID badge		Money
Comments		

UPP Card 001-000

Inspector Venn loves to play the simple provincial cop when dealing with off-worlders. He is assigned as a senior inspector in the Special Investigations branch of the police department in the city that borders the starport on this world. Special Investigations is called in whenever off-worlders are involved in a case, or anytime that a particular case is so delicate or difficult that a liaison from SpecInv needs to be involved. Lately, that seems to be nearly all the time.

Despite Venn's act, he is actually a highly talented and very shrewd investigator. It was Venn who convinced the Chief of Police to seal the port for 48 hours or until he manages to catch the bad guys. The Port Administrator blew his stack at the order, but Venn does not care — he has a job to do, and his instincts tell him that this one could be a horrendous mess if he is not careful. The Chief trusts Venn's instincts, but is pressuring him mercilessly to come up with the perps in a hurry.

Venn knows that the characters are the crew of the ship that the little girl and the woman are travelling on, but he cannot tell yet why they are interested. He has seen enough personal security agents before to recognize that the two men who were in the market with the woman and the girl are bodyguards. He has trumped up charges on the one (Terhune) in the hospital in order to keep him in protective custody and keep him from interfering with the case. He also knows that the younger of the two is injured, but not how badly. So his concentration has been on what the characters have been doing. He must admit, they're not doing a bad job of investigating, but they are on his turf, and there are ways he must handle things.

Venn is really quite an easy-going fellow. He always has a ready (if occasionally somewhat plastic) smile, and prefers to be pleasant with perpetrators, giving them a chance to surrender peacefully before

turning the heat up a bit. With the characters, he will be nice and relaxed until they give him reason not to be. Then he'll lean on them a little, citing obstruction of justice statutes and such.

## Rescue

The characters will likely have two pieces of information that will lead them to Tess and her governess. First, they have the information on where Renni Daniels met with the two men concerning the sale of his car. Second, if they managed to speak with the merchants in the local market, they have the local comm-number that the blond-haired man called after the kidnapping. If the characters successfully complete a Difficult Computer task, they will be able to get an address that matches the phone number. The address is relatively near where Daniels met with the two men.

If the characters decide to turn the matter over to the local law, they can attempt to contact Inspector Venn. After about two hours of calling the police headquarters in the port city, they manage to get in touch with him. He will want to meet with them rather than discuss anything over the comm, and suggests that he meets them at the same place they met before (i.e. their ship or the local hotel where they spoke with him). He will show up in about 30 minutes.

If the characters decide to take matters into their own hands, they will need to be more circumspect in their actions. In the event that they rescue Tess and Donata without any violence, they will have little to fear from the local authorities. Such a rescue will be difficult, but if the characters can come up with a thorough plan, they may be able to carry the day. In the event that the characters leave several dead or injured kidnapers, the result of a violent confrontation, it will be considerably more difficult for them to get away with it. Unless they time the rescue attempt to coincide with the end of the grounding of ships in the starport, they will have to wait to escape from the world they're on. This will allow surviving kidnapers to attempt an assault on their ship, or it will give local police authorities time to track them down and arrest them for violations of local laws. Inspector Venn's association with the characters and his knowledge of two Sylean Guard members on planet will make things somewhat easier for the characters if they run into the local law, but it will still take several days for Venn to convince the political apparatus to allow them to leave the planet with an admonition not to return. This option will *not* be open to the characters if any locals were injured or killed.

Assuming the characters decide to take matters into their own hands, here are some general guidelines that the referee may want to keep in mind:

- The building itself is four stories tall, and the insurgents' apartments are on the third floor. There is a fire escape on the back of the building, which could be used to get to the apartments, but it is old and appears in some disrepair. There is a greater likelihood that anyone climbing it will make noise (requiring a Difficult Stealth task success to prevent any noise).

- The kidnapers have paid the rent for two apartments one across from the other in a low-rent building. Tess and Donata are in one, along with the woman insurgent, Arshad Gotari, and two of the male

insurgents. Yeveni Ilkos, Suvo Kaan, and the other insurgents are across the hall in the other apartment, one always on duty near the door, listening for anyone approaching the apartments. The apartments themselves are simple one-bedroom units.

- The characters can get building plans for the building from the local city hall. It will take at least two hours to find them and requires a successful Average Research task check. The plans are eleven years old.

- Tess, Donata, and the woman insurgent are in the apartment's only bedroom. The others are spread out in the main room of the apartment.

- Two calls have been made from either of the two apartments. One was to a local fast-food place, made the night before the attack. The second one was to a local news agency approximately an hour after the kidnapping of Tess and Donata. Both calls were made from the same apartment (the one in which Ilkos and the other male insurgents are staying).

- If the characters manage to take down the male insurgents, they will still have to get to the woman guarding Tess and Donata. She will hesitate for three rounds before acting. Either she will kill Tess and Donata (on a 1-2 on a six-sided die roll), flee down the fire escape (on a 3-4 on a six-sided die roll), or come out into the main room to aid her comrades in dealing with the characters (on a 5-6 on a six-sided die roll).

- Persons living in neighboring apartments are sure to hear any noise coming from the two apartments where the insurgents are staying (especially if they hear gunfire). One of them will alert the police that something is going on. The first police cruiser will arrive 3+1D6 minutes at the front of the building after the first sounds of violence are heard. Two more will arrive 1-2 minutes after that (one at the front, the other sent around back), and four more 1-3 minutes after the second group arrives (two in front, two sent to the back of the building). A crowd will start forming when the second group of police cruisers arrive.

- There are no working internal surveillance systems in the building except for a camera which monitors the front door of the building. It displays its images on a monitor hidden below the counter of the service desk. The monitor is not accessible through an outside computer net.

Combat should be resolved according to the rules outlined in the rulebook. The insurgents wear the equivalent of diplo armor (armor value 3).

Name <b>Yeveni Ilkos</b>		UPP <b>A79A96</b>
Service		Rank
Birthdate	Birthworld	
Skills <b>Brawling-2, Leadership-2, Perception-1, Pistol-2, Recon-1, Rifle-3, Stealth-1, Tactics-2</b>		
Possessions cP-003 combat pistol, diplo armor		Money
Comments Leader of the Independent Front Team Two		

## The Kidnappers' Plan

The kidnappers are a group of insurgents called the Independence Front; they are from the world where Sir Kaplin hired the characters to take his daughter to the world where his estate is located. They are determined to chase Imperial influence off their world, for they fear the sort of government that rules far removed from its constituent peoples. To date, they have not made any spectacular headway in their operations against the Imperials, and the local population of their world has not placed its support behind them. The decision to kidnap Tess will change all that, they believe.

The insurgents discovered the plans to move Tess to Harbouss' estate through electronic surveillance of Sir Kaplin's residence. They knew that the characters had been contacted by Sir Kaplin, but they did not know why. Fearing that the characters might be a mercenary survey team, they decided to investigate. A van from a local utility company was stolen and used to set up a surveillance of Sir Kaplin's home. Despite the countermeasures employed against just such surveillance, they managed to get the gist of Sir Kaplin's request to send Tess away. Their leadership decided to take the opportunity to strike at Sir Kaplin and publicize their goals to the people of their world in what was certain to be covered in great depth by the local media: they decided to attempt to kidnap Tess.

They sent out two twelve-person teams, one each to the two worlds they expected the characters to stop at on their journey to Sir Kaplin's foreign estate. The characters encounter Team Two. The team consists of eleven men and a woman. Most of them are not especially well-trained in combat, but three of them have military or police experience. Their leader, a man named Yeveni Ilkos, is a four-term veteran of his home-world's army. The blond-haired man (Suvo Kaan) was a police officer for nearly twenty years until he was kicked out for excessive brutality just short of retirement age. The driver of the car (Arshad Gotari) had also served in the planetary army for a few terms, serving in an armored cavalry and reconnaissance unit.

Team Two located the characters' ship in port about two hours after it landed. Ilkos put two of his team watching it, and when Tess and Donata went out to the market to look around, they followed them and struck. They had originally intended to head straight for the ship they had hired and depart the world, but the fast action of the local police has prevented that.

Name <b>Suvo Kaan</b>		UPP <b>8BB766</b>
Service		Rank
Birthdate	Birthworld	
Skills <b>Brawling-2, Interrogation-3, Perception-2, Pistol-2, Shotgun-1, Small Blade-4</b>		
Possessions		Money
Comments		

Name <b>Arshad Gotari</b>		UPP <b>A77975</b>
Service		Rank
Birthdate	Birthworld	
Skills <b>Brawling-1, Ground Craft-3, First Aid-1, Perception-1, Pistol-2, Recon-2, Stealth-1, Submachinegun-2</b>		
Possessions		Money
Comments		

UPP Card

001-000

Now they are holed up in a couple of low-rent apartments they rented for the week (two apartments, one across from the other), awaiting the re-opening of the port. Tensions are very high among them right now, and Ilkos is having a difficult time keeping them under control. Suvo wants very much to track down Renni Daniels and kill him, but Ilkos does not want anyone stirring up anymore trouble.

### Other Insurgents

Age: Varied

UPP: 777776-0

Skills: Brawling-1, Pistol-2, Small Blade-2, Submachinegun-1; three have First Aid-1 as well.

(Referees are free to add whatever skills to these characters they wish if it becomes necessary. For the nine general team members, their skills should be drawn from the Rogue career.)

## Conclusion

If the characters approach the situation cautiously, they should be able to prevail against the terrorists without unduly endangering Tess or Donata. If the referee believes their plan to be too dangerous or too likely to fail, he can offer suggestions to the players through Averi Colaán (he will probably not be able to accompany the characters when they attack the terrorists' hideout, due to his injuries, but he will gladly assist them in whatever other way he can). Colaán will also suggest that the characters leave the terrorists to the local authorities, to be dealt with through due process of law (either punished or extradited back to their world of origin).

If the characters manage to overcome the terrorists and rescue Tess and Donata, they will find a frightened woman and a very scared little girl. Once they get them back to the ship, the characters will be approached by Inspector Venn, who report a terrible occurrence in town earlier that day. It seems some criminal elements got into a bit of a gang war. One gang must have hit another gang's safehouse and then fled the scene. When local police arrived, all they found was the remnants of one gang, and most of them looked pretty beat-up. Sad thing, he'll say, but those who live by the sword die by the sword. He just stopped by to see whether the characters managed to find any decent trade opportunities here on this lovely world. It is obvious that he knows the characters were involved in the tussle at the terrorists' safehouse, but he does not seem to be threatening in his manner, nor does it seem that he wants any hush money or anything. He makes all this clear when he asks, "By the way, how's the little girl?" If the characters say nothing, Venn just smiles briefly and tells them, "You all have a nice trip, now," and then he leaves. As the characters are preparing for departure, one of them will spot a small teddy bear left by the entrance to one of the airlocks.

# 9: THE GIFT

In this adventure, the characters rediscover a people that have been cut off from the rest of interstellar civilization since the end of the Second Imperium (the Rule of Man). The scenario, linked to "Psilent Escort", involves interacting with a people who believe that Tess is the prophet sent by one of their gods to guide them.

Referees can approach this adventure in different ways. While there is the possibility of violence for those players who wish to solve problems with firepower, the scenario is more flavorful if player characters explore their options through investigation and negotiation. There is room for humor as well, if referees choose to make this a more light-hearted scenario. Another approach might be to instill in characters (and the players!) the sort of terror that only comes from a mob on the rampage, touched off by those who would defile their beliefs and heritage.

The scenario is relatively simple. The characters are enroute to the world on which Sir Kaplin Harbouss's estate is located, transporting his only daughter, a girl of five named Tess. (See the adventure, "Psilent Escort", contained in this anthology.) With Tess are her governess, a woman approaching middle age named Donata Terin, and her two bodyguards, Sylean Guard Marines named Harlik Terhune and Averi Colaan. (If any of these persons was injured or killed in "Psilent Escort", they will not be part of this adventure.) Tess is an untrained psionic of great potential power. She has demonstrated the capability of interacting directly with machines on a few rare occasions, and seems to possess other rudimentary psionic talents as well. While the characters' ship is in an uninhabited system to draw on water to fuel their ship, Tess has a nightmare that causes some unintentional damage to one of the ship's systems. The damage is not severe, but if at least temporary repairs are not made, it could become worse, imperiling the ship. The characters can land on a world which possesses a breathable atmosphere, where they discover that the survey data they have in their computer's data banks is in error. There are people here!

The characters discover a small but vibrant civilization that have not encountered interstellar travellers for nearly two millennia. Earlier surveys must not have catalogued their presence. They will make contact with the characters, cautiously at first, but more confidently as time passes. It is when one of the local people is with the characters that one of Tess's strange psionic quirks manifests itself. The local person will be in awe and will begin murmuring to himself. Others will join him, and they will seem peacefully overjoyed. The focus of their attention is clearly Tess. Their prophet has returned.

## The Setting

The characters' ship is in this system for wilderness refueling. In their computer memory banks, the system is listed as uninhabited. It does not have a gas giant, but there is a terrestrial planet with abundant water in the fourth orbit out from the sun.

The basic data about the world shows it to possess

a breathable atmosphere, near standard gravity, and a variety of as-yet uncataloged flora and fauna. The survey results from the previous scout team showed a soil analysis unsuitable for agriculture, and no known exploitable minerals were discovered in the system. The last survey was conducted about eight years ago by an independent team contracted by the Imperium, which took approximately 36 hours to conclude. Any character with Survey skill or a background in the Scout Service will realize that 36 hours was an especially fast survey of a terrestrial planet. The team did everything they were supposed to do, but the normal survey of such a world is supposed to take at least 96 hours. There is no mention in the computer as to why the survey was concluded so quickly. The basic UPP of the world that was recorded by the previous team is: X-687000-0.

## The Setup

As the ship is approaching the planet, there is a malfunction in the fuel pump to the starboard engine. The engine is drawing only about one third of the fuel it should be receiving, and the automatic backups from the power plant are not functioning either. The ship begins to rotate slowly around its centerpoint axis (a flat spin around its yaw axis). It is not dangerously out of control, but unless the characters do something, it could become so in a matter of minutes. Success at an Average Pilot task check will restore the ship to equilibrium.

If the characters try to look at the starboard fuel pump, they will discover that it is frozen solid. It will take hours simply to thaw the equipment around the pump assembly, and it must be done gradually, to keep the housing from cracking. Any character who succeeds at an Average Engineering or Mechanical task will recognize this and be able to develop a means by which the assembly is thawed without risk of damage.

The characters have to refuel on the planet, using water hoses to draw water from one of the lakes or oceans on the planet, so if they wish to try to repair the fuel pump there, they could probably have a decent chance of fixing the problem.

To repair the faulty pump will require that a character succeed at an Average Mechanical or Engineering skill test. This will take at least four days, and it should be done before the ship takes on any fuel. Refueling and refinement will take another twelve hours.

It may be that the characters are on some sort of deadline, and they may not wish to take the time to deal with the damaged pump. The referee can have those with Engineering experience to attempt an Average skill test. If they succeed, they will be able to inform the group that there is at least some risk to attempting to make a jump with a faulty fuel pump. Although the maneuver engines are separate from the





jump drive, the pumps that bring fuel to either drives are the same. If the ship attempts a jump, the jump drive might not get enough refined fuel, resulting in a misjump. The risk is not great, but it is significantly more than usual (referees: the ship will misjump on a 4- on 2D, rather than the usual 2-).

If the characters decide not to attempt repairs here, and they indicate that they will attempt the jump with the damaged fuel pump, one of the party travelling with Tess will ask that they reconsider, since it places not only the ship and its crew in danger, but Tess as well. Their protests will become stronger if the characters become stubborn about not taking the time to repair the pump, and if the characters become belligerent about it, they will threaten a reduction in their pay for the mission. If the characters make the jump anyway, the referee should roll for the misjump as outline above and continue making them in every system, each jump raising the chance of a misjump by one (i.e. the second jump will be a misjump on a 5-, etc.). In addition, the pump will become irreparably damaged, requiring replacement.

The characters manage to find a landing site on a patch of bedrock near large inland lake. They can confirm the survey data about the world with a successful Average Survey or Sensors skill check. The terrain nearby is primarily forest and grasslands, the nearest stand of trees about a half a kilometer from the refueling site.

## First Contact

While the characters are on planet effecting repairs and refueling, one of them notices some movement out of the corner of his eye. Characters who succeed at a Difficult Perception task check will notice movement in the tree line half a kilometer away. If the character looks at the source of the movement, he will see nothing further if he stares in the direction of the woodline. When he looks away, he can attempt another Difficult Perception check to notice the movement again. A character who surreptitiously watches the tree line out of the corner of his eye will notice more detail when the stir in the brush occurs again — the figure looked like that of a human!

If the characters investigate what they saw (or think they saw), they can search the area around where the movement was. Characters who succeed at an Average Recon (or Difficult Perception) skill check will spot a set of tracks leading deeper into the woods. The tracks join a narrow trail approximately 200 meters into the forest. A successful Difficult Recon (or Formidable Perception) skill check will reveal that the trail shows signs of use by humans or another humanoid species, although it seems to get relatively little use. The particular set of tracks that the characters were following disappear when they merge with the trail. Should the characters decide to follow the trail, the referee should have the players roll Difficult Recon (or Formidable Perception) task checks for their characters; this should be done a few times as the characters move down the trail. Success indicates that the characters notice marks cut into the base of a tree or etched onto a rock. The characters will not be able to determine what they mean, but by succeeding at an

Average Intelligence check, they can discern that the marks are some sort of trail sign. If a character beats the required Recon or Perception roll by 2 or more, the referee should inform the player that the character feels he is being watched. A character who beats the required roll by 4 or more catches glimpses of movement on the slopes of hills near the trail, but when they turn to look, they are unable to discern anything definite. Only with a critical success can the character notice that the group is being shadowed. He can see that they are human or near-human, and that they are simply watching the characters; they show no signs of hostility, only caution. About two kilometers down the trail, it enters a clearing surrounded by thickly-wooded hills. In the sides of the hills are numerous openings. At many of these openings are people who are peering at the characters nervously. From the forest behind the characters emerge several more people (the ones who were trailing the characters down the trail), and approaching the characters from the clearing is an unarmed middle-aged man. With him is a boy, who speaks rapidly to the man while gesturing to the characters. The man approaches the characters; he is smiling nervously and showing plainly that his hands are empty.

If the characters approach with no obvious hostile intention, the man will greet the characters. His language sounds familiar, but the characters do not readily understand it. Those characters who succeed at a Difficult Linguistics skill (or Formidable Education characteristic) check will recognize the language as an old form of the Galanglic that is spoken today. Even if the characters fail the skill test, they will realize that the man is simply greeting the characters and welcoming them to his village. The characters might be able to make use of a computer to assist them in understanding the language, if the referee allows it.

The man motions for the characters to follow him. He leads them to one of the caves, where he offers them something to eat. It is an unfamiliar but safe meat from a local game animal, heavily flavored with a peppery spice. He will gesture for them to sit, and will offer them more of the meat and some water. As the characters eat, other older men and women will filter into the cave, looking at the characters in wonder. They will occasionally murmur to themselves or to one another, and the characters can hear the din of other voices outside the cave. Every hour, the characters can attempt a new language test (Difficult Linguistics or Formidable Education) to puzzle out bits and pieces of the language they are using.

The oldest of those who came into the cave clears her throat, and the others in the cave fall silent. She begins to address the characters in the unfamiliar language, and her attempts are assisted by the sign language of the man who first greeted them in the center of the village. It is clear that she makes no attempt to use this sign language herself to communicate with the characters. She seems to be asking the characters questions, but the meaning is not quite clear. It has something to do with the sky, and with the characters' ship. The "translator" also signifies something by looking first to the left, where he appears sad, then to the middle, where he seems mirthful, and then to the

right, where he appears inscrutable. If there is a character among the party who is adept in the psionic discipline of telepathy, he can attempt an Average skill test, using empathy, to discern some of the message the old woman is trying to convey. She seems to be asking if the characters are from the stars, and if they bear a message from any of their three gods: Yatemm, Miri, or Kirol. They seem to put a great deal of stock into their gods.

The questions continue, but unless the characters have been succeeding at the language checks, they are likely to be going nowhere. The old woman, whose name is Ranae, seems to realize this, for she abruptly ceases speaking. With this, all of the persons who came into the cave with her get up and prepare to leave. It is obvious they are disappointed. One or two of them eye the characters suspiciously, but no hostility is evident among them. It is as they are about to leave that Tess shows up. She is unescorted neither by her governess nor her guards. The people from the village draw an a collective breath, as if they are in awe of her arrival. The characters hear repeated numerous times the names Kirol and Miri. Moments after she arrives, the old woman bows deeply to her, and the others follow suit. Tess is nonplused for a moment, but when one of the women offers her a gourd of water, she giggles, accepts it, and drinks. If characters ask Tess where Donata, Harlik, and Averi are, she tells them that they are on the ship; she thinks they're sleeping, or at least Harlik is, because she heard him snoring really loudly. If the characters decide to take Tess back to their ship and check on the others, they will get their first indication of hostility from the Irathi, when one of the younger hunters moves to stop them. Things are about to get nasty when Tess reaches out her hand, pats his, and says that it's okay.

If the characters investigate the ship, they will find that everyone who was left behind is okay. Terhune was more or less keeping an eye on things, but he will shame-facedly admit that he fell asleep on the bridge. Colaen and the governess were tending to some chores when Tess disappeared. They searched the lakefront, but couldn't find her, and were just about to head into the forest where the characters had gone earlier. As the characters and Tess's retainers are there on the ship, they notice a delegation from the village has followed them to the ship. They are staring in open fascination at it. One of them, the youth that spied them from the forest, speaks excitedly to one of the adults, who looks thoughtful for a moment and nods.

## **Irathi**

The people of this world, who call themselves the Irathi, are a remnant of long ago. Actually settlers from the Second Imperium, their descendants passed the era of the Long Night with no outside contact. The world itself, while not suited to great agricultural tracts, nonetheless provides enough for a people to exist as hunter/gatherers and enables them to grow food in small quantities.

There are only about 900 Irathi living on the world today, nearly all of them in the enclave near the lake that the characters discovered. The people there have no record of how many were in the original colony;

many believe that their ancestors had always been on the world, despite traditions held by some of the elders that they came "from the stars."

The modern Irathi are organized into a religious oligarchy (treat as government type C). Their laws stem from their religious beliefs, and they are actually a fairly well-regulated society. For purposes of UWP, however, treat them as having a law code of 5, although their laws do not readily apply to weapon ownership. Rather, it is a representation of the intrusiveness of their society's laws in the daily lives of their individual citizens. Since they have no concept of modern weapons, they have no regulations dealing with them. As a hunter/gatherer society, they can easily understand the need for weapons that are useful for bringing home food. Weapons that are designed purely for combat (automatic weapons, and even certain blades), however, they cannot see a use for except to kill other people. These sorts of weapons they will not allow around them. Their tech level is effectively a 1, but their skill in producing them suggests a higher technological capability than that. Their knives are very well-made, and hold an edge for some time. This is equally true of their spear and arrow points. They make hunting bows designed for the strength of the user, which also suggests a more sophisticated manufacturing capability than that typically associated with a tech level of 1.

The Irathi have a religious tradition that has its roots in an ancient Solomani cultural heritage. They follow three gods. Kirol is the goddess of the future, her husband Yatemm is the god of the past, and their daughter Miri is the goddess of the present. Some of their elders have suggested that they are but three faces of the same god, and while the people do not rail against such an interpretation, they hold onto the idea that they are three separate gods.

Kirol is an enigmatic goddess who will unlock her secrets only to those with insight. The future is not for her followers to know except through wisdom. The Irathi honor her by placing a fifth of the food they gather and grow in storage. As long as they continue this practice, they believe, she will reward them with food even in times of want. Yatemm is a sad god. They believe he appears as an old man who has seen too much of life. The wise record dutifully what has gone before, both to honor Yatemm and to seek inspiration for the future. Miri is an ephemeral goddess. She appears as a young girl dressed in a bright dress reminiscent of spring. She is also known to be temperamental, given to great excesses of mood. One moment she is delightfully playful, the next dangerously wrathful. Her anger is brought on by those who forget to live, for she is existentialist in her philosophy. The people's teachings say that she reminds her people that insight and wisdom can lead to passivity. They have their place, but they must be meshed with an appreciation of the moment in order to bring true enlightenment. Of the three philosophies espoused by the gods, hers is the most Difficult to understand. It is deceptively simple. Those who follow her ways over the ways of her parents are often young and unschooled in the union of the three gods.

Legends claim that Kirol promised the Irathi a gift.

She would send, from the future, a prophet to her daughter Miri. The prophet would help the people unlock the ways of the goddess, the way of the future. The prophet is to be an incarnation of Miri, and she would appear in a way that the people have lost to the past. If they embrace her, learn from her, they can learn the secrets of their past, and in this way, discover the way of their future.

### **Worship**

The villagers gesture for the characters to follow them, and they lead them off in another direction into the hills. They show no hostility toward the characters, but they maintain an almost respectful distance. They walk for over an hour before they come to a thicket of woods. It takes a while to get into the middle of it, and when they do, the characters see the remains of what can only be a starship. They are badly rusted and overgrown with foliage (imagine finding the site of a plane crash in a rain forest thirty years after it went down), but they are unmistakably a ship. The characters can attempt a Staggering History skill check to determine that the ship is a Solomani design from the time of the height of the Second Imperium. (Referees should make this task easier or more difficult based on the known interests or lack of relevant knowledge of the characters.) Exploring the wreck reveals little but more decaying remains and an occasional small animal (some of which could be quite dangerous, at the discretion of the referee). No name is visible on the exterior, and any human remains inside the vessel have long since decayed into formlessness.

As the characters trek back to their ship, the boy, whose name is Salaa, sidles near and watches them with open curiosity. He will work up his courage to ask them a question, which the characters can attempt to make out with the task described previously. He is asking whether Miri has come to show her people the stars again. If the characters cannot answer him, he will shrug and scamper off, but if the characters show that they are starting to understand their language, he will ask again.

The adults will use whatever communication means that works to invite the characters and Tess's party to their village. The characters can sense no hostility in them, and Tess seems quite willing to go see them again. In fact, she seems almost to have forgotten her recent ordeal. Donata and the two guards are reluctant, but even Terhune cannot see what harm it will pose to Tess, and considering that her mood seems to have improved so considerably since slipping off the first time, he offers no objection.

When the party arrives in their village the second time, it has changed noticeably. Nearly the whole village has turned out to see Tess and the characters. They will not approach her or the characters, but this is less out of fear than shyness. The elders will invite the characters to join them in a feast commemorating their arrival and paying homage to their gods. Tess seems to understand at least the basic idea that they want to celebrate and asks Donata if they can join them. If the characters agree, Donata, Harlik, and Averi will as well. Tess spies some other children and runs off to play with them. They are very reluctant at first, but the boy

whom the characters saw in the woods emerges from among the other kids and motions them to join him. At that, they all seem to converge on Tess, running and laughing all the way. Terhune and Colaán keep a close eye on her, but nothing untoward occurs.

As the characters listen to the chatter of the villagers around them, they can begin to pick up enough similarity in the language structure of the old form of Galanglic that the Irathi speak to that of their own modern form of Galanglic that they can begin to communicate better with the Irathi. (Referees: This may seem unrealistic, but the idea here is to assist communication, not stifle it. The Irathi will want to talk with the characters as much as possible, for they believe they must prepare themselves for whatever the prophet of Miri —for that is exactly how they view Tess— asks of them.) The evening meal is not lavish, but the light-heartedness of the people makes it seem like one. The Irathi attempt as best they can to explain to the characters something of their cultural beliefs. This will be halting at first, but over the course of the next few days, it will become more clear as each side become more adept in understanding the other. The referee should summarize the information contained in the previous section describing various aspects of Irathi culture, adding whatever he likes to provide whatever additional depth to the Irathi he chooses.

### **Trouble!**

On one of the last days the characters plan to be on the Irathi world, a group of men armed with bows, spears, and long knives enter the encampment. It is clear that they are Irathi, and it is equally clear that they are regarded with some suspicion and fear by the villagers. They begin shouting demands loudly, and several of the village elders come out to speak with them, although they don't seem too happy about it. The leader of the group speaks rudely to the village elders, who respond with equally harsh words. If the characters are visible during this exchange, he will be eyeing them closely while he speaks, and his men look ready for a fight.

If the characters are out of sight, and they ask one of the villagers who these people are, he will tell them that it is Tergah and his band, a group comprised mostly of hunters who were exiled for one reason or another. They have come to ask about the visitors, and they mock the gods before the elders when they claim that the visitors are not messengers from the gods, but thieves come to steal their goods.

The characters can deal with this in whatever way they choose. If they ignore Tergah and his accusations, he will continue to rail for a while, but seeing that he has little support among the villagers, he will gather up his followers and depart back into the forest. The characters could also choose to fight. They probably have the firepower to make short work of Tergah's band, but in so doing, they will certainly shock the villagers, who are completely unused to violence of the magnitude that the characters can dish out. This will make the characters unwelcome, at the very least. (Referees could also choose to have the villagers realize that the characters are abominations in the eyes of their gods, and they must be destroyed. This option is

one which may leave the characters against a wall and trigger an overwhelming response against the villagers. Any chances for successfully talking with the villagers will be gone if this option is chosen.) If the characters choose to fight Tergah on more even terms, they can ask the villagers, who will tell them that tests of strength and skill are often used to resolve conflicts between disputants. These tests include unarmed fights (Brawling skill), athletic tests (Athletics skill) that challenge a person's physical and mental skills, a knife fight to first blood (Blade Combat skill), archery contests (Bow Combat skill), a hunt challenge (several skills, including Survival, Recon, Stealth, and some sort of weapon skill), or a verbal challenge (using such skills as Fast-Talk, Acting — for storytelling, Diplomacy, Intimidation, or even Writing — which could also be used for storytelling — at the referee's discretion). Referees are encouraged to add other possibilities, or ones which include more than one of these options.

If the characters manage to handle the threat posed by Tergah without alienating the villagers, they will have gained an advantage in future dealings with them.

## Negotiations

When the characters give signs that they are preparing to leave, the villagers will be very unhappy. They have waited for the arrival of the prophet of Miri for millennia, and many of them believe that they do not yet understand her message. Others will argue that they must search their histories and prophecies to find her message. Her arrival here was but the key, they argue. A few of the more hard-line voices want to keep her with them, even if her guardians do not wish to allow it, but their voices are drowned out with protests from the others.

The problem facing the characters is what to do about the Irathi now that they have been (re)discovered. Clearly they believe that Tess is the prophet of Miri, the gift of the goddess Kiorl to her daughter and to her people. And Tess has been a delightful child throughout the stay on the Irathi world, an odd circumstance considering her recent ordeal. Furthermore, despite the carefree fun she is having among the Irathi, she does not protest when Donata tells her that soon it will be time to leave. She simply says that she would like to come back here and see her friends again someday.

If the characters wish to help the Irathi, they can offer to trade with them. To the Irathi, this really is not trading like they practice it, for they see it as offering something for Miri and her guards to take with them on their way. The bounty they will receive in return will far outweigh whatever unworthy gifts they offer.

When it come time for the characters and Tess to say goodbye to the Irathi, nearly the whole village will turn out to the edge of the forest to watch her leave. Tess will flit among them, saying goodbye. Many of the children follow her around as she dashes from person to person. The old woman, Ranae, smiles down at Tess, who smiles back. She then gives Tess a small carved wooden ring, which she explains is very old, worn by her great-grandmother when she was but a girl. Ranae does not know who gave it to her. Tess pulls off her locket and gives it to Ranae, who accepts it with a smile. Tess continues her passage among the

Irathi, stopping to give a smile, a giggle, or a touch of the hand to practically all of them. What the characters see is a delightful little girl making her farewells among the friends she made on an especially joyful holiday. What the Irathi see is their youngest goddess reminding them of the joy of each day of life.

## Trading With Irathi

If the characters part company on good terms with the Irathi, they can achieve a significant boon. The Irathi have knowledge of a place in which crystals grow inside a cave in the side of a hill not far from their home. When the wind blows into the cave, the crystals hum, creating a harmonic effect that is very pleasing to the ear. They are willing to give the characters some of these crystals for their assistance in bringing to them the gift of prophecy. They will not allow the characters to "harvest" the crystals themselves, not because they see any significant economic worth in the crystals, but because they have learned how to remove them without damaging their harmonic qualities. These crystals have little inherent value as gemstones, but they are worth a fair amount of money as novelty items. Referees can assign whatever value they wish to the crystals, depending on where they're sold, who buys them, etc. As a general guideline, assume they will be worth double what a normal novelty cargo will yield. If demand quickly outstrips supply, certain agents may begin to attempt to learn the source of the crystals from the characters, and they may very well resort to whatever means necessary to obtain that information.

In addition to the crystals, the Irathi are able to trade products of both indigenous plants and animals. This may mean furs, meat, or bone carvings, as well as lumber and wood carvings. They have developed an intricate design for furniture made from the wood of local trees that stays together without nails or other fastenings. All of these are available from the Irathi at a price reasonable enough to make it worth an enterprising merchant's while. As is the case with the crystals described above, it is up to the referee to decide the relative worth of various of these products. It may very well be that consumers find the meat of the animals hunted by the Irathi unappealing, but they cannot get enough of the bone carvings they craft. Furthermore, since consumer tastes are a finicky thing, this may change from time to time and place to place.

The Irathi are likely to need basic foodstuffs, processed ores of a quality with which they can continue to make their excellent weapons, and simple medicines. Technological items of a sophistication beyond what they can readily understand will be treated more as curious oddities or religious items. While they may value them, they will gain no use from them.

It is entirely possible that characters will realize that they can get away with making an unfair trade with the Irathi for their products while making a fortune for them off-world. They will probably be able to get away with this for some time, for the Irathi have no real concept of what value others place on their products. If they ever discover that the characters have been "cheating" them, they will become angry with them. They will refuse the characters their hospitality

in the future. Some among them may argue that the characters have brought a false prophet in order to take advantage of them. While others will not readily believe that, they will realize that Miri's associates are not spun of the same stuff she is, and to exchange goods with them is to dishonor her. The Irathi are not stupid, only ignorant of the ways of modern people.

These trade possibilities will likely be available to the characters for only a few months if they have informed the Imperial government of their find (see Conclusion, below). The referee might wish to consider allowing the characters to trade for a few choice cargoes and then having the trade contact dry up as a result of the Imperial interdict. Characters who have made friends on the world or who wish to continue to have contact with the Irathi will have to get approval from the Scout Service — not an easy task!

## Conclusion

The characters experience no further malfunctions on their ship during the rest of the trip to their destination. It is as if Tess's sense of happiness makes the ship run almost as if effortlessly. When they arrive, Terhune sees that they are paid a substantial bonus for their efforts. Tess says goodbye to each of the characters, as do Donata Terin, Harlik Terhune, and Averi Colaan. As Tess says goodbye, the characters might wonder if maybe the Irathi were right.

## Further Adventures

If the characters report their findings about the Irathi to Imperial authorities, the Imperial Scout Service will send a team to investigate. In a matter of months, they will set up an interdict of the world, to protect its civilization from being adversely affected by the technology (and rapaciousness) of the rest of interstellar civilization. This will mean that even the characters will have some difficulty getting back to the world. The interdiction force will consist of twelve lightly armed sensor satellites, six more heavily armed interdicator orbital platforms, and a small manned scout orbital station with two scout/couriers. The satellites will detect most ships entering within 30 diameters of the world, and they will broadcast a continual automated message that warns approaching ships that the system is under Imperial interdict and sends a message to the manned station (which will usually scramble a scout vessel if one is available at the station). The satellite also records the information broadcast by the transponder of the incoming vessel. If the ship does not halt its approach, the satellites will contact one of the armed interdicator platforms, which will head out on an intercept course. The satellite will continue to warn the incoming ship that it will have to open fire on it if it does not stop. If a ship still ignores the warnings, it will open fire; if the interdicator platform is within range, it will also open fire in an attempt to disable the approaching ship. Only one interdicator platform will respond to any given satellite warning. The ship will eventually have to deal with the armed scout/courier ship that is sent out from the orbital base.

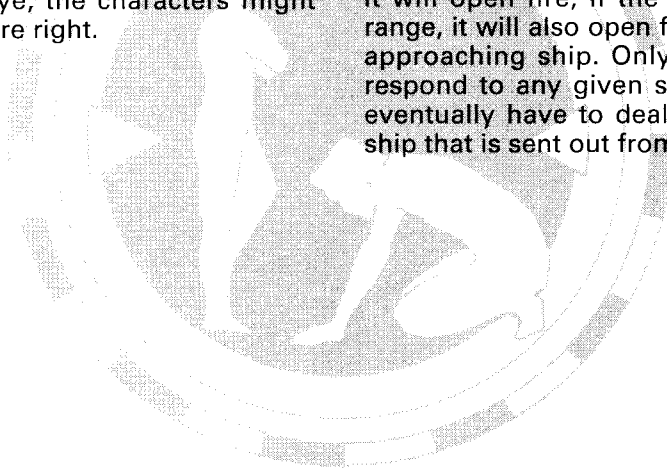



# 10: DEAD SPACE

---

In this adventure, the player characters are hired by an Imperial bureaucrat to deliver cargo to a remote research station. The station is at the edge of the range of their fuel tanks, but they are promised refined fuel once they off load their cargo there. However, when they arrive at the station, it is apparently deserted. The truth is that all the researchers were killed by a genetic experiment gone awry. A monstrous, living killing machine roams the station now, and the characters must fend it off long enough to refuel their ship and make good their escape. If the characters risk exploring the station and uncover what happened there, they earn the good will of an Imperial intelligence agent and thus have access to a patron who can offer them several well-paying (and potentially dangerous) assignments in the future.

## The Setting

This adventure takes place in two separate star systems. The first stage of the adventure is the encounter with Sir Neevaln, the party's potential employer. He is encountered on a world with an A or B class star port that is located on or near a major trade route in the referee's campaign. The second stage of the adventure takes place in a system with no gas giants, no worlds capable of supporting humanoid or known alien life forms, and no known spaceports. The system is at the extreme edge of the jump capability of the party's ship, and it is the location of a secret Imperial research facility.

## The Setup

The characters find themselves on a major hub world, either having just delivered cargo, or just completed an adventure. As they are relaxing, or hunting for their next job, a page arrives at the ship from Imperial Plaza, the governmental center of the solar system. She relays a message from Sir Neevaln Wierianeel, Vice System Director of Imperial Ministry of Information, a high-ranking local bureaucrat. Sir Neevaln wishes to retain the characters and their ship for an important and urgent cargo delivery, a task for which they will be handsomely rewarded (15,000 credits, plus full fuel tanks before they depart on the trip, when they arrive at their destination, and upon their return to the star port they are presently at). The page has instructions to bring the characters straight to Sir Neevaln's office at Imperial Plaza. If the characters don't wish to go with her immediately, she says Sir Neevaln would like them to join him for dinner at the Diademion Club, if they need time to think about whether they wish to work for him.

Suspicious characters may wish to gather information on Sir Neevaln. Whether they use Investigation, Streetwise, or Carousing in their attempt to get information on their prospective employer, they must make Difficult skill rolls. Not much information can be found on Sir Neevaln; everyone knows him as the scion of a local noble family who received a highly placed position with the Imperial Ministry of Information after a short and lackluster stint as a Naval officer. He is a known playboy of Vilani heritage, and it is said that a high society party is not a success unless Sir Neevaln is in attendance. It is also well-known that Sir Neevaln occasionally hires ships and crews like the characters for cargo runs. No one knows where the cargo is taken, and Neevaln pays so well that the crews keep

their mouths shut about their destinations in hopes of getting more work. Spectacular successes only yield the additional poisonous gossip that it is popularly believed that Sir Neevaln's appointment and retention is little more than a result of his family pulling strings on his behalf. He is not known as a brilliant man, and it is widely suspected that the plum deals he gives to travellers with freighters is just his way of making sure his budget is spent to the fullest each year so that it is not cut.

Should a character who is either an active or former member of one of the branches of Imperial Intelligence attempt to use contacts to get more information on Sir Neevaln, he needs only to succeed an Average Carousing or Streetwise task to learn that Sir Neevaln has extensive contacts in both Naval and Army Intelligence, and deals frequently with operatives from the Ministry of Justice, and the Bureau for Interstellar Affairs. Exactly what Sir Neevaln does for the Imperium the characters' contacts can't say for certain, but they feel confident that he is more than the bumbling bureaucrat he appears to be. As far as they know, he is trustworthy and honest with hirelings. A spectacular success while inquiring about Neevaln with intelligence sources means the character is actually speaking with one of the knight's actual operatives. While the operative doesn't reveal much more than anyone else, he does vouch for Sir Neevaln, commenting that he has worked for him in the past, but cannot comment on the nature of the missions. "You can work for far worse people than Sir Neevaln," the NPC says, "but only a few who are better."

If the characters decide not to meet with Sir Neevaln, this adventure is over, and they will not be contacted by Sir Neevaln again.

## Meeting Sir Neevaln

They meet with Sir Neevaln either in the opulent surroundings of his spacious office at Imperial Plaza, or a private dining room at the Diademion Club. If they are wearing simple duty uniforms or ships utility suits, they will feel woefully underdressed for both places, and they will feel disdainful eyes of nobles, functionaries, and servants everywhere they go.

Neevaln greets the characters warmly, and if they are meeting him for dinner at the Diademion Club, he makes sure everyone has ordered meals before anything but introductions occur. He then engages the player characters in small talk, asking about their recent missions or cargoes, telling them about the natural wonders of the world they find themselves on,

that they "must get away from the spaceport some day to experience them," and just generally conversing about life as an Imperial functionary while asking questions about how the various regulations impact on the lives of common citizens like the characters.

If they are meeting in his office, Neevaln chit-chats for about 30 minutes of game time, or until one of player characters ask to get down to business. The same is true if they meet him over dinner, except that Neevaln continues to small talk until dessert is served, or until, again, a player character asks to get down to business. At that time, Neevaln says, "I'm sure sentiments of your experience are aware of the ever-expanding activities of the Imperium. Perhaps the ever-expanding red tape that follows has impacted on your routines once or twice, hmmm? Well, no matter, for there is no red tape involved here. No, instead we are faced with a situation where the Imperium's growth has extended its resources.

"In a portion of space not too distant from this world is a secret scientific research station. Still, it is distant enough so as to be difficult to reach — one must have a ship with a Jump rating of two to do so. It is located in a small asteroid field you won't find on most star charts, because it's not on any standard shipping lanes and is in what most folks consider 'dead space.' The men and women at the installation are completely dependent on shipments from here for all their supplies, as well as raw materials with which to continue their research. And, yes, the base is primarily engaged in weapons research, which is why it is located in such an isolated place. One would hate for an accident to claim the lives of civilians, should the worst happen, hmm?

"Still, I find myself in the unenviable position of having been asked to insure the base receives its quarterly shipment of supplies. Yes, I know this might seem as though it is a job for the Navy, but the duties of a functionary of the Ministry of Information sometimes takes a person in unexpected directions.

"Since this is a secret installation, I have need of a crew that can be trusted not to reveal its location, once the delivery has been made. In fact, if you choose to take the job, you will be assured a repeat engagement every quarter, should you be in system at the time when another shipment needs to be made. The Imperium wishes to keep the location of this base known to as few as possible. And, yes, if not for the current limited availability of Naval and IISS vessels in the area, a ship in the direct service of the Imperium would be making the delivery.

"Still, mutual friends have assured me that your professionalism makes you the next best thing presently in port. As my page hopefully already mentioned, I am willing to pay you 15,000 credits up front, and to pay all costs associated with refueling your ship before you leave on this mission. The base will refuel your vessel upon completion of the off-load, and your ship will be refueled when you return here, once again, free of charge.

"The freight you'll be carrying is perfectly harmless. It consists of nothing but research raw materials, food stuffs, medical supplies, tools, and clothing. A manifest will be provided to you if you accept the job.

Dr. Rhysa Linser, the facility's director, must sign your manifest upon delivery, and if you bring the signed manifest right back here upon completing delivery, I'll give you a bonus 5,000 credits. So, does this sound like a contract you may find acceptable?"

If the characters are interested in the job, Neevaln gives them the cargo manifest and presents the ship's captain (or owner) with a contract for him to sign. Neevaln says the coordinates of the space station to which the cargo must be delivered will be brought to their ship along with the character's payment once the cargo has been loaded completely. Their ship will also be fueled at that time, or they will receive reimbursement for their fuel costs if they had already seen to it before their conversation.

### The Shipment

Three hours after the characters have accepted the job, a cargo hauler arrives with their shipment. The manifest they have state that all their cargo is to be exempt from customs inspection. (This applies only to the items on Sir Neevaln's manifest. Any cargo the characters might secure before their departure in the hopes of sneaking something by customs is still subject to inspection and tariffs. This is evident to anyone who reads the manifest and successfully performs an Easy Administration task.)

The crates are all sealed, and roughly half of them are portable, self-contained and self-powered cryogenic storage units that are labeled "Specimens" both on the boxes themselves and on the manifest. Others are said to contain "Canned Foods," "Vacuum Packed Rations," "Clothing," "Tools," or other mundane everyday items. It is not a big shipment — only a total of 5 displacement tons — and four of them are taken up by the bulky cryogenic units. The freight is loaded within two hours, and shortly after that the page who came to the characters' ship arrives once again, carrying a credit chip that can be deposited or cashed at the bank of the characters' choice, and a data disk which she says contains the coordinates of the station. The deep space research installation is designated EDX 17-T, and an Average Astrogation task reveals that it is located in a part of space that is reportedly empty.

The characters are ready to depart now, but those with suspicious natures may wish to investigate their freight themselves. It will take 2D6+2 hours for the characters to search every crate, and they will find that they match what is on the manifest. There are no hazardous materials in their shipment.

The contents of the portable cryogenic storage units may be a bit disconcerting to the characters. They contain preserved bodies of a variety of the Imperium's known intelligent species, and even some the characters don't recognize — even with spectacular successes on Xenobiology or Zoology task rolls!

If the characters are foolish enough to contact Sir Neevaln about the corpses, he becomes quite annoyed, saying that there is a reason for sealing shipments and he thought they were professional enough not to go snooping in crates they have been paid to ship. He assures them that there is nothing illegal about their cargo, and asks that they get underway immediately. (This incident will damage their credibili-



ty in the eyes of Sir Neevaln, and unless they perform exceptionally well in the latter half of this adventure, it is unlikely that he will call on them for any delicate work in the future — not that the characters will be aware of this, of course. In fact, Sir Neevaln may decide that he has created a security risk, and may call on them to carry out a mission he *knows* will fail so they will be killed and thus eliminating the risk.)

Hopefully, the characters won't be foolish, and will simply get underway. If they choose, they can spend the time in jump space attempting to reseal the crates. This requires seven successful Difficult Forgery tasks, and the whole process takes five days, less one day for each additional character working on forging the seals.

### Sir Neevaln Wierianeel

Neevaln Wierianeel can serve the referee in an ongoing campaign as a PC patron within the Imperium's government. If the dealings with Sir Neevaln end positively, this character serves as the perfect way to get the player characters involved with the adventure seeds presented in Chapters 4 and 5 of the *Milieu 0* supplement.

Sir Neevaln is a tall man with thinning brown hair and an easy smile. Middle-age and the time he spends behind his desk are settling on his otherwise fit body, and he is developing a slight paunch. But his business suits are always impeccably tailored, and he is never seen in anything but the latest styles whether he is at the office or at a high society ball.

To all appearances, Sir Neevaln is a foppish bureaucrat of middling competence who can thank his family connections for his high placement in the system branch of the Imperial Ministry of Information. The truth, however, is that Sir Neevaln is an agent controller in Imperial Intelligence who specializes in managing information and contacts relating to secret military projects and installations scattered across the sector. He is a formidable foe in his own right, but the real dangers to those who cross him actually comes from the many loyal intelligence agents under his command. Sir Neevaln is not a petty man, but he does not easily forgive serious challenges to his operations or his person.

Sir Neevaln tends to rely on intelligence operatives for most missions he needs performed, but with the ever-expanding activities of the Imperium, and with new star systems coming under the sway of the government he serves, he occasionally finds his need for

recourses stretched beyond what he has access to. In these cases, he turns to travellers who have reputations of being capable and discreet individuals — a category into which the player characters hopefully fit.

## Arrival

When the ship emerges from jump space, the cylinder-shaped station floats in the blackness of space in front of them. It is equipped with powerful communications arrays, something which even simple visual observation of the station reveals, yet the characters receive no answer to any hails.

Successful Average Sensors scans of the station reveals that all systems are operational, and that the station is receiving the character's broadcast, but that no one there is responding. Successful Difficult scans further reveal that there are no life forms onboard the station — it appears to have been abandoned.

The characters, however, have no choice but to dock with the station. They barely have enough fuel to use their maneuvering thrusters to do so. (The referee should call for Piloting task rolls; failures give him an opportunity to create a dramatic situation where the characters completely exhaust their fuel, and that the final stage of the docking is done on nothing but momentum and piloting skill. Don't strand the characters away from the station, however. That would end the adventure before it begins.)

Once the characters have docked, they can explore the station in an effort to find out what has happened here, or they can simply try to refuel their ship as quickly as they can, and be on their way back to their employer to inform him the cargo couldn't be delivered.

As they will discover, they will hope they did the latter instead of the former.

## The Research Station

As soon as the characters have docked, the station's computer automatically uploads the following information to the character's ship's computer. The information appears on the primary data screens of the ship.

"Welcome to EDX 17-T. Due to the delicate nature of the research we conduct here, we must insist that you restrict your activities to Levels One and Two. Off-load your cargo on Level Two. Refuel your ship from the pumping stations on Level One. You will find an access door to the station's elevators directly across from the airlock to the bay. Once you step out of the elevator on Level One, find the door that matches the letter designation of the bay at which you docked. Instructions on how to operate the fuel pump beyond are to the left of the console. Dr. Rhysa Linser will soon join you in the docking bay to sign for your cargo, and to see if we require your assistance in transferring it to our storage area. Thank you for your cooperation."

Assuming the characters follow the automated directions, there is a good chance they will escape the station with all hands still alive. If they don't, they will most assuredly be attacked by the monster that destroyed and utterly consumed the majority of the personnel.

Name <b>Sir Neevaln Wierianeel</b>		UPP 78789B
Service Imperial Functionary		Rank
Birthdate	Birthworld	
Skills Administration-3, Athletics-1, Astrogation-1, Bribery-2, Carousing-1, Computer-2, Diplomacy-2, Disguise-2, Fast talk-2, Fencing-1, Grav Craft-1, Ground Craft-2, Interrogation-2, Investigation-2, Jack-of-all-trades-1, Law-2, Leadership-1, Perception-1, Rifle-2, Sensors-1, Streetwise-2, Tactics-1, Vac Suit-2		
Possessions		Money
Comments		

UPP Card

001-000

## General Station Notes

The hallways are spacious and lit by panels every meter. All doors are electrically powered, but can be cranked open in case of emergencies. The doors to all interior rooms and offices slide into the wall when opened, while the interior and exterior airlocks are similar to iris valves. Working the cranks on all interior doors takes an Average Strength test while opening airlocks requires a Difficult test. Once an airlock has been cranked open, it must be cranked shut as well.

An elevator shaft runs along the center of the station. Two elevators can be found here. Each holds four people.

The creature who will be stalking them through the station is detailed below. A description of the station follows, keyed to the map on page 107. There is a chance that the creature is lurking in one of the station's areas whenever the characters enter it. That chance is listed as part of the description. The following modifiers, which are all cumulative, apply to the die rolls:

- If the character is alone, add 2 to the result.
- If more than two characters are together, subtract 1 from the result.
- If one or more characters have already been killed, subtract 1 from the result.
- If one or more characters have been killed and consumed, subtract 2 from the result.
- If two characters are actively guarding the entrance to the area (such as to the character's ship), subtract 1 from the result.
- If the creature has already attacked in that area, subtract 3 from the result.

Even if the creature is not in a room when the characters enter it, the referee should roll 2D6. The result equals the number of minutes that pass before there is another chance the creature might come to that area of the station. When the allotted time has passed, the referee should roll the first check again, without applying any modifiers. If the result indicates the creature is present, it enters either through the door or through an air duct and attacks.

If the characters have split up and are spread all across the station, the referee may have to apply common sense to the results dictated by the dice. If the creature attacks characters on Level Six, it won't be able to attack a character at the pumping station on Level One at the same time. It might attack a character on Level Six, and then be waiting on top of the elevator when the character on Level One goes to investigate, however. There is only one creature, and the referee should take care to not have it be in more than one place at a time.

During this adventure, the referee should strive to create a sense of fear and claustrophobia in the player characters. When describing most of the areas in the station, he should emphasize sounds and shadows in the base, particularly after the characters have been attacked by the creature. Focusing on details that illustrate the suddenness with which the personnel of the station vanished when they appear in the area descriptions will help put the characters on edge even before they know there is a monster roaming the facility. The key sensations in this adventure should be fear and terror. The characters who escape the station alive should feel lucky to have done so.

## The Nature of the Terror

The antagonist creature in this adventure is a being born from a twisted union of human creativity, science, and the never-ending quest for more powerful weapons.

Dr. Rhysa Linser was a brilliant geneticist who had been secured by the Imperium's military to create a race of super-soldiers that could be used against planets that were too hostile for diplomatic efforts, and too militarily strong or too technologically advanced for the Imperium to defeat swiftly. The High Command wanted a humanoid being — so, if need be, it could use standard issue equipment — that was chameleon-like in its ability to blend into surroundings, didn't show up on most scanning equipment, was powerful enough to shrug off much gunfire, was a rapid healer, and had an insatiable killing instinct, along with a cunning nature.

Dr. Linser assembled a team of men and women who were her near-equal in ingenuity, and after several years of trying, they finally created the super-soldier. Unfortunately, like so many other scientists who attempt to twist the miracle of life to their will, they found themselves faced by a force they could not control, and it quickly destroyed them.

One of Dr. Linser's final acts were to erase and overwrite all of the logs and research data in the station's computer. The only thing left in the banks, aside from the programs needed to maintain basic station functions, which she did not have time to shut down, is a recording from the doctor, warning others not to repeat the mistake she made here. She had long since destroyed her personal notes.

Dr. Linser's creation is a superhuman beast. It is roughly human in shape, but stands over 2 meters when at its full height, has a face that resembles that of a shark more than anything else and a mouth that is filled with hundreds of razor-sharp teeth. It is far more heavily muscled than a human being, and its arms are slightly longer as well. It has opposable thumbs and four fingers, but the fingers each have claws that function as daggers when the creature is engaged in melee. Each successful hand strike inflicts 4D6 points of damage. It should be noted, however, that the creature may also use weapons retrieved from slain characters.

The creature has a natural flexible Armor Rating of 4. When injured, it heals 1 damage point per minute, even to the point where it recovers from death. This accelerated healing has left the creature with a very high metabolism. In order to survive, it typically consumes its victims. (This behavior was also programmed into the beast's nature, so that when an army of them were unleashed upon an enemy, they would devour all the corpses so the Imperium need not worry about disposing of them.) The creature can only be destroyed by prolonged exposure to a vacuum, or through complete disintegration. Despite its high metabolism, however, it typically assumes the temperature of whatever environment it is in, making it very hard to detect on sensors, particularly because of its ability to adapt the color of its surroundings as well.

Referees will note that the creature's statistics are presented in the format typically used for characters; this is because the creature is basically humanoid, and so the referee can run him with maximum efficiency and lethality. The "skills" are more natural abilities

and instincts. (For example, the creature's Stealth and Camouflage skills are a representation of its ability to blend in with its surroundings.) Think of the creature like an opponent from a horror movie: Even if the evil being has been trapped in a tomb for centuries, he still knows where to find the master power switch in order to plunge a structure into darkness. Similarly, the creature has a small chance to bypass security efforts the characters might attempt to use to protect themselves, and otherwise take actions that make him a relentless, lethal, and terrifying foe.

Name <b>The Creature</b>		UPP <b>CCD520</b>
Service		Rank
Birthdate	Birthworld	
Skills <b>Blade combat-1, Brawling-4, Camouflage-6, Computer-1, Demolitions-1, Gun Combat-1, Intrusion-1, Melee combat-2, Perception-2, Recon-2, Stealth-6, Survival-2, Tactics-1</b>		
Possessions		Money
Comments Artificially Created Monster, Damage: 4D (claws), Armor: 4, flexible.		

UPP Card

001-000

## Station EDX 17-T

All doors are electrically powered, but can be cranked open in case of emergencies. The doors to all interior rooms and offices slide into the wall when opened, while the interior and exterior airlocks are similar to iris valves. Working the cranks on all interior doors takes an Average Strength test while opening airlocks requires a Difficult test. Once an airlock has been cranked open, it must be cranked shut as well.

An elevator shaft runs along the center of the station. Two elevators can be found here. Each holds six people comfortably, and is wide enough for a fully grown adult human male to lay outstretched on the floor.

### Level One

This level contains refined starship fuel tanks and the monitoring and pumping stations needed to operate them. There is one tank for each of the base's four docking bays. Each station has instructions for their use clearly displayed near the operation controls. They are fairly straight forward, and characters who successfully perform an Easy Intelligence task can operate the equipment.

**1A-1D. Refueling Stations:** These areas are identical in nature, except the tank for Refueling Station A is empty. The characters dock at Docking Bay B, which means Refueling Station B is where they must go to refuel the ship. The creature lurks or attacks here on a D6 roll of six or better.

**2. Elevators:** Whenever the characters use one of the elevators, the creature attacks on a D6 roll of six or better. If the first roll indicates the creature is not in the elevator, the referee should immediately roll again. If the second roll indicates an attack, the creature is actually on the roof of the elevator, and it smashes down into the car as soon as it is set into motion.

### Level Two

**3A-3D. Docking Bays:** Each of these areas correspond to a fuel pumping station on Level One. Each contains a TL12 exoskeleton that is equipped for cargo handling. Doors marked "Authorized Personnel Only" connect the four docking bays to each other.

**4. The Characters' Ship:** Whenever the characters come or go from their ship, the creature attacks on a D6 roll of 5 or better. If the creature doesn't attack on the first roll, the Referee should immediately roll again. If the result indicates an attack, the creature is actually hiding somewhere onboard the character's ship. Unless they conduct a thorough search of the vessel, they do not find the creature until it attacks one of them after they have entered jump space. The creature attacks on a D6 roll of five or better.

### Level Three

**5. Control Center:** All station functions are monitored from here, and with successful Average Computer tasks a character can adjust, or deactivate and activate any systems ranging from life support to the brightness of the lights. The creature attacks here on a D6 roll of 5 or better.

If the characters search the computer system for station logs, they discover all data have been deleted and overwritten a little over two weeks ago, with no ways to retrieve them.

**5a. Conference Room:** This small room contains a table that seats four people, a view screen, a vid-player, and a computer terminal that is linked to the master control station in area 5. The creature never attacks in this area, but the referee should roll a check regardless. If the modified result is 4 or better, the creature is lurking in the Control Center when the characters emerge from this area.

**6. Observation Room:** A large plasti-steel window allows characters to look into a room with stark, bare walls. The door that leads to the room can be securely locked from the outside, and is far more sturdy than the other interior doors on the station. The creature attacks here on a D6 roll of 6 or better. If the modified result indicates the creature does not attack immediately, it is not encountered here at all.

**7. Testing Center:** This room sports three auto-docs which are designed to monitor and diagnose conditions rather than heal them. They are all hooked to a central computer that, upon a successful Easy Computer task, the characters discover has had all data erased from its hard drive. The files have also been overwritten and are irrecoverable. Only one file remains. It was created minutes after all the other data was erased. It is a data file that includes a visual recording, and it may be opened and played back with an Easy Computer task.

The file was recorded by Dr. Linser, a pudgy woman in her late forties with short blond hair. Sweat literally runs off her face and she stares into the recording device with wide, panic-filled eyes. Her voice never raises above a whisper. She says, "Whoever you are, leave this place immediately. There is nothing for you here. I've destroyed all records of our research. We were trying to create a weapon. Instead, we created a monster. It's already killed the others. I'm the last one left. I intend to open the station to space, for a complete vacuum is

one of the few things the creature can't withstand. If I succeed, the galaxy will be safe. If I fail, I implore you — do not use the creature to create more. It will destroy all of us. It will — " A sound off-screen interrupts Dr. Linser, and she turns and moves out of the field of the recording device. Then she shrieks in utter terror and a splash of blood covers the lens. Moments later, the blurry image of her face can be seen through the red haze as she reaches up to save the recording she has just made. Her final words are, "Destroy this place. Please."

A search of the Testing Center reveals the digital camera that was used to record Dr. Linser's final moments. There is no sign of blood anywhere, however. If the characters haven't already been attacked, they should now realize that they are not alone on the station.

Two other banks of controls allow researchers and observers to monitor the condition of individuals in the observation rooms (areas 6 and 8). The doors to each room can also be securely locked or opened from these stations. Like the central computer, all data has been erased from the monitoring stations, and it is also unrecoverable. The creature attacks here on a D6 roll of 3 or better.

**8. Observation Room:** This area is identical to area 6, except the creature attacks on a D6 roll of 4 or better. (This is the room where the staff observed the creature. It is still drawn to it.)

#### Level Four

**9. Storage Deck:** This dimly lit area is piled high with crates and deactivated cryo-storage units. The characters may find virtually any type of scientific equipment one would expect on a research station dedicated to genetic manipulation.

Searching this deck is like wandering through a maze — a maze which the creature might also stalk through. It is impossible for characters to remain within sight of each other, unless they stay within three feet of another character. Any farther apart, and they have turned a corner or such. Unless the characters specifically state they are sticking close together, the referee should treat any activities on this deck as if several characters have entered the area alone. A D6 should be rolled for each character on the Storage Deck, and the first result of 2 or better means that character is the first one to be attacked. If others are nearby, the creature will probably not have a chance to finish the character off, and it flees up onto the top of the crates as soon as others start approaching, blending into the background.

If the target survives the attack, a successful Difficult Intelligence task means he was alert enough during the attack to know that he was assaulted by a humanoid creature with huge teeth and vicious claws. The creature appeared to materialize out of thin air, and it vanished as quickly as it appeared when the character's companions arrived.

#### Level Five

**10. Laboratories:** Each of these areas is a bewildering array of equipment designed for genetic sequencing, manipulation, and splicing. Every item is on the cutting edge of Imperial technology, and characters who examine it must make successful Difficult Biology,

Chemistry, or Medical task rolls before they can even discern the manner of the work conducted here.

Along the outer walls of each lab are dozens of cryo-storage units. A computer in each lab at one time monitored the units, ensuring that those stored in stasis within here whole and well. An Easy Computer task lets the characters discover that someone reset the settings on the cryogenic units, causing them to malfunction and kill those held in stasis within while inflicting severe tissue damage to them. (Once again, this was an act of sabotage performed by Dr. Linser as she tried to eliminate all avenues through which the work of her and her team could be recreated.)

The creature attacks here on a modified D6 roll of 4 or better.

**11. Common Area:** Although it follows the same basic configuration as the other areas on this level, this room contains no lab equipment and several of the cryogenic storage units have been replaced with video monitors, microwave ovens, food storage units, an entertainment center, and shelves with books, magazines, art supplies, musical and video recordings, and any other manner of diversion with which that one might imagine a crew of highly intelligent and creative individuals would use to unwind and entertain themselves. A large table with enough chairs to seat eight stands at the center of the room.

The creature attacks here on a modified D6 roll of 3 or better.

#### Level Six

**12. Access Corridor:** This spacious hallway is lit by panels in the ceiling every meter. The creature attacks here on a modified D6 roll of 6 or better.

**13. Personal Quarters:** Each of these rooms holds the personal belongings of one or more scientist, ranging from clothes and personal hygiene items, to books, love letters and pictures of family. Most rooms housed a single individual, although if the referee rolls a 1 on a six-sided die when the characters enter it, a couple shared the room. The creature attacks in one of these rooms on a modified D6 roll of 4 or better. Once the creature has attacked in one of the quarters, it does not appear on this level again.

### Further Adventures

If the characters make a full report to the Imperium, they may have a new patron in Sir Neevaln. One assignment may be for the characters to travel to Dr. Linser's homeworld and see if there are any notes that might help the Imperium recreate her research there, assuming the characters *want* to help recreate Linser's research. Any other kind of service to the Imperium's covert activities can also grow out of the characters' connection with Neevaln.

Another possible adventure can originate with the creature itself. The referee can simply have the creature hide on the characters' ship until they reach their port of destination. Then it leaves their ship and goes on a rampage of terror on the world. The characters may well have to face the creature again. Worse, the creature may be able to breed with humans, and it may create offspring that may begin to depopulate the planet in a most violent and terrifying fashion.

# THE RESEARCH STATION

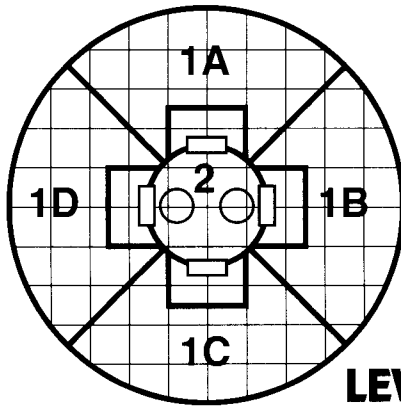

**LEVEL 1**

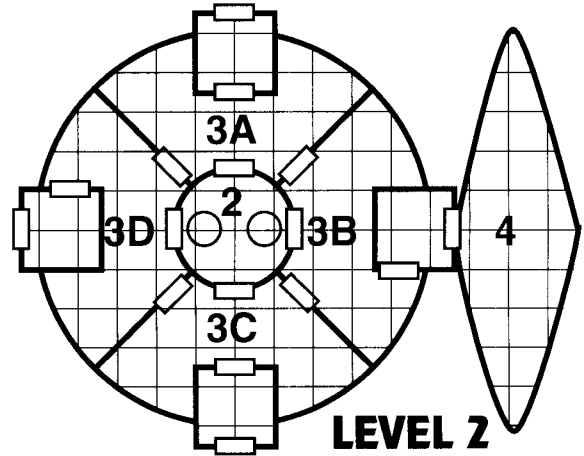

**LEVEL 2**

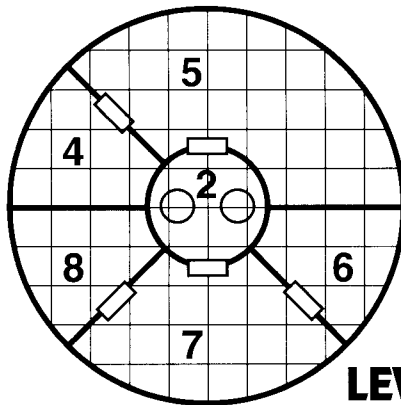

**LEVEL 3**

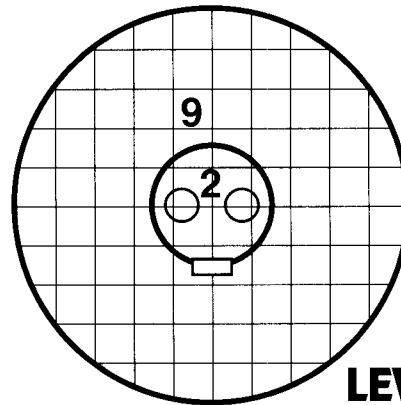

**LEVEL 4**

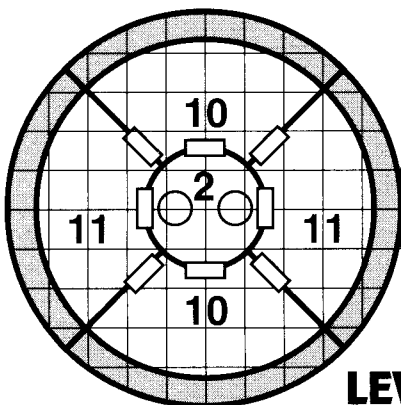

**LEVEL 5**

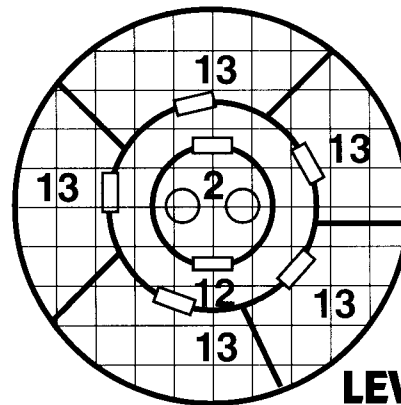

**LEVEL 6**

 = 2 Meters

## MAP LEGEND



Airlock/Docking Collar



Cryo-Berths



Elevator



Door

# THE BASE: GROUND LEVEL

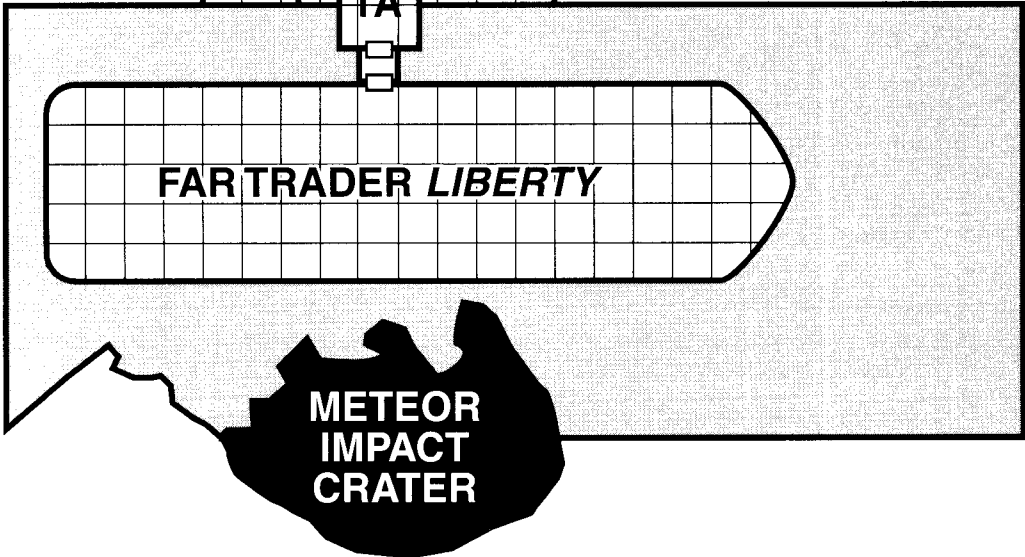
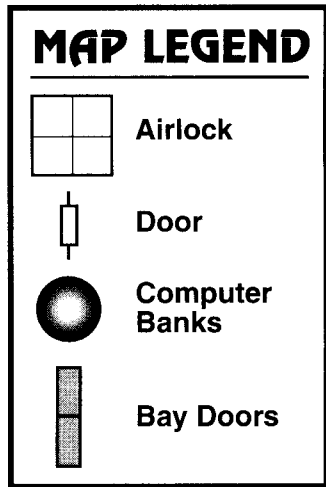
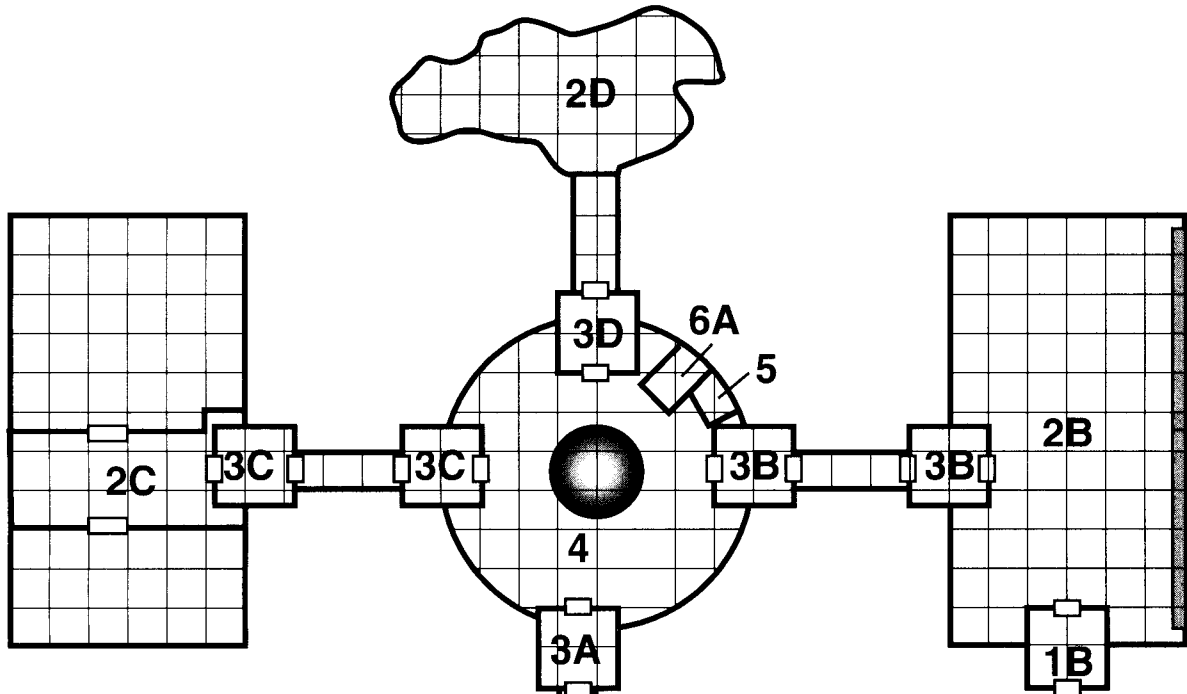

= 2 Meters

# THE BASE: UNDERGROUND LEVELS

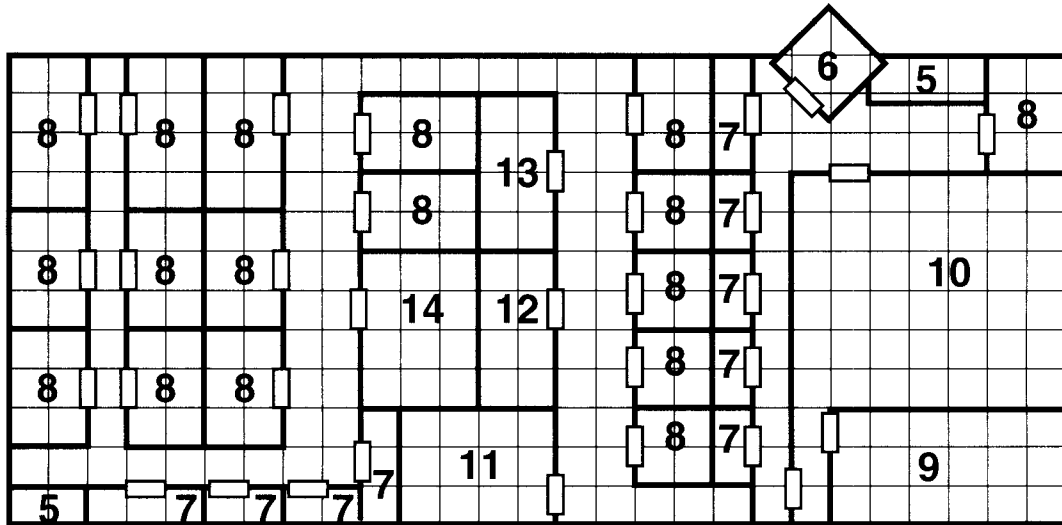

**LEVELS 1-5**

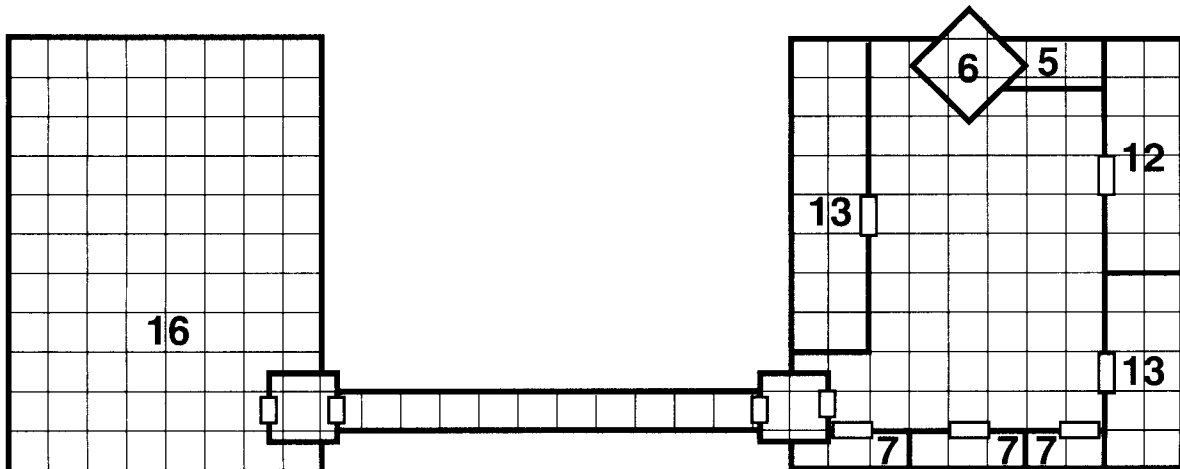

**LEVEL 6**

□ = 2 Meters

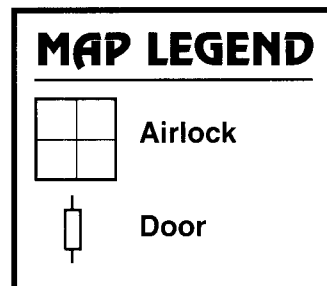





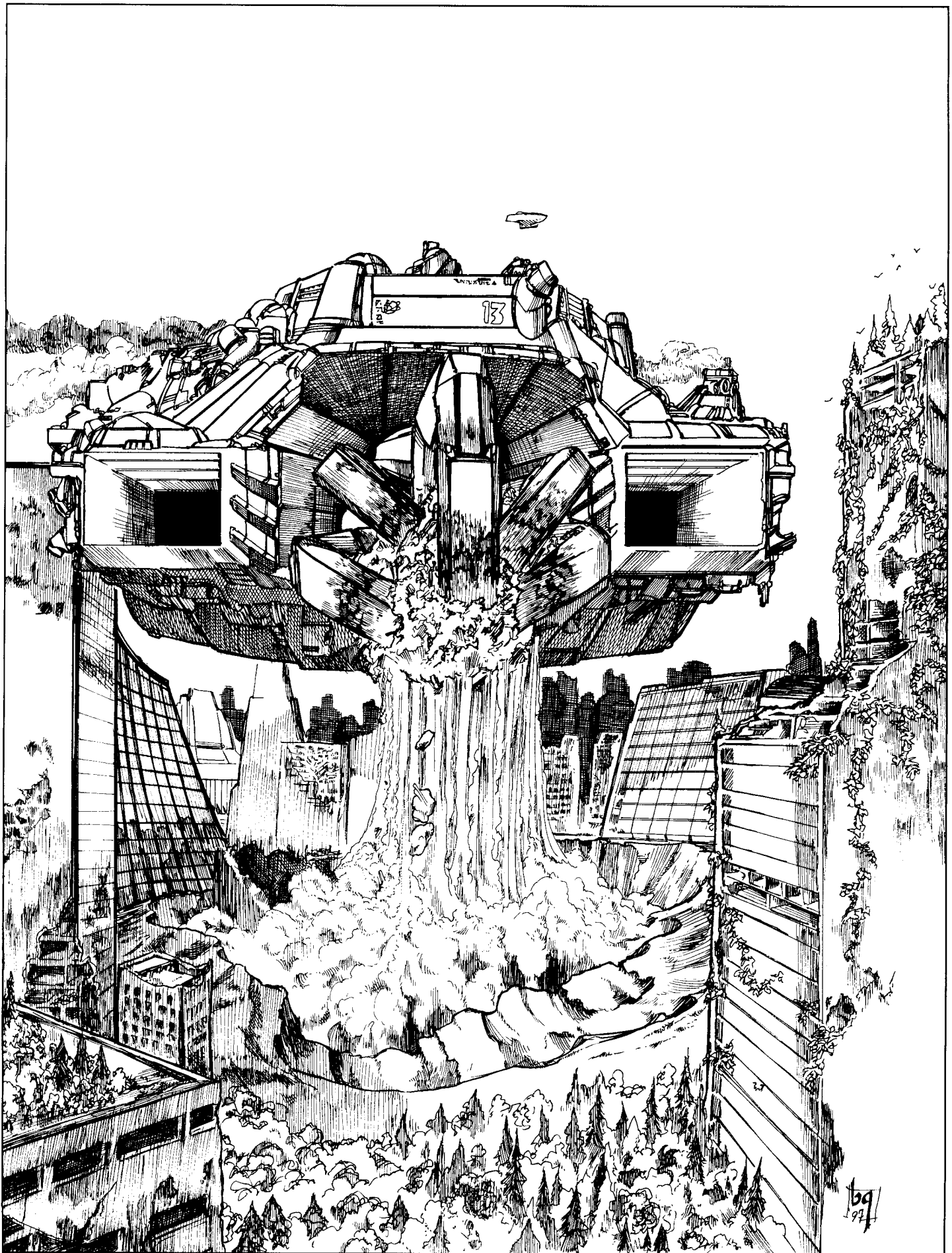

# JTAS

## Journal of the Travellers' Aid Society

The source for the newest Traveller information, from exciting scenarios that take adventuring to new heights to the latest development within Third Imperium.

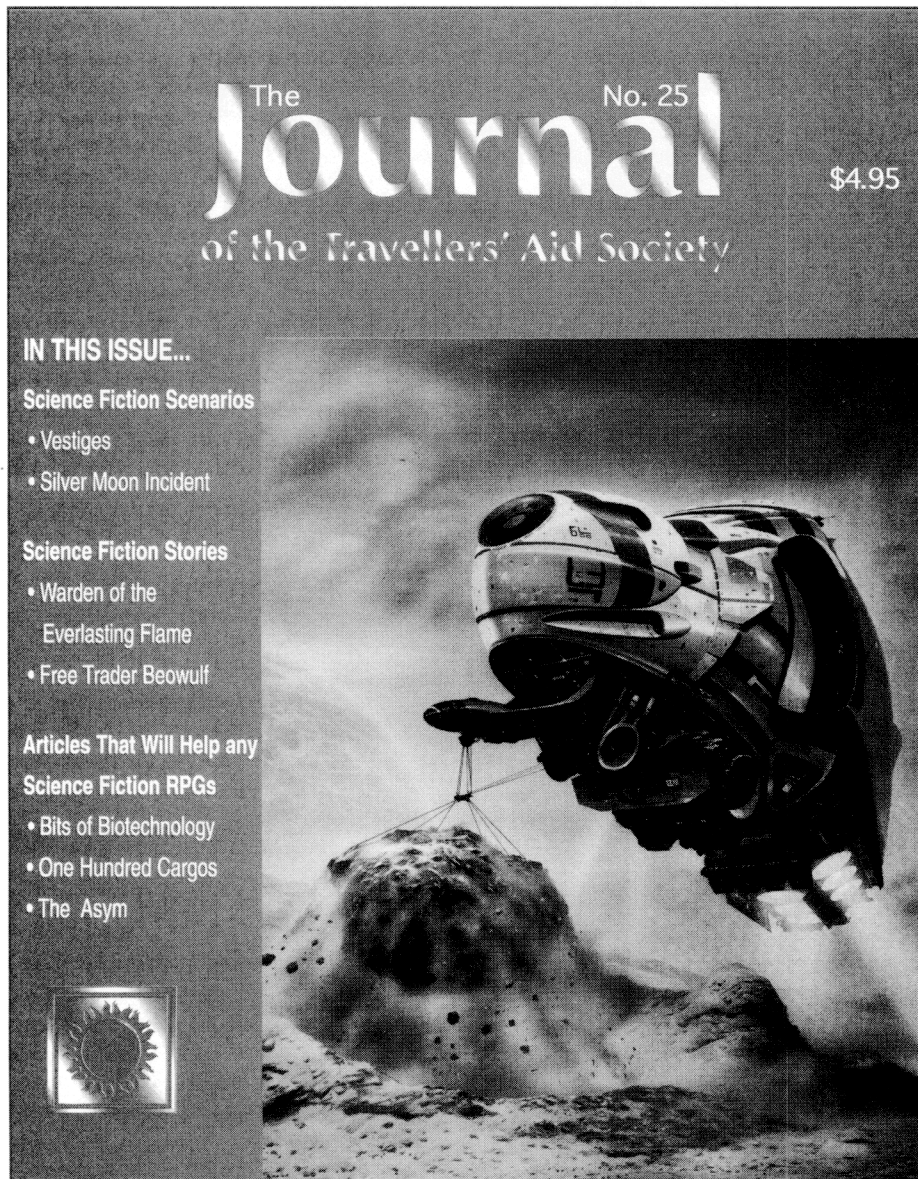

No serious Traveller fan should miss an issue!  
If you don't have it...you don't get it!

Pick it up at your local game store, order it directly via the Imperium web site at <http://www.imperiumgames.com>, or send a check or money order for \$30.00 for a one year subscription to Imperium Games, 9461 Charleville Blvd. #307, Beverly Hills, CA 90212



# MARC MILLER'S TRAVELLER®

## ANOMALIES

Take an adventurous odyssey among the star systems of the growing Imperium. Wander the systems of Core sector, discover the secrets of a strange, psionic, child, enter and explore a research station, and confront the many mysteries of worlds of humans beneath other suns.

Anomalies sets the stage for nine exciting adventures for Marc Miller's Traveller set in Milieu 0. Play them individually, or put them together to create a long-term, fascinating Milieu 0 campaign!

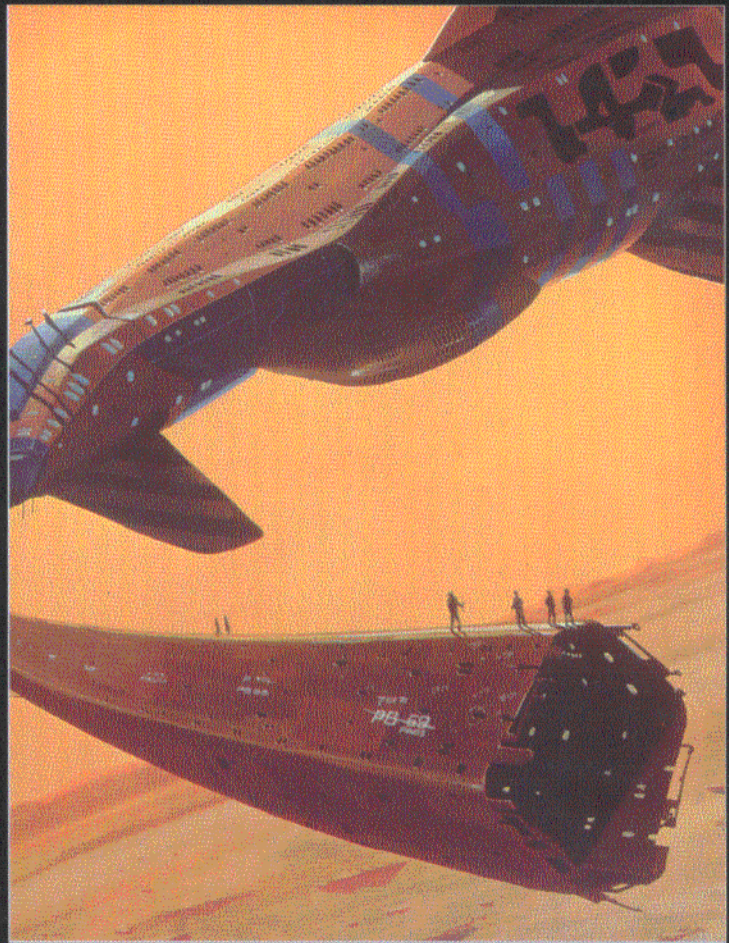

**IMPERIUM GAMES, Inc.**  
9461 Charleville Blvd. #307  
Beverly Hills, CA 90212



9 781578 283866

ISBN 1-57828-386-8 \$22.95 IGI-1700



Marc Miller's  
TRAVELLER 4TH EDITION