

# Thieves' Guild III

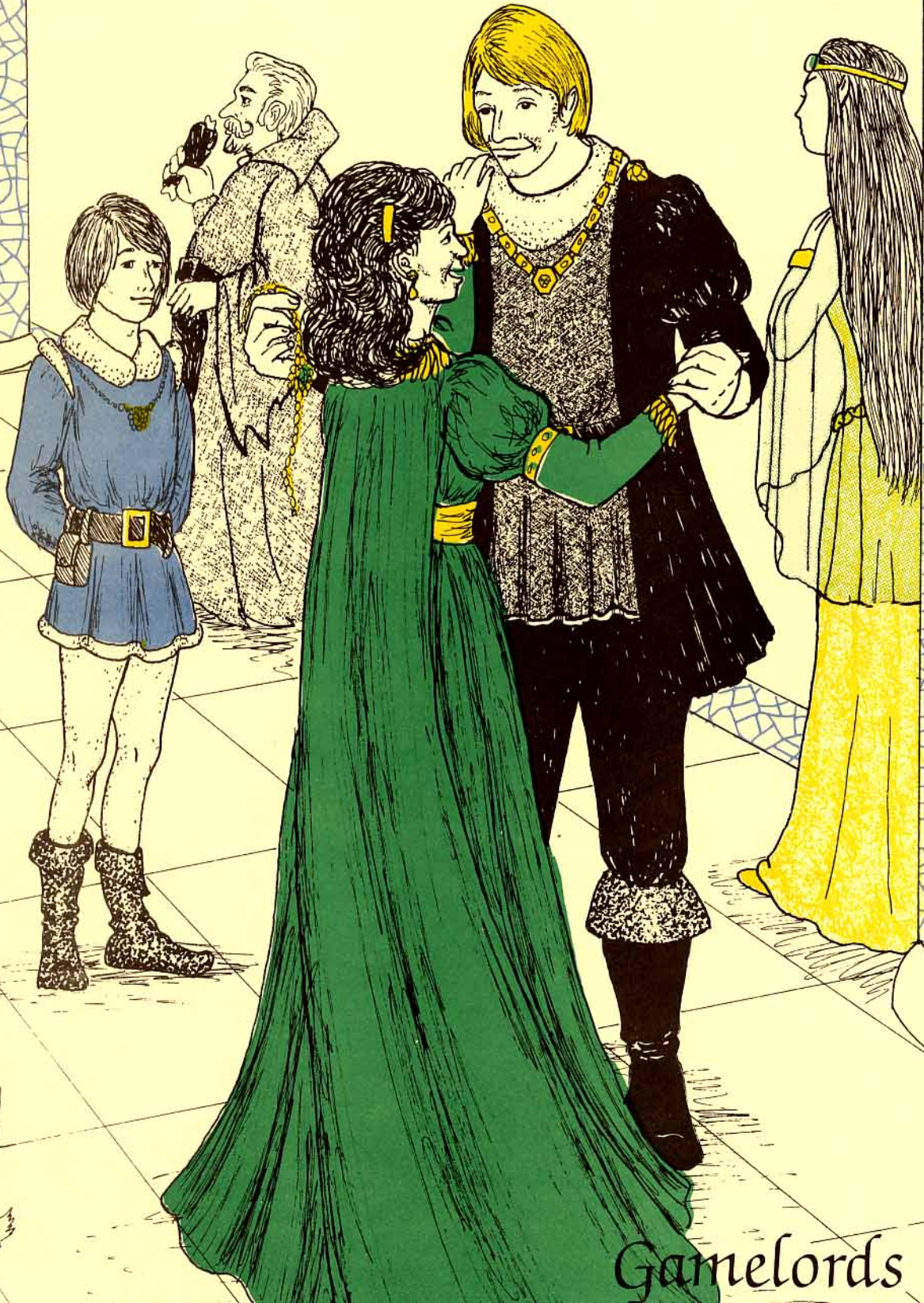

©1991 Janet Trautman

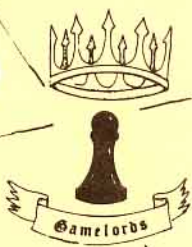

Gamelords Ltd.





Harken the Horrible was a rogue to be reckoned with...a 13th level Thief with the subtle touch that made him one of the best cutpurses in all of Haven. He had wealth, respect, and power. Yet one fateful day he lost everything -- his freedom, his honor, and his livelihood -- for, in the pursuit of criminal challenges worthy of his stature he committed a tragic mistake....

HE WAS CAUGHT  
STEALING A COPY  
OF THIEVES' GUILD!!!

High Judge Cardallo laid down an understandably harsh sentence -- because everyone (except poor Harken, apparently) knows that a three issue subscription to Thieves' Guild costs only \$15.00, a criminally low price to pay for 12 months of the best in thieving adventure! And for a limited time only, new or renewal subscribers will receive FREE, in September, a copy of the scenarios used in this summer's Prince of Thieves competition\* -- making a sub even more of a steal!

So don't you get caught "empty handed" -- subscribe now to Thieves' Guild!

(Use the handy order blank on the last page of this issue to reserve your copies of TG today!)

\* Prince of Thieves © is a GameLords sponsored tournament to be held at Origins 81, GenCon and GenCon East.

# *Thieves' Guild III*

by

Richard Meyer

and

Kerry Lloyd

illustrated by

Janet Trautvetter

©1981 Gamelords, Ltd.

## TABLE OF CONTENTS

	<b>page</b>
Foreword.....	ii
Index of Key Abbreviations (TG 2).....	iii
<b>Section I: Rules of Play</b>	
Chapter 1 - Character Creation (TG 1).....	I-2
Chapter 2 - Rules of Play (TG 1).....	I-17
Chapter 3 - Outfitting the Character (TG 1).....	I-29
Chapter 4 - Awarding Experience (TG 1).....	I-33
Chapter 5 - Additional Rules	
A. Expanded Combat Rules (TG 2).....	I-35
B. Other Experience Awards (TG 2).....	I-37
C. Obtaining Hiredlings (TG 2).....	I-39
D. Lockpicking Expansion (TG 3).....	I-43
E. Pickpocketing Expansion (TG 3).....	I-43
<b>Section II: The Scenarios</b>	
Chapter 6 - Bandit Scenarios and Highwayman Adventures	
A.-D. Highwayman Adventures (TG 1).....	6-1
E. Additional Highwayman Adventures (TG 2).....	6-21
Chapter 7 - Cat Burglaries and Second Story Adventures	
A. Heligor's Jewelry Shop (TG 1).....	7-1
B. Magic Books and Scrolls (TG 1).....	7-11
C. The Tower of Tsitsiconus (TG 3).....	7-25
Chapter 8 - Armed Robbery Scenarios/Pursuit Adventures	
A. Waylaying the Couriers (TG 1).....	8-1
Chapter 9 - Temple Looting Scenarios/Tomb Robbing Adventures	
A. The Tombs of Shale-Chuun (TG 2).....	9-1
Tomb 1 - the Magus.....	9-8
Tomb 2 - the Merchant.....	9-15
The Monastery.....	9-25
Chapter 10 - Pickpocketing Scenarios and Cutpursing Adventures	
A. The Duke's Dress Ball (TG 3).....	10-1
<b>Section III: Maps, Charts and Diagrams</b>	
	<b>rear of book</b>
<b>Appendices:</b>	
Appendix A - Character Conversion Instructions.....	A-1
Appendix B - Reference Charts for Players (TG 1).....	B-1
Appendix C - Gamesmaster's Aids (TG 1).....	C-1

\*\*\*\*\*

### Index of Key Abbreviations

Throughout this book, a number of abbreviations are commonly utilized. The meanings of these abbreviations are summarized below.

<p>AC - Armor class; represents the protective value of armor, shields, and skin</p> <p>APP - Character's appearance rating</p> <p>CDN, CO - Character's coordination rating</p> <p>D (3D6, 1D8, etc.) - Number and type of dice to be thrown in resolving a given situation</p> <p>DSC - Character's discretion rating</p> <p>EAC - Effective armor class; represents armor class + character's Dodge ability</p> <p>FRP - Fantasy Role-Playing</p> <p>GM - the GamesMaster, or moderator, of an FRP game</p> <p>GP - Gold pieces; 1 GP = approximately \$5</p> <p>HACO - Die roll that must be exceeded on a D20 in order to successfully strike an unarmored foe</p> <p>HP - Hit probability</p>	<p>HTK - Hits to kill; the amount of damage a character can sustain before dying</p> <p>IQ - Character's intelligence rating</p> <p>MA - Movement allowance; number of 5' hexes (or squares) a character can move in one melee round</p> <p>MAG - Character's magnetism rating</p> <p>MGR, MR - Character's magic resistance rating</p> <p>mr - Melee round; a 15-second time span used to regulate the flow of play</p> <p>NPC - Non-player character</p> <p>REF, RF - Character's reflexes rating</p> <p>SP - Silver pieces; 10 SP = 1 GP</p> <p>STM, SM - Character's stamina rating</p> <p>STR, ST - Character's strength rating</p> <p>TAL - Character's magical talent rating</p>
---	---



## THE GUILDMASTER SPEAKS

Greetings and salutations, brothers in crime! This printing of Thieves Guild 3 comes almost one year to the day after work began on the original Thieves Guild. It's been a rich and rewarding year for us here at Gamelords - one that we'll not soon forget. The reception we've gotten from everyone who's purchased TG has been extraordinarily favorable, as evidenced both by your letters and by the many who have either subscribed or bought other Gamelords products as a result of their Thieves Guild experience. And this is just the beginning, because we've got some projects slated for release in the coming year that we know you're going to love -- including the long awaited, complete Fantasy System; The Free City of Haven, our lovingly populated, scenario-filled adventure locale; and a project so secret we can't tell you anything except its initials - MEHSTG. Watch this space for details -- we guarantee that it's a daringly different approach to role-playing adventure!!

But in the meantime, we don't intend to stand on our laurels with Thieves Guild, either. In our contacts with readers over the past year, we've been continually asked two questions: When are we gonna put out adventures designed especially for other special classes?, and When are we gonna put out thieving adventures set in other time periods? Frankly, both concepts appeal to us as ways to expand the focus and interest of this series to more FRPers, without sacrificing our commitment to provide different, playable adventures. The staff has already sketched out a number of scenario ideas that could employ the unique skills of clerics, mages, or rangers -- even one adventure specially designed for a bard. Similarly, there are a number of other genres that would fit easily into the Thieves Guild concept. Imagine a spaceport heist or space piracy adventure, designed for use with systems like Traveller or Space Opera -- or a bank or train robbery set on the old frontier, and compatible with any of the Wild West RPGs. And if those aren't enough to pique your interest, how about scenarios for gangsters, or buccaneers, or moonshine runners, or CIA agents?

We've decided to put the question to you, our readers: What directions should we pursue in the coming year? Should we continue to restrict our attentions to detailing fresh pursuits for thieves in the age of sword and sorcery, or expand to include occasional adventures of the kinds mentioned above? On the bottom of this page is a brief questionnaire where you can give us your feedback on these expansion ideas -- and in order to encourage you to fill it out and send it in, we've added a little inducement. Two of the responses received will be drawn at random and awarded a one year subscription to TG (or, if a winner is already a subscriber, a two year extension to that subscription). Deadline for this drawing is April 30, so don't delay!

While you're thinking about your answers, we suggest you feast your eyes on this issue's goodies. Our rules section this time is short but sweet, with expanded discussions of the mechanics of lockpicking and pickpocketing. Then it's off to the little hamlet of Alduree, for a visit to the Tower of Tsitsiconnus (unless, of course, you're afraid of a 450 year old mage whose hobbies are mechanical engineering and demonology)?! Finally (but by no means least), it'll be time to dress your thief up in his Sunday best, to experience a pickpocket's dream at the Duke's dress ball. We guarantee that this scenario is unlike anything you've ever seen in an FRP playing aid -- and once you play it, you'll find out what you've been missing! So off with you, my intrepid rogues, and til next time - Good thieving!!

---

### WHITHER TG: GAMELORD'S 1ST SEMIANNUAL FACTFINDING MISSION

1.  Yes, I'd like to see adventures specially designed for other character classes.
  - 1a. These adventures should appear  occasionally;  once an issue;  in special issues devoted totally to other classes.
  - 1b. The classes I'd most like to see adventures designed for are  Mages;  Clerics;  Rangers;  Bards; Other \_\_\_\_\_
2.  Yes, I'd like to see adventures designed for other FRP universes besides sword and sorcery.
  - 2a. These adventures should appear  occasionally;  once an issue;  in special issues devoted totally to other genres.
  - 2b. The other time periods I'd like to see thieving adventures set in are  far future;  wild West;  Roaring Twenties;  Cold War; other \_\_\_\_\_
3.  Don't change a thing! Thieves Guild is great just the way it is.

Name \_\_\_\_\_

Address \_\_\_\_\_

I am a current subscriber to TG \_\_\_\_\_

I would like to subscribe to TG (enclose \$16 for a three issue sub) \_\_\_\_\_

Return to Gamelords, Ltd., 202 N Horners Lane, Rockville MD 20850

QUICK REFERENCE TABLES FOR THIEVING ACTIVITIES

**PICKPOCKETING**

Character base pickpocketing chance = 15%

- 1) Add 10% for every level of experience (above 1st) attained (e.g., 4th level = 45%, 7th level = 75%)
- 2) Racial Bonuses:  
 Hobbit, Elf, Centaur +5%  
 Orc, Kobold, Goblin +10%  
 Pixie +15%
- 3) Requisite Bonuses and Penalties  
 If character CDN is:  
 3 or less -35%      15-17 +5%  
 4-5 -20%      18-19 +10%  
 6-8 -10%      20-21 +15%
- 4) Complexity level of item stolen  
 Level 1 - multiply normal chances by 1.0  
 Level 2 - multiply normal chances by .9  
 Level 3 - multiply normal chances by .7  
 Level 4 - multiply normal chances by .4
- 5) If victim pickpocketed is not sober, multiply adjusted chances (step 4) as follows:  
 Tipsy - x 1.1      Smashed - x 1.6  
 Drunk - x 1.3      Blind Drunk - x 2.0

**CHANCES OF WITNESSES**

**VICTIM**

- On Successful theft:  
 (Victim's experience level - thief's experience level) squared
- On Botched theft:  
 (Victim's level - 1/2 thief's level) squared

**OTHER**

- On Successful theft:  
 (if thief green - 3%, intermediate - 2%, veteran/elite - 1%)
- On Botched theft:  
 (all levels - 20%)

**DISGUISE**

Base chance of success = 50%

- 1) Add or subtract 5% for each point of difference between thief's IQ and IQ of the individual presented with the disguise.
- 2) Add 5% for each pt of MAG >14
- 3) Add 5% for each pt of APP >14, if dealing with members of opposite sex (subtract same amount when dealing with members of same sex as thief)
- 4) Social Class Adjustments:  
 -30% if noble portrays peasant, or vice versa  
 +10% if thief is guildsman  
 +5% if thief is merchant
- 5) Racial Adjustments

ROLE \ RACE OF ASSUMED THIEF	HUMAN	DWARF	HOBBIT	ELVEN
Servant	+10	-50	+20	-40
Constr. Worker	0	+25	-40	-15
Cook/Chef	+10	-40	+30	-10
Entertainer	+5	-30	+5	+25
Comm Gds Merchant	+15	+20	+20	-15
Fine Gds Merchant	+10	+25	-10	0
Artisan	+10	+25	0	+20
Mage	0	-15	-40	+20
Military/Warrior	+15	+15	-30	0
Nobility	+10	0	-50	+20

If disguise if challenged (crisis situation):

- Base chance of sustaining disguise = 10%
- 1) Add 5% for each pt of thief DSC >8
  - 2) Add 5% for each pt of thief MAG >11
  - 3) Add 10% if thief receives racial bonus of 15% or greater in his current role



## Chapter 5

### New Treatments and Interpretations

#### LOCKPICKING

As described in Thieves' Guild, lockpicking is a simple affair involving only the complexity of the lock and the ability of the thief. This expansion allows for a bit more realism in the process, involving time taken to pick a lock, and the possibility that a particular lock is simply beyond the capabilities of the thief involved.

#### Time

Using the new method, there is no limit to the number of times a thief may attempt to pick a lock. Each attempt simply requires time. This time is measured in mr, and depends on the level of the thief and the complexity of the lock.

Thief Grade	Levels	Melee Rounds Required
GR	1-2	4
INT	3-5	3
VET	6-8	2
EL	9+	1

To adjust for the complexity of the lock, simply multiply the mr required by the complexity of the lock, and divide by 2, rounding up. Thus a INT thief picking a lock of complexity 4 would require  $([3 \times 4] / 2)$  or 6 mr for the lockpicking attempt. This time would be spent whether the thief was successful or not.

#### Lockpicking Success

The new method utilizes a die roll on D100, but includes a chance for total failure. The chance for total failure is dependent both on the thief's abilities and the complexity of the lock; total failure is always the high end of the percentage roll. The failure percentage is the high  $(5 + [5 \times \text{complexity}])\%$  of the non-success result. For example, a 3rd level thief with a lockpicking chance of 45% is trying to pick a lock of complexity 3. His working chance of success is 15%  $(45\% / 3)$ ; his chance of total failure is 20% of 85%, or 17%. So the rolls would be 01-15 success, 18-83 no success this attempt, 84-00 the lock is totally beyond the capability of the thief.

#### ADDITIONS to PICKPOCKETING RULES

##### 1. Chances of Detection by Victim

In TG1, a method for determining whether a victim has noticed a pickpocketing attempt was described. Using this method, the GM made a Detection roll for the victim after any successful or unsuccessful attempt; the percentage chances of detection were calculated by subtracting the thief's experience level from the victim's experience level, and squaring the result.

These rules have now been expanded to consider a somewhat more complete range of possible outcomes. If the thief's attempt has been Successful, the procedure outlined above is still used. Unsuccessful attempts are now divided into two categories, Missed and Botched. A Missed attempt means that the character has failed to complete the theft because of some unique circumstance - the victim shifting his body position, the entrance of a potential witness, etc. Therefore a Missed chance very likely involves no real risk of detection to the thief, and no roll is made. A botched attempt represents just the opposite situation, where the thief may literally have his hand in another man's pocket when the unforeseen occurs; in such circumstances, detection is much more likely than usual. If a thief has Botched his attempt, he is assumed to be operating at half his normal experience level (rounded down) for Detection purposes. Detection chances are recalculated using the formula presented above, and a D100 roll made.

To determine if an unsuccessful attempt is Missed or Botched, subtract the thief's currently effective Pickpocketing Ability from 100, and divide by 5 (rounding up). The result represents the percentage chance, on a D100 roll, that the thief will Botch his attempt.

Example: A 6th level thief is attempting to pickpocketing Ability is 60%. His chances of Botching the attempt are  $(100-60)/5 = 8\%$ . Therefore on a die roll of 01-60, he is successful; on 61-92, he misses; and on 93-00, he Botches the job. On a Successful attempt, the chances his victim will Detect his efforts is equal to 9-6 squared, or 9%. On a Botched job, Detection chances are equal to 9-3 squared, or 36%; no Detection roll is made on a Missed attempt.

Regardless of a thief's Pickpocketing Ability (even if it is greater than 100%), a roll of 00 always represents a Botched attempt. For Green thieves, a 00 Botch is always Detected; for Intermediate thieves, 75% Detection chance; Veteran, 60%; Elite and above 40%. (Note: These percentage chances of detection do not apply if the normal Detection chance of the victim would be greater than that stated.)

##### 2. Chances of Detection by Other Witnesses

Pickpocketing is a subtle thievery art, most often practiced in large, milling crowds, and with the theft accomplished by one quick inobtrusive motion. Consequently, chances of a proper pickpocketing being witnessed by a third party are usually very small. (This is not to say that, if the victim detects the theft and cries out for help, that others will not see and be able to describe the thief; only that the latter group's likelihood of independently observing the crime in progress is slight).

Only Successful and Botched pickpocketing attempts may be witnessed. Chances of third party detection of a Successful attempt are dependent on the thief's experience level: Green 3%, Intermediate 2%, Veteran and Elite 1% each. On Botched attempts, the general chance for a witness is 20%, regardless of the thief's level (since on a Botched attempt, a high level thief has obviously failed to utilize his greater proficiency).

There are, of course, situations in which a player-character can virtually guarantee that no third parties will witness his misdeeds; but cases where the thief has such absolute control over his environment are rare. In any event, the GM should require that the pickpocket exhibit the careful planning and attention to detail necessary to ensure such a situation. Never let a thief tell you, "I walk over to where I can't be seen, and...". Instead, describe the scene of the crime in detail, indicating the placement of other characters in area, and have the player show you what he is doing. Be fair, and reward good role-playing; but also be willing to increase the base witness chances listed here if the thief makes an obvious mistake, or simply is careless in observing his surroundings. Indeed, sometimes circumstances will exist that conspire against a thief's desires to operate unseen. For example, if the thief's target is a good-looking man or woman, the chances of other eyes being on the victim are much greater than usual.

### 3. Using Pickpocketing Abilities to Steal Other Items

In the Duke's Dress Ball scenario in this issue, the player-thief will have the opportunity to steal jewelry, weapons and other decorative adornments from the other guests at the ball. A thief's skills in pilfering such items are based on his Pickpocketing Abilities. However, the thief will find it more difficult to steal certain of these items than it is to simply slit a pocket or filch a purse, because these other possessions may be in closer body contact with the victim, or highly visible to other potential witnesses.

The table below indicates the special properties of the various personal effects likely to be worn during this time period. Although this information should be specifically used by the GM in moderating the Dress Ball scenario, items are included on this list that are not present at the ball in order to make the table more generally applicable. For each item on the list, a numerical rating from 1 to 4 indicates the relative complexity involved in stealing the item, with Level 1 representing an item that is equivalent in difficulty to a simple pickpocketing, and Level 4 an item in tight contact with the person's body and difficult to remove. If a player attempts to steal an item more difficult than Level 1, he will suffer the following adjustments to his base Pickpocketing Abilities:

- Level 2 - Thief functions at 90% of normal ability.
- Level 3 - Thief functions at 70% of normal ability.
- Level 4 - Thief functions at 40% of normal ability.

Each item has also been assigned a letter rating representing the item's visibility to potential witnesses. Three descriptive forms are used:

- Hidden (H) - the object is not in plain sight, and its absence can not normally be noticed.
- Noticeable (N) - the object is partly or completely in plain sight, but is not the type of item that attracts attention if it is not in its usual location.
- Visible (V) - the object is in plain sight, and is of such a size or physical magnificence that its absence would be readily noticed.

If the object being pilfered is in the noticeable class, the chances of a third party witness to its attempted theft are 1.5 times the normal chances (rounded up). For visible items, there is double the normal chance of witnesses; for particularly special and/or valuable items, the GM may even wish to triple these chances.

#### PROPERTIES OF ITEMS FREQUENTLY STOLEN BY CUTPURSES

Item	Level of Difficulty	Visibility to Public
Pockets (and small in-pocket items)	1	H
Tiaras, Hair Combs	1	V
Headbands, Coronets	3	V
Headresses	4	N
Hat Trims (Hatpins, etc.)	2	N
Earrings (Clip)	2	H(a)
Earrings (Pierced)	4	H(a)
Brooches, Pins, Awards	2	N
Necklaces, Medallions, Pendants	2	N(b)
Collars	4	V
Bracelets	3	H(c)
Armllets	4	N
Cufflinks	1	H
Ring (personal)	4	H
Ring (decorative)	3	H
Reticules	3	N
Sticks, Canes, other in-hand items	4	N(d)
Belt Buckles	4	H
Weapons, Pouches, other on-belt items	2	H
Knee Buckles	1	N
Shoe Buckles	1	V
Anklets	3	H

- Notes**
- (a) if extremely large and gaudy, class as N
  - (b) if large or flashy, class as V
  - (c) presumes item is worn under long-sleeves; otherwise class as N
  - (d) if laid down, class as 1 - H



CAT-BURGLARY SCENARIOS

AND

SECOND STORY ADVENTURES

C. THE TOWER OF TSITSICONUS

The old man accepted the mug of steaming mulled wine the slim young girl had bought him. He sipped at the hot concoction for a moment, looking at her over the rim of the mug with his rheumy eyes. "So you wish to know of Tsitsiconus, is it, young mistress? Well, tis many a tale of him I can tell you. He was old when I was young and spry meself, and of interest to pretty little jades like you. And his mistress...oh, how beautiful she was; half the men in the city doted on her, it seemed, me among 'em, and I was only 14 when she died.

"But to tell a tale...



"Fifty years ago and more, Tsitsiconus the puissant mage did move from the free city of Haven to a wondrously fashioned tower of polished green marble set within a cunningly landscaped green walled garden. He was very old, nearly four centuries having passed for him since his birth, and also terribly tired from many decades of prodigious spell-casting and mighty mancies. He wished simply to retire, and to putter with experimenting, and to go quietly down the last years of his lengthy life.

"And too, he wished solitude to be alone with his great loss, for gone was the one true love of his life, the beautiful Sharella, a lithe and nimble lady of roguish demeanor for whom he had created many an aid to her dangerous avocation (tis true, fair lass, the lively wench was an accomplished thief). Even the arts of Tsitsiconus, mighty though they might have been, could no longer stay the hand of Time, for she had already lived, and kept her great beauty, more than three times the normal human span of three score and ten. Now

she lay cold and wan, and the mage grieved for her.

"The tale is told that he gathered up all his possessions (and they were many, and very wonderful to describe), and moved into the slender green spire inside the high wall of the garden (yea, and not far from here, even, only down the road to the village of Alduree), and that there he stays. The folk of the village see him occasionally of an evening, standing proud and lonely on the palisaded promenade at the tower's very top, gazing out toward the sunset. And other times (thanks to the gods, only rarely), there are strange moans heard, and glittering flashes spied, and wierd and unearthly lambent blue glowings descried surrounding the tower's high reaches -- and the villagers of Alduree hide in their cots and hovels, and pray to whatever gods they hold dear, that nothing dire befall.

"Seldom indeed for the five decades past did Tsitsiconus leave his tower and garden. Lately, though, he has been seen going much more frequently, traveling to the city Haven or to one of the nearby towns and hamlets, probably for some oddment of arcane value necessary in his experiments in mancy and conjuration. And he travels in arcane splendor, in a curious cart pulled by no visible earthly steed. This marvelous cart has not tongue nor harnessing, but seems to move of its own accord. Tsitsiconus may be seen, sitting in luxury within, as the contrivance hurtles along the road at a speed faster than a galloping horse.

"Yes, he is still there, although it seems of late, that he is much more active than in the yesteryears, for he goes abroad more often, and stays agone longer. He is absent, sometimes, even two or three days..."

\*\*\*\*\*

This scenario could be considered a test, for 3 to 6 higher level (veteran and above) thieves wishing to make a connection with the Guild in Haven. The village of Alduree is located only forty miles westerly from Haven along the Great Trade Road, and is easily reachable by either foot or mount.

It is probably a good idea for the GM to have the group of player-character thieves (if they have not already joined the Guild) be "caught in the act" by a group of Guild-affiliated thieves (this could produce interesting subplots), and be offered three choices:

- get out of town, and never return;
- accept the mission to the tower of Tsitsiconus; or,
- suffer a slow and probably painful death at the hands of the Guild.

For those thieves who are already members of the Guild, the Guildmaster might have heard of

a special treasure in the tower that he wishes for himself, or, possibly, he has accepted an unusual commission from a potent mage from a distant land to procure a special book which is in the possession of Tsitsiconus (the thieves will most probably be warned not to open the book under any circumstances). There are multitudes of ways to introduce the scenario.

Over the next few pages, the GM will find descriptions of the tower itself (and its

various contents), and the gardens surrounding the tower, as well as the village of Alduree, a small population center with only 300 inhabitants. Maps of these locales may be found scattered in among the sections dealing with the locations. The mage, his mechanical servants, and other enchanted creatures that may be encountered during the adventure, are described at the end of the scenario, including details on their fighting capabilities and special abilities.

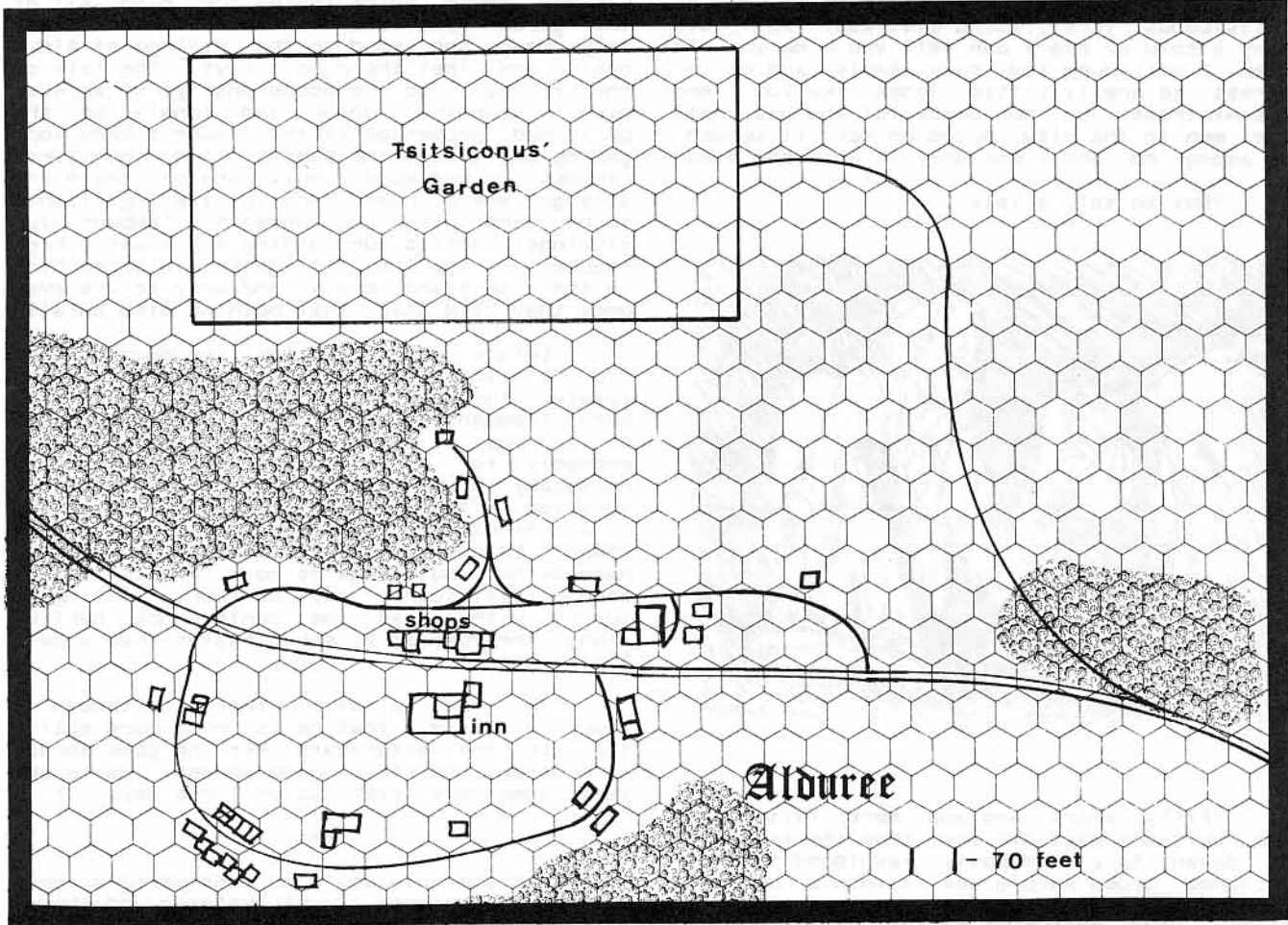

THE VILLAGE OF ALDUREE

Alduree is a small village with are few shops (a fletcher/bowyer, a seamstress, a blacksmith who does wainwrighting on the side, and a sutler who carries a reasonably decent selection of everyday goods, nothing fancy), and a single tavern, the Gilded Plow, generally considered the center of social activity. Most of the village's men are small farmers and herders; the tavern serves as their one contact with events in the outside world.

The Gilded Plow is a two-story brick and timber building, with a heavy oaken door. Over the entrance hangs a plow painted a shiny yellow (the owner cannot afford real gilt paint), from which the tavern draws its name.

The common room is almost deserted during the day (occasional travelers may be found enjoying a good home-cooked meal from noon to about 2:00 in the afternoon), but is crowded, smoky, and noisy from 5:00 til nearly midnight. There will usually be 10-40 farmers and travelers in attendance (10D4).

Hurkash Drythroat, the owner of the inn, is growing old, but still serves his customers (and himself, frequently, complaining of a throat arid from talking, smoking, etc.; this earned him his name) with jacks and flagons of golden homebrewed ale or sparkling white and red wines. Prices in the inn are quite low, and value for price is excellent; meals are available as well as drink, and are prepared by Lynnea, the daughter of Hurkash; this



young woman is generally considered the best cook in the village, and probably some 50 miles around. Two other young girls aid Hurkash and Lynneia with the customers: Elena is tall, slender, and blond (and eminently patable), while Delyla is a cute young brunette. Neither is particularly averse to friendly foolin' around.

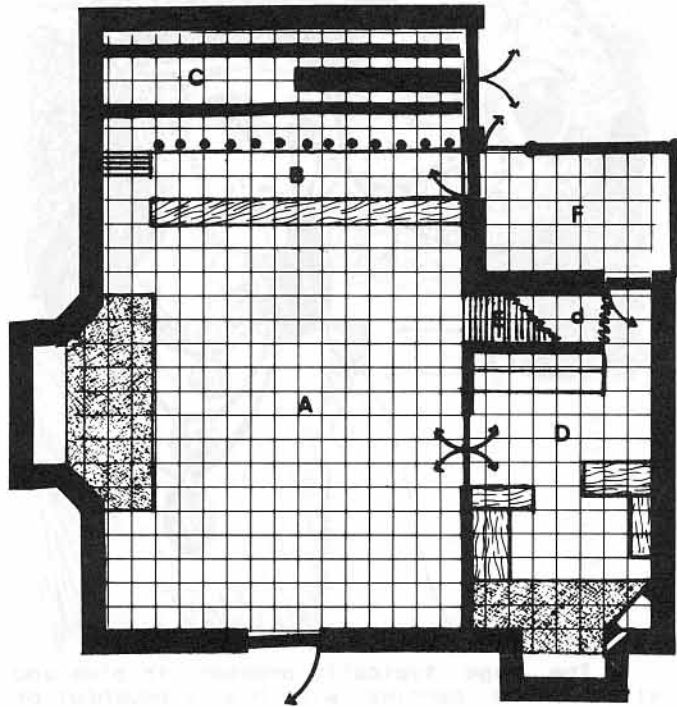

## The Gilded Plow

The inn is a lively place in the early evening, with local musicians, singers, and dancers (almost all bad, but well-intentioned) displaying their talents. Occasionally, a brawl between friends will break out; there is a 15% chance of a fight, and a 60% chance that it will turn into a larger free-for-all possibly involving as many as 40% of the denizens of the tavern. Rarely (5%), the entire common room will become one swirling fight, with virtually everybody in attendance being dragged into participation, willing or not.

In the Gilded Plow, many rumors are traded, started, embroidered, and otherwise amplified. There is a 35% chance that a local treated to a flagon will have some juicy bit of gossip to relate. Some of the current dirt is (roll D10):

- 1) Fregaln, the shepherd's son, saw Tsitsiconus leaving in his magical cart yesterday at noon. (True)
- 2) Morris, a locally raised boy who joined the mercenaries, has returned for a visit, and he has a magic sword for sale. (Mostly true, but the sword's magic is a Detect Value spell which gives highly inflated values for worthless items, and extremely low values for important items; Morris will ask 5,000 GP for the sword, but can be bargained down to 1,000 GP.)

- 3) A wierd black hawk-like creature was seen yesterday evening, circling the mage's tower. (False, some drunk's delirium.)
- 4) Lynneia has many suitors; chief among them is Bardol, the biggest, toughest, nastiest young farmer in the village. Bardol will make life very unpleasant for anyone he thinks is a serious rival for Lynneia's hand. (True, Bardol is mean.)
- 5) Tsitsiconus was seen returning to his tower late the previous night; he had a mysterious woman in the cart with him. (False)
- 6) Lynneia is sweet on Jareth, a young shepherd, who frequently plays his harp at the tavern in the evening; Bardol hates him, and will start fights with him if both are there. (True; there is a 50% chance for each boy that he will be in attendance; if a fight starts, there is a 35% chance that it will devolve into a general brawl.)
- 7) A large silver bowl was dug out of the field of Nicodraj only two days ago; some think it is a burial gift to some olden warrior or wizard. (True; the tomb is buried 50' under the large oak, in the northeast corner of the field. It is suggested to GM's that they either design this one themselves, or wait for Thieves' Guild V, which will contain "The Illusionist's Tomb.")
- 8) The mage Tsitsiconus has been gone for three days. (True only if 1. has not been rolled)
- 9) Three of the village's young bucks hopped the wall into the garden of Tsitsiconus only a fortnight past; they were chased out by a large black ferocious monster; all of the boys escaped without injury. (True)
- 10) Kermit, the local arrowsmith, is overstocked with finished arrows, and will sell many for only half the normal price. (True, but the arrows he sells at the bargain price are improperly balanced, and are at a penalty of 2 to HP; a trained archer has a 35% chance of detecting this on handling, a bowyer 50%, and a fletcher 60% -- mastery of any of these fields adds 15% to the chance of detection.)

There are some rooms available upstairs at the Gilded Plow; prices vary depending on the dress of the person seeking lodging. The finer a person's habiliment, the higher the price on the room; the top is 5 GP for a private room (for one night), scaling down to 1SP for a one-quarter share of a bed in a 3-bed dormitory.

(GM's Note: If you wish to make a complete adventure out of the Gilded Plow, see THE COMPLEAT TAVERN, also by Gamelords; this booklet contains everything you always wanted to ask about running a tavern but were too busy to ask.)

Players may also wish to stop into the other trade establishments in the village.

Blythe, the seamstress, is competent but not outstanding; she is capable of mending rips and tears in clothing or doing a new garment in 2 to 3 days, depending on the amount of sewing (female styled clothing takes longer than male).

The looks of Snanderbatch, the blacksmith, belie his trade. He is a small man (of wiry strength, though), and does not appear to be able to perform his duties. His appearance is a shock to those who engage him in battle (he has a 40% chance of a KO on any punch that lands) or in tests of strength (he is the local arm-wrestling champion). There are possibilities for an interesting match, since the locals will challenge any large man with apparent strength to contest their champion, and are willing to bet money on the outcome (the amount of the bet placed by any individual is limited to a high of 2 GP, since no one in the village has much money other than Tsitsiconus). The blacksmith's chances of winning such a match are 50%, + 5% for each point of STR by which he exceeds his opponent.

The sutler is sharp and a wheeler-dealer; he is likely to present a shopper with what the shopper thinks is an excellent bargain, but is actually a slightly high-priced lower-quality version of the same item. His name is Lyndon, and there is a 65% chance that any item he sells to an outsider (the villagers are used to him, and his tricks) will be worth only 80% of its cost, particularly if the individual looks to be leaving the village shortly (an additional 15% chance). The cash drawer contains 420 GP in assorted coins and small gems, and is located under the pile of blankets at the left end of the counter.

The fletcher/bowyer (mentioned above) is a good solid craftsman. Other than the arrows mentioned in Rumor #10, his stock is of good quality (there is a 5% chance of finding a superior bow among his wares [a bonus of 2 to HP]; use the chances for recognition of the faulty arrows as chances for recognition of the superior workmanship of the bow), and is priced normally. If he is asked, Kermit has an excellent quality magic long bow, which he is willing to sell for only 5,000 GP. The bow has a bonus of 3 to HP, and has a Shedwater spell embedded which prevents it from becoming wet under any circumstances (a wet bow has a penalty of 6 to HP, and all ranges are halved - bows take 1D4 days to dry to normal, and the bowstring must be replaced); there is also a Support spell embedded which allows breakage of the bowstring only 15% of the times it would normally break. The bargaining price from Kermit will start at 15,000 GP, but he can be argued down (use Hagglng procedure outlined in Thieves' Guild I). A small box (with a Complexity 1 Lock) under the counter in his shop contains 140 GP in assorted coins and small gems.

#### TSITSICONUS, MAGE

Tsitsiconus' tower is slightly north of the village proper, in plain sight. Since the bulk of the adventure takes place here, it seems appropriate to introduce its builder and sole resident.

Tsitsiconus is half-elven, and his ancestry is shown by his pointed ears, of which he is inordinately proud (he does consider them his best feature). He has thick brown hair, worn long, with a touch of gray at the

temples. Of average height and build, Tsitsiconus would not stand out in a crowd, were it not for his eyes - they, alone show the centuries he has seen pass.



The mage typically dresses in blue and silver, and carries with him a pouchful of powder-potions with different potentialities for use in emergencies. He has a sense of humor, and is not sadistic or cruel; in fact, he will tend to stand by and watch in any situation not involving harm to him personally, or to someone (or something) he is particularly fond of, or involving a loss of some object important to him (attempting to steal any of Sharella's possessions while Tsitsiconus is watching is a probable death sentence).

Tsitsiconus wears three medallions almost constantly. The first allows total invisibility once a day, lasting until he drops the glamour, or until he makes an attack. The second provides protection against damage from fire and heat (cancelling 75% of damage automatically; a successful saving roll against STM cancels the remainder). The third allows him to assume the guise of a very small green dragon (guise only, none of its powers are available to Tsitsiconus, although Tsitsiconus's own powers are considerable and can be used to reinforce the image). These three medallions are of bronze, and are strung on a triple thong which he wears around his neck. He also wears a small ball of clay, with 6 pieces of turquoise stuck in it, on another leather thong (this was a gift from Sharella, which she gave him in the early days of their love; he has worn it constantly ever since - it has absolutely no powers of any kind); this is most often strapped around his left wrist.



If rumors garnered at the Gilded Plow do not place Tsitsiconus away from home, there is a 15% chance that he is absent without the villagers having observed his departure. If he is at home, there is a 65% chance he will watch the thieves' attempts with amusement (until they make a mistake); if he is not desirous of visitors, he will send the Servant to inform them (loudly, very loudly; requires a saving roll against STM, or the resultant deafening will last for 5 to 15 days [2D6 + 3], with a 10% chance of being permanent) that their presence is not appreciated. If the Servant fails to drive them away, he will employ the methods listed below to encourage departure.

Since he is a mage, Tsitsiconus is quite capable of casting many varieties of spells. He is very competent with fire, and excels in bodily control of anything living. If he decides that whomever he is watching is going too far, he will cast various influences upon them to make them stop, return items, and eventually leave; if this doesn't seem to work, Tsitsiconus will use spells of control. If all friendly (i.e., not instantly fatal) methods fail, Tsitsiconus will start tossing flame. He is capable of 'firing' shafts, balls, and walls of fiery destruction (averaging about 5D12 in damage potential); up to 6 of these can be hurled before Tsitsiconus needs to rebuild his power. Only one flame blast may be flung per mr, and there must be a mr's rest before the next may be gathered and thrown. When he has tossed his limit, the mage will attempt to leave the immediate area; if he can procure water, mix a special powder in it, and drink the resulting potion, he will regain sufficient power for another set of flame blasts. There are four packets of this particular powder in his pouch; their parchment wrapping is marked with green and black stripes.

The other packets in the pouch are marked with red stars, with blue and yellow diamonds, and with blue crescents. The first contains a curative powder (there are eight packets) which will heal 2D8 points of non-critical damage; the second is simply salt (there are 6 packets), and will flavor food; the third contains a powerful sleep spell (saving roll against both MGR and STM, at a penalty of 4; if either is missed, "Lulla-bye and good night"), which can affect any being of up to 200 HTK, putting him to sleep for 15 to 25 hours (2D6 + 13) - there are 4 of these last. All powders must be mixed with either water or wine, and drunk; taking them dry completely negates the effect; the exception is the sleep powder, which may be blown upon its victim (if dry, there is no penalty to the saving rolls, and sleep lasts for 2 to 12 hours [2D6]). Taking the salt, dry or as a potion, requires a saving roll against STM, or the person will be seized with violent nausea and cramps (too much salt can kill); there is a 5% chance of death if the STM save is missed.

If Tsitsiconus is in mortal danger, a slender red-haired figure dressed in black will be seen trying to shield him. This is Sharella, whose love for Tsitsiconus is so strong that she will return from beyond to protect him. Sharella will be able to stop

any spells cast by a mage of less than 7th level, and has a 35% chance of deflecting up to three weapon strokes per mr (each weapon stroke [missile or close] should be rolled individually); she cannot affect any living being other than to deflect weapon blows or to dissipate spells cast at Tsitsiconus. Tsitsiconus does not know he has this supernatural protection.

The Servant of Tsitsiconus is a mechanical-magical automaton, which the mage built over a century ago. It has 4 soft, rubbery balls mounted in its base (on which it rolls all over the tower in its various duties), and 12 tentacles of flexible metal coils. It is semi-intelligent, and can absorb (and carry out) a medium complex program; it does have a number of built-in programs, which define its normal tasks in the tower. The Servant's body is a box 3' long by 2' wide and 1.5' high (remember this is magic, not technology - the box is hollow), and is decorated with gold scroll-work, and a number of small gems set in a peculiar pattern.

This pattern is one of the magical controls on the Servant. It also responds to verbal commands if prefaced by the words "Tsitsiconus commands"; the magical-machine has a reasonably large vocabulary, and there is an 85% chance that it will understand any given set of instructions; add 1% to 14% if the instructions are very simple, or very common words (e.g., "Go to the first level" would be about a 9% bonus, while "Stop" would be 14%). The Servant will consider any person not wearing a special medallion to be an unauthorized intruder in the tower (these medallions are kept in a small niche on the first level, inset in the portion of the fountain's rim facing the elevator). If Tsitsiconus is not on the first level, the Servant will suggest that they leave, and go in search of its master. If Tsitsiconus is on the same level (even in invisible form, for the Servant's vision is not obscured by such devices), the Servant will ask its master if the party is authorized (it will ask until it gets an answer, which could prove embarrassing to Tsitsiconus if he wished to remain concealed). The Servant will request departure of unauthorized people three times, and will then attempt to remove them; it is capable of holding even a struggling person in two of its tentacles (each arm of the Servant has an equivalent STR rating of 27), and it can carry 900 lbs. without difficulty. Special behavior for the Servant is noted in the various level descriptions, where such behavior is applicable.

#### THE GARDENS OF TSITSICONUS

The walls of Tsitsiconus's retreat enclose an area 800' by 400'. The walls are 13' high and 2' thick -- it is quite easy to stand atop them. In one of the 400' lengths, there is a gate, with two wings of black wrought-iron grating, each 10' wide and 15' high; this gate is centered on the wall. The pair of gates has a chain securing them, fastened by a Complexity 2 padlock. The chain can be broken with use of a prybar; make a saving roll against STR for each mr of attack - a successful roll snaps the chain.

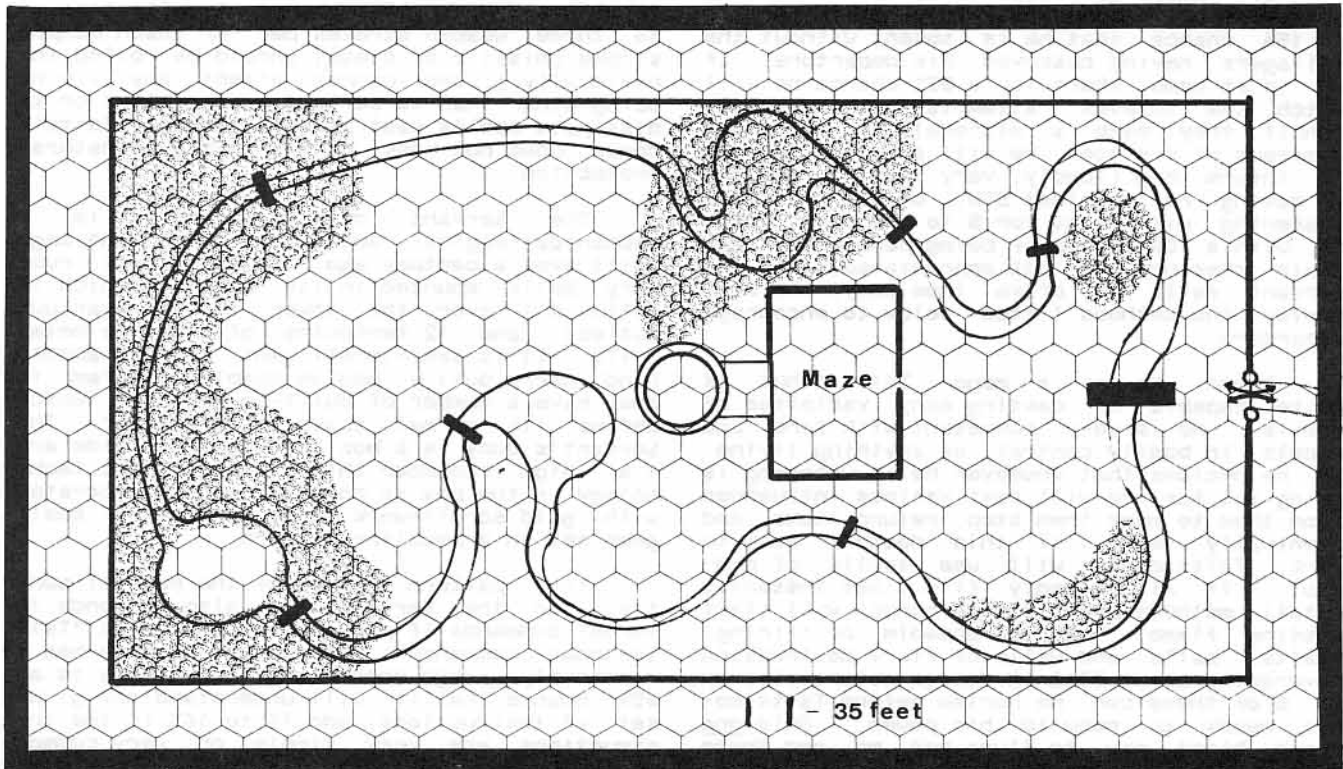

The acreage inside is covered with beds of blooming flowers, soft green turf, and small copses of trees. A little stream meanders throughout the park, until it turns eventually in a complete circle; there is one big bridge which crosses the stream near the gate, and 6 smaller ones scattered along its length. In three different areas, the stream widens into pools. The base of the tower is completely surrounded by thick hedgerows (described in greater detail in the next section).

This lush garden is inhabited by a pair of black leopards and the Floating Eye. The leopards were sent to Tsitsiconus as a gift, and are purr-fectly tame, having received nothing but kindness since they were small cubs. The leopards are very friendly, so friendly in fact that they will come bounding up to greet any one they discover in the garden (there is a 10% chance one or both will be in the vicinity of the thieves' entrance, and a 35% chance that they will appear every 10 mr thereafter) in typical housecat fashion, with purrs, leg stroppings, and licking of hands. They are harmless unless attacked.

The Floating Eye patrols throughout the garden area; it responds to movement, and frequently will be found investigating a swaying flower or one of the leopards as they gambol about on the sward. It is one of Tsitsiconus' failures in enchantment and construction (few and far between), but the device's mentality was so child-like and appealing that Tsitsiconus did not have the heart to dismantle it. The Eye is capable of telepathic communication, and will occasionally regale Tsitsiconus with tales of meandering moles, tossing treetops, and pouncing pussycats. If

it approaches, there is only a 20% chance that the movement it detected in the thieves' vicinity was the thieves; even so, it is likely to be distracted by some other movement, if the thieves lie motionless for a moment or two. On the other hand, if they flee in panic, or try to attack it, the Eye is almost sure to report these "strange creatures" to Tsitsiconus.

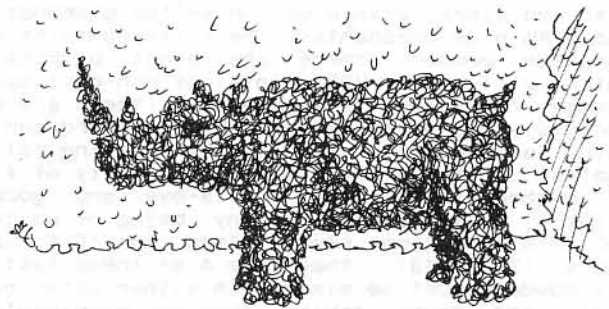

#### THE TOPIARY MAZE

Topiary was a popular artform in which close-grown hedging was planted around wooden or metal frames, and then carefully pruned to resemble the forms of animals, mythical beasts, or just fanciful shapes. Within the hedge surrounding the single entrance to Tsitsiconus's tower is a maze of hedged pathways, with chambers occupied by some of these topiary animals. The only way to the entrance is to solve the maze (unless, like Tsitsiconus, you have a magical way of entering).

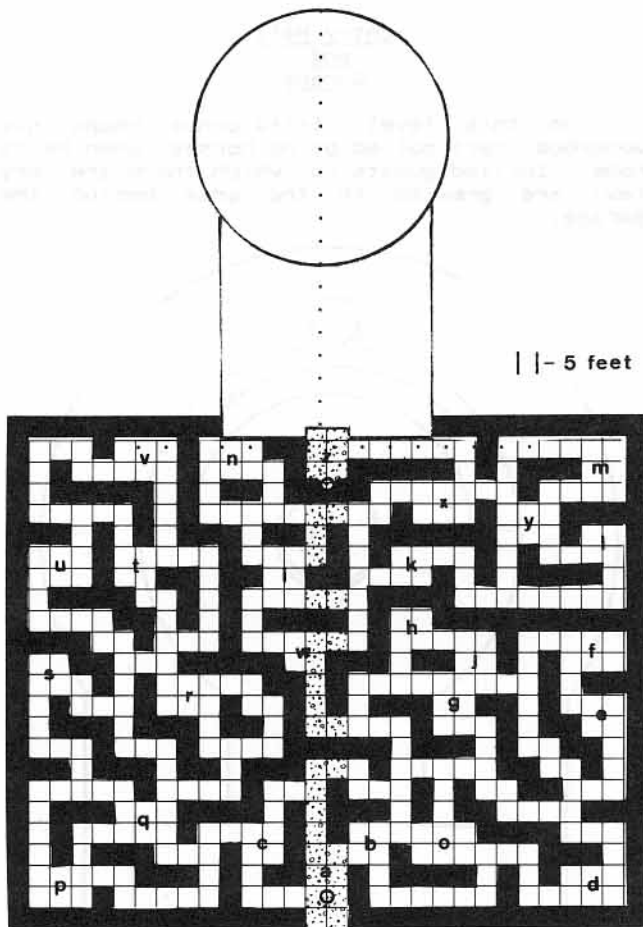

At the entrance to the maze (the area marked 'A') is a white marble statue of a slender man in a robe. The sculpture stands on a cubic pedestal, about 3' on a side; it resembles Tsitsiconus. In the right hand is a key, in the left a lock; the key obviously fits the lock. As a party approaches, the statue (which is enchanted, and has a Message spell embedded) will intone "Depart hence! Thy presence merely intrudes upon my grief. Only one who holds the key to death's lock is truly welcome."

The party may make what they wish of this statement (they probably will anyhow), but it refers to a solution to Tsitsiconus' problem in raising Sharella from Death's grip, not to the action of the lock and key described below. The arms of the statue are articulated, and it is capable of inserting the key into the lock (Tsitsiconus can activate this effect from his special cart, or the statue's hand can be manipulated to place the key in the lock and turn it without touching the key itself). The lock and key may both be removed (very easily) from the statue's hands. However, any living being who personally inserts the key into the lock must make a saving roll against STM at a penalty of 3 to avoid instant death; if the statue is holding the key when it is inserted into the lock, this effect can be ignored. When the key is inserted and turned (either by the statue or

someone who has made his saving roll), a bridge of a glittering crystalline substance resembling a solidified rainbow (it's actually temporarily condensed air) will form from about 20' in front of the statue straight to the double doors at the base of the tower; these doors will automatically swing open at the same time. The bridge will remain for 4 mr (about 1 minute), and then disappear (dropping anyone standing on it about 20'); the key will fall out of the lock and the process must be repeated to recreate the bridge. It takes about 3 mr or 45 seconds to cross the bridge on foot (or 1 mr in the cart).

Throughout the maze (areas 'B' to 'Y') can be found the topiary animals. Statistical descriptions of these animals will be found on the last page of this section; each of them is protected by the equivalent of chain armor (AC6 - it's hard to kill a bush), and have a MGR of 10. Animal control spells will not work (remember, these are just bushes), but plant control spells would be effective against them.

If the party remains in an area for a length of time, the animal in that area will activate in the 5th to 10th mr (1D6 + 4) after their arrival. No animal will leave its area unless the animal is a beast of prey (marked \* in the descriptions) and is pursuing a wounded person. In all the areas except 'A', 'B', 'I', AND 'W', there is an 8% chance (approximately 1 in 12) that there is a decayed, rotting corpse (altogether deserving of interest) in the area. A search will require a saving roll against STM to avoid nausea (the worse the saving roll is missed, the worse the nausea will be; there is a concomitant penalty of 3 to HP for a period of [30 - STM] minutes); the search will bring to light 2D20 GP in assorted coins and small gems, and will require 2D4 mr (30 seconds to 2 minutes) to complete.

At the end of the maze (area 'Z') is another statue, life-size in pink marble; it is standing in a small niche in the hedge, and has no pedestal. The statue is of a lovely young woman (Sharella); her arms are extended in loving invitation towards the doors of the tower. At her feet in the ground is a golden plate, about 2' by 1'; engraved on it are the words "Beloved, come unto me." (This is simply a statue, but, oh boy, what a statue!)

If the party has reached this point, they find themselves at the entrance to the tower. If they have arrived by bridge, the doors are open; otherwise, they can be opened only by inserting the key (from the first statue) into the lock on the door (the keyhole is quite visible), or by picking the lock (it is a Complexity 4 piece of work). If the key is used, there is no saving roll required.

#### WITHIN THE TOWER

The tower itself contains fifteen levels, each of which will be described in its own section. There are some areas of description which are common to all levels, and it would be pointless to repeat these in each section.



## RAMPS

At the back of each level is a ramp to the floor above; these ramps are marked on the diagrams with an arrow -- the arrow indicates down. The lower terminus of a ramp is always on the right side of the diagram; the upper terminus is to the left on the level above.

The ramps are stone, cantilever supported from the wall of the tower. Each is 4' wide and ascends at an approximate angle of 22.5°. Surfaces are paved with a rubbery substance, which allows traction for the Servant (and other mechanisms). The ramps are screened from the remainder of each level by two panels of pierced-metal lacework which reach from floor to ceiling; at midpoint between these two panels is an opening 3' wide where a bridge of glowing crystal running beneath the ramp to the floor above leads to the arcane elevator.

There is a penalty of 20% of speed assessed when running up a ramp, and running down requires a saving roll against REF for each 5' descent (3 saving rolls for most floors, 5 for 2nd to 1st). A fall will inflict 1D4 damage, and deposits the faller at the bottom of the ramp; a saving roll against STM is required, or the person is stunned for the following 1D4 hr.

## FLOORS

The floors are constructed with planks of polished ebony 12" wide and 2" thick. These are laid in three crisscrossing layers, and have been firmly pegged in place. The first floor is done in marble, not wood.

The floors are occasionally covered with fine carpeting or, rarely, parquet or mosaic (any non-ordinary floor coverings will be mentioned in the particular section).

## CEILINGS

The ceilings are comprised of the supporting beams for the floor above; heavy beams (18" square cross-section) of flamewood (a reddish wood of flame-like grain with alternating light and dark hues) run from side to side of the diagram. The underside of the floor above is easily discerned between the beams of the ceiling.

From these beams swing chains of wrought gold suspending glowing crystal globes in baskets of golden filigree work. The crystals are enchanted, embedded with Variable Intensity Light spells which are voice controlled -- the command "Dawn" brightens the light, "Dusk" dims it, and "Dark" extinguishes it. All globes on a particular level respond to the same command at the same time.

## THE ELEVATOR

The arcane elevator is reached on all floors but the first by crossing the bridges of illuminated clear crystal; these bridges are always lit, and can be extinguished only by Tsitsiconus himself. The elevator will arrive at the level stop by the time a person has crossed the bridge.

The elevator itself is a 4' diameter disc of 3" thick blue metal. It responds to thought commands for the level the passenger(s) wish to reach. If Tsitsiconus is in the tower, the disc will always be found at whichever level he is upon; if he is not present, it will rest on the first level until summoned by someone crossing a bridge.

## LEVEL I

### Entry Hall and Garage

On this level, Tsitsiconus keeps his wondrous cart pulled by no horses, when he is home. Invited guests (of which there are very few) are greeted in the area behind the garage.

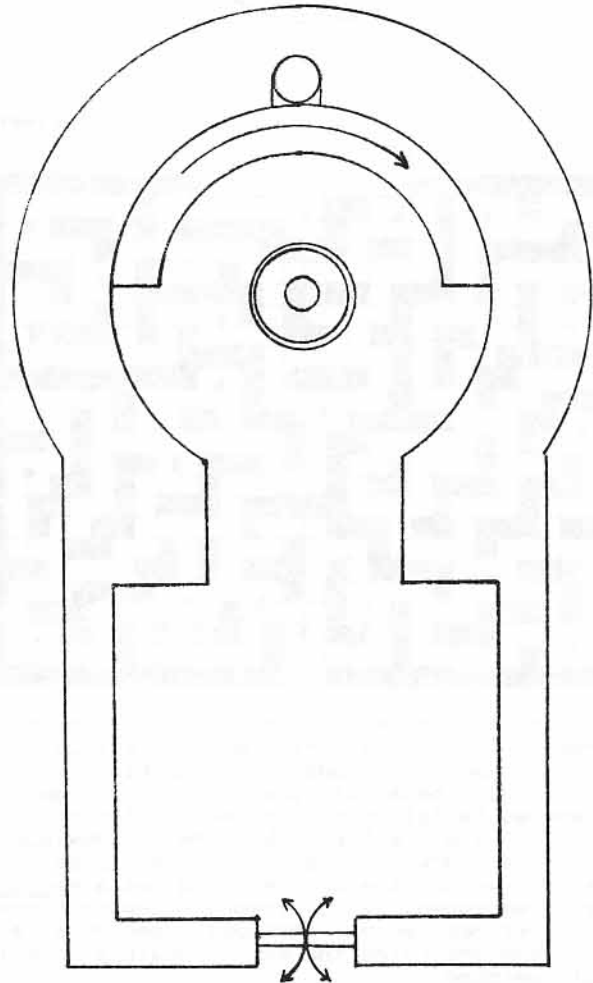

"Diagram of Level I"

### What the Players See:

As the doors swing open, one can see a nearly square room, with a wide opening to the rear. The opening leads to a passage which extends 8' into another chamber, circular.

In the center of the second chamber is a fountain, double-tiered, which sprays a reddish substance into the air above it. There are 16 goblets set on the rim of the lower bowl of the fountain.

At the rear of the second chamber can be seen a ramp leading upward from right to left; the ramp appears to be of stone, about 18" thick. Under this ramp, directly at the back of the chamber can be seen another opening.

On the floor of the small (4' diameter) chamber may rest a thick disc of a bluish metal.

### Gamemaster's Description:

If Tsitsiconus is at home, a cart will be parked in the center of the squarish area. This cart is 4' wide and 6' long; it has two axles, front and rear, both apparently movable, but there is no visible method to attach an animal. The interior of the cart is luxuriously appointed, and golden rods from the four corners support a silken canopy. There is a small door at the rear, with a locking arrangement; a keyhole is obvious. (The horseless carriage can make speeds of up to 30 mph on smooth level ground, and 15 mph uphill or on rough ground. It requires an expenditure of 1 Tau point per 10 minutes of running. The cart resists entry by any object when the door in the rear is closed, as a screen is erected up from the cart's sides to the canopy; the screen can prevent the entry of objects up to 250 lbs. in weight, if moving at more than a snail's crawl. The key to the door's lock, a Complexity 5 masterpiece, is found on the person of Tsitsiconus.)

If Tsitsiconus is not at home, there is a 60% chance that the Servant will be stationed in the center of the 8' passage, awaiting his arrival with mechanical patience. If the Servant is not on guard, there is a 60% chance it is in the back portions of the garden, tending the plants and animals; otherwise, it is on one of the upper levels (roll 2D8, with a result of 16 giving Level II), and will arrive in (4 x levels distant) mr. The thieves may avoid the Servant by riding the elevator; it is possible to avoid it entirely by simply changing levels at the proper time, since it requires 4 mr for the Servant to ascend or descend a level.

The fountain sprays a fine quality wine, which has an unusual effect on interlopers if they consume it (if the drinker has been invited in by Tsitsiconus, the wine will have no effect whatsoever -- other than the usual): an imbiber will feel a total loyalty to Tsitsiconus, and will attempt to persuade (or force if necessary) the other members of the party to leave without further ado. A saving roll against MGR, at a penalty of 4, is allowed.

The opening in the rear lead to the elevator. It can, and will, operate in response to anyone's thought commands.

The 16 goblets are of top quality leaded crystal, and the set is worth 2,000 GP. The cart has a base value of 10,000 GP, 150,000 GP if the magic is known.

### LEVEL II

#### Mechanical Tinkering Area

Many intricate and puzzling devices, like the Floating Eye in the garden and the Servant of Tsitsiconus, were constructed here.

#### What the Players See:

A well-equipped workshop greets the eyes. There is a workbench with a partition upon which are hung all manner of woodworking and carpentry tools, and a platform with a small quarter-arc ramp leading to its top. Cabinets and bins line the walls, and there is a forge, with anvil, bellows, coal bin, and tool rack to one side.

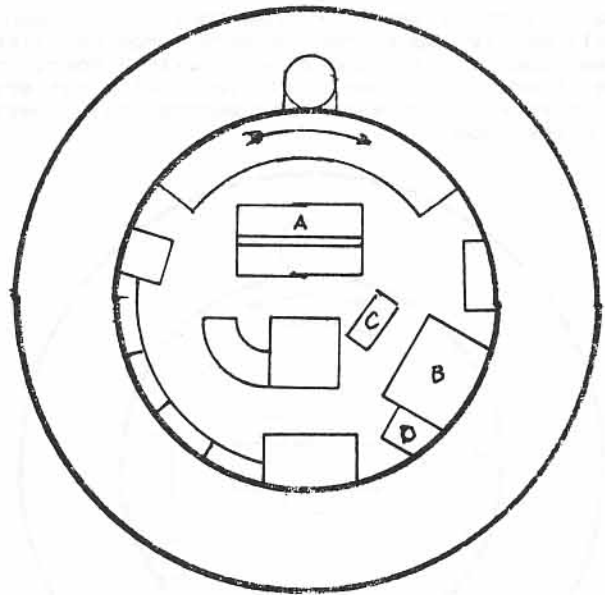

"Diagram of Level II"

### Gamemaster's Description:

The equipment in this area is all of excellent quality, as are the various supplies and components. Underneath the workbench (A) can be found 1D100 ingots of assorted metals, composition:

<u>D20</u>	<u>Metal</u>
01	Gold
02-04	Silver
05-08	Copper
09-10	Brass
11-14	Bronze
15-20	Iron

These ingots weigh 10 lbs. each.; brass and bronze are 2x and 3x the value of copper, respectively, while iron is 1/2. There are 100 coins to a pound.

Only the forge, anvil, and bellows are enchanted. The forge and the bellows are demon-inhabited, and the anvil weighs 75 lbs. If the anvil is successfully removed, it will give a bonus of 1 or 2 to any weapon or armor forged upon it; the bonus itself is non-magical, simply quality workmanship facilitated by the spells in the anvil.

There is a 25% chance that there is a partially constructed mechanism sitting upon the platform (B); it will be 20% to 80% complete (2D4 x 10%).

### LEVEL III

#### Kitchen and Food Storage

If there are guests, Tsitsiconus prepares the repast; otherwise, he eats whatever the Servant provides.

#### What the Players See:

A large dining table, surrounded by eight comfortable chairs, occupies most of the area near the ramp. Counter-clockwise from the elevator bridge along the walls, can be seen a tall chest of black wood, a set of cabinets, storage shelves and drawers underneath a finely-crafted maple counter-top some 14' long

and 3' wide, a set of narrow shelves with many small bottles upon them, a very large box-like item about 3' high and 5' wide with 2 doors in the front, a butcher block table with cutlery in a rack on its side, and another tall chest of black wood.

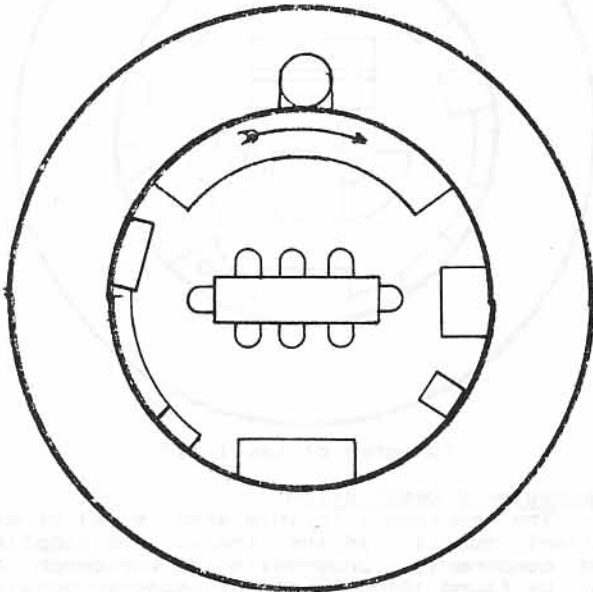

"Diagram of Level III"

Gamemaster's Description:

The two tall chests are stasis cabinets, the one on the left for hot preparations, the right-hand one for cold storage (the right-hand cabinet is about twice the size of the left-hand one); there are no dishes in the "Hot" keeper, but there is a quarter of beef, an already cooked haunch of venison, and 8 2-quart jacks of good ale in the "Cold" keeper.

The box-like item with the two doors is a magical kitchen center. It combines stove, oven, and dishwasher. The top is quite hot, with the heat increasing to the right (it is capable of virtually cooking a hand should it be carelessly placed on the surface). The left-hand door reveals an oven of respectable size; a 60 lb. roast will cook in less than an hour. Behind the right-hand door is a pair of racks; any pots, pans, or dishes placed on these racks will have any food remaining on them transported to a large silver bowl embedded in the ground behind the largest copse of trees in the garden (thus cleaning the dishes, and simultaneously providing food for the leopards).

There is a set of chef's cutlery in a fine wooden knife rack, sitting on the counter. The knives are enchanted, and have Ever-Sharp, and Multi-Speed spells embedded in them; HACO against vegetables (and other foodstuffs being prepared) is -20, with 60 blows per mr (otherwise known as a magical medieval mincing machine). The set of knives (there are 10 of them) weighs 12 lbs., and is worth 150 GP to any chef of repute, and about 2,500 GP if the magical powers are known. The knife block weighs 5 lbs., and is worth about 25 GP (but it's great for storing the cutlery). Two different complete sets of tableware (utensils, drinking apparatus, and

dishes) can be found under the maple counter; one is obviously valuable, worth some 2,800 GP for the complete set; the other is well used, but Tsitsiconus will track down and dispose of whomsoever has a hand in stealing it, since it is one of his mementos of Sharella -- in itself, the set is virtually worthless. In the drawers here, can be found three lace tablecloths (worth 800 GP each), and some sets of fine linen tablecloths and napkins (worth 450 GP, 900 GP, and 150 GP; the gadiest set is the least costly).

The narrow shelves hold a collection of spices and condiments in apothecary style jars. A jar will contain 106 ozs. of a particular herb or spice, and will be worth (1D10 X 10GP) per ounce. The jars themselves are worth 15 GP each, and weigh 1 lb. There are 145 of them.

LEVEL IV

Tsitsiconus's  
Bedchamber  
and  
Dressing Area

Tsitsiconus located his sleeping area centrally to many of his varied interests.

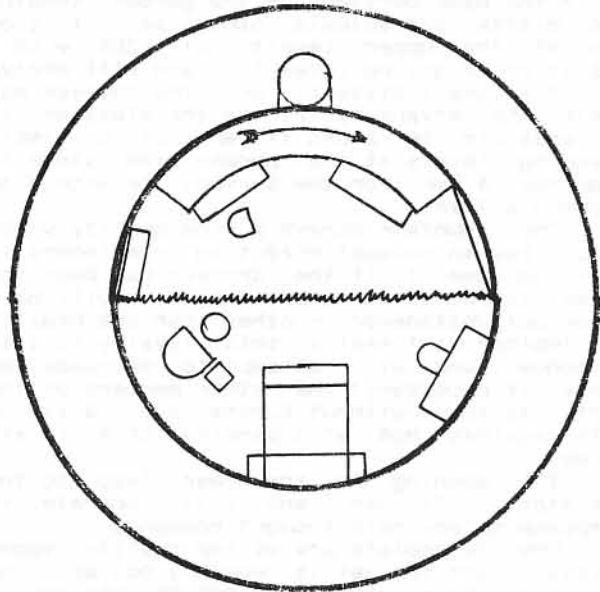

"Diagram of Level IV"

What the Players See:

A heavy curtain of blue and silver brocade divides the level in approximate halves. In the near side can be seen a 5-drawer dresser, two wardrobes, and a wooden chair. On the wall at the foot of the ascending ramp is a large mirror, some 6' wide by 8' high.

Through the curtain (which divides neatly into quarters) can be found a large, very comfortable bed with a canopy suspended from the ceiling, a desk and chair, and an armchair, footstool, and side-table grouping. At the foot of the bed is a large cedar chest with a padded top. On the wall over the desk is a portrait of a very lovely woman, and tapestries adorn the walls. There is an excellent carpet under the armchair, and a white fur rug on each side of the bed. The bedspread is also of fur, lustrous, long-haired, and golden-red.



### Gamemaster's Description:

The dresser contains normal underclothing, and personal items. In the wardrobe near the chair will be found some 30 outfits, tailored to fit a man of average height and build. All of the clothing is of excellent quality, well above the normal cut. The second wardrobe contains footgear; there are approximately 10 pair of sandals, 16 assorted pair of shoon (some even have bells on their toes), and 6 pair of boots (3 dress, 1 riding, 1 work, and 1 mountain). Three of the pairs of sandals (#3, #8, and #9) are enchanted, for wall-walking, water-walking, and triple-speed, respectively. The riding boots and the mountain boots are also enchanted, the former for mental communication with one's mount, the latter for finding (and gripping on) any ledge of at least 1/4" depth. None of the other footgear is enchanted.

The mirror is of polished silver, and is totally unbreakable (although attempts will cause resounding metallic banging), as well as thoroughly unenchanted.

The portrait over the desk in the bedroom of Tsitsiconus is of Sharella. Any man gazing at the portrait for more than a few moments must make a saving roll against DSC, or fall in love with her. This will create a longing for only Sharella, and general disinterest in most other women (it requires the attentions of another female with a combined MAG and APP of at least 32 to break the spell).

In the desk's four drawers can be found: a packet of three-century old love letters from Sharella to Tsitsiconus (if these are stolen, and Tsitsiconus is contacted, he will agree to ransom the letters for 25,000 GP; if they are destroyed, his vengeance will be terrible); some quality stationary with Tsitsiconus's device (a silver griffin on a background of blue and gold diamonds) imprinted in the upper left corner of each sheet; a small metal cash-box containing 360 GP in assorted coins and small gems, a chain with a small round gold pendant set with a winking red stone (this is the switch for the magical component of the treasure vault locks), and a small slip of parchment with the words SHARELLA, MUSIC, and BRAVERY written on it (these are the authorization references for the Librarian, the first allowing access to anything, the second to all but books of spells and demonological forms, and the third to all but the above and books on improvement of physical characteristics); and 3 crystal wands (red, white, and blue). Each drawer contains a different type of item.

The wands are similar in construction, and action, but each color has a different result. Each wand is 24" long, and 1/2" in diameter, tapering smoothly to a point. The effects are:

**RED** - delivers a blast of flame in a 230 cone to a distance of 40'. Anyone caught by the flame within the first 20' will suffer 4D10 of damage, the next 10' 3D10, and the last 10' 2D10; past that, the damage is negligible. A saving roll against MGR reduces damage by 1/2; hiding behind a solid object blocks the flame in the shape of the object.

**WHITE** - shoots a thunderbolt. this travels in an absolutely straight line to the first and second objects only. The first object

in line will take 10D10 of damage, the second half that amount. A living being may make a saving roll against MGR and STM; if either succeeds, damage is reduced by half; if both succeed, no damage is suffered. In all cases, the being is stunned until he makes a saving roll against 1/3 STM, or for 1 hour, whichever is shorter; also, any metallic objects in the being's possession at the time of being struck stand a 95% chance of being fused, twisted, and generally rendered useless.

**BLUE** - projects a freezing blast in a 100 cone that reaches up to 100'; if the beam strikes any large solid object (something the size and weight of a 1960's American automobile, for instance), it will be absorbed, and lose all effectiveness; the beam does 12D10 to the first object it strikes, 8D10 to the second, and 4D10 to the third -- if any of these amounts is double or more the the absolute damage of the being struck, he is instantly frozen solid, and there is a 75% chance that the expansion caused by the freezing will cause the subject to shatter spontaneously. A saving roll against MGR will reduce damage by 1/3, and a saving roll against STM by 1/2; if both are successful, damage is reduced to 1/3. In all cases (if the being survives), he will be inactive (due to shivering) until a saving roll against 1/3 STM is made.

In all cases of these wands, operation requires a minimum TAL of 9 and an expenditure of 5 Tau points per blast. The wands have not been reloaded recently, and each will have 1D6 charges. Tsitsiconus does know exactly how many charges are left in each.

On top of the desk are two magical globe lamps, and what appears to be financial papers; there are two letters of credit among them, one for 5,000 GP, the other for 40,000 GP -- both are on banking houses in the city of Haven, but the House of Jerudon, which guarantees the smaller amount, knows Tsitsiconus very well, and will find some excuse to delay the thieves while the guard is summoned.

There are four tapestries adorning the walls; each is worth (1D100 x 1D10) GP.

The armchair is very comfortably upholstered, and the side-table sports a globe lamp similar to those on the desk. There is a 35% chance that there is a book or scroll from the library on the table; if so, there is a 75% chance that it is a book of spells (contains 3 + 1D10 spells, each of level 2D6). There is a 40% chance that Tsitsiconus's favorite pipe is also on the side-table; it has been specially enchanted to allow the smoker to always blow perfect smoke rings, in different colors, and to control their movements (a dance of the smoke rings is a frequent form of entertainment for the mage).

The carpet is an antique from far Kadiristan, and is worth 25,000 GP; it is 8' x 12', and weighs 60 lbs.

The white fur rugs are polar-bear skins, and have been specially treated to render them superbly soft and silky. They are valued at 1,500 GP each, and weigh 20 lbs. each. The fur bedspread is from the great woolly megathere of the far southern reaches of Lumineris, and would fetch an easy 8,000 GP; it weighs 40 lbs.

The chest at the foot of the bed contains silk and satin sheets and pillow-cases (Tsitsiconus is a believer in luxury). All of the bedding is monogrammed.

**LEVEL V**

Bathing  
and  
Laundry

When it comes to bathing, Tsitsiconus is a sybarite; he also prefers his clothing immaculately clean.

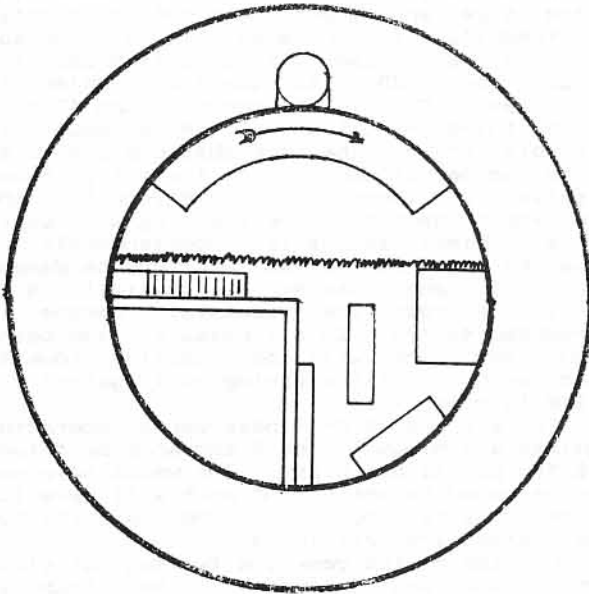

"Diagram of Level V"

What the Players See:

A curtain of green and gold brocade hides most of the level from the view of the casual passer-by.

When the curtain is parted at one of its three breaks, a large tub, constructed of glistening blue stone and rising 4' from the floor and occupying fully 1/4 of the level, can be seen; a set of steps climbs to a small platform at the rim of the pool. On the other side is a large green box reaching from floor to ceiling and about 8' wide, with a single door centered about 4' off the floor. There is a shelving unit against the wall which appears to be filled with a large number of pieces of fluffy white cloth. A long bench runs beside the pool, and a curious table, 6' by 3', covered with a clean white cloth, is set near the bench.

Gamemaster's Description:

Much magic can be detected on this level, since the pool, the large box, and the table are all heavily enchanted and ensorcelled.

The pool is magically heated, and, after use, will drain itself (into the nearby river), and refill with clean, hot water which is lightly scented with flowers.

When clothing or other material is placed inside the door of the large green box, it is cleaned, folded or pressed, and returned to the area of storage most commonly reserved for

that clothing. Any person attempting to investigate the interior of the box physically will be returned to the table nearby, cleaned and folded (this is very likely to prove fatal). This arcane laundry is run by a group of demons (not particularly intelligent ones), and any magical attack is 85% likely to release them from the confines of the box. This includes any and all disenchantment spells; physical attacks will have the same effect each blow after 60 points of damage have been dealt to the box.

The table provides a thorough massage when any being reclines upon it; it is not activated by inanimate objects.

**LEVEL VI**

Alchemical  
Laboratory

The mage can brew or concoct virtually any potion he desires in this well-equipped laboratory.

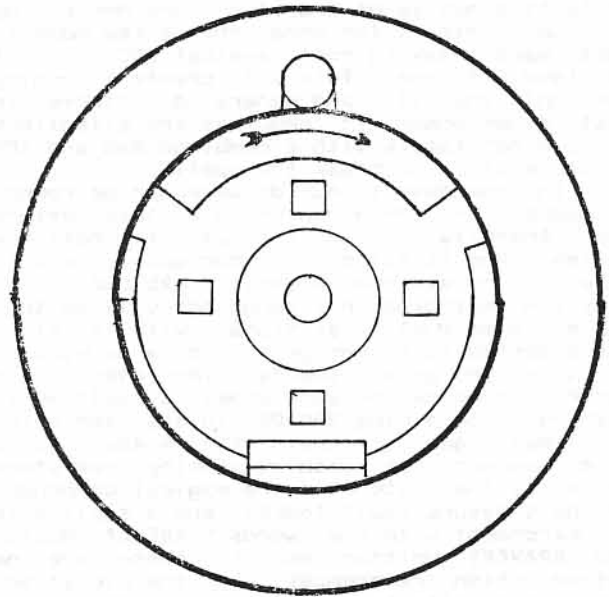

"Diagram of Level VI"

What the Players See:

In the center of the floor is a raised area comprised of fire-brick; set upon this is a large copper cauldron, 3' deep and 5' in diameter. Four bookstands surround the brick-ed area, and the wall is covered with shelving upon which can be seen many large (about 2-gallon) jars, all at least half-filled with substances. A counter and shelf unit stands at the back, the counter covered with measuring devices and grinding equipment (mortar and pestle sets), while the shelves are lined with various forms and shapes of glassware. Under the counter lie many pieces of split firewood (alchemy does not function properly on any but natural fuels; arcane heat and magical fires produce only ineffectual potions).

Gamemaster's Description:

Virtually any substance required for potion brewing can be found in one of the jars on the shelves. There is a 20% chance that

Tsitsiconus has been brewing, and that there are 2D6 beakers of some potion sitting on the counter (this potion may not be of particular use to the party of thieves, but it will not, under any circumstances, be poison). A beaker will contain 2 + 1D4 doses of the potion. (Console yourself, GM; even though it will not be poison, no rule says it cannot be a sleeping potion or something equally non-fatal but hampering.)

There may be alchemical recipe books on the bookstands; the chances are:

D100	Books
01-40	None
41-65	1
66-85	2
86-95	3
96-00	4

One of these books, if any are present, will be open to the recipe for the potion in the beakers. Each book will contain 3 to 18 recipes (3D6), and the lower the number of recipes in the book, the higher the complexity of the recipes (and the power of the potions) will be.

### LEVEL VII

#### Demonological Summoning Chamber

Within this velvet-enclosed sanctuary, Tsitsiconus has bound many of the dwellers of the Abyss to his service.

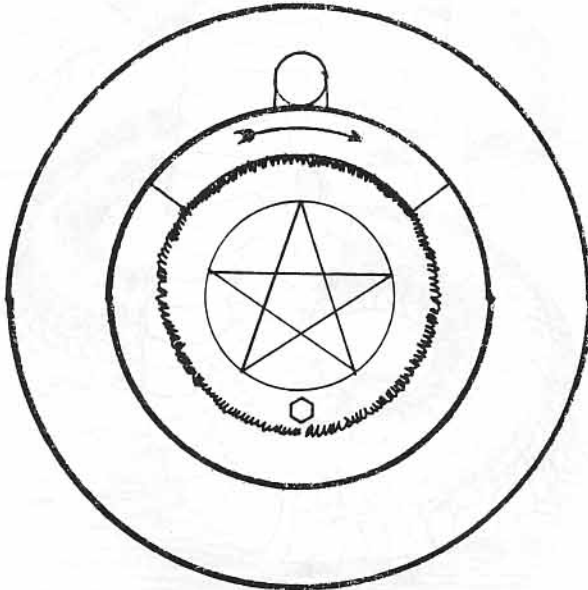

"Diagram of Level VII"

#### What the Players See:

A red velvet arras completely surrounds the central portion of the level and totally blocks the view into the center. The curtains are firmly attached to the ceiling. (There are only two breaks in the fabric, one for the elevator, the other directly opposite.)

Within the central area, a huge piece of obsidian 12' in diameter and 4" thick occupies the exact center. It is etched and inscribed with a carefully drawn pentacle filled in with silver. A tall candelabrum with five branches

stands at each of the points of the pentacle. There is a podium between the legs of the pentacle farthest from the elevator. Upon this podium lies a huge tome, 3' high by 2' wide, and 12" thick; it is covered with a scaly reddish leather with gold-embossed trim, and is secured with a golden strap hasp and a heavy padlock.

#### Gamemaster's Description:

The book is one of the objects of the mission, and it is relatively easy to steal. However, it is extremely heavy, weighing some 45 lbs., and will not be easy to carry. If the book is opened, two very powerful demons will be released; it is unlikely that any of the party will be strong enough to resist (unless the robe described below has been located), so opening the book will generally be fatal to whichever party members are on this level. The lock on the hasp has a Complexity 10 (it was made over 3,000 years ago by a master locksmith), and will firmly resist all attempts to break it. The key is one of those on the ring in Tsitsiconus's possession.

Within the podium will be found, carefully folded, a robe apparently made of netting; the material used is gold wire, and most of the interections have been set with small gems in mystic patterns. (This robe has the power to nullify all magical or arcane powers directed at its wearer. When worn, it emanates a field some 3' from its surface through which no spell will penetrate. It does require an expenditure of Tau points equivalent to 1/10 the power expended by the caster of the hostile spell to nullify that spell. Demonic powers may be nullified also [Tsitsiconus wears this robe whenever he summons dwellers in the Abyss]. The robe has a base value of 45,000 GP, and 150,000 GP if the magic is known; however, it is a notorious item, and will be hard to dispose of.)

### LEVEL VIII

#### The Library

Here are over 10,000 books, tomes, and scrolls - and the Librarian knows them all.

#### What the Players See:

The entire level seems to be comprised of shelves, built in a semi-circular pattern; they reach from floor to ceiling, and are nearly filled with assorted scroll cases, scrolls, books, tomes, librums, etc.

Between the arms of the ramp is located a small grouping of a comfortable armchair, hassock, and side-table. An odd-looking multi-armed statue of a woman's torso with a snake's lower body sits on the floor nearby; it stands 7' tall, and appears metallic.

#### Gamemaster's Description:

The statue is the Librarian, one of Tsitsiconus' favorite mechanical toys. The Librarian knows the location of every one of the 10,000-odd volumes on this level, and will fetch a particular book on request, or a selection of reading material if a particular subject is specified.

Under the side table can be found a white box with a white leather carrying strap; the box is 11" by 11" by 18" high, and the strap is designed to allow it to be slung from one



shoulder to the opposite hip. The top of the box is hinged, and is pierced by a 1" diameter hole, centered. When the box-top is lifted, it may be seen that there are 100 6" deep pigeonholes at the bottom in a 10 x 10 lattice. There are 2 scrolls in the pigeonholes.

The librarian will defend the volumes with her mechanical life if necessary.

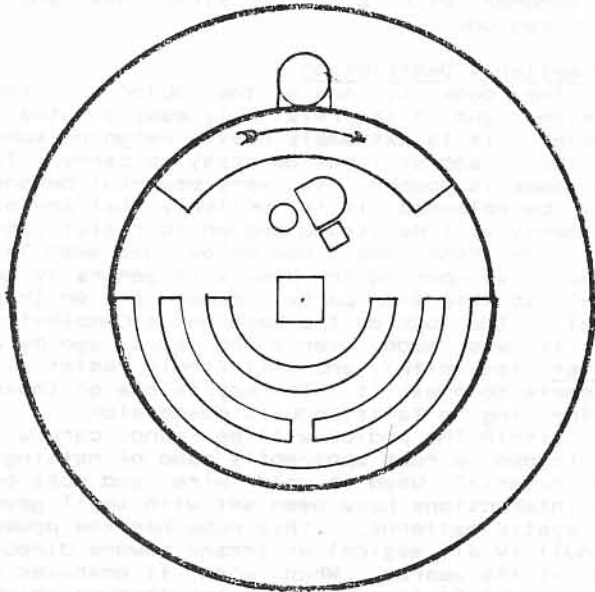

"Diagram of Level VIII"

(This box is a spellcaster's scroll case; it will hold up to 100 scrolls, and will present any scroll the wearer thinks of, provided it has been inserted in the box in the first place, to the small hole in the top. The two scrolls presently in the box are both "Discern Magic". The base value of the box is 750 GP; if the magic is known, the value is 50,000 GP.)

If someone attempts to wander among the stacks, the Librarian will first warn them (in a sweet feminine voice), "The stacks are off-limits to unauthorized personnel. Please do not disturb the arrangement of the volumes." If the intruders do not remove themselves from the shelving area within a reasonable amount of time, or if they remove material from the shelves, the warning will be repeated. If it is again ignored, she will state, "I have summoned the Servant. If you do not leave the stacks, he will be forced to eject you." The Servant will arrive in normal limits, plus an additional 20 mr if he was outside. If a battle ensues, the shelves will be blocked off by an arcane shield to prevent damage to the materials; this shield is impenetrable by any normal means.

The Librarian will respond to any normal requests for books. If the request is for anything of major significance (i.e. spell books, manuals to increase abilities, etc.), she will state, "Authorization is required for the volume you have requested. Please state your authorization reference." This reference (which Tsitsiconus changes weekly) may be found on the slip of paper in the cash-box in Tsitsiconus's desk on the bedroom level. If it is not given, only light reading material will be provided. If more than one reference is given, only the original reference provided will be used (on any given day).



## LEVEL IX

### Museum and Study Area

Mementos of past triumphs, and of a dear lady, as well as unusual items of all types, are displayed throughout the glassed cases of this level.

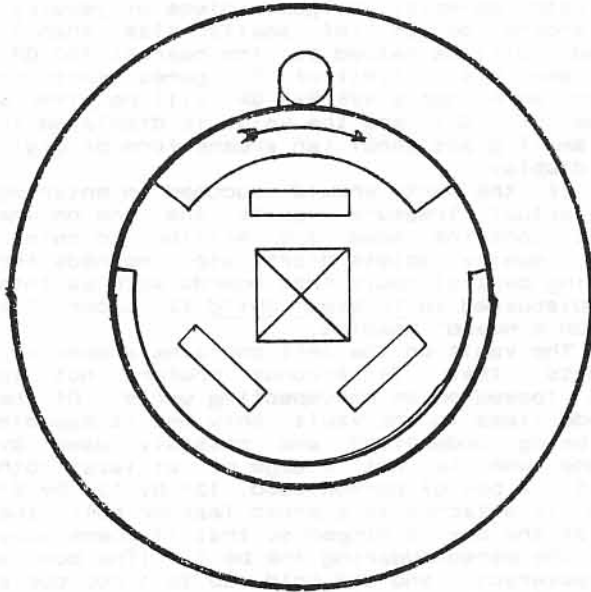

"Diagram of level IX"

#### What the Players See:

Glass-fronted display cases line the wall opposite the ramp, and three are also set in a triangle about the room. In the center of the floor is a tall revolving stand divided into 4 areas, each of which appears as the stand turns. There appear to be a multitude of items on display on this level.

#### Gamemaster's Description:

All items in the cases are unreachable unless the glass is shattered (if this occurs, the Servant will be teleported to the middle of the ramp leading up to Level X, and will forthwith attack anything on Level IX). Only the items in the revolving stand are easily accessible.

The case along the back wall is devoted to general mementos and souvenirs, including a 2' high, 1' square block of clear crystal in which appears to be a doll resembling a mage in full robes. On closer inspection, it can be seen that the doll is looking back at the person inspecting -- this is actually Borandor, Tsitsiconus's arch-enemy, whom he beat in duel arcane, and subsequently shrank and imprisoned in the crystal. Borandor can be freed and restored to normalcy by cracking the crystal with some heavy object; it is extremely unlikely that Borandor will be grateful, and the chances are 85% that he will simply blast the party out of existence, and then go hunting for Tsitsiconus. Borandor could be described as evil to the core, and if he does not destroy the party, he will probably imprison them in some arcane fashion to await

his return (Tsitsiconus will most likely win; Borandor is 250 years out of practice; the thieves will be found by Tsitsiconus when he returns). There are various oddments of magic scattered in and among the items in these cases, and the walls above the cases are decorated with many different weapons and shields, souvenirs of Tsitsiconus' travels. None of the armament is enchanted, however.

Each of the four sections of the revolving stand display a different exhibit:

Section 1 - a display of specialized weapons, such as tiger claws (called bagh nakh), cesti (Roman-style boxing gloves, usually studded with nails and broken glass), and about 10 different styles of infighting knives (poiniard, khukhri, bolo-knife, machete, tulwar, snicker-snee [8 blades, 4 out each end with a grip in the center], etc.). The khukhri is enchanted, and will treat any armor that is basically leather (including scale, banded, studded, etc.) as if it didn't exist; basic HACO is 9, and it does 2D4 damage; there is no way to be taught this weapon, normal usage may be attained by eight weeks of solid practice.

Section 2 - a number of very early magical artifacts, wands (most looking like divining rods), amulets, etc. None of these presently have any power, although all have been successfully enchanted, some with as many as 7 full enchantments (roll 2D6, add 2, and divide the result by 2, rounding down).

Section 3 - 6 arcane toys:

- A set of 50 toy soldiers, which march on command. Value 250 GP.
- A remarkably true-to-life bird in a cage, which sings lull-a-byes. Value 500 GP.
- A doll, which can talk (answering simple questions, and making the sort of sounds which please a little girl) and walk. Value 1,000 GP.
- A rocking horse in the form of a pegasus; it can actually fly, but can only bear the weight of a child. Value 2,500 GP.
- A doll in the form and costume of a jester (wearing motley); it can dance and do prat-falls. Value 750 GP.
- A game-board with animated pieces, which can provide an opponent when no one else is available. Value 1,500 GP.

Section 4 - a life-size mannequin resembling Sharella. It is dressed in a black body-hugging suit of wool such as she used for her thieving escapades, a black felt hat with a floppy brim, and a black cloak of velvet. Around its waist is wrapped a rope with a small grapnel attached and a belt with two formed leather pouches. (The rope and grapnel are permanently fastened, and enchanted as a unit. The rope is 100' long and is easily cast to that distance, even straight up. The grapnel will land silently and fasten itself to good purchase automatically. A simple twitch releases the grapnel, and the falling rope will silently coil itself. The rope will support up to 150 lbs.) In one of the pouches is a set of lock picks in a red leather roll-up and a 4" circlet of braided bronze wire, in the other is a blowgun 12" long and 1/2" diameter with a small snuffbox 3" by 2" by 1", full of blue powder. (The lock picks are of 9th level equivalency, and bestow an additional 15% to lock-picking skill, which is added after adjustments are

made for the Complexity of the lock. The bronze circlet will outline the disarming area of a known [not just suspected] trap, when the trapped object is examined using the circlet to look through. The powder in the snuffbox will carry up to 25' if blown through the blowgun; it is a very powerful sleeping potion [saving roll against MGR at a penalty of 5], and can affect up to 150 HTK.)

#### LEVEL X

#### Treasure and Strongrooms

Little meets the eye of the casual passer-by, save an innocuous door, but this level conceals fabulous wealth and mighty artifacts of conjury.

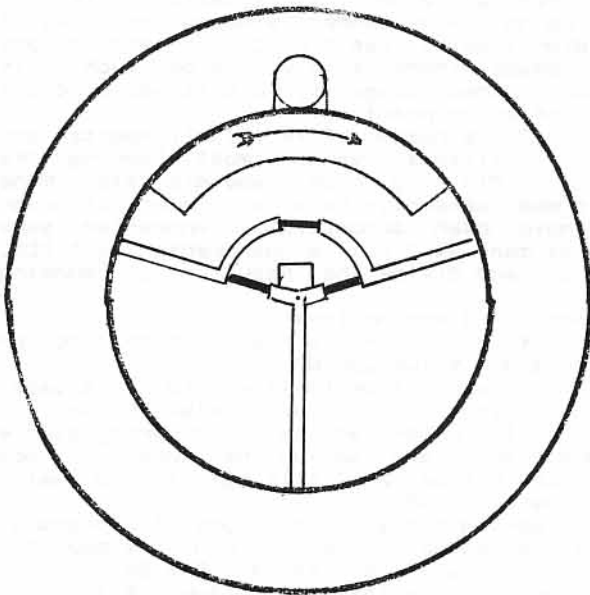

"Diagram of Level X"

#### What the Players See:

Walls from floor to ceiling form a small passage only 4' wide. The center section of the wall is semi-circular, and is broken by a door.

Inside the door is a small chamber shaped like a wedge of cheese. Two doors, doubly barred and locked (the locks are integral parts of the massive bars), are placed opposite the first entrance. Between them stands a small table on which is set a box, 24" by 15" by 6" high; there is a glass panel centered on the 24" length of the box.

#### Gamemaster's Description:

Tsitsiconus's treasure vaults are well secured, even from a determined assault on their integrity. There are two bars and two locks for each room; each lock has a magical component as well as a key (there is actually only one key, which is kept on Tsitsiconus's belt at all times). The magical component prevents the insertion of any material object (like a key or lock pick) into the keyhole; it may be released by the small pendant found in Tsitsiconus's desk on the

bedroom level (it is a toggle switch effect -- one touch releases it, the next resets it). The locks themselves are Complexity 10, with a separate enchantment to negate the effects of the various ability enhancers Tsitsiconus made for Sharella (when you know of an effect, you try to protect against it). If Tsitsiconus should ever lose the key or the pendant, the Servant has built-in duplicates.

The box is enchanted, and embedded with many spells. Its primary purpose is to evaluate objects; any gem, piece of jewelry, or arcane object (of smaller size than 2' cubed) will be valued to the nearest 100 GP. The box has a limit of 7 figures (anything worth more than 9,999,999 GP will be given a value of 1 GP), and the value is displayed in the small glass panel (an arcane form of digital display).

If the party should succeed in entering the actual treasure vaults, the one on the right contains some 3.5 million in coins, gems, jewelry, objets d'art, etc.; methods for valuing partial hauls from hoards such as this are discussed in Thieves' Guild II, under "The Dragon's Hoard" heading.

The vault on the left contains arcane artifacts that Tsitsiconus prefers not to have loosed on an unsuspecting world. Of the 60-odd items in the vault, only one is capable of being understood and possibly used by anyone who is not a mage of at least 10th level. A box of carved wood, 12" by 12" by 6" high is attached to a broad leather belt; the top of the box is hinged so that it opens away from the person wearing the belt. (The box is a tesseract, and can hold up to 1,000 cubic feet of material [or 75,000 lbs.]. Large amounts of metal [such as large piles of coins] will anchor the box in place; otherwise, weight and inertia tend to be neutralized [when the box is reasonably full, it will require extra effort to get started and to slow down; this may be reflected by cutting planned movement for the initial three mr of movement in half if the person had planned to move 4 hexes, he may only move 2 and extending the movement on an attempt to stop move less than the speed of the previous mr for 1 additional mr]. Once objects have been placed inside the box, a person reaching inside may mentally call for an object, and it will be placed in his hand. The box is presently empty, and its base value is 500 GP; if the magic is known, it is valued at 100,000 GP.) The remaining objects in the room may be described very generally. An object will be 2D20" by 2D12" by 2D8", and will weigh 1D6 x 1D10 x 1D3 lbs. (a maximum of 180 lbs., with an average of 38.5 lbs.). The base value of the object is the weight x 1D10 x 1D10 (this does give different values than multiplying by 1D100; see the multiplication table chart for a 10 by 10 matrix).

#### LEVEL XI

#### Burial Chamber of Sharella

Quite often will Tsitsiconus be found here, gazing on the sweet countenance of his lost love.



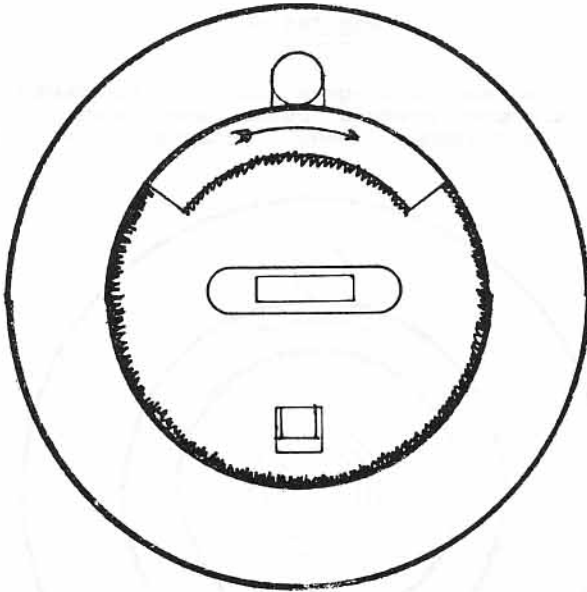

"Diagram of Level XI"

What the Players See:

The entire level is draped in heavy blue velvet. In the center is a stand, 7' by 4' by 3' high, covered with a glistening green fabric. On this stand lies a coffin of clearest glass, containing the body of a woman attired in a skin-tight black body suit. At each end of the bier is a 7' tall golden brazier, from which rise flames of many colors (there is no standard lighting on this level; all illumination is provided by the braziers). Opposite the elevator is a heavy but comfortable chair.

Gamemaster's Description:

This is the resting place of Sharella; she lies here, untouched by time, uncorrupted. Around her neck is the Talisman of the Thief. Her feet are shod with sandals, and there is a finely crafted dagger in a jeweled scabbard belted to her slender waist (the dagger is on her left side and can be seen from the top of the ramp; if anyone notices, the large piece of faceted quartz set as a pommel will begin to glow brightly as the party approaches the bier).

Any man who succumbed to the portrait on Level IV, and has not been decharmed, will, when he gazes at the actuality, be totally entranced, and will refuse to leave. If other members of the party attempt to despoil her, he will attempt to prevent such despoilment, employing violence if necessary. (Tsitsiconus has a number of agents, men who have come under the spell of Sharella's beauty, whom he uses to search for the ingredients he needs in his grand attempt to resurrect his lost love. Any thief remaining behind [no man under the spell will leave consciously, unless treated by Tsitsiconus] will become one of these agents.)

The dagger and the sandals are, very obviously, enchanted. (The sandals have a multiple strength Silence spell embedded, and will muffle any sounds [including speech] made by the wearer to the whisper of a zephyr. The

dagger has a pommel, a 2" sphere of faceted clear quartz, which will begin to glow redly when anyone approaches within 15'.)

The casket is made from glass and will shatter easily. There is no other way to gain access. There is a 15% chance that the broken glass will cut Sharella's body. If any damage is done to her, Tsitsiconus will seek out and destroy those responsible for the sacrilege (this will probably require some time, and in an on-going campaign, will provide some interesting side-line adventures for those not under the threat of Tsitsiconus's displeasure; any involved in the actual vandalism will receive a series of 8D10 flame bursts, when Tsitsiconus catches up to them, until they are completely incinerated; there should be a 10% chance per month of this occurrence, with an additional 10% if the character is not in hiding).

LEVEL XII

Sharella's  
Personal Chambers  
(reconstruction)

To keep her memories always fresh in his mind, Tsitsiconus constructed this level as a near duplicate of her chambers in their mansion in Haven.

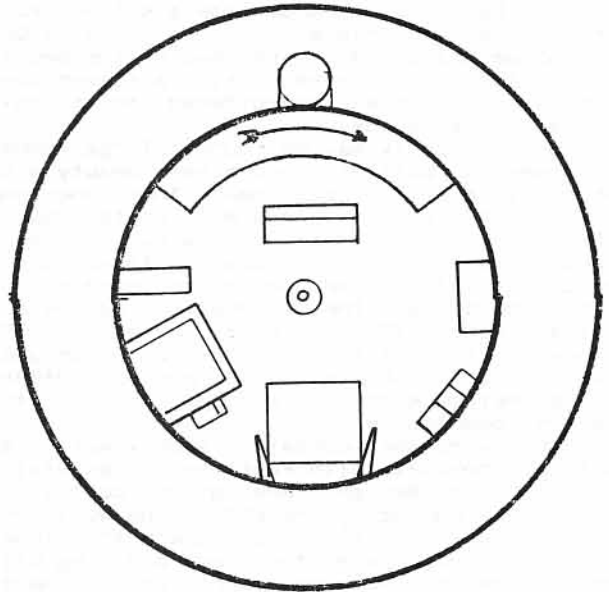

"Diagram of Level XII"

What the Players See:

The level is well furnished, and there seems to be an attractive young woman in residence; she appears to be moving around the level, attending to various duties. She can be seen sleeping, bathing, attending to her toilet, selecting clothing from the wardrobe and dresser, and sitting and reading.

Widdershins (counter-clockwise on the diagram) from the top of the ramp, there is a small cedar chest, a bathing pool of pink marble 8' long by 6' wide and 3' high, with a bench, also of pink marble, and a set of wooden steps, a magnificent bed, with a partial canopy hung from the ceiling, and, on

either side, a night stand, a chest at the foot of the bed, a mirrored vanity with a padded seat, and a large wardrobe. In the center of the floor may be found a brocaded divan, a comfortable chair, and a dresser with a hutch mirror (the small shelves at the sides of the mirror have assorted decorative knick-knacks displayed on them). The entire level is carpeted in a soft bluish-gray fur, very thick and very soft.

(If anyone inspects the ceiling, it will be seen that, in addition to the normal lighting fixtures, there is a large black ball about 3' in diameter affixed to the central beam, and completely centered on the level.)

Gamemaster's Description:

The large ball on the ceiling is a projector of a fully programmed illusion incorporating sight, sound, smell, presence, and touch; it was done for Tsitsiconus by one of his oldest friends, a powerful Master of Illusions. The full program requires about 6 hours. The young woman is Sharella (charmed men will have problems on this level too), but, since she is a programmed illusion, she will not notice the presence of the party.

The cedar chest near the pool contains toweling, and scents for the water in the pool. The pool itself is very similar to the one on Level V. The chest at the foot of the bed contains silken sheets and pillowcases.

The bedspread is made from a silvery fur, very soft and luxurious; it is valued at 4,000 GP and weighs 30 lbs. The head of the bed is in a light blue velvet, with a silver dove with wings outspread embroidered on it (this is Sharella's device).

On the vanity may be found a large number of cosmetic bottles, and other beauty aids (Sharella didn't really need them; when one has an APP of 21 and a MAG of 16, that's generally enough to entrance any man who isn't already dead [and mayhap some of those too]); there is a set of comb, brush, and hand-mirror worth 500 GP, and the various bottles are cut crystal worth 150 GP each; there is a 35% chance that a bottle is filled with perfume, 1D6 ozs. worth 1D10 x 1D10 GP per oz. Others are cosmetics such as lip-rouge, kohl for the eyelids, powders, etc.

The wardrobe contains approximately 50 outfits (complete with footgear) of exquisite quality and design; any given outfit is capable of enhancing the APP of the woman who wears it by  $[(20 - APP) / 2]$  (the better looking you already are, the less clothing will enhance beauty; however, poorly worn garments may easily detract from anyone's APP). These outfits are all of the quality demanded by the higher nobility.

In the dresser with the hutch mirror can be found accessories and feminine undergarments of incredible luxury. On top of the dresser is Sharella's jewelry case; it contains many different pieces (2D20), among which are a platinum and diamond tiara worth 15,000 GP, a butterfly brooch in gold, whose wings are set with multitudes of differently colored gem chips, worth 6,500 GP, a pair of diamond earrings worth 3,500 GP, and a fine bracelet-necklace (it may be used for either) of gold chain connecting pierced-work gold cages of rubies worth 8,000 GP. (For the other pieces, the value is  $[50 \times 1D10 \times 1D10]$  GP each.)

LEVEL XIII

Meditation Chamber

The heavy blue-green curtains surrounding the chamber promote peace and tranquility, and, Tsitsiconus hopes, acceptance of his loss.

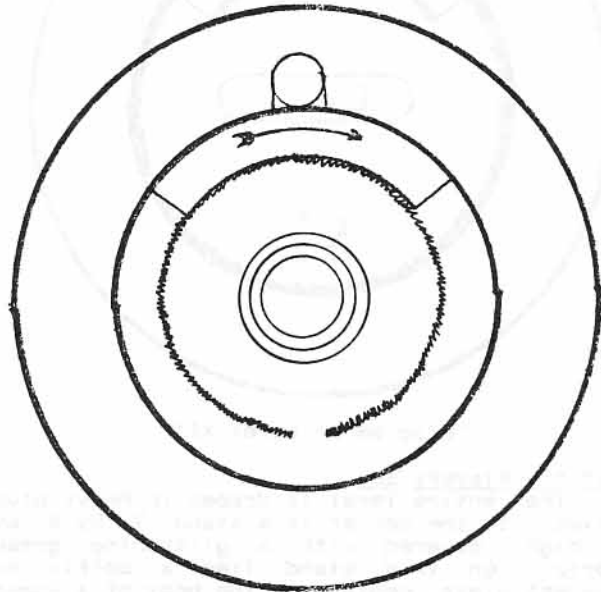

"Diagram of Level XIII"

What the Players See:

A floor to ceiling arras of sea-blue-green conceals most of the level from sight. The curtain parts opposite the elevator.

In the center of the floor is a three-tier dais, covered in the same color as the arras; the ceiling inside the enclosure is also draped in a blue-green cloth. The dais rises 2' from the floor, and the rings are 8', 6', and 4' in diameter respectively; the top is comfortably padded.

Gamemaster's Description:

This is a chamber for meditation; there is nothing of particular interest to be found here.

LEVEL XIV

Throne Room and Promenade

Twas a throne carved for two; now only one occupies the seat of the huge red stone.

What the Players See:

A large throne, seemingly carved from a single block of carnelian, occupies the center of the level. The level is completely open except for the back where the elevator is, and there are pillars supporting the level above. The inner circle of pillars is in blue marble, and the outer is in white.

On the arms of the throne may be found two items, a short 3' staff with a 1' diameter, 2" thick disc of clear crystal mounted at one end, and a belt, 4" wide, comprised of small (1" on a side) golden squares, linked together. On the seat of the throne can be found two large cushions, which fill the entire seating area.

A promenade extends 12' out from the tower, and is bordered by a palisade 3' high and 18" thick; these are of the same green marble as the tower itself. The view from the promenade is magnificent.

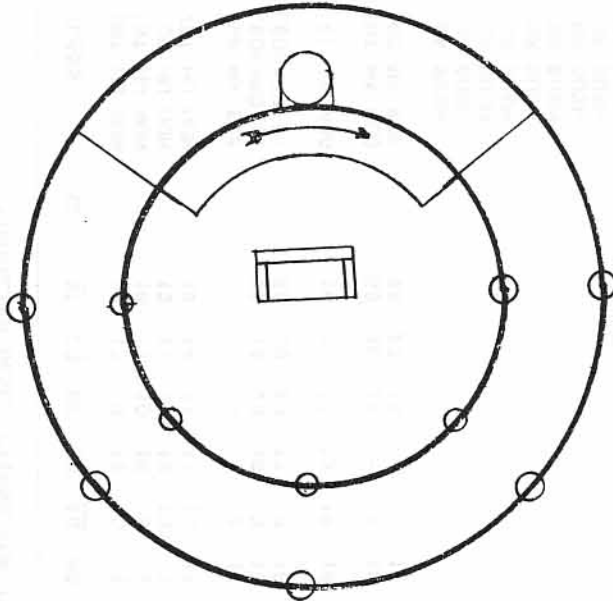

"Diagram of Level XIV"

Gamemaster's Description:

The two cushions are heavily embroidered with heraldic devices, one a silver griffin on a background of blue and gold diamonds, the other a silver dove with wings outstretched on a blue background. These are the arms of Tsi-tsiconus and Sharella.

The two items on the arms of the throne are indeed enchanted. The crystal disc, when focused on any scene in direct line-of-sight, will show a perfect 1/6 scale representation of that scene, no matter how far distant it may be; it cannot penetrate any barriers, only line-of-sight can be viewed in detail. The belt contains a 16-point missile repulsor spell (spears and javelins are 4, knives and quarrels 2, and arrows 1), and incidentally functions as an arcane raincoat in all but the heaviest downpours (which it will reduce to the effect of a gentle rain).

LEVEL XV

Astrological  
Observation  
Facility

On clear nights, the entire Zodiac may be described from this small but well-equipped observatory.

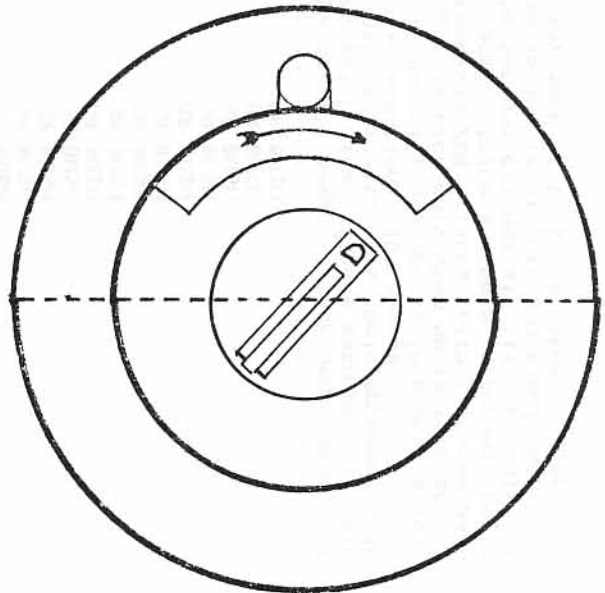

"Diagram of Level XV"

What the Players See:

In the center of the level is a raised disc of wood 6" thick and 12' in diameter. On this is a 10' long, 3' wide platform supporting a chair and a 6" diameter tube mounted so it can be easily swiveled up or down; at the end of the platform opposite the seat a golden arrowhead emerges from the wood. The rim of the outer disc is marked off in gradations (there are 360 major demarcations, with 60 lesser demarcations, every fifth one slightly longer, between each pair).

There are no beams for the ceiling here; the roof is a hemisphere of clear crystal, through which one may see the sky.

Gamemaster's Description:

The person sitting in the seat can control the direction the entire apparatus points in by simply thinking directions. This is a small but well constructed arcane version of Palomar.



CHARACTER DESCRIPTIONS FOR THE TOWER OF TSITSICONUS

CHARACTER NAME	CLASS	GP	ST	CO	RF	SM	IQ	MR	WEAPON	HACO	DAMAGE	WEAPON NOTES	ARMOR CLASS	HTK	RIDING ANIMAL
In The Gilded Plov	INT HU NON		12	13	9	12	10	8	HANDS	9	1D4		NON 0	23	
Hurkash Drythroath	INT HU NON		16	11	10	16	8	12	HANDSe	6	1D8		NON 0	31	
Jareth	GR HU NON		12	17	13	13	13	7	HANDS	5	1D4		NON 0	19	
Snanderbatch	VET HU NON		18	14	11	17	10	11	HANDSe	3	1D8		NON 0	37	
The Floating Eye	GR MX EYE		-	-	-	-	2	19	-	-	-		MAG 9	85	
Grimdal	LEOPARD(m)		22	19	23	16	3	10	CLAWS	3	2D4	(1)	FUR 8	59	
Bethla	LEOPARD(f)		20	20	23	17	3	16	CLAWS	3	2D4	(1)	FUR 8	65	
In the Tower	EL / E MAG		14	13	11	13	19	18	SPELLS	8	1D6	(2)	MAG 4	30	
The Servant	INT MX ROB		68	10	28	-	6	15	ARMS	2	2D5	(3)	PLT18	126	
The Librarian	GR MX ROB		28	23	18	-	7	11	HANDS	5	2D4	(4)	SCA13	53	
In the Maze															
"B" Tortoise	GR BUSH								SNAP	9	2D6		VEG 6	34	
"C" Rabbit	GR BUSH								KICK	10	2D4		VEG 6	22	
"D" Cobra	GR BUSH								STRIKE	6	1D6		VEG 6	27	
"E" Boar	GR BUSH								GORE	8	2D4		VEG 6	25	
"F" Swan	GR BUSH								SNAP	9	1D2		VEG 6	16	
"G" Raccoon	GR BUSH								BITE	10	1D4		VEG 6	20	
"H" Eagle*	GR BUSH								SNAP	8	1D6		VEG 6	16	
"I" Ostrich	GR BUSH								KICK	9	2D4		VEG 6	18	
"J" Wasp	GR BUSH								STING	7	1D6		VEG 6	15	
"K" Kangaroo	GR BUSH								KICK	7	1D3		VEG 6	19	
"L" Leopard*	GR BUSH								CLAWS	7	2D4		VEG 6	22	
"M" Musk Ox	GR BUSH								GORE	9	2D6		VEG 6	25	
"N" Clam	GR BUSH								CLOSE	-	1D8		VEG 6	34	
"O" Hippo	GR BUSH								STOMP	10	2D8		VEG 6	30	
"P" Stork	GR BUSH								RAPR	8	1D8		VEG 6	14	
"Q" Bee	GR BUSH								STING	9	1D4		VEG 6	16	
"R" Rhino	GR BUSH								STOMP	12	2D8		VEG 6	38	
"S" Griffin*	GR BUSH								SNAP	7	2D5		VEG 6	32	
"T" Hydra	GR BUSH								BITE	9	1D4		VEG 6	14/30	
"U" Weasel*	GR BUSH								BITE	8	1D6		VEG 6	26	
"V" Wolf*	GR BUSH								BITE	7	1D6		VEG 6	23	
"W" Lion*	GR BUSH								CLAWS	5	1D8		VEG 6	35	
"X" Tiger*	GR BUSH								CLAWS	5	1D8		VEG 6	40	
"Y" Yak	GR BUSH								STOMP	9	2D6		VEG 6	25	

- (1) The two leopards will never attack unprovoked. If provoked, they get 2 claw attacks each mr. If both claw attacks hit, they also rake their opponent with hind claws for an additional 2D8 damage.
- (2) Tsitsiconus will normally use spells in combat situations; the dagger is used only when he is trapped.
- (3) The Servant receives 2D6 attacks with its arms each mr. If two arms strike a single opponent, he is caught. If the Servant catches all its opponents, it will carry them to the front gate and eject them.
- (4) The Librarian may make up to six strikes in a mr.

The animals in the maze are immune to missiles and pointed weapons such as spears and rapiers, and take only 1/4 damage from blunt weapons. Only edged weapons give full damage (remember, these are BUSHES!!).

Fliers are able to fly. The bee, wasp, clam, weasel, and rabbit are gnat-sized versions. The clam can only close and do damage if a person is foolish enough to stick his hand, head, or torso into the clam (there is what appears to be a large pearl near the back of the clam). The hydra takes 14 points of damage to each of its 7 heads, and can sustain an additional 30 to its body; on any given mr, it will attack with (1D8 - 1) heads.

PICKPOCKETING SCENARIOS

AND

CUTPURSING ADVENTURES

A. THE DUKE'S DRESS BALL

Harden Sheerfall halted the team of horses when he saw the human-sized form lying crumpled and unmoving by the side of the road. Leaping down from the wagon onto the gravel roadway, he scrambled through the gathering dusk to the prone figure, who uttered a low moan as if in response. The other man was a pudgy, well-dressed gentleman of middle age; he was bleeding profusely from a deep wound across his forehead. Harden cursed as he removed a cloth from his pocket and clamped it over the wound; with his other hand, he withdrew a thin metal flask from his belt, and forced some brandy down the other's throat.

The older man gagged and roused briefly; his eyes tried to focus on Harden's face in the dim light, but could not. He gasped softly "Brigands -- gold -- must stop -- them". Harden muttered "Save your strength, friend", but he felt in his heart it was already too late. He dragged the now unconscious form back to the wagon, and lifted it with difficulty into the front seat. Clambering back aboard, he reached beneath the seat, and removed a small first aid kit. He quickly bandaged the still bleeding wound, and wheeled the team of horses at a gallop back in the direction of town. Harden felt certain that he was making the biggest mistake of his life; but he was a thief, not a killer, and he prided himself on that distinction.



Two miles later, when the victim's shallow breathing ceased, the whole point of his efforts abruptly became moot. Again he halted the wagon, this time along a flat stretch of farm plain, and took a stiff draught of the brandy. He could not risk continuing on to

town now, not with the price currently on his head and a dead man in the front seat of a stolen wagon. He would have to bury him here - and quickly, too. Still, he instinctively began to search the body of the victim, hoping against hope for some monetary recompense to justify his extravagant risk-taking. He was about to give up until he opened the other man's satin waistcoat, and felt the envelope and stiff slip of vellum that partially protruded from an inner pocket. Anxiously scanning the moonless night to assure that he was still alone, Harden decided to take one further chance and lit a torch. By its flickering light, he read the contents of the slip, not once but twice:



Duke Fernando di Cotillion,  
Sovereign Lord of the Free City of Haven,  
cordially invites  
Sir Edry Buwinban  
to a Dress Ball  
honoring the betrothal of his niece,  
Lady Madalena, Baroness Overbrook,  
to  
Beneadios Cellini.

Reception will begin at 8pm  
on the fifth day of Krios  
at the Duke's city estate.  
Guests are welcome to hospitality  
and lodging for the night.



Hands trembling, Harden hastily examined the name on the envelope: Sir Edry Buwinban, Master of Hamptonshire. He stripped the clothes from the still warm body, and dragged the corpse into a recently harvested field. Using a small shovel from the back of the freight wagon, he dug a shallow ditch, and laid the former master of Hamptonshire to rest. Turning back to the wagon, the new master of Hamptonshire was already calculating how many days of travel it would take to reach Haven. He had an appointment with destiny on the night of the 5th, and there was much to be done in very little time . . .

\* \* \*

In this adventure, player-thieves will use a purloined invitation like the one described above to gain access to the Duke's Ball. If the thieves design appropriate disguises, they will be able to move freely about; attempting to pilfer some of the fabulous jewelry items worn by the other guests. Players may choose to pickpocket these items one by one during the course of the night's festivities, or to try to locate the central repository where many of these prized possessions will be placed for overnight safekeeping.

If a pickpocketing adventure is selected, the thieving party should be limited to one to three player-characters (preferably with two portraying a husband-wife, brother-sister, or other related combination). If more players are present, they can be accommodated in one of two ways:

- 1) by sharing a thief character among several players, making decisions by group agreement, or
- 2) by having some of the players portray prominent NPCs in the adventure (and awarding them general EP for good role playing).

Any thief attempting the straightforward pickpocketing adventure should have a minimum 60% pickpocketing ability, and above average intelligence and discretion (the prime requisites for designing and sustaining a reasonable disguise). Characters of noble or guild upbringing will also have a natural advantage, for they will have a good understanding of the intricacies of court behavior, and be less likely to commit a fatal faux pas.

If, on the other hand, a full-scale heist is planned, the thief characters using their invitations to attend the party will likely require additional help. To provide such assistance, other gang members may gain access to the ball by other means (as servants, entertainers, etc.), or may be provided an entry to the estate by their confederates. Appropriate party size for such a heist would be 4-6 characters.

For the "inside" men on the job, disguise skills would be even more critical, for the character will likely be in attendance at the ball for the entire evening; but abilities in Lock Picking and Detecting Hidden Objects would assume greater importance than Pickpocketing skills. The "outside" gang members should provide added muscle and fighting skill to the party.

\* \* \*

The GM should be aware before starting to read through this scenario that this adventure is drastically different from a traditional dungeon delving expedition. There are no monsters hiding in the Duke's mansion, no vicious deadly traps at every intersection, and - except for the members of the Duke's personal guard - no "other side" directly doing battle against the thieves' efforts. The substance of the adventure will be the players' interactions with the other characters they meet, and their success will depend on their abilities to react quickly to opportunities that appear. And there will be many of these opportunities, because instead of having one or two NPCs capable of playing an active role in the course of an adventure, there are 54 active well-detailed NPC guests at this ball! So, please . . . take your time, and read completely through this scenario two or three times before you try to set it up -we think you'll find the Duke's Ball an exciting and enjoyable change of pace, well worth the effort!

## GENERAL BACKGROUND

The Free City of Haven, strategically located along the banks of the swiftly flowing Dorian River, was founded during the time of Allemande the Great to serve the two major overland trade routes of his realm. Over the years, Haven built on its centralized location to establish itself as a leading producer and seller of quality goods, and rapidly expanded its boundaries. The city was governed for years by the feudal aristocracy; but political and economic power has shifted in the last two centuries into the hands of a select number of Guildmasters whose goals are to foster the continued commercial growth of the city.

Duke Fernando is at present the last surviving male heir of the di Cotillion family, the traditional (and still titular) ruling lords of Haven City. Although many of the local nobles have actively and bitterly opposed the Guild leadership, and still seek to restore their own hegemony over the city's affairs, Fernando has vocally supported the new leadership, and has used that support as a powerful bargaining chip to retain political influence for himself and for his family. The fortunes of the di Cotillions have increased dramatically under the Duke's management, at the same time that many of the other great houses have lost much of their traditional wealth. Slowly, some of his noble peers have begun to recognize the two basic principles that reshaped Fernando's own thinking, his strong beliefs that a) regardless of who controls political power, the guildsmen have created a fundamentally more profitable economic structure, and b) that the nobles must learn to take advantage of that structure in order to survive. As a result, Fernando is again respected by all but the most rabid royalists, and his lavish social affairs are the most widely attended in the city.

Fernando has put a large portion of the family's money into the development of iron and silver mining enterprises, and used the profits from these initial ventures to move into the smelting and casting of finished metal goods. In this way, he first became acquainted with Salvatore Cellini, a fiery and extremely wealthy Guildmaster and disputably the best metal working artisan in the city. The Duke sought to further ensure his continuing political influence, Cellini to legitimize his family's claim to power beyond the skill of his own hands. Over time, the two agreed that it would be to their mutual advantage to unite their families, through a marriage between Salvatore's son and heir, Benedios, and Fernando's niece Madalena. Tonight's ball is in celebration of this event, with the nuptial ceremony scheduled to take place in two days.

Through the completion of this alliance is a result that brings joy to the hearts of the two responsible, some of the others involved are not so happy. Though Fernando did not have difficulty convincing his brother, Baron Tyndal, of the wisdom of the marriage (for Tyndal is not a strong man, and has frequently gone to Fernando in the past for financial favors, Madalena's mother, Baroness Marika remains convinced that mingling di Cotillion blood with that of a commoner is an insult and



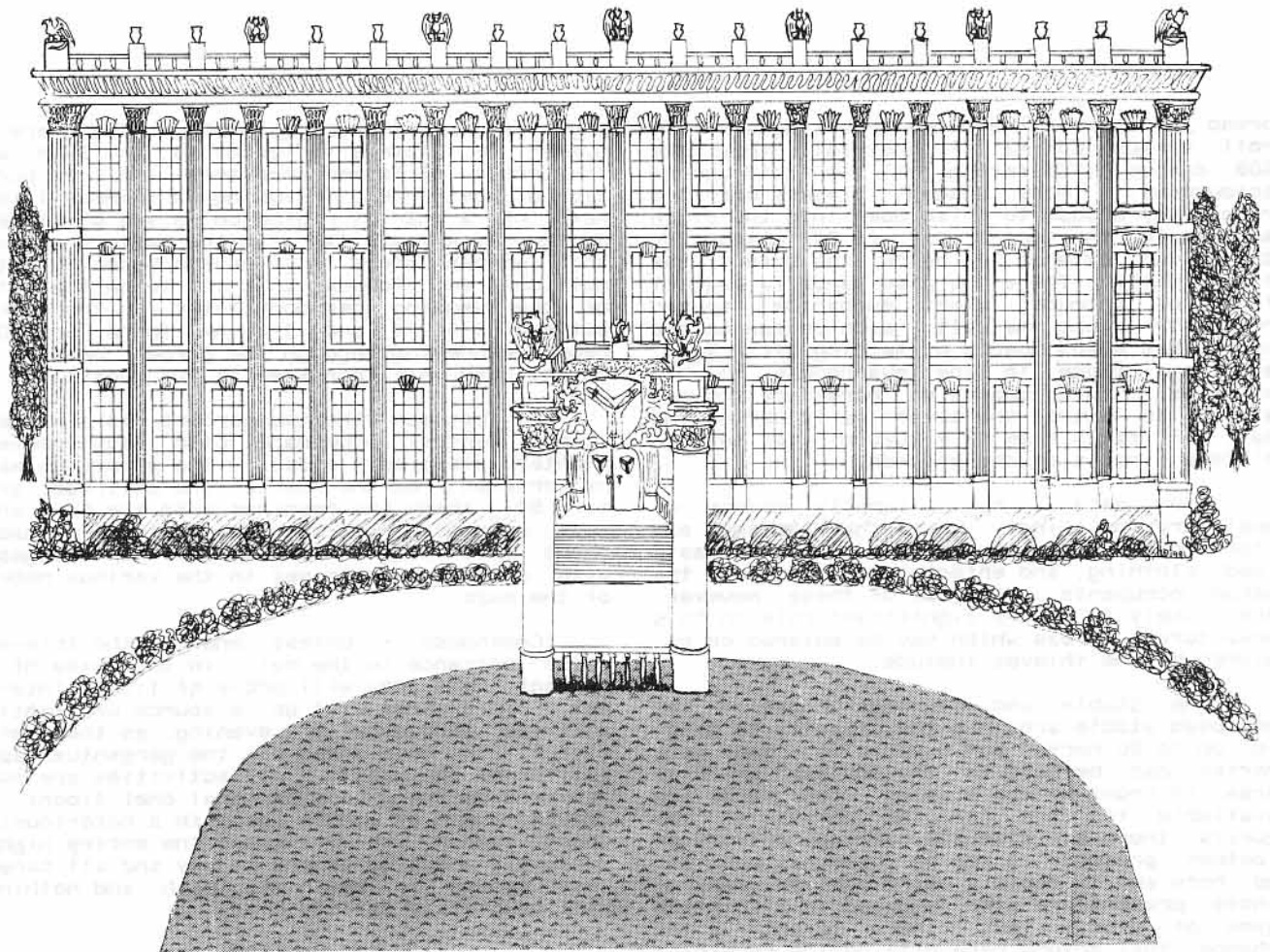

a mistake. At the dinner party preceding the ball, she left no doubts about these feelings, though she received a vicious upbraiding from Fernando in response. As for the bride herself, it is not the mixing of bloodlines that causes her drawn and pale countenance tonight. Poor girl! For alas, she loves another, the young nobleman Varkin, whose suit has been rejected because of his family's abject poverty. Thus, she longs only for the end of this evening, wondering if Varkin can possibly keep his promise to rescue her from this fate.

Meanwhile, across the great city, the lucky individuals (some 300 in all) with invitations to the ball, outfit themselves in their best finery, occupied with their own private thoughts. Most are simply looking forward to a pleasant evening of partying, an opportunity to taste wondrous delicacies and mingle with the high and mighty.

Others will come to the ball beset with their own personal conflicts - like Anson Blackbourne, threatened with exposure of a terrible secret that could jeopardize his political career; or Antonio Berensten, a young nobleman who has been a bitterly outspoken critic of Guild rule, but finds his thoughts consumed by visions of a beautiful Guildsman's daughter. These conflicts bring their own undercurrent of emotions to the events of the ball, and may themselves erupt during the course of the evening.

## THE DUKE'S ESTATE

### Front Gate, Grounds, and Auxiliary Buildings

The Duke's estate sits upon a gently rolling hillside, and is a completely walled 100 acre tract of land. There is but one main gateway onto the property, a double gate made of elaborately wrought iron marked with the ducal insignia. There is a square stone gatehouse on either side of the gates, which are connected by a rough granite archway. The gates are normally locked, but will be thrown open between 8 PM and 1 AM on ball night. Five guards will be on duty at the gate during that period: two standing in the roadway to verify invitations, one in each of the gatehouses, and the fifth (armed with a bow) standing on the archway. After 1 AM, the guards will have to manually open the gates to allow guests to depart (a situation sure to give a booty-laden thief cause for paranoia), and will not allow anyone personally unknown to them to enter the grounds.

The remainder of the estate is surrounded by a 30' high double wall. The first wall is of quarried stone, providing ample footholds for anyone attempting to scale it. There is a 10' wide ditch separating this wall from a second wall made of the same material; the latter wall is crumbling in a few places from age (it predates the first wall by almost 200 years). Characters may attempt to standing

broad jump across the ditch by making a saving roll versus CDN -3; if they fail, they take 4D6 damage (STM saving roll to avoid unconsciousness). More prudent players carrying ropes may choose to climb down into the ditch and scale the second wall (a 50' climb, for the ditch extends 20' below the base of the first wall). There are also Wards (a magical form of intruder alert mechanism) spaced regularly along the wall; each person on the walls has a 40% chance of setting off a Ward, alerting those in the guardhouse to his presence. Three guards on horseback are assigned to patrol the outer walls during the ball; it takes them 15 + 1D20 minutes to complete a circuit of the grounds.

The estate has literally dozens of auxiliary buildings, where the servants and staff of the estate provide for the basic food, clothing, and entertainment needs of the manor occupants. Very few of these, however, are likely to play a significant role in this adventure. Areas which may be entered or explored by the thieves include:

**The Stable and Carriage House** - The enclosed stable area has the capacity to handle up to 80 horses and 8 vehicles. Many more horses can be held in the enclosed exercise area in front of the stables. Ten grooms are available to care for the horses of the guests; there are also 2D6 carriage drivers or footmen present. A keg of beer has been set up here and is rapidly being emptied; many of those present are also engaged in a spirited game of dice. Thus, there is only a 15% chance that anyone here will notice something happening in the surrounding area (e.g., a thief successfully sandbagging a guest on his way to or from the stables), unless a great deal of noise is made.

**The Guard Barracks** - The barracks house, a long one story structure of stone, is about 50' south of the stables. At any time, it is likely that 50-80% of the off-duty guard can be found here, sleeping or relaxing between shifts. Intrusions are not normally appreciated.

**The Gardens** - The grounds immediately behind the mansion are surrounded by a 10' ivy-covered stone wall, and are subdivided into three garden areas. The West Garden is a true formal garden patterned in a series of regular ovals, and populated with elegantly trimmed hedgerows and a variety of late-blooming flowers. A large stone fountain sits in the center of the garden; a temporary canopied stage has been erected in the NE corner. Between 8 PM and midnight (unless otherwise noted in the timetable), 3D20 guests will be seated or standing near the stage area, watching the entertainments provided; another 3D6 people will be strolling the gardens. Between midnight and 2 AM, there will be 2D12 guests in the West Garden, and there is a 30% chance that 1D6 couples will be contentedly spooning here long into the night. Entrances to the West Garden are symmetrically set into its eastern and western walls.

The East Garden is more informally arranged, with long winding flagstone paths that wind their way through stands of fruit trees,

dogwoods, and flowering shrubs. There are a number of statues (tributes to the Gods, or likenesses of former ancestors) in this portion of the garden, including an immense likeness of a chariot riding on a sea of flame, driven by a young lad. In the eastern end of this garden there is a gazebo bedecked with multicolored flowers; this is to be the site of the wedding ceremony later in the week. Between 8-9 PM and 1-3 AM, there are 2D6 people wandering through the garden; between 9 PM and 1 AM this increases to 3D8 guests.

In between the two gardens is a hedge-lined central promenade, with flower boxes planted along both sides. The promenade may be entered from the rear of the ballroom; after 50', there are openings onto the East and West gardens. At the end of the promenade there is a lover's maze of well kept hedges, with several benches set in the various nooks of the maze.

**Cookhouse** - Unless one of the thieves gains entrance to the ball in the guise of a servant, this area will prove of little interest. This area will be a source of frantic activity throughout the evening, as the chefs attempt to keep ahead of the gargantuan appetites of the guests. All activities are supervised by the Duke's personal chef Atoni, a greying human of middle age with a notoriously short temper. He will spend the entire night furiously shouting orders to any and all careless enough to be in his path, and nothing will completely satisfy him.

#### THE MANSION INTERIOR

Four types of information are provided in the room descriptions that follow:

- 1- What the player sees,
- 2- GM's description,
- 3- Special furnishings and contents, and
- 4- Population, if any.

Furnishings and their arrangement seldom change, but the population of an area normally changes with the hours and is so noted.

#### THE FIRST FLOOR

##### A) Entryway and Guard Room

1- The front doors of the manse are immense double doors of polished bronze embossed with the Ducal coat of arms; they are thrown open during the course of the ball, but will be shut and locked at 2:30 AM. The doorway empties into a 20' wide passageway, lit by two enormous crystal chandeliers; there is an opening immediately upon the righthand wall that leads into a small office containing a desk, four chairs, and a strange looking apparatus of crystal.

2- The room to the right is the Guard's day room, the centralized location used by the duty sargeant to receive reports from current patrols. The entryway is lined with paintings depicting great moments in the di Cotillion heritage.

3- The set of linked crystals mounted into the guard room wall are Voice Teleportal units

that can be used to communicate with a) the guard barracks, b) the Duke's sitting room, and c) the front gate. They are used in cases of emergency to relay information or call for assistance. They are of no value if removed unless their corresponding units are also stolen (in which event each pair is worth 1500 GP).

4- The entrance passageway will be bustling with activity throughout the evening (2D8 people passing through at any time). There will be 2 guards stationed in the guard room for the entire evening, with a change of personnel at 2 AM; the captain and the sergeants charged with patrolling the interior of the building will be found here whenever they are not making their half-hourly patrols.

#### B) Drawing Room and Informal Audience Chamber

1- A spacious sitting room with velvet curtained windows and a stone fireplace in its eastern wall. There are two couches and four chairs set about the room, all upholstered in blue or gold satins. There is also a high-backed chair of mahogany, adorned with finely carved detail and covered with crimson velvet embroidered with gold and platinum threads; there is a small side table beside it.

2- This room is normally used on occasions when the Duke wishes to consult informally with visitors. Tonight, with its fireplace blazing cheerily and its relative seclusion from the main focus of activity, it is primarily occupied by young lovers wishing to share a few private moments without braving the cool autumn evening. The uniquely styled chair is the one that Fernando occupies during his meetings in this room.

3- The chairs are of excellent quality, but aren't going anywhere. In the single drawer of the table (locked, complexity level 1), there is a supply of parchment bearing the Duke's emblem, quills, and a small candle used for sealing wax; there is also a small porcelain box half-full of snuff (worth 120 GP including contents).

4- Between 8 and 10 PM, there is a 45% chance that the room will be empty, otherwise there will be 1D5 people present. After 10, there is only a 15% chance that the room is empty, and it otherwise will be occupied by 1D4 couples.

#### C) Museum and Trophy Room

1- This room, located between the parlor and the salle d'armes, can be reached through doors at either end of its west wall. It is filled with a wide variety of family memorabilia sitting in glass cases, mounted on pedestals, or hung from the walls. The items constitute a truly unique selection, including the pickled head of a medusa and the stuffed head of a cave bear, a fully preserved horse, an assortment of weapons and medals, a bejewelled goblet and ceramic bowl, and a suit of young boy's clothing.

2- The museum contains a number of interesting items. The cave bear head is mounted on the wall and was a trophy acquired by the Duke's

grandfather on a hunting expedition. The medusa's head was brought back by the Duke himself during his adventuring days; he has never told anyone how he obtained it. The horse is the steed he rode during his service in Prince Beragond's cavalry, magically preserved; his lance and pennon are also on display. The goblet is richly bejewelled, and was used on the occasion of a great treaty signing; it is worth 35,000 GP and is kept in a glass case trapped with an alarm (which rings in the guard room [A]). The ceramic bowl is also encased, but of sentimental rather than monetary value (400 GP).

Finally, there are two rather unique magical items in the room. The first, the boy's suit of clothes, is more than 350 years old; its only magical attribute is that it will never wear out. The clothing is being saved for the Duke's son, if the Duke ever has a son. The second item, a sword in a scabbard, is the infamous Sword of Fraeddus Ta'hr. This sword, one of the dwarven weaponer Marildo's less successful efforts, was designed to be a Sword of Dancing -- unfortunately, what actually resulted was a Dancing Sword, capable of doing the cha-cha, the tango, and even the Aztec two-step, but totally inept as a fighting weapon. The sword even hums a little song to itself while it is in use (worth 20 GP, or 200 GP to someone with a really sick sense of humor).

3- As listed above.

4- There will be 1D6 people browsing through the museum between 9 PM and 11:30 PM; at other times there is an 80% chance of 1D3 visitors. A single guard is always on duty here, stationed at the G on the floor plan (see the Maps section at the end of this book).

#### D) Salle d'Armes and Armory

1- Double doors lead into a 30' by 70' room, with mats lining the floor and several pieces of light exercise equipment along the north wall. In the back of the room there is a padded dummy with a rapier clenched in its hands. There are two doors along the south wall; both are closed.

2- In this room the guardsmen practice their weapon skills and maintain their physical training. The dummy is an automaton used for weapons practice; it becomes activated if touched by a weapon, or if the weapon it holds is touched. Once activated, the dummy continues to fight until its opponent can land a blow to its head or chest area. The doors lead to the armmaster's quarters and to the armory. The armmaster is present in his room, and between 8 PM - 1 AM there is a 60% chance that he will come out to speak with anyone who enters the room, proudly showing off the facilities they have available. The doors to the armory are locked (level 3 complexity); there are 3 enchanted (+2 to hit, plus 1D4 to damage) broadswords in the supply of 80 in the room; there are also 24 maces, 50 longbows, and 30 quivers of arrows stored here.

3- The enchanted blades are valued at 1200 GP each; they can be identified by using a Detect



Magic spell, or an expert swordsman will have a 30% chance of recognizing these swords by their feel. The armstrong has a small box hidden beneath his bed that contains 140 GP in coins.

4- There is a 40% chance that there will be 1 (01-28 on the die roll), 2 (29-36) or 3 (37-40) persons in the room, with the additional possibility that the armstrong is present.

#### E.) Steward's Office and Quarters

1- These rooms can be entered through either a double door on the north wall, or a single door on the east wall. The room is covered with wood paneling, and contains a desk and a set of hardwood cabinets that cover most of the eastern wall. Doorways in the western wall lead to a staircase and a set of living quarters.

2- In this office, the steward Harchens manages the household affairs of the mansion. The drawers of his desk are filled with the typical details of his office - receipts, bills and other records, names and addresses of local tradespeople, etc. There are also 5 letters of credit in the Duke's name, worth 2,000 GP each. In the middle of the Southern wall there is a secret panel -- it slides back to reveal a safe with two keyholes in it. The two locks are Level 3 and Level 5 complexity, respectively; the steward keeps one of the keys in his desk, and Fernando keeps the other in his private rooms. The safe is alarmed, but the alarm will not be set until the door is opened (so that Trap Sensing rolls before that point will not be successful). The alarm, which is located in the wall below the safe, is tripped whenever an object breaks the plane of the safe's door; it can be deactivated by a third key kept by the ranking guardsman on duty, or by a thief making a successful detrap roll (at 1/2 normal abilities, for it is a Level 2 trap).

3- The safe contains Carn-ne-Seval's sceptre of power, and Tarquinio Alder's wedding present to Madalena (both described in the individual descriptions of these characters). In addition, there are 3 class B items of jewelry belonging to the Duke's family (all with a notoriety of S); 1 A and 2 C jewelry items belonging to the von Vogelsangs, and a piece of C jewelry belonging to Marika di Cotillion.

4- There should be no one present in the office during the ball. The steward's wife will be in the inner room after 10 PM, trying to sleep; there is a 40% chance she will be wakened by an intruder in the office (unless the latter specifies and successfully makes a Moving Silently roll); if wakened, she will call out (several times if unanswered), but will not enter the office.

#### F.) Game Room

1- A room filled with various gaming tables to test the physical or mental skills of their participants. There is a billiard table (the newest gaming sensation from the East), a dart board, and four marble inlaid gaming tables. Doors lead from this room into the ballroom,

the library, the east corridor, and the east gardens.

2- The gaming room is a place of high conviviality during this evening, and sometimes of high and serious competition. The billiards table is a matter of great interest, though very few know exactly how to play. On the gaming tables, contestants may be seen playing fox and hounds, backgammon, or shaturanga (a four person game that was a precursor of chess).



3- The billiard balls (3 red, 1 white) are made of ivory and are worth 15 GP; the cues are of inlaid ebony and worth 200 GP. There is a beautifully carved set of pieces used for shaturanga (a four color set made of ivory, carnelian, jade, and polished basalt - 32 pieces in all). Each piece is worth 50 GP, but a complete set would be worth 2500 GP.

4- There will be 3D10 guests in the game room between 8-12 PM; after midnight, when the arm-wrestling contest is taking place, this will rise to 5D10. There will be one guard stationed in the game room from 8 PM to 2 AM.

#### G.) Library

1- An enormous room, 55' x 120', with more than 2000 books and scrolls lining all four of its walls. In the NW corner, there is a librarian's desk and chair, with a set of wooden cabinets built into the wall behind it; in the center of the room, there are four huge tomes on stands and a huge globe. There is also a comfortable reading chair and a scribe's desk with slanted top in the room; in the SE corner, there is a stairway, but it is blocked by a bolted gate. There are double doors in each of the four walls.

2- The Duke's library is well stocked with a collection of religious, historical and geographical tomes. The encrypted key to the location of the various tomes is kept in the top drawer of the librarians' desk; a character has a 5% chance of deciphering the code for each point of INT he possesses above 14.

The most valuable volumes are kept under lock and key in the wall cabinets; the locks are Complexity level 3, and the keys to fit them are on a ring kept by the librarian in her room (see First Floor plan for location of her room). The four huge tomes each weigh 50-60 lbs; one of them is the Canticle of Fire, the holy book of the Sun God sect. The scribe's desk contains a good supply of quill pens, ink and vellum. The staircase is locked (complexity 5 lock) and trapped with a Tanglefield spell (MGR saving roll or no movement possible for 10 mr). The stairway leads to the Duke's private chambers, and the Duke has the only key.

3- Most of the books in the library have a value of 5-30 GP each; those in the locked cabinets are worth 100-300 GP. The materials available in the scribe's desk are of above average quality, but are otherwise unspic-tacular.

4- There is a 75% chance that 1D6 people will be browsing through the shelves at any point in the evening. For 15 minutes between 11 and 11:15 PM, all the doors to the library will be locked from the inside.

#### H.) The Ballroom

1- The ballroom is an awesome architectural feat, 200' long and three stories high, with ornate dwarven stonework in its walls and ceiling, and a polished, patterned wood dance floor. The room is a sea of dancing and mingling people. A 30 piece orchestra plays from a platform on the second floor; elsewhere on this balcony, threescore personal servants stand awaiting their masters' commands from below. Regularly spaced wood shields bearing the Duke's device line the walls of the first level; in the southern end of the room, there is a raised dais bearing the ducal throne.

2- Lighting and sound amplification in this room are provided by magical means. Between 8:30 PM and 10 PM, all guests entering the ballroom for the first time will be formally announced by Harchens, the steward, and then descend the velvet-carpeted stair to the floor, where they will be received by the families of the bride and groom-to-be. (This alone may unnerve a thief unsure of his ability to carry off his disguise, and any unnatural actions on his part may rouse the suspicions of Harchens [see Servants listing under the character descriptions].)

There are four guards stationed around the hall, and servants with trays filled with food circulating through the room. The shields on the walls are enchanted with the noise amplification spells that transmit the orchestral music to its dancing audience. The Duke's ceremonial sword is laid across the seat of the throne; two of the guards keep guests away from the dais and throne.

3- Since touching the sword is almost a sure bet to get you bruised and beaten by the guards (if not worse), the only items worth stealing are attached to the various guests in the room.

4- In addition to the four guards and the servants who are constantly present, there will

be 2D100 other people in the ballroom (with an absolute minimum of 50 at any time before 12 PM) until 1 AM, and 4D20 thereafter. While the orchestra is playing, 20-50% (10 + 1D4x10) of the ballroom occupants will be dancing.

#### I.) Formal Dining Room

1- This 50 x 150' room is dominated by two objects: a very long table of mahogany, with gold leaf inlaid on its legs; and a mosaic mural that covers the west wall from waist height to ceiling. There is a high wooden hutch filled with pewter dishes on the northern wall.

2- The table has been moved back from its normal central position in the room, to allow people to move freely about. On the table are three serving trays of sterling silver, laden with various delicacies. There are also two large punchbowls of cut crystal, with matching cups. The mural portrays important scenes from the di Cotillion family history and includes many significant events from the early years of Haven.

3- The trays are worth 350 GP each, but are engraved with the di Cotillion emblem; the punchbowls are worth 425 GP each, and the cups 8 GP each. The hutch contains plates, cups and saucers, and bowls; individual pieces would be worth 10-15 GP, while a complete place setting would be valued at 75 GP.

4- There will be 2D20 guests in the dining room between the hours of 8 PM and midnight; and 3D8 after that point. During the first period, 40% of the occupants will simply be entering briefly to grab a bite of food; later in the evening this percentage will drop to 10%. There are also 2 guards present in this room between 8 PM-2 AM.

#### Second Floor

There are four stairways connecting the first and second floors, as detailed on the map below. The stairwell in the library is locked; the other three each have two guards placed on the second floor landing. Only those who have arranged to lodge at the mansion for the night will be allowed to continue upstairs to the third floor (since the stairway from the steward's office does not extend up to the third floor, all guests climbing this stairway will be turned back). No one outside the Duke's immediate family (Kataleyna, Elise, or Castillia) will be allowed access to the second floor, unless they are accompanied by one of the aforementioned. The doors to the chambers on this floor are all locked, and only the family members and the ranking officer currently on duty have keys; the locks are Complexity level 4; and are hooked to alarms in the guard room (no penalty to trap disarming attempts). We believe these security measures should be adequate to protect the lives and personal belongings of the Ducal family; and have therefore not detailed the contents or floor plans of these rooms. If the GM chooses to allow his players to broach these carefully planned defenses, it is his option to generate the treasures that will be found.

### THIRD FLOOR

There are 58 guest rooms on the third floor of the mansion, of assorted shapes and sizes. All contain either 1 or 2 beds (comprised of a goose down mattress and a straw tick), a wash basin, and a dressing table with mirror. 3 sets of rooms have been converted into linked suites; each of these has a well-furnished sitting room and a fireplace as well as 4 or 6 bedrooms. If the thief decides to stay at the mansion for the night, he or she will be assigned to Guest Room #58 (if a second thief participates in this adventure and also stays, use Room #22 as a second choice). The following rooms on this floor will be occupied sometime during the night of the ball.

#1 - The acrobat is taken here after his fall. He does not stay in the room for long (see timetable, and character description under Entertainers). No additional contents.

#3 - Erich and Marta von Vogelsang's rooms. Both have heavy leather traveling cases. Erich has a pin embossed with the family insignia (C,S) and a pair of gold cufflinks (C,N) kept in the room; Marta a pair of jade earrings (D,N), and a matching bracelet (C,N). If the acrobat has managed to enter this room, Marta may notice that her items are missing when she retires for the evening at 2:20 AM. Erich will return to his room blind drunk at 4:20 AM, escorted by a member of the guard.

#5- Room of Flame Master Carn-ne-Seval. Seval has three small cases in his room; each, however, is protected by a Blaze of Noon spell (MGR saving roll -4, or blinded for 1D8 hours) if opened by hands other than his own. In addition to his vestments and incenses, the cases contain a headband with a sunburst emblem on the front (in zircons and rubies,C,Y), and two armlets of filigreed gold (C,S); he also has a gold cloth purse with 20 x 2D10 GP in it in coins and small gems. He will go upstairs to his room at 3 AM but will not go to sleep, instead preparing a ritual for the coming dawn.

#8- One of the unidentified guests is billeted here. He has a locked wooden chest, containing a purse with 5D10 GP in it, and a platinum brooch with small quartz chips (D,N). He will retire at 1:10 AM.

#17- Donia Savonna's room. She has left a small leather make-up case, and a small roll of parchment which contains a number of crude sketches of trees and buildings.

#18- Margery Savonna's room. She has a small leather case crammed with a variety of rouges and scents (there are six small perfume bottles, in various degrees of fullness; each contained 200-250 GP of perfume when full). At 12:30 AM, she will come up to her room and leave her large leather handbag behind; it contains a purse with 1D100 GP in coins, and a crumpled and dirty bank draft note worth 600 GP.

#20- Another unidentified guest (young female noble). Traveling chest items include a

sequined silk scarf (50 GP), and a bottle of good brandy (half full). She will return to her room at 12:45 AM (30% chance she does not return alone); she is wearing 1 C and 1 D value item of jewelry (hair combs, bracelet).

#28 and #29 - Rooms occupied by Harz and Claudia de la Riis. After staying late into the evening, the elder de la Riises decide to remain at the mansion instead of driving back to their country estate. Consequently, there is nothing unusual in these rooms until they retire for the night at 2:45 AM.

#32- High Judge Cardallo is brought up here at 3 AM, after his gout and drunkenness combine to incapacitate him. He will remain clothed, and spend the night either passed out or throwing up.

#34- Suite occupied by Tyndal, Marika and Madalena. Their four traveling cases are kept under a table in the sitting room and include the bulk of Madalena's clothing, in preparation for her planned move to the Cellini city estate. In Tyndal's room there are two letters of credit, worth 500 GP each, signed by the Duke.

#36- Portia Maggia's room. No additional contents until she retires at 3:15 AM; she wears the bracelet mentioned in her character description to bed with her, but leaves her other possessions on the dressing table.

#39- Arden and Alyra's room. There are two elven traveling cloaks of excellent quality left in the room; when worn, they block out 80% of the adverse effects of bad weather. No other unusual contents.

#42- Tarquinio Alder's room. Tarquinio has brought along five rather weighty tomes (on subjects like astral projection, herbology, etc.). Each might be worth 250 GP to the right buyer; they weigh 7-10 lbs each. He also carries a substantial supply of medicinal herbs; which he has been using to treat his stomach ailment (a pinch in a cup of tea adds 5% to a character's chances of recovering from a disease).

#53- Hulee Packard's room. In it are his purse (1D12 GP; like we said, times are hard) and a notebook filled with maps planning a new expedition route (the route is one fraught with high risks, but offering an equally high payoff if successful).

#56- Unidentified guest. Purse (empty) in traveling case; its contents (50 x 1D8 GP in gems) and a silver medallion (D,N) are hidden under his mattress (will be missed by the acrobat if he enters here).

#58- The room assigned to the thief. If the thief drops off any purloined prizes here before midnight, there is a very good chance that they will be in the hands of the acrobat by 1:15.

All other rooms contain the contents identified at the beginning of this page, and nothing more.



## CHARACTER DESCRIPTIONS

This section contains detailed descriptions of 55 NPCs likely to be encountered during the Duke's ball. For each character so described, four categories of information are provided:

- 1) GM's description of the character;
- 2) Character's physical appearance, as seen by the player;
- 3) Character's personal possessions; and
- 4) Character's special features.

In describing the personal possessions of these guests, letter codes are used to identify three facts about each item: a) the location of the item on the character's person, b) the relative value of the item, and c) the relative notoriety of the item. The ID codes used for each of these categories of information are listed below.

### Location

CH - chest	LW - left wrist
CP - coat pocket	NK - neck
HD - head	RA - right arm
HP - hip pocket	RH - right hand
LA - left arm	RL - right leg
LG - both legs	RW - right wrist
LH - left hand	VP - vest pocket
LL - left leg	WS - waist

### Value

A - very expensive	500-50000 GP (D100 X 50)
B - expensive	800-8000 GP (2D10 X 400)
C - good	200-2000 GP (2D10 X 100)
D - fair	150-900 GP (3D6 X 50)
E - inexpensive	10-200 GP (2D20 X 5)
F - facsimiles	.5-50 GP (D100 X 5SP)

### Notoriety

- N - not well known
- S - some notoriety (25% chance that any fence within 200 miles will recognize item as hot; see Fencing Stolen Goods section of TG1 for effects)
- Y - very notorious (70% chance that fence will recognize item as hot)

Following these detailed descriptions, general information is provided on other types of characters that may be encountered - guards, entertainers, servants, or uninvited guests. All relevant statistical information on the major characters in this scenario (fighting abilities, requisite characteristics, states of drunkenness, likely location) is presented in the Character Description table at the end of this scenario.

## THE NOBILITY

### THE DI COTILLION FAMILY

#### Gamemaster's Description:

The Duke's current household consists of his fiery consort, Lady Katalayna, his daughter by an earlier marriage, Elise, and an older recognized bastard daughter, Castillia of Argonne. The Duke has been heard to complain half-seriously on more than one occasion of the trials of living with three women; and certainly the strong wills of Katalayna and Elise are enough to test any man. These two

often live in an uneasy truce, competing for Fernando's attentions; occasionally they may unite to concoct mutually rewarding schemes. Castillia is frequently mocked or excluded by the other two, but remains content with her good fortune in being here.

Tyndal, Fernando's brother is an indecisive man, and this hesitancy has cost him greatly in his financial dealings. He has never been able to refuse his generous but overpowering brother, although his wife Marika has often demanded that he do so. His daughter Madalena, the unwilling pawn in this wedding gambit, felt herself completely trapped and alone upon arrival; she now senses a possible bond of kinship with Castillia, and has begun to hope of getting her freedom.

#### Physical Appearance

- A) Duke Fernando - A handsome, stocky middle-aged man with a full black beard and steely grey eyes. He is dressed entirely in black, highlighted with silver. Invariably debonair and charming around members of the fairer sex, he has a calm and regal bearing when dealing with the politically important.



- B) Lady Katalayna - A slender lady of great grace, with red hair and a temper to match. Half-elven, she is well aware of her physical allure, and how to use it. She is extremely jealous of any who might threaten her present position. She is dressed to complement the Duke's outfit, in a low-cut sleeveless silver lame gown with black accessories.
- C) Elise - A young girl of fourteen, just approaching the full blossoming of her womanhood, and already very cocky and headstrong. Elise has dark, shoulder length curly hair, and a dark complexion; she wears a crimson gown with silver

brocade. She is always looking to be the center of attention, and is still capable of throwing tantrums if she doesn't get her way.

- D) Castillia - A girl of sixteen, with dark straight hair, blue eyes, and a sunny disposition. She wears a gold satin gown with black velvet piping and matching sash.
- E) Baron Tyndal - Heavy-set man in his late thirties, with a square jaw, brown hair, and a nervous tic in one eye. He wears a long rust-colored tunic trimmed with fur, and black leather belt and boots with elaborate buckles. He has a slumped posture, and a drink in one hand at all times.
- F) Baroness Marika - Her plump, pale face already shows the ravages of age. She wears a soft white linen wimple around her head to hide her double chins and greying hair. Her blue gown of fine imported wool is somewhat old-fashioned in style and is adorned at the waist by a long girdle of embroidered linen. She carries a lace handkerchief that sees frequent use during the course of the evening.
- G) Madalena - A tall young woman, with long blond hair partially drawn up under a blue velvet cap. She wears a floor-length gown of white velvet and satin with blue piping and pearls embroidered at neck and wrists. She appears shy around all the strange guests, and very fidgety.

#### Personal Possessions

- A) Fernando
  - 1- Coronet carved from ebony, inset with five evenly spaced rectangular pieces of silver-white moonstone feldspar, each in turn set with a pair of tiny diamonds (HD,A,Y).
  - 2- Ducal signet ring, made from a lead-silver alloy, enchanted with a permanent Repulse Missiles spell (RH,B,Y).
  - 3- Three other rings - of black opal, moss agate, and diamond, all in silver settings (LH/RH each C,N).
  - 4- Diamond miniature replica of a sceptre (CH,B,N).
  - 5- Ornamental baton studded with rubies (WS,C,S).
  - 6- Black cloth purse (HP,2D10GP).
- B) Katalayna
  - 1- Hair combs of obsidian with matching snowflake markings (HD,D,N).
  - 2- Black star sapphire pendant mounted on a silver fleur de lis, and hung from a heavy silver chain (NK,A,S).
  - 3- Matching rings of black pearl triplets (LH/RH, B pair, SS).
  - 4- Silver reticule (LW, 2D8GP).
  - 5- Silver shoe buckles (LG,E,N).
- C) Elise
  - 1- Clip earrings of silver lion's heads, with ruby eyes and an opal dangling from its mouth (HD,D,N).
  - 2- Ring set with a black star beryl (RH,C,N).
  - 3- Gold bracelet, with seven paste diamonds (2nd level fake; LW,F,N).
  - 4- Hair combs of bronze and gold, with tiny glass rubies (2nd level fake [-5% to detection chances]; HD,E,N).
- D) Castillia
  - 1- Black obsidian pendant in the shape of a heart (NK,E,N).

- 2- Mother of pearl hair combs (HD,E,N).
- 3- Matching copper bracelets with glass emeralds (LW/RW,F,N).

- E) Tyndal
  - 1- Necklace of gold and multi-colored irregularly shaped pieces of coral (NK,E,N).
  - 2- Silver belt buckle embossed with family insignia (WS,D,Y).
  - 3- Knee and shoe buckles of gold (LG,D,N).
- F) Marika
  - 1- Wedding band of finely worked gold, a family heirloom (LH,C,N).
  - 2- Necklace of yellow and brown topaz on a thin gold chain (NK,D,N)
- G) Madalena
  - 1- Gold necklace, exquisitely crafted, of miniature gold roses with pearl centers -- a gift from her father-in-law to be, Salvatore Cellini (NK,B,Y).
  - 2- Small bronze ring with the di Cotillion arms (LH,E,S).
  - 3- Silver ankle bracelet, a gift from Duke Fernando (RL,D,N).

#### Special Characteristics

- A) Fernando is an inveterate womanizer, and is very likely to "set his cap" for any woman present who has an APP of 15 or greater.
- B) Katalayna - The Duke's dalliances are likely to ignite an outburst from Katalayna, who is very insecure about her position in the household. She has been trying for months (with the Duke and any other available man) to establish herself permanently by producing a male heir for Fernando, who as yet has none. If she succeeds, she is sure that the Duke will marry her.
- C) Elise is very careless with her possessions, and may lay down her earrings or bracelet if the jewelry begins to hurt.
- D & G) Madalena has broken down and confided in Castillia, telling her the entire story of her secret lover. Castillia has promised to aid Madalena's elopement attempt and the two will stay together for much of the evening. This will eventually pique Elise's curiosity, and she will start to tag along, asking questions and being a general nuisance.
- F) Marika is wholly opposed to letting her daughter marry outside the nobility; she will be openly hostile to the Cellini family throughout the ball.

#### THE DE LA RIIS FAMILY

(GM's note: In this and other family descriptions, an asterisk next to a name means that particular family member is not present at the ball.)

#### Gamemaster's Description:

The de la Riis, like the di Cotillion, are one of the oldest noble families in Haven. Their line boasts an outstanding military heritage, and many of their land holdings are the spoils of war. The current patriarch of the family is Count Tybalt von Bremenwald, 70; his senile younger sister, Grazia, lives with him on the family's country estate. Tybalt has four surviving children - Harz, 50, his eldest son and heir (married to Claudia, with three adult children, sons Paul and Thomas and daughter Cortina); Sir Bruning, 45, knight

and warrior (recently remarried to a 22 year-old gypsy woman, K'maill, he has a daughter of 20, Ingrid, by his previous marriage, and a bastard son\*); Rutmilla, daughter, 40, (married to Clemente Panfusille\*, a member of the Citadel Guard of Haven); and youngest son Morgan, 34, also a haughty member of the Citadel Guard (married to Astrilde\*, with 10 year old son Carlo and newborn daughter Bismunde\*).

The de la Riis are deeply divided among themselves these days over two internal family conflicts. Paul has become a rabid leader of the Young Stallions, a group of young nobles dedicated to returning political control of Haven to the aristocracy; he views his father as a fool for acquiescing to the hegemony of the Guildsmen, and is openly hostile to Harz. Since young Paul is the apple of his grandfather Tybalt's eye, tensions become further exaggerated by frequent arguments between Tybalt and Harz. The second family crisis revolves around Bruning's hasty courtship of, and marriage to, the ravishingly beautiful commoner K'maill, a woman but two years older than his daughter. Ingrid is intensely jealous of her new stepmother, and she and Rutmilla (who is envious of K'maill's beauty) have spread rumors that K'maill has used some sort of gypsy witchcraft to gain and hold Bruning's affections (these rumors are completely false). Bruning, always publicly reserved and quiet, seems able to ignore this malicious gossip; but K'maill, who at first was in awe of her new relations, has become frustrated by such unjust treatment and is beginning to fight back.

#### Physical Appearance

- A) Tybalt - An older man of small stature with shaggy, shoulder-length white hair, a broad nose, and a crooked scar across his lower lip. Dressed in a light blue, leather-belted tunic, with a dark blue satin cloak; wears a silver coronet studded with amethysts on his forehead.
- B) Grazia - Frail and small white-haired woman, with cataracts on her eyes and hands twisted by arthritis. Walks unsteadily, but will not use a cane; will almost certainly be seated if encountered. Wears a simple, unadorned long lavender gown, and a fur cloak wrapped tightly around her shoulders.
- C) Harz - A husky, broad-shouldered man of medium height, with grey-streaked dark hair and a deeply furrowed, careworn face. Wears a dark-green fur-trimmed tunic and soft brown leather boots.
- D) Claudia - A tall spare woman with sharp angular features and a thin oval face. She uses excessive make-up, perfume, and a tightly bosomed gown in a vain attempt to hide the effects of age on her former beauty. Her long brown hair is pulled back from her face to display a matched diamond necklace and earring combination; her floor-length gown is of light yellow silk, high waisted and sashed, with elaborate lace trim on the high neckline and long sleeves, and a long train.
- E) Paul - Young man of medium height, clean-shaven with dark, elaborately pomaded hair, and lively dark eyes. Well built and very handsome, he has a haughty bearing that exudes self-confidence. Wears a white

lace-trimmed silk shirt, grey leather breeches and black fur-trimmed boots. Also wears a dark green velvet swordsman's cloak, with an emblem of a rearing white horse on its back, and a matching broad-brimmed velvet hat with a feathered plume.

- F) Thomas - Sandy-haired, with brown eyes and his father's broad features. His attire is a carbon copy of his brother's, except that the garments look awkwardly suited to his taller, more gangly frame. Subject to asthmatic coughing spells when he exerts himself physically.
- G) Cortina - Small and somewhat chunky, with long, upswept brown hair and hazel eyes, and a slightly crooked but enticing smile. Dressed in a low-cut, sequined gown of green chiffon, loose-fitting from the waist down and elaborately ruffled.



- H) Bruning - Stocky, sandy-haired man whose robust appearance belies his age. Square-shouldered, with a very formal military gait. Wears a long sleeved dark brown tunic adorned with several awards, and a heavy bronze-studded leather belt.
- I) K'maill - A voluptuous, raven-haired beauty who stands almost as tall as her new husband. K'maill has very expressive green eyes, long lashes and full, pouting lips painted a deep crimson. Her ankle-length gown of cloth of gold is sleeveless and outrageously low-cut, and her arms are covered with multi-colored bracelets. She moves with a natural, feline grace, now tempered with a touch of intentionally brazen exhibitionism.
- J) Ingrid - A well-proportioned young lady of medium height, with curly, shoulder-length auburn hair, pale complexion and green eyes. She seldom smiles, for her facial appearance is marred by poorly-spaced teeth. Wears a white taffeta gown with a finely embroidered lace shawl around her shoulders, and silver cloth slippers.
- K) Rutmilla - A big-boned, very homely middle-aged woman with straight sandy hair (worn forward to cover disproportionately large ears), a broad flat nose and two moles on her chin. Built more like a linebacker than a beauty queen, she walks slump-



- shouldered and with an extremely heavy step. Wears a long loose-fitting dress with a dark blue embroidered bodice, and a parti-color skirt of blue and purple satin.
- L) Morgan - Tall but slightly built, with a plain face adorned by a well-kept Van Dyke beard, and very bushy brown eyebrows and sideburns. Wears the scarlet and grey uniform of Haven's Citadel Guard. Moves about incessantly, exhibiting a great deal of nervous energy.
- M) Carlo - The young lad is dressed in a brown velvet shirt and tan corduroy breeches, with white leggings, black shoes and silver buckles. He is thin and frail, with an unkempt mop of brown hair, and very round peering brown eyes. His left arm is severely withered and hangs uselessly at his side.

#### Personal Possessions

- A) Tybalt
- 1- Silver coronet studded with small amethysts, symbol of the de la Riis land rule (HD,B,S)
  - 2- Pair of matched daggers with inlaid mother-of-pearl handles in black leather scabbards (WS,D,N). Also carries a regular throwing knife in the sleeve of his cloak.
  - 3- Leather purse (HP,2D10GP)
- B) Grazia
- 1- Large turquoise pendant carved in the shape of a flower, mounted in silver and hung from a heavy iron chain (NK,E,N).
  - 2- Thin bronze headband, covered with a garland of assorted wildflowers and fragrant herbs (HD,F,N).
- C) Harz
- 1- Large gold ring engraved with the family device, and surrounded by five small emeralds (LH,C,Y).
  - 2- Small green jade medallion carved into a woman's profile, hung from a silver chain; it contains a miniature portrait of Claudia holding the infant Paul (NK,E,S).
  - 3- Ceremonial long knife with a handle carved from black jade (WS,E,N).
  - 4- Cloth Purse (IP, 3D12GP).
- D) Claudia
- 1- Ring set with with a deep yellow topaz stone (RH,D,N).
  - 2- Thin circular ring of banded serpentine (LH,E,N).
  - 3- Matched diamond set - necklace, earrings, and ring - all clever facsimiles; treat as 7th level for detection (HD/NK/RH,F,N).
- F) Paul and Thomas
- 1- White ivory brooch of a horse's head (NK,E,Y).
  - 2- Golden belt, knee, and shoe buckles (WS/LG,E,N).
  - 3- Ceremonial broadsword (WS,E,N)
  - 4- Hickory walking sticks, also with horse-head design (LH,E,S).
  - 5- Belt pouch (WS, Paul 2D8GP, Thomas 5D10GP).
- G) Cortina
- 1- Large, flat aquamarine pendant cut in the shape of a C, hung from a silver chain (NK,D,N).
  - 2- Matching hair clips of white opal (HD,E,N).

- H) Bruning
- 1- A shortsword emblazoned in gold leaf with the insignia of the house of Kveklan, held in a velvet-lined metal scabbard (WS,D,N).
  - 2- Bronze armband studded with emeralds, embossed with a picture of a mounted lancer (RA,D,S).
- I) K'mail
- 1- Earrings of pinkish coral, in a shell pattern (HD,E,S).
  - 2- Assorted armlets of quartz, nephrite jade, and glass (LA/RA,E,N).
  - 3- Diamond wedding ring (RH,C,N).
  - 4- Gold ankle bracelet, with clasp in the shape of two tiny crossed swords (RL,D,N).
- J) Ingrid
- 1- Pin in the shape of a sailing vessel, made from onyx and dyed chalcedony (CH,E,N).
  - 2- Bracelet of small yellowish pearls (RA,D,N).
  - 3- Lace mantilla (NK,D,N).
- K) Rutmilla
- 1- Wedding ring of purple amethyst (RH,D,N)
  - 2- Paste tiara of moderate quality (treat as 3rd level fake [-10% for detection purposes]; HD,F,N).
- L) Morgan
- 1- Silver pin with two small garnets, symbolizing ten years of service in the Citadel Guard (CH,E,Y).
  - 2- Leather purse (HP, 2D6GP).

#### Special Characteristics

- B) Grazia - After 11PM, there is a 10% chance that Grazia will confuse any young male she meets for her lost son Porcassio, and will make an enormous scene. After 12PM, chances rise to 30%.
- D) Claudia - Loves to gossip, and will be an attentive hanger-on if she overhears any provocative conversation. Anything she hears of interest will be known by at least 10% of the ball-goers within an hour.
- E/F) Paul and Thomas - Will travel in the company of the other Young Stallions for the entire evening, and pointedly ignore their father. May become involved in a scuffle with Romano Maggia (see time schedule).
- H) Bruning - Is being wooed by Duke Fernando to take the job of captain of his personal guard. Bruning is not interested in such a sedentary duty, but does not wish to offend the Duke.
- I) K'mail - Seeks to prove to the crowd that her new husband is completely devoted to her. At 11:30 PM in the ballroom, when her tormentor relatives are nearby, she will fall into a well-rehearsed swoon, counting (rightly!) on her husband to rush to her aid. This could provide a few moment's diversion for a thief, if used properly.
- M) Carlo - Boy has minor precognitive abilities (i.e. he has visions of events a few moments in the future). If a thief is operating within 10-15 feet of Carlo, there is a 75% chance that he will know what is going on. Carlo's likely response will be to approach the thief with his knowledge, seeking either a piece of the action or training in the thieflly art.

## THE GERONDE FAMILY

### Gamemaster's Description:

The Geronde are an old aristocratic family that have actively joined the new merchant class. Lady Rowena, Baroness Windemere, is an Enchanter of magical items, and owns the largest (by far) establishment providing such services in the city. She is a shrewd businesswoman and a hard bargainer, and has single-handedly restored the family's financial resources to their former greatness. She remains aloof from the Nobility-Guild struggle, judging each individual by character rather than rank. She is grudgingly respected by most in the community, but is rumored to be hard to get along with.

Rowena's husband died ten years ago, leaving her with the responsibility of caring for his deaf-mute brother Udral\*. She has four children: Karl, the eldest, already an intermediate level Enchanter in his own right; Valma\*, a married daughter; Gunter, a member of the Young Stallions; and young Adrienne, tomboyish and exceptionally bright. The family is not close-knit, save for Karl and Adrienne, for Rowena's mind has often been preoccupied with business.

### Physical Appearance

- A) Rowena - Tall and stately woman in her mid-forties, more regal than beautiful, with dark hair and grey eyes. Hair is bound up under a blue veil held in place by a silver coronet; her gown is dark blue satin with pearl trim and a high neckline.
- B) Karl - In his late twenties, Karl is very tall and thin, with a long bearded face, angular jaw, and prominent nose. Dressed simply in a long grey tunic, and a dark blue velvet cloak fastened by two handsomely crafted copper clasps. Easy going, smiles often; very good listener.
- C) Gunter - A thin, dirty-blond haired lad of twenty, Gunter wears the recognized outfit of the Young Stallions - the black leather boots, and green swordsman's cloak with the white horse on its back. His tunic is of lighter green silk, with a mahogany-colored leather belt.
- D) Adrienne - A young girl of sixteen, tall but full-bodied, with a thin aquiline nose and long, dark hair. Her dark green cap matches her eyes; the gown of the same color is embroidered with gold latticework on the cuffs and shoulders. She is likely to gently nag Karl to take her home early.

### Personal Possessions

- A) Rowena
  - 1- Coronet set with sapphires and pearls (HD,B,Y).
  - 2- Silver pendant set with a large sapphire, on a strong silver chain; magically enchanted (see below; NK,B,S).
  - 3- Plain gold wedding band (LH,D,N).
- B) Karl
  - 1- Copper cloak-pins in serpent shapes, with ruby eyes (NK,D,N).
  - 2- Similar serpent-knot design embossed on a bronze belt buckle (WS,D,S).
  - 3- Large silver ring with small sapphires, carved in the shape of the family arms (LH,R,S).

4- Belt pouch - contains a very small sum of money, and a magic item (see below; WS,C,N).

- C) Gunter
  - 1- Ivory stallion brooch (CH,D,N).
  - 2- Hickory walking stick (RH,E,N).
  - 3- Shortsword and scabbard (WS,D,N).
- D) Adrienne
  - 1- Necklace of banded serpentine, with an ivory unicorn hung as a pendant from it (NK,D,N).
  - 2- Open silver ring with a fire opal, containing a Daylight spell (RH,D,N).

### Special Characteristics

Rowena's medallion Detects and Discerns Magic within 100' of her. If held by anyone other than her, it becomes unbearably hot after sixty seconds and must be dropped. Karl's purse contains a tiny Wizardly Lock device that allows anyone possessing it to lock any door, etc., and to unlock and reverse such a spell at any time.

MATHILDE HOCHRITTER

### Gamemaster's Description:

A somewhat plump middle-aged woman with short-cropped, greying blond hair, a double chin, and a prominent mole on her left cheek. She is garbed in traditional "widow's weeds" - a black satin gown with a long train, veil and black velvet slippers. In spite of this, she is also elaborately bejeweled from head to toe.

### Physical Appearance

"The widow Hochritter" has been mourning her late husband Stephan for 16 years, and with each passing month, her fond memories grow more elaborate - though when he was alive, she sang a different tune. The Hochritter's fortune has been greatly dissipated in recent years, and many of the family's valuables have been sold off; consequently, much of what Mathilde wears are clever imitations. Mathilde has one son, Zender\*, who is an extremely hot-tempered member of the Young Stallions, and refused to attend the ball tonight; the subject of her son invariably flusters Mathilde, and initiates another sorrowful round of "If only Stephan were here . . ."

### Personal Possessions

- 1- Filigreed wedding band from "dear Stephan", dwarven-made of intertwined gold and silver (LH,C,N).
- 2- Pendant, headband, bracelet, and 3 other rings of paste diamonds and sapphires (treat as 8th level fakes [-35% to detection chances],F).

THE SAVONNA FAMILY

### Gamemaster's Description:

The Savonna family has long owned one of the largest tracts of good farming land in the area of Haven; and this fertile ground still yields an excellent profit each year. The dowager Lady Margery duMond Savonna leaves the handling of the estate's affairs to male cousins and uncles, preferring as always the faster-paced life of the city. She spends her afternoons at the Golden Ducat, chatting with out-of-town noble guests; she makes it her

business to follow all the comings and goings around town. Margery had two daughters by her first husband: the oldest, Willetta\*, is a priestess of the city's Earth Mother cult, while the younger, Donia, lives in Margery's imposing shadow. The family still has money to burn and Margery is doing her best to burn it. She does not understand her daughter's shy, retiring manner at all, and nags her incessantly to be more outgoing (often in public). Donia will act like a total wallflower for the entire evening, even if approached (see below).

#### Physical Appearance

- A) Margery - An immense woman, with a booming voice; she wears a shoulder length strawberry blond wig over her sparse brown hair, and has sparkling grey eyes and a gap-toothed smile. She is clad in an extremely loose, tent-like lilac gown, with amethysts sewn into its brocaded pattern. A profusion of jewelry - everything but the proverbial kitchen sink - adorns her costume.
- B) Donia - A very plain young woman, with lifeless straight brown hair worn under a brown velvet cap, and a haunted look in her evasive brown eyes. Her dress is a biege satin, with lace trim, long sleeves, and a high sash. She speaks with a stutter that becomes pronounced in the company of men.

#### Personal Possessions

- A) Margery
- 1- Obsidian hair combs flecked with ruby chips (HD,C,N).
  - 2- Enormous dangling diamond earrings (HD,B,S).
  - 3- Necklace of a half-dozen immense sapphires. Each is set in a teardrop-shaped piece of beaten gold, surrounded by small amethysts, garnets and tourmaline; the teardrops are hung from a thick collar of white gold (NK,A,S).
  - 4- Large, circular diamond on a deep purple velvet choker, lined with tiny yellow pearls (NK,A,S).
  - 5- Matching 2" gold bracelets, set with diamonds and emeralds (LW/RW,B,S).
  - 6- Three rings on each hand, all gold and silver with enormous settings of rubies, diamonds, or emeralds (LH/RH, each B,S).
  - 7- Lavender silk reticule (LW,2D10GP).
  - 8- Blond wig (HD,D,N).
- B) Donia
- 1- Small gold ring in an S-shape, set with a single pearl (RH,C,N).

#### Special Characteristics

- A) Margery has three notable features. First, she is scatterbrained, and frequently leaves her possessions behind as she flits about the ball. Second, because of her incredible pudginess (which has increased since her husband's death, through that hardly seemed imaginable) her bracelets and rings are very difficult to remove (reduce normal pickpocketing abilities by an additional 20%). Finally, Margery has a vast store of trivial knowledge about almost any noble family within a 500 mile radius of Haven; consequently, she is very quick to loudly comment on any misinformation given by a thief impersonating a noble (give her a +6 to intelligence for purposes of

determining Disguise effectiveness). If she catches the thief in a lie, she will quickly relate this peculiarity to others, making it perhaps wise for the thief to begin looking for the exits.

- B) Donia is painfully nervous around men of her age group, and stutters horribly in their presence. Nonetheless, she is desperately starved for affection, and any kind word or gesture from another will make that person a friend.

#### ANTONIO BERENSTEN

#### Gamemaster's Description:

Antonio is a young nobleman who has been "fostered" to the household of a local aristocratic family to complete his education and training. For the past three years he has been a leader of the Young Stallions movement, a charismatic Pied Piper, vociferously condemning the rule of the great guilders. Now he finds himself torn, for his heart has been stolen by Marita Maggia, daughter of one of the city's Guild leaders. In recent weeks he has become quiet and brooding, and begun to spend much of his time away from his formerly inseparable companions. This has caused a number of heated arguments, particularly between Antonio and Paul de la Riis, though the Stallions do not suspect anything about his affections for Marita. Tonight, although he has come in the company of the Stallions, he hopes to find a way to see Marita alone, and profess his love. During the course of the evening, he will be confronted by Marita's twin brother Mano, who suspects what is going on.

#### Physical Appearance

Antonio has a muscular build, long shaggy blond hair, and a bushy moustache. He wears the green cloak emblazoned with the emblem of the Stallions, and a gold long-sleeved tunic and blue breeches. He is outwardly calm, but drums his fingers nervously against his sword belt as he walks.

#### Personal Possessions

- 1- An ivory brooch of a horse's head (NK,E,Y).
- 2- Silver cufflinks with monogram AB (LW/RW,D,S).
- 3- Pendant in the shape of a golden claw, hung from a thin bronze chain (NK,D,NO).

#### Special Characteristics

In his confrontation with Mano, Antonio will attempt to avoid a fight at all costs, although his friends will be egging him on, hoping to teach the hot-blooded Maggia a lesson. Later on in the gardens, Antonio will leave a message for Marita, and if received, the two will meet later in the evening (see timetable).

#### PRINCE HARRULD

#### Gamemaster's Description:

Prince Harruld, heir to the rule of a semi-barbarian province at the edge of the southern hill country, was traveling through town and caught wind of this evening's festivities. Never one to miss a party, he arrived unannounced and unexpected, and only the swift intervention of Fernando prevented a wild brawl between Harruld and the half dozen



guardsmen at the gate (it is likely that Fernando was merely protecting the health of his men). The prowess of Harruld's tribesmen in war is long renowned in legend, and none wish to incur their wrath. Unfortunately, legend also tells of their Herculean proclivities for drink and wenching; here too they do not exaggerate. Harruld will spend the night and early morning consuming every potable in sight, between rather crude forays into attempted seduction. He will remain until the last guest passes out, and even willing maidens cannot satisfy his gargantuan appetites.

#### Physical Appearance

Harruld is shaggy maned, rangy and well-muscled; His jaw is square, and a day's growth of beard darkens his face. He has a booming voice, and an infectious laugh (at least he'd call it infectious -- if he laughs, you'd better laugh too). He wears a long woolen tunic with fur trim, heavy boots, and a grey woolen cloak.

#### Personal Possessions

- 1- A necklace made of enameled bone fragments from wild animals, strung on a thick iron chain (NK,E,N).
- 2- A headband containing an enormous gemstone of golden beryl -- a focus to store the sun's power (HD,C,N).

#### Special Characteristics

This guy isn't strange enough for you already?

#### GUILDSMEN, MERCHANTS, AND CITY OFFICIALS

#### THE CELLINI FAMILY

#### Gamemaster's Description:

Salvatore Cellini was the second son of a struggling blacksmith, an unlikely candidate for great wealth and stature. As an apprentice to a silversmith in a small seaport city far south of Haven, he showed remarkable talent and craftsmanship, and his works (purely through chance) caught the eye of a local noble Baron Addressa. From the moment the patronage of Baron Addressa began, Cellini produced some of the greatest examples of metalworking skill in the memory of man. As his fame grew, so did his prices, and his skyrocketing wealth gave him the independence to write himself a ticket to anywhere in the world. It is not surprising that he chose to relocate in Haven, the city where the strength of the Guild movement had reached its apex, or that, within two years of his arrival, he had seized leadership of the powerful Artisans' Guild. Unsurprising, that is, to all but the dwarven craftsmen who had traditionally wielded that power, and who believed the work of the brash interloper to be no better than their own. . . . Thus did the raging feud over control of the city's artisans begin, a rancorous battle marked by underhanded trickery on both sides, and one that shows no signs of ending.

Salvatore, it must be fairly said, represents virtually everything that is wrong with the nouveau riche. He is pushy, crass, and totally oblivious to the dictates of chivalry -- a street fighter made king by his creative gift. Everything he owns is the

height of ostentatiousness, an attempt to make up for lost time. His son and likely successor, Benedios, has inherited his brashness, but only a fraction of his skill. Thus, Salvatore has decided to vouchsafe his family's future by arranging a marriage that allies him with the traditional great houses. Though he is hard-hearted and ruthless in his business dealings, he is intensely loyal to his family and ignores their flaws. His brother Nicolo, a profligate spendthrift and incompetent card cheat, has relied on Salvatore to pull his irons out of the fire on several occasions. Benedios himself is no bargain, carrying a large chip on his shoulder as a result of his small stature. Daughter Vecchia is still a tomboy at seventeen, ill at ease in the high society life her family thrusts her into. Only wife Linnea causes no problems; she is a steadfast partner who keeps Salvatore's spirits high.

#### Physical Appearance

- A) Salvatore - A somewhat plump middle aged man of small stature, with wavy brown hair worn swept back from his forehead and pomaded, and dark darting eyes. His fingers are extraordinarily long and supple for a man of his size, and are adorned with oversize rings. Wears lush oversized robes of purple and crimson velvet, and a huge medallion of intricately worked gold and jewels; smokes a pipe incessantly.
- B) Benedios - A very short (4'11") young man, homely of face and with oily skin that perspires heavily. Dressed all in gold, with a vast assortment of decorative ribbons and buckles; he wears a long flowing cape and carries a heavy blackthorn walking stick shod with gold on both ends.



- C) Nicolo - A slender, dandified gentleman of late middle age, with dark hair silvering at the temples and scarred, gnarled hands. A man of frequent mood changes -- can be boisterous, then turn serious and introspective in a matter of moments. Wears a white silk shirt with elaborate lace trim, and a sleeveless coat and breeches of black velvet.
- D) Linnea - Though in her late thirties, Linnea shows no signs of age; she has a magnificent mane of mahogany hair, wrapped up about her head in a gold mesh cone. Extremely fair complexion, and green eyes; wears an orange satin gown with a flowing train.
- E) Vecchia - Tall, tomboyish girl with no figure to speak of, and short dark hair with reddish highlights. Dressed in a long-sleeved satin gown, with a violet skirt and white bodice, and gold slippers; she looks extremely uncomfortable in her finery.

#### Personal Possessions

##### A) Salvatore

- 1- Intricately detailed medallion depicting an artisan at his bench, adorned with small chips of rubies and emeralds (NK,A,Y)
- 2- Four gold rings set with purple sapphires, morganite beryls, rubies, and greened amethysts; all the gemstones are large, and the settings of a delicate filigree (LH/RH,B each,S)

##### B) Benedios

- 1- Walking stick (LH,C,N)
- 2- Ornamental buckles on shoes and stocking tops each with unusually rich detail (LL/RL,C,S)
- 3- A collar of beaten gold, with engraved depictions of a warrior in an array of battle scenes (NK,A,Y)

##### C) Nicolo

- 1- Brooch of a triplet of pearls set in gold (NK,C,N)
- 2- Walnut walking stick with a mother-of-pearl handle (RH,D,N)

##### D) Linnea

- 1- Gold mesh cone with platinum clasps, studded with rubies (HD,B,S)
- 2- Earrings in the shape of tiny pixies, filigreed wings, each holding an opal in its hands (HD,B,S)
- 3- Necklace of interlocking geometric shapes, interspersed with red and orange gemstones (NK,A,Y)
- 4- Belt of beaten gold octagons (WS,B,N)

##### E) Vecchia

- 1- A magnificent cap of gold wire net, with golden roses and leaves interweaved in its mesh (HD,A,Y)
- 2- Matched pair of filigreed bracelets, each over 4" wide, and worn tight over the sleeves of her gown (LW/RW,B,S)
- 3- Pendant of white gold rimmed by a ring of black opals, with a raised diamond encrusted V in its center (NK,A,Y)

#### Special Characteristics

- B) Benedios will be extremely overbearing in trying to impress his bride-to-be, especially in attempting to play up his physical skills. These efforts may be dealt a severe blow if he should be cornered by the Young Stallions, who are likely to taunt

him ruthlessly. In such an event, father Salvatore is liable to come to his aid by summoning the Duke's guard to intervene.

#### THE BLACKBOURNE FAMILY

#### Gamemaster's Description:

The Blackbourne family first made its fortune through the importation of fine fabrics; they have now expanded into other aspects of the clothing trade (dyeing, tailoring, and retailing). The family patriarch, Hamlin, is an incredibly vigorous man of sixty whose sole love is now his work. His extensive trade networks bring him the latest in fashion concepts, and he has the good sense to hire the best clothiers in the city to produce these innovative designs. He has three sons: Anson, the eldest, who is adroitly learning both how to manage the business and how to make use of the family's considerable political clout; Marcus\*, apprenticing as a cloth trader; and Gladiolus\*, a ne'er-do-well who is his father's shame. Only Anson is married, to Talia Corio, whose uncle is master of Haven's Builders Guild; they have one young daughter, Amatheia\*.

Hamlin is a very austere man, who views formal occasions with great disdain. His son is much more politically aware, and normally uses occasions like this to expand his ever-widening group of well-placed acquaintances.

#### Physical Appearance

- A) Hamlin - A small bald man with a nagging cough and darting watery eyes. Wears a somewhat worn, out-of-style blue satin jacket and breeches. Very stern demeanor (almost never laughs or smiles).
- B) Anson - Pale-complexioned, with prematurely thinning blond hair; not physically strong. His dress, as always, is a tasteful advertisement for the latest Blackbourne fashion styles; tonight he wears a grey velvet vest and breeches, a rust-colored lace trimmed shirt with elaborate cuffs, and a jeweled walking stick. Normally polite to all, and very friendly toward those whose influence he covets, tonight he seems restless and distracted (see below).
- C) Talia - A rail-thin young woman with straight long blond hair and placid doeish eyes. Dressed in a yellow and green parti-color gown of satin, with high bodice, long flowing sleeves and a lace collar. She blushes easily, and gets very giggly when tipsy.

#### Personal Possessions

##### A) Hamlin

- 1- Watch on a long platinum neck-chain, with a cover of beaten gold; the timepiece itself is exceptional in the accuracy of its craftsmanship (NK,B,N)

##### B) Anson

- 1- Walking stick with diamond inset inommel, and several small jewels set along its length (LH,C,S)
- 2- Octagonal silver belt buckle, with personal inscription on its obverse face (WS,D,Y)
- 3- Pin and cufflink set, each a small pearl set into a replica of the Guild of the Loom insignia (NK/LW/RW,C,Y)



- 4- Silk drawstring purse with false bottom (VP, 650 GP in gemstones)
- 5- Gold wedding band (LH, D, N)

C) Talia

- 1- Hair combs of tiger's eye (HD, E, N)
- 2- Ring of orange-red zircons in a gold setting (LH, D, N)
- 3- Clip earrings of amber, with a tiny leaf inside (HD, B, N)
- 4- Belt of interlocked bronze ringlets, worn low on the hips (WS, D, N)

Special Characteristics

- A) Hamlin - Is a teetotaler, and not at all fond of music. He will be found in either the dining room or gardens, most likely engaging one of the out-of-town guests in a conversation about fashion.
- B) Anson - Is being blackmailed by Alarkon, the owner of Magic Books & Scrolls (described later in this section). The latter has evidence linking Anson to a young trollop recently found strangled in the South End, and wants a 2000 GP payment to keep silent. Anson is hoping (futilely) to talk Alarkon down to 500 GP; if that fails, he has enlisted the services of an assassin, Galena Cordovan, who is at the ball in her everyday guise as a chamber musician. Anson and Alarkon will meet in the library and fail to reach an agreement (see timetable). Anson will then signal Galena to proceed, and go out into the gardens, where he will sit and drink alone and miserable, rebuffing even the well-intentioned inquiries of his wife.
- C) Talia - Knows nothing of her husband's extramarital affairs, and loves him deeply. At the time she is rebuffed by Anson in the garden, she will already be quite drunk (having a very low capacity for liquor). His gruffness will greatly depress her, and she will return inside, continuing to drink; if encountered after this point, there is a 60% chance she will break down

into a crying jag on the other person's shoulder, desperately seeking solace and attracting some degree of attention from others in the vicinity.

THE MAGGIA FAMILY

Gamemaster's Description:

The Maggia family is one of the oldest Guild families, and its members are engaged in diverse activities throughout Haven (and, it is rumored, on both sides of the law). Of the nine brothers, sisters and cousins of the current generation, three have made the greatest mark -- Gilberto\*, Master Winemaker and fiery strong-willed head of his Guild (ill and unable to attend); sister Portia, a learned scholar of philosophy and successful spice trader; and Prospero\*, owner of a large grain mill, and reputed to be a major figure in the Black Hand underworld organization. Gilberto and Prospero are not speaking to one another, since Prospero claimed that the family has forsaken its roots by moving into the Heights and adopting a flashier lifestyle.

Gilberto's eldest children, the twins Romano and Marita, are also at the ball. "Mano", at eighteen, is already well-advanced in his wine-making apprenticeship, and has exhibited an uncommon intuitive skill for producing top quality products. He is impatient and quick to anger, however, and jealously protective of his sister. He believes (correctly) that Marita has been eyeing the Young Stallion Antonio Berensten, a sworn enemy of the Guilders, and has vowed to do everything in his power to keep them apart. Marita for her part is very confused, for the young man she has spoken to briefly is nothing like the monstrous villain he was proclaimed to be; indeed she finds Antonio attractive and exciting, and grows tired of her sheltered existence.



### Physical Appearance

- A) Portia - A small, delicately boned woman, with intense dark eyes short curly hair, and finely chiseled features. She dresses in a distinctly male style, in wine red velvet tunic and breeches with gold embroidered trim, a brocaded blue satin cloak with fur trim and a gold inner lining, and high leather boots.
- B) Romano - Tall, wiry young man with heavily pomaded black hair and a thin moustache. Dressed in a dark brown shirt and tights, and bronze colored breeches. Always appears to have one eye looking over his shoulder, or a suspicious glare . . .
- C) Marita - A beautiful young woman, with olive skin, and jet-black hair and eyes. She wears a light blue cap with a narrow band of lace trim; her gown of powder blue linen is moderately low cut, with half sleeves, silver embroidery at the throat and a lace girdle.

### Personal Possessions

- A) Portia
- 1- Necklace of beaten silver in 1" wide squares, each with a turquoise stone (NK,C,N)
  - 2- Belt buckle of silver, inlaid with lapis lazuli, enchanted with a defensive spell; when touched, anyone grasping her receives a shock equal to 1D6 temporary STM loss per mr (WS,C,N)
  - 3- Filigreed mithril bracelet with a seashell pattern, identifying her as an elf-friend (LW,B,S)
  - 4- Matched ceremonial daggers (WS,D,N)
  - 5- Purse (concealed in hidden pocket in her cloak, 1D6x50 GP)
- B) Romano
- 1- Golden pendant in the shape of a goblet, inset with chips of deep red topaz (NK,C,S)
  - 2- Shortsword with ornately carved runes in its blade (WS,C,N)
- C) Marita
- 1- Gold locket, with personal keepsake (NK,D,N)
  - 2- Copper bracelet with two small pieces of jade (RW,E,N)
  - 3- Unicorn pendant made of ivory; will glow red if held by a non-virgin (NK,D,S)

### Special Characteristics

- A) Portia - wishes to be respected as an intellectual equal, and is offended by a man who makes a forceful advance. She is well able to take care of herself in such situations, for she has some training in the martial arts. She will be outgoing and friendly with anyone who deals with her straightforwardly, and has a great store of useful knowledge about events occurring inside and outside the city.
- B) Romano - Will press his confrontation with Antonio to the limit, hoping to expose the latter's hatred of the Guilders to Marita. If he fails to goad Antonio into a rash act, he will spend the rest of the evening in a sulk, and has only a 20% chance of noticing his sister's disappearance.
- C) Marita - If Antonio succeeds in avoiding a fight, and she receives his note (see timetable), she will rendezvous with him in the open fields behind the estate.

## KORIDIAN, MASTER OF WIZARD'S ISLE

### Gamemaster's Description:

Koridian is the highest ranking mage in Haven, very "lawful-good" in his philosophical alignment. He is especially fond of good food and drink, and will not stray far from the buffet tables during the course of the evening. Although he does not look formidable, he is worth his weight in precious gems (no mean feat, given his roly poly stature).

### Physical Appearance

A very rotund, jolly looking fellow, with elaborately pomaded moustaches and pointed beard. Bald, he wears flowing blue robes that trail along the floor; there is a spider embroidered on the front in silver thread. He has a ring on each finger, and a variety of other jewelry.

### Personal Possessions

- 1- Ten rings, each enchanted with a different magic spell (GM can choose any spells from his system roughly equivalent to 8th-10th level difficulty) (LH/RH, C each, N).
- 2- Circlet of crystal, quartz and diamonds, also enchanted with a potent set of personal Protection spells (HD,B,N).
- 3- Turquoise brooch (NK,D,N).
- 4- Wizard's staff, patterned after the Egyptian Cross (RH,D,N).

## HIGH JUDGE LUCIUS CARDALLO

### Gamemaster's Description:

Cardallo is a rotund, full-bearded man of late middle age, with a receding hairline, aquiline nose, and dark, smoldering eyes. Will spend the night seated in the game room, his left foot heavily bandaged and propped up on a stool. Wears long flowing robe of dark blue velvet, belted by a white sash at the waist.

### Physical Appearance

One of Haven's five high judges, Cardallo is totally venal and corrupt, with his hand in the pocket of nearly every prisoner in his dock. A dangerous enemy, whose vendettas against those he believes have done him wrong are legendary throughout the city. Lecherous, and possessing a truly obscene sense of humor, Cardallo believes himself irresistible to women; in truth, he does possess a perverse magnetism which, coupled with the power of his office, does make him appealing to many.

### Personal Possessions

- 1- Ivory staff, metal shod at both ends, with a 6" diameter bronze circle mounted halfway up its length. Replicas of the city insignia and the scales of justice are on this circle in gold filigree (leaning on table, B,Y).
- 2- Badge of office, a golden miniature gavel surrounded by diamond and emerald chips (CH,B,Y).
- 3- Large pocket watch, with bronze case and hands (RW,D,N).

### Special Characteristics

Cardallo's foot is bandaged because he is suffering from a bad attack of gout. If

anyone should bump into his foot, an anguished outcry (of intense agony) will certainly result. If the perpetrator does not immediately apologize profusely, Cardallo is almost certain to remember his face (and not warmly, either). Will come on to any lone woman with an APP greater than 12.

#### LEANDER PERKINS

##### Gamemaster's Description:

A red-faced man with thinning white hair, he wears spectacles, and a red satin tunic with thickly ruffed collar and cuffs. Has a high-pitched, scratchy voice. Will be fawning and sycophantic when in the company of nobles, stiff-lipped and haughty with others.

##### Physical Appearance

Leander is the proprietor of the Golden Ducat, the rather stuffy inn in Haven where visiting nobility most frequently stay. He makes much of his chosen status as an invitee to such occasions, and loves to mingle with the aristocracy. A vocal supporter of the Young Stallions, who treat him respectfully and use his inn as a meeting place.

##### Personal Possessions

- 1- Carved and veneered hickory walking stick (RH,E,N).
- 2- Ceremonial awards bestowed to his establishment by visiting nobles over the years (CH,D,N).
- 3- Lace cuffs and collar (LW/RW/NK,D,N).
- 4- Heavy silver belt-buckle with a ram's head (WS,E,N).
- 5- Leather drawstring purse (SP, 3D10GP).

##### Special Characteristics

Leander has a very discerning eye for quality in jewels; treat as a 10th level jeweler for detecting fakes (thus, he may well notice if a paste item has been substituted for a real one). Though not as knowledgeable as Margery Savonna (see Nobility above), his personal hobby is collecting and reading histories of the great aristocratic families; add +3 to his Intelligence ratings in assessing whether or not he believes the story of a thief impersonating a noble.

#### ALARKON

##### Gamemaster's Description:

A Master Scribe, Alarkon is the proprietor of Haven's Magic Books & Scrolls shop (see Thieves' Guild 1 for more details). His customers number many of the city's elite, despite his own merchant family background. He mingles freely at the ball, and seems in an inordinately happy mood.

##### Physical Appearance

Short, clean-shaven man, with wavy brown hair and extremely bushy eyebrows; a heavy pipe smoker. He wears a greyish tunic, and a rust-colored sleeveless coat.

##### Personal Possessions

- 1- A pendant on a thin bronze chain, composed of faceted aquamarines set in the shape of an A, and mounted onto a solid piece of beaten gold (NK,C,N).
- 2- A silver pocket watch, with an inscription (CP,D,Y).

3- Cloth purse (CP empty).

4- Bronze tobacco canister - has false bottom concealing a double-folded sheet of paper (CP,E,N).

##### Special Characteristics

The sheet of paper Alarkon carries is a clever facsimile of an incriminating note written by Anson Blackbourne to a young woman recently found strangled in the South End. Alarkon is asking 2000GP in exchange for the note, threatening to send it to the Guard if not paid off. Alarkon and Anson will meet on this subject during the ball (see timetable).

#### HULEE PACKARD

##### Gamemaster's Description:

Hulee is an explorer and sometime trader for the Blackbourne family. He recently gained a great deal of unpleasant notoriety when he was captured by brigands in the wild Eastern mountains, and had to be ransomed by the Blackbournes. Having wheedled an invitation here, Hulee is trying to find someone (anyone!) willing to sponsor a new expedition, hoping to restore his former reputation.

##### Physical Appearance

Red-headed and of medium build, with green eyes and a somewhat scruffy beard. He wears a gold colored satin tunic and light brown leather breeches. Exceptionally graceful on the dance floor, yet can at times awkwardly trip over his own feet.

##### Personal Possessions

- 1- A jade necklace comprised of mottled green "teeth", a good luck charm from his most successful expedition (NK,D,N).

##### Special Characteristics

There is a 20% chance that Hulee will notice the conversation between Alarkon and Anson Blackbourne, and their adjournment to the library. If he does notice, Hulee will follow along and attempt to eavesdrop.

#### THE VON VOGELSANGS

##### Gamemaster's Description:

Erich and Marta von Vogelsang rule a small barony about 200 miles south of Haven. Marta has been Lady Kataleyna's closest friend since youth. The Count and Countess are in their early thirties, good looking and impeccably dressed. Though quite happily married, both will mingle separately at the ball and openly flirt with interesting strangers. However, Marta's loyalty to her friend, and her concern over her emotional outburst of this afternoon, will keep her in sight of the latter whenever possible.

##### Physical Appearance

- A) Erich - Tall, blond-haired man in his physical prime, wearing a crimson tunic and white breeches trimmed with gold piping, and knee-high black boots with bronze buckles. Has a hearty, ringing laugh; exhibits substantial flair on the dance floor (with a number of different women).
- B) Marta - Red haired woman of medium height, with sparkling green eyes, and a deadly (seductive) smile. She wears a scoop-necked green satin gown, decorated with a

brocaded pattern of birds in flight, and trimmed with gold embroidery. She wears dancing slippers of gold lame.

#### Personal Possessions

##### A) Erich

- 1- Gold ring with enormous ruby setting (LH,B,N)
- 2- Ring of yellow-green jade carved in the shape of a dove (RH,C,S)
- 3- Pair of white gold cufflinks (LW/RW,C,N)
- 4- Gold belt buckle embossed with a bird holding an olive branch (WS,D,S)
- 5- Medallion with four reddish-orange sapphires encircling a golden crescent (NK,B,S)
- 6- Shortsword in a velvet-lined scabbard (WS,E,N)
- 7- Four miniature silver spears arranged one below the other, and pinned to a red and black silk ribbon (CH,D,N)
- 8- Black leather purse, gold embroidery (HP, 5D10 GP)

##### B) Marta

- 1- Gold tiara set with emeralds (HD,C,N)
- 2- Necklace depicting a string of birds in flight, each one of a different species; birds crafted of gold, and feathered with semi-precious stones of the appropriate hue (NK,B,Y)
- 3- Four gold-inlaid arm bracelets, matched set (RA,C set,N)
- 4- Wedding band, a cluster of small diamonds set in white gold (RH,C,N)
- 5- White opal ring with miniature diamond chips (RH,C,N)
- 6- Large, pierced diamond earrings (HD,C,N)

#### Special Characteristics

Either Erich or Marta will flirt suggestively with any new acquaintance of the opposite sex with (MAG + APP) / 2 greater than 13. Erich will, in the course of the evening, find someone that piques his interest (see timetable). If Lady Kataleyna makes an outburst about the Duke's womanizing, Marta will attempt to calm her and remove her from the crowd. The von Vogelsangs are in Guest Room #3.

#### THE EMISSARIES FROM THE WOLD

#### Gamemaster's Description:

The Wold is a loosely confederated community of sylvan elves who reside in the forest lands directly west of Haven. They maintain friendly, though infrequent, relations with the city, with standing agreements for free transit, open trade and mutual defense. Arden, Prince and heir, and his consort Alyra bear the wedding wishes of their people. Arden is a man of few words, plainly uncomfortable with crowds and cities; he will spend the evening roaming the grounds and gardens outside the mansion. Young Alyra, who has been to the city but once previously, is much more in thrall of the pageantry and spectacle of this event. She will remain a shy background observer if left alone, but is likely to openly participate in the festivities if encouraged.

#### Physical Appearance

A) Prince Arden - Male elf of medium build, clean-shaven with light brown hair and piercing grey eyes. He is dressed in a

short tunic and tights of dark green elven silk, richly embroidered with a gilded leaf pattern around hem, collar and sleeves. Also wears a woven grey-green cloak with a mithril clasp, and soft brown shoes. On his forehead is a headband set with a large sapphire.

B) Alyra - Tall, slender elf-maiden, gentle of face, with golden eyes and waist-length golden brown hair flowing loosely down her back. Wears a loose fitting gown of brown, sleeveless and high-bodiced; over this is a layer of glittery gold chiffon that drapes over her shoulders. Speaks the Common tongue with a slight elvish accent.

#### Personal Possessions

##### A) Prince Arden

- 1- Headband of three intertwined strands of gold, silver, and platinum, with a circular blue sapphire mounted on the front (HD,B,S)
- 2- Amethyst ring set in a silver band (RH,E,N)
- 3- Reddish-purple garnet ring with star pattern, enchanted with a permanent Sleep spell (RH,B,N)
- 4- Ceremonial crystal dagger (WS,D,N)

##### B) Alyra

- 1- Headband of four green beryls, set in a thin gold band (HD,C,N)
- 2- Armlets of worked gold, in a leaf and flower pattern (LA/RA,C,N)
- 3- Necklace of small pieces of filigreed gold wrought into a leaf and bough pattern (NK,D,S)

#### Special Characteristics

Arden can communicate telepathically with Alyra, by using the headband's sapphire to focus his latent psychic energies; he can also detect any other telepathic activity in his vicinity. Staying in Guest Room #39.

#### SIR TIMOTHY HIGGINBOTHAM

#### Gamemaster's Description:

Sir Timothy has been a close friend of Duke Fernando since the two served together as teenagers in Prince Beragond's cavalry. He is loud and full of practical jokes, frequently the life of the party; he can be gruff and impatient when drunk, however, and is difficult to appease once he gets out of sorts. He loves to talk about hunting (and will tell incredible tales of his own adventures to anyone he can corner).

#### Physical Appearance

A ruddy-faced middle-aged man with rust brown hair, a bushy walrus moustache, and a faint scar across his left cheek. He stands over 6 feet tall, and is lean as a whippet. Wears a dark blue satin tunic decorated with gold buttons and a red shoulder sash; his cowhide shoes are adorned with elaborate golden buckles.

#### Personal Possessions

- 1- Pocket watch with elaborately engraved gold case (depicting a fox on the run), and a lapis lazuli face (CP,C,N)
- 2- Ceremonial saber with bronze studded leather pommel (WS,E,N)
- 3- Walking stick of cherry, carved wolf's head on handle, small dagger concealed



- in tip (released by pressing wolf's eyes simultaneously; LH,C,S)
- 4- Hexagonal-shaped pin of pale blue moonstone, surrounded by six cabochon cut turquoises (NK,D,N)
  - 5- Silver belt buckle embossed with family emblem (WS,E,S)
  - 6- Brass snuffbox, initials inlaid in mother of pearl on lid, velvet interior (HP,D,S)
  - 7- Blue velvet clasp purse with sequined trim (SP,3D20 GP)

#### Special Characteristics

Staying at Golden Ducat.

SUTTER CREEVY and KALFI

#### Gamemaster's Description:

These two yeomen manage one of Duke Fernando's silver mining interests in the northern hills; their attendance here is a reward for their recent heroism in saving three workmen trapped in a cave-in. Both are "hicks from the sticks" and in awe of the entire spectacle around them; if encountered, they will probably "Gosh", "Golly", and "Oh, wow" a player to death -- providing they can stop stuttering long enough to speak.

#### Physical Appearance

A stocky human of medium height (Creivy) and a muscular dwarf with a short black beard (Kalfi) wander together through the crowd. The human wears brown leather breeches and vest and a gold silk shirt; the dwarf a short grey cotton tunic and black leather boots, with rune-adorned iron circlets around his wrists and neck.

#### Personal Possessions

- A) Sutter
  - 1- Medallion of fool's gold (NK,F,N)
  - 2- Purse (HP,50 GP)
- B) Kalfi
  - 1- Bracelets and collar (LW/RW/NK,E,N)
  - 2- Purse (SP,35 GP)

#### Special Characteristics

There is nothing spectacular, or extraordinary about these two yokels.

TARQUINIO ALDER

#### Gamemaster's Description:

Alder is a renowned inventor residing in the court of the now King Beragond; he is also a domesticator of animals, a botanist, and geologist. In this last capacity, he first piqued the young Fernando's interest in mining while tutoring him. Alder still retains a fatherly interest in Fernando, and since he too is torn by the noble-guild class conflict, he watches with approving interest the talent Fernando has shown for dealing with this situation. Because of his deep love for his former pupil, Tarquinio has come here, though he normally shuns social occasions. While at the ball, he will seek out the company of those guests with similar intellectual interests (Koridian, Karl Geronde, possibly Portia Maggia).

#### Physical Appearance

Short, grey-haired man, with high cheekbones and watery blue eyes. He wears a dark

purple robe tied at the waist by a white satin sash around his spindly frame; the robe is beautifully embroidered in gold and silver thread with the likenesses of beasts and birds.

#### Personal Possessions

- 1- Walnut walking stick with an ivory handle sculpted in the shape of a dragon's claw; stick has a built-in direction finder in its tip, and the claw can be activated to function as a hand (RH,C,N)
- 2- Green cloth purse protected by a permanent Full Invisibility spell (HP,250 GP in small gems)
- 3- Alder has brought a wedding present for Madalena: a pair of diamond studded gold bracelets (B,Y), with the insignias of the di Cotillion and Cellini families engraved side by side on each. Kept in central safe all night.

#### Special Characteristics

Tarquinio is suffering from a severe stomach ailment which requires him to retire periodically to his room upstairs to drink some special medicinal herb teas. His frequent and sudden disappearances may arouse the curiosity of other party-goers; he may also be in a unique position to stumble across other events occurring during the evening. Staying in Guest Room #42.

GLAUDRIM OSTENSCHLOSS

#### Gamemaster's Description:

Minister of Trade for the small neighboring town of Walnagroff, who has journeyed to Haven on a number of previous occasions to discuss trade matters. A quiet man, he will converse briefly with the Duke and the guildsmen he has met and dealt with previously. Thereafter, he will be a sideline observer, wandering back and forth between the various entertainments provided. Glaudrim is the only guest at the ball who has ever met Sir Edry Buwinban (remember him?) previously (see below).

#### Physical Appearance

A short stocky man in his fifties, with thinning grey hair and square wire-framed spectacles. He carries a heavy, carved wooden walking stick and walks with a limp; his velvet coat and breeches are somewhat worn with age.

#### Personal Possessions

- 1- Gold pocket watch with thin link chain, engraved with a testimonial to his long years of public service (CP,D,S)
- 2- Cedar walking stick with a wide, decahedral pommel, and runes carved into each facet (RH,D,N)
- 3- Cloth drawstring purse (IP,2D20 GP)

#### Special Characteristics

Glaudrim has met Sir Edry on two previous official occasions. His sight and hearing are failing somewhat with age; however, if he encounters or overhears a thief impersonating Sir Buwinban, there is a base 30% chance he will immediately recognize the other as an impostor; add 5% to these chances per minute the two remain in close contact. If he does recognize the thief, he will quietly give this

information to one of the Duke's guards; there is a 50% chance that they will put the false Sir Edry under surveillance rather than act immediately. Ostenschloss is staying at the Golden Ducat.

#### FLAME MASTER CARN NE-SEVAL

##### Gamemaster's Description:

The Flame Master is a regional religious leader equivalent in rank to a cardinal in the Kol (Sun God) sect, come to officiate at the wedding ceremony at the request of the Duke, who is a prominent parishioner of the local temple. Seval is a man sure in his self-righteousness, accustomed to respect and deference, and wise in the value and uses of power. He hopes to use this occasion as an opportunity to convince some of the prominent Guild families to join the Kol sect (and thereby ensure continuing political influence in the city). He knows a great many priestly spells (treat as a 10th level cleric, if his spellcasting abilities need to be identified).

##### Physical Appearance

The High Priest is a tall, broad-shouldered man of late middle age, whose robust physical appearance is dwarfed by his spectacularly elaborate costume. He wears an enormous red and gold headdress with a sunburst pattern, a gold lame robe under a red velvet tabard emblazoned in gold thread with another sunburst, gold lame slippers, and various gold jewelry.



##### Personal Possessions

- 1- A collar of linked 2" wide gold plates, each with a small flame emblem made of ruby chips (NK, A, Y)
- 2- Matching bracelets of gold, each set with a dozen cabochon-cut fire opals (LW/RW, C, S)

- 3- Gold headdress adorned with faceted orange and red-orange garnets, yellow sapphires, orange-red zircons, and citrine red quartz (HD, A, Y)
- 4- (In central safe) Sceptre of the Sun, Seval's symbol of office. One of twelve in existence, contains a vast store of magical power (Blaze of Noon, Fireball, Rapid Growth, other spells related to solar energies).

##### Special Characteristics

Seval is staying in Guest Room #5.

#### PROTECTORS OF THE PEACE

Duke Fernando maintains a personal Guard of 50 men, comprised of three patrols of fifteen men, each commanded by a Sargeant. The full guard is commanded by a Captain, and there is a Quartermaster in charge of supplies, barracking, etc. Each on-duty guardsman is armored in a chain shirt and leather skirt (AC 5), and an open helm. All wear a sleeveless high-collared black tunic trimmed with silver buttons and piping, black leather boots, and a small silver replica of the ducal insignia on their collars. A guardsman's rank and length of service can be distinguished from the color of his cloth belt (silver for officers, black for enlisted men), and the number of awards above his breast pocket (one for each year served).

As a general rule, the morale of the personal Guard is high; the men are well-fed and well-trained, and are only infrequently required to risk their lives in the performance of duty. The guardsmen are primarily intermediate level fighters who survived an unsuccessful dungeon adventure and became disillusioned with questing, or older men retired from more active armed service. All are experienced with mace or sword, and have been encouraged to capture rather than harm intruders on the grounds.

Normally, the three patrols alternate eight-hour duty shifts. For special occasions like the ball, however, two patrols remain on duty throughout the festivities. From 6 PM to 2 AM guardsmen are assigned to the following outdoor or indoor stations:

##### Exterior:

- 5 at front gate (including Sargeant Ebrahim)
- 3 patrolling\* the outside walls (riding)
- 4 at the four entrances to the formal gardens
- 2 patrolling\* the perimeter of the house

##### Interior: (precise locations marked on the map with a G)

- 1 in the museum
- 2 at the guard station just inside the front entrance
- 4 in ballroom
- 2 in formal dining room
- 1 in game room
- 2 at the head of each of the stairwells to the second floor (these guards will permit only those with accommodations upstairs, or their companions, to pass further)
- 3 patrolling\* the complete interior of the mansion (including Sargeant Hampton Rodes, and Captain Pettifog)

At 2 AM, the replacement patrol takes over, stationed in the following manner:

Exterior:

- 2 at front gate
- 2 at front entrance
- 2 patrolling\* the outside walls and perimeter of the house (including Sergeant Graves)

Interior:

- 2 in front of Duke's chambers
- 2 in front of the chambers of Katalayna and Elise
- 2 each in museum corridor and ballroom/dining room area
- 2 patrolling\* the complete interior (wait between rounds at Guard station)

"\*" Patrols of the outside walls take 15 + 1D20 minutes to complete. Patrols of the mansion perimeter (including gardens) takes 20 minutes, with a 40% chance of a 1D8 minute delay; and interior patrols of the mansion take 15 minutes, with a 30% chance of a 2D6 minute delay. Interior patrols are always completed; there is a 10% chance that an exterior patrol will skip a particular round if the weather is very inclement.

The Hearing abilities of any particular guard range from 20 to 50% (10% + 1D4 X 10); their Detect Ambush skills from 25 to 60% (20% + 1D8 X 5). All guards have double the normal chances of witnessing a crime in progress (see Rules section of this book), if the crime takes place in their field of vision. They are experienced in their duties and will not be easily suckered by a thief's tale of woe. There is a 5% chance (and this only on the night shift) of a guard dozing off at his station, and an equal chance (all shifts) that he has momentarily left his post (to check out a noise, satisfy nature's call, etc.).

Guards will directly confront any intruders they encounter, unless they are clearly outnumbered. In the latter event, they will attempt to summon additional assistance by blowing on the ram's horn each carries on his belt. If a call for aid is delivered, only guards from the following locations are authorized to respond to a call: 1st floor guard station (1), formal dining room, interior and exterior patrols, and inner garden entrances. If still further help is needed (an unlikely circumstance, unless the house has been attacked by the 102nd Airborne) a second call will be issued. The remaining guard at the 1st floor guard station can use a Voice Teleportal installed there to rouse guards from the barracks.

ENTERTAINERS, SERVANTS, AND UNINVITED GUESTS  
Entertainers

To satisfy the diverse tastes of his guests, Duke Fernando has arranged for a variety of entertainments to be staged during the ball. In the ballroom itself, an orchestra comprised of thirty of the best musicians in Haven provides music for formal dancing. More visceral entertainments are presented on the canopied stage area in the East Gardens, where acrobats, jugglers, actors

and illusionists hold forth to amaze and amuse their audiences. And throughout the grounds, wandering minstrels serenade the gentler pleasures of a cool, early autumn evening.

Of all these performers, two will play a greater than planned role in the night's proceedings. The traveling troupe of players mentioned in the timetable of events are a company of eight men and women, including a thespian, a strongman, two troubadours, two acrobats, and two puppeteers. They are also the same company described in the Highwaymen Adventures section of Thieves' Guild I, a group that regularly includes larceny as part of their repertoire. The "injurious" tumble taken by the acrobat during their performance is a ruse to enable him to get inside the house to ply his thieving trade. He has a Lock Picking ability of 65%, a 45% chance of Moving Silently, a 50% Hiding in Shadows skill, and 50% Hearing. Upon entering a room (after listening at the door), he will immediately look for the traveling cases brought by the guests, and search through these for small but valuable stealables. He will not bother with coins or very small gems, for these are not worth the pocket space they would consume. He carries a small puppet from the troupe's props in his belt pouch; the puppet is enchanted with a Befuddle spell (if looked upon, make MGR saving roll or be confused for 10mr). If encountered while in the hallway, he will claim that he just regained consciousness, and was looking for the stairway; if the other party appears suspicious, he will try to use the puppet to gain him time to escape. If encountered in a room, he will fight, trying to render his victim unconscious; if he fails, (or if a lot of noise is made during the struggle) he will exit through a window, climbing down (3% chance to fall) to safety.

One of the flutists in tonight's orchestra is a stocky young human woman named Galena Cordovan. Though she is quite an accomplished professional musician, she also pursues a dangerous second career -- as a paid assassin. She has been contacted by Anson Blackbourne through an intermediary, and contracted to kill the scribe Alarkon. The assassination attempt is scheduled to be made tonight, whenever Blackbourne gives her a pre-specified hand signal. Galena knows Blackbourne on sight from their one meeting, but does not know his name; she refers to Anson by the nickname "The Clothesline" (making fun of the way that his expensive clothes hang loosely from his thin frame). After receiving the signal to proceed, Galena will leave the ballroom at her next rest break, and initiate a search for Alarkon. If and when she finds the Scribe, she will seek to introduce and ingratiate herself to him, her modus operandi is to puncture his skin with a tiny poison-tipped dart that can be concealed in one of the charms on her bracelet. The poison released is a slow-acting one; it kills by inflaming the respiratory tract and causing suffocation to occur (after 2D6 minutes, victim suffers 4D8 damage to STM with a 30% chance of instant death; a STM saving roll can reduce damage by 1/2 if the venom is not immediately fatal). If Galena fails to get close enough to Alarkon to inject the poison by hand, she will use a



tiny blowgun to fire the dart; she has a Move Silently skill of 60% and a 70% chance of Hiding in Shadows. (See table at the end of this scenario for details on her prowess with the blowgun.) Regardless of her success or failure, Galena will make but one attempt on her target, and then return to her other job. If Galena is encountered while stalking Alarkon, she will be polite, but firmly excuse herself from a conversation as quickly as possible and hasten back to her purpose.

#### Those Who Serve

The Duke regularly maintains a household staff of 30 to 40, including maids, kitchen help, personal servants, and a few very specialized personnel (e.g., librarian, armstrong, etc.); for the ball, another 3D20 servants have been temporarily hired to help prepare and serve food and drink. Many of the nobles and wealthy Guildsmen will also bring their personal handservants along to attend them.

Personal servants stand along the second floor balconies of the ballroom, awaiting the call of their masters or mistresses. Since a handservant is likely to receive a stiff beating if he fails to respond to a summons from his employer; most (80%) are very attentive to what is going on down below! Consequently, on any theft that takes place in the ballroom, there is a chance that it was witnessed by one of the servants (12% for Green thieves, 9% for Intermediate, 6% for Veteran, and 3% for Elite). These chances should be treated as an addition to the normal witness chances outlined in the Rules section of this book, before the D100 roll is made.

Servants carrying platters laden with food and drink will circulate throughout the first floor and formal garden. This sort of job becomes very tedious after an hour or two, and is primarily manned by temporary help of somewhat lesser quality. Therefore, although there is a fair chance that a serving girl is somewhere in the vicinity of a crime when it is committed, the chances that she will be alert enough to actually witness a criminal act are very slight.

If a player character ventures into the servant's wing of the first floor between 8 and 11 PM, there is a 15% chance he will encounter a servant in the hallway, and a 5% chance thereafter. There is a 40% chance that any room entered in this wing by a player will be occupied by 1D2 talking (40%), or sleeping (60%) servants. If wakened, a servant may scream; however, if the character displays a regal bearing and gives any kind of plausible alibi, the incident will probably (80%) be quickly forgotten.

One "servant" who may be encountered several times during the course of the evening is the Duke's trusted Steward, Harchens. Harchens will be at the front gate from 6:30 to 7:30 PM, checking in the temporary help and assigning them to their duties. From 8:00 to 9:30 PM, he will be charged with officially announcing the guests upon their arrival; thereafter, he will be in constant motion, checking on every aspect of the festivities to

ensure that all is going smoothly. Harchens has of course, dealt with hundreds of nobles and servants in his time, and thus has an above average chance of noticing flaws in a thief's disguise (add +3 to his INT rating in determining his reaction to a disguise attempt). If he senses something wrong, he will try to keep an eye on that person during the course of the ball; for he is a cautious man, and will say nothing to the Duke without substantial proof. If the thief is portraying a noble, and notices that the Steward is watching him closely, he may be able to frighten Harchens off his trail with a display of righteous outrage at being followed (make a saving roll against DSC-2 for Harchens; if he misses his save, he will relent).

#### Uninvited Guests

Any event as large as this is likely to attract other uninvited individuals adventurous enough to try to gain entry to the grounds. In addition to the unsuccessful gate crasher mentioned in the timetable of events, there is a 30% chance each half hour that 1D4 such people will try to get onto the grounds. Roll a D100 to determine the method used: 01-30, presenting a forged invitation (50% chance of successful entry); 31-70, trying to bluff their way past the guards (3% chance of success); 71-00, scaling the walls (25% chance of success). If a player-thief should chance to encounter a fellow uninvited guest, the latter will either be modestly outfitted (one stealable item, value E), or elaborately bejewelled with paste facsimiles (value F, treat as first level fakes for Detection purposes).

In addition to these random interlopers, Madalena's suitor Varkin and his friend will definitely attempt to scale the wall in their effort to rescue Madalena. The rescue mission will only affect thieves if they have elected to spend the night in one of the mansion guest rooms. If they are present, however, and Varkin is discovered on the grounds, the resultant chase and struggle should provide the thieves with an excellent opportunity to search for the central safe relatively unhindered by the Duke's guards.

### DETERMINING ENCOUNTERS

#### Random Encounters

In the course of the ball, the player-thief may become involved in encounters in two ways. The timetable of events presented in the next section indicates encounters between NPCs that are planned to occur at given times throughout the evening. These encounters may directly involve the thief or provide opportunities that he may try to exploit. Alternatively, the thief may himself choose to initiate encounters with other guests in order to ply his larcenous trade. This section provides a generalized procedure for answering the player who says, "I walk up to the nearest person and introduce myself. Who am I talking to, and what is he or she wearing that I can steal?"

Although there will be approximately 300 guests present at the ball, and only 55 of

these have been described in detail, it is desirable to assume that about 65% (roll D100) of all random encounters involve these well-described NPCs. Obviously, this assumption will make the GM's job more manageable; but it makes a great deal of common sense as well. The NPCs that have been detailed represent the vast bulk of the guests who appear to be wearing items of genuine value; they will therefore make the most appealing targets for an enterprising pickpocket.

The selection of which of these NPCs has been encountered will be somewhat dependent on the area of the mansion or grounds where the encounter occurs. Some characters will spend almost the entire evening in a single location, while others roam freely about. The GM can use the location information provided in the Character Description table to determine logical encounters for a given situation; this choice should be responsive to any stated desires of the thief (e.g., "I'm looking for the woman in this room wearing the most jewelry and am going to talk to her."). In determining the size of the party encountered the GM may wish to use the reference table below:

Number of NPCs in party encountered					
Location (roll D100)					
# in Party	Ball-room	Dining Room	Garden	Game Room	Other 1 FLR
1 person	01-15	01-35	01-25	01-05	01-50
2 people	16-35	36-60	26-40	06-25	51-75
1 couple	36-65	61-75	41-90	26-35	76-85
3 people	66-85	76-90	91-95	36-50	86-95
4 or more people	86-00	91-00	96-00	51-00	96-00

If the encounter falls in the 35% category of unidentified guest, the GM can use the following roll-up procedures to generate the necessary information on the encountered character:

- Determine the number of characters in the group from the table above.
- Determine the background of the group based on a D20 roll (80% group is all of same background; 20% roll separately for each NPC).
 

1-6	Nobility
7-13	Guildsman
14-17	Merchant
18-19	Local bureaucrat
20	Out-of-town dignitary
- Determine the character's experience level on a D20: 1-4 Green (1st-2nd level), 5-10 Intermediate (3rd-5th level), 11-17 Veteran (6th-8th level), 18-20 Elite (9th-12th level).
- If the drunkenness rules are being used, turn to that section to determine the encountered character's current state of sobriety.
- Roll two separate color D20, and cross reference the results on the matrix below, to determine the characters's general purse, and the number and quality of their on-person possessions (based on the results of the character

background roll, make the following adjustments to these die rolls: Wealth - Nobility +1, Guildsman +3, Local Bureaucrat -2; Style - Nobility +4, Merchant -2)

Style		<6	6-14	>14
Wealth		Under- Stated	Normal	Osten- tations
<7	E	1 E**	1 E	1 D
Purse	1D6 GP		1 F	3 F
7-12	D	1 C	1 D	1 D
Purse	2D8 GP		1 E	2 E
				2 F
13-17	C	1 B	2 C	3 C
Purse	3D10 GP		1 D	2 D
18-20	B	1 B	2 B	2 B
Purse	3D20 GP	1 D	1 C	4 D
>20	A	1 A	1 A	2 A
Purse	5D20 GP	1 C	2 B	2 B
				2 C

(\*\* - Letter codes in this chart refer to the item value codes used in the major NPC character descriptions; see page 10-9 for definitions)

We strongly recommend that the GM set up 10 or 15 of these characters before play begins, since the generation process tends to be rather time consuming.

#### Planned Encounters

The following section summarizes a number of events and encounters that are liable to take place during the day and night of the ball. These events are of several different types, and present a wide variety of problems or potential opportunities to the thief characters. The scheduled arrivals of workmen and servants during the earlier periods of the day represent possible opportunities for the thieves to get accomplices successfully admitted to the mansion grounds. To find out about these possibilities, however, it will be necessary for the thieves to spend one or two days wandering through Haven, making a serious effort to obtain information from the rumormill of neighborhood taverns or from the local Thieves Guild. Over the course of the ball, some of the events that occur will provide diversions that a thief can take advantage of to shield his pickpocketing attempts; others will offer him opportunities to take action, and thereby gain the confidence or gratitude of other guests. There are even some encounters which the thief cannot avoid, if he happens to be in a certain place at a certain time; these latter events represent the uncontrollable twists of fate that should be part of every adventure.

The GM should carefully read through these planned encounters before attempting to run this adventure, and consider what each of the characters might do in response to various actions by other parties. Hints for role-playing can be obtained from the personal descriptions provided in the last section; the appropriate descriptions may be easily located by using the reference numbers provided in parentheses after each character mentioned. If the GM decides to have players portray NPCs, we recommend that he provide them with a

photocopy of these descriptions, and some sort of written summary of the basic encounters they will be involved in. Natural candidates for NPCs would include Antonio Berensten, Paul de la Riis, Mano and Marita Maggia; Alarkon, Anson Blackbourne and Galena Corridan; Prince Harruld; the acrobat-thief; Madalena, Castillia, and Varkin; or Duke Fernando and Lady Katalayna. Alternatively, a player may wish to select an NPC who has only a minor role in planned encounters, and determine what the character's objectives for the evening will be.

#### TIMETABLE OF EVENTS

- 8:00 AM** A team of ten construction workers arrives to erect a canopied stage area in the East Garden. The men are common day laborers selected from those who assemble each day outside of Gerannahue's warehouse along the northern waterfront; they are supervised by two foremen from the company.
- 12:15 PM** Lady Madalena and her parents arrive at the Duke's residence. The family is placed in the Suite of guest rooms marked #34.
- 3:00 PM** Four hobbit chefs arrive (separately, within a 12 minute span) to assist in the food preparation for the evening's festivities. All are well known to each other and to the Duke's personal chef, except Biggs Oldbuck, a young cook from the common section of town whose desserts have become a minor sensation around the city, justly so.
- 3:20 PM** Lady Katalayna leaves the estate in the company of Hampton Rodes, a sargeant of the Duke's private guard (and a close personal "friend" of Katalayna's), to visit Othmar the astrologer.
- 3:45 PM** Tarquinio Alder arrives at the Duke's residence, and retires immediately to Guest Room #42. Some valuables he carries are placed in the safe in the steward's office.
- 4:00 PM** A large freight wagon, bearing kegs of wine and ale, is admitted to the grounds. The kegs are unloaded into a cold storage cellar under the kitchen.
- 4:10 PM** Lady Katalayna returns in an extremely agitated state (alas, no heir is in the offing yet!), and almost immediately engages in a screaming tirade at a downstairs chambermaid. This scene is interrupted by the arrival of Count Erich and Countess Marta von Vogelsang (and their retinue of personal servants). The von Vogelsangs calm Katalayna, and the three adjourn to the sitting room for tea, remaining there until 5 PM when they leave to dress for the evening. Some of their valuables are placed in the safe in the steward's office.
- 4:20 PM** Brewers helpers leave.
- 4:45 PM** A troupe of performers arrive, hired to provide some of the evening's entertainment. They are dissatisfied with the placement of the stage, and their leader argues unsuccessfully with both the construction foreman and Fernando to have it moved.
- 5:15 PM** Construction workers leave.
- 5:30 PM** Cellini family arrives, followed closely by the wizard Koridian. They, the

Duke's family, and the other house guests share a light supper in the formal dining room while Benedios and Madalena become acquainted. From all accounts the dinner is a less than festive occasion.

- 5:50 PM** Rodes and two guardsmen inspect the premises to ensure security before the ball guests arrive. Rodes cannot get Lady Katalayna out of his mind. He seems preoccupied and uncommunicative, and as a result the patrol has only 1/2 its normal chance of spotting irregularities on the grounds (such as unlatched windows, ropes or ladders left near the estate's walls, etc.
- 6:05 PM** High Judge Cardallo arrives, seemingly oblivious to his lateness, and joins the others at dinner.
- 6:30-6:55 PM** Thirty chamber musicians, some of the best in Haven, arrive at the mansion and begin to set up in the ballroom. All have been personally selected for this orchestra by Valvidi, the noted conductor. They begin to tune up and rehearse.
- 6:40 PM** Madalena and the Duke's bastard daughter Castillia take a stroll together through the gardens, and Madalena tells Castillia about her other suitor. Castillia promises to help Madalena escape with her lover, if possible.
- 7:15-7:32 PM** A variety of additional temporary serving help begins to arrive. These servants have been recommended by a number of different sources and are primarily (85%) unknown to the Duke's staff except as a list of names. The guards at the front gate and the Duke's steward both have copies of the list.







**8:00 PM** Ball guests begin to arrive.

**8:30 PM** (Ballroom) Music and dancing begin.

**8:35 PM** (Ballroom) Flame Master Carn-ne-Seval offers a benediction and prayer of good fortune to the prospective bride and groom. Salvatore Cellini and Duke Fernando both give presents of jewelry (a necklace and an anklet) to the bride-to-be, who gets extremely flustered. Castillia takes Madalena up to her room, so that the latter can compose herself; while there, she convinces Madalena to wear her new gifts.

**9:00 PM** (Dining room, front hall) Tarquinio Alder goes upstairs to his room, returning in 2D8 minutes.

**9:35 PM** (Front hall) Four members of an activist's noblemen's group, the Young Stallions (Antonio Berensten, Paul and Thomas de la Riis, Gunter Geronde) arrive together, moving through the crowd in a pack.

**9:45 PM** (East garden) Nadji the illusionist puts on a fifteen minute show that is a true spectacle of macabre menace. As he conjures up images of fearsome beasts and strange visions of distorted shapes and colors, four members of the audience faint, two others begin to throw up (and the Duke's steward makes a note never to invite Nadji to perform here again).

**9:45 PM** (West garden, front gate) A gate crasher is caught before he can blend into the crowd; as he is being dragged off to be ejected, he can be heard to shout "Wait! I'm not the only one who doesn't

belong here!" One of the house guards appears to bend over close to hear his next words, as the crasher gesticulates wildly around him. (No information is actually passed; this is merely a red herring to frighten any thief in the area.)

**9:53 PM** (Dining room, front hall) Tarquinio Alder goes upstairs to his room, returning in 2D6 minutes.

**10:02 PM** (Ballroom) Antonio Berensten shocks many in attendance (including his friends) by asking Marita Maggia to dance. They make a beautiful, graceful pair on the dance floor, but at least two men (Romano Maggia and Paul de la Riis) very obviously do not like what they see.

**10:10 PM** (Front gate) Prince Harruld arrives unannounced, and is denied entrance. He lightly injures two of the Duke's guards in a brief altercation before the Duke is summoned, and vouches for the Prince's identity.

**10:15 PM** (Gameroom) Sir Timothy Higginbotham corners any occupants of the room who fail to make a saving roll against IQ, and tells a long-winded story about his latest hunting expedition. The story will take 25 minutes to complete; any listeners leaving prematurely will incur Timothy's wrath.

**10:20 PM** (West garden) Mano Maggia confronts Antonio Berensten, and threatens to kill him if the latter does not stay away from his sister. The other Stallions want to teach Mano a stiff lesson for his threat, but Antonio will attempt to prevent a

- fight (10% chance that a fight does break out; if so, a further 30% chance that weapons are drawn and used in the course of the fight).
- 10:30 PM (Dining room) Harruld accosts a young woman and grabs her by the punchbowl (how he ever got his hands on her punchbowl, we'll never know) -- there is a 80% chance that the lady will object loudly to such treatment.
- 10:30-11:10 PM (East garden) The thespian and two troubadours from the traveling troupe stage a very effective morality play in drama and song. The play is well received and begins to attract a substantial crowd (almost 100 people at its peak) into the East Garden; many pay very close attention to the show (and would make excellent victims for a thief).
- 10:35 PM (Dining room, front hall) Tarquinio Alder goes upstairs to his room, returning in 2D10 minutes.
- 10:45 PM (Ballroom) If a thief is present and satisfies the statistical requirements indicated in their personal descriptions, there is a 60% chance that either Erich or Marta Vogelsang (depending on thief's sex) will flirt suggestively with him/her.
- 10:48 PM (Dining room) The Young Stallions corner and browbeat a young nobleman who has just sold part of his family's land holdings to one of the wealthy Guild families (the Stallions oppose this sort of sale, because it reduces the aristocracy's unique claims as landlords on the affections and loyalties of the common people). Antonio vociferously joins in this abuse (somewhat assuaging Paul's worries about Antonio's continued commitment to their cause).
- 10:53 PM (Ballroom) Alarkon the scribe walks across the room and engages Anson Blackburne in what appears to be a friendly conversation. After a few moments, the two leave the ballroom together and go into the library (which is empty); they close and lock the door behind them.
- 11:00 PM (Ballroom) There is a 20% chance that the Duke has met a woman that appeals to him and is raptly attending her. If so, there is a 40% chance that Katalayna will make a scene about the Duke's attentiveness at 11:30 PM.
- 11:00 PM (Ballroom) There is a 10% chance that Grazia de la Riis will mistake a young man passing by sometime in the next hour (roll 3D20 to determine exact time) as her lost son Porcassio, and will make a tremendous fuss over him.
- 11:05 PM (Dining room) Harz de la Riis and his son Paul engage in a rather rancorous discussion about Paul's behavior at the ball. While this takes place, Antonio slips away from the Stallions and walks outside the house.
- 11:07 PM (Front hall, ballroom) Anson Blackburne leaves the library alone; he appears distracted and somewhat nervous. Alarkon sits in the library, contentedly puffing on his pipe.
- 11:10 PM (West garden) Antonio leaves a hastily scrawled note concealed on one of the statues in the garden. He return to the ballroom and rejoins the Stallions.
- 11:10 PM (Gameroom) Harruld accosts a young woman and grabs her by the pool table (getting his hands in her pockets, no doubt) -- there is a 60% chance that the lady will object loudly to such treatment.
- 11:12 PM (Ballroom) Anson Blackburne passes quickly through the ballroom, pausing briefly near the orchestra. He makes some sort of hand signal (GM's choice) to one of the musicians, Galena Cordovan; and then walks out into the gardens.
- 11:17 PM (Dining room, Front hall) Tarquinio Alder goes upstairs to his room, returning in 3D6 minutes.
- 11:20-11:40 PM (East garden) Flary Chammlen, a fire-eater, entertains the crowd with his feats of daring. (Since none of the people here have ever tasted the cooking of Flary's wife, they do not realize how much Flary actually enjoys this work.)
- 11:30 PM (West garden) If no one else has removed the note left by Antonio, it is retrieved by Marita Maggia, who reads it and puts it away in her purse.
- 11:30 PM (Ballroom) (GM's Note: This action will occur only if Katalayna does not confront the Duke at 11:30 PM.) K'maill stages a swoon on the dance floor, apparently overcome by the heat in the crowded room. Her husband Bruning immediately rushes to her side, calling for brandy to revive her. When she "recovers," they will immediately leave; several guests will swear later that K'maill had a self-satisfied smirk on her lips as she departed.
- 11:35 PM (Front hall, front gate) Castillia leaves the grounds of the estate, fabricating a rather flimsy excuse to satisfy the questions of the guards at the gate. Her half-sister Elise sees her depart. Castillia goes to meet Madalena's suitor, Varkin, at midnight outside the Golden Ducat inn, and tries to look inconspicuous (Though a young woman in formal evening wear standing in the shadows near a street corner is not an everyday sight).
- 11:35 PM (Ballroom, front hall) In the aftermath of K'maill (or Katalayna's) interruption of the festivities, the orchestra takes a short break. Galena Cordovan goes in search of Alarkon. (From this point, the success or failure of Galena's assassination attempt is up to the GM to describe in any manner he wishes. If two players are assigned to portray these NPC's, this can prove to be quite an interesting confrontation for all concerned.)
- 11:50 PM (East garden) In the midst of a difficult triple somersault, one of the acrobats in the traveling troupe seems to lose his balance, and falls into a nearby hedgerow. The troupe asks and receive permission to take their (apparently) unconscious comrade upstairs and lay him down in one of the empty guest rooms on the third floor.
- 11:50 PM (Ballroom) Harruld accosts a young woman from the orchestra and grabs her by the bass fiddle (How he -- what's that? You say you're tired of this joke? That's OK, we've got others). There is a 40% chance the lady will object loudly to such treatment.
- 12:00 PM (Ballroom) At the stroke of midnight, the somewhat drunken prospective bridegroom walks over and plants a sloppy



(albeit affectionate) kiss on Madalena's cheek. This evokes some laughter from the nearby crowd; Madalena for her part looks vaguely queasy about the whole incident.

12:00 Midnight (Ballroom) If the Duke had not previously found an interesting woman to flirt with, there is a 40% chance that he has found one by now. If he has found such a woman, and Katalayna has not already complained, there is a 60% chance that she will throw some sort of temper tantrum at 12:30 AM.

12:00 Midnight (Ballroom) If Grazia has not mistaken anyone for her missing son, there is a 30% chance she will do so in the next thirty minutes (for exact time throw 3D10).

12:05 AM (3rd floor) The supposedly "out cold" acrobat steals out of his room and begins to systematically loot the other rooms on this floor. (Again, the GM can plot out this NPC's precise route before play begins, to determine if any encounters result.)

12:12 AM (East & west gardens) Antonio and Marita (if she has received the note) separately depart the gardens, watching carefully to avoid being followed, and rendezvous in a wooded glade behind the stables. Antonio professes his love for Marita, and they hold each other for a few moments of bliss. They then return to the ball by separate routes.

12:20 AM (West garden) Talia Blackbourne goes outside to try and find out what is wrong with her husband; she is gruffly rebuffed.

12:30 AM (Gamerom) An impromptu arm-wrestling contest begins, with 8-12 participants, including Paul de la Riis, Gunter Geronde, Sir Timothy Higginbotham, and Hulee Packard, (it can include the thief, if he is interested); and with the High Judge Cardallo acting as arbiter. Some observers may decide to bet on the outcome of this contest.

12:45 AM (Front gate) Erich von Vogelsang leaves the grounds in the company of an unidentified woman. Both appear to be well lubricated with drink, and are singing a bawdy song (off-key).

12:45 AM (Ballroom) If a thief is present in this room, there is a 20% chance that Talia Blackbourne will walk up to him and burst into tears on his shoulder. If not, she does the same thing to some other guest in this room.

12:55 AM (Ballroom, 3rd floor) Madalena excuses herself to the remaining guests, and retires upstairs. She believes that matters are hopeless because Castillia has not returned; she paces in her room for a few moments, then cries herself to sleep.

1:00 AM Varkin finally arrives at the Golden Ducat, accompanied by his trusted friend Polander. Castillia hastily tells Varkin which room Madalena is in and where the night guards are normally stationed, and promises to keep her own window unlatched so that the rescuers can gain entry. She then rushes back to the mansion.

1:00 AM (Ballroom) If the Duke had not previously found an interesting woman to flirt with, there is a 60% chance that he has found one by now. If he is busily flirting, and Katalayna has not already

complained, there is an 80% chance that she will throw an incredibly violent temper tantrum at 1:30. Items not bolted securely to the floor or walls may be jeopardized in this assault.

1:10 AM (Ballroom) Castillia returns to the estate. If the Duke is not engaged in womanizing, he will be aware of Castillia's absence, and sharply demand to know where she has been. When she refuses to tell him, he will send her to her room.

1:15 AM (Front hall) The acrobat, if he has not been witnessed in his thieving endeavors by one of the other guests, returns downstairs and rejoins his troupe, which is packing up and preparing to leave.

1:40 AM (Dining room) Harruld picks up a half-full punchbowl and drains it in several mighty gulps. He then flings a young woman over his shoulders (at this point, no one is likely to get in Harruld's way even if the girl is screaming bloody murder), and carries her away to the meadows behind the estate. (It is indeed fortunate for the other guests that Harruld is one of the most civilized members of his tribe, otherwise, he might have done something really barbaric!)

2:20 AM (3rd floor) Marta von Vogelsang staggers up to her room; and discovers (75% chance) that several of her possessions are missing. If so, she will come to the top of the stairs and scream for the guard. A general commotion results. Remaining guests may even be searched (40% chance), unless someone remembers that the "injured" acrobat might have done it (10% chance this is mentioned by a random guest; player-thief may of course think of this himself).

3:00 AM The commotion has quieted down one way or another. All but the 3 or 4 guests passed out in the ballroom and gardens leave, or go into the sitting room for a last glass of brandy.

3:30 AM Varkin and Polander scale the outer wall and enter the grounds. If anyone cares, or if players are portraying the NPCs involved in this situation, the rescue attempt can be played out.

4:15 AM Erich von Vogelsang returns, whistling (even more off-key) and dead drunk. A guardsman from the front entrance firmly escorts him upstairs to his room.

#### CHARACTER DRUNKENNESS AND ITS EFFECTS

(Editor's Note: The following section is intended in the spirit of irreverent good fun to be used by those of us who view the medieval period as a rather ribald celebration of the adventurous life. For those GMs and players who have always assumed that their characters drink nothing stronger than grape juice, fruit punch, or an occasional sasparilla, we recommend that you skip this portion of our narrative - RM)

As the festivities of the ball continue on into the night, many of the revelers will begin to feel the effects of their alcoholic intake. As many of you in our reading audience doubtless know from personal experience, these effects can range from mild sensory distortion to the complete loss of



muscular, mental, and/or moral control. Plainly, an NPC's state of sobriety will greatly influence both his ability to perceive an attempted theft of his possessions, and the relative ease with which a cutpurse may remove these items. This section outlines two approaches the GM can use to incorporate character drunkenness into the flow of the scenario.



The drunkenness of a character at any particular point in the festivities will depend on three factors: 1) the character's proclivities toward drinking, 2) his bodily capacity to handle the liquor that has been consumed, and 3) the amount of time spent drinking. For each of the major NPCs described in this scenario, assumptions have been developed on their attitudes toward drinking and their absorptive capacity. Using these two pieces of information, the Character Description table at the end of this scenario classifies every NPC, for each two hour period of the ball's duration, into one of five categories:

- 1) Sober (N) - Character is unaffected by any drinking done so far.
- 2) Tipsy (T) - Character suffers minor reductions in eye-hand coordination (CDN -1) and reaction time (REF -2). No significant impairment of mental or sensory faculties.
- 3) Drunk (D) - Character coordination (-2) and reflexes (-3) are more substantially reduced. Vision may be occasionally hazy; overall sensory awareness is noticeably diminished. Character may exhibit heightened emotional responses (amorousness, hostility, fear, etc.) to situations. Conversation may sometimes become illogical and convoluted.
- 4) Staggering (S) - Character cannot per-

form complex physical actions without great effort (CDN -4, REF -6). May have double vision, nausea, or suffer frequent lapses of conscious memory. May lose emotional control, and explode into sudden outbursts of laughter or tears.

- 5) Blind drunk (B) - Character cannot perform even simple physical acts, like walking in a straight line (CDN -7, REF -9). Sensory input becomes virtually nonexistent.

If a player-thief attempts to pilfer an item from a non-sober character, his base pickpocketing success chances (including any adjustments already made to normal skills to reflect the difficulty level of the article being stolen) are upwardly adjusted by the following percentages: Victim tipsy = +10%, drunk +30%, staggering +60%, blind drunk +100%.

Example: Slevryt, a 6th level thief, has a 60% chance of picking a normal pocket; he is attempting to steal a woman's bracelet (difficulty level 3, making his base chances 60% x .7, or 42%). If the woman being robbed is drunk, Slevryt's actual success chance would be 55% ( $42 \times 1.30 = 54.6$ )

A victim's chances of detecting a theft are also diminished by drunkenness. Detection chances, as outlined in the Rules section of this book, are calculated by comparing the experience levels of the thief and victim. For these purposes, drunkenness is assumed to implicitly reduce a victim's effective experience level by the following percentages (all results rounded to the nearest whole number): Victim tipsy = -10%, drunk = -20%, staggering = -40%, blind drunk = no detection possible.

Example: Slevryt's intended victim is an 11th level Trader. The woman's normal detection chances are 25% (Victim Level 11 - Thief Level 6, squared). Her drunken state makes her effectively a 9th level character, however ( $11 \times .8 = 8.8$ , rounded up), which means that her detection chances will be only 9% ( $9 - 6$ , squared).

If the victim being targetted is one of the random characters at the ball, the following general table can be used to determine the character's sobriety:

Random Encounter Drunkenness Table						
Hour of Day	State of Sobriety (roll D100)					
	N	T	D	S	B	
8PM-10PM	01-80	81-95	96-99	00	00	
10PM-12PM	01-35	36-70	71-95	96-99	00	
12AM- 2AM	01-15	16-55	56-90	91-97	98-00	
2AM- 4AM	01-05	06-25	26-75	76-95	96-00	

It is possible, of course, that the thief himself may succumb to the spirit of the evening and fall under the influence of the Demon Rum. If this proves the case (and a GM may wish to place temptation directly in the thief's path to force the latter to confront the issue), and the thief becomes drunk, he would suffer penalties to his pickpocketing abilities equivalent to those described above.

CHARACTER DESCRIPTIONS FOR THE DUKE'S DRESS BALL

CHARACTER NAME	LVL	CLASS	ST	CO	RF	SM	IQ	MAG	APP	WEAPON	HACO	DAMAGE	GAME ROOM	PROBABLE OCCUPANTS			STATE OF SOBRIETY			
														BALL ROOM	DINING ROOM	GARDEN	OTHER	8-10	10-12	12-2
di Cotillion (page 10-9)																				
Fernando	12	11th NON	12	14	13	16	13	16	8	DGR	8	1D4	1	1	T	T	T	T	T	
Kataleyna	9	5th NON	9	11	11	12	12	13	19	BDSWde	3	3D4	2	2	N	N	N	N	N	
Elise	7	1st NON	7	8	16	11	11	7	12				3	3	T	T	D	D	D	
Castillia	8	1st NON	8	11	12	11	8	10	15				1	2	N	N	N	N	N	
Tyndal	11	10th NON	11	10	10	11	10	7	11				5	5	D	D	N	N	N	
Marika	6	3rd NON	6	12	13	8	8	6	6				6	6	N	N	N	N	N	
Madalena	6	1st NON	6	17	14	10	9	14	15				7	7	N	N	N	N	N	
de la Riis (page 10-10)																				
Tyballt	7	9th NON	7	10	08	13	12	12	7	THRKN	4/8/13	1D4	8	8	N	N	N	N	N	
Grazia	4	2nd NON	4	6	7	4	6	2	6				9	9	T	N	T	T	T	
Harz	13	7th NON	13	7	11	11	10	8	10	DGR	10	1D4	10	10	N	N	T	T	T	
Claudia	8	4th NON	8	12	9	12	9	12	12				11	11	N	N	T	T	T	
Paul	11	4th FTR	11	16	17	12	13	17	15	RAPRe	3	1D12	12	12	N	N	N	N	N	
Thomas	12	2nd FTR	12	8	9	7	14	8	11	RAPR	11	1D8	13	13	N	N	D	S	B	
Cortina	8	1st NON	8	11	10	9	11	11	12	SHSWD	6	3D3	14	14	T	D	N	S	S	
Bruning	13	8th FTR	13	12	14	15	11	14	6				15	15	N	N	N	T	N	
K'mall	7	2nd NON	7	13	12	9	10	13	20				16	16	N	N	T	T	T	
Ingrid	8	1st NON	8	12	13	10	9	9	13				17	17	N	N	T	T	T	
Rutmillia	13	5th NON	13	12	11	14	8	7	5				18	18	N	N	T	T	T	
Morgan	10	3rd FTR	10	11	10	11	9	9	11	BDSWde	6	3D4	19	19	T	T	D	S	N	
Carlo	6	1st NON	6	9	14	8	16	6	11				20	20	N	N	N	N	N	
Geronde (page 10-13)																				
Rowena	12	12th ENC	12	15	14	16	16	7	13	MAGIC	VAR	VAR	21	21	N	N	N	N	N	
Karl	12	6th ENC	12	17	15	15	14	17	7	MAGIC	VAR	VAR	22	22	N	N	N	N	N	
Gunter	13	2nd FTR	13	15	12	9	10	10	10	RAPR	5	1D8	23	23	N	N	T	D	S	
Adrienne	5	3rd SCH	5	9	10	13	17	11	13				6	6	N	N	N	N	N	
Other Nobles (page 10-13)																				
M. Hochritter	8	3rd NON	8	9	8	9	6	8	9				24	24	N	N	T	D	S	
Margery	5	10th NON	5	10	10	10	8	11	5				25	25	N	N	N	N	N	
Donia	4	2nd NON	4	13	13	7	14	5	8				26	26	T	T	T	D	D	
Antonio B	14	5th FTR	14	13	11	13	9	19	13	BDSWde	5	4D4	7	27	N	N	N	T	D	
Harruid	19	9th FTR	19	12	16	17	6	10	8	HANDse	4	1D4	8	28	-	-	N	N	D	
Cellini (page 10-15)																				
Salvatore	9	12th NON	9	19	14	7	14	9	7	DGR	11	1D4	9	29	N	N	T	D	D	
Nicolo	11	3rd NON	11	11	14	11	8	15	13	DGR	11	1D4	10	25	D	D	D	T	D	
Linnea	7	5th NON	7	11	9	8	12	14	17				30	30	N	N	N	T	T	
Vecchia	9	1st NON	9	16	16	13	11	12	10	DGR	10	1D4	11	31	N	N	N	N	N	
Benedios	5	2nd NON	5	12	12	10	12	5	5	DGR	11	1D4	32	27	T	T	D	D	S	
Blackbourne (page 10-16)																				
Hamlin	8	10th NON	8	12	10	6	16	9	6				28	28	N	N	N	T	S	
Anson	6	6th NON	6	10	13	10	11	15	12				33	33	N	N	T	D	S	
Talia	7	3rd NON	7	13	13	6	9	11	13				34	29	T	T	D	S	S	

CHARACTER LVL CLASS ST CO RF SM IQ MAG APP WEAPON HACO DAMAGE GAME ROOM PROBABLE OCCUPANTS STATE OF SOBRIETY  
 NAME CHARACTER LVL CLASS ST CO RF SM IQ MAG APP WEAPON HACO DAMAGE ROOM ROOM ROOM GARDEN 1 FLR PM PM PM AM AM

Maggia (page 10-17)	6th TRD	7	11	15	10	16	13	15	DGR	9	1D4	12	35	30	22	13	N	N	T	T	
Portia	2nd NON	10	15	13	15	7	11	9	SHSWD	7	2D3	36	31	32	23	14	N	N	B	-	
Marita	2nd NON	5	13	8	14	10	14	17									N	N	T	-	
City Dwellers (page 10-18)																					
Koridian	15th MAG	8	17	15	13	18	11	10	MAGIC	VAR	VAR	37	33	33	15	16	N	N	N	N	
Cardalio	8th JDG	15	9	14	10	10	15	15	6	MACE	8	3D4	34	35			N	D	D	S	
Perkins	5th NON	7	9	14	10	10	12	8				13	38	35			N	T	T	-	
Alarikon	9th SCR	9	16	11	9	13	13	13				14	39				N	N	T?	T?	
Hullee	2nd TRD	12	10	9	11	8	13	14				15	40				N	T	D	D	
Out of Town Guests (page 10-19)																					
Erich	8th NON	9	16	9	16	9	15	16	DGR	9	1D4	16	41	24	17		T	D	S	-	
Marita	7th NON	8	12	12	13	11	16	15				43	43	26			N	N	T	-	
Arden	7th FTR	10	14	16	12	12	13	14	SHSWD	6	2D3	17	45	26			N	N	T	-	
Alyra	4th ARC	6	14	13	9	12	12	18	THRKN	3/7/12	1D4	17	45	36			T	T	T	-	
Sir Timothy	8th FTR	13	14	14	15	8	7	9	DGR	8	1D4	18	45	36			T	T	T	D	
Sutter Creevy	3rd NON	12	10	10	14	8	7	7				19	46	37	28	19	T	D	S	B	
Kalfi	3rd NON	15	11	9	16	8	6	6				18	47	38	29	20	T	T	D	S	
Tarquinio	13th SCH	6	13	12	9	19	9	9				48	48	39			N	N	T	-	
Glaudrim	6th NON	10	10	10	10	10	10	10				49	49		30		N	N	T	-	
Carr-ne-Seval	10th PRM	13	11	9	15	14	16	8	MAGIC	VAR	VAR	20	50	40			N	N	D	T	
Guards																					
Captain Pettifog	6th FTR	9	12	14	13	10	11	12	MACEE	5	3D4	X	X	X	X	X	N	N	D	-	
Sargeant Ebrahim	5th FTR	17	10	9	14	14	9	8	BDSWDE	5	5D4	X	X	X	X	X	N	N	T	-	
Sargeant Rodas	5th FTR	13	12	12	15	9	13	15	BDSWDE	5	4D4	X	X	X	X	X	N	N	N	-	
Sargeant Graves	7th FTR	13	16	14	8	10	8	7	BDSWDE	4	4D4	X	X	X	X	X	N	N	-	N	
Guard, Type A	3rd FTR	11	14	12	12	11	10	12	BDSWDE	5	3D4	X	X	X	X	X	N	N	N	N	
Guard, Type B	5th FTR	14	12	12	15	10	7	10	MACEE	6	4D4	X	X	X	X	X	N	N	N	N	
Other NPCs																					
Gatena Cordovan	7th THF	11	18	14	15	14	10	10	BLWGN	1/6/11	1D2	X	X			X	N	N	N	N	
Acrobat	4th THF	10	19	18	8	12	8	10	DGR	6	1D4						N	N	N	-	
Harchens	5th NON	7	12	9	12	14	9	9				X			X		N	N	N	-	
Varkin	2nd FTR	15	15	10	11	7	8	15	GRSWD	5	2D8						N	N	T	-	
Potlander	3rd FTR	12	10	17	13	9	10	11	BDSWDE	6	2D4						N	N	-	N	
									LBDW	2/6/9/	1D6						N	N	-	N	

NOTES:

Probable Occupants: To use this table to identify NPCs encountered by the player, roll the appropriate die: Game Room D20 Other 1st Floor D20 Ballroom D50 (D100/2) Dining Room D40 (D10 & D4) Gardens D30 (D10 & D3)

State of Sobriety: The symbols used in these columns are: N sober T tipsy D drunk S smashed B blind drunk

These conditions are discussed on page 10-30.



THE DUCAL ESTATE:  
EXTERIOR GROUNDS

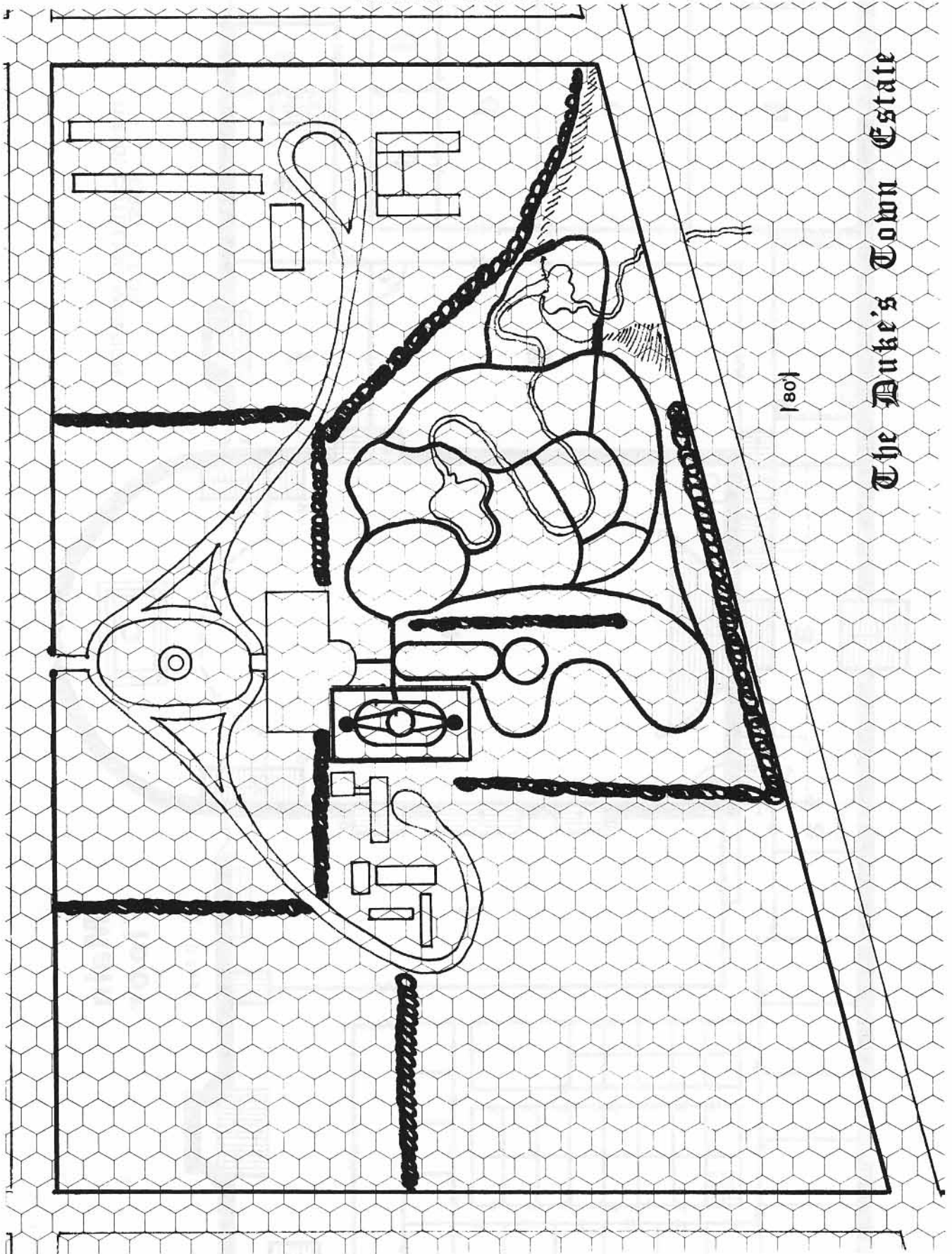

The Duke's Town Estate

THE DI COTTILLION MANSION:  
FIRST FLOOR

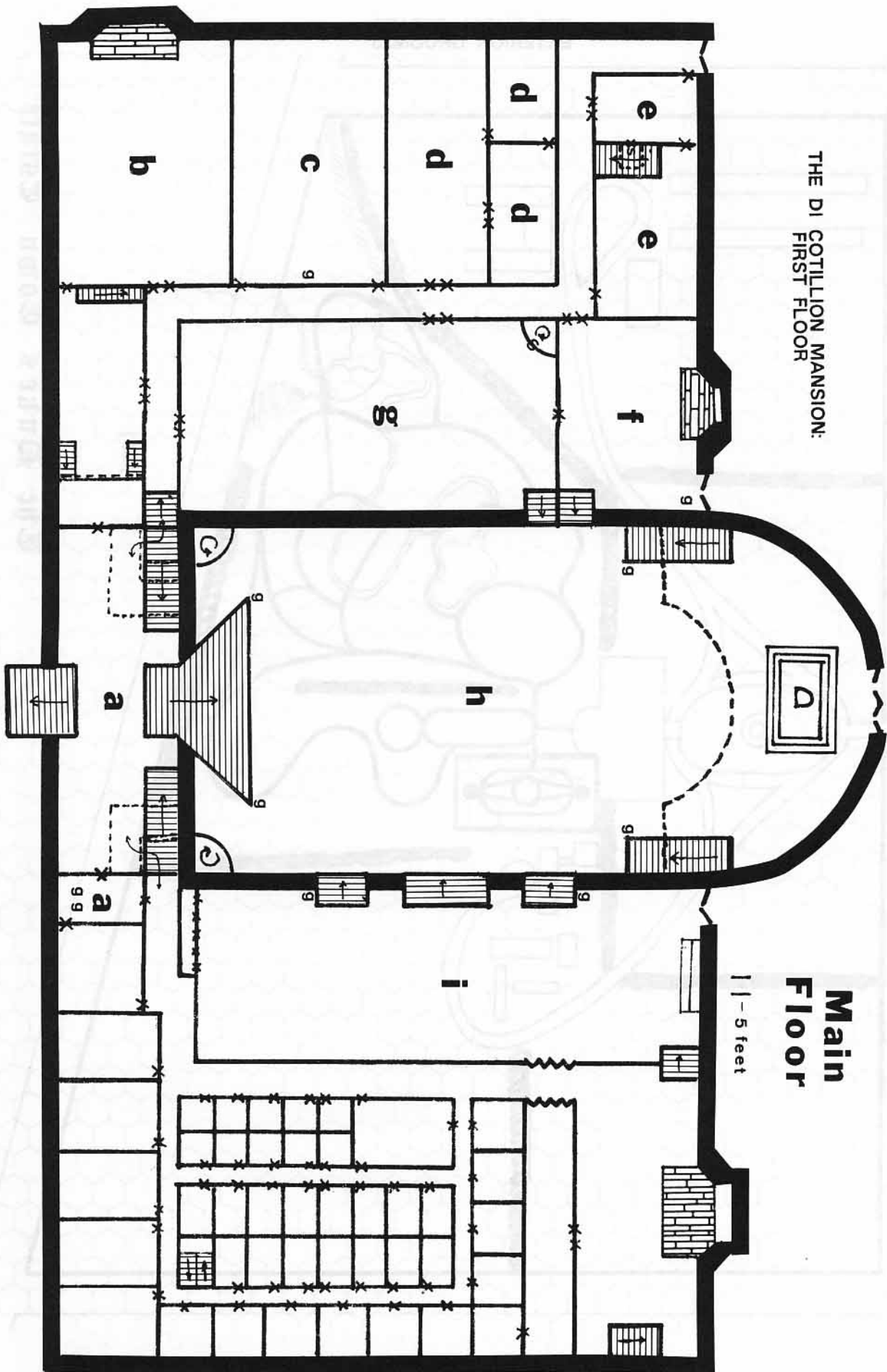

Main  
Floor

5 feet

# Second Floor

THE DI COTILLION MANSION:  
SECOND FLOOR

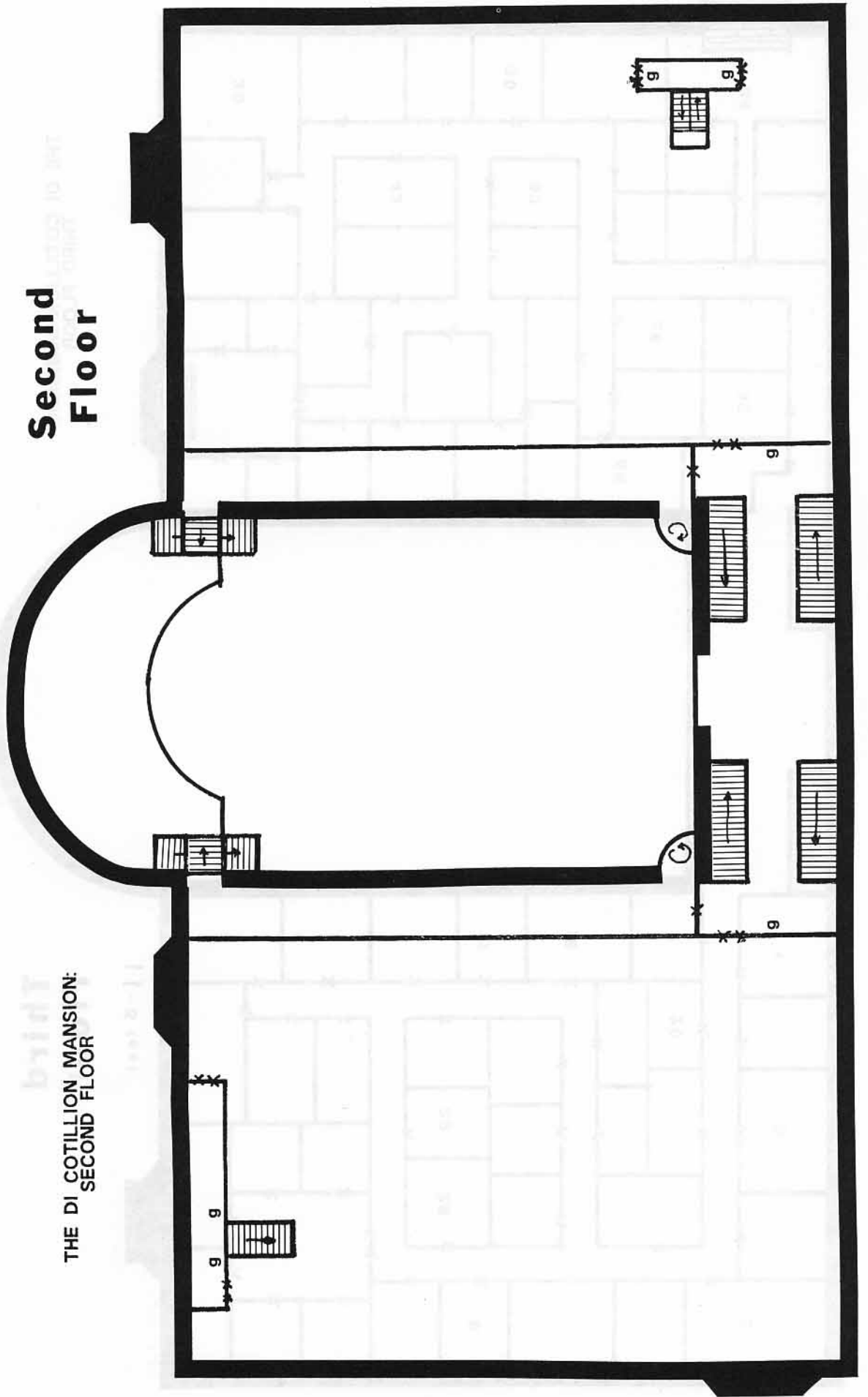



THE DI COTTILLION MANSION:  
THIRD FLOOR

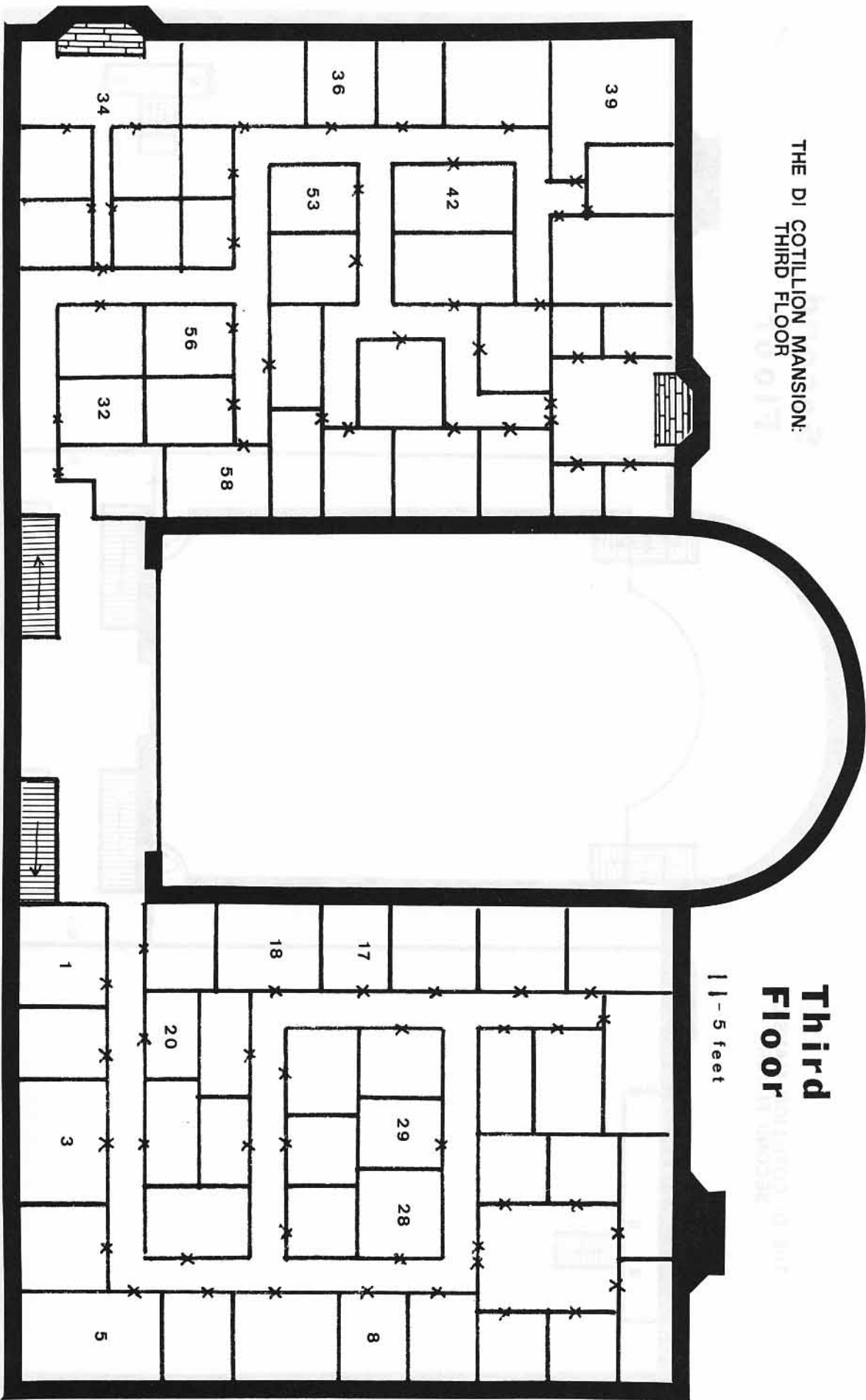

**Third  
Floor**

|| - 5 feet

GAMELORDS, LTD.

1981

CATALOG

CURRENTLY AVAILABLE

Thieves' Guild --

The first adventure series devoted to thief characters in fantasy role-playing: 128 pages of rules and robbery; scenarios bound to prove that sometimes it's more fun to play the bad guys!!

Thieves' Guild II --

The Tombs of Snale-Chuun: a foray into the treasure filled (and decidedly deadly - no pun intended) Valley of the Dead. Or try out 10 new highwaymen encounters, and the expanded combat rules first.

Thieves' Guild III --

The Duke's dress ball, and the Tower of the Mage: use a forged invitation for a chance to lift fabulous jewelry from the necks of dowager nobility, or accept a mission from the Guild to steal an item (a special one) from the residence of an old, retired mage.

Thieves' Guild IV --

The Guild against the Black Hand: join the local Guildmasters in preventing the loss of valuable merchandise (and Guild honor) by Black Hand smugglers, or be a Hand thief in the revenge upon the Guild.

Thieves' Guild Special #1 --

The special scenarios used in "Prince of Thieves, '81", the tournament conducted at the major gaming conventions, Summer, 1981, by Gamelords, Ltd.

Duel Arcane --

A duel between shape-changing mages: lightning-quick shifts of advantage, as players engage in individual combat by transforming themselves from legendary beast to mythical monster.

Monday Morning Manager

(What?? a fantasy company producing a baseball mini-game?? Darned right!! and it's a good one, too!) A fast paced game of sports strategy that allows you, as the owner of a major league franchise, to build your team carefully; and, as manager of that team, you can make all the right tactical decisions as the pennant race unfolds. All the action and fun of the big league games!

THE COMPLEAT TAVERN

Settle in for a night of mis-adventures at a medieval tavern - where you can try your hand at games of skill and luck, get involved in a wild barroom brawl, or even attempt amorous liaisons. A great evening of diversion for fantasy role-players of all ages.

The Free City of Haven --

A city of 80,000 people can provide a lot of adventure, especially when it's already the site of many of the adventures in the Thieves' Guild series -- but you don't have to be a thief to enjoy all the city has to offer: scores of temples and religions, taverns and barkeeps, beggars and wealthy businessmen, streetvendors, shops, homes; you can even join one of the companies of the City Guard. Multitudes of encounters to occupy even the busiest of adventurers.

COMING SOON!!

Thieves' Guild V --

Assassination and temple robbery: stop the new messiah of the orcs...dead, or join in an expedition to relieve a fast growing cult of some of its treasure.

Thieves' Guild Special #2 --

Thieving in the far future: rules for foiling electronic surveillance gear, how to use your thieving abilities in major SF role-playing systems, etc., and special scenarios to delight the soul of any SF role-playing fan.

Thieves' Guild VI --

Piracy on the high seas: ship to ship combat, and all the excitement of life on the briny deeps - loot fabulous treasures and capture beautiful women from the ships of many nations.

THE FANTASY SYSTEM --

A complete set of role-playing rules, with many new character races, new classes for characters to adventure in, two combat systems (one quick'n'dirty, the other very precise), and a magic system that allows imaginations free rein. If you use the Thieves' Guild rules, you've already tried it out.

Mine Eyes Have Seen the Glory --

(MEHSTG for short) A role playing game placed in the milieu of the American Civil War. Be a Federal or a Confederate, Billy Yank or Johnny Reb -- join your comrades on patrol, or be the regimental colonel, leading your men on a desperate push to capture an important position from the enemy. Complete with dice, and a unique experience system that rewards the player rather than the character!

All the above are available from (we hope!) your local game store. If these masterpieces of writing and imagination are not to be found in your area, they are available from

GAMELORDS, LTD.

18616 Grosbeak Terrace

Gaithersburg, MD 20879

Prices for our products will be found on the enclosed order blank. If ordering by mail, please include \$1.00 for postage and handling (Maryland residents also include 5% state sales tax).