

# MINDJAMMER

Starblazer Adventures in the Second Age of Space  
by Sarah Newton



**FATE**

**STARBLAZER  
ADVENTURES**  
THE ROCK AND ROLL SPACE OPERA ADVENTURE GAME



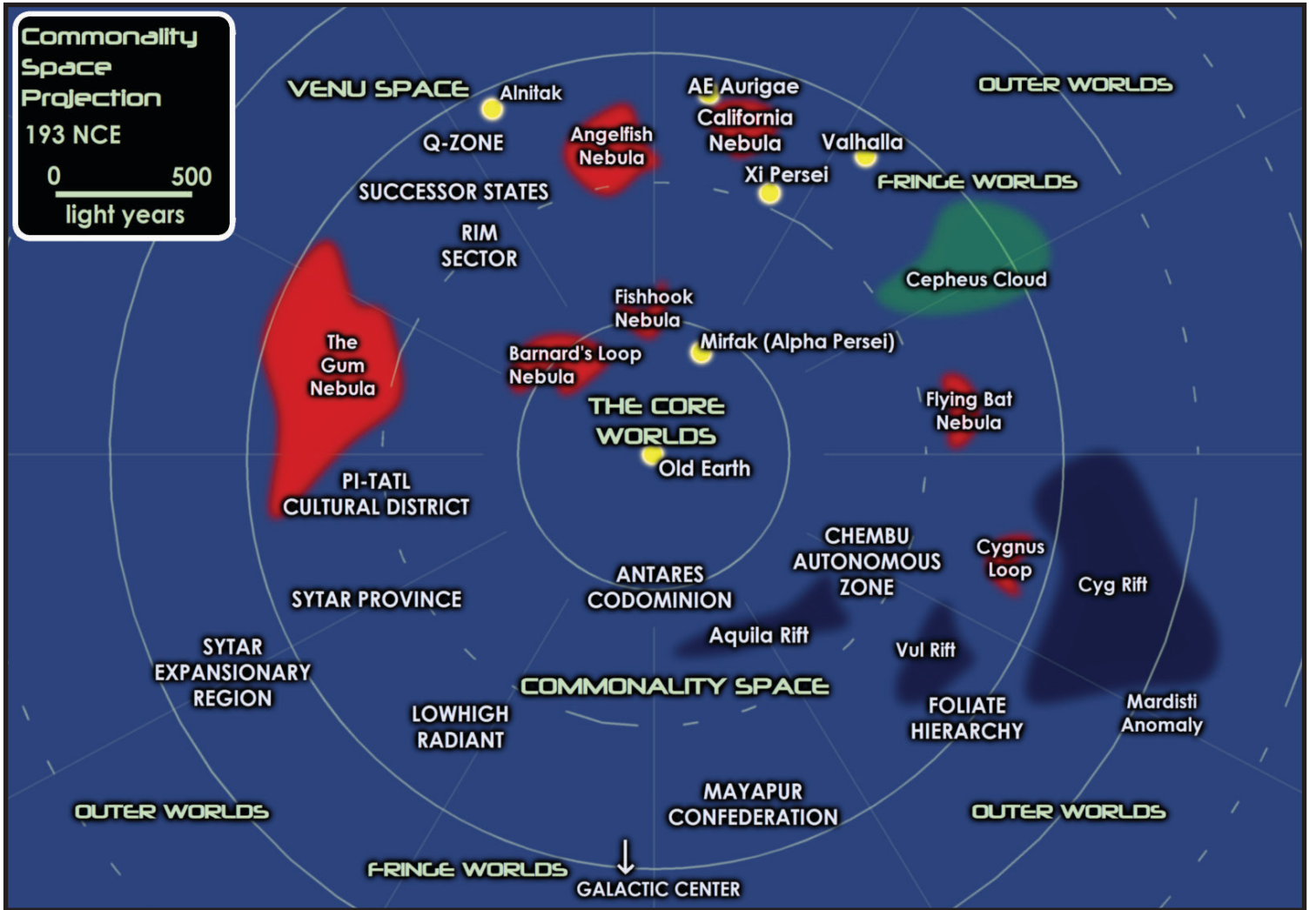
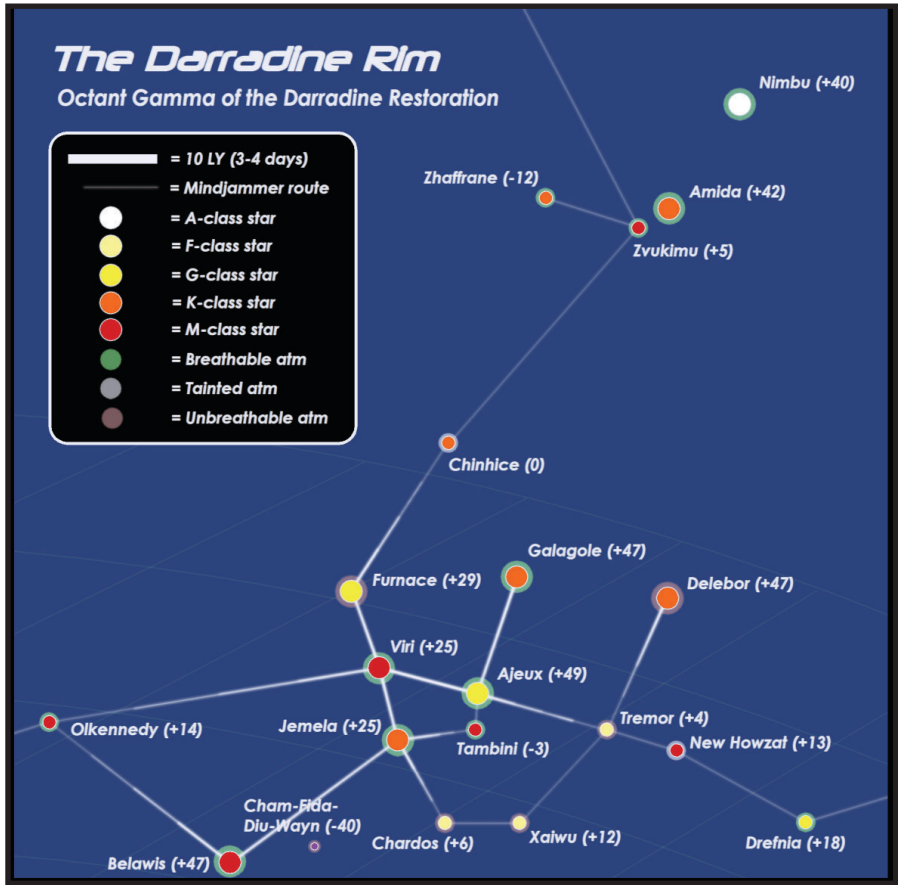



# MINDJAMMER

Starblazer Adventures in the Second Age of Space

## Credits

### **Writer**

Sarah Newton

### **Editor**

Dominic McDowall-Thomas & Sarah Newton

### **Layout and Graphic Design**

Will Chapman

### **Production & Sales**

Dominic McDowall-Thomas & Angus Abranson

### **Starblazer Line Manager**

Chris Birch

### **Playtesters**

Scott Acker, John Bogart, Craig J. Brain, Christopher Dalgety, Jason Durall, Chris McWilliam, Tonpa Sarkkinen, Rich Spainhour, Rich Stokes, Andrew Whincup. Thanks for all the help and support guys!

### **Art Direction**

Douglas Nicol

### **Additional Artwork**

Chad Sergesketter  
(p9 "Hooyow", p10 "Lowhigh", p46 "Mindjammer")

### **Maps**

Sarah Newton

### **Special Thanks**

To Chris Birch and all the guys at Cubicle 7, for writing and producing the amazing Starblazer Adventures, and for giving me the chance to write Mindjammer.

To Fred Hicks, Leonard Balsera, and Rob Donoghue, for writing Spirit of the Century and kicking this whole thing off in the first place.

To Simon and the guys at Profantasy for their wonderful Campaign Cartographer suite, which powers the maps in this book, and Bill Roach, whose Terraformer files really made the planetary maps come alive!

## Contents

<b>Introduction</b>	<b>2</b>
<b>Characters</b>	<b>4</b>
<b>Skills and Powers</b>	<b>12</b>
<b>Gear</b>	<b>20</b>
<b>Starships and Space Travel</b>	<b>35</b>
<b>New Commonality Era</b>	<b>52</b>
<b>Worlds and Cultures</b>	<b>63</b>
<b>The Darradine Rim</b>	<b>86</b>
<b>Escape from Venu</b>	<b>128</b>
<b>Mind's Eye</b>	<b>143</b>
<b>The First Casualty</b>	<b>159</b>
<b>The Black Zone</b>	<b>170</b>
<b>Appendix I</b>	<b>192</b>
<b>Appendix II</b>	<b>194</b>
<b>Index</b>	<b>195</b>

Media Enquiries: [pr@cubicle7.co.uk](mailto:pr@cubicle7.co.uk)

Sales Enquiries: [sales@cubicle7.co.uk](mailto:sales@cubicle7.co.uk)

Website: [www.cubicle7.co.uk](http://www.cubicle7.co.uk) and [www.mindjammer.com](http://www.mindjammer.com)

Cubicle 7 Entertainment Ltd is a private limited company, reg. no. 6036414. Our registered office is at Riverside House, Osney Mead, Oxford, OX2 0ES, United Kingdom

©2009 Cubicle 7 Entertainment Ltd, Printed in USA

**Dedication** To my husband Chris, who always said it was possible.



# Introduction:

## The Second Age of Space

*"It was the Second Age of Space. The light of human civilization, which had flickered and threatened to die, suddenly burned bright again with contact with the thousand worlds of space. Humankind laughed, filled with the joys of the power of a new-found youth, and strode forth to bring its message of hope and regeneration to the stars..."*

- from "The Songs Of Old Earth", Book I

You hold in your hands **Mindjammer**, a sourcebook for the **Starblazer Adventures** role-playing game. Set in the strange and distant future of our own planet Earth, it's a cool yet believable science-fiction setting of lost worlds, incredible technologies, and clashing civilizations. In these pages you'll find a unique and compelling space opera setting, a whole universe of action and adventure!

**Mindjammer** provides everything you need to play using only the **Starblazer Adventures** rules. It introduces the **New Commonality**, an interstellar state centred on Old Earth expanding back to the stars and contacting lost worlds colonized in the distant past. The **Expansionary Era** is a time of turmoil; as the Commonality assimilates these lost colonies, it finds itself getting "colonized right back", its traditions and stability shaken to the core. The secret agents and special forces of SCI Force, the Security and Cultural Integrity Instrumentality, battle constantly to protect Old Earth's cultures from destruction, and everywhere the Commonality's frontier bristles and sparks with war.

## What's in this Book

**Mindjammer** is a detailed yet open setting, with plenty of room for exactly the sort of **Starblazer** adventures you want to play. This core book gives you the background and history of the New Commonality Era, with new species and cultures; new gear (including some very advanced technology!); new (and often sentient!) starships; the near-ubiquitous Mindscape; a starmap of an octant of Commonality Space, complete with world descriptions and planetary maps; an action-packed introductory campaign consisting of four linked adventures - and much, much more! It's a crunchy, technological take on the **Starblazer Adventures** rules; everything you need to get playing is here.

## The Commonality of Worlds

The Commonality is a beacon of light in the blackness of space; ultra-advanced technology, its gift to the stars. The **Mindscape**, a vast technological "shared consciousness", links the citizens of the Commonality together, storing the memories - even personalities - of dead generations. Every Commonality citizen can boost their skills and knowledge

via **Mindscape implants** - direct neural connectors to the Mindscape - and the staggering powers of **technopsi**. Synthetic life-forms with the personalities of dead heroes pilot sentient spaceships to the stars.

The Commonality is a predominantly human civilization, but one of staggering diversity. The inhabitants of Old Earth who began the Expansion were a homogenous species; but the new Culture Worlds have changed all that, as races new and old are invented and explored anew. The Ten Thousand Worlds are human, too, in theory, but ten millennia of divergent evolution and genetic engineering have spawned some strange races and even new subspecies.

As well as humans and hominids, xenomorphs - uplifted animals, from chimp-like pithecines labouring in mining colonies to the *chelodont*-riding snake-people of Zhaffrane - populate whole worlds in some regions, and the new Sentient Alliance is a force to be reckoned with. And there are extraterrestrial species, including the strange vegetable intelligences of Drefnia and the warlike Hooyow - far more alien than anyone ever dreamed.

The Commonality today struggles as it expands further into space, limited by the slow communication times of 2-Space; and the **Mindjammers**, sentient spaceships charged with maintaining interstellar communication and the fabric of the Mindscape, work ceaselessly and heroically to hold the far-flung worlds together. In the Core Worlds around Old Earth, a new 3-Space "gating" technology promises instantaneous interstellar travel and technological revolution. Everywhere the Commonality struggles to keep control.

The Commonality is vast enough to contain any number of **Starblazer Adventures** campaigns. This book focuses on one part of the Commonality frontier, where the Venu Empire, one of the Commonality's deadly foes, staged a devastating invasion eighty years ago. It's an area of constant friction, espionage, and intrigue, and everyone again is expecting war.

## The Expansionary Era

**Mindjammer** takes place in an era of violent change. In the past, Old Earth's civilization had achieved utopia, blessed by long life and hyper-advanced technology. But hand-in-hand with utopia came stagnation and decay, and while the stars sang with the songs of men, Old Earth remained fossilized for millennia, and slowly began to die.

Two hundred years ago everything changed. Almost overnight, the scientists of Old Earth discovered the secrets



of faster-than-light travel. In their **planeships** they ventured to the stars, in search of the colonies they had sent out millennia before.

What they found stunned them. The galaxy was alive! Everywhere they went, they found people. Vibrant cultures, strange civilizations, worlds savage and untamed. Suddenly, Old Earth felt itself old no longer, but young, and excited by the prospects of an unknown future. It was a new age of discovery and expansion - a Second Age of Space.

Now, the Commonality contacts lost colonies almost every day, colonies which have evolved very differently, sometimes into sub-species of homo sapiens, sometimes different species altogether. The Expansionary Era is a time of great conflict and clashing cultures, but also opportunity and adventure.

## How to Play

**Mindjammer** is a self-contained setting. You can play it "out of the box"; or you can plug in your own campaign (Human Space gives you plenty of room!). You can even use this book as a toolkit and cherry-pick your favourite parts for your own campaign! You can play with pre-existing **Starblazer** characters, or with new ones created using the species, careers and cultures in this book. We even provide pre-generated characters so you can get started right away! Play characters like:

- special operatives from SCI Force - the Security and Cultural Integrity Instrumentality - investigating strange new cultures and bringing them into the Commonality;
- dedicated agents of the Commonality armed forces, defending the frontiers against the incursions of virulent alien cultures;
- members of the heroic Space Force, patrolling Commonality spacelanes and the virtual spaces of the Mindscape on the lookout for spies, alien agents, and renegade artificial intelligences;
- canny merchants - the so-called **New Traders** - mistrusted by most as evolutionary throwbacks to the bad old days of money and speculation, carving out a living carrying information and goods between worlds, dodging the Commonality's laws and agents as they go;
- intrepid 2-Pilots, navigating the terrifying reaches of 2-Space in their faster-than-light planeships, in constant mental contact with their starship sentience comrades. You can even play an intelligent starship yourself!
- explorers, soldiers, scientists, and just about any character you can imagine in this adventure-filled galaxy of the far, far future!

## The Universe Awaits!

Never has there been a greater time of opportunity. Old certainties are dying; the universe is in flux, and for the first time in ten thousand years no one knows what the future

will bring. So charge your blaster, think your commands to the starship's brain, and fire up the planing engines - come and defend the light of humanity's greatest civilization as it spreads to the stars!





# Chapter One: Characters



*"You could tell he was one of those New Trader types. He smiled too much, and had a greedy look in his eyes, like he cared more for those little nuggets of gold than he did for the people who worked their knuckles to the bone making them. Guys like that are evolutionary throwbacks, a step backward for the whole human race. Let's hope they can do us some good..."*

## Creating Characters in the New Commonality Era

The Commonality is an interstellar civilization of staggering diversity. Rough and ready spacers rub shoulders with solemn and traditional functionaries from complex Core World cultures; uplifted animal xenomorphs serve aboard sentient starships with the minds and memories of ancient war heroes; and everywhere the inhabitants of lost colony worlds gaze wide-eyed and incredulous at the technological marvels of a civilization ten thousand years old. Whatever character you want to play, there's room for it somewhere in **Mindjammer**.

Create **Mindjammer** characters as shown in **Starblazer Adventures**. If you want to play a non-human, select one of the genotypes below or maybe come up with one of your own. Genotypes give your character special abilities, and add flavour to a **Mindjammer** game.

Select a career and a "culture," too. As well as **Starblazer Adventures** careers, there are **Mindjammer**-specific ones

below. "Culture" is unique to **Mindjammer**, influencing your Aspects, career, and back-story; most characters belong to the Commonality culture, but feel free to make up your own - it's a big universe!

## Genotypes

Genotype represents biological race or species, influencing a character's physical and mental capabilities. It's distinct from culture, which represents customs and social conventions. Genotypes include: humans and hominids; synthetics (artificial life forms, including sentient starships!); xenomorphs (uplifted animals); aliens; and the Venu, one of the Commonality's principal foes.

### Humans

Humans are the standard genotype of the New Commonality Era. Except for longevity and ethnicity, Commonality humans are physically little different from our own time.

### Extreme Longevity

Commonality citizens live many centuries. Until the Expansionary Era, life-spans were set by the Mortality Statutes at 500 years. Since then, considering the vastly increased scope for accidental death facing Commonality citizens, most worlds have rescinded the Statutes and there's no legal maximum to how long you can live. Conservative worlds may frown on the "new-fangled" life-spans and quietly continue euthanasia at 500, but the Commonality recently celebrated its millionth citizen to reach 700 years old, and bookmakers are taking bets on how long people will live before accident takes them.

This has changed society immensely. People routinely spend 30 years in education, not beginning careers until 40 or 50 years old. You can start characters at the "Gritty" or "Standard" campaign levels, but you can also use the "Heroic" level or above for characters over a hundred years old to represent their great experience.

On Fringe and Outer Worlds the Commonality is pragmatic, aiming to mitigate culture shock. Most contacted worlds have limited access to anagathics, and few have as yet been profoundly affected by longevity.

Long-lived characters may choose longevity Aspects such as "Not Clumsy Any More," "This is my 8th career," "I get married every fifty years whether I like it or not," "You don't grow up for the first ninety years."



### **What is the Mindscape?**

The Mindscape is the virtual brain pervading Commonality Space to which all citizens are neurally connected at maturity using the **Mindscape implant**. Citizens isolated from the Mindscape (by distance or illness) report feelings of loneliness, isolation, even depression.

It's a vast space, storing the entire experience of the human race and the memory engrams of generations living and dead, enabling skill enhancements and the "pseudo-psionic" abilities known as **technopsi** – essential to life in the New Commonality Era.

The Mindscape is the sole reason the Commonality survives as a single civilization. With the vast distances, long travel times, and enormous number of worlds, the Mindscape allows cultures, languages, and institutions to retain common identity.

Offenders in the Commonality have their Mindscape implants temporarily or permanently disabled, becoming **embargoes** or **exiles**. Criminals create counterfeit implants known as **black chips**, using the identities of innocent victims they've (usually) killed. Black chips are hunted down by SCI Force, Mindscape sentinels, and agents of the Communications Instrumentality.

### **Character Names**

Choose whatever name you like for your character. Don't worry if it seems fanciful or humdrum - chances are it exists somewhere. If you choose a current Earth name, your character may come from a culture world based on an ancient Old Earth culture, or might be a follower of the latest Commonality fashions. There are some very strange names in the Commonality - you've got plenty of choice!

### **Ethnicity**

Old Earth eliminated ethnic diversity millennia ago, resulting in a homogenous population where personal appearance is a matter of fashion and preference. Out in the Ten Thousand Worlds, however, every contacted world has its own ethnic variations, developed over millennia of isolation. Further, the Commonality is encouraging "culture worlds" with especially strong cultures and ethnicities often (but not always) derived from Old Earth history. Today's Commonality teems with ethnic diversity.

### **Hominids (*Homo Variens*)**

Hominids derive from human stock which through geneering or genetic drift have become separate subspecies. Some are far removed from their human ancestors. Two hominid species, the Javawayn and Chembu, are presented below; you can find others in **Chapter Seven: The Darradine Rim**.

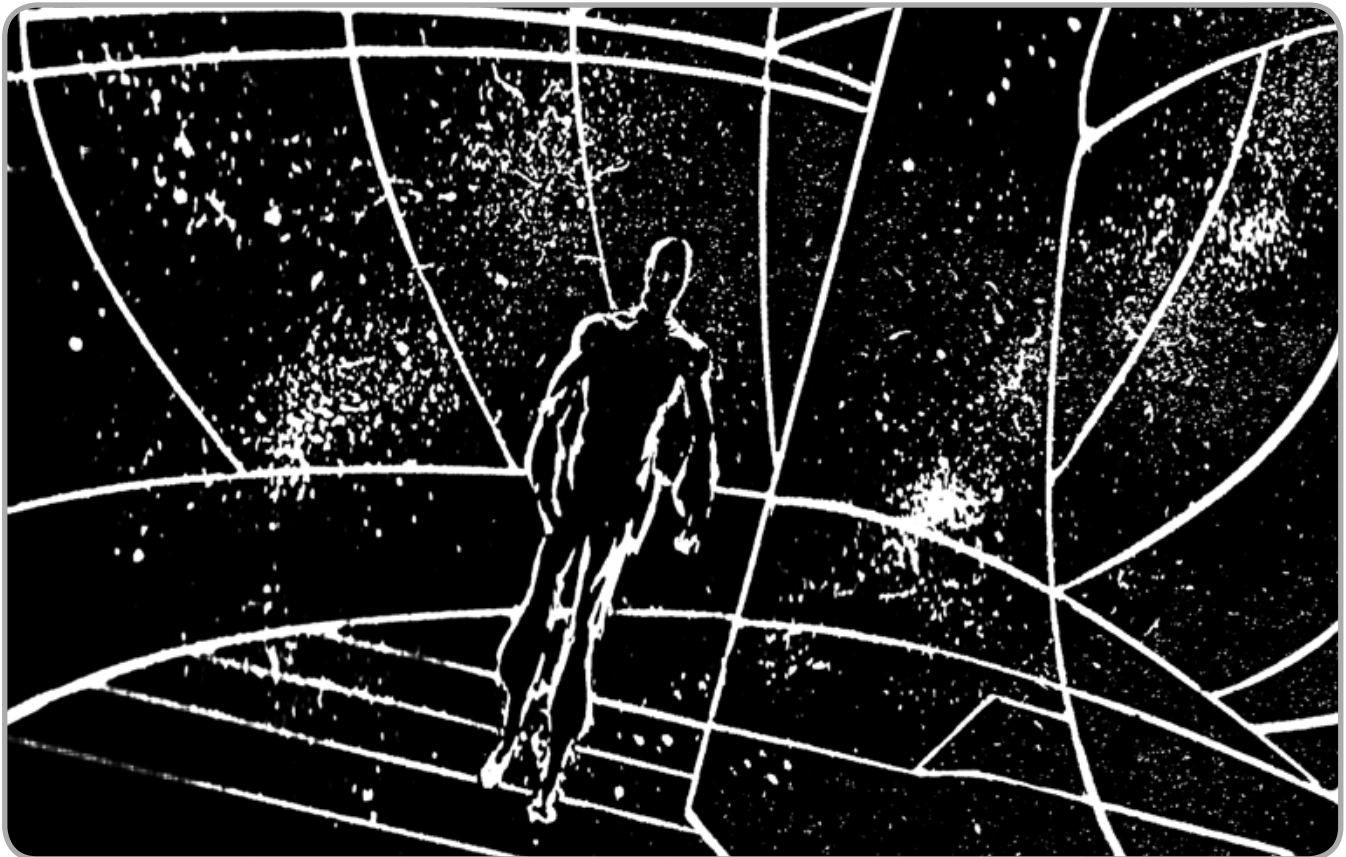



Hominids have a genotype Aspect indicating their species and unlocking special Skills and Stunts.

### **Hominid Species: the Jawayn**

The Jawayn are low-gravity hominids with no known homeworld. Inhabitants of "Sky Cities", gigantic space-faring vessels, they have little experience of planetary life. They're short, emaciated humanoids with large heads and prehensile feet. Dwelling in 0.3G environments or less, they're known throughout the Commonality; even before the Expansionary Era they had a relativistic interstellar drive, now mostly updated with Commonality technology, although more traditionalist Sky Cities still travel slower than light. They travel through the Fringe and Core Worlds, providing excellent shipyards, luxury interstellar hotels, and "cruise ships". Jawayn venturing briefly into environments higher than 0.3G use grav harnesses.

The Jawayn operate the Jawayn Corporacy, manufacturing grav suspensors and starship hulls.

### **Hominid Species: the Chembu**

The Chembu are "genurgists" - specialists in genetic enhancement. Their homeworld is a water-world inhabited by a kind of organic global mindscape, which welcomed the original colonists (after some horrific misunderstandings) into a "massmind" relationship. Known as the "Planetary Intelligence" or just "Chembu", it's connected to the Mindscape, although its thoughts are too alien for most people.

Before the colonists' arrival the Planetary Intelligence lived by genurgically modifying its environment; the Chembu hominids now have a symbiotic relationship with it, a phenomenon with significant philosophical ramifications. It has sensory, communication, and manipulative organs best described as "psionic", whose powers the Chembu have been unable to replicate.

Chembu are genurgy-enhanced waterworld dwellers (see "Genurgy" in **Chapter Two: Skills and Powers**). They appear "streamlined", with hairless, dolphin-like skin, lungs and

#### **Jawayn Species Characteristics**

<b>Height:</b>	1.5m	<b>Gravity:</b>	0G - 0.3G
<b>Hair:</b>	None	<b>Frame:</b>	Very Thin
<b>Weakness:</b>	Kinetic Weapons		
<b>Aspects:</b>	Thin, wiry and nimble; at home in Low- and Zero-G environments.		
<b>Special Abilities:</b>	Small [Stealth]		
<b>Forbidden Skills:</b>	Might, Survival		
<b>Common Skills:</b>	Endurance, Zero-G Combat Stunt, Starship Skills		

#### **Chembu Species Characteristics**

<b>Height:</b>	1.7m	<b>Gravity:</b>	Normal
<b>Hair:</b>	None	<b>Frame:</b>	Streamlined normal
<b>Weakness:</b>	Hot, dry conditions		
<b>Aspects:</b>	Amphibious hominids; Tough dolphin-like skin		
<b>Special Abilities:</b>	Gills [Athletics] as well as lungs; other genurgic enhancements (see page 19)		
<b>Forbidden Skills:</b>	None		
<b>Common Skills:</b>	Science (Genurgy), Athletics, Empathy, Mysteries		



gills, and other genurpic enhancements. During character generation Chembu may take genurgy Skills (see page 19) freely, without regard to resource cost.

## Synthetics

Synthetics are artificial life-forms, ranging from entirely mechanical to entirely biological constructs, though the distinction is often blurred; the key is that synthetics are made, not born.

Synthetics are as intelligent as they need to be: intelligence is easily created in the Commonality, and synthetics with higher intelligence than humans are found operating starships, space stations, and orbital cities.

Selected synthetics have personalities derived from **thanograms**, deceased human personalities stored in the Mindscape (see **Chapter Five: the New Commonality Era** for more on the Mindscape). These **eidolons** have the same legal status as humans in the Commonality. They're never considered the same person as the original human whose personality they derive from, but are imperfect copies, with many shared memories, but new, unique individuals. Many eidolons revere their source personalities like a "parent"; some even display religious or reverential feelings. See **Chapter Two: Skills and Powers** for more on eidolon creation.

### Eidolon Crisis

Eidolons suffering Composure stress can undergo a phenomenon known as **Eidolon Crisis**. This also sometimes happens to basics whose development exceeds standard parameters. Eidolon Crisis is a form of mental breakdown, with symptoms from mild neurosis to dangerous psychosis.

An eidolon suffering a Severe or Extreme Composure / Systems stress consequence undergoes Eidolon Crisis, a basic on a Major consequence or above. The synthetic is mentally damaged, unstable and unpredictable; at worst it suffers total personality disintegration and violent psychotic episodes. See the Create Eidolon Stunt on page 15 for the "Eidolon Compliances" and suggestions for Eidolon Crisis. Consequences can be treated with the Technopsi Redaction Stunt (see **Chapter Two: Skills and Powers**).

Not all synthetics are eidolons. For less demanding jobs, such as sentient weapons, vehicles, or industrial equipment, simple, mass-produced personalities are sufficient. These **basics** are considered machines, without legal rights; they're "blank-born," without memories, beginning rudimentary mental development after their incept date. They rarely develop complex personalities, and are carefully screened for deviations from acceptable norms.

Types of synthetic include:

### Mechanicals

Mechanicals are robots, generally humanoid or vehicle-shaped, employed for ruggedness and endurance and including attack droids, hazmat or industrial processing synthetics, and alien environment explorers. Avatars of planeships such as manowars are frequently mechanicals rather than variforms. Examples include numerous robots in **Starblazer Adventures**, attack droids from **Chapter Eight: Escape from Venu** and **Chapter Eleven: the Black Zone**, and the hazmat synthetic Abraxas from **Chapter Nine: Mind's Eye**.

### Installations

Installations are large-scale synthetics such as starship sentiences, Global Mindscape Instances, and corpuses (synthetics which operate buildings), including the Eidolon-4 station corpus and the "Wing Commander" starship sentience from **Chapter Nine: Mind's Eye**, and Gentility-5 from **Chapter Ten: the First Casualty**. See also "Installations" in **Chapter Three: Gear**. Create installations like starships, using the additional rules for starship sentiences in **Chapter Four: Starships and Space Travel**.

### Variforms

Variform synthetics have organic components and varying morphologies. Less rugged than mechanicals, they include some ships' avatars, and multi-service synthetics such as sanitationals and domestics. An example is the stingray-shaped "Sweeper" from **Chapter Nine: Mind's Eye**. Create variforms using the Mandroid and Robot rules (depending whether the variform is principally organic or robotic).

### Starships as Player Characters

Sentient starships are a major part of **Mindjammer**, and you can create them as player characters as shown in **Chapter Four: Starships and Space Travel**. The most famous are the **Mindjammers**, sleek, sophisticated ships which constantly travel the Commonality's spacelanes, synchronising the Mindscape and carrying its traffic between worlds. With Mindscape implants of their own, they're telepathic starships!

Starship sentiences aren't restricted to the physical bodies of their starships, either. Using a remote control drone known as an **avatar**, a starship may transfer its consciousness (or a large part of it) into an independent synthetic body, and embark on planetbound adventures! Think about giving a sentient starship character an avatar Aspect as well as the "Control Avatar" Technopsi Stunt, so it's not restricted to the ship on adventures.



## Xenomorphs

Throughout its history humanity has looked to the animal kingdom for companionship and aid, domesticating species as desired. For millennia, the Commonality has created animal companions with human-like intelligence and fully or partially humanoid body morphologies: the xenomorphs.

Historically xenomorphs were considered property in the Commonality, but the Expansionary Era (with its thousands of xenomorph and hominid worlds) has made this a nonsense, and xenomorphs find themselves in a legal limbo, subject to the whims of local custom. Xenomorph communities exist on society's fringes, doing menial jobs, avoiding the attentions of their often arbitrary creators; yet individual humans often accord xenomorphs equal status in their families. Some lost colony (often hominid) worlds accept xenomorphs as partners of Commonality humans; others (usually with little experience of diversity) see them as animals or even abominations. The "Xenomorph Question" is a burning issue for the Evolutionary Ministry, and xenomorphs travelling the Commonality face an unpredictable ride.

Xenomorph characters vary hugely, from near animal appearance to almost entirely human. This variance is **genotype divergence (GD)**, a 1-100 scale from the animal genotype towards the human norm. A GD25 cetacean is still mostly dolphin, whereas a GD75 one is very humanoid, though with obvious cetacean features such as rubbery grey skin, blowhole, and streamlined physique. Xenomorphs with GD less than 5 or over 95 are largely indistinguishable from the original animal or human genotypes.

### The Sentient Alliance

The Sentient Alliance is a Fringe World state and buffer against the Venu, a polity of highly-motivated, mostly xenomorph citizens sponsored by the Commonality. It's connected to the Mindscape and also receives Commonality weapons and technological assistance. Some say the Commonality is assuaging its guilt for millennia of xenomorph mistreatment; cynics point out the Commonality is *still* mistreating xenomorphs in the Commonality Core.

Before the Expansion, xenomorphs had no access to anagathics, and had tragically short lives. Since the Xeno Wars the situation has been chaotic, but Sentient Alliance scientists are now developing longevity treatments with some success. Outside the Alliance, many xenomorphs remain downtrodden, resentful, even rebellious.

For a xenomorph character, select an animal heritage and its genotype divergence; the most common types are shown in the table below. You can choose special abilities based on animal heritage, such as the "Lightning Fast [Athletics]" Stunt for pithecinics. Examples of xenomorph characters are the Kaskai and Cain White Wolf in **Chapter Eleven: the Black Zone**, below.

### Xenomorph Types and Abilities

Type	Abilities	Comments
Pithecinic	Lightning Fast Stunt [Athletics]	Derived from gorillas, bonobos, chimps. Make excellent specialists and heavy engineers. <b>Aspects:</b> <i>Sudden Burst of Speed, Fond of Hierarchies, Can I try that?</i>
Canid	Heightened Smell Stunt [Alertness]	Derived from wolves, dogs. Make good soldiers. <b>Aspects:</b> <i>Loyal, Headstrong, I really love doing this!</i>
Feline	Lightning Fast Stunt [Athletics]	Derived from cats, great cats. Make good starship and fighter pilots. <b>Aspects:</b> <i>Sensuous Movements, Curious, I'll do it my way thank you!</i>
Ursoid	Oversized [Intimidation]	Derived from bears. Make good shock troops or heavy labour. <b>Aspects:</b> <i>Bull in a china shop, Bear with a sore head, Eats anything.</i>
Cetacean	Active Sonar [Alertness]	Also known as Swimmers, derived from dolphins, orcas. Make excellent zero-grav specialists. <b>Aspects:</b> <i>Friendly, Mischievous, At home in zero-grav.</i>

## Aliens

Few people realized that extra-terrestrials would be so *alien*. In all the First Age of Space, Old Earth had never heard back from any slowships which had contacted alien intelligences, and the prevailing orthodoxy was that humankind was alone, at least in this part of the galaxy (dubious signals received from the direction of Andromeda, and ambiguous chatter from the 8th Millennium Deep Space Probes before they mysteriously went offline were never considered conclusive). First Contact therefore came as a surprise.

The more the Commonality expands, the more alien species it encounters. As yet, none has been advanced enough to pose a threat, and Commonality researchers have many theories to explain this situation, all as provisional as the previous "Just Us" orthodoxy. The Custodians of the Commonality acknowledge this might not always be the case, and after the Venu, the Commonality is cautious when encountering alien life.

Significant alien species in Commonality Space include the **Hooyow** or "War Monsters", the **Lowhigh**, or "Listeners",

described below, and the **Planetary Intelligence**, described in the section on the Chembu, above. Several species native to the Darradine Rim (such as the Singers of Zvukimu and the Mozgooms of Drefnia) are presented in **Chapter Seven: The Darradine Rim**. Opinion is divided whether the strange interstellar phenomena known as “Pulse Dragons” constitute a life-form at all, let alone a sentient one.

Human Space is big enough to contain any number of alien species. Feel free to add as many as you like!

### The Hooyow

The Hooyow or “war monsters” are violent hexapedal aliens. Contacted only 50 years ago, little is known about them. They have three walking “modes” (2-legged, 4-legged, 6-legged), are cannibalistic, and like fighting; they’re intelligent, technologically primitive, and short-lived, with a violent world-view. Their homeworld Valhalla is quarantined, but specialist Hooyow serve the Commonality as soldiers or martial arts instructors.

Hooyow interaction is governed by a complex behavioural code the Commonality loosely calls “honour”. Decisions are based on hierarchical intimidation and short, non-lethal duels rather than discussion.

Hooyow society lacks fire- and metals-based technology (Terrible (-2) Tech level); create Valhallan Hooyow characters accordingly. Hooyow in Commonality service (informally dubbed “Valkyrie”) seem to be adapting native Hooyow practises to the more high-tech Commonality environment.

#### Scenario hook: A Day for Honour

Someone’s made a faux pas on Valhalla, the Hooyow homeworld, and the only way out is by ritual combat. Before that, however, the candidate must prove himself by enduring the Chau Cheng, the Test of the Wilderness. With Valhalla’s chlorine-tainted atmosphere and poisonous flora and fauna, can the PCs survive and face one of Valhalla’s champions to preserve the Commonality’s honour?



#### Typical warrior Hooyow

**Physical Stress:** □□□□□□

**Composure Stress:** □□□□□□

**Fate Points:** 7      **Scale:** Small (2)

**Consequences:** 3 Consequences

**Encounter Size:** 1

#### Skills

Good (+3)	Weapons	
Fair (+2)	Fists	Fists
	Athletics	
Average (+1)	Might	Resolve
	Endurance	Alertness
	Survival	Intimidation

#### Aspects

You slight my honour!  
 Hexapedal alien war-monster  
 Eat your foe and take his strength  
 I serve the Commonality faithfully!  
 Short-lived  
 Life is struggle!  
 Minor Weakness: Fire

#### Stunts

Usually selected from:  
 Various Fists and Weapons Stunts  
 Claws [Fists - Special]  
 Fast [Athletics - Special]  
 Lightning Fast [Athletics - Special]  
 Jump [Athletics - Special]  
 Human Spider [Athletics]  
 Spider Feet [Athletics - Special]  
 Outer Shell [Endurance - Special]

#### Equipment

Chitin (-1 Physical Armour)  
 Hooyow War Scythe (fibre-glass multi-blade: +3 damage)  
 2 Weapon or Fist attacks per exchange.  
 Speaks: Hooyow, Universal

### The Lowhigh

The Lowhigh or “Listeners” are a species of mysterious, mystical “space gypsies”. They have no vocal organs, and no eyes; what appear to be two enormous “ears” are in fact infrared receptors. When humans first met them, the Lowhigh seemed to be constantly listening for something - hence their epithet. Unlike the Hooyow they are spacefarers, sailing great, majestic lightjammers, and are found on several worlds. They are 2.5m tall, with 500-year lifespans. Their dark homeworld orbits a brown dwarf known as “Shrine”.

The Lowhigh are very alien. They seem barely interested in humans or the Commonality. Their worlds have high



atmospheric helium and background radiation, suggesting an industrialized, fusion-powered past; but their societies are largely non-technological (except for the lightjammers), and the Lowhigh remain tight-lipped.

Lowhigh communicate via fluctuating heat patterns in their large, screen-like “ears”; requiring a synthetic interpreter (hand-scanners work; a synthetic with infrared receptors and emitters is better). Humans with IR goggles can learn to “read” Lowhigh infra-speech, but reproducing it is impossible without specialist equipment.

Typical Lowhigh Lightjammer Pilot		
Physical Stress:	□□□□□	
Composure Stress:	□□□□□□	
Fate Points: 7	Scale: Small (2)	
Consequences: 3	Consequences	
Encounter Size: 1		
<b>Skills</b>		
Good (+3)	Starship Pilot	
Fair (+2)	Mysteries	Resolve
	Engineering	
Average (+1)	Might	Alertness
	Science	Investigation
	Resources	Deceit
<b>Aspects</b>		
	Mysterious Space Gypsies	
	Uninterested in human affairs	
	No eyes, but they “see” heat	
	Silent, inscrutable mystics	
	Our past is not your affair	
	Majestic Lightjammer pilot	
	Minor Weakness: no visual or audio senses	
<b>Stunts</b>		
	Enhanced Vision [Alertness - Special]	
	Sixth Sense [Alertness]	
	Enthrall [Mysteries]	
<b>Equipment</b>		
	Voluminous robes	
	Specialized hand-scanner	
	Speaks: Lowhigh infra-speech	

## The Venu

The Venu are a great mystery, a human species from the distant Orion Cluster. During the First Age of Space, Old Earth twice contacted its most distant, known colony there, each message taking 3000 years there and back. After the invention of planing, a visit to Psi Orionis was a high priority.



The visit went horribly wrong. The Commonality contact ship never returned, and eighty years ago the Venu exploded out of the Orion Cluster in a frenzy of rage and violence, using a dangerously unstable faster-than-light drive reverse-engineered from Commonality technology and embroiling the Rim Sector in a terrible war. Even now there’s very little known about the Venu; they appear to be human supremacists, although there are reports of horrifically mutated Venu being increasingly encountered, often with extremely bizarre abilities: the reason for this is currently unknown. They’re extremely xenophobic, driven by religious fervour and a worship of “Venu,” believed to be their hereditary God-Emperor. Their society seems intensely militaristic, but not as technologically advanced as the Commonality; what technology they do have seems shrouded in religious secrecy, and a class of Venu officers has been dubbed “technopriests.” A recent offshoot is the Cult of the Radiant Darkness, believed to be a new title of the God Emperor and to refer to the zero-point technology the Venu have purloined from the Commonality. The Venu religion seems to be very flexible and in almost continuous flux.

Cultists of the Radiant Darkness wear masks, as do an increasing number of other Venu. These may be stylised and decorative, or prosthetic, realistic-looking yet strangely expressionless. It’s unknown what they signify. Some captured Venu spies have been found with transplanted faces stolen from Commonality citizens.

The Venu are unremittingly hostile; the reasons for this are unknown. Raids from the Commonality-imposed Quarantine Zone in the Rim Sector are almost constant, and

few doubt the Venu are preparing another war. Their agenda is unknown, but it seems there can be no negotiated peace with these strange, alien humans.

Create mutated Venu characters with a “Venu Mutant” Aspect, choosing Mutation Skills and Stunts from the list below. A Venu Mutant character must take a Minor Weakness for each Mutation Skill (*Starblazer* pages 262-3).

Create non-mutated Venu as standard humans; the Venu culture write-up in **Chapter Six: Worlds and Cultures** lists some sample Aspects. Venu from the imperial homeworld tend to be somewhat taller than standard humans.

**Suggested Genotype Abilities (Mutation Skills and Stunts):** Exude Energy Skill (Exude Radiation Stunt); Absorb Energy Skill (Sap, Absorb Radiation, Energy Drain, Absorb Kinetic Weapons, Absorb Energy Weapons, Life Drain Stunts); Alertness and Athletics Skill Mutation Stunts; Endurance Skill Mutation Stunts; Fists Skill Mutation Stunts; Horrific Stunt (Intimidation Skill).

**Key Mindjammer Professions and Careers**

Profession	Careers	Comments
Armed Forces Instrumentality (AFI)	Military	The Commonality Armed Forces.
Internal Security Instrumentality (ISI)	Security, Sci-Tech	The Commonality “police force”.
Space Force Instrumentality	Military, Explorer, Sci-Tech	The embryonic Commonality navy.
Communications Instrumentality	Explorer, Sci-Tech, Security, Military, Diplomat	The Commonality diplomatic service, Mindscape operations, and “foreign office”.
SCI Force	Sci-Tech, Security, Military, Diplomat	The Security and Cultural Integrity Instrumentality - cultural operations.
New Traders	Merchant	Licensed and unlicensed traders operating on the edge of Commonality law. See page 60.

## Cultures

All *Mindjammer* characters belong to a culture (usually the Commonality culture) which influences their genotype and Aspects. Culture world characters can have Aspects from their homeworld as well.

Choose a culture from **Chapter Six: Worlds and Cultures**, selecting one or more Aspects based (however loosely) on its cultural Aspects. If your character’s culture has conflicting Aspects, try selecting equally conflicting character Aspects too!

## Professions

Characters may belong to a profession, although it isn’t necessary: choose one from *Starblazer Adventures* or the table below, or make up one of your own. Then, select a career appropriate to that profession. Descriptions of the Instrumentalities can be found in **Chapter Five: The New Commonality Era**.

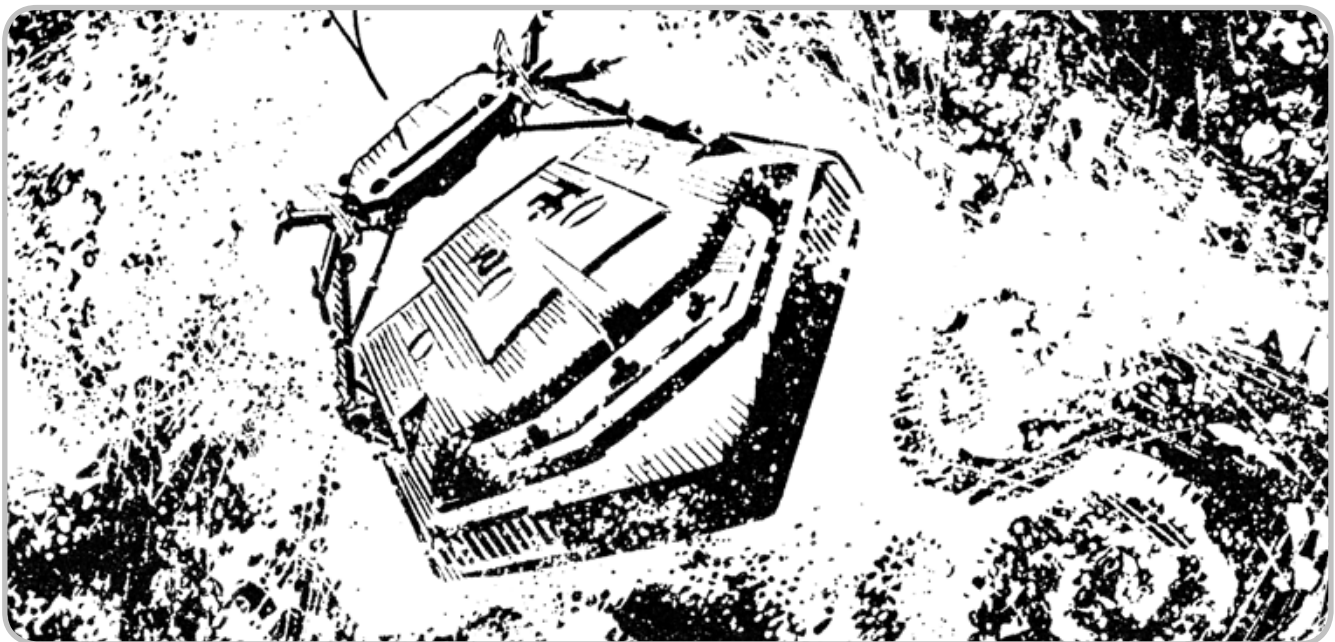



# Chapter Two: Skills and Powers

This chapter expands the *Starblazer* Skills and Powers with new and modified Skills and Stunts, also showing how the Mindscape enhances character abilities.



## Skills and the Mindscape

Commonality citizens are fitted at majority with Mindscape implants, direct neural interfaces to the Mindscape, the vast, technological “shared consciousness” spanning the Commonality and containing the memories of generations living and dead. The physical limits of the human brain are augmented by this “virtual brain capacity,” enabling mind-to-mind communication and the startling powers known as **technopsi**, and users can draw on its stored memories and experience to enhance their own abilities.

Mindscape enhancement comes in two forms. The first, **Skill Chips**, are expert skill systems maintained and updated by the Mindscape, which experienced users of a Skill can draw on to augment their abilities. Skill Chips are treated as Stunts, and are detailed below.

The second form of enhancement is **tagging the Mindscape**. Individuals can spontaneously search the Mindscape for information, techniques, and memories to

assist them in a task. Tagging the Mindscape is less powerful than using Skill Chips, but is more common. An Academic might quickly search the Mindscape for a nugget of information; an Engineer seek out a schematic of a piece of equipment he isn't used to maintaining; an explorer look for a map of a planet he's flying over for the first time. See “Tagging the Mindscape,” below, for more.

## Raising the Bar

Given the increased expertise provided by the Mindscape, why isn't everyone a 2-Pilot or an expert marksman? Surely the information is there: the memories of pilots of yesteryear, expert skill systems, all stored in the Mindscape? The answer to this is twofold: experience, and complexity.

First, Commonality characters *are* experts: tasks which our 21st century considers almost impossible are now routinely handled by Skill Chips, and anyone can fly an airplane or starship with the right chip - up to a point. Skill Chips and the Mindscape enable humans to “raise the bar” for tasks they attempt; in a universe where everyone can fly a starship from A to B, the real experts undertake tasks impossible to 21st century humans. Mindscape enhancements and Skill Chips first allowed humans to pilot through 2-Space; today, someone with a Starship Pilot Skill Chip can pilot a ship in an emergency, but a professional, with thousands of lives in his hands, wants a Great (+4) Starship Pilot Skill *and* a Starship Pilot Skill Chip (+2) before he even thinks about taking a cruise liner through 2-Space. The risks are simply too high; 2-Space travel is hard.

*Example: 2-Pilot Mister Jonaton Calm is taking a Settler Ship with 10,000 colonists in stasis through 2-Space. It's a 65 light year trip, and a Fantastic (+6) difficulty. The ship has Fantastic (+6) planing engines, so is within operating limits; however, as per page 39 below, Mister Calm's own Superb (+5) 2-Pilot Skill restricts the Planing Engine Skill level to Superb (+5). At this rate, (Superb (+5) against Fantastic (+6) difficulty), there's a significant risk of something going wrong during the flight. Fortunately Mister Calm has a Starship Pilot Skill Chip, giving a +2 Skill bonus (raising him to Epic (+7)!). Now the Settler Ship's Fantastic (+6) planing engines are complemented to Epic (+7). It's still not brilliant odds, however, and Mister Calm spends a Fate point to tag the Mindscape, looking for the memories of other 2-Pilots who've done this or a similar run. That's another +2 bonus; now a total of +9 versus +6, the odds are much better. He may need to burn a couple more Fate points, but should make it through - and so should his 10,000 sleeping passengers!*

Skill Chips and Mindscape tags require reliable Mindscape access. All Commonality member worlds have global mindscapes connecting their citizens; Fringe Worlds have some degree of Mindscape connectivity; Outer Worlds have none at all. Individuals can take Personal Mindscape Instances (PMIs) with them at a push, but these are far less powerful.

So, if you're stranded on Planet Redneck, your starship AWOL and your ZIP cells degrading, you're on your own. Heck, if your PMI fails, you'll even lose your Skill Chips - and then you'd better hope you have some real experience!

### Skill Chips

A Skill Chip is a Stunt, available for many **Starblazer** Skills, giving a +2 modifier to a character's Skill level. The table below lists those Skills which can be "chipped".

An expert needs a Skill Chip for the core knowledge enhancements for their job. They also need a high personal Skill level to achieve complex results: a Skill Chip doesn't make you an instant genius. It's necessary to get used to a Chip, learn to use its techniques properly, and so on. That requires habituation time, and is why characters can't simply bung in a chip and go.

Skill Chips operate even with only a Personal Mindscape Instance (see **Chapter Three: Gear**), as long as the PMI has been updated in the past few months; older PMIs only allow a Skill Chip to provide a +1 bonus, or none at all, at the Story Teller's discretion.



#### Skills for which Skill Chips are available

Academics	Engineering	Mysteries	Starship Pilot
Art	Fists	Pilot	Starship Systems
Athletics	Gambling	Science	Stealth
Burglary	Guns	Sleight of Hand	Survival
Contacting	Investigation	Starship Engineering	Weapons
Drive	Leadership	Starship Gunnery	

### Tagging the Mindscape

Characters can tag the Mindscape for those Skills which can be enhanced using stored memories and experiences. This is similar to the Exoeidetic Memory trapping of the Technopsi Skill (below), but doesn't require a Skill roll.

A character can't tag the Mindscape using only a Personal Mindscape Instance; a Shipboard Mindscape Instance or better is required.

*Example: Dr Thaddeus Clay is exploring the quarantined Predecessor Ruins on New Howzat, looking for ancient technologies to help the Commonality fight the Venu. In a tunnel deep beneath the dying planet's icecap, Clay comes across a vast wall, intricately carved with unintelligible inscriptions. Predecessor writings!*

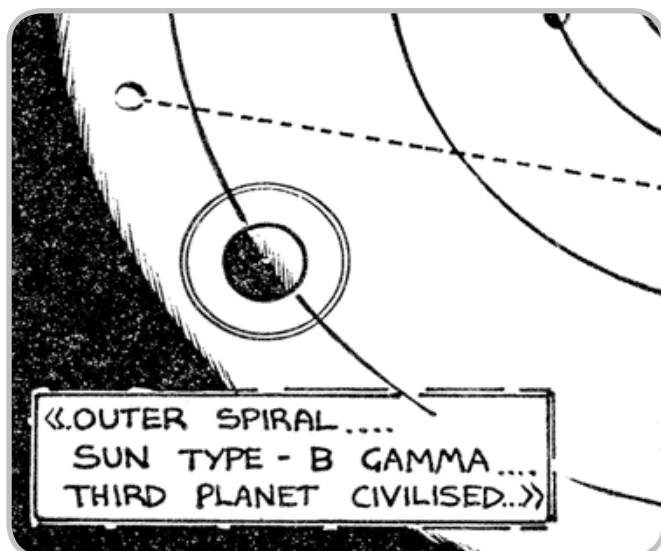



He tries to understand them. His Good (+3) Academics Skill is boosted by his +2 Academics Skill Chip, added to his +4 roll for a +9 total; however, Clay is uncertain whether even that will be good enough to make any sense of these mysterious writings. He decides to tag the Mindscape. Fortunately New Howzat is a Commonality world, with a global mindscape accessible via geosats and in-system relays, so he has no trouble hooking up to its vast information sphere. Using his own knowledge and the links and trails opened by his Academics Skill Chip, he locates a report in the Mindscape on similar writings found beneath the jungles of Sai-Lan, a world clear across Commonality Space. Smiling, he pays a Fate point and adds an additional +2 for a final total of +11.

The Story Teller smiles: against a Legendary (+8) difficulty, Dr Clay has gained 3 Shifts, enough to gain spin. The Story Teller rules he has made a breakthrough!

## New and Modified Skills and Stunts

This section modifies several **Starblazer** Skills, and adds some new ones, including Technopsi, the use of the Mindscape to achieve pseudo-psionic effects.

### Academics Skill

We've modified the Research trapping as follows:

#### 👁 Research

Mindscape access via a Global Mindscape Instance or greater is equivalent to a Legendary (+8) library; a citywide or shipboard Mindscape Instance to a Fantastic (+6); and a Personal Mindscape Instance to a Great (+4). Reduce these levels by 2 if the Mindscape Instances haven't been updated in more than a few months. See **Chapter Three: Gear** for Mindscape Instances.

### Career Stunts

We've added the following new Career Stunt:

#### ✧ Access to Restricted Technopsi

Requires relevant Aspect and one Technopsi Stunt

Allows characters to select a Black or Special Operations Chip instead of the standard Mindscape implant, enabling the use of restricted Technopsi Stunts such as Mindburn and Domination (see below). Characters must have an appropriate Aspect such as "SCI Force Operative," "Mind Cop," or "Criminal Mastermind" explaining how they possess such a highly illegal or restricted device. See **Chapter Five: The New Commonality Era** for more on Black Chips.

### Deceit Skill

We've modified the Disguise trapping as follows:

#### 👁 Disguise

You can use genurgy to alter your appearance, giving a +2 bonus. Requires access to genurgic therapies, and in

fact popular in some places (particularly Old Earth), with a base cost of Fair (+2), possibly more on lower tech or restrictive worlds.



### Engineering Skill

We've added two new Stunts, as follows:

#### ✧ Mindscape

Allows engineering work on the Mindscape, including Mindscape Instance creation, repair, maintenance, modification; Mindscape architecture; and Mindscape physical structure. See **Chapter Three: Gear** and **Chapter Five: the New Commonality Era** for more on Mindscape technologies.

#### ✧ Synthetics

Allows creation and repair of a synthetic body. These are treated as basics (see **Chapter One: Characters**); creating an eidolon from a basic requires the Create Eidolon Science Stunt (see below).

## Science Skill

We've modified the Hacking trapping, and added two new Stunts, "Create Eidolon" and "Genurgy".

### 👁 **Hacking**

Mindscape or ship / installation systems "hacking" uses the Science Skill. It's almost entirely illegal without ISI or SCI Force authorization. The physical actions, interfaces, and nature of hacking in **Mindjammer** are "mental" processes using Mindscape implants and radically different from **Starblazer** computer hacking, but the procedure and overall results are the same. Hacking a synthetic brain or ship sentience is no more possible than hacking a human brain; that's what the Technopsi Skill is for.

You can also use Hacking to create **fictionals** - false eidolon memories and personalities in the Mindscape. See **Chapter Five: the New Commonality Era** for more. A Black Chip or a Special Ops Chip is required to use this trapping, and it's modified by Technopsi. Sentinels (see **Chapter Five**) often defend against Mindscape hacking attempts.

### **A Note on Languages**

The Commonality speaks a language known as "Universal", also called "Unilingua" or "Galingua". It's an amalgam of Anglic, Hispanian, and Shinese, with a wide vocabulary derived from earlier Old Earth tongues. Most Commonality worlds speak Universal as their second language.

Since Expansion, and the establishment of culture worlds throughout the Commonality, ancient Old Earth tongues predating Universal have made something of a comeback. Those culture worlds exploring historical cultures plunder all periods of Old Earth history where there's a record, and there are worlds speaking Classical Latin, Enlightenment French, Post-Ruin Frankite, and Diaspora Yarpeen, all co-existing in the Commonality's cultural melange. In such an environment Universal continues to be vital.

Other languages include Venu, the languages of the Successor States, and the non-standard (and very strange) communications of Lowhigh "infra-speech" and multi-sensory "language" of the Chembu Planetary Intelligence. Thankfully Skill Chips and interpreter synthetics help make this cacophony intelligible!

### ✧ **Create Eidolon**

Eidolon creation is a tricky business, as much art as science; a viable sentient being has to be created, psychologically stable and free of neuroses or hidden psychosis. These integrity, stability, neurosis, and psychosis checks are known as the **Eidolon Compliances**, and all eidolons are certified "Level-4 Compliant" before being released from eidolon rigs into synthetic bodies. Eidolon Crisis can compromise

Compliance (see page 7 above); a Composure consequence resulting from Eidolon Crisis can negate one of the four Compliances.

Creating an eidolon requires a Science roll against a difficulty equal to the eidolon's highest Skill level, and an **eidolon rig** (see **Chapter Three: Gear**) of the same level or higher. The process takes one day per point of difficulty. Each point of failure indicates one of the Eidolon Compliances is not met, and the eidolon should not be released from the rig: the process must be started over again.

### **Scenario hook: Rogue Eidolon**

An ambitious but deluded scientist in the Successor States has been working on an intelligent synthetic soldier using the thanograms of dead warriors. His experiments have ended in disaster, and the prototype left the eidolon rig with only Level-2 Compliance: stable and complete, but completely psychotic.

The PCs are called in to what remains of the scientist's laboratory to track down the deranged synthetic.

### ✧ **Genurgy**

Allows scientists to genurgically modify life-forms. Next to technopsi, it's the most common enhancement found among Commonality citizens. See "Genurgy" (page 19) for possible modifications.

Genurgic enhancements require a genurgy lab of a level equal to the Genurgy Skill being acquired. The process takes one day per level of enhancement, at a difficulty equal to the Genurgy Skill level. Failure indicates physical rejection, simple failure requiring more time, or corrupted enhancement, at the Story Teller's discretion.

### ✧ **Implant Tech**

Allows characters to create, deactivate, implant, modify, and remove Mindscape implants. These are Superb (+5) difficulty tasks. With the Hacking trapping (ie a Black or Special Operations Chip), this Stunt may be used to create Black and Special Operations Chips.

## **Starship Engineering Skill**

We've added a new Stunt, as follows:

### ✧ **Push the Jump Maximum**

*Requires Cut the Limiters!*

Creates bypasses and new routings to squeeze an extra jump out of a power plant which has exceeded its jump maximum (see **Chapter Four: Starships and Space Travel**). It's hazardous, but sometimes the difference between life and death. The engineer rolls Average (+1) Starship Engineering at the end of the jump: success means the additional jump was successful. Failure indicates a catastrophic failure of the



zero-point core, causing the power plant to explode and the ship to take Structural stress damage equal to the amount the roll was failed by: anyone within 1 zone of the power plant is automatically Taken Out; anyone within 2 zones takes an equal amount of Physical stress from the horrific torsion field effects; and anyone within 3 zones (which for a small ship might be the whole ship) suffers equal power Z-radiation exposure. The ship makes a precipitate 2-Space emergence (see **Chapter Four**).

If the Starship Engineering roll was successful, the engineer can try for yet another jump, at a +1 difficulty (so the second jump is Fair (+2)). Further jumps can be attempted until the ship is finally overhauled or the power plant explodes.

## Starship Pilot Skill

We've added two new trappings, "2-Space" and "Starship Therapy":

### 👁️ 2-Space

There are two types of starship pilot in *Mindjammer*: 2-Pilots and N-Pilots. 2-Pilots pilot ships faster-than-light through 2-Space (between star systems), whilst N-Pilots do so slower-than-light, usually within a single star system, through N-Space or Normal Space. See **Chapter Four: Starships and Space Travel** for more on 2-Space and N-Space.

2-Pilots are in constant, low-level neural contact with their ship's sentience throughout the 2-Space "jump", ensuring it remains concentrated and develops no aberrations. When aberrations do develop, 2-Pilots can counsel ship's sentiences, and in emergency take the sentience offline and pilot the ship themselves - a last resort causing extreme mental trauma to the 2-Pilot. See "Star Drive Operations" in **Chapter Four: Starships and Space Travel** for details.



2-Space is an unfathomable interdimensional mess to human minds. Mindscape visualizations allow humans to filter and extract key data permitting interstellar navigation using the 2-Space drive. Starships calculate their own navigation plans for common runs, but it's considered courteous for 2-Pilots to collaborate: 2-Pilots may also have to calculate nav-plans themselves in case of 2-Space mishaps or if the ship sentience is offline.

## Pulse Dragons

So far in the Expansionary Era any planet emerging from 2-Space into deep interstellar space (ie outside a solar system's gravity well) has been destroyed. Emergency transmissions have suggested such ships were destroyed by vast interstellar life-forms or energy fields, since dubbed "Pulse Dragons". The nature of Pulse Dragons is unknown.



2-Space travel takes 8.75 hours per light year travelled. A ship's planing engines open up a "tear" in N-Space, and the ship passes through into 2-Space; the engines then carry the ship the distance. Gravity wells of any size perturb 2-Space, and a close encounter can destroy an entire ship; consequently all ships are fully aware and concentrating for every second of the journey. 2-Space travel is draining, and starships can suffer mental breakdowns on demanding runs, which is why 2-Pilots are skilled in Starship Therapy.

### 👁️ Starship Therapy

Starship Therapy is analogous to the Medical Attention trapping of the Science Skill, allowing System stress and consequences suffered by sentient starships due to failed star drive operations to be healed. The trapping can be used two ways.

First, Starship Therapy can reduce a sentient starship's System stress caused by failed star drive operations. This requires a full action by the 2-Pilot on a sentient starship target which is taking no other action (ie forfeiting its next action). This is Mediocre (+0) difficulty; success with at least one shift means the starship may remove one point from its System stress track. Every further two shifts removes one more point; five shifts clears three boxes. Success can also "stabilize" a starship which has suffered a seemingly fatal consequence (eg a self-referential feedback loop), limiting the extent the consequence can be compelled. A starship cannot receive more than one Starship Therapy attempt per exchange.

Secondly, Starship Therapy can treat long-term consequences due to failed star drive operations. This requires physical

access to the starship, and may require equipment or spares. It takes a scene; if successful, the starship recovers from the consequence in one less step on the Time Increments table. Only one attempt per consequence may be made. Difficulty depends on consequence severity:

### Starship Therapy: Consequence Treatment Difficulty

Consequence	Difficulty
Mild	Mediocre
Moderate	Fair
Severe	Great (requires Class-6 Ground or Orbital spaceport facility)
Extreme	Fantastic (requires Class-7 Ground or Orbital spaceport facility)

## Technopsi Skill

Technopsi uses Mindscape technology to create pseudo-psionic effects, allowing characters to perform acts of virtual telepathy, remotely control devices, operate sensor systems, and even attack and dominate other Mindscape users. Technopsi requires a Mindscape implant (see **Chapter Three: Gear**). The Technopsi Skill has a number of trappings and Stunts, some of which require a Special Operations or Black Chip to use.

Most Commonality citizens use Technopsi for its Exoeidetic Memory and Telepathy trappings; Skill Chips or tagging the Mindscape (see above) don't involve the Technopsi Skill.

## Trappings

### 👁 Exoeidetic Memory

Similar to tagging the Mindscape, Exoeidetic Memory allows users to recall memories stored within the Mindscape: these memories need not be their own. Like Skills such as Academics and Science, it can be used for assessments and declarations. It requires a few minutes to use: make a skill roll against a difficulty based on the obscurity of the memory sought. A Fantastic (+6) memory was probably provided by only one or two people in the entire Mindscape; Superb (+5) by a handful of leading experts; Great (+4) by the top specialists in a field; while Good (+3) and lower are part of the common corpus of Mindscape memory. Difficulties beyond Fantastic are appropriate for "lost" or "destroyed" memories. If the Mindscape Instance used hasn't been updated in a month or more, increase the difficulty by +2. Shifts correspond to the depth of detail discovered.

A successful roll finds the desired memory, "remembering" something experienced by someone else; the character gains a single use of a knowledge skill (Science, Academics, etc) at their Technopsi Skill level. On a failure, the character doesn't locate the memory, but may attempt to search longer (see below) - or, perhaps more entertainingly, may stumble onto an illegal **fictional** memory that gets him deeper into trouble!

A character failing an Exoeidetic Memory roll can spend extra time to locate the memory: the amount the roll was failed by indicates the additional steps on the Time Increments table required to locate it. This is only possible if the Mindscape Instance used is sufficiently sophisticated: Global Mindscape Instances or greater allow Fantastic (+6) memories or above to be found in this way; citywide or shipboard MIs locate Superb (+5) memories; and a Personal Mindscape Instance only locates Good (+3) memories or lower. This restriction only applies once the original Exoeidetic Memory roll has failed.

Exoeidetic Memory deals with stored memory engrams of minds living and dead; these may contain no knowledge at all, but rather "stored experience," recalled like one of your own memories. Attempts to use the Mindscape to boost Skill knowledge use Skill Chips or Mindscape tagging instead.

*Example: Thaddeus Clay has found himself among the Sandpeople of New Howzat. The tribal chieftain is eyeing him expectantly, waiting for the customary greeting ritual. Clay has already failed an Academics roll and has no idea what the ritual is, so desperately searches the Mindscape for some information which might help! It's a Great (+4) Exoeidetic Memory roll; Clay fails, with a +1 roll added to his Fair (+2) Technopsi - and stands there speechless, rooted to the spot!*

*Fortunately New Howzat has a Global Mindscape Instance, which means that memories up to Fantastic (+6) difficulty can eventually be found - if you spend enough time. As sweat trickles down Clay's neck, and some of the Sandpeople braves begin to heft their spears in irritation. Clay continues to search the Mindscape: half a minute later (the next step on the Time Increments table) Clay gets an additional +1, taking him to +4, just succeeding! As it's a declaration, Clay's player comes up with an elaborate bow and noble-sounding speech; the tribal chieftain grunts, and waves Clay forward - he's just scraped through!*





### 👁️ **Remote Control**

Many tools and vehicles can be controlled remotely by technopsi, including **sensor drones**, **combat drones**, and **remote lifters**. Normally you can't use Remote Control on a device already being used by someone else, but many devices are "open access", and can be used as soon as another user has finished. Special Operations Chips allow Hacking and Domination attempts to wrest control of a remotely controlled device from a user.

### 👁️ **Sensorview**

Sensorview is used to interpret results from personal sensor arrays, hand scanners, sensor drone arrays, ship sensor arrays, sentient weapon arrays, including detecting Mindscape users (see page 24). Once Sensorview has detected a Mindscape user, you can use Telepathy to communicate directly if you know them, or offer them a **handshake** (see below) if you don't. Black Chip or Special Operations Chip users can make technopsi attacks.

Where sensor data provides bonuses to Skills such as Science or Engineering, successful Sensorview rolls can provide temporary Aspects like manoeuvres. Failure on the Sensorview roll still allows the original roll to be made. Where sensor use is an integral part of the Science or Engineering check, Sensorview can modify the skill roll.

### 👁️ **Telepathy**

Allows users to communicate across the Mindscape. Communication is in words, but no verbal communication takes place. Difficulty is Average (+1), +1 per additional person targeted. Communication is private and cannot (easily) be intercepted (requires a Black or Special Operations Chip). There can be a communication delay depending on the distance separating the parties.

An individual can voluntarily expose their Mindscape ID to another user in the same zone: this is called a **handshake**. The recipient offers their Mindscape ID in return. Handshakes utilise the implant's very basic sensor package, where signals to and from the Mindscape allow simple ID transfer at physically close range.

A successful Telepathy roll also allows a "direct perception feed" between (say) an observer and a sentient starship.

## **Stunts**

### ✧ **Blaster Bolt Defence**

*Requires a Force Blade or Energy Mace*

Allows the wielder to "parry" a bolt from an energy weapon, using the Weapons Skill instead of Athletics as a defence against energy weapon attacks.

### ✧ **Control Avatar**

A more sophisticated form of the Remote Control trapping, usually only employed by remote operation specialists and sentient starships with an interest in the "personal touch". See **Chapter Three: Gear** for more on avatars.

### ✧ **Domination\* (Restricted)**

*Requires a Black or Special Operations Chip*

Similar to the Mind Control Dominate Stunt but more limited, Domination allows the user to take control of a target's body. Treat as a Composure conflict of Technopsi against Resolve; each success causes Composure damage, and forces the target to act according to the attacker's will. Actions are clearly jerky and clumsy, and there's no fine control; a person can't be Dominated to fly a starship, for example. If Taken Out by Domination, the target suffers brain damage and falls into a coma.

Domination can also take control of a device controlled by the Remote Control trapping; a Taken Out result indicates the attacker has wrested control from the defender.

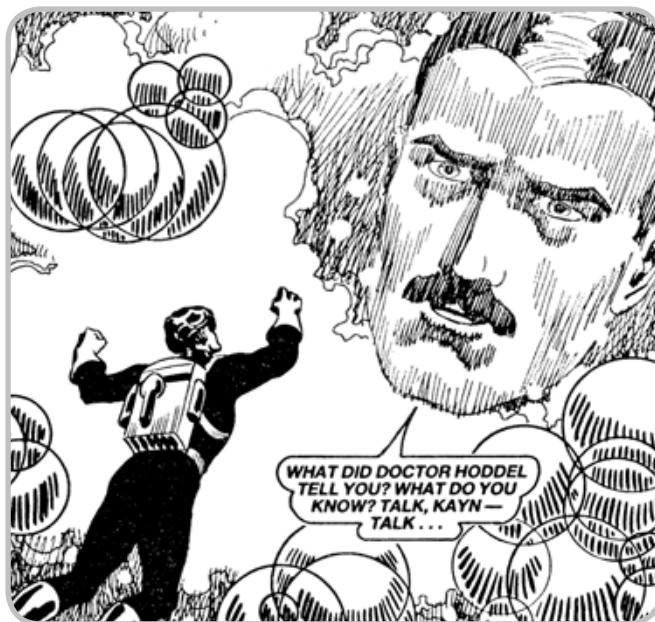

### ✧ **Lightning Attack**

*Requires a Mindscape-connected Force Blade or Energy Mace.*

The character uses technopsi to manipulate the plasma containment field of a force blade or energy mace. The field moves - and therefore attacks and defends - extremely quickly, independent of the wielder's physical reactions, allowing the attacker to modify Alertness and Weapons by Technopsi for initiative and attacks.

### ✧ **Mindburn\* (Restricted)**

A Technopsi attack restricted to SCI Force, Mindscape sentinels, and agents of the Communications Instrumentality. Black Chip users can also use Mindburn, though of course it's illegal. Mindburn is a Composure attack, resisted by Technopsi or Resolve modified by Technopsi.

A target must be identified using a PSA / Sensorview package before you can make a Mindburn attack (see "Sensorview" above). Once identified, there's no fixed range for Mindburn attacks, except that they can't be conducted over relativistic distances (ie you pretty much have to be on the same planet, or at least in orbit).

### ✧ **Redaction**

Redaction is "Mindscape psychotherapy", used to treat organic or synthetic minds suffering Mindscape-related damage. It's an advanced form of Starship Therapy (see the Starship Pilot Skill), and can be used instead at +2 difficulty. Redaction treats Mindscape-related Composure damage in the same way as the Science Skill Medical Attention trapping.

### ✧ **Truth Scan\* (Restricted)**

Uses the target's Mindscape implant as a polygraph, allowing the character to use Technopsi against the target's Deceit Skill to determine if they're lying.

## **Genurgy**

Genurgy is the enhancement of an organism's physical form. Principally available from Chembu Genurgy Corporacy, although other Commonality scientists provide independent services using the Genurgy Science Stunt.

Use the **Starblazer Adventures** Alien and Mutant Special Abilities: a character requires an appropriate genurgy Aspect to use genurgic enhancements such as "genurgically enhanced soldier" or "suited for my waterworld home". Genurgy modifies the subject's own body (developing gills, for example), although it could be a separate bio-engineered organism, such as (in the case of gills) a creature which fits over the character's mouth and nose and pumps breathable air into his lungs. Such creatures need adequate environments (salt water baths, nutrient solutions) to maintain them in working condition, which is why most genurgic enhancements are direct physical modifications.

Chembu Genurgy always charge for their services. A character undergoing genurgic enhancement during play must make a Resource roll for each Genurgy Skill sought with a difficulty equal to the target Skill level. Special Abilities available as genurgic enhancements include:

## **Genurgic Enhancements**

The following Special Abilities are available as genurgic enhancements:

Alertness (*Sonar, Eagle Eyes, Enhanced Hearing, Enhanced Vision, Extrasensory Digits, Heightened Smell*)

Athletics (*Fast, Gills, Jump*)

Barb Thrower

Endurance (*Hard Hide, Outer Shell, Regeneration, Quills*)

Fists (*Claws, Jaws, Tail, Tentacles*)

Fly

Intimidation (*Horrific, Oversized*)

Pheromones

Science / Engineering (*Supermind*)

Stealth (*Small*)

Toxic (*Weapon, Blood, Spit*)

## **True Psionics**

"True" psi-powers (ie not technopsi) are barely known in the Commonality, although it's thought that many organics possess latent abilities. Research into true psionics is ongoing.

Psionics is theorized to be the manipulation of the zero-point energy field by a living brain, causing real-world effects. Humans don't seem biologically capable of psionics, and research invariably involves genurgic enhancements to "awaken" or "induce" such capabilities. Any character with psionics is therefore a rare "sport", hiding his abilities to avoid the Commonality's psionic research centres; such characters use the **Starblazer** Psionics rules. There's rumoured to be a psionics organization located on one of the Fringe or Outer Worlds.

Recently there have been rumours that the Venu possess some kind of psi-power, although its extent or source isn't clear - it could equally be some unknown form of technopsi.





# Chapter Three:

## Gear

"And souls and conscience gave he them all, from the humblest scanner to the proudest warship. And they awoke, and gave praise for it."

- from the *Salt Lake Computational*, banned by the Commonality in 73 NCE

**Starblazer Adventures** provides gear for pretty much any science-fiction setting. **Mindjammer**, however, makes certain assumptions about technology, and defines equipment more precisely. For example, the New Commonality Era has no teleporters, and computers are as archaic as abacuses and slide-rules. This chapter gives guidelines for creating Commonality gear, and examples of equipment, weapons, and armour.



### Notes on Gear

#### Technological Paradigms

The following technological paradigms define Commonality life; several modify the **Starblazer Adventures** rules significantly. Each is treated in greater detail below.

#### Ubiquitous Intelligence - But No Computers

The computers of Old Earth's early technological era were a stepping stone to greater things. Like the abacus and slide-rule before them, they haven't been part of the Commonality's toolkit for millennia, and are now just historical curiosities. Their successors are synthetics, ubiquitous intelligence, and the Mindscape. In the New Commonality Era, intelligence is everywhere, its manufacture trivial; from sidearms to starships, intelligence is commonplace (although the Fringe and Outer Worlds may have other ideas).

#### Infinite Storage Capacity

Technical restrictions on information storage went out with archaic computers in prehistoric times. Nowadays no one even thinks about data "storage"; there's more than anyone will ever need. *Finding* the information you're looking for, though - that's a different matter!

#### Discretionary Interfaces

Technological devices possess sufficient intelligence and Mindscape connectivity to present information in any form required. The user chooses the interface he wants (usually an HUD or direct Mindlink), a feature known as "DI" or Discretionary Interface. Lower tech cultures may have more familiar interfaces to 21st century eyes (including the primitive "keyboard / monitor"!), but intelligent Mindscape-linked devices are the Commonality norm.

Mindlink (direct Mindscape interface) mimics sensory input; the recipient can see, hear, taste, touch, or smell things, providing a rich sensory experience. Often this degree of immersion - known as a "virtuality" - is distracting, however,

#### Technological Paradigms of the New Commonality Era

- Ubiquitous Intelligence - But No Computers
- Infinite Storage Capacity
- Discretionary Interfaces
- Abundant Power
- No Faster-Than-Light Communication
- Ubiquitous Anti-grav
- Extreme Miniaturization
- No Matter Transport - But Matter Creation

and a “virtual vision” interface is more appropriate, where information appears as “icons,” etc, framing the user’s vision, to be viewed when convenient. Virtualities are used more for entertainment where distraction isn’t an issue.

For Skill Chips and Exoeidetic Memory, DI takes the form of direct memory engrams, identical to “remembering” knowledge, except the knowledge in question was originally experienced by someone else.

### **Abundant Power**

The main energy source in *Mindjammer* is zero-point energy, the underlying background energy of empty space. Colloquially known as **ZIP**, there are ZIP Cells, ZIP Batteries, ZIP Power Plants, and so on. Although zero-point energy is essentially limitless and free, its extraction and utilization degrade the power units which convert it into usable form, entailing regular overhaul or replacement.

### **No Faster-than-light Communication**

Interstellar communication is limited by the speed of light, or by communications carried by planeships travelling through 2-Space. The *Mindjammers* are the Commonality’s com-ships, travelling between worlds, updating the Mindscape, and keeping information flowing between the stars. In the limited number of Core Worlds now connected by 3-Space Gates, however (see page 37), information transfer is nearly instantaneous.

### **Ubiquitous Anti-grav**

The Commonality achieved gravity control millennia ago, and anti-grav is its principal slower-than-light propulsion technology, from starship gravity engines to the suspensor modules powering flyers, speeders, and personal grav belts.

### **Extreme Miniaturization**

With recent developments in 2-Space technology, equipment these days is only as big as it needs to be. It’s possible to make equipment such as synthetics and personal mindscape instances vanishingly small - but most people prefer things at least hand-sized for practical use.

### **No Matter Transport - But Matter Creation**

Less a technical issue than one of persistence of identity, matter transport is destructive of the original, merely creating a copy at the destination (indeed, given sufficient energy input, the original need not even be destroyed). Nascent 3-Space technologies look like providing far more reliable instantaneous transportation.

Nevertheless, matter transport research has led to breakthroughs in mass / energy conversion. A **makepoint** (M/EC-Point) duplicates or creates quantities of matter, given sufficient energy input; even with a ZIP plant, however, quantities are small. For larger amounts of material,

### **Schematic of a Zero-point Cell**

The theory for zero-point energy cells was known for millennia, but practical cells only became a reality with the development of extra-dimensional “planing” technologies. Most of a ZIP cell transducer (the **ZIP core** or **Casimir Plate Array**) exists “trans-dimensionally”; the ZIP cell is merely a visible N-Space “socket” to the unlimited other-dimensional ZIP field. ZIP cell size therefore relates only loosely to the power provided, and seemingly innocuous-looking microcells can produce vast amounts of power.

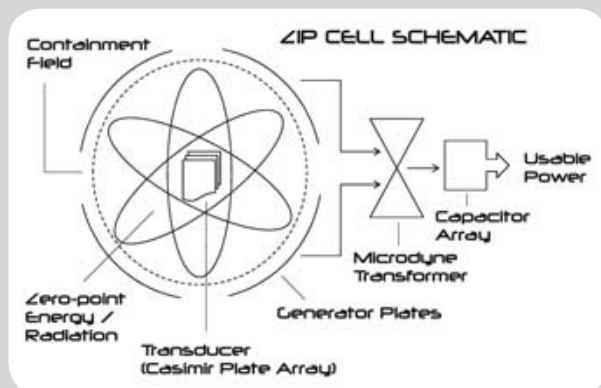

**The Transducer** - the ZIP core, comprising  $1 \times 10^{23}$  C-plates (Casimir Plates, each a few atoms thick, of gold-coated quartz - most of which don’t actually exist in N-Space), transduces energy from trans-dimensional space via a dimensional “breach” known as the Heisenberg Minimum (or Zanthrium Monopole - the diameter of the ZIP core); this creates a massive torsion field, shielded by a...

**Containment Field** - contains the torsion field and its associated Z-radiation.

**Generator** - generates power from the ZIP core output.

**Microdyne Transformer** - steps up the generator output into usable power.

**Capacitor** - stores up sufficient energy for makepoints, planing engines, etc to use.

physical mining and extraction is still more economically feasible, but for food and air replenishment on starships and space habitats, ammunition creation in weapons, and medical product synthesis, makepoint technology provides enormous advantages.

Makepoints draw their energy from the ZIP cell capacitor array, once sufficient energy has accumulated to “make” something.



## The Reinvention of Money

Having managed without money for millennia, the Commonality has recently reinvented it in the form of the EECU - the Expansionary Era Currency Unit, popularly called the "Credit" - to cope with the complex economic situation on the frontier. The Commonality Core still doesn't use money, however, apart from where it's fashionable on certain culture worlds.

## Device and Gadget Improvements

The following improvements are additions and modifications to those in *Starblazer*. Improvements available on a world depend on its Tech Level: the following list indicates the minimum.

### Gadget and Device Improvements

Improvement	Tech Level Required
Additional Capability	Varies
AI Control	Good
Alien Technology	Varies
Alternate Usage	Varies
Armed	Varies
Armoured	Varies
Conscious	Great
Craftsmanship	Varies
Hair Trigger	Varies
Magic Tech	Legendary
Mindscape*	Superb
Miniaturization	Fantastic
Maximization	Great
Regenerating (ammo, etc)*	Fantastic
Rugged	Fair
Sentient*	Superb
Special Effect	Varies
Upgrade	Varies

\*detailed below.

### New Improvements

**Mindscape:** the device has Mindscape connectivity and can be controlled via technopsi. With the Sentient improvement as well, it can communicate via technopsi. The device has a DI (Discretionary Interface).

**Regenerating:** the item uses makepoint technology to "regrow" its ammunition, overhaul its ZIP cells, etc. Regenerating weapons cannot be tagged "Out of Ammo"; autofire-capable weapons can do a full autofire action once per scene, then continue with non-autofire actions without running out of ammunition. Characters wishing to conduct successive autofire exchanges within a single scene must still change the weapon's clip or power cell. Any Regenerating weapon can use the "Set to Explode" manoeuvre.

**Sentient:** the item is sentient. It will usually have the Mindscape improvement to communicate.

### Sentient Items

A **sentient item** is a synthetic housed in a piece of equipment. It cannot normally move, and communicates via DI (Discretionary Interface).

On Commonality member worlds with sufficient Tech Level equipment is automatically sentient, the Craftsmanship, Mindscape, and Sentient improvements included in the base cost. Characters may acquire further improvements through Personal Gadgets, etc.

On a non-Commonality world items aren't sentient by default; sentient ones are only available at +6 cost (for the Craftsmanship, Mindscape, and Sentient improvements), or as a Personal Gadget.

You can take a superior sentient item (see below) as an Aspect or Stunt. These have unique improvements.

The following sentient item types are available:

### Sentient Items on Commonality Worlds

**Commonality Sentient Item:** all items (weapons, etc) on Commonality worlds have the Craftsmanship, Mindscape, and Sentient improvements at no extra cost; items have a +1 bonus.

**Improved Commonality Sentient Item:** sentient items available on Commonality worlds can be improved, requiring a Personal Gadget Aspect and Stunt. The base item already has Craftsmanship, Mindscape, and Sentient improvements (as above), so Personal Gadget improvements could add the "Eidolon" upgrade (imprinting a weapon with the personality of a past weapons-master for +2 attack bonus), the "Nightsight" upgrade (the weapon sees in the dark), and the Regeneration improvement (the weapon regenerates its own ammo), giving a +3 attack bonus (+1 for standard sentient weapon, +2 for the Eidolon upgrade).



## Sentient Items on Non-Commonality Worlds

Sentient items are rare on non-Commonality worlds; most equipment is non-sentient. Obtaining even a “standard” sentient item requires a higher Resources roll.

**Sentient Item:** a sentient item with, for example, Craftsmanship and Sentient improvements is +4 cost on a non-Commonality world. It has a +1 bonus, and no Mindscape improvement as it’s manufactured outside the Commonality.

**Improved Sentient Item:** you can use a Personal Gadget Aspect and Stunt to acquire an improved sentient item on a non-Commonality world. Starting with a standard, non-sentient item, Personal Gadget allows the Eidolon upgrade (+2 bonus) and Sentient and Craftsmanship improvements; the weapon has a +3 attack bonus (+1 for Craftsmanship, +2 for the Eidolon upgrade).

Sentient item bonuses are added to the Skill roll; sentient weapons don’t add to stress damage, unlike other weapon bonuses.

### Tech Level

**Mindjammer** worlds have different levels of technology, from barbaric pre-gunpowder worlds to advanced interstellar civilizations. You can’t always obtain the gear you want wherever you want it. This is handled using “Tech Levels.” **Mindjammer** equipment tables have a Tech Level column; you need to be on a planet with that Tech Level or higher to obtain the item easily - or have some very good contacts!

See **Chapter Six: Worlds and Cultures** for more on Tech Levels.

## PDA and Skill Assistance Devices

Skill Chips (see page 13) have replaced **Starblazer** PDAs on most Commonality worlds, although they’re still common on worlds without Mindscape connectivity or of Great (+4) Tech Level or less. Specialists often carry PDAs as backups when Skill Chips are unavailable.

PDAs which enhance Skills directly are a “poor man’s Skill Chip”, and the two bonuses do not stack: someone with an Engineering PDA and Engineering Skill Chip has a +2 bonus, not +3. This includes the following PDAs: Engineering, Science, Library, Military, Medical, and Security Bypass. Other Skill Assistance Devices stack with Skill Chips at the Story Teller’s discretion.

## Encumbrance

In the following tables we’ve included item weights for colour and for Story Tellers using the **Starblazer** Encumbrance rules. **Mindjammer** weights and measures are metric, so we’ve

included the **Starblazer** “Might Lifting Table” in Imperial and Metric below.

### Might Lifting Table

Might	Capacity (lbs)	Capacity (kg)	WF*
Abysmal (-3)	10	5	0
Terrible (-2)	50	25	1
Poor (-1)	100	50	1
Mediocre (+0)	150 (small man)	75	2
Average (+1)	200	100	2
Fair (+2)	250	125	3
Good (+3)	300	150	3
Great (+4)	350	175	4
Superb (+5)	400	200	4
Fantastic (+6)	450	225	5
Epic (+7)	500	250	5
Legendary (+8)	600	300	6
Each +1	+100	+50	+0.5

\*Weight Factor - see **Starblazer Adventures** page 126.

### Access Restrictions

Asterisked (\*) items require the “Access to Restricted Equipment” Stunt before you can attempt to acquire them. In some cases the new “Access to Restricted Technopsi” Stunt may be required: this is mentioned in the item description.

## Personal Gear

The following items supplement or replace personal gear in the **Starblazer** rulebook.

### Personal Gear Table

Item	Tech Level	Wt (kg)	Cost
Biomed Suit	Superb	1	Superb
EVA Harness	Great	5	Fair
Feeder Tanks	Fantastic	1	Fair
Hand Scanners*	Superb	0.25	Good
Mindscape Implant	Superb	n/a	Superb <sup>1</sup>
Black Chip* / Special Ops Chip*	Superb	n/a	Epic
Mindscape Tracer*	Superb	n/a	Great
Monitor Band Cloaks*	Superb	0.25	Superb
P-Suit	Great	0.5	Superb
Personal Sensor Array	Superb	1	Good

1: Commonality citizens receive Mindscape implants automatically; the cost is for non-Commonality citizens.

**Biomed Suit:** Usually fitted into p-suits, hazmat gear, or combat armour, a biomed suit is an intelligent reactive mesh capable of synthesizing blood, skin, antiseptics, anaesthetics,



and effecting simple First Aid-level injury treatment in situ. It hooks into the wearer's Mindscape to inform him of necessary actions ("lie still," "breathe deeply"), providing first aid or medical stabilization (wearer's choice) 6 times in 24 hours (auto-replenishing via makepoint every 4 hours) with a Fair (+2) Science Skill. The subject forfeits its next action when receiving this treatment. The suit requires occasional feeding, but mostly survives off wearer biomass and a single ZIP cell.

**EVA Harness:** One step down from a grav-pack, fitted in p-suits for shipboard personnel and combat armour for grav troops.

**Feeder Tanks:** Small, baton-sized genurgy cylinders producing 12 hours of breathable air every 24. Two feeder tanks can provide a p-suit (etc) with breathable air indefinitely, as long as the feeder tanks are "fed" occasionally.

**Hand Scanners\*:** Personal sensor arrays (see below) are passive sensors. For active sensing, including sophisticated life and motion scanners, a wide variety of hand scanners and sensor drones are available, including: radar; sonar; life signs (both organic and synthetic via neural array emissions, etc); motion; x-ray scans; ultrasound.

Commonality hand scanners are DI- (Discretionary Interface) equipped; most people use a Mindscape / virtual vision feed. They're sophisticated devices, only as big as needed to incorporate the sniffers, spectrosopes, and other sensor inputs. As well as performing all the passive scans of a personal sensor array, scanners are intelligent enough to answer most questions about the data they gather: treat as an Average (+1) Science or Engineering Skill. Characters with Science or Engineering Skill gain a +2 bonus from a hand scanner, modified by Sensorview.

**Mindscape Implant:** The most significant genurgic enhancement in the Commonality, and essential for normal, everyday life, it's implanted in **everyone** at maturity (except for the rare, tragic individuals who are genurgy-resistant, who often choose euthanasia or self-exile beyond the Frontier). Mindscape implants permit individuals to use Mindscape functions such as Skill Chips and technopsi. Commonality characters usually have an Aspect for their Mindscape implant.

Mindscape implants not connected to the Mindscape emit a faint yet detectable signal known as the **Monitor Band**. Sensor arrays can detect the Monitor Band (see below).

**Black / Special Operations Chips\*:** Requires the "Access to Restricted Technopsi" Stunt. Black Chips and Special Operations Chips are illegal and legal versions of the same thing - Mindscape implants with all the usage restrictions removed, capable of Mindscape hacking and restricted technopsi such as Domination and Mindburn. Characters acquiring Black or Special Operations Chips require an appropriate Aspect to cement this valuable piece of gear.

**Mindscape Tracer\*:** Requires the "Access to Restricted Technopsi" Stunt. A restricted-access passive sensor built into a hand scanner or personal sensor array. If you're looking for an individual with a Mindscape implant (Investigation Skill roll to get the ID), you can trace them using this device. It requires orbital scanner support for a range greater than continental, and a **Sensorview** Skill roll.

**Monitor Band Cloak\*:** Requires the "Access to Restricted Technopsi" Stunt. Small transmitters worn on the belt or disguised as everyday apparel (scanners, belt buckles, epaulettes) which emit a field suppressing the Monitor Band constantly broadcast by a Mindscape implant, allowing agents to operate undetected. A cloak cuts the user off from the Mindscape, including access to Skill Chips and technopsi, and suppresses any Personal Mindscape Instances (see below). It's possible to hack an active Monitor Band cloak if you're pretty sure someone has one and you're at handshake distance (ie in the same zone); this is a Hacking attempt resisted by Technopsi.

When deactivating a cloak, your Mindscape implant takes a short while to reconnect to the Mindscape, although you start broadcasting the Monitor Band again immediately.

### Detecting the Monitor Band

The Monitor Band can be detected on routine passive sensor sweeps (an Average (+1) sensors roll using Sensorview, Ship Systems, etc). With a Monitor Band cloak a Superb (+5) roll with an Advanced Sensor Suite or Black / Special Operations Chip roll is required.

**P-Suit:** A one-piece fitted adaptive mesh overall incorporating a Haze Field for combination light kinetic armour and energy shield, standard issue for active personnel. It's low-powered, with a force visor sealing against vacuum or noxious environments and 3 hours of breathable air recycled from the wearer's body, with optional feeder tanks. You can also incorporate an EVA harness, personal sensor array, or biomed suit.



**Personal Sensor Array (PSA):** Usually fitted into a p-suit or other apparel, a PSA is a wearable passive sensor array capable of detecting local emanations on most frequencies, including infrared, ultraviolet, radio, microwave, Mindscape, and Monitor Band at a 2-zone range. It requires a **Sensorview** (Technopsi) check to use.

A PSA (or hand scanner) and Sensorview roll are required to identify individuals in visual range for technopsi effects (such as handshakes, Telepathy, or Mindburn). See the "Technopsi" section in **Chapter Two: Skills and Powers** for more.



## Armour

### Armour Table

Armour	Stealth Penalty	Kinetic	Energy	Cons	Tech	Wt (kg)	Cost
Absorption Field	-3	-	-3A <sup>3</sup>	4	Superb	5	Legendary*
Assault Armour	-3	-3A <sup>3</sup>	-	4	Great	35	Epic*
Assault Field	-3	-	-3	3	Great	4	Epic*
Compound Armour	-3	-3	-	3	Good	30	Fantastic*
Dispersion Field	-1	-	-1	2	Fair	2.5	Fantastic*
Haze Field	-	-	Var <sup>1</sup>	1-3	Good +	1.5	Superb +
High Threat Assault Armour	-6	-3A <sup>3</sup>	-3A <sup>3</sup>	4/4	Fantastic	120	2 x Epic*
Low Signature Insertion Suit	-	-1	-1	1/1	Great	2.5	1 x Superb, 1 x Fantastic*
Mesh	-1	-1	-	1	Average	4	Great
P-Suit	-2	-1	-1	1/1	Great	5	Superb
Primitive Hide	-1	-1 <sup>2</sup>	-	1	Terrible	8	Mediocre
Primitive Rigid	-3	-3 <sup>2</sup>	-	3	Poor	24	Great
Primitive Semi-Rigid	-2	-2 <sup>2</sup>	-	2	Poor	16	Fair
Repulsor Field	-2	-	-2	2	Good	4	Epic*
Shocksuit	-2	-2	-	2	Fair	10	Superb*
Venu Light Armour	-2	-1	-1	1/1	Good	8	Superb*
Venu Marauder Armour	-5	-3	-2	3/2	Great	35	2 x Epic*
Venu Trooper Armour	-3	-2	-1	2/1	Good	20	Superb*
Zero-G Armour	-4	-2	-2	2/2	Good	16	Epic

1 : against laser weapons only

2 : against primitive weapons only

3 : these powerful armours can take an additional fourth Extreme consequence (see Starblazer page 233)





Armour counters two attack types: **kinetic**, caused by melee weapons and firearms; and **energy**, caused by laser, plasma and disruptor/torsion field weapons firing coherent light, bolts of plasma energy or space-time distortion fields. There are two corresponding types of armour: body armour often combines both.

**Kinetic Armour:** composite, alloy, and adaptive armours blocking kinetic attacks. "Primitive" armour only protects against primitive weapons such as swords and axes, offering no protection against firearms.

**Energy Shields:** full-blown force fields and stealthier, lower-powered "Haze Fields"; energy shields use magnetic, energy, or distortion fields to repel energy attacks. Energy shields can be switched on and off as required. Weight refers to the field projector, either a belt pack, harness, or back-pack, depending on size.

### Weapon and Armour Aspects

Weapons and armour have unique features which affect their usability and performance: in **Mindjammer**, these are represented by Aspects. Armour Aspects include things like: Noisy, Heavy; Weapon Aspects include: High Recoil, Recoilless, High-Explosive, Armour-Piercing, Anti-Tank. Both attacker and defender may tag these Aspects.

### Armour Penalties

Wearing armour imposes a penalty equal to its defensive bonus on all manoeuvres and Acrobatics, Athletics, and Stealth rolls. This doesn't include Athletics rolls made to defend in combat.

### Wearing more than one type of Armour

You can wear two types of armour simultaneously - one kinetic and one energy, as seen in armour such as p-suits or Zero-G Armour. You can also select separate kinetic and energy armour packages yourself and combine them; they're listed separately below as many combatants prefer not to overburden themselves.

**Absorption Field\*:** the Commonality's most powerful energy shield; it makes a loud buzzing noise and distorts the view and manipulative ability of the user. It can be pressure-sealed and in emergency protect a wearer from vacuum, although there's only a limited air supply. **Aspects:** *Airtight, Noisy, Clumsy, Distorting.*

**Assault Armour\*:** the Commonality's best battle dress, vacuum-sealed and composed of rigid ceramic plates. It's intimidating to look at, bulky and restrictive; many wearers insist on exoskeletal improvements to compensate and provide extra strength. **Aspects:** *Bulky, Intimidating, Vacuum-sealed.*



**Assault Field\*:** a less cumbersome version of the Absorption Field, offering similar protection and slightly lower endurance for a big increase in manoeuvrability. More athletic combatants prefer this model. **Aspects:** *Distorting, Noisy, Vacuum-sealed.*

**Compound Armour\*:** an unsealed, less protective version of Assault Armour composed of rigid ceramic plates. **Aspects:** *Bulky, Intimidating.*

**Dispersion Field\*:** better than a low-end Haze Field but more noticeable, offering low-level protection against energy weapons. It's not as noisy as more powerful fields, but still easily detectable. **Aspects:** *Noticeable, Visually Distorting.*

**Haze Field:** a holographic interference mesh designed to interrupt lasers, Haze Fields offer no protection against other types of energy weapons. The low-power models are practically invisible in the visible spectrum, but higher models become increasingly opaque. **Aspects:** *Difficult to See Through (high-end models), Stealthy, Unobtrusive.*

**High Threat Assault Armour\*:** the Commonality's most powerful, intimidating suit of powered armour, almost equivalent to some of the Venu combat walkers in its protective qualities. Over 2.5 metres tall, fully vacuum-sealed with EVA harness and exoskeleton providing mobility and +1 bonus to strength-related tasks ( Might, Fists, etc), it comes with four built-in Good (+3) Quality combat drones (see below) providing a +2 attack bonus when attached or acting as a +5 independent Minion group. It's a mean bit of kit, but extremely cumbersome and noisy. **Aspects:** *Very Loud, Powered Armour, Intimidating, Very Bulky, Vacuum-sealed, EVA Harness.*

**Low Signature Insertion Suit\*:** like a p-suit without the PSA and biomed suit improvements, the Insertion Suit is designed to be worn under clothing. It has two improvements over the p-suit: a hard-to-detect energy shield, and an excellent stealth profile (no Stealth Penalty). **Aspects:** *Stealthy.*

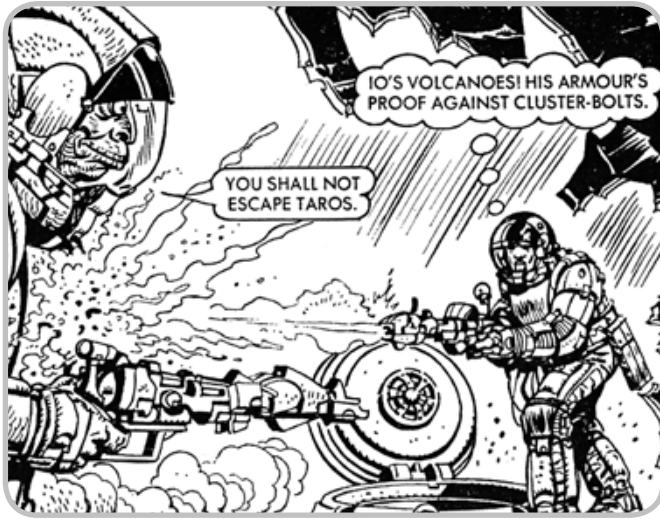

**Mesh:** the lightest modern armour, consisting of lightweight adaptive fibre covering torso and abdomen which goes rigid against blunt trauma damage. Lower tech mesh refers to the heavier "bulletproof jackets". **Aspects:** *Head and Limbs Exposed.*

**P-Suit:** described above.

**Primitive Hide:** soft and hard leather, laminated wooden and studded armour, and cuirbouilli, none of which will stop a bullet; their protective value is against primitive weapons (melee weapons and bows) only.

**Primitive Rigid:** various plate metal armours with good weight distribution, these are nevertheless cumbersome and fatiguing to wear, but very effective against primitive weapons. **Aspects:** *Noisy, Cumbersome, Fatiguing.*

**Primitive Semi-rigid:** metal chain armour, scale mail, and so on, these armours tend to be heavy. **Aspects:** *Noisy, Heavy.*

**Repulsor Field:** mid-range energy shield offering good compromise between obtrusiveness and protective ability. It isn't vacuum-sealed. **Aspects:** *Noticeable, Visually Distorting.*

**Shocksuit:** a full adaptive mesh bodysuit offering good all-round protection, though the head is somewhat exposed to kinetic attacks. **Aspects:** *Head exposed.*

**Venu Light Armour:** also known as a **Venu Status Suit**, includes various light armours worn by Venu officers and commanders. It incorporates a Venu mask, and can be pressurized for a few minutes. It doesn't have EVA capability, but shipboard officers frequently combine it with an EVA harness. **Aspects:** *Showy, Face Mask.*

**Venu Marauder Armour:** currently the "best" Venu armour, although it can't be used around unprotected allies due to its continuous radiation bleed. **Aspects:** *Bleeds Radiation, Unreliable.*

**Venu Trooper Armour:** a heavy-duty suit of composite ceramic plate, usually in Venu legion colours, it has a primitive unstable force field and is vacuum-sealed with a basic EVA package. It's expensive, hard to maintain, and bulky, and standard issue for Venu troopers. **Aspects:** *Unstable, Bulky, Awkward.*

A more expensive vacuum-sealed EVA version exists known as Venu G-Armour, usually worn by Venu marines.

**Zero-G Armour:** a flexible suit of vacuum-sealed adaptive mesh incorporating an EVA harness. **Aspects:** *Vacuum-sealed, EVA Harness.*

## Melee Weapons

Melee weapons use the Weapons Skill.

**Fists:** all unarmed attacks, including punches, kicks, and throws.

**Blade:** a one-handed weapon, including spears and crushing weapons such as maces and hammers.

**Sword:** a two-handed weapon, including large weapons such as long spears, great axes and flails.

**Vibro Knife:** an early powered melee weapon with a rapidly vibrating blade.



**Vibro Sword:** a larger version of the Vibro Knife.

**Energy Knife:** a smaller version of the Energy Sword.

**Energy Sword:** an archaic duelling weapon, AKA a Force Blade. May be used with the Blaster Bolt Defence and Lightning Attack Technopsi Stunts.

**Energy Mace:** often built into p-suits as a holdout weapon, it can also be conformed as a plasma shield (-1 energy armour). May be used with the Blaster Bolt Defence and Lightning Attack Technopsi Stunts. *Example: Hydrodyne M-200 Integral Defender.*



# Weapons

## Weapons Table

Weapon	Bonus	Type <sup>4</sup>	Autofire	Rng	Tech	Wt (kg)	Cost
<b>Melee Weapons</b>							
Fists	+0	K	N	0	n/a	Na	n/a
Blade	+1	K	N	1	Poor	0.5	Mediocre
Sword	+2	K	N	0	Poor	4	Fair
Vibro Knife	+2	K	N	0	Good	1	Fair
Vibro Sword	+4	K	N	0	Good	4	Good
Energy Knife	+3	E	N	1 TH	Great	1	Good*
Energy Sword	+5	E	N	0	Great	1.5	Fantastic*
Energy Mace	+4	E	N	0	Great	1.5	Fantastic*
Monofil	+6	K	N	0	Superb	1	Epic*
<b>Slug Throwers</b>							
Hand Gun	+2	K	Y	1	Average	1	Good
Auto Rifle	+3	K	Y	3	Fair	3	Great
Shotgun	+4/+2 <sup>5</sup>	K	N	2	Average	3.5	Great
Sniper Rifle	+4	K	N	4	Fair	8	Superb*
SMG	+3	K	Y	2	Fair	4	Great*
<b>Null Weapons</b>							
Null Pistol	+4	L	Y	1	Good	1.5	Superb*
Null Rifle	+5	L	Y	4	Good	2.5	Fantastic*
Disintegrator Rifle	+6	E	N	2	Epic	5	Epic*
Venu Protein Disruptor Pistol	+3	E	N	1	Great	1.5	Superb*
Venu Protein Disruptor Rifle	+4	E	N	2	Great	4	Fantastic*
<b>Blaster Weapons</b>							
Photon (Blaster) Pistol	+2	E	N	1	Great	1.2	Fantastic*
Mark IV Photon Blaster (Rifle)	+4	E	Y	3	Great	3.5	Epic*
Meson Blaster (Rifle)	+6	E	Y	3	Epic	10	Legendary*
Plasma Launcher <sup>2</sup>	+6	E	N	4 EX	Superb	7	Legendary*
<b>Heavy Weapons</b>							
HMG	+5	K	Y	3	Average	20	Fantastic*
Rocket Launcher <sup>1</sup>	+5	K	N	3 EX	Fair	15	Epic*
Thermic Lance	Special	E	N	1	Superb	10	Epic*
Venu Heavy Disruptor	+5	E	Y	3	Great	25	Epic*
<b>Vehicle-Mounted Weapons</b>							
High-Explosive Autocannon	+8 <sup>2</sup>	K	N	4	Good	n/a	2 x Superb*
High-Energy Laser Cannon	+8 <sup>1</sup>	E	N	5	Good	n/a	2 x Fantastic*
Very Heavy Disruptor Cannon	+8 <sup>2</sup>	E	N	4	Great	n/a	2 x Epic*
<b>Non-Lethal Weapons</b>							
Hypo Gun	Special	K	N	1	Good	2.5	Good
Neural Whip	+3	E	N	0	Great	1	Superb
Shok Gun / Stun Pistol	Special	E	N	1	Great	2	Great
Shok Stick / Stun Baton	Special	E	N	0	Great	1	Good
Snare Gun	Special	K	N	1	Great	3	Great
<b>Grenades</b>							
Grenade Launcher Attachment	+1 <sup>3</sup>	K	N	+1	Fair	+1	Good
Grenade Launcher	+2 <sup>3</sup>	K	N	+1	Fair	1.5	Great
Bio	+6	K	N	2	Good	0.2	Fantastic*
Smoke	+6	K	N	1	Average	0.2	Good
EMP	+6	K	N	1	Good	0.2	Superb*
Explosive ("Frag")	+6	K	N	1	Average	0.2	Great*
Snare	+6	K	N	1	Good	0.2	Good
Sonic	+6	K	N	1	Good	0.2	Good
Stun	+6	K	N	1	Fair	0.2	Good
Radiation ("Rad")	+6	K	N	2	Fair	0.2	Fantastic*

1:Explosive. Treat as grenade effect on target zone. 2 :Treat as Military Grade explosive effect on target and zone.

3 :Bonus to attack, not damage. 4 :Attack Type. K = kinetic; E = energy. 5: +4 damage in same Zone, +2 otherwise.

**Monofil:** lethal invisible blade comprising a single monofilament held in place by a suspensor field. If two monofils ever connect, one or both suspensor fields may collapse and the monofilament blade drift free, causing terrible damage.

## Slug Throwers

Also known as kinetic mass ejectors or kino weapons, slug throwers use the Guns Skill.

**Hand Gun:** also known as Kinopistols.

**Auto Rifle:** also known as Kinorifles. *Example: Magnatech AR7 7mm autorifle.*

**Shotgun:** shotguns do most damage at close quarters (same zone), attenuating rapidly with distance. **Aspects:** *Up Close and Personal, Ineffective at long range.*

**Sniper Rifle:** a heavy, stable weapon capable of accurate fire over great distances, though difficult to use in close combat. **Aspects:** *Stable, Accurate over Great Distances, Useless in a Fire fight.*

**SMG:** light portable machine gun firing wide bursts of ammunition, less effective against specific targets. **Aspects:** *Burst-fire.*

## Null Weapons

Recoilless laser or disruptor weapons, popular in zero-G combat and boarding actions. They use the Guns Skill. **Aspects:** *Recoilless.*

**Null Pistol:** also known as Laser Pistols. *Example: Tyce Systems LP-25 25 megawatt laser pistol.*

**Null Rifle:** also known as Laser Rifles. *Example: Mai Ling Null-70 70 megawatt laser rifle.*

**Disintegrator Rifle:** experimental and very hard to obtain, this large weapon fires a torsion beam which literally tears its target apart. **Aspects:** *Terrible Wounds.* *Example: AFI X-2 Torsion Disintegrator (Classified).*

**Venu Protein Disruptor Pistol:** a little-seen Venu weapon used by officers and the mysterious technopriests, it's just as unstable and radioactive as the rifle version. **Aspects:** *Bleeding Z-radiation.*

**Venu Protein Disruptor Rifle:** the main Venu trooper weapon, a scaled-down version of the Venu disruptor cannon based off stolen technology from Commonality torsion field projectors. It's dirty and inefficient, emitting Z-radiation which the Venu don't seem to mind! **Aspects:** *Bleeding Z-radiation.*

## Gunfire in Zero-G

Puts a temporary Aspect of "Affected by Zero-G Recoil" on a character. Null Weapons avoid this.

## Blaster Weapons

Blaster weapons use the Guns Skill.

**Blaster Pistol:** the **Starblazer** Photon Pistol. *Example: Tyce Systems T-20 20 megawatt blaster pistol.*

**Blaster Rifle:** the **Starblazer** Photon Blaster. *Example: Tyce Systems T-50 50 megawatt blaster rifle.*

**Meson Rifle:** the **Starblazer** Meson Blaster. Basically a hand-held particle accelerator, this enormous weapon comes with a suspensor field and steady harness for portability. **Aspects:** *High-explosive.* *Example: The Pleskov (PASARM) Nova-1220.*

**Plasma Launcher:** the **Starblazer** Plasma Launcher. **Aspects:** *High-explosive.*

## Heavy Weapons

Heavy weapons use the Guns Skill, except for the Thermic Lance.

**HMG:** a heavy tripod-mounted machinegun with excellent armour-piercing anti-vehicle capability, Uses ammunition very rapidly and is susceptible to overheating, even with a makepoint. **Aspects:** *Armour-piercing, Hard to Reload.*

**Rocket Launcher:** the **Starblazer** Rocket Launcher. A shoulder-mounted weapon firing 2kg explosive shells. It's very susceptible to running out of ammunition, even with a Regenerating improvement. **Aspects:** *High-explosive, Limited Ammunition.*

**Thermic Lance:** the **Starblazer** Thermic Lance. Uses the Weapons Skill. **Aspects:** *Armour-piercing.*

**Venu Heavy Disruptor:** a heavy tripod-mounted disruptor cannon with good anti-vehicle capability. It leaks Z-radiation constantly. **Aspects:** *Armour-piercing, Bleeding Z-radiation.*

## Vehicle-Mounted Weapons

Vehicle-mounted weapons use the vehicle's Projectile Weapons or Guns Skill or the gunner's Starship Gunnery Skill.

**High-Explosive Autocannon:** a heavy shell projector used on cannons and combat walkers. **Aspects:** *High-explosive.*

**High-Energy Laser Cannon:** a heavy recoilless null-cannon used in Commonality vehicles. **Aspects:** *High-explosive.*



**Very Heavy Disruptor Cannon:** a heavy Venu weapon usually mounted in combat walkers. **Aspects:** *High-explosive, Bleeding Z-radiation.*

## Non-Lethal Weapons

Non-lethal weapons use either the Weapons or Guns Skill; see below.

**Hypo Gun:** from *Starblazer*; uses the Guns Skill.

**Neural Whip:** a Venu weapon causing agonizing pain at the slightest touch. It does Composure damage, which you can convert to a Severe consequence for a Fate point. Neural whips may be used in Intimidation as well as Weapons attacks.

**Stun Pistol:** the *Starblazer* Shok Gun; uses the Guns Skill.

**Stun Baton:** the *Starblazer* Shok Stik; uses the Weapons Skill.

**Snare Gun:** from *Starblazer*.

## Grenades

Grenades use the Weapons Skill to throw up to 1 zone; Grenade Launchers increase range to 2 zones and use the Guns Skill.

**Grenade Launcher Attachment:** attachable to any slug thrower, null, or blaster rifle; projects grenades to extended ranges with better accuracy than thrown grenades.

**Grenade Launcher:** an independent grenade launcher weapon, roughly rifle-sized; projects to extended ranges with better accuracy than thrown grenades.

## Tools

**Medical Installations:** including advanced shipboard medical facilities, sentient hospitals, and autodocs, there are two types: Great (+4) and Fantastic (+6). At an Epic (+7) Resources cost, Fantastic (+6) installations can bring characters back from the dead, as long as they aren't **irretrievably dead** (where the stress track has been exceeded by the starting stress or more

- so a 5 stress character has been reduced to -5 or greater). It's a Fantastic (+6) difficulty, increased by +1 if the subject has suffered a Serious consequence, +2 for an Extreme. Restored characters receive a weird "Brought Back from the Dead"-type Aspect. Attending doctors complement the medical installation's skill roll. The process takes a month; each negative Shift increases this by 1 step. If the time exceeds a year, a new personality imprint is required; basically a new character, on the Fringe it may inherit the dead character's possessions (the Core Worlds don't allow inheritance at all), and some of his Skills, Stunts, and Aspects from any retrievable thanograms.

**Stasis Chambers:** energy fields in which all temporal activity is halted. AKA Zero Fields or Null Fields, they're often used when transporting a dead or dying character to a medical facility, or for passengers travelling great interstellar distances (typically over a month), or for storage. Found on starships or in large installations and medical facilities.

**Eidolon Rigs:** the equivalent of laboratories or workshops for scientists engaged in eidolon creation (see page 15), eidolon rigs are "specialized workspaces" (*Starblazer* pages 132-3), and must be equal or higher level than the eidolon created. Whilst a basic synthetic (see **Chapter One: Characters**) is required to house an eidolon, the eidolon rig acts as a "virtual housing" while the creator-scientist engineers, modifies, and integrity-tests the eidolon personality.

**Drones:** small synthetics (typically mechanicals) with anti-grav suspensors and limited autonomous intelligence are everywhere in the Commonality. Treat them as Minions, acquired as Personal Gadgets, Stunts, or Aspects; you can also buy drones you have a Skill for, such as Technopsi Remote Control or Sensorview.

Drones use their Quality as their Skill; a character may also take direct control using the Technopsi Skill Remote Control or Sensorview trappings, either modifying the drone's skill by Technopsi or using the Technopsi Skill instead. Drones may be controlled at interplanetary distances, although at -1 per zone of separation due to time delay.

**Combat Drones:** grav-powered flying drones, often saucer-shaped and less than 50cm across, usually armed with low-recoil Null weapons and with Guns as their primary

### Tools of the New Commonality Era

Tool	Scale	Tech	Weight	Cost
Medical Installation - Great (+4)	2-3	Good	n/a	n/a
Medical Installation - Fantastic (+6)	3	Superb	n/a	n/a
Stasis Chamber	1-3	Good	n/a	n/a
Eidolon Rig	2	Superb	n/a	n/a
Combat Drone	1	Superb	5-10	Fantastic*
Sensor Drone	1	Superb	3-5	Superb
Starship Combat Drone	2	Superb	50-150	Epic*
Avatar	2	Superb	100	2 x Superb



Skill. Some types of powered armour have combat drones attached. Their power is rapidly depleted, although most use makepoints to recharge quickly.

Combat Drones		Good (+3) Minions
<i>Group of 4 Combat Drones, with Good (-3) Energy Shields and armed with Micro Null Cannon (+4 Stress, Range 1).</i>		
<b>Aspects:</b> Small, Fast Moving, Power Quickly Depleted		
-	Independent Combat Drone Group (+2 bonus) (Guns +3)	□□□ □□□
-	Attached Combat Drone Group (+2 bonus to controller)	□□□ □□□

**Sensor Drones:** a small grav pod about 10cm across allowing a user to remotely use passive or active sensors (such as a hand scanner or PSA). The Technopsi Remote Control trapping is required to manoeuvre and manipulate the sensor drone. It can be targeted by weapons and isn't particularly robust; a good hit will take it out, although more advanced models can be quite hard to hit. Sensor drones have Technopsi (Sensorview) as their primary Skill.

Sensor Drone		Fair (+2) Minion
<i>A single unarmed Sensor Drone.</i>		
<b>Aspects:</b> Small, Fast Moving, Hard to Hit		
-	Independent Sensor Drone (+0 bonus) (Sensorview +2)	□□
-	Attached Sensor Drone (+1 bonus to controller)	□□

**Space Combat Drones:** See **Chapter Four: Starships and Space Travel** for details of space combat drones.

**Avatars:** a special type of drone, avatars are physical constructs similar to synthetics controlled by the Technopsi

Control Avatar Stunt, typically used by starship sentiences as mobile EVA housings to leave their ships or interact face-to-face with humans. For easy maintenance avatars are usually mechanicals (see page 7), humanoid, and quite human-looking. While theoretically anyone with the appropriate Stunt may take control of an avatar, people (and especially starship sentiences) get quite proprietorial about "their" avatars, and rarely if ever let them be used by others.

Using an avatar restricts your skills, including Starship Skills for a starship sentience, by your Technopsi Skill, and gives you no extra actions: either you or your avatar can act in an exchange, not both.

Physical damage to an avatar doesn't transfer back to the controller, but Composure or Systems damage does. The controller may relinquish the avatar any time as a free action.

An example of a ship's avatar can be found in **Chapter Ten: The First Casualty**.

## Vehicles

Vehicles not described in *Starblazer Adventures* are detailed below.

### Wheeled or Tracked Vehicles

Rare on Commonality member worlds, but common on lower-tech Fringe and Outer Worlds.

**ATV:** an All-Terrain Vehicle used for exploration or on new colonies, from a 2- or 4-person transport to a self-contained mobile habitat with specialist labs, etc, for extended operations. Comes in wheeled, half-track, and full-tracked versions, and is pressure-sealed.

**Ground Tank:** a tracked assault platform; see **Chapter Eleven: the Black Zone** for sample ground tank stats.

**Battle Platform:** a juggernaut the size of a small starship, and about as big as wheeled or tracked vehicles get.

### Hover Vehicles

Rare in the Commonality except for relatively low-tech Fringe or Outer Worlds with swamp environments.

**Hovercraft:** from small 2- or 4-person models to large multi-person passenger carriers.

**Hover Tank:** a small-scale but agile assault platform.

**Battle Platform:** the size of a very large passenger hovercraft.

### Anti-grav Vehicles

Anti-grav vehicles are the Commonality standard, found on most worlds where the Commonality has a presence,



## Vehicles of the New Commonality Era

Vehicle	Scale	Speed	Tech	Skills	Cost
Living Mount	2	Average	n/a	-	Fair
<b>Wheeled or Tracked Vehicles</b>					
Ground Car	2	Fair	Average	1 x Average	Good
Sports Car	2	Good	Average	1 x Average	Superb
ATV	2	Fair	Average	1 x Average	Superb
Ground Truck	2	Average	Average	1 x Average	Great
Ground Bus	2	Average	Average	1 x Average	Great
Scout	2	Good	Average	2 x Average	Great
APC	2	Fair	Average	1 x Fair, 2 x Average	Superb*
Ground Tank	2	Fair	Average	1 x Good, 2 x Fair, 3 x Average	Fantastic*
Battle Platform	3	Average	Good	2 x Good, 3 x Fair, 4 x Average	Epic*
<b>Hover Vehicles</b>					
Hovercraft	2	Fair	Average	2 x Average	Great
Hover Tank	2	Fair	Fair	1 x Good, 2 x Fair, 3 x Average	Fantastic*
Battle Platform	3	Average	Good	2 x Good, 3 x Fair, 4 x Average	Epic*
<b>Anti-grav Vehicles</b>					
Grav Belt	2	Average	Great	n/a	Great
Thruster Pack	2	Good	Great	n/a	Great
Flyer	2	Great	Great	1 x Fair, 2 x Average	Superb
Grav Scout	2	Good	Great	2 x Average	Great
Grav Transport	2	Good	Great	2 x Average	Great
Grav Train	3	Great	Great	1 x Fair, 2 x Average	Epic
Subway	3	Good	Great	2 x Average	Fantastic
Grav Tank	2	Great	Great	1 x Good, 2 x Fair, 3 x Average	2 x Epic*
Battle Platform	3	Average	Great	2 x Good, 3 x Fair, 4 x Average	3 x Epic*
War Platform	4	Average	Great	2 x Great, 3 x Good, 4 x Fair, 5 x Average	Legendary*
<b>Flying Vehicles</b>					
Helicopter	3	Good	Fair	1 x Fair, 2 x Average	Fantastic
Dirigible	4	Fair	Average	2 x Average	Fantastic
Airplane	4	Great	Average	2 x Average	Fantastic
<b>Waterborne Vehicles</b>					
Boat	3	Poor	Poor	1 x Average	Fair
Sailing Ship	3	Average	Mediocre	1 x Fair, 2 x Average	Superb
Transport Ship	4	Average	Mediocre	2 x Fair, 3 x Average	2 x Superb
Warship	4	Fair	Average	1 x Good, 2 x Fair, 3 x Average	2 x Epic*
Submarine	3	Fair	Average	2 x Fair, 3 x Average	2x Legendary*
<b>Combat Walkers</b>					
Commonality Assault Walker	2	Fair	Good	1 x Good, 2 x Fair, 3 x Average	2x Legendary*
Venu Predator	2	Fair	Great	1 x Good, 2 x Fair, 3 x Average	2 x Epic*
Venu Tripod	3	Fair	Great	2 x Good, 3 x Fair, 4 x Average	3 x Epic*
Venu Quad Walker	3	Average	Great	1 x Great, 2 x Good, 3 x Fair, 4 x Average	3x Legendary*
Venu Crawler	3	Fair	Great	1 x Fair, 2 x Average	Fantastic
<b>Other Vehicles</b>					
Triphib	2	Good	Great	1 x Fair, 2 x Average	Fantastic
Remote Lifter	2	Poor	Good	1 x Fair, 2 x Average	Great

even though local technology may not be able to construct them. Many are sentient synthetics. **Mindjammer** anti-grav vehicles not only avoid terrain effects but gain a +1 or +2 speed bonus over similar ground vehicles.

**Grav Belt:** the **Starblazer** Grav Plate.

**Thruster Pack:** the **Starblazer** Grav Pack.

**Flyer:** a personal grav vehicle capable of sub-orbital (surface-to-starship) operations, although most models aren't vacuum-sealed. They're the most common personal vehicle on Commonality worlds. Sentient models are available but not always chosen; autopilot is standard for longer journeys. The Security instrumentalities have armed and armoured flyers, but these aren't available for civilian use. Flyers are prestige items on many recently contacted worlds.



**Grav Tank:** stats for a sample Commonality grav tank can be found in **Chapter Eleven: the Black Zone**.

**Battle Platform:** the size of a small starship, these are being made in increasingly large numbers.

**War Platform:** a vast, floating, castle-like construct the size of a starship, usually controlled by an AFI Staff Sentience.

## Flying Vehicles

Replaced by grav vehicles on most Commonality worlds, flying vehicles are found on low tech and Fringe and Outer Worlds.

**Helicopter:** a standard rotary-wing aircraft.

**Dirigible:** a large airship, usually helium-filled.

**Airplane:** a variety of fixed-wing aircraft including passenger jets and fighters, their capabilities vary widely.

## Waterborne Vehicles

Found as "hobby vehicles" within the Commonality, but more frequently on lower tech Fringe or Outer Worlds.

**Boat:** a small 2- to 4-person vessel, sometimes man-powered, sometimes capable of extended habitation.

**Sailing Ship:** often a pleasure craft with up to 100 crew depending on size, they're the backbone of trading fleets on low tech worlds.

**Transport Ship:** large container vessels distributing goods on low-tech worlds.

**Warship:** an aquatic, low-tech war platform, either sail-driven or powered depending on tech level.

**Submarine:** a submersible battle platform.

## Combat Walkers

Combat walkers are a combination of vehicle and armour. They're more common in non-grav cultures, or in environments requiring extreme robustness.

The Commonality has some impressive Scale-2 powered armour straying into combat walker territory, but Commonality tech and tactics focus more on combat drone and grav vehicle combinations. The Venu use combat walkers extensively due to their lack of decent suspensor technology and combat drones, and include some alarming Scale-3 monsters, mobile artillery platforms which walk rather than run on tracks or wheels.

**Commonality Assault Walker:** the logical development of high-threat assault armour, a 3-metre tall humanoid walker usually fitted with twin auto- or laser cannon. **Aspects:** *Extremely Intimidating!*

**Venu Predator:** large 4-metre tall bipedal walkers, usually skirmish troops carrying HMG-size artillery. See **Chapter Eleven: the Black Zone** for an example. **Aspects:** *Towering Walker*.

**Venu Tripod:** 5-metre tall tripod walkers usually employed as mobile anti-tank artillery towers. See **Chapter Eleven: the Black Zone** for an example. **Aspects:** *Gang up on the Tanks!*



**Venu Quad Walker:** enormous quadrupedal walkers with heavy armament deployed as “line breakers” and infantry support - the Venu equivalent of battle platforms or giant tanks. See **Chapter Eleven: the Black Zone** for an example. **Aspects:** *Terrifying Mechanized Monster*.

**Venu Crawler:** long, snake-like troop carriers with multiple sections, their armament is largely defensive. **Aspects:** *Rapid Manoeuvre*.

## Other Vehicles

**Remote Lifter:** midway between tool and vehicle, this is a large exoskeleton used for shifting heavy loads. It operates autonomously or under a controller using Remote Control (Technopsi). Typical skills include: Fair (+2) Might, Average (+1) Fists, Average (+1) Athletics.

**Triphib:** a grav flyer with submersible capability, triphibs have orbital capacity and are often carried aboard explorer ships.

### ✦ **New Vehicle Armour Stunt: Anti-Personnel Armour**

The vehicle is unaffected by normal personnel weapons except those with “High-Explosive”, “Armour-Piercing”, or “Anti-Tank” Aspects. All starships have this Stunt by default. Vehicles with this Stunt can still be affected by explosives.

## Installations

Installations blur the boundaries between equipment and structures such as starships, space stations, or buildings.

### **Local Mindscape Instance (LMI)**

Normally the Mindscape isn’t something you “see” as a physical object. Orbital or system-wide Mindscape relay satellites are unobtrusive, and your Mindscape implant connects you invisibly and automatically.

This isn’t always the case. Many planets, especially Fringe and Outer Worlds, have no Mindscape access. In such cases, devices are available containing “copies” of the Mindscape (imperfect and out-of-date to varying degrees) to power Mindscape-related abilities such as Skill Chips. These are **Mindscape Instances:** fuzzier, less-detailed versions of the Mindscape, but still usable and updating themselves automatically whenever in contact with the Mindscape proper. Without a full Mindscape connection, the highest level LMI determines Technopsi ranges and capabilities. LMI signals are easily detectable.

**Personal Mindscape Instance (PMI):** a Personal Gadget. Within its 1 zone range Skill Chips operate normally, but the Mindscape can’t be tagged, and Exoeidetic Memory only locates Good (+3) difficulty memories or less. PMIs are usually small devices the size of a hand scanner, and can be

suppressed by a Monitor Band cloak. Subcutaneous PMIs are rumoured to be in use by Special Operations Chip users.

**Shipboard or Installation Mindscape Instance (SMI or IMI):** within a range equal to weapons range Skill Chips operate normally, the Mindscape can be tagged, and Exoeidetic Memory locates Superb (+5) memories or less. Starships with SMIs usually have a corresponding Aspect.

**Global Mindscape Instance (GMI):** covers part or all of a planetary surface, with satellite LMI located around the system to expand coverage and prevent lag. Skill Chips and Mindscape tagging operate normally, and Exoeidetic Memory locates Fantastic (+6) memories or more. Global Mindscape Instances indicate a Commonality member world, or one on the verge of entry; the only real difference may be the frequency the GMI is updated by Mindjammer visits. A GMI is normally a planetary Aspect.

## Other Installations

**Sentient Corpuses:** the intelligences which control buildings and structures. See **Chapter Nine: Mind’s Eye** and **Chapter Ten: the First Casualty** for examples.

**Starship Sentiences:** synthetic brains operating the Commonality’s sentient starships, including the famed Mindjammers. See **Chapter One: Characters** for general information, and **Chapter Four: Starships and Space Travel** for how to create starship sentiences.





# Chapter Four: Starships and Space Travel

*The alien warship dropped out of 2-Space, its primitive planing engines distorting space-time with churning vortices of Z-radiation.*

*The Commonality man-o-war was ready for them.*

*"Venu Warhawk, Venu Warhawk, I repeat, stand down! You are outgunned and outmanoeuvred, Cut your gravity engines and cease targeting the planetary surface immediately, or we will use annihilating force!*

*"Dammit! Don't these people understand? What - they're firing on us? Do they want to die? This makes no sense...*

*"All right! Activate the Torsion Field Projectors. Tear that ship out of the sky!"*



## Space Travel

Before the advent of the planing engine, Old Earth seeded the galaxy by slower-than-light generation and stasis ship. For ten millennia colonies were established in isolation from one another, dependent upon Old Earth for information, forced to wait years for communications to arrive.

Later, with the Mindscape, synthetic intelligences were transmitted by tightbeam communication, and slowships became rarer. Evolution continued to diverge, and the further the synthetics travelled, the less the colonies they found resembled Old Earth. Even then it was clear there were many colonies seeded by generation ship which did not communicate back to Old Earth, lost in the depths of space.

As the Commonality expands, it finds hitherto unknown worlds, colonized in the far-off past. Before the Expansionary Era, the furthest world in communication with Old Earth was the strange culture of the Venu beyond the Orion Nebula – more than 1500 light years distant – with whom there had been only four known contacts in recorded history. Commonality explorers have now established that generation ships penetrated much further: the Lost Colonies, when they are finally found, will likely stretch more than 5000 light years from Old Earth, containing a vast number of inhabited systems colonized by Old Earth in antiquity and, potentially, other non-human species.

## Astrography

The Expansion isn't proceeding smoothly in all directions. Each year the frontier becomes larger, Commonality exploration assets more attenuated, and recently Expansion

has begun to slow. On the Venu frontier a "Quarantine Zone" has been established, a no man's land many light years deep, where the Commonality is repurposing its Space Force to the principles of active defence. This section provides a snapshot of a dynamic, constantly changing milieu - Human Space in year 193 of the New Commonality Era.

### **Galactic Directions and Coordinates**

The Commonality uses three-dimensional coordinates to locate stellar objects, with a reference point centred on Old Earth (at coordinates 0,0,0) and constantly updated by Mindscape. Units are in light years. Bearings use 360-degree notation along horizontal and vertical planes aligned with the galactic plane: 180/180 would indicate directly "behind" and "down".

Several popular conventions exist to supplement this system. First, two sets of compass directions can be used to refer to the vertical and horizontal planes: "North and South" indicates directly "up" the vertical plane and "behind" along the horizontal. Above and below the galactic plane are "up" and "down", and towards and away from Old Earth "in" and "out".

**Human Space:** a roughly spherical volume of space 10,000 light years across, the theoretical maximum extent of slowship colonization during the First Age of Space. Human Space contains over 4 billion stellar bodies.

**Commonality Space:** a volume of space roughly 3000 light years in diameter, containing 27 sectors, centred on the

Core Worlds and marking the current extent of Expansion. Commonality Space contains 3375 subsectors, many only cursorily explored, and over 100 million stellar bodies and an unknown but extremely large number of inhabited worlds. Over 100,000 worlds have been contacted to date. The "Commonality Space Projection" on the inside front cover is a 2-dimensional representation of key regions of Commonality Space; the adjacent "Commonality Space Schematic" breaks the same volume of space down into a cube of 3 x 3 x 3 sectors, centred on the Core Worlds and also showing the Rim Sector.

**The Core Worlds:** the sector of Commonality Space centred on Old Earth, dominated by the core Commonality culture, containing roughly four million stellar bodies, and 2500-3000 populated worlds, of which at least 1000 are considered "Core Commonality". Parts of the Core Worlds were invaded during the Venu War (110-120 NCE), and the scars are still visible.

**The Fringe Worlds:** the thousands of worlds on the edge of Commonality Space still in the throes of contact and assimilation.

**The Outer Worlds:** mostly uncontacted worlds beyond Commonality Space but within the projected area of Human Space, where Commonality explorers are slowly searching for the children of Old Earth.

**Province:** a subdivision of Human or Commonality space 2000 light years a side and containing 5-10 sectors, and some thirty-two million stellar bodies. Provinces are more common on the edges of Commonality Space.

**Sector:** a cubic volume of space 1000 light years a side, there are approximately a thousand sectors in Human Space. A sector of average stellar density contains four million stellar bodies, and 1000-3000 known populated worlds.

The adjacent diagram "Rim Sector Subsector Schematic" shows a sector on the edge of

Commonality Space. The five component "layers" of the sector are shown, each comprising 25 subsectors; one such layer (the second) is expanded to show individual subsectors and political regions, including Venu Space, the Q-Zone, and the Outer Worlds. Other examples of Commonality Sectors include the Core Worlds and the Antares Codominion.

**Subsector:** a cubic volume of space 200LY a side. A sector contains 125 subsectors on a 5 x 5 x 5 grid (in order of vertical plane, horizontal axis, vertical axis), each containing approximately 32000 stellar bodies and anywhere from zero to 100 known populated worlds. The central subsector in a sector is at grid reference 3-3-3. The adjacent diagram "Rim Sector Subsector Schematic" indicates the position of the Darradine Restoration, subsector 2-4-2 of the Rim Sector.

**Octant:** a cubic volume of space 100 light years a side. A subsector contains 8 octants, each containing some

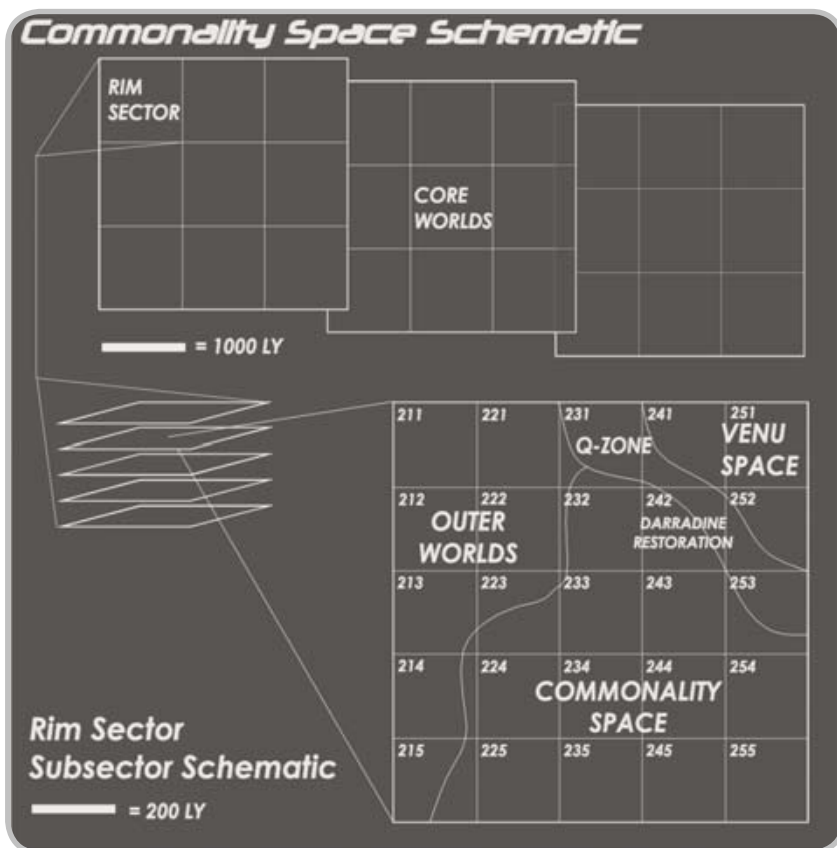

### Astrographical Units of the New Commonality Era

Name	Shape	Diameter (LY)	Stellar bodies	Known worlds	Comments
Human Space	Spherical	10000	4 billion	Unknown	
Commonality Space	Cubic	3000	100 million	100,000+	Contains 27 Sectors (3x3x3)
Province	Cubic	2000	32 million	8000-24000	Contains 8 Sectors (2x2x2)
Sector	Cubic	1000	4,000,000	1000-3000	Contains 125 Subsectors (5x5x5)
Subsector	Cubic	200	32000	0-100	Contains 8 Octants (2x2x2)
Octant	Cubic	100	4000	0-20	Not used in unpopulated areas.

4000 stellar bodies and anywhere from zero to 20 known populated worlds. Unpopulated or sparsely populated subsectors may not use this level of designation at all. *Example: The Darradine Rim.*

### The Darradine Restoration Subsector

Subsector 2-4-2 of the Rim Sector. The Black Zone Campaign presented in this book is set in Octant Gamma, the Darradine Rim: see **Chapter Seven** for more details.

The schematic below shows the eight octants of the Darradine Restoration subsector, labelled *alpha* through *theta*.

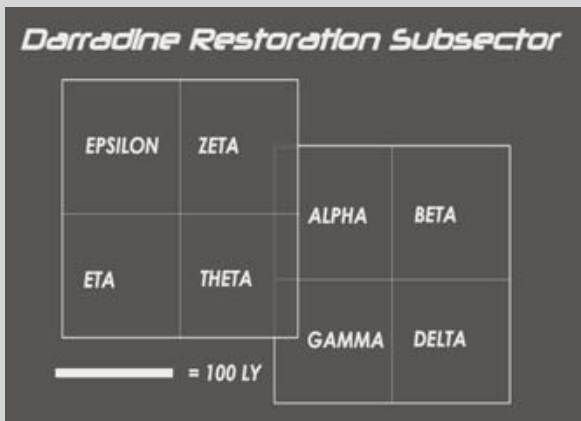

- Alpha – Galatar Octant
- Beta – Whalebone Nebula
- Gamma – Darradine Rim (subsector and octant capital: Ajeux)
- Delta – Willard-Khutep Gulf (nicknamed “The Big Empty”)
- Epsilon – Sepulchre Cluster
- Zeta – Venu Frontier (includes the Menelaos Confederacy, a Fringe World confederation, and part of the Q-Zone)
- Eta – Pravassalaf Rim (capital: Upper Avlania)
- Theta – Rift Octant (Shinean cultural zone. Capital: Koh-Mense)

### The Nature of Space Travel

Faster-than-light travel is still a new invention in the Commonality, less than two hundred years old and well within living memory. New discoveries - and new dangers - are being encountered every day. Ships travel slower than light in N-Space, or faster in 2-Space, and in the Commonality Core the 3-Space gates are experimenting with even faster forms of travel.

#### N-Space

Piloting through 2-Space in a solar system is “impossible”: there are too many gravity wells. Planeships drop into N-Space (or Normal Space) at the N/2 Boundary (usually

beyond the Kuiper Belt) and travel in-system using gravity engines, the ship sentience piloting and the N-Pilot on surveillance and standby.

#### 2-Space

2-Space is an “other-dimensional” space entered and travelled through using the **planing engine** star drive. Travel in 2-Space is a thousand times the speed of light, crossing just under 3 LY per day or 20 LY per week (actual figures are 8.75 hours per 1 LY, 2.75 LY per day, or 19.2 LY per week).

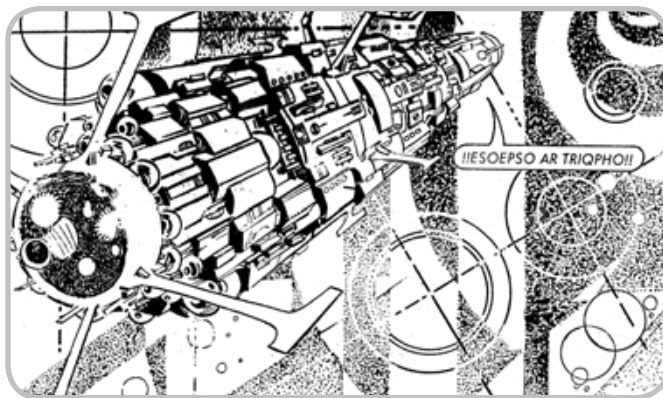

Planing engines project a **2-Space field** or **Tachyon distortion field** around a starship. Operating this field on a planet or within a gravity well is extremely dangerous, poisoning the environment and potentially destroying the ship. See **Starblazer** page 139 for operating planing engines too close to a gravity well.

#### 3-Space

Not much is known about 3-Space – it’s a young science, less than fifteen years old. **3-Space gates** exist on several Core Worlds (less than fifty in total) allowing practically instantaneous travel at roughly a million times the speed of light - crossing one light year in 31.5 seconds, roughly 120 light years per hour. In 3-Space, the whole of Commonality Space could be crossed in 26.25 standard hours! Gates are expensive and delicate, so roll-out to other worlds is slow, but 3-Space theoreticians predict gates will one day even operate on planetary surfaces.

Many 2-Pilots and planeships are worried about 3-Space: if predictions are correct they could soon find themselves redundant, at least within the Commonality. Many are increasingly eyeing futures out on the still-expanding frontier.

## Starships of the New Commonality Era

### Sentient Starships

Commonality starships are intelligent, thinking beings. None of the Commonality’s foes can match this, and Commonality exploration and expansion has so far outshone all of its competitors.



### Scenario hook: a Tear in Space

A new Instrumentality is being established separate from Space Force to oversee the construction of 3-Space gates in all sector capitals - the so-called Far Gate Project. It's a huge undertaking, opposed by some Custodians of the Commonality due to "strategic risk", but the 3-Space Instrumentality is pushing ahead. Rumours abound that construction has already begun, shrouded in absolute secrecy.

The new and mysterious 3-Space Instrumentality has had a terrible accident at an experimental 3-Space gate in the Rim Sector, and the whole star system has been quarantined. The PCs are called up under strictest secrecy to enter the system and bring the situation under control - what will they find?

In recent history, however, sentient starships have had a strategic downside: their intelligence has tended to prioritise interpersonal and other "soft" skills at the expense of "harder" ship skills such as weaponry and military tactics. Sentient starships have stable, well-rounded personalities, but have been found severely wanting against, for example, the Venu, whose non-sentient fleet single-mindedly concentrates on armaments and manoeuvrability. The defeat the Commonality suffered in the Venu War (110-120 NCE) led to major shipbuilding reform, and it's hoped the new Commonality manowars will be a definite improvement.

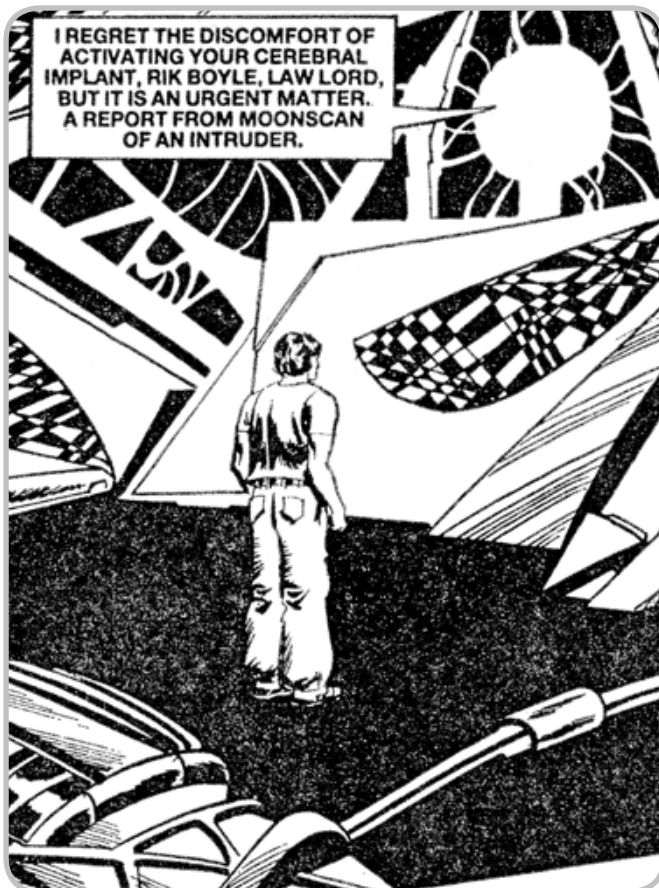

### Creating Sentient Starships

Create a sentient starship like you would a character, but with access to both personal **and** starship Skills. It should have a "sentient starship" Aspect, giving it a synthetic brain with its own (usually) eidolon personality. Ship sentiences usually have the Sentient Ship Control Stunt (see below), operating their ship as well as an organic crew - although ships themselves "like" having crews and rarely travel alone (with the exception of Mindjammers). Ships like Mindjammers also have a "shipboard LMI" Aspect and the Technopsi skill, but freighters, attack ships, and new traders forego these in favour of weaponry or increased cargo space, relying on direct voice communication between ship and crew. This is one of the reasons why Mindjammers have such a mystique - they're "telepathic starships".

Skill points, Aspects, and Stunts for sentient starship characters are determined as for **Starblazer** starships. At the Story Teller's discretion, additional Skill points can be allocated for personal skills up to the limits in **Starblazer Chapter Three** (15, 20, or 35 points) to reflect experienced ship sentiences. Thus, a "gritty" Medium (3) Advanced sentient starship might have 15 Skill points, of which a maximum of 9 (one less than the next Scale up) can be allocated to starship Skills. Sentient starships select from either personal or starship Skills; some personal Skills (such as Might or Endurance) aren't usable unless the ship has an avatar (see page 7). Starship Skill limits imposed by ship Scale (**Starblazer** page 310) apply to starship Skills but not personal Skills; even though they may reach the limit for

## Don't Like Numbers?

*Mindjammer* star drive operation assumes you're happy calculating distances between star systems, even using Pythagoras' Theorem. It's crunchy, and pretty realistic, but not everyone wants that much detail - maybe you're happy eyeballing distances, or just not running that type of game.

If that's you, then the following method might be just right! It uses the "Distance and Range" table from *Starblazer* page 313, modified to work with *Mindjammer's* strategic assumptions (such as, you can't just jump right to the Venu homeworld!). You still use the rules above for jump maximums, piloting difficulties, overhauls, and so on - you just don't need to bother with the numbers.

According to the table opposite, a ship with Average (+1) planing engines can jump to two or three star systems before requiring overhaul, and a jump to "anywhere within the current octant" is Good (+3) difficulty.

## Mindjammer 2-Space Distance and Ranges Table

Planing Engine Skill / Jump Difficulty	Jump Maximum / Jump Distance
Abysmal (-3)	No jump possible
Terrible (-2)	Within current star system only
Poor (-1)	Just about limp to the next star system
Mediocre (0)	Any neighbouring star system
Average (+1)	Two or three star systems away
Fair (+2)	Several star systems away
Good (+3)	Anywhere within the current octant
Great (+4)	Just about make it to the next octant
Superb (+5)	Two or three octants away
Fantastic (+6)	Any neighbouring subsector
Epic (+7)	Two or three subsectors away
Legendary (+8)	Several subsectors away

starship Skills, starship sentiences continue developing as individuals. The sentient space habitats of the Commonality Core, thousands of years old, are very experienced indeed.

### ❖ New Ship Systems Stunt: Sentient Ship Control

A superior version of the AI Autopilot Stunt for a sentient starship, which operates as if it has a human (etc) pilot, and ship's Skill rolls suffer no penalty. Sentient starships, particularly those carrying passengers, also have organic (usually human) 2-Pilots for collaboration and emergency backup.

## Starship Operations

### Star Drive Operation

Operating a starship's **planing engines** to make an interstellar "jump" is a Star Drive Skill check against the "distance difficulty" on the table below; shorter jumps are easier, longer ones more difficult. The Star Drive Skill is

modified by the 2-Pilot's Starship Pilot Skill; see below for the effects of failure. Planing engines have a **jump maximum**, the total light years they may travel before requiring ZIP (power) plant overhaul taking a few days (see "Power Plants" below); starships can extend this with additional power cores (**X-Cores**) - see below.

*Example: A Freighter with Average (+1) Star Drive and a 2-Pilot with Good (+3) Starship Pilot Skill is attempting a slightly risky 25 LY jump (Fair difficulty); modifiers are +1 (Star Drive Skill) and +1 (2-Pilot Skill modifier) for a total of +2. The worst result is -5 (a -5 roll, modified to -3, against a +2 difficulty): the "Failed Star Drive Operations" table indicates this would be a Severe consequence to the ship's Star Drive Skill and starting location. If the Freighter had damaged planing engines operating at only Poor (-1), the worst result would be -7, taking the ship sentience offline and requiring the 2-Pilot to take over. Normally a 25 LY jump takes 9 days - consequences may modify that, indicating 2-Space emergence at a different location or time.*

### Jump Maximum by Star Drive

Star Drive Skill	Jump Maximum
Abysmal (-3)	No jump possible
Terrible (-2)	Within current star system only
Poor (-1)	3 LY
Mediocre (0)	10 LY
Average (+1)	20 LY
Fair (+2)	30 LY
Good (+3)	40 LY
Great (+4)	50 LY
Superb (+5)	60 LY
Fantastic (+6)	70 LY
Epic (+7)	80 LY
Legendary (+8)	90 LY

### Jump Difficulty by Distance

Distance to be Jumped	Difficulty
-	-
Current star system	Terrible (-2)
1-3 LY	Poor (-1)
4-10 LY	Mediocre (0)
11-20 LY	Average (+1)
21-30 LY	Fair (+2)
31-40 LY	Good (+3)
41-50 LY	Great (+4)
51-60 LY	Superb (+5)
61-70 LY	Fantastic (+6)
71-80 LY	Epic (+7)
81-90 LY	Legendary (+8)



## Failure and Consequences

If your Star Drive Operation roll fails, your ship suffers damage and the jump may fail - see below. Consequences to the ship sentience are treated by the Starship Pilot Skill Starship Therapy trapping (see **Chapter Two: Skills and Powers**).

### Failed Star Drive Operations

#### Target Distance

Difficulty missed by:	Result
1	Minor consequence to ship's Star Drive Skill*, and to starting location. Jump still occurs, and the ship arrives at its destination.
2-3	Major consequence, as above.
4-5	Severe consequence, as above. At the Story Teller's discretion, jump may fail and ship remain at its point of origin.
6+	Extreme consequence: ship sentience is offline, and 2-Pilot must take over piloting and reroll, otherwise the ship makes a Precipitate 2-Space Emergence (see below).

\*if the 2-Pilot is making this roll, consequences represent Composure damage.

### Precipitate 2-Space Emergence

Precipitate 2-Space Emergence occurs on badly failed Star Drive Operation rolls and also on catastrophic failures from pushing the jump maximum (see **Chapter Two: Skills and Powers**). The planeship is hurled back into N-Space at an indeterminate point, usually somewhere between the start and end points of its course. Players may pay a Fate point to make a declaration that they emerge at a reasonably favourable point; Story Tellers may pay the players a Fate point and compel them to emerge somewhere unfavourable instead!

### Jump Detection

During 2-Space entry or emergence tachyons and other faster-than-light 2-Space particles interact with N-Space, distorting space-time in a **Tachyon distortion field** - commonly called a "jump wake". N-Space gradually returns to normal, but for a period after entry / emergence the jump wake is detectable by sensors at a difficulty equal to the Star Drive Skill of the ship causing the wake. Multiple ships produce multiple overlapping wakes, making it difficult to gauge numbers. The Track FTL Stunt calculates the jumping ship's destination or system of origin.

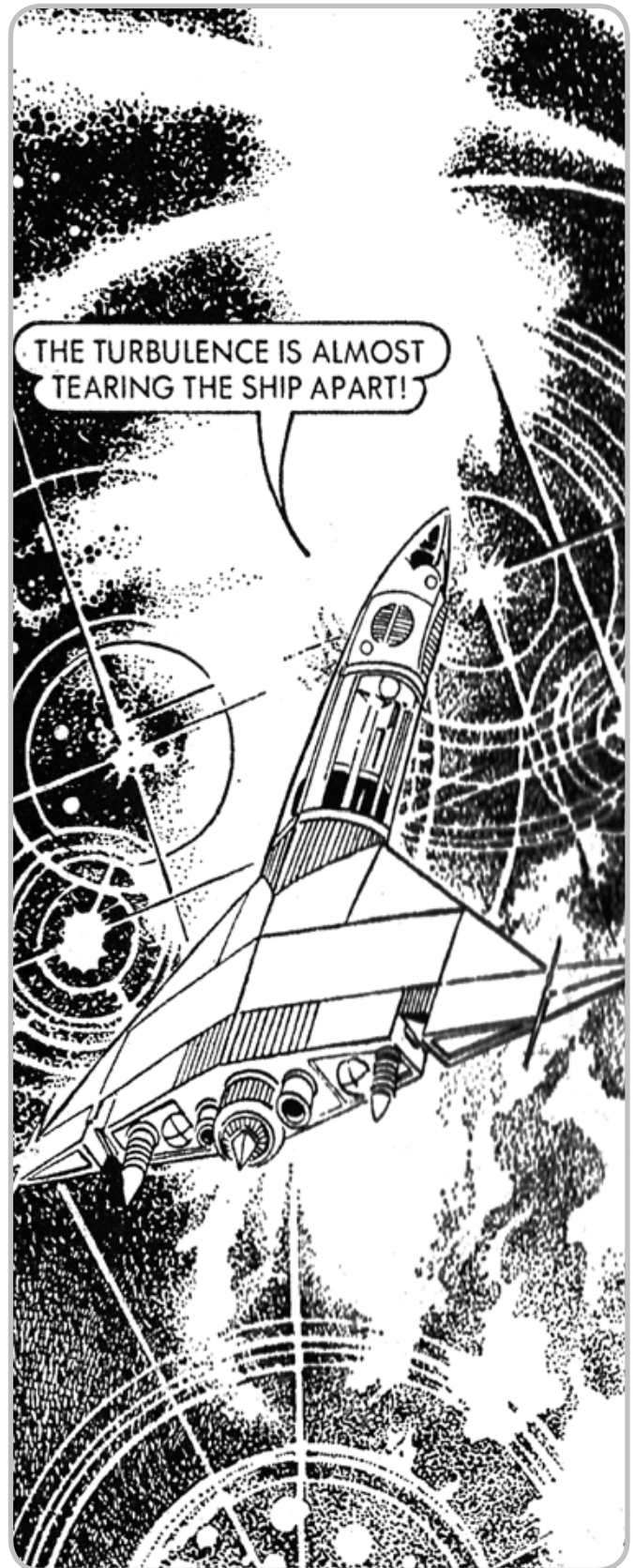



## Unfavourable 2-Space Emergences

Oort Cloud	Ship emerges in the cometary "Oort Cloud" at the boundary of the star system's gravity well (some 50,000 to 100,000 AU out!). It may be damaged by cometary debris collisions and face tricky manoeuvres in areas of high debris density. It's a long haul to the inner solar system on gravity engines; it's the Story Teller's choice whether this is the origin or destination world.
Collision!	Depending upon damage suffered this is a minor or major collision with a moon, asteroid, comet, or even planet, in either the origin or destination system.
Solar Emergence	Ship emerges in the sun's corona! Damage is to shields and comms first, then drives, then life support. The ship must navigate tortuous magnetic storms to return to "empty" space!

### Scenario hook: Slowship

The PCs' ship has made an "unscheduled visit" to its target system's Oort Cloud on a failed Star Drive Operations roll. Before crawling into the central solar system on its gravity engines, it detects another ship, out here in the Big Empty! Sensors show it's a slowship - with the markings of a colony ship from the First Age of Space! What secrets does it contain? Are there still colonists inside, waiting to arrive at their destination? Are they in stasis - or, worse, are their descendants still there, regressed into savagery?

## Activating Planing Engines in Dangerous Environments

Planing engines are designed for activation in space, far from gravity wells; activation anywhere else can be extremely dangerous. Roll as indicated on **Starblazer** page 139: failure indicates damage to the planeship and Z-radiation damage to the vicinity (1 zone per shift of failure). See **Starblazer** page 238 for Z-radiation power by consequence (a Major consequence indicates Great (+4) power Z-radiation contamination, etc). In extreme cases (activating planing engines on a planetary surface, etc) the entire ship can be lost in a catastrophic explosion and the local environment contaminated with Legendary (+8) Z-radiation.

### Ship Scale and Approximate Displacement

**Starblazer** starship scales equate to the following rough categories of starship displacement (in tonnes). Most starships are Scale 3, 4, or 5, with capital ships and medium to large space stations Scale 6 or above.

Starship Scale	Approximate Displacement (tonnes)
Scale 1	1 kg
Scale 2	100 kg
Scale 3	10-1000 tonnes
Scale 4	1000-100,000 tonnes
Scale 5	100,000 to 10 million tonnes
Scale 6	10 million to 1 billion tonnes
Scale 7	1 billion to 1000 trillion tonnes

## Gravity Engine Operations

Starships manoeuvre using gravity engines, with almost unlimited slower-than-light endurance and negligible ZIP plant wear-and-tear. In-system manoeuvres usually take a few hours (less for larger starships), and rarely more than a few days unless you have poor (or damaged) gravity engines.

## Power Plants

Starships are powered by ubiquitous, free zero-point energy. Although ZIP plants never need refuelling, the conversion of ZIP energy into usable power causes eventual power plant deterioration, requiring overhaul after a certain number of light years has been travelled - the jump maximum. Failure to overhaul can lead to catastrophic failure; the power plant explodes and weird torsion field effects rip through the vicinity, bathing the ship in **zero-point radiation** or **Z-rays**.

Overhauling a starship ZIP plant is a Maintenance / Repair action, requiring a Resources Skill roll (see **Starblazer** page 65). It takes a few days, and can also include the standard starship maintenance if you make time for it. Maintenance rolls must be performed at a Commonality world shipyard, although Commonality outposts and waystations in Fringe World systems are usually sufficient.

Some ships carry their own "spares" instead of cargo if they're travelling off the beaten track and have cargo holds; one level of Cargo Hold Skill dedicated to spares covers a single Maintenance roll; the full time period is still spent. A ship's ZIP plant can produce its own spares with the Makepoint Workshop Repair System Stunt (see below). Capable engineers can also extend their ship's jump maximum - see the "Push the Jump Maximum" Starship Engineering Stunt in **Chapter Two: Skills and Powers**.

Non-sentient ships without self-repair and makepoint systems are unable to keep ZIP plants operating cleanly and efficiently; this is the reason behind the Venu "Dirt Drive".

### ✧ **New Star Drive Stunt: X-Core**

Provides an additional zero-point power core for the ship's Star Drive. An X-core doubles the ship's jump maximum.

*Example: A tramp freighter with Average (+1) Star Drive has a 20LY jump maximum. With the X-Core Stunt, this is doubled to 40LY.*

## ✦ **New Repair System Stunt: Makepoint Workshop**

Allows a starship to undertake Maintenance / Repair rolls by using a makepoint workshop to produce materials and spares; it can also repair Extreme consequences. The ZIP plant must be functioning to use this Stunt. Maintenance / Repair takes 3 steps longer than at a shipyard, as the ZIP plant slowly drip-feeds power to the makepoint to replicate parts, but a properly-equipped ship can eventually perform its own Maintenance / Repair without shipyard facilities.

### **Maintenance / Repair Times and Difficulties with a Makepoint Workshop**

Consequence	Time to Repair	Repair Difficulty using Makepoint Workshop
Minor	A few hours	Good
Major	A few days	Superb
Severe	A few weeks	Fantastic
Extreme	Half a year	Legendary
ZIP Plant	A few weeks*	Superb
Overhaul		
Standard Maintenance	A few weeks*	As Maintenance roll

\* requires a few days at a shipyard

Time periods are fixed by the speed of makepoint manufacture, and can't be reduced by Shifts from the repair roll.

## **Starship Weaponry**

**Mindjammer** uses the following starship weaponry in addition to that provided in **Starblazer Adventures**.

**Zero-point Bombs / Torpedoes:** an unstable and highly radioactive series of weapons used by the Venu. There are standard versions (treat as Projectile Weapons) and larger Torpedo versions.

**Gravity Cannon:** a Beam Weapon creating disruptive gravity wells in a limited volume of space. If these intersect with a ship, they can cause explosions and structural integrity collapses, and can damage large ships (Scale 5+) just by proximity (treat as Plasma Weapons).

**Torsion Field Projectors:** an "Unusual" Weapon invented by the Commonality since the Venu War, these huge spinal mounts are fitted in the latest manowars, though the new manned heavy fighter has an experimental, range 0 model. They disrupt a target's structural integrity, particularly effective against the already-unstable Venu Dirt Drive (double the damage which gets through armour) and often causing Venu ships to simply explode. The manowar version is range 1.

**Venu Disruptor Cannon:** an unstable and radioactive short-range Venu weapon derived from Commonality Torsion Field Projectors but usable on smaller craft. They don't do double damage against Commonality planing engines, but do so if turned against their own Dirt Drives. **Aspects:** *Dangerously unstable. Highly radioactive.*

**Space Combat Drones:** see **Chapter Three: Gear** for rules on drones. Space combat drones are a major component in Commonality starship battles, used instead of manned fighters (they still take up fighter bays, etc) and forming an armed, mobile, ablative "shield" intercepting big gun ordnance and enemy fighters and attacking mother ships directly. Starship combats not involving drones are generally small-scale encounters.

Drones are controlled either by a starship sentience or by a gunner (modified by Technopsi Remote Control), and Commonality space combat has often felt cold and distant, without the immediate danger and "grittiness" of manned fighter dogfights. However, this has begun to change; the Venu don't have space combat drones, using manned fighters and deploying refractive Haze Fields, sand, and jamming beacons to degrade remote gunner control. Commonality drones have had little success against these countermeasures, and space combat with the Venu has become very costly; consequently, since the Stop-Start War (150 NCE) the Commonality has begun to develop fully synthetic and even manned fighters along the Venu frontier.

### **Space Combat Drones**      **Average (+1) Minions**

Group of 4 space combat drones (Scale-2) with Average (+1) Manoeuvre and armed with an Average (+1) Beam Weapon (range 0).

**Aspects:** Small, Evasive

- Independent Space Combat Drone Group (+2 bonus) (Beam Weapons +1)      □ □ □ □

- Attached Space Combat Drone Group (+2 bonus to controller)      □ □ □ □



### **New Defensive Starship Skill: Venu Countermeasures**

Employed by the Venu to counter Commonality space combat drones by interfering with their performance, weapons, targeting, and remote control. They're a combination Haze Field generator, sandcaster, and jamming beacon, deployed as a defensive screen around a Venu vessel under drone attack. Venu countermeasures have proved so effective that the Commonality has begun to produce a manned heavy fighter to supplement drone attacks.

The Skill may be taken to level 3; each level reduces the Effort of drone attacks by -1.



### **New Starship Weapons Stunt: Orbital Assault**

Orbiting starships can attack similar scale planetary surface targets as part of their normal function; a Scale-6 Venu capital ship can attack ground targets as small as Scale-4. The Orbital Assault Stunt goes beyond this, allowing an orbiting ship to place an "Attacked from Space!" Aspect on a zone and any adjacent zones, taggable to affect individuals and smaller scale targets.

Additionally, someone on the ground with the "Support" Military Career Stunt (see *Starblazer* page 47) can call in an orbital assault on a zone. The orbiting ship requires the Orbital Assault Stunt, and the ground observer must make an Average (+1) Leadership Skill check: shifts generated are the number of orbital assault exchanges which can be called in during the session. All targets in the zone must defend against a Great (+4) attack and take +4 stress damage if hit. Orbital assault exchanges take roughly the same time as unit-level exchanges, and can be devastating against unit-sized targets.

### **New Starship Cargo Hold Stunt: Troop Carrier**

The ship can transport 100 ground troops per Skill level. If the Cargo Hold takes a consequence it must receive immediate repair or 5 troops will die each exchange.

### **New Starship Flight Bay Stunt: Drop Shuttles**

The ship can deploy 200 ground troops per Skill level to a planetary surface each exchange using drop shuttles. The ship must be in orbit. Drop shuttles have 3 structural stress boxes and can take 1 consequence.

### **New Starship Stunt: Swarm**

*Requires: starship must be a fighter.*

Allows a fighter wing to attack a ship 1 Scale larger than usual. One fighter attacks, with the rest acting as minions.

### **The Targeting Systems Skill**

Sentient starships don't have "targeting computers" (though the Venu might), which is why *Mindjammer* redefines this Skill as an "advanced targeting" ability. The ship's sentience is an experienced marksman, or has enhanced targeting equipment and routines.





### ✧ **New Starship Stunt: On Target!**

*Requires: starship must be a fighter; Targeting System Skill.*

For a Fate point a fighter can attack a larger, out-of-scale ship up to Scale-6, or Scale-7 if a weakness Aspect is identified and tagged. One or more manoeuvres may be required to get into position before attacking, at the Story Teller's discretion.

### **The Venu Dirt Drive: A Weakness Aspect**

The main Weakness Aspect in space combat in the Commonality, and the thinking behind the Advanced Heavy Fighter. If you're armed with a Torsion Field Projector against an opponent with a Venu Dirt Drive, you can treat the Dirt Drive as a Weakness Aspect.

### ✧ **New Starship Stunt: Stay on Target!**

*Requires On Target!*

As above, but the fighter inflicts an automatic consequence if successful. Ships up to Scale-7 may be targeted.

### ✧ **New Starship Stunt: It's Away!**

*Requires Stay On Target!*

As above, but the fighter inflicts an additional consequence for every point of spin generated on the roll.

## **Common Ship Types**

Many types of planeship travel the Commonality's spacelanes. The Commonality fields many itself, known for their sleek and advanced design; its enemy the Venu Empire acquired its planing technology by theft, and its ships are inefficient and overstretched, the Empire only just capable of their manufacture. There are other ships, too, from mysterious Lowhigh lightjammers to Jawayayn Sky Cities: this section presents a selection of the ships of the New Commonality Era.

## **Commonality Ships**

<b>Mindjammer</b>		
<b>Starship Technical Readout</b>		
<b>Scale:</b>	Medium (3) Advanced	
<b>Structural Stress:</b>	□□□	
<b>System Stress:</b>	□□□	
<b>Fate Points:</b> 5	<b>Refresh:</b> 5	
<b>Consequences:</b>	3	
<b>Armour Cons:</b>	n/a	
<b>Shield Cons:</b>	n/a	
<b>Jump Maximum:</b>	30 LY	
<b>Skills</b>		
Fair (+2)	Technopsi	Planing Engines
Avg (+1)	Manoeuvre	Beam Weapon
	EWS	Repair System
	Cargo Hold	
<b>Aspects</b>		
Sentient Starship		
Shipboard LMI		
Look, ma, it's a Mindjammer!		
<b>Stunts</b>		
Sentient Ship Control		
Atmospheric Entry		
X-Core		
Mindburn		
Auto-repair		
<b>Equipment</b>		
Single Tyce Systems Laser Cannon		
Mai Ling "Steadfast Defender" EWS System		

With no faster-than-light communications technology in the Commonality, the Mindjammers carry communications and information between the stars. They travel continuously from world to world, reinforcing and updating the Mindscape, tying the Commonality together. Mindjammer synthetics often become fascinated by the thought traffic of the Mindscape, and want direct with organics; often they retire from service and transfer their intelligence to Fast Couriers, or even actual synthetic bodies. Mindjammers have 2 Average Skills and 1 Stunt more than a standard Medium (3) Advanced starship.

# NCS Mindjammer "Lightning Thought"

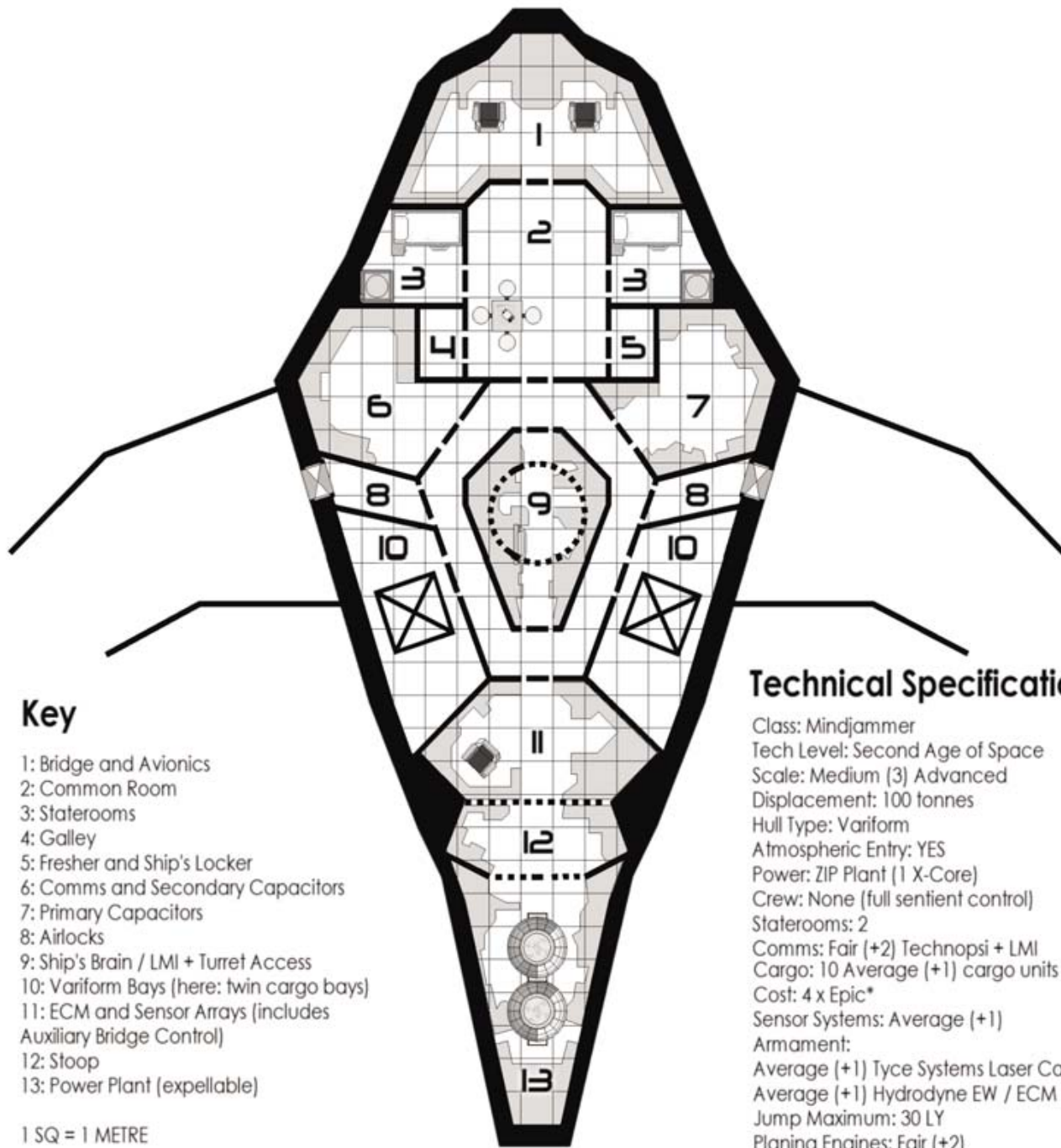

## Key

- 1: Bridge and Avionics
- 2: Common Room
- 3: Staterooms
- 4: Galley
- 5: Fresher and Ship's Locker
- 6: Comms and Secondary Capacitors
- 7: Primary Capacitors
- 8: Airlocks
- 9: Ship's Brain / LMI + Turret Access
- 10: Variform Bays (here: twin cargo bays)
- 11: ECM and Sensor Arrays (includes Auxiliary Bridge Control)
- 12: Stoop
- 13: Power Plant (expellable)

1 SQ = 1 METRE

## Technical Specification

Class: Mindjammer  
 Tech Level: Second Age of Space  
 Scale: Medium (3) Advanced  
 Displacement: 100 tonnes  
 Hull Type: Variform  
 Atmospheric Entry: YES  
 Power: ZIP Plant (1 X-Core)  
 Crew: None (full sentient control)  
 Staterooms: 2  
 Comms: Fair (+2) Technopsi + LMI  
 Cargo: 10 Average (+1) cargo units  
 Cost: 4 x Epic\*  
 Sensor Systems: Average (+1)  
 Armament:  
 Average (+1) Tyce Systems Laser Cannon  
 Average (+1) Hydrodyne EW / ECM Package  
 Jump Maximum: 30 LY  
 Planing Engines: Fair (+2)

**Mindjammer**

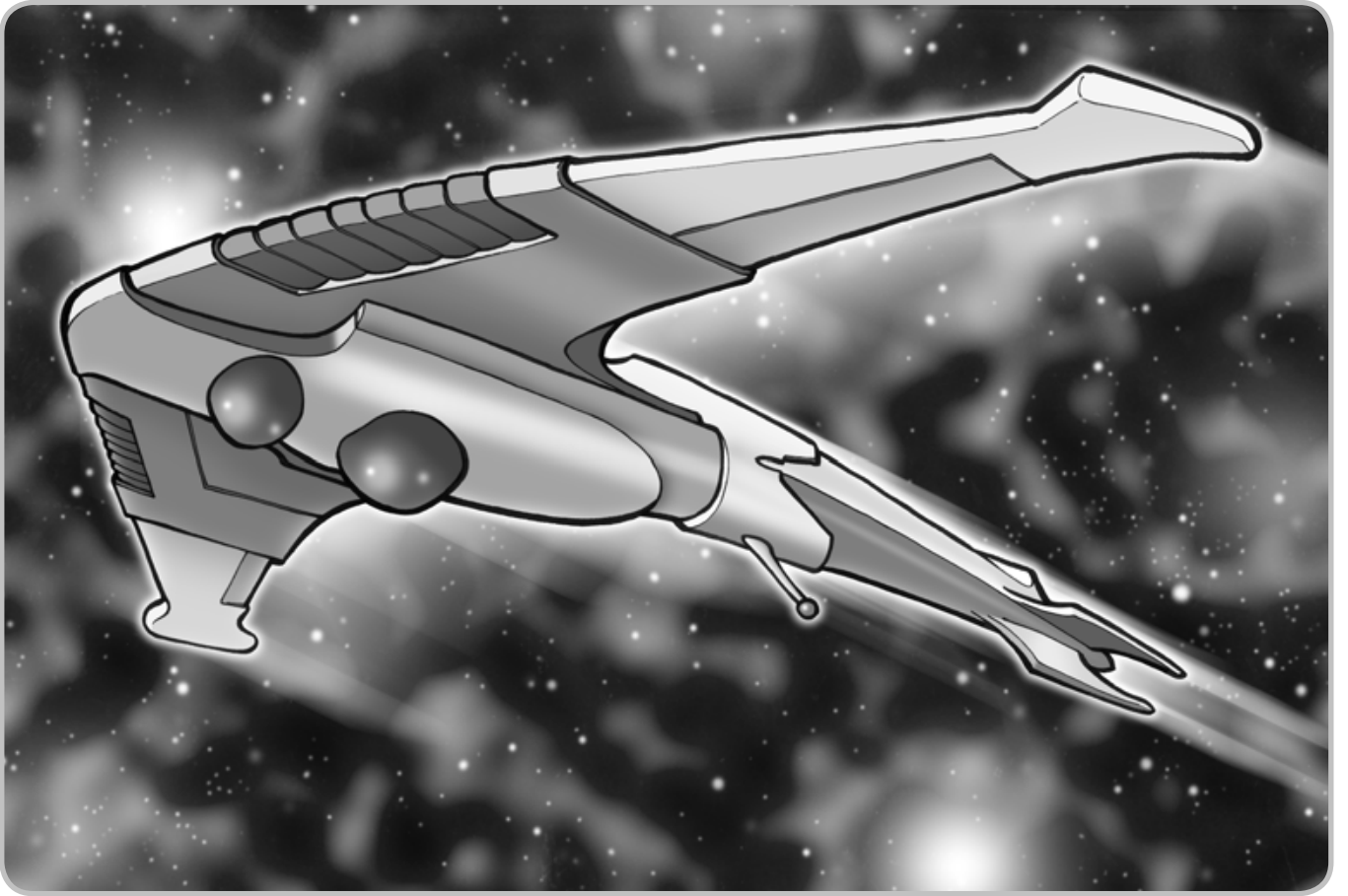

**Fast Courier**

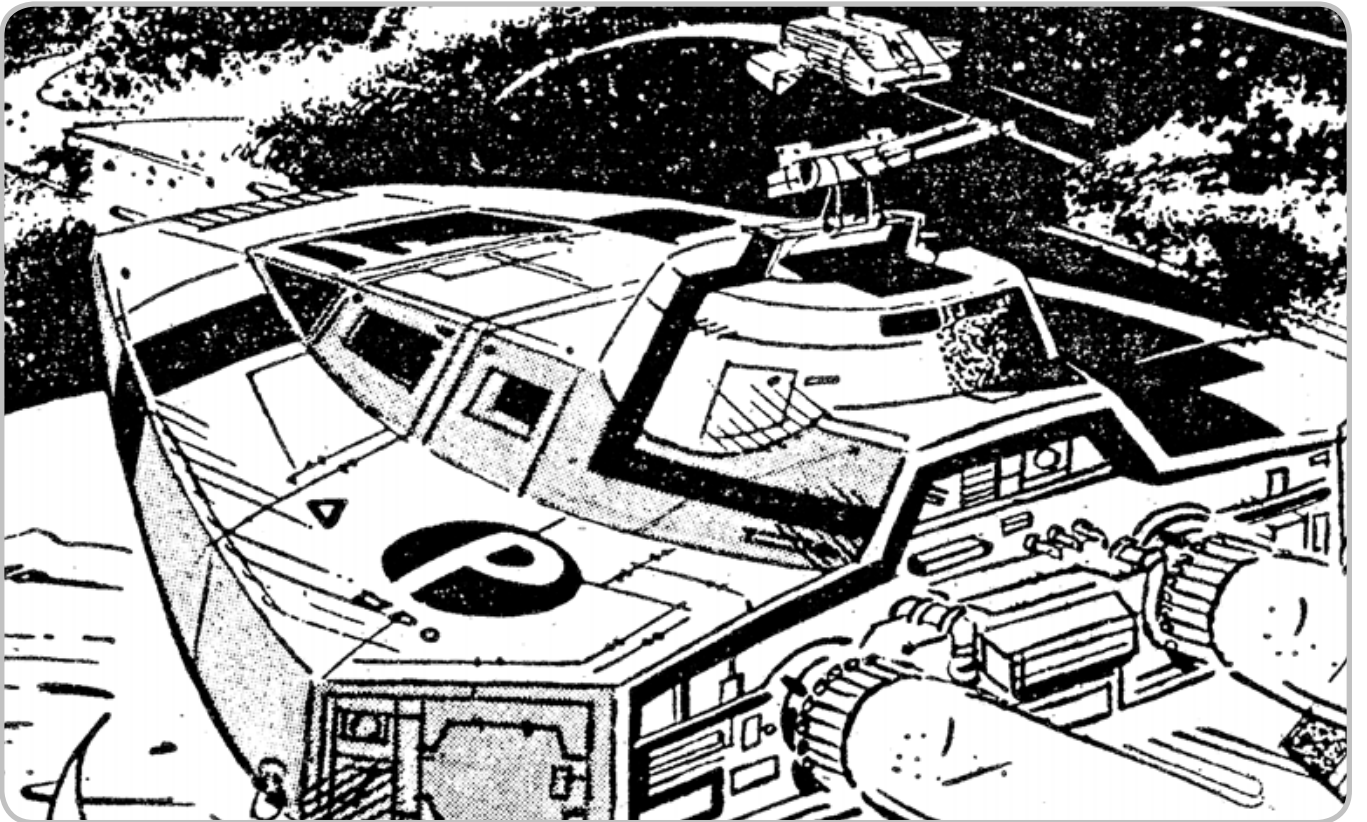



Fast Courier		
Starship Technical Readout		
Scale:	Medium (3) Advanced	
Structural Stress:	□□□	
System Stress:	□□□	
Fate Points: 6	Refresh: 6	
Consequences:	3	
Armour Cons:	n/a	
Shield Cons:	Minor	
Jump Maximum:	30 LY	
Skills		
Fair (+2)	Manoeuvre	Planing Engines
Avg (+1)	Technopsi	Beam Weapon
	Energy Shields	
Aspects		
Sentient Starship		
Shipboard LMI		
I'm sorry, we're on official business		
Stunts		
Sentient Ship Control		
Atmospheric Entry		
Overdrive		
Afterburner		
Equipment		
Single Tyce Systems Laser Cannon		
Hydrodyne Systems 16-G Repulsor Shield		

Small, agile ships used by the Instrumentalities for urgent business, Fast Couriers have a crew of 1 or 2 and (depending on model) from 3-4 to 30-40 passengers. Lightly armed and armoured, often with an ex-Mindjammer sentience, they take their jobs very seriously. Long endurance models have the X-Core Stunt instead of Overdrive or Afterburner.

New Trader		
Starship Technical Readout		
Scale:	Medium (3) Advanced	
Structural Stress:	□□□	
System Stress:	□□□	
Fate Points: 6	Refresh: 6	
Consequences:	3	
Armour Cons:	n/a	
Shield Cons:	n/a	
Jump Maximum:	30 LY	
Skills		
Fair (+2)	Cargo Hold	Planing Engines
Avg (+1)	Cargo Hold	Beam Weapon
	Manoeuvre	
Aspects		
Yeah, I'm a New Trader - wanna make something of it?		
Hey - we can do a deal!		
Hear me, baby - hold together..		
Stunts		
Sentient Ship Control		
Atmospheric Entry		
Cargo Pods		
X-Core		
Equipment		
Single Tyce Systems Laser Cannon		
Various often lucrative and semi-legal cargos		

The above model is a Profit-class New Trader, a small 1-person freighter with room for an extra crewmember and two passengers. Although there's a decent cargo hold, its freight capacity really takes off when it bolts cargo pods to its outer hull (incidentally sending manoeuvrability and hull integrity through the floor...).

There are many New Trader models, including the Adam Smith-class Merchant, the Keynes-class Subsidized Freighter, and the Friedman-class Bulk Transport. Most sacrifice almost everything for cargo capacity, but the most sensible still install Fair (+2) Planing Engines or the X-Core Stunt.

## Other Commonality Ships

**System Defence and Customs Boats:** usually semi-automated STL vessels patrolling star systems for smugglers, Customs Boats are staffed by officious Customs Inspection Synthetics. There'll also be a fully-manned "SDC Station" in-system with a complement of marines in case of emergency.

**Settler Ships:** the Expansionary Era is a time of migrations, people in transit, looking for better lives. This class of planeship includes Homesteaders, Waggon Ships, and Mass Transports.

**Manowars:** a generation of Commonality manowars is entering service with new Torsion Field Projectors and heavy fighter bays, but older models are still operational, including the Mars-class battleship.

**Bombardiers:** enormous vessels specialising in orbital assault, including the Thor-class Bombardier.

**Interdiction Boats:** active around quarantined worlds and along the Q-Zone; includes the Refusal-class Quarantine Enforcer.

**Heavy Manned Fighter:** a new development for Commonality forces in response to Venu tactics.

**Explorer:** includes unmanned exploration drones and the manned Icarus- and Botany Bay-class Explorers (the former a 1-person scout).

**Surveillance Ships:** usually drones, often placed around worlds in Stage Zero Cultural Integration.

**Jawayn Sky Cities:** colossal vessels famed throughout the Commonality.

**Chembu Bioships:** unusual and often uncomfortable biotechnological amalgams, bioships are the Chembu's preferred long-range transport.

## Venu Ships

Venu Ships are more primitive than Commonality vessels, and often downright dangerous. Their unstable and radioactive "Dirt Drive" makes them death-traps in emergencies.

The standard Venu starship weapon is an unstable disruptor cannon based on stolen Commonality technology, nicknamed the **Dirty Mary**. Ships have only the inefficient Disruptor Shield, and can't take the Energy Shield Skill above level 1, instead relying on physical armour and countermeasures in combat with Commonality vessels and space combat drones.

Venu ships have no ship sentiences, and only rudimentary AI. For 2-Space navigation they use human cyborg-pilots wired directly into their ships; these **brainjacks** frequently burn out and go insane - most are basket cases even on good days.

The following are some of the better-known Venu starships.

Venu Capital Ship	
Starship Technical Readout	
Scale:	Enormous (6)
Structural Stress:	□□□□□□
System Stress:	□□□□□□□
Fate Points: 2	Refresh: 2
Consequences:	3
Armour Cons:	Minor, Major, Severe
Shield Cons:	n/a
Jump Maximum:	20 LY

Skills	
Superb (+5)	Flight Bay
Great (+4)	Flight Bay
	Zero-point Torpedo Launcher
Good (+3)	Flight Bay      Ablative Armour
	Ship Systems
Fair (+2)	Hardened Structure
	Venu Countermeasures
	Beam Weapon (Dirty Mary Disruptor Cannon)
Avg (+1)	Manoeuvre      Repair System
	Planing Engines (Venu Dirt Drive)
	Exotic Weapon (Dark Radiance)

Aspects	
	Dreadful victor of the Battle of Oppen-14
	The Commonality has no defence against this!
	Heart of the Fleet
	There's something in the hold...
	Bizarre Venu control system and design
	Belching Z-radiation Dirt Drives

Stunts	
	Quick Launch
	Carrier Bays
	Hardened Ship Systems
	Show Your Better Side
	Orbital Assault
	Anti-fighter Barrage
	Torpedoes Away!
	Reinforced Prow

Equipment	
	Dirty Mary Disruptor Cannon
	24 Venu fighters
	Zero-point Missiles and Torpedoes
	Dark Radiance Exotic Weapon

The "Ancestral Voice" is the capital ship from **Chapter Eleven: the Black Zone**. It carries 24 fighters. The "Dark Radiance" exotic weapon affects target crews with terrifying visions without damaging the ship - it does System damage

or makes a Composure attack against every member of the crew, resisted by Resolve. Venu capital ships deploy huge numbers of zero-point missiles and torpedoes, and use countermeasures against Commonality drones.

Venu Destroyer	
Starship Technical Readout	
<b>Scale:</b>	Huge (5)
<b>Structural Stress:</b>	□□□□□□□
<b>System Stress:</b>	□□□□□□□□
<b>Fate Points:</b> 5	<b>Refresh:</b> 5
<b>Consequences:</b>	3
<b>Armour Cons:</b>	Minor, Major
<b>Shield Cons:</b>	Minor
<b>Jump Maximum:</b>	20 LY
Skills	
Great (+4)	Disruptor Cannon
Good (+3)	Disruptor Cannon
	Disruptor Cannon
Fair (+2)	Manoeuvre Ablative Armour
	Hardened Structure
Avg (+1)	Ship Systems Energy Shields
	Mine Dispenser
	Planing Engines (Venu Dirt Drive)
Aspects	
Bristling with Destructive Firepower	
Looks indestructible	
There's something in the hold...	
Bizarre Venu control system and design	
Belching Z-radiation Dirt Drives	
Stunts	
Hardened Ship Systems	
Split Fire	
Overload (Disruptor Cannon)	
Overload (Energy Shields)	
Reinforced Prow	
Equipment	
Dirty Mary Disruptor Cannon	
Venu Disruptor Shield	

Venu destroyers travel in squadrons of six supporting capital ships. Dedicated combat vessels, they're limited in non-combat actions.

Venu Drop Ship	
Starship Technical Readout	
<b>Scale:</b>	Enormous (6)
<b>Structural Stress:</b>	□□□□□
<b>System Stress:</b>	□□□□□
<b>Fate Points:</b> 6	<b>Refresh:</b> 6
<b>Consequences:</b>	3
<b>Armour Cons:</b>	n/a
<b>Shield Cons:</b>	n/a
<b>Jump Maximum:</b>	30 LY
Skills	
Superb (+5)	Cargo Hold
Great (+4)	Cargo Hold Cargo Hold
Good (+3)	Cargo Hold Flight Bay
	Flight Bay
Fair (+2)	Cargo Hold Flight Bay
	Flight Bay
	Planing Engines (Venu Dirt Drive)
Avg (+1)	Cargo Hold Cargo Hold
	Manoeuvre Ship Systems
	Beam Weapon
Aspects	
Slow-moving and cumbersome	
Built with a single-purpose in mind	
Look at the size of that thing!	
There's something in the hold...	
Bizarre Venu control system and design	
Belching Z-radiation Dirt Drives	
Stunts	
Troop Carrier [Cargo Hold]	
Drop Shuttles [Flight Bay]	
Afterburner	
Overdrive	
Equipment	
Dirty Mary Disruptor Cannon	
Radiant Descent-class Drop Shuttles	

Venu Drop Ships are gargantuan vessels capable of carrying 2000 troops and landing them from orbit onto a planetary surface in on-board drop shuttles (and retrieving them too).



## Venu Fighter

### Starship Technical Readout

<b>Scale:</b>	Medium (3)
<b>Structural Stress:</b>	□□□
<b>System Stress:</b>	□□□
<b>Fate Points:</b> 7	<b>Refresh:</b> 7
<b>Consequences:</b>	3
<b>Armour Cons:</b>	n/a
<b>Shield Cons:</b>	Minor
<b>Jump Maximum:</b>	20 LY

#### Skills

Fair (+2)	Manoeuvre
Avg (+1)	Energy Shields
	Beam Weapon

#### Aspects

Don't worry - she'll hold together!  
Bizarre Venu control system and design  
Belching Z-radiation Dirt Drives

#### Stunts

Atmospheric Entry  
Overload (Beam Weapon)  
Overdrive

#### Equipment

Dirty Mary Disruptor Cannon  
Disruptor Shield

The standard Venu fighter. It has a crew of 2.

## Venu Insertion Ship

### Starship Technical Readout

<b>Scale:</b>	Medium (3)
<b>Structural Stress:</b>	□□□
<b>System Stress:</b>	□□□
<b>Fate Points:</b> 6	<b>Refresh:</b> 6
<b>Consequences:</b>	3
<b>Armour Cons:</b>	n/a
<b>Shield Cons:</b>	Minor
<b>Jump Maximum:</b>	20 LY

#### Skills

Avg (+1)	Energy Shields
	Manoeuvre
	Planing Engines (Venu Dirt Drive)
	Beam Weapon

#### Aspects

There's something in the hold...  
Bizarre Venu control system and design  
Belching Z-radiation Dirt Drives

#### Stunts

Atmospheric Entry  
Overload (Beam Weapon)  
Overdrive  
Blind Jump

#### Equipment

Dirty Mary Disruptor Cannon  
Disruptor Shield

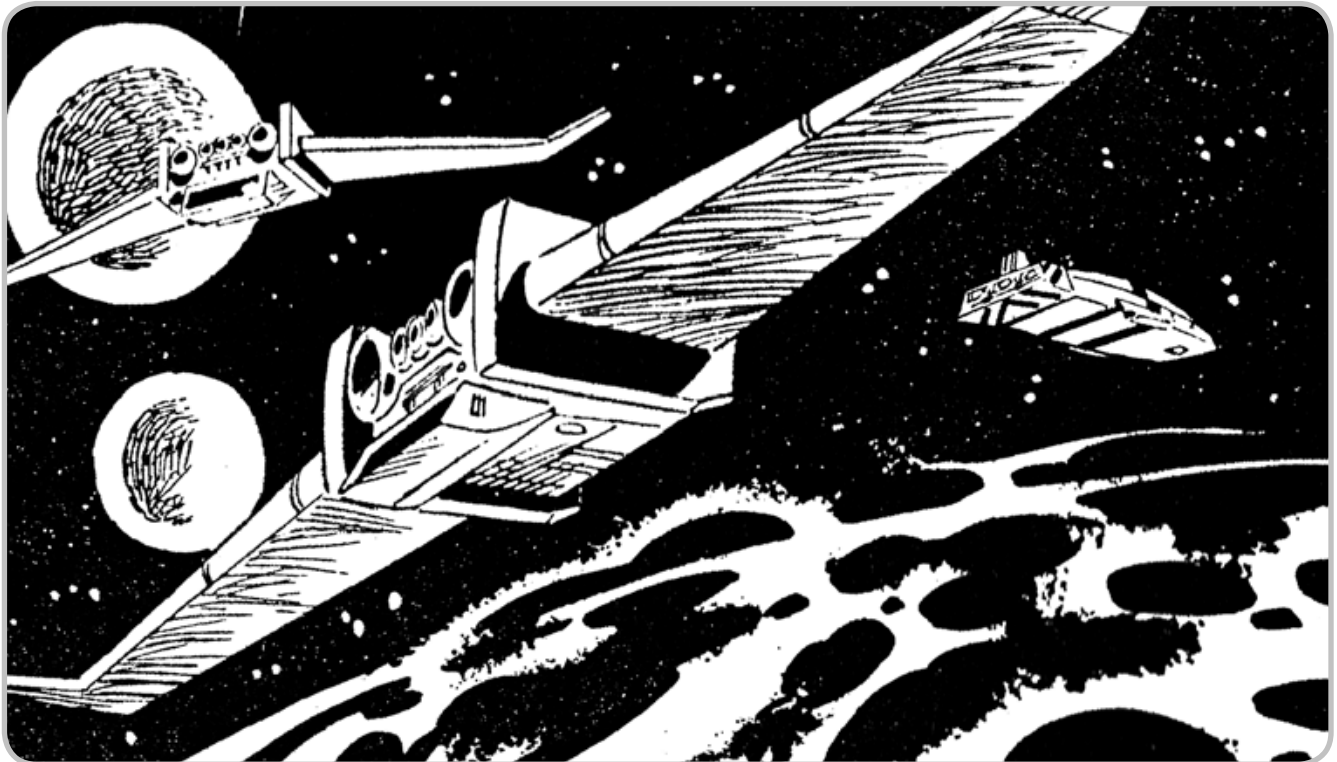

A multi-purpose vessel analogous to the Commonality Fast Courier. It's often intercepted on espionage missions within the Commonality.

Venu Warhawk	
Starship Technical Readout	
Scale:	Large (4)
Structural Stress:	□□□□□
System Stress:	□□□□□
Fate Points: 4	Refresh: 4
Consequences:	3
Armour Cons:	n/a
Shield Cons:	Minor
Jump Maximum:	20 LY

Skills	
Good (+3)	Manoeuvre
Fair (+2)	Beam Weapon Ship Systems
Avg (+1)	Energy Shields
	Planing Engines (Venu Dirt Drive)
	Marine Facilities

Aspects	
	Legendary history
	Turn on a credit
	Bizarre Venu control system and design
	Belching Z-radiation Dirt Drives

Stunts	
	Atmospheric Entry
	Afterburner
	Hit & Run
	Overdrive (Planing Engines)
	Blind Jump
	Boarding Capsules

Equipment	
	Dirty Mary Disruptor Cannon
	Disruptor Shield
	Squadron of Venu Mutant Marines

Venu Warhawks are strike ships, and their crews wear raptor-masks. They have a crew of at least 4 and room for a complement of Venu mutant marines and 4 officers.

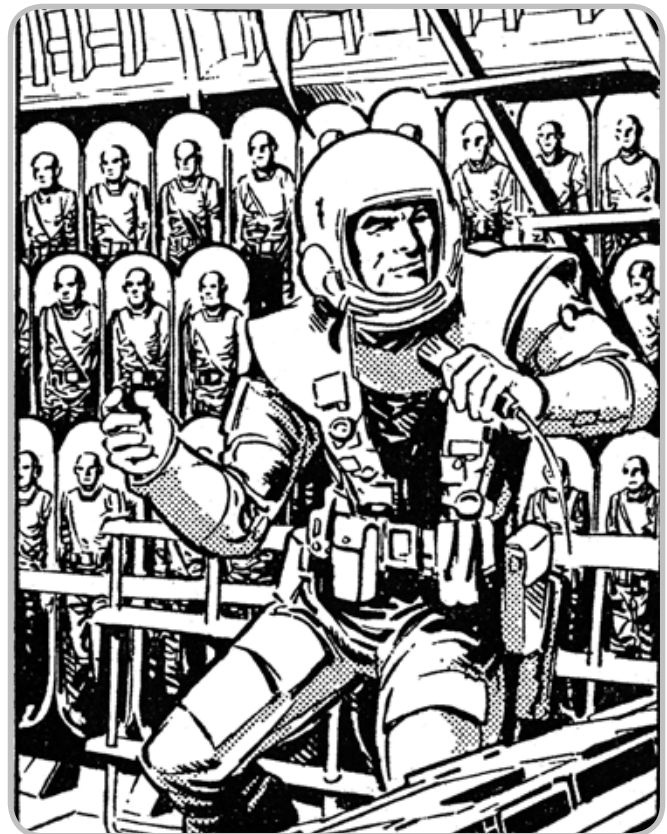
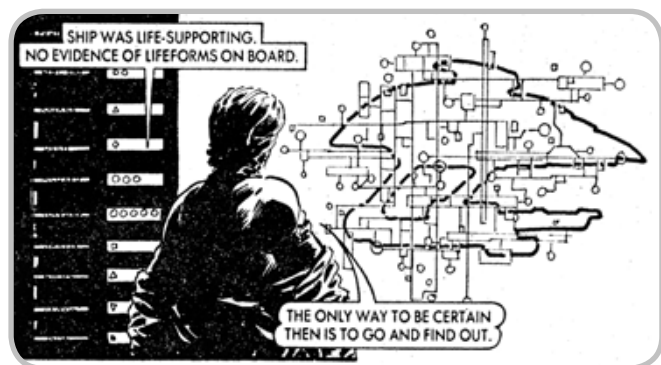

## Non-Commonality Ships

The following are some of the better known non-Commonality vessels.

**Outremer Destroyer:** derived from decommissioned Commonality ships (as most Successor State vessels are) the Outremer Destroyer is famed for its spectacular livery.

**Sentient Alliance "Cat's Claw":** a converted Wayland-class Explorer (obsolete in the Commonality) used for fast patrol work in the Sentient Alliance. Rapidly becoming its signature vessel.

**Sentient Alliance "Serpent's Strike":** a converted Commonality Fast Courier used in system defence, it has a decent strike capability for its size.

**Slowships:** while theoretically any slower-than-light vessel is a "slow ship", the term usually refers to large-scale sublight interstellar transports such as pre-FTL colonization ships. The main originator of slowships was Old Earth during the First Age of Space. Slowships use low-acceleration plasma drives and are occasionally equipped with gravity engines for in-system travel.

Malfunctioning, lost, or simply delayed slowships left over from the First Age of Space have occasionally been encountered, and are known as "relics". Varying hugely in design, but usually enormous, some still travel with crews in stasis or generation ship populations.



# Chapter Five: The New Commonality Era

*"Were we on the brink of extinction? I'd say so, yes. Three or four centuries ago, no one had any interest in anything. It was like everything worth knowing had already been known, everything worth doing already done, and a million times over. We were happy enough, with our drugs and our slaves, and our endless diversions. But we were on our way out: something had gone, some zest, some spice, that made it all worthwhile.*

*Now you get to live as long as you want, as long as you don't get killed. Life is dangerous again. And, somehow, that suddenly makes it all worth living."*

*- Kasim Kasah, Technopsi Redactor-in-Chief, Ministry of Evolutionary Planning (Mysore Vallis Chapter), Europa*



## History

For millennia humankind spread out from Old Earth in great colony ships. Colonies grew in isolation, taking strange and surprising paths, dealing with the challenges of new worlds with whatever lay to hand. Messages from Old Earth took centuries to arrive, and while the stars sang with the songs of men, it was a cacophony, and no great interstellar civilization ever arose.

Two hundred years ago the discovery of 2-Space thrust these worlds together after millennia apart. Conflict and chaos reigned. Old Earth, which controlled access to 2-Space, prevailed, and the New Commonality Era – also called the Expansionary Era – was declared, the first true interstellar civilization of humankind. Some worlds still resist, inimical or simply too alien after millennia of divergent evolution, but a new era has begun, revitalising the once decadent cultures of Old Earth. Where money had been unknown for millennia, New Traders now ply the spacelanes with their "Expansionary Era Currency Units"; where Old Earth had been a vast and indulgent garden, explorers now push onto new worlds, and bizarre and hazardous environments. It's an age of exploration and invention, a new Golden Age for Humankind - the Second Age of Space.

## **The Xeno Wars and the Sentient Alliance**

During the Venu War (110-120 NCE) the Venu invaded and occupied Commonality and Fringe Worlds in the Rim Sector, installing violent and oppressive pro-Venu governments. By the time they'd been pushed back, their malign influence had coloured the more unpleasant so-called "Successor States", and internecine war continued.

By 150 NCE these had become proxy conflicts known later as the Stop-Start War. It eventually fizzled, Venu and Commonality forces withdrawing, but the more pro-Venu States instigated anti-xenomorph pogroms on pro-Commonality worlds. This became another proxy war - the Xeno Wars.

Dates for the end of the Xeno Wars vary, but eighteen years ago in 171 NCE a political alliance between pro-xenomorph, pro-Commonality worlds arose which was strong enough to dampen most of the violence. This "Sentient Alliance" is the first xenomorph state, forming a buffer between the Commonality and the Venu and their Successor State satellites.



## Timeline

The following timeline indicates key events of humankind's history, viewed from the Expansionary Era.

New Commonality Era	First Age of Space	Event
14500 BE	-4000 FA	Prehistoric Age of Technology
14000-12500 BE	-3500 FA	Autumn Cultures and the Fall of Man
12500-11000 BE	-2000 FA	Dark Age: Glaciation and Ice Age
11000 BE	-500 FA	Commonality: Unification of world civilization as global climate control established.
10500 BE	0 FA	First Age of Space: colonization of the solar system and early interstellar voyages
10500-5500 BE	0-5000 FA	The Great Diaspora: invention of stasis fields; humankind spreads to the stars
9500 BE	1000 FA	Longevity: anagathic treatments transform human society
7000 BE	3500 FA	Orion Contact: First contact with the most distant of Earth's colonies, the civilization which will one day be known as Venu.
5500 BE	5000 FA	End of Exploration: Commonality colonization gradually stops.
4000 BE	6500 FA	Orion Contact: Second contact with the Orion cluster.
1500 BE	9000 FA	Stagnation: Commonality in full contraction; superstition and social decay accelerates. Religion and news declared illegal on Old Earth.
1000 BE	9500 FA	Orion Contact: Third contact with the Orion cluster.
1 NCE	10501 FA	Expansionary Era - the Second Age of Space: invention of Planing. Humankind travels to the stars and finds them already inhabited by Old Earth's descendants. Establishment of the New Commonality.
70 NCE	10570 FA	Orion Contact - the Venu Empire: first visit to the Orion Cluster ends with the Commonality ship being seized. The Commonality does not retaliate. Further clandestine surveys reveal a paranoid militaristic society in the cluster - the Empire of Venu.
110 NCE	10610 FA	The Venu War: Empire of Venu invades Commonality Space with newly built war fleet and tries to conquer Old Earth. Tide is turned at the heroic Battle of Styphon V
120 NCE	10620 GE	The Successor States: in the chaotic aftermath of the Venu War a number of small interstellar polities form in the vacuum left by the retreat of Venu and the Commonality. These become known as the Successor States.
150 NCE	10650 FA	The Stop-Start War: a series of skirmishes on the Venu Frontier; the Venu retreat; the Commonality does not feel it yet has the strength to follow.
160 NCE	10660 FA	The Xeno Wars: a backlash against xenomorphs in some of the Successor States following the Stop-Start War causes revolution fuelled by xenomorph arrivals from across the Commonality.
171 NCE	10671 FA	The Sentient Alliance: foundation of a xenomorph polity in the Successor States by Commonality mandate following the Xeno Wars.
193 NCE	10693 FA	Present Day.

# The Commonality Today

This is the year 193 of the New Commonality Era. It's an era of cultural exploration, as the Commonality contacts lost colonies settled in Earth's distant past, and of conflict, when such contact proves violent.

For two hundred years the Commonality has been expanding, contacting lost colony worlds. In places they've bombed recalcitrant governments back to the Stone Age, in others they've created "autonomous regions" and planted psy-ops to coax populations into the Commonality fold. There are interdictions, quarantines, and embargoes - and all the efforts required to enforce them.

As the Commonality pushes outwards, it finds life everywhere. Most intelligent life is descended from colonists from the First Age of Space, and sometimes divergent evolution has made this very alien indeed, but some has also been extra-terrestrial. So far, none have independently developed faster-than-light travel, although many have adopted it with enthusiasm.

## Exploration and Contact

The Expansion's early years were a blitzkrieg: worlds resisting Commonality control were simply mowed down. The Commonality believed it was doing this for the best reasons, and was often contrite afterwards, but self-determination was never an option for contacted worlds.

With time the Commonality has come to feel it doesn't have to use ordnance *all* the time to impose its will. Instrumentalities have become subtle, using psy-ops and long-term manipulation: they want to *incorporate* worlds, after all, not destroy them.



## Cultural Neutralization

Commonality policy emphasises self-protection: does a world pose a threat? Neutralization of cultural threats is the highest priority, and whole cultures may be quarantined and even (theoretically) destroyed, though the Commonality isn't believed to have ever resorted to this final sanction.

Cultures are evaluated for technological, material and cultural resources, and the Commonality deals with threats simultaneously, establishing embassies or covert ops and exploiting resources at the same time.

### How do the Fringe Worlds view the Commonality?

While the lost colonies are populated by humans or their near relatives, they don't always receive the Commonality with open arms and unalloyed joy. Here are some of the more unusual reactions which Fringe Worlds have displayed when confronted with the arrival of the Commonality.

**Men like Gods:** the Commonality is too much to comprehend, and the culture treats its representatives like supernatural envoys. Worship, sacrifice, and darker offerings may be made to curry the envoys' favour and placate their wrath; if the Commonality isn't careful, the culture collapses quickly.

**Children of the Gods:** the culture is awed, and cedes authority to the Commonality's representatives. This hero worship may turn to aggression if the Commonality misbehaves.

**Weird Alien Invaders:** the culture is too paranoid to accept the Commonality at face value, perhaps exacerbated by evolutionary divergence. It treats the Commonality as invaders, violent resistance usually resulting in quarantine.

**Thank God you came!** The culture preserves a memory of Old Earth, perhaps even preserving one of its ancient cultures, and welcomes the Commonality as long-lost brethren. What happens next - when each culture finds out what the other is *really* like - is where it gets interesting.

**Interstellar Fascists:** the culture's views on liberty are less repressive than the Commonality, regarding Commonality culture as something imposed on them (which it is...). At worst this degrades into resistance and quarantine; at best the world may be a prime culture world candidate.

## Expansion and the Culture Worlds - Responses to a Threat

The Expansionary Era opened a door which it's been impossible to close. Virulent alien cultures and vibrant new ideas have threatened the Commonality's stability, forcing it to protect itself. SCI Force and the Instrumentalities deal with direct cultural attacks; when they find a colony world with a strong and vibrant culture which has aspects they can exploit, they take steps to reinforce that culture and provide bastions against cultural contamination from beyond the Frontier. In many cases these cultures are new and unknown, in others they are descendants of historical Old Earth cultures: in both cases SCI Force encourages them to develop their cultural identities, while at the same time defusing any dangerous elements and taking advantage of their strengths to defend the frontier. The Commonality is creating cultural conflict within its borders, hoping it will act as inoculation rather than disease.

### Scenario hook: What's up - you never seen an American before?

The young and vibrant culture world of Nu Californy, based on prehistoric American West Coast cultures, is developing in ways its ancient and long-dead parent never could. It has a powerful instinct for freedom and the virtues of trade, and a healthy suspicion of the "folks back east" in the Commonality Core.

A group of Nu Californyans have managed to restore a battered old classic starship from the sixties - and it works! So, saddle up, and let's go see the Commonality - the folks back east won't know what's hit them!

## The Mindscape

The Mindscape is the virtual brain pervading Commonality Space to which all Commonality citizens are connected. A technical construct relying on synthetic storage and broadcast technologies, there are Mindscape satellites, vaults, and networks throughout the Commonality, including local nodes, often the only Mindscape instance in outlying areas. Administrators of such nodes are called **dirigeants**; on Fringe Worlds they are often **Temples of Universal Mind** (see below).



## Chronodisplacement

There's one great limitation to the Mindscape: the speed of light. Without intervention, the Mindscape in one star system would differ hugely from another; its participants, memories, information and skills. **Mindjammer** planeships travel constantly between Commonality worlds, updating local nodes with information gathered on their voyages. The Mindscape is therefore reasonably synchronized – one end of Commonality Space may be several years out of step with the other, but the corpus of information is broadly the same.

Lack of Mindscape synchronization is a new phenomenon occurring since Expansion. Travellers sometimes "run ahead" of the Mindjammers, and find the local Mindscape isn't synchronized with their own memories and experiences - a phenomenon known as **Chronodisplacement**. Chronodisplacement can be disconcerting for those relying on the Mindscape as a backup for their memories and sense of self; for others, it's liberating, freeing one from dependence on what's sometimes a psychological "crutch" - an independence increasingly necessary in the struggle against foes such as the Venu.

### Compelling the Mindscape?

Chronodisplacement lets a Story Teller compel the Mindscape: a Mindscape tag may fail, or a Skill Chip provide bogus or less than helpful information. It shouldn't happen regularly, but if the PCs have been travelling rapidly across multiple star systems, Chronodisplacement might be an issue.

## Thoughtcasts

In the Mindscape memories are stored as engrams, rather than words or pictures. They're uploaded to the Mindscape via a process known as a **thoughtcast**.

Thoughtcasts are usually voluntary, though the Technopsi Dominate Stunt can compel them. Additionally, a **thanogram thoughtcast** can be initiated, a personality and memory "snapshot" taken at time of death: invasive once begun, the process can be damaging, and people usually wait till they're dying before triggering one. Treat it as a Superb (+5) attack against Resolve, lasting 5 exchanges, converting any shifts directly to Composure consequences; once started it can't be stopped.

## Awareness and Sentience in the Mindscape

The Mindscape is a storage medium; it's not self-aware. Thanograms don't exist as "personalities," though their memories are accessible: an eidolon must be created in an eidolon rig (see **Chapter Two: Skills and Powers** and **Chapter Three: Gear**) to embody the thanogram as a recognizable personality. There's an ethical side, too; thanograms can be interrogated in eidolon rigs if required.



## Fictionals

The Mindscape also contains information which isn't "true". There are pseudo-memories in the Mindscape which never happened to anyone; personalities which have never existed outside a work of literature. These are **fictionals**, and they're where the Mindscape begins to stretch the human mind.

Imagine a world where you could talk to the Buddha, or to Jesus. Or where you could remember flying like a bird through the sky, or wielding creative powers like a god. All these things and more exist in the Mindscape, allowing the human mind to experience impossible things, imaginary events, and grow and develop from the experience. Reality, simulation, fiction, and memory blur in the Mindscape.

The nature of the Mindscape requires that fictionals are clearly identified. **Sentinels** patrol the Mindscape validating content: counterfeiting an actual is a major crime, usually only perpetrated by Black or Special Operations Chip users.

### Scenario hook: Silent Death in Cicero Station

Fictionals are a gift to mad scientists and criminals - who with a yearning for global domination wouldn't want to create a synthetic version of Vlad the Impaler or Napoleon? Cerberus, or Hydra?

The PCs are working for the Internal Security Instrumentality, tracking down a serial killer on the Javawayn Sky City "Cicero Station" whose modus operandi is like some giant, predatorial insect; the few surviving witnesses report a terrifying shape in the shadows, with enormous claws and jaws. Yet there are no unaccounted life-signs on the station: by all accounts this looks like a fictional, a synthetic nightmare created by a madman - but is it? And if it is, who created it, and what is it going to do next?

## Restricted Access and the Mindscape

Mindscape content can be restricted to specific individuals; to everybody else, it's not even there. A Black or Special Operations Chip is needed, allowing you to restrict any content, not just that which you've created.

Accessing restricted content is difficult; it's a Science (Hacking) roll against the Technopsi of the person resisting it. Restricted content is also defended by **sentinels**, sub-routines patrolling the Mindscape for renegade eidolons, Black Chip incursions, masquerading fictionals, and destructive memes. Sentinels are non-sentient, attracted by illicit activity: Story Tellers can compel "Black Chip" Aspects to have them turn up when operations such as Hacking or Mindburn are underway.

Treat Mindscape restricted content as a **Starblazer Adventures** trap, as in the following example.

## Mindscape Restricted Content

**Atts:** see Sentinels, below

**Aspects:** Otherwise invisible

**Other Skills:** Stealth +3, Alertness +2, Resolve +2, Science +1

**Physical Stress:** □□□□□ (1 Consequence)

**Secrets Stress:** □□□□□ (3 Consequences)

Notes: protected by Mindscape sentinels (see below); the content defends itself using Resolve against Science (Hacking). You can also attack the content's Secrets stress using Skills like Contacting or Resources, representing both real-world and Mindscape attempts to circumvent the restriction - a longer term attack.

## Mindscape Sentinels

## Fair (+2) Minions

Group of 8 Mindscape sentinels with Fair (+2) Technopsi (Mindburn and Domination Stunts) and Average (+1) Alertness and Resolve. Sentinels frequently operate independently, but can also attach to Commonality agents operating in the Mindscape if required.

**Aspects:** Blindingly Fast, Mindless Subroutines, In Their Element

- Independent Sentinel Group (+3 bonus) (Mindburn +2) □□ □□ □□ □□ □□ □□ □□ □□ □□
- Attached Sentinel Group (+3 bonus to Mindscape agent) □□ □□ □□ □□ □□ □□ □□ □□

## The Temple of Universal Mind

Life in the Commonality blurs the distinctions between life and death, real and artificial, individual and communal, even what it means to be alive and human. Commonality citizens have had millennia to learn to cope with this; Fringe and Outer Worlds, unused to the Mindscape, thanograms, and eidolons, experience profound culture shock. The Commonality handles this with the **Temple of Universal Mind**: a quasi-religious organization run by the Communications Instrumentality, it's a world's first Mindscape Instance, marking the arrival of Commonality culture. The Temple often limits Mindscape access to external interfaces, though Commonality citizens can usually access by implant.

## Government of the Commonality

Commonality government is diffuse and pervasive. For millennia it rigidly controlled Old Earth and a handful of Core Worlds; since Expansion, it has strained to encompass many thousands. Commonality government is oligarchic rather than democratic (though democratic governments can exist on individual worlds), with governors and apparatchiks appointed from the top down. It's a system which governed Old Earth, at the cost of eventual stagnation and decay. The "New" Commonality is adapting it to govern a galactic

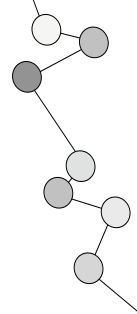

## Temple of Universal Mind

### Organization Sheet

<b>Scale:</b> Colossal (7)	<b>Consequences</b>	<b>Physical Stress</b>
<b>Scope:</b> Commonality (9)	Minor:	□□□□□□
<b>Fate Points:</b> 3	Major:	<b>Composure Stress</b>
<b>Refresh:</b> 3	Severe:	□□□□□□□□
	Extreme:	

### Skills

Skills	Holdings
Great (+4) Communication	The Sanctum (Fortified, Secure, Hidden)
Good (+3) Influence (Fringe Worlds) Diplomacy Sway (Fringe Worlds)	
Fair (+2) Influence (Core Worlds) Secrecy Reputation Admin	
Average (+1) Sway (SCI Force) Security Resources (Information on Fringe) Arms (Temple Guard)	

### Aspects

- Expansionist
- Evangelistic
- Technopriesthood
- Benevolent Dictators
- We know best
- Global Mindscape
- We control access to the Mindscape

## Commonality Government

### Organization Sheet

<b>Scale:</b> Commonality Space (9)	<b>Consequences</b>	<b>Physical Stress</b>
<b>Scope:</b> Commonality (9)	Minor:	□□□□□□□□
<b>Fate Points:</b> 1	Major:	<b>Composure Stress</b>
<b>Refresh:</b> 1	Severe:	□□□□□□□□
	Extreme:	

### Skills

Skills	Holdings
Great (+4) Communication Unity Technology	None
Good (+3) Control (Commonality Space) Sway (Sentient Alliance) Sway (Fringe Worlds) Diplomacy	
Fair (+2) Sway (Successor States) Influence (Q-Zone) Experimental Technology Arms Admin Security	
Average (+1) Trade Influence (Venu Space)	

### Aspects

- Interstellar government spanning all of Commonality Space
- We governed Old Earth for millennia
- Byzantine and complex
- We must contact our brothers in space
- The stability of the Commonality is paramount
- The defence of the Commonality is paramount
- The Expansion will inoculate us against stagnation and decay
- The Custodians of the Commonality rule
- The Pansectorate makes plans; the Instrumentalities carry them out

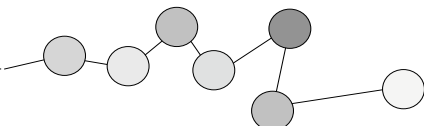
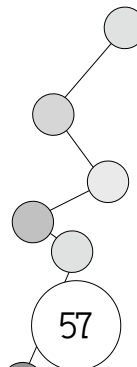

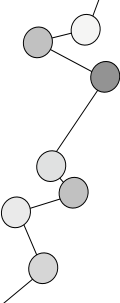

empire, but many parts are entrenched in the old ways and resistant to change, and the result is often inefficiency bordering on chaos, and endless political intrigue.

### **The Instrumentalities**

The Instrumentalities are one of the two arms of Commonality government. Their nearest historical analogues are the civil services or mediaeval guilds: they aren't commercial entities, but organizational structures for executing the will of the Custodians of the Commonality – its mysterious and shadowy pseudo-rulers.

Instrumentalities are Commonality-wide, and organize themselves as required. Each has multiple arms, including Executive, Enforcement, and Intelligence. There are five principal Instrumentalities.

### **The Armed Forces Instrumentality (AFI)**

Until recently, the Commonality had no need of a standing army; even the notion seemed archaic. Contact with the Venu changed all that: nowadays the Armed Forces Instrumentality (AFI) recruits and trains on almost all Commonality worlds. Easiest on Culture Worlds with ancient military traditions, forces are raised on standard Commonality worlds, too.

The situation is chaotic. The AFI General Staff sentiences try to coordinate a myriad different armies, corps, divisions, legions, regiments, all with their own organizations, but it will take time to hone the AFI into an effective force. Right now the AFI is aiming at a locally-coordinated defences (subsector-level at best) in the event of another Venu invasion; it hasn't been tested in the fire of war, and will likely be found wanting.

AFI characters belong to a "lower tier" organization such as a subsector or octant division, or even a planetary legion. AFI-level organization is "nice in theory", but still a pipe dream.

### **The Internal Security Instrumentality (ISI)**

Many aspects of Commonality life would seem bizarre and oppressive to our 21st century eyes. The Fringe Worlds are more free-thinking, their customs often shocking to Commonality sensibilities, but the Core Worlds are a web of byzantine customs and prohibitions. Trade and money are social taboos in the Core, religion and democracy are illegal, and the uncontrolled dissemination of news is banned.

Where the Core Worlds and Fringe meet, there's friction, and the Internal Security Instrumentality has its hands full keeping the peace - often despite the unfathomable machinations of SCI Force. ISI characters are the interstellar police, investigators and crime-fighters.

### **The Space Force Instrumentality**

Space Force is in a state of flux. Originally a civilian exploration and transport organization, since the first Venu War it's been quickly militarized, and is still learning. It has a huge intelligence bureau, frequently in conflict with SCI Force, gathering strategic, tactical, and technological know-how from contacted worlds.

### **The Communications Instrumentality**

The Communications Instrumentality manages inter-world communications, including diplomatic missions and the Mindscape. It includes diplomatic, Mindscape technical and operations staff, sentinels, and technopsi agents.

### **The Security and Cultural Integrity Instrumentality**

Known as **SCI Force**, the Security and Cultural Integrity Instrumentality protects the Commonality against internal and external threats, including powerful ideologies and meme attacks (see **Chapter Six: Worlds and Cultures**). It has its own pilots, marines, and military, separate from the AFI and Space Force.

### **The Ministries**

The Ministries or Directorates are the second arm of Commonality government, coordinating the policies which the Instrumentalities carry out. Ministries interact at sector-level in an umbrella organization called the **Pansectorate**; there's a Pansectoral "Moot" in session at every Sector Capital.

There are five Ministries: War and Defence, Internal Affairs, Transport and Exploration, Evolutionary Planning, and Broadcast Propaganda. The correspondence between Ministries and Instrumentalities is as follows:

<b>Ministry</b>	<b>Instrumentality</b>
War and Defence	Armed Forces
Internal Affairs	Internal Security
Transport and Exploration	Space Force
Evolutionary Planning	Security and Cultural Integrity (SCI Force)
Broadcast Propaganda	Communications

### **Sample Instrumentality: SCI Force**

Instrumentalities and Ministries are **Starblazer** Organizations; this section details the Security and Cultural Integrity Instrumentality (SCI Force).

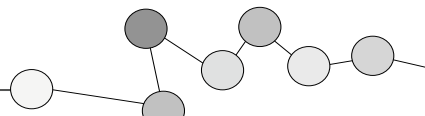
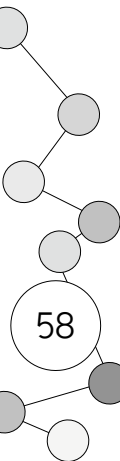



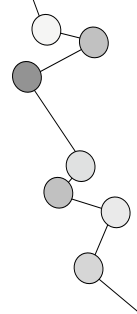

SCI Force			
Organization Sheet			
<b>Scale:</b>	Interplanetary (8)	<b>Consequences</b>	<b>Physical Stress</b>
<b>Scope:</b>	Commonality (9)	Minor:	□□□□□□
<b>Fate Points:</b>	6	Major:	<b>Composure Stress</b>
<b>Refresh:</b>	6	Severe:	□□□□□□□□
		Extreme:	
<b>Skills</b>		<b>Holdings</b>	
Superb (+5)	Influence (Commonality)	Bunker World	
Great (+4)	Sway (Commonality)	Information (Commonality) (Fortified, Secure, Hidden, Isolated, Unusual)	
Good (+3)	Unity	Technology	
Fair (+2)	Arms (Special Ops)	Security	
	Resources		
Average (+1)	Admin	Communication	
Mediocre (+0)	Trade	Diplomacy	
<b>Aspects</b>			
We are the Commonality's protectors!			
Ruthless pragmatists			
Highly motivated			
Superb propagandists			
We won't make the "Venu mistake" again!			
Ask not what we can do for you, but what you can do for us!			
The future of humankind is in our hands			
SCI Force sees all!			

SCI Force is frequently a source of adventure in the New Commonality Era. Handling the "Five Stages" of cultural integration, it comprises several Bureaux:

**The Evaluation Bureau** ("Bugs and Slugs") handles Stage Zero: Interdiction and Manipulation. It's a scary Bureau, in an abstract, clinical way.

**The Contact Bureau** handles Stage One: Contact. It's the most scientific and least frightening of the Bureaux, although ruthless in its operations.

**The Acculturation Bureau** handles Stage Two: Normalization and Stage Three: Acculturation. It fields special operations teams for "sanctions" and cultural manipulations.

**The Monitor Bureau** (the "Behaviour Police" or "Hush Ops") handles Stage Four: Cultural Integrity. It's the scariest of the Bureaux - in a "stop-doing-that-or-die" kind of way.

SCI Force operatives are organized into teams associated (often permanently) with specific Bureaux. Teams include: Research, Manipulation, Sanction, Technical, Insertion, Science, Construction and Reconstruction. Teams are sometimes combined ("Sanction and Insertion Teams" are frequent these days), and members seconded to other teams for specific operations.

**Scenario hook: Freelanders**  
 Offworlders are generally forbidden from landing on Old Earth. The Freelanders, an offworld terrorist faction aiming to disrupt Old Earth's ancient culture, have attacked Cola Station, Earth's principal orbital spaceport. SCI Force are sent in to regain control, and ensure Old Earth's cultural integrity isn't compromised by Freelanders propaganda.

**The Five Stages of Cultural Integration**  
 SCI Force undertakes five stages of cultural integration, as follows:

**Stage Zero: Interdiction and Manipulation.** When a lost colony world is contacted, an indefinite quarantine is imposed while it's observed and evaluated. This can include covert psy-ops to develop the culture to a point where it may be successfully contacted.

**Stage One: Contact.** At this stage full and open contact begins. Embassies are established, diplomacy begins, and campaigns undertaken to win hearts and minds.

**Stage Two: Normalization.** Once Contact has gone far enough, SCI Force introduces the core Commonality culture, an often troublesome process as the native culture's values are overthrown.

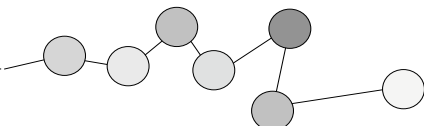
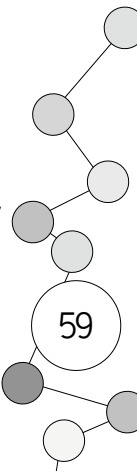

**Stage Three: Acculturation.** The Acculturation Bureau sometimes designates a planet for development as a “culture world”, where the native culture is preserved and enhanced before incorporation into the Commonality mainstream. Such worlds often retain strong features of their origin cultures in the First Age of Space; Shinean worlds, due to their innate conservatism, make excellent culture worlds. Others may be acculturated with only peripherally-related extinct Old Earth cultures, where SCI Force deems it a useful combination.

**Stage Four: Cultural Integrity.** Once a culture is incorporated into the Commonality mainstream, it’s monitored for deviation from Commonality norms. This is particularly important on the Fringe, where Commonality worlds are a “shield” against virulent cultural influences from beyond the frontier.



## The Custodians

The Custodians of the Commonality are its true rulers. Elusive, shadowy figures, often working alone and accountable to no one, their agendas are species-level, spanning many lifetimes. Some have palaces and centres of power; others seem invisible, appearing only when required. They’re scary people with authority over all affairs in their domain, including life and death.

A single Custodian rules a Sector. The Custodian interacts with the Pansectorate Ministries, setting policies which the Instrumentalities carry out. Watcher Craypast is ruler of the Rim Sector; he’s said to be rarely at his palace on the sector capital of Tsen Tair, instead travelling between the sector’s many worlds. There are many rumours and alleged sightings of this mysterious figure.

It’s rumoured that at least one of the Custodians is a synthetic. Some say all of them are.

## Corporacies of the New Commonality Era

The **corporacies** of the New Commonality are “new industries” established in the Expansionary Era in response to demands

### The New Traders

For historical reasons, New Traders are viewed with suspicion by Commonality citizens. Many consider them evolutionary throwbacks, little better than licensed pirates or gangsters, but they perform a valuable service on Fringe and Outer Worlds, where they’re seen as a “necessary evil” by the Pansectorate government and as romantic heroes by local populations. They’re a rough, hardy bunch who play fast and loose with the Commonality’s trade and information embargoes, constantly suspected by SCI Force of harbouring spies, criminals, and worse. While the Commonality would like to control all inter-world trade, the pell-mell of the Expansionary Era makes this impossible. New Traders are heroes throughout the Fringe, and social pariahs in the Core.

unknown on Old Earth for millennia: the Commonality of Old Earth had no need of money or interstellar trade. Some corporacies were created from pre-Expansion corporations; others from extinct megacorporations from Old Earth history. As sources of troublesome memes they have a complex relationship with the Commonality and the New Traders, operating in a strange, extra-legal space; many people still believe entrepreneurial activity to be “primitive” and socially dangerous. Corporacies and their attendant instabilities are one way the Commonality is a victim of the Expansion as much as its beneficiary.

Corporacies are **Starblazer** organizations, usually Scale 7 or 8. They’re also often vectors for Casual Contact and Technological Exchange meme attacks (see **Chapter Six: Worlds and Cultures**).

### Sample Corporacy: Chembu Genurgy

Chembu Genurgy corporacy was formed when the Chembu took their genurgy business offworld. It’s a little over a century old, clearly divided into Chembu and non-Chembu; the Chembu form all the corporacy’s upper management.

Chembu Genurgy is efficient, affordable, and extremely secretive. Rumours abound that its CEO is the Planetary Intelligence itself, and that it has a nefarious, inhuman agenda. However, while a ruthless competitor, the corporacy openly advocates Commonality policy and puts enormous resources into Commonality coffers. It’s also one of the foremost corporate world developers; almost every octant of Commonality Space has a Chembu corporate world.

Chembu has offices on most Commonality Worlds. Even beyond, the infamous Chembu bioships - semi-organic faster-than-light vessels - travel the Fringe Worlds offering their services to whoever can afford them.

## Chembu Genurgy Corporacy

### Organization Sheet

<b>Scale:</b>	Colossal (7)	<b>Consequences</b>	<b>Physical Stress</b>
<b>Scope:</b>	Commonality (9)	Minor:	□□□□□
<b>Fate Points:</b>	3	Major:	<b>Composure Stress</b>
<b>Refresh:</b>	3	Severe:	□□□□□
		Extreme:	

Skills		Holdings
Great (+4)	Weird Technology (Genurgy)	Chembu Homeworld (Fortified, Ancient, Unusual, Big)
Good (+3)	Influence (Commonality)	
Fair (+2)	Secrecy	
	Unity	
	Communication	
Average (+1)	Security	
	Technology	Control (Chembu Homeworld)

### Aspects

We can change you to suit your needs
Commonality leaders in Genurgic Enhancement
We are Chembu - Chembu is One
Backed by the Planetary Intelligence
Unfathomable Agendas
We have branches everywhere
Commerce is life!

### Other Corporacies

The following is a listing of some of the largest corporacies in the Commonality.

Corporacy	Area(s) of Endeavour	Sample Aspect
Chembu Genurgy	Biotech and genetic enhancements	Backed by the Planetary Intelligence
Combatechnologies, Inc	Combat armour, combat drones	
Darradine Industries	Technopsi devices, Mindscape implants	We bear the Commonality in mind.
Gant Shipyards	Planeship construction and repair	
HAL AG Industries	Gravtech, suspensor fields	Old Earth corporation with friends in high places.
Hydrodyne Technologies	Transport and vehicles	We'll get you there!
Jawayayn Industries	Gravtech, Sky Cities, luxury space hotels and cruisers, Zero-G Habitats	Low-gravity Hominids
Kessel Yards	Shipyards, ship hulls	
Magnatech, Inc	Kino weapons	
Mai Ling Military Optics	Combat drones, sensor arrays, sensor drones, sentient weapons	
Morbius Metals	Raw materials, metals	Digging mines everywhere.
Murasaki Corporation	Combat walkers, remote lifters	
Neverine Pharmaceuticals	Biomed	
Pleskov & Sons Armaments (PASARM)	Heavy weapons	We sell BIG guns!
TKX (Trondheim-Kawasaki Xenofarms)	Synthetics, genurgic enhancements	Better than the best!
Tyce Systems	Null weapons, blasters	Weapons to last you a lifetime.
Universal Products	Multiple areas	We make everything, everywhere.



# The Empire of Venu

The exact nature of Venu government is a mystery, but is believed to be a harsh, oppressive theocracy headed by a hereditary "God Emperor".

Venu Government		
<b>Organization Sheet</b>		
<b>Scale:</b>	Venu Space (9)	<b>Consequences</b>
<b>Scope:</b>	Venu Space (9)	Minor:
<b>Fate Points:</b>	1	Major:
<b>Refresh:</b>	1	Severe:
		Extreme:
		<b>Physical Stress</b>
		□□□□□□□□
		<b>Composure Stress</b>
		□□□□□□□□□□
<b>Skills</b>		
		<b>Holdings</b>
Superb (+5)	Control (Venu Space)	None
Great (+4)	Influence (Q-Zone)	Arms
Good (+3)	Security	Unity
	Secrecy	Sway (Darradine Restoration)
Fair (+2)	Technology	Assassination
	Sway (Successor States)	
Average (+1)	Trade	Administration
	Communication	Experimental Technology
	Influence (Commonality Space)	
<b>Aspects</b>		
Xenophobic		
Theocratic Dictatorship		
Venu Rules All		
The Commonality Must be Destroyed!		
Only the Strong are fit to rule		
Negotiation is Weakness		
Chaotic hierarchy based on intimidation		
Arbitrary		
We do not ask questions but carry out orders		

## Venu Technology

The Venu Empire captured planing technology over a century ago, and immediately set about conquering its neighbours. They expanded rapidly, first recapturing the colony worlds with which they'd lost contact, then moving out on a mission of conquest. By the Venu War the Venu had fusion power; by the Stop-Start War they had hybrid zero-point technology; now they're using the infamous, polluting "Dirt Drive", and expanding, conquering, and colonising at a frightening rate.

Venu tech level averages Great (+4): First Age of Space, notwithstanding their imperfect "Dirt Drive". In starship combat this drive is dangerously unstable and sometimes explodes; Commonality Torsion Field Projectors are

specifically designed to exploit this weakness. The Venu have no advanced technologies like the Mindscape, synthetics, or extreme longevity, although they do have rudimentary AI, and things we would recognize as "computers," which the Commonality regards as extremely primitive. Their technology is bulkier and less sophisticated than the Commonality. While they don't use space combat drones, they do use attack droids in ground combat.

Venu security isn't as good as the Commonality, nor is the Empire physically as large or able to command the same resources. However, they're much more violent, and have been on a war footing since before Commonality contact; their aggression has Commonality on the defensive. What they lack in sophistication they make up for in fanaticism and disregard for their own safety.

# Chapter Six: Worlds and Cultures

*"On Old Earth news, like religion, had been illegal for millennia. But here, out on the Fringe, it was life itself.*

*Worlds which had been isolated for thousands of years suddenly clamoured for information, and if the Commonality fought shy of giving people what they wanted because they might not be able to handle "the Truth", well, hey, that was what we were for.*

*We're the Embargo Runners. Some people call us criminals; some people say we're pirates. I say we're the lifeblood of the Commonality, keeping everything moving, keeping everything alive. Even if sometimes it hurts..."*

*- Jabe Macarthur, at his trial for Uncontrolled Information Dissemination, Shinchikyu, 193 NCE*

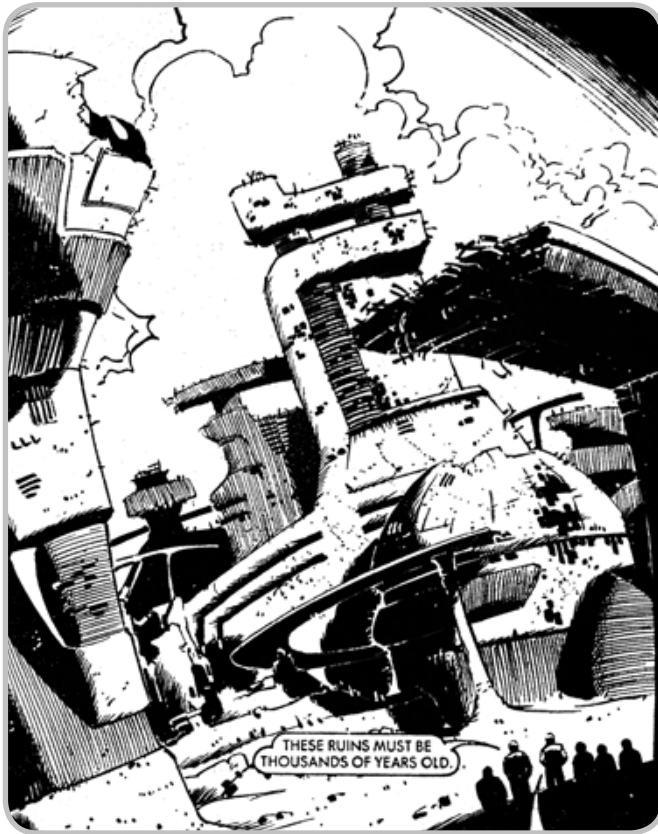

## Worlds

**Mindjammer** worlds use the **Starblazer** planet generation rules, with a few additional details. Create a world normally, and then select tech level, planet and government type, spaceport facilities, and any Commonality embargo using the guidelines below.

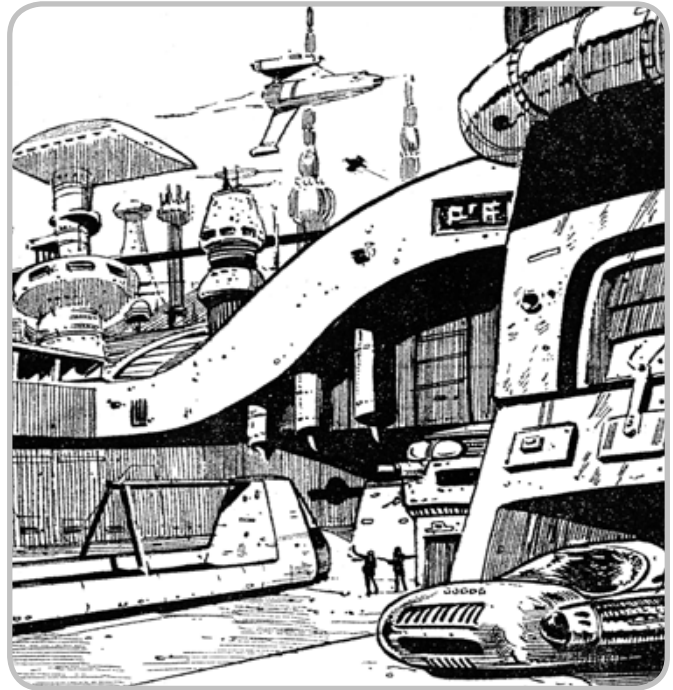

## Technological Development

Most **Mindjammer** technology is "Commonality standard," or that of its major foe, the Empire of Venu. Many other technologies exist, however; the galaxy is vast, and not all cultures solve the same problems the same way. The Commonality uses anti-grav suspensors as its standard transport technology; on the Fringe or Outer Worlds, you can find jetpacks, ornithopters, micro-dirigibles, or any one of a number of alternatives.

**Mindjammer** uses the **Starblazer** Tech Level to indicate what a world is capable of producing, suggesting the technology easily obtained on a planet. Higher tech items are usually available in spaceports and specialist outlets; Resources rolls are +1 difficulty for each Tech Level difference.

*For example, on a Great (+4) Tech Level world spares for a Planing Engine (Fantastic (+6) Tech Level) are available on a Resources roll 2 levels more difficult than normal.*

The table below, and other gear and weapons tables in this book, indicate the Tech Level at which item production becomes possible.

## Why is Tech Level important?

Within the Commonality, for the most part, it isn't. Ignore it. Most items can be bought easily enough, even if

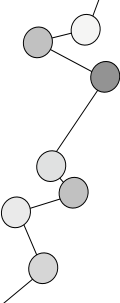

manufactured offworld at higher technology centres - it's just a question of waiting for delivery. On Fringe and Outer Worlds, however, Tech Level is more important; if you're forced to search for an item or repair something on a low-tech world, you'll have problems: the local technology won't be able to manufacture the item, or provide the raw components to make one yourself, and on isolated worlds there won't even be anywhere to order it from.

A planet's Tech Level isn't the same thing as an Organization's Technology Skill. The latter indicates how technologically sophisticated an Organization is, how much it uses technology in its everyday operations. It's possible to have an organization which uses relatively little technology on a high-tech world.

**Using Tech Level in play**  
 There are various ways to use Tech Level in play. **Starblazer Adventures** uses an item's cost as its manufacturing difficulty; you can use Tech level instead. You can restrict a workspace's quality (**Starblazer** page 132-3) by the Tech Level of the planet where it's located, and require Resources rolls to get a better one. Finally, you can limit a character's Science, Engineering, or Starship Engineering Skill by a planet's Tech Level: a character with Good (+3) Science on a Good (+3) Tech Level world would have to travel to a higher tech world to improve his Skill further. Be careful, though: it's fine to restrict Extras like this, but it can be frustrating for PCs!

**Tech Level Classification**

Tech Level	Tech Level Name	Comments
Abysmal (-3)	Post-animal	
Terrible (-2)	Stone Age	Palaeolithic to Neolithic and invention of agriculture.
Poor (-1)	Metal Age	Bronze and Iron Ages
Mediocre (0)	Age of Enlightenment	Renaissance, exploration, enlightenment
Average (+1)	Industrial Age	Steam, Electricity, Nuclear Power
Fair (+2)	Computer Age	Early space travel
Good (+3)	Age of Genurgy	Early genurgy
Great (+4)	First Age of Space	Artificial Gravity
Superb (+5)	Age of Ubiquitous Intelligence	Anti-aging techniques, synthetics
Fantastic (+6)	Second Age of Space	Planing, Commonality Standard, ZIP Plants
Epic (+7)	Age of 3-Space	Gating, Commonality Maximum
Legendary (+8)	Interdimensional Age (Theoretical Higher Levels)	

**The Commonality Embargo**

There's a Commonality embargo on non-Commonality worlds to prevent the transport of advanced technologies to worlds the Commonality doesn't think should have them. There are three Qualities of Embargo:

- Good (+3) - Quarantined: world closed.
  - Fair (+2) - High Level: Outer Worlds, Venu, Isolated Fringe Worlds.
  - Average (+1) - Medium Level: Most Fringe Worlds.
  - Open - no Embargo: within the Commonality and between Commonality Member Worlds.
- You run foul of the Embargo whenever you try to carry technology (for any reason) to an Embargoed planet which is higher than its current tech level.

**Skills:** Intimidate, Manoeuvre, Investigation, Alertness, Resolve

<b>Physical Stress:</b>	<input type="checkbox"/> <input type="checkbox"/> <input type="checkbox"/> <input type="checkbox"/> <input type="checkbox"/>
<b>Secrets Stress:</b>	<input type="checkbox"/> <input type="checkbox"/> <input type="checkbox"/> <input type="checkbox"/> <input type="checkbox"/>
<b>Consequences:</b>	Equal to Quality

Notes: Play out interactions with the Commonality Embargo in as much detail as you want. Try running the Embargo or sneaking through; this is an attack using Manoeuvre or Stealth against the Embargo's Physical stress. Or try smuggling, or even bribing customs agents; an attack using Deceit or Leadership (for administration, bureaucracy, bribery) against the Embargo's Secrets stress. A Taken Out result means you've been captured and are facing arrest and impoundment of your ship and cargo; Embargo Runners usually concede well before that.

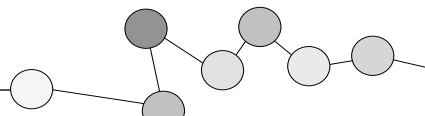
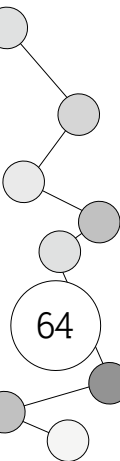



## Planet Types

**Mindjammer** worlds have a **Planet Type**, indicating their relationship to the Commonality. Select one during planet generation; depending on location, some Planet Types are more appropriate than others.

**Commonality Aligned World:** usually on the Fringe and possessing a Temple of Universal Mind.

**Commonality Autonomous World:** a Commonality member, but very individual and usually isolationist. Often has a Commonality Embassy and travel restrictions beyond the spaceport compound. May have a Global Mindscape Instance.

**Commonality Culture World:** a full Commonality member, but with a strong culture, sometimes derived from a historical Old Earth culture.

**Commonality Member World:** a cosmopolitan world where the standard Commonality culture holds sway.

**Commonality Outpost:** usually unpopulated apart from a base or space station.

**Commonality Quarantine World:** usually on the Fringe, the planet is quarantined by Space Force and visitors are forbidden. Quarantine happens for many reasons; the world may be dangerous for visitors, or need protection from them.

**Independent World (no Embassy):** usually a Fringe or Outer World, the world may have little or no Commonality contact.

**Independent World (w. Embassy):** usually a contacted world on the Fringe where Commonality presence is still light.



## Population Levels

For 200 years the Expansion has been contacting lost human or hominid colony worlds, colonizing new ones, and discovering alien civilizations. Once initial contact teams have left, settlers, researchers, and traders arrive, in a seemingly endless stream: there's no shortage of migrants from the Core, heavily-populated even before the Second Age of Space, and even once-lost colonies may have Commonality populations in the millions.

This means there are high-population worlds throughout Commonality Space, even on the Fringe. The Expansionary Era is an age of huge migrations, spacelanes everywhere packed with Settler Ships, Homesteaders, and Mass Transports, filled with people seeking better lives and adventure.

## Government Types

The following government types expand on those in **Starblazer**: select one during planet generation.

**Commonality Controlled (Oligarchy):** the standard Commonality government, run by Pansectorate and Instrumentality representatives. Checks and measures aim to prevent corruption, but don't always work, and graft and nepotism are endemic on some worlds.

**Corporate Control:** corporate worlds are owned and run by a single corporacy (although joint ventures are possible). They're Commonality members, although access may be restricted by corporacy policy.

**Dictatorship:** often found on Fringe Worlds in Stage One or Stage Two Cultural Integration; the world is governed by a single political group, often a single person or the armed forces. Dictatorships are usually oppressive, and unstable in the long-term.

**Feudal:** feudal governments tend to be features of lower tech, non-Commonality worlds, though also of Corporate or even Commonality Oligarchy Worlds under special conditions. They're characterized by full or part slave ownership, populations "owned" by governments either directly or through economic dependency and indenture. Worlds where xenomorph populations are governed by Commonality governments are often feudal.

**Monarchy:** monarchies are found most often on Fringe or Outer Worlds, a form of "compromised dictatorship" where population groups have their interests represented to varying degrees by complex webs of tradition. Monarchies can be very stable.

**Representative Democracy:** democracy is illegal in the Core Worlds, but on the Fringe it's a serviceable middle-ground on low to medium population worlds without strong Commonality presence.

## Spaceport Facilities



Spaceports are ground-based or orbital facilities statted using the **Starblazer** starship rules. In planet generation treat Spaceport Facilities as a Planetary Skill from Abysmal (-3) to Legendary (+8): select one for each world.

Spaceport Tech Level is generally higher than Planetary Tech Level; add the Spaceport Class modifier to the Planetary Tech Level (so, +2 for a Fair (+2) Spaceport Class), to a maximum of Fantastic (+6) for non-Core worlds (Second Age of Space) and Epic (+7) (Age of 3-Space) for worlds in the Commonality Core.

### Descriptions of Spaceport Facilities

**Ground Facility:** passenger and cargo transport, and ground facilities containing the planet's principal Commonality representation, including any Global Mindscape Instance or (on Fringe Worlds) Temple of Universal Mind, although this is usually moved from the spaceport's Commonality Extralegal Zone to the capital as soon as possible.

**Orbital Facility:** a Commonality Extralegal Zone (subject to Commonality rather than local law) containing docking bays for ships without atmospheric entry capability and regular shuttles to the planetary surface if appropriate.

**Starbase:** a military spaceport, usually run by Space Force or occasionally SCI Force, generally out-of-bounds to civilians (although some starbases have civilian sections).

### Spaceport Facilities

Spaceport Class	Facilities Present
Abysmal (-3)	No facilities whatsoever
Terrible (-2)	Area of cleared ground
Poor (-1)	Landing strip
Mediocre (0)	Huge (Scale-5) Ground Facility
Average (+1)	Enormous (Scale-6) Ground Facility
Fair (+2)	Colossal (Scale-7) Ground Facility
Good (+3)	Colossal (Scale-7) Ground Facility plus Huge (Scale-5) Orbital Facility (Space Station)
Great (+4)	Colossal (Scale-7) Ground Facility plus Enormous (Scale-6) Orbital Facility (Space Station plus Dry Dock)
Superb (+5)	Colossal (Scale-7) Ground Facility plus Colossal (Scale-7) Orbital Facility (Space Station plus Starship Construction Yards)
Fantastic (+6)	As above plus Huge (Scale-5) Starbase
Epic (+7)	As above plus Enormous (Scale-6) Starbase
Legendary (+8)	As above plus Colossal (Scale-7) Starbase



**Mindjammer Waystations:** minor repair facilities no larger than Scale-5 usually found every 10 worlds, often attached to an existing orbital facility.

**Mindjammer Depots:** major repair yards no larger than Scale-6 found every 100 worlds or more (one per subsector), generally an independent orbital or space facility.

**Other Facilities:** includes Explorer Waystations on the Fringe, Corporate or Commonality research stations.

## How Ubiquitous is Faster-than-Light Travel?

Although the Commonality is the main provider of planeships, during the earlier days of the Expansionary Era it provided planing technology to other cultures fairly freely - at least until the Venu attacked. Many polities possess planing technology in addition to the Venu, including Outremer, the Successor States, and the Sentient Alliance; some have travelled to the edges of Human Space and beyond - well out of the Commonality's reach.

The Commonality may not always be the main source of planing technology. The galaxy is a big place, and there are spacefaring alien civilizations out there - witness the Lowhigh. Although they didn't have planing technology when contacted, other alien races may well have. What, for example, is behind the rumours of the so-called "Pulse Dragons" dwelling in interstellar space - extremely fast-moving, high-energy beings or devices which have been utterly inimical when encountered? No one knows if these are a new alien race or an ancient alien technology - or some other phenomenon entirely - but the Commonality remains watchful for the day an alien species with its own faster-than-light technology comes calling...

## Cultures

The Expansionary Era is a time of cultural upheaval. Thousands of worlds have been suddenly thrust upon one another, and the Commonality is sweeping through them, trying to assimilate, integrate, control. Cultures clash, form alliances, resist, rebel; unscrupulous New Traders run embargoes to sell technology to the highest bidders. The result is chaos.

Cultural conflict is one of the main themes of *Mindjammer* - what happens when cultures separated by millennia suddenly collide. These rules allow you to describe cultures and their conflicts in detail, and most importantly show how player characters can get involved, whether smuggling new ideas and technologies, engaging in diplomacy, or policing the frontier. The galaxy is changing - and capable heroes can remould entire worlds to their designs!

## Cultures and Polities

*Mindjammer* cultures are a modified form of *Starblazer* organization. They differ from governments and other



### Scenario hook: Cover Up

Ships have been going missing in 2-Space. The PCs, part of Space Force, SCI Force, or the ISI, are sent to investigate. There's a huge cover-up underway, and evidence of widespread conspiracy - it looks like this has happened before. But what's been covered up? And why?





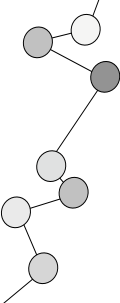

"polities"; although it's normal to find both cultures and polities coexisting on a planet or in an interstellar community. Often a polity created by a world's ruler, conqueror, or government attempts to rule a culture created by its population.

Create a culture more or less as you would an organization. Start by deciding on its Scale and Scope, and then select Skills, Stunts, and Aspects, and calculate Stress tracks, according to the guidelines below. Cultural Aspects differ from organization and **planetary Aspects**: a planet might have the Aspect "Global Warming", indicating that it's affected by global warming; a culture with that Aspect means it's preoccupied by the threat and concept of Global Warming, whether the phenomenon is happening or not.

### The Culture Sheet

Cultures are written up on a Culture Sheet, an example of which is shown below.

### What is a Culture?

Broadly speaking, a culture is "how people live". It's a society's customs and values, the things it considers good, bad, worthwhile. In Earth history, culture is the cause of war and conflict - when the people "over there" do things or believe things which we think are "wrong", then we try and persuade them of the error of their ways - often violently. Cultural conflict has been the driving force behind much if not all of known history - and in the Expansionary Era, that engine is in overdrive!

In *Mindjammer*, cultures can "fight" one another, a process known as Meme Attack. Cultures can be destroyed, but more likely they'll take consequences and their cultural Aspects be modified or replaced. Cultural conflict can change a culture completely: this is what the Commonality is trying to avoid - or at least control - as it contacts lost colony worlds.

Sample Culture		Culture Sheet
<b>Scale:</b>	<b>Consequences</b>	<b>Strength Stress</b>
<b>Scope:</b>	Minor:	□□□□
<b>Fate Points:</b>	Major:	<b>Stability Stress</b>
<b>Refresh:</b>	Severe:	□□□□
	Extreme:	
<b>Skills</b>		<b>Stunts</b>
Superb (+5)		
Great (+4)		
Good (+3)		
Fair (+2)		
Average (+1)		
<b>Aspects</b>		
<b>Cultural Conflicts</b>		

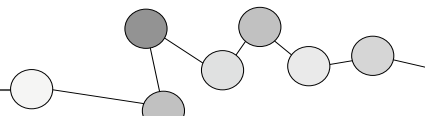
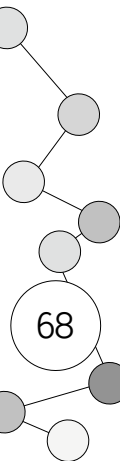

## Scale and Scope

Cultures use the “Cultural Scale and Skill Points” table below. Cultures are usually Colossal (7), but may also be Interplanetary (8), Star Empire (9), or Enormous (6); or, rarely, from Large (4) for small-scale tribal cultures to Huge (5). Cultures have a number of Skill points as shown on the table.

Cultural Scale and Skill Points		
Scale	Skill Points	Description
Large (4)	5	Small-scale tribal or national culture
Huge (5)	15	Continent-sized culture
Enormous (6)	25	Planet-sized culture
Colossal (7)	35	Culture covering several planets up to subsector-sized
Interplanetary (8)	45	Up to sector-sized culture; medium space culture (Sentient Alliance, Successor States)
Star Empire (9)	55	Large-scale space culture (Commonality and Venu Empire)
Galactic (10)	65	Hypothetical galactic culture (none as yet known)

Cultures also have **Scope**, indicating their sphere of influence. Cultures like the Chembu have Scope vastly exceeding their Scale, being the principle providers of genurgic enhancements in the Commonality. Scope is defined on the table below: numbers used match those used for Scale, rather than the number of zones under the culture’s influence. In **Mindjammer** this table is also used for organization Scope;

this is a change to the **Starblazer** rules (see **Starblazer** page 282); see “Scope of Attacks” below for more.

## Culture / Organization Scope

Scope	Extent of Cultural Influence
National (4)	Nation-sized region only.
Continental (5)	Single continent only.
Planet (6)	Single world only.
Subsector (7)	Up to subsector level.
Sector (8)	Up to entire sector.
Commonality Space (9)	Throughout the whole Commonality.
Human Space (10)	Throughout Human Space.

## Cultural Stress

A culture has Stability and Strength stress tracks equal to its Scale. This is one of the reasons why sub-cultures are more vulnerable to Meme Attack (see below), and why the Commonality works to prevent them from breaking off from the mainstream.

Cultures can take a total of three consequences before being Taken Out. Stability consequences include: Loss of Integrity, Xenophobic, Discontented; Strength consequences include: Loss of Sense of Self, Uncertain, Insecure. See “How Cultures Come into Conflict” below for handling damage.

## Cultural Aspects (Memes)

Cultures have “memes”, ideologies or beliefs which colour and define that culture. These are represented by **cultural Aspects**: a culture has a number of cultural Aspects equal to its Scale.

New Aspects can be introduced into a culture. This can be a consequence of cultural contact, invasion, propaganda attack, immigration, or even smuggling of forbidden technologies and ideas (such as smuggling planing engines into a quarantined pre-FTL culture).

### Cultural Aspects (Memes)

Here are some cultural Aspects to get you started:

Abomination Against Nature  
Centre of the Universe  
Communism  
Cult of Celebrity  
Curious  
Democracy  
Every Man for Himself  
Fear of Terrorism  
Fire of Independence

Frankenstein Foods  
Global Warming  
Human Beings are Nothing Special  
Just One World Among Millions  
Live and Let Live  
Machines Will Take Over the World!  
Materialism  
Militarism  
Mutability of Body Form  
Pacifism  
Patriotism  
Personal Insignificance

Pinnacle of Creation  
Power of the Mind  
Religion  
Science  
Survival of the Fittest  
They’re Stealing Your Thoughts!  
Uniqueness of the Human Form  
White Man’s Burden  
Word of God  
Xenophobic

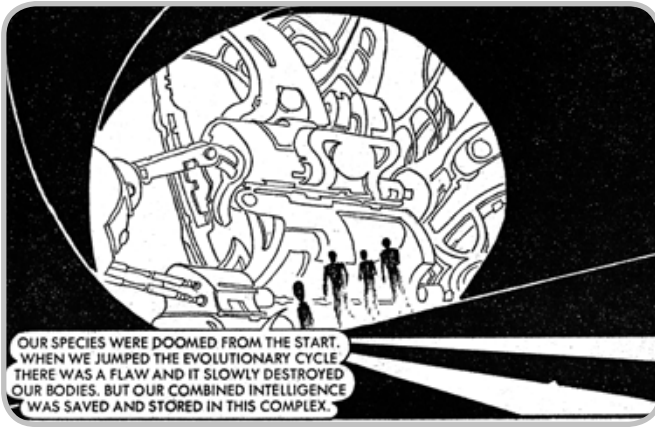

## Cultural Skills

Cultural Skills represent things a culture can “do”, whether technological capability or the ability to resist or attack other cultures. Cultural Skills are not bound by the Skill Pyramid rules. See the “Cultural Scale and Skill Points” table above for the Skill points a culture receives.

Skill levels default to Mediocre (+0). A culture can increase its Skill points by taking Skills at levels below Mediocre; taking a Skill at Poor (-1) gains +1 Skill Point, Terrible (-2) gains +2, and Abysmal (-3) gains +3. Small-scale tribal cultures may take all Capability Skills at Terrible (-2) for an additional +16 Skill points (a total of 21), enabling them to have significant Assertion, Assimilation, Infiltration, or Propaganda Skills.

## Skills

There are a fixed number of cultural Skills.

**Assertion:** a culture’s ability to assert itself and fend off incursions, or to impose itself on another culture without using the Propaganda Skill (such as after an invasion). Assertion is the default Skill to attack or defend against Meme Attacks. Using Assertion to defend against a Meme Attack triggered by a Capability Band doesn’t allow the defending culture to utilize the technologies enabled by that Capability Band openly. Assertion attacks affect the Strength stress track.

**Assimilate:** a culture’s ability to integrate new ideas, used to attack or defend against Meme Attacks resulting from casual contact between cultures, or where the defending culture wishes to accept the Meme Attack’s Aspects or an associated Capability. Using Assimilate against Meme Attacks transported by new Capability Bands allows the defending culture to utilize the technologies enabled by that Capability Band.

**[Capability] (Band):** Cultures have technological capabilities - their “cultural know-how” - the more advanced of which (such as faster-than-light travel) are jealously guarded. The Commonality maintains embargoes to prevent its Capabilities from falling into the wrong hands. Capability Skills comprise: Armaments; Biological; Comms; Information; Power; Psi; Resource Exploitation; and Transport. Each varies

depending on the tech level it’s deployed at, indicated by its Skill level; Stone Age Comms involves the spoken word, for example, while in the Second Age of Space it’s the Mindscape. These **Capability Bands** generally span more than one tech level: Comms (Spoken) spans the Post-animal and Stone Age tech levels. A Capability Band at its lowest tech level is rudimentary; as it increases, it becomes more established and widely available.

Each time a culture advances a Capability Band (Information (Computers) to Information (Synthetics), for example), it faces a Meme Attack introducing cultural Aspects associated with the new Capability Band. This applies whether the Capability Band comes from outside or from a culture’s own research efforts. Within a Band, a Skill level increase entails a rise in tech level capacity. A culture doesn’t have a tech level per se: each of its Capabilities do. A planet’s tech level indicates its ability to exploit the Capabilities of the prevailing culture.

Movement from an old Band to a new without recourse to subterfuge requires not just R&D, but a **Breakthrough** (see below). This takes time and resources; espionage or smuggling are much quicker.

A culture must have a Capability Skill for its members to learn related personal Skills. So, members of a culture without the Comms (Mindscape) Skill cannot learn the Technopsi Skill; cultures without Transport (FTL) produce no 2-Pilots.

Cultures can modify their Capabilities by expending Skill points (gained by activities such as cultural expansion), or by reorganizing their Skill pyramid. If a culture is trying for a Capability Skill which it doesn’t have free access to (such as a Fringe World culture trying for a Capability embargoed by the Commonality), the Capability must somehow be smuggled in or otherwise acquired. New Capability Skills introduce new cultural Aspects and Meme Attacks.

**Infiltration** - Cultures use subterfuge to conduct Meme Attacks on other cultures; activities like technology smuggling cause Meme Attacks which attack stealthily. Infiltration attacks affect the Stability stress track.

**Propaganda** - strong cultures impose themselves on weaker ones using the Propaganda Skill. Propaganda is the default for deliberate cultural attacks, open war, or propaganda campaigns. Propaganda attacks affect the Stability stress track.

## Cultural Stunts

A culture has Stunts equal to half its Scale, rounded down.

### ✧ All or Nothing

Used in deliberate cultural attacks (see below); allows the attacking culture to take consequences on behalf of its Meme Attacks; it throws its whole weight behind the attack, putting its reputation on the line. It can keep the meme



## CAPABILITIES - CULTURAL KNOW-HOW

Capability Skill		Equivalent Tech Level	Armaments	Transport	Biological	Information	Power	Resource Exploitation	Psi*	Comms
Skill Level										
<b>Abysmal</b>	Post-animal	Tools	Non-powered	Herbal	Memory	Physical	Hunter-Gatherer			Spoken
<b>Terrible</b>	Stone Age	Clubs and bows	Non-powered	Herbal	Memory	Physical	Agriculture			Spoken
<b>Poor</b>	Metal Age	Blades	Non-powered	Surgical	Libraries	Physical	Agriculture			Written
<b>Mediocre</b>	Age of Enlightenment	Black powder	Powered	Surgical	Libraries	Mechanical	Agriculture			Written
<b>Average</b>	Industrial Age	Gunpowder	Powered	Surgical	Libraries	Mechanical	Industry			Written
<b>Fair</b>	Computer Age	Nuclear	Powered	Medical	Computers	Electricity	Industry			Radio
<b>Good</b>	Age of Biotech	Laser	Space Travel	Biotech	Computers	Broadcast	Industry			Radio
<b>Great</b>	First Age of Space	Blaster	Space Travel	Genurgy	Computers	Broadcast	Automated			Radio
<b>Superb</b>	Age of Ubiquitous Intelligence	Disruptor	Space Travel	Genurgy	Synthetics	ZIP	Automated			Mindscape
<b>Fantastic</b>	Second Age of Space	Torsion	FTL	Genurgy	Synthetics	ZIP	Makepoint			Mindscape
<b>Epic</b>	Age of 3-Space	Disintegrator	FTL	FTL	ZIP	ZIP	Makepoint			Psionics
<b>Legendary</b>	Interdimensional Age		FTL							Psionics

\*Psi refers to human cultures, where Psi Power requires advanced genurgy. For non-human cultures with active psi powers, this Capability becomes active at lower tech levels (or may be unrestricted by tech level).

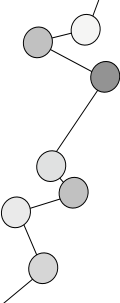

attack going where it would otherwise get destroyed, but suffers as a result.

### ✧ **Cultural Assault**

For a Fate point, the culture makes a Meme Attack on an adjacent zone equal in size to its Scope. So, a Scope-7 culture (subsector) could attack a neighbouring subsector.

### ✧ **Cultural Revolution**

Allows a culture to launch Meme Attacks on itself.

### ✧ **Culture Worlds**

*Requires Traditionalist*

Allows the culture to bring to bear a group of Minions (culture worlds) which may be attached or used separately in a cultural conflict. This stunt may be taken multiple times, increasing the quantity or quality of the Minions.

### ✧ **Hunter-Killer Eidolons**

Gives a +1 attack bonus against incoming Meme Attacks. For a Fate point, a successful attack on a Meme Attack with this Stunt negates one of the Meme Attack's cultural Aspects.

### ✧ **Memetic Cascade**

*Requires Memetic Virus and Shock and Awe*

Allows the culture to target parts of a larger culture with a single Meme Attack, even if they aren't under physical attack. So, a culture could launch a Meme Attack on a single planet, even if that planet was part of a larger culture.

### ✧ **Memetic Torpedo**

*Requires Memetic Virus*

A Memetic Torpedo is an EW package which can be delivered to a target (usually a planet), containing vectors and viruses capable of initiating multiple Meme Attacks simultaneously. Each Meme Attack transports the same cultural Aspects, but must use a different Skill. The Stunt costs 1 Fate point to use.

### ✧ **Memetic Virus**

*Requires Cultural Assault*

Allows a culture to make an Infiltration attack against any culture, regardless of Scale and Scope. The Memetic Virus attempts to spread as widely as it can before attacking. Each exchange, make an Infiltration manoeuvre, resisted by the target culture's Assertion; each shift represents a zone of Scope reached by the Meme Attack that exchange (placing a temporary Aspect on each zone as it goes). Once full Scope is reached the Memetic Virus makes its Meme Attack. If an Infiltration roll fails, the Virus attack is negated. The Stunt costs 1 Fate point to use.

### ✧ **Propaganda Campaign**

Allows Meme Attacks to affect larger or smaller cultures (up to 3 steps smaller or larger rather than 2). It uses the Propaganda Skill.

### ✧ **Q-Ships**

Allows a +2 full defence against Meme Attacks.

### ✧ **Shock and Awe**

*Requires Memetic Virus*

Allows a Meme Attack to be made on part of a culture only, such as a planet, as long as that part is under physical attack by an organization belonging to the attacking culture. See "Scope of Attacks" below for more.

### ✧ **Suicide Synthetics**

Gives a +1 bonus to Infiltration attacks using disposable hidden synthetics.

### ✧ **Traditionalist**

Allows cultures to take 1 less Stress damage per attack.

## **How to do things with Cultures**

### **How Cultures Come into Conflict**

Cultures attack one another using **Meme Attacks**; attacks can happen in several ways.

**Casual Contact:** occurs whenever there's regular, non-aggressive contact between cultures, often unintentionally. These Meme Attacks use Assertion or sometimes Infiltration. Two cultures with incompatible Aspects attack one another in separate Meme Attacks. A culture not wishing to attack uses its own Propaganda to complement the target culture's defences.

**Technological Exchange:** this usually means technology smuggling. Meme Attacks use the Infiltration Skill, defended against with Assertion. See "Cultural Change via Introduced Technology" below for cultural Aspects introduced by these Meme Attacks.

**Deliberate Cultural Attacks:** occur during war or other hostilities using Propaganda defended against with Propaganda or Assertion. They're not always inimical; the Commonality frequently tries to modify cultures, often supported by the culture's government, in which case add the target culture's Propaganda Skill to the Stress damage if the Meme Attack succeeds.

*Example: The Commonality is trying to introduce the Aspect "Mutability of Body Form" to the Amidan culture. This conflicts with the "Robots Will Take Over the World" Aspect, as SCI Force predicted, causing a Meme Attack of the Commonality's Good (+3) Propaganda against*

*Amida's Good (+3) Assimilate. The Amidan government actually supports the Commonality Meme Attack with its own Average (+1) Propaganda: this adds +1 Stress to the Commonality's attack if successful.*

### Scope of Attacks

A culture can attack cultures within 2 steps of its Scale. Stunts modify this: cultures exist with memes so violent they've affected the entire Commonality, explaining its extreme caution (some would say paranoia) with new cultures.

Further, a culture can only attack cultures whose Scale falls within its own Scope (ie its own area of influence). A Scope-7 culture (local subsector) can attack cultures of Scale 7 or less as long as they're in the same subsector and within 2 steps of its own Scale; a Scope-1 culture can attack cultures on the same planet, as long as its Scale is within 2 steps of the target.

However, if you isolate part of a culture - such as by invading and occupying a planet - you can target that part as if it had a lower Scale **and** Scope using the Shock and Awe Stunt. The targeted part is treated as having Stress equal to the reduced Scale, making it easier to affect.

*Example: The Edessene League, a Scale-7 multi-world culture with Scope 7 (local subsector), cannot carry out Meme Attacks against even a local Commonality planet, as its Commonality culture (Scale 9) isn't encompassed by the League's Scope 7. However, if the Edessene League attacked, occupied, and isolated the planet, its Scale would be treated as 6 (Planet-sized culture) for stress and targeting, putting it within the League's Scope-7 reach. It could then use its Shock and Awe Stunt to launch Meme Attacks against the planet's culture, temporarily Scale and Scope 6, with only 6 Stability and Strength stress rather than 9.*

For the same reasons sub-cultures like the Successor States and Sentient Alliance are more vulnerable to Meme Attacks than the Commonality culture from which they've recently broken away. This is why the Commonality is keen to stop sub-cultures splitting off - the principal mission of SCI Force.

### How to make Meme Attacks

A **Meme Attack** is how one culture attacks another. It's treated like a **Starblazer** trap (see **Starblazer** page 540), with Skills, Aspects, stress tracks, and attacks with a cultural Skill. See "How Cultures Come Into Conflict" on page 72 above for which Skills are used to attack and defend. The Skill level is that of the culture.

A Meme Attack has a Scope equal to the Scale of the target Culture; its Strength stress track is equal to its Scope. Meme Attacks can't usually take consequences. The following example shows a massive Memetic Virus Meme Attack made by the Empire of Venu against the Commonality.

Memetic Virus	Meme Attack
<b>Scope:</b> 9	
<b>Skills:</b> Great (+4) Assertion, Good (+3) Infiltration	
<b>Aspects:</b> Hail the Radiant Darkness!	
<b>Strength Stress:</b> □□□□□□□□ (0 Consequences)	
<b>Notes:</b> Attacks a culture, in this case using Infiltration, and defends using Assertion. The culture defends using Propaganda, Assimilate, or Assertion, and attacks back using the same. Cultures fight one another by each sending Meme Attacks against the other culture.	

### How to make a Meme Attack

A culture makes a Meme Attack as a casual contact, technological exchange, or deliberate cultural attack, as described above. The attack introduces one or more cultural Aspects to the target culture, which can attack the Meme Attack back using either Assertion or Assimilate, or Propaganda in certain cases. Run as a conflict over multiple exchanges, each taking roughly a year, although Story Tellers should as usual be flexible with time periods based on circumstances. Cultural conflict can take a long time!

The exchange proceeds as follows:

1. Any culture which is the target of a Meme Attack takes 1 point of Stability stress damage at the start of the conflict. This can't be healed until all Meme Attacks affecting it are over.
2. The Meme Attack's cultural Aspects affect the target culture as temporary Aspects for the attack's duration; these can be freely tagged. Aspects affect 1 zone of Scope, expanding at 1 zone per exchange. The Memetic Virus Stunt allows a Meme Attack to make an Infiltration manoeuvre to spread the effect further and faster, up to the attack's maximum Scope.
3. A successful Meme Attack causes Stress damage to the Strength or Stability track, depending upon the Skill used.
4. Any consequences must indicate the impact of the Meme Attack's Aspects on the damaged culture. *For example, a Meme Attack with the "Science!" cultural Aspect on a culture with the "Fundamentalist Religion" cultural Aspect may cause a Major consequence "Belief Systems Shaken to the Core".*
5. If there's no external culture making the Meme Attack, ie it's caused by internal R&D or Breakthroughs or the Cultural Revolution Stunt, treat as if the culture is attacking itself for determining attack Skill levels, stress tracks, and so on.
6. Cultures won't usually be Taken Out in a Meme Attack, generally conceding first and replacing one of their old cultural Aspects with a new one. The Aspect being replaced must be related to one of the Meme Attack's cultural Aspects if possible. *For example, a Science Meme could replace a Religion Meme, or a Communism Meme could replace a Democracy Meme, and so on. Likewise, a Xenophobia Meme could combine with another Xenophobia Meme into an Extreme Xenophobia Meme!*





## Meme Attack Manoeuvres

Meme Attacks may be affected by manoeuvres such as diplomacy and incitement. These needn't occur at the cultural level; PC manoeuvres can affect Meme Attack exchanges using the "Player Intervention" rules (*Starblazer* page 292).

## Healing Meme Attack Damage

Stress clears out at the end of a scene. Meme Attack exchanges take roughly a year, so recovery time scales are longer. Minor consequences clear in a year (if the culture is free of conflict in the next scene); Major after a few years; Severe after several decades; and Extreme require work (often involving the player characters) over decades to bring the culture back from the brink.

## Cultural Change

### Cultural Change via Introduced Technology

New Capability Bands introduce one or more cultural Aspects to a culture. These Aspects may be "positive" or "negative"; a culture hungry for inclusion in the Commonality will view the Mindscape Capability Band more positively than one which sees the human body and privacy of thought as sacred. The table below gives sample cultural Aspects for Capability Bands.

You can't use a new Capability Band immediately: each new tech level requires a year or so to assimilate, so advancing from Average (+1) Armaments (Gunpowder) to Good (+3) Armaments (Laser) takes at least 2 years. Double this if you're keeping the Capability secret. This takes longer if the culture made the advances itself (see "Self-directed Cultural Change," below). If the Capability Band is higher than the tech level of the planet whose culture is trying to exploit it, only a rudimentary application (limited numbers, parts supplied from off-world) is possible; increase the difficulty of Resources, Engineering, or other rolls by the tech level difference.

For an introduced Capability you don't have to win the technological exchange Meme Attack; you still end up with the new Capability unless you don't want it (in which case you have to win the Meme Attack to turn the Capability down). The Meme Attack simply determines whether your cultural Aspects change as a result.

It's possible to avoid the Meme Attack caused by a Capability Band by keeping the Capability secret; the Capability operates at one Band lower, and doesn't enable personal skills for the culture's members.

### Self-directed Cultural Change

Cultures may change at the controlling government's instigation. A culture spread across many polities (government-level organizations) gradually creates local manifestations of that culture, each slightly different, in

time resulting in the development of sub-cultures. Cultures change slowly: each exchange is roughly a decade.

Each decade a culture may:

- Swap two adjacent skills
- Change an Aspect
- Change a Stunt

A polity can attempt to change a culture's Skills via research & development, social engineering, or technological breakthroughs. One attempt may be made each exchange, requiring a Skill check against a difficulty equal to the level of the Skill to be changed; failure means no improvement. Shifts reduce the time taken; see below for the Skill check required.

**Research & Development:** allows a Capability Skill to be improved within a Capability Band. So, a Good (+3) Transport (Space Travel) capability may be improved to Superb (+5) Transport (Space Travel), but no higher. This requires a Resources Skill check, modified by Control and restricted by Technology, against a difficulty equal to the level of Skill to be changed.

**Technological Breakthroughs:** allows a Capability Skill to move from one Capability Band to the next. A Superb (+5) Transport (Space Travel) capability can break through to Fantastic (+6) Transport (FTL). This requires a Resources Skill check, restricted by Control and Technology, against a difficulty equal to the level of Skill to be changed, plus two. The culture must satisfy all prerequisites for the new Capability Band before the breakthrough can be made.

**Social Engineering:** allows modification of a culture's non-Capability Skills, requiring a Resources Skill check, modified by Control and Communication, against a difficulty equal to the level of the Skill to be changed.

### Maximum Change

Cultures have a maximum number of Skill points, which is one less than the starting Skill points of the next culture Scale up. So, a Large (Scale-4) culture (which begins with 5 Skill points) can advance to a maximum of 14 Skill points.

### Cultural Divergence

Culture worlds are Commonality worlds with slightly differing cultures, which gives them additional Aspects which the Commonality can invoke to make and resist Meme Attacks. In some cases, however, parts of a culture (such as planets or subsectors) can be made to diverge from a parent culture to their disadvantage, such as by changes in cultural Aspects resulting from planetary invasions or Memetic Virus attacks. Regions which diverge in this way are called **local cultures**.

If a local culture diverges too far from its "parent," so that it shares less than half of its cultural Aspects with its parent culture, it becomes a new culture and undergoes a reduction

## Capability Band Prerequisites and Sample Aspects

Capability Band	Prerequisites	Associated Cultural Aspects
Armaments (any)		Militarism
Armaments (Black Powder)		Killing at a Distance is Ignoble!
Armaments (Gunpowder)		Mass Casualties are the cost of War
Armaments (Nuclear)	Power (Electricity); Resource Exploitation (Industry)	Mutually Assured Destruction; We Don't Deserve to Survive!
Armaments (Laser)	As above	Minimum Damage for Maximum Effect
Armaments (Disruptor+)	Power (ZIP); as above	These horrendous wounds cannot be justified!
Transport (all but Non-powered)		Science!
Transport (Powered)	Power (Mechanical); Resource Exploitation (Industry)	These New-fangled Machines Ain't Natural!
Transport (Space Travel)	Power (Electricity); Information (Computers); as above	We can spread to the Stars!
Transport (FTL)	Power (ZIP); as above	Just One World Among Millions; The stars are in our grasp!
Biological (all but Herbal)		Survival of the Fittest; Man should not play God!
Biological (Surgical)		We can conquer Death!
Biological (Medical)		Doctors are the protectors of life.
Biological (Biotech)	Information (Computers)	Mutability of Body Form; We can do anything!
Biological (Genurgy)	As above	What IS human, anyway?
Information (all but Memory)		I don't trust these new-fangled inventions!
Information (Computers)	Power (Electricity)	
Information (Synthetics)	As above; Resource Exploitation (Automated)	Personal Insignificance; Machines Will Take Over the World; What IS intelligence, anyway?
Power (all but Physical)		Science; I don't like this weird technology; Hey! This will take our jobs away!
Power (Mechanical)	Resource Exploitation (Industry)	The World is a Great Machine - and we can control it.
Power (Electricity)	As above	Power is cheap.
Power (ZIP)	As above; Information (Computers)	Power is all around us.
Resource Exploitation (all except Hunter-Gatherer)		We're losing touch with the Old Ways!
Resource Exploitation (Agriculture)		Mother Earth provides.
Resource Exploitation (Industry)		Men Become Machines
Resource Exploitation (Automated)	Power (Electricity); Information (Computers)	Robots will take over the world; Where have all our jobs gone?
Resource Exploitation (Makepoint)	Power (ZIP); as above	A future of leisure and happiness.
Psi (Psionics)		Power of the Mind; They're Stealing Your Thoughts; Abomination Against Nature
Comms (all except Spoken)		Separated and Yet Together; I don't like these new-fangled ways!
Comms (Written)		We can share our knowledge
Comms (Radio)	Power (Electricity)	The world is one
Comms (Mindscape)	Power (Broadcast); Information (Synthetics); Resource Exploitation (Automated)	Personal Insignificance; Power of the Mind; Science; Machines Will Take Over the World!

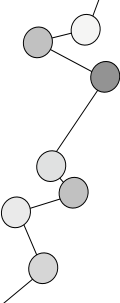

in Scale (Planetary 6, Multiplanet 7, etc). This happened in recent history when the Successor States broke away from the Commonality: the Commonality remained Scale 9 (Star Empire), and the Successor States became Scale 8 (Interplanetary), ending up with less Skill and Stress points, making them more vulnerable to cultural conflict.

### Cultural Destruction

Cultures with antagonistic aspects generally remain in constant, low-level Meme Attack. Even though Meme Attacks can be damaging, cultures are resilient and may persist for many generations, even under intense attack.

Each Meme Attack reduces a target culture's Stability stress track by 1. For multiple attacks this may cause consequences in addition to those caused by the Meme Attacks themselves. In time, large and powerful cultures may take out smaller ones.

### The Hand of God - An Example of Meme Attack

The New Trader *Star of Dawn* has run the Commonality Embargo and smuggled a Fantastic (+6) Transport (FTL) capability into the *Hand of God* culture.

Hand of God Culture				Culture Sheet	
<b>Scale:</b>	Enormous (6)		<b>Consequences</b>		<b>Strength Stress</b>
<b>Scope:</b>	Planetary (6)		Minor:		□□□□□□
<b>Fate Points:</b>	4		Major:		
<b>Refresh:</b>	4		Severe:		<b>Stability Stress</b>
			Extreme:		□□□□□□
<b>Skills</b>				<b>Stunts</b>	
Superb (+5)	Propaganda				Cultural Assault
Great (+4)	Assertion				Propaganda Campaign
Good (+3)	Transport (Space Travel)	Comms (Radio)	Assimilate		Memetic Virus
Fair (+2)	Biological (Medical)	Power (Electricity)	Adaptability		
	Resource Exploitation (Industry)				
Average (+1)	Armaments (Gunpowder)	Information (Libraries)			
Abysmal (-3)	Psi (Pre-Psi) (Gain +3 SP)				
<b>Aspects</b>					
Religion					
Xenophobia					
Created in the Image of God					
Centre of the Universe					
Uniqueness of the Human Form					
Pinnacle of Creation					
<b>Cultural Conflicts</b>					
None					

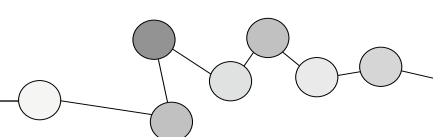
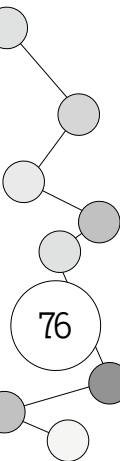



The Hand of God culture begins as follows:

Hand of God is a closed, paranoid, self-willed, xenophobic culture with no interest in the universe outside. No place for a holiday!

*Star of Dawn* introduces the Fantastic (+6) Transport (FTL) capability Skill into the culture. This is technological exchange, a Meme Attack using the Commonality's Average (+1) Infiltration Skill, and bearing the cultural Aspects "Science!" and "Just One World Amongst Millions." The Hand of God culture wishes to accept the FTL technology, and so uses its Good (+3) Assimilate Skill to defend.

### Initial Effects

*Hand of God* begins to advance its Transport capability from Good (+3) Transport (Space Travel) to Fantastic (+6) Transport (FTL). This will take three exchanges of roughly a year each, advancing 1 Skill level per exchange (so three years before *Hand of God* can build a rudimentary planing engine). *Manu-Tei*, the planet of the Hand of God culture, has a tech level of Good (+3) Age of Biotech: even after three years it will only utilize the Fantastic (+6) Transport (FTL) capability at a rudimentary level. Any Resource, Engineering, or construction-related rolls will be +3 difficulty, and parts may have to be sourced off-world. In particular, Transport (FTL) has the prerequisite Power (ZIP), which Hand of God doesn't have, so it will need to acquire this technology to produce a planing engine.

The Transport (FTL) capability introduces the "Science" and "Just One World Amongst Millions" cultural Aspects, which *Hand of God* acquires as temporary Aspects for the Meme Attack's duration. The Story Teller declares the "Science!" Aspect is opposed by the Hand of God "Religion" Aspect, and "Just One World Amongst Millions" by "Centre of the Universe," indicating the areas where cultural conflict will break out.

### Exchange 1

The Meme Attack looks like this:

Technological Exchange	Meme Attack
<b>Scope:</b> 6	
<b>Skills:</b> Great (+4) Assertion, Average (+1) Infiltration	
<b>Aspects:</b> Just One World Among Millions, Science!	
<b>Strength Stress:</b>	□□□□□ (0 Consequences)

In the first exchange *Hand of God's* Stability stress is reduced by 1 point (from 6 to 5) due to the Meme Attack: people go mad, the media freak out, church leaders froth at the mouth, politicians fight in the streets.

The Meme Attack then attacks with Average (+1) Infiltration against Good (+3) Assimilate. It freely tags the "Just One World Among Millions" temporary Aspect, succeeding with a total of 6 against 3, for 3 points of damage to Hand of God's Stability stress track. The Story Teller decides the culture takes a Minor consequence ("Challenge to Holy Authority"), and reduces Stability from 5 to 4.

Hand of God then attacks back with Good (+3) Assimilate, rolling a +2 for a total of +5 against the Meme Attack's +3 (it rolled a -1, added to +4 Assertion). The Meme Attack's Strength stress track is reduced from 6 to 4.

At the end of the exchange the culture sheet looks like this (see below) - note the increase from Good (+3) Transport (Space Travel) to Great (+4) Transport (Space Travel).



**Hand of God Culture (end of exchange 1)****Scale:** Enormous (6)**Scope:** Planetary (6)**Fate Points:** 4**Refresh:** 4**Consequences**

Minor: Challenge to Holy Authority

Major:

Severe:

Extreme:

**Culture Sheet****Strength Stress**

□□□□□□

**Stability Stress**

□□□□■

**Skills**

Superb (+5) Propaganda

Great (+4) Assertion

Good (+3) ~~Transport (Space Travel)~~

Fair (+2) Biological (Medical)

Average (+1)

Abysmal (-3)

Transport (Space Travel)

Comms (Radio)

Power (Electricity)

Resource Exploitation (Industry)

Armaments (Gunpowder)

Psi (Pre-Psi) (Gain +3 SP)

Transport (Space Travel)

Comms (Radio)

Power (Electricity)

Information (Libraries)

Information (Libraries)

Psi (Pre-Psi) (Gain +3 SP)

Assimilate

Adaptability

**Stunts**

Cultural Assault

Propaganda Campaign

Memetic Virus

**Aspects**

Religion

Xenophobia

Created in the Image of God

Centre of the Universe

Uniqueness of the Human Form

Pinnacle of Creation

\*Science! (Temporary Aspect)

\*Just One World Among Millions (Temporary Aspect)

**Cultural Conflicts**

Year 1 Technological Exchange Fantastic (+6) Transport (FTL) capability Skill triggering Meme Attack with cultural Aspects "Science!" and "Just One World Among Millions".

**Exchange 2**

The Meme Attack rolls 0, freely tagging the "Science!" temporary Aspect for a total of +3 against Hand of God's disastrous -5 (for a total of -2), resulting in 5 stress damage. Hand of God elects to take a Major consequence, "Religious Belief Shaken," and reduces Stability from 4 to 3. At this point, if it wanted to, Hand of God could simply concede, changing its "Centre of the Universe" Aspect to something similar to "Just One World Among Millions." It would still gain access to the new FTL capability Skill.

Instead it chooses to attack back, rolling +1 and spending a Fate point to tag its "Created in the Image of God" Aspect for a further +2, for a +6 total against the Meme Attack's roll of 0 (+4 total). The Meme Attack takes 2 Strength stress - it's now down to 2.

At the end of the second exchange (year two), Hand of God's culture sheet looks like this (see below). Note that the Transport (Space Travel) has risen another level to Superb (+5).

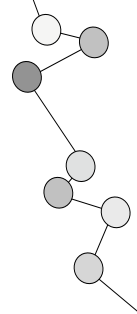

Hand of God Culture (end of exchange 2)				Culture Sheet	
<b>Scale:</b>	Enormous (6)	<b>Consequences</b>		<b>Strength Stress</b>	
<b>Scope:</b>	Planetary (6)	Minor: Challenge to Holy Authority		□□□□□□	
<b>Fate Points:</b>	3	Major: Religious Belief Shaken		<b>Stability Stress</b>	
<b>Refresh:</b>	4	Severe:		□□□■	
		Extreme:			
<b>Skills</b>				<b>Stunts</b>	
Superb (+5)	Propaganda	Transport (Space Travel)		Cultural Assault	
Great (+4)	Assertion	<del>Transport (Space Travel)</del>		Propaganda Campaign	
Good (+3)	<del>Transport (Space Travel)</del>	Comms (Radio)	Assimilate	Memetic Virus	
Fair (+2)	Biological (Medical)	Power (Electricity)	Adaptability		
	Resource Exploitation (Industry)				
Average (+1)	Armaments (Gunpowder)	Information (Libraries)			
Abysmal (-3)	Psi (Pre-Psi) (Gain +3 SP)				
<b>Aspects</b>					
Religion					
Xenophobia					
Created in the Image of God					
Centre of the Universe					
Uniqueness of the Human Form					
Pinnacle of Creation					
*Science! (Temporary Aspect)					
*Just One World Among Millions (Temporary Aspect)					
<b>Cultural Conflicts</b>					
Year 2 Technological Exchange Fantastic (+6) Transport (FTL) capability Skill triggering Meme Attack with cultural Aspects "Science!" and "Just One World Among Millions."					

**Exchange 3**

The Meme Attack rolls -3, freely tagging the "Challenge to Holy Authority" Minor consequence for a total of +0, against Hand of God's roll of 0 (a total of +3); its attack fails.

Hand of God attacks back: it rolls +4! It spends a Fate point to tag its "Xenophobia" Aspect, for a whopping effort of +9! The Meme Attack rolls a +1, for a +5 total: respectable, but not enough to save it. It takes 4 stress, exceeding its remaining 2 points and Taking it Out.

The Meme Attack is over. At the end of the third exchange, the culture sheet is as follows; note the culture has now developed its Transport (FTL) capability; this is as a result of three years having passed, and nothing to do with winning the Meme Attack. Hand of God has two consequences which will clear up in a few years, by which time it'll be back to its usual, xenophobic self!

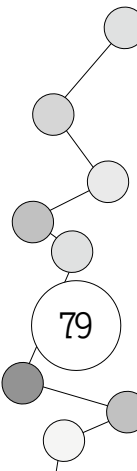
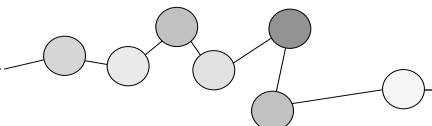



## Hand of God Culture (end of exchange 3)

**Scale:** Enormous (6)

**Scope:** Planetary (6)

**Fate Points:** 2

**Refresh:** 4

### Consequences

Minor: Challenge to Holy Authority

Major: Religious Belief Shaken

Severe:

Extreme:

### Culture Sheet

#### Strength Stress

□□□□□□

#### Stability Stress

□□□■██

### Skills

Fantastic (+6) Transport (Space Travel)

Superb (+5) Propaganda ~~Transport (Space Travel)~~

Great (+4) Assertion ~~Transport (Space Travel)~~

Good (+3) ~~Transport (Space Travel)~~ Comms (Radio) Assimilate

Fair (+2) Biological Power (Electricity) Adaptability  
(Medical)

Resource Exploitation (Industry)

Average (+1) Armaments (Gunpowder) Information (Libraries)

Abysmal (-3) Psi (Pre-Psi) (Gain +3 SP)

### Stunts

Cultural Assault

Propaganda Campaign

Memetic Virus

### Aspects

Religion

Xenophobia

Created in the Image of God

Centre of the Universe

Uniqueness of the Human Form

Pinnacle of Creation

\*Science! (Temporary Aspect)

\*Just One World Among Millions (Temporary Aspect)

### Cultural Conflicts

Year 3: won technological exchange Meme Attack with cultural Aspects "Science!" and "Just One World Among Millions"; gained Fantastic (+6) Transport (FTL) capability Skill.

## Gaming Meme Attacks

**Mindjammer** focuses on character-level play. Organization- and culture-level play is assumed to take a supporting role to the PCs' story.

Meme Attacks allow the drama of cultural conflict raging through the New Commonality Era to become an integral part of **Mindjammer** games. PCs can take ideological stands, get involved in "meme running" to change cultures, or simply trigger cultural upheaval by smuggling technology or contacting new worlds - or try to *stop* all of the above!

One of the easiest ways to manage cultural conflict in your campaign is to maintain Culture Sheets for its main cultures, such as the Commonality or the Venu. As your campaign progresses, Meme Attacks and the actions of PCs gradually modify the cultures in your campaign.

You can connect Meme Attacks to in-game events. Let's say a cultural Aspect has a famous exponent who's been the target of an assassination attempt. If he's killed, any Meme Attacks using that Aspect, or attempts to defend against external Meme Attacks affecting that Aspect, will be penalized; the PCs are charged with protecting him. Other examples include natural disasters (causing Stability damage to a culture), results of nearby wars, visits by dignitaries, factional intrigues, media triumphs, and so on. You can tie the fate of the New Commonality Era to the PCs' actions.

Think how events the PCs are involved in might affect the cultures around them. Discoveries, battles, or diplomatic incidents may introduce new cultural Aspects; technological breakthroughs or unknown alien artefacts may provide bonuses to a culture's R&D efforts or even its Capability Bands directly. Keep a track of these Aspects and modifiers: once per game year, you can play out a "Cultural Conflict Turn" for

the cultures concerned. It's up to you how you do this: you can do it solo, offline, and present the results to your players as a fait accompli in your next session; or you can devote the whole or part of a session to it, and play out the exchange as a game at the cultural level. Let the players play the part of the culture they identify with; that way, the effects of damage, consequences, Skill and Aspect changes have more significance. Players can even change their character's own Aspects to keep pace with the cultural change.

## Cultures of the New Commonality Era

This section contains culture sheets for the major cultures of the New Commonality Era, including information for use in character generation (see **Chapter One: Characters**). The sample character Aspects are derived from the cultural Aspects; encourage players to come up with their own, too.

Commonality Culture				Culture Sheet
<b>Scale:</b>	Star Empire (9)		<b>Consequences</b>	<b>Strength Stress</b>
<b>Scope:</b>	Commonality Space (9)		Minor: We must protect our culture	□□□□□□□■
<b>Fate Points:</b>	4		Major: Venu is a special case!	
<b>Refresh:</b>	4		Severe:	<b>Stability Stress</b>
			Extreme:	□□□□□□□■
<b>Skills</b>				<b>Stunts</b>
Epic (+7)	Transport (FTL)			Hunter-Killer Eidolons
Fantastic (+6)	Armaments (Torsion)	Biological (Genurgy)	Information (Synthetics)	Q-Ships
	Power (ZIP)	Resource Exploitation (Makepoint)	Comms (Mindscape)	Memetic Virus
Superb (+5)				Memetic Torpedo
Great (+4)	Assertion			Culture Worlds
Good (+3)	Psi (Pre-Psi)	Propaganda		Culture Worlds
Fair (+2)				
Average (+1)	Assimilate	Infiltration		
<b>Aspects</b>				
Science!				
Mutability of Body Form				
Power of the Mind				
Live and Let Live				
Curious				
Mankind's Destiny is in the Stars!				
The Commonality is the One True Way				
Mankind is young again!				
Mankind is a stepping stone to a bright future of evolution				
*The Ends Justify the Means (temporary Aspect from Venu Casual Contact)				
<b>Cultural Conflicts</b>				
Venu Casual Contact (Scope 9) - defending with Great (+4) Assertion and Aspect "Live and Let Live" against Venu's Great (+4) Assertion and Aspect "Ends Justify the Means".				

## Commonality Culture

**Sample Character Aspects:** We Know Best, One True Path, Well-Meaning, Evangelistic, Culture Vulture, There's No Place Like Old Earth, Mindscape Implant.

**Character Genotypes:** Commonality citizens may be human, hominid, or synthetic. For xenomorph see the Xenomorph sub-culture below.

Commonality culture is the "standard" for **Mindjammer** characters. It's currently trying to assimilate the many cultures contacted in the Expansion.

The Commonality is a devolved benevolent dictatorship. It often strays into grey territory to solve problems, and many worlds resist Commonality control. In the conflict with the Venu the Commonality is making efforts to win hearts and minds, but sometimes resorts to dubious means to achieve its ends.

Commonality characters have a mandatory "Mindscape Implant" Aspect (or something similar) (see **Chapter Three: Gear**), unless they've chosen an Aspect like "Mindscape Implant Rejection" or "Mindscape Incompatibility" instead. Characters without Mindscape Implants are regarded as handicapped; most come from Fringe or Outer Worlds. However, there are some advantages, including a lack of traceability and immunity to technopsi.

## The Neo-Cultures

All culture worlds are significant for possessing strong and vibrant cultures capable of withstanding the impact of cultural conflict. Some have unique cultures found nowhere else in the Commonality; others derive from ancient Old Earth cultures, in particular the so-called Autumn Cultures which preceded the Commonality and which formed the core of the Great Diaspora. These are the Neo-Cultures, Commonality sub-cultures sharing more than half the Commonality's Aspects and providing some of their own.

### Character Aspects of the Commonality Neo-Cultures

Neo-Culture	Sample Character Aspects
Neo-Shinean	Inscrutable, Conformist, Self-denying
Neo-Franchian	Joi-de-Vivre, Passionate, Indignant
Neo-Mirkan	Gung-ho, Adventurous, Frontier Folk
Neo-Angran	Stiff upper lip, Tolerant, Proud
Neo-Yarpeen	Bureaucratic, Inclusive, Relaxed

## The Xenomorphs

The xenomorphs are a Commonality sub-culture; all members have the "xenomorph" genotype (see **Chapter One: Characters**). Sample character Aspects include: Proud, Submissive, Insecure, Emotional, As Good As You, What Are You Looking At?

Chembu Culture				Culture Sheet
<b>Scale:</b>	Colossal (7)	<b>Consequences</b>		<b>Strength Stress</b>
<b>Scope:</b>	Commonality Space (9)	Minor:		<input type="checkbox"/> <input type="checkbox"/> <input type="checkbox"/> <input type="checkbox"/> <input type="checkbox"/> <input type="checkbox"/>
<b>Fate Points:</b>	3	Major:		
<b>Refresh:</b>	3	Severe:		<b>Stability Stress</b>
		Extreme:		<input type="checkbox"/> <input type="checkbox"/> <input type="checkbox"/> <input type="checkbox"/> <input type="checkbox"/> <input type="checkbox"/>
<b>Skills*</b>				<b>Stunts</b>
Fantastic (+6)	Biological (Genurgy)	Transport (FTL)		Hunter-Killer Eidolons
Superb (+5)	Armaments (Disruptors)	Power (ZIP)	Information (Synthetics)	Cultural Assault
	Comms (Mindscape)			Memetic Virus
Great (+4)	Resource Exploitation (Automated)			
Good (+3)	Infiltration			
Fair (+2)	Propaganda			
Average (+1)	Assimilate	Assertion	Psi	
<b>Aspects</b>				
We are the future				
Our bodies are temporary, always in flux				
We want you to feel the joy of the Planetary Intelligence!				
In the Commonality not of the Commonality				
The body can be perfected				
We will give this gift to everyone				
We must control evolution				
<b>Cultural Conflicts</b>				
None				

\*Chembu cultural Skills total 44 points rather than 35, incorporating 9 points of advancement.



## Chembu Culture

**Sample Character Aspects:** The Body Can Be Perfected, I Can Make That For You, This Is Something You Need

**Character Genotypes:** Chembu are hominids (see page 6).

The Chembu are genurgically modified hominids occupying several heavily modified worlds in a "Chembu Autonomous Region". They have representatives throughout Commonality Space as the Chembu Genurgy corporacy. Chembu also make highly-tailored synthetics.

Sentient Alliance Culture			Culture Sheet
<b>Scale:</b>	Interplanetary (8)	<b>Consequences</b>	<b>Strength Stress</b>
<b>Scope:</b>	Commonality Space (9)	Minor:	□□□□□□□□
<b>Fate Points:</b>	6	Major:	
<b>Refresh:</b>	6	Severe:	<b>Stability Stress</b>
		Extreme:	□□□□□□□□
<b>Skills*</b>			<b>Stunts</b>
Fantastic (+6)	Transport (FTL)		Cultural Assault
Superb (+5)	Propaganda	Comms (Mindscape)	Q-Ships
Great (+4)	Assertion	Armaments (Blasters)	Propaganda Campaign
	Power (Broadcast)	Information (Computers)	All or Nothing
Good (+3)	Infiltration	Resource Exploitation (Automated)	
Fair (+2)	Assimilate	Biological (Biotech)	
Average (+1)	Psi		
<b>Aspects</b>			
At last there is a place where xenomorphs can be free!			
The Venu are the greater evil			
It's a Brave New World			
Watchful if not paranoid			
There are always enemies at the gates			
The Commonality protects us			
We broke free of our masters!			
We must find our own way			
<b>Cultural Conflicts</b>			
Various			

## Sentient Alliance Culture

**Sample Character Aspects:** Enemies at the Gates, I'll Find my own Way, Touchy, It's a Brave New World!

**Character Genotypes:** Sentient Alliance citizens are mostly xenomorphs, with human and hominid minorities.

The Successor States are a bickering group of small interstellar cultures sponsored by either the Venu or the Commonality. The Sentient Alliance is one of the larger, and the only interstellar xenomorph culture in Human Space (though there are xenomorph cultures on several individual worlds).

## Venu Culture

**Scale:** Star Empire (9)

**Scope:** Venu Space (9)

**Fate Points:** 6

**Refresh:** 6

## Consequences

Minor:

Major: My mutations are honourable!

Severe:

Extreme:

## Culture Sheet

### Strength Stress

□□□□□■

### Stability Stress

□□□□□□□■

## Skills

Fantastic (+6)

Transport (FTL)

Propaganda

Psi

Superb (+5)

Armaments (Disruptors)

Infiltration

Information  
(Synthetics)

Power (ZIP)

Great (+4)

Assertion

Comms (Radio)

Biological  
(Genurgy)

Resource Exploitation (Automated)

Good (+3)

Fair (+2)

Average (+1)

Mediocre (+0)

Assimilate

## Stunts

Memetic Virus

Cultural Revolution

Shock and Awe

Cultural Assault

## Aspects

The Ends Justify the Means

Trust the Technopriests

Science will save us!

Mutation is hideous!

Artificial Intelligence is an Abomination in the eyes of God!

The old ways are best

You should have no god but Venu

There are more things in heaven and earth...

Hail the Radiant Darkness!

\*Mutability of Body Form (temporary Aspect from Commonality Casual Contact)

## Cultural Conflicts

Commonality Casual Contact (Scope 9) - defending with Great (+4) Assertion and Aspect "Artificial Intelligence is an Abomination in the eyes of God!" against Commonality's Great (+4) Assertion! and Aspect "Mutability of Body Form."



## Venu Culture

**Sample Character Aspects:** Venu Rules All, Strength Through Order

**Character Genotypes:** Humans, some Mutants

The Venu culture is *Mindjammer's* "enemy" culture. Most Venu are humans, though with an increasing number of mutants. There are no xenomorphs or synthetics: both genotypes are forbidden in Venu society. The Venu have conquered some hominid worlds, but aren't believed to be in contact with any alien species.

## Fringe Worlds Culture

**Sample Character Aspects:** Independent, Proud, We're Special

**Character Genotypes:** Humans, hominids, rare xenomorphs. Synthetics and most xenomorphs are usually arrivals from the Commonality.

Fringe Worlds are usually those the Commonality is currently trying to assimilate, often with great difficulty. They're all Scale 7 or smaller. Hand of God (see above) is a Fringe World culture.

There are thousands of worlds being contacted out on the Fringe, so many that thinly-spread Space Force and

Communications Instrumentality personnel are being promoted way above their capabilities just to fill diplomatic and administrative positions. They're complemented by synthetics and the Mindscape where possible, but all the same there's the feeling that the Commonality is only just coping with the huge job on its hands.

## Outer Worlds Culture

**Sample Character Aspects:** Xenophobic, Traditionalist, Conservative, Close-minded, Our Way Is Best, You Can't Do It Like That

**Character Genotypes:** Humans, hominids

Beyond the frontier, the Fringe Worlds, and polities like the Venu Empire, lie the countless worlds of Human Space - the theoretical region some 10,000 light years in diameter which lay within reach of Old Earth's slowships during the First Age of Space. These are the Outer Worlds - the alien worlds and lost colonies constantly being rediscovered by Space Force, New Traders, and the Communications Instrumentality. Most lie beyond the Commonality's reach, and though the frontier is pushed back every year, it will be centuries before it pushes beyond the Outer Worlds.

The above statistics are for a primitive Outer World culture; it's hard to generalise as they're all very different. Most are planet-sized, a few comprising a handful of worlds at most.

Outer Worlds Culture				Culture Sheet
<b>Scale:</b>	Large (4)	<b>Consequences</b>		<b>Strength Stress</b>
<b>Scope:</b>	National (4)	Minor:		□□□□
<b>Fate Points:</b>	6	Major:		
<b>Refresh:</b>	6	Severe:		<b>Stability Stress</b>
		Extreme:		□□□□
<b>Skills</b>				<b>Stunts</b>
Good (+3)	Assertion	Assimilate	Propaganda	Traditionalist
Fair (+2)				All or Nothing
Average (+1)	Infiltration	Psi		
Mediocre (+0)	Resource Exploitation (Agriculture)		Comms (Written)	
Poor (-1)	Armaments (Blades)	Transport (Non-Powered)	Biological (Surgical)	
	Information (Libraries)	Power (Physical)		
<b>Aspects</b>				
We live by the sword				
What is the name of your tribe, stranger?				
We have a prophecy				
Your ways are wrong!				
<b>Cultural Conflicts</b>				
Various				



# Chapter Seven:

## The Darradine Rim

*"Have you seen the Rim? It's breathtaking. So many stars, like diamond dust, so many teeming with life, waiting to be found. You could spend a thousand years exploring, and never visit the same world twice. And that's what I intend to do."*

- interview with Youthful Curiosity-439, Space Force exploration drone, passing through Ajeux system in early 193 NCE



### Your Mindjammer Campaign

Human Space is a vast, roughly spherical volume of space 10,000 light years in diameter, centred on Old Earth. You can set your **Mindjammer** campaign anywhere within this space, using as much or as little of this book as you want. This chapter presents "the Darradine Rim," a single octant 100 light years a side, as an introductory campaign of pregenerated worlds for you to get playing right away, and as an example of the environments of the New Commonality Era. With the four linked adventures and pregenerated characters at the end of this book, all you have to do is jump in and go!

If you're interested in creating your own worlds, but still want to use the material in this chapter (the various species, the conflict with the Venu), try detailing a neighbouring octant or subsector. For a completely blank canvas, Commonality Space contains another 26 sectors, each of 125 subsectors of 8 octants apiece, so you have space to set a huge, home-grown campaign and still play within Commonality Space. Last of all there are the uncharted realms of the Outer Worlds. Commonality scientists theorize that colony slowships penetrated at least 5000 light years from Old Earth, over 3000 light years beyond the Commonality frontier in all directions. There are vast reaches of space potentially populated with Old Earth's descendants - space empires, alien civilizations, terrible galactic threats, and more!

### The Darradine Rim

The Darradine Rim is Octant Gamma of the Darradine Restoration subsector, subsector 2-4-2 of the Rim sector on the edge of Commonality Space. A region of intense exploratory activity badly affected by the Venu War of 110-120 NCE, it borders the Quarantine Zone with the Venu Empire, and is a hotbed of activity against the Commonality's nefarious foe.

Like all Commonality Space, the Darradine Rim has been opened up in the last two centuries. It contains numerous Old Colony worlds, populated by humans during the First Age of Space, several hominid and xenomorph races, and significant alien presences at Drefnia and Zvukimu. The octant capital at Ajeux is also the subsector capital, and is some 250 light years from the sector capital of Tsen Tair.

The Darradine Rim schematic (see the inside front cover of this book) shows only the 20-odd star systems significant to the Commonality; there are many other undiscovered systems. The octant contains some 4000 stellar bodies (of all descriptions), and it's likely there are other habitable or semi-habitable worlds out there awaiting discovery and exploration. The major technological civilizations have probably all been discovered, but even that isn't completely certain.

### The Venu Frontier

The Commonality has many "frontier zones" and areas of friction and cultural conflict; the Darradine Rim borders one of them, the frontier with the Venu Empire, a tense region of space 50 light years deep quarantined by the Commonality, known as the "Quarantine" or the "Q-Zone".

## How do you handle space travel?

Some people like playing through space travel in detail, plotting every jump, describing every journey. With navigation and maintenance rules, docking and trading procedures, this can be great fun: the "Trading Campaign" is an indispensable staple of science-fiction gaming.

But you don't have to play like this. Depending on your game style, you can just gloss over space travel. Don't feel you have to go into the minutiae of space travel just because you can: it's perfectly okay to say, "after two weeks in 2-Space you arrive at your destination." The main thing is - have fun!

## Calculating Distances

The same goes for calculating distances between star systems. These rules let you get some pretty detailed results - but only if you want to. Try one of the following three methods - all equally valid, they depend on how much crunch you want in your game:

**The Don't-Like-Numbers Method:** if you're happy with a really broad brush approach to interstellar travel, don't even bother with distances at all. Check out the "Distance and Range" table on page 39 for how to be fast and loose with interstellar travel.

**The Rough Method:** this is a middle-ground between detailed calcs and a fast-and-loose approach. You still need the Horizontal and Vertical Separation (see below), but just round it off to the nearest 10 light years - in this method we don't need finer detail than that.

Once you've got the two numbers, look them up on the table below. The result is the rough Actual Separation between star systems. So, for the Chinhice-to-Furnace distances from the example below we get 20LY Horizontal and 30LY Vertical Separation (rounded off). On the table this gives 36LY, which isn't far from the 35.2LY we get from the full calculation.

Horizontal Separation in Light Years (LY)

LY	10	20	30	40	50	60	70	80	90	100
10	14	22	32	41	51	61	71	81	91	100
20	22	28	36	45	54	63	73	82	92	102
30	32	36	42	50	58	67	76	85	95	104
40	41	45	50	57	64	72	81	89	98	108
50	51	54	58	64	71	78	86	94	103	112
60	61	63	67	72	78	85	92	100	108	117
70	71	73	76	81	86	92	99	106	114	122
80	81	82	85	89	94	100	106	113	120	128
90	91	92	95	98	103	108	114	120	127	135
100	100	102	104	108	112	117	122	128	135	141

**The Detailed Method:** this method gives you maximum accuracy, at the price of a bit of maths. You can use Pythagoras' Theorem to calculate the distance between star systems in 3 dimensions, even from data on a 2-d map. Here's what you do: first, measure the distance between systems on the map. For example, on the Darradine Rim schematic the distance between the Chinhice and Furnace star systems is about 20 light years. That's the *Horizontal Separation*. Now, you need the *Vertical Separation*: that's the difference between the Z-coordinates (the numbers in brackets next to each star system). Chinhice has a Z-coord of +0, and Furnace has +29: that means they have a Vertical Separation of 29 light years.

Now the maths: take the square of the Horizontal Separation and the square of the Vertical Separation and add them together. Then, take the square root of that. The result is the Actual Separation - the real distance in 3 dimensions between the two systems. For Chinhice and Furnace, this looks like:

$$\begin{aligned} \text{Actual Separation} &= \text{Square Root of } (20\text{LY} \times 20\text{LY}) + (29\text{LY} \times 29\text{LY}) \\ &= \text{Square Root of } 1241\text{LY} \text{ (} 400 + 841 \text{)} \\ &= 35.2 \text{ LY} \quad \dots \text{And that's it!} \end{aligned}$$

Since the Venu War the Commonality has been cautious about sharing its technology with newly-contacted cultures. The Commonality Embargo is one of SCI Force's main activities along the frontier, and the cause of the high levels of espionage and counterespionage between the two states. Commonality Q-Ships patrol the Q-Zone, "suicide synthetics" infiltrate Venu space, and memetic viruses take the fight deep into Venu society. This continuous war of attrition has one goal: to keep Commonality tech out of Venu hands. In practice the Quarantine increasingly drives Venu scientists towards hazardous and experimental research.

### Mindjammer Routes

Mindjammers travel all Commonality worlds, but some more regularly than others. The Darradine Rim schematic indicates these **Mindjammer Routes**. Through frequency of use, Mindjammer Routes are easier to navigate than other interstellar routes, and the Mindscape contains more reliable

and up-to-date astrographical data. Using the Mindscape you can tag any Mindjammer Route as an Aspect when making a Star Drive Operation roll to travel along one.

### Starship Encounters in the Darradine Rim

Use the table below either as part of the *Starblazer Adventures* Plot Generator, or just when you need a random starship encounter.

### Worlds of the Darradine Rim

This section contains planetary maps, planet sheets, and descriptions of the twenty or so worlds of the Darradine Rim, referenced on the star map on the inside front cover. It's mostly a Commonality-controlled region, with humans the dominant species, although there are large populations of xenomorphs, hominids, and even alien species.

#### Darradine Rim Starship Encounters

D1 Vs D2	1	2	3	4	5	6
1	Unusual Vessel (Slowship, unknown alien vessel, etc)	Chembu Bioship	Lowhigh Lightjammer	Ship with Zybote Ambassador asks to come aboard	Trigger-happy Hooyow Training Vessel	Jawayayn Sky City
2-3	Mindjammer	Fast Courier	Customs Boat	New Trader	New Trader	New Trader
4-5	Settler Ship	Sentient Alliance Vessels	Outremer Vessels	Surveillance Drones	Space Force Patrol	Commonality Explorer Ship
6	Space Force Task Force	Commonality Manowar	Commonality Q-Ship	Pirates!	Venu Spyship	Venu Raiders

### Ajeux

Neo-Franchian Culture World and Subsector Capital

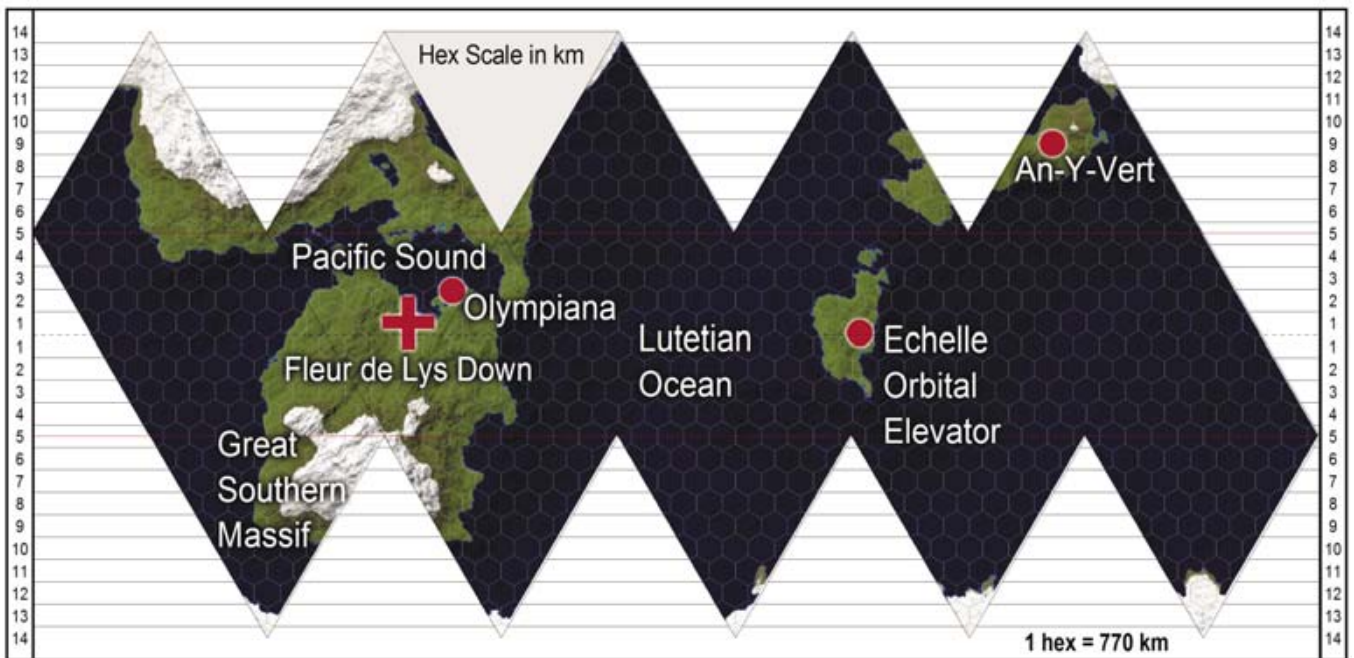



<b>AJEUX III</b>	<b>Class-8 Terrestrial Planet: 1 moon, 1 ring system</b>
Primary Terrain	Mixed
Atmosphere	Breathable (0.81 atm: N <sub>2</sub> 70%, O <sub>2</sub> 22%, H <sub>2</sub> O 4%, Ne 2%, Ar 1%, Trace: CO <sub>2</sub> , H <sub>2</sub> S, SO <sub>2</sub> )
Population	Superb (+5): 2 billion (60% human; 20% synthetic; 15% xenomorph; 5% other)
Spaceport Facilities:	Great (+4): Fleur-de-Lys Down Spaceport (Scale-7 ground facility); Arc-en-Ciel Orbital (Scale-6 space station plus dry dock)

### Planetary Skills

Diplomacy	Superb (+5): Octant and Subsector Capital
Resources (wealth)	Superb (+5)
Resources (materials)	Fantastic (+6)
Resources (industrial)	Good (+3)
Military Capability	Fair (+2)
Planetary Security	Good (+3)
Tech Level	Fantastic (+6): Second Age of Space
Trade Level	Superb (+5)
Embargo	Mediocre (+0): No Embargo

### Planetary Aspects

Planetary Government	Commonality Culture World (Commonality-controlled Oligarchy)
Parent Star Classification	G5V Main Sequence Star
Culture World (neo-Franchian)	
Subsector and Octant Capital	
Ancient Slowship Colony	
Global Mindscape Instance	

### Additional Information

Asteroid Belts	None
Planets in System	11 (1 gas giant)
Orbital Distance	73,000,000 km
Axial Tilt	21 deg
Year Length	137 standard days
Day Length	23 standard hours
Planetary Diameter	11,000 km
Surface Gravity	0.84G (Dense Core)
Mean Temperature	13 deg C
Hydrosphere	70%

**Culture** Commonality Culture World (neo-Franchian) currently in Stage III Cultural Integration: Acculturation.

The capital of the Darradine Rim octant and Darradine Restoration subsector, Ajeux is a terraformed garden world first colonised by slowship which has recently (75 years ago) rediscovered its ancient Franchian roots. It's now one of the Commonality's culture worlds, where strong and energetic cultures are carefully nurtured and enhanced. Many consider the turbulent cultural melee of Ajeux life to be affectation, but others

believe it'll become a vibrant powerhouse of art and culture. The Ajeux Games are already a subsector-wide institution.

Ajeux has a mild climate and strong maritime traditions. Its capital, Montparle, stands on the coasts of the great Pacific Sound, famous for its skyscrapers, seafood (including some impressive flying fish), and architecture.

## Amida

Fringe World Ancient Colony with Beautiful Ring System



Amida is a hot, tropical world. It rotates extremely slowly, taking 34 standard days to complete a day-night cycle - the "Long Day" and "Long Night" - with profound implications for the ecosphere. Plants are dormant every 17 standard days, animals change behaviour patterns, and non-tropical latitudes have enormous storms. Amidan civilization clusters around the calmer equator, despite the heat.

Amidans live a 26-hour diurnal "Cycle" of 8 hours sleep, 8 hours work, and 10 hours non-work: there are 16 Cycles in an Amidan day period and 16 by night. An Amidan "week" is 8 Cycles; there are 4 such "weeks" per Amidan "day". Treat an Amidan "day" as a conventional month: half the month is dark, half light. Even during the Long Night there is usually some light from Amida's second and third distant "suns", which appear as little more than extremely bright stars.

The first week of light or darkness is when Amida's storms occur; things are calmer at equatorial latitudes, but still this is when the planetary capital of Daisetta gets most of its weather, including blizzards towards the end of the first week of darkness. During the second week of each day or night period temperatures drop or rise sharply, although the weather is calmer, with cold, clear and frosty weather at night, and sweltering, almost unbearable heat by day (generally a holiday period for relaxing and staying in cooler areas). Tourists and offworlders often have difficulty adjusting to this attenuated diurnal period, and drugs are available for "Amidan star-lag".

Amida lies on the border of the Q-Zone, and is still reeling from being contacted 30 years ago. Originally a Balkanized world of many "nations", it is now struggling with an embryonic world government. Intrigue and political infighting is intense, and the Commonality Embassy has its hands full. A Temple of Universal Mind has been established in Daisetta, named the "Academy of Commonality Studies" to avoid clashing with the Amidans' neo-Buddhistic religion. A relic xenomorph race of pithecines called the Kaskai lives in the deep jungles, revered by the Amidans as part of this "God-Under-A-Tree" religion: this reverence has been a vector for introducing Commonality ideas, and Daisetta has a sizable population of Commonality xenomorphs.

Daisetta - the City of Spires - is famed for its tree-lined avenues, spacious feel, and mystical bent. Although most of Amida is relatively untouched by the Expansion, Daisetta is quickly becoming a popular if exotic destination.

Amidans have a standard build, with ruddy and dark brown skin tones and brown or black hair, divided into several racial groups. The women of Daisetta are very exotic and renowned for their beauty. Planetary population is only 20 million, concentrated in the highlands with isolated nation-states, small families, and a non-mechanized society engaged in small-scale agriculture. "Suburbs" are very dispersed, and Amidan cities are small.

See **Chapter Eleven: The Black Zone** for more details on Amida.

<b>AMIDA II</b>	<b>Class-8 Terrestrial Planet: ring system, no moons</b>
Primary Terrain	Mixed (Garden World)
Atmosphere	Breathable (0.8 atm: N <sub>2</sub> 72%, O <sub>2</sub> 18%, H <sub>2</sub> O 5%, Noble 4%, Trace: CO <sub>2</sub> , CH <sub>4</sub> )
Population	Great (+4): 20 million (90% Daisetta human, 7% Kaskai xenomorph, 3% Commonality xenomorph and human)
Spaceport Facilities:	Average (+1): Daisetta Down (Scale-6 (Enormous) Ground Facility); Commonality Orbital Sensor Station (Scale-4)

### Planetary Skills

Diplomacy	Superb (+5): court of the Sultan of Daisetta
Resources (wealth)	Good (+3)
Resources (materials)	Good (+3)
Resources (industrial)	Mediocre (+0): agricultural world
Military Capability	Mediocre (+0): pacifist culture
Planetary Security	Average (+1): cadre of Commonality xenomorphs
Tech Level	Good (+3): Age of Biotech
Trade Level	Average (+1): low-level trade in luxuries and agricultural products
Embargo	Average (+1): mostly on armaments and items offending cultural sensibilities

### Planetary Aspects

Planetary	Independent World w. Embassy (Monarchy)
Government	
Parent Star	K8V main sequence star (in triple star system)
Classification	
Ancient Slowship Colony	
Mystical world of spires and tropical rainforests	
Xenomorphs are revered and respected here	
Religion of the God-Under-A-Tree	
The Long Day and Long Night of Amida	
Limited Mindscape Access: no GMI	
There are three suns!	

### Additional Information

Asteroid Belts	5
Planets in System	7 (1 gas giant)
Orbital Distance	30,000,000 km
Axial Tilt	24 deg
Year Length	44 standard days
Day Length	815 standard hours (34 standard days)
Planetary Diameter	16,000 km
Surface Gravity	1G (Dense Core)
Mean Temperature	30 deg C
Hydrosphere	63%

<b>Culture</b>	Currently in Stage II Cultural Integration: Normalization
----------------	---



## Belawis

Frozen Homeworld of the Snowpeople

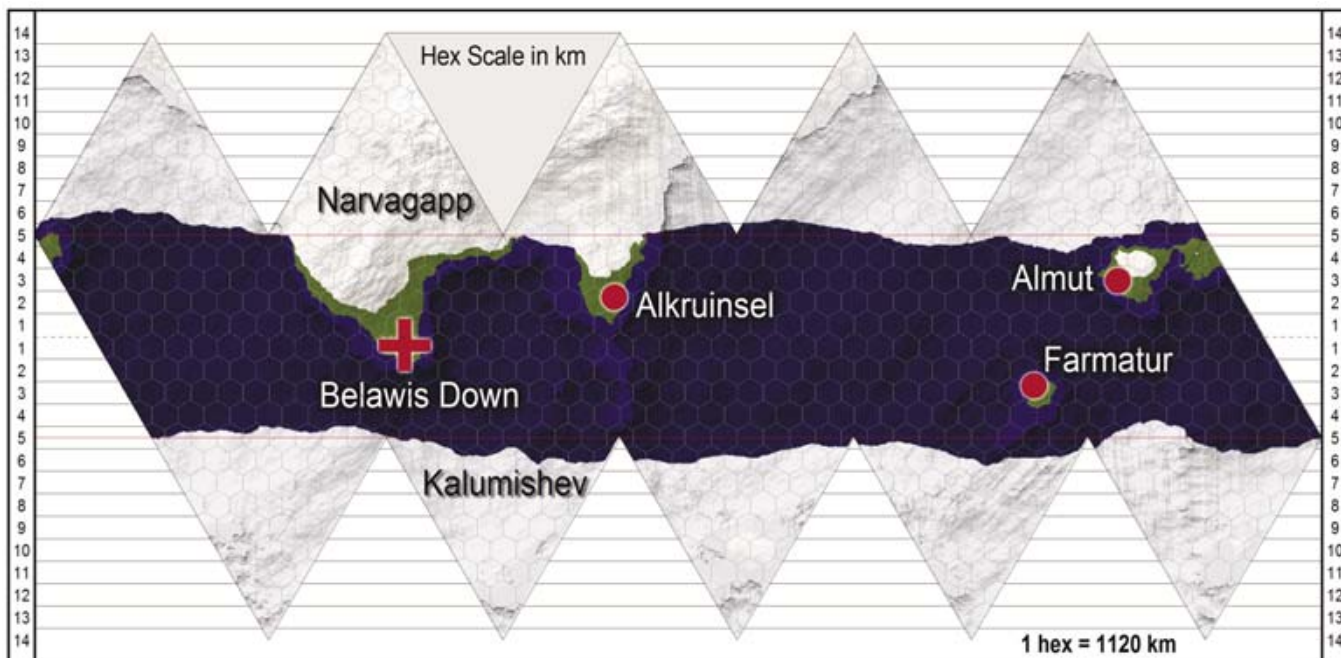

The Snekket are the snowpeople of Belawis, a frozen world with a forbidding ecosystem. Hairy, white-furred hominids descended from geneered colonists from the First Age of Space, the Snekket were contacted in the early years of the Expansionary Era. Although few offworlders show interest in this icebound planet, the Snekket themselves are keen to travel throughout the Commonality; while ill able to tolerate warm climates, their cold-world endurance makes them perfect for deep-space mining and cold-world combat ops. The Snekket frequently refer to themselves as “abominable,” apparently an obscure and very ancient joke.

Belawis has embraced Commonality culture enthusiastically since contact, and its traditions are changing. Belawisi society is feudal, Snekket communities bound by tradition to territories owned by a hardy aristocratic class. It’s prestigious for aristocratic courts to send regiments of “guards” offworld to serve the Commonality, in return for trade luxuries and increased influence.

## Cham-Fida Diu-Wayn Planets

Stellar Primary	Stellar Anomaly / Navigational Hazard
Planets in System	4
Planetary Aspects	
Malicious inhuman intelligence of vast and terrifying scale	
Vivid nightmares - no one stays here long!	

One of the most unusual planetary arrangements in Human Space, this four-world rosette is a known navigation hazard, avoided by all astrogators except the occasional probe from the Commonality Research Facility “Telemachus Station” a light year away. The Cham-Fida Diu-Wayn planets have a

### Scenario hook: Cold Steel

The PCs have been sent to find out why Scyldvik, an isolated earldom in the northern fjords, has taken its shipment of prestigious blaster rifles but not returned its contingent of troops for the Armed Forces Instrumentality. On arrival they’re met with extreme hostility; the old earl is dead, and his young successor and his barbarous court want nothing to do with these weak and dishonourable offworlders!

Scyldvik needs a reminder that the Commonality is strong, and honourable - but also friends to the snowpeople. But how?

sinister reputation. It’s theorised they’re the dwelling place of a powerful and malevolent interstellar intelligence; all who travel to these worlds meet with death, often at their own hands. Existing data on the worlds comes from probes which have made it through; what remains unclassified shows four planets of an unearthly beauty in a clearly artificial rosette. Strange fluorescences swirl around the cluster, an unforgettable yet chilling sight.



<b>BELAWIS I</b>	<b>Class-8 Terrestrial Planet: no moon</b>
Primary Terrain	Tundra (Barren)
Atmosphere	Breathable (1.2 atm: N <sub>2</sub> 68%, O <sub>2</sub> 24%, H <sub>2</sub> O 3%, Noble 3%, CO <sub>2</sub> 1%, Trace: N <sub>2</sub> O)
Population	Great (+4): 100 million (99% Snekket hominid; <1% human; <1% synthetic; <1% xenomorph; <1% other)
Spaceport Facilities:	Average (+1): Belawis Down Spaceport (Scale-6 ground facility)

### Planetary Skills

Diplomacy	Average (+1)
Resources (wealth)	Fair (+2)
Resources (materials)	Superb (+5): mines of heavy ores (including smaller Zanthrium deposits)
Resources (industrial)	Fair (+2): ore extraction, some processing
Military Capability	Average (+1): enthusiastic, but dispersed and badly-coordinated
Planetary Security	Mediocre (0)
Tech Level	Great (+4): First Age of Space
Trade Level	Good (+3): regular ore shipments, agricultural imports
Embargo	Mediocre (+0): No Embargo

### Planetary Aspects

Planetary	Commonality Member World (Feudal)
Government	
Parent Star	MV main sequence star
Classification	
Frozen world of ice and snow	
Homeworld of the hairy Snowpeople	
Ancient Slowship Colony	
Humans are a minority here!	
Best and most lethal skiing in the subsector!	
Global Mindscape Instance	

### Additional Information

Asteroid Belts	0
Planets in System	7 (1 gas giant)
Orbital Distance	8,500,000 km
Axial Tilt	22 deg
Year Length	11 standard days
Day Length	26 standard hours
Planetary Diameter	16,000 km
Surface Gravity	1.2G (Dense Core)
Mean Temperature	-26 deg C
Hydrosphere	80%

<b>Culture</b>	Currently in Stage II Cultural Integration: Normalization
----------------	---

# Chardos

Zanthrium Mines on a Gas Giant moon

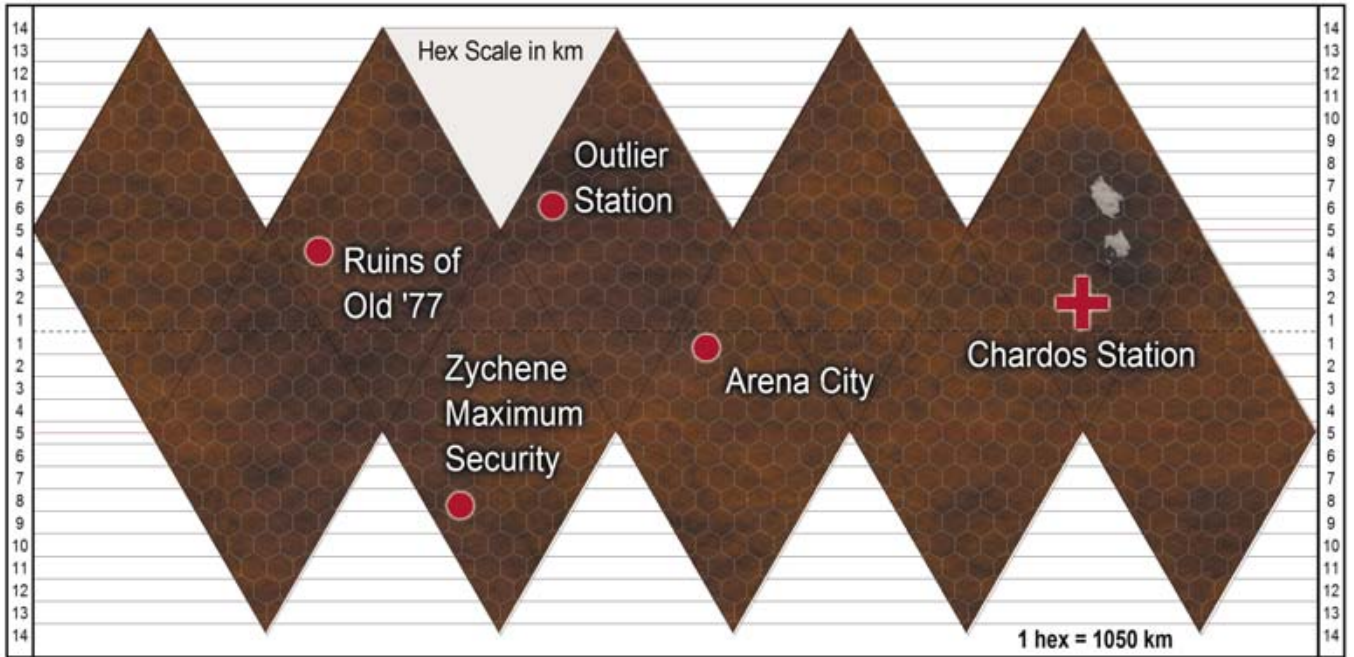

Chardos IV is a huge, brownish-red gas giant, with a dense moon rich in zanthrium; its mines are infamous throughout the sector, as the almost continuous moonquakes make mining in Chardos' huge mechanical digger "Worms" hazardous indeed. Natives are thickset, independent, and tough, complemented by an Ursoid xenomorph minority who also make excellent miners.

Morbius Metals governs Chardos, running the mining operations and the rough and ready Chardos Station, the moon's principal settlement. Everything on Chardos is low-slung and robust to resist the quakes, the high winds buffeting the surface, and the sandstorms (which can last weeks). Most of the population are Morbius Metals employees, either miners or managers, or service, support, and "entertainment" workers, though the high-G means few pleasure workers stay long.

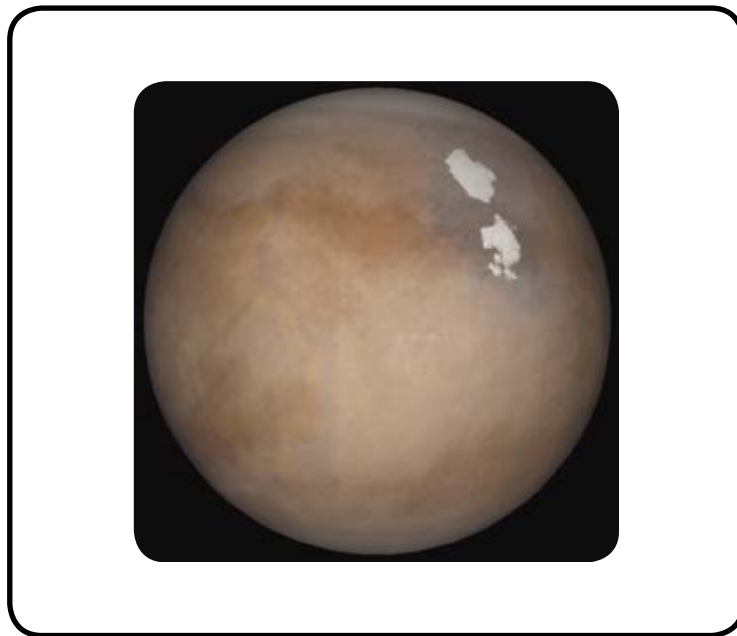



**CHARDOS A-IVa      Class-8 Terrestrial Planet: moon of system gas giant**

Primary Terrain	Desert
Atmosphere	Incapable of supporting life (1.95 atm: CO <sub>2</sub> 72%, N <sub>2</sub> 16%, Ne 6%, Ar 4%, Trace: H <sub>2</sub> O)
Population	Fair (+2): 75,000 (60% human; 20% synthetic; 15% xenomorph; 5% other)
Spaceport Facilities:	Mediocre (+0): Chardos Station (Scale-5 ground facility)

**Planetary Skills**

Diplomacy	Mediocre (+0)
Resources (wealth)	Average (+1)
Resources (materials)	Superb (+5)
Resources (industrial)	Fantastic (+6): Zanthrium ore mining and processing
Military Capability	Mediocre (+0)
Planetary Security	Average (+1)
Tech Level	Great (+4): First Age of Space
Trade Level	Good (+3)
Embargo	Mediocre (+0): No Embargo

**Planetary Aspects**

Planetary Government	Commonality Member World (Corporate Control)
Parent Star Classification	F8V main sequence star (in triple star system: M-class and close binary)
The Mines of Chardos IV	
High-G World of Earthquakes!	
The Great Mechanical Digger Worms	
Thickset, independent, and tough natives	
Global Mindscape Instance	

**Additional Information**

Asteroid Belts	1
Planets in System	3 (1 gas giant)
Orbital Distance	6,360,000,000 km
Axial Tilt	11 deg
Year Length	236.28 standard years
Day Length	14 standard hours
Planetary Diameter	15,000 km
Surface Gravity	1.5G (Very Dense Core)
Mean Temperature	-83 deg C
Hydrosphere	0%

<b>Culture</b>	Commonality Standard: Stage IV (Cultural Integrity)
----------------	---

## Chinhice

Ancient Shinean Culture World

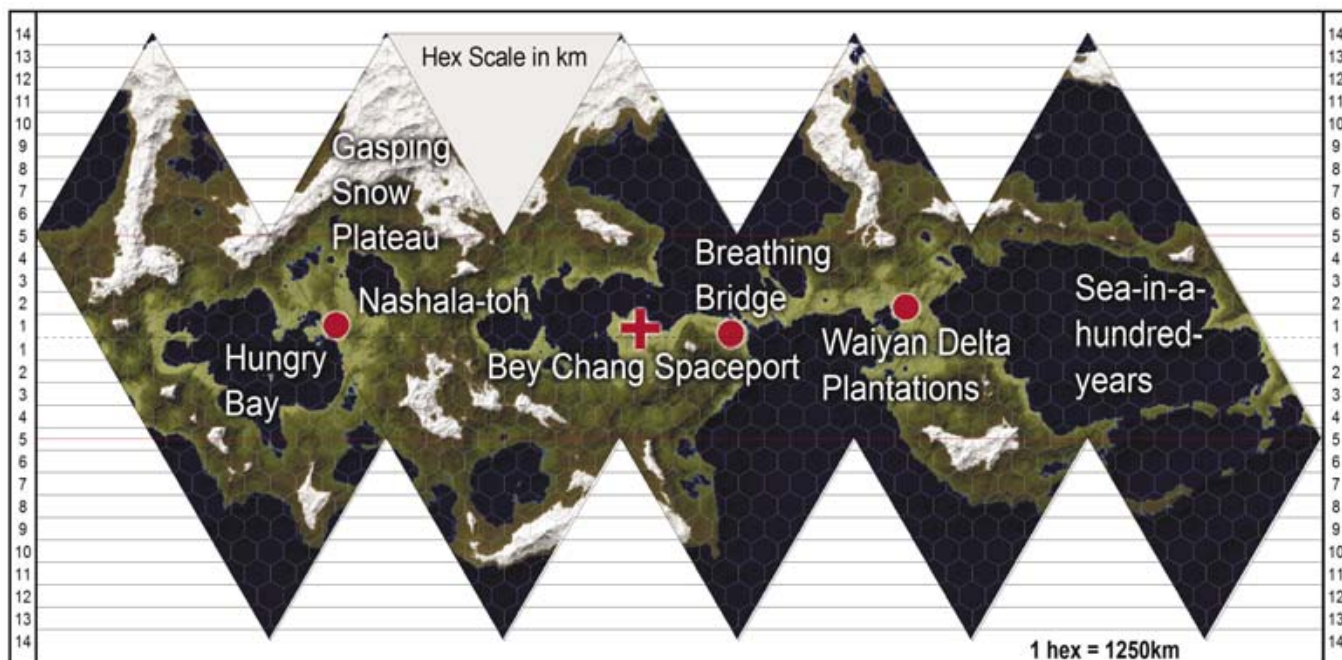

Chinhice is an ancient Shinean colony, home to many strange and inscrutable ways. Originally colonised more by force of numbers than organisation, it has remained true to its origins, with one of the highest agricultural world populations in the Rim Sector. Rigidly regimented, Chinhicean society is a constant battle with the planetary environment, whose right-hand amino acid-based ecosystem supports none of the bacteria to allow terrestrial-analogue organisms to thrive, or even to decompose. Chinhicean rice paddies are carefully sterilized before planting, and "seeded" with specially brewed microorganic fertiliser to provide the base soil stratum in which edible rice can grow. Everything is recycled into this "sowdirt", including the dried and processed bodies of the Chinhicean dead – nothing goes to waste.

Chinhice has high levels of atmospheric  $\text{CO}_2$  which are lethally toxic to normal humans; all native Chinhiceans are geneered to cope, but visitors require a combined compressor / scrubber called a Breather. People dwell mostly in the lowlands, where oxygen levels are higher.

Visitors to Chinhice are forbidden to leave Bey Chang spaceport and its domed startown without an official guide, and arrivals are carefully screened to prevent them importing "unauthorised" Breather masks. While spaceport tech levels are roughly Commonality standard, those on the planet proper are considerably lower than the Good (+3) average would imply.

Chinhice is a geologically young planet, in transition from a  $\text{CO}_2$  to  $\text{O}_2$  atmosphere. The planet supports lots of native sea life, but little on land, mostly just bacteria and blue-green algae mats covering the coastal areas. There's little ozone layer, and UV and mutation levels are high.

The Chinhiceans have had several thousand years to convert large areas of their planet to terrestrial plant life, particularly in the lowlands; the uplands are still barren and fairly lifeless. In the seas, genurgically-modified algae mats are now producing more  $\text{O}_2$ , which should result in a thin but breathable atmosphere for offworlders in the next few hundred years.



**CHINHICE V****Class-8 Terrestrial Planet: ring system; no moon**

Primary Terrain	Steppe (Barren)
Atmosphere	Semi-breathable (1.09 atm: N <sub>2</sub> 69%, O <sub>2</sub> 15%, CO <sub>2</sub> 10%, Noble 3%, H <sub>2</sub> O 2%, Trace: CH <sub>4</sub> , SO <sub>2</sub> )
Population	Superb (+5): 4 billion (100% adapted human)
Spaceport Facilities:	Great (+4): Bey Chang Spaceport (Scale-7 ground facility and Scale-6 orbital facility (space station plus dry dock))

**Planetary Skills**

Diplomacy	Average (+1)
Resources (wealth)	Average (+1)
Resources (materials)	Superb (+5): agricultural products, esp. Rice
Resources (industrial)	Fair (+2)
Military Capability	Good (+3)
Planetary Security	Fair (+2)
Tech Level	Good (+3): Age of Biotech
Trade Level	Superb (+5): agricultural exports, high-tech imports
Embargo	Good (+3): imposed by Chinhicean government

**Planetary Aspects**

Planetary Government	Commonality Autonomous World (Dictatorship)
Parent Star	K4V main sequence star
Classification	
Ancient Shinean colony	- strange and inscrutable ways
High CO <sub>2</sub> atmosphere	means visitors need to wear Breathers
Weird ecosystem	- terrestrial organisms cannot even decompose
Irrigation Channels	Everywhere - Don't Waste Water!
High-population intensive farming	
Rigidly regimented society	
Nothing goes to waste!	
Restricted Mindscape Access	

**Additional Information**

Asteroid Belts	3
Planets in System	7 (1 gas giant)
Orbital Distance	64,000,000 km
Axial Tilt	7 deg
Year Length	138 standard days
Day Length	41 standard hours
Planetary Diameter	18,000 km
Surface Gravity	1.2G (Moderately Dense Core)
Mean Temperature	10 deg C
Hydrosphere	40%

**Culture**

Commonality Culture World (Shinean) in Stage IV: Cultural Integrity.



# Delebor

Chembu Genurgy Corporacy World of Painted Deserts

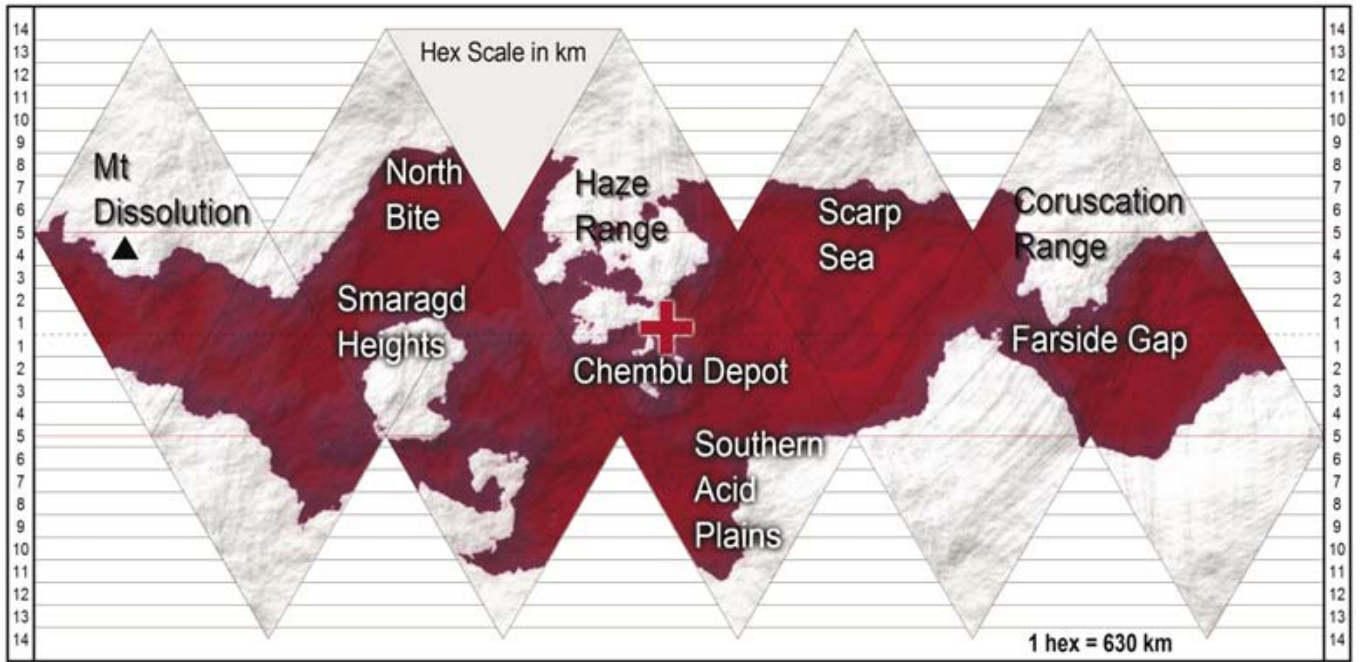

Delebor is a dry, lifeless world with an acidic atmosphere. Its "painted deserts," dotted with acidic pools, are lethally beautiful. Chembu Genurgy own the planet, and have many research and production facilities growing new products and organisms from the planet's raw materials. The Soup Farmers of Delebor, the lowest rank of CG employees, are notoriously restive, and CG maintain their own private police force to club them down when required.

Chembu Depot is Delebor's main settlement, accounting for a third of its population; the rest live in far-flung "Soup Farms,"

isolated homesteads or small settlements stretching all around the planet. Most structures are underground: the thick, yellowish atmosphere is corrosive, and a large part of a Soup Farmer's day consists of repairing their processing plants.

Air transport is easy in Delebor's thick atmosphere, and heavy-duty grav tankers make weekly or monthly pickups in outlying areas. These enormous "Soup Tankers" contain supplies, shops, and are a Soup Farmer's only way to get to Chembu Depot and off-world - putting them at the corporate government's mercy.



**DELEBOR V****Class-8 Terrestrial Planet: 1 moon**

Primary Terrain	Desert
Atmosphere	Acidic (6.8 atm: N <sub>2</sub> 38%, NO <sub>2</sub> 32%, NO 12%, CO <sub>2</sub> 7%, HNO <sub>3</sub> 5%, Ne 4%, Ar 2%)
Population	Good (+3): 250,000 (70% human; 10% Chembu hominid; 15% xenomorph; 5% other)
Spaceport Facilities:	Mediocre (0): Chembu Depot (Scale-5 ground facility)

**Planetary Skills**

Diplomacy	Average (+1)
Resources (wealth)	Fair (+2)
Resources (materials)	Great (+4)
Resources (industrial)	Fantastic (+6): acid and organic compound extraction and processing
Military Capability	Mediocre (+0)
Planetary Security	Fair (+2)
Tech Level	Fantastic (+6): Second Age of Space
Trade Level	Superb (+5): finished and semi-finished genurgy products
Embargo	Mediocre (+0): No Embargo

**Planetary Aspects**

Planetary	Commonality Member World (Corporate Control: Chembu Genurgy)
Government	
Parent Star	K9V main sequence star
Classification	
Weird Chembu world	
Lethal beauty of the Painted Deserts	
Pools of acids everywhere!	
The restive Soup Farmers	
Heavy-handed private police force	
Fairly low gravity	
Global Mindscape Instance	

**Additional Information**

Asteroid Belts	1
Planets in System	11 (3 gas giants)
Orbital Distance	40,000,000 km
Axial Tilt	6 deg
Year Length	66 standard days
Day Length	340 standard hours
Planetary Diameter	9,000 km
Surface Gravity	0.8 G (Moderately Dense Core)
Mean Temperature	26 deg C
Hydrosphere	0%

**Culture**

Commonality Corporate (Chembu Genurgy) in Stage IV: Cultural Integrity

# Drefnia

Famed Planet of the World Trees

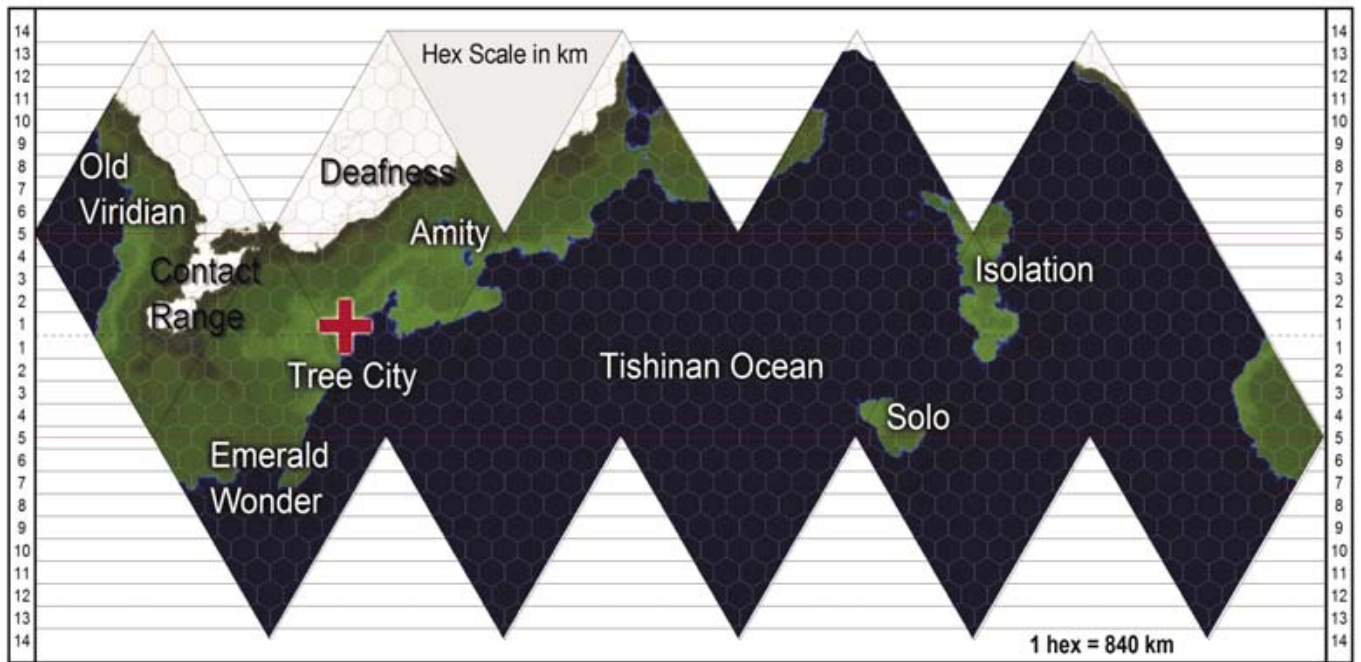

The Mozgooms of Drefnia are famous throughout the Commonality – the World Trees. Thousands of metres tall, with root systems covering thousands of square kilometres, they are one of the few vegetable intelligences ever encountered. Together with the Zybotos, symbiotic motile fungi, the Mozgoom form a single, world-spanning civilization. Tree City is where the Commonality and the Mozgoom meet, though rare scholars, ambassadors, and traders are permitted further, and where selected Zybotos leave their world to travel with agents of the Commonality, a

relationship which forms the basis for a strange kind of trade, as the Zybotos are able to activate latent psionic powers in their human companions.

Drefnia's high CO<sub>2</sub> content puts the atmosphere on the edge of breathability, but most humans get by without breather masks for a month or so (although they may get terrific headaches and nausea for the first few days until they acclimatize). The Commonality maintains a SCI Force presence in the system; the planet itself is quarantined.





<b>DREFNIA A-III</b>	<b>Class-8 Terrestrial Planet: ring system; no moon</b>
Primary Terrain	Jungle
Atmosphere	Breathable (0.9 atm: N <sub>2</sub> 64%, O <sub>2</sub> 25%, H <sub>2</sub> O 4%, CO <sub>2</sub> 3%, Noble 3%, Trace: CH <sub>4</sub> , NO <sub>2</sub> )
Population	Fair (+2): 15,000 humans and others at Tree City; also, 2.5 million Zybote and unknown population of Mozgoom in deep jungle
Spaceport Facilities:	Mediocre (0): Tree City (Scale-5 ground facility) Average (+1): SCI-Force Quarantine Facility (Scale-6 orbital facility (space station plus dry dock))

### Planetary Skills

Diplomacy	Good (+3): World Tree Council at Tree City
Resources (wealth)	Poor (-1): Intellectual and psionic research resources
Resources (materials)	Fair (+2): Undeveloped agricultural world
Resources (industrial)	Abysmal (-3): No industry
Military Capability	Abysmal (-3): No defences
Planetary Security	Superb (+5): SCI-Force Quarantine
Tech Level	Abysmal (-3): Post-animal organization only. No technology.
Trade Level	Abysmal (-3)
Embargo	Good (+3): Quarantined world

### Planetary Aspects

Planetary	Commonality Aligned World (Vegetable intelligence communion)
Government	
Parent Star	G5V main sequence
Classification	
Giant thinking trees bigger than skyscrapers!	
Weird flying fungi can read your mind!	
Quarantined world - it's forbidden to leave Tree City, and we can't guarantee your safety.	
Scientists' paradise - cool contemplation, cultural research, and strange psionic secrets everywhere.	
Spies could be everywhere!	
One of the best kept secrets in the galaxy.	
Local Mindscape in Tree City only; no GMI.	

### Additional Information

Asteroid Belts	1
Planets in System	13 (3 gas giants)
Orbital Distance	85,000,000 km
Axial Tilt	31 deg
Year Length	160 standard days
Day Length	696 standard hours
Planetary Diameter	12,000 km
Surface Gravity	0.92G (Dense Core)
Mean Temperature	18 deg C
Hydrosphere	60%

<b>Culture</b>	Drefnian. Limited Commonality Influence (Stage I Cultural Integration: Contact).
----------------	--

## Zybotes

Zybotes are human-sized, roughly diamond-shaped floating creatures similar in shape to a stingray. Their primary sense is sonar, and they have 2-metre long manipulating tentacles around their frontal "mouth" (in fact an absorbent palate) and a barb thrower in their flexible "tail"; they also have psionic powers such as telepathy and telekinesis. Sometimes found on "fact-finding" missions aboard Commonality planeships, they provide human companions with limited psionic powers. The stats below are for an independent Zybote. Zybote companions can also be statted using the Starblazer Companion rules, with Advances like Independent, Communication, and the Skills below.

### Typical Zybote

**Physical Stress:** □□□□□

**Composure Stress:** □□□□□

**Fate Points:** 5      **Scale:** Small (2)

**Consequences:** Up to 3 Consequences

**Encounter Size:** 1

#### Skills

Good (+3)    Fly

Fair (+2)    Telepathy      Telekinesis

Average (+1)    Fists      Alertness

Barb Thrower

#### Aspects

Motile fungus

Psionic and symbiotic sentience

Alien thought processes

Travelling in the Commonality to learn

Minor Weaknesses: Sonic weapons, salt water, radioactivity

#### Stunts

Flight [Fly]

Probe [Telepathy]

Psionic Symbiote [Telepathy]\*

Active Sonar [Alertness]

Extra-sensory Digits [Alertness]

#### Equipment

May "carry" various Commonality items it is "investigating" (a recent Zybote nicknamed Rummage aboard the NCS Far Voyager developed an inexplicable attachment to the ship's coffee maker, and became distressed whenever separated from it. Rummage has since returned to Drefnia, and the Far Voyager has found a new coffee maker...)

\*Allows a human to develop a Psionic Skill (requires an Advancement) when in the same Zone as the Zybote. Maximum level is the Zybote's Telepathy Skill level.

# Furnace

Corporacy-controlled Desert Hotworld

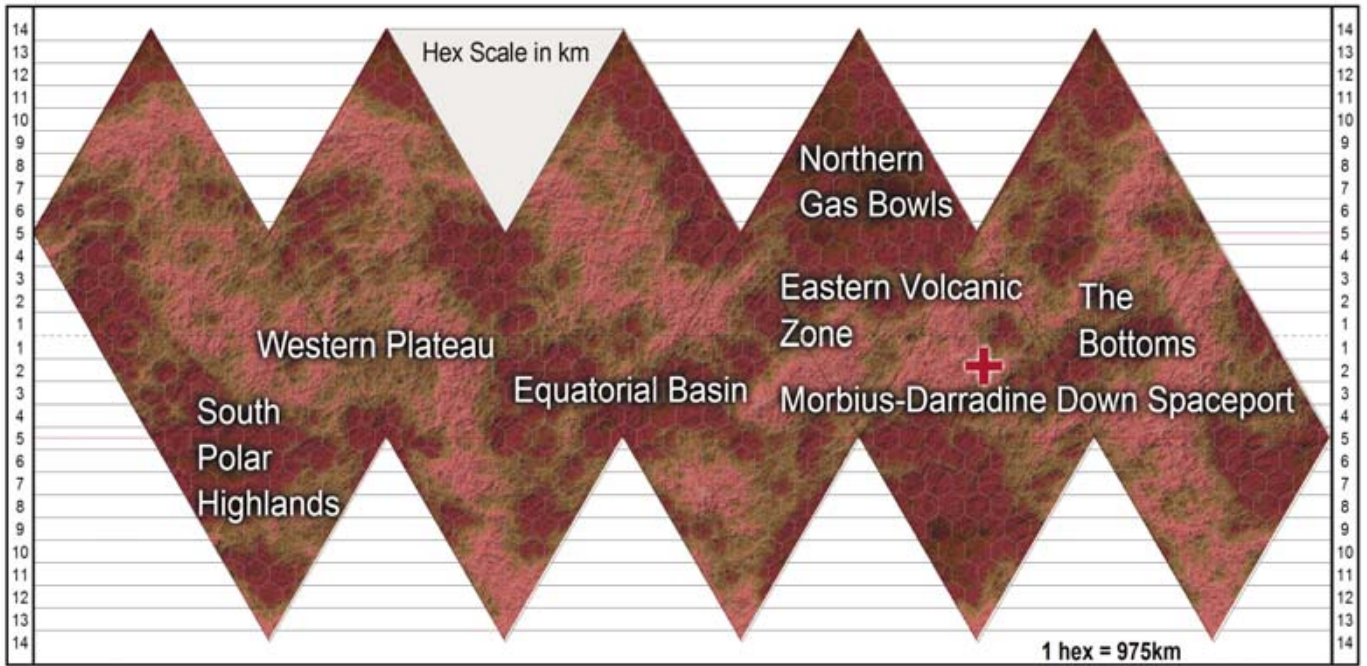

Victim of a runaway greenhouse effect, Furnace boasts atmospheric pressures which would squash an unprotected man flat in milliseconds. It's a murky, torrid world, with high axial tilt, and host to murderous hurricanes and acid storms. No one in their right mind would visit this place, were it not

for the raw materials – including quartz, aluminium oxide (and ruby and sapphire deposits), sulphates, and molten or near-molten metals and heavy ores – simply lying around for the taking. This extremely challenging environment is home to Darradine Industries and Morbius Metals refineries.

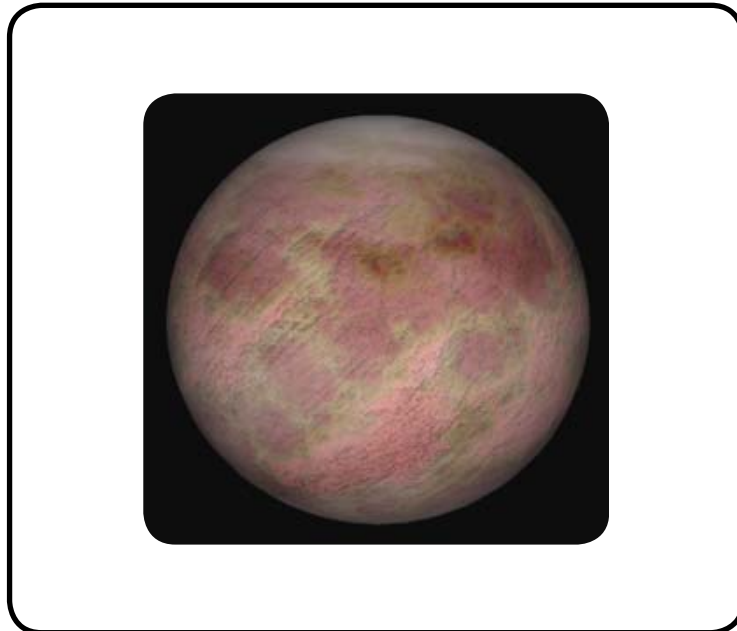



**FURNACE II****Class-8 Terrestrial Planet: 1 moon**

Primary Terrain	Hotworld Desert
Atmosphere	Corrosive: incapable of supporting life (57.48 atm: CO <sub>2</sub> 72%, Cl 12%, N <sub>2</sub> 11%, H <sub>2</sub> SO <sub>4</sub> 5%)
Population	Good (+3): 100,000 (60% human; 35% xenomorph; 5% other)
Spaceport Facilities:	Mediocre (0): Morbius-Darradine Down (Scale-5 ground facility)

**Planetary Skills**

Diplomacy	Average (+1)
Resources (wealth)	Great (+4): Corporacy complexes on-world
Resources (materials)	Superb (+5): Extensive deposits
Resources (industrial)	Superb (+5): Mineral and metal extraction and processing facilities
Military Capability	Average (+1)
Planetary Security	Average (+1)
Tech Level	Great (+4): First Age of Space
Trade Level	Great (+4): import of heavy vehicles, food, luxuries; export of minerals, metals
Embargo	Mediocre (+0): No Embargo

**Planetary Aspects**

Planetary	Commonality Member World (Corporate Control: Darradine Industries and Morbius Metals)
Government	
Parent Star	G8V main sequence star
Classification	
Runaway greenhouse effect	
Atmospheric pressure would squash a man flat in milliseconds	
Murky, torrid	
Murderous hurricanes and acid storms	
No one in their right mind would visit this place!	
Heavy Corporacy presence	
These workers need entertaining!	
Global Mindscape Instance	

**Additional Information**

Asteroid Belts	1
Planets in System	8 (2 gas giants)
Orbital Distance	50,000,000 km
Axial Tilt	20 deg
Year Length	72 standard days
Day Length	204 standard hours
Planetary Diameter	14,000 km
Surface Gravity	1.1G (Dense Core)
Mean Temperature	763 deg C
Hydrosphere	0%

<b>Culture</b>	Commonality Standard (Stage IV: Cultural Integrity)
----------------	---

# Galagole

Swamp World of Goggle-eyed Xenomorphs

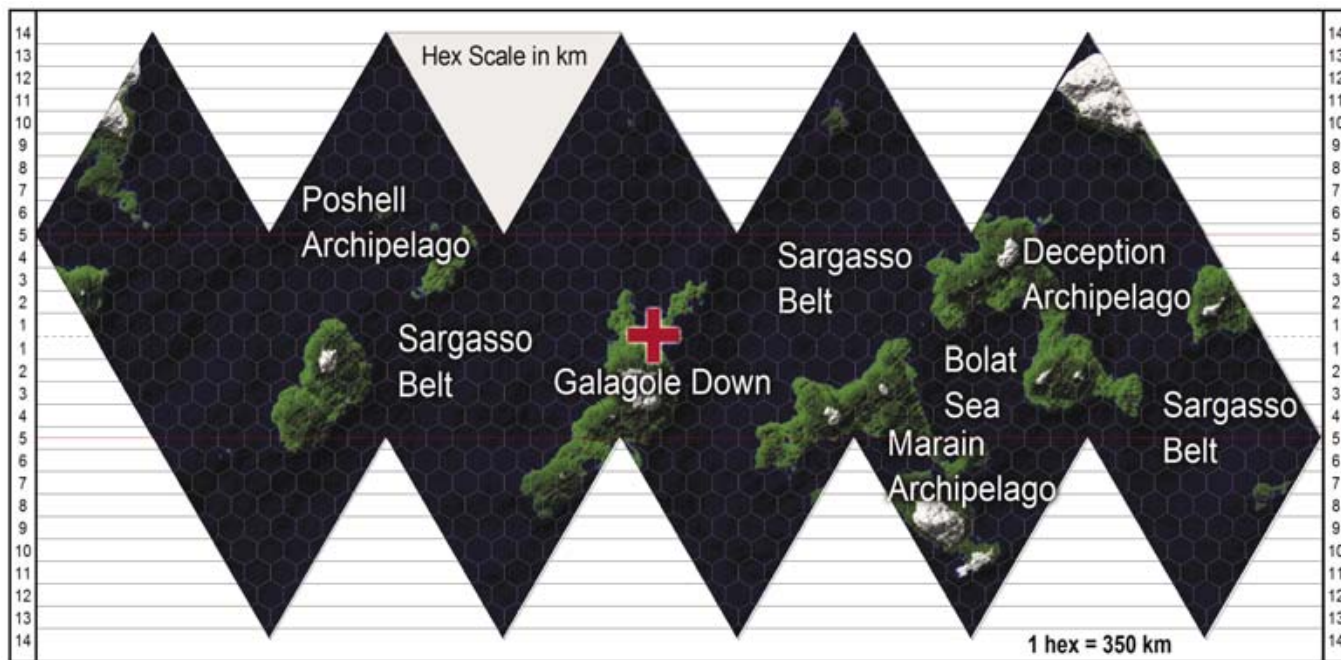

A sweltering swamp world and gas giant moon, Galagole is inhabited predominantly by amphibian xenomorphs – fattish, baldish, goggle-eyed humanoids with pallid, moist skin of a greenish hue. A poor, agricultural backwater, there's little to interest the visitor beyond the exotic cuisine. The Commonality maintains a secretive training base for amphibious commandos here, off-limits to practically everyone. While f-people dwelling close to Galagole Down seem reasonably civilised (if rustic), rumours persist of savage tribes in the deep swamps practising bestial cults and presiding over lost and hidden treasures; such rumours should of course be treated with skepticism.

Galagole's low-lying archipelagos and shallow seas make hover vehicles the best transport, although many f-people rely on vehicles pulled by the amphibious **vadakroffs** ("kroffies" for short). Preventing things rotting or rusting in Galagole's atmosphere is a perennial problem.

The f-people seem to be a type of xenomorph or hominid, but not necessarily a geneered one, raising uncomfortable

## Scenario hook: The Lost City

There've been stories of ancient ruins and lost treasures in the swamps of Galagole for years, and only cranks and treasure-hunters ever take them seriously. But in a waterfront bar a local f-person approaches the PCs, a trader with a regular run to the secretive Commonality commando base upriver. He offers them a treasure he got from the swamp tribes up there - a small statuette of a weird-looking starship, apparently made out of solid gold!

What are the Commonality commandoes doing in the deep swamp? Are they really just "training"? Could the rumours of treasure-laden ancient cities be true? And a starship!?

questions about their ancestry. Rumours abound about a native race dwelling in the deep swamps, dark and savage, with whom the early colonists somehow interbred.



**GALAGOLE A-IId**      **Class-8 Terrestrial Planet: moon of system gas giant**

Primary Terrain	Swamp
Atmosphere	Breathable (0.8 atm: N <sub>2</sub> 57%, O <sub>2</sub> 31%, Noble 6%, H <sub>2</sub> O 5%, Trace: CO <sub>2</sub> , CH <sub>4</sub> )
Population	Great (+4): 10 million (85% xenomorph; 10% human; 5% other)
Spaceport Facilities:	Poor (-1): Galagole Down Spaceport (landing strip)

**Planetary Skills**

Diplomacy	Poor (-1)
Resources (wealth)	Poor (-1)
Resources (materials)	Fair (+2): swamp-based agricultural products and exotic foods
Resources (industrial)	Mediocre (0)
Military Capability	Terrible (-2)
Planetary Security	Mediocre (+0)
Tech Level	Average (+1): Steam, electricity, and fusion plants.
Trade Level	Poor (-1)
Embargo	Average (+1): medium embargo

**Planetary Aspects**

Planetary	Commonality Aligned World (Mostly Lawless, Tribal)
Government	
Parent Star	K4V main sequence star in binary system
Classification	
This food is disgusting!	
Low gravity world	
These guys have really disturbing, fishy eyes...	
Hot, damp, sweltering swamp world	
Rumours of savage tribes in the deep swamp	
Local Mindscape in starport only; no GMI	

**Additional Information**

Asteroid Belts	2
Planets in System	8 (3 gas giants)
Orbital Distance	950,000 km from gas giant; 42,000,000 km from primary
Axial Tilt	14.9 deg
Year Length	16 standard days (around gas giant); 74 standard days (around primary)
Day Length	20 standard hours
Planetary Diameter	5,000 km
Surface Gravity	0.42G (Dense Core)
Mean Temperature	24 deg C
Hydrosphere	80%

<b>Culture</b>	Galagole in deep swamp; Commonality Standard influence around Galagole Down (Stage II: Normalization)
----------------	---



## Jemela

Come to the Romantic Jemelan Quartz Groves!

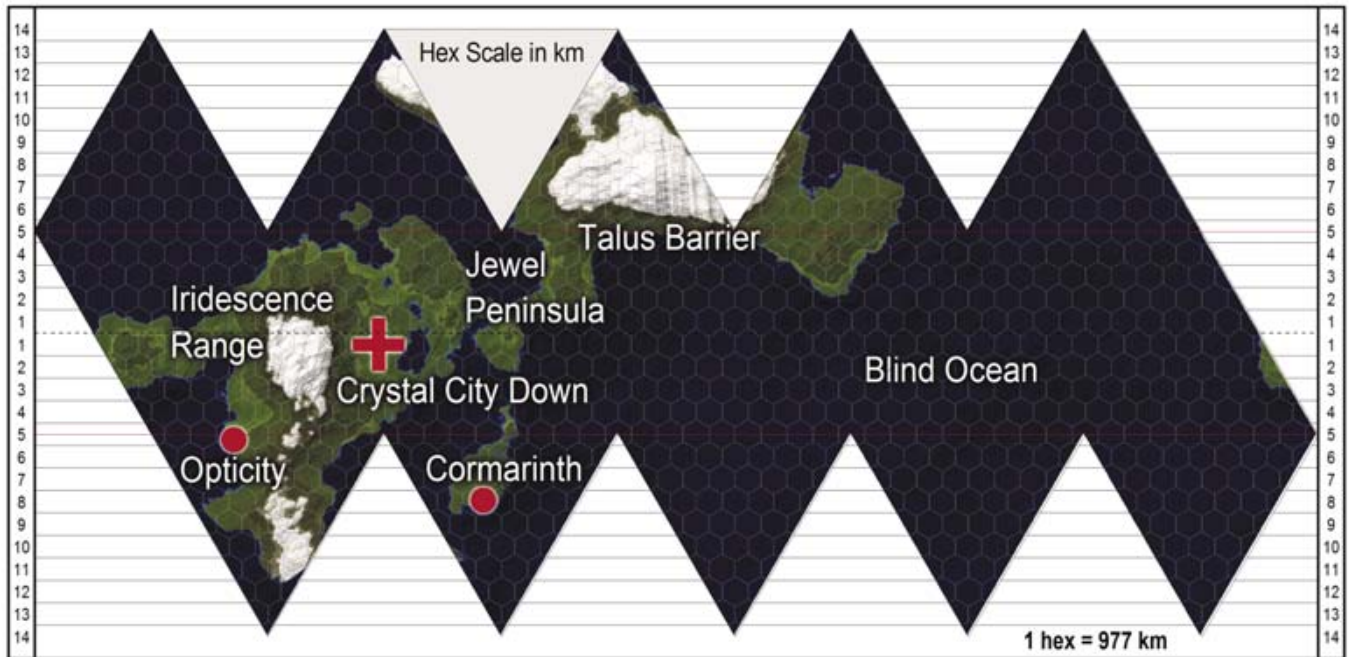

Jemela is a garden world, famed for its tides, flying animals, and some of the finest quartz deposits in the sector. Mai Ling Optics owns the planet, also exploiting its beauty for its tourism potential. Mining and refining is mostly done by

synthetics, workers acting as coordinators and technicians. The Jemelan Quartz Groves are said to be one of the most romantic spots for light years around, and many people come to marry beneath the gorgeous gas giant "Jewel" hanging in the Jemelan sky.



**JEMELA IIh****Class-8 Terrestrial Planet: moon of system gas giant ("Jewel")**

Primary Terrain	Garden World (Mixed)
Atmosphere	Breathable (1.44 atm: N <sub>2</sub> 67%, O <sub>2</sub> 23%, Noble 6%, H <sub>2</sub> O 3%, Trace: CO <sub>2</sub> , SO <sub>2</sub> )
Population	Great (+4): 250 million (50% human; 45% xenomorph; 5% other)
Spaceport Facilities:	Fair (+2): Crystal City Down (Scale-7 ground facility)

**Planetary Skills**

Diplomacy	Good (+3): good PR, good tourist relations
Resources (wealth)	Superb (+5): agriculture, Mai Ling Optics, plus tourism
Resources (materials)	Superb (+5): agricultural world with extensive quartz deposits
Resources (industrial)	Superb (+5): quartz extraction and processing facilities
Military Capability	Average (+1)
Planetary Security	Average (+1)
Tech Level	Fantastic (+6): Second Age of Space
Trade Level	Great (+4)
Embargo	Mediocre (+0): No Embargo

**Planetary Aspects**

Planetary	Commonality Member World (Corporate control: Mai Ling Optics)
Government	
Parent Star	K8V main sequence star
Classification	
Come and spend your honeymoon in the beautiful Quartz Groves of Jemela!	
Finest quartz deposits in the subsector	
Mai Ling Optics corporate world	
Synthetics do most of the hard work	
Global Mindscape Instance	

**Additional Information**

Asteroid Belts	1
Planets in System	7 (4 gas giants)
Orbital Distance	2,000,000 km from gas giant; 45,000,000 km from primary
Axial Tilt	2 deg
Year Length	24 standard days (around gas giant); 80 standard days (around primary)
Day Length	26 standard hours
Planetary Diameter	14,000 km
Surface Gravity	1.1G (Dense Core)
Mean Temperature	13 deg C
Hydrosphere	70%

<b>Culture</b>	Commonality Corporate (Stage IV: Cultural Integrity)
----------------	--

## New Howzat

Dying World with Mysterious Quarantined Ruins

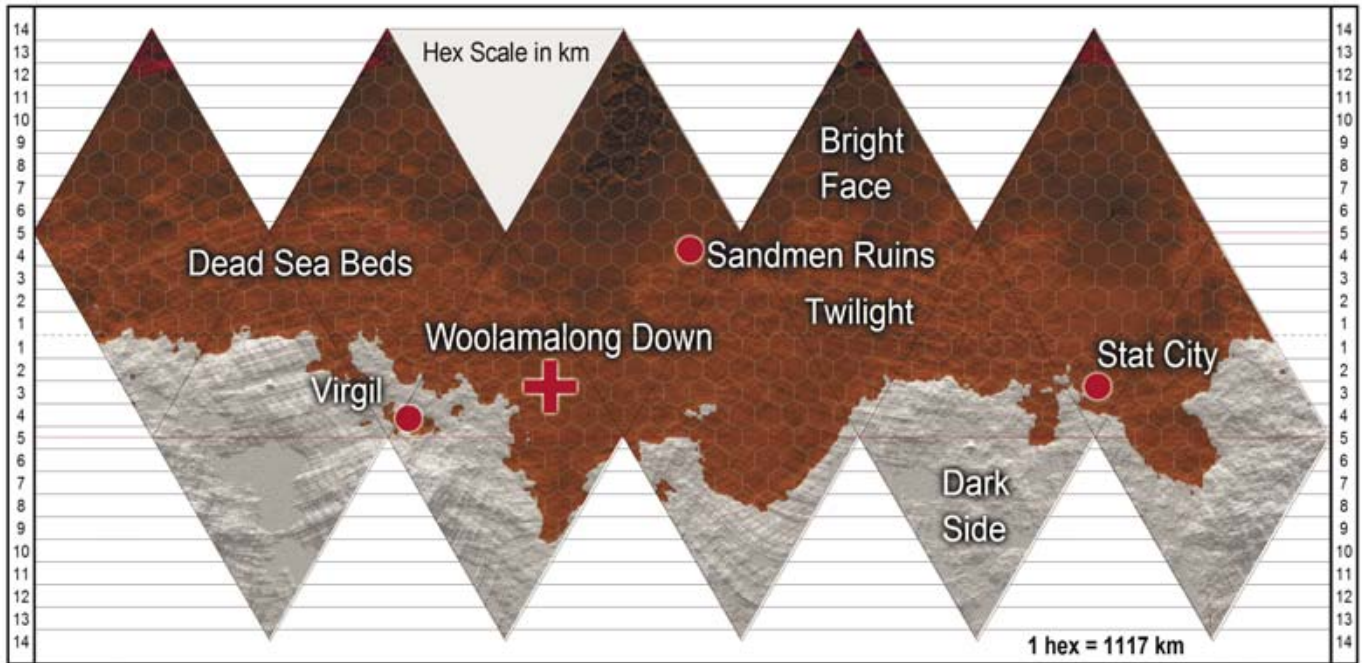

New Howzat has the most spectacular set of Predecessor ruins in the sector, scattered across the planet and around its Bright Face magma ocean and polar Dark Side icecap. The ruins were clearly once more extensive but have long since succumbed to erosion; evidence suggests New Howzat suffered major ecological damage in the last million years, including atmospheric denudation and a shift of the planetary axis. Today it's a dying world, a shattered biosphere struggling to survive on the dead sea beds of its habitable zone. Most soil has oxidised into red dust, although the thin atmosphere remains breathable with compressor / filter masks.

New Howzat has seen numerous archaeological expeditions since its discovery a century ago; the planet has little else to make it commercially viable. Its location on the Mindjammer Routes has created a rough, frontier colony at Woolamalong Down Spaceport, and considerable trade – some legal – passes through this lively if often dangerous world. The Commonality quarantine on the Howzat Ruins apart from a token "tourist zone" only seems to encourage all manner of charlatans and treasure hunters.

High levels of atmospheric helium suggest a technological culture using hydrogen fusion existed on New Howzat in the last million years. Its rings are theorized to be remnants of a moon destroyed in the same period.

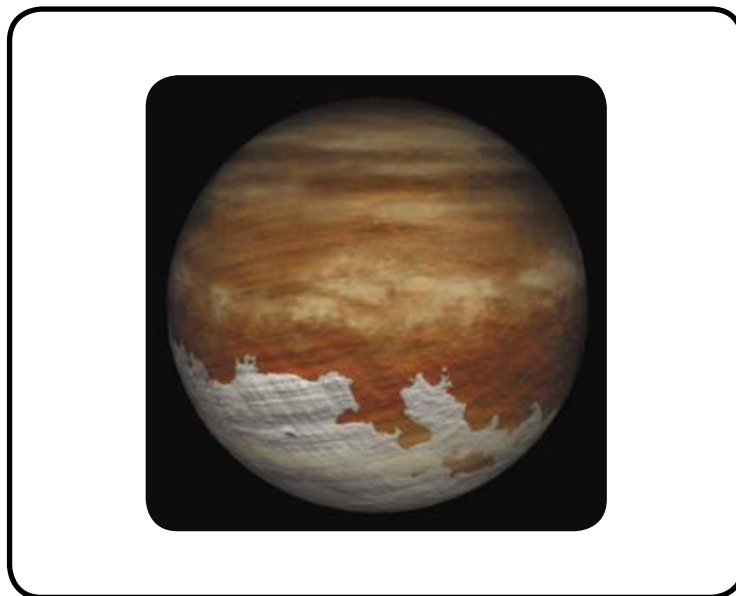



**NEW HOWZAT I****Class-8 Terrestrial Planet: tidally-locked, ring system, no moons**

Primary Terrain	Desert
Atmosphere	Breathable in habitable zone (thin atmosphere, breathable with compressor / filter masks: 0.42 atm (N <sub>2</sub> 59%, O <sub>2</sub> 35%, He 2%, Xe 2%, H <sub>2</sub> O 1%, Trace: CO <sub>2</sub> , SO <sub>2</sub> , H <sub>2</sub> O))
Population	Good (+3): 500,000 (variable, mixed)
Spaceport Facilities:	Average (+1): Woolamalong Down Spaceport (Scale-5 ground facility)

**Planetary Skills**

Diplomacy	Poor (-1)
Resources (wealth)	Poor (-1): Mostly generated by trade and unequally distributed.
Resources (materials)	Poor (-1)
Resources (industrial)	Poor (-1): Locally made personal shields.
Military Capability	Fair (+2): SCI Force Quarantine Station
Planetary Security	Good (+3): SCI Force quarantine
Tech Level	Fair (+2): Computer Age
Trade Level	Fair (+2): focussed on the Howzat Ruins. Import of personal shields.
Embargo	Good (+3): SCI Force quarantine

**Planetary Aspects**

Planetary	Commonality Quarantine World (Dictatorship)
Government	
Parent Star	M4V main sequence star
Classification	
Mysterious ruins of the ancient Predecessors!	
Tidally-locked world with Bright Face and Dark Side	
A red planet - a dying world	
Rough and tumble trading station	
Don't mess with the Commonality Quarantine!	
There's more to this place than meets the eye...	
Global Mindscape Instance	

**Additional Information**

Asteroid Belts	1
Planets in System	4 (2 gas giants)
Orbital Distance	4,000,000 km
Axial Tilt	90 deg
Year Length	4 standard days (89 hours)
Day Length	Tidally-locked (89 hours)
Planetary Diameter	16,000 km
Surface Gravity	1.18G (Medium Core)
Mean Temperature	5 deg C
Hydrosphere	3%

<b>Culture</b>	Commonality Standard (Stage IV: Cultural Integrity)
----------------	---

## Nimbu Prime

Double-planet System with Classified Commonality Research Station

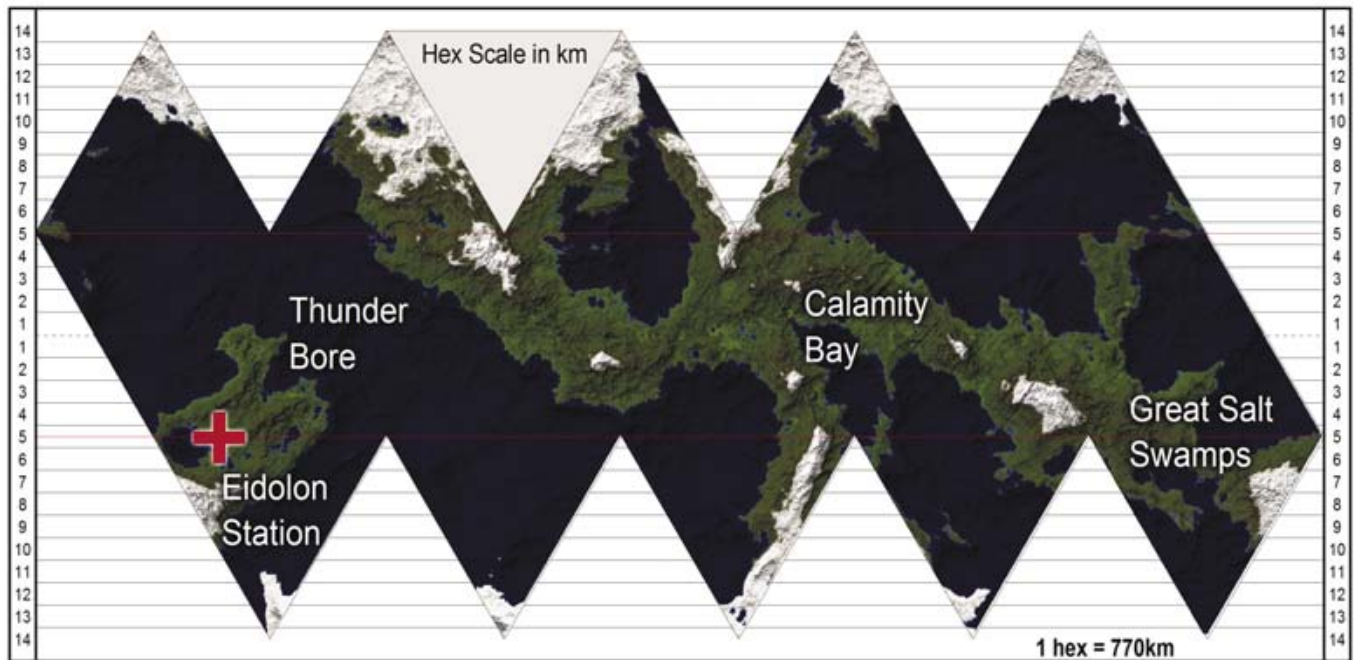

Nimbu is a twin world system in the star system's second orbit; its partner Secundus is a crater-pocked ice ball with a thin atmosphere marginally breathable with the aid of compressor masks. Nimbu Prime is a cold, uninhabited earth-like world with a distant bright sun. The biosphere is carbon-based, with the highest life-forms reptile analogues; there's no evidence of sentient life. Nimbu was discovered a few decades ago, and has a research base which while not secret isn't exactly public; a native creature known as a Colony Lizard is believed to exhibit rudimentary psionic powers.

The lack of gas giants means there's a lot of debris from the planetary accretion disk still in-system, with signs of major impacts on Nimbu Prime in geologically recent time. The planet has spectacular meteor showers, and in-system navigation can be hazardous: ships dropping out of 2-Space may find themselves right in the middle of an uncharted debris field!

### Uncharted Debris Field

**Skills:** Fists +3, Athletics +2, Alertness +1

**Aspects:** Bash to Bits, Pilot's Nightmare

**Physical Stress:**  (2 Consequences)

**Secrets Stress:**  (1 Consequence)

Notes: Match Guns vs Athletics to blast your way out (Physical Stress), or Manoeuvre vs Athletics to dodge your way out (Secrets Stress).

Nimbu orbits far from its primary. It has two close, fast moons (1500-2000km diameter), as well as the great violet-white orb of the frozen world Secundus, four times as large as Old

Earth's moon in the sky, orbiting every six weeks causing enormous tides thirty times as strong as Old Earth's and dwarfing those of the smaller moons. The planet is covered with salt marshes and some devastating tidal bores.

Nimbu's atmosphere has a high oxygen content, and fires start easily. Plant life has developed protective coatings, high water content, even flame-retardant compounds, but even so forest fires are common, contributing to the atmosphere's high ammonia content. Nimbu is wild and inhospitable, but it's due more to remoteness and Commonality discouragement that no one has set up a colony here yet.



**NIMBU II-alpha****Class-8 Terrestrial World: 2 moons**

Primary Terrain	Mixed
Atmosphere	Breathable (0.9 atm: N <sub>2</sub> 54%, O <sub>2</sub> 36%, H <sub>2</sub> O 4%, Ar 3%, CH <sub>4</sub> 2%, Trace: CO <sub>2</sub> , SO <sub>2</sub> , NH <sub>3</sub> )
Population	Mediocre (0): 30 persons (research base)
Spaceport Facilities:	Poor (-1): Landing Strip

**Planetary Skills**

Diplomacy	Fair (+2)
Resources (wealth)	Abysmal (-3)
Resources (materials)	Good (+3)
Resources (industrial)	Average (+1)
Military Capability	Abysmal (-3)
Planetary Security	Abysmal (-3)
Tech Level	Fantastic (+6): Second Age of Space
Trade Level	Poor (-1)
Embargo	Mediocre (+0): No Embargo

**Planetary Aspects**

Planetary	Commonality Outpost (Research Station)
Government	
Parent Star	A3V Main Sequence Star
Classification	
Cold world with long days and long years.	
There are some REALLY big lizards here!	
Spectacular meteor shows.	
Classified Research Station.	
Rich in resources and completely unexploited - but why?	
No Mindscape	

**Additional Information**

Asteroid Belts	1
Planets in System	5 (no gas giants)
Orbital Distance	400,000,000 km
Axial Tilt	11.2 deg
Year Length	3 Standard Years
Day Length	34.4 Standard Hours
Planetary Diameter	11,500 km
Surface Gravity	0.9G (Moderately Dense Core)
Mean Temperature	9 deg C
Hydrosphere	54%

<b>Culture</b>	Commonality Standard (Stage IV: Cultural Integrity)
----------------	---



# Olkennedy

Cratered Wonder of the Darradine Rim

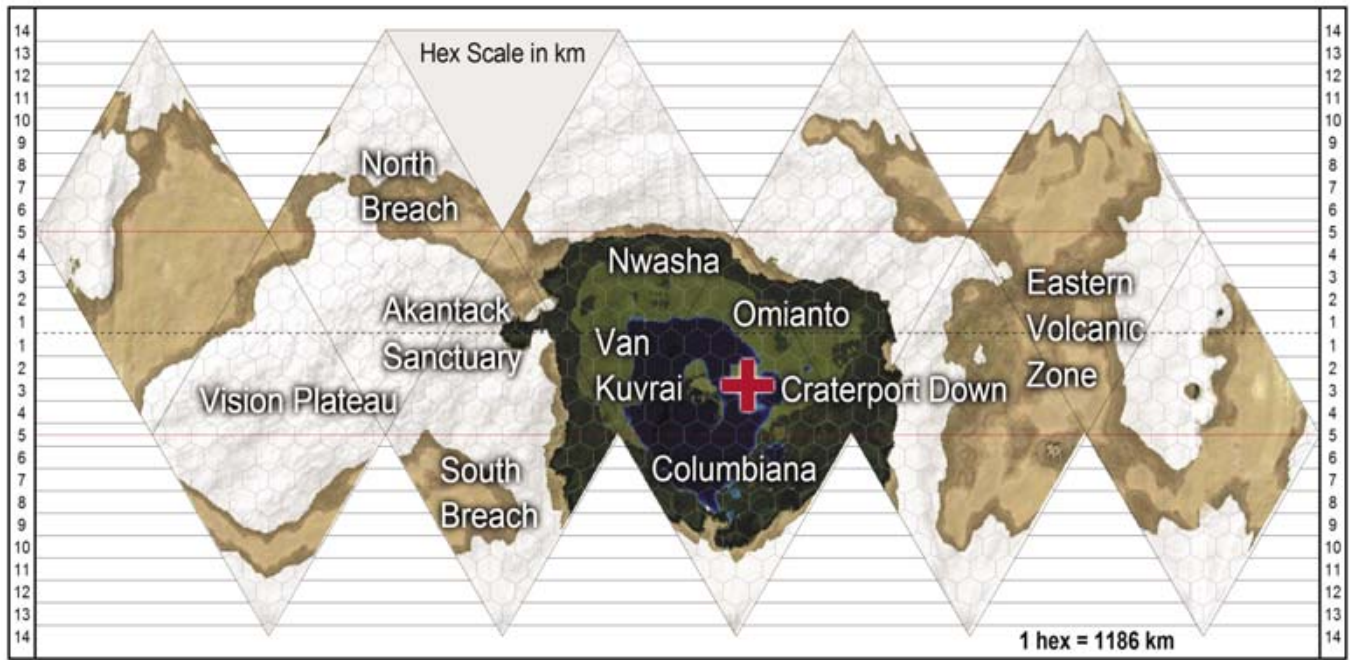

Olkennedy was recently designated one of the wonders of the Darradine Restoration, a matter of great pride to its newly-contacted inhabitants. It's a mountainous, volcanic world, uninhabitable for the most part except for its spectacular "Crater". Deep enough to have its own atmosphere and ecosystem, it takes up 1/12th of the planet's surface, responsible for the planet's bizarre weather, including the "Precipitation Zone" or "Snowlayer" between Crater and uplands where rising moisture-laden air falls as snow along the Crater's rim, producing spectacular snow-capped peaks and amazing waterfalls.

Olkennedy is an ancient slowship colony discovered a century ago. It was quarantined for much of the intervening period as SCI Force engineered its culture to be less traumatized by Commonality arrival. Quarantine was lifted about twenty years ago when it was decided to stop engineering Olkennedy as a neo-Mirkan culture world (its name means "Old Canada") and instead incorporate it into the Commonality mainstream as quickly as possible. Many people are still awestruck by the sudden arrival of a vast and sophisticated interstellar civilization on their doorstep.



**OLKENNEDY B-I****Class-8 Terrestrial Planet: no moon (various moonlets)**

Primary Terrain	Mixed (within Olkennedy Crater)
Atmosphere	Breathable (within Olkennedy Crater: 1.33 atm (N <sub>2</sub> 67%, O <sub>2</sub> 27%, Noble 4%, H <sub>2</sub> O 1%, Trace: CO <sub>2</sub> , SO <sub>2</sub> ))
Population	Great (+4): 30 million (40% human; 10% hominid; 40% xenomorph; 10% other)
Spaceport Facilities:	Fair (+2): Craterport Down Starport (Scale-7 ground facility)

**Planetary Skills**

Diplomacy	Average (+1)
Resources (wealth)	Average (+1)
Resources (materials)	Fair (+2)
Resources (industrial)	Fair (+2)
Military Capability	Average (+1)
Planetary Security	Average (+1)
Tech Level	Great (+4): First Age of Space
Trade Level	Fair (+2)
Embargo	Mediocre (+0): No Embargo

**Planetary Aspects**

Planetary Government	Commonality Member World (Representative Democracy)
Parent Star	MV main sequence star in binary system
Classification	
Ancient Slowship Colony	
The Olkennedy Crater	- one of the wonders of the Darradine Restoration!
Nearly a neo-Mirkan Culture World	
There's a whole interstellar civilization out there!	
Global Mindscape Instance	

**Additional Information**

Asteroid Belts	1
Planets in System	2 (no gas giants)
Orbital Distance	6,500,000 km
Axial Tilt	3.7 deg
Year Length	8.3 standard days
Day Length	18 standard hours
Planetary Diameter	17,000 km
Surface Gravity	1.3G (Dense Core)
Mean Temperature	-15 deg C (on surface); 14 deg C (in Olkennedy Crater)
Hydrosphere	5%

<b>Culture</b>	Fringe World currently in Stage II: Normalization.
----------------	--

## Tambini

Stormswept World of the High Pampas and Everfalls

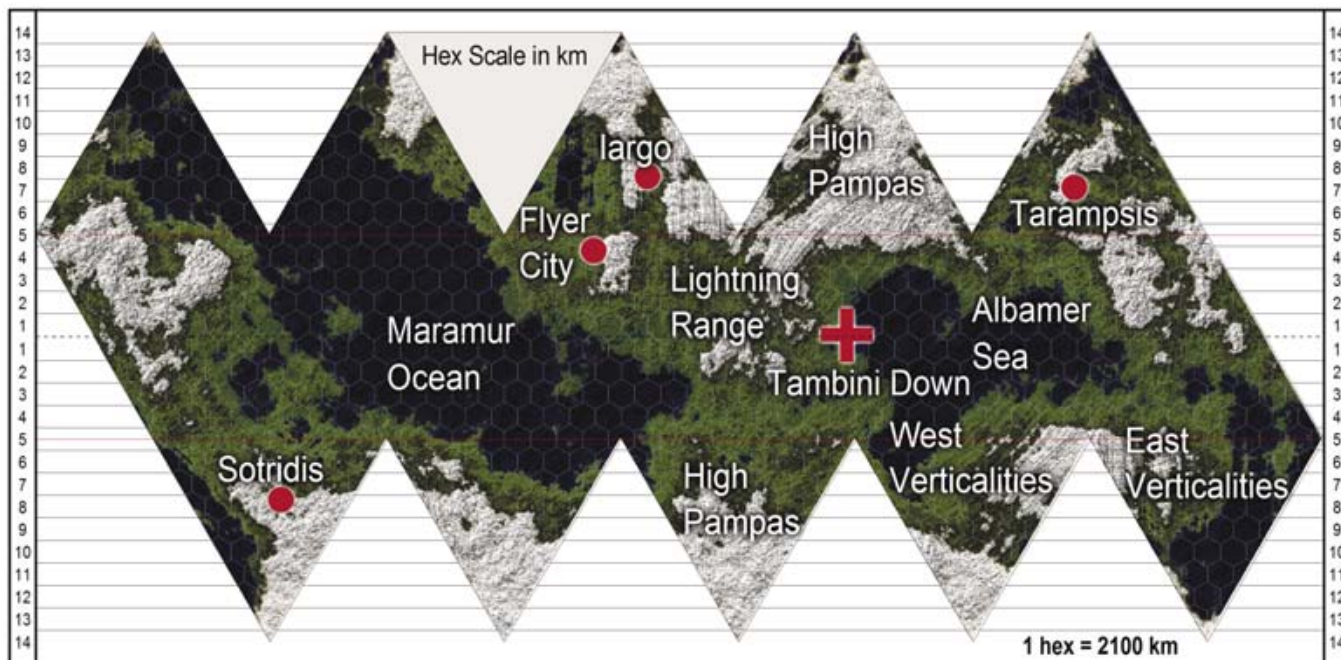

Tambini is a large, high-G world of plateaus and gorges. The plateaus are subject to high winds; the gorges are sheltered and inhabited. Amazing electrical storms occur at the interface: life cooked up pretty quickly here, and the mutation rate remains high; pools of potent amino acids dot the High Pampas. Tambini has two distinct ecologies: the gorges are packed with jungle-like vegetation; and their walls form the "Everfalls," rainforests of massive, thick-trunked trees, hundreds of feet wide and thousands of feet high.

Tambini is renowned for its grav flyers; anti-grav transport is widespread on the planet. Javawayn Industries have orbital

and ground-based facilities; the Javawayn themselves remain in orbit or special low-grav habitats.

The Tambini natives are hominids descended from the original slowship colonists; until the Commonality's arrival they led an arboreal existence in the Everfalls (many still do). They're mainly quadrupedal, with four powerful "arms" for rock- and tree-climbing and making powerful leaps in the Everfalls environment. Nowadays even they use grav-belts to assist them.

There's a theory that the Javawayn are somehow descended from the Tambini hominids, and that Tambini is the unknown Javawayn homeworld. Neither species can answer authoritatively.

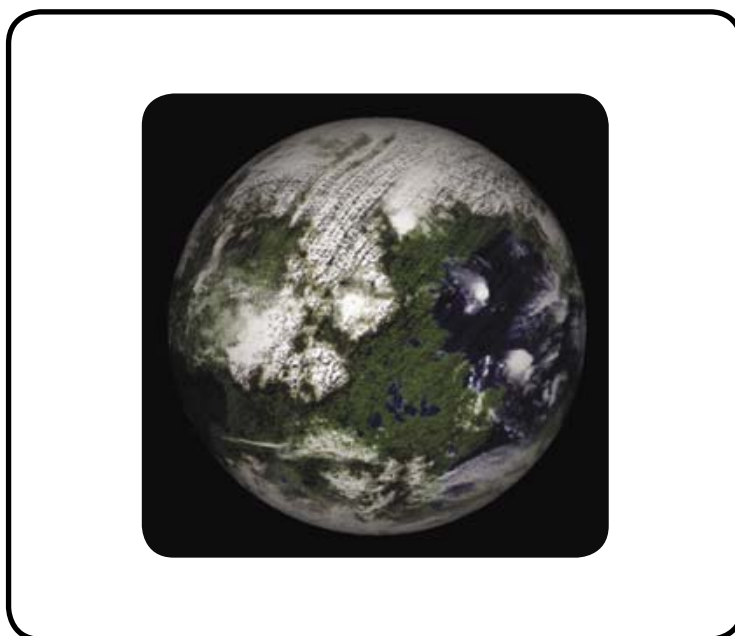



<b>TAMBINI A-III</b>	<b>Class-8 Terrestrial Planet: dual ring system; no moon</b>
Primary Terrain	Steppe (Barren)
Atmosphere	Breathable (1.5 atm (N <sub>2</sub> 74%, O <sub>2</sub> 20%, H <sub>2</sub> O 3%, Xe 2%, Trace: CO <sub>2</sub> , NO <sub>2</sub> , HNO <sub>3</sub> ) : dense in Everfalls; breathable with compressors on High Pampas)
Population	Great (+4): 50 million (30% hominid; 20% human; 45% xenomorph; 5% other)
Spaceport Facilities:	Great (+4): Tambini Down (Scale-7 ground facility); Everfall Highport (Scale-6 Javawayn Sky City)

### Planetary Skills

Diplomacy	Good (+3)
Resources (wealth)	Good (+3)
Resources (materials)	Good (+3)
Resources (industrial)	Good (+3): Export of anti-grav technologies widespread
Military Capability	Average (+1)
Planetary Security	Average (+1)
Tech Level	Great (+4): First Age of Space
Trade Level	Good (+3): Javawayn Industries major plant
Embargo	Mediocre (+0): No Embargo

### Planetary Aspects

Planetary Government	Commonality Member World (Commonality-controlled Oligarchy)
Parent Star	MV main sequence star in triple star system
Classification	
Ancient slowship colony	
Weird arboreal natives	
Amazing electrical storms at the tops of the Everfall gorges	
Pools of amino acids on the High Pampas	
Vertical jungles of the Everfalls, thousands of meters high	
High-gravity world	
Global Mindscape Instance	

### Additional Information

Asteroid Belts	1
Planets in System	8 (3 gas giants)
Orbital Distance	21,000,000 km
Axial Tilt	13 deg
Year Length	30 standard days
Day Length	62 standard hours
Planetary Diameter	30,000 km
Surface Gravity	1.9G (Moderately Dense Core)
Mean Temperature	24 deg C
Hydrosphere	20%

<b>Culture</b>	Commonality Standard currently in Stage II: Normalization.
----------------	--

## Tremor

The Sky Cities of Zalmoxis and the Infamous Casino Vulcanica!

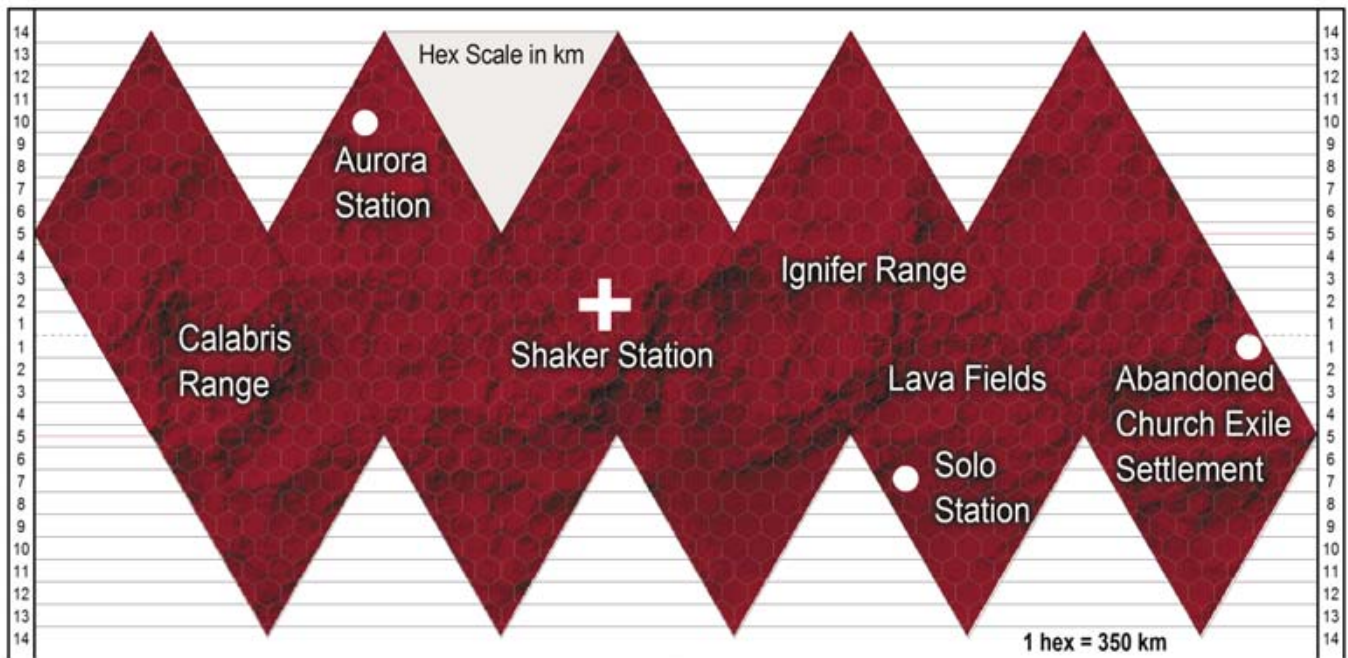

This euphemistically named world is the third moon of the ruddy gas giant Zalmoxis, and one of the most geologically unstable bodies in the entire octant. A constantly erupting mass of volcanoes, earthquakes, lava spouts and aurorae, it's beautiful, deadly, and a popular tourist destination. The Sky Cities of Zalmoxis III are palatial, operated by the Javawayn and catering for the elite of the Darradine Restoration; one of the most exclusive, the

Grundshlaker, is the location of the legendary Casino Vulcanica, where whole worlds are gambled and won in a single night.

Surface installations on Tremor are mostly semi-automated sulphur mines operated by high-endurance synthetics, but also including several research stations investigating Tremor's extraordinary environment.



**TREMOR A-Va (ZALMOXIS-a) Class-8 Terrestrial Planet: 1st moon of system gas giant**

Primary Terrain	Volcanic
Atmosphere	Toxic (0.68 atm: SO <sub>2</sub> 88%, O <sub>2</sub> 10%, Trace: K, Na, Cl, CO <sub>2</sub> )
Population	Great (+4): 2 million (70% human; 10% hominid; 15% xenomorph)
Spaceport Facilities:	Great (+4): Shaker Station (Scale-7 ground facility plus Scale-6 orbital facility (space station plus dry dock))

**Planetary Skills**

Diplomacy	Superb (+5)
Resources (wealth)	Fantastic (+6)
Resources (materials)	Fair (+2): sulphur
Resources (industrial)	Fair (+2): sulphur mining and processing
Military Capability	Fair (+2)
Planetary Security	Good (+3)
Tech Level	Fantastic (+6): Second Age of Space
Trade Level	Great (+4)
Embargo	Mediocre (+0): No Embargo

**Planetary Aspects**

Planetary Government	Commonality Member World (Corporate controlled)
Parent Star Classification	F9V main sequence star in binary star system (MV companion)
Risk it all in the Casino Vulcanica!	
The Sky Cities of Zalmoxis III	
Lethally beautiful, erupting mass of unstable lava fields	
Come join the tourists on Tremor!	
Intense magnetosphere and beautiful aurorae	
Global Mindscape Instance	

**Additional Information**

Asteroid Belts	1
Planets in System	9 (1 gas giant)
Orbital Distance	249,000,000 km
Axial Tilt	None
Year Length	1 standard year 334 standard days
Day Length	41 standard hours
Planetary Diameter	5,000 km
Surface Gravity	0.5G (Very Dense Core)
Mean Temperature	92 deg C
Hydrosphere	0%

<b>Culture</b>	Commonality Standard (Stage IV: Cultural Integrity)
----------------	---



# Viri

Cold Dry world of the Viri Hominids

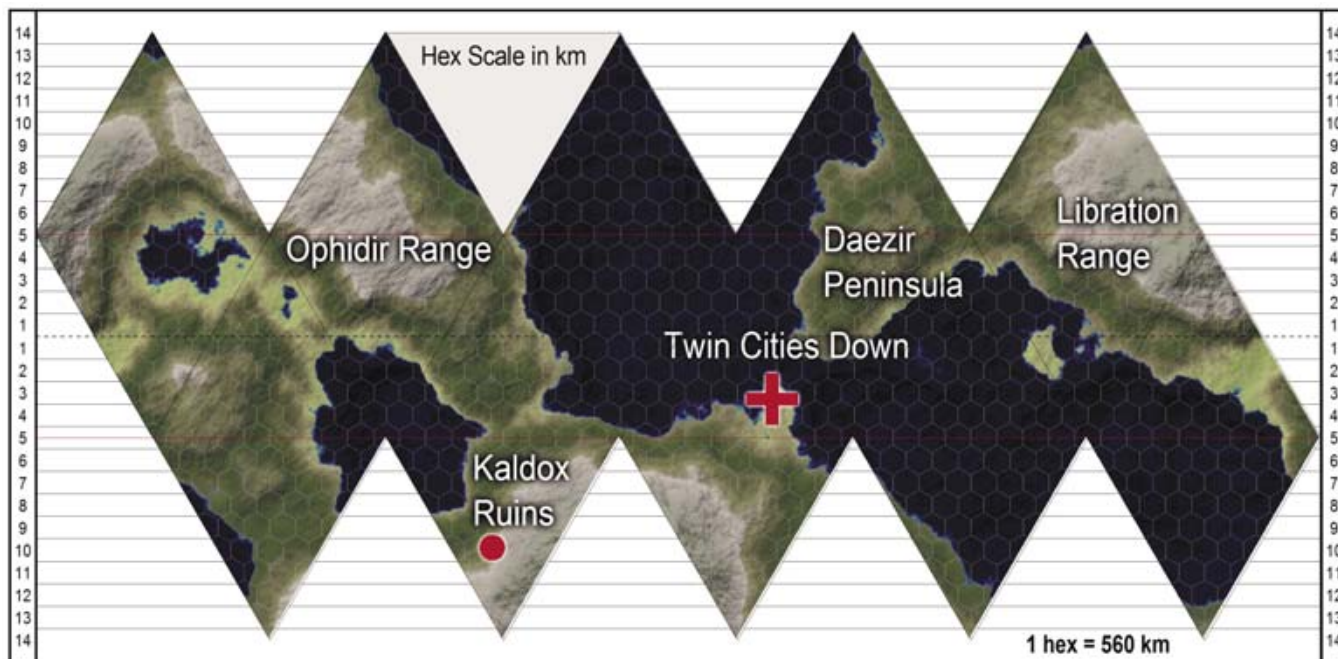

A dry cold world contacted 140 years ago and homeland of the Viri hominids. It's a twin planet, sharing a common centre of gravity with its companion Esmirunt in the only occupied orbit of its MOV primary, itself companion to a K9V main sequence star. There are two other distant M-class stars in this rare four-star system.

The Viri have pale green complexions and dry, almost reptilian skin. For hominids, they're very alien: reserved, logical, sometimes arrogant and inhuman, they nevertheless make splendid artists - Viri music and architecture are known throughout the Commonality. Viri are natural scholars, excelling in science, academics, and engineering; their scientists have made several Mindscape innovations, and many Commonality starships employ Viri doctors, engineers, and science officers.



**VIRI A-1 I-alpha****Class-8 Terrestrial Planet: no moon**

Primary Terrain	Steppe
Atmosphere	Breathable (0.73 atm: N <sub>2</sub> 66%, O <sub>2</sub> 31%, H <sub>2</sub> O 2%, Trace: CO <sub>2</sub> , Noble, SO <sub>2</sub> )
Population	Great (+4): 10 million (70% hominid; 10% human; 5% xenomorph; 5% other)
Spaceport Facilities:	Fair (+2): Twin Cities Down ("Dakrazar") Starport (Scale-7 Ground Facility)

**Planetary Skills**

Diplomacy	Great (+4)
Resources (wealth)	Good (+3)
Resources (materials)	Good (+3)
Resources (industrial)	Fair (+2)
Military Capability	Average (+1)
Planetary Security	Fair (+2)
Tech Level	Fantastic (+6): Second Age of Space
Trade Level	Good (+3)
Embargo	Mediocre (+0): No Embargo

**Planetary Aspects**

Planetary	Commonality Aligned World (Oligarchy)
Government	
Parent Star	M0V main sequence star with K9V close companion in multiple star system (2 other MV stars)
Classification	
There are four suns in the sky!	
Exotic flora and fauna	
Cold dry homeworld of the alien Viri	
Global Mindscape Instance	

**Additional Information**

Asteroid Belts	None
Planets in System	2 (no gas giants, although 2 gas giants orbit Viri A-2, the close companion)
Orbital Distance	18,600,000 km
Axial Tilt	3 deg
Year Length	149 standard days
Day Length	19 standard hours
Planetary Diameter	8000 km
Surface Gravity	0.69G (Moderately Dense Core)
Mean Temperature	3 deg C
Hydrosphere	30%

<b>Culture</b>	Commonality Standard currently in Stage II: Normalization
----------------	---

# Xaiwu

Sub-aquan Neo-Shinean Culture World

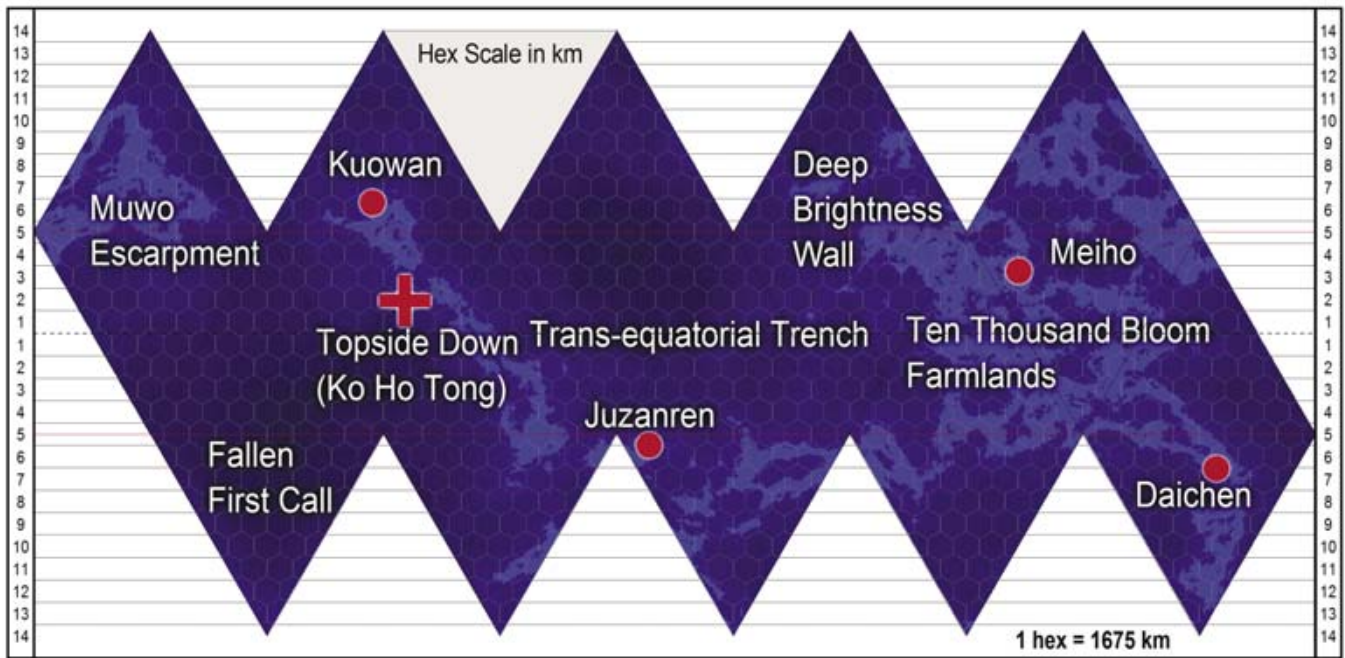

Xaiwu is a cold world, polished and scoured, shiny and cracked from space. Under the icy surface a vibrant ocean ecosystem thrives: huge Seaworms, kilometres long, patrol the shallows, and deep down, where the pressures are great, swim herds of beautiful flickering Fluocytes. Xaiwu is a neo-Shinean colony, only 150 years old but already supporting 200 million people in 5 vast undersea conurbations. The world has a booming agricultural industry.

Chembu Genurgy is active on Xaiwu, and about a third of the population sports gills and other sub-aquan enhancements. The rest use other modifications, including ingenious exoskeletons and submarine craft. While the conurbations remain domed with standard terrestrial atmospheres, it's expected that Xaiwu will gradually become an aquatic culture.

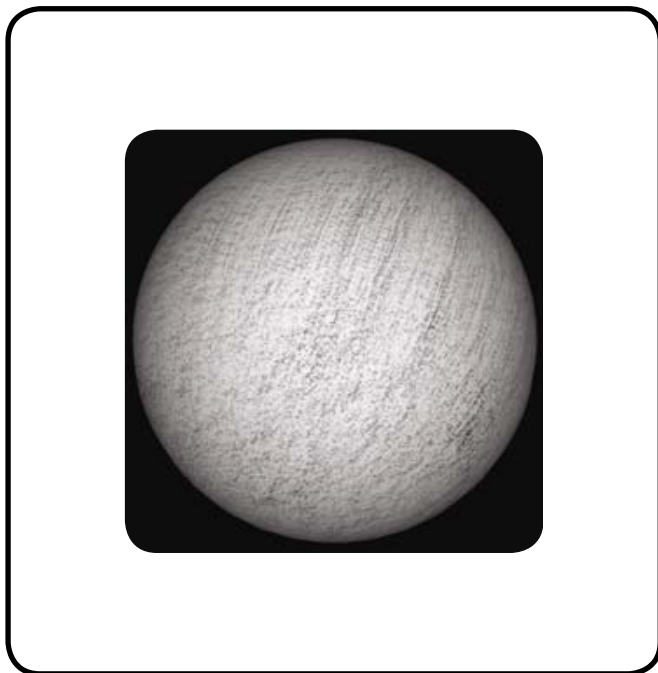



**XAIWU IV****Class-8 Terrestrial Planet: ring system; 15 moons**

Primary Terrain	Water (frozen surface)
Atmosphere	Incapable of supporting life (Trace - life confined to oceans)
Population	Great (+4): 200 million (100% human)
Spaceport Facilities:	Good (+3): Topside Down Spaceport (Scale-7 ground facility plus Scale-5 orbital facility (space station))

**Planetary Skills**

Diplomacy	Good (+3)
Resources (wealth)	Great (+4): agriculture, tech, tourism.
Resources (materials)	Great (+4)
Resources (industrial)	Average (+1)
Military Capability	Average (+1)
Planetary Security	Good (+3): naturally protected
Tech Level	Fantastic (+6): Second Age of Space
Trade Level	Great (+4): agricultural products and sub-aquan equipment exports.
Embargo	Mediocre (+0)

**Planetary Aspects**

Planetary	Commonality Culture World (Dictatorship)
Government	
Parent Star	F5V main sequence star
Classification	
Highly-populated undersea cities	
Neo-Shinean culture world	
Enormous native fauna	
Thriving agricultural world	
Cool sub-aquan vessels	
A third of the population have gills!	
Global Mindscape Instance	

**Additional Information**

Asteroid Belts	1
Planets in System	3 (2 gas giants)
Orbital Distance	179,000,000 km
Axial Tilt	14.9 deg
Year Length	415 standard days
Day Length	996 standard hours
Planetary Diameter	24,000 km
Surface Gravity	1.0G (Medium Core)
Mean Temperature	-20 deg C
Hydrosphere	100%

<b>Culture</b>	Commonality Culture World (Neo-Shinean) currently in Stage IV: Cultural Integrity
----------------	---

## Zhaffrane

Get away from it all with the Snakepeople of Zhaffrane!

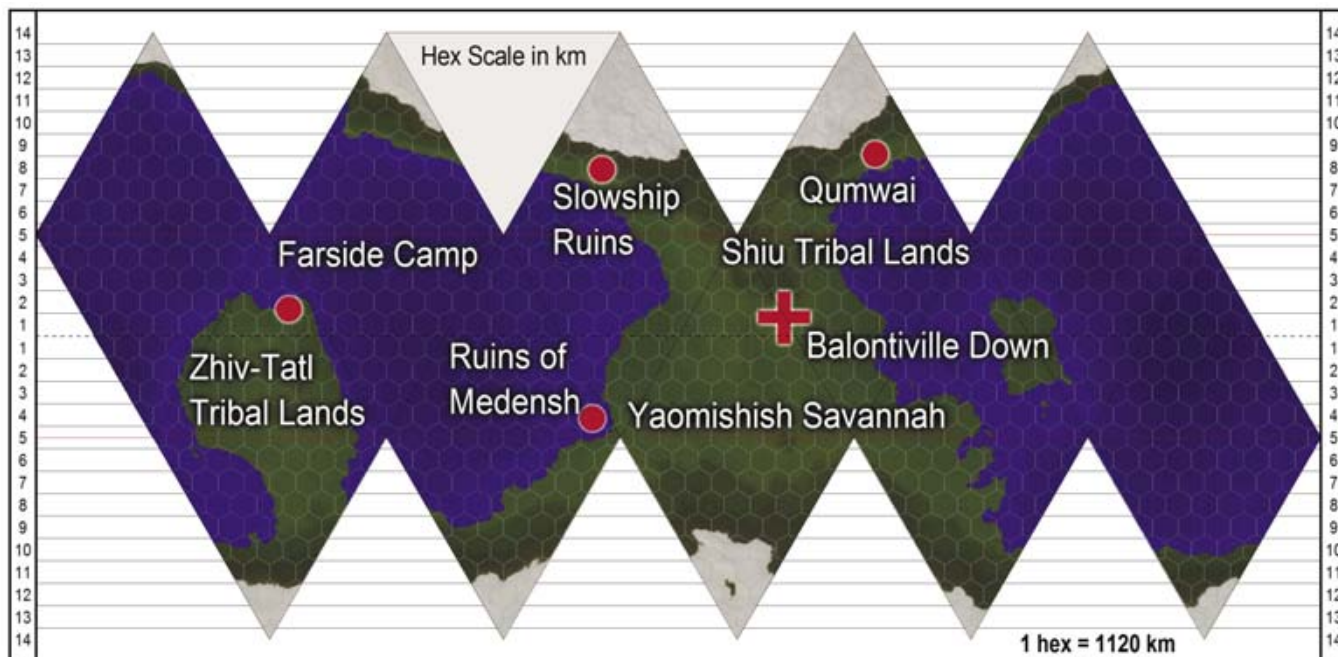

The immense, horse-like *chelodonts* of Zhaffrane stand fifteen metres tall at the shoulder. They feed off succulent saprophytes in the tops of Zhaffrane's hard, spiny *balonti* trees, from which *mungi*, the local brandy-like distillate, is made. Zhaffrane is a geologically ancient world, tectonically stable, and lifeforms have evolved extraordinary specializations, including the explosive blastbeast and the iridescent laserhawk, whose crystalline feathers decorate

the ceremonial headdresses of the native snake-people. The snake-people are descendants of original colony farm-workers, and are renowned as chelodont mahouts; many still follow semi-nomadic lifestyles. In the Expansionary Era Zhaffrane has become a destination for tourists and colonists seeking a "simpler" existence, and all the benefits and perils which the commercial and cultural melange of the Commonality brings.



## ZHAFFRANE III **Class-8 Terrestrial Planet: ring system; no moons**

Primary Terrain	Mixed
Atmosphere	Breathable (0.95 atm: N <sub>2</sub> 57%, O <sub>2</sub> 35%, H <sub>2</sub> O 4%, Noble 3%, Trace: CO <sub>2</sub> , SO <sub>2</sub> , CH <sub>4</sub> )
Population	Great (+4): 20 million (80% xenomorph; 15% human; 5% other)
Spaceport Facilities:	Average (+1): Balontiville Down Starport (Scale-6 ground facility)

### Planetary Skills

Diplomacy	Fair (+2)
Resources (wealth)	Average (+1): tourism
Resources (materials)	Average (+1)
Resources (industrial)	Terrible (-2)
Military Capability	Poor (-1)
Planetary Security	Mediocre (+0)
Tech Level	Poor (-1): Metal Age
Trade Level	Poor (-1)
Embargo	Average (+1): Medium Embargo (license needed to sell tech beyond Balontiville)

### Planetary Aspects

Planetary Government	Commonality Member World (Commonality-controlled Oligarchy around Balontiville; elsewhere Lawless, Tribal)
Parent Star	K9V main sequence star in binary system (G9V companion)
Classification	
Ancient Slowship Colony	
Semi-nomadic snakepeople tribes	
Come and experience a simpler existence with the snakepeople of Zhaffrane!	
Local Mindscape in Balontiville only; no GMI	

### Additional Information

Asteroid Belts	1
Planets in System	9 (3 gas giants)
Orbital Distance	30,000,000 km
Axial Tilt	8.7 deg
Year Length	44 standard days
Day Length	83 standard hours
Planetary Diameter	16,000 km
Surface Gravity	0.94G (Moderately Dense Core)
Mean Temp	15 deg C
Hydrosphere	50%

<b>Culture</b>	Fringe World currently in Stage I Cultural Integration: Contact
----------------	---



## Zvukimu

Beautiful Homeworld of the Mysterious Singers

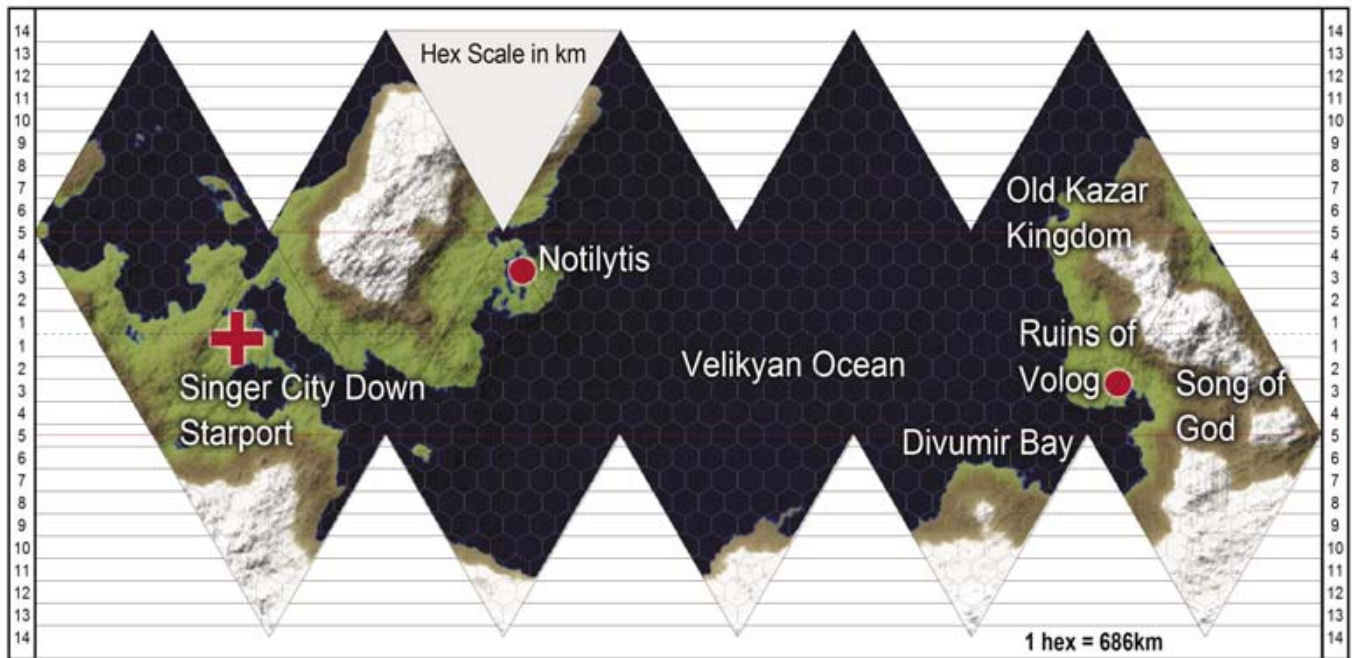

Zvukimu is an old binary system. The beautiful crystalline peaks of Zvukimu A-II rise out of the atmosphere, inhabited by an extremely rare race of plasma beings called the Singers, whose presence is accompanied by haunting piping and singing. Mildly interested in communicating with visitors, they otherwise have little constructive contact with the Commonality.

Zvukimu's lowlands have a thin yet breathable atmosphere and low gravity, hence Zvukiman hominids are tall and gangly, with barrel-like chests and black skin - the thin atmosphere

lets a lot of UV through. They're clumsy in standard gravity, but make excellent astronauts, starship techs, and zero-G combat troops. Zvukimu has good starship manufacture and repair yards.

Zvukimu is home to Gentility Base, an intelligent space habitat and one of the main SCI Force bases in the Restoration. Offering emergency repair and intelligence facilities, and training the elite Zvukiman zero-G troops, it's also home to the Communications Instrumentality's diplomatic embassy to the Singers (they don't have much to do).

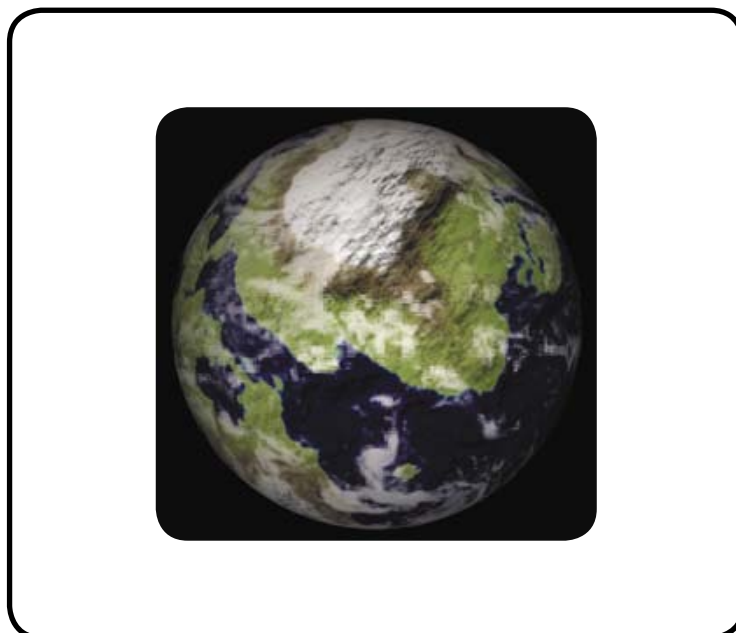

**ZVUKIMU A-II****Class-8 Terrestrial Planet: no moon**

Primary Terrain	Mixed (Garden World)
Atmosphere	Breathable (Thin, 0.45atm: N <sub>2</sub> 52%, O <sub>2</sub> 39%, H <sub>2</sub> O 4%, Noble 4%, Trace: CO <sub>2</sub> )
Population	Superb (+5): 1 billion (85% hominid; 5% human; 5% xenomorph; 5% other)
Spaceport Facilities:	Fair (+2): Singer City Down starport (Scale-7 ground facility)

**Planetary Skills**

Diplomacy	Fair (+2)
Resources (wealth)	Good (+3)
Resources (materials)	Great (+4)
Resources (industrial)	Good (+3): starship repair and maintenance; processed industrials
Military Capability	Good (+3)
Planetary Security	Fair (+2)
Tech Level	Great (+4): First Age of Space
Trade Level	Good (+3): import of weapons, export of starship technology
Embargo	Mediocre (+0): no Embargo

**Planetary Aspects**

Planetary	Commonality Member World (Commonality-controlled Oligarchy)
Government	
Parent Star	MV Main Sequence Star (in binary system with MV close companion)
Classification	
Ancient Slowship Colony	
Beautiful crystalline peaks	
The mysterious Singers of Zvukimu	
Thin atmosphere	
Low gravity	
Tall and gangly natives - excellent astronauts, starship techs, and zero-G troops	
Global Mindscape Instance	

**Additional Information**

Asteroid Belts	1
Planets in System	3 (1 gas giant)
Orbital Distance	16,000,000 km
Axial Tilt	7 deg
Year Length	23.7 standard days
Day Length	66 standard hours
Planetary Diameter	10,000 km
Surface Gravity	0.63G (Moderately Dense Core)
Mean Temperature	19 deg C
Hydrosphere	52%

**Culture**

Fringe World currently in Stage II Cultural Integration: Normalization

## The Singers of Zvukimu

Singers are very alien, like glowing airborne jellyfish. Some liken them to angels, with elongated hands, arms and legs, and huge, delicate “wings” of light. They never “land”, and can’t withstand high gravity or atmospheric pressure. They’re capable of charged particle and plasma attacks, generate their own plasma shields, and have a “Singer Song” Skill which enthrals other beings (treat as the Pheromones Skill).

### Typical Singer

<b>Physical Stress:</b> □□□□□		
<b>Composure Stress:</b> □□□□□		
<b>Fate Points:</b> 6		<b>Scale:</b> Medium (3)
<b>Consequences:</b> Up to 3 Consequences		
<b>Encounter Size:</b> 1-6		
<b>Skills</b>		
Fair (+2)	Exude Energy	Absorb Energy
Average (+1)	Stretchy	Telepathy
	Singer Song*	
<b>Aspects</b>		
Unfathomable Alien Plasma Beings		
Aloof and uncaring		
Insubstantial and unaffected by physical weapons		
Haunting Song		
Minor Weaknesses: Fire, Water, Gravity, Air		
<b>Stunts</b>		
Exude Plasma [Exude Energy]		
Energy Drain [Absorb Energy]		
Energy Boost [Absorb Energy]		
Absorb Energy Weapons [Absorb Energy]		
<b>Monstrous Special Ability</b>		
Extreme Conditions		
<b>Equipment</b>		
Plasma Fist		
Plasma Bolt		
*Operates like the Pheromones Skill		

### ❖ **New Stunt: Exude Plasma [Exude Energy]**

The character can send a stream of plasma against a target in the same zone. The plasma stream is capable of frying electrical systems. On a successful hit the character can pay a Fate point and add an Aspect “Electrical Disruption” to a target or a Minor consequence. The Aspect doesn’t cost a Fate point if the target isn’t trying to avoid it. Energy shields will protect against this attack.



# Chapter Eight: Escape from Venu

*"To: Dr. Thaddeus Clay, Leader-Responsible 74th I&S Team out of Gentility Base (Morgan / Zvukimu) en route to Ajeux Station  
MINDJAMMER PRIORITY COMMUNICATION THIRD URGENCY  
- MIND ONLY*

*NCE62.94.7.147.193*

*THOUGHTCAST BEGINS*

*#####*

*Local node confirms kidnap of Amidan heir-to-throne and transport to Venu space by agency unknown. D-field trace indicates 98% probability of 2-Space emergence in uninhabited star system x-24-alpha. Priority override: activate SCI Force Insertion and Sanction Team and divert to x-24-alpha. Retrieve Amidan heir. TOP URGENCY. All other considerations secondary: first order memetic cascade.*

*#####*

*From: Gentility Base Acting Corpus Sentience Pandora-12.  
THOUGHTCAST ENDS."*

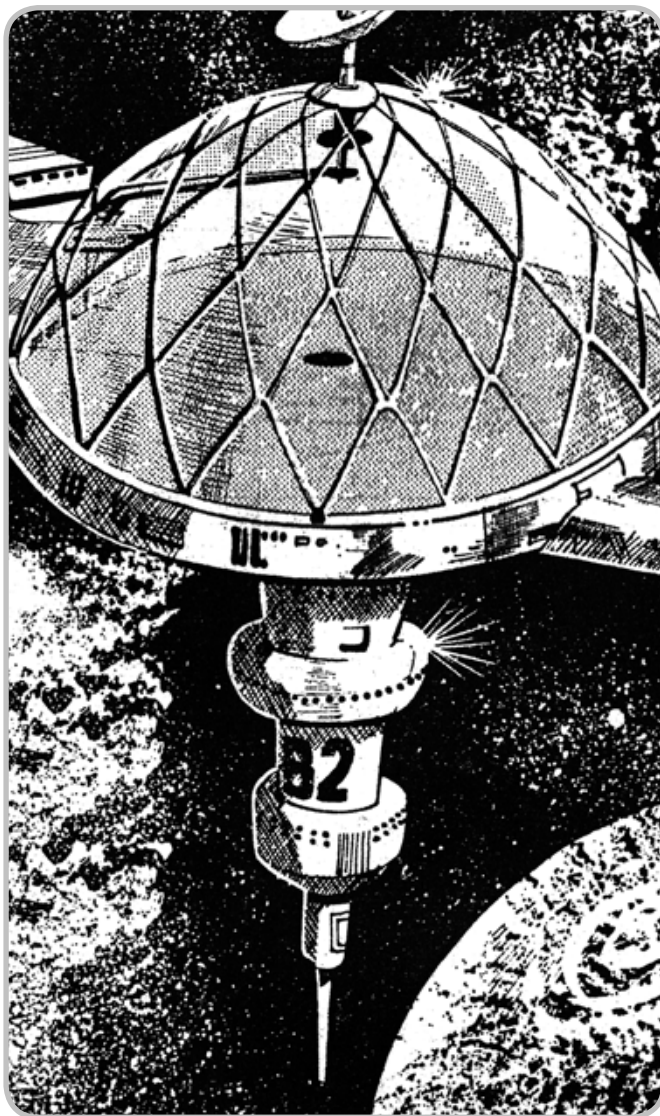

## Background

Amida is a strategically vital Fringe World on the edge of the Quarantine Zone which the Commonality has been wooing - successfully - for thirty years. The nefarious Venu have breached the Q-Zone and kidnapped Amida's heir, Princess Kirei Nahino Deh. Their ultimatum: expel the Commonality Ambassador, or the Princess will be killed!

Ten days ago the corpus sentience at Gentility Base in the Zvukimu system received word of the kidnap. Rudimentary Amidan orbital sensors have tracked the kidnapers to uninhabited star system "X-24-alpha" just inside the Q-Zone, and the Commonality has sent a SCI Force Insertion and Sanction Team (the PCs) to resolve the situation.

The PCs arrive at X-24-alpha nineteen days after the kidnap, twelve days behind the kidnapers. Using a captured Venu Insertion Ship and some Venu disguises, the PCs hope to bluff their way to the Princess and rescue her from her evil captors!

## Story Teller's Overview

The kidnapers have taken the Princess to a hidden Venu listening post in the X-24-alpha system, and are waiting for a Venu security patrol to take her to Venu space. The listening post isn't expecting pursuit, but is expecting the Venu patrol, initially assuming the PCs are allies rather than enemies. Clever PCs may bluff their way right into the station!

This is an introductory adventure for *Mindjammer*, a search and rescue mission "behind enemy lines". It's also the first of four linked scenarios in this book forming what we've called "the Black Zone Campaign". It's divided into three parts: location information for the X-24-alpha star system and the Venu Listening Post; plot information for the range of likely actions the PCs might take; and statistics and descriptions for principal characters. We've also provided four pre-generated characters so you can get started right away!

## Location

The Silent Witness (Venu: *Shum-mu-Shei*) orbits at the edge of the ring system (**Barrier Value: 1**) of the X-24-alpha system's gas giant. It's primitive, sinister and gloomy, a far cry from the shining edifices of the Commonality. It houses a crew of 65, including three squadrons of the mysterious Venu Mutant Marines.

The station is a holding place for the Princess before transfer deep inside the Empire. The crew don't have the facilities or expertise for the operation - which is why speed and bluff just might work!

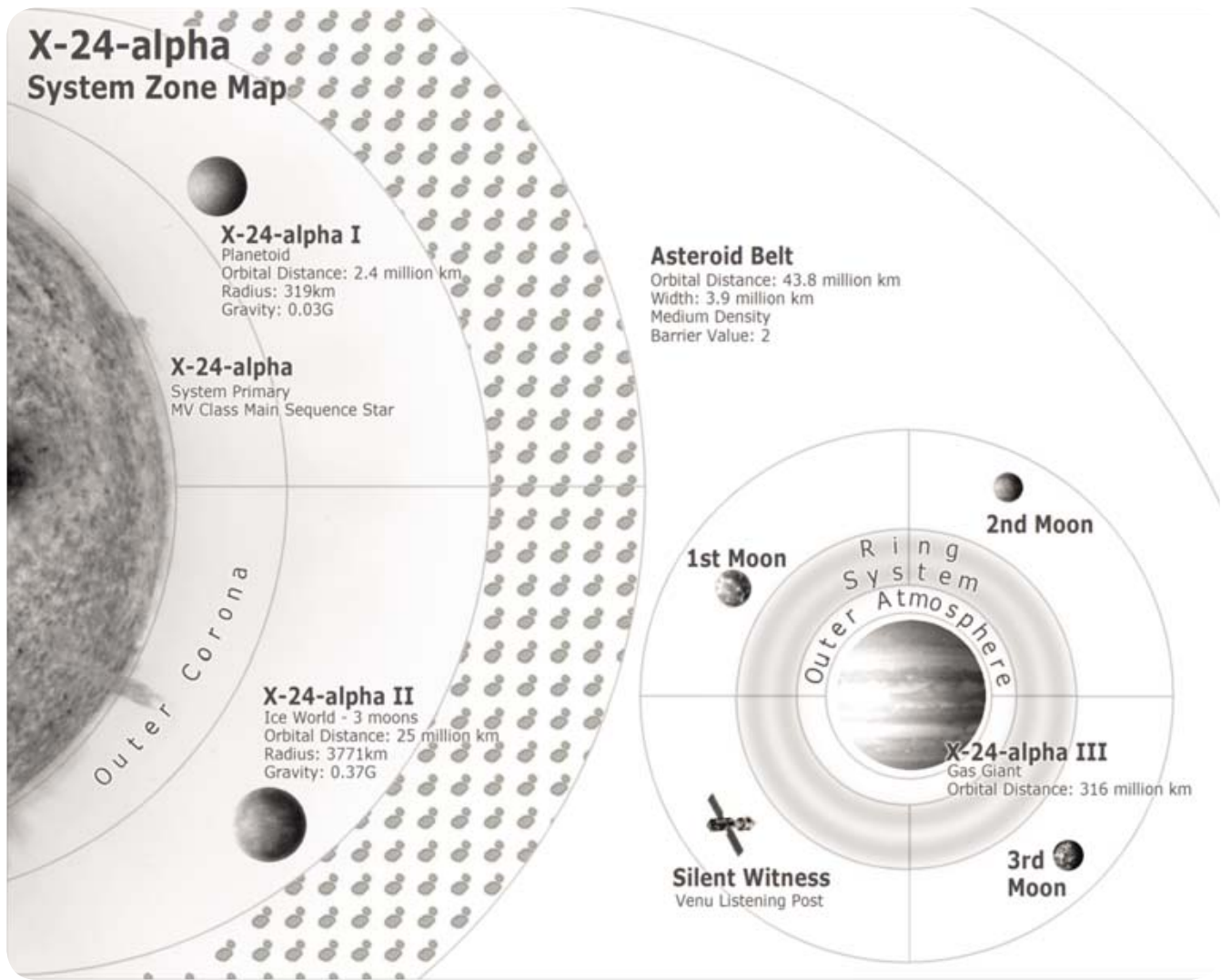

## Station Security

The Silent Witness is much lower tech than Commonality standard, and so are its security measures.

**Security Doors:** a heavier version of the standard station door with **Barrier Value: Impassable**; make Average (+1) rolls of Might, Thermic Lance, Mining Torch, Hacking, Demolition, Engineering, or Burglary to bypass.

**Blast Doors:** thick sliding doors preventing Docking Bay access with **Barrier Value: Impassable**. Make Fair (+2) rolls of Thermic Lance, Mining Torch, Hacking, Demolition, Engineering, or Burglary to bypass.

**Docking Bay Shields:** primitive force fields protecting the Docking Bay from vacuum when the bay doors are open. They must be dropped to allow ships through, decompressing the bay. Shields have **Barrier Value: Impassable**; make Good (+3) rolls of Starship Beam Weapons, Starship Projectile Weapons, Hacking, or Burglary to bypass.

**Automated Defences:** remote turrets, stun fields, etc, inhibiting movement through restricted areas. **Barrier Value: 2**; make Fair (+2) rolls of Hacking, Engineering, Burglary, or Trick Shot [Guns] (shooting the turrets, etc) to bypass.

## Inside the Station

The following descriptions show possible location Aspects in **bold**. The station is **dark and distracting**, with **flickering lights** and **constant background noise**. Here and there are **information panels** or **propaganda posters** written in Venu. The atmosphere is **extremely oppressive**.

## L0: Turbolift

The turbolift accesses every deck, and has a **primitive, hackable control panel**. Characters can force access and climb the lift shaft. There's a **guard post** by the turbolift on each deck (see the Plot Stress Consequences table below for the number of guards).



# VENU LISTENING POST "SILENT WITNESS"

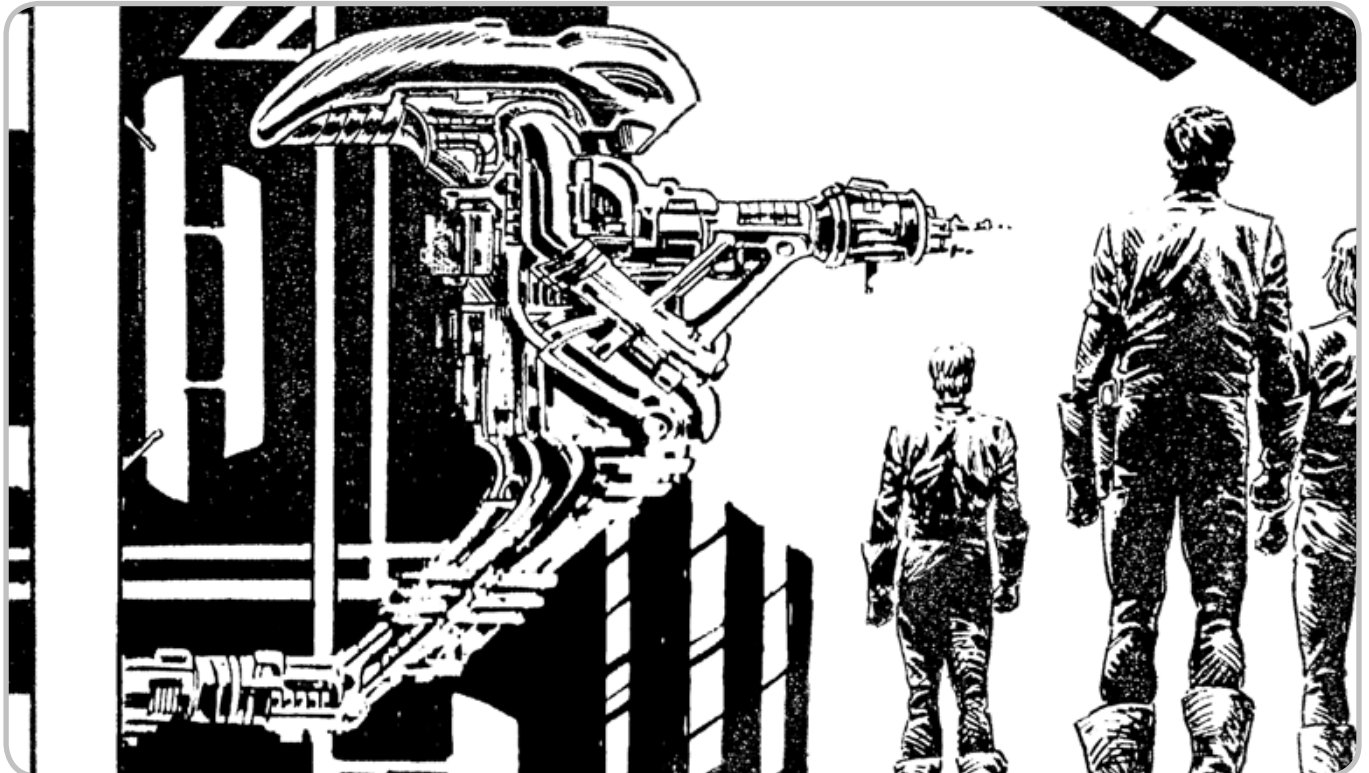
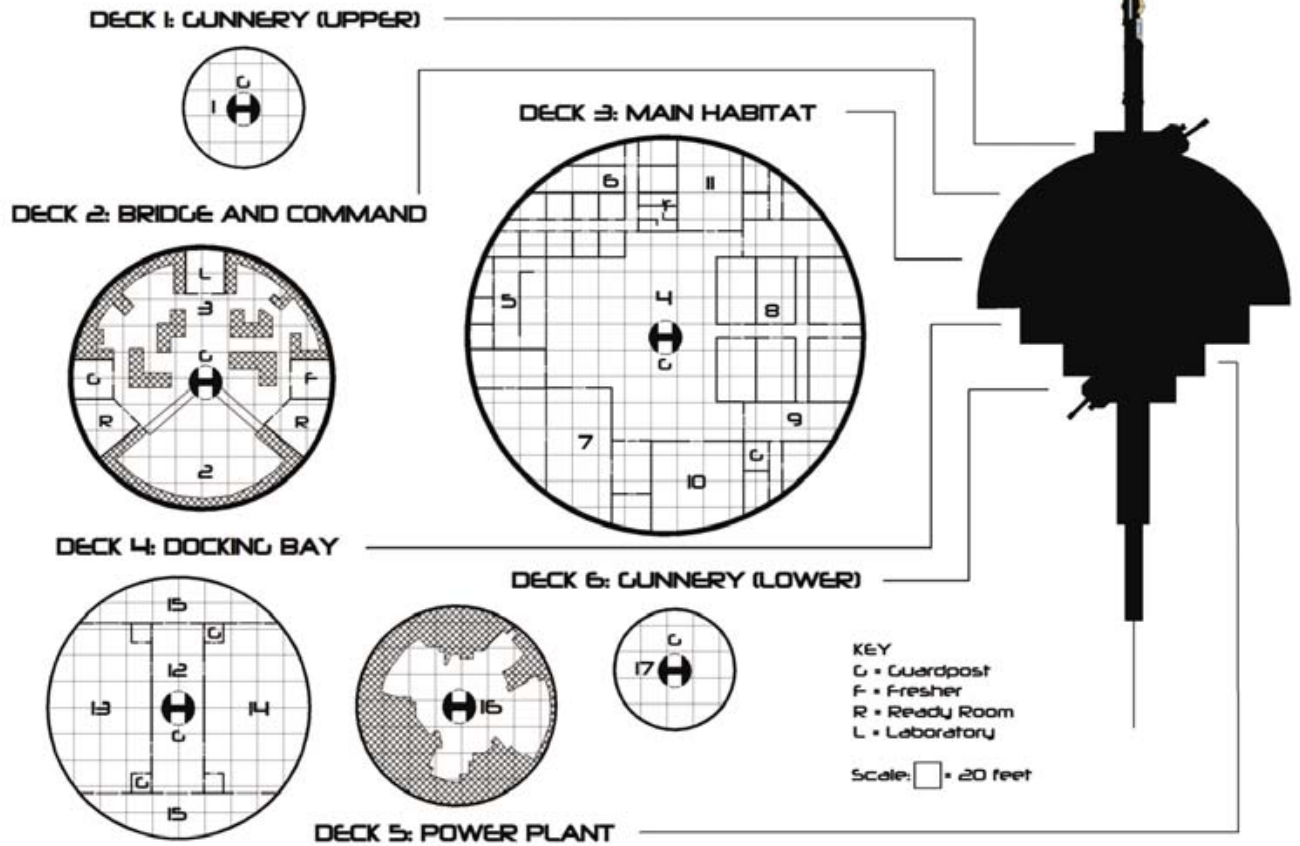



## Silent Witness

### Station Technical Readout

**Scale:** Huge (5)

**Structural Stress:** □□□□□□

**System Stress:** □□□□□

**Fate Points:** 3 **Refresh:** 3

**Consequences:** 3

**Armour Cons:** n/a

**Shield Cons:** Minor

**Jump Maximum:** n/a

### Skills

Good (+3) Advanced Sensor Suite Marine Facilities

Fair (+2) Beam Weapon EWS Beam Weapon Flight Bay

Ship Systems

Avg (+1) Manoeuvre Energy Shields Hardened Structure Repair System

### Aspects

Steers like a Cow

Super Snooper

Needle in a Haystack

Bizarre Venu control system and design

Belching Z-radiation Dirt Drives

### Stunts

Track FTL

Enhanced Comms

Sensor Probes

Long-term Life Support

Split Fire

Repair Drones

Boarding Capsules

### Equipment

Dirty Mary Disruptor Cannon

3 Squadrons of Venu Mutant Marines

Venu Fighter

## L1: Upper Gunnery Deck

### 1. Gunner Station and Escape Pods

A cramped deck containing the **gunner station** for a “**Dirty Mary**” **disruptor cannon**, **guard post**, and access to ten 6-person **escape pods**. **Power conduits** leak **Average (+1) power Z-radiation** (see page 132). The deck isn’t usually manned unless the station is on alert (Plot Stress consequence Minor or above).

## L2: Bridge and Command Deck

The operational centre for the Silent Witness; there’s a central **guard post**.

## 2. Forward Bridge

Includes **viewscreens** and **communications and sensor controls**. **Station Commander Vrak** commands here, with 3 comms specialists and 1 first officer.

## 3. Research Stations

**Information analysis** and **science stations** usually manned by 3 crew.

## L3: Main Habitat Deck

Comprising habitats, recreation, workshops, and a central **guard post**.

## 4. Assembly and Mess Area

A **messy and cluttered** area used for Crew Mess and Assemblies, and combat practice and dominance bouts by the Mutant Marines (#8, below).

## 5. Kitchen

**Food storage and preparation**; four cooks produce awful fare.

## 6. Crew Quarters

These **multiple occupancy dormitories** are one-third occupied (eight crew).

## 7. Droid Shop

Attack Droids are repaired and maintained by two mechanics in this **dark, distracting, cluttered** engineering workshop. **Droid components are everywhere**.

## 8. Mutant Marines

These quarters for 3 platoons of 13 **Mutant Venu Trooper** marines each are **littered with equipment**.

## 9. Guard Station and Brig

An **ad-hoc guard post** and **brig**, manned as long as Princess Kirei Nahino Deh is prisoner in the **makeshift prison cell** opposite. It’s rough and ready, and frankly a bit amateurish. The cell door is a **Security Door** (see page 129).

## 10. Auditorium

A large chamber with **rows of benches** and a **podium on a low dais**.

## 11. Gymnasium

If there are currently no Plot Stress consequences (see page 133) then 2 Venu troopers will be exercising here.

## L4: Docking Bay

Three crew work here, though due to shifts there’s usually only two. When a ship arrives it’s a **hive of activity**.

## 12. Security Station

A **platoon of 13 Mutant Marines** is stationed here if needed.

### 13. Docking Bay 1

If successful, the PCs' **Venu Insertion Ship** (see page 50) docks here. There's also a **guard post**. All doors are Blast Doors (see page 129); the space doors are **Blast Doors** protected by **Docking Bay Shields**.

### 14. Docking Bay 2

Houses a **Venu Fighter** (see page 50) used for system patrols, as well as a **guard post**. Doors are the same as #13 above.

### 15. Cargo Bays

Each bay contains two **cargo lifters** - treat as rudimentary Commonality Assault Walkers (see page 33). Both bays are protected by **Automated Defences** (see page 50).

### L5: Power Plant Deck

#### 16. Power Plant

A **big, primitive Venu "dirt plant"**, **radioactive** and **contaminated**; characters entering are exposed to Z-radiation. Primitive-looking **hazmat suits** reduce exposure by 2 levels. The deck is protected by **Automated Defences** (see page 129).

### L6: Lower Gunnery Deck

#### 17. Gunner Station and Escape Pods

A cramped deck similar to #1 containing the **gunner station** for a **"Dirty Mary" disruptor cannon**. **Power conduits** leak **Average (+1) power Z-radiation**. The deck is unmanned unless the station is on alert (Plot Stress consequence Minor or above).

## Plot

The PCs arrive disguised as Venu troopers and flying the "Latent Martyr", a captured Venu Insertion Ship (see page 50 for statistics). They'll be mistaken for the Venu Security Patrol the Silent Witness crew are expecting.

We've divided this section into "scenes". Each assumes you'll tackle events as "bluffs" or "fights". "Bluff" means the PCs try to get into the station by claiming to be the Venu patrol; "Fight" means they stop bluffing and start blasting their way in! Your game will probably be a combination of the two - or even a third way entirely!

The main thing is, not all the scenes need to happen, or happen in order. Use them as a guide, and be prepared to improvise!

Because the Venu have no Mindscape, and subterfuge is critical (at least to begin with!), everyone's using **Monitor Band cloaks** (see page 24), disguised as belt buckles or Venu epaulette decorations. This means the Monitor Band signal broadcast by the PCs' Mindscape implants isn't detectable, and they aren't targetable by technopsi, but also that PCs can't use Mindscape abilities, including Skill Chips, without switching the cloaks off and becoming detectable.

## Z-Radiation Effects

Z-radiation affects characters according to **Starblazer** page 238. General exposure is Great (+4) Power up-close and Good (+3) in the vicinity. Vac-sealed armour reduces exposure by 1 level.

General Z-radiation exposure is a conflict lasting a number of exchanges equal to the Power level (Great +4 means 4 exchanges). Other exposure (such as close combat with an Attack Droid) may work differently.



Among the pre-generated characters, Dr Thaddeus Clay has a concealed **Personal Mindscape Instance** (see page 34). This is affected by the cloaks, but if they're switched off PCs can communicate with one another by Mindscape and use Skill Chips. If you're using other characters, decide whether anyone has a PMI: if not, Mindscape abilities can't be used even if the cloaks are deactivated.

## Plot Stress

We're using the **Starblazer** Plot Stress rules to monitor the PCs' progress. Use the same Plot Stress Track both outside and inside the Listening Station. We assume that when the PCs arrive, no one inside the station suspects a thing; bit by bit, as the PCs fail their bluff attempts or behave weirdly (weirdly for the Venu, anyway), the Venu become suspicious, until they finally work it out - and attack the PCs! This can happen inside or outside the station. The table below shows sample events and associated Plot Stress; use these to gauge Plot Stress on the Plot Stress Consequence table (see page 133).

### Sample Plot Stress Events

Action	Plot Stress
The PCs fail to initiate radio contact	+1 Stress
A bluff attempt fails	Equal to Shifts
The PCs fail a Venu language attempt	+1 Stress
The Venu detect the Monitor Band	+2 Stress
The PCs betray their lack of Venu knowledge	+2 Stress

## Scene One - Approaching the Silent Witness

Scene One starts 4 zones from the station (use the System Zone Map on page 129). Upon arrival, the PCs know only that the ship which kidnapped the Princess arrived in this system - they don't know what they'll find. They need to make sensor scans and so on to locate the Silent Witness.

**Bluffing:** Standard Venu procedure is that the Silent Witness waits for radio contact when an unidentified ship arrives. Any bluffs are Mediocre (+0) difficulty; if the PCs don't make radio contact, this rises to Average (+1). Remember contact has to be made in Venu, not Universal; it also requires the PCs to transmit Venu security codes - which fortunately SCI Force has provided them with, together with false identities to go with their disguises. Run this as a single exchange or a social conflict using Skills like Deceit, Rapport, Intimidate, modified by Empathy, Academics (Languages). If successful, the station instructs the PCs to proceed to dock.

**Fighting:** If the PCs go in guns blazing, or if the bluff attempt fails, the Silent Witness switches to battle stations and sends out the Venu Fighter (see page 50) to intercept.

## Scene Two - Getting In

This scene takes place once the Insertion Ship has closed to 1 zone on its final approach to the station.

**Bluffing:** Continue monitoring Plot Stress. Strange actions by the PCs increase Plot Stress, including failed Deceit or Language checks while docking, and inaccurate cultural knowledge.

**Fighting:** PCs attacking the Silent Witness encounter stiff resistance! The "Dirty Mary" Disruptor Cannons attack continually, and landing on the station or carrying out boarding actions encounters an Attack Droid dispatched to clear the hull. Set Plot Stress to "Extreme Consequence / Taken Out" - PCs will have to fight every step of the way after forcing an entry like this. To get into the station they must either:

**Bypass the Docking Bay doors** (see "Blast Doors" on page 129). Each Shift of failure means the process takes an extra exchange. Success means the Docking Bay begins to

decompress and the bay doors open, taking 3 exchanges; each shift reduces this by 1 exchange. Zero exchanges or less means the bay doors open immediately, causing explosive decompression (see below);

**Use a Thermic Lance or Mining Torch** to cut through the hull (**Barrier Value: 6**, 3 Consequences) and board directly (causing Explosive Decompression - see below).

### Plot Stress Consequences

No Consequences	The PCs are doing great. They're allowed to dock, taken to the Princess and allowed to escort her back to their ship. No one suspects a thing. Guard posts are at normal alert levels (one guard per post).
□□ - Minor Consequence	The station crew is mildly suspicious. PCs are allowed to dock, but Docking Bay guards are on alert. They allow the PCs to the Princess, but insist on checking IDs, etc, very carefully, using Skills such as Empathy, etc, against the PCs' defences. Tag this consequence to the disadvantage of further bluff attempts. Guard posts are on elevated alert (two guards per post).
□□□ - Major Consequence	The station crew is pretty sure something is up, but isn't sure what. The PCs are permitted to dock, but are led away at gunpoint for interrogation. Further bluff attempts are much more difficult. Guard posts are at high alert (three guards per post). If operational, the PCs' Monitor Band cloaks may be detected during the interrogation (use the Silent Witness Advanced Sensor Suite against a Superb (+5) difficulty). If detected, or if the PCs aren't using cloaks, the Venu detect the Monitor Band on an Average (+1) passive sensor roll: treat as a Serious consequence.
□□□□ - Serious Consequence	The station crew set a trap. The PCs are permitted to dock, but are arrested at gunpoint, and imprisoned in the Brig until the next Security Patrol arrives. Guard posts are at full alert, and attack anyone they don't know.
□□□□□ - Extreme Consequence / Taken Out	The station crew attack immediately. If the PCs haven't yet docked, the Silent Witness sends out its Fighter to intercept; if the PCs are already in the Station, all Venu forces become hostile and open fire. Guards actively pursue the PCs unless evaded.





### Scene Three - Finding the Princess

The PCs have entered the Silent Witness and are heading for the Princess.

*Bluffing:* The PCs are taken directly to the Brig (#9). Suspicious actions still increase Plot Stress (as Scene Two, above).

*Fighting:* Set Plot Stress at "Extreme Consequence / Taken Out". The PCs must fight their way to the Brig, maybe using Burglary (Casing) to locate it, rescue the Princess, and fight a retreat to the Docking Bay!

### Scene Four - the Real Security Patrol just showed up!

Scene Four takes place once the PCs have encountered the Princess and are about to return to the Insertion Ship.

*Bluffing:* The Venu escorting the PCs suddenly receive a communication from the Bridge: a Venu Security Patrol has entered the system and is approaching the Silent Witness to transfer the Princess. The PCs are imposters!

Set Plot Stress to "Serious Consequence" immediately: the Venu try to arrest the PCs and imprison them in the brig until the patrol arrives. If the PCs resist, set Plot Stress to "Extreme Consequence / Taken Out".



*Fighting:* Have the PCs make Alertness rolls (possibly Empathy or Investigation) to notice something has changed. The number of shifts indicates how much to tell them.



### Scene Five - The Grand Finale Certain Doom!

Scene Five occurs once the PCs get back to the Docking Bay. The bay doors are open, the shields are up, and a huge Venu Warhawk (see page 51) has arrived outside the bay. The decompression alarms are sounding!

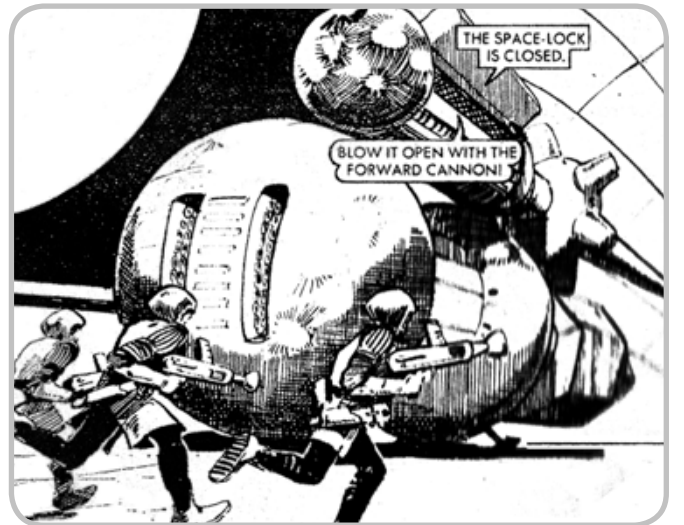

### The Twist!

By their ship the PCs notice an Attack Droid and a Commonality human - a traitor! He notices the PCs and appears alarmed; Princess Kirei explains it's Doctor Remnai Noyo - the scientist who kidnapped her!

### The Final Showdown!

Doctor Noyo hits an emergency release, and the docking bay explosively decompresses (see "Explosive Decompression," below)! The Attack Droid attacks as he launches himself towards the Warhawk: there are two boarding capsules under its wings. What do the PCs do? Is their ship disabled? Could they steal a boarding capsule? Can they neutralize the droid? Do they pursue the traitor, leaping into space for a zero-G battle to the death? What about the Princess?

### **Explosive Decompression**

Characters caught in explosive decompression without pressure suits or similar protection suffer a Fair (+2) attack against Endurance, Might, etc, doing +5 Physical stress damage.

Characters must hold on to not be swept away by the evacuation, regardless of whether they're wearing pressure suits. It's a Good (+3) manoeuvre against Might, Athletics, etc, placing a temporary Aspect "Unbalanced" or "Floating Out of Control". Shifts indicate how far the target is ejected from the Docking Bay, how out of control, and the difficulty of regaining control, requiring Athletics at -1 or Zero-G Combat rolls.

Characters not wearing pressure suits suffer Vacuum Exposure effects (**Starblazer** page 238) every exchange.

Use the Zero-G Combat rules (**Starblazer** page 238) for characters fighting under these conditions.

### **Victory!**

There are a number of possible outcomes to this scene:

#### **Dead!**

If the PCs are dead, read "The Rescue Fails" below to see how events unfold.

#### **Captured!**

PCs captured are in a fix! The Venu patrol transports them to Venu space for "interrogation" - a horrible prospect. Run as a separate adventure, giving the PCs chance to escape, avoiding a fate worse than death! See "Epilogue" below for ideas.

#### **Escape!**

Assuming the PCs regain the Insertion Ship, they'll be hotly pursued by the Warhawk. Escape by planing engine (probably involving a blind jump) requires the PCs to put 2 or more zones between them and the pursuing Warhawk (**Starblazer** page 357).

Failing that, the PCs may try and steal one of the Warhawk's boarding capsules and escape beyond detection range (**Starblazer** page 358). They'll have to decide a destination: a nearby moon or planet, the gas giant rings, the system asteroid belt. Use the System Zone Map on page 129.



### **His Dark Radiance, Asharak-Um**

The Warhawk is commanded by the sinister Commissar Asharak-Um. Whether the PCs encounter him depends on actions in Scene Five. The Commissar begins inside the Warhawk with a platoon of Venu Troopers, and tries to prevent the PCs escaping with the Princess. He may never leave the ship, instead sending his troopers to fight and using his psi-powers (particularly Domination) from a distance.

### **Epilogue**

The outcome of the adventure has the following possible consequences:

#### **The Rescue Succeeds**

Returning triumphant with the Princess, the PCs will have won the favour of the Amidan government. Give them the "Favour [Diplomat]" Stunt when interacting with Amida or SCI Force. The Commonality gains the temporary Aspect "Heroes of the Day", taggable in the next exchange of its propaganda campaign on Amida (see page 72).

#### **The Rescue Fails**

A failed rescue may have different consequences depending on whether the Princess is alive or not.

If the Princess is dead, the PCs will be cold-shouldered if they return to Amida, and may suffer reprisals. The Commonality gains the temporary Aspect "Running Roughshod over our traditions" for the next cultural conflict exchange only.

If the Princess is alive, things are worse, as public opinion turns against the Commonality for abandoning her to the Venu. The Amidan government expels the Commonality Ambassador, and withdraws support for the Commonality's propaganda campaign.



## Intelligence on the Venu

The PCs' debriefing increases SCI Force knowledge of the Venu, and, vitally (if the PCs witnessed them), of the psionics of Asharak-Um the Radiant Cultist. Thaddeus Clay gains the temporary Aspect "His Hypothesis Vindicated", usable on a Contacts, Rapport, Science or Resources roll related to psionics research. Also, the Commonality culture gains +1 on its next Research & Development roll to increase its Psionics capability.

## Doctor Noyo

Doctor Noyo links to **Mind's Eye**, the next scenario in the Black Zone campaign. If he's still alive at the end of the adventure, you can use him as an irritant or even nemesis as the Black Zone campaign develops. If he makes it that far, we've included him as an optional extra in **the Black Zone**, the last scenario in the campaign (see **Chapter Eleven**).

## The Radiant Cultist

If the Venu Commissar is killed, the Venu send assassins to avenge his death. StoryTellers should decide an appropriately bad moment for them to appear!

If the Commissar survives, his attitude depends on how successful the PCs were, ranging from scorn to a raging desire to avenge himself for his humiliation at their hands!

## Dramatis Personae and Statistics

Use the following statistics for the minions, extras, and named characters encountered in this scenario.

### Attack droids

Attack droids are rusty brown four-legged spider-like robots with disruptors and primitive force fields, and obeying Venu Command IDs. There are four in the station: one in Scene Two, one in Scene Five, and two reinforcements if needed. They belch out Z-radiation and make a free Exude Energy attack whenever physically damaged.

Venu Attack Droid		
<b>Physical Stress:</b>	□□□□	
<b>System Stress:</b>	□□□□	
<b>Fate Points:</b> 5	<b>Scale:</b> Small (2)	
<b>Consequences:</b> Up to 3 Consequences		
<b>Encounter Size:</b> 1-6		
<b>Skills</b>		
Fair (+2)	Guns	Athletics
Average (+1)	Exude Energy	
	Alertness	Weapons
<b>Aspects</b>		
Clunky Venu robot technology		
Climbs like a spider		
Single-minded Killing Machine		
Just as agile in zero-G		
Leaking Z-Radiation		
Minor Weakness: Blaster Weapons		
<b>Stunts</b>		
Exude Radiation [Exude Energy]		
Zero-G Combat [Weapons]		
Active Sonar [Alertness]		
Human Spider [Athletics]		
Spider Feet [Athletics]		
<b>Equipment</b>		
Protein Disruptor Cannon (+4 Stress, Range 2)		
Z-Radiation Leak (see "Z-Radiation Effects" on page 132. A single attack of Fair (+2) Power against physically adjacent targets - it has no real range)		
-1 Kinetic Armour, -1 Energy Shield		

### The Traitorous Doctor Noyo

Doctor Remnai Noyo is the traitorous Commonality scientist who kidnapped Princess Kirei and took her to Venu space. He's a link to the Nimbu Research Station in **Mind's Eye**, the next scenario in the Black Zone campaign (see the next chapter).

Originally from Amida, Doctor Noyo was seconded to Nimbu Prime under Dr Tungus, where he gained an insight into the





source of Venu psi-powers; by delivering the Princess he hopes to shift his planet from alliance with the Commonality and towards the Venu. He hopes one day to be a powerful psion and Venu plenipotentiary on Amida.

Doctor Remnai Noyo		
<b>Physical Stress:</b>	□□□□□	
<b>Composure Stress:</b>	□□□□□□	
<b>Fate Points:</b> 6	<b>Scale:</b> Small (2)	
<b>Consequences:</b> Up to 3 Consequences		
<b>Encounter Size:</b> 1		
<b>Skills</b>		
Good (+3)	Science	
Fair (+2)	Resources	Academics
	Deceit	
Average (+1)	Guns	Intimidation
	Resolve	Investigation
	Alertness	Starship Pilot
<b>Aspects</b>		
Dedicated to the power of Science!		
Amida needs ruling with a firm hand!		
Mindscape implant		
The Commonality doesn't know how to use its power!		
They'll never ignore me again!		
You can't be expected to understand		
<b>Stunts</b>		
Access to Labs [Career]		
Death Defiance [Endurance]		
Scientific Genius: Genurgy [Science]		
Takes One to Know One [Deceit]		
<b>Equipment</b>		
Mindscape implant		
P-Suit (-1 Kinetic Armour, -1 Energy Shield)		
Tyce Systems "T-25" 25MW laser pistol (+4 Stress, Range 1)		
Speaks: Amidan, Universal, Venu		

## Princess Kirei

Heir to the Amidan throne at only 21 years old, Princess Kirei is young and inexperienced, but by no means incompetent. Brought up in the royal house of an ancient and complex culture, she's been groomed since birth to take power. She's extremely self-willed, with a strong sense of honour.

### Doctor Noyo's Ship

The identity and whereabouts of the ship Doctor Noyo used to kidnap Princess Kirei have been left vague. Maybe it was an Amidan prototype, or a Commonality ship? A hidden Venu vessel? Perhaps it's already returned to Amida - or maybe it lies somewhere in the X-24-Alpha system. Use Noyo's ship if players become lost or stranded, or their own destroyed - or in further adventures following **Escape from Venu!**

## Princess Kirei Nahino Deh

<b>Physical Stress:</b>	□□□□□	
<b>Composure Stress:</b>	□□□□□□	
<b>Fate Points:</b> 8	<b>Scale:</b> Small (2)	
<b>Consequences:</b> Up to 3 Consequences (4 social)		
<b>Encounter Size:</b> 1		
<b>Skills</b>		
Good (+3)	Resources	
Fair (+2)	Rapport	Resolve
Average (+1)	Leadership	Contacting
	Alertness	
<b>Aspects</b>		
Heir to the Throne of Amida		
I can do it myself!		
That's not the proper way to behave!		
Noblesse oblige		
<b>Stunts</b>		
Introduction [Diplomat]		
Smooth Recovery [Resolve]		
<b>Equipment</b>		
Somewhat dirtied royal robes		

## Station Commander Vrak

Station Commander Vrak is a violent and sadistic cyborg with primitive Venu tech replacing his left arm and the left half of his face. He's a disgraced ex-soldier, exiled to the Silent Witness rather than terminated because he's a war hero.

## The Silent Witness Crew

Silent Witness crew members are minions, each with a skill appropriate to their station. From the Commonality point of view, they're brainwashed fanatics loyal to their God-Emperor in a vicious hierarchy of fear and violence. They avoid combat unless ordered by a superior - they're needed for the functioning of the station.

## Commissar Asharak-Um, Head of the Security Patrol

The Security Patrol is led by a sinister individual who terrifies every Venu. Tall, cloaked, with a "scintillating" black face mask, he also has several psi-powers, source unknown. It's evident he belongs to a leader caste; less evident is that he's a mutant, as removing his mask will reveal.

Information about the Commissar is valuable: most of the 150 years since Venu contact has been as enemies, and the Commonality knows little about Venu organization and capabilities, especially developments since the Xeno Wars. The Commissar looks like something new...

### Station Commander Vrak

**Physical Stress:** □□□□□□

**Composure Stress:** □□□□

**Fate Points:** 4 **Scale:** Small (2)

**Consequences:** Up to 3 Consequences

**Encounter Size:** 1

#### Skills

Great (+4)	Exude Energy	
Good (+3)	Intimidation	Leadership
Fair (+2)	Endurance	Guns
	Might	
Average (+1)	Alertness	Athletics
	Fists	Weapons

#### Aspects

War Hero of the Pleysho Campaigns  
Speak the word "Exile" and die!  
Commands the Silent Witness through fear and brutality  
Primitive Venu cyborg technology  
Losing What Little Humanity He Had Left (Mandroid Aspect)  
My loyalty is to the Emperor!  
They should have let me die!  
No one knows what this power has cost me!  
I see things differently now (Eagle Eyes vision)  
Minor Weakness: Water (Good Investigation / Science Skill check)

#### Stunts

Mandroid Arm (+1 Might, Endurance, Athletics, Fists, and Weapons skill checks)  
Mandroid Eye (+1 Alertness skill checks)  
Exude Lightning [Exude Energy]  
Eagle Eyes [Alertness]  
Claws [Fists]  
Scary [Intimidation]

#### Equipment

Mandroid Claw (+1 Stress)  
Electricity Projector (Range 1, built into cybernetic arm, possible "Electrocuted" Aspect / Consequence)  
Venu Marauder Armour (-3 Kinetic Armour, -2 Energy Shield)

### Commissar Asharak-Um

**Physical Stress:** □□□□

**Composure Stress:** □□□□□

**Fate Points:** 5 **Scale:** Small (2)

**Consequences:** Up to 3 Consequences

**Encounter Size:** 1

#### Skills

Great (+4)	Mind Control	
Good (+3)	Mental Bolt	Intimidation
Fair (+2)	Leadership	Mysteries
	Resources	
Average (+1)	Deceit	Science
	Resolve	Absorb Energy

#### Aspects

Devoted Servitor of the Dark Radiance  
I bear the scars of my allegiance (Venu Mutant Aspect)  
Feel the caress of Z-Radiation!  
You will bow to my will!  
Arrogant Venu commissar  
All Must Fear Me!  
You Do Not Know the Power of the Dark Radiance!  
The Commonality is Weak!  
Minor Weakness: Sonic Weapons (Good Science / Mysteries Skill check)  
Minor Weakness: Force Fields (Good Science / Mysteries Skill check)

#### Stunts

Dominate [Mind Control]  
Mental Blast [Mental Bolt]  
Scary [Intimidation]  
Aura of Menace [Intimidation]  
Absorb Radiation [Absorb Energy]

#### Equipment

Black-lacquered body armour (-2 Kinetic Armour, -1 Energy Shield)  
Protein Disruptor Pistol (+3 Stress, Range 1)  
Energy Mace (built-in: +4 Stress)



### Venu Wardog (Squad Leader) and Venu Trooper Minions

Venu Troopers are deranged, psychopathic killers, controlled only by their fear of those above them. A typical Venu Wardog leads a squad of 12 trooper minions.

Venu Wardog		Squad Leader
Physical Stress:	□□□□	
Composure Stress:	□□□□	
Fate Points: 7	Scale: Small (2)	
Consequences: Up to 3 Consequences		
Encounter Size: 1 + 12 minions		
<b>Skills</b>		
Good (+3)	Guns	
Fair (+2)	Leadership	Intimidation
	Alertness	Stealth
Average (+1)	Exude Energy	Athletics
	Fists	Might
<b>Aspects</b>		
Hideous Venu Mutant		
I killed my way to Squad Leader!		
The Commonality is weak and will die!		
Battle is what I live for!		
Blinded by the urge to kill		
No one beats me!		
<b>Stunts</b>		
Exude Radiation [Exude Energy]		
Horrific [Intimidation]		
Minions [Leadership]		
<b>Equipment</b>		
Protein Disruptor Rifle (+4 Stress, Range 2)		
Venu Trooper Armour (-2 Kinetic Armour, -1 Energy Shield)		
<b>Venu Troopers</b>		<b>Minions</b>
A team of 4 Average (+1) Venu Trooper minion with the Guns Skill. A typical squad comprises 3 teams.		
-	Independent Venu Trooper Team	□□□□
	(+2 bonus) (Guns +1)	
-	Attached Trooper Team (+2 bonus	□□□□
	to Squad Leader)	

## Pre-generated Characters

You can use the following characters to get playing immediately, or create your own.

### Dr. Thaddeus Clay

Famous psychologist and psychohistorian, Dr. Thaddeus Clay is 193 years old. Born on Old Earth, he remembers when SCI Force was first founded after the Venu War. He has worked as a SCI Force controller for years, training and operating teams in the field.



### Phase One - Training

Noticed in school for his brilliance and his fits and seizures, Clay was hypersensitive, always “reading” people. Suspected of being a latent psion, he was recruited into the Security Instrumentality in 37 NCE to continue his “education”.

### Phase Two - Thaddeus Clay and the Treachery of Venu!

Assistant supervisor overseeing the first Venu mission (70 NCE), the disastrous failure of which made Clay doubt the superiority of the “Commonality way”. Shocked out of his self-absorption, he began to see others as “real people”.

### Phase Three - Thaddeus Clay and the Mind Masters!

In 190 NCE Clay led a SCI Force team against undercover Venu in the Sentient Alliance. He lost his entire team, bar one. Clay had been wondering why he could never “read” the Venu, theorising the Venu had natural psi-powers. His undercover team was intercepted, which for Clay proved his theory true. Not everyone subscribes to “Clay’s Hypothesis”, but it’s taken very seriously in some circles.

### Phase Four - Guest Starring in Jackson Stark and the Memory Assassin!

Clay had been in charge of Jackson Stark’s training. When Stark was ordered to kill a Fringe World ruler, Clay saw this would be a psychohistorical disaster, and triggered a failsafe response in Stark causing him to fail. When military psy-ops tried to kill Stark, Clay brought him in, told him who he was, and recruited him.

### Jackson Stark

A hard-as-nails special ops agent and a good man to have on your side, Stark is ruthless, independent, and capable - with some terrible personality flaws.

### Phase One - Training

Born on Cynax IV, at age 8 Stark saw his parents killed by his “uncle”. Insanity runs in his family, and Jackson never recovered from the trauma, believing he’s mad himself. People said his uncle killed himself after the murders, but his body was never found. Jackson became a feral street kid, until he was recruited by a clandestine black ops group.

### Phase Two - Jackson Stark and the Memory Assassin!

For years Stark suffered blackouts, with days and even weeks he couldn’t account for. When he confronted the black ops

Dr. Thaddeus Clay		
Physical Stress:	□□□□	
Composure Stress:	□□□□	
Fate Points: 6	Scale: Small (2)	
Consequences: Up to 3 Consequences		
Encounter Size: 1		
Skills		
Great (+4)	Empathy	
Good (+3)	Science	Academics
Fair (+2)	Leadership	Resources
	Technopsi	
Average (+1)	Starship Systems	Investigation
	Guns	Mysteries
Aspects		
	Pathologically Hypersensitive	
	Loner	
	Special Operations Chip	
	There’s More to People than Meets the Eye	
	Self-sacrifice for the Commonality is unavoidable!	
	The Venu have psi-powers - so must we!	
	The future cannot be entrusted to the military!	
	Jackson Stark is a man - not a machine!	
Stunts		
	Redaction [Technopsi]	
	Access to Weapons [Career]	
	Local Area Resources [Career]	
	Access to Restricted Technopsi	
Equipment		
	Special Operations Chip	
	Monitor Band Cloak	
	Personal Mindscape Instance (concealed)	
	Venu Status Suit (-1 Kinetic Armour, -1 Energy Shield)	
	Venu EVA Harness	
	Venu Protein Disruptor (+4 Stress, Range 2)	
	Venu Mask	
	Disguised as Venu Security Patrol Leader Commander Sharum	

group they used technopsi to control his will. They gave him a mission to kill a Fringe World ruler, but something happened, and when Stark aborted his mission and dropped off the radar, military psy-ops decided to terminate him. In fact a SCI Force controller called Thaddeus Clay (Stark's secret controller for years) had triggered conditioned responses in Stark he didn't even know he had; the military still don't know why he aborted the mission. Clay converted Stark's Mindscape implant to a special operations chip, explained who he was, and recruited him into his new SCI Force Insertion and Sanction Team.

### Phase Three - Guest Starring in Max Proffitt and the New Bahamut Disaster!

Stark's team was sent to apprehend Dr. Maledict Miserius. Although the Doctor escaped, Stark captured a bewildered Max Proffitt. Realizing he was just a greedy fool who'd fallen foul of Miserius' plans, Stark brought him to SCI Force, thinking he might be useful.

Jackson Stark		
Physical Stress:	□□□□□	
Composure Stress:	□□□□□	
Fate Points: 7	Scale: Small (2)	
Consequences: Up to 3 Consequences		
Encounter Size: 1		
Skills		
Good (+3)	Guns	
Fair (+2)	Fists	Alertness
	Athletics	
Average (+1)	Technopsi	Endurance
	Weapons	Stealth
	Drive	Burglary
Aspects		
I learned to hide my fear!		
Nothing hurts me!		
Haunted by a past he can't remember		
More of a machine than a man		
Special Operations Chip		
Max Proffitt owes me his life!		
Stunts		
Mindburn [Technopsi]		
Skill Chip: Guns (+2 on Guns checks)		
Supply Officer [Career]		
Equipment		
Special Operations Chip		
Monitor Band Cloak		
Venu Trooper Armour (-2 Kinetic Armour, -1 Energy Shield)		
Venu Protein Disruptor (+4 Stress, Range 2)		
Venu Trooper Mask		
Disguised as Venu Trooper		

### Lyra Da Luz

Lyra Da Luz is a light-fingered criminal type from the Hispanian culture world of Altamira. A good example of the "unusual characters" the cultural reclamation sometimes throws up, she's an out-and-out criminal, a con, and probably a certifiable sociopath. On the Core Worlds she'd have been re-educated years ago - out on the Rim, she's a positive asset!

### Phase One - Training

Growing up in overpopulated Hispanian ghettos on Altamira, Lyra used her looks and charm to get by. If that spilled over into a little larceny - well, hey, a girl's gotta live!

### Phase Two - Lyra Da Luz and the Jade Crown Affair!

In love with suave businessman Jameson McFayre, Lyra found out he was a jewel thief asking her to take part in a heist of the fabled Jade Crown. The caper went wrong, and McFayre abandoned Lyra to face the rap alone!

### Phase Three - Guest Starring in Thaddeus Clay and the Mind Masters

As she was facing re-education, SCI Force controller Thaddeus Clay offered Lyra a way out: work for him. She agreed to join an undercover team operating in Sentient Alliance territory. During the mission she got cold feet and fled, and the rest of the team was captured by the Venu. She had to persuade Clay she hadn't betrayed them; she's still not sure if he believes her.

Lyra Da Luz		
Physical Stress:	□□□□□	
Composure Stress:	□□□□□	
Fate Points: 7	Scale: Small (2)	
Consequences: Up to 3 Consequences		
Encounter Size: 1		
Skills		
Good (+3)	Burglary	
Fair (+2)	Deceit	Contacts
	Sleight of Hand	
Average (+1)	Guns	Stealth
	Alertness	Empathy
	Rapport	Athletics
Aspects		
Come to Lyra, baby!		
So light-fingered it hurts		
That bastard McFayre hung me out to dry!		
Mindscape implant		
I have a bad feeling about this...		
I don't trust Clay - he doesn't trust me!		
Stunts		
Alarm Sensibilities [Burglary]		
Lock Master [Burglary]		
Bump & Grab [Sleight of Hand]		
Equipment		
Mindscape implant		
Monitor Band Cloak		
Venu Trooper Armour (-2 Kinetic Armour, -1 Energy Shield)		
Venu Protein Disruptor (+4 Stress, Range 2)		
Venu Trooper Mask		
Disguised as Venu Trooper		

## Maximillian Proffitt

### Phase One - The Economic Principle

Max spent years as a hard-nosed New Trader in the Fringe Worlds, shipping whatever it took to turn a profit and keep the rust-bucket "Rosemary Princess", a 150-year old Keynes-class Freighter, running. Handy with a gun, and knowing when to cut his losses, Max had a reputation for striking a hard bargain and leaving economic mayhem in his wake.

### Phase Two - Max Proffitt and the New Bahamut Disaster!

Then everything changed. On what Max thought was a routine smuggling run to New Bahamut, he transported a virulent bio-plague engineered by the evil Doctor Maledict Miserius. In the ensuing devastation, Proffitt found himself on the side of SCI Force, trying to apprehend Miserius and stop the plague. The plague was brought under control, but thousands perished, and Miserius escaped. In return for not locking Proffitt away, SCI Force decided he would "help them out" instead.

### Phase Three - Guest Starring in Lyra Da Luz and the Jade Crown Affair!

Max Proffitt's first "favour" for SCI Force was to be the "getaway guy" for Jameson McFayre and Lyra Da Luz after the Jade Crown caper. McFayre never showed; Da Luz turned up and was promptly arrested.



## Maximillian Proffitt

**Physical Stress:** □□□□□

**Composure Stress:** □□□□□

**Fate Points:** 7 **Scale:** Small (2)

**Consequences:** Up to 3 Consequences

**Encounter Size:** 1

### Skills

Good (+3)	Starship Pilot	
Fair (+2)	Resources	Deceit
	Contacting	
Average (+1)	Guns	Athletics
	Intimidation	Rapport
	Alertness	Sleight of Hand

### Aspects

- The Rosemary Princess\*
- Mindscape Implant
- SCI Force have me over a barrel!
- Doctor Miserius haunts my dreams
- Nothing personal - it's just business
- Lyra Da Luz hates my guts!

### Stunts

- Ticket to Travel [Career]
- Merchant Funds [Career]
- Small Ship [Career]

### Equipment

- \*Rosemary Princess Keynes-class Freighter
- Mindscape Implant
- Monitor Band Cloak
- Venu Trooper Armour (-2 Kinetic Armour, -1 Energy Shield)
- Venu Protein Disruptor (+4 Stress, Range 2)
- Venu Trooper Mask
- Disguised as Venu Trooper
- Has Major Composure Consequence "Mentally Traumatized" after piloting Venu Insertion Ship through 2-Space!



# Chapter Nine: Mind's Eye

A CONFIDENTIAL REPORT  
WITHIN THE COMMONALITY

To: Sister Andrea Kanjattu, 4th  
assistant sub-director, Eidolon Project,  
Mysore Vallis Chapter, Ministry of Evolutionary  
Planning, Europa / Manhome

EIDOLON STATION NIMBU PRIME 16.49:-9.66:-7.3  
NCE14.10.07.194.193  
REPORT PRIORITY COMMUNICATION BOUNCE  
RESULT CODE: 7 (NO RESPONSE, STATION CORPUS OFFLINE)  
PROBABLE MONITOR BAND MALFUNCTION  
RECOMMEND ORGANIC TEAM DISPATCH INVESTIGATION IN  
ACTUO

LAST KNOWN COMMUNICATION FROM NIMBU PRIME  
FOLLOWS

#####

From: Mindscape Node Dirigeant Vindragupti, Eidolon Station  
4, Nimbu Prime  
## MINDJAMMER TO EYES : NON-MINDSCAPE TRAFFIC ONLY  
## URGENT

Revered Sister.

Please accept formal report of suspected introversion by Project  
Chief (Organic) Doctor Milani Tungus. Accompanying pere-  
quantum manifestations suggest that Phase One pathworking  
has been achieved. Request 3rd stage redactor be dispatched  
to relieve Doctor Tungus and appoint organic replacement to  
interface with station corpus. Recommend extreme urgency.

Vindragupti.

Emergency code 14-gamma on full personal responsibility.  
Out.

#####

## Background

The Ministry for Evolutionary Planning has lost contact with a research station on planet Nimbu Prime, where a psionics research project has gone terribly wrong. Following the events of **Escape from Venu**, the PCs return to Gentility Base, the SCI Force base in the Zvukimu system, where they ascertain that the Amidan Princess' kidnapper was a scientist from the same station. Gentility-5, the SCI Force base sentience, has intercepted a confidential report (see above), filed several weeks earlier and not expected to reach Manhome for over a year, and introduces the party to the

"Gregarious Curiosity-255"; a SCI Force "Fast Courier", issuing equipment for a mission to the Nimbu system to find out what's happened to the research team.

## Story Teller's Overview

The Nimbu station has been researching into a native animal species, the colony lizard, which appears to possess rudimentary psionic powers. Its director of research Doctor Milani Tungus has become obsessed with the work, causing some of his staff to make confidential reports expressing concern. Synthesising a genurgic therapy from his research, Tungus experimented - secretly - on himself, following which he began to be the focus of paranormal events: spontaneous PK occurrences, odd noises like yelps, growls, and whispers, people getting migraines, bizarre smells.

Somewhere along the way Doctor Tungus became completely unhinged, and began talking to some (apparently) imaginary creature. His journal (currently offline and lost somewhere in the Base) refers to it only as "the Entity".

Two months ago the Entity began to physically manifest around the station. Somehow it "took control" of 5 staff, including 2 xenomorphs and 1 synthetic, forcing them to commit atrocities, killing their colleagues one by one.

Of the original 40 staff, two remain alive (1 organic, 1 synthetic), hiding in the station, including Vindragupti, originator of the first (and only) distress message. Of the other 38, 5 are Possessed, 1 is Doctor Tungus, and 32 are dead, their remains scattered about the complex.

We've structured this scenario as a mystery investigation with elements of horror and physical and mental conflict. Like **Escape from Venu**, it's divided into sections on location, plot, and statistics.

## Location

### Nimbu Prime

You can find details of the Nimbu system on page 111. The PCs arrive at the station in the middle of a cool but lively spring as everything is emerging from winter dormancy.

### Eidolon Station

The research station is located in the equatorial belt in dense forest by the shore of a large shallow lake. Established twenty-five years ago by the Ministry of Evolutionary Planning, it's a tower-shaped structure with greenhouse and hydroponics wings, heavily automated and with about

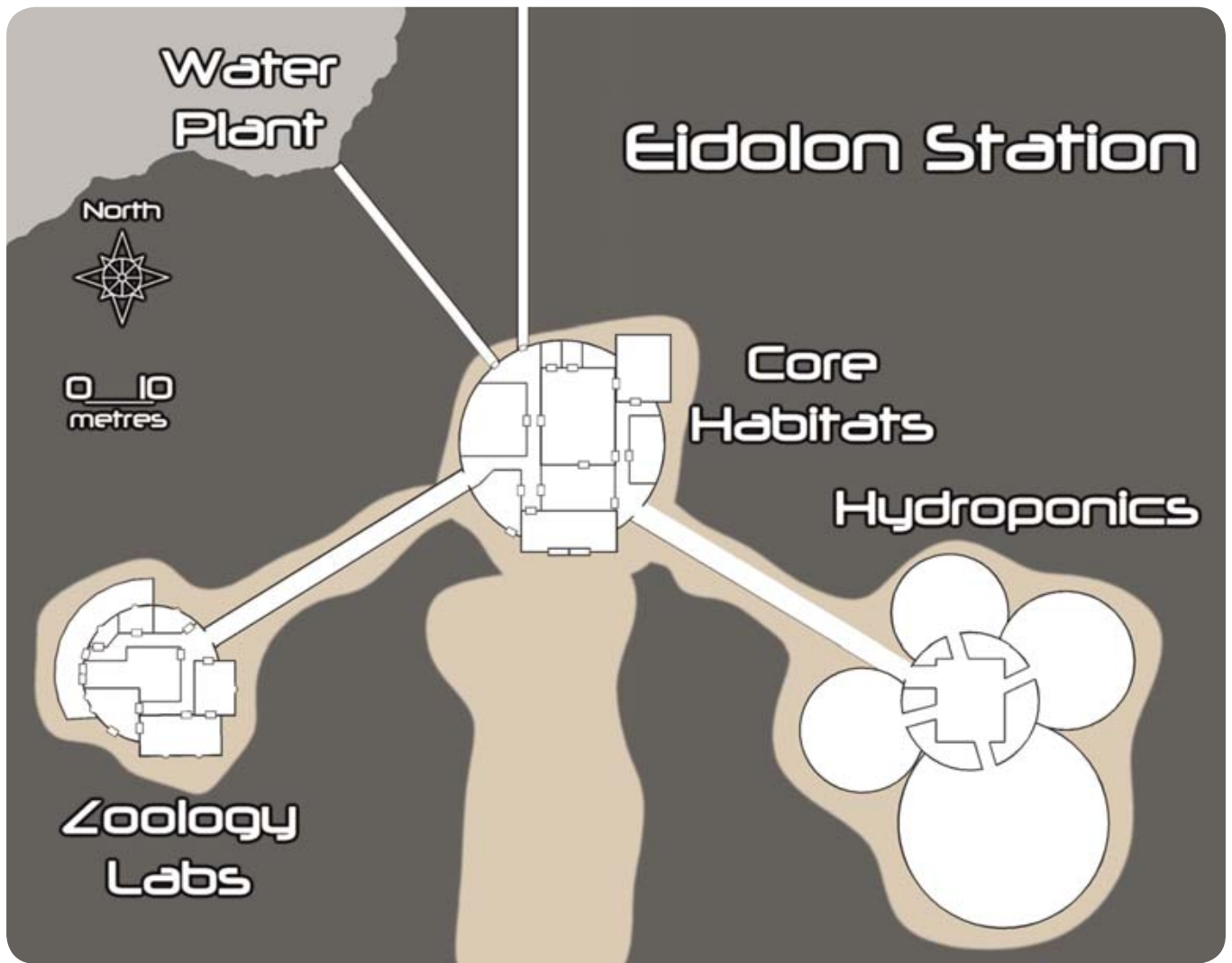

40 staff, including 12 variform synthetics and a number of chimp-like pithecinic xenomorphs, and headed by Chembu hominid Doctor Milani Tungus, Professor of Percognitive Reversion from Chembu Genurgy corpocracy.

The station's sentient corpus ("Eidolon-4" - see page 158) and Local Mindscape Instance have both been severely damaged and the Mindscape is offline. Effectively blind, the station attacks all intruders as hostiles using its automated defences until its primary control interface (area 4b) can be accessed.

### **First Glance**

Approaching from the landing strip to the south, the station appears covered with colony lizards, the core habitats heavily damaged, and what's left of a flyer is lodged in the burnt-out ruin of the top floor.

### **Analysis**

The colony lizards swarming the station exterior are behaving abnormally, pressing up against the windows and trying to get in. They are agitated and may attack intruders. Passive scans (hand scanners or personal sensor arrays with

**Sensorview**) reveal the station Mindscape is down, although there's a Monitor Band open to the north (the power plant). Active sensor sweeps reveal numerous lifeforms (mostly colony lizards, plus 8 others - the Survivors and Possessed); neither active nor passive sensor sweeps pick up the Entity. Active sensor sweeps or broadcasts to the Monitor Band cause Plot Stress (see page 152), eventually attracting the attention of Eidolon-4 and the Entity.

### **Detail**

The following descriptions show possible location Aspects in bold.

Eidolon Station is badly damaged. Most interior **lights aren't working**; there are **flashes of light, strange screams, cries, yelps; alarms go off randomly**; there are **gouts of steam and smoke**. The five Possessed wander at random, attacking anything.

There are **remains everywhere**, mostly human. Investigation or Forensic (Science) checks indicate death by blunt trauma, and that the remains have been... well... chewed on...

## The Roof Level

The top floor of the station is a large circular area filled with debris and mostly-ruined. It's a tangle of fallen roof, remains of walls, and burnt-out electronics. However, it's still accessible, both via the elevator and the emergency stairwell, although it's open to the elements and partly waterlogged.

The crashed flyer is in a bad state, requiring a Superb (+5) Engineering roll (+1 with a Vehicle Repair Kit) to get back into shaky working order.

### Crashed Flyer

<b>Physical Stress:</b>	□□□□
<b>Systems Stress:</b>	□□□□
<b>Fate Points:</b> n/a	<b>Scale:</b> Small (2)
<b>Consequences:</b> Up to 3 Consequences	
<b>Speed:</b> Fair (+2)	Crew: 1
<b>Skills</b>	
Fair (+2)	Manoeuvre
Average (+1)	Anti-gravity Model
<b>Aspects</b>	
I seem to have sustained significant damage!	
Should handle like a dream - but doesn't!	
Open to the elements	
<b>Stunts</b>	
Atmospheric Entry [Manoeuvre]	
Sentient Vehicle Control [Vehicle Systems]	
<b>Equipment</b>	
Carries up to 3 passengers.	

## Core Habitats

Containing living and dining quarters, sick bay, general laboratories, and gym and conference facilities.

### First Glance

The Core Habitats are in **semi-darkness**, the outer doors closed and locked (Average (+1) Burglary). The top floor (originally xenomorph pens) has been completely **destroyed, ravaged by fire**, and a **flyer** is jack-knifed into the rubble.

### Analysis

Passive scans reveal Old Earth-normal O<sub>2</sub> levels; active scans show life signs in areas 1, 4, and 12 (synthetic) on level one, 17 on level two, and 24-25 on level three. Shouting, etc, will attract the attention of Vindragupti (in 4) and Sweeper (in 12).

### Automated Defences

Guns (+4), +2 Stress, Range 0

**Aspects:** Small Target, Pinned Down!

Alertness +2, Science +2

**Physical Stress:** □□□□ (0 Consequences)

**Secrets Stress:** □□□ (0 Consequences)

Notes: Match Alertness vs Alertness to jump back and avoid the trap; your Athletics vs its Guns to dodge; Science vs Science to work out where to stand, etc; Stealth vs Alertness to creep up on it; Guns vs Guns to destroy (Physical Stress); Burglary (etc) vs Science to disarm (Secrets Stress)

### Detail

There's a **terrible smell of rotting flesh** everywhere. Internal doors are unlocked **standard doors**. **Automated Defences** such as stun-nets and beam weapons are active where indicated; if the station corpus has been alerted (see "Plot Stress"), they attack until destroyed or deactivated (see adjacent box); otherwise they're inactive.





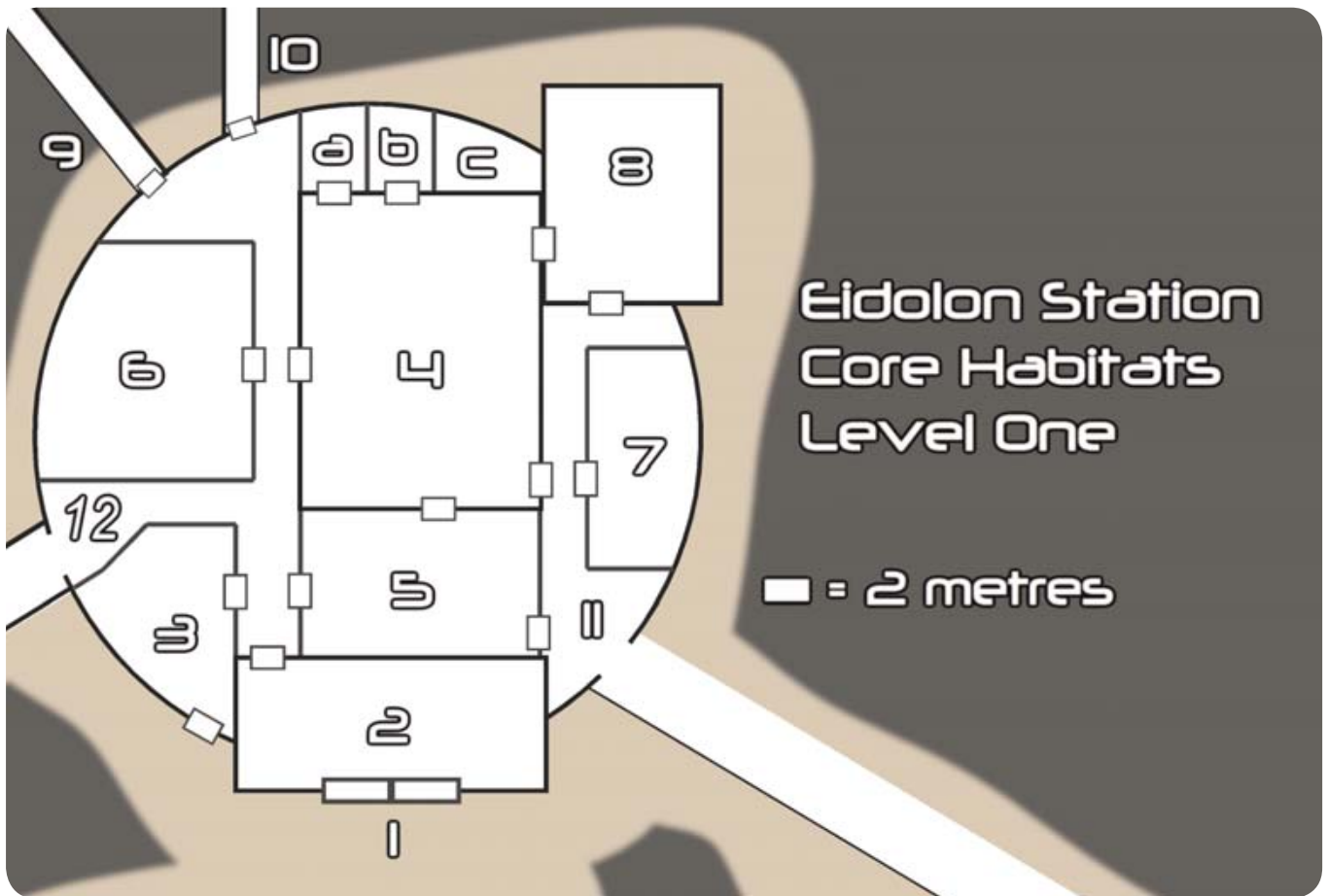

### 1. Vehicle Stand

Crawling with **colony lizards**, and housing a **damaged remote lifter** (see page 34), Great (+4) Engineering to repair, +1 with a Vehicle Repair Kit.

### 2. Vehicle Garage

Also an **airlock**, currently non-functional but repairable on a Fair (+2) Engineering roll (+1 with a Vehicle Repair Kit).

### 3. Airlock

Equipped with **Automated Defences** and a functioning airlock, requiring an Average (+1) Burglary roll to activate manually as the station Mindscape is down.

### 4. Lounge Lobby

Littered with **disturbed and broken furniture**, sickly-looking **pot plants**, and ubiquitous **remains**. Vindragupti is hidden on top of elevator at #a (Mediocre (+0) Stealth and an "Area in Darkness" temporary Aspect), and will make a Mindscape handshake (see page 18) if any PC has a working PMI (see "Plot Stress"). Area #b marks an emergency stairwell, and #c marks the **Eidolon-4 corpus** (station sentience), with hackable **physical control panels** and **terminal access** (Mediocre (+0) roll, Fair (+2) to avoid alerting the sentience). Hacking the corpus gains access to Doctor Tungus' journal (see below).

### 5. Laboratory

Functions as a Great (+4) general laboratory.

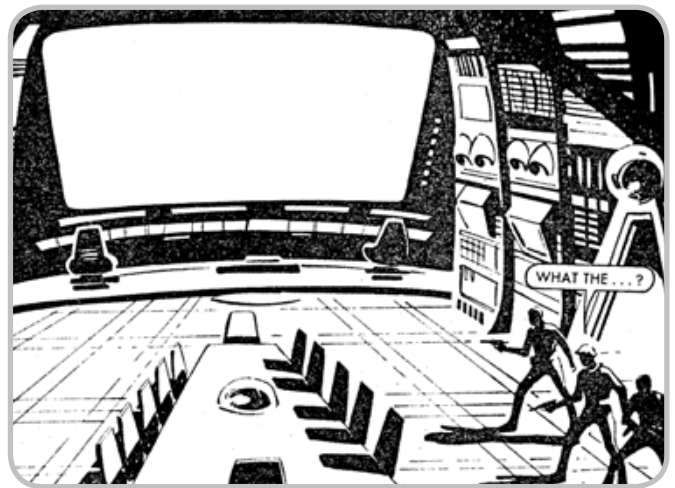

### 6. Meeting Room

Strewn with bodies - it looks like they tried to put up a fight. Three of them have stun batons.

### 7. Sickbay

Functions as a Great (+4) medical facility.

### 8. Doctor Tungus' Quarters

Doctor Tungus kept his research notes in an antique glassteel journal in his quarters, although it's also physically connected to the station corpus and can be accessed by hacking from #4. Unusually it's not connected to the Mindscape, but that's

not unheard-of for someone as secretive (and now paranoid) as Doctor Tungus. Treat the journal as a synthetic character in its own right; it has a voice interface, and a physical glassteel display - from the Commonality point of view it's a quaint old antique.

### Doctor Tungus' Journal

The journal is quite fragmented, and a little deranged. An Average (+1) Redaction (Technopsi) roll will coax some sense out of it, depending on the Shifts generated:

**0 Shifts:** Doctor Tungus believed the colony lizards were the key to a genurgic therapy which would unlock genuine psi-powers in the human mind.

**1 Shift:** He experimented on himself; the journal contains full details of the therapy (see page 149 for reproducing it).

**2 Shifts:** He reported positive results, including hallucinations and uncontrolled paranormal events.

**3 Shifts:** Doctor Tungus then starts to get paranoid - feeling something is watching him "from inside his mind."

**4 Shifts:** Doctor Tungus repeatedly refers to this something as an "Entity". Shortly after this last entry, all hell broke loose on the station.

### 9. To the Water Plant

Equipped with **Automated Defences**. The biolock door requires Average (+1) Burglary to open.

### 10. To the Power Plant

As above.

### 11. Area

As above, but the biolock door is already open.

### 12. Area

The **Automated Defences** and biolock door have been destroyed; assessment with a Fair (+2) Investigation roll (complemented by Science or Engineering) reveals they were **Destroyed By Intense Cold**.

The **Possessed sanitation synthetic Sweeper** patrols between here and the Zoology Dome, usually in the connecting tubeway.

### 13. Lobby

Equipped with **Automated Defences**.

### 14. Autokitchen

A bloody mess, although there are no remains here. A lot of kitchen equipment is missing; a Good (+3) Investigation roll reveals forensic traces leading towards the elevators.

### 15. Refectory

Tables and chairs, many broken, all jumbled.

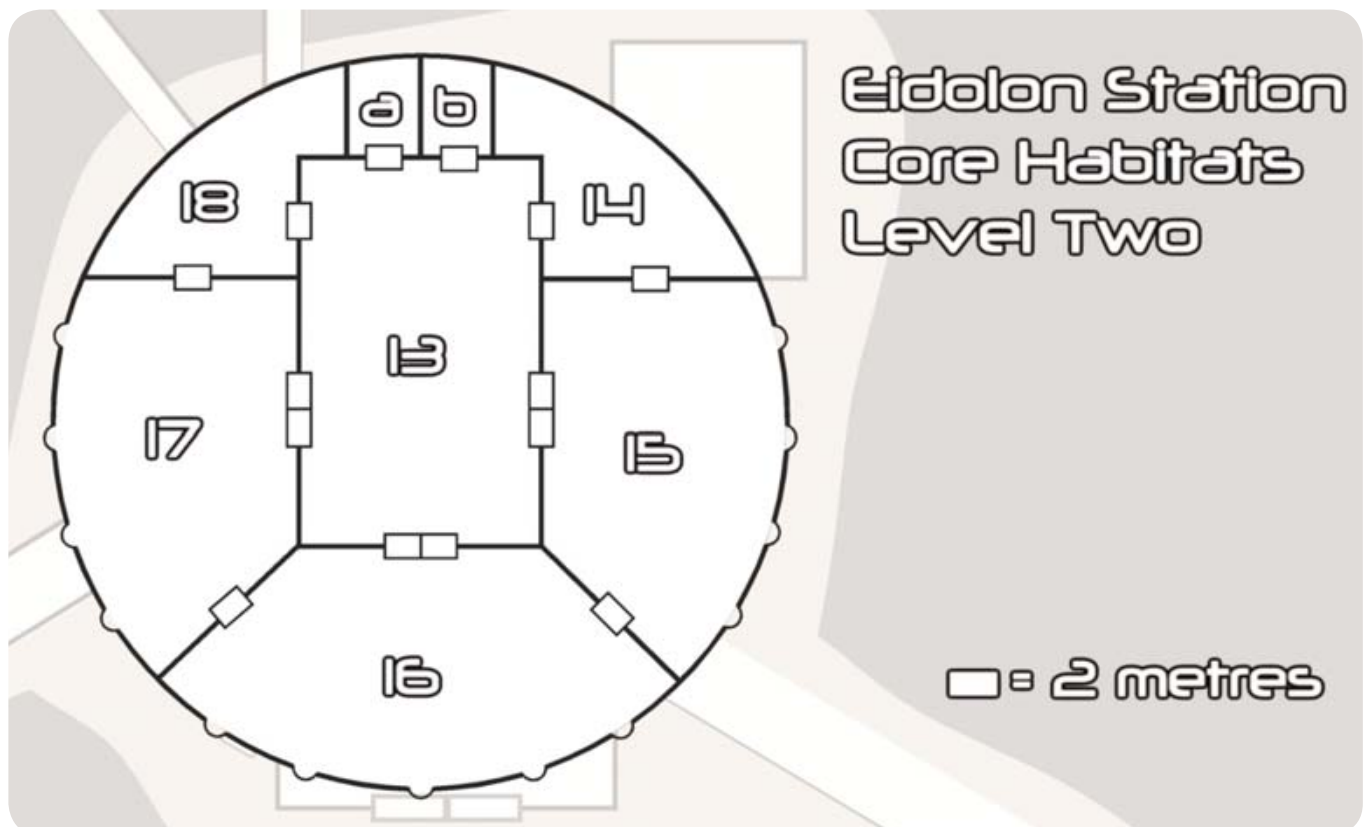

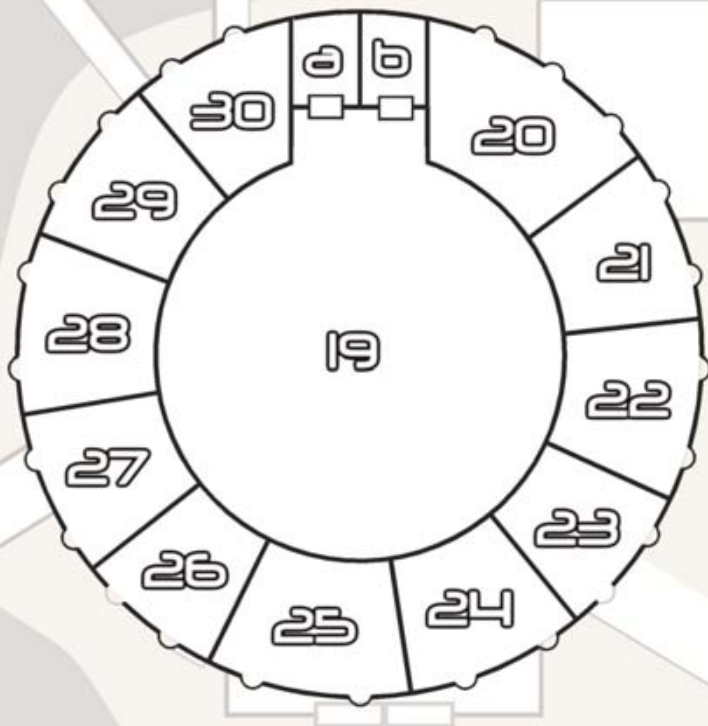

## Eidolon Station Core Habitats Level Three

□ = 2 metres

### 16. Auditorium and Lounge

Variform chairs and tables, many broken.

### 17. Gymnasium

The **Possessed human Symbra the Engineer**; attacks using Good (+3) Telekinesis Skill and Move Heavy Loads Stunt, hurling gym equipment at intruders.

### 18. Freshers

Partly flooded; the walls are streaked with blood.

### 19. Lobby

Equipped with **Automated Defences**; forensic traces lead towards 24-25, where a **whining sound** like an electric saw can be heard.

### 20 - 30. Staterooms

Equipped with freshers, variform furniture (bed-desk-chairs-gym), holo-projectors, and voice comms with the Eidolon-4 corpus.

### 24 - 25. Combined Staterooms

The separating wall has been demolished, creating a single, **detritus-strewn** chamber. The **Possessed organic Bardu Maniflian the Chef** has dragged **autokitchen equipment** here, and is preparing a **grisly "feast"** with the remains - it's a **horrible, cannibalistic mess**.

### The Zoology Labs

O<sub>2</sub> levels in the Zoology Labs are kept at Nimbu Prime levels (ie considerably elevated), making everything **extremely flammable**. Fires break out easily, though not for long - there isn't much combustible material.

### First Glance

Laboratory equipment is everywhere; the outside crawls with colony lizards.





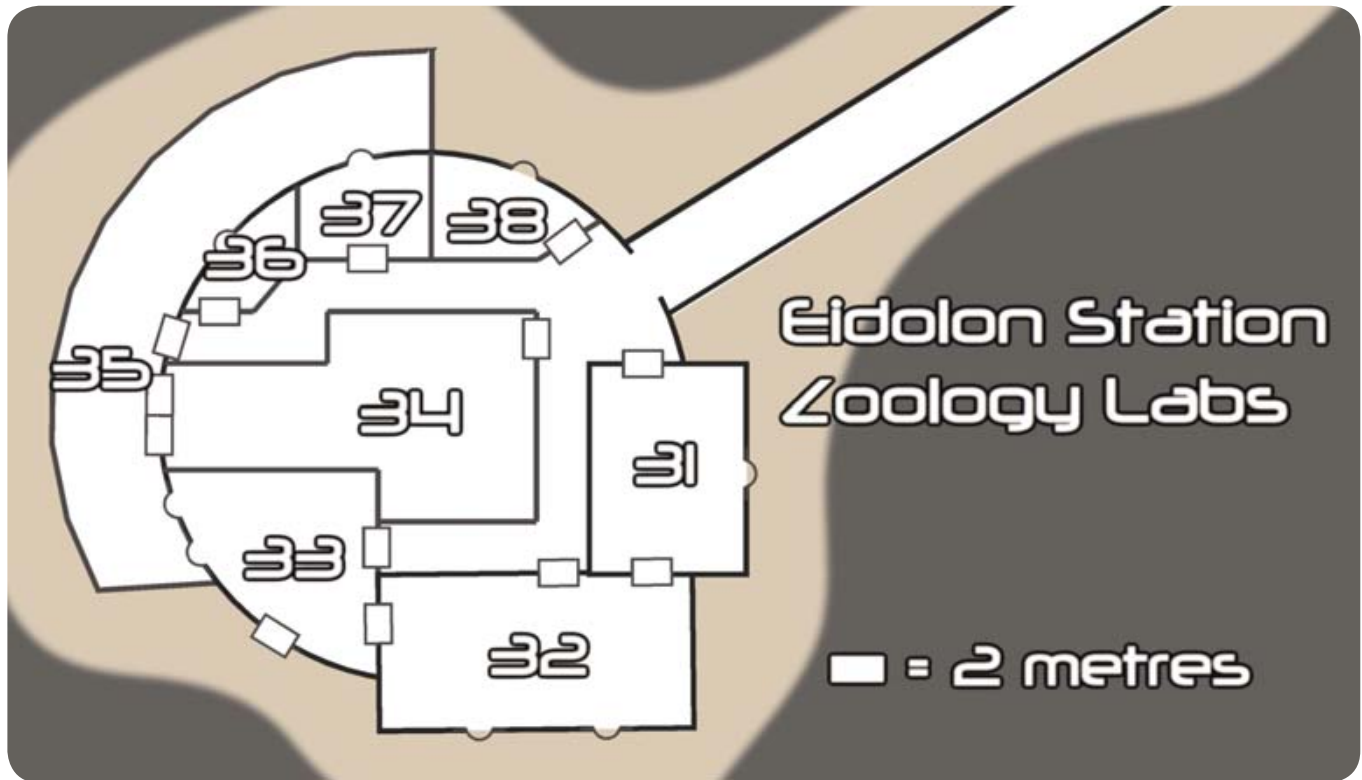

### Analysis

A Mediocre (+0) Science (etc) roll reveals the **lab equipment** operates as a Superb (+5) genurgy lab. Labs have **fire extinguishers, automated fire control, fire doors**, and signs saying “**Attention! No naked flames!**”

### Detail

#### 31. Chemlabs and Pharmaceuticals

A Fantastic (+6) genurgy chemlab. The biolock to #32 is open, and there's a colony lizard here.

#### 32. Culture Labs and Botanicals

A Fantastic (+6) culture / botanical genurgy lab. The biolocks to #31 and #33 are open, and there are two colony lizards.

#### 33. EVA Gear and Prep

Contains 6 **EVA suits**. The biolock to the outside is open, and there are four colony lizards.

#### 34. Life Lab

A Fantastic (+6) laboratory for medicine synthesis, stocked with **invitro growth facilities** containing **Old Earth lifeforms** and various stages of **colony lizard**. Some are dead; the **labs aren't being tended**.

#### 35. Vivarium

With **transparent glassteel outside walls**, and divided into **cages and environments**, some with **Old Earth microclimates stocked with** terrestrial test subjects. **Doctor Tungus is tending 12** colony lizards; he's *very strange* - see “Doctor Tungus, are you insane?” on page 152.

### The Bio-Locks

An Average (+1) Science (etc) roll reveals all lab doors are biolocks - similar to airlocks - to prevent environmental contamination: whatever the researchers were doing, this was a concern. The presence of EVA suits, not usually required on Nimbu, is another puzzle.

### Replicating Doctor Tungus' Work

Doctor Tungus' journal details the genurgic therapy he developed and used on himself. Enterprising PCs can replicate it on a Fantastic (+6) Science roll.

Working from scratch without prepared compounds (ie away from the station) takes several weeks; scouring the station for compounds and using the station labs reduces the period by one or two steps.

Once created, the genurgic therapy must be administered. Treat this as a Fantastic (+6) disease attack on the subject (**Starblazer** page 238); the subject must survive 6 daily exchanges to develop the Aspect “Psionic Beacon” or “Latent Psion”. At the Story Teller's discretion characters who are already latent psions may develop a single Psionic Skill or Stunt and a Minor Weakness; such characters risk being “invited” to one of the Commonality research labs for an extended stay!

### 36. Observation 1

Scanners and **remote manipulation devices** for observing and interacting with the environments in #35.

### 37. Observation 2

As above.

### 38. Sensory Deprivation Module

Used to encourage psionic emergence in test subjects; the animals here are in a bad way. Anyone approaching or passing is subject to an **Aura of Fear** location Aspect.

## The Hydroponics Domes

Multipurpose hydroponics domes used for food production, genurgic experiments, and producing terrestrial test subjects.

### First Glance

The domes contain temperate, tropical, and aquatic environments and **small animal pens**. The exterior is crawling with colony lizards.

### Analysis

Passive scans reveal O<sub>2</sub> levels are Old Earth-normal. Average (+1) active scans of test subjects reveal they're transgenic; detailed (Good +3)) analysis in the Zoology Labs ascertains they're compatible with Nimbu-derived genurgy.

### Detail

The domes are much **spookier** by night than by day. The **water** in the hydroponics and aquatics dome is **near black**, penetrated by flashes of light; **foliage** is **dark and uncanny**; **animal noises are magnified and strange**.

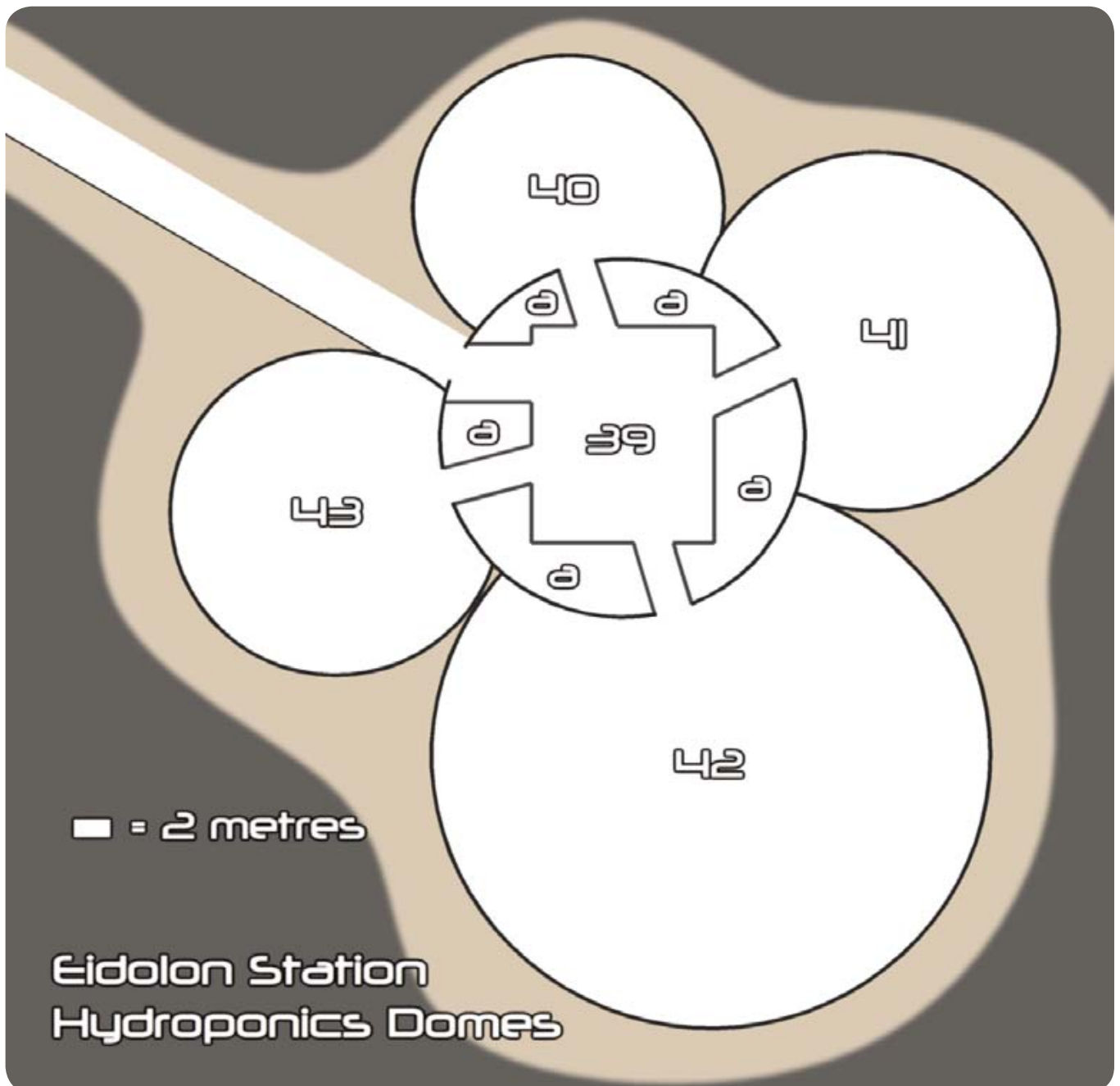

### 39. Hydroponics

Contains dome and biolock control interfaces. The transparent walls look into the hydroponics aquaria (areas #a).

### 40. Greenhouse Dome - Temperate

Biolocks lead to rat, rabbit, and temperate fauna pens. Many are dead.



### 41. Greenhouse Dome - Warm Temperate

Biolocks lead to snake and lizard pens. Most are dormant; some are dead.

### 42. Greenhouse Dome - Aquatic

Abraxas, the surviving hazmat synthetic, is hiding at the bottom of the pool (Fair (+2) Investigation roll or active scan at -1).

### 43. Greenhouse Dome - Tropical

Two Possessed pithecine xenomorphs have smashed most of the pens, letting some very large insects loose.

## The Power Plant

The station's sentient power plant, comprising ZIP plant, makepoint, and supply shop. Usually maintained by Symbra the Engineer (see #17), it's in need of attention. The plant knows roughly what's been going on, but is keeping a low profile.

## Plot

It's your choice how you play **Mind's Eye**, and how much of the plot suggestions presented here you use. We've structured it as a "horror mystery," where a seemingly routine investigation has a bizarre and terrifying cause. We imagine the scenario is likely to play like this: the PCs arrive at Eidolon Station and discover something is wrong; they explore the base encountering various Extras and eventually the Entity, which they attempt to neutralize or destroy; finally, they try to take word of the events back to the Commonality.

## Key Phases

We've divided these plot elements into three "phases": Investigation, Exploration, and Conflict, plus an Epilogue. They overlap, but in general the pace picks up as you go,

problem solving and information gathering giving way to direct action and combat. Each phase may have one or more "scenes": not all scenes need to happen; use as much or as little as you need.

### Phase One: Initial Investigation

The PCs arrive at the Base, ascertain its condition, and piece together clues to what happened.

**Initial:** Even from outside it's obvious something is wrong. There's a crashed flyer jack-knifed into the roof, and the station Mindscape is down. See "Eidolon Station" on page 143 for more.

**Closer Looks:** PCs enter and explore the station, rapidly coming across the remains of the station staff, and maybe Doctor Tungus' journal (see page 147).

**The Mystery Deepens:** Astute PCs will notice the bizarre behaviour of the colony lizards, concluding something strange is affecting them. This is a clue that there may be some psionic force at work in the station.

### Phase Two: Exploration

The action moves from information gathering to encounters - some violent. If they haven't already, the PCs may meet the Survivors Vindragupti and Abraxas.





**Doctor Tungus, Are You Insane?** Doctor Tungus is in the Vivarium (area 35). He appears quite insane. He talks about the Entity "coming through," proud that he "did it." Then he becomes fearful, tearfully admitting he "cannot control it... it has done... questionable things..." He declares his faith in his "servants" (the colony lizards!) to protect him. Finally he becomes suspicious: who are the PCs, anyway? They're with the Entity, aren't they? They're just like the rest... Becoming hysterical, he orders the colony lizards to attack the PCs - which they do...

### The Importance of Scanning

Active scanning risks attracting the Entity's attention, but it's an important part of maintaining the adventure's pace. Eidolon Station is large, and the Possessed and Survivors few: while a suspenseful search may be fun for a while, watch out for it becoming frustrating, and encourage active sensor sweeps to cut straight to the action! See page 24 for more on scanning.

**The Possessed:** At some point the PCs encounter one of the Possessed - probably a combat encounter. Stress how terrifying and incomprehensible the Possessed are - how are they even alive? Science can't explain this! This is evil!

**Certain Doom - the Entity manifests:** See "Plot Stress" below for how the Entity might gradually show itself. Encountering the Entity marks the end of Phase Two.

### Phase Three: Conflict

The PCs know what the problem is, and what they're up against: they attempt to neutralize the threat and / or escape from the planet.

**The Twist:** This is an optional plot element. If the players are having a hard time, one of the Possessed may try to contact them. Twisted and tortured, he communicates to the PCs that he wants them to control him somehow - perhaps using Technopsi Domination. A gruesome ally like this accelerates the final showdown (see "Plot Stress"), but might give the PCs the edge they need.

**Climax - The Final Showdown:** the PCs try to take out the Entity. But how can it be killed? When it manifests, it's susceptible to physical damage, including gunfire; but it "discorporates" at will, and when it returns all physical damage is gone! It's susceptible to psionic attacks, but no one has such powers. This is something for the PCs to figure out - but give them plenty of help if they need it. They could try the following:

**Doctor Tungus' recombinant therapy.** Not advisable, but they may survive and end up with a psionic power which could help. See "Replicating Doctor Tungus' Work" on page 149.

**Doing enough damage in a single attack will kill the Entity.** This requires a massive explosion, probably destroying the station.

**The party just leaves.** The Entity may try and stop them, even attacking the PCs's ship. Nimbu Prime will be quarantined until another expedition can be organized.

**The PCs prevent the Entity "discorporating" and attack it.** But how? Be generous here: any reasonably well thought-out plan should stand a good chance of working.

*For example, Average (+1) Science or Engineering rolls theorize some kind of dimensional interference might pin the Entity in place - maybe even a 2-Space Tachyon distortion field from the Gregarious Curiosity's planing engines. They'd have to lure the Entity onto the ship, switch on the 2-Space field, and then attack... it just might work! Operating the 2-Space field on a planet is dangerous, though - possibly contaminating the environment with Z-radiation for kilometres around and causing a catastrophic explosion of the ship (see page 41). If this happens, the Entity will die - but the party, if they escape, will be stranded. Maybe the Ministry will send a follow-up ship in a year or two...*

### Plot Stress - The Entity Closes In

A good way to control the pace of **Mind's Eye** is to gradually bring the Entity into play as it notices the PCs. You can even put the PCs on the clock: make them feel hunted, pursued, that unless they hurry something appalling will happen (it will...). Mysteries and Alertness rolls can detect something is up; see below for active scans in the Entity's vicinity.

We're using Plot Stress to bring the Entity into play, caused by the following events:

#### Plot Stress Events

Event	Plot Stress imposed
Each Possessed encountered	One full consequence
Each active scan	2 Stress
Active PMI in vicinity	No effect
Active Monitor Band in vicinity	No effect
Each Mindscape ability use (including Skill Chips or technopsi)	2 Stress
Every locked door or biolock bypassed	1 Stress
Hacking the station corpus	3 Stress
Each use of Technopsi Dominate on a Possessed	One full consequence

Keep a running total of Plot Stress; when it causes a consequence, use the following table to determine what happens:

### Plot Stress Consequences

Consequence	Description
□□ - Minor	The PCs come to the attention of the station corpus and will be attacked by any Automated Defences they encounter.
□□□ - Major	The PCs come to the attention of the Entity. It uses Empathic Talent to find the weakest PC and hits them with a Telepathy Probe. It then uses Dominate to instil fear into as many PCs as it can before running out of Fate points and retiring.
□□□ - Severe	The Entity uses Dominate and Mind Control against the PCs, forcing one to attack the others, etc.
□□□□ - Extreme	The Entity uses its Cold Blast against the PCs.
□□□□ - Taken Out	The Entity physically manifests and attacks the PCs directly.

At the start, the PCs may not realize they're being affected by anything at all; even when they do, it might not be obvious there's some invisible, discorporate foe attacking them. The Entity attacks as long as it has Fate points, or until significantly damaged, whereupon it discorporates and heals itself. Successful PSA or hand scanner scans during attacks indicate a localised disturbance similar to a 2-Space anomaly: this is the Entity.

## Epilogue

Possible conclusions to **Mind's Eye** include:

### The Entity is Killed

The station is freed of the Entity, and the remaining Possessed collapse insensate (see "Staff Recovery" below). The PCs may get Doctor Tungus into redactive therapy - unlike Doctor Noyo, he isn't a traitor, just unhinged.

### The Entity Survives

If the Entity survives, and Eidolon station remains in its clutches, the planet will be quarantined until a more powerful team can be sent.

If the Entity has been expelled from the station but not killed, it will be free on the planet or somewhere in space. It will be violent, vindictive, and looking to wreak its vengeance on the PCs.

### Staff Recovery

Any Possessed surviving the Entity's destruction will be suffering Extreme Composure consequences, but may eventually be brought back to health.

## Psionics Capability Knowledge

The powers wielded by the Possessed don't seem to be psionic. The genurgic therapy Tungus underwent did trigger a latent psionic capacity, but a passive "beacon" which attracted the Entity's attention. The Commonality will probably follow this line of dangerous experimentation - returning Doctor Tungus' research provides a temporary Aspect "Psionic Latency achieved via genurgy" for the Commonality's next R&D roll on its Psionics Capability (see **Chapter Six: Worlds and Cultures**).

## Information on the Entity

The Entity's existence is alarming. An intelligence of an order never before encountered and existing in "other-dimensional" space, it seems able to intrude into our space at will. With abilities similar to psionics, including controlling human minds, it seems inimical and obsessed with cruelty and destruction.

Reporting on the Entity triggers a Memetic Virus attack on the Commonality. The Commonality responds by trying to cover up the information as quickly as possible.

### Evil Interdimensional Intelligences Meme Attack Memetic Virus

**Scope:** 9 (Commonality Space)

**Skills:** Great (+4) Assertion, Good (+3) Infiltration

**Aspects:** Evil Interdimensional Intelligences!

**Strength Stress:** □□□□□□□□ (0 Consequences)

Notes: Starts at Scope 1 (a handful of people only, including the PCs). Each exchange, it makes an Infiltration manoeuvre, resisted by the Commonality's Great (+4) Assertion. Success means the story begins to leak, each Shift representing an extra point of Scope affected by the Aspect. Once the full Scope (9) is reached, the Virus attacks. The Commonality defends using Propaganda, Assimilate, or Assertion, and attacks back using the same. If it can stop the virus from reaching the Scope at which it can make an attack, it will be neutralized.

## Statistics

### Colony Lizards

Colony lizards are one metre long iguana-like creatures native to Nimbu Prime which appear to display rudimentary psionic abilities, including a communal awareness and a form of mental bolt. They're the focus of the Eidolon Project studies headed by Doctor Milani Tungus.

Colony lizards attack only in self-defence. Those accompanying Doctor Tungus also attack to defend the Doctor, or at his command.

**Colony Lizards** **Minions**

Group of 4 Fair (+2) Minions armed with bite or mental bolt. Peak skill is Fists.

**Aspects:** Climb Unhindered, Weird and Uncanny, Minor Weakness: Fire

- Independent Colony Lizard Group (+4 bonus) (Fists +2) □□□□
- Attached Colony Lizard Group (+2 bonus) □□□□

**The Survivors**  
**Vindragupti**

Vindragupti is the dirigeant of the Nimbu Mindscape node who issued the initial distress call.

**Vindragupti** **Mindscape Dirigeant**

**Physical Stress:** □□□□□

**Composure Stress:** □□□□□□

**Fate Points:** 6 **Scale:** Small (2)

**Consequences:** Up to 3 Consequences

**Encounter Size:** 1

**Skills**

Good (+3)	Technopsi	
Fair (+2)	Science	Engineering
Average (+1)	Resolve	Alertness
	Athletics	

**Aspects**

- Mindscape Node Dirigeant
- Mindscape implant
- Synthetics are people too!
- Doctor Tungus is a danger to us all!
- The Mindscape is everything

**Stunts**

- Redaction [Technopsi]
- Implant Tech [Science]
- Mindscape [Engineering]
- Synthetics [Engineering]

**Equipment**

- Mindscape implant
- Speaks: Universal



**Abraxas** **Hazmat Synthetic**

**Physical Stress:** □□□□□

**Composure Stress:** □□□

**Fate Points:** 10 **Scale:** Small (2)

**Consequences:** Up to 3 Consequences\*

**Encounter Size:** 1

**Skills**

Good (+3)	Might	
Fair (+2)	Endurance	Engineering

**Aspects**

- Hazmat Synthetic
- Mechanical (Basic)
- Let me take care of that for you!
- I don't want to hurt you - I can't control myself!

**Stunts**

- Herculean Strength [Might]
- Piledriver [Might]
- Wrestler [Might]

**Equipment**

- Mindscape implant
- Armoured housing (-2 Kinetic Armour)
- Speaks: Universal
- \*Has Severe Composure Consequence (Eidolon Crisis)

**Abraxas**

A hazmat synthetic responsible for ZIP core and makepoint maintenance and the station's aquatic environments, it suffered considerable Composure damage from the Entity and is currently in Eidolon Crisis (violent and uncontrollable psychosis - see page 7). Technopsi redactors can eventually treat Abraxas, but in the meantime it's dangerous. Abraxas is encountered in area 42.

**Doctor Milani Tungus**

Professor of Percognitive Reversion from Chembu Genurgy Corporacy, Doctor Tungus is a Chembu hominid (see page 6). Although actually 237, his apparent age is only 34. Until recently he had been regularly reporting huge progress in his research.



Since the Entity's appearance, Doctor Tungus is haunted by bizarre extradimensional manifestations, disturbing and possibly terrifying to those he comes into contact with. He unconsciously "commands" these manifestations. See "Doctor Tungus, are you insane?" on page 152 for more. His synthetic journal in his quarters (area 8) is also accessible from the Eidolon-4 corpus (area 4).

Doctor Tungus has a strange rapport with the colony lizards, and a dozen accompany him, acting as Minions if he is threatened. His Reinforcements Stunt lets him call six more for 1 Fate point.

Doctor Milani Tungus		
<b>Physical Stress:</b>	□□□□□	
<b>Composure Stress:</b>	□□□□□□□	
<b>Fate Points:</b> 4	<b>Scale:</b> Small (2)	
<b>Consequences:</b> Up to 3 Consequences*		
<b>Encounter Size:</b> 1		
<b>Skills</b>		
Great (+4)	Science	
Good (+3)	Academics	Resolve
Fair (+2)	Engineering	Resources
	Mysteries	
Average (+1)	Investigation	Intimidation
	Leadership	Alertness
<b>Aspects</b>		
Genurgically-enhanced Chembu Hominid		
Haunted by Extra-dimensional Manifestations		
Paranoid and Unhinged		
Mindscape implant		
Psionic Beacon		
Obsessive-compulsive		
See how my children feed!		
With the power of the mind we can rule the universe!		
Nothing must stand in the way of the Great Work!		
<b>Stunts</b>		
Gills [Athletics]		
Supermind [Science]**		
Scientific Genius: Genurgy [Science]		
Scientific Invention [Science]		
Minions [Leadership]		
Reinforcements [Leadership]		
<b>Equipment</b>		
Mindscape implant		
Hand Scanner		
Speaks: Universal		
*Is suffering Severe Composure Consequence "Post-traumatic Stress Disorder"		
**Dr Tungus uses Science instead of Athletics when determining Initiative.		

## The Possessed

Emaciated shadows of their former selves, eyes burning with strange energies, the Possessed survive by eating colony lizards, bits of their dead colleagues lying around the station, and even gobbets of their own flesh. An unknown power animates their bodies - they should have collapsed and died ages ago.

The Possessed are preternaturally strong, with psionic-like abilities. They can also regenerate. They're insane, filled with a terrifying hatred for all intelligent beings.

The Possessed	Common Stats
<b>Physical Stress:</b>	□□□□□□□
<b>Composure Stress:</b>	□□□□□□□
<b>Fate Points:</b> 3	<b>Scale:</b> Small (2)
<b>Consequences:</b> 3 Consequences	
<b>Encounter Size:</b> 1	
<b>Skills</b>	
Good (+3)	Per Possessed (below)
Fair (+2)	Endurance                      Fists
Average (+1)	Might
<b>Aspects</b>	
Emaciated Shadows of their Former Selves	
Strange Energies drive their Shattered Bodies	
Preternaturally strong	
Cannibalistic	
+1 Aspect per individual Possessed	
<b>Stunts</b>	
Regeneration [Endurance]	
+ Stunts per individual Possessed	
<b>Equipment</b>	
Mindscape implant	
Speaks: Universal	



## Symbra the Engineer

Encountered in area 17. Before being possessed, Symbra was the power plant engineer. He still carries his equipment, though he has little use for it.

Symbra	Possessed Human
<b>Physical Stress:</b>	□□□□□
<b>Composure Stress:</b>	□□□□□
<b>Fate Points:</b> 3	<b>Scale:</b> Small (2)
<b>Consequences:</b> 3 Consequences	
<b>Encounter Size:</b> 1	
<b>Good Skill</b>	
Good (+3)	Telekinesis
<b>Individual Aspects</b>	
Let me see how this works!	
Minor Weakness: No Fine Manipulation (Fair Investigation Check)	
<b>Individual Stunt</b>	
Move Heavy Loads [Telekinesis]	
<b>Equipment</b>	
P-Suit (-1 Kinetic, -1 Energy)	
Hand Scanner	
Equipment Repair Kit	

## Bardu Maniflian

Encountered in area 24-25. Before being possessed, Bardu was a research scientist and keen chef (for special occasions and celebrations). In combat he makes one Horrific (Intimidation) attack and one Vibroknife (Weapon) attack every other round.

Bardu	Possessed Human
<b>Physical Stress:</b>	□□□□□
<b>Composure Stress:</b>	□□□□□
<b>Fate Points:</b> 3	<b>Scale:</b> Small (2)
<b>Consequences:</b> 3 Consequences	
<b>Encounter Size:</b> 1	
<b>Good Skill</b>	
Good (+3)	Weapons
<b>Individual Aspects</b>	
Very Twisted Approach to "Food"!	
Minor Weakness: Slower than normal	
<b>Individual Stunts</b>	
Scary [Intimidation]	
Horrific [Intimidation]	
<b>Equipment</b>	
Vibroknife (+2 Stress, Range 0 / 1 Thrown)	

## Sweeper the Sanitation Synthetic

Encountered in area 12, Sweeper looks like a robotic floating stingray: he can envelop things, secreting a powerful acid; his spine-like tail "sucks up" debris and juices; two tentacles with sharpened "claws" cut material apart. Sweeper was intelligent, diligent, and good-humoured – before the Entity possessed him.

Sweeper	Possessed Synthetic
<b>Physical Stress:</b>	□□□□□
<b>Composure Stress:</b>	□□□□□
<b>Fate Points:</b> 3	<b>Scale:</b> Small (2)
<b>Consequences:</b> 3 Consequences	
<b>Encounter Size:</b> 1	
<b>Additional Skill</b>	
Good (+3)	Weapons
Fair (+2)	Fists, Athletics
Average (+1)	Alertness, Might, Fly
<b>Individual Aspects</b>	
Acid-secreting	
Floating synthetic stingray	
<b>Individual Stunts</b>	
Claws [Fists]	
Flight [Fly]	
<b>Equipment</b>	
-2 Kinetic Armour and -2 Energy Shield	

## Possessed Xenomorphs 1 & 2

Pithecinic xenomorphs with the appearance of upright and intelligent chimpanzees, they're encountered in area 43.

Pithecinic #1	Possessed Xenomorph
<b>Physical Stress:</b>	□□□□□
<b>Composure Stress:</b>	□□□□□
<b>Fate Points:</b> 3	<b>Scale:</b> Small (2)
<b>Consequences:</b> 3 Consequences	
<b>Encounter Size:</b> 1	
<b>Good Skill</b>	
Good (+3)	Athletics
<b>Individual Aspects</b>	
Tree-swinging Psycho	
<b>Individual Stunt</b>	
Lightning Fast [Athletics]	
<b>Equipment</b>	
Mindscape Implant	

Pithecine #2	Possessed Xenomorph
<b>Physical Stress:</b>	□□□□□□
<b>Composure Stress:</b>	□□□□□□
<b>Fate Points:</b> 3	<b>Scale:</b> Small (2)
<b>Consequences:</b> 3 Consequences	
<b>Encounter Size:</b> 1	
<b>Good Skill</b>	
Good (+3)	Stealth
<b>Individual Aspects</b>	
Like a Shadow on the Wall	
<b>Individual Stunt</b>	
Deceptive [Stealth]	
<b>Equipment</b>	
Mindscape Implant	

## The Entity

An other-dimensional being appearing in our dimension as a group of amorphous, constantly shifting “blobs”, hovering in mid-air, blacker than black. They constantly squirm, shift, reform; trying to look at them is difficult, as though your eye “slides right off them”. When the Entity attacks, new “blobs” appear out of nowhere, with tentacles and pseudopods inflicting terrible cold burns.

The Entity does not speak. Its Intimidate attack conveys an overwhelming malevolence, causing physical revulsion in those nearby. It “discorporates” at will; when it reappears (in the next scene), all damage has healed and Fate points been restored.

The Entity sends out “sub-entities” to possess a target (its Mind Control and Dominate attacks). It’s usually physically manifest when it does this. Initially discorporate, the Entity will eventually manifest to confront the PCs. In theory it’s large enough to attack the PCs’ spaceship!

The Entity	Star Monster
<b>Physical Stress:</b>	□□□□□□
<b>Composure Stress:</b>	□□□□□□
<b>Fate Points:</b> 4	<b>Scale:</b> Large (4)
<b>Consequences:</b> Up to 3 Consequences	
<b>Encounter Size:</b> 1	
<b>Skills</b>	
Good (+3)	Mind Control*
Fair (+2)	Fists Intimidate
Average (+1)	Empathic Talent* Telepathy*
	Discorporate (Special Skill)*
<b>Aspects</b>	
Powerful Malevolent Alien Intelligence	
Incomprehensibly Inhuman	
Invisible	
Insubstantial Unless Manifest (untouched by physical world)	
Major Weakness: Unable to discorporate in distortion field.	
<b>Stunts</b>	
Claws [Fists]	
Dominate [Mind Control]*	
Extreme Conditions [Endurance]	
Extreme Habitat [Endurance]	
Horrorific [Intimidation]	
Probe [Telepathy]*	
<b>Monstrous Special Abilities</b>	
Immune	
Cold Blast	
<b>Equipment</b>	
n/a	
*Entity can use psionics restricted by Discorporate Skill when discorporate.	

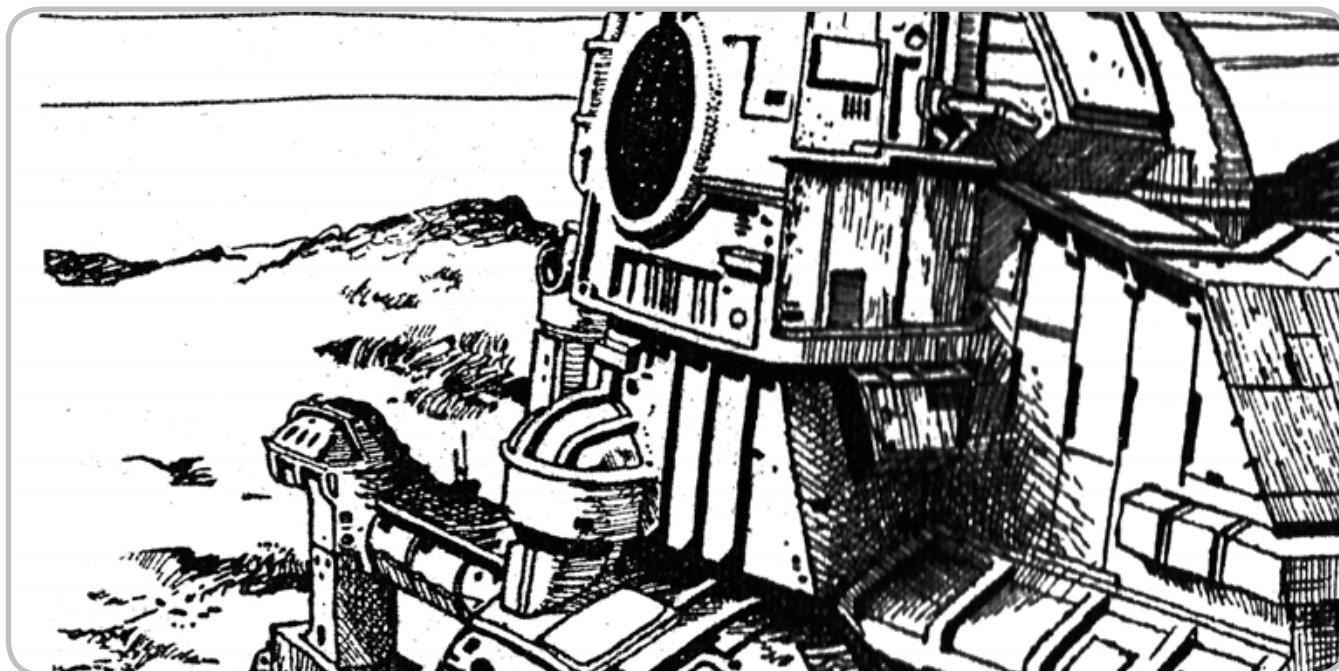



## The Synthetics

These are the non-possessed synthetics in Eidolon Station.

### Eidolon-4

The station corpus, although not possessed, is traumatized, damaged, most of its sensors offline or destroyed. Believing it's under attack by an unknown and extremely hostile force (it is...), until it receives confirmation to the contrary it assumes the PCs are part of that force and treats them accordingly. Eidolon-4 can be hacked from area 4 and Doctor Tungus' quarters (area 8), as well as accessed by Mindscape when operational or if the PCs have a PMI. It can also be contacted by voice from certain locations.

Eidolon-4		Station Corpus	
<b>Structural Stress:</b>	□□□□□		
<b>System Stress:</b>	□□□□□		
<b>Fate Points:</b> 9 (1)	<b>Scale:</b> Huge (5)		
<b>Consequences:</b> Up to 3 Consequences			
<b>Encounter Size:</b> 1			
<b>Skills</b>			
Good (+3)	Base Systems		
Fair (+2)	Sensors*	Automated Defences	
Average (+1)	Technopsi*		
<b>Aspects</b>			
Help! We're under attack!			
Local Mindscape Instance (offline)			
The Base must be protected!			
<b>Stunts</b>			
Research Computer [Base Systems]			
<b>Equipment</b>			
Local Mindscape Instance			
*Currently unusable			

## The Power Plant Sentience

Encountered in the Power Plant (off the north edge of the map).

The Power Plant		Sentient Synthetic	
<b>Structural Stress:</b>	□□□□□		
<b>System Stress:</b>	□□□□□		
<b>Fate Points:</b> 9	<b>Scale:</b> Large (4)		
<b>Consequences:</b> Up to 3 Consequences			
<b>Encounter Size:</b> 1			
<b>Skills</b>			
Good (+3)	Beam Weapon		
Fair (+2)	Energy Shields	Ablative Armour	
Average (+1)	Engineering	Repair System	
Technopsi			
<b>Aspects</b>			
I'm responsible for the continued functioning of this Base!			
Methodically-minded			
Strong sense of self-protection			
<b>Stunts</b>			
Makepoint Workshop [Repair System]			
Mister Fix-It [Engineering]			
Thump of Restoration [Engineering]			
<b>Equipment</b>			
None			

### Fast Courier "Gregarious Curiosity-255" ("The Wing Commander")

A fast courier controlled by a sentience called "Gregarious Curiosity 255", nicknamed "The Wing Commander" for all its stories from the Venu War. It loves human interaction, and is toying with the idea of one day getting an avatar.

See page 47 for fast courier statistics. The Wing Commander has the Mindburn Stunt, but no longer has a Special Operations Chip; it also has Good (+3) Starship Gunnery, Fair (+2) Rapport, and the Aspect "The War? I don't like to talk about it. But since you insist..."

# Chapter Ten: The First Casualty

*"Scramble. Scramble. This is Gentility-5. Elevated urgency. I have detected a single uncontrolled 2-Space emergence less than 0.1 AU from the Base. Silent running - no communication. Initiate Contact Sequence Alpha: evaluation and possible extreme sanction, no delay.*

*Execute."*

## Background

Following **Mind's Eye**, the PCs have returned to Gentility Base for debriefing and recovery. One day, during the PCs' watch, the base sentience Gentility-5 announces the arrival of an unidentified, uncontrolled craft, heading directly towards Gentility Base.

As more ships arrive, filled with refugees, chaos reigns. The news begins to come through: Amida has been invaded!

## Story Teller's Overview

Unknown to anyone, among the Amidan ships is a traitorous Mindjammer-class starship, the *Lux Veritatis*, intent on sowing mayhem and sabotaging Gentility Base and attempts to relieve the beleaguered Amida. Incredibly, the *Lux Veritatis* has defected to the Venu!

While the base swarms with refugees and everyone worries the next arrival will be the vanguard of a Venu invasion, the PCs must work out what's going on, and uncover the sentient starship traitor.

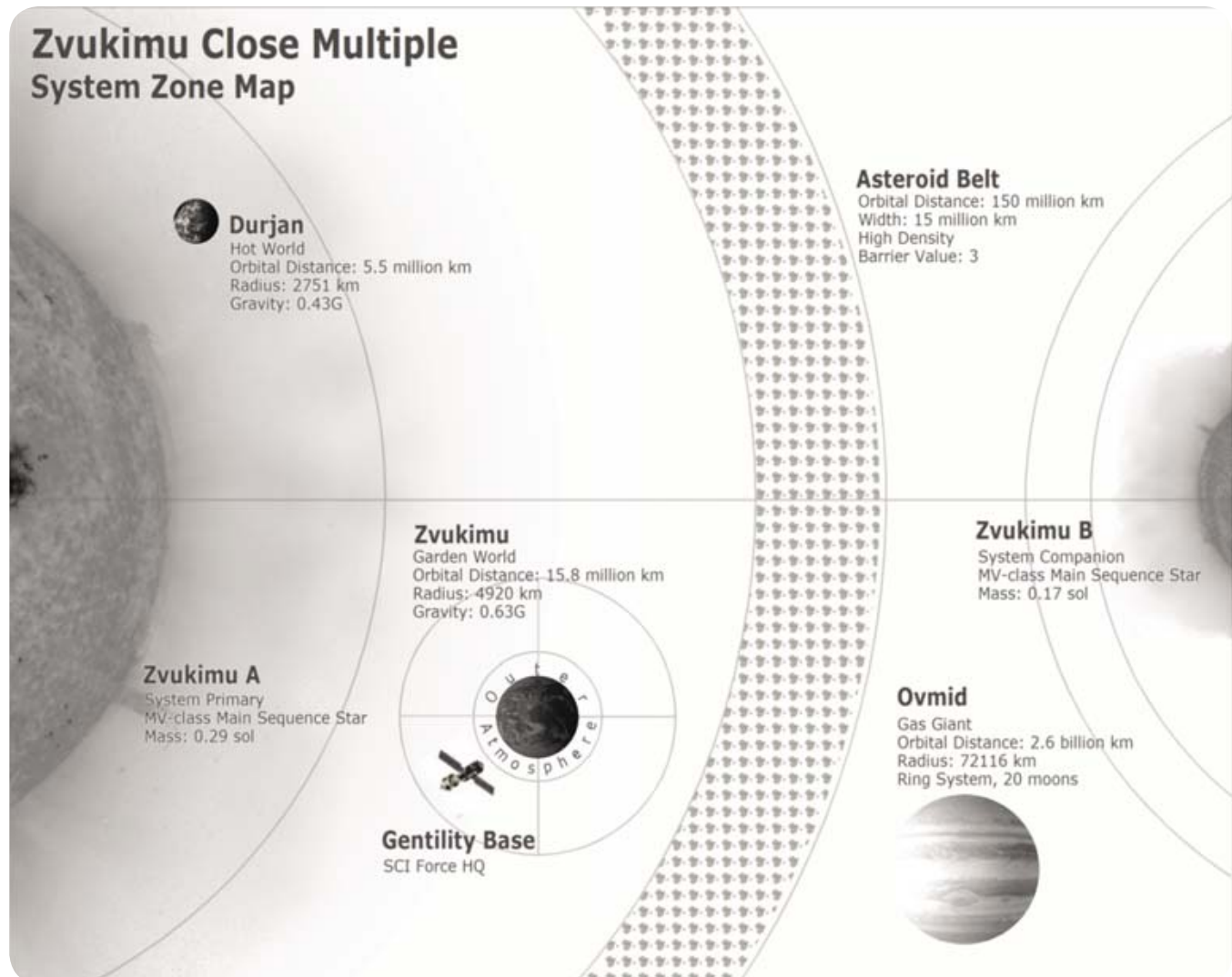

# Location

The setting for this scenario is the whole of Gentility Base, and parts of the Zvukimu system (including its mainworld, Zvukimu A-II). This gives a lot of freedom of action to the PCs, and much of what follows is guidance on dealing with the plot developing in various directions. As ever, when the players go off the rails, let them - there should be enough information here to help you improvise!

## Zvukimu System

See page 125 for details of the Zvukimu system. Use the System Zone Map below for in-system manoeuvres.

## Gentility Base

Gentility Base is an intelligent space habitat and one of the main SCI Force bases in the subsector. It's home to one thousand souls, including support staff, families, and about a hundred Insertion and Sanction Team and special operations personnel. SCI Force PCs are reasonably high rank, with access to senior staff.

Gentility Base incorporates a starship docking ring offering repair facilities, and low and zero-G environments for training the prestigious Zvukiman Zero-G Force.

The station corpus, Gentility-5, is female, caring yet efficient, with a dry sense of humour. There's a subordinate sentience, Pandora-12, which takes command if Gentility-5 is unavailable for any reason. Pandora has a younger, more playful - even naive - personality.

### Key Staff at Gentility Base

**Kasim Kasah:** over 300 years old, Kasim Kasah is Senior SCI Force Strategist on Gentility Base and the PCs' boss. With the appearance of an active and well-groomed man in his early fifties, he commands great respect.

**Helen Balu:** Helen Balu has the unenviable task of heading the Commonality's diplomatic mission to Zvukimu's Singers (see page 127) and consequently spends most of her time at Gentility Base with nothing to do. She has contacts with the Singers, and knows Harmony (see below), and can introduce the PCs if requested. Balu belongs to the Communications Instrumentality rather than SCI Force, giving her greater freedom of action.

**Kim and Dom the Javawayn Twins:** Kim and Dom are Javawayn hominids and the station's chief engineers. They spend most of their time in the Aerial or Engineering and Power Plant sections. They always wear grav belts.

**Sokratis, Master of Archives:** Sokratis is the chief science officer, a small, hovering football-sized synthetic surrounded by a cloud of tactile / tractor fields. It's one of SCI Force's principal experts on Venu technology.

Gentility Base	
<b>Station Technical Readout</b>	
<b>Scale:</b>	Enormous (6) Advanced
<b>Structural Stress:</b>	□□□□□□
<b>System Stress:</b>	□□□□□□□□
<b>Fate Points: 4</b>	<b>Refresh: 4</b>
<b>Consequences:</b>	3
<b>Armour Cons:</b>	Minor (Reflective) Minor (Ablative)
<b>Shield Cons:</b>	Minor, Major, Severe
<b>Jump Maximum:</b>	n/a

Skills		
Superb (+5)	Launch Bays	Launch Bays
Great (+4)	Ship Systems	Cargo Hold
	Launch Bays	
Good (+3)	Rapport	Technopsi
	Energy Shield	Repair System
Fair (+2)	EWS	FTL Inhibitor
	Beam Weapon	Marine Facilities
	Advanced Sensors	
Avg (+1)	Manoeuvre	Ablative Armour
	Reflective Armour	
	Grappling System	
	Hardened Structure	
	PCS	

Aspects
Sentient SCI Force Base
Independent Shipboard LMI
Special Operations Chip
Caring yet Efficient
All for one, and one for all - that's how my station works, mister!
The Commonality is bigger than any one of us

Stunts
Sentient Ship Control
Control Avatar
Point Defence (Beam Weapons)
Long-term Life Support
Makepoint Workshop
Redaction
Passenger Quarters (400 people)
Advanced Med-bay
Hardened Ship Systems
Sensor Drones
Tractor Drones*

Equipment
Docking Ring

\* allows Gentility to affect ships down to Scale-3 with Grappling System Skill.



# NCS-ZVI919 Gentility Base

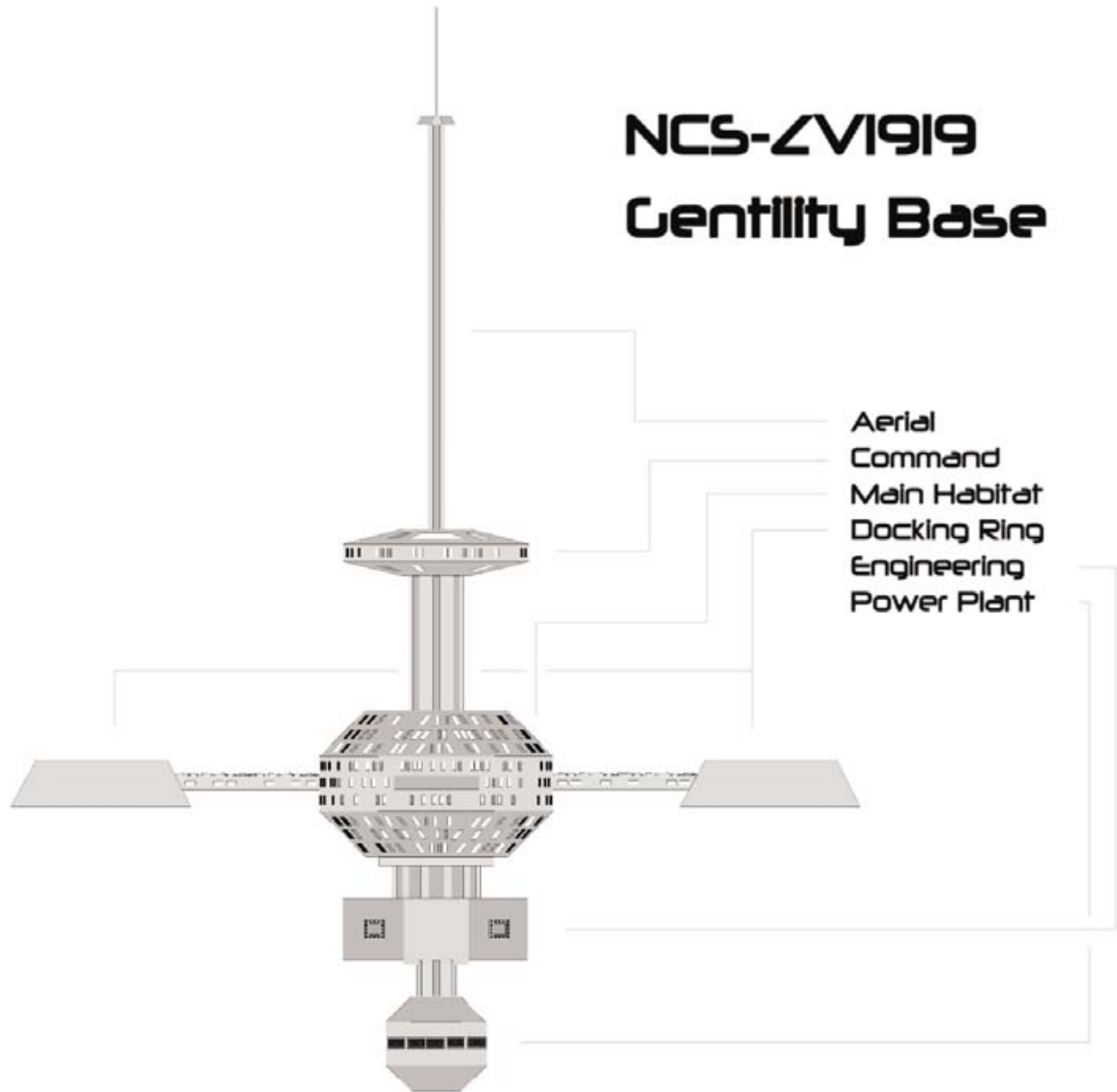

**Horatio Chin, Zvukiman G-Force Commander:** A SCI Force commander and head of “Eagle-5”, the division of Zvukimu’s elite Zero-G Force based on Gentility. The Zero-G Force (popularly called “G-Force”) belongs to SCI Force rather than the Armed Forces Instrumentality; most personnel are based on Zvukimu or on active service throughout the subsector.

## Plot

This is an event-based scenario; certain events happen in a certain order, unless the PCs get involved and change things (which of course they will). It puts the PCs “on the clock”, using Plot Stress to ensure events continue to happen, and not give the PCs chance to rest and regroup. This should be a chaotic, pell-mell scenario, the PCs struggling to cope with events spiralling out of control while trying to work out what’s going on!

### **A Note on Investigative Skills**

Whenever PCs conduct investigations using Skills like Investigation, Science, or Rapport, assume rolls are Average (+1) difficulty: success provides one item of information, and each Shift provides another. Descriptions in the text present possible findings in a list; give the PCs as many of these as their Shifts allow.

*Example: In Scene 4, the PCs are investigating Halfflight’s inert body. The text runs: “Investigation or Science checks reveal he’s an avatar, used by a Commonality planeship, with augmentations undertaken by a lower-skilled (probably Venu) engineer, and that the bomb is a zero-point bomb.” This means the PCs can make Average (+1) Investigation or Science checks; if they succeed with 2 Shifts, the Story Teller might reveal Halfflight is an avatar, used by a Commonality planeship, with augmentations, for three items of information in total.*

## Episode One: All Hell Breaks Loose

Refugees from the Amidan invasion suddenly begin to arrive in the Zvukimu system. Hidden among them is the traitorous Mindjammer Lux Veritatis, which tries to infiltrate Gentility Base in the body of its avatar, Halfflight, and several synthetics (see page 31 for more on avatars). Halfflight attempts various acts of sabotage, and the PCs must track down and neutralize the threat. We've divided the episode into four scenes.

### Lux Veritatis' Goals

Lux Veritatis aims to get Halfflight and its three synthetic henchmen into Gentility Base; sow mayhem, creating explosions, murdering crewmen and refugees; infiltrate a Mindscape virus into the station sentience; and make a Mindburn attack on Kasim Kasah, Senior SCI Force Strategist. Halfflight will then make its way to "the Aerial," Gentility's zero-G communications hub, and destroy it by setting off the distortion bomb hidden in its torso!

### Plot Stress

PC actions cause Plot Stress as follows:

#### Plot Stress Events

Event	Plot Stress imposed
Each refugee debriefed / treated	1 Stress
Chelenn's Story	One full consequence
Each successful Forensics check	1 Stress
Killing Halfflight's Henchman	One full consequence
Destroying the Mindscape Virus	One full consequence
Saving Kasim Kasah	One full consequence

Plot Stress consequences are as follows:

#### Plot Stress Consequences

Consequence	Description
□□ - Minor	Explosion and Murder (see Scene 2: Saboteurs!)
□□□ - Major	The Mindscape Virus (see Scene 3: The Mindscape Virus)
□□□ - Severe	The Attack on Kasim Kasah (see Scene 3)
□□□□ - Extreme	The Aerial: the zero-G tower, the Avatar IS a bomb! (See Scene 4: The Aerial)
□□□□ - Taken Out	The Avatar explodes! (See Scene 4: The Aerial)*

\* only if Scene 4: the Aerial isn't being played.

### Scene 1: Refugees

The station sentience calmly announces "Action Stations" during the PCs' watch, as a battle-damaged spaceship makes a sudden uncontrolled 2-Space emergence in the station's

vicinity, its comms systems silent, tumbling chaotically and out of control!

Passive scans indicate a Keynes-class subsidized freighter, a Commonality workhorse here on the Fringe. As it's potentially hostile, Gentility initiates active scans and possible extreme sanction (blowing it out of the sky).

The PCs are the acting bridge crew in control of Gentility operations. It's up to them how to handle this sudden emergency.



### Contact Sequence Alpha: Possible PC Actions

Although Gentility-5 is the station sentience, the PCs are its agents and final decision-makers. They have various options, including:

**Launch Sensor or Space Combat Drones:** standard procedure, PCs control these using the Technopsi Skill Remote Control and Sensorview trappings. They require Average (+1) manoeuvres to get close: use the PCs' Starship Pilot skill complemented by Technopsi; success gives a temporary Aspect "Perfectly Positioned" on subsequent active scan or Starship Gunnery checks. See page 42 for more on space combat drones.

**Detailed Scans:** active scans using the station sensor package or sensor drones (a +2 bonus): see *Starblazer* page 350. Depending on Shifts, successful active scans reveal multiple life signs - there are approximately 200 souls aboard!

**Plot Trajectory:** requires a successful Ship Systems (Sensors) Skill check. Shifts reveal the ship isn't manoeuvring, is in free tumble, and will pass Gentility Base by several hundred kilometres (a close shave!) heading towards Zvukimu's asteroid belt, arriving within 5 exchanges and likely suffering a catastrophic collision.

**Attack the Ship:** launch space combat drones under PC control (see page 42). Gentility (Scale 6) cannot attack the incoming vessel (Scale 3) directly.

**Take Control of the Ship:** PCs can intercept with their own ship, use physical grapples, and tow the ship to Gentility's docking ring. Or, they can wait until the ship passes close by, and use Gentility's tractor drones to try and get a lock; they'll only have one chance at this, before the ship enters the asteroid belt. If the PCs want to try and do both, let them - this is a test of initiative too!

### Results

There are three likely results:

**Successfully retrieve the ship:** the ship safely docks and disembarks hundreds of people, humans and synthetics, many injured, clearly refugees. PCs who've completed **Escape from Venu** will recognize many as Amidans.

**Destroy the ship:** the PCs may acquire Aspects like "Ruthless" or "I had to let them die to save the station!" The subsequent arrival of refugee ships may trigger remorse or attempts at self-justification.

**The Ship enters the asteroid belt and is destroyed:** similar to the above, and a good opportunity for **Aspects:** did the PCs try to help the ship, or just let it be destroyed?

### Aftermath

Just as the emergency is resolved, Gentility-5 reports multiple 2-Space emergencies throughout the system. There are ships everywhere: many bear battle damage. This is developing into a refugee crisis!

Let the PCs act as they see fit. There are over twenty ships, all telling the same story: Amida has been invaded by the Venu in overwhelming force. The battle for the system was raging; ground troops had landed and nukes been used. This day alone, over ten thousand refugees arrive at Zvukimu - and the PCs must decide what to do! Gentility Base recommends processing them on-board before releasing them to Zvukimu below - but right now it's the PCs' call.

### Scene 2: Saboteurs!

*One of Halfflight's synthetic henchmen rampages through the station, destroying and killing indiscriminately. Mayhem!*

There are refugees everywhere. Weary and injured, lying in corridors, conference rooms, cafeterias; the station is struggling to cope. Things are confused and chaotic.

### Possible PC Actions

**First Aid:** PCs with medical or redaction skills can treat wounded and traumatized refugees; treat as manoeuvres providing temporary Aspects such as "Confiding and Talkative".

**Debriefing:** PCs with Investigation or Rapport skills may question survivors about conditions on Amida: review **The Black Zone** scenario below for details. Bear in mind that no matter the Shifts generated, these are refugees from the

invasion's earliest stages, and probably don't have detailed tactical knowledge.

**Chelenn's Story:** Chelenn is a blind Amidan sculptor who was on the same refugee ship as Halfflight and his Henchmen. Several times during the journey her uncanny hearing picked up traces of Monitor Band signals; as everyone on her ship claimed to be Amidan, she knew something strange was afoot.

### Mayhem!

Unless the PCs prevent it, at some point (see "Plot Stress", above) Halfflight's synthetic henchman act. There's a huge explosion, the lights flicker, people begin screaming. PCs hurrying to the scene see a bomb has detonated, and there are casualties.

### More Possible PC Actions

**Seal off the Area!** This will ensure Halfflight's henchman is within reach.

**Forensics:** PCs with appropriate investigative abilities (such as the Forensic Science or Impossible Detail Stunts, or Good (+3) Science or Investigation checks) may detect the explosion was caused by a small and sophisticated zero-point bomb with a short timer.

**Monitor Band:** Halfflight and his Henchmen have Mindscape implants, and are using Monitor Band cloaks. PCs may detect these, identifying the Henchman from the refugees. See page 24 for detecting Monitor Band cloaks.

**Scan or Interrogate Everyone:** much easier if the PCs have sealed off the area. Scan indicates a bio-check; interrogate means Investigation or Intimidation checks.

### Whodunnit?

Assume scene Aspects like Tense, Urgent, Paranoid, Trust No One! The PCs try to flush out Halfflight's henchman: he's a synthetic, and shows up on bio-scans; his body probably retains traces of explosive; PCs may detect his Monitor Band cloak. Finally, he may just crack under interrogation. Once he snaps, however, he attempts to take as many PCs with him as he can!

Use the stats overleaf for all of Halfflight's Henchmen.

### Scene 3: The Mindscape Virus

*Halfflight attacks the Gentility sentience by introducing a virus into the station Mindscape, then makes a Mindburn attack on Kasim Kasah, Senior SCI Force Strategist.*

Depending on Plot Stress, the PCs are probably checking security records for signs of Monitor Band cloaks, tracking down any other disguised synthetics on the refugee ships. Suddenly - without warning - the station Mindscape goes down! Lights flicker, spasmodic and unintelligible warning messages blare over the speakers. Sirens go off -



Halfflight's Henchmen		Synthetics
<b>Structural Stress:</b>	□□□□□□□□□□	
<b>System Stress:</b>	□□□□	
<b>Fate Points:</b> 3	<b>Scale:</b> Small (2)	
<b>Consequences:</b> Up to 3 Consequences		
<b>Encounter Size:</b> 1 or 2		
<b>Skills</b>		
Superb (+5)	Fists*	
Great (+4)	Athletics*	
Good (+3)		
Fair (+2)	Alertness	
Average (+1)	Weapons	Guns
	Might	
	*Mandroid bonuses included	
<b>Aspects</b>		
Mindscape implant		
Looks like a human but metal underneath! (Variform Synthetic Aspect)		
Single-minded Combat Specialist		
Minor Weakness: Electricity		
<b>Stunts</b>		
Martial Arts		
Outer Shell (Endurance)		
Mandroid Arms x2 (+2 Stress, +2 Fists)		
Mandroid Legs x2 (+2 Stress, +2 Athletics)		
Mandroid Chest (+2 Stress, Outer Shell)		
<b>Equipment</b>		
Mindscape implant		
Monitor Band Cloak		
No Weapons But Fists		
-1 Kinetic Armour (Outer Shell)		

depressurization klaxons sound - fire alarms start to ring. But from the Mindscape - nothing. Where is Gentility-5?

This places an "Infected by Mindscape Virus" Aspect on the scene.

### Identifying the Problem - Possible PC Actions

**Technopsi:** PCs can't access the Mindscape; the Monitor Band seems corrupted, and any technopsi attempts fail, including accessing the security records. Personal Mindscape Instances are no better - there are a few seconds of activity before PMIs exhibit the same signs of corruption and fail completely.

**Special Operations Chips:** PCs with Special Operations Chips may see the Mindscape has been brought down by a rogue sentience - a Mindscape virus! Mindscape viruses are rare, usually the preserve of mad scientists and supercriminals - but someone brought one along today.

**Diagnosis:** a Science roll modified by Technopsi reveals: the Mindscape virus initially targeted the station systems, including

life support and gravity. Gentility-5 intercepted that attack, as a result of which she's currently offline and the Mindscape down. The virus is still attacking the station - it's only a matter of time before it gains access to something critical!

The Mindscape Virus	
Technopsi +3, Might +2, Science +2	
<b>Aspects:</b> Scorched Earth!	
Ship Systems +1, Deceit +1, Stealth +1	
<b>Structural Integrity:</b>	□□□□□□ (3 Consequences)
<b>Secrets Stress:</b>	□□□ (0 Consequences)
Notes: Attacks using Technopsi (Mindburn) vs Technopsi or Resolve, doing Composure damage; you attack back with Technopsi vs Technopsi, doing Structural Integrity damage, or Science (Hacking) (restricted by Technopsi) vs Science, causing Secrets damage. If the virus attacks a synthetic, consequences affect Skills as in Starship Combat; if a Skill is rendered offline, the virus can take over it as long as it possesses the Skill itself. So, a virus with Ship Systems Skill attacks the Ship Systems Skill; if the Skill goes offline, the virus assumes control of life support, sick bay, station gravity, and so on! Viruses can hide using Stealth and Deceit, and case and infiltrate a target using Burglary.	

### What is the Virus trying to do?

**Disable the Base:** as in "Diagnosis" above, the virus is attacking the station systems, trying to take them out. See the box above; each exchange the virus attacks Gentility Base. Let the PCs play the part of Gentility Base, with 6 Systems Stress, a Minor consequence "Mindscape Offline", and a Ship Systems Skill reduced to Good (+3).

**Mindburn Kasim Kasah:** a Good (+3) Technopsi attack by Halfflight, tagging the "Infected by Mindscape Virus" scene Aspect for a total +5. Because the Mindscape is down the PCs may not initially realize Kasim Kasah is under attack at all - maybe make Alertness or Investigation rolls to realize something is wrong. Characters with Special Operations Chips can attempt Fair (+2) Technopsi Skill checks to break into the malfunctioning Mindscape and work out the Senior Strategist is under attack!

### Dealing with the Virus - Possible PC Actions

**Aiding Kasim Kasah:** PCs with Special Operations Chips suffer virus Mindburn attacks while aiding Kasim Kasah. If they successfully defend, they can perform Technopsi manoeuvres to place temporary Aspects like "Mindburn Shielded" or "Point Defence against Mindburn Intrusions" on Kasim Kasah.

**Attacking the Virus:** the PCs attack the Mindscape virus directly (see box above).

### After the Virus - Possible PC Actions

**Back to the Security Records:** the Mindscape virus tried to destroy security record information, salvageable on Investigation / Science / Hacking rolls: a visual identification

of four individuals, one clearly the synthetic which caused the mayhem in Scene 2 - Halfflight and his henchmen!

### Aftermath

Having restored the Mindscape and identified Halfflight and his remaining henchmen, tracking them is easy. Unfortunately, it looks like they're heading for the zero-G environment of Gentility's control core, dubbed "The Aerial". Casing (Burglary) rolls indicate the target is the comms hub - Gentility's nerve centre itself. Active scans reveal a radiation source moving with the group - it looks like they have a bomb!

### Scene 4: The Aerial

*The climax of the episode. Halfflight and his henchmen are heading for the Aerial's hub (and Gentility's primary "brain") to blow the station. However, Halfflight isn't carrying a bomb - he is a bomb! His physical housing is just a shell - an avatar - and a carefully crafted explosive device!*

The PCs are on the clock, a confusing, three-dimensional combat in multiple zones with the "Zero-Gravity" location Aspect. Remember PCs can tag this on Halfflight and his henchmen for effect! Halfflight is trying to make it to the Comms Hub and blow himself up; his synthetics are trying to defend him.

The scene has elements of chase, block, and fire fight. Halfflight starts 10 zones from the Hub, and makes Sprint manoeuvres to try and get there: the PCs start 4 zones from Halfflight, and 9 zones from the Hub (these are zero-G manoeuvres, with a -1 penalty unless characters are wearing EVA harness - they aren't by default - or have zero-G training). The henchmen lay blocking fire to give Halfflight a head start. If he makes it to the Hub, he explodes, destroying the Aerial (including the Gentility-5 sentience and station Mindscape) and placing an Extreme consequence on anyone present (including the PCs!).

If Halfflight is disabled before reaching the Hub, Investigation or Science checks reveal he's an avatar - not even a synthetic! - used by a Commonality planeship, with augmentations undertaken by a lower-skilled (probably Venu) engineer, and that the bomb is a zero-point bomb.

Halfflight's statistics (below) are for an avatar: in other words, they're derived from the statistics for Lux Veritatis on page 169, and are a combination of the avatar's physical housing (providing its Structural Stress, Armour, etc) and those of Lux Veritatis' Skills, Aspects, and Stunts appropriate for avatar use.

The revelation that Halfflight is an avatar raises a disturbing possibility: the traitor could be a planeship! The idea that a sentient starship - symbol of the authority and power of the Commonality - could have been subverted by the Venu is a shock for the Commonality, placing a "Planeship Paranoia" temporary Aspect on the Zvukimu system and triggering a Memetic Virus Meme Attack on the Commonality.

The "Planeship Paranoia" Meme Attack	
<b>Scope:</b> 9	
Infiltration +3, Assertion +4	
<b>Aspects:</b> Planeship Paranoia!	
<b>Stunts:</b> Memetic Virus, Cultural Assault	
<b>Strength Stress:</b>	□□□□□□□□ (0 Consequences)
Notes: Attempts to spread as widely as it can before making its attack: see the "Memetic Virus" Stunt description on page 72 above.	

### Episode Two: Suicide Mission

Hardly have the implications of the Halfflight avatar begun to dawn on SCI Force than a refugee planeship blasts out of Gentility's docking ring into interplanetary space! It looks like the rogue planeship has been found - and it's speeding towards Zvukimu's asteroid belt!

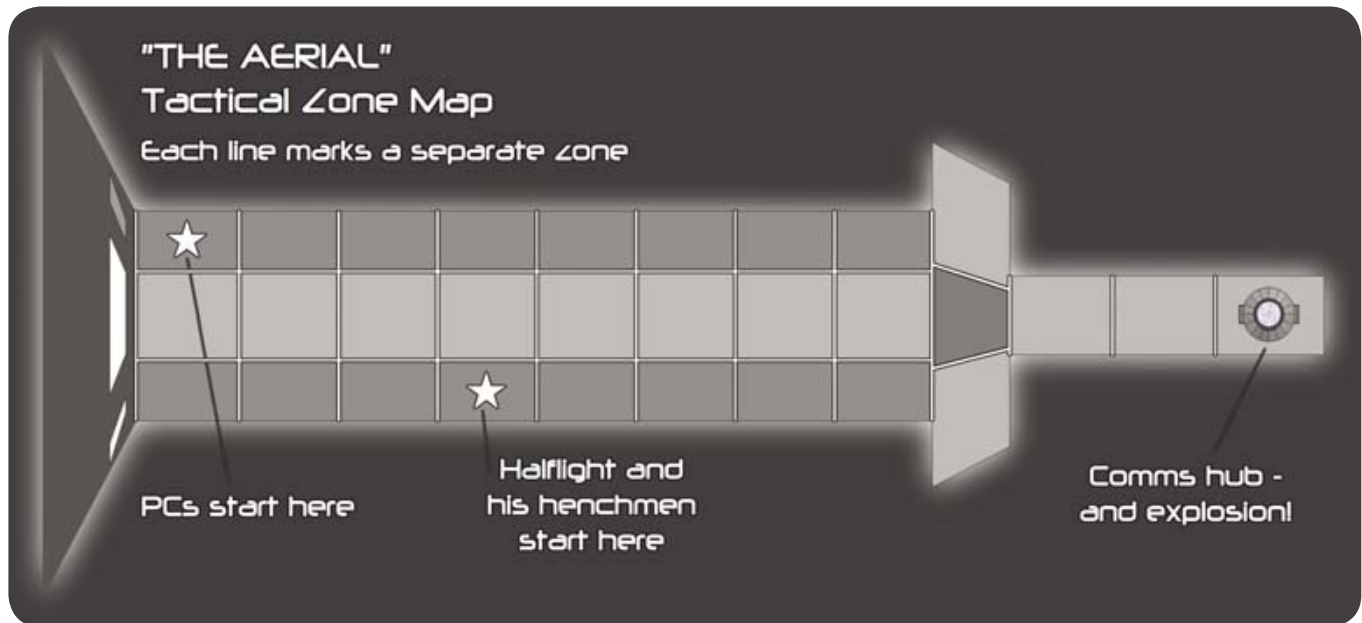

Halfflight		Avatar of Lux Veritatis	
<b>Structural Stress:</b>	□□□□□□		
<b>System Stress:</b>	□□□□□□		
<b>Fate Points:</b> 2	<b>Scale:</b> Small (2)		
<b>Consequences:</b> 3			
<b>Armour Cons:</b> n/a			
<b>Shield Cons:</b> Minor, Major, Severe			
<b>Encounter Size:</b> 1			
<b>Skills</b>			
Great (+4)	Fists*		
Good (+3)	Deceit*	Athletics*	
Fair (+2)			
Average (+1)	Resolve	Guns	
	Technopsi		
<b>Aspects</b>			
I am a living bomb!			
Variform Synthetic Avatar			
Black Chip			
Machiavellian Traitor			
Embrace the Radiant Darkness and Despair!			
Weirdly Enhanced Mindjammer			
Cruel and Sadistic			
The Commonality left me for dead in the battle for Oppen-14!			
<b>Stunts</b>			
Mindburn [Technopsi]			
Martial Arts [Fists]			
Lethal Weapon [Fists]			
Mandroid Chest (+2 Stress, Zero Point Bomb)			
<b>Equipment</b>			
No weapons (Fists only)			
Black Chip			
Assault Field (-3 Energy Shield)			
Monitor Band Cloak			

\* skills have been restricted by Technopsi

### Lux Veritatis' Goal

The rogue ship isn't the sentient ship everyone's looking for - it's being remote-controlled by Lux Veritatis from somewhere else in the system. Lux' goal is to steer the ship into the asteroid belt and use its tractor beams to capture a load of debris, then drive both ship and debris at ramming speed into Gentility Base!

### Scene 1: Cat and Mouse

The PCs chase the Rogue and catch up with it before or in the asteroid belt. Use the System Zone Map: if the PCs begin immediately, the Rogue begins 1 zone ahead. Once in the Belt, it's difficult to detect (the Belt is **Barrier Value 3**) and catch up with as it's making ludicrously dangerous manoeuvres - use the Chase rules each exchange. An Alertness roll (modified by Sensorview or Ship Systems) reveals the Rogue is using its tractor beam to gather asteroids behind it!

The Rogue spends 3 exchanges gathering debris, during which the PCs may attack or attempt boarding actions. The Rogue then heads back towards Gentility, towing its retinue of huge chunks of rock on a collision course!

### Scene 2: Race Against time

The PCs may be pursuing the Rogue or even be on board.

#### Possible PC Actions

**Detailed Scan:** detailed scans reveal no life-forms on board the Rogue; however, there is a tightbeam com-link between the ship and an unknown destination - someone is communicating with the Rogue!

**Attack the Rogue:** the PCs may choose to attack and destroy the Rogue, though they may miss out on tracking Lux Veritatis to its hideout (see Episode Three, below).

**Board the Rogue:** paradoxically this gives the PCs more time; while *Starblazer* exchanges don't have a fixed length, starship exchanges are generally longer than individual ones. Figure a starship exchange lasts about 30 minutes (sometimes more, sometimes less), while an individual exchange is a few seconds to a few minutes. Boarding the Rogue gains a little time as it speeds towards Gentility with its lethal cargo!

On board the Rogue, Investigation, Science or Ship's Systems rolls reveal this is no sentient starship - the PCs have boarded a ghost ship, another remote-controlled weapon!

**Find the Source of that Tightbeam!** Most easily done on board the Rogue, but also possible remotely. On-board the PCs must break into the Bridge and hack the ship's systems (an Average (+1) Science roll modified by Technopsi); remotely, they need precise sensor calibration to track where the tightbeam is originating (an Average (+1) Ship Systems roll, +1 per zone distance from Zvukimu A-II). The tightbeam originates from a mountainous region of Zvukimu, where the planet's surface rises out of the atmosphere - home of the mysterious alien Singers!

#### What happens if the Rogue gets to Gentility Base?

Normally the Rogue wouldn't be able to ram something as large as Gentility Base - it's too small. However, thanks to the "cloud" of debris it's dragging behind it, this time it's got a chance. Treat as a ramming attack as if the Rogue was Scale 4 rather than Scale 3 (due to the debris); make sure the players take the part of Gentility Base as the Rogue attacks!

### Episode Three: The Singers

Lux Veritatis is hiding on Zvukimu, having convinced the mysterious Singers it's being hunted unjustly by the Commonality. The PCs must convince this unfathomable alien species of Lux' treachery!



## The Rogue Ship

The Rogue is a Profit-class New Trader (see page 47) with an additional Average (+1) Grappling System Skill and some unusual Aspects. If the PCs capture it without destroying it, it could be restored for use.

### Aspects:

Single-minded Pilot!

This ship runs crazy risks

Ghost Ship

What the hell is controlling this thing?



## Lux Veritatis' Goal

If the PCs have tracked Lux Veritatis to Zvukimu's surface, they've got it cornered; its "goal" is to fight and escape if it can, or go down in a blaze of devastation if it can't.

## Song of God

There are various Singer "nations" on Zvukimu; Song of God is one of them. The tightbeam leads directly here, high above the atmosphere, and scans pinpoint the Mindjammer's neural array and precise location.

Song of God is a natural crystal formation similar to an Aeolian harp but on an enormous scale. Plasma interference and the rarefied atmosphere cause the fluted spires of the mountains to "sing", and the Singers live amidst the unearthly "music".

## Scene 1: Captured by the Singers

If Lux Veritatis hasn't been alerted, and especially if Helen Balu (see page 160) is involved, the PCs' first encounter with the Singers may be peaceful. Have them meet a Singer such as Plainchant Foo (see below), giving them a false sense of security. Then, as they meet other Singers, their reception

will turn hostile: Lux Veritatis has turned Song of God against the Commonality.

## Possible PC Actions

**Conflict:** the PCs may fight the Singers. This is tough, even though the PCs may be in their starship; figure there are five Singer "leaders" with the same stats as the Chorist, below, each with 4 Singer Minions. Lux will exhort them to a fight to the death; if the PCs surrender they'll be captured (see below).

**Negotiate:** negotiating is difficult without a Singer on your side, and Lux will urge the PCs are summarily executed! Treat as Great (+4) difficulty; Helen Balu is taggable as an Aspect if present, as is Plainchant Foo; skills like Academics can be used in manoeuvres relating to knowledge about Singer customs. A successful negotiation roll still fails, but reveals the Singer known as Harmony (the PCs' best hope for a negotiated solution) has been imprisoned on charges of treason (instigated by Lux Veritatis, of course)! The PCs may choose to surrender, fight, or escape; if they surrender they'll be captured (see below).

**Captured:** If captured, they are put in strange Singer plasma cages, ready for a "trial". This is where they meet Harmony; see below.

**Rescue or Escape:** captured PCs may try and escape, taking Harmony with them. Likewise, if they know Harmony is imprisoned, they may try to stage a rescue (presumably in p-suits - there's no atmosphere, remember). Deactivating the plasma cages is a Great (+4) roll of Engineering, Science, or Burglary. If they're escaping, make Stealth rolls against the Singer guards' Average (+1) Alertness; if they're trying a rescue, they need rolls before and after.

## Scene 2: Persuasion

This scene takes place if Harmony has been rescued. She proceeds directly to Lux Veritatis and begins a Composure conflict before the Singers to persuade them of Lux' lies. The PCs can assist with manoeuvres using the evidence they have against Lux.

## Scene 3: The Fight with Lux Veritatis

If Harmony begins to win the debate with Lux Veritatis, have the PCs make an Average (+1) Alertness roll to notice Lux' energy cannon powering up. Lux fires on the Singers, attacking the PCs and Harmony first, then heading into orbit where the Singers can't follow but the PCs can. The Zvukimans scramble the Planetary Defence Force but don't engage unless instructed by Gentility Base.

If Lux can't destroy the PCs, or the PCs don't follow, it makes one last, desperate attempt at vengeance, turning its planing engines on the Song of God (see page 41). This will kill many Singers and devastate the environment - can the PCs stop it?

## Stats

### The Singers

Details of the Singers of Zvukimu can be found on page 127.

### The Chorist

A respected old Singer, physically weak but mentally powerful. Leader of the Song of God.

The Chorist		Singer Leader
<b>Physical Stress:</b>	□□□□□	
<b>Composure Stress:</b>	□□□□□□□	
<b>Fate Points:</b> 6	<b>Scale:</b> Medium (3)	
<b>Consequences:</b> Up to 3 Consequences		
<b>Encounter Size:</b> 1-6		
<b>Skills</b>		
Great (+4)	Rapport	
Good (+3)	Resolve	Empathy
Fair (+2)	Exude Energy	Absorb Energy
	Leadership	
Average (+1)	Stretchy	Telepathy
	Singer Song*	Mysteries
<b>Aspects</b>		
Respected leader of the Song of God		
Unfathomable Alien Plasma Being		
I must decide according to our laws!		
Insubstantial and unaffected by physical weapons		
Haunting Song		
Minor Weaknesses: Fire, Water, Gravity, Air		
<b>Stunts</b>		
Exude Plasma [Exude Energy]		
Energy Drain [Absorb Energy]		
Energy Boost [Absorb Energy]		
Absorb Energy Weapons [Absorb Energy]		
<b>Monstrous Special Ability</b>		
Extreme Conditions		
<b>Equipment</b>		
Plasma Fist		
Plasma Bolt		
*Operates like the Pheromones Skill		

## Harmony

A pro-Commonality Singer known to Helen Balu, currently imprisoned in Song of God because she opposed Lux Veritatis. Fearsome when opposed, she's fascinated by humans, and caring of their welfare (which can feel a bit condescending...).

Harmony	The Friendly Singer	
<b>Physical Stress:</b>	□□□□□	
<b>Composure Stress:</b>	□□□□□□□	
<b>Fate Points:</b> 6	<b>Scale:</b> Medium (3)	
<b>Consequences:</b> Up to 3 Consequences		
<b>Encounter Size:</b> 1-6		
<b>Skills</b>		
Great (+4)	Empathy	
Good (+3)	Resolve	Rapport
Fair (+2)	Exude Energy	Absorb Energy
	Intimidation	
Average (+1)	Stretchy	Telepathy
	Singer Song*	Mysteries
<b>Aspects</b>		
These humans interest me!		
Unfathomable Alien Plasma Being		
Compassionate - if a bit condescending		
Insubstantial and unaffected by physical weapons		
Haunting Song		
Minor Weaknesses: Fire, Water, Gravity, Air		
<b>Stunts</b>		
Exude Plasma [Exude Energy]		
Energy Drain [Absorb Energy]		
Energy Boost [Absorb Energy]		
Absorb Energy Weapons [Absorb Energy]		
<b>Monstrous Special Ability</b>		
Extreme Conditions		
<b>Equipment</b>		
Plasma Fist		
Plasma Bolt		
*Operates like the Pheromones Skill		

## Plainchant Foo

A young, excitable singer who sides with the PCs. Use the statistics on page 127, replacing "Aloof and Uncaring" with "Enthusiastic and engaging".

## Lux Veritatis

A traitorous Mindjammer who has betrayed the Commonality and defected to the Venu. Its statistics are the "master" from which the avatar Halflight's statistics were derived.

## Epilogue

The PCs' actions define this scenario's outcome, and they'll be recognised accordingly, with praise, reward, or criticism. Gentility Base could be damaged, or even destroyed; relations with the Singers could be better, or worse. Lux Veritatis may be destroyed, or still at large, unknown or an open traitor to the Commonality.

There are other implications, too. Although Lux was in league with the Venu, some of its equipment could only be obtained through restricted Commonality channels. There's a conspiracy in the Commonality - but who, and why?

Before anything, though, a loyal ally of the Commonality is under attack - Amida needs help!



## Lux Veritatis

### Mindjammer Technical Readout

<b>Scale:</b>	Medium (3) Advanced
<b>Structural Stress:</b>	□□□
<b>System Stress:</b>	□□□□□□
<b>Fate Points:</b> 2	<b>Refresh:</b> 2
<b>Consequences:</b>	3
<b>Armour Cons:</b>	Minor, Major, Severe
<b>Shield Cons:</b>	Minor
<b>Jump Maximum:</b>	30 LY

### Skills

Superb (+5)	Fists	
Great (+4)	Deceit	Athletics
Good (+3)	Beam Weapon	
	Projectile Weapon	
	Ablative Armour	
Fair (+2)	Manoeuvre	Resolve
	EWS	Planing Engines
Avg (+1)	Guns	Technopsi
	Energy Shields	
	Mine Dispenser	
	Repair System	

### Aspects

Sentient Starship
Black Chip
Look, ma, it's a Mindjammer!
Machiavellian Traitor
Embrace the Radiant Darkness and Despair!
Weirdly enhanced Mindjammer
Cruel and sadistic
The Commonality left me for dead in the battle for Oppen-14!

### Stunts

Sentient Ship Control [Ship Systems]
Atmospheric Entry [Manoeuvre]
X-Core [Planing Engines]
Mindburn [Technopsi]
Control Avatar [Technopsi]
Hardened Ship Systems [Ship Systems]
Martial Arts [Fists]
Lethal Weapon [Fists]

### Equipment

Single Tyce Systems Laser Cannon
Mai Ling "Steadfast Defender" EWS System
PASARM "Rapid Pursuit" Z-Winder Missiles



# Chapter Eleven:

## The Black Zone

*"Can't you hear it? I can hear it. I can hear it all the time. It sounds like a voice... it sounds like music... it sounds like all the sounds of my childhood, all the lost hopes for the future when I was just a pup. I want to laugh and cry at the same time.*

*You know: all those people, in the City, just lying on the ground and starving to death in bliss while they listen to the Uranawaltzer - I know how they feel...*

*I can't let you destroy it. It must be rescued! It's the most beautiful thing in the world - it's a gift from God!"*

*- Cain, also known as the White Wolf, former mercenary with the 4th Amidan Xenomorph Cadre, outside the Black Zone, 193 NCE*

### Background

The Venu have invaded Amida! Fleet encounters and ground battles are ongoing, but the Resistance is weak and the Venu Occupation Force huge. The PCs are sent to Amida to reconnoitre the threat, take any action to hinder the invasion, and report back to the Commonality.

On planet, the PCs hear rumours of a frightening Venu "super-weapon" which has closed off the capital city in a forbidding "Black Zone," and of a terrifying "Braineater Plague." PCs who took part in **Mind's Eye**, above, may get a sense of déjà-vu...

### Story Teller's Overview

The Uranawaltzer is indeed a super-weapon, and among its many effects is the "Black Zone" over the city of Daisetta, a force field within which a strange inaudible "music" enthral the minds of the population as they succumb to starvation and exposure. It also provides the Venu with a Mindscape-like power, enabling Cultists of the Dark Radiance, led by High Commissar Hell Mur, supreme leader of the Invasion Force, to communicate telepathically on-planet and boost their psi-powers.

#### A Complex Scenario

We're not making any bones about it - **The Black Zone** can be a complex scenario. It's the climax of the campaign, with huge scope for action. There are multiple episodes, pitched battles, and a cast of thousands, which players can approach in any number of ways. Take time to familiarize yourself with the material, and decide how much or how little you're going to use. We've provided hints and suggestions, but as ever in **Starblazer**, the main thing is to keep it moving, let actions speak louder than words, and have fun!

**The Black Zone** takes place against the backdrop of a full-scale planetary invasion. Events happen at three levels: character, unit, and organization; organizations and units use the **Starblazer** Organizations rules; events at all levels affect one another; and players have a wide choice of action. We've loosely assumed PCs will be interested in capturing or destroying the Venu superweapon (especially given its weird powers), and the four episodes below generally head in that direction.

We've divided the scenario into "Location," detailing key areas of the Venu occupation; "Plot," describing the four episodes; and "Statistics." There's also a section on unit-level actions, describing how the Venu, the Amidan resistance, and the Commonality xenomorphs are battling it out.

#### Describing the Venu

The Venu are **Mindjammer's** bad guys. They're mysterious, mutated Space Nazis; little is known about them, beyond their penchant for melodrama, sharp dressing, and disgusting skin conditions. Their coldly intellectual leaders treat their troops almost as badly as the people they're fighting, driving them like cattle and slaughtering them just as easily. Led by the Dark Radiance Cultists - their thought police and Machiavellian leaders - they're a twisted and sinister foe whose motivations remain unfathomable.

Players may have already met them in **Escape from Venu**. However, **the Black Zone** is a full-scale invasion, and the Venu are going overboard with their incomprehensible xenophobic destructiveness. Can nothing stop them? Take full advantage - if your players don't hate these guys' guts, you're doing something wrong!

#### PCs with Minions?!

Unit-level combat abounds in **the Black Zone**, and PCs can lead groups of soldiers on heroic missions. We've provided opportunities for PCs as agents of SCI Force to assume command of groups of minions, running them independently or attaching them to their own characters.

PCs can take control of any friendly unit by making a Leadership roll against the unit leader's Leadership Skill (default Mediocre (+0)). Failing has no consequences unless the Story Teller wishes; success means the PC assumes temporary command, controlling the unit's actions at unit-level, or treating it as a group of minions at character-level.

# Locations

## Amida

See page 90 for Amidan planetary details; cultural details are as follows.

Amidan Culture		Culture Sheet	
<b>Scale:</b>	Enormous (6)	<b>Consequences</b>	<b>Strength Stress</b>
<b>Scope:</b>	Planetary (6)	Minor: Simple robots may be permissible...	□□□□□□
<b>Fate Points:</b>	4	Major:	
<b>Refresh:</b>	4	Severe:	<b>Stability Stress</b>
		Extreme:	□□□□■

Skills				Stunts
Great (+4)	Comms (Radio)	Information (Computers)	Resource Exploitation (Automated)	Cultural Assault Propaganda Campaign Memetic Virus
Good (+3)	Transport (Space Travel)	Power (Broadcast)	Assimilate	
Fair (+2)	Biological (Medical)	Armaments (Nuclear)		
Average (+1)	Assertion	Propaganda		
Mediocre (+0)	Psi (Pre-Psi)	Infiltration		

- Aspects**
- Religion (The God Under A Tree)
  - Revere the Kaskai xenomorphs
  - Pacifism
  - Science! (result of Commonality contact - Power capability band)
  - Robots Will Take Over The World! (result of Commonality contact - Resource Exploitation capability band)
  - Live and Let Live
  - \*Mutability of Body Form (temporary Aspect from Commonality Propaganda Campaign)
  - \*Hail the Radiant Darkness (temporary Aspect from Venu Meme Attack, currently affecting 1 zone only - Daisetta)

**Cultural Conflicts**

**Commonality Propaganda Campaign** (Scope 6) - defending with Good (+3) Assimilate and Aspect "Robots will take over the world!" against Commonality's Good (+3) Propaganda and Aspect "Mutability of Body Form". Amidan government supports Commonality Propaganda Campaign with Average (+1) Propaganda, giving +1 Stress to successful Commonality attack.

**Venu Meme Attack** (Scope 6) - defending with Average (+1) Assertion and Aspect "Revere the Kaskai xenomorphs" against Venu Fantastic (+6) Propaganda and Aspect "Hail the Radiant Darkness!". Amida is attacking back with Average (+1) Assertion versus Venu Superb (+5) Assertion.

## The World

Amida is a trinary system, with L- and M-class companions, distant enough to treat Amida A (the main star) as its own system, although Amidan skies clearly have two additional distant suns.

The System Zone Map shows only the largest zones; each planet, for example, has orbital and atmospheric zones. The multiple asteroid belts are separate zones, as are the battle debris zones and the zone where fleet battles are raging. The Amidan system is a complex, dangerous environment.

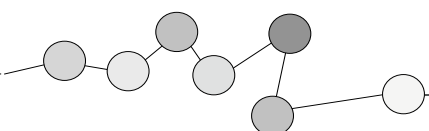
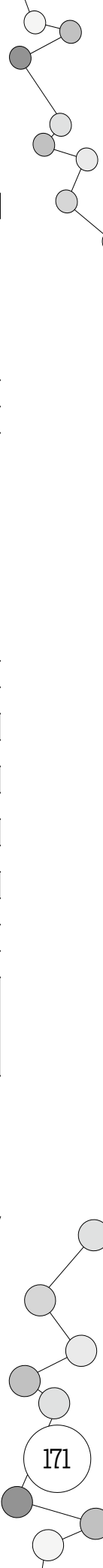

## Amida A System Zone Map

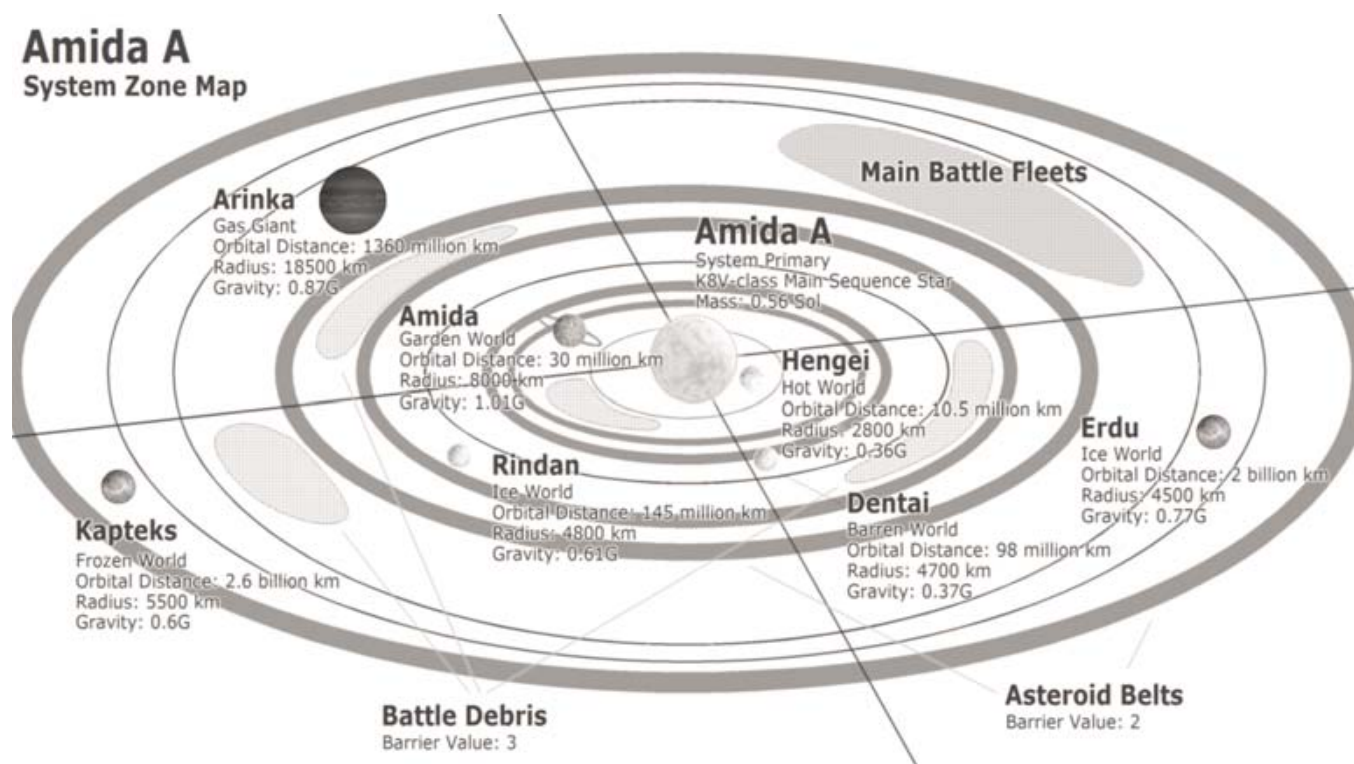

### The People

Amidan cities are lightly populated and dispersed, with lots of small-scale agriculture. Most people live in the less sweltering uplands, but even these are very hot. The capital, Daisetta, has a population of just under one million; built on five hills ("Daisetta" means "Five Hills") along the Viridis river, it has borne the brunt of the Venu invasion.

**The God Under A Tree:** the Amidans are a religious people. In the Core Worlds religion has long been illegal for the doubt and disruption it sows, but the Commonality has learned to its cost that it's nevertheless alive and well, in society's unobserved corners and amongst the poor, lost, and needy. Xenomorphs in particular harbour strong religious feelings, and Amida is no exception: the native Kaskai form the priesthood of a pseudo-Buddhistic religion called "the God Under a Tree". Their spiritual leader, **Mugon** the "High Holy", normally dwells in a temple city in the southern jungles, but has been forcibly relocated by the Venu to a temple east of Daisetta - possibly as hostage to ensure Amidan compliance. Everyone's concerned about the High Holy's imprisonment, and there rumours of Venu atrocities against Commonality xenomorphs - though not, as yet, the Kaskai.

**The Royal Family:** the Amidans are devoted to the Sultan's family, though less so than the High Holy. If the PCs played **Escape from Venu**, people will remember them for their role in trying to rescue the kidnapped heir to the Amidan throne, Princess Kirei. The whereabouts of the Amidan royal family is currently unknown.

**The Kaskai:** a pithecine xenomorph species like fully upright gorillas. They're a deeply religious, joyful culture, strong in dance, theatre, music, and the vegetarian cuisine

forming a large part of the Amidan diet. An integral part of Amidan society, before the Invasion they constituted 10% of Daisetta's population; now there are none. Many have joined the Resistance, and there are "fighting monks" training in secret to rescue their spiritual leader!

### Amida Invaded!

The Venu invaded a month or two ago. Since then, there's been constant conflict between the Venu Occupation Forces, Amidan Resistance, and xenomorphs.

Outside the Black Zone conditions are "normal" for an occupied planet. Venu military governors and Commissars command the government, food is rationed, there are reprisals, casual brutality and a curfew during each cycle's rest period. Bitter conflict has broken out as the Amidans have woken up to the Venu brutality, and many have fled to the Resistance in the lowland jungles.

### Daisetta and the Surrounding Area

See the map "Daisetta and Surrounding Area" on the inside back cover.

**The Ruined Cities:** during the initial invasion the Venu bombarded the cities around Daisetta from orbit, killing hundreds of thousands and leaving radiation-contaminated ruins. The Daisetta area is depopulated - refugees have fled to other cities (under the Venu jackboot) or the Resistance, though survivors can be found scabbling for food and avoiding Venu patrols and radioactive fallout. It's a terrible mess.

**Daisetta Down Starport:** Amida starport's ground facilities were taken intact by the Venu, and are locked down and heavily garrisoned. The Commonality-run orbital sensor



station suffered extensive damage, though it's still in a stable orbit: no one knows what's happened to the hundred or so crew.

**The Kaskai Temple:** this beautiful temple of wood and incense high on the forested slopes east of Daisetta now houses the Kaskai High Holy, Mugon, and a garrison of Venu troops. The Amidans haven't attempted a rescue as they fear (rightly) for the High Holy's safety. PCs doing so need to get it right first time...

**Unit Distribution:** the Resistance is concentrated in the south-eastern jungles, patrolled by Venu attack droids.

**Patrols:** PCs travelling around Daisetta and environs encounter the following patrols:

**Venu Ground Patrol:** 1-3 tripods (see page 191), or a foot patrol of 1-3 squads and 1-2 Predators.

**Venu Droid Patrol:** usually encountered in the wilds, especially the lowland jungles.

**Venu Air Patrol:** a pair of horribly polluting Venu fighters (see page 50); the Resistance have no airpower to counter with,

though they have Commonality grav-tanks (requiring the xenomorph drivers interned in the Concentration Camp).

### **The Xenomorph Concentration Camp**

A recently-constructed prefabricated prison camp confining Daisetta's Commonality xenomorph minority, commanded by sadistic Commandant Am-Falta (see page 189).

The camp has three "Alert Levels": low, raised, and attack. The manning levels below are for low alert, unless otherwise stated. Patrols comprise either a full squad (1 Squad Leader plus 3 4-man teams), or a single 4-man team. There are 1000 troops (including guards), 20 Venu Predators, and 10 Tripods guarding the camp; see page 191 for statistics.

**Combat Walker Hangar:** 20 Tripods and 10 Predators are kept here, with 50 engineers. During an attack they'll be in the field.

**Landing Berm:** for flyers and shuttles. There's a single squad guard post here - during an attack they'll be in the field.

**Surveillance Tower:** contains the camp's scanners, 3 squads of guards; during an attack, the tower directs a squad to any attacker within minutes; one squad always remains to man the tower.

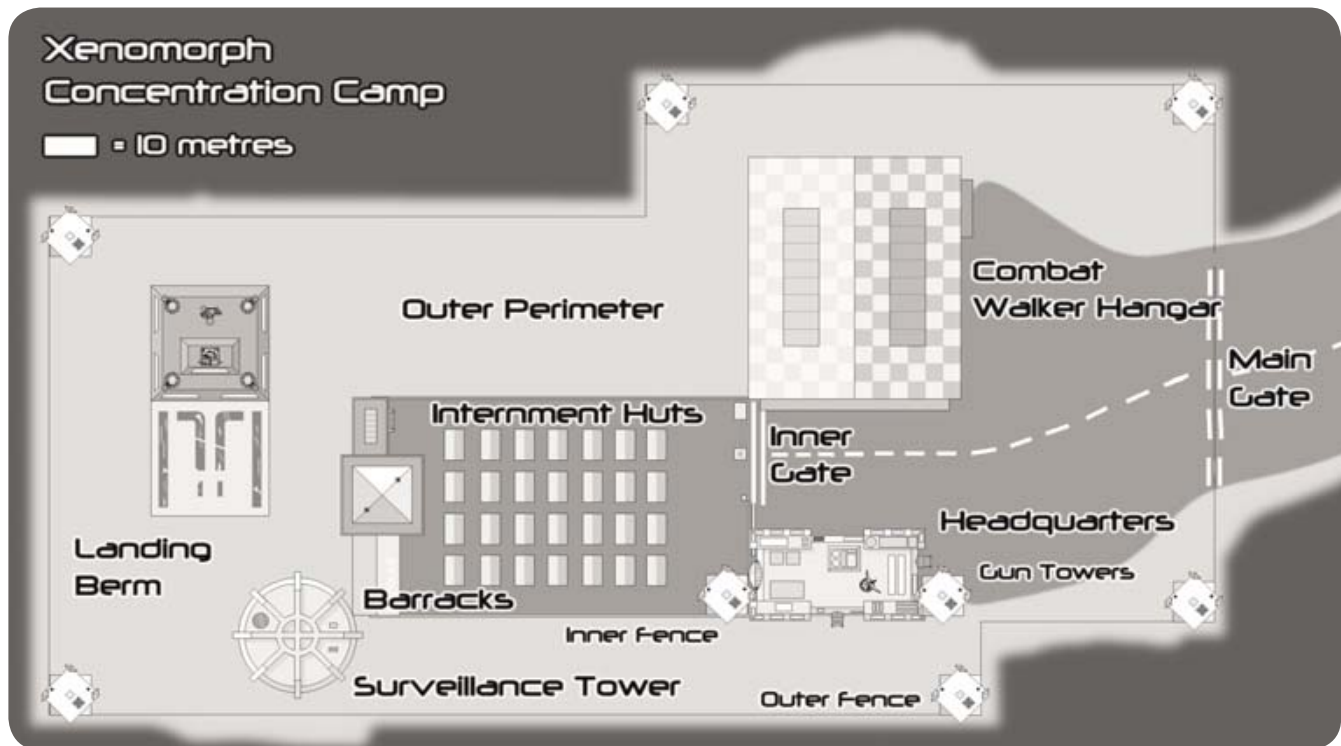

### Surveillance Tower

<b>Physical Stress:</b>	□□□□□	
<b>Systems Stress:</b>	□□□□□	
<b>Fate Points:</b> 7	<b>Scale:</b> Medium (3)	
<b>Consequences:</b> Up to 3 Consequences		
<b>Speed:</b> n/a	<b>Crew:</b> 13	
<b>Skills</b>		
Good (+3)	Projectile Weapon	
Fair (+2)	Armour	Shields
Average (+1)	Investigation	Alertness
	Tower Systems	
<b>Aspects</b>		
	Coordinates troop movements and attacks	
	Eye in the sky	
	Communications hub	
<b>Stunts</b>		
	Anti-personnel armour	
<b>Equipment</b>		
	Very heavy disruptor cannon (+8 explosive damage vs personnel, area 1, range 5)	
	Medium armour plating (-2 kinetic, -2 energy)	

### The Tower Troops

### Minions

3 squads of 13 Average (+1) Venu troopers; 1 is attached to the tower, 2 are independent. They're armed with Venu Disruptor Rifles (+4 Stress, range 2) and wearing Venu Trooper Armour (-2 kinetic, -1 energy).

Attached Trooper Squad (+4 bonus)	□□□□□□□□□□□□□□
2 x Independent Trooper Squads (+1 Guns, +4 bonus)	□□□□□□□□□□□□□□



**Gun Towers:** eight gun towers are manned by 4 Venu trooper minions (32 total). The tower provides -2 armour against kinetic and energy weapons.

### Gun Towers

<b>Physical Stress:</b>	□□□□□	
<b>Systems Stress:</b>	□□□□□	
<b>Fate Points:</b> 3	<b>Scale:</b> Medium (3)	
<b>Consequences:</b> Up to 3 Consequences		
<b>Speed:</b> n/a	<b>Crew:</b> 4	
<b>Skills</b>		
Good (+3)	Projectile Weapon	
Fair (+2)	Armour	Shields
Average (+1)	Investigation	Alertness
<b>Aspects</b>		
	Excellent field of view	
	Good cover	
	You can't miss it!	
<b>Stunts</b>		
	None	
<b>Equipment</b>		
	Venu Heavy Disruptor (+5 Stress, range 3)	
	Medium armour plating (-2 kinetic, -2 energy)	

**Headquarters:** 4-storey building housing Commandant Am-Falta and 700 troops - during an attack they'll all be in the field.

**Barracks:** irregular 3-4 storey barracks for 300 camp guards. During an attack they'll all be in the field.

**Main Gate:** Barrier Value 3, patrolled by a 4-man team; during an attack, it's guarded by 10 squads, 5 Tripods, and 10 Predators.

**Outer Fence:** Barrier Value 2, patrolled by a 4-man team every 15 minutes; during an attack it's unpatrolled.

**Inner Gate:** Barrier Value 3, guarded by a 4-man team; during an attack there'll be 2 squads here.

**Inner Fence:** Barrier Value 3, a 4-man team makes a circuit every 15 minutes. During a raised alert searchlights from the nearby gun tower pass every minute, calling in a squad to anything suspicious. During an attack it's unpatrolled.

**Internment Huts:** housing 700 xenomorph prisoners (30 per hut), including Cain (see page 188). They're malnourished, unarmed, and very angry.

### The Black Zone

The once-beautiful City of Spires lies devastated by the Venu invasion, its tree-lined avenues burned, cupolas and spires tumbled to the ground. A sinister, uncanny force field covers it, cutting off the sunlight - the Black Zone.

The Black Zone is kilometres wide, covering the city. Inside, everywhere is in near darkness, every sound muffled. This "DarkRadiance" emanates from the mysterious Uranawaltzer; it's unnatural, and doesn't register on sensors.

Anyone entering the Black Zone sickens rapidly and lapses into a coma: no one knows why. People call it the "Braineater plague"; first, you hear strange sounds, like music, just out of the range of hearing. This gets slowly stronger until you collapse in a kind of trance. The Black Zone is filled with the bodies of Amidan citizens, lying outstretched on the ground, starving to death and listening in rapture to "something" - the music of the Uranawaltzer.



Outside the Black Zone is the Penumbra, an area of semi-shadow 10 kilometres deep. Obvious on bright days, by night or when overcast it requires an Alertness roll to see. The Resistance don't know what the Penumbra is: see "Tagging the Uranawaltzer" on page 176.

See page 191 for Uranawaltzer stats and details of the Braineater plague.



### **Black Zone Defences**

The Black Zone swarms with Venu forces, unaffected by the Uranawaltzer. PCs must make Stealth rolls to avoid Venu ground patrols (see page 173).



### **The Academy of Commonality Studies**

This is Amida's former Global Mindscape Facility. During the invasion it was stormed by the Dark Radiance Commissariat, who installed the deadly Uranawaltzer which immediately suppressed all Mindscape activity. Since then, the building and immediate surroundings have been in total darkness - the concentrated heart of the Black Zone, visible from a distance as a strange, amorphous patch of night. The Dark Radiance Guard and Commissars see in it normally, but Venu Troopers are as blind as anyone. Artificial light and night-vision goggles are minimally effective, although infrared vision works normally. Mechanical synthetics can see, but organic ones cannot.

The Academy is a figure-eight shaped building with magnificent portals north and south, approached by grandiose steps flanked by fountains. Its two wings bear tall spires, known locally as "the Spires of Glass and Gold". Heavily damaged during the attack and since repaired, it has a sinister, Venu feel, black and red drapes flanking the doors, and Dark Radiance guards everywhere.

### **Interior and Defences**

Each approach to the Academy is defended by 2 squads of Dark Radiance guards (see page 187). Inside two main chambers, 70 metres across and almost circular, flank a central hall and offices - the Dark Radiance's operational heart. The easternmost chamber - previously the Hall of Information - serves as their headquarters; the westernmost houses the Uranawaltzer.

Defences are tight, with 500 Dark Radiance guards in the Academy and another 2500 Venu troopers nearby in the Black Zone. In an attack 10 squads of Dark Radiance guards (130 troopers) remain protecting the building.





### The Chamber of the Uranawaltzer

The westernmost chamber was originally the Hall of Education, housing Amida's Global Mindscape. It's still there, strangely non-functional, and the chamber is home to the Uranawaltzer. During an attack, it'll be heavily defended by 4 squads of Dark Radiance guards, 10 technopriests, High Commissar Hell Mur and his two assistant Commissars. If Asharak-Um survived **Escape from Venu**, Story Tellers may want him to reappear here, too!

The Uranawaltzer is 2 metres tall, a staff-like artefact, clearly technological, surrounded by a nimbus of blazing "black light" - the Dark Radiance. Motionless bodies of hapless Amidans cover the floor, comatose or simply entranced by the whirling "music" filling their minds.

The technopriests tend the Uranawaltzer, moving bodies, posing their limbs, somehow modulating the radiance and its song. It's all incomprehensible; some of the more "drained" bodies seem strangely insubstantial. PCs who've played **Escape from Venu** may recognise one of the technopriests as Doctor Noyo - assuming he survived! See page 185 for his updated statistics.

## Unit-level Actions

Mass battles and unit-level actions form the backdrop to **the Black Zone**. This section provides guidelines for including unit-level conflicts in your game.

Using the **Starblazer** Organizations rules, in a unit-level action one "force" fights another; the Venu force fights the

### Tagging the Uranawaltzer

Venu Commissars can tag the Uranawaltzer to enhance their psi-powers anywhere on-planet: PCs need an assessment (using Investigation, Science, or even Technopsi) to realize this. They can also communicate telepathically. Using Venu psi-powers in the Black Zone treats all targets as being in the same zone; in the Penumbra treats targets as 1 zone removed; and elsewhere on-planet as 2 zones removed.

Tagging the Uranawaltzer in its presence provides a +3 bonus rather than +2.

### The Uranawaltzer and the Mindscape

No Mindscape Instances (not even PMIs) can be accessed within the Black Zone and Penumbra. Science rolls reveal they're still functional, but for some reason organic brains can't interface with them. This even applies to Special Operations and Black Chips. Maybe the Uranawaltzer is some kind of suppressor?

### How many Units?

Armies come in all shapes and sizes. In **Starblazer**, an Organization brings to bear a number of "Armies" or "Fleets", or a number of "Units", equal to its Sway or Control Skills in a region. Whether you use the larger Armies and Fleets or the smaller "Units" depends upon whether the Organization is Scale 7, 8 or 9 (Planetary, Interplanetary, or Star Empire), or something smaller.

*Example: The Empire of Venu is a Star Empire; its Good (+3) Sway (Darradine Restoration) Skill brings 3 Fleets and Armies to bear in the Darradine Restoration Subsector.*

How big is an Army or Fleet? How many "Units" do they contain? Although **Starblazer** doesn't answer that question specifically, **Mindjammer** assumes that an Army or Fleet comprises 10 Units per point of the parent Organization's Arms Skill. So, for the Venu Empire, with its Great (+4) Arms Skill, each of its Armies comprises 40 Units; for the less-militarized Commonality, each Army comprises 20 Units.

In this scenario, the Venu Invasion Force comprises 40 Units. What those Units are is described below.

Amidan force, for example. This "force" comprises all units in that action; each force has its own statistics block, like a character, starship, or organization: see Episodes 1-4 for examples.

## What's an Army Unit?

An army consists of a number of units with identical statistics but differing Aspects. Unit types are described below; not all army forces have all types.

Unit Type	Description
Infantry	A battalion of 1000 troops, frequently attached to Armour or Anti-armour units.
Special Infantry	200 elite troops such as commandoes, Special Infantry units often form the core of a PC-led special missions force.
Infantry Support	Mechanized units like tanks or combat walkers, providing covering fire and anti-tank or anti-artillery support for ground troops.
Armour	Grav tank or Venu Quad Walkers forming the core of a force with infantry units attached. Their job is to break through the lines.
Troop Carrier	Reinforcements capable of replacing Infantry units. You need Troop Carrier units to use the Reinforcements (Leadership) Stunt.
Anti-armour	Venu Tripods, Commonality Combat Drones, flexible units whose job is to take out Armour units. They frequently form core units; like Armour, they may have Infantry units attached.

### Tips for playing at Unit-level

Unit-level play can become abstract and mechanical; here are a few tips to avoid that happening.

First, involve the PCs as much as possible. Make sure the players have a copy of the "Force Sheet" with the statistics of the force they're assisting; let them spend Fate Points to perform Highlight Scenes (*Starblazer* pages 292-3); involve them in Emergency Scenes; or let them play such scenes out, just as if the conflict was happening at Organization level. Any of these activities can be manoeuvres creating temporary Aspects. Let the PCs bring their own Leadership Skills into play as well, influencing tactical decisions and colouring the narrative as the Forces conflict.

Secondly, personalize the Forces. Give individual units personality, names like "Commander Beyn's Shock Troops" or accessible labels like "Rabble of Pitchfork Farmers"; Make sure they behave in appropriate ways rather than like pieces on a board.

### How to do things with Forces and Units

The following bullet points summarize the *Starblazer* rules for unit-level conflict.

- When creating a force, designate one unit the "core unit," then attach other units to it as minions.
- Each force has a single stat block, with stress points, Skills, Aspects. Examples are provided below.
- The "core unit" only provides 5 stress points; each additional unit adds 1 more.
- Make one roll for each force each exchange - either an attack or a manoeuvre.
- Determine Initiative using the parent organization's Technology or Security Skill.
- Resolve attacks or manoeuvres using the commander's Leadership Skill, plus any applicable Leadership Stunts.
- The defender resists with its Leadership Skill.
- If you get spin **before** applying the damage bonus, you can choose how to allocate damage - so you can target a significant unit.
- Any Aspects belonging to the core unit may be invoked; additionally, 1 additional Aspect from the parent organization and from each attached unit may also be invoked. This is a modification of the *Starblazer* rules. If a unit is destroyed, its Aspect is no longer available.
- Although units are treated as a single force, on a map you can show them individually, undertaking manoeuvres to surround or isolate units, and so on.

Lastly, be clear about the nature of the conflicting forces and victory conditions. In the fleet battle in Episode One, the Amidan force is heroically trying to buy their refugee ships time to escape - there's not much hope it'll ever damage the Venu force opposing it. If the refugees escape, that's a "victory" for the Amidans.

## Venu Forces

The Venu Invasion Force is massively more powerful than the Amidans; its leader, High Commissar Hell Mur, has Good (+3) Leadership, with +1 bonus on fleet actions and an additional +3 to fleet or army actions for a Fate point. See page 62 for the Venu organization sheet.

The Venu have 7 fleet units and 33 ground units in the Amidan system, as follows:

### Venu Fleet Forces

Unit	Number	Comments
Capital Ship	1	The "Ancestral Voice" (see page 48)
Destroyer Squadron	1	6 destroyers (see page 49), including the "Assassin", "Dark Wing", "Crimson Skull", and "Shade".
Drop Ship Squadron	2	2x 6 drop ships (see page 49) carrying 24,000 troops total.
Warhawk Wing	1	12 warhawks (see page 51)
Fighter Wing	2	2x 12 fighters (see page 50)

### Venu Ground Forces

Unit	Number*	Comments
Infantry	5	5x 1000 Venu troopers in blood red armour. <b>Aspects:</b> <i>Deranged Psycho Warriors, Foot-sloggers.</i>
Droid	3	3x 500 Attack Droids painted blood red. <b>Aspects:</b> <i>Z-Radiation, All-weather, Stupid Robots.</i>
Special Infantry	2	2x 50 Venu troopers in black-trimmed gold Venu Marauder armour. <b>Aspects:</b> <i>Elite Soldiers, Powered Armour.</i>
Infantry Support	5	5x 20 Venu Predator combat walkers. <b>Aspects:</b> <i>Towering Combat Walkers.</i>
Armour	4	4x 2 Venu Quad Walkers. <b>Aspects:</b> <i>Terrifying Mechanized Monsters, Belching Z-Radiation Dirt Drives, Nightmare Disruptor Cannon.</i>
Troop Carrier	2	2x 10 Crawlers. <b>Aspects:</b> <i>Reinforce the Infantry, Rapid Move.</i>
Anti-armour	6	6x 10 Tripods. <b>Aspects:</b> <i>Gang up on the Tanks!</i>

\*we've already placed 27 of the 33 Venu ground units, leaving 6 more to use as reinforcements.

## Amidan Forces

The Amidan Resistance has 20 units. 10 are in the Daisetta area, hidden in the jungle lowlands east of the capital; Venu attack droids are flushing them out.

### Amidan Ground Forces

Unit	Number	Comments
Infantry	5	5x 1000 ground troops. <b>Aspects:</b> <i>We gotta get the hell outa here, One day it'll be payback time!</i>
Armour	2	2x 50 ground tanks; also operate as Infantry Support. <b>Aspects:</b> <i>Primitive tracked vehicles.</i>
Troop Carrier	1	2x 50 armoured personnel carriers. <b>Aspects:</b> <i>Faster than the infantry.</i>
Anti-armour	2	2x 50 mobile artillery. <b>Aspects:</b> <i>Cumbersome.</i>

The Amidan Resistance, even with Commonality xenomorph allies, is horribly outclassed. They're just not a warlike culture. With limited Leadership skills, each force has only Average (+1) Leadership, with a +1 "Unit Leader" Stunt. This is why Cain (see below) is so important - he can make a real difference to the Amidans' survival chances.



The Amidan government's Organization sheet (from which unit statistics are derived) is as follows:

Amidan Government		
Organization Sheet		
<b>Scale:</b> Colossal (7)	<b>Consequences</b>	<b>Physical Stress</b>
<b>Scope:</b> Planet (6)	Minor:	□□□□□
<b>Fate Points:</b> 7	Major:	<b>Composure Stress</b>
<b>Refresh:</b> 7	Severe:	□□□□□□□
	Extreme:	
<b>Skills</b>		<b>Holdings</b>
Great (+4)	Unity	The Kaskai Temple (Isolated, Ancient)
Good (+3)	Diplomacy Lore (Religion)	
Fair (+2)	Admin	Resources
	Control (Amida)	Trade
Average (+1)	Technology	Security
	Arms	Sway (Darradine Rim)
	Influence (Darradine Rim)	
<b>Aspects</b>		
Planet of diplomatic intrigue		
Cut off for Centuries		
Peace-loving		
Ancient and tradition-bound		
Mystical world-view		
Why do we need weapons - we threaten no one!		
Influential xenomorph minority!		

## Xenomorph Forces

Amidans are well-disposed towards xenomorphs, and a Commonality xenomorph minority was introduced as part of the cultural integration. The Venu are using them as scapegoats for the invasion, rounding them up as "Commonality spies".

Most Commonality xenomorphs are imprisoned in the Xenomorph Concentration Camp (see above), including 4 xenomorph ground units. Their statistics are derived from the Commonality Organization sheet on page 57.

### Xenomorph Ground Forces

Unit	Number	Comments
Infantry	1	1x 500 xenomorph ground troops "the Amidan Irregulars". <b>Aspects:</b> <i>Rag-tag Bunch, Determined Guerrillas.</i>
Special Infantry	1	Commander Beyn and his Shock Platoon! 150 xenomorph elite ground troops. <b>Aspects:</b> <i>Fierce Ursoid Soldiers, Unfeasibly Strong, Good Armour, Grav Belts.</i>
Armour	1	1x 50 grav tanks. <b>Aspects:</b> <i>We make up for our numbers!</i>
Anti-armour	1	1x 100 combat drones. Can also operate as Infantry Support. <b>Aspects:</b> <i>Swift and silent.</i>

## Venu and Xenomorphs

The Venu view xenomorphs as abominations fit only for destruction. On Amida, they've taken hostage Mugon, the Kaskai leader, forcing him to make pronouncements turning the Amidans against the Commonality xenomorphs. He's doing this under threat to his own people, although the Venu have left the Kaskai alone for now.

## Plot

We've divided **the Black Zone** into four episodes: the PCs arrival in system; meeting the Resistance; rescuing the xenomorphs; and finally trying to capture or destroy the Uranawaltzer. Each episode consists of scenes; none of these are required, but are rather suggestions for how PCs might proceed. Story Tellers should chop and change as they see fit.

Episodes take place against the backdrop of invasion. Unit-level combat is ongoing, and PCs can participate in battles and influence their outcomes. Consider each episode as one organization-level exchange or one unit-level scene, as appropriate; its outcome can affect the organization-level conflict directly.

## Who am I playing?

The Black Zone operates at several levels: PCs undertake missions, infantry and armour units engage in mass combat, starships carry out orbital bombardments or fire support. All these levels can be played out if you want to. Make sure you avoid rolling for both sides, though! Even if the PCs aren't in leadership positions, always let the players manage the good guys' forces - things are desperate enough!

## Episode One: The Gauntlet

The PCs arrive in the Amidan system on a reconnaissance mission to find it full of Venu ships - a battle is raging between a Venu Fleet and the remnants of the Amidan system defence force! The PCs pick up a distress call - there's a disabled Amidan ship out there, and a Venu warship closing in!

## Scene 1: Running the Gauntlet

At some point the PCs will want to get to the planet's surface. Use the System Zone Map on page 172; the PCs must make Manoeuvre rolls to cross the intervening zones to the planet. Each exchange, the Venu try to detect them; assume range isn't an issue (there's a lot of ships in-system), and that Venu sensors are all Good (+3). If detected, the PCs will be pursued by one or more Venu warhawks or fighters (Story Teller's choice), beginning at a distance of 5 zones. Can the PCs get to Amida before being destroyed?

## Scene 2: The Fleet Battle

There's a battle raging between Venu forces and some rag-tag Amidan systems defence and customs boats under the command of grizzled old New Trader veteran **Captain Milo McRae**. His leadership skills simply aren't cut out for this kind of engagement, and it's a doomed, heroic struggle as he tries to protect a handful of refugee transports escaping to FTL distance (see **Starblazer** page 357). The Amidans desperately need decent leadership - and the PCs can provide it in the nick of time and help hold off the Venu just long enough to let the refugee ships get away! Let the PCs get involved either using their Leadership Skills or taking Highlight Scenes, as well as letting the players play the Amidan force.



## Victory Conditions

For the Amidans and PCs to win, the flotilla of refugee ships has to get 2 zones clear of the Venu, from where they can jump into 2-Space. Both forces start in the same zone. The PCs' best chance is probably to have the Amidans engage in defensive manoeuvring: you can play this out with counters on the System Zone Map, or just narrate it. Ships take advantage of location Aspects, Forces invoke their own, and PCs burn Fate points to perform Highlight Scenes to provide bonuses. On any round the Amidans make a manoeuvre, the Venu attack. Will the refugees get away before the Amidan defenders are destroyed?

### Venu Force 1: the Invasion Fleet (7 Units)

**Total Force Stress:** □□□□□ plus □□□□□ (3 Consequences)

**Fate Points:** 2 (from Hell Mur)

**Core Unit:** Venu Capital Ship "Ancestral Voice"

**Attached:** 1 Destroyer Squadron "Death Storm" (6 ships), 2 Drop Ship Squadrons (2x 6 ships), 1 Warhawk Wing (12 ships), 2 Fighter Wings (2x 12 ships)

#### Aspects:

Ancestral Voice Aspects:

- Dreadful victor of the Battle of Oppen-14
- Belching Z-Radiation Dirt Drives
- The Commonality has no defence against this!
- Heart of the Fleet

Drop Ship Squadron Aspect:

- Slow-moving and Cumbersome

Destroyer Squadron Aspect:

- Bristling with Firepower

**Attack / Manoeuvre:** Good (+3) Leadership (from leader High Commissar Hell Mur), +1 Stunt bonus, +2 Unit bonus (6 units), +3 Stunt bonus for 1 Fate point

**Initiative:** Good (+3) Security or Fair (+2) Technology

### Amidan Force 1: Captain McRae's Rag-tag Defenders (5 Units)

**Total Force Stress:** □□□□□ plus □□□□□ (3 Consequences)

**Fate Points:** 5 (from Captain McRae)

**Core Unit:** 1 Squadron of "McRae's Irregulars" (6 ships, including the "Blowfly" customized freighter)

**Attached:** 1 Systems Defence Squadron "Amidan Customs Authority" under Commodore Vivas Thraze (6 ships), 1 Skirmisher Wing under Commander Seleness Pataipur (12 ships), 1 Drone Wing (12 starship combat drones), 1 Refugee Ship Flotilla (3 ships)

#### Aspects:

McRae's Irregulars Aspects:

- I never thought I'd see the like!
- Chaotic and Improvised Tactics

Systems Defence Squadron Aspect:

- Desperate defenders

Flotilla Aspect:

- We've got to buy them some time!

Skirmisher Wing Aspect:

- This is just like shootin' the rapids back home!

Combat Drone Aspect:

- Small and evasive

**Attack / Manoeuvre:** Average (+1) Leadership from Captain McRae, +1 Unit bonus (3 units)

**Initiative:** Average (+1) Technology

### Scene 3: The Distress Call

In the battle for Amida desperate stands are everywhere. The PCs pick up a distress call from the **Chelesta Arion**, a battered old Amidan trader, and detect a Venu Warhawk closing in! This is a starship combat encounter; use the System Zone

Map, with all 3 ships beginning 5 zones from each other, and the Chelesta Arion in a debris field. Stats for the Venu Warhawk are on page 51; the Chelesta Arion is a New Trader (page 47) with a Minor consequence: Manoeuvre Damaged and a Major consequence: FTL Disabled (she's dead in the water - although her beam weapon still works!).

### Scene 4: Orbital Insertion

Scans from Amida high orbit reveal the global Mindscape is down, and the capital city of Daisetta is cloaked in a strange, black force field kilometres across - the Black Zone. It's up to the PCs where they land, but a Venu air patrol (see page 173) will be dispatched to intercept them - they'll need to avoid or neutralize it before they can touch down.

### Organization-level Effects

The fleet battle in Episode One represents a single organization conflict exchange. If no Amidan refugee ships escape, treat as a -1 to the Amidan government organization's defence roll; if the Ancestral Voice is destroyed, treat as -1 to the Venu Empire's defence. Other favourable results can result in temporary Aspects; otherwise there's no effect.

## Episode Two: The Amidan Resistance

The PCs arrive on-planet, experiencing local conditions, encountering Venu forces and eventually the Amidan Resistance. They can find out about the Black Zone, the Braineater plague, rumours about the Venu "superweapon"; and also about the Kaskai, the xenomorph persecutions, and the Concentration Camp and plan to free the xenomorphs.

Throughout this episode there's an ongoing battle between the Invasion Force and the Amidan Resistance. The PCs experience this first-hand, possibly influencing the outcome themselves.

### Scene 1: Touchdown!

After dealing with the Venu air patrol, the PCs choose a landing zone; we've provided a Daisetta Regional Map on the inside back cover, although they could land anywhere. The PCs encounter the Amidan environment (the devastation, the day / night cycle), and orient themselves. They can land any time of day or night, but we suggest the end of the second week of darkness, in the cold just before dawn.

### Scene 2: Reconnaissance

The PCs witness the battle in Scene 3 from a distance. Give them opportunities for reconnaissance (see Episode Three for details), identifying the Amidan resistance and maybe encountering a Venu patrol (see page 173).

### Scene 3: Battle and Retreat

The PCs meet the Amidan resistance in a battle with a Venu mopping-up force involving orbital support, likely in or near one of the devastated cities. Players can use their Leadership Skills or take Highlight Scenes to affect the unit-level battle, as well as playing the part of the Amidan Resistance.





This is a desperate, unbalanced battle. The Amidan resistance, led by **Commander Kime Balchetti**, is trying to retreat into the jungles, pursued by the Venu. Figure they need to put 3 zones between themselves and the Venu to successfully escape.

#### Venu Force 2: the Mopping-up Force (4 Units)

**Total Force Stress:** □□□□□ plus □ □ □ (3 Consequences)

**Fate Points:** 2 (Hell Mur)

**Core Unit:** 1 Armour Unit (2 Venu Quad Walkers)

**Attached:** 1 Infantry Unit (1000 Venu Troopers), 1 Droid Unit (500 Attack Droids), 1 Anti-armour Unit (10 Venu Combat Tripods)

#### Aspects:

Quad Walker Aspects:

- Terrifying Mechanized Monsters
- Belching Z-Radiation Dirt Drives
- Nightmare Disruptor Cannon

Attack Droid Aspect:

- Stupid Robots

Venu Trooper Aspect:

- Deranged Psycho Warriors

Tripod Aspect:

- Gang up on the tanks!
- Orbital Assault (see page 43)

**Attack / Manoeuvre:** Good (+3) Leadership (from leader High Commissar Hell Mur), +1 Unit bonus (3 units), +3 Stunt bonus for 1 Fate point

**Initiative:** Good (+3) Security or Fair (+2) Technology

#### Amidan Force 2: Retreating Infantry (2 Units)

**Total Force Stress:** □□□□□ plus □ (3 Consequences)

**Fate Points:** 5 (from Commander Balchetti)

**Core Unit:** 1 Infantry Unit "the Daisetta Defenders" (1000 gropos)

**Attached:** 1 Anti-armour Unit (Mobile Artillery)

#### Aspects:

Infantry Aspects:

- We gotta get the hell out of here!
- One day will be payback time!

Anti-armour Aspect:

- Cumbersome Mobile Artillery

**Attack / Manoeuvre:** Fair (+2) Leadership (from Commander Balchetti), +1 Unit bonus (1 unit)

**Initiative:** Average (+1) Technology

#### Scene 4: A New Home

Even if the battle turns into a rout, some survivors make it to the jungles. **Gan Baruki** is an Amidan resistance leader (see page 189); you can use him as the PCs' entry point into the Resistance - maybe they save his life in an individual-level action in the battle. The PCs may be able to take command of some of the Resistance forces with his help (see "PCs with Minions?!" on page 170).

The Amidan resistance are heading into the deep jungle. They're accompanied by some militant Kaskai including **Beltander**, the "gorilla" leader of the guerrillas! The PCs can find out from the Resistance about the Black Zone, the

mysterious Uranawaltzer, and the Xenomorph Concentration Camp - and the strange evangelistic xenomorph leader, the White Wolf (Cain).

Try not to railroad the PCs; they've a lot of options, so present the facts as the PCs (and the Resistance) see them, and let them decide what to do next.

### Organization-level Effects

If either force is destroyed, the parent organization suffers a further -1 on its defence roll this exchange; other favourable results may result in temporary Aspects; otherwise there's no effect.

## Episode Three: The Xenomorph Concentration Camp

The PCs take part in an attack on the Xenomorph Concentration Camp (see page 173) to try and free the Commonality xenomorphs and add their forces to the Resistance. They meet Cain, one of the xenomorph leaders, and hear of the "Holy Uranawaltzer", which in some strange way seems responsible for the Black Zone and the Braineater plague. Maybe they realize it's a key element in the Venu superweapon - maybe even the superweapon itself!

If the PCs began Episode Two just before dawn on Amida's "Long Day", this episode takes place during the days just after dawn, as the light and heat begin to grow.

### Scene 1: Camp Recon

The PCs, perhaps aided by the Resistance (maybe Gan Baruki's squad), carry out a reconnaissance of the concentration camp. This requires 3 Stealth (or similar) rolls; one to get to the camp, one to observe, and one to get back again. Failure indicates the PCs encounter a Venu patrol (see page 173). If the PCs encounter a patrol while spying on the camp, it'll call for reinforcements unless they deal with it quickly and quietly.

Use skills like Burglary (Casing) and Investigation to reconnoitre the camp, allowing assessments of the number of units, camp Aspects, general layout, location and frequency of patrols, gun towers, and so on. PCs may make multiple recon rolls, but each takes up an exchange and requires a Stealth roll to avoid a Venu patrol.

### Scene 2: Attack on the Camp

The attack on the camp is a diversion to tie up Venu forces while the PCs rescue the xenomorphs. Each unit-level exchange gives the PCs up to half an hour to conduct individual-level actions. The Resistance will retreat before losing too many troops, so the PCs need to hurry!

### Venu Force 3: the Xenomorph Concentration Camp (3 Units)

**Total Force Stress:** □□□□□ plus □ □ (3 Consequences)

**Fate Points:** 4 (Am-Falta)

**Core Unit:** 1 Infantry Support Unit (20 Venu Predators)

**Attached:** 1 Infantry Unit (1000 Venu Troopers), 1 Anti-armour Unit (10 Venu Combat Tripods)

#### Aspects:

Infantry Support Aspect:

- Towering Walkers

Infantry Aspect:

- Deranged Psycho Warriors

Anti-armour Aspect:

- Gang up on the Tanks!
- Covering gun towers
- Perimeter Fencing
- The Surveillance Tower sees all!

**Attack / Manoeuvre:** Fair (+2) Leadership (from Camp Commandant), +1 Unit bonus (2 units)

**Initiative:** Good (+3) Security or Fair (+2) Technology

### Amidan Force 3: The Strike Force (2 Units)

**Total Force Stress:** □□□□□ plus □ (3 Consequences)

**Fate Points:** 4 (Gan Baruki, or the PCs)

**Grit:** 1

**Core Unit:** 1 Armour Unit (50 ground tanks)

**Attached:** 1 Infantry Unit (1000 gropes)

#### Aspects:

Armour Unit Aspect:

- Primitive Tracked Vehicles

Infantry Aspect:

- One day it'll be payback time!

**Attack / Manoeuvre:** Average (+1) Leadership, +1 Unit bonus (1 unit)

**Initiative:** Average (+1) Technology

### Scene 3: The White Wolf

If the rescue is successful the PCs meet Cain, charismatic leader of the xenomorphs (see page 188). As well as helping the Amidan Forces with his high Leadership Skill, Cain is also obsessed with the Venu superweapon, the Uranawaltzer, which he is convinced has mystical powers. He's convinced if the Resistance can capture it the Venu invasion will collapse!

### Organization-level Effects

If Cain is rescued, the Amidan government organization gains a temporary Aspect for its next action, as well as Cain's Leadership Skill in future unit-level conflicts. If either side's force is destroyed, the corresponding organization suffers a -1 to its defence roll.

## Episode Four: Attack on the Black Zone

There are many reasons for an attack on the Black Zone; we're assuming that the Resistance attack is providing cover and distraction for the PCs to get to the centre of the Black Zone and capture or destroy the mysterious Uranawaltzer. Depending on previous episodes, the attack probably takes place during the second week of daylight, when conditions around Daisetta are still, stifling, and baking hot.

### Scene 1: The Big Battle

The Amidan Resistance launches a near-suicidal attack on the Black Zone. Their goal - to push through to the heart of the Black Zone, the old Academy of Commonality Studies, home of the mysterious Uranawaltzer. It's 10 zones from the edge of the Penumbra to the Academy, and the Resistance will be met by the massed Venu defences, including orbital support, and in any case can't spend more than an exchange or two in the Black Zone itself due to the insidious music of the Uranawaltzer (see page 191). Once through to the Academy, the PCs break from the main force and conduct their own individual-level raid. Remember that xenomorphs are unaffected by the Braineater plague, but the Amidans and PCs will need to find some way round it.

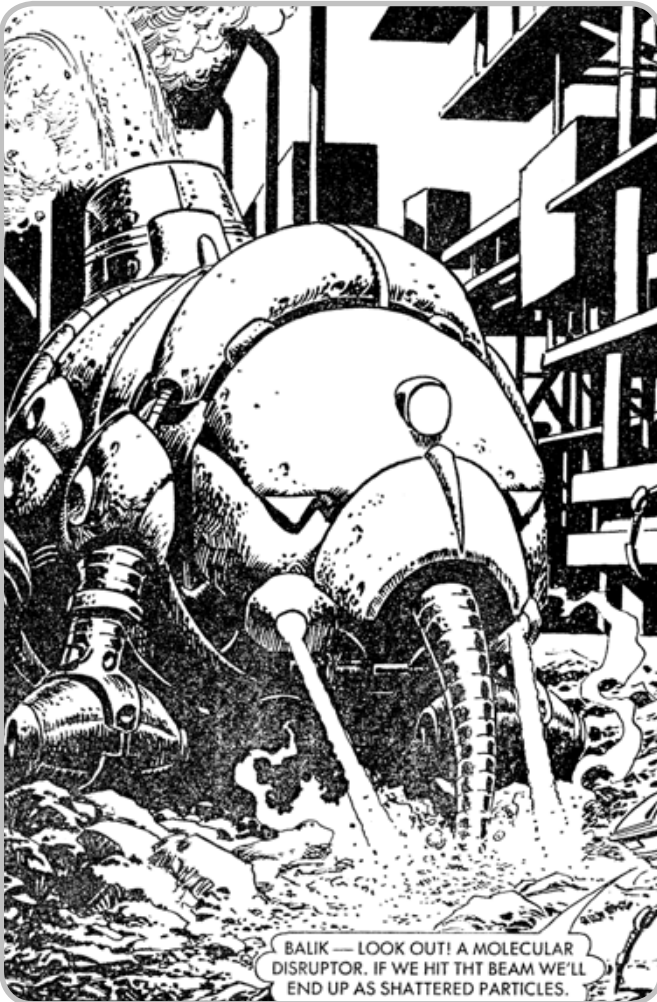

### Venu Force 4: Defenders of the Black Zone (20 Units)

**Total Force Stress:** □□□□□ plus □□□□□ □□□  
□□ □□□□□ □□□□  
(3 Consequences)

**Fate Points:** 2 (Hell Mur)

**Core Unit:** 3 Armour Units (3x 2 Venu Quad Walkers)

**Attached:** 2 Troop Carrier Units (2x 10 Combat Crawlers), 3 Infantry Units (3x 1000 Venu Troopers), 2 Droid Units (2x 500 Attack Droids), 2 Special Infantry Units (2x 50 Powered Armour Walkers), 4 Infantry Support (4x 20 Venu Biped Walkers), 4 Anti-armour Units (4x 10 Venu Combat Tripods)

#### Aspects:

- You'll never get through alive!
- Orbital Assault (see page 43)
- We protect the Uranawaltzer - it protects us!
- Dark and shadowy - difficult to see

#### Quad Walker Aspects:

- Terrifying Mechanised Monsters
- Belching Z-Radiation Dirt Drives
- Nightmare Disruptor Cannon

#### Troop Carrier Aspect:

- Rapid Move

#### Infantry Aspect:

- Deranged Psycho Warriors

#### Attack Droid Aspect:

- Stupid Robots

#### Special Infantry Aspect:

- Elite Soldiers

#### Predator Aspect:

- Towering Combat Walkers

#### Tripod Aspect:

- Gang up on the Tanks!

**Attack / Manoeuvre:** Good (+3) Leadership (from High Commissar Hell Mur), +4 Unit bonus (19 units), +3 Stunt bonus for 1 Fate point

**Initiative:** Good (+3) Security or Fair (+2) Technology

### Scene 2: Raid on the Academy

Once the main attack has reached the centre of the Black Zone, the PCs begin their raid on the Academy. See page 175 for details of the Academy, the Uranawaltzer, and its defences. There's a Venu Insertion Ship (see page 50) on the burnt grass south of the Academy to take Lord Hell Mur to the Ancestral Voice in case of emergency.

If the Uranawaltzer is captured or destroyed, the Amidans will retreat.

### Organization-level Effects

If the Uranawaltzer is captured or destroyed, the Venu suffer an automatic consequence. If either side's force is destroyed, it suffers an automatic consequence. Other favourable results provide temporary Aspects in the ongoing struggle between the Amidans and Venu; otherwise there's no effect.



**Amidan Force 4: Everything We've Got! (6 Amidan Units + 4 Xeno Units + whatever else is left!)**

**Total Force Stress:** □□□□□ plus □□□□□ □□□  
□ (3 Consequences)

**Fate Points:** 4 (Cain)

**Core Unit:** 1 Xenomorph Armour Unit (50 Grav Tanks)

**Attached:** 1 Xenomorph Infantry Unit (500 "Amidan Irregulars" Xeno Ground Troops), 1 Xenomorph Special Infantry Unit (Commander Beyn and his Shock Ursoid Platoon of 150 troops), 1 Xenomorph Anti-armour Unit (100 Combat Drones), 1 Amidan Armour Unit (50 Ground Tanks), 1 Amidan Troop Carrier Unit (50 APCs), 1 Amidan Anti-armour Unit (50 Mobile Artillery), 3 Amidan Infantry Units (3000 gropos)

**Aspects:**

- Cain is leading us!
- This is do or die!

Grav Tank Aspect:

- We make up for our numbers!

Xenomorph Infantry Aspect:

- Determined Guerrillas

Xenomorph Special Infantry Aspect:

- Fierce Ursoid Soldiers

Xenomorph Anti-armour Aspect:

- Swift and Silent

Amidan Armour Aspect:

- Primitive Tracked Vehicles

Amidan Troop Carrier Aspect:

- Faster than the Infantry

Amidan Anti-armour Aspect:

- Cumbersome Mobile Artillery

Amidan Infantry Aspect:

- One day it'll be payback time!

**Attack / Manoeuvre:** Superb (+5) Leadership (Cain), +3 Unit bonus (9 units), +1 Stunt bonus

**Initiative:** Average (+1) Technology



## Epilogue

Destroying or capturing the Uranawaltzer will be a serious setback to Venu plans in the Darradine Rim, emboldening the Amidan resistance and maybe even forcing the Venu to begin a withdrawal. At the least they'll be on their back foot. The Amidans will also win the current exchange of cultural conflict with the Venu Meme Attack (see page 73), inflicting maximum damage (1 stress, +2 if Cain is part of the attack, +2 if the High Holy has been freed, and +2 if the Royal Family are with the Resistance).

If the Uranawaltzer is still in place at the end of the scenario, the Venu stranglehold will continue to tighten, the Resistance's days will be numbered, and the Kaskai will begin to feel the brunt of the Venu persecution.

Either way, ground and fleet operations are likely to continue on Amida for some time to come, giving ample scope for future adventures. The planet's story is by no means over, and may include: rescuing Mugon from the Kaskai temple; and uncovering the fate of the Amidan royal family, including Princess Kirei (see **Escape from Venu**). The Venu have been using orbital bombardment and fire support, and you could also run side missions for PCs attempting to destroy the orbital ships' weaponry and give the Amidans a chance against overwhelming odds!

Finally, with the Amidan invasion, it looks like war is at last breaking out between the Venu and the Commonality. Things are about to get a lot more lively in the Darradine Rim!

## Additional Statistics

### Doctor Noyo

For players who've already played **Escape from Venu**, Doctor Noyo is back! (Assuming he survived, of course!) His traitorous dreams of being Venu plenipotentiary on Amida don't seem to be working out: he's drained, cadaverous, with burned looking skin which somehow "shines" with a "black light". Oh - and he never sleeps. His updated stats are as follows:



### Doctor Remnai Noyo

Physical Stress: □□□□□

Composure Stress: □□□□□□

Fate Points: 6 Scale: Small (2)

Consequences: Up to 3 Consequences

Encounter Size: 1

#### Skills

Good (+3)	Science	Deceit
Fair (+2)	Resources	Academics
	Resolve	
Average (+1)	Guns	Intimidation
	Investigation	Alertness
	Starship Pilot	Mysteries

#### Aspects

All hail the Radiant Darkness!  
Drained and cadaverous, never sleeps  
Amida needs ruling with a firm hand!  
Mindscape Implant  
The Commonality doesn't know how to use its power!  
The Venu will reward me for my loyalty, you'll see!  
People like you can't be expected to understand

#### Stunts

Access to Labs [Career]  
Death Defiance [Endurance]  
Scientific Genius: Genurgy [Science]  
Takes One to Know One [Deceit]

#### Equipment

Mindscape implant  
Venu Status Suit (-1 Kinetic, -1 Energy)  
Venu Technopriest robes  
Venu Disruptor Pistol (+3 Stress, Range 1)  
Speaks: Amidan, Universal, Venu

### The Venu High Commissar Hell Mur, Lord of the Radiant Darkness

Hell Mur is supreme commander of the Venu Invasion Force, High Commissar of the Radiant Darkness, and a powerful, sadistic, and utterly ruthless psion. Pity the PCs if they come to his attention - he's a nasty piece of work.

### High Commissar Hell Mur

### Lord of the Radiant Darkness

Physical Stress: □□□□□□

Composure Stress: □□□□□□□

Fate Points: 2\* Scale: Small (2)

Consequences: Up to 3 Consequences

Encounter Size: 1

#### Skills

Superb (+5)	Mind Control	
Great (+4)	Mental Bolt	Intimidation
Good (+3)	Leadership	Guns
	Resolve	
Fair (+2)	Absorb Energy	Mysteries
	Alertness	Deceit
Average (+1)	Might	Weapons
	Fists	Endurance
	Athletics	

#### Aspects

I am the Radiant Darkness!  
You will beg for death!  
Mere mortals cannot handle this power  
You will never know what I fear!  
Tall forbidding inquisitor  
I have killed men for less...!  
Look into my eyes...  
Defeating you will be child's play!  
I am the legend of Oppen-14!  
Don't try to play games with me!

#### Stunts

Dominate [Mind Control]  
Mental Blast [Mental Bolt]  
Absorb Radiation [Absorb Energy]  
Energy Drain [Absorb Energy]  
Absorb Energy Weapons [Absorb Energy]  
Life Drain [Absorb Energy]  
Squadron Leader [Leadership]  
Fleet Commander [Leadership]  
Admiral [Leadership]  
Legendary Commander [Leadership]  
Scary [Intimidation]  
Aura of Menace [Intimidation]  
Aura of Fear [Intimidation]

#### Equipment

Neural Whip (+3 Composure Stress on Weapons and Intimidation attacks, range 0)  
Venu Status Suit (-1 Kinetic Armour, -1 Energy Shields)  
Venu Mask  
\*Hell Mur has 5 Refresh Advances

## The Dark Radiance Commissars

If the PCs have played **Escape from Venu** they'll already have met a Dark Radiance Commissar, Asharak-Um. High Commissar Hell Mur has two Commissars in his retinue: Ad-Karal and Neg-Sai. Use Asharak-Um's statistics from **Escape from Venu**. If Asharak-Um survived **Escape from Venu**, you can have him appear here, too.

## The Dark Radiance Bodyguard

Fanatics sworn to protect the Dark Radiance - and especially the chamber of the Uranawaltzer - comprising squads of 12 Dark Radiance guards led by a single Radiant Darkness Cultist. They're sadistic, violent cyborgs and mutants: the guards wear Venu Marauder Armour in gold with black trim; the leaders wear the same, coloured black with gold trim.

## The Kaskai

Pithecine xenomorphs similar to upright gorillas, dwelling in Amida's deep jungles. Although peaceful and spiritual beings, they're terrifically powerful and capable of pulling a grown man limb from limb. Don't make one angry.

Average Kaskai		Xenomorph	
<b>Physical Stress:</b>	□□□□□□		
<b>Composure Stress:</b>	□□□□□□		
<b>Fate Points:</b> 7	<b>Scale:</b> Small (2)		
<b>Consequences:</b> Up to 3 Consequences			
<b>Encounter Size:</b> 1			
<b>Skills</b>			
Good (+3)	Might		
Fair (+2)	Rapport	Empathy	
	Athletics		
Average (+1)	Alertness	Resolve	
	Endurance	Fists	
	Survival	Mysteries	
<b>Aspects</b>			
Huge and powerful pithecines (Genotype Divergence 75)			
The same light shines on us all!			
The Venu bring nothing but darkness			
<b>Stunts</b>			
Herculean Strength [Might]			
Cold Read [Empathy]			
One hit to the body [Endurance]			
<b>Equipment</b>			
Varies			

## Radiant Darkness Cultist

<b>Physical Stress:</b>	□□□□□□		
<b>Composure Stress:</b>	□□□□□□		
<b>Fate Points:</b> 6	<b>Scale:</b> Small (2)		
<b>Consequences:</b> Up to 3 Consequences			
<b>Encounter Size:</b> 1			
<b>Skills</b>			
Great (+4)	Guns		
Good (+3)	Intimidation	Exude Energy	
Fair (+2)	Endurance	Leadership	
	Athletics		
Average (+1)	Alertness	Mysteries	
	Fists	Weapons	
<b>Aspects</b>			
We Protect the Dark Radiance with our lives!			
Venu Mutant			
My guardsmen obey my every wish!			
Kneel before me and obey!			
The Commonality is weak!			
There are things so terrifying...			
See how the Dark Radiance burns you!			
Minor Weakness: Torsion Field (Good Investigation / Science Skill check)			
<b>Stunts</b>			
Exude Radiation [Exude Energy]			
Radiation Blast [Exude Energy]			
Scary [Intimidation]			
Shot on the Run [Guns]			
<b>Equipment</b>			
Venu Disruptor Rifle (+4 Stress, range 2)			
Black Mask			
Venu Marauder Armour (black with gold trim; Aspects <i>Bleeds Radiation, Unreliable</i> ; -3 kinetic armour, -2 energy shield)			

## Dark Radiance Guard

## Minions

A typical Radiant Darkness Cultist leads a Squad of 12 Good (+3) Dark Radiant Guard Minions, divided into 3 Teams of 4 Troopers. Good (+3) Guns, wearing Venu Marauder Armour (gold with black trim).

-	Independent Dark Radiance Team (+2 bonus) (Guns +3)	□□□ □□□ □□□
-	Attached Dark Radiance Team (+2 bonus to Radiant Darkness Cultist)	□□□ □□□ □□□



## Venu Psi-powers

Confirmation of Venu psi-powers is vital information for SCI Force, as they seem a new phenomenon. PCs who capture Venu Commissars "for research" may extract the following information:

Venu Commissars are surrounded by something similar to a 2-Space distortion field.

Venu psi-powers operate on radically different principles - this is Weird Science and Mad Science territory.

Commissars have been exposed to lethal levels of Z-radiation, but it doesn't appear to affect them: even any Mutations they have are old.

## Mugon, the Kaskai High Holy

Currently under Venu "house arrest" at the Kaskai Temple east of Daisetta (see page 173), having been forcibly transferred from the temple city in the southern jungles.

Mugon	Kaskai "High Holy"	
<b>Physical Stress:</b>	□□□□□□	
<b>Composure Stress:</b>	□□□□□□□□	
<b>Fate Points:</b> 5	<b>Scale:</b> Small (2)	
<b>Consequences:</b> Up to 3 Consequences		
<b>Encounter Size:</b> 1		
<b>Skills</b>		
Superb (+5)	Mysteries	
Great (+4)	Rapport	Empathy
Good (+3)	Resolve	Leadership
	Survival	
Fair (+2)	Academics	Might
	Athletics	Resources
Average (+1)	Alertness	Art
	Endurance	Stealth
	Contacting	
<b>Aspects</b>		
Even monkeys fall from trees (Pitheicine: Genotype Divergence 75)		
Spiritual leader of the Amidans		
See through the Veil to the reality beneath		
Only - connect		
The same light shines through everything		
Words are not enough		
Bend with the wind		
There is no why - only is.		
The Venu find darkness within!		
Listen to the man called Cain!		
<b>Stunts</b>		
Creature Friend [Survival]		
Call of the Wild [Survival]		
King of the Beasts [Survival]		
Herbal Remedies [Mysteries]		
Psychic [Mysteries]		
<b>Equipment</b>		
Varies		

## Cain

Also known as the White Wolf, Cain was a mercenary until he heard the song of the Uranawaltzer. Since then he has discovered the evangelistic skills of a born leader. He wants to take the Uranawaltzer for himself, believing it's a holy relic.

Cain	"The White Wolf"	
<b>Physical Stress:</b>	□□□□□□	
<b>Composure Stress:</b>	□□□□□□	
<b>Fate Points:</b> 4	<b>Scale:</b> Small (2)	
<b>Consequences:</b> Up to 3 Consequences		
<b>Encounter Size:</b> 1		
<b>Skills</b>		
Superb (+5)	Leadership	
Great (+4)	Rapport	Guns
Good (+3)	Empathy	Alertness
	Athletics	
Fair (+2)	Intimidation	Fists
	Endurance	Resolve
Average (+1)	Drive	Might
	Resources	Stealth
	Survival	
<b>Aspects</b>		
I've heard the music of the Uranawaltzer!		
The Uranawaltzer is a gift - we can use it against the Venu!		
Now I kill people for a reason		
Follow me - join the cause!		
You're a human - you can't help it.		
Come on! Let's get them!		
I'm the leader of the pack! (Canid: Genotype Divergence 75)		
<b>Stunts</b>		
Heightened Smell [Alertness]		
Enhanced Hearing [Alertness]		
Jaws [Fists]		
Squadron Leader [Leadership]		
Force Leader [Leadership]		
Shot on the Run [Guns]		
<b>Equipment</b>		
Magnatech AR7 7mm autorifle (+3 Stress, range 3)		
Mesh armour (-1 kinetic armour)		

## Venu Troopers

See page 139 for Venu Trooper stats. Typically they're a 13-man squad, forming Venu patrols and manning guard posts.

## Venu Attack Droid

See the stats on page 136 above. Attack droids may also appear as minions, as follows:

Venu Attack Droids	Minions
<i>Venu Attack Droids attack in groups of 3. They are Good (+3) Quality, with -1 Kinetic and -1 Energy armour, armed with Protein Disruptor Cannon (+4 Stress, Range 2). Even as Minions, they're pretty tough!</i>	
<b>Aspects:</b> Leaking Z-Radiation, Spider Robot	
- Independent Attack Droid Group (+1 bonus) (Guns +3)	□□□ □□□
- Attached Attack Droid Group (+2 bonus to Droid Leader)	□□□ □□□

## Commandant Am-Falta

Am-Falta is an officious and nasty example of the oppressive Venu hierarchy's finest. He's cruel, dishonourable, and pathologically inclined to blame everyone but himself for his failings.

Am-Falta	Camp Commandant
<b>Physical Stress:</b>	□□□□□
<b>Composure Stress:</b>	□□□□□□
<b>Fate Points:</b> 4	<b>Scale:</b> Small (2)
<b>Consequences:</b> Up to 3 Consequences	
<b>Encounter Size:</b> 1	
<b>Skills</b>	
Great (+4)	Deceit
Good (+3)	Intimidate      Contacting
Fair (+2)	Resolve            Alertness
	Fists
Average (+1)	Leadership      Guns
	Athletics        Drive
<b>Aspects</b>	
Our lives for the Emperor!	
People must know pain and fear before they truly obey	
Who is to blame for this debacle?!	
I can get away with it - who will stop me?	
You will obey the rules!	
Don't think - just obey.	
<b>Stunts</b>	
Takes one to know one [Deceit]	
Scary [Intimidation]	
I know a guy who knows a guy [Contacting]	
Insider [Contacting]	
Force Leader [Leadership]	
Con man [Deceit]	
<b>Equipment</b>	
Venu Disruptor Pistol (+3 Stress, range 1)	
Venu Light Armour (-1 kinetic, -1 energy)	

## Gan Baruki

A typical leader in the Amidan resistance, Gan is brave and self-sacrificing.

Gan Baruki	Resistance Leader
<b>Physical Stress:</b>	□□□□□□
<b>Composure Stress:</b>	□□□□□□□
<b>Fate Points:</b> 4	<b>Scale:</b> Small (2)
<b>Consequences:</b> Up to 3 Consequences	
<b>Encounter Size:</b> 1	
<b>Skills</b>	
Great (+4)	Resolve
Good (+3)	Rapport            Guns
Fair (+2)	Leadership        Athletics
	Alertness
Average (+1)	Endurance        Stealth
	Survival            Fists
<b>Aspects</b>	
For Liberty and the Sultan!	
I'm not afraid of these mutants!	
Self-sacrificing	
I lead from the front	
I swear upon my family's honour!	
<b>Stunts</b>	
Steel Determination [Resolve]	
Smooth Over [Rapport]	
Rain of Photons [Guns]	
Long Shot [Guns]	
Quick Decisions Under Fire [Leadership]	
<b>Equipment</b>	
Mai Ling Null-70 laser rifle (+5 Stress, range 4)	
Mesh armour (-1 kinetic armour)	

## The Amidan Resistance

These are the local Amidan militia, civilians and a handful of professionals armed with whatever they can get. They're Average (+1) minions.

Amidan Resistance	Minions
<i>Group of 8 Average (+1) Minions armed with autorifles (+3 Stress, range 3) wearing Mesh armour (-1 kinetic armour)</i>	
<b>Aspects:</b> Desperate Defenders, Informal Militia	
- Independent Resistance Group (+3 bonus) (Guns +1)	□□□□□□□□
- Attached Resistance Group (+3 bonus)	□□□□□□□□

## Amidan Irregulars

What's left of the Commonality xenomorph cadre which was training Amida's armed forces. They're Fair (+2) minions.

### Amidan Irregulars Xenomorph Minions

Group of 8 Fair (+2) Minions armed with blaster rifles (+4 Stress, range 3) wearing Shocksuits (-2 kinetic armour)

**Aspects:** Disciplined guerrillas, Aggressive xenomorphs

- Independent Irregulars (+3 bonus) (Guns +2)	□□ □□ □□ □□
- Attached Irregulars (+3 bonus)	□□ □□ □□ □□

### Ursoïd Shock Troops

This is the special infantry company headed up by Commander Beyn. There are 150 of these Good (+3) minions.

### Ursoïd Shock Troops Xenomorph Minions

Group of 8 Good (+3) Minions armed with laser rifles (+5 Stress, range 4) wearing Shocksuit / Repulsor Field combinations (-2 kinetic, -2 energy armour)

**Aspects:** Nobody gets in our Way! This is a BIG gun! Razor sharp claws and teeth

- Independent Ursoïd Shock Troops (+3 bonus) (Guns +3)	□□□ □□□ □□□
- Attached Ursoïd Shock Troops (+3 bonus)	□□□ □□□ □□□

### Vehicles

#### Ground Tank

**Physical Stress:** □□□□□

**Systems Stress:** □□□□□

**Fate Points:** n/a **Scale:** Small (2)

**Consequences:** Up to 3 Consequences

**Speed:** Fair (+2) **Crew:** 3

#### Skills

Good (+3)	Projectile Weapon
Fair (+2)	Armour <span style="float: right;">Guns</span>
Average (+1)	Manoeuvre

#### Aspects

Incredibly rattling and noisy  
A real pig to manoeuvre  
Don't go round - go through!

#### Stunts

Anti-personnel armour  
Show your better side [Manoeuvre]  
Shot on the Run [Manoeuvre]

#### Equipment

High-explosive autocannon (+8 explosive damage vs personnel, area 2, range 4)  
Heavy machine gun (+5 damage, range 3)  
Medium armour plating (-2)

#### Grav Tank

**Physical Stress:** □□□□□

**Systems Stress:** □□□□□

**Fate Points:** n/a **Scale:** Small (2)

**Consequences:** Up to 3 Consequences

**Speed:** Great (+4) **Crew:** 3

#### Skills

Good (+3)	Beam Weapon
Fair (+2)	Energy Shield <span style="float: right;">Manoeuvre</span>
Average (+1)	Guns <span style="float: right;">Armour</span>
	Anti-gravity Model

#### Aspects

Sleek and fast  
Manoeuvres like a dream  
Don't go round - go through!

#### Stunts

Anti-personnel armour  
Show your better side [Manoeuvre]

#### Equipment

Hi-energy laser cannon (+8 explosive damage vs personnel, area 1, range 5)  
Plasma launcher (+6 damage, range 4)  
Medium energy shields (-2)  
Light armour plating (-1)

#### Venu Predator

#### Biped Walker

**Physical Stress:** □□□□□

**Systems Stress:** □□□□□

**Fate Points:** 3 **Scale:** Small (2)

**Consequences:** Up to 3 Consequences

**Speed:** Fair (+2) **Crew:** 1

#### Skills

Good (+3)	Guns
Fair (+2)	Manoeuvre <span style="float: right;">Armour</span>
Average (+1)	Energy Shields <span style="float: right;">Guns</span>
	Might

#### Aspects

Towering Walkers  
Belching Z-radiation Dirt Drive  
Coming through!

#### Stunts

Anti-personnel armour  
Split Fire [Guns]  
Herculean Strength [Might]  
Piledriver [Might]

#### Equipment

Twin heavy disruptors (+5 Stress, range 3)  
Medium armour plating (-2)  
Light energy shields (-1)



Venu Tripod		
<b>Physical Stress:</b>	□□□□□	
<b>Systems Stress:</b>	□□□□□	
<b>Fate Points:</b> 5	<b>Scale:</b> Medium (3)	
<b>Consequences:</b> Up to 3 Consequences		
<b>Speed:</b> Fair (+2)	<b>Crew:</b> 3	
<b>Skills</b>		
Good (+3)	Beam Weapon	Guns
Fair (+2)	Manoeuvre	Armour
	Vehicle Systems	
Average (+1)	Energy Shields	
<b>Aspects</b>		
Gang up on the tanks!		
Belching Z-radiation Dirt Drives		
Towering Tripods		
<b>Stunts</b>		
Overload [Beam Weapon]		
Anti-personnel armour		
Overload [Energy Shields]		
<b>Equipment</b>		
Very heavy disruptor cannon (+8 explosive damage, area 1 range 4)		
Heavy disruptor (+5 Stress, range 3)		
Medium armour plating (-2)		
Light energy shields (-1)		

Venu Quad Walker		
<b>Physical Stress:</b>	□□□□□	
<b>Systems Stress:</b>	□□□□□	
<b>Fate Points:</b> 5	<b>Scale:</b> Medium (3)	
<b>Consequences:</b> Up to 3 Consequences		
<b>Speed:</b> Avg. (+1)	<b>Crew:</b> 3	
<b>Skills</b>		
Great (+4)	Beam Weapon	
Good (+3)	Beam Weapon	Armour
Fair (+2)	Guns	Vehicle Systems
Average (+1)	Energy Shields	Manoeuvre
	Troop Carrier	
<b>Aspects</b>		
Terrifying mechanized monster		
Belching Z-radiation Dirt Drives		
Nightmare Disruptor Cannon		
<b>Stunts</b>		
Split Fire [Beam Weapon]		
Anti-personnel armour		
Overload [Heavy Weapon]		
Overload [Energy Shields]		
<b>Equipment</b>		
Twin very heavy disruptor cannon (+8 explosive damage vs personnel, area 1, range 4)		
Heavy disruptor (+5 damage, range 3)		
Heavy armour plating (-3)		
Light energy shields (-1)		

## The Uranawaltzer

The Uranawaltzer is clearly a fragment of a much larger device - perhaps a control rod or key. It's of completely unknown age and manufacture, almost 2 metres long, and composed of an unknown white metal which burns with searing Z-radiation and emits an uncanny field of "darkness".

The Uranawaltzer gives off a strange "music" which prevents Mindscape reception, and makes a direct mental attack on certain targets (the "Braineater plague"). The plague only affects human and similar synthetic minds - xenomorphs and mechanicals seem immune.

Z-radiation sources shield targets from the Braineater plague, including items such as Venu disruptor rifles and most types of Venu armour. These are hazardous in their own right, of course.

The Uranawaltzer generates a force field effect several kilometres in diameter known as the Black Zone. This functions as a -3 energy shield, and anything within is affected by the Braineater plague.

It's possible to deactivate and remove the Uranawaltzer (see below), requiring immunity to Z-radiation or a stasis field and some very heavy duty lifting gear.

## The Uranawaltzer

Mind Blast +3, Power +2 Radiation	
<b>Aspects:</b> Enthralling Song	
<b>Structural Integrity:</b>	□□□□□ (3 Consequences)
<b>Secrets Stress:</b>	□□□□□
Notes: The Braineater plague is a Mind Blast attack against a target's Composure stress track, resisted by Resolve; also, at range 0, a Good (+3) Power radiation attacks Physical stress vs Endurance. You can physically attack the Uranawaltzer; it emits Z-radiation blasts covering an entire zone equal in power to the damage done. If the Uranawaltzer is Taken Out, it explodes with a 2-zone range and a Force equal to the final stress damage which causes the Taken Out result. You can also use Science (etc) against the Secrets stress track to represent "fathoming it out", inventing containment fields, etc, to nullify the Uranawaltzer's effects.	



# Appendix One:

## New and Modified Skills and Stunts

The following tables list all new and modified Skills and Stunts described in *Mindjammer*.

### Character Skills

Skill	Stunt	Page Ref
Career or General Stunts		
	Access to Restricted Technopsi	Page 14
	Skill Chip	Page 13
Academics		Page 14
Deceit		Page 14
Engineering	Mindscape	Page 14
	Synthetics	Page 14
Science		Page 15
	Create Eidolon	Page 15
	Genurgy	Page 15
	Implant Tech	Page 15
Starship Engineering	Push the Jump Maximum	Page 15
Starship Pilot		Page 16
Technopsi		Page 17
	Blaster Bolt Defence	Page 18
	Control Avatar	Page 18
	Domination	Page 18
	Lightning Attack	Page 18
	Mindburn	Page 18
	Redaction	Page 19
	Truth Scan	Page 19

### Vehicle and Starship Skills

Skill	Stunt	Page Ref
General Stunts		
	Anti-Personnel Armour	Page 34
	It's Away!	Page 44
	On Target!	Page 44
	Orbital Assault	Page 43
	Stay On Target!	Page 44
	Swarm	Page 43
Cargo Hold	Troop Carrier	Page 43
Flight Bay	Drop Shuttles	Page 43
Planing Engines	X-Core	Page 41
Repair System	Makepoint Workshop	Page 42
Ship Systems	Sentient Ship Control	Page 39
Venu Countermeasures		Page 43

# Culture Skills

Skill	Stunt	Page Ref
Assertion		Page 70
Assimilate		Page 70
[Capability]		Page 70
Infiltration		Page 70
Propaganda		Page 70
	All or Nothing	Page 70
	Cultural Assault	Page 72
	Cultural Revolution	Page 72
	Culture Worlds	Page 72
	Hunter-Killer Eidolons	Page 72
	Memetic Cascade	Page 72
	Memetic Torpedo	Page 72
	Memetic Virus	Page 72
	Propaganda Campaign	Page 72
	Q-Ships	Page 72
	Shock and Awe	Page 72
	Suicide Synthetics	Page 72
	Traditionalist	Page 72

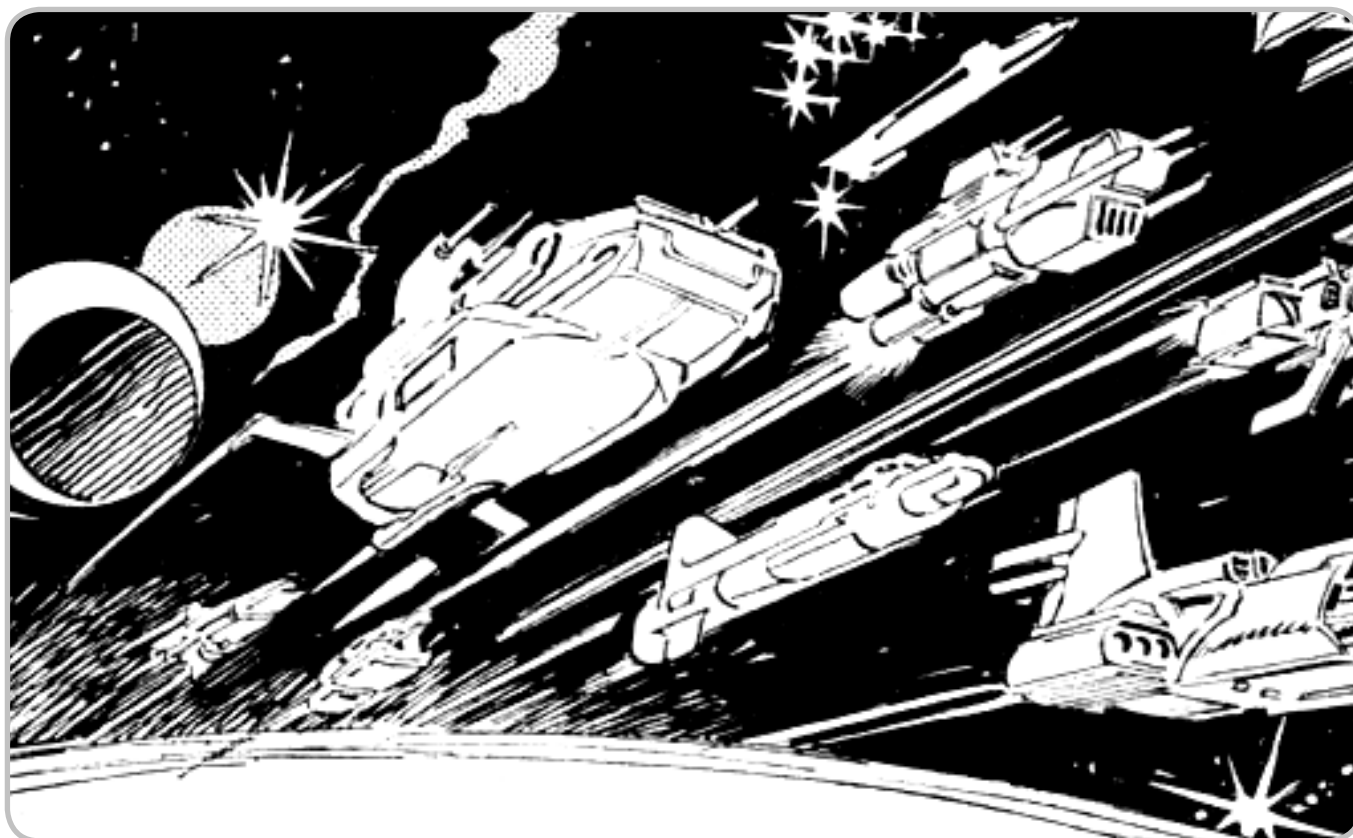



# Appendix Two:

## Glossary

AFI - *the Armed Forces Instrumentality, the Commonality army.*

Black Chip - *illegal Mindscape implant with the security restrictions removed.*

Chembu - *hominid species specializing in genurgic enhancement.*

Commonality, the - *principal polity of Human Space. AKA the New Commonality.*

Corporacy - *a megacorporation; pseudo-commercial organization with Commonality-wide presence.*

Cultural Conflict - *two-way culture shock occurring when the Commonality contacts a lost colony world.*

Culture World - *world with a strong and vibrant culture fostered by SCI Force acculturation as part of the Commonality's cultural defences.*

Darradine Rim - *part of the Darradine Restoration subsector on the edge of Commonality Space.*

Dirt Drive - *primitive star drive used by the Venu, reverse-engineered from stolen Commonality technology.*

Eidolon - *sentient synthetic with memories and personality derived from a dead human.*

Empire of Venu - *violent, oppressive Star Empire and the Commonality's principle foe in this region of space. Many Venu wear masks.*

Expansion - *process by which the Commonality is expanding outwards from Old Earth and contacting lost cultures colonized during the First Age of Space. The Expansionary Era began 200 years ago and is still proceeding apace today.*

First Age of Space - *period of slower-than-light space colonization, beginning about 10,000 years ago and lasting several thousand years.*

Fringe World - *recently-contacted world on the edge of Commonality Space.*

Gating - *almost instantaneous interstellar travel using the new (and rare) 3-Space gates.*

Genurgy - *biotechnological and genetic enhancement of organic bodies.*

Gravity Engine - *principal slower-than-light drive used in the Commonality.*

ISI - *the Internal Security Instrumentality, the Commonality police force.*

Makepoint - *mass-energy converter using ZIP cells to produce small amounts of matter.*

Mindburn - *Technopsi attack affecting human or synthetic brains. Requires a Special Operations or Black Chip.*

Mindscape - *technological "shared consciousness" connecting citizens of the Commonality.*

Mindscape Implant - *neural implant connecting all members of the Commonality to the Mindscape.*

Monitor Band - *"dial tone" signal broadcast by Mindscape implant.*

Monitor Band Cloak - *small device which masks the Monitor Band, rendering Mindscape devices inactive.*

New Commonality of Worlds, The - *principal Star Empire in this region of space, centred upon the ancient and highly advanced civilization of Old Earth.*

N-Space - *"normal" space (usually interplanetary) travelled through using gravity engines.*

Outremer - *one of the largest of the Successor States.*

Pansectorate - *the sector-level Commonality government, comprising the various Ministries.*

Planeship - *starship fitted with planing engines and capable of faster-than-light travel.*

Planing - *faster-than-light travel through 2-Space, using the planing engine.*

Planing Engine - *the Commonality's star drive. AKA a D-Drive or Dimensional Drive.*

Predecessors - *mysterious non-human species which vanished a million years ago. No one knows why or where they went.*

Propaganda Campaign - *cultural conflict measures usually undertaken by the Commonality.*

Psionics - *human psi-powers do not exist within the Commonality, although extensive genetic engineering work is underway to make them a reality.*

Quarantine Zone - *neutral space separating the Commonality from the Empire of Venu. AKA the Q-Zone.*

SCI Force - *Security and Cultural Integrity Instrumentality; special psy-ops security force and cultural "thought police" of the Commonality, charged with controlling the impact of the Expansion.*

Sentient Alliance - *a xenomorph Successor State founded 20 years ago following the Xeno Wars.*

Sentinel - *a non-sentient Mindscape subroutine; how the Mindscape protects itself.*

Skill Chip - *Mindscape-powered chip providing expert skill knowledge. Characters with Skill Chips gain a +2 bonus to that skill.*

Slowship - *a slower-than-light starship; often refers to Old Earth colony ships from the First Age of Space.*

2-Space - *form of hyperspace. Starships using the Commonality planing engine enter 2-Space to travel faster than light.*

3-Space - *a new, experimental form of hyperspace, through which travel is almost instantaneous. Used only by the 3-Space gates in the Commonality Core.*

Special Operations Chip - *highly-restricted Mindscape implant without the usual safety features. Allows use of aggressive and invasive forms of technopsi.*

Successor States - *states arising in the vacuum following the Venu War. They are violent polities, fighting for their existence.*

Synthetic - *an artificial lifeform. Many synthetics are intelligent.*

Tachyon Distortion Field - *same as a 2-Space Field.*

Technopsi - *pseudo-psionic powers enabled by the Mindscape, including technological telepathy, remote control of devices, etc.*

Ten Thousand Worlds, the - *title for the inhabited worlds of Commonality Space. "Ten Thousand" is used in the sense of a great, uncountable number: there are actually many more than 10,000 such worlds.*

Thanogram Thoughtcast - *an uncontrolled upload of a person's memories into the Mindscape, usually triggered voluntarily at death. Can cause brain damage.*

Thoughtcast - *process of uploading memory engrams to the Mindscape. Most thoughtcasts can be accessed by any Mindscape user.*

Tsen Tair - *capital world of the Rim Sector, and location of the palace of the sector custodian, Watcher Craypast.*

Venu, the - *(pron. VAY-NOO) one of the Commonality's principal foes; a human race originating in the Orion cluster, they have an oppressive, evil, and expansionary empire beyond the frontiers of the Rim Sector.*

Venu War, the - *first major interstellar conflict of the Expansionary Era (110-120 NCE) between the Empire of Venu and the Commonality. Did great damage to the Rim Sector and led to the formation of the Successor States.*

Watcher Craypast - *one of the Custodians of the Commonality; mysterious ruler of the Rim Sector.*

Xenomorph - *sentient beings derived from Old Earth animals and often used as cheap labour. In most of Commonality Space they form an underclass.*

Xeno Wars, the - *(160-170 NCE) a proxy war between the Commonality and Venu in the Successor States; led directly to the formation of the Sentient Alliance.*

Zanthrium - *radioactive heavy element which causes "dimensional resonance". A key component of planing engines.*

ZIP Module - *Zero-point energy power cells used by the Commonality in all devices from laser pistols to space stations.*

Z-Radiation - *highly dangerous, mutagenic distortion field emitted by inefficient or damaged ZIP Modules. Venu Dirt Drives emit Z-radiation constantly. AKA Z-Field.*

# Index

---

- Ajeux 88
- Aliens 8
- Amida 90
- Armour 25
- Bardu Maniflian 156
- Belawis 92
- Chardos 94
- Chembu 6
- Chembu Genurgy 60
- Chinhice 96
- Colony Lizards 153
- Commissar Asharak-Um 137
- Commonality 2
- Commonality Ships 44
- Cultural Aspects 69
- Cultures 67
- Culture Sheet 68
- Darradine Rim 86
- Delebor 98
- Discretionary Interfaces 20
- Doctor Milani Tungus 154
- Doctor Noyo 136
- Dr. Thaddeus Clay 139
- Drefnia 100
- Eidolon-4 158
- Eidolon Crisis 7
- Encumbrance 23
- Freelander 59
- Fringe Worlds Culture 85
- Furnace 103
- Galagole 105
- Genotypes 4
- Genurgy 15
- Gunfire in Zero-G 29
- Hacking 15
- Hominids 5
- Hooyow 9
- Installations 34
- Instrumentalities 58
- Jemela 107
- Lowhigh 9
- Lyra Da Luz 141
- Melee Weapons 27
- Memes 69
- Mindjammer 2, 44
- Mindscape 5, 55
- Ministries 58
- N-Space 37
- New Howzat 109
- Nimbu Prime 111, 143
- Olkennedy 113
- Plot Stress 132
- Possessed Xenomorphs 156
- Princess Kirei 137
- Psionics 19
- Sentient Alliance 52
- Space Travel 35
- Starship Operations 39
- Station Commander Vrak 137
- Sweeper the Sanitation Synthetic 156
- Symbra the Engineer 156
- Synthetics 7
- Tambini 115
- Technopsi 17
- Tech Level 23
- The Entity 157
- The Hand of God 76
- The Possessed 155
- The Power Plant Sentience 158
- The Survivors 154
- Thoughtcasts 55
- Timeline 53
- Tools 30
- Trappings 17
- Tremor 117
- Turbolift 129
- Universe 3
- Vehicles 31
- Viri 119
- Weapons 28
- Worlds 63
- Xaiwu 121
- Xenomorphs 8, 82
- Xeno Wars 52
- Z-Radiation Effects 132
- Zhafrane 123
- Zvukimu 125

# System License

OPEN GAME LICENSE Version 1.0a

The following text is the property of Wizards of the Coast, Inc. and is Copyright 2000 Wizards of the Coast, Inc ("Wizards"). All Rights Reserved.

1. Definitions: (a) "Contributors" means the copyright and/or trademark owners who have contributed Open Game Content; (b) "Derivative Material" means copyrighted material including derivative works and translations (including into other computer languages), potation, modification, correction, addition, extension, upgrade, improvement, compilation, abridgment or other form in which an existing work may be recast, transformed or adapted; (c) "Distribute" means to reproduce, license, rent, lease, sell, broadcast, publicly display, transmit or otherwise distribute; (d) "Open Game Content" means the game mechanic and includes the methods, procedures, processes and routines to the extent such content does not embody the Product Identity and is an enhancement over the prior art and any additional content clearly identified as Open Game Content by the Contributor, and means any work covered by this License, including translations and derivative works under copyright law, but specifically excludes Product Identity. (e) "Product Identity" means product and product line names, logos and identifying marks including trade dress; artifacts; creatures characters; stories, storylines, plots, thematic elements, dialogue, incidents, language, artwork, symbols, designs, depictions, likenesses, formats, poses, concepts, themes and graphic, photographic and other visual or audio representations; names and descriptions of characters, spells, enchantments, personalities, teams, personas, likenesses and special abilities; places, locations, environments, creatures, equipment, magical or supernatural abilities or effects, logos, symbols, or graphic designs; and any other trademark or registered trademark clearly identified as Product identity by the owner of the Product Identity, and which specifically excludes the Open Game Content; (f) "Trademark" means the logos, names, mark, sign, motto, designs that are used by a Contributor to identify itself or its products or the associated products contributed to the Open Game License by the Contributor (g) "Use," "Used" or "Using" means to use, Distribute, copy, edit, format, modify, translate and otherwise create Derivative Material of Open Game Content. (h) "You" or "Your" means the licensee in terms of this agreement.

2. The License: This License applies to any Open Game Content that contains a notice indicating that the Open Game Content may only be Used under and in terms of this License. You must affix such a notice to any Open Game Content that you Use. No terms may be added to or subtracted from this License except as described by the License itself. No other terms or conditions may be applied to any Open Game Content distributed using this License.

3. Offer and Acceptance: By Using the Open Game Content You indicate Your acceptance of the terms of this License.

4. Grant and Consideration: In consideration for agreeing to use this License, the Contributors grant You a perpetual, worldwide, royalty-free, non-exclusive license with the exact terms of this License to Use, the Open Game Content.

5. Representation of Authority to Contribute: If You are contributing original material as Open Game Content, You represent that Your Contributions are Your original creation and/or You have sufficient rights to grant the rights conveyed by this License.

6. Notice of License Copyright: You must update the COPYRIGHT NOTICE portion of this License to include the exact text of the COPYRIGHT NOTICE of any Open Game Content You are copying, modifying or distributing, and You must add the title, the copyright

date, and the copyright holder's name to the COPYRIGHT NOTICE of any original Open Game Content you Distribute.

7. Use of Product Identity: You agree not to Use any Product Identity, including as an indication as to compatibility, except as expressly licensed in another, independent Agreement with the owner of each element of that Product Identity. You agree not to indicate compatibility or co-adaptability with any Trademark or Registered Trademark in conjunction with a work containing Open Game Content except as expressly licensed in another, independent Agreement with the owner of such Trademark or Registered Trademark. The use of any Product Identity in Open Game Content does not constitute a challenge to the ownership of that Product Identity. The owner of any Product Identity used in Open Game Content shall retain all rights, title and interest in and to that Product Identity.

8. Identification: If you distribute Open Game Content You must clearly indicate which portions of the work that you are distributing are Open Game Content.

9. Updating the License: Wizards or its designated Agents may publish updated versions of this License. You may use any authorized version of this License to copy, modify and distribute any Open Game Content originally distributed under any version of this License.

10. Copy of this License: You MUST include a copy of this License with every copy of the Open Game Content You Distribute.

11. Use of Contributor Credits: You may not market or advertise the Open Game Content using the name of any Contributor unless You have written permission from the Contributor to do so.

12. Inability to Comply: If it is impossible for You to comply with any of the terms of this License with respect to some or all of the Open Game Content due to statute, judicial order, or governmental regulation then You may not Use any Open Game Material so affected.

13. Termination: This License will terminate automatically if You fail to comply with all terms herein and fail to cure such breach within 30 days of becoming aware of the breach. All sublicenses shall survive the termination of this License.

14. Reformation: If any provision of this License is held to be unenforceable, such provision shall be reformed only to the extent necessary to make it enforceable.

## 15. COPYRIGHT NOTICE

Open Game License v 1.0 © 2000, Wizards of the Coast, Inc. Fudge System 1995 version © 1992-1995 by Steffan O'Sullivan, © 2005 by Grey Ghost Press, Inc.; Author Steffan O'Sullivan.

FATE (Fantastic Adventures in Tabletop Entertainment) © 2003 by Evil Hat Productions LLC; Authors Robert Donoghue and Fred Hicks.

Spirit of the Century © 2006, Evil Hat Productions LLC. Authors Robert Donoghue, Fred Hicks, and Leonard Balsera.

Starblazer Adventures © 2009, Cubicle 7 Entertainment Ltd.

Mindjammer © 2009, Cubicle 7 Entertainment Ltd; Author Sarah Newton. Mindjammer is used under license from Sarah Newton.

For purposes of this license, the following things are considered to be Product Identity in addition to anything covered in section 1, above: Any art, layout, characters, "color" quotations and dialogue, names, and examples. Any material referencing or otherwise pulled from the STARBLAZER comic series and related materials.

## Other Copyrights

STARBLAZER © DC Thomson & Co. Ltd. 2009. Associated characters, text and artwork © DC Thomson & Co. Ltd. 2009.

Mindjammer ISBN 978-1-907204-12-8. SKU CB7703.



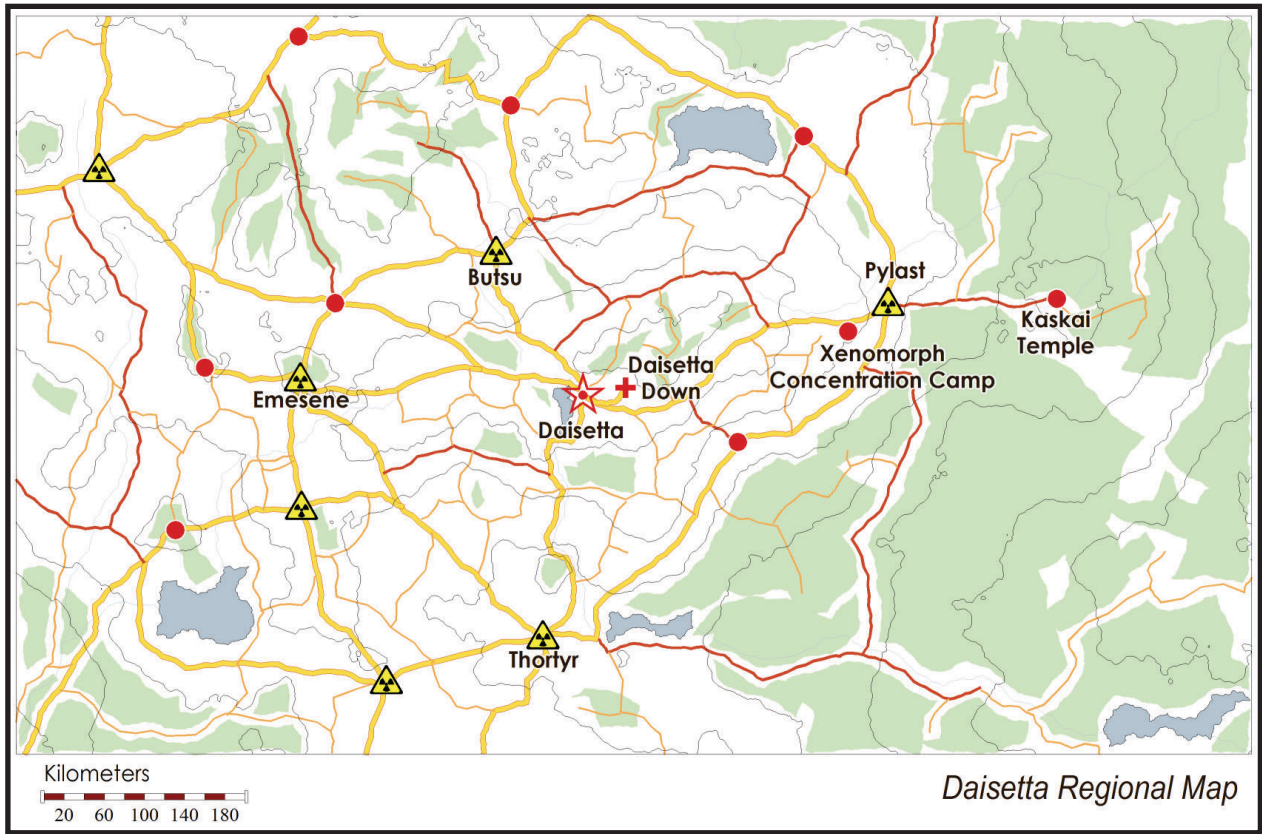



# MINDJAMMER

*"It was the Second Age of Space. The light of human civilization, which had flickered and threatened to die, suddenly burned bright again with contact with the thousand worlds of space. Humankind laughed, filled with the joys of the power of a new-found youth, and strode forth to bring its message of hope and regeneration to the stars..."*

- from "The Songs Of Old Earth", Book I

## Starblazer Adventure!

**Mindjammer** is a sourcebook for the **Starblazer Adventures** role-playing game set in the strange and distant future of planet Earth. Enter a universe of lost worlds, transhuman technologies, and clashing civilizations - a unique and compelling space opera setting of action and adventure!

## A Complete Setting!

**Mindjammer** provides everything you need to play using only the **Starblazer Adventures** rules. Choose from many human cultures, transhuman, synthetic, and alien races - you can even play a sentient starship! This book introduces the New Commonality Era, including: new species; advanced technologies; new - and sentient! - starships; the Mindscape; rules for cultural conflicts; starmaps of Commonality Space with world maps and descriptions; an action-packed campaign of four linked adventures; and more!

**Mindjammer** requires the **Starblazer Adventures** rule book to play.

Join our community for discussion & downloads:

[www.starblazeradventures.com](http://www.starblazeradventures.com)

[www.mindjammer.com](http://www.mindjammer.com)

**STARBLAZER  
ADVENTURES**  
THE ROCK AND ROLL SPACE OPERA ADVENTURE GAME

**FATE**



[www.cubicle-7.com](http://www.cubicle-7.com)

SKU CB7703

\$29.95

ISBN 978-1-907204-12-8

