

# The **STAR WARS**®

Rebel Alliance

Sourcebook



**WEST  
END  
GAMES**®

**A long time ago in a galaxy far, far away ...**

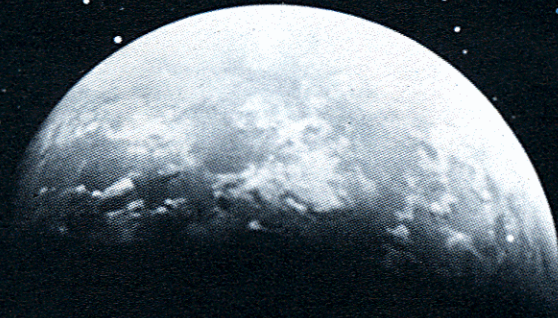

**A terrible civil war burns throughout the galaxy; a rag-tag group of freedom fighters has risen from beneath the dark shadow of the EVIL GALACTIC EMPIRE. Against all hope, they have dealt the oppressors a mighty blow.**

**But although the Death Star has been destroyed, Imperial troops have driven the freedom fighters from their hidden base and pursue them across the galaxy. The Emperor has turned his attention toward extinguishing this last spark of resistance, and everywhere the forces of the Empire have redoubled their efforts to seek out and destroy the elusive prey.**

**Throughout the vastness of space, valiant beings engage in a desperate struggle against the overwhelming might of the Empire. They are ill-equipped and pitifully few, but their courage and determination has fostered new hope for freedom in the galaxy. These are the men, women, and aliens of the Rebel Alliance.**

**This is the galaxy of ...**



---

Additional Material: **Michael Stern, Greg Farshtey**  
Editing: **Jennifer A. Williams**  
Graphics: **Rosaria J. Baldari, Stephen Crane, Jacqueline M. Evans, Richard Hawran, Cathleen Hunter**  
Cover Photograph: **Lucasfilm, Ltd.**  
Interior Illustrations: **Rob Caswell, David Deitrick, Karl Martin, Allen Nunis**  
Special Thanks To: **Lucasfilm Licensing**

---

---

Published by  
**West End Games**  
RD 3 Box 2345  
Honesdale, PA 18431

---

Publisher: **Daniel Scott Palter** • Associate Publisher: **Richard Hawran** • Assistant Publisher: **Denise D. Palter** • Editorial Director: **Bill Slavicsek** • Associate Editors: **Greg Gorden, Paul Murphy** • Assistant Editor: **Greg Farshtey** • Art Director: **Stephen Crane** • Graphic Artists: **Jacqueline M. Evans, Cathleen Hunter** • Production Manager: **Steve Porpora** • Sales Manager: **Fitzroy Bonterre** • Sales Assistants: **Tony DeCosmo, Maria Kammeier** • Special Projects Manager: **Ron Seiden** • Warehouse Manager: **Ed Hill** • Treasurer: **Janet Riccio**

---

©,™ & 1990 Lucasfilm, Ltd. (LFL). All Rights Reserved. Trademarks of LFL used by West End Games under authorization.

First Printing: **October 1990**

---



The **STAR  
WARS**<sup>®</sup>  
**Rebel Alliance Sourcebook**  
by Paul Murphy

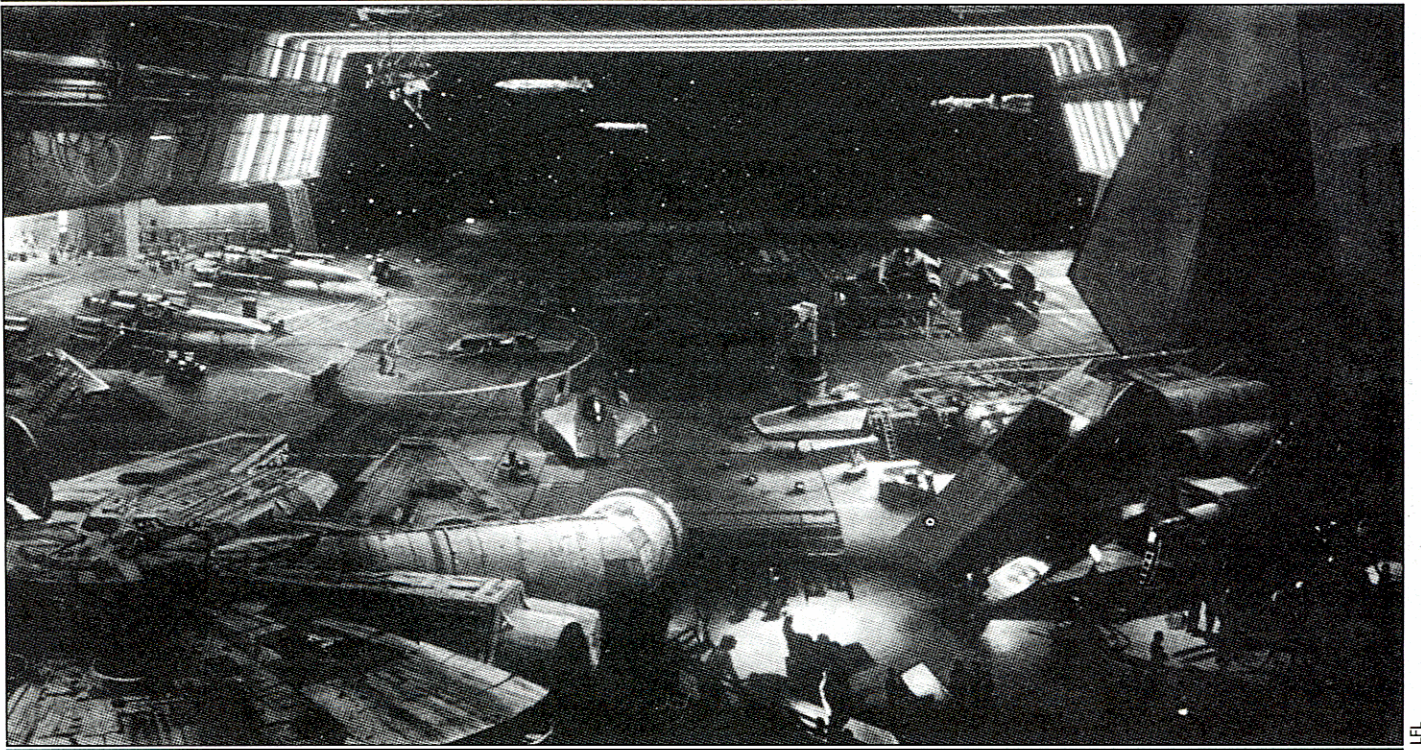

---

---

# T A B L E O F C O N T E N T S

---

Prologue .....	5
Introduction .....	6
Chapter One: Birth of the Rebellion .....	8
Chapter Two: Alliance Intelligence .....	20
Chapter Three: Alliance Military .....	30
Chapter Four: Combat Starships .....	48
Chapter Five: Starfighters .....	68
Chapter Six: Ground Combat .....	90
Chapter Seven: Droids .....	116
Chapter Eight: Alliance Bases .....	124
Chapter Nine: Support Services .....	131
Chapter Ten: Recruitment and Training .....	139
Afterword .....	144

---

---

**P**

# rologue

# The Growing Rebellion

**To:** Mon Mothma

**From:** Arhul Hextrophon

**Security Status:** Top Secret

**Regarding:** Report on Growth, Organization, Equipment, Activities and Objectives of the Rebellion.

Mon Mothma:

My office has completed the report you commissioned, compiling all known information concerning the Rebel Alliance from its earliest beginnings. In its entirety, the report is 168,000 DSUs in length and takes over 700 hours to read (assuming a rather high reading rate of one data screen unit per 15 seconds). Therefore, because we will be using the material to organize a briefing manual for incoming officers of the Alliance, I asked my most trusted assistant, Voren Na'al, to prepare a condensed summary of the report, which can be read in a much shorter time. I send you now the summary; if you wish a copy of the expanded version, one will of course be sent to you immediately.

Several notes concerning the report:

- The first section, concerning the birth and growth of the Alliance is somewhat sketchy and incomplete. Due to the number of losses we suffered when Alderaan was destroyed, and the fact that you are one of the only people who has been with the Alliance since the beginning, we only had a small pool of sources to interview for background information. However, the intelligence and underground networks section is better documented.
- The remainder of the report, examining the military structure, vehicles, troop types, support services and recruitment and training of the Rebellion, is concise and complete. My men have spent thousands of man-hours inspecting first-hand reports from Alliance Army, Navy and intelligence personnel to come up with the information contained herein.

**In Conclusion:** Considering the short time allotted for the creation of this report and the difficulty of contacting primary sources without lifting the veil of secrecy, our committee has done an exceptional job. Voren Na'al is a fine historian and I am sure the material contained in this report will be satisfactory for your needs.

Respectfully,

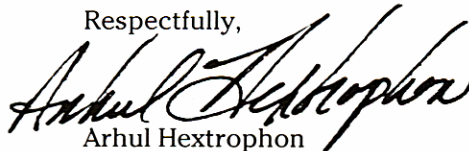

Arhul Hextrophon

## I

# Introduction

## The Rebel Alliance

The Old Republic is dead, gone beyond any hope of recall. The Jedi Knights are no more, their flame extinguished — possibly forever — from the galaxy. Across thousands of worlds, untold billions writhe in the terrible, implacable bonds of tyranny. There is a darkness in the galaxy, and it is called the Empire.

But where there is Darkness there must surely be Light, and where there is Tyranny, there must be Rebellion.

The Rebel Alliance is a frail thing to oppose the awesome power of the Empire. It is not a single military or political force at all. Instead, it is a true alliance of diverse groups, organizations and beings, many with nothing more in common than a deep, all-consuming hatred of tyranny and love of freedom. But, somehow, it is succeeding.

In the beginning, the first Rebels were pathetically ill-equipped to wage the titanic struggle upon which they embarked. With no organization, no unified command, no supply, no communications, they were little more than small, isolated pockets of resistance scattered across space. They were a mere annoyance to the Imperial military monolith, to be wiped out at the Empire's leisure. They knew how to fight — they did not know how to wage war. They needed leaders.

As these beings — mainly the poor, downtrodden and oppressed — took to the hills, to the asteroid clusters, to the far, abandoned edges of space, waging an all but futile guerrilla war against the most powerful Emperor the galaxy had ever seen, the Emperor's malignancy began to be felt in the higher strata of the Empire, as well, even among the most privileged. To solidify his rule, Emperor Palpatine imposed oppressive new laws and onerous taxes, imprisoned or simply made disappear all those who defied him. Mon Mothma, Bail Organa, and a handful of others had never trusted him: now they realized that Palpatine was mad — or worse.

These natural leaders looked in vain for a weapon with which to oppose him. The army and navy were firmly under his control; the Senate was powerless; the Jedi were dead; the Corpo-

rate Sector was, as always, more interested in profits than politics. There seemed to be no one with the power, courage and vision to face the Emperor.

In desperation, with little expectation of success, they turned to the scattered Resistance. These beings, with long memories of Senatorial abuse of power, incompetence, and outright evil (Palpatine started out as a Senator and a noble, after all) had no reason to trust Mothma or Organa. In addition, many of these groups had been fighting on their own for years, and instinctively distrusted any outsiders.

However, the more visionary leaders among the Resistance realized that they needed a galaxy-wide uprising to have any hope of success. The only beings capable of gathering support for and running such an insurrection were those who were well-known, with experience in thinking on a galactic scale — Senators, in fact. Thus was born the Alliance — an uneasy marriage between the outcasts of the Resistance and the nobility of the Senate.

Despite early setbacks, the marriage has worked better than anyone had dared dream. With the help of the Force, embodied in a young man named Skywalker, the Alliance has won its first victory at the Battle of Yavin. Now the Empire no longer can take the Rebellion against his rule lightly. Now the war has really begun ...

## The Rebel Alliance Sourcebook

The *Star Wars* universe is vast in its scope and intricate in its detail. It stretches across the farthest reaches of space, encompassing a thousand-thousand worlds. At the heart of the *Star Wars* universe, and particularly at the center of *Star Wars: The Roleplaying Game*, is the Rebellion.

As the fighting group to which all player characters belong, the Rebel Alliance is the game's most important component — the player characters' fortunes rise and fall with the Alliance's. It is their destiny to perform great things for the Rebellion. It is the goal of *The Rebel Alliance Sourcebook* to better acquaint players and gamemasters with

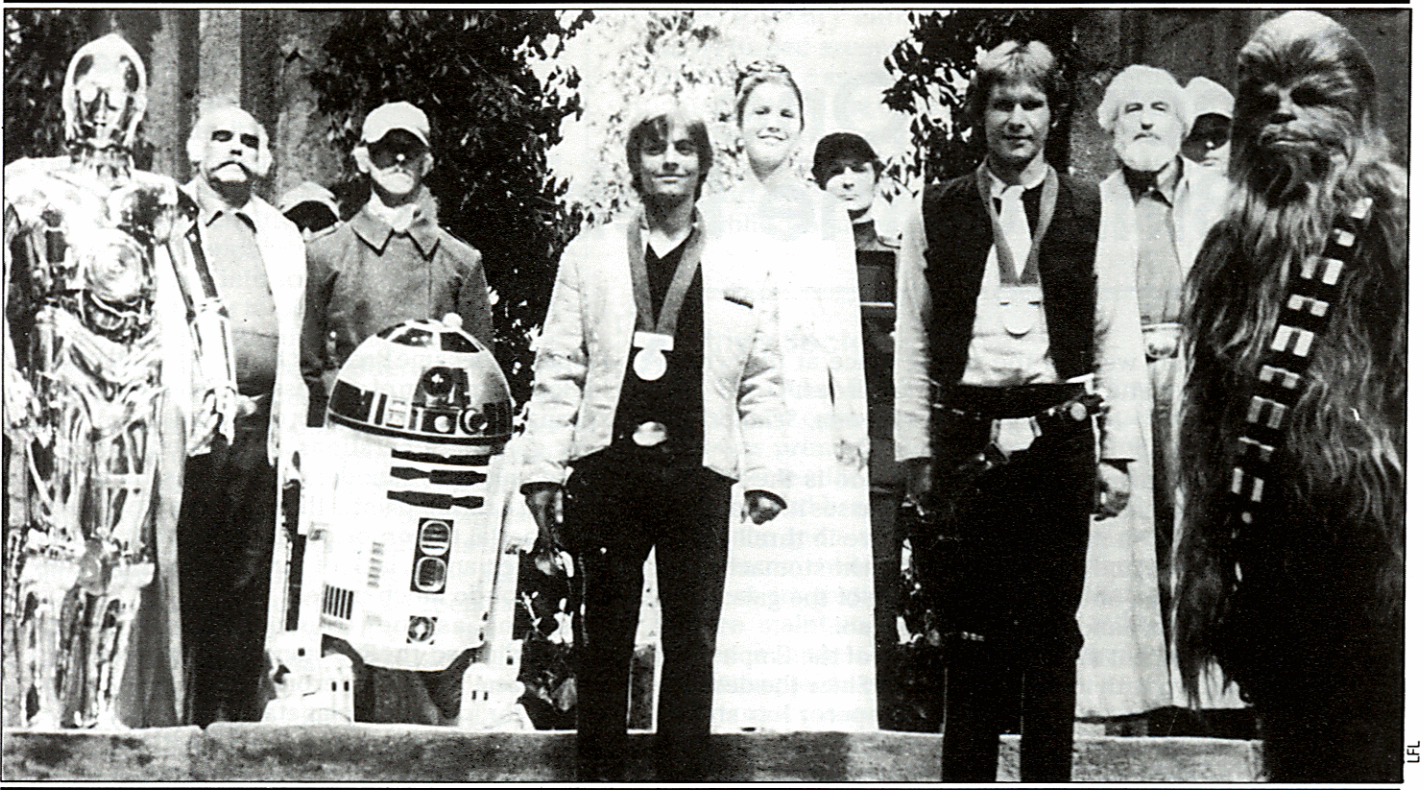

the valiant men, women and aliens of the Alliance. To give them an idea of how the Alliance works. To make them feel a part of it.

*Star Wars: The Roleplaying Game* is set in the turbulent time beginning with the destruction of the first Death Star and ending with the establishment of the Rebel base on Hoth — that is, between the end of *Star Wars IV: A New Hope* and the start of *Star Wars V: The Empire Strikes Back*.

This period begins with the Alliance's first great victory. Beings from all over the galaxy are beginning to take notice of the so-called "insignificant Rebellion," and they are starting to believe that open resistance against the Emperor and his awesome forces may indeed be possible.

It is a golden age for the Alliance. While the Empire regroups for its next attempt to squash the Rebels, the Alliance has a chance to expand and grow. To take the fight to the Empire — to turn the tide of battle.

*The Rebel Alliance Sourcebook* details this extraordinary force from top to bottom. You will find explanations of procedure and diagrams, descriptions and accounts of everything from as-yet-unseen ships, vehicles and equipment to the overall political and military hierarchy, underground operations and safe worlds.

The Alliance grows strong. And the Force is with them.





# Chapter One

## Birth of the Rebellion

“They were in the wrong place at the wrong time. Naturally they became heroes.”

— *Leia Organa of Alderaan, Senator*

The galaxy is vast, and so, too is the Empire which enshrouds and encompasses it. Countless beings on numerous worlds are in thrall to the Empire, and precious few have the stomach to do anything about it. The people of the galaxy are terrified, and understandably so.

In recent months, the might of the Empire has grown with frightening speed. Since the destruction of the Death Star, the Emperor has shifted the focus of his limitless military and industrial power almost exclusively toward crushing this upstart Rebellion; as a result, the Imperial Armed Forces have nearly doubled in strength.

To replace the mighty Death Star, infuriatingly lost due to the stupidity of its commanders at Yavin, the Emperor has ordered the assemblage of an unprecedentedly huge fleet, built around the newly-commissioned *Super-class Star Destroyer Executor*.

Perhaps even more dangerous to the Alliance than any of these awesome new weapons is the change in command the Emperor has implemented. In command of this fleet — indeed, in direct control of the entire effort to crush the Rebellion — the Emperor has placed none other than Darth Vader. No longer will the Emperor rely on incompetent generals and power-hungry Moffs to crush the elusive Rebels, who have outsmarted and outfought them time and again. From now on, his most trusted and powerful servant will be in control.

What does this say about the Rebellion? That it has been successful enough to secure the complete attention of the Emperor. And that it has grown strong enough to cause this incredibly powerful monarch to utilize his most valuable resources in an effort to crush it once and for all.

### The History of the Alliance

There was Rebellion long before there was a Rebel Alliance. Almost immediately after Senator

Palpatine became President Palpatine and began his long campaign of oppression, Resistance units sprang up in every corner of the galaxy.

As guerrilla operations in isolated systems, these units were moderately successful in presenting a rather painful thorn in the side of many an Imperial Governor or Moff. But with limited resources and a lack of overall direction, they could not do much more.

As long as they remained isolated and uncoordinated, the Resistance fighters presented little threat to the Emperor. Though perhaps too strong for individual planetary militia to handle, they were completely unable to withstand the Imperial Army and Navy — whenever a group became too noxious, the Empire could concentrate large forces against them in a remarkably short period of time, usually before they even knew they were threatened. The Emperor had the resources of a galaxy at his beck and call; the Resistance fighters had nothing except what they could steal.

One by one, the “trouble systems” were tamed by coldly efficient Imperial counterstrikes. The Resistance units operating in these systems were scattered, or in some cases completely destroyed, and the systems themselves left to suffer under Imperial martial law.

Hope for freedom in the galaxy was waning.

### The Leaders

Even now it is unclear who is the true creator of the Rebel Alliance as it exists today. Clearly Mon Mothma played a major role, allying many disjointed resistance groups into larger, more organized units. The former leader of the planet Alderaan, Bail Organa, played a pivotal role as well. In fact, Mon Mothma gives him credit for first envisioning the overall structure of the Alliance.

Mothma and Organa had been friendly adversaries on the Senate floor for years. By the time Mothma had arrived as a freshman Senator from Chandrila, Organa was a veteran of many years in Republic politics. Mothma was a young firebrand, advocating rapid expansion and growth

## **F**rom the Officials Records of the Senate of the Old Republic

**Senator Mon Mothma of Chandrila:** Madam Speaker, it is obvious that my learned friend from Alderaan refuses to acknowledge the peril in which we find ourselves. If we do not take bold, definitive action — and quickly — this great Republic will die, or worse, will be transformed into something foul and evil. We must act *now* to preserve the principles upon which this Republic was founded!

**Senator Bail Organa of Alderaan:** Madam Speaker, no one argues that we are in great peril. We are. This Republic is in more danger than it has ever been. Corruption is everywhere. Basic services are breaking down. The Navy is almost out of our control. It is as if the very fabric of our civilization is unraveling. However, I do not see how the Senate can do anything about that if we spend all of our time in useless debate over the “big issues”! We must do what we can — not argue over what we cannot!

**Senator Mothma:** And so we repair the plumbing while our ship plunges into a sun!

**Senator Bail Organa** Better that than do nothing!

for the Republic, and putting forward visionary — some said “wildly impractical” — new plans for social change.

Organa, on the other hand, was more of a realist. He believed in many of the same things as Mothma, but his years in the morass of Old Republic politics had made him cynical, had destroyed some of his idealism. While Mothma and her disciples were passionate and outspoken, proclaiming loudly to any who would listen about the imminent fall of the Old Republic, Organa worked behind the scenes to keep things together for “just one more day.”

## The Conception of the Alliance

Despite their differences, Mothma and Organa worked closely together to keep Senator Palpatine from becoming President of the Republic. When it became obvious that they would fail, Mothma began to discuss Revolution. Organa was horrified.

Mon Mothma recalled some of those early conversations, the so-called “Cantham House Meetings”:

“At first, Bail would not hear of it. He was aghast at the very idea of attempting to overthrow the government he had given his whole life to.” She chuckles. “For a moment after I broached the

subject, I thought he was going to have me arrested. It wasn’t until the Ghorman Massacre that he turned around.”

Ghorman is a small planet located in Sern Sector, just outside the Core Worlds. The citizens of Ghorman were staging a peaceful demonstration against new taxes; they staged a sit-in at the spaceport, blocking all of the port’s landing pads. A Republic warship, arriving at the planet to

## **A**trivis Sector

The Outer Rim Territories were among the boldest opponents to the new Emperor. This was primarily due to their location on the extreme edge of the Old Republic — their isolation had bred in them a stubborn independence and a remarkably strong distaste for government of any kind, totalitarian government in particular. (The fact that the Empire maintained only a token military presence in the Outer Rim might have had something to do with it, as well.)

Foremost among the territories in opposition was Atrivis Sector, a relatively small sector of space which included the Mantooine and Fest systems. These systems had long histories of petty bickering among themselves, and they distrusted each other almost as much as they hated the faraway Emperor. Resistance to the new Emperor was scattered among the different systems, each group of freedom-fighters isolated from and suspicious of the others.

Despite their many weaknesses, the Resistance was an annoyance to the Imperial forces, and before long, an Imperial garrison post was established on Mantooine, where the Resistance was most active. The Resistance group there, the self-proclaimed “Liberators,” wasted no time in attacking the under-defended post and confiscating its weapons and equipment. However, instead of quickly retreating into the wilderness as an experienced force might have done, they occupied the remains of the Imperial garrison and boldly broadcast their triumph, urging all on Mantooine to join them in revolt.

Because this was the first and only Imperial presence in the system, the Liberators had thought themselves safe from Imperial retribution. They had no knowledge of the Imperial strike fleet waiting in orbit around the nearby moons of Fest. The Resistance group on Fest knew about the fleet, but they had no communication with the Mantooine Rebels. There was no way to warn them ...

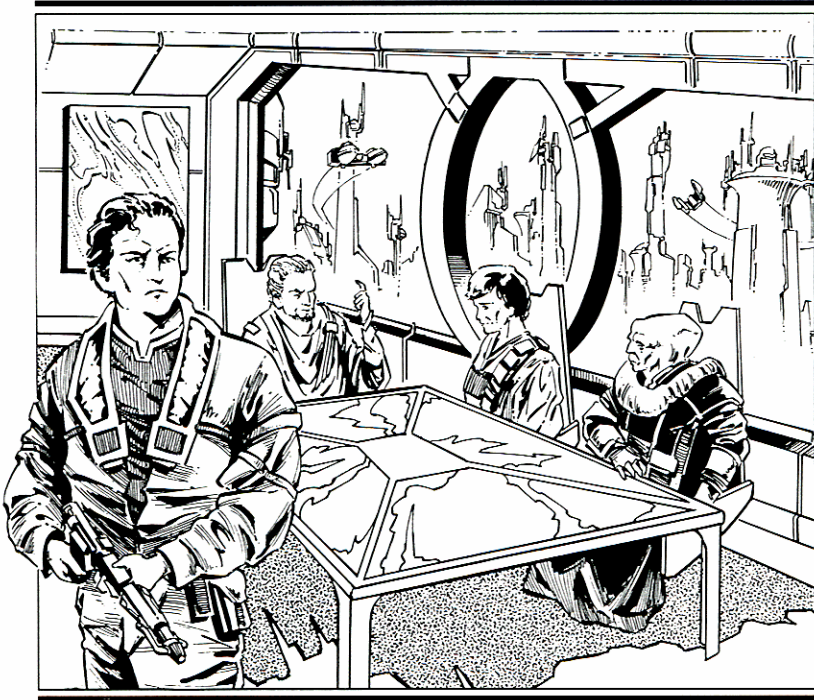

collect the taxes, landed in spite of the citizens, killing dozens and wounding hundreds more. The commander in charge of the warship, one Captain Tarkin, was not prosecuted for the murders; in fact, he was promoted.

Mon Mothma continues. “After Ghorman, Bail realized that the Republic was dead. He began to use all of his influence and political skill to aid us, while still pretending to be against me on the floor of the Senate. He was on many influential committees — Finance, Appropriations, Intelligence Oversight — and he was able to funnel money, weapons, and, most importantly, information to us without anyone suspecting him.

“In fact, when ‘Emperor’ Palpatine decided to arrest me for treason, one of his lapdog Senators informed Bail beforehand. Bail, while pretending to gloat with the swine, sent one of his men to warn me. I got off-planet about two minutes ahead of the ISB agents.”

On the run, with no more reason to maintain even the pretense of loyalty to the Republic — now the Empire — Mothma began to work in earnest organizing the Alliance. Using the framework hammered out with Organa during visits to Cantham House, his home in Imperial City, she was able to smoothly integrate the many diverse organizations and groups springing up in opposition to the Emperor into what is now known as “the Alliance.”

Several months later, once he felt he could do no more in the Senate, Bail Organa returned home to his beloved Alderaan, where he resumed the mantle of Viceroy and First Chairman.

He worked diligently to prepare his people for the coming struggle, convincing them to renounce the pacifism he had instituted after the Clone Wars, turning the planet, which had known only peace for years, into a center for Rebellion. He died with his people.

## The Corellian Treaty: The Birth of the Alliance

The years spent on the run were exciting and fraught with peril. Mothma traveled from system to system, making contact with the Resistance groups where they existed, starting new groups where there were none. Her fame was as much hindrance as help during these years. Though it gained her access to important nobles and industrial leaders, some Resistance groups were afraid to meet with her — they feared that she might be a plant, her well-publicized opposition to the Emperor a ruse to get them to trust her so that she could infiltrate and then expose them. She faced death many times, both from Imperial troops and suspicious guerrilla agents.

Mothma’s first major success occurred in the Corellian System Meetings, where she convinced three large Resistance groups to ally. The Corellian Treaty, written by her and signed by the leaders of the three groups, signaled the true beginning of the Alliance. In the Corellian Treaty, the Resistance groups agreed to work together to overthrow the Empire. They pledged their “lives and property” to the Alliance, and swore to “fight the battle until the Empire is destroyed or we are.”

The specifics of organization and command of the Alliance as described in the treaty were very close to what she and Organa had determined months before, in Cantham House. The individual Resistance groups would maintain their existing structures and have limited autonomy in the areas in which they were based; strategic command of the Alliance was strictly in Mothma’s hands. She, with the help of the Advisory Council, had complete control over supply, recruitment and training, inter-ally communication, intelligence, and all space operations.

In essence, this meant that the Allies each had authority only over operations on their own planets; Mothma and her people had all other control. Mothma’s decisions could not be overturned or refused by the Allies. The Alliance was “forever binding, until the Empire is destroyed.” Once in the Alliance, the Resistance groups could not withdraw. The battle was to the death.

Some have claimed that, when forming the Alliance, Mothma assumed dictatorial powers almost rivaling the Emperor against whom she fought. In some ways, this is indeed true, but

**R**egrouping Atrivis

... Mantooine's Liberators were decimated by the Imperial strike fleet, hunted down almost to the last man. But the Resistance group on nearby Fest remained intact and uncompromisable. Both groups now realized the value of communication and an expanded underground network. With this in mind, the Fest group formed its own Mantooine arm, as well as several other branches in various systems throughout Atrivis Sector.

The newly-dubbed "Atrivis Resistance Group" (or ARG) was far more efficient than its ill-fated predecessors. With lines of communication firmly established, the ARG was able to keep track of Imperial movement and operations throughout the Sector. The underground net-

work worked feverishly to feed information to the ARG leaders, who had set up a hidden base of operations aboard a long-abandoned space station in the barren Gerenis system.

Striking from their hidden base, the ARG was able to harass the Imperial establishment in Atrivis Sector. But as confidence grew within the Resistance ranks, so did concern. The ARG leaders realized just how isolated they were from all other groups throughout the galaxy. For all they knew, the Imperials could be mounting a major offensive against them from the very next sector. They simply had no way of knowing what was happening outside their remote sector of space. That was, until Mon Mothma arrived...

there were several very important reasons why it was necessary. Mothma knew that the coming battle was going to be long, painful, and very bloody. It was likely that the Emperor would use every means at his disposal to destroy the Rebels. Even before the Death Star, he had more than enough firepower to wipe out whole planets. Many, many people were going to die, and often the Alliance would have to just let it happen.

However, it was simply impossible to expect individual Resistance groups to be able to coldly weigh the odds and make those kinds of decisions when it was their planet — their people — who faced death. They would be determined to

fight for their homes and families, despite the damage the battle might do to the cause of freedom elsewhere. Mothma was determined that the Alliance would fight for the whole galaxy, not for specific planets or people. She knew *she* was strong enough to make the hard decisions; she could not afford to trust others to make them when their families were at stake.

Though she knew she needed it to win, Mothma detested the concept of absolute power — she did not want to become another Emperor. The Corellian Treaty contains one important clause — every two years, representatives from all of the Allies *must* meet to vote for a leader. The

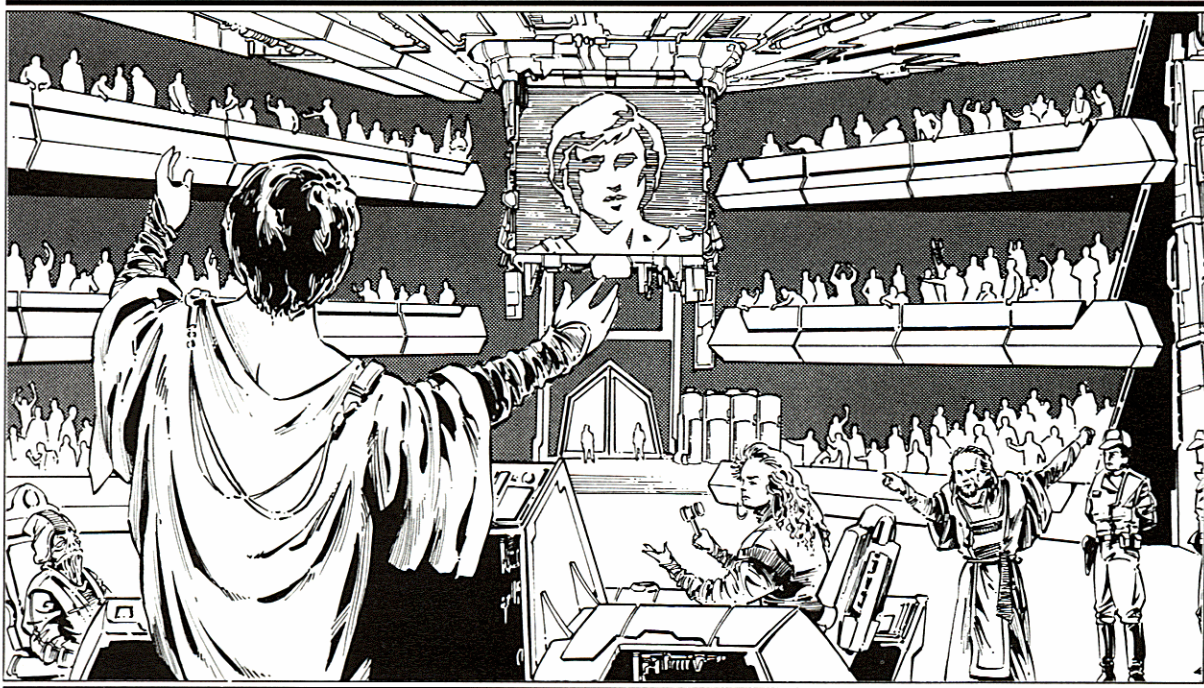

Allen Nunis

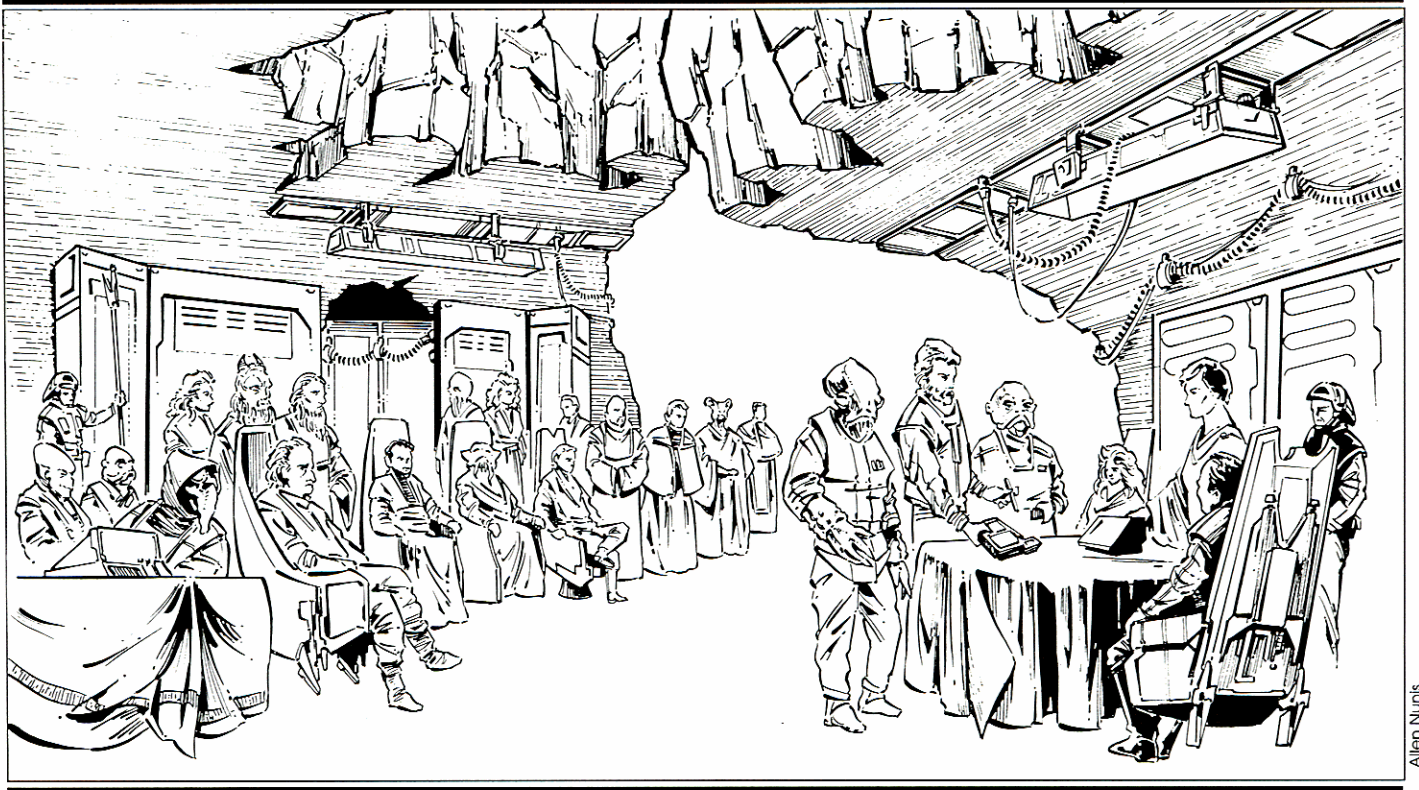

Allen Nurnis

leader is chosen by a simple majority, and all pledge to support him or her to their utmost abilities. In the many votes that have occurred so far, no one has yet put up a single candidate against her.

Once the first three Resistance groups were allied, the Alliance grew at an astonishing rate, as other groups saw how well the Allies functioned together. The expansion was rapid but careful, the Alliance never growing too quickly or without proper discipline and organization. They had learned from earlier mistakes.

Resources, mostly anonymous untraceable “donations” from wealthy families and corporations, were quietly and efficiently gathered. Ships were purchased through dummy corporations, or “stolen” from friendly governments. Recruitment and training organizations were placed on populated planets. Safe worlds were set up. Within a few short years, the Alliance was recognizably the same organization it is today.

No longer would this be a scattered, haphazard group of weak, uncoordinated Resistance units. Now it would be a highly organized, efficient *Alliance*, working as a unified force for the common good of all beings, to restore freedom to the galaxy

## The Declaration of Rebellion

Shortly after the signing of the Corellian Treaty, Mon Mothma decided that it was time to make

clear to the galaxy the political objectives of the Rebellion. Until this time, Imperial propagandists had been having good success portraying the Rebels as “pirates, criminals, and anarchists, intent upon overthrowing the Empire for personal gain.” Issuing the “Declaration of Rebellion,” Mothma wanted to set the record straight for all time.

The Declaration of Rebellion was written by Mothma herself and addressed directly to the Emperor. Millions of holo-copies of the document were made and distributed by the Alliance’s growing intelligence network. Within days, the Declaration could be found on virtually every planet in the Empire. Its effect was everything that the Alliance could have hoped for — and more.

Soon after the Declaration was distributed, several systems openly declared their allegiance to the Alliance. This was valiant, but foolish — Mothma attempted to stop them but was too late. Imperial response was swift and harsh, and within weeks all the “Secession Worlds” were suppressed. However, in their few weeks of freedom, the planets were able to transfer much of their weaponry, resources and manpower off-world, into the hands of the Alliance.

The Imperial Propaganda Bureau immediately went to work to discredit the Declaration, but if anything their wild tales of “blatant terrorism” and “anti-establishment insurgency” merely

## **F**ormal Declaration of Rebellion

**W**e, the beings of the Rebel Alliance, do this day send forth this Declaration to His Majesty, the Emperor, and to all sentient beings in the galaxy, to make clear to all the Purposes and Goals of this Rebellion.

**W**e firmly acknowledge the importance and necessity of the institution of Galactic Government. We accept that all must subjugate themselves to that Government, giving up certain rights and freedoms, in return for peace, prosperity and happiness for all.

We believe that the Galactic Government derives its power and right to rule from the consent of the governed. We believe that, should the rights of free beings be willfully and malignantly usurped, it is the unalienable right of said beings to alter or abolish said Government.

**W**e believe that the Galactic Empire has willfully and malignantly usurped the rights of the free beings of the galaxy and therefore, it is our unalienable right to abolish it from the galaxy.

We do not take this course lightly. Governments long established should not be changed for light and transient causes, but when a Government displays a history of usurpation, abuse and moral atrocity, displaying a clear design to subjugate totally and absolutely beings born free under the auspices of nature, it is our right — our duty — to depose that Government.

**T**he history of the present Galactic Empire is

of repeated injuries upon its members, with the direct objective of establishing you, Emperor Palpatine, as absolute tyrant over the galaxy:

You have disbanded the Senate, the voice of the people;

You have instituted a policy of blatant racism and genocide against the non-human peoples of the galaxy;

You have overthrown the chosen rulers of planets, replacing them with Moffs and Governors of your choice;

You have raised taxes without the consent of those taxed;

You have murdered and imprisoned millions without benefit of trial;

You have unlawfully taken land and property;

You have expanded the military far beyond what is necessary and prudent, for the sole purpose of oppressing your subjects.

**W**e, the Rebel Alliance, do, therefore, in the name — and by the authority — of the free beings of the galaxy, solemnly publish and declare our intentions:

To fight and oppose you and your forces, by any and all means at our disposal;

To refuse any Imperial law contrary to the rights of free beings;

To bring about your destruction and the destruction of the Galactic Empire;

To make forever free all beings in the galaxy.

**T**o these ends, we pledge our property, our honor and our lives.

served to fuel the fire. Many people of the galaxy had become acutely aware of, and generally sympathetic to, the Rebel Alliance, and there was nothing that the Empire could do about it.

## **The Battle of Yavin**

Although the Alliance was growing rapidly and conducting successful guerrilla operations against the Empire, they had yet to win a formal battle against the vaunted Imperial Navy, something they badly needed if they were to prove to everyone that they were for real. Mothma counseled patience — she knew that the fledgling Alliance fleet was no match for the Imperial fleet — but fate intervened, forcing battle long before the Rebels were ready.

The Empire had completed its new ultimate weapon, the massive Death Star, a machine ca-

pable of destroying an entire planet with one shot. The Death Star was slow, and unbelievably expensive, but as a weapon of terror it was unparalleled in the history of the galaxy.

Alderaan was destroyed in the blink of an eye. Other “trouble planets” were warned that they too would soon follow if all anti-Imperial activities did not cease. It seemed as if nothing could stand up to the Death Star’s awesome destructive power.

The Alliance was shaken, but, even under this new threat of genocide on a scale never seen before, most Rebels held firm to their vow to fight on until victorious. They did not make this decision lightly; upon reflection, the Death Star was not without flaws.

Though awesome indeed, the Death Star was also indiscriminate. Many Alliance bases were

## Atrivis and the Alliance

Mon Mothma's visit to Atrivis Sector began a new era for its Resistance fighters. She proposed to link Atrivis' forces with countless others throughout the galaxy, integrating them into the Rebel Alliance.

The ARG's leaders were hesitant at first. It had taken them a long time to establish an efficient organization, and they were afraid to give control to outsiders. But Mon Mothma was persuasive. She pointed out the benefits to the ARG of a galaxy-wide communications net, and of the usefulness of a single galactic Resistance command as opposed to multiple uncoordinated ones. She admitted that this entailed some loss of control on the part of the ARG, but stressed that it was necessary if they were to have any chance of success against the monolithic Empire.

She also noted that the ARG would get something in return for their loss of control. As she proposed to make the base on Gerenis a key communications station linking many Outer Rim resistance units through satellite beam transmissions, the Alliance would establish a fighter outpost on Gerenis to protect the base. Up until then, the ARG had had no starfighters at all.

There was some mild argument over the proposition among the ARG leaders, but it quickly became obvious that the positive points of joining the Rebel Alliance far outweighed the negative. Yes, there would be an influx of foreign personnel, as well as new responsibilities and dangers. But the promise of new weapons, equipment, and the added security of open communication with other Resistance groups was more than enough to convince them.

The Treaty of Gerenis was signed shortly thereafter, binding the ARG to the Alliance for the Duration. The ARG was in the war.

hidden on Imperial planets; the Death Star could not destroy the Rebels without also destroying the loyal citizens. If the Emperor decided to mass-murder his own citizens on that kind of scale, even the loyal worlds would rebel for their own survival. The Death Star could only be used effectively against Rebel planets, and the Empire didn't know where they were.

Then, disaster struck: the Empire discovered the location of the main Alliance base. This was the worst thing that could have happened to the fledgling Alliance: with one swift blow, the Empire could wipe out their entire command struc-

ture — and a good deal of their weaponry, ships, medical equipment and supplies — crippling the Alliance for years, if not beyond repair.

Within moments of learning the Alliance base's coordinates, the Death Star was in motion. The Emperor believed that nothing could save the Rebels now.

But fortune, luck, courage and the Force proved him wrong. Weeks before, striking from a hidden base, a team of Rebel spies intercepted a data file containing the technical readouts to the Death Star battle station. With the assistance of a diverse group of heroes including the late General Obi-Wan Kenobi, Luke Skywalker, and the privateer Han Solo, Princess Leia managed to transport the plans to the Rebel base on the fourth moon of Yavin.

From there, Alliance technicians, led by General Jan Dodonna, found a minute, yet exploitable flaw. A titanic starfighter conflict erupted along the surface of the Death Star as it approached the no-longer-hidden Rebel base, and a single, miraculous shot destroyed the massive battle station in one swift stroke.

This was the Rebellion's finest hour.

## The Alliance Now

The destruction of the Death Star brought about a great deal of confusion and upheaval within the ranks of the Imperial armed forces. The highest ranking officers were summarily demoted (or worse), and a major shake-up of command hierarchy followed.

Since then, the Emperor has wasted no time in regrouping his forces for a devastating counter strike — putting Lord Vader personally in charge of hunting down and exterminating the Rebellion. At the Dark Lord's command, the mightiest fleet yet assembled in the history of the galaxy, centered around the incomparable *Super-class Star Destroyer Executor*.

In contrast to the disarray within the ranks of the Empire, the Rebel Alliance is working together more smoothly than ever before. The victory at Yavin has given the Alliance new life, new vitality. In its early stages, the Rebellion looked to the older, renowned heroes of the Old Republic for inspiration. Now it looks to its own, dynamic youth — the new Heroes of the Rebellion.

## The Rebellion in the Galaxy

The Rebel Alliance has gained a new-found image of respectability as a military force. Word of the Death Star's demise has spread rapidly throughout the galaxy and given new hope to freedom-loving beings everywhere.

Particularly impressionable are the outlying

systems, those not yet fully under the domination of the Empire. The Empire applies a lot of political pressure against these systems, using the threat of force to keep them in line. Most systems, knowing the awesome fleets at the Emperor's command and the relatively puny forces of the Alliance, used to see no option but to surrender to the Empire without a battle.

Now, however, the Alliance's stirring victory has given them new backbone. Even if they are not willing to absolutely cast their lot in with the Alliance, they are also less willing to cave in to pressure from the Empire. More importantly, many are surreptitiously aiding the Rebellion, supplying much-needed money, equipment, and soldiers.

Within the Empire's Core systems, where Imperial presence is strong and the Imperial Propaganda Bureau is functioning at full power, there is still much skepticism concerning the Rebellion. The Alliance's success at the Battle of Yavin is attributed to Imperial incompetence rather than Rebel strength. Many people there perceive the Alliance as brigands, pirates and anarchists. Even those who view it in its best light see it as a pathetic remnant of the Old Republic, doomed to eventual failure.

## Politics

For the Alliance, success in politics is as important — if not *more* important — than success in the field of battle, though the two tend to reflect upon each other. The Battle of Yavin was of critical military importance — it saved the Alliance Main Base from extinction — but the alliance with the famed Mon Calamari shipbuilders, concluded several years before, made the victory possible. Any government who can be convinced to assume friendly relations with the Alliance is a boon — any government convinced to *ally* is a great victory.

Within the Core systems, the Alliance has no allies; in fact, it has few political connections at all. Even if a planetary governor or Moff were to wish to open discussions with the Alliance, their staffs are usually riddled with Imperial Security Bureau agents, making any kind of contact extremely risky for both sides. The huge businesses of the Corporate Sector are even more tightly monitored. Consequently, the Rebellion looks to the outlying systems, underground organizations and nomadic free-traders for political support.

Further complicating the diplomatic picture is the Alliance's reputation. The Imperial propagandists have been most effective at portraying the Alliance as a terrorist group, making many planetary and system leaders more than a little hesitant about opening discussions with them. The Alliance Ministry of Education is dedicated to

altering that image through counter-propaganda, a task which has been made easier by the Empire's genocide at Alderaan.

Though there are many systems which are generally sympathetic to the Alliance, only a few are willing to openly support it, the others effectively cowed by fear of Imperial retribution. This is *not* unjustified — if the Empire discovers that a planet has been actively assisting the Alliance, it uses the harshest means at its disposal to punish the planet — witness again Alderaan.

Still, it takes time and effort to find and properly chastise Rebel-friendly planets, particularly if they possess space-going fleets which could mount any kind of effective resistance. Though the Imperial Navy is incredibly strong, it cannot be everywhere at once. The Empire is fully aware of the help which the Alliance receives from the planet Calamari, but the Calamaris maintain a formidable defensive fleet in the system. The Empire has yet to be able to spare the ships from other, more important, duties to break through the Cals' defenses and reduce the annoying planet to rubble.

One of the most important jobs of Alliance diplomacy is to point out the weakness of the Empire in this respect. This is never easy: planetary leaders *know* that the Empire can't destroy all planets which are against them, but what if the Empire decides to pick *their* planet to punish?

## Command Hierarchy and Administration

There are two main organizations within the Alliance structure — the Civil Government and the Military. The Civil Government handles supply, transport, taxation, diplomatic relations, and so forth. Military, of course, controls the Alliance fleet and ground forces. Both branches are governed by Mon Mothma, though she tends to concentrate upon Civil, leaving control of the Military to those better suited to the work.

Descriptions of the Civil government follow; Military is discussed in another chapter.

### The Civil Government

The Alliance Civil Government must fulfill the functions of governments everywhere — protection of the people, revenue-gathering (taxation), maintenance of vital services, foreign relations, and defense. Many of these functions it leaves to the local authorities, that is, the member governments of the Alliance, but due to necessity it must conduct some of them itself.

The chart on page 16 shows the basic structure of the Alliance Civil government.



### Alliance Political Structure

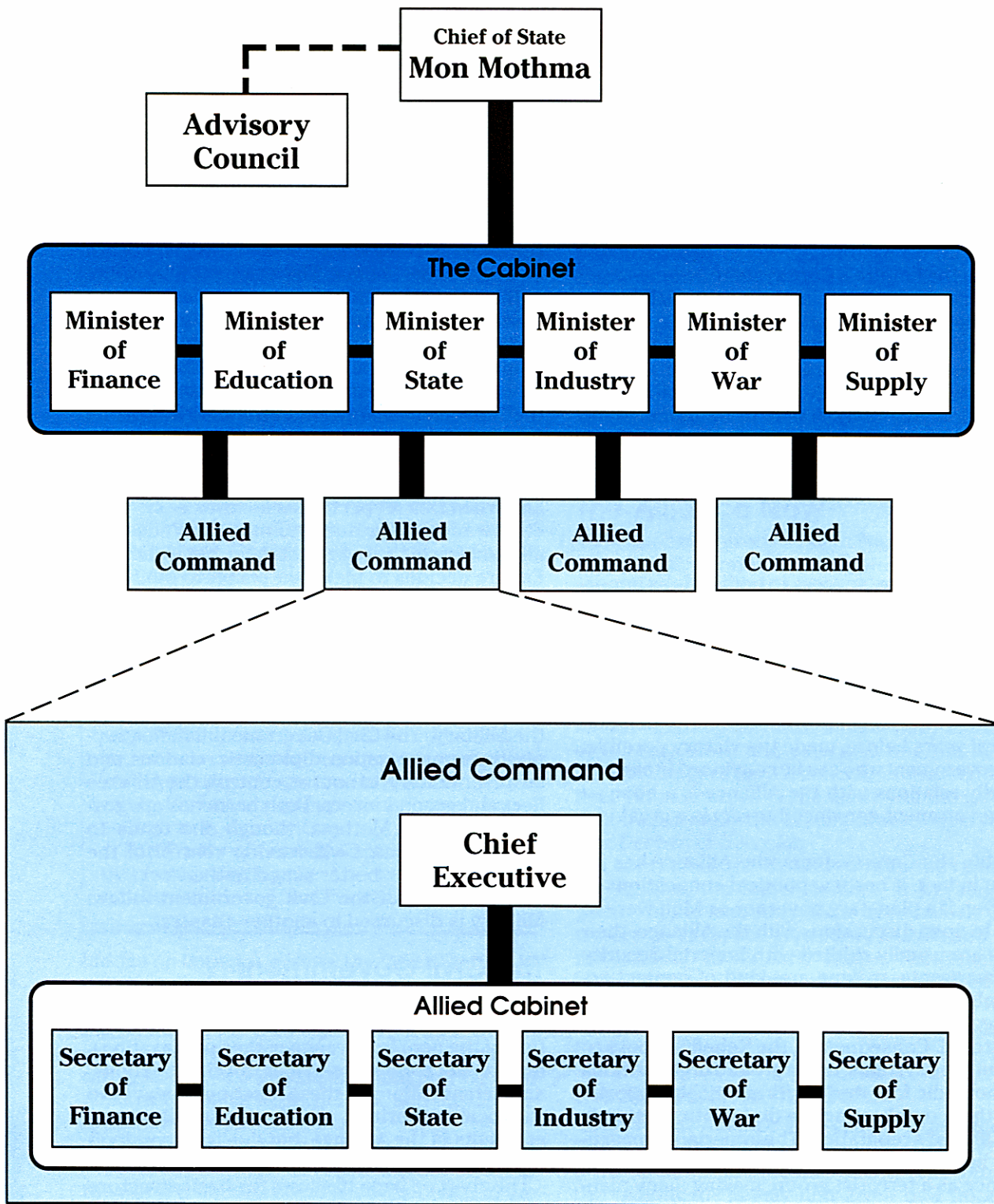

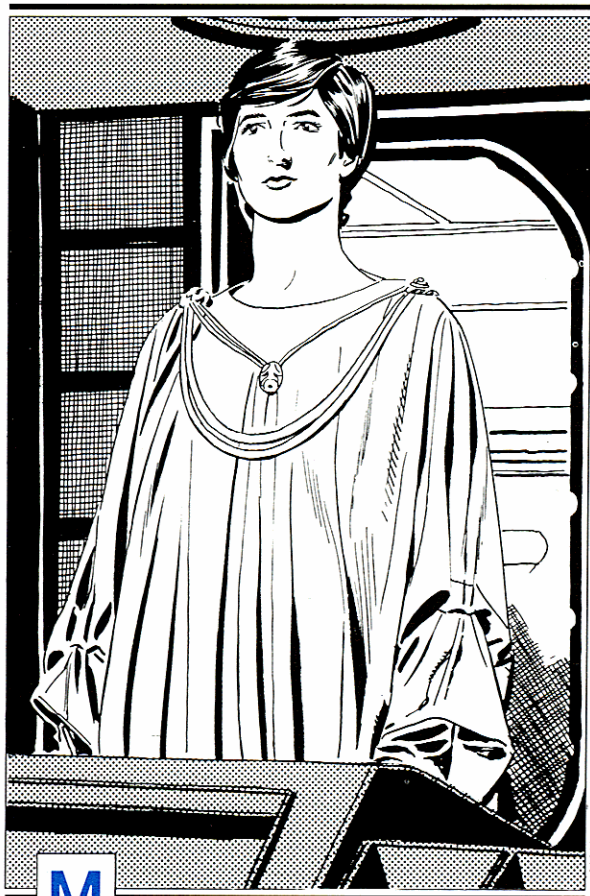

Al Williamson

**M**on Mothma, architect of the Rebel Alliance.

### The Chief of State

The position of Chief of State was created to be an elected dictatorship. Mon Mothma, so far the first and only Chief of State, has virtually unlimited powers over the Civil Government. During her two-year term of office, her decisions can be overturned only if two-thirds of the Advisory Council vote her down, in which case she is ousted from office as well. In addition, every two years elections are held for Chief of State. Each Allied government has a single vote and the election is decided by a simple majority.

According to the Corellian Treaty, the position of Chief of State "will be abolished when the Emperor is deposed, killed, or resigns his position of power." The Advisory Council will immediately assume Executive Power, and a Constitutional Convention will convene to decide the form of government of the Second Galactic Republic.

Mon Mothma believes that the primary job of the Civil Government is to support the Alliance Military. In her capacity of Chief of State, she attempts to focus all of the energies of the Allied governments into supplying, maintaining, and

expanding the war effort. As Chief of State, she is responsible for planning overall military strategy, mobilizing the industrial might of the Allies into war industries, and keeping the Alliance fleet and armies supplied.

The Chief of State is also responsible for the Alliance's relationships with non-Allied governments. She is the final arbiter of disputes between Allied governments, as well.

Finally, the Chief of State is responsible for the well-being of every being in the galaxy whose life has been affected by the Rebellion. The fight to overthrow the Empire has, unfortunately, caused a lot of pain to innocents throughout the galaxy. The Corellian Treaty orders the Chief of State to "direct all resources not required in the war effort to alleviate the suffering of those whose lives have been disrupted by the Rebellion." Unfortunately, almost all of the Alliance's limited resources are required to maintain the war effort; there's little they can do to help others in need except the most unfortunate individuals.

### The Advisory Council

The Advisory Council is comprised of representatives of the seven Allied governments "who have given the most lives to the battle against the Emperor." Obviously, this is not a position that the Allied governments strive for, but the system ensures that those Allies who have suffered the most have a say in the running of the Alliance.

The Council's legal authority is limited to simple



Allen Nurnis

**T**he Advisory Council.

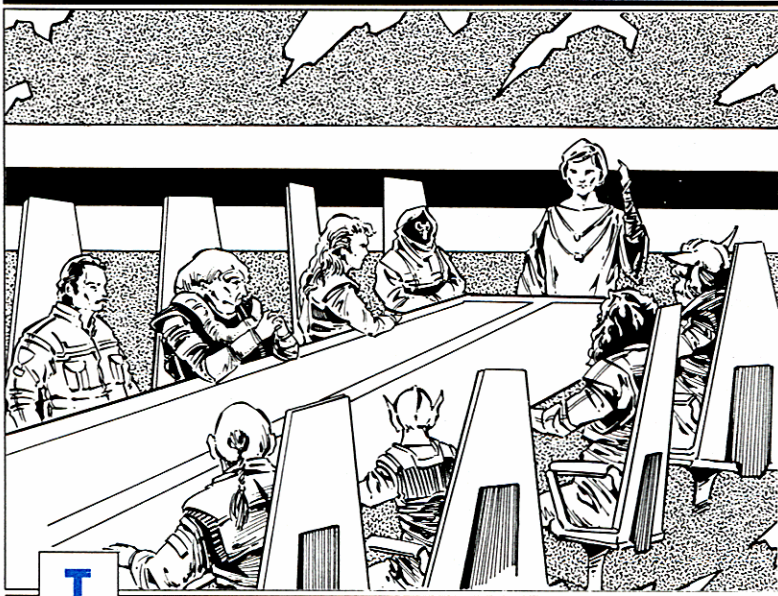

**T**he Alliance Cabinet.

approval or disapproval of the actions of the Chief of State. They have the right to dismiss the Chief of State and call for new elections if two-thirds (five of the seven members) disapprove of her conduct. This has yet to occur.

In addition to their legal power, the Advisory Council wields a good deal of moral clout, as well. Mothma listens carefully to their advice, and is not likely to take any actions of which most of them disapprove.

By rights, Princess Leia Organa of Alderaan should be a member of the Council — Alderaan is still considered an Allied government and, by all reckoning, has given by far the most lives to the struggle. However, the princess has refused a seat, preferring to devote her efforts to the Rebellion in other areas.

## The Cabinet

The Alliance Cabinet is the instrument through which Mothma runs the huge and diverse Alliance. The Cabinetmembers are chosen for their intelligence, drive, and ability to get things done. Mothma makes the policy decisions for the Alliance, and the Cabinetmembers are responsible for carrying out her decisions.

The Secretary of the Cabinet is responsible for organizing and running the Cabinet's meetings. The Secretary chairs the meetings when Mothma is unavailable; the Secretary also trains and provides security-cleared staff members for the various ministries.

Every attempt is made to keep the Alliance Ministries lean and efficient. Though a ministry may contain thousands of bureaucrats on dozens of Alliance planets across the galaxy, the

Ministers themselves each have personal staffs of under 50 secretaries, assistants, coordinators, and other functionaries.

## Minister of Finance

This ministry is in charge of the Alliance's income and expenditures. The Finance Ministry is responsible for raising the money necessary to pay for the war.

War is expensive. Capital ships, starfighters, small arms, food, clothing and shelter must all be accounted for in the budget. To cover expenses, the Minister is empowered to levy taxes on Allied governments. This imposes a very heavy burden: many must pay onerous taxes to the Empire at the same time.

In addition, the Ministry issues "Alliance War Bonds." These are low-yield, long-term bonds redeemable five to 25 years after the war. According to stock analysts, the Alliance is not a particularly sound financial investment. Individuals and governments who purchase AWBs don't really expect to make any money on them, they merely wish to help the war effort.

The Minister of Finance is also responsible for printing the Alliance's money. The Alliance Credit (AC) is supposedly worth the same as the Imperial Credit. However, the actual rate on the open (black, that is) market is 25 Alliance Credits to one Imperial — though Alliance sympathizers usually accept an Alliance Credit at face value and the Empire denies that the Alliance Credit has any value at all.

## The Minister of Education

This Ministry has two primary functions: it is the Intelligence branch of the Civil Government and it is in charge of propaganda as well. (During the present crisis, education is left to the control of the Alliance governments.)

Civil Intelligence concentrates primarily on passive Intelligence-gathering and monitoring Imperial civil broadcasts, news-holos, and so forth. The more glamorous (and dangerous) undercover operations are left in the hands of Military Intelligence — though Civil Intelligence maintains liaison officers with most System Intelligence Branches to ensure that the government is kept up to date on all important information. Civil Intelligence also monitors the Civil Government for Imperial infiltration.

The Propaganda Bureau is charged with presenting the galaxy with a true picture of the Alliance. For the most part, they seek to counter Imperial propaganda, which portrays the Alliance as an organization of lunatics, brigands and anarchists. The Alliance's Declaration of Rebellion was remarkably effective at countering this line. Since then, Imperial propagandists have

concentrated their efforts upon showing the limitless might of the Empire and the weakness of the Rebellion in order to convince the galaxy that the Rebellion is doomed to failure. This was working quite well, until shortly after the Battle of Yavin, when the Ministry of Education distributed over 20,000 holo-tapes showing the destruction of the Death Star.

### **The Minister of State**

The Ministry of State and the subordinate Diplomatic Corps handles relations with non-Allied governments. This is the single most important post in the Cabinet. In the event of the Chief of State's death or impeachment, the Minister of State takes charge of the government until a new Chief of State is elected.

### **Minister of Industry**

This Ministry controls the Alliance's industrial production. The Alliance has almost no large factories under its direct control — one or two on safe worlds and a couple on planets which have openly declared for the Alliance (such as Mon Calamari). These heavy-industry factories work day and night to produce the vital war materiel which cannot easily be acquired elsewhere — starships, heavy artillery, and the like.

Most other equipment such as small arms, clothing, medpacs, and so forth, is manufactured in small cottage industries hidden on Rebel-sympathetic planets, purchased on the black market, or stolen from the Empire.

### **Minister of Supply**

This Minister is in charge of begging, borrowing, or stealing the food, clothing, and other supplies necessary to keep the Alliance Fleet and Armies in the field.

On the face of it, this shouldn't be too difficult a task. The Alliance has an abundance of food. The safe worlds and Outer Rim Territories produce a tremendous surplus of crops. However, the Alliance has a terrible time getting the food-stuffs to the places they are needed. Transport of goods is handled by the Alliance Military's Support Services. There aren't nearly enough transport ships in the Alliance fleet; to get the supply through, Support is forced to rely upon a rapidly-aging fleet of small, slow transports, easy pickings for any Imperial ships they encounter.

The recent evacuation of the Alliance Base on Yavin has aggravated the already bad situation. Virtually all of the Alliance supply ships were pressed into duty transporting the personnel and equipment from Yavin, leaving few ships free

for transport of food. Rebel bases everywhere are going hungry.

### **Minister of War**

The Minister of War is responsible for directing the Alliance's military forces, turning Mon Mothma's general directives into concrete military strategy. The Minister leaves most operational decisions to the Chiefs of Staff, concentrating his efforts upon grand strategy and coordinating the ministry's efforts with those of the Ministers of Finance, Education, State, Industry, and Supply.

For more details about the Alliance military, see Chapter Three.

### **Allied Commands**

The Allied Commands are the governments of the individual Allies and the Sector Commands of those areas of space in which there are no Allies. Each, though answerable to Alliance High Command on most important issues, has limited autonomy within their own operational area.

Though Allied Commands outwardly mimic the Alliance government's organization, each containing Chief Executives, Cabinet, and so forth, the process by which these posts function varies a great deal from Command to Command. There are a number of reasons for this. Some alien races' political structures are radically different from humans', and they are unable to comprehend or work comfortably within the Alliance command structure. Further, many of the Allies had working command structures before they joined the Alliance; wherever possible, the existing structure was kept intact.

In some Allies, the Chief Executive may be the hereditary ruler of the planet and the Cabinet members of his or her family. In others, the Chief Executive and Cabinet may be elected by the people, appointed by the senate, or, in one very special case, chosen by lot. The Executive may be a group: hive intelligence, board of directors or entire legislative body. One being may control many seats in the Cabinet or many beings may share control of a single seat.

Alliance High Command is indifferent to the form these offices take, as long as they function smoothly. If the Minister of Industry can call the Secretary of Industry for Churnis to find out how many tons of ore Churnis Sector can produce in the next five years and get a quick, correct answer, Alliance High Command doesn't care whether the Secretary is man, woman, alien, Droid, group, sub-committee, board, or hive.



# Chapter Two Alliance Intelligence

*"Hey, Troomis, what's shaking?"*

*Troomis straightened up slowly, carefully wiping the expression of fear and surprise from his face and replacing it with a look of dim-witted amiability. He turned to face the Imperial officer, ducking his head subserviently.*

*"Uh, hey, Cap'n Creeve. Nuttin' much; jest cleanin' the air intake dealies on this comm unit booster ... Uh, I've got my orders here somewhere ..."*

*He began digging hurriedly through a very large and very dirty pouch, scattering tools, greasy rags, and other unidentifiable objects across the floor, much to the Captain's disgusted amusement, before emerging triumphantly with a badly-dented, food-encrusted authorization chip.*

*He tried to hand the chip to Captain Creeve, who backed away from it hastily. Troomis's data chips were famous for their ability to clog up and ruin a good comp input. Other than that, the moron was okay: friendly, perfectly harmless and a tireless worker. After hours, he'd come around to the Officers' Mess and shine shoes, clean bunks and do any other menial jobs for almost nothing.*

*That was one of the nice things about this posting: the locals were so poor that they'd do anything for*

*a credit. A man could spread his pay pretty far, wide and deep around here, as the saying went.*

*Women were nice, too, though perhaps a trifle more spirited than absolutely required. Creeve rubbed a scar on his neck and chuckled, not noticing the look of raw hatred which crossed Troomis's face.*

*The Captain returned to business. "No need to see your authorization, little buddy. I can tell you're hard on the job. Keep up the good work." He turned to go, then turned back.*

*"Oh, and stop by my bunk when you're off duty, will you? Another 'surprise' inspection tomorrow; my quarters need cleaning."*

*Receiving Troomis's greedy nod in reply, Captain Creeve waved amiably and continued on his rounds.*

*The smile dropping off of his face as if it had never been there — as if the act of smiling was foreign to him and acutely painful — Troomis waited until the Captain was out of sight, then quickly knelt down and finished installing the recording device under the console.*

*Soon, he promised Creeve silently, soon the Alliance will strike, and the real war will start. Then I will drop this charade and continue the work that my sister began. Soon your "little buddy" will cut your head off and place it on her grave.*

\*\*\*\*\*

*Captain Ioth, Analysis, Navy Supply, rubbed his eye blearily as he continued reading the data. The numbers flew up the screen far more rapidly than a human could ever have assimilated, but Ioth did not miss a detail. He'd been at it for hours, looking for patterns, for aberrations, for some hint of the enemy's intentions. Ioth's race were naturals at this kind of work, able to digest numbers with the precision of a computer, and judge them with the creativity of a living being. The Empire lost a lot when it dismissed aliens from important posts in the government.*

*Ioth was currently studying Imperial Navy supply requisitions for the past eight months. He didn't know where the Alliance had gotten the data; a bit squeamish, hating killing above all else, he didn't really want to know.*

*"Requisitions up .05 percent in Carrion Sector ...*

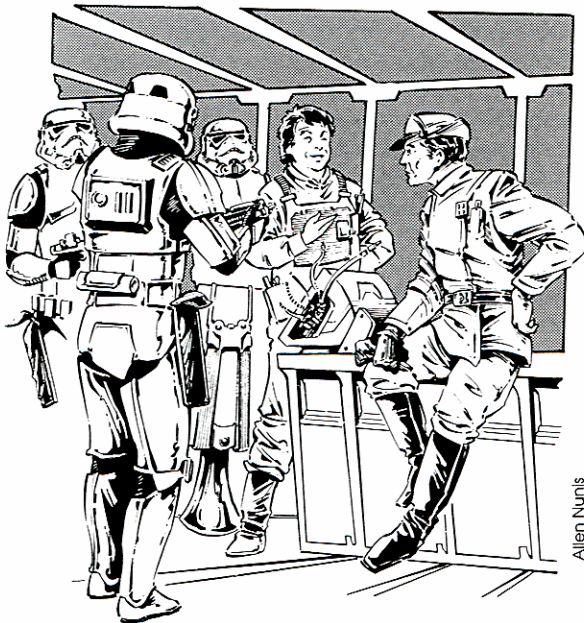

Allen Nunis

trivial. Down .04 percent in Tierfon ... Hmm ... raised 4.1 in the Oplovis sector fleet ..."

He made a note and continued reading. Somebody else would decide if it meant anything.

\*\*\*\*\*

Commander Zgorth'sth, Senior Officer, Intentions, drank another cup of gava as he worked his way through the reports. He was responsible for culling the data that his fifteen subordinates had organized and marked as potentially important—a bureaucrat he was, separated from the real action by three layers of other bureaucrats, all sifting meaningless data for the "glory of the Alliance."

Hah.

Not a lot here today, but then there usually wasn't. Mostly, the job was dull and unrewarding: loads of effort for marginal results.

He wished he was out in the field again. He liked the cloak and dagger stuff, even if he did stick out like a sore thumb on most Imperial worlds. Still, there were places in the Outer Rim where his kind fit in and were practically invisible ...

Wait a bit.

Requisitions up 4.1 percent in Oplovis Fleet? Why did that ring a bell? He sat perfectly still for a long moment, shutting down his primary sensory apparatus while he dredged up the answer.

That's it.

He pounded rapidly on his terminal keyboard and retrieved operational records he had briefly scanned nine weeks previously.

Let's see. Eight months ago, Oplovis Fleet got drubbed by a line of battle from the Alliance Fleet in—where was it?—Yuvern system. Two months later, the Emperor's creature Vader visited Oplovis, "retiring" the unfortunate admiral in Vader's own inimitable fashion and placing a new admiral in charge. Since then, Oplovis has pretty much done nothing, staying within covering range of its base on Harrod's planet. Now it requisitions an extra four percent supplies.

Think.

Two months for the new admiral to process the paperwork and take official control of the fleet; four months of maneuvers to shake down the men and the new command structure. Now Naval Command is beginning to get impatient and has prodded the fleet into action. So the admiral orders a bunch of extra supplies and gets ready to move.

The evidence was flimsy, but, in Zgorth'sth's opinion, good enough to file a prelim report and maybe get some assets assigned to watch the fleet and see which way it jumped. He made a quick call on his comm unit and went back to the reports.

\*\*\*\*\*

Alliance Probe Droid D-127X hummed and beeped contentedly to himself as he hovered on the edges of Oplovis sector, monitoring the Oplovis fleet's



transmissions. He had a lot to do, for Oplovis fleet fairly flooded the communications frequencies with data—conversations over unshielded comm units within a ship, computer transmissions between ships, high-density coded bursts from the fleet flagship to the base on the planet below. Foolishly, the Imperial Navy refused to implement adequate communications discipline, expecting their "unbreakable" codes to shield them from Alliance interpretation.

D-127X didn't care about any of this, of course. He just did his job: recording as much of the information as possible and sending off weekly copies to Alliance HQ via slaved hyperspace Probe Droids. It had five of them when it first came to Oplovis and it was down to one. When that was gone, D-127X would be relieved by another Droid while it returned to base to resupply.

Two days before he was scheduled to be relieved, D-127X noticed an Imperial vessel approaching his quadrant. His sensors identified the craft as a standard deep picket vessel; the Imperial fleet was beginning to cover its flanks. D-127X charted the craft's course and began to slowly move out of range. Suddenly, the picket accelerated, changing course to come directly at him.

D-127X weighed the odds. There was now a 99.001 percent chance that the ship had spotted him. He was a surveillance Droid, built for stealth, not for speed. He could not outrun the approaching vessel. His orders left him no options.

Deploying his last hyperspace Probe Droid—much faster than he was—to inform Alliance HQ of the situation, D-127X waited until the Probe was safely away, beeped sadly three times, wiped his internal memory and self-destructed.

\*\*\*\*\*

General Vernan, Chief, Alliance Intelligence, was in bed, asleep, when his priority comm unit buzzed. Swearing, he rubbed his eyes and gulped down some water before acknowledging the call.

"This had better be good," he said by way of greeting.

"Evening, General! I trust I haven't disturbed your 'beauty sleep'?"

Commander Zgorth'sth's laugh boomed through the comm unit at Vernan's obscene reply. Zgorth'sth was, as usual, entirely too cheerful. But a fine officer. Must get him back into the field soon.

Zgorth'sth was speaking. "Sir, a Probe Droid just came in. Our Oplovis surveillance Droid self-destructed 12 hours ago; apparently the fleet has started putting out pickets."

"At this time of the night? Don't those Imperials have any consideration for a poor, hard-working general? Ah well. Notify Fleet Intelligence: looks like Oplovis is coming out to play. Tell Fleet I still think they are heading for Atrivis to smear the army on Mantooine. If they are following standard procedures, they'll be moving tomorrow. If Ackbar moves fast and gets to Mantooine first, he can pop 'em as they come out of hyperspace."

Precious minutes passed while Zgorth'sth translated the General's words into militaryspeak for encoding. When he was finished, he read it back to the General to make sure it was correct. As usual, it was.

"Sounds good. Send it off by courier Droid immediately. I'm going back to bed. Have somebody, preferably a Twi'lek dancing girl, wake me up in two hours."

Vernan paused with his hand on the disconnect button, grinned maliciously, then continued. "Better make that four hours, Commander. If I don't get my full six hours of beauty sleep, I may end up as

ugly as you, Ziggy.

"Vernan out."

He hit the button before the outraged Zgorth'sth could think up a retort. Chuckling, he went back to bed.

\*\*\*\*\*

Three days later, Oplovis Fleet was attacked by a battle line of three Alliance cruisers as it exited hyperspace in Atrivis system. Surprise was complete. Oplovis fleet was defeated in detail with minimal Alliance casualties, and the army on Mantooine was saved.

## The Role of Alliance Intelligence

Alliance Intelligence is the nervous system of the Rebel Alliance. Through its activities, the Alliance is kept apprised of the Empire's activities and intentions. Without Intelligence, the Alliance forces would be blind, unable to parry the much greater power of the Imperial Army and Navy. Without Intelligence, the Alliance military would surely be defeated.

Though under the direct control of the Alliance military, Intelligence also serves as the prime information-gathering organ for the Civil Government, particularly the diplomatic corps. The process of gaining allies for the Rebellion is extremely delicate and extremely dangerous. The Empire's agents are everywhere. The Alliance's diplomats must be sure that a meeting with prospective allies is not a cover for an ambush.

Even if the planetary leaders sincerely wish to join the Alliance, there is important work for Intelligence before they may do so safely. For fear of Imperial reprisals, most planets keep their membership in the Alliance secret. If they are to have any chance to do so, the Empire's agents and assassins on that planet must be sought out and neutralized — killed, subverted, or otherwise diverted. If not, the planet's conversion will last only as long as it takes an agent to make his report and the Empire to ship an occupying army to the planet.

In addition to these other critical roles, Intelligence is also a very potent offensive weapon, as well. Intelligence has recruited many millions of beings on Imperial-held planets. These dedicated, highly-trained beings do more than channel information; they also destroy supply dumps, disable transportation, attack outposts, assassinate collaborators, and so forth.

While these covert attacks in themselves are useful in bleeding Imperial strength, forcing the diversion of assets from the battlefield to the back areas, they are particularly potent when used in cooperation with the Alliance military. Blowing up a power station on a backwater planet



Allen Nunis

**Alliance Intelligence**

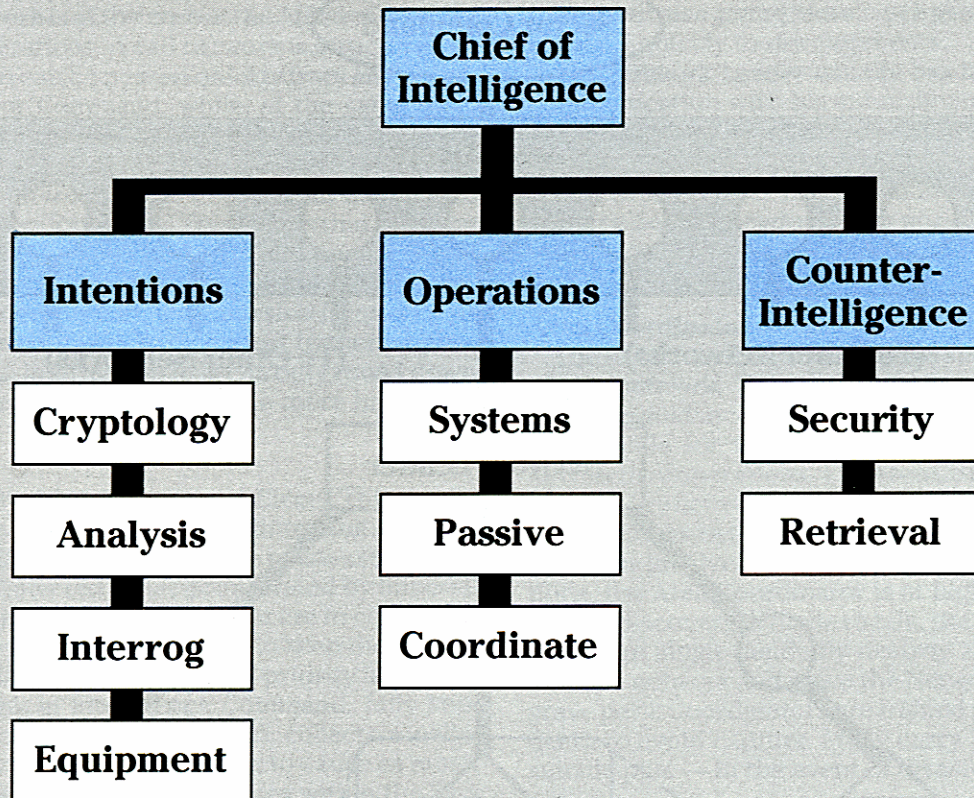

Stephen Crane

may cause some inconvenience and expense to the garrison there; doing so hours before an Alliance Special Forces unit attacks the planet can have far more devastating results.

**Chief of Intelligence**

The Chief of Intelligence occupies an extremely important post on the Supreme Allied Command. This individual is responsible for bringing Intelligence’s data to the other Allied Commanders, and for passing on the Commander-in-Chief’s orders to his department.

With ultimate responsibility for all Intelligence operations in the Alliance, the Chief of Intell must, upon a daily basis, make critical decisions which dramatically affect the course of the war. His department receives literally trillions of bytes of data from operatives across the galaxy — holos of bugged conversations, transcripts of interrogations of captured Imperial officers, interceptions of “unbreakable” Imperial scandocs, etc. The Senior Intelligence Officers correlate and interpret this data, presenting the Chief with daily briefs outlining the important information gathered, along with statistical analyses of the

chances of the data being planted, compromised, or incorrectly interpreted.

From this information, Chief of Intell makes daily reports to the Commander-in-Chief and Supreme Commanders. The C-in-C and Supreme Commanders use these reports to plot the war. If Intell’s reports are inaccurate, or, even worse, have been compromised by Imperial agents, the effects can be catastrophic.

For example, the Chief of Intelligence recently made a report predicting that the Oplovis Sector fleet was soon going to Atrivis Sector to put down the revolt upon the planet of Mantooine. From that report, the Alliance fleet decided to deploy three ships of the line to Atrivis to ambush Oplovis.

Intell’s report was based, in large, upon data received from one semi-demented agent on a backwater planet. If that agent, Troomis, had been “turned” by Imperial Intelligence and his transcript of the Naval supply requisitions a plant designed to draw out Ackbar’s fleet, the three cruisers themselves could have been ambushed and destroyed, costing the Alliance a significant fraction of their fleet’s firepower.



**N**etworking

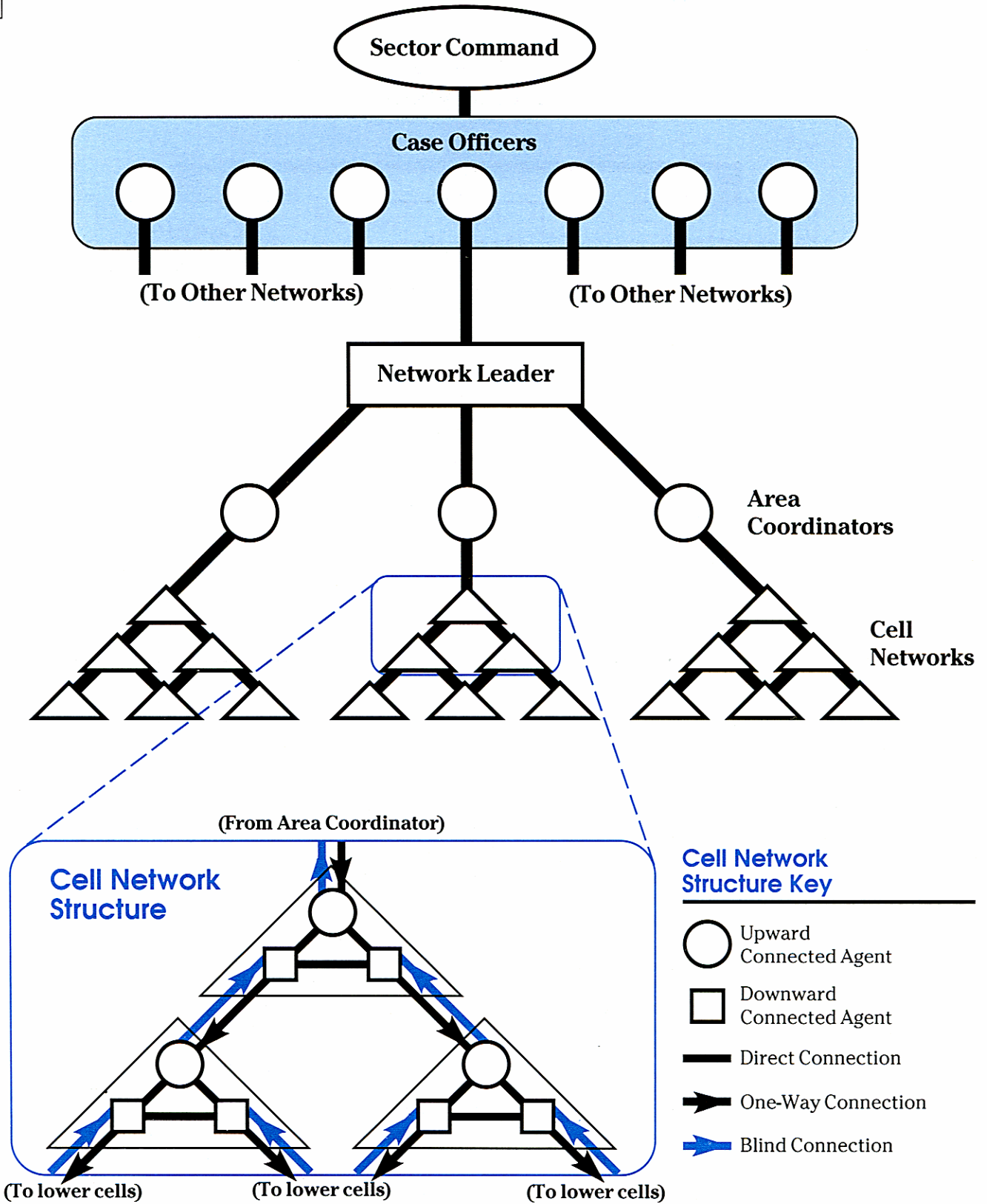

Stephen Crane

The cell network is at the core of the Alliance's Sector Intelligence operations. A cell network is structured so that information can be passed quickly from any operative up to Sector Command, while, at the same time, protecting Sector Command from discovery in the event of infiltration of the network.

Communication from cell to cell or from the cells to the leaders is often "one-way." This means that those on the upper end of a connection have full knowledge of those on the lower end. However, those on the lower end have only a drop point, transmission frequency or scrambled code with which to connect to their superiors. This way, an information leak can only travel down the network tree and not up it to the more important levels.

#### **Case Officer**

Each cell network has a Case Officer. This is the Alliance officer responsible for maintaining the network. A Case Officer's first priority is to ensure that his network is not "infected", that is, infiltrated by Imperial agents. His second and third priorities are to collect the intelligence his network gathers and to keep the System Commander fully posted. His fourth priority is to keep Operations, back in Intelligence Command, fully supplied with the intelligence his network collects. Finally, his fifth priority is to use his network to cause as much grief as possible to the Empire's forces within the Sector.

If a problem develops in communication, or an operative is captured or killed, the Case Officer must reorganize the network to minimize the danger to the rest of the structure. Any single operative can expose and endanger at least three other operatives (the other two members of the operative's cell, and the operative's single connection to another cell). If an operative is compromised, it is the Case Officer's job to stop the domino effect of operatives informing on each other, by reshuffling the cell structure, and/or disbanding cells as needed. If the network is contaminated beyond repair, the Case Officer must disband the entire operation and set up another with entirely new recruits.

The Case Officers for a given sector are usually based together in the Sector Headquarters, where they have easy access to the Sector Commander and the sector's communications with Alliance HQ.

#### **Network Leader**

The Network Leader is the highest-ranking native in the cell network. The Network Leader is responsible for day-to-day operations in the network, and also for making periodic reports to the Case Officer.

Unlike the Case Officer, the Network Leader lives on the planet containing the network, putting him at some risk of capture in the event that the network is compro-

mised, but also giving him a much greater ability to respond quickly to developments.

The Network Leader usually has fairly efficient communication with his subordinates in the network, but, again, only difficult "blind" communication with his Case Officer in Sector HQ. Normally, the Network Leader will not know the location of Alliance Sector Headquarters nor will any of the other operatives in the network. This insulates SecHQ from contamination.

#### **Area Coordinator**

The Area Coordinator controls a smaller portion of the network. This operative receives overall strategic guidance from the Network Leader and is responsible for turning the Leader's directives into tactical operations. The Area Coordinator will accompany network agents on operations, coordinating efforts between the various cells.

As he is involved in many of the network's operations, the Area Coordinator is at high risk of capture or discovery. If made to talk, the Area Coordinator can single-handedly destroy an entire section of a network and place the Network Leader at grave peril. Coordinators are trained to fight to the death to avoid capture. Many carry "lullabies" — suicide pills — in the event of disaster.

#### **Cell Structure**

The majority of the operatives within a Network are the members of the cells. These people are undercover, living as good citizens of the Empire by day, seeking to destroy it by night. The risks are extremely high. Many underground members have families. If discovered, their husbands, wives, children, relatives, neighbors, co-workers and friends are all at grave peril. On some planets, the Imperials will not hesitate to round up and execute entire communities because of the mere suspicion of Rebel activity.

Making matters even worse, the members of the underground are not aware of each other's identities. They will know at most three people in the network: the other members of their cell, and possibly a member of the cell directly above or below them. This means that an operative may not be aware that his brother, sister, friend, or possibly husband or wife is also a member of the underground.

Imperial truth drugs and torture are virtually irresistible — as is their money and power, to some. That the cell networks have survived, let alone proven a very large thorn in the side of the Empire, is an important testament to the tenacity and courage of the people of the galaxy.

The agents of Imperial Intelligence are past-masters of this kind of deception. The Chief of Alliance Intelligence must constantly be on the lookout for just such scams. On the other hand, he cannot let the risk of compromised data paralyze his department, causing it and him to distrust and ignore good data it receives.

The post requires the judgement of a corporate exec, the killer instinct of a warrior and the nerves of a high-stakes gambler. The Chief of Intelligence walks a constant tightrope over catastrophe, with death for millions the punishment for one slip.

### Intentions

This branch of Intelligence analyzes and interprets data acquired by Operations and other sources, using the data to predict what the Empire's forces are going to do. Intentions officers spend their time in small, poorly-lit rooms poring over reports from other agents in the field. The work requires patience, an eye for detail, and the ability to synthesize seemingly unrelated information into a coherent picture.

It is about as unglamorous as you can get in the Intelligence business — Intentions officers are known for being “pale and skinny, with goggle-eyes, nervous twitches and stooped shoulders

from staring for an extended period into data screens” — but the service they perform is vital to the war effort.

### Cryptology

This department attempts to decipher the myriad of codes the Empire employs to shield their communications. Thus far, their efforts have had limited success. Though they employ some of the most creative beings and are equipped with the very best computers and communication Droids in the Alliance, Cryptology still has managed to break only 15 percent of the Empire's civil codes and under five percent of its military ciphers — and this after much heroic effort.

Cracking the scandocs — Imperial Intelligence's brilliant system for sending coded messages — remains Cryptology's primary assignment. Until recently, the scandocs had resisted every effort to break them. However, Cryptology has just acquired a scandoc decoding computer from a recent Alliance Armed Forces operation. It is hoped that the machine will give Cryptology important details upon how the system works and how to unravel it.

### Interrogation

This department is in charge of questioning captured personnel. Interrogation maintains a fully-equipped laboratory with the Fleet and another with Alliance Headquarters; in addition, most Sector bases have one or more trained Interrogation officer on staff. If an important prisoner is too difficult for a base Interrogation officer to handle, he is sent up to HQ or Fleet for further interrogation.

Forbidden by law and by common decency from using the harsh methods of their Imperial counterparts, Alliance Interrogation officers are still extremely effective at getting at the truth. They employ a sophisticated array of scanners, psychologists, undercover operatives “planted” in holding cells, alien telepaths, truth drugs, and, admittedly, the threat of violence, to get even the most recalcitrant Imperial to talk.

The Alliance Civil Government often has Interrogation officers, disguised as aides, sit in on important diplomatic sessions. The officers are trained to interpret facial expression and body language, and are often able to discern if the foreigners are lying.

### Equipment

This office is responsible for designing and building the esoteric equipment required for undercover Intelligence operations: bugs, scanners, miniaturized holo-cams, detection-resistant weaponry, untraceable poisons, shielded com-

### Intelligence Slang

Following are some of the more common slang terms used by Alliance Intelligence operatives:

**Blind Jump:** Setting up an Intelligence network on a new planet.

**Busted Vacc Suit:** Blown cover.

**Busy:** Stormtrooper.

**Father:** Alliance Intelligence.

**High-Altitude:** Undercover.

**Jobber:** Assassin.

**Lullaby:** Suicide Pill.

**Mother:** Case Officer.

**Noxious; Smelly:** Imperial Security.

**Orphan:** To disband a network (thereby “orphaning” agents in the field).

**Pacify:** To kill.

**Poison:** Imperial Intelligence.

**Toxic:** Infiltrated by Imperial Intelligence agents.

**23er:** An agent who has made 20 field assignments and been retired; any very competent agent.

**Vaccinate:** To remove known Imperial agents.

**Vacuum:** Deep undercover

municators, and the like. They are also responsible for analyzing and countering all Imperial Intelligence gadgets captured in the field.

Equipment has numerous laboratories scattered about on safe worlds across the galaxy. Each is equipped with the best scientists, technicians, engineers and equipment available. Though they have a surprisingly good safety record, the labs are invariably nicknamed “boom rooms.” The Equipment officers themselves are also usually given nicknames — most of them unprintable.

The “boys in Equipment” have earned a high reputation for eccentricity and whimsy. They are famous for the pranks they pull on each other — and on anyone unfortunate enough to occupy an office nearby. Their humor is usually juvenile, at best. Most of their jokes involve the placement of a bugging device where it will record someone — usually a security officer — in the most embarrassing moment possible. The recording is then played back over the base’s holo-channel or comm unit for everyone to enjoy.

This behavior is tolerated only because no one has figured out a way to stop them. It also keeps the security officers on their toes: bases with Equipment labs in them tend to be much more thoroughly scanned for bugs than those without.

## Analysis

The largest office in Intentions, Analysis is responsible for sifting through the data provided by Cryptology, Interrogation, and the Operations department. They must determine what is true and what is false, compiling Intelligence reports for each of the sector Intelligence units, and preparing daily briefs for the Chief of Intelligence and the other Supreme Allied Commanders.

Analysis HQ is always chronically swamped with more information than it can handle. There are hundreds of statisticians, interpreters, correlators and retired field operatives in Analysis; though specially trained for rapid turnaround of data and heavily assisted by Droids and computers, the officers cannot hope to keep up with the gigabits of information they are given to analyze.

For a while during its early days of operation, Analysis was literally paralyzed by too much data. With more information than it could digest, Analysis was incapable of interpreting or disseminating any of it, and High Command and the sectors were dangerously uninformed about Imperial operations. Analysis had the information, but its operatives simply could not sort through it fast enough.

To combat this, a special sub-unit of Analysis — named “Triage” — was set up to pre-judge all data on its potential usefulness, ruthlessly filing or discarding anything which was not of obvious



Allen Numis

importance. Though useful information has no doubt been discarded or filed away through this process, the Intelligence chiefs reason that it is usually better to act quickly on partial data than it is to wait until everything is processed, by which time the data is probably out of date anyway.

In addition to its main headquarters, which is always with the Alliance Military High Command, Analysis maintains offices in each of the Sector Headquarters and a branch aboard the flagship of the Alliance Fleet. These offices perform the same function as the main headquarters, except that they concentrate exclusively upon data from sources in their areas of operation. This takes some of the load off of Analysis HQ and ensures a more rapid turnaround of time-sensitive local information.

## Operations

This is the largest department in Intelligence. It is responsible for all of Intelligence’s field operations: spying, infiltration, blackmail, subversion, assassination, and any other operations which might bring agents into direct contact with the enemy. Field operations is the most dangerous posting in Intelligence; any time he takes the field, an agent has roughly a seven percent chance of being captured or killed.

On the surface, this may not sound particularly grim. A bookie would bet you 14 to one that an agent would survive any given mission — not bad odds for wartime, you might say. However, dur-

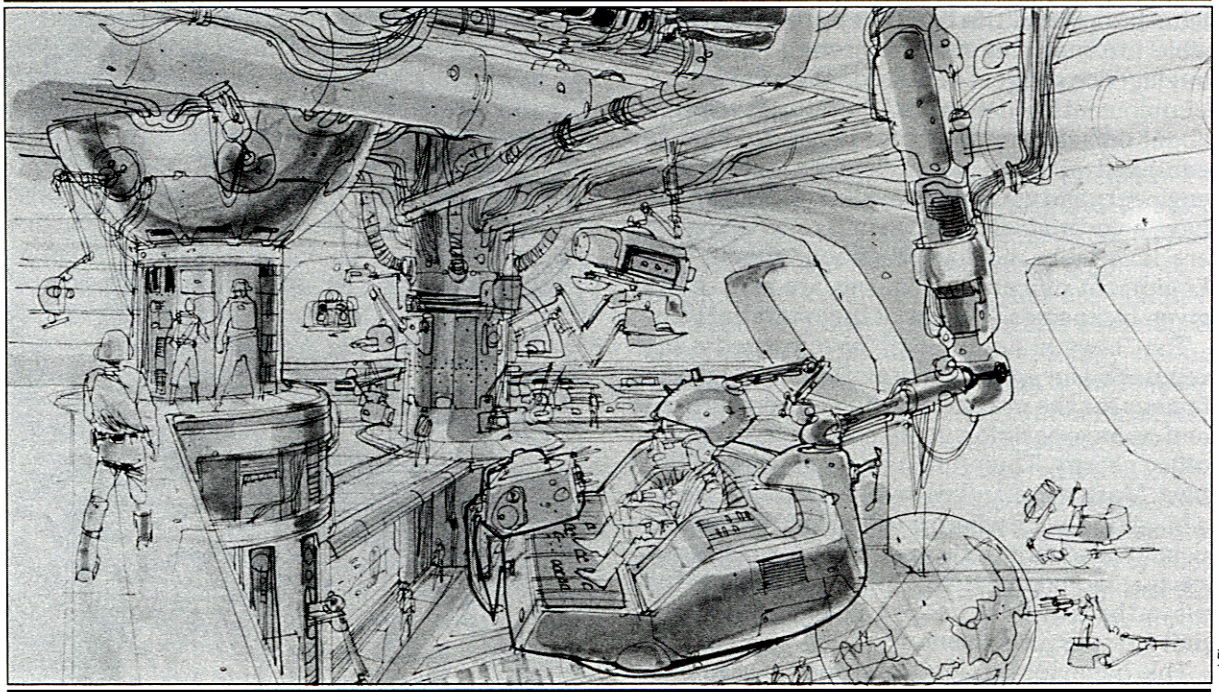

ing his career in Operations, an agent can go on 20 missions before he retires from field duty. He has a 23 percent chance of surviving those 20 missions — four to one against.

Agents who survive 20 missions — “23ers,” in Intelligence slang — are legally barred from further field duty and forced to take desk jobs in Ops or to transfer to another department.

### **Systems Ops**

Systems Operations are immobile Intelligence networks run by Case Officers stationed at Systems Headquarters. The operatives are almost always natives of the system or planet, recruited by the Case Officer or other in-place operatives. Unless the system is of critical importance to the Alliance, the operation receives little or no direct assistance from outside the system. Alliance Intelligence will provide a Case Officer to run the network; beyond that, the operation is usually on its own.

For these reasons, networks can vary wildly in terms of size, composition, quality of Intelligence, and extent of contamination. The Case Officer, usually a retired 23er, must be constantly on guard against Imperial infiltration, and ready to shut the entire operation down at the merest hint of contamination.

System operatives are never told the location of the Sector base; all contact is made through “blinds:” one-way information drops, memory-wiped Droids, or the like. (See the network diagram, pages 24 and 25.)

### **Coordinate**

The Coordinate office handles operations which are considered to be more important than systems operations or those which cannot be effectively controlled by a system Case Officer. These include the operations infiltrating Imperial Intelligence, COMPNOR, the Army and Navy, Corporations, and other high-risk, high-priority targets.

Coordinate operations get the best the Alliance has to offer. The operatives are Alliance-Intelligence trained and equipped, the operations are directly controlled by the best Case Officers, and coordinated from Operations HQ itself.

Coordinate will occasionally send operatives to planets which contain active networks, if the job is too large for the network or the network isn’t trusted. To limit the chance of infection, the Sector Intelligence network will often not be informed of Coordinate’s activities, or called upon solely for diversionary operations.

### **Passive Operations**

The name “Passive Operations” is a ruse. In truth, this shadowy service branch provides Operations with firepower. This unit is staffed by ex-mercenaries, Elite Special Forces soldiers and the best operatives from Systems and Coordinates. Operatives from Passive are assigned missions where combat is considered likely — kidnapping, assaults upon prisons to rescue important captured Rebels, attacks against heavily-guarded bases or power or communications stations, and the like.

Passive Operatives also perform the few assassinations called for by Supreme Allied Command. Mothma is diametrically opposed to assassination as a tool of state, but, in special circumstances, she will very reluctantly agree. Passive has made several attempts upon Darth Vader's life, with predictable results.

## Counter-Intelligence

This department is strictly concerned with rooting-out and destroying Imperial infiltration of Alliance forces. Though nominally under the administrative control of the Chief of Intelligence, CI is given extremely wide latitude in its operations, and reports directly to the Commander-in-Chief, Mon Mothma, if it discovers high-level contamination in Intelligence.

CI's agents are everywhere. They are undercover in virtually all branches of the Alliance — the Military, Intelligence, the Civil Government and the Sector Commands. They are given the best equipment and manpower available, because, as Mon Mothma is fully aware, Imperial infiltration of the Alliance is the single largest threat to the Rebellion — including that posed by Darth Vader's Fleet.

CI itself is not immune from its own scrutiny, either. Given its virtual free run of all other parts of the Alliance, Imperial infiltration of CI would have devastating results. A large portion of CI's time and energy is spent policing itself.

## Security

This is the branch of CI which recruits agents and inserts them into the other sections of the

Alliance. No one outside of Security — including Mon Mothma — knows for sure how many operatives Security has, or where they are planted.

Mothma herself is not immune from Security's scrutiny. In fact, she suspects one of her senior aides of being a Security agent, though she of course does not let on that she suspects the aide. (She's wrong: *two* of her aides are agents, and the woman she suspects is not one of them.)

## Retrieval

If a Security operative suspects that someone is an Imperial plant, the case is turned over to Retrieval, the other branch of CI. Retrieval operatives "do a number" on the suspected plant — set up covert surveillance operations, interview his friends and family, bug his apartment, and, if necessary, arrest the person and subject him to rigorous interrogation.

If the suspect is proven innocent, he is freed with no blemish on his record — though possibly with an extremely large headache from the truth drugs and psychic interrogation.

If the suspect is found guilty, or his innocence cannot be proven beyond a shadow of a doubt, the suspect may be imprisoned on a safe world, "turned" to work as a double agent for the Alliance, or, if necessary, quietly killed.

Retrieval does not kill except when absolutely necessary. However, if an infiltrator has information which would be severely damaging to the Alliance — mindwipe and personality construction being illegal in the Alliance — Retrieval will not hesitate to terminate the infiltrator without question.

## C

# Chapter Three

## Alliance Military

*In the grave of Alderaan,  
In the night of Charenthoth,  
In the sands of Tatooine,  
And the bloody hell of Hoth.*

*We will meet the enemy;  
We will sound the battle-cry.  
With our comrades at our sides,  
We will fight and we will die.*

*Though they hunt us across space;  
Though they kill us by the scores.  
Though they crush our blessed home;  
Though the mighty Death Star roars.*

*We will meet the enemy;  
We will sound the battle-cry.  
With our comrades at our sides;  
We will fight and they will die.*

— Battle Chant of the  
Legion of Alderaan.

### Objectives

The Alliance military is charged with defeating the Empire's Army and Navy and bringing down the Emperor. To that end, every soldier, technician, mechanic, tactician, communicator, pilot, general, and admiral pledges his or her very life.

The Alliance military battles the Empire in the dark reaches of space, in the most populous cities of the Galactic Core, in the asteroid belts, in near-planetary orbit, or anywhere in between.

Despite the staggering size of the job and the many setbacks and defeats they have suffered, the warriors of the Alliance are not cowed — if anything, they are overconfident, believing that any one Rebel can whip any 10 Imperials. Morale is terrific. As the popular and somewhat obscene Alliance fighting song, "Yer in the Rebellion Now, Farmboy," says:

*The pay is lousy, the food is even worse,  
But we're tougher 'n' a Wookiee's stomach,  
And meaner 'n' a Princess's curse.*

### Structure

The formal structure of the Alliance Military is, like the Alliance's political structure, a product of the Cantham House meetings between Senators Bail Organa and Mon Mothma.

Organa, a veteran of the Clone Wars and a long-time member of the Senate Military Oversight Committee, used this considerable military knowledge, in tandem with Mothma's political savvy, to design a military structure which would be flexible enough to handle the huge problems caused by a fight against the single largest military power the galaxy has ever seen, yet would still remain firmly under the control of the Alliance civil government.

The solution to the flexibility/control problem is the separation of the military into two distinct forces, the Alliance Forces, and the Sector Forces, both under the control of the High Command.

### High Command

Alliance High Command includes Mon Mothma and all of her closest military advisors. High Command is responsible for setting overall strategy, directing the operations of the Fleet and the Allied Forces, and coordinating the activities of the Sector Commands. To better pursue these activities, High Command is usually stationed with the Fleet.

### The Alliance Forces

The Alliance Forces is that part of the Rebellion's military under the direct control of the High Command. It includes the Fleet and attached starfighter wings, most major support services, and a small but powerful ground forces unit. The AF is designed for rapid response — to take advantage of any opportunity, or to counter any particularly dangerous Imperial threat, as it is discovered.

### The Sector Forces

Sector Forces are semi-autonomous military units, charged with keeping the fight alive in their particular sectors. On most day-to-day business

they are independent, able to make tactical decisions without consulting High Command (which can take weeks). When coordination between Sector Forces or between Sector Forces and Alliance Forces is necessary, it is usually handled by a Command Group appointed or supplied by High Command.

Sector Forces are microcosms of the Alliance Forces, usually consisting of starfighter wings, ground forces (usually a larger part than in the AF), intelligence units, and so forth. Each SecForce is a complete fighting unit, capable of weeks of sustained combat without outside support.

### High Command

Alliance High Command is the mind of the Alliance military. It is the tool through which Mon Mothma directs the war effort, and, as such, closely reflects her beliefs about command and control.

For a structure which directs the efforts of millions of beings, High Command is surprisingly small, containing fewer than one thousand officers. The emphasis of HC is upon flexibility,

speed of response, and taking initiative. There are no button-pushers in HC, no petty bureaucrats to clog up the works, no officers putting their time in before retirement. A soldier in HC is "firing full-throttle" for the Alliance, or he is replaced.

The diagram below describes the structure of High Command.

### Commander-in-Chief

Mon Mothma holds the title of Alliance Forces Commander-in-Chief. This title is automatically given to whomever is Chief of State. With another leader, this position could be a mere formality, the actual decisions on the conduct of the war being made by the Chiefs of Staff and the Supreme Commanders, but Mothma is quite actively involved in the running of the war.

The C-in-C is the highest-ranking officer in the Alliance Forces. She exercises virtually unlimited power over the Rebellion's war machine, and cannot be removed except by the hand of the Chief of State. As Mothma holds this position as well, she cannot be removed as C-in-C unless

### Alliance High Command Structure

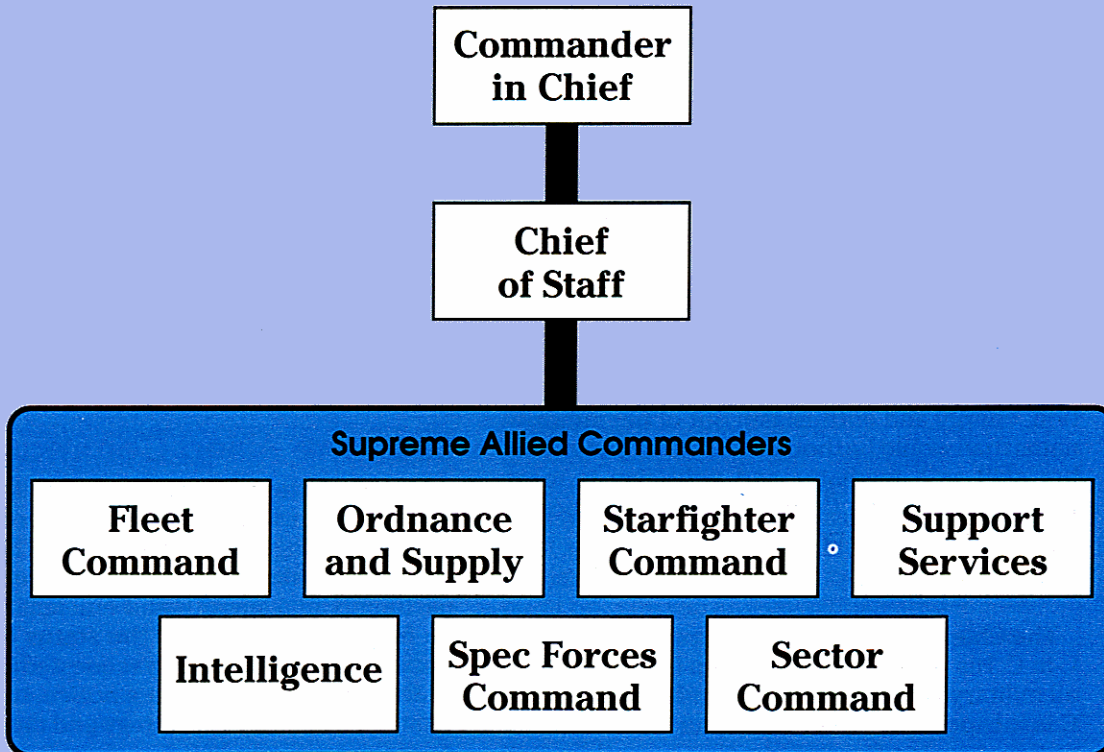

Stephen Crane



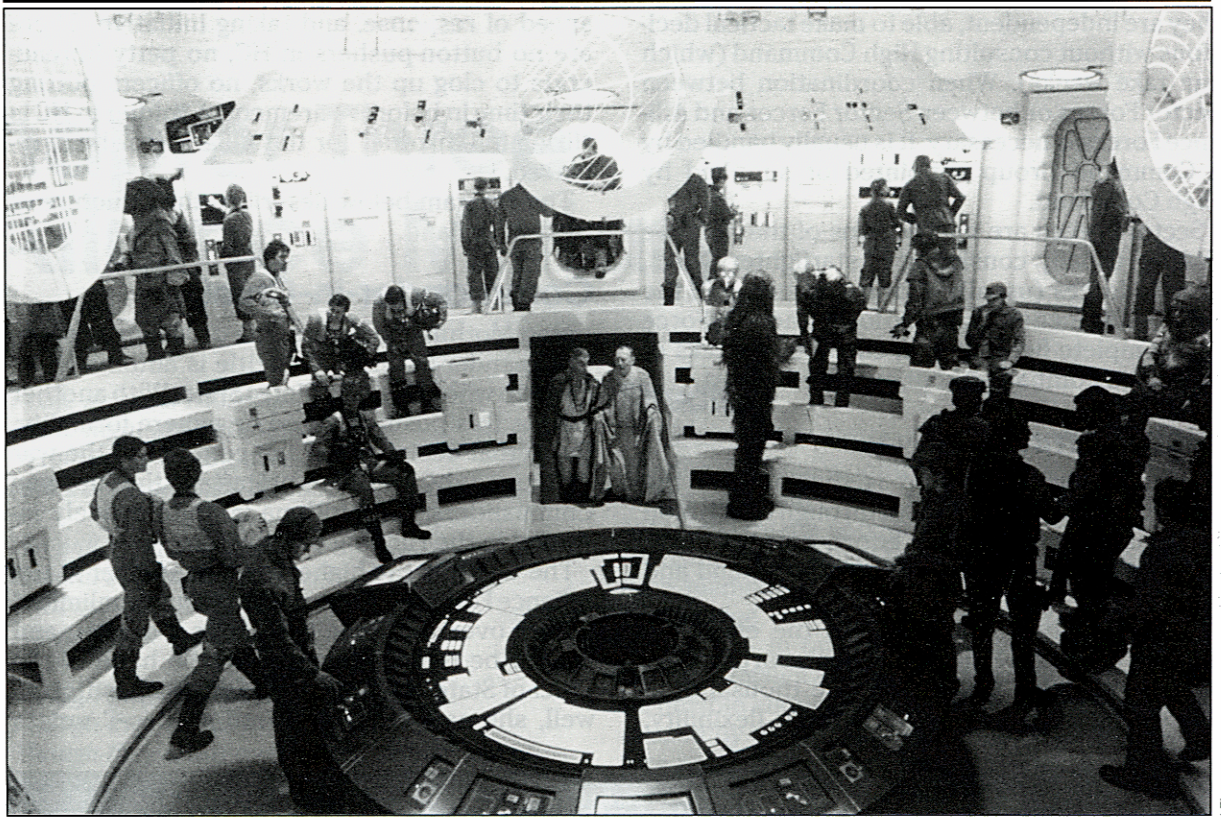

removed from leadership of the Alliance.

Despite her near-dictatorial powers, the C-in-C is not so foolish as to attempt to run the war effort on her own. She relies heavily upon the expertise of the professional military men and women in the Supreme Allied Command.

Mon Mothma describes her position as C-in-C as “more like a chairman of the board than a soldier.” She spends most of her time in conferences, meeting once a day with the Supreme Allied Commanders, and usually following that with many informal meetings with commanders, subcommittees, and task forces. She says little at these meetings, yet somehow keeps them focused and productive, getting more cooperation, energy and enthusiasm out of her subordinates than would be thought possible. If anything, her skill as a mediator and politician is more beneficial to High Command than her not-inconsiderable military savvy.

### Chief of Staff

The Chief of Staff is second in command to the C-in-C. His primary job is to keep fully briefed on all military actions, so that, in the event the C-in-C is incapacitated, he can step in at a moment’s notice, keeping the war running smoothly until the C-in-C recovers or the civil government names a successor.

Beyond that, the Chief of Staff acts as a filter or buffer for the C-in-C, deciding what matters require her attention and what problems can be resolved at a lower level. This is a critical job: with a war raging across several hundred systems, the C-in-C must concentrate her efforts on the crucial decisions and leave the rest to others; with an inefficient Chief of Staff, the C-in-C could easily be swamped by details, paralyzing the entire High Command.

Finally, the Chief of Staff is empowered to act in the C-in-C’s name, when pressing political business takes her away from command of the military. When Mothma is gone, the Chief of Staff has complete authority.

### Supreme Allied Commanders

These are the chiefs of the various departments of the Alliance war machine: Fleet, Ordnance and Supply, Intelligence, and so forth. These beings and their staffs are expected to run their departments in a smooth and efficient manner, to be fully up-to-date upon the status of their departments, ready to supply requested information to the C-in-C at a moment’s notice, to make recommendations upon strategy and tactics, and to coordinate efforts between departments.

These beings are also the main interface between the military High Command and the Civil Government. They are often required to work

quite closely with member of the Cabinet: Intelligence with Education, Ordnance with Industry, and so forth.

### Fleet Command

This department represents the Fleet in the Supreme Command, the single most important component of the Allied Forces. This position is usually occupied by the commander of the Fleet itself — Admiral Ackbar — when the High Command operates with the Fleet, but, when the Fleet is on maneuvers or Admiral Ackbar is otherwise unavailable, he supplies a staff officer to this position.

Though with no authority over the Fleet, the staff officer is fully conversant with the Fleet's status and Admiral Ackbar's intentions, making him at the very least able to keep the other departments abreast of the Fleet's goings-on.

### Ordnance and Supply

This department is responsible for procuring the equipment, weaponry, and foodstuffs for the

Alliance forces. As most of the Sector Commands are expected to supply food and small arms to their ground forces from the sectors they occupy, OaS concentrates upon the more difficult items to supply: starfighters, starships, ship-grade fuel, and the like. OaS is also responsible for keeping the Fleet and special forces fully supplied at all times.

As OaS is not in charge of transport, it must closely coordinate efforts with Support Services to ensure that there is transport available to take the supplies to the final locations.

A small part of the OaS's efforts goes toward weapons and vehicle research and development, attempting, with depressingly limited resources, to equip the Alliance forces with the latest, most up-to-date, equipment.

### Starfighter Command

This department is charged with strategic control of the Alliance's starfighter contingent. It is responsible for training pilots, assigning wings to the Fleet and to individual Sectors, and for opera-

## **E**xtract of Minutes from the 251st Meeting of the Alliance High Command

**Chief of Staff:** In reference to the discussion last week on the "Cobolt Offensive." StarCom: anything to report?

**Chief of Starfighter Command:** A conditional yes. We've got two wings of X- and Y-wings available during that time; Fleet Ops can give us another one; Sector Command says they can scrape up two more —

**Chief of Sector Command:** Probably. We've got the 'fighters who survived the Tocan system disaster recuperating in Ghorman; they'll be maybe 75% effective in two weeks. Plus, we can strip Tierfon, Homon and Farstey for the other wing, *if* the Imps hold off on their offensive in that quadrant.

**Chief of Staff:** Intell?

**Chief of Intelligence:** According to my operatives, the Tierfon Sector Fleet isn't planning to launch their attack for three weeks — they too need to rest and refit after Tocan — but the new Fleet Admiral Tzenkens is supposedly a real firebrand: he might push the thing ahead to keep us hopping. I'd say there's maybe a 70% chance we've got our three weeks.

Seeing what we stand to gain — the new Imperial Scandoc decoding computer — 70% is good enough to go on ...

**Starfighter Command:** A week isn't much time to pull off Cobolt and then get set to parry whatever Tzenkens is up to ...

**Support Services:** If Fleet gives their approval, we can give you a couple of extra repair ships to hurry things along ...

**Fleet:** I see no problem there. We've got fleet maneuvers scheduled for that time; we can just cut down on starfighter operations until the repair ships get back.

**Chief of Staff:** OaS?

**Chief of Ordnance and Supply:** Fuel and weaponry are already assigned; awaiting pickup in deep space caches in Reegian system. Support has given us the necessary transports.

**Chief of Staff:** Good. Spec Forces?

**General Madine, Special Forces Command:** We've set up the liaison group with Sector Command; we're just waiting for up-to-date maps of the base from Intell. It's a risky operation and murder if we mess up, but I'm willing to take the shot if Starfighter Command is.

**Chief of Staff:** Anyone have anything to add? That's it, then. General Madine will take control of planning and operation of Cobolt from this point on. You will all assign officers to Madine's task force. General, I want daily progress reports.

**General Madine:** Yes sir.

**Commander in Chief:** Nicely done, gentlebeings. Chief of Staff, what is the next subject on the agenda?

tional control over “rogue” wings — those wings in the Allied Forces and not permanently assigned to Sectors.

Once it has assigned a starfighter wing to a Sector, StarCom relinquishes operational control of that wing to the Commander of the Sector. The Wing Commander will then answer to the Sector Commander, but will also file reports to StarCom — if, in StarCom’s opinion, the wing is being poorly used, it can submit a complaint to Sector Command.

In addition, High Command periodically organizes large operations — against Imperial supply trains, heavily-defended bases, and so forth — requiring more starfighter assets than StarCom has on hand. To fulfill these, StarCom may ask the Sector Commands to temporarily return their starfighter wings to StarCom for the duration of the operation.

As might be expected, these requests often elicit bellows of anguish from the Sector Commanders, all of whom are convinced that the dangers in their Sectors are so pressing that they cannot afford to give up their fighters. These conflicts are resolved by Sector Command, or, in extreme cases, by the Chief of Staff.

## Support Services

This department controls the Alliance’s limited transportation network — bulk and light freighters and other vessels. It also provides cooks, doctors, mechanics and repair facilities for the bases and the Fleet. Finally, it maintains the Alliance’s safe worlds and hospital ships.

Though not at all glamorous, Support is one of the most important service branches in the Alliance military. Without Support, The Alliance war machine would grind to a halt within a matter of months.

For more information on Support Services, see Chapter Nine.

## Intelligence

Intelligence is responsible for keeping track of the Imperial Army and Navy. Intel’s operatives are everywhere — in the enemy’s military, in Sector capitals, in the bases, in the spaceports, and anywhere else that military information can be found. Their jobs are dangerous in the extreme, but, if they are lucky, they can pick up crucial data for the Alliance.

In addition to its undercover operatives, Intel employs many less-glamorous — but often more reliable — methods to determine the enemy’s location, strength, and intentions. Alliance deep space vessels and probe Droids are stationed at the fringes of Imperial base worlds, cataloguing the comings and goings of the Imperial ships.

Hundreds of operatives scan thousands of hours of news-vids, looking for fragmentary reports of the movement of Imperial craft and armed forces.

Putting all of this information together, Intel can get a surprisingly accurate picture of the activities of the enemy.

For more information on Intel, see the previous chapter.

## Special Forces

These are the ground troops of the Allied Forces. Small in number — totalling perhaps ten divisions — SpecForces make up for this by the excellence of their training, the brilliance of their leadership and their high morale. SpecForce units defend High Command, are attached to the Fleet, and are sent on detached duty to Sectors across the galaxy. For more information on the SpecForces, see below.

## Sector Command

Sector Command is in charge of the various Sector Forces, assigning assets, coordinating activities between sectors, and the like.

There are thousands of Alliance Sector Forces in existence, each with its own peculiar tactical and strategic problems, each with varying amounts of manpower, weaponry, command competence, and Imperial opposition. It is literally impossible for any organization to closely coordinate (or keep track of) all of the Sector Forces; SecCom doesn’t even try. Instead, it attempts to provide overall strategic guidance to the sectors, limiting its direct control to only the few most important. SecCom is one of the largest branches in High Command, employing hundreds of officers, soldiers and Droids.

Despite the charter of the Alliance, which gives Mon Mothma — and, by her authority, the Alliance Command — near-dictatorial power over all Allied Commands and their military forces, SecCom rarely uses this power to interfere with the internal workings of a Sector Force. However, when a Sector Force must cooperate with the Alliance Forces for a crucial operation, SecCom will not hesitate to pull rank to get the job done.

Typically, SecCom will receive strategic directives from the Supreme Commanders or the Chief of Staff or C-in-C. These orders will usually be of the most general. For example: SecCom may be told that a critical shortage of fuel is projected for six months away; they are to direct all available assets to increase fuel production. Or, an offensive is planned to take place in the next month; all sectors in a certain area are to concentrate their efforts against the enemy’s starfighters. SecCom passes these directives to the Sector Forces; they are expected to decide how to best imple-

## **M**inutes of the Planning Meeting for Operation Cobolt

**General Madine:** Afternoon, ladies and gentlemen. Cobolt is a hit-and-run operation. We're assaulting the Imperial orbital base above Mantooine in Atrivis Sector after our starfighter wings draw off the TIE cover.

The raid has two objectives: first, steal the new Imperial Intelligence Scandoc coding computer on board the base; second destroy the base, covering the theft and, incidentally, stranding the TIEs in space. Your briefing chips contain the layout of the base as well as our latest intelligence on troop complement, dispersion, and a psych profile of the commander of the base.

How do we get in?

**Colonel Gharom:** I'd say we use a variant on the "Erasmus" gambit. We insert 10 infiltrators aboard an Imperial supply craft. They disable the base's shields and as many guns as possible, and then hold up until relieved. I'll see what transport's got available and I'll get Intelligence to forge the orders.

**Madine:** Fine. But there are a lot of Stormtroopers aboard; I'd go up to 20 men.

**Gharom:** Aye, aye, sir.

**Madine:** Colonel Seertay?

**Seertay:** If the shields are down, the Marines can crack the cargo doors, no problem. One assault boat should do it — it will also serve to draw enemy fire, showing us which guns are still operable and must be taken out before the transport gets within range.

**Madine:** Good, Anna. Once inside the bay, set up a temporary airlock on the exit hatchways: we don't want to vent the base to vacuum — yet. How long will you need?

**Seertay:** I'll need at least five minutes to clear out resistance and set the airlocks up ...

**Madine:** You've got three. Any longer gives the enemy too much time to regroup. Take as many Techs as you need.

**Seertay:** Yes sir.

**Madine:** Fine. We're in. Toombs and Gideon, you will be in charge of the assault teams. Work up a team profile, based upon a transport capacity of a *Wolden*-class shuttle — remembering that you need to reserve space for the 20 Infiltrators, though you can reasonably expect them to sustain 50 percent casualties. Also, our reports list 10 to 20 civilians on the base; we want to evacuate them if possible. Assume you've got no more than 20 minutes to complete the mission and get out.

First thoughts?

**Colonel Toombs:** That gives us room for about 75 troopers and maybe 1000 kilos of equipment. It'll be tight. If we're wearing space suits, you can cut down our efficiency and speed by 18 percent. We need that airlock —

**Seertay:** You'll have it.

**Toombs:** — Good. I'll want three units of 25 soldiers each. One to hit the Intelligence Center, call it White Team, one to hit the power station, call it Black Team, and the third in reserve, call it Red Team. Figure 20 Marines, two Heavy Weapons, two Techs, and one Med in each. We'll need a heavy repulsor sled and lift suit with White Team to move the computer. Gideon and I will requisition the men and equipment this afternoon.

**Madine:** Excellent. I want detailed operational profiles by this time tomorrow. We'll start training exercises in 48 hours. Let's roll.

ment SecCom's instructions.

SecCom's communications equipment is massively extensive and massively expensive — even so, it may take weeks for a SecCom directive to reach its final destination. The galaxy is vast indeed, and only a very few systems are equipped with hyperspace communicators. Most messages must be sent by relay, or carried by hyperspace Droid or ships.

Because of the time delay inherent in these methods, in cases where rapid response is required, SecCom will often send a Command Group to the critical sector to take charge for the duration of the emergency.

SecCom is also responsible for organizing new Sector Force Commands upon uncontrolled

planets. Intell handles the recruitment, Support the training, but SecCom provides the cadre of trained officers to man the command until the natives are capable of running it on their own.

## **Fleet Command**

The Fleet is firmly under the control of one being: Admiral Ackbar. He is the father of the Alliance Fleet. He created it from virtually nothing and he wields it as if it were an extension of his own body.

The organization of the Fleet is displayed below.

Fleet Command

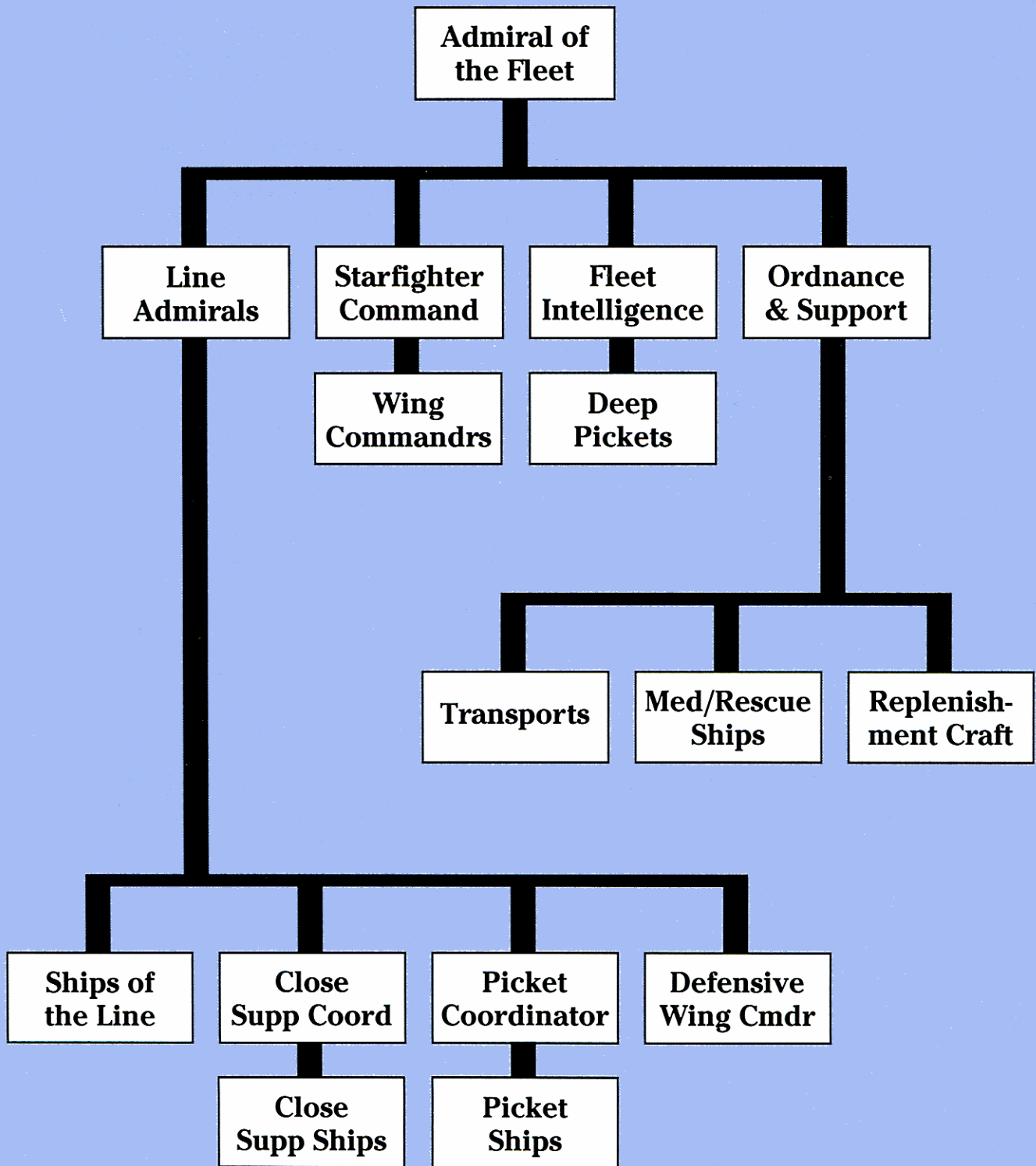

## Line Admirals

The line of battle is the main unit of maneuver in the Fleet. The battle line consists of four elements. At the core are the ships of the line, usually heavy cruisers. These are surrounded by close support vessels, frigates and corvettes. In turn, those are surrounded by picket craft, fast-attack and patrol ships. Finally, the battle line is guarded by one or more wings of starfighters.

For more details on starships and the battle line, see Chapter Four.

## Ordnance and Support

This post combines the functions of support services and ordnance and supply. The commander of Ordnance and Support has direct charge of the Fleet's transports, medical, rescue and replenishment craft.

OaS is charged with ensuring that all of the vessels in the fleet are fully armed, fueled and supplied for battle. During battle, the lightly-armed transports and replenishment craft stand well away from combat if possible, while the rescue ships and the medical frigate are in the thick of things, picking up survivors from disabled starfighters and starships — though there usually aren't very many of them.

## Fleet Intelligence

Fleet Intelligence has two main functions: to interpret information supplied by High Command Intelligence, and to organize and run the Fleet's deep picket line.

The deep picket line is a group of long-range sensor boats and Droids deployed many thousands of kilometers from the main body of the fleet. They are there simply to warn the fleet of approaching vessels. If a deep picket spots a ship, it immediately sends a short-burst, coded message back to the Fleet. Hopefully, they have been given enough time to deploy for battle or flee.

Though Commander of Fleet Intelligence is not a combat post — his deep picket craft are not battle-worthy and flee when the enemy attempts to engage — he is one of the Fleet Admiral's chief strategic advisors.

## Starfighter Command

Starfighter Command is usually given to a general, though occasionally a commander has the post. Starfighter Command is in charge of the Fleet's complement of offensive starfighter wings, those not specifically assigned to the tactical defense of a line.

Often the starfighter commander is also the wing commander of the lead attack wing, though

sometimes he is posted aboard the Fleet Admiral's flagship. This is a matter of the commander's style — aboard the flagship, the commander is able to get a more clear picture of the entire battle; at the head of the lead wing, the commander assures a more rapid response to his orders, and is able, by his example, to get the very most out of his starfighter pilots.

For more details on starfighter tactics, ships and organization, see Chapter Five.

## Special Forces

Special Forces are the ground units attached to Alliance High Command. Specifically selected for morale, courage, skill and devotion to the cause, Special Force troopers are the finest ground troopers in the Alliance — and quite probably, the galaxy.

These superbly trained, fully-equipped soldiers are capable of handling a tremendous variety of missions. A number of the troopers are permanently assigned to the Fleet as Marines, protecting the fleet's ships against boarders and assaulting Imperial ships if the opportunity arises. Other SpecForces provide base security, guarding the Alliance High Command Center against sudden attack. (The troopers assigned to guard Hoth Base are SpecForces.)

SpecForce troopers are trained to go anywhere, use any equipment, and succeed at any assignment. Some have been trained in covert operations, acting as assassins, couriers, counter-intelligence, or the like. Others are Pathfinders, trained to scout out a planet, locate likely places to stage an invasion, and then land secretly, place landing beacons, and protect the landing zone (LZ) until the regular troops arrive.

Still others are specially trained guerrilla recruiters, who land on a planet and recruit natives to fight against the Empire, leading the natives in battle until they are capable of taking over the operations themselves.

## Organization

The key to SpecForce's flexibility is its unique command structure, allowing virtually any composition of troops and equipment with minimum confusion and friction.

When not engaged in combat, SpecForce is organized in divisions, regiments, companies, platoons and squads, similar to the Imperial armed forces. However, they rarely operate in these formal groups in the field. Instead, in battle, SpecForce soldiers are organized into task forces, consisting of as many soldiers and as much equipment as is necessary to complete the job.

## Special Forces Classifications

In addition to standard combat training, which they all receive, each regiment within a SpecForces division receives additional training in a specialty. When creating a task force, the commander can combine regiments or elements of regiments into a single force, thus gaining troopers with the specialties he believes appropriate to the situation.

Following is a list of some of the special training given to SpecForces regiments, and the equipment generally available to those regiments.

### Marine SpecForces

Marine regiments are trained to fight on-board ships, either to repel boarders or to board and take over enemy vessels. Marines receive special training in 0-gee and space suit/battle-suit combat, corridor fighting, hand-to-hand combat, space survival, and some starship repair skills.

Marines are typically armed with blaster pistols, rifles, grenades and vibroknives. A platoon might have access to a light or medium repeat blazer, but these weapons are generally too powerful to employ inside a spaceship, where rupturing the ship's hull would be as dangerous to the Marines as it would be to the enemy.

Marines are also equipped with space suits. They have access to the few battle suits the Alliance has available.

### Pathfinders

These troopers make covert drops onto an enemy planet, establish a beachhead, and hold until relieved by Alliance ground forces.

This is an extremely dangerous undertaking. It is quite difficult to insert a large number of troops or heavy weapons onto an enemy planet without



**P**athfinders making night paradrop landing — an extremely dangerous maneuver.

being detected; traveling light, the Pathfinders rely upon surprise to overwhelm resistance.

If surprise is achieved, a small number of men can wreak havoc upon a larger force — for a while, anyway. However, as the enemy gets organized and brings his strength to bear, the Pathfinders soon find themselves in real trouble. If not relieved, the Pathfinders risk annihilation.

To accomplish their missions, Pathfinders are trained in survival, alien races, repulsorcraft operation, and combat skills. They are equipped with blaster rifles, grenades, heavy weapons,

### SPECFORCES MARINES

<b>DEXTERITY: 2D+2</b>	<b>PERCEPTION: 2D+2</b>
Blaster: 3D+1	Command: 3D+1
Brawling Parry: 3D	Search: 3D
Dodge: 3D	<b>STRENGTH: 2D+2</b>
Grenade: 3D+1	Brawling: 3D+2
<b>KNOWLEDGE: 1D+1</b>	Stamina: 3D+1
Survival: 2D	<b>TECHNICAL: 1D</b>
Technology: 2D	Medicine: 2D
<b>MECHANICAL: 1D+2</b>	Security: 2D
Starship Gunnery: 2D+1	
Starship Repair: 2D	

### SPECFORCES PATHFINDERS

<b>DEXTERITY: 2D+2</b>	<b>PERCEPTION: 2D+2</b>
Blaster: 3D+1	Command: 3D+2
Dodge: 3D	Hide/Sneak: 3D+1
Grenade: 3D+1	Search: 3D
Heavy Weapons: 3D	<b>STRENGTH: 2D+1</b>
<b>KNOWLEDGE: 2D</b>	Brawling: 3D+2
Survival: 3D	Climb/Jump: 3D
<b>MECHANICAL: 1D+1</b>	Stamina: 3D+1
Stamina: 3D+1	<b>TECHNICAL: 1D</b>
Repulsorlift Op: 2D+1	Demolition: 2D
	Medicine: 2D+1

survival gear, and, if space allows, repulsorcraft.

**Urban Guerrillas**

These SpecForce soldiers are trained in urban warfare — streetfighting. They are expert at using the constricted urban terrain to its best advantage, and, in their special environment — the streets, buildings and sewers — they are able to take on many times their number of enemy troops.

For urban soldiers, the emphasis is upon making do with the materials at hand. They do not expect to fight formal engagements, supported with heavy weapons, repulsortanks, and the like. Instead, they employ hit-and-run tactics, sniping at the attackers from the rooftops, lobbing homemade explosives from dark alleys, and making their way to a new position before the enemy can pin them down.

Guerrilla troopers are trained experts in hand-to-hand combat skills, light weaponry, street savvy, stealth, and demolition.

**Wilderness Fighters**

Wilderness SpecForce troopers are trained in outdoor combat and survival. Like the urban guerrillas, they learn to use their terrain to its greatest advantage to foil overwhelming numbers. Because wilderness combat usually requires much greater mobility than urban warfare, wilderness troopers are often trained and equipped with repulsorcraft — speederbikes, skiffs, repulsortanks, or whatever else is available and appropriate to the mission.

Wilderness troopers receive general training in all types of terrain; in addition, individual brigades receive special training in one particular terrain type: arctic, aquatic, forest, mountains, and the like.



**U** rban-trained SpecForce unit assaults Imperial repulsortank.

**Technicians**

These troopers are trained to operate and repair any equipment the SpecForce units have — and to build anything they don't out of available materials. Techs do not usually operate as a unit. Instead, individuals are attached to other units to take charge of their equipment.

Though primarily mechanics and engineers, they must also have combat and survival skills. When not patching a comm unit together with "spit and plasticord," the techs fight as well and as hard as their comrades.

**SPECFORCES URBAN SPECIALISTS**

<b>DEXTERITY: 2D+1</b>	<b>PERCEPTION: 2D+2</b>
Blaster: 3D+1	Command: 3D+1
Dodge: 3D	Hide/Sneak: 3D+2
Grenade: 3D	<b>STRENGTH: 2D</b>
Melee: 3D	Brawling: 3D
Melee Parry: 3D	Climb/Jump: 2D+2
<b>KNOWLEDGE: 2D+1</b>	Stamina: 3D
Streetwise: 3D+2	<b>TECHNICAL: 1D+1</b>
Technology: 3D	Demolition: 3D
<b>MECHANICAL: 1D+1</b>	Medicine: 2D
Repulsorlift Op: 2D	

**SPECFORCES WILDERNESS**

<b>DEXTERITY: 2D+1</b>	<b>PERCEPTION: 2D+2</b>
Blaster: 3D+1	Command: 3D+1
Dodge: 3D	Hide/Sneak: 3D+2
Grenade: 3D	<b>STRENGTH: 2D</b>
Heavy Weapons: 3D	Brawling: 3D
Melee: 3D+2	Climb/Jump: 2D+2
<b>KNOWLEDGE: 2D+1</b>	<b>TECHNICAL: 1D+1</b>
Survival: 3D+2	Demolition: 3D
Technology: 3D	Medicine: 2D
<b>MECHANICAL: 1D+1</b>	
Repulsorlift Op: 3D	





**S**pecForce Techs often operate at the very front line of battle.

### Infiltrators

These are the eyes and ears of the SpecForces. They are trained to slip through the enemy's lines in order to sow confusion and consternation in secure areas. Infiltrators are masters of stealth, able to foil most mechanical and human security measures.

Chosen from those in the Alliance with the most reason to hate the Imperials, their weapons are the vibroknife and the garrotte. With good reason, they are among the most feared of all the SpecForce troopers.

### Heavy Weapons Specialists

These troopers are trained to operate heavy weapons, providing protection against enemy air and ground vehicles and giving friendly forces

the extra punch needed to crack a tough position.

In battle, casualty rates in these units are extremely high — once a heavy weapons battery has revealed its position, the enemy is likely to concentrate all of his energy upon suppressing it. In training, heavy emphasis is placed upon holding your position at all costs; a heavy weapons crewman would rather die than abandon his gun.

Heavy weapons specialists also receive training in starship gunnery. When stationed with the Fleet, they stand ready to replace any gunners incapacitated in battle.

### Other Specialists

Additional classes of SpecForce troopers include: transportation specs (drivers and mechanics), pilots, communications experts, translators, medical technicians, supply specialists (commonly known as "scroungers"), and others.

General Madine, the commander of the Alliance SpecForces, has claimed, "In half an hour I can put together a strike team of 20 men, capable of succeeding at any mission, under any conditions, anywhere in the galaxy."

So far, he has not been proven wrong.

### Sector Forces

While the Alliance Forces are mobile, fighting the Empire wherever and whenever Alliance High Command sees fit, the Sector Forces are static. They fight the Empire in their sector of space. They fight it on a daily basis, for miniscule gains and potentially catastrophic losses. Their defeats — and victories — often go unnoticed and unrecorded.

And if successful, their success may simply drive the Empire to greater efforts to destroy them. Having little or no space transport, of necessity based in a single system, they are

#### SPECFORCES TECHNICIANS

<b>DEXTERITY: 2D</b>	<b>STRENGTH: 1D+2</b>
Blaster: 2D+2	Brawling: 2D
Dodge: 3D	Lifting: 2D+2
<b>KNOWLEDGE: 2D+1</b>	Stamina: 2D
Survival: 3D	<b>TECHNICAL: 2D+1</b>
Technology: 3D+2	Comp. Prog./
<b>MECHANICAL: 2D</b>	Repair: 3D+2
Repulsorlift Op: 3D+1	Demolition: 3D
<b>PERCEPTION: 1D+2</b>	Droid Prog./
Command: 2D+1	Repair: 3D+2
Hide/Sneak: 2D	Repulsorlift
	Repair: 3D+2

#### SPECFORCES INFILTRATORS

<b>DEXTERITY: 2D+2</b>	<b>PERCEPTION: 2D</b>
Blaster: 3D	Con: 3D+1
Brawling Parry: 3D	Hide/Sneak: 3D+2
Dodge: 3D	Search: 3D
Melee Parry: 3D+2	<b>STRENGTH: 2D</b>
Melee: 3D+2	Brawling: 3D
<b>KNOWLEDGE: 2D</b>	<b>TECHNICAL: 1D+2</b>
Streetwise: 3D+1	Demolition: 2D+2
Survival: 2D+2	Security: 2D+2
<b>MECHANICAL: 1D+2</b>	
Repulsorlift Op: 2D+1	



Allen Nurnis

**I**nfiltrators are among the most feared of all the SpecForce troopers.

sitting targets and the planets in their systems can be held hostage against their actions. A Sector Force which is *too* successful may drive the Empire to destroy by orbital bombardment planets suspected of collaboration.

### Creation of Sector Forces

Like their political opposites, the Allied Commands, Sector Forces are created out of whatever resistance organization is in place when the sector is recruited into the Alliance, built out of whatever manpower, equipment, and level of commitment is available. Some SecForces are

#### SPECFORCES HEAVY WEAPONS CREW

<b>DEXTERITY: 2D+2</b>	<b>PERCEPTION: 1D+2</b>
Blaster: 3D	Search: 3D
Heavy Weapons: 3D+2	<b>STRENGTH: 2D</b>
<b>KNOWLEDGE: 1D+2</b>	Brawling: 2D+2
Survival: 2D	Lifting: 3D
Technology: 2D+2	Stamina: 2D+1
<b>MECHANICAL: 2D</b>	<b>TECHNICAL: 2D</b>
Repulsorlift Op: 2D+1	Demolition: 2D+2
Starship Gunnery: 3D	Medicine: 2D+1



Allen Nurnis

**H**heavy weapons crewmen generally suffer the highest casualty rates among Special Forces units.

powerful, smoothly-integrated military units, with complete ground, air, and space forces at their command. Other units are mere shells or fragments, with perhaps several thousand part-time guerrillas and a few motley spacecraft — if that.

Though, by treaty, they have the right, the Alliance military has neither the time nor the resources to mold every sector's forces into a smoothly-integrated machine and bring it up to full power. Instead, it concentrates its efforts upon ensuring that its interface with the sector — the Sector Forces Command — has a sound basic understanding of the Alliance's military objectives, strategy and tactics and has sufficient communications to keep in contact with the Alliance Command. Beyond that, unless the sector warrants the commitment of Alliance-supplied material such as starfighters, the Sector Forces are allowed to set up their own structure and use their assets however they see fit.

There have been cases where Alliance Sector Command has stepped in and completely reorganized a Sector Force's command structure because it was highly incompetent, corrupt, or riddled with Imperial spies, but these instances have been rare — the Alliance simply does not have the resources, and the last thing it needs to get embroiled in is a power struggle with an entrenched military organization.

Usually, if a Sector Force is not trusted, the Alliance merely does not commit any starfighters, men, or secret intelligence to it. When the Sector



## General Madine's Report on Operation Cobolt

**To:** Commander in Chief, Alliance Forces  
**From:** Commander, Alliance Special Forces  
**Regarding:** Operation Cobolt

### **Commander Mothma:**

Operation Cobolt commenced yesterday, 02500 hours, as scheduled. The Infiltrators, posing as crew of an Imperial resupply ship, successfully docked at the base and began off-loading the dummy cargo.

The starfighter attack commenced at 02510 hours, engaging the enemy's picket and patrol craft, damaging or destroying at least three ships without sustaining any appreciable damage in return. The enemy scrambled its TIE fighters by 02512, at which point the starfighters began a fighting withdrawal, leading the TIEs several thousand kilometers from their base.

At 02514, the Infiltrators attacked the security forces and successfully disengaged the shielding, the communications systems, and the gun positions. The assault shuttle impacted the cargo bay area by 02515; the area was secured and an airlock in position by 02519.

The transport arrived at 02521, two minutes behind schedule because of a navigational error in the hyperspace jump. The assault teams were disembarked by 02523; they began their attack at 02525.

White Team reached its objective, the Intelligence Center, by 02528, against negligible resistance. The sandoc decoding computer was loaded by 02536, one minute behind schedule. Resistance had stiffened as the Imperials began to get organized; Red Team was dispatched to their assistance. Remnants of both teams returned to the cargo bay at 02540.

Black Team reached the power station at 02531; the station was disabled by 02533. As they were completing their assignment, Black Team was attacked and overwhelmed by vastly superior numbers of enemy troops, the majority of them stormtroopers.

The Marines at the cargo bay held the perimeter against mounting enemy pressure, attempting to give survivors a chance to escape. When the starfighter coordinator announced that the enemy's TIE fighters were on their way back to the base, our forces retreated to the assault shuttle and the transport, exiting the base at 02546. The ships entered hyperspace by 02550.

According to Intelligence reports, without power, the Imperial base entered Mantooine's atmosphere and broke up by 02740. It is unknown whether the Imperials discovered — or lived to report — the theft of the computer.

Our losses were as follows: 13 starfighters destroyed; all pilots missing and presumed dead. Four starfighters heavily damaged but hyperspace-worthy. One of the pilots, Commander Nin Nemb, badly wounded, heroically brought his damaged ship back to rendezvous point, but died before he could be treated. Sixty-eight soldiers missing, presumed dead — including the entire Infiltrator team and all of Red Team — out of a force of 110 Special Forces troopers. I sorrow to report that Colonels Toombs and Seertay fell in the action; with your permission I will recommend them for posthumous promotion and commendation.

With respect,  
 General Madine  
 Commander,  
 Special Forces

Force eventually falls apart, as it inevitably does, Alliance Command then steps in and rebuilds it from scratch. These draconian measures can be cruelly hard upon the often innocent resistance fighters in the Sector under the incompetent leadership, but, given the scale of the conflict, there is nothing else to be done.

## Organization of Atrivis Sector Forces

Sector Forces vary from sector to sector due to available resources, Imperial and Alliance interest in the sector and the manner in which the SecForce was created. Therefore, it would be

pointless to describe the "ideal" Sector Force simply because none of them would exactly match the designated standards. However, as much as any, Atrivis represents a typical Alliance SecForce, and serves as a useful model (see diagram, page 44).

### Growth of Atrivis

The Atrivis Sector Force was created out of the Atrivis Resistance Group, which in turn came out of the alliance of two smaller groups based upon Fest and Mantooine.

When the ARG formally joined the Alliance, Alliance Sector Command sent an advisory unit, consisting of officers specializing in command

organization and communication, to help the ARG set up a liaison office with SecCom. They also sent several dozen SpecForces drill officers to give ARG's fighters rudimentary training in guerrilla operations. At the same time, Alliance technicians, engineers and pilots came to oversee the construction of the starfighter docks and communications equipment upon Generis base.

Within six months, Atrivis was a fully-operational Sector Force.

### Commander-in-Chief, Atrivis Sector

Travia Chan is the commander-in-chief for Atrivis Sector. A frail, aging woman, confined to a repulsorchair by a childhood illness, she hides within her weak frame a sharp mind and iron determination.

Chan was one of the original founders of the Fesl Resistance Group and then, later, the principle architect of the marriage of Fesl to the Mantooine Liberators, creating the ARG and becoming its first and only military commander. She naturally maintained that position when ARG joined the Alliance.

Despite — or perhaps because of — her physical infirmities, Chan is a fine theoretical strategist, able to judge the most complex and dangerous military situation coolly and without emotion. Her enemies call her the "Icewoman."

### Chief of Staff

Loom Carplin is Chan's chief of staff. Highest surviving founding member of the Mantooine "Liberators," Carplin is about as different from

### TRAVIA CHAN



Allen Numis

<b>DEXTERITY:</b> 1D	<b>PERCEPTION:</b> 4D
<b>KNOWLEDGE:</b> 4D	Bargain: 5D+2
Alien Races: 5D+1	Command: 6D
Bureaucracy: 4D+2	Con: 5D+1
Technology: 4D+2	<b>STRENGTH:</b> 1D
<b>MECHANICAL:</b> 3D	<b>TECHNICAL:</b> 3D+2
	Comp. Prog/ Repair: 3D+1

Chan as is possible. Big, bluff, immensely strong, Carplin looks every inch the warrior that he is.

Carplin's main job is to act as Chan's eyes and ears in the field. Chan's disability keeps her firmly tied to Generis base and its medical facilities; Carplin travels constantly from outpost to outpost, checking up on the soldiers and personally taking charge of difficult missions.

When Carplin is off Generis base on a mission, his assistant, a Wookiee named Busurra, acts as

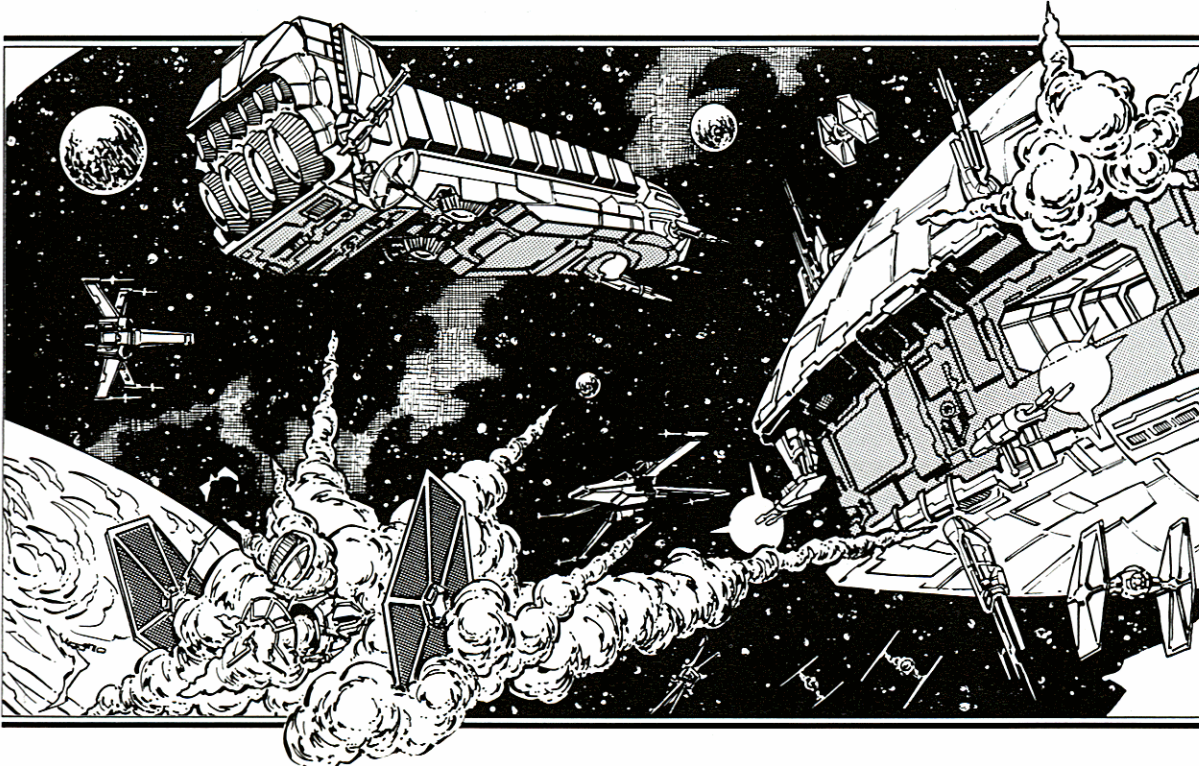

Allen Numis

chief of staff in his place. Busurra is another cripple — blind in one eye and missing three fingers from his left hand as a result of Imperial torture. Despite his mutilation at the enemy's hands, Busurra is surprisingly mild-mannered and good-natured. For a Wookiee, he is an amazingly good organizer and administrator. Because many humans have difficulty understanding his speech, Busurra is always accompanied by his translator, a protocol Droid named C3-L1.

**Starfighter Command**

Atrivis Sector's complement of starfighters is based out of Generis base, offering protection to both the Sector Headquarters and the Outer-Rim Communications link.

Atrivis' starfighters do not provide much of a punch to the Alliance forces in the sector. On paper, Atrivis Sector is equipped with a full wing of 36 starfighters, but, in reality, Sector HQ can rarely put more than 18 into an offensive operation at one time.

There are a number of reasons for this. First, Sector Command has decreed that six starfighters must always stand ready — fully fueled and armed, with pilots nearby, able to be launched within 45 seconds — to defend the base against Imperial attack. The Communications Link is too important to the entire Outer Rim command structure to risk losing it to a lightning raid, no matter how unlikely such a raid is.

Second, Starfighter Command is often calling for the donation of one or more flights for operations outside of the sector. These missions

**LOOM CARPLIN**



<b>DEXTERITY: 3D+2</b>	<b>PERCEPTION: 3D+2</b>
Blaster: 5D	Bargain: 4D
Brawling Parry: 4D+1	Command: 5D+2
Dodge: 4D+2	Con: 4D
Grenade: 4D	Hide/Sneak: 4D+2
Heavy Weapons: 4D	Search: 4D+2
<b>KNOWLEDGE: 2D</b>	<b>STRENGTH: 4D</b>
Bureaucracy: 3D+2	Brawling: 4D+2
Languages: 2D+2	Climb/Jump: 4D+2
Planetary Systems: 3D	Stamina: 4D+1
Streetwise: 3D+2	Swimming: 4D+2
Survival: 4D	<b>TECHNICAL: 2D+1</b>
Technology: 3D	Demolition: 4D
<b>MECHANICAL: 2D+1</b>	Medicine: 3D+1
Repulsorlift Op: 3D+1	Security: 3D+2

Allen Nunis

**Atrivis Sector Forces Organization**

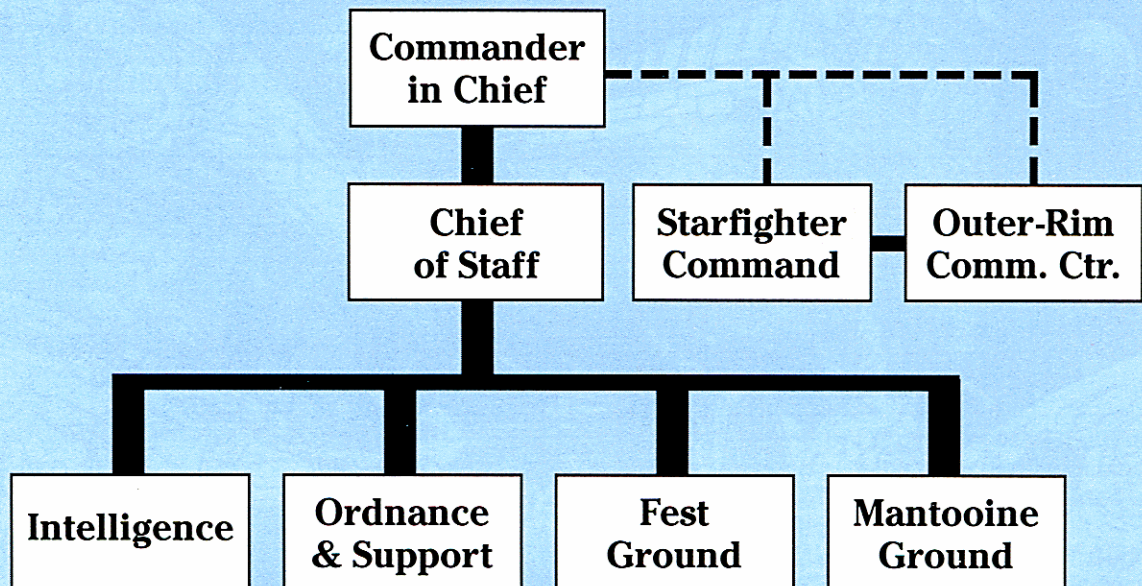

Stephen Crane

**BUSURRA**



Allen Nunis

<b>DEXTERITY: 2D+2</b>	<b>PERCEPTION: 2D</b>
Blaster: 3D	Bargain: 4D
Brawling Parry: 4D	Command: 4D+2
Dodge: 4D+1	Search: 3D+1
Heavy Weapons: 3D+2	<b>STRENGTH: 5D</b>
Wookiee	Brawling: 6D+2
Bowcaster: 4D+2	Climb/Jump: 5D+2
<b>KNOWLEDGE: 2D</b>	Lifting: 5D+1
Alien Races: 3D	<b>TECHNICAL: 3D+1</b>
Bureaucracy: 4D+1	Demolition: 4D+2
Cultures: 3D+1	Medicine: 4D
Languages: 3D+1	Security: 5D
Planetary	Starship
Systems: 3D	Repair: 3D+2
Streetwise: 2D+2	
Survival: 4D	
Technology: 3D+2	
<b>MECHANICAL: 2D</b>	
Astrogation: 3D	
Repulsorlift Op: 2D+2	
Starship Gunnery: 3D	
Starship Piloting: 3D	
Starship Shields: 3D	

are, of course, critically important to the war effort, but they can also denude Atrivis Sector of firepower at inopportune moments.

Third, the base itself is woefully under equipped in both mechanics and spare parts. In its original incarnation, Generis base was not designed to house starfighters, and maintenance facilities are primitive, to say the least.

On top of all that, there are only 20 or so competent Alliance starfighter pilots in the entire Sector. Flying a starfighter is not something you just pick up; it requires months — if not years — of training and actual flight time. Sector HQ is required to supply all of the Sectors in the Alliance with trained pilots; apparently, there are other sectors with a more pressing need.

The being in charge of wresting some offensive punch from this nightmare is one Wing Commander Varth, a bitter, taciturn disciplinarian. Varth is cordially hated by his pilots, who only put up with him because he is a brilliant soldier

whose flawless tactics have kept them alive and victorious against terrible odds.

Varth's position in the Atrivis chain of command is somewhat ambiguous, to say the least. He is under the control of the Sector commander-in-chief, Trav, for offensive operations in Atrivis. Yet, he is also directly answerable to Alliance Sector Command for the protection of the Outer-Rim Communications center — and to Alliance Starfighter Command for combined operations with other sectors' starfighters. This might easily explain his — or anyone's — sour disposition.

**WING COMMANDER VARTH**



Allen Nunis

<b>DEXTERITY: 3D</b>	<b>PERCEPTION: 3D</b>
Blaster: 3D+2	Bargain: 3D+2
Dodge: 4D	Command: 5D+2
<b>KNOWLEDGE: 2D</b>	<b>STRENGTH: 3D</b>
Bureaucracy: 4D+1	Brawling: 3D+2
Languages: 3D+2	Stamina: 4D
Planetary Systems: 4D	<b>TECHNICAL: 3D</b>
Survival: 2D+2	Comp. Prog./
Technology: 4D+2	Repair: 4D
<b>MECHANICAL: 4D</b>	Medicine: 4D+2
Astrogation: 5D	Security: 3D+1
Starship Gunnery: 6D	Starship
Starship	Repair: 5D+2
Piloting: 6D+2	
Starship Shields: 6D	

**Outer-Rim Communications Center**

The Outer-Rim Communications Center is located on Generis base, along with Sector HQ and the Sector's starfighter base. ORCC is not, strictly speaking, part of Atrivis Sector Force at all — it answers directly to Alliance Sector Command for everything except for matters relating to security, manpower and supplies, which are controlled by Atrivis Sector HQ.

ORCC is commanded by General Kryll, an Imperial officer who defected to the Alliance when he heard of the destruction of Alderaan by the Death Star. Kryll maintains a stern military bearing, a legacy from his Imperial service, softened somewhat by his penchant for singing old spacers'

songs off-key in the base's bar when not on duty. In lighter moments, he claims that he defected not because of Alderaan, but because the Imperial officers corps didn't appreciate his fine tenor voice.

### Intelligence

Intelligence is a small but extremely important branch of the Atrivis Sector Forces. Intell is responsible for keeping tabs on Imperial activities within Atrivis and keeping the Imperial Intelligence units from infiltrating Atrivis Sector Forces.

Intell uses a variety of methods to fulfill its mission — infiltration, passive and active communications monitoring, blackmail, bribery, theft, and other, even less savory means. For more details on Alliance Intelligence, see Chapter Two.

### Ordnance and Support

This department keeps the Atrivis Forces supplied with weaponry, food, and equipment. It is in charge of providing transport, maintenance, medical, Droids, and virtually all other material and services for the combat units in the sector.

Also, Atrivis Sector is a prime supplier of food for the Alliance Armed Forces. SecOrd is respon-

sible for gathering the food from farms and factories scattered across the sector and processing and storing it for periodic pickup by Alliance transport ships.

SecOrd is not a glamorous service branch, but it can be extremely dangerous, nonetheless. The Imperials are not unaware of Atrivis's role as food supplier to the Alliance Fleet, so they employ highly-toxic defoliants to ruin farms which are suspected of collaboration with the enemy. It takes a tremendous amount of courage for the poor farmers of Atrivis to risk their land and the lives of their families for something as nebulous as the Rebellion.

Ord medics, who accompany their military forces into combat to aid the wounded, will expose themselves to extreme danger to rescue a soldier fallen in sight of the enemy. In many operations, they have suffered a higher casualty rate than the soldiers themselves.

### Fest Ground Forces

These are the combat forces operating on the planet of Fest and in the nearby systems. Fest is a densely-populated planet, with few wilderness areas available for guerrilla operations. Thus, the Fest Alliance Forces are streetfighters (the Imperials call them "terrorists"), disrupting Imperial communications and supplies, hitting barracks, bombing power stations, and, generally, attempting to make control of the planet more expensive than it is worth. Essentially, they are willing to turn their planet into an Urban wasteland to deny its resources to the enemy.

Because Fest is an urbanized planet, complete with spaceports, spy satellites and an Imperial base in high orbit, getting men, supplies and equipment on and off-planet is extremely difficult, slow and dangerous. Communications between dispersed Fest armed units is also dangerous — most land communications lines are suspect, and the Imperial satellite monitors random comm unit frequencies.

Because of this, most resistance units on Fest are on their own. They are assigned "hunting preserves" within which they do what they will, with only occasional communication and cooperation between units in different preserves.

### Fest Commando Units

An average Fest commando unit consists of between five and 20 men and women under a command team with a commander, second in command, intelligence officer, and supply officer. Most are part-time soldiers, law-abiding citizens during the day, fighting the Empire at night.

The unit's base of operations is a small chamber in a sub-basement of an abandoned warehouse, wherein the unit's weapons, supplies, and

### GENERAL KRYLL



Alien Numis

<p><b>DEXTERITY: 2D+2</b> Blaster: 3D+1 Heavy Weapons: 3D+2 Melee Parry: 3D Melee: 3D+2 <b>KNOWLEDGE: 3D</b> Alien Races: 3D+2 Bureaucracy: 4D Cultures: 3D+1 Planetary Systems: 4D+1 Technology: 4D <b>MECHANICAL: 3D+2</b> Astrogation: 4D Starship Piloting: 4D</p>	<p><b>PERCEPTION: 3D+1</b> Command: 4D Gambling: 4D <b>STRENGTH: 2D+1</b> <b>TECHNICAL: 3D</b> Comp. Prog./ Repair: 3D+1 Security: 3D+2</p>
------------------------------------------------------------------------------------------------------------------------------------------------------------------------------------------------------------------------------------------------------------------------------------------------------------------------------------	-------------------------------------------------------------------------------------------------------------------------------------------------------------------------

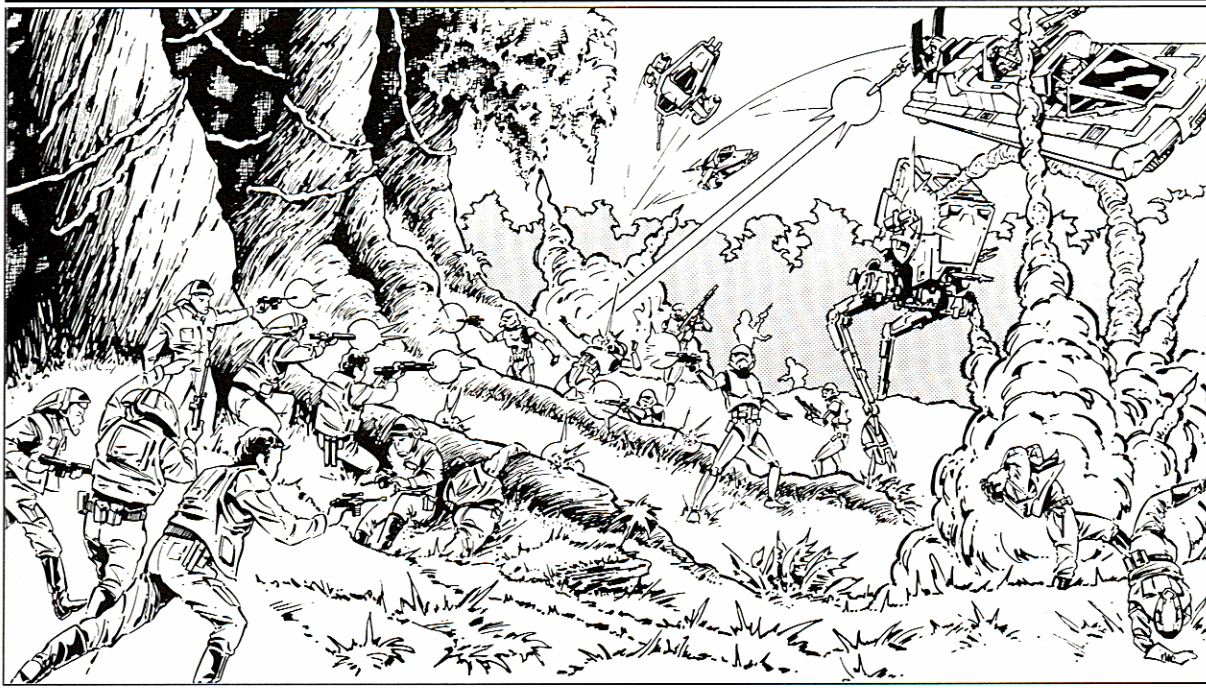

Allen Nunis

communications equipment is stored.

The unit performs perhaps one to three raids a month, hitting whatever target offers the greatest opportunity for the smallest risk.

From time to time, a unit may receive a message from High Command, ordering them to attack a specific target or to meet with one or more other units to perform a combined operation. These messages are passed via, of all things, the planet-wide entertainment holo-network, coded into local news programs by newscasters secretly in the Alliance.

A favorite target of the Fest underground is the planetary government, particularly the citizens of Fest working with the Imperials. In the Resistance's mind, it is bad enough to oppress people of another planet; it is far worse to help others oppress your own people.

The Fest police force, the most visible arm of the Fest collaborationist government, are never safe from attack. Desertion from the force has reached epidemic proportions, forcing the Fest military to take over much of their functions.

### Mantooine Ground Forces

Mantooine is in a much different situation from Fest. The planet is lightly populated, with most of the people concentrated in several cities in the southern continent. In addition, Mantooine is less important to the Imperials, and they devote less resources to it, allowing the Mantooine "Liberators" to operate with much greater freedom than their opposites in Fest.

The Liberators maintain an army in Mantooine.

Several thousand Rebels, organized into companies, regiments, and even divisions, occupy the mountainous regions near the cities, battling the government army raised to oppose them.

The government army is composed mostly of locals drafted into service at gunpoint, commanded by Imperial officers. They far outgun the Liberators and are better supplied and equipped, but their morale is terrible. If supplied with overwhelming air and artillery support, they can drive the Liberators from the field; if not, they lose.

As with virtually every other armed force in the Alliance, supplies and communications are the Liberators' biggest problems. With the farmers in the wilderness on their side, the Liberators can usually get enough to eat, but they are always critically short of weapons, ammunition, transport, medical and communications equipment, and the other impedimenta of war.

The Liberators have a few primitive factories hidden in smaller villages friendly to their cause, and Sector Ordnance and Supply sends what it can, but this provides only a fraction of their needs. The rest must be stolen from the enemy. The government army's supply dumps are always the first target in battle.

Because of the Liberators' success in the field, the Mantooine government has pretty much conceded the countryside to them, concentrating all of their efforts upon protecting the major cities. The Liberators are gathering their forces, saving up supplies and weapons and intensifying their recruiting and training efforts, in anticipation of the coming great battles for the cities.





# Chapter Four Combat Starships

## My Beloved Friend:

Following are the orders assigning you to command of the Alliance Fleet.

*I am well aware of your reluctance to assume this position of extreme importance to our cause, but in these desperate days, many are forced to take upon themselves more responsibility than they desire.*

*Forgive me. I have given you perhaps the most difficult command in the galaxy. Your "fleet" is small, untrained, ill-supplied, and woefully inadequate for the trials ahead of it. Turning this mob into an effective weapon will take extraordinary courage, patience, and skill. You can do it. You are the finest commander I have ever had the privilege to meet. Admiral, I have the utmost confidence in you.*

*Ackbar, my hopes and prayers are with you. I know you cannot fail us.*

*May the Force be with you.*

*Mon Mothma*

## Orders This Day:

**From:** Mon Mothma, Commander-in-Chief, Alliance Armed Forces

**To:** Admiral Ackbar, Commander, Alliance Fleet

**Admiral:** You are hereby requested and required to proceed by fastest available means to the Telaris system and assume command of the Alliance fleet. Once in command, you will do the following:

1.

### Avoid Battle:

Under *no* circumstances is the Fleet to engage the enemy. If the

Fleet is discovered, you are to evacuate the system immediately. If attacked, you are to retreat, abandoning supplies and equipment as necessary to ensure the Fleet's escape.

This order specifically requires you to abandon the Alliance base upon Hoth if it is discovered and attacked. The Alliance can survive the loss of either the Fleet or the headquarters; it cannot survive both.

2.

### Send a Detailed Report upon the State of the Fleet.

3.

### Complete the Training of the Fleet:

The individual beings under your command are without a doubt the finest soldiers in the galaxy. However, they are not at all experienced in fleet combat. You must teach them to work together as a team. The Fleet is a collection of ships: you must turn it into a weapon which can challenge the Empire's navy.

We expect your command to more than treble in size within the next year; those currently in the Fleet must form the cadre of the larger force.

4.

### Reorganize Fleet Replenishment:

As we are painfully aware, Fleet supply is inadequate, with less than

a month's worth of food and fuel on hand. We can do little to correct this. What few freighters we have are already assigned to the Fleet; there's nothing more. You must somehow find a way to increase efficiency or reduce consumption.

I know that training requires the expenditure of a good deal of fuel. However, under no circumstances are you to reduce your available supplies to below two weeks. You *must* have enough fuel on hand at all times to be able to maneuver.

5.

### Maintain a High Level of Morale in Your Command:

This is perhaps the most difficult assignment of all.

These are young, high-spirited beings. You must convince them that they are the best soldiers in the galaxy, that "a good Rebel can whip ten Imperials any day." But, at the same time, you have to teach them to wait. You will be on the run for at least the next year, and possibly longer. Under those circumstances, it is easy for even the best troops to become stale, to be infused with a sense of inferiority. You must keep them sharp, itching for the fight, but willing to wait for the right moment.

Patience is perhaps the hardest lesson for new troops to learn. You *and I have spent years in this battle.* We understand the risks involved and we know that time is on our side. Somehow, you must pass this along to those underneath you.

6.

**Organize Raiding Forces:**

As events in the galaxy warrant, you will be required to detach up to four ships from the line and appropriate escort vessels for duties outside the Fleet. Their missions will include space lane interdiction and, occasionally, combat missions against isolated Imperial capital ships. At no time will your Fleet's effective firepower be reduced by more than 25 percent by detachments.

These missions will also serve as useful live-combat training exercises for your ships and men.

7.

**Be Prepared to go to Battle within a Month's Notice:**

Currently, we have no intentions of sending your Fleet into formal battle against the Imperial Navy. All of our energies are engaged upon building up our forces and fomenting rebellion on Imperial worlds.

The only Alliance forces which are actively conducting offensive operations are the independent starfighter wings, guerrilla forces and covert ground assault units. These are, of necessity, very limited in scope.

However, we are willing to fight if the prize is large enough. The Emperor is all that holds the Empire together. Destroy him, and all will crumble.

Palpatine cannot hide in Imperial City forever. All of our activities are designed to bring him out in the open, to create situations which demand his personal attention, situations with which even Lord Vader cannot deal.

We will rip at his flanks, frighten his Moffs and Grand Moffs and encourage his most important planets to rebel. If we can, we will kill Vader. Eventually, when we become noxious enough, the Emperor will take the field himself. When he does, we will risk everything — including your command — to destroy him. You must be ready for that day.

If we are successful, the war is won. If not, the conflict will drag on for decades.

**Starship Acquisition**

The Alliance has two main sources for its growing starship Fleet: construction and defection. Of the two, the latter provides the most ships by far.

**The Mon Calamari Starship Construction Facilities**

At present, the Alliance has only one planet

with the facilities to construct capital starships: Mon Calamari. The Cal are tireless workers, driving themselves and their orbital ship-construction facilities far beyond capacity, but, even at this killing speed, they are capable of producing perhaps one frigate or corvette a month, or one cruiser every six months.

However, this is still an extremely important addition to the Alliance's arsenal, and High Com-

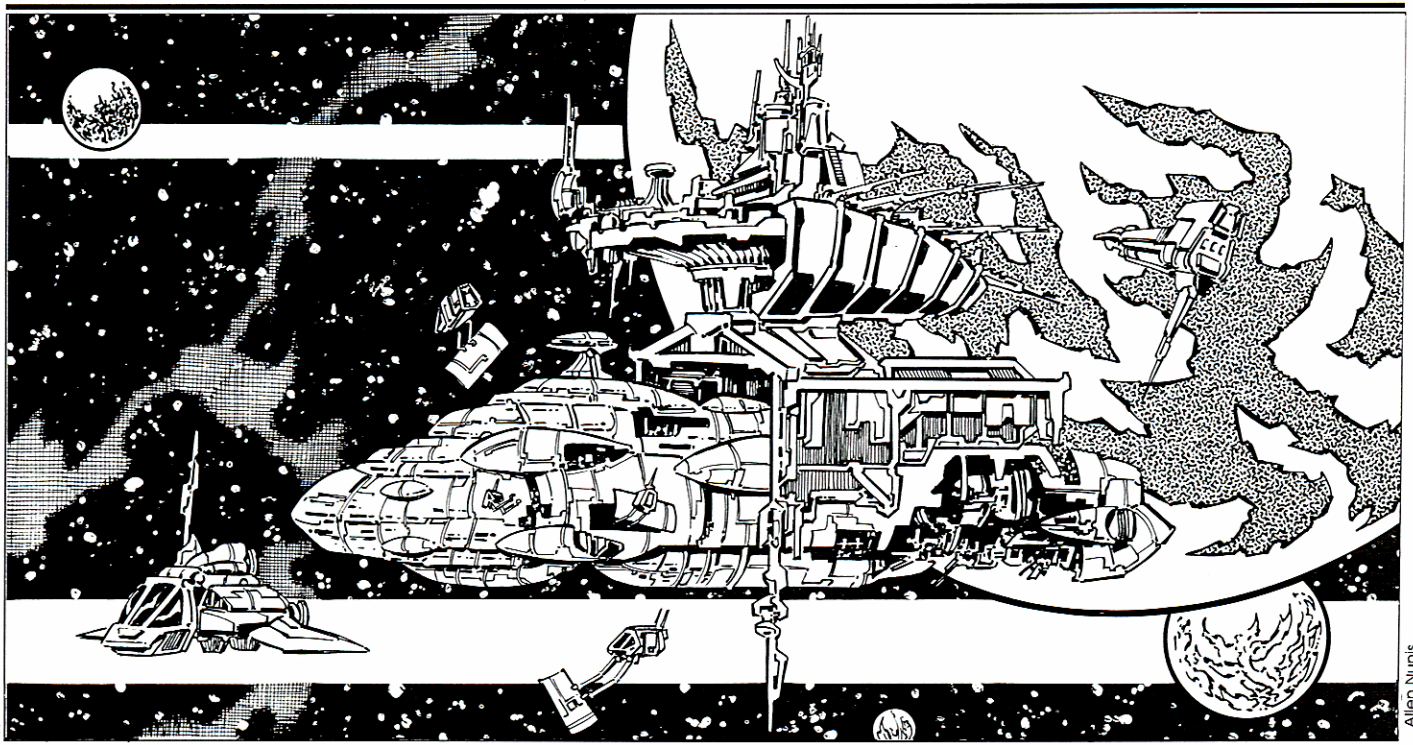

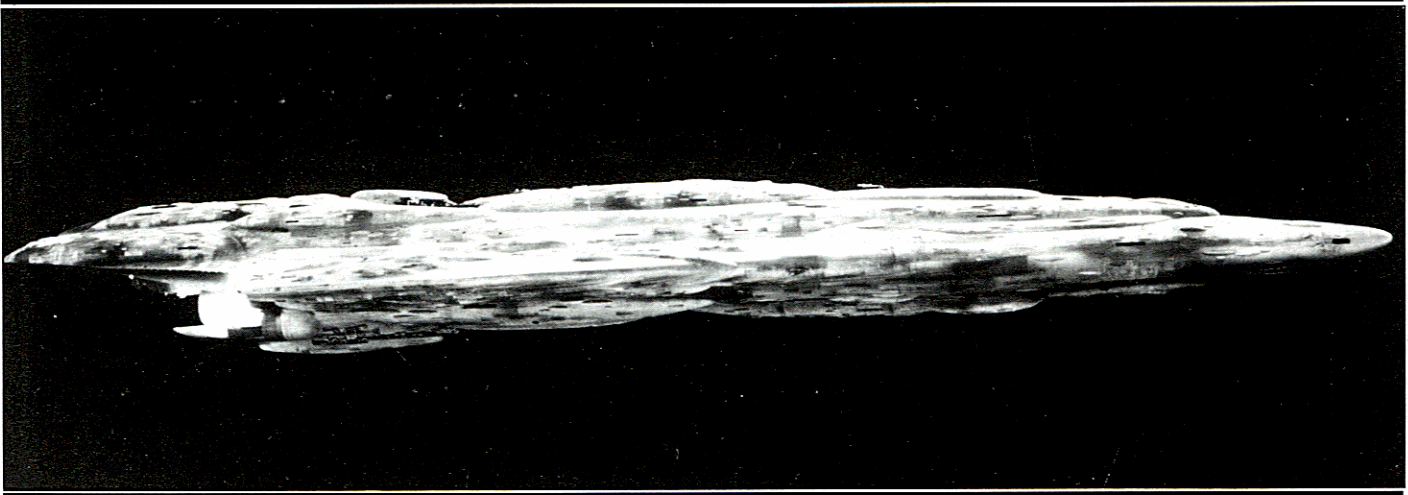

mand has done what it can to protect the Cals. The Alliance maintains a formidable presence in the Calamari system, including enough capital vessels to deal with a standard Imperial battle line or perhaps even a squadron.

But the defensive fleet could not hope to take on an Imperial attack fleet and survive. The Alliance Fleet is the only force large enough to do that, and the Fleet is too precious to risk in such a dangerously exposed position — even to defend the Mon Calamari shipworks.

It is only a matter of time before the Empire decides to deploy a fleet to shut the Mon Cals down — permanently. That the Calamaris and Quarren continue to work for the Alliance under such circumstances and at such grave risk speaks volumes about the courage and tenacity of these aquatic people.

### Defection

Quite simply, a large number of starship captains, officers and crews are fed up with the Empire — its blatant abuse of power, its growing racism against non-humans, and the ever-increasing corruption of its officials, particularly customs officers. By nature, the beings who ply the spaceways are hardy, independent types, disliking rules and regulations and unwilling to knuckle under to tyrants.

Many spacemen have no families — they have spent virtually their entire lives in space or in far-off ports, and thus have little to fear from Imperial reprisals against their home worlds. If a captain and his officers or a large enough portion of the ship's crew decide to defect with their vessel, there is little to stop them.

This, of course, is not as true for Imperial Navy spacemen. It is extremely dangerous for an Imperial ship to attempt to defect. The Imperial Navy takes a particularly dim view of their spacecraft

defecting to the enemy, and they hunt down defectors with ruthless determination.

Apparently, the Navy has begun inserting undercover agents aboard many of its ships. These agents have orders to sabotage any vessel which is seeking to defect to the Alliance; they are supposed to destroy the ship rather than let it fall into Rebel hands.

Spacebar scuttlebutt has it that this is what happened to the Imperial frigate *Liberator*. With the complicity of his crew and officers, its captain was attempting to take the vessel to a rendezvous with a Rebel force stationed in deep space near Bespin. Something happened while the ship was in hyperspace and it arrived at Bespin a complete wreck, with no survivors.

It is possible that the *Liberator* suffered a normal hyperspace accident and the Imperial Propaganda Bureau started the rumor to make Imperial vessels think twice about defecting. In either case, since the rumor, Imperial vessel defection attempts have decreased perceptibly.

### Capital Ship Tactics

Capital ship tactics have been refined through uncounted years of space combat. The moves are well known, as are the counter-moves and alternatives. The battle becomes a kind of ghastly dance of death between the combatants, and events unfold with an almost stately inevitability. From far off — where one cannot hear the screams of wounded and dying men — it is quite beautiful.

### Classification of Capital Ships

Though capital ships can vary tremendously, certain weapons and engine and shield configurations have time and again proven themselves to be the most effective in battle. Many ships share similar characteristics, even though they

may vary greatly in outward appearance.

Following are the standard Imperial classifications of capital ships; with some variations, these are also used by the Alliance and by many other spacefaring races. It should be noted, however, that the distinction between vessel types is often muddy, and individual corporations or navies may give their ships wholly inappropriate classifications.

### Starfighter

(Note that starfighters are not capital ships, but, as they are a critical component of the battle fleet, they are listed here for completeness.)

A starfighter is a one or two-man vessel designed for speed, maneuverability, and limited firepower. They are not sturdy enough to take much damage; their superior maneuverability and speed is expected to allow them to survive long enough to damage their opponents. Starfighters use swarming tactics to battle larger vessels.

Starfighters are high-performance, high-maintenance craft; they have limited ranges and carry few supplies. They must operate from bases or larger starships. Imperial starfighters are not equipped for hyperspace, but Alliance vessels are.

### Fast Attack Vessels and Patrol Craft

Fast-attack and patrol vessels are somewhat larger than starfighters and have between four and 20 crewmembers. The two types are quite similar in design; the major difference between

them is that fast-attack vessels are hyperspace-equipped, but patrol craft are not. The craft are better armed and armored than starfighters, but also usually slower and less maneuverable.

These craft are primarily employed for picket duty, or to take on armed merchanters, pirate craft, and the like. In formal engagements, they are used for defense, or to make slashing attacks against frigates and corvettes. They are too small to menace cruisers, and too unwieldy to effectively fight starfighters.

Patrol craft and fast attack vessels also are designed to operate from bases or motherships; they rarely carry much fuel or supplies.

### Corvettes

These are general-purpose vessels with crews of between 40 and 200, designed to be tough enough to withstand one or two shots from another vessel, and heavily-armed enough to take on starfighters and at least annoy frigates and cruisers. For their size, they are quite maneuverable. They are often used for systems patrol and fleet or convoy picket duty.

These vessels are hyperspace-equipped, much more durable than smaller craft, and can remain in space for months without requiring excessive maintenance or resupply.

### Frigates

Frigates are larger than corvettes, much better armed, and usually slower and less maneuverable. A frigate may carry a crew numbering up to 1000.

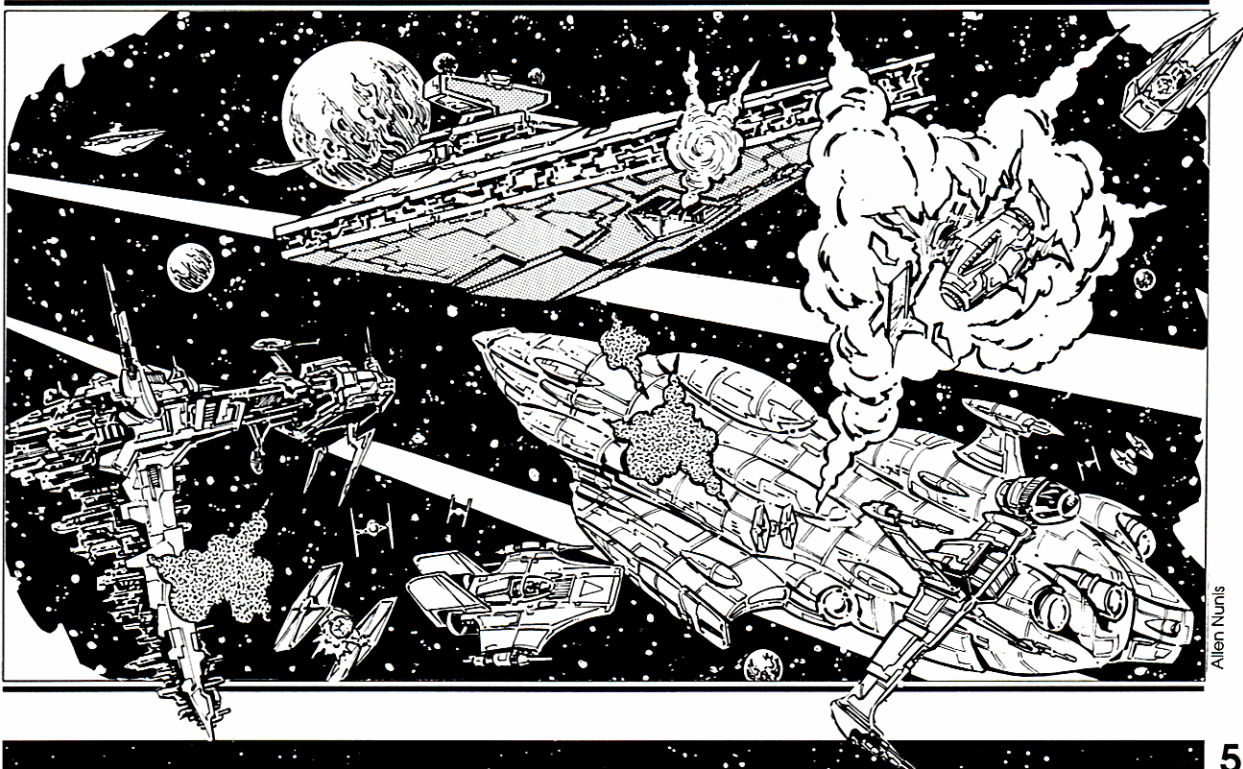

# Capitol Ship Fire Arcs

## Mon Calamari Cruiser

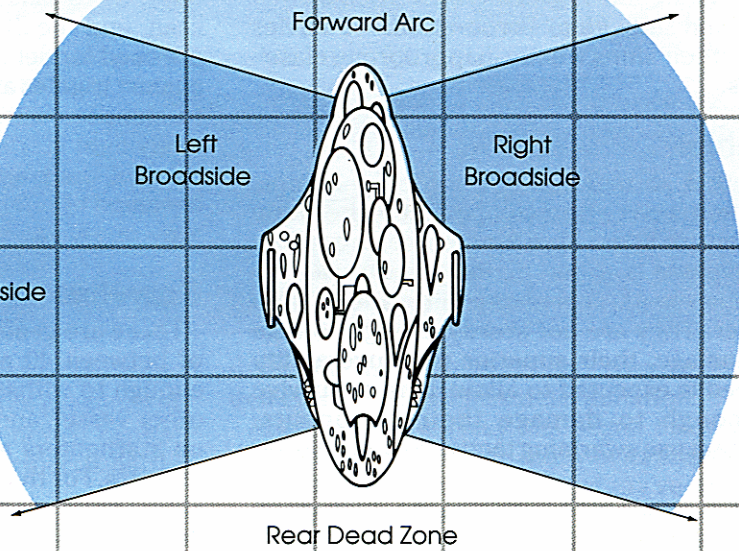
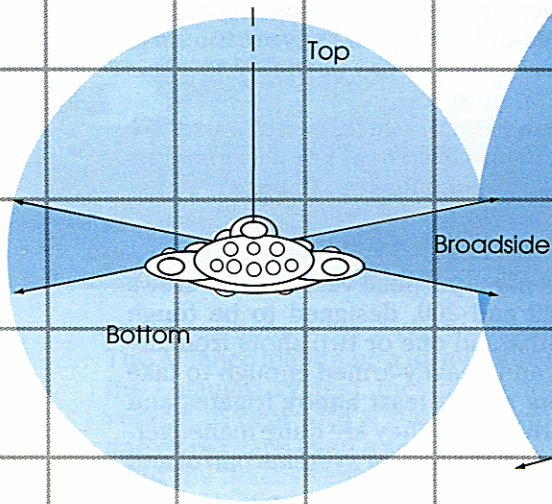

## Imperial Star Destroyer

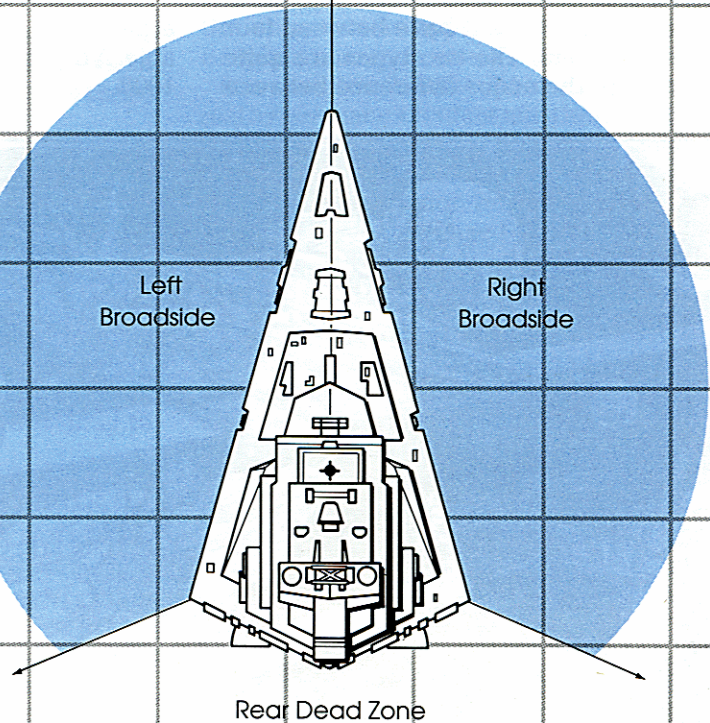
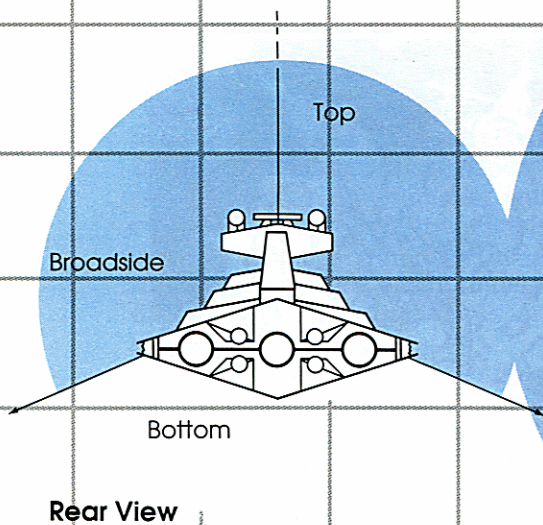

Frigates are designed to provide anti-starfighter and larger vessel protection for ships of the line and they also have limited offensive capabilities against the enemy's cruisers. Many Imperial frigates carry starfighters, usually up to three squadrons.

Frigates are equipped with months of supplies and fuel.

## Cruisers

With the exception of a few bizzarreties such as the Death Star battle station, cruisers are the most powerful ships in space. The biggest cruiser yet built, the *Super*-class Star Destroyer, carries up to 280,000 crewmen, a staggering array of heavy weapons, shielding, and tractor beams. They are designed to take an extraordinary amount of punishment and are capable of dishing out extensive amounts of fire power.

Cruisers have two functions: to frighten enemies into flight or submission, and to batter other cruisers to pieces. They usually ignore starfighter attacks, leaving them to their own carried starfighters and concentrating upon blowing larger craft to bits.

Cruisers are capable of spending years in space without needing drydock or resupply and the larger cruisers can carry hundreds of starfighters into battle.

## Cruiser Design

When designing cruisers, the architect attempts to provide the craft's weaponry with the greatest possible "field of fire" — that is, to ensure that as many weapons as possible can focus on and fire at a target, no matter where it is in relation to the cruiser.

Imperial Star Destroyers' unique triangular shape gives these vessels excellent fields of fire. Virtually half of each ship's weaponry can bear upon any target to the front, side, or on top of the craft. Star Destroyers have dead zones only to the bottom and rear.

Converted from non-military craft, Alliance cruisers are not so fortunate. Power constraints limit the number of heavy weapons the ships can mount, and the crafts' weaker, non-military superstructure necessitates that most of the heavy weaponry be mounted on the long axes on the vessels' sides. Alliance cruisers thus have distinct left and right broadsides, where the majority of their heavy weapons can bear. The front, top and bottom arcs have only a few heavy weapons, and, like Star Destroyers, Alliance cruisers have almost no weapons capable of firing directly aft.

When engaging Star Destroyers, Alliance cruisers seek to attain a broadside position to the rear

or just below the Star Destroyers. From these positions, their weapons can do the most damage and the enemy's cannot fire at all. Considering the high level of competence of most Imperial Star Destroyer captains, this is quite difficult indeed.

As the cruiser is the most powerful component in a fleet's arsenal, the fleet's battle tactics are designed to allow these vessels to most effectively project their firepower against the enemy's cruisers. All other ships are assigned to either protect friendly cruisers or harass the enemy's cruisers.

## The Battle Line

In the Alliance Fleet, the primary unit of maneuver is the battle line. A battle line consists of between two and ten cruisers and any number of escort craft and starfighters. Battle lines are under the command of the senior captain of the cruisers in the line; this vessel has the lead position in any maneuvers the battle line performs. The diagram on page 55 shows a typical Alliance battle line.

## Composition of the Battle Line

### Cruisers

The cruiser forms the heart, or more appropriately, the backbone, of the battle line. The cruisers have the majority of the line's offensive firepower. Other ships in the line are mainly concerned with protecting the cruisers.

Since the cruisers have the available fire power, their primary target is usually the enemy cruisers. If they can be destroyed, the frigates, corvettes and starfighters will soon follow.

### Starfighter Escort

The starfighter escort consists of any number of wings of starfighters, each operating independently of the other wings. They roam around and between the cruisers, engaging any enemy vessels — particularly starfighters — which manage to get within the primary or secondary zones.

### Close Support Vessels

The battle line's frigates act as close support to the cruisers. They are assigned to engage the enemy's frigates and starfighters within the kill or secondary zone; they are not allowed to enter the line's primary zone (for fear of collision with the cruisers).

As the battle develops, some or all of these craft may switch from the defensive to the offensive, launching their own attacks against enemy

smaller ships or seeking to penetrate to the enemy battle line's primary zone.

**Picket Vessels**

These are usually fast-attack and patrol boats. Their function is to develop the enemy's strength — that is, to engage the opposing vessels at a distance from the battle line, forcing them to deploy into battle formation, thus decreasing their operational mobility.

**Attack Starfighters**

These craft are the other offensive arm of the battle line. In a standard attack, they attempt to penetrate the enemy's picket and close support lines, in order to attack their cruisers directly.

However, some Alliance tacticians advocate throwing the attack starfighters against the enemy's starfighters, corvettes and frigates first. Once these are seriously damaged, all of the Alliance ships would be able to go over to the

**B**attle Zones

The battle line's area of effectiveness, that is, where it can effectively project its firepower, is divided into zones.

*The Long Engagement Zone:* The long engagement zone has a radius of approximately 120,000 meters. This is long range for the cruisers' weapons. As lasers lose coherency and thus power over distance, cruisers are pretty much unable to harm enemy cruisers in the long engagement zone. Therefore, at this range, they concentrate their fire against the more fragile escort vessels.

*The Kill Zone:* This is medium range for the cruisers' weapons, but still long or extreme for the enemy's escort vessels and starfighters. At this range, the cruiser can concentrate its fire

against the enemy's cruisers without worrying about the smaller opponents.

*The Secondary Zone:* At this range, the enemy's smaller craft begin to be a threat. The cruisers must decide whether to switch targets and deal with the annoying smaller craft, or continue to concentrate upon their primary targets, the other cruisers, and risk one of the smaller craft getting off a lucky shot.

*The Primary Zone:* If they reach the primary zone, smaller craft — particularly starfighters — have a distinct advantage against the cruisers. They can use their superior mobility and speed to stay within the cruisers' dead zones, and they can pinpoint their fire against the cruiser's vulnerable points.

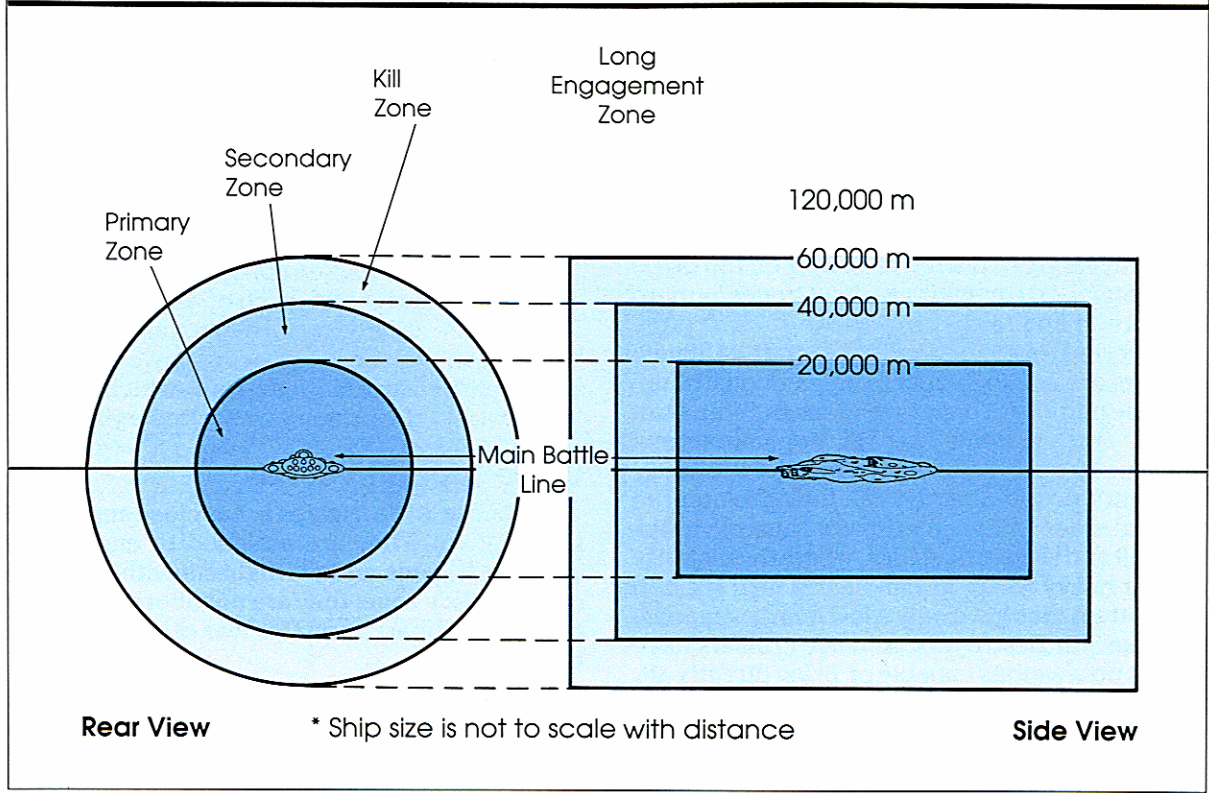

offense and engage the cruisers without fear of the smaller ships. As Admiral Ackbar is somewhat dubious about this tactic, it has yet to be tested in battle.

### Battle Line Maneuvers

Following are descriptions of the most common starship combat maneuvers.

It is an interesting fact that, though space is, of course, three-dimensional, with a vessel's orientation of no particular importance, humans find it distinctly unsettling to view a ship which appears to be upside down or which appears to be "hanging over" their vessel. To counteract this, fleets almost always orient their vessels so that "down" is in the same direction for all craft. (Tradition has it that the approaching vessel orients itself to match the vessel already in position.) This psychological quirk makes capital starship combat surprisingly similar to water-based ship combat.

It might be noted that, if a race were fully comfortable with the three-dimensional nature of space, they would be at a distinct advantage when fighting humans in space.

### The Exchange

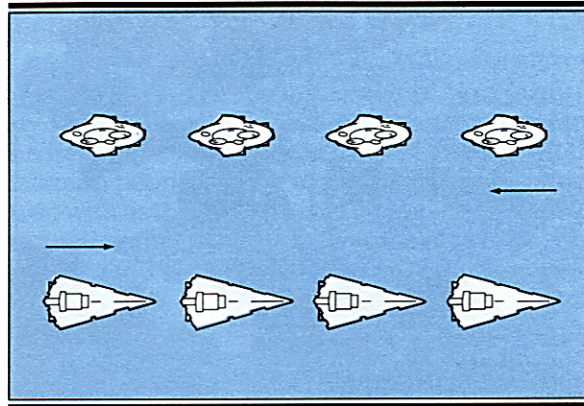

The exchange is the simplest of all battle line maneuvers. The opponents sweep past each other, exchanging broadsides as they go. The starships with the strongest shields and hulls and best weaponry will generally come off the best in an exchange.

### The Alliance Fleet Main Battle Line

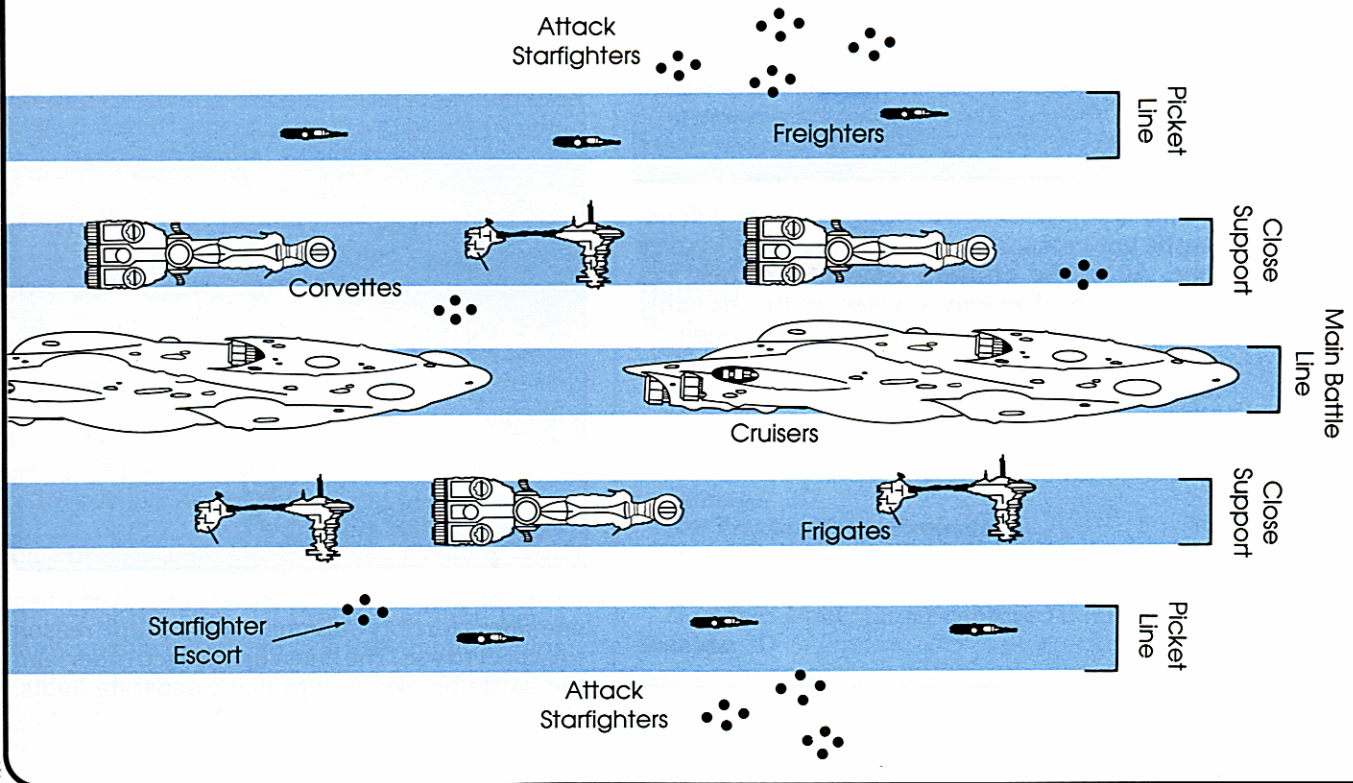





Allen Nunis

### The Ackbar Slash

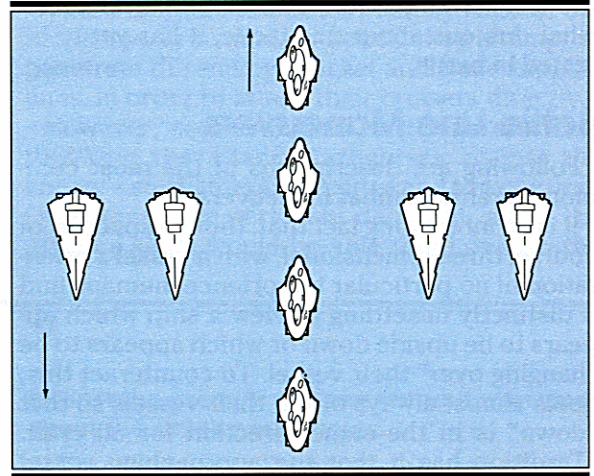

This is a very daring attack in which the battle line drives directly through the heart of the enemy's formation, and one uniquely suited to the design of Alliance vessels. Each ship blasts at the ships to their right and left as they pass, again, quite possibly damaging them severely, while the enemy's ships on the outer edges of the battle line get no or very poor shots in return.

The danger of this attack is that the enemy might disable the lead vessel as it closes, in which case the following vessels will have to break formation to avoid a collision. Once cruisers have broken formation, they lose command control, and run the risk of being destroyed by an enemy who maintains his formation.

### Capping the "T"

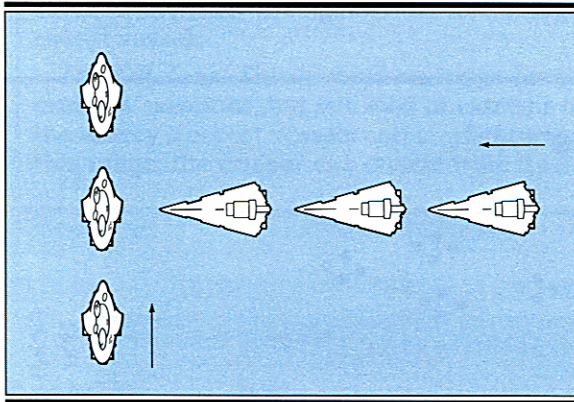

This is a most effective maneuver in which the battle line crosses the front of the enemy's battle line. All of the cruisers concentrate their fire upon the lead enemy cruiser, quite probably damaging it severely, while two of the enemy's cruisers get no shots back at all, or at best, shots at long range.

### The Brawl

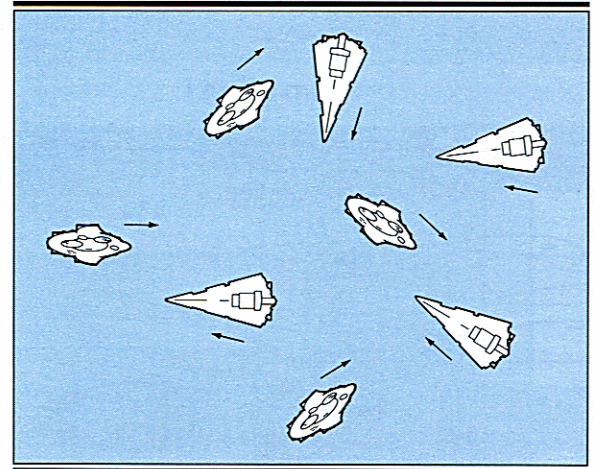

This is a desperation maneuver, employed when one side is terribly outgunned or has little reason to expect to win. The lines rush at each other, and the battle breaks up into many separate fights. Ships may collide, or two or three vessels may gang up on one. In a dogfight between these

colossal ships, anything can happen.

Basically, a brawl is won by the luckier admiral.

### The Fake

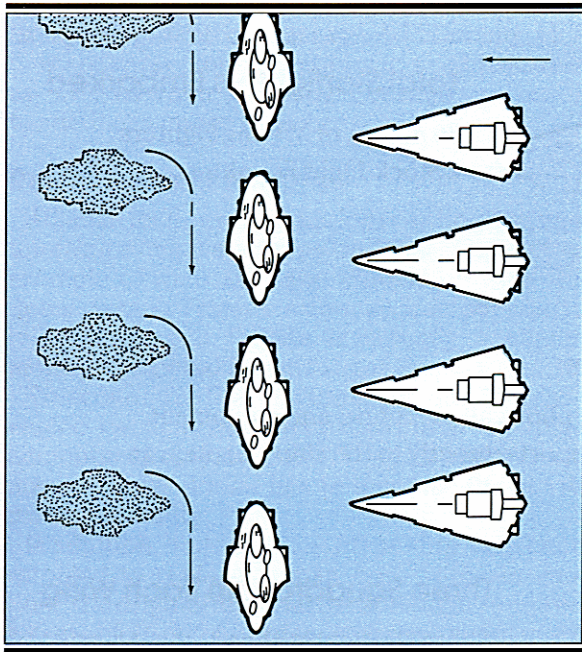

In this attack, the attacker pretends to be coming in for a brawl, hoping to drive his opponent out of formation. However, at the last second, his vessels heel over hard and form into line, blasting the the enemy with a running broadside.

If the enemy captain keeps his nerve and maintains his formation, he has the opportunity to wheel his ships in behind the attackers after they pass and pound the last ship. If he is fooled into thinking the attackers are brawling and breaks his formation to evade, he's in trouble.

## Capital Ship Descriptions

### Mon Calamari Star Cruisers

Mon Calamari Cruisers are virtually the only cruisers in the Alliance arsenal; they are the backbone of the Fleet. These impressive vessels combine a remarkable durability with excellent speed and maneuverability. Compared with Imperial Star Destroyers, they are somewhat lacking in volume of firepower, but the skill and courage of the Alliance gunners partially make up for this weakness.

The Imperial Navy badly underestimated the potency of the Mon Cal Cruisers at first, being simply unable to believe that their mighty ships could be menaced by "converted pleasure craft" built by "fish-headed gravity dwellers." However, after several individual engagements in which even *Imperial*-class Star Destroyers came out

much the worse against the nimble Cruisers, the Navy has begun to take them very seriously indeed.

Admiral Ackbar, an important and well-respected person on his home planet, was primarily responsible for procuring the Cruisers for the Rebellion. He was able to convince the Mon Calamari people to give the ships to the Alliance to do with as they saw fit, sacrificing the immense protection that these craft gave the planet for the greater good of the Rebellion and the galaxy as a whole.

Each Mon Calamari Cruiser differs from every other. Mon Cal ship designers are as much artist as engineer, and each vessel has its own distinct, smooth, aesthetically-pleasing shape. Because these ships were originally designed for deep space exploration, the ships had to be severely modified to make them battleworthy. Unfortunately, much of the ships' smooth lines were altered in the process — something which distinctly pains the artistic Cals.

While most of a Mon Cal Cruiser's crew consists of various races of Rebel personnel, recruited from all across the galaxy, the command crew is

### MON CALAMARI STAR CRUISER

**Craft:** Mon Calamari MC80a

**Type:** Star Cruiser

**Length:** 1,200 meters

**Scale:** Capital Ship

**Crew:** 5,402 (668 officers, 4,734 enlisted)

**Troops:** 1,200

**Cargo Capacity:** 20,000 metric tons

**Consumables:** 2 years

**Hyperdrive Multiplier:** x1

**Nav Computer:** Yes

**Hyperdrive Backup:** Yes

**Sublight Speed:** 3D

**Maneuverability:** 2D

**Hull:** 6D

**Weapons:**

**48 Turbolaser Batteries** (fire separately)

*Fire Control:* 2D

*Damage:* 4D

**20 Ion Cannon Batteries** (fire separately)

*Fire Control:* 3D

*Damage:* 3D

**Six Tractor Beam Projectors**

(fire separately)

*Fire Control:* 2D+2

*Damage:* None; target captured if hit

**Shields:** 3D

**S** tandard Rebel Mon Calamari Cruiser Fighter Complement

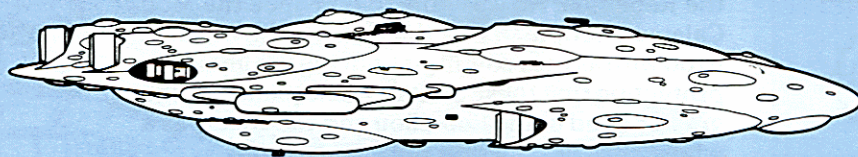

**Total Starfighters Embarked**

36 A, B, X, or Y-Wing Fighters  
2 Stock Light Freighters

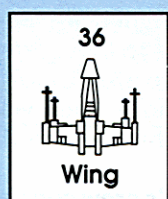

**One Wing on Each Cruiser**

The wing includes starfighters, pilots, all personnel and equipment. The fighter wing commander reports directly to the ship's captain as well as to fleet fighter command.

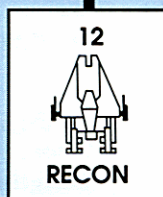
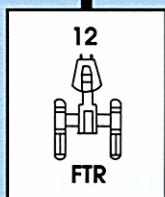
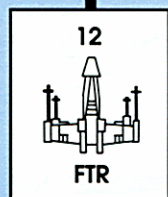

**Three Squadrons in Each Wing**

Three starfighter squadrons. Always include one recon squadron. Each squadron is made up of a different fighter type. Each squadron has a squadron commander who reports directly to the wing commander.

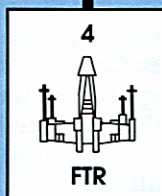
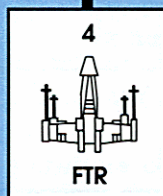
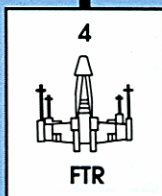

**Three Flights in Each Squadron**

Flights commonly consist of four fighters. Flight commanders report to squadron commander.

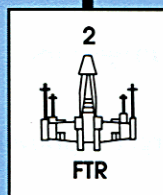
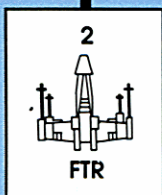

**Two Elements in Each Flight**

The element is the smallest tactical unit deployed. Each element consists of a leader and his wingman. Wingmen are responsible for each others' safety at all times.

Cathleen Hunter/Cruiser illustration by Rob Caswell

almost always exclusively made up of Mon Calamarians. This is chiefly due to the unusual design of the ship's controls. Mon Cals do not see in the same spectrum as humans, and many of the holo-displays and battle graphics are more easily deciphered by that race. Additionally, Mon Cals are known for their ability to work together, as well as their amazing courage and cool-headedness under pressure.

### Rebel Assault Frigates

Alliance techs are famous for re-fitting and customizing combat starships, and there is no better example of their skill and innovation than the Rebel Assault Frigate. Although it is difficult to tell, the Assault Frigate is actually a highly-modified Imperial Dreadnaught Heavy Cruiser.

To economize fuel consumption and increase engine capacity, the techs stripped off huge amounts of superstructure. They also added two massive solar dorsal fins to increase the ship's maneuverability.

In addition, huge portions of the ship have been retooled to replace human crew with automation. The original Imperial Dreadnaught required a crew of 16,000 in order to operate, far more than any other war vessel of comparable size. This is simply not practical for the Alliance, who has a much smaller manpower pool to draw from than does the Navy, and an infinitely smaller pool of trained crew. Once the Alliance techs were through with the ship, it required a little less than one third the original complement to operate.

Unlike its Imperial predecessor, the Assault Frigate has no docking bays or landing platforms, but there are twenty umbilical docking fixtures along the ship's surface. Several of these are large enough to dock a standard Rebel transport, while the rest are better suited to starfighters and stock light freighters. The ship cannot carry docked craft through hyperspace.

In addition, each Assault Frigate carries a modified Imperial assault shuttle "piggy-back" atop its superstructure. The Frigates are able to carry these vessels through hyperspace.

Because of the exhaustive and expensive re-fit, there are very few Assault Frigates currently employed by the Alliance. Those that are in service are extremely effective, however, and, as time permits, more will be added.

### Bulk Cruisers

Bulk Cruisers are among the most common capital starships seen throughout the galaxy. They are employed by numerous planetary and local governments as well as by larger corporations in the Corporate Sector. Typically, these are star systems or corporations which receive

### REBEL ASSAULT FRIGATE

**Craft:** Rebel Assault Frigate  
**Type:** Modified Imperial Dreadnaught  
**Length:** 700 meters  
**Scale:** Capital Ship  
**Crew:** 5,000  
**Troops:** 100  
**Cargo Capacity:** 7,500 metric tons  
**Consumables:** 1.5 years  
**Hyperdrive Multiplier:** x2  
**Nav Computer:** Yes  
**Hyperdrive Backup:** Yes  
**Sublight Speed:** 3D  
**Maneuverability:** 1D+2  
**Hull:** 5D  
**Weapons:**  
**15 Laser Cannons** (fire separately)  
*Fire Control:* 3D  
*Damage:* 2D  
**20 Quad Laser Cannons** (fire separately)  
*Fire Control:* 2D  
*Damage:* 4D  
**15 Turbolaser Batteries** (fire separately)  
*Fire Control:* 1D  
*Damage:* 7D  
**Shields:** 3D

minimal Imperial protection, and have received permission to deploy their own forces to defend against smuggling, piracy, Alliance attacks, and other profit-draining enterprises. Several of these vessels have since defected to the Alliance.

Though of course happy to receive any ships,

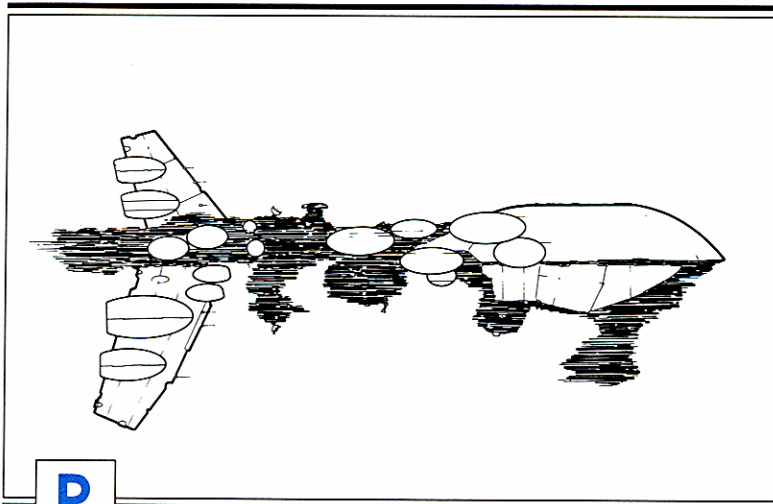

**R**

Rebel Assault Frigate

Karl Martin

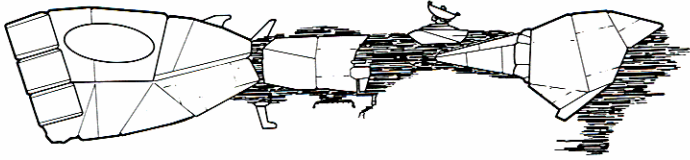

Karl Martin

R

endilli Star Drive's modified bulk cruiser.

the Alliance fleet techs and tacticians have at times almost wished that these cruisers hadn't shown up. They are slow, old, break down with alarming frequency and are expensive to run — a nightmare to make battleworthy.

In many cases, the necessary modifications simply are not worth the cost and effort. The ships are simply too untrustworthy to put into battle against the Imperial Navy. Instead, many of these cruisers have been assigned to transport escort work.

Other cruisers have been converted into starfighter carriers. This is a much cheaper and faster fix involving turning large areas of the ship into docking bays and repair facilities. Carrier Cruiser commanders are taught to use their fighter squadrons as their primary weapon, keeping the cruiser itself well out of range if at all possible. A single cruiser can carry up to three starfighter squadrons, and can dock two standard transports at a time on the docking couplers on the cruiser's belly.

### Escort Frigates

The Escort Frigate is the Alliance's best all-around close support vessel. It is well suited for anti-starfighter and anti-medium vessel work, and is capable of doing real damage to a cruiser which chooses to ignore it. Additionally, the ship is extremely adaptable for long-range patrol and non-combat missions, as well.

The Alliance Medical Frigate, a variant of the standard Frigate configuration, travels with the fleet and is equipped with the most sophisticated medical equipment available. The Med Frigate can treat over 700 patients simultaneously.

Other famous (or infamous) Rebel Frigates include the *Far Orbit*, a combat starship which launches privateering raids in several near-Core

### REBEL CARRIER CRUISER (MODIFIED BULK CRUISER)

**Craft:** Rendili Star Drive's *Neutron Star*

**Type:** Modified Bulk Cruiser

**Length:** 600 meters

**Scale:** Capital Ship

**Crew:** 2,050

**Troops:** 200

**Cargo Capacity:** 5,000 metric tons

**Consumables:** 1 year

**Hyperdrive Multiplier:** x2

**Nav Computer:** Yes

**Hyperdrive Backup:** Yes

**Sublight Speed:** 2D

**Maneuverability:** 1D

**Hull:** 5D

**Weapons:**

**30 Quad Laser Cannons** (fire separately)

*Fire Control:* 2D

*Damage:* 4D

**Two Tractor Beam Projectors**

*Fire Control:* 2D

*Damage:* 4D

**Shields:** 2D

Sectors, and the *Yavaris*, which functions primarily as a personnel and equipment transport for the Fleet.

The Escort Frigate has the capacity to carry up to two starfighter squadrons into battle. In addition, the Frigate has docking fixtures to accommodate ships of up to medium freighter size.

Other features of the Nebulon-B include extremely sophisticated scanners and a huge deep-space, multi-frequency antenna, making the vessel a more than adequate battle command base.

### Corellian Gunships

The Corellian Engineering Corporation has always been known for the versatility of their designs. Most of their craft are easily adaptable to a variety of missions — combat, escort, transport, or freight hauling. However, such is not the case with the Corellian Gunship. Unlike its close cousin, the Corellian Corvette, the Gunship is geared entirely for combat.

There is little room for storage, passengers, or even troops aboard this ship. The gunship is designed to be fast and carry tremendous firepower. The Gunship's engines take up almost half of the ship's area; most of what's left is weaponry and shielding.

The gunners are the key to the gunship's suc-

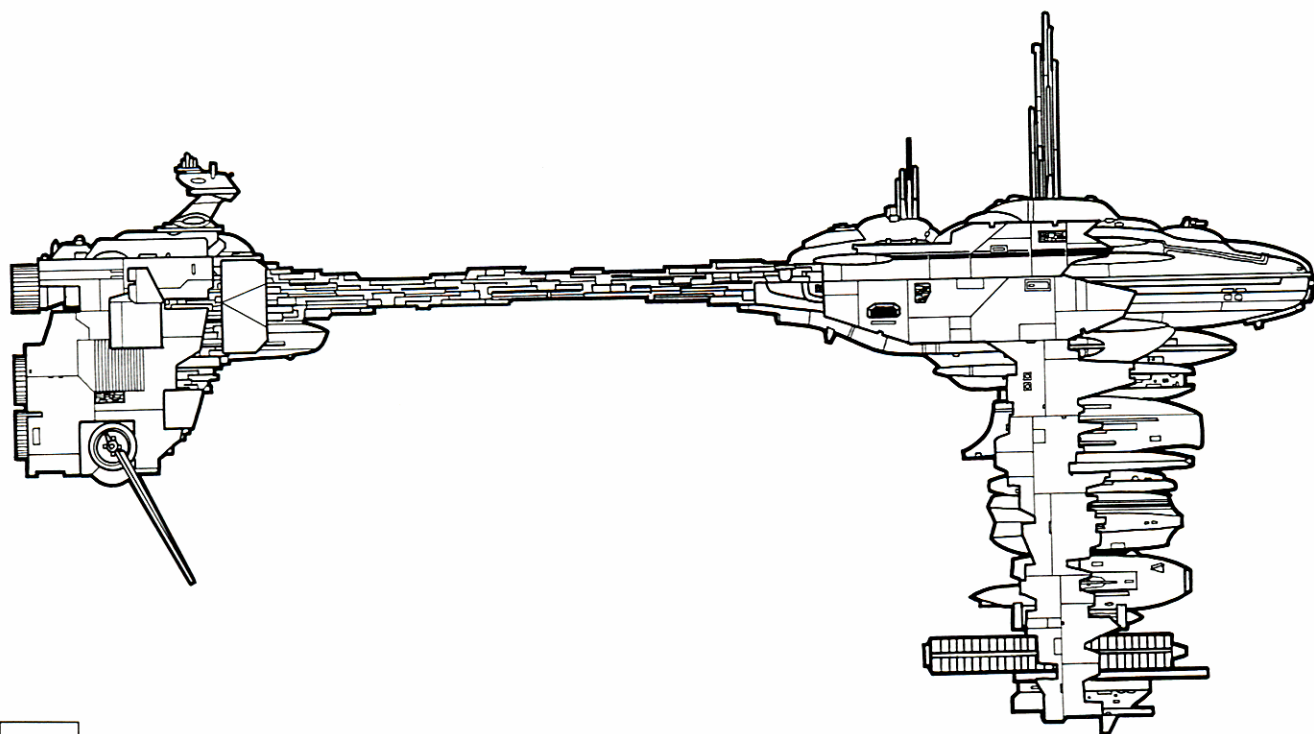

K

DY's Nebulon-B Frigate.

Rob Caswell

## ESCORT FRIGATE

**Craft:** KDY's Nebulon-B Frigate

**Type:** Escort starship

**Length:** 300 meters

**Crew:** 920

**Troops:** 75

**Cargo Capacity:** 6,000 metric tons

**Consumables:** 2 years

**Hyperdrive Multiplier:** x2

**Sublight Speed:** 2D

**Maneuverability:** 1D

**Weapons:**

**12 Turbolaser Batteries** (fire separately)

*Fire Control:* 3D

*Damage:* 4D

**12 Laser Cannons** (fire separately)

*Fire Control:* 2D

*Damage:* 2D

**Two Tractor Beam Projectors**

*Fire Control:* 2D

*Damage:* None; target captured if hit

cess. If they work together and utilize the vessel's tremendous weapons to their utmost capabilities, they can surround the ship with a nearly impenetrable barrier of laser fire, doing real damage to any starfighter squadrons who dare attack. However, each of the Gunship's batteries is manually operated and cannot be controlled from the bridge. Coordination of fire is difficult — for untrained crews, all but impossible to master.

For its size and speed, there is no better anti-starfighter platform than the Corellian Gunship.

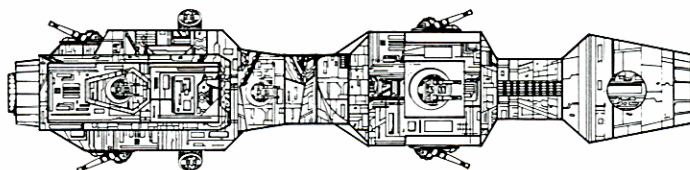

C

Corellian Engineering Corporation's Gunship.

Jacqueline M. Evans/Stephen Crane

**S** tandard Corellian Quad Laser Gunport

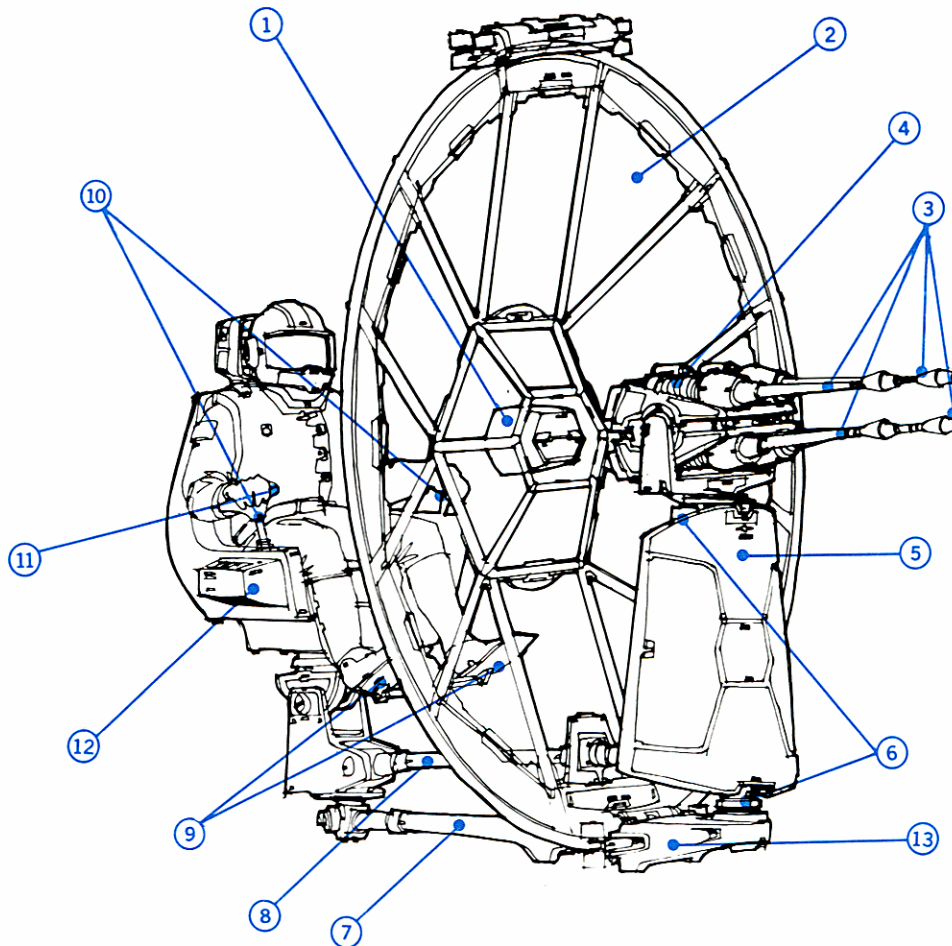

Corellian Engineering Corporation's AG-2G Quad Laser Battery is the standard anti-starfighter weapon employed by most capital starships. It is especially known for rapid transverse movement and for a good tight beam for long-range shooting.

The gunner uses the horizontal control pedals (9) to rotate the gun left or right, while using the vertical control sticks (10) to point it up or down. The entire turret automatically rotates on a ball-swivel rotation mounting (13), under the command of the tactical targeting computer (1).

The targeting computer is accurate up to 25,000 meters, and will lock on to any target of greater than 4 meters in length which stays within scanning range for more than 1.5 seconds. Unfortunately, most Imperial TIE models are fast enough to avoid the "one-point-five

lock," as it is called, and the gunner must often rely on his or her sharp eye and steady hand.

The laser barrels (3) fire one at a time, following a pattern of rotation selected by the gunner. Each barrel fires each 1.32 seconds.

1. Tactical Targeting Computer
2. Transparisteel Viewport
3. Laser Barrels
4. Laser Actuator
5. Protective Ray Shielding
6. Swivel Mountings
7. Horizontal Control Arm
8. Vertical Control Arm
9. Horizontal Control Pedals
10. Vertical Control Sticks
11. Fire Release Stud
12. Systems Functions Console
13. Turret Rotation Mounting

**CORELLIAN GUNSHIP**

**Craft:** Corellian Engineering Corporation Gunship  
**Type:** Mid-sized anti-starfighter starship  
**Length:** 120 meters  
**Crew:** 35  
**Passengers:** 10  
**Cargo Capacity:** 300 metric tons  
**Consumables:** 8 months  
**Hyperdrive Multiplier:** x2  
**Nav Computer:** Yes  
**Hyperdrive Backup:** Yes  
**Sublight Speed:** 3D+2  
**Maneuverability:** 2D+1  
**Hull:** 4D+2  
**Weapons:**  
**8 Double Turbolaser Cannons**  
*(fire separately)*  
*Fire Control:* 3D  
*Damage:* 4D+2  
**6 Quad Laser Cannons** *(fire separately)*  
*Fire Control:* 3D  
*Damage:* 5D  
**Four Concussion Missile Tubes** *(fire separately)*  
*Fire Control:* 3D  
*Damage:* 9D  
**Shields:** 2D+1

**CORELLIAN CORVETTE**

**Craft:** Corellian Engineering Corporation Corvette  
**Type:** Mid-sized multi-purpose vessel  
**Length:** 150 meters  
**Crew:** 46-165 depending on configuration  
**Passengers:** up to 600 depending on configuration  
**Cargo Capacity:** 3,000 metric tons  
**Consumables:** 1 year  
**Hyperdrive Multiplier:** x2  
**Nav Computer:** Yes  
**Hyperdrive Backup:** No  
**Sublight Speed:** 3D  
**Maneuverability:** 2D  
**Hull:** 4D  
**Weapons:**  
**Six Double Turbolaser Cannons** *(fire separately)*  
*Fire Control:* 3D  
*Damage:* 4D+2  
**Shields:** 2D

**Corellian Corvette**

These mid-sized, multi-purpose vessels are the most common starship in the Alliance.

They are an extremely popular vessel galaxy-wide, and apparently they tend to be owned by people with Alliance sympathies — no one knows why this is so, except perhaps the Corellian Engineering Corporation’s advertising managers.

Because of the Corvette’s widespread popularity in the private sector, it is extremely difficult for the Empire to identify Rebel ships among the many civilian vessels. Realizing the tactical advantage of such a situation, Mon Mothma and her staff have suggested that Sector Commands utilize the ubiquitous Corvettes as transportation for clandestine operations. Barring boarding actions against every single corvette encountered, it is difficult to imagine what kind of tactics the Empire will come up with to counter this.

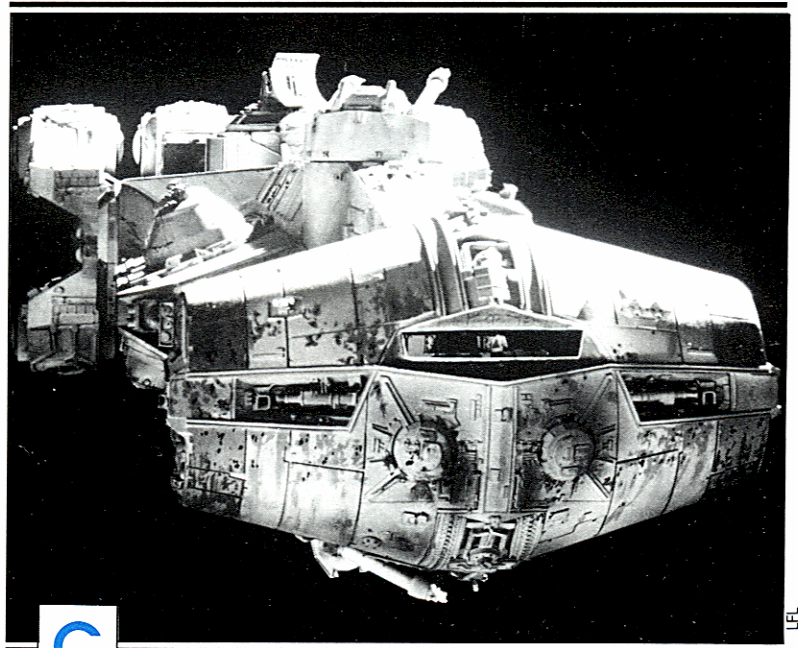

Corellian Engineering Corporation’s ubiquitous Corvette.



### Corellian Engineering Corporation's Corvette (Example shown: the *Tantive IV* Blockade Runner)

Top View

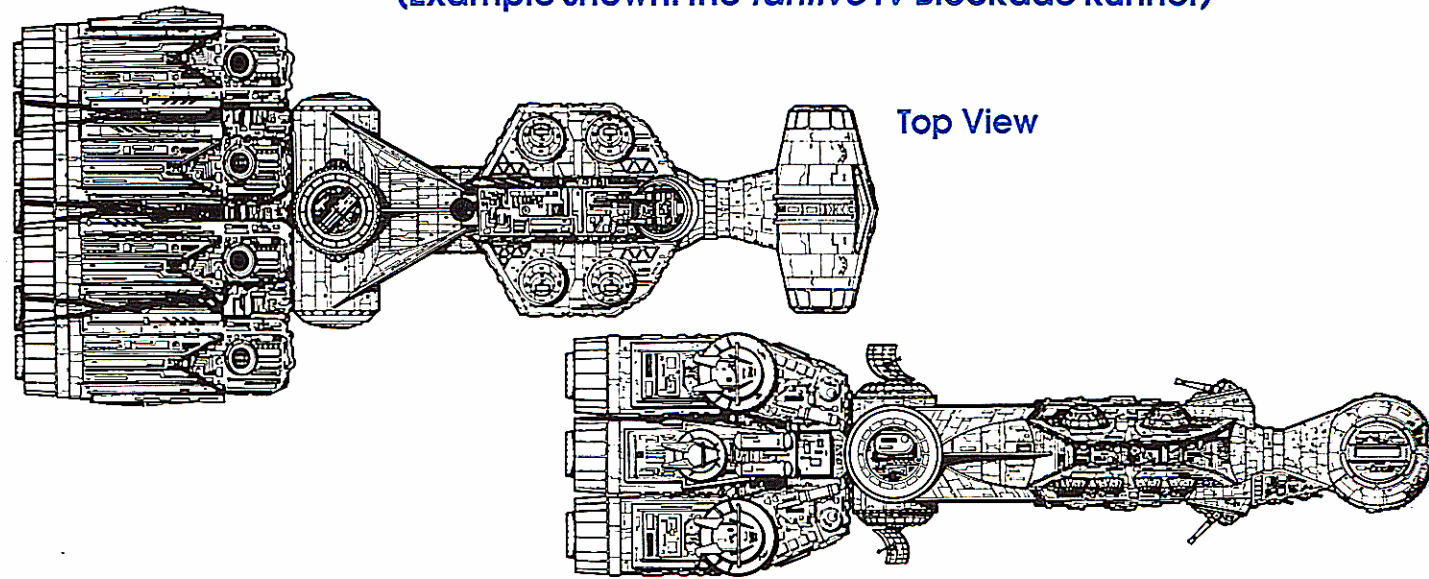

Side View

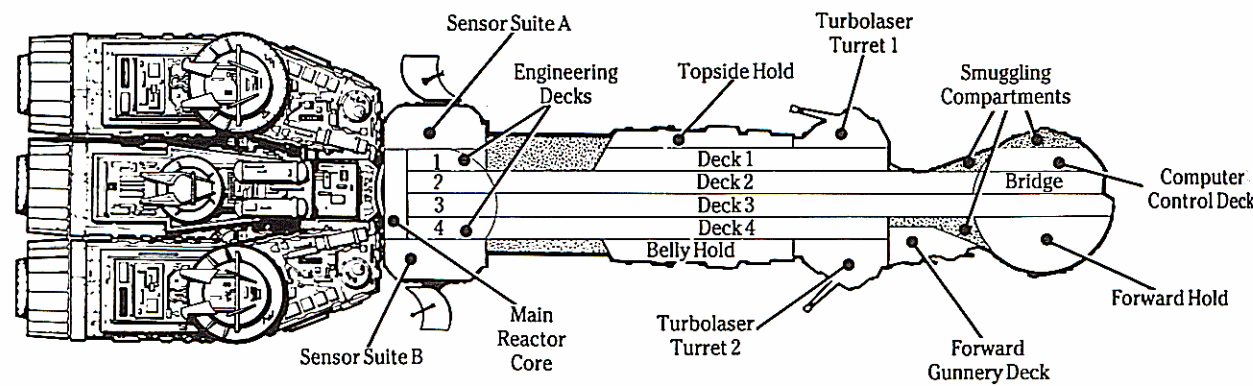

Deck 1

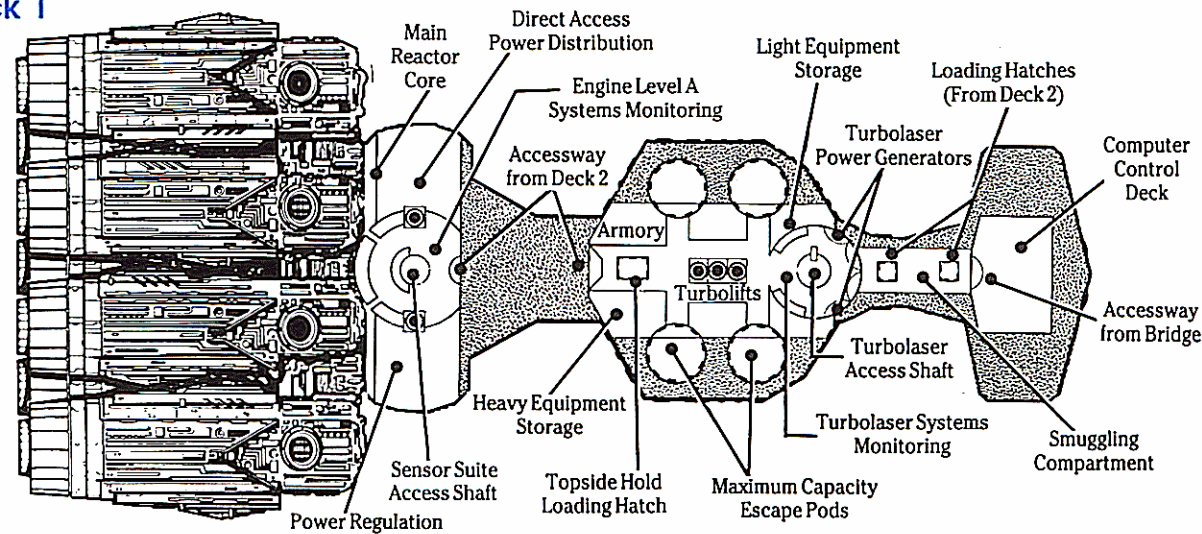

Deck 2

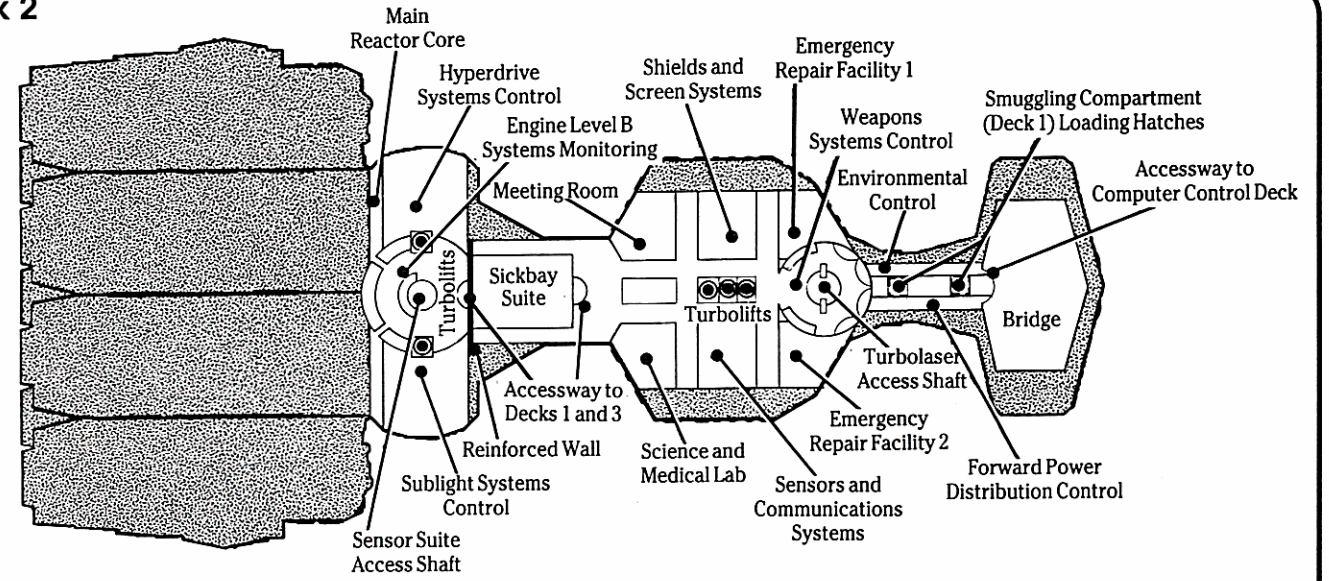

Deck 3

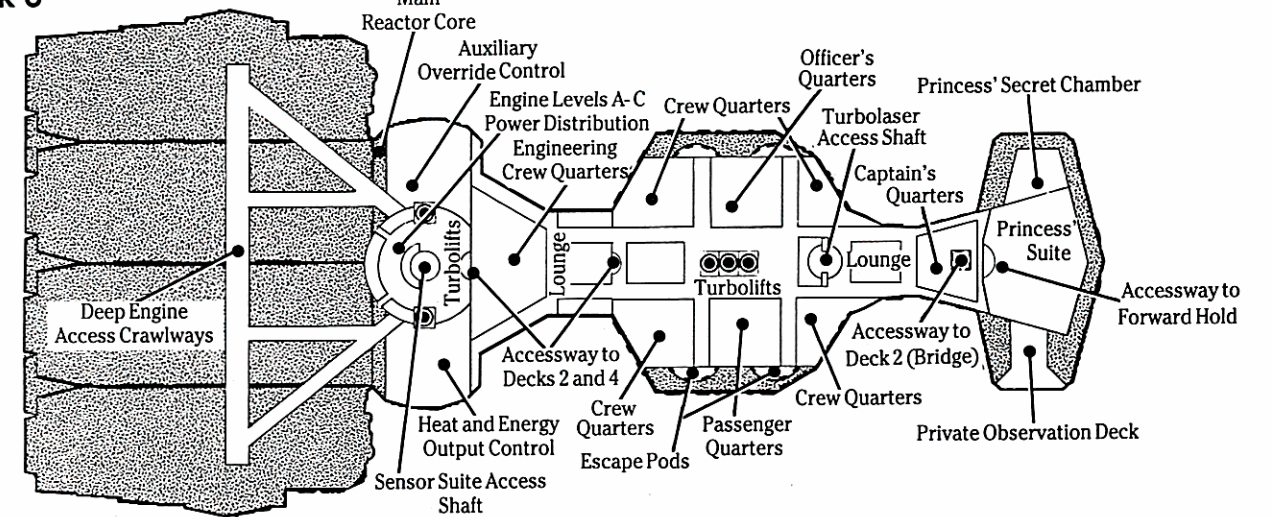

Deck 4

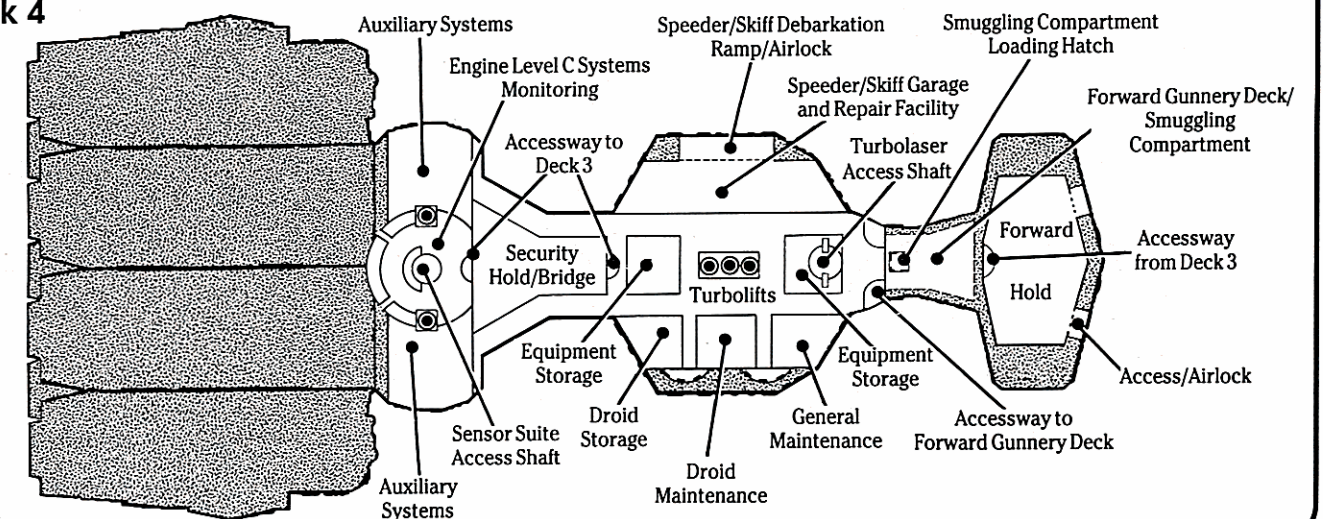



# Alliance Capital Ship Recognition Guide

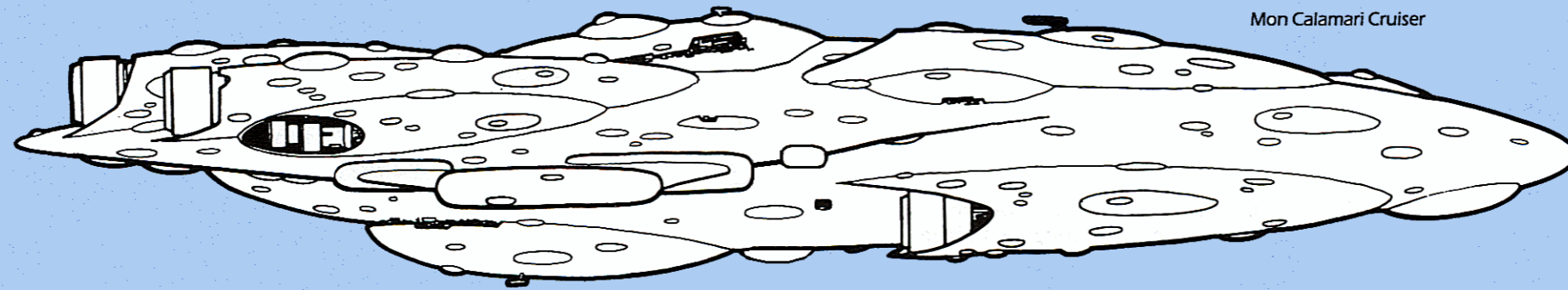

Mon Calamari Cruiser

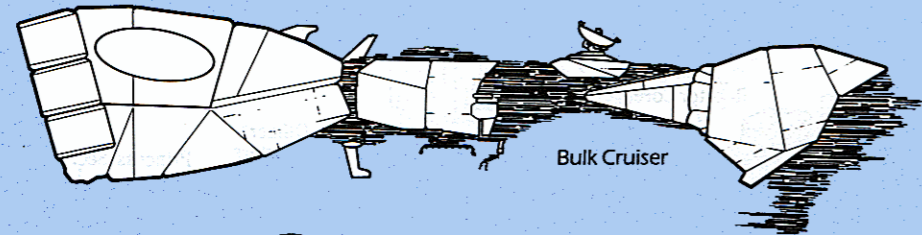

Bulk Cruiser



Corvette



Transport

YT-1300 Transport



Gunship

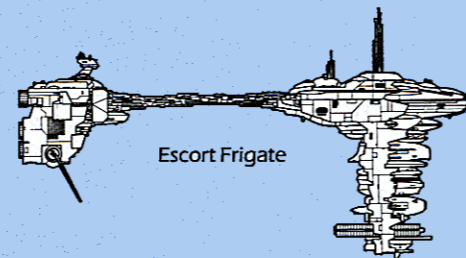

Escort Frigate

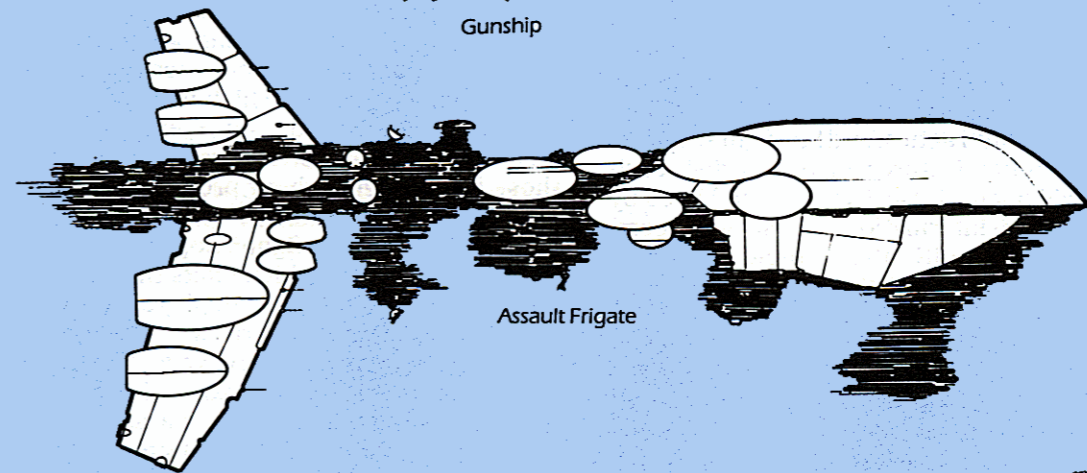

Assault Frigate



Bulk Freighter

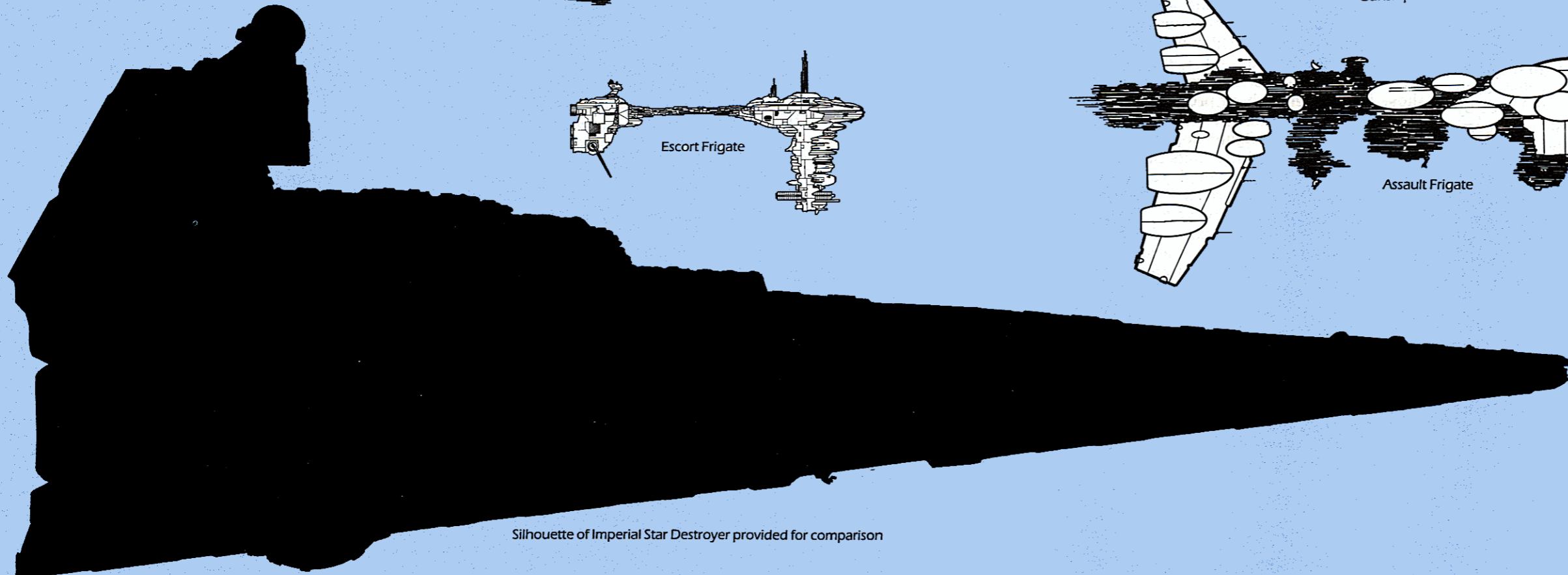

Silhouette of Imperial Star Destroyer provided for comparison

Note: All vessels are shown to scale.

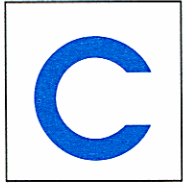

# Chapter Five Starfighters

*The following is excerpted from "Alliance Strategy and Tactics Lecture 137: Combat Starfighters," one of a series of a holo-lectures created by the Alliance Ministry of Education for distribution to mid-level Alliance political and military leaders.*

Greetings, gentlebeings. I am Wing Commander Wedge Antilles. In this lecture, I am going to discuss the importance of starfighters in the Alliance's strategy and tactics. This will give you a better idea of how to use starfighters in your various commands. It is suggested that you re-examine holo-tapes 134 to 136 before you continue.

This lecture will be presented in four sections: General Overview, Acquisition and Supply, Strategy and Tactics, and Starfighter Types. As in the other lectures in this series, each section will open with an overview, followed by more detailed information. Those with commands not specifically concerned with starfighters may wish to view only the overviews and skip the detailed sections.

You may wish to calibrate your holo-viewer so that the counter reads zero at my mark. The General Overview begins at holo-disk sector 5,101; Acquisition and Supply begins at holo-disk sector 11,245; Strategy and Tactics at holo-disk sector 56,070 ...

## Combat Starfighters: A General Overview

Combat starfighters are one of the Alliance's primary tools for denying control of space to the Empire. As our Main Fleet must avoid combat except where absolutely necessary, starfighters are virtually the only forces in daily contact with the enemy. Roughly 35 percent of the Alliance's military budget is dedicated to the creation and maintenance of starfighters.

### Space Denial

The main purpose of combat starfighters is *denial* of control of space to the Empire's forces, not the *control* of that space itself. Denial of space

means to curtail the free movement of the enemy's vessels without significant protection. Control of space suggests that one's own vessels are able to move freely without protection. Except in rare cases, the Alliance is unable to control space with its starfighters.

Unlike the larger capital ships, starfighters are not self-contained; they require a staggering amount of fuel to operate and an equally staggering amount of expensive maintenance to keep in space. For them to control a system, therefore, requires expensive and extensive base facilities within that system or nearby. Unfortunately, this is a luxury which we enjoy only in systems so firmly under our control or off the beaten track that Imperial starship attack against those bases is unlikely or prohibitively expensive.

Therefore, our starfighters operate primarily from hidden bases (which limits the amount of starfighters which can be deployed safely), or from bases far from Imperial scrutiny, necessitating long, fuel-consuming voyages to the battle area. Within these tactical strictures, our starfighters concentrate upon harassment and hit-and-run raids rather than attempting to defeat the enemy outright.

Despite these limitations, the starfighter is still a very effective weapon. Their very existence threatens every Imperial supply ship, warship and space station with destruction at any second, forcing dramatic changes in Imperial strategy and tactics ...

Except in the Core Worlds, space travel has become a slow and dangerous business for every Imperial ship.

## Acquisition and Supply

A sizeable chunk of the Alliance's precious treasury is devoted to the acquisition and supply of starfighters. Underscoring the importance of this to the Alliance, the Minister of War himself chairs the Committee on Starfighter Acquisition and Maintenance; other permanent members include the Ministers of Supply, Industry and Finance, as well as a number of starfighter Wing Commanders and ace pilots. Starfighter supply is

controlled through the Department of Naval Ordnance and Supply.

For more details on this subject, see “Lecture Number 522: Organization of Alliance Command.”

## Acquisition

The Alliance gained the majority of its original complement of starfighters through the wholesale defection of planetary and systems defense forces after President Palpatine took the title of Emperor and before he had solidified his hold on the Navy. During those months, literally thousands of pilots went “underground” and joined the growing Rebellion. However, most of these ships were outdated and in poor repair, unable to stand up against the Navy’s modern starfighters.

A notable addition to the Alliance space forces was gained when the entire senior design staff of Incom Corporation defected to the Alliance, taking with them the plans and prototype models for the X-wing starfighter. As most of you know, the X-wing has stood up very well indeed to the Navy’s vessels.

As Palpatine secured his position and crafted the Navy into his complete tool, it became more and more difficult to entice home defense forces into defecting and virtually impossible to acquire starfighters through arms merchants at any cost — Imperial reprisals were greatly feared even before the Death Star. Therefore, the Alliance had to learn to build its own starfighters.

As you will understand, precise information regarding the location and nature of the Alliance ship design and manufacturing capabilities is highly classified and no exact details will be given here.

The Alliance has a number of starfighting manufacturing plants in operation across the galaxy. These are extremely secret, their locations known only to a few pilots and Mon Mothma’s top senior advisors. Even those working in the plants often do not know exactly where it is located. They are brought in “blind” and, even if later captured, are unable to give their interrogators precise information.

Because of the difficulty of shipping starfighter-grade materiel across deep space in secret, most Alliance manufacturing facilities are based upon worlds or in solar systems which provide everything needed to build the ships: raw material, foundries, heavy industry, and so forth. The computer and electronics manufacturing facilities are often on-site as well. However, these components are smaller, and therefore easier to transport without undue attention.

A small cadre of Alliance pilots is responsible for testing new starfighters and, if acceptable, transporting them to their assigned bases. These pilots are extremely dedicated beings, sworn to

die before capture — and provided with secret means to ensure that they can end their lives if they fall into Imperial hands.

The Alliance is always searching for places to build new starfighter manufacturing facilities. If you have knowledge of a likely site, contact your Sector Supply Secretary immediately. It should be noted, however, that the Empire is extremely determined to find and destroy our capacity to build spacefaring vessels; planets they discover harboring such are routinely space-bombed into rubble.

## Numerical Superiority Versus Qualitative Superiority

There is an age-old argument as to the relative importance of numbers and quality: in battle, is it better to have many adequate ships or a few good ones? Though the debate may provide hours of amusement for armchair strategists, for the Alliance, the question is rather moot.

We simply cannot hope to match the Empire in numbers. They have an entire galaxy’s resources to draw upon, and we have but a few hidden manufacturing plants. Since we cannot beat their numbers, we concentrate our efforts upon making sure that our ships are better than theirs, and that our pilots are better, as well.

It has been my experience that superior quality vessels and pilots can offset extremely high numbers — provided the numerical imbalance is not too great. For example, when first introduced by Admiral Ackbar, the Rebel B-wing starfighter was far superior to anything the Imperials had at the time. But in the Rebel raid on Fara’s Belt, the small squadron of B-wings was wiped out by massive numbers of inferior TIE fighters. However, in the long run, superior intelligence, superior communication and superior command may be more important than numbers *or* quality.

## Supply

Starfighters are extremely expensive to fuel and keep in operating condition. A starfighter requires expensive fuel cells for power. The most efficient fighters drain their power after a few short weeks of standard flying — and the same amount of energy is exerted in just under *an hour* of combat flight. Starfighter fuel cells consist of refined plutonium/uranium mixes; these cells must be roughly twice as pure as standard starship-grade cells. Few civilian manufacturing facilities are capable of producing them. If you have knowledge of facilities which could be converted to manufacture starfighter fuel cells, please contact your Sector Supply Secretary immediately.

**B**attle Maintenance Schedule for an X-Wing Starfighter

The following is excerpted from "Alliance Maintenance Lecture 139: Battle Maintenance Schedule for an X-Wing Starfighter," given by C-3PO and R2-D2.

C-3PO and R2-D2 come bustling into the lecture room.

**C-3PO:** "Good afternoon Gentlebeings. I am terribly sorry for our delay, but this R2 unit was tiresomely delayed in completing his last assignment. I am C-3PO, human cyborg relations. For those of you who are not familiar with my particular model, I am fluent in over six million forms of communication, and can—"

Standing next to him and impatiently rolling back and forth on his three legs, R2-D2 issues a series of irritated beeps, hoots, and whistles.

**C-3PO:** "Yes, Yes, R2 I am getting to that (Threepio mutters to his companion and then turns back to the audience). This beastly little Droid who has seen fit to interrupt my flow of communication is R2-D2, an Astromech Droid. The two of us are currently in the service of Commander Skywalker who has instructed R2 to produce a copy of a typical battle maintenance schedule for an X-wing starfighter. Due to R2's rather limited means of direct communication with beings unlike himself, I have been called upon to translate."

Artoo emits a long feisty cry in Threepio's general direction while wheeling toward the datapad control panel. He hooks into the computer and transfers the material.

The following lasercopy lists the information contained in R2-D2's original computer input.

**T-65C-A2 X-Wing Space Superiority Fighter Battle Maintenance Schedule**

A.) Complete a diagnostic test on the astromech Droid assigned to the X-wing in question. If its systems are stable, instruct the Droid to do a thorough check of the vessel. It will then monitor the following systems (parenthesized numbers refer to diagram on opposite page):

- |                                    |                                      |
|------------------------------------|--------------------------------------|
| 1. Sensor Window (2)               | 13. Ejection Seat (21)               |
| 2. Primary Sensor Array (3)        | 14. Sensor Jammer (24)               |
| 3. Sensor Computer (4)             | 15. Power Coupling (26)              |
| 4. Flight Computer (6)             | 16. Cooling Sleeve (34)              |
| 5. Holo Heads-up Display (7)       | 17. Deflector Screen Projectors (35) |
| 6. Targeting Computer Screen (9)   | 18. Stabilizer (39)                  |
| 7. Life Support System (10)        | 19. Power Converter (40)             |
| 8. Power Generator (12)            | 20. Exhaust Nacelle (45)             |
| 9. Deflector Shield Generator (13) | 21. Reactant Agitator Injector (47)  |
| 10. S-Foil Servo Actuator (15)     | 22. Hyperdrive Motivator (50)        |
| 11. Rear Warning Sensor (16)       |                                      |
| 12. Acceleration Compensator (20)  |                                      |

After completing the systems check, the Droid shall make a full report to the being currently in charge and, with permission, proceed to make any small repairs. If an item needs to be replaced, the Droid will so inform the supply personnel. If no maintenance is required, the R2 unit will also make note of that information.

B.) While the astromech Droid is investigating the above-mentioned systems, the maintenance crew will repair or replace the following items:

23. Primary Power Cells (17)
24. Proton Torpedo Launcher (22)
25. Laser Power Line (25)
26. Laser Actuators (28)
27. Laser Cannon (29)
28. Laser Barrel (30)
29. Power Surge Vent and extinguisher system (49)
30. Landing Gear (23)

During combat situations, speed is critical. Both the Droid and the crew are working on the X-wing at the same time. Providing a full crew and that there are no serious complications, the entire check and replacement process should be completed within 30 standard minutes.

**INCOM**

**T-65C-A2 X-WING Space Superiority Fighter**

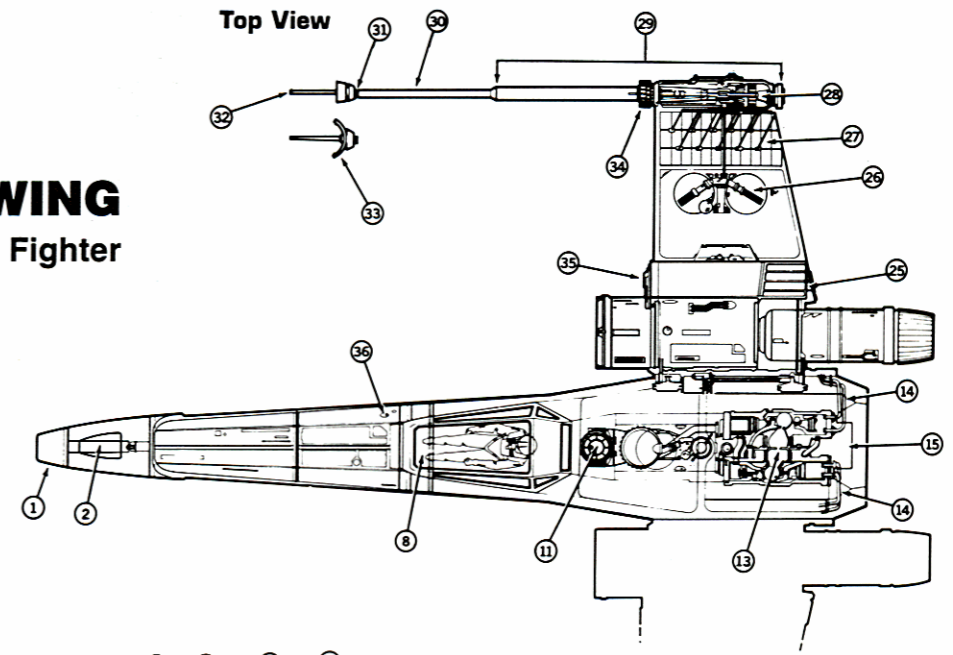

Side View

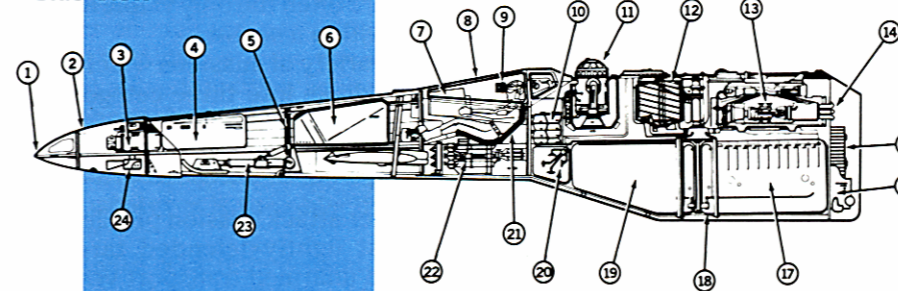

**INCOM 4L4 Fusial Thrust Engine**

Side View

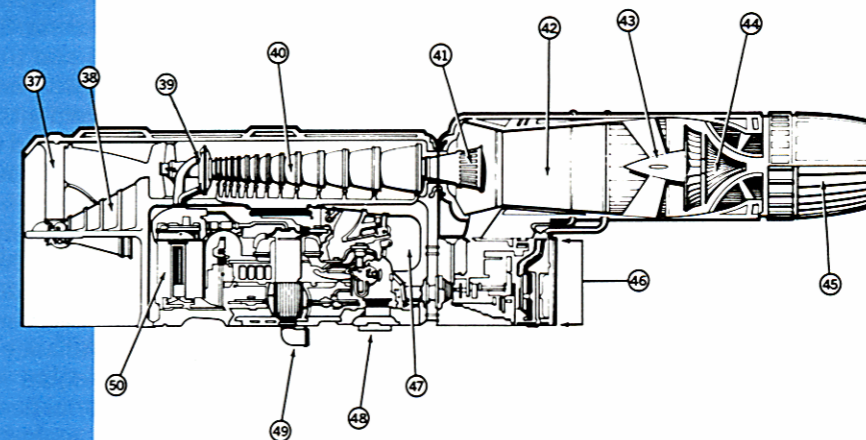

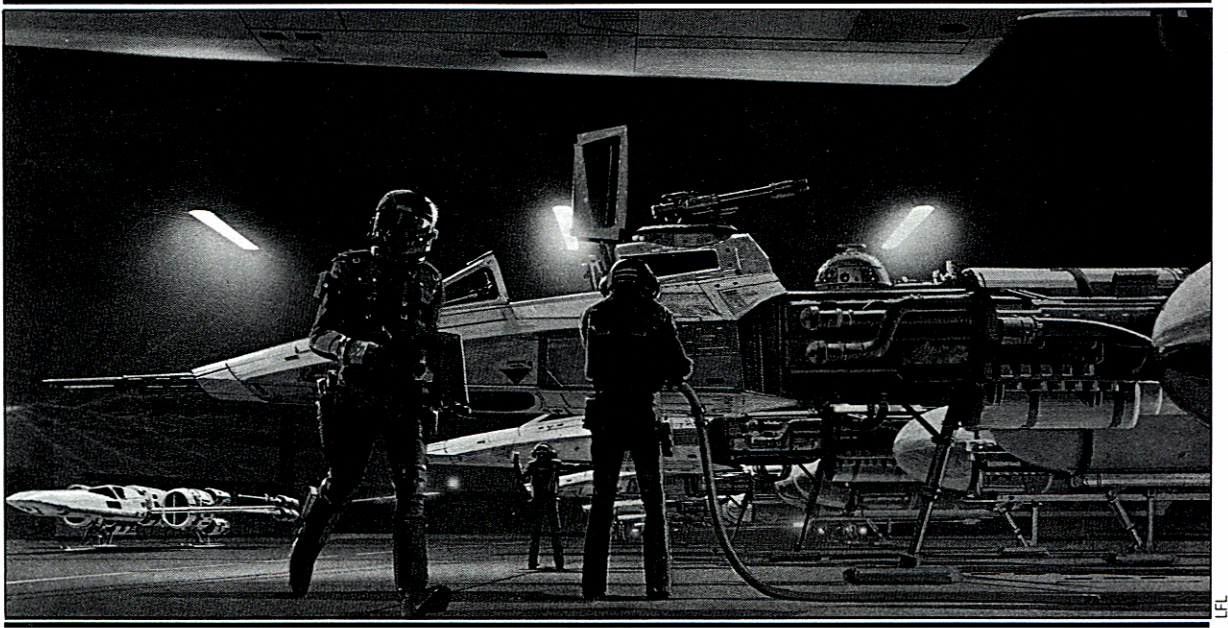

## Maintenance

To keep in peak fighting condition, a starfighter requires about an hour's heavy maintenance for each 10 minutes of combat flight time. Combat places incredible stress upon the vessel's engines, chassis, shields, and life-support systems; even a near-miss by an enemy's weapons can severely damage a starfighter's electronics gear.

Most Alliance ships do not get nearly as much maintenance as they require. If a squadron has been in active combat for more than a week, odds are that they will suffer almost as many casualties from ship malfunction as from the enemy's fire.

However, it must be noted that this applies equally to both sides in the conflict. Imperial starfighters usually operate from superbly-equipped bases, often aboard Star Destroyers, but their ships are generally inferior in design and construction to ours, and their mechanics of a low grade of competence indeed. Down-time for TIE craft between battles is roughly four times as long as it is for Alliance ships, and TIEs have a reputation for severe loss of effectiveness if flown into battle without being properly maintained.

## Strategy and Tactics

This section discusses strategy of unattached Alliance starfighters. Details on the use of starfighters in the Alliance Fleet are highly classified and available only to military personnel in the Fleet.

To carry out their primary goal of space denial, starfighters must be able to strike anywhere

within the Empire, at any time. They are stationed on small, hidden bases, usually near Imperial supply routes. As the Alliance Fleet is in hiding, these craft are often the only viable Rebel military presence within a sector.

Starfighters fly a variety of missions which can be broadly broken down into three categories: attack, defense and reconnaissance.

## Attack Missions

Ideally, a starfighter attack mission profile pits starfighters against lightly-defended targets, preferably slow and unarmed transport vessels or bases, or smaller military ships without adequate TIE protection. To succeed at its primary strategic objective of space denial, the Alliance must constantly harass Imperial forces that are not adequately defended, causing precious military resources to be stripped from the fighting fronts to deal with our starfighters. As long as we can attack at places and times of our choosing, we maintain the initiative and force the enemy to conform to our movements.

Attacks against defended targets are usually to be discouraged. Though our vessels and pilots are undoubtedly better than the enemy's, his manufacturing and training resources far outweigh ours. He can more easily afford to lose 10 starfighters than we can afford to lose one.

There are cases, however, when such attacks are justifiable. The Alliance is in desperate need of supplies and in equal need of denying the supplies to the Imperial fleets; starfighters often spearhead attacks against guarded transport convoys.

Politically, it is sometimes necessary to launch attacks in enemy-held systems to “show the flag;” that is, to tell the oppressed peoples on the planets that they have friends, and to remind our enemies that they are not secure — anywhere.

Finally, attacks may be launched to divert enemy attention and strength from other areas of more importance. The diversionary force may be required to remain on the attack for far longer than is safe, allowing the enemy to gather enough strength in that area to severely damage the attackers. While this is occurring, other Alliance Forces attack the areas the Imperials have deeded to hit the diversion.

It must be stressed, however, that all such attacks can be ordered only at the Sector Command level or higher. Base commanders *do not* have the authority to attack strongly-defended targets without prior approval from Sector HQ. These attacks should always be part of a coordinated, sector-wide action; otherwise, valuable ships and pilots may be lost for no cause.

## Defense

The Alliance cannot successfully defend against Imperial attack. Period. The Empire can *always* muster enough force to wipe out any defenses; even the Alliance Fleet could not successfully defend a fixed position against the full might of the Imperial Navy. Once a base is discovered, it is lost. Alliance starfighter defense tactics are, therefore, designed to slow Imperial attack to allow whatever is the objective of the attack to escape.

Though it is extremely painful to do so, Alliance pilots must be ready to abandon the defense when Imperial strength becomes overwhelming. Futile fights to the death to save an already-lost base are not encouraged.

## Reconnaissance

These are intelligence-gathering missions. For the most part, passive monitoring of the enemy is handled by other agencies; starfighters are used to actively attack the enemy to find the disposition of his forces.

In its most simple form, a recon mission consists of an attack against an unknown target by fast, maneuverable craft. The attack is prosecuted until the enemy sends forth enough ships to discourage the attack, at which time the Alliance vessels withdraw.

These tactics allow the Alliance to determine where the enemy’s strength is. Experienced pilots can quickly judge how many flights of TIE fighters they face, the makeup and disposition of any heavier ships, what kind of ground-based support is available and so forth.

This information can be crucial to a successful campaign; if the attackers have up-to-date data, they can plot their actions with much greater accuracy and chance of success.

## Hyperspace in Starfighter Combat

Because all Alliance fighters are hyperdrive-capable (unlike their Imperial counterparts), strikes can be rapidly executed on Imperial targets far away from the base. This is the starfighter’s preferred tactic — striking quickly from out of hyperspace, taking full advantage of the element of surprise, then disappearing back into the hyperlanes before substantial resistance can be organized.

To maximize surprise and limit the enemy’s reaction time, Alliance pilots attempt to come out of hyperspace extremely close to the target — if possible, *within* its outer defense perimeter. There are risks involved, but if correctly executed, this maneuver leaves the target extremely vulnerable.

## Starfighter Combat Tactics

According to Adar Tallon’s *Treatise on Starfighter Tactics*, starfighter combat can be broken up into five stages.

**Detection:** The first stage is *detection* (and its opposite, *avoidance of detection*). Starfighters can be detected by two methods — visual and electronic. These are the keys to *identification* — the main objective in detection.

**Closing:** The second phase of starfighter combat is called *closing*. The objective during this stage is to reach an advantageous position from which to attack the enemy.

**Attack:** The third, and most decisive stage is *attack*.

**Maneuver:** *Maneuver* is the fourth and most glamorous stage of starfighter combat. Its importance is often overrated, however. A successful attack stage renders maneuver academic.

**Disengagement:** Finally, there is the fifth and most underrated stage, *disengagement*. New pilots often take this stage for granted — usually to their dismay.

## Stage One: Detection and Identification

Starfighter combat begins thousands of kilometers before the ships are within weapons range, a silent, deadly battle of machine versus machine. Given the tremendous speed which starfighters are able to attain, early and accurate detection is vital if a threat is to be met in time.

## The Five Stages of Starfighter Combat

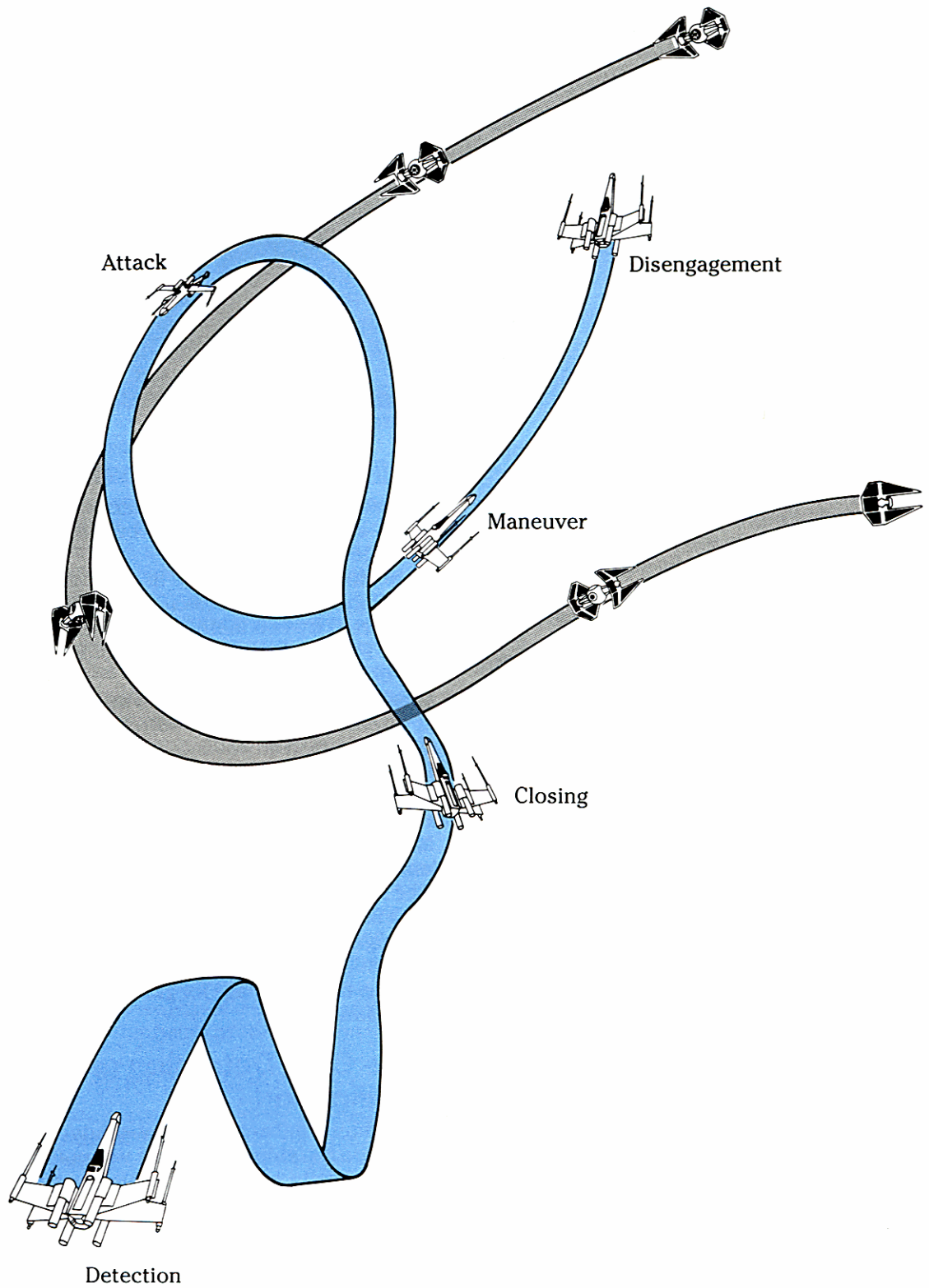



## Sensors

Successful interception of an enemy fighter is dependent on early detection and positive identification. Individual Alliance ships are generally better equipped for long-range scanning than their Imperial counterparts; a lone X-wing is very likely to spot a lone TIE fighter well before it spots him. However, according to Imperial tactical doctrine, TIEs are supposed to stay well within sensor range of their base or capital ship — and a starfighter’s sensors cannot match those aboard larger vessels or bases.

After a target is detected, it must be positively identified. For Rebels, this is handled by the starfighter’s data-sorting computers directly linked to the sensor suite. After examining profile, heat and electromagnetic signature, these identify all craft within range, assigning threat levels to each and displaying the information on the starfighter’s video display.

The Empire’s starfighters tend to rely on flight controllers for this information. After the craft have been identified by the ground or ship-based sensors and computers, the flight controllers assign targets to individual TIEs, relaying the information about the target’s course and speed directly to the TIE’s combat computer.

This system is generally as effective as the flight controller; a good, imaginative controller can judge the ebb and flow of a battle and send the TIE fighters to the appropriate sectors before the enemy can react; a mediocre controller who

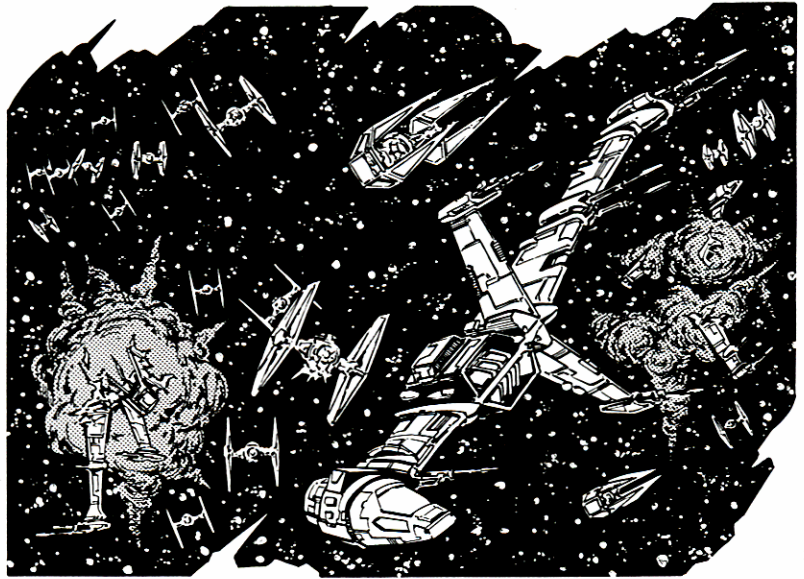

Allen Nunis

does everything “by the numbers” can severely hamper the fighters’ ability to respond quickly and intelligently to events.

Recently, the Alliance has experimented with flight controllers, as well. In the early stages of the battle of Yavin, General Dodonna acted as flight controller for the starfighters’ first run at the Death Star; however, once battle was joined, most tactical decisions were left up to the wing commanders.

## Raid on Fara’s Belt

An example of the disastrous effects of compromised intelligence reports is the Rebel raid on the Imperial communications station in Fara’s Belt.

General Dodonna had planned this fighter strike from the moment Admiral Ackbar gave him a squadron of the new, highly sophisticated B-wing fighters. The destination of the attack was an Imperial base, code-named “Understar.”

Unknown to the Rebels, Imperial Intelligence had broken the Rebel code and was listening in to Rolion Sector transmissions, and they knew that an Imperial base would shortly be attacked. However, though they knew of the attack, and that it would take place somewhere in Rolion Sector, they didn’t know which of their 752 bases there was Understar.

Imperial Intelligence’s Major Herrit, in an uncharacteristically brilliant move, came up

with a plan to trick the Rebels into telling them where the attack would be. He contacted every Imperial installation in Rolion Sector and told each to report some sort of common systems malfunction to the central Imperial HQ. Each installation was given a different malfunction to report: Chirion Base had “environmental problems;” Lobaq Station had “power supply problems;” and so forth.

Then Herrit waited.

When Imperial Intelligence intercepted a Rebel transmission stating that “Understar” had a “gravitational fluctuation malfunction,” Herrit knew that the target of the Rebel attack was the communications station in Fara’s Belt.

When Dodonna’s B-wing squadron dropped out of hyperspace above the Imperial base, they were immediately surrounded and attacked by an overwhelming number of TIE fighters.

## Visual Scanners

If a fighter's electronic sensors are jammed, the pilot must rely on *visual scanners*. This is a short-range sensor resembling a video camera with a telescopic lense, giving the pilot visual contact with the enemy craft long before it can be seen by the naked eye. These sensors are almost impossible to jam, though cloaking devices are effective against them.

## Visual Contact

The last, and most reliable, means of identification is actual visual contact. Despite their sophisticated array of long-range detection devices, Rebel pilots depend the most on their own eyes. Eyes cannot easily be jammed, altered or otherwise interfered with.

## Surprise

A detailed analysis of recordings that have been registered during starfighter victories reveals that four out of every five starfighters shot down in dogfights never saw their assailant. In battle, the key to a quick victory is to surprise the enemy. The key to avoiding a quick defeat is to avoid being surprised.

The perfect way to achieve surprise would be to render your vessel completely invisible — not only to the naked eye, but to highly-sophisticated sensors as well. Some larger ships are equipped with quite effective cloaking devices;

however, the equipment required for cloaking is simply too massive and expensive to fit into a starfighter.

Rendering your ship "invisible" by keeping out of close sensor range and using long-range weapons is generally an ineffective battle tactic. Lasers lose coherency and thus "punch" over long range; concussion missiles and other extreme range weapons are easily tracked by starfighters' sensor equipment, allowing an excellent chance of evasion. It is for these reasons that starfighter combat most often takes place within visual range.

The most effective method of achieving surprise is to drop in close to your enemy from hyperspace. This tactic is commonly employed by Alliance pilots, and it is both extremely rewarding and extremely dangerous.

Sensors cannot operate from out of hyperspace to scan the intended target. Therefore, when Rebel ships employ this tactic they are attacking "blind," relying on intelligence reports of the enemy's position, course and composition. If intelligence reports are accurate, and the attacking Rebel squadron achieves the desired surprise, the raid can be devastating. But, if the Imperials are prepared for such an attack or have changed course or position, the result could be disastrous for the Rebels.

## Scanning in Formation

There was an age old saying among pilots of the Clone Wars: "The first to spot the enemy wins." While this may be a slight exaggeration, spotting the enemy first does give a pilot the initiative. In battle, initiative is everything.

To improve their chances of first detection and thus winning the initiative, starfighters fly in formations which allow their sensors to work together in the most efficient manner possible.

In formation, the pilot has two tasks. The first is to monitor his own detection systems, and the second is to keep a visual lookout for any enemy ships which may have evaded the formation's detection net.

## Deciding to Attack

When a formation of fighters is detected, a decision must be made whether or not to attack. Ideally, this decision is made by a flight controller, who should have a better overall picture of the battle's tactical situation than the pilots.

For a controller, the battle is a game of probabilities: he knows the tactical situation; he knows his ships' capabilities and can make good guesses about his opponents'. He judges the odds of success and the price of failure; if the odds are in his favor and the price of failure acceptable, he sets up his ships in the most advantageous position he can and lets them go.

### **C**ombat Targeting Computer

The advanced tactical targeting computer employed by Alliance starships is designed to augment the pilot's firing skill. It takes only a small fraction of a second for a skilled pilot to center his sights upon his target and pull the trigger and an equally short time for his weapons to energize and fire, but, given the high speeds of modern starfighters, his target could have traveled meters during that split second, moving right out of his sights. Targeting computers compensate for the delay, charting the speed and course of the target and firing just slightly ahead of the point at which the pilot aims.

When firing manually, the pilot must judge these things for himself. This is an extremely difficult skill to master, particularly with high-speed, quick-turning targets such as the Imperial TIE Interceptor. A pilot who can judge the *angle of deflection* by eye without the aid of a targeting computer is a skilled flyer, indeed.

**S**canning Responsibility in Formation

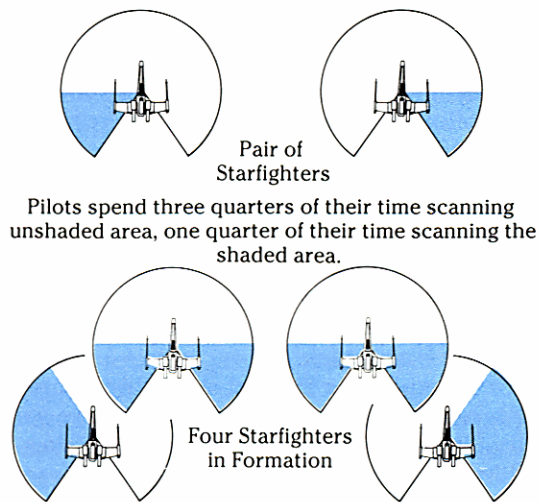

Rosario J. Baldiri

For the pilot or wing commander without a flight controller and therefore without a clear picture of the battle, the decision is not so clear-cut. When his sensors pick up an enemy, he has to answer some difficult questions very quickly: Does the contact pose an immediate threat? What are his squadron's chances of surviving an engagement with the contact? What support is available? Getting any of these questions wrong can mean not only the pilot's personal death, but also make him the cause the deaths of his comrades.

### Stage Two: Closing

If the decision to engage is made, the pilot must attempt to attain an advantageous position for his attack run. This stage of battle is known as "closing."

### Speed and Concealment

The two essential elements to a successful closing are speed and concealment. Both aid in limiting the amount of time the opponent has to react to the attack. High speed is useful for another reason, as well. It increases the energy available to the fighter for maneuver combat or disengagement, should either become necessary.

Because of the sophistication of Imperial sensor equipment, concealment is very difficult to achieve. Sensor jamming is usually attempted, but it screws up the jamming starfighter's equipment even more than its target, and the pilot has no idea how effective it is. Further, while it *may* blur the starfighter's exact location, it *will* alert everyone within a light year that there is an unfriendly starfighter somewhere in that area.

### Deception

Assuming that, as usual, concealment fails, there are other ways to surprise your opposition and maintain the initiative. Of these, deception is the most important.

Essentially, the pilots have to fool their opponents into believing that the attacker's objectives are different than what they really are, that there are more or fewer attackers than there really are, that the main assault is really a feint, that a feint is really the main assault, and so forth. The attackers must do the unexpected. For instance:

- The starfighters make their approach in a dangerously tight formation, which, for a while at least, appears as a single blip on an enemy's sensor screen. The formation stays together until the last possible moment — until they reach visual scanning range of the targets. Only then does the formation break up into individual ships. If carried off well (and no ship blunders into its wingmate) the enemy finds themselves facing much larger numbers of starfighters than they are prepared for.
- Attack in two wings, forcing the opposition to split up to meet both threats. When the enemy gets in range of one of the wings, they discover that it consists entirely of drone starfighters — completely harmless. The other wing has all the real ships in it, and the opposition suddenly finds itself for a short time very badly outnumbered.
- Send in one very large attack force to engage the enemy's starfighters. Once the ships are locked in battle and all of the enemy's reserve ships thrown in, send in a small force at top speed to make a run against the undefended battle control ship.

- Break your attack into three separate components. The first begins jamming the enemy's transmissions as soon as they are within range, drawing a great deal of attention to themselves by doing so. The second component goes in quietly, attacking from the other direction, using visual scanners only. The third waits.

The enemy must decide which threat is more dangerous, and split his forces accordingly. The attackers he chooses to concentrate upon turn tail and run, and the third attacking component joins the other force, once more hopefully gaining local superiority.

The possibilities are literally endless, particularly when you realize that the enemy can and will also be simultaneously attempting to deceive you.

## Stage Three: Attack

The attack stage accounts for four out of every five starfighter kills. It is thus the single most decisive stage of starfighter combat.

Two factors affect the attack: The tactical situation and the capabilities of the vessels involved. Taking both of these into account, the attack must be launched from the best possible position at the best possible moment. If the attack is launched correctly, the attacker has a tremendous advantage. If not, he is in grave peril.

The head-on attack will result in a quick, decisive victory — for one pilot or the other, usually the one with the best ship and steadiest nerves. There is no subtlety in this attack, no finesse: both starships can fire at each other, both are relatively easy targets, and the one who gets in the first telling shot wins.

The best place from which to attack is astern (behind) your opponent. Your opponent cannot return fire, and, as there is little lateral movement, he is an easy target. This is a difficult posture to attain during the attack stage, unless the attacker has achieved a high level of tactical surprise during his closing run.

## Deception in Attack

It is essential to the success of any attack to positively identify the type of enemy formation a pilot has encountered. If a lone ship is spotted, where is his wingman? A favorite Imperial ploy is to have one fighter trail some distance behind his wingman, waiting for an enthusiastic young Alliance pilot to jump in behind the front TIE to attack it from the rear. If he does so, the Rebel has unknowingly lined himself up for a devastating attack by the trailing fighter.

Alliance pilots often use a somewhat more complicated strategy of deception, known as the “feint and backstab.” In this technique, a decoy formation attacks in order to distract the enemy from the true attack.

For example: one flight of starfighters forms up for a head-on run in full view of enemy sensor surveillance, while a second flight skirts around behind the enemy, remaining outside sensor range. The first flight closes as if to attack, but breaks away before close range is reached. At the same time, the other flight closes from an advantageous position, ready to take advantage of the

### F Feint and Backstab

Red Flight makes a head-on attack, but turns off before reaching effective combat range

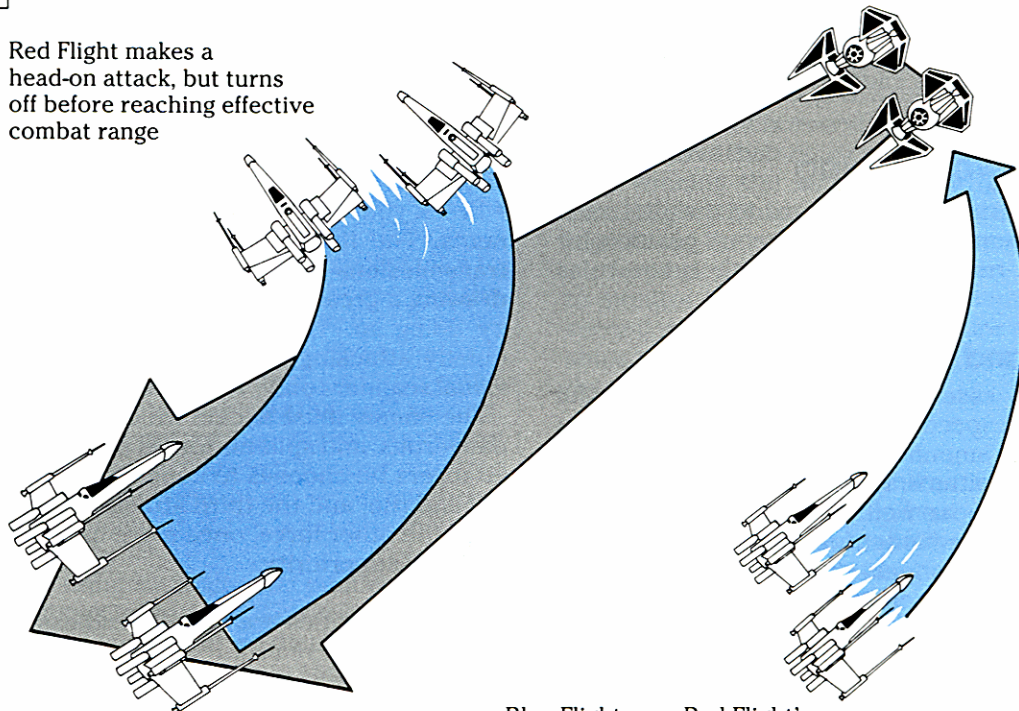

Blue Flight uses Red Flight's distraction to close with enemy undetected

enemy's confusion. The diversionary flight stands by, ready to re-enter the fight if needed.

If they survive their first battle, pilots quickly learn never to take anything for granted.

### Stage Four: Maneuver

The maneuver stage of combat occurs only when an attack fails and the starfighters begin jockeying for position. During maneuver combat, the experienced pilot will strive to deny his adversary the initiative. He knows that dogfights are more often lost than they are won; that is, the first pilot who makes a mistake loses. The pilot who holds the initiative can keep his opponent under constant pressure. The longer the pressure continues, the greater the stress on the defending pilot. Stress breeds mistakes.

The maneuver stage begins as soon as a pilot realizes that he is about to come, or is already under attack. His first priority is simple survival; turning the tables is secondary. The opening moves of the maneuver are defensive, with the attacker attempting to defeat the defender's evasive actions. If the defender is able to "shake" his attacker, he can then either break off the engagement or attempt to turn the tables; if the attacker can hang on, it is merely a matter of time until he destroys his opponent.

Each maneuver has a counter-maneuver. It is the execution of the maneuver which is most important, not necessarily the quality of the starfighter itself. The most technically advanced fighter in the galaxy is only as good as its pilot.

### Some Basic Maneuvers

Most successful attacks during maneuver combat are made from astern. The closer an attacker angles in to the intended target's stern, the better shot he will get. Adar Tallon refers to this vulnerable target area as the "prime target cone."

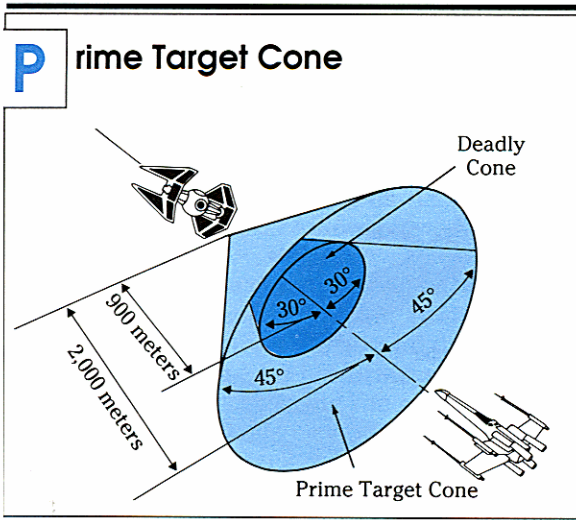

The limits of this cone, according to Tallon, are no more than a 45 degree angle toward the rear of the target, and no more than 2,000 meters distant. A smaller, even more ideal target cone, the "deadly cone," is confined to 30 degrees, and 900 meters.

### The Break

This maneuver is used when an attacker is first detected as attempting to close in, or is already in the defender's prime target cone. Its purpose is to spoil the attacker's aim and cause his fighter to "overshoot" (move out in front of you, thus allowing you to move in behind him and into his prime target cone). To execute the break, the pilot turns his starfighter and cuts in his reverse thrusters.

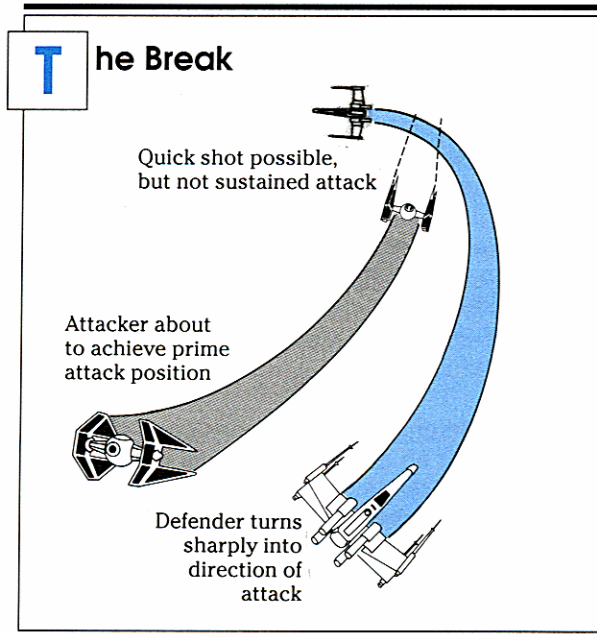

Rosario J. Baldoni

The break is always made toward the direction of attack. Both the turn itself and the loss of speed forces the attacker to either overshoot or compensate by turning inside, which takes him out of the prime target cone.

The break does present the attacker with an opportunity to fire just as the defender sweeps across his sights, but this is a difficult shot and allows no sustained fire.

### The Scissors

This is a series of sharp turn reversals performed in an attempt to get the attacker out in front of the defender and into a position of disadvantage.

The initial turn reversal is made after the attacker has overshoot (perhaps after a successful *break*). Timing is critical when performing a scissors maneuver. If one fighter turns too quickly,

**T**he Scissors

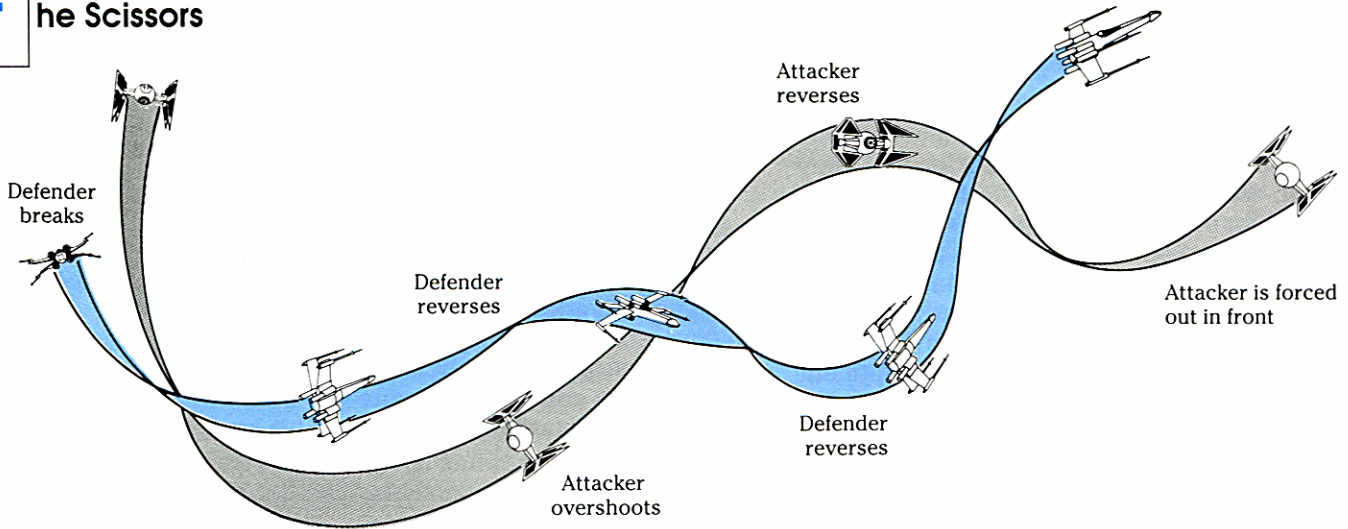

the other ship may drift wide more slowly and come up behind him.

This maneuver may become a stalemate, with neither fighter ending up behind the other. The winner in a scissors contest is usually the fighter which can reduce its forward velocity the most while making the sharp turn reversals, thus ending up behind his opponent.

**Jinking**

This is a defensive strategy designed to throw off the aim of an attacker who has achieved an excellent attack position (in the prime target cone). It is a series of random turns, slips, waggles and dives which will hopefully prevent the attacker from getting a target lock.

While the attacker is still able to retain his excellent advantage, the longer he is forced to concentrate on shooting at the opponent, the less aware he will become of what is going on around him, making him a prime target for other defending starfighters in the area.

**The Reverse Throttle Hop**

This maneuver is a way of retaining the advantage when the target breaks. As the defender goes into his break, the attacker pulls up above his opponent and decelerates. As the defender finishes his break, the attacker drops back down behind the defender, having performed a sort-of exaggerated "hop."

This is a very difficult maneuver to perform well. It requires split-second timing, precise execution, and a bit of intuition. If it is started too early, the defender will simply loop back and follow the attacker up, giving himself the advantage. If it is started too late, the attacker is in

danger of overshooting and once again ending up in front of his opponent.

**The Tallon Roll**

This difficult maneuver is performed when the attacker becomes aware that he is going to overshoot a breaking defender. He comes level, pulls his nose hard up, then rolls *away* from the direction of the turn. This three-dimensional maneuver is completed by sliding in astern of the target. Effectively, this maneuver alters the angle of approach to the target without losing speed or distance. It is difficult for a defender to counter the roll, as it takes place entirely behind him and in his blind spot.

The difficulty of the maneuver is the roll itself. It is easy to become disoriented while in a roll and an unskilled attacker can easily overshoot, tak-

**T**he Reverse Throttle Hop

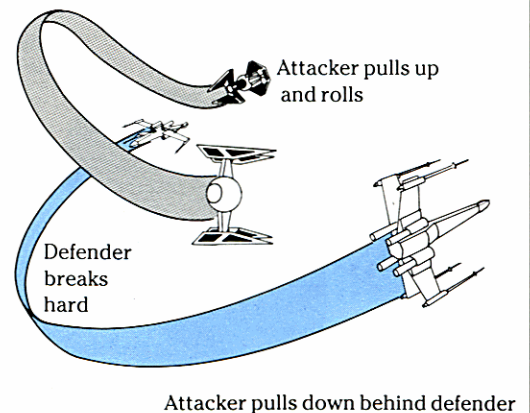

tactical diagrams by Rosaria J. Baldari

**T**he Tallon Roll

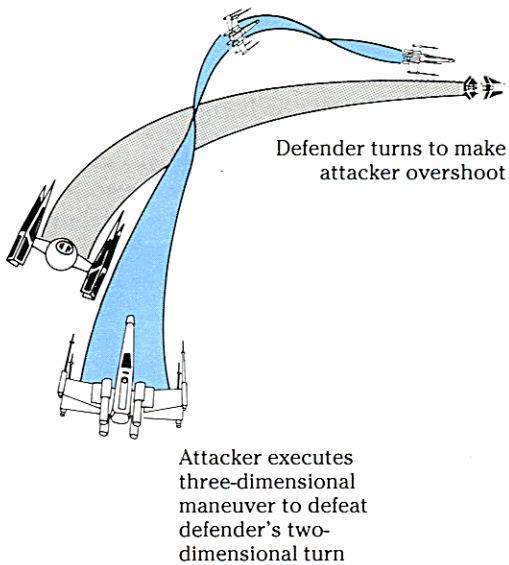

**T**he Trap

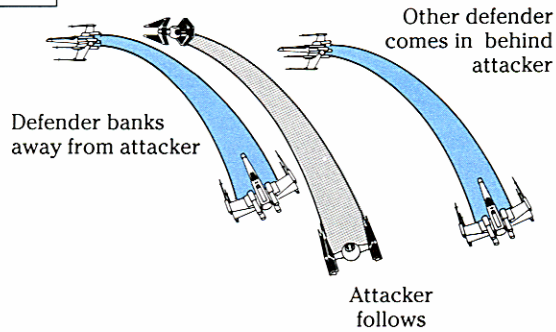

ing himself out of the fight completely and possibly putting himself at the mercy of the defender.

**Maneuvering in Pairs**

A single starfighter in a hostile environment is extremely vulnerable. Alliance starfighters operate in elements of two. "Battle Spread" is the most commonly used pairs formation. In it, the two fighters fly side by side with approximately 200 to 300 meters between them.

A pair, working as a team, has the potential to be far more effective than two single starfighters each operating on its own. They guard each others' blind spots and hunt together as a coordinated unit.

Following are two of the more effective maneuvers for starfighters operating in pairs.

**The Trap**

The trap is the oldest, simplest, and still most effective trick in the book. If either fighter is attacked from behind, he turns hard in either direction. If the attacker follows, he is trapped by the second man.

The most effective defense against this maneuver is for the attacker to feint, pretending to follow the first man. As the second man slots in behind the attacker, he performs a full-throttle hop or a Tallon roll, forcing the second man to overshoot him. This leaves both defending fighters in front of the attacker.

**The Under Split**

This maneuver involves some danger for the lead man, and should only be attempted if the lead starfighter can take a bit of punishment. In it, the lead man shoots out ahead of his wingman in full view of a pair of enemy fighters. As the enemy ships turn toward the lead man, his wingman crosses under unobserved and pulls up hard for a belly shot.

Trainee pilots are always taught to keep a sharp lookout for this type of decoy move. Unfortunately, in the heat of battle, the chance of a quick kill against an outnumbered opponent often drives out this training, leaving the starfighters at deadly peril.

**T**he Under Split

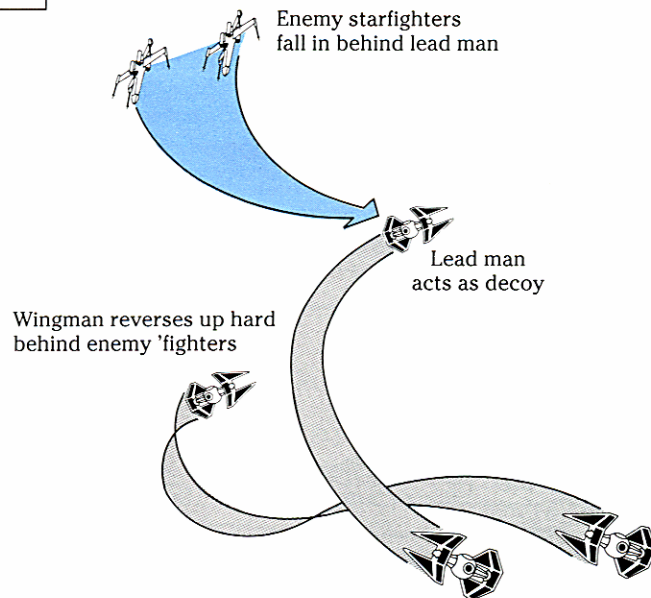

## Stage Five: Disengagement

This is the final stage in starfighter combat. Adar Tallon's comments on the subject are rather strong: "It is rarely given adequate attention. The inexperienced pilot frequently believes that following an attack pass, particularly a successful one, the engagement is over and he can relax. This is dangerous nonsense."

Diminished vigilance at this final stage of combat is a recipe for disaster — particularly for Alliance pilots. This is because we almost always find ourselves outnumbered. In a typical quick-strike attack, the pilots cannot afford to dally, for fear of giving the Imperials too much time to regroup or gather reinforcements. If a pilot cannot disengage, he cannot make a clean jump into hyperspace. The longer he stays in the combat area, the more vulnerable he is to being swarmed by superior numbers of Imperial fighters.

The ideal way to disengage is, of course, to destroy all the enemy. This is not always possible. A plan for disengagement should be considered before an attack is commenced. Angling-off at full-throttle following a full-throttle attack is the simplest method, and is effective if the attacker has not become engaged in a dogfight.

Getting free from a dogfight is much more difficult because the timing must be perfect. The best moment to break off from maneuver combat is when the situation is neutral, with neither starfighter having the positional advantage.

The words of Adar Tallon once again: "If a pilot is under enemy attack and manages to recover to a neutral position and disengage, he has won the engagement. If he is the assailant and his target manages to attain a neutral position, he should immediately disengage and look for easier prey. If he remains engaged, he risks becoming disadvantaged himself."

### Lifesaving Techniques

There are several crucial elements to any disengagement. First and foremost, the pilot must have speed. It is far easier for a pilot to disengage when travelling at full-throttle, particularly when

**Z-95 "HEADHUNTER"**

**Craft:** Incom/Subpro Z-95 Headhunter  
**Type:** Multi-purpose space fighter  
**Length:** 11.8 meters  
**Crew:** 1  
**Passengers:** None  
**Cargo Capacity:** 85 kilograms  
**Consumables:** One day  
**Hyperdrive Multiplier:** None  
**Nav Computer:** None  
**Hyperdrive Backup:** None  
**Sublight Speed:** 3D+2  
**Maneuverability:** 1D  
**Hull:** 4D  
**Weapons:**  
**Two Triple Blasters** (fire linked)  
*Fire Control:* 1D  
*Combined Damage:* 3D  
**Concussion Missiles**  
*Fire Control:* 1D  
*Damage:* 7D  
**Shields:**  
*Rating:* 1D

the combatants are not on parallel courses. Full-throttle puts a great deal of distance between a pilot and an adversary attempting to turn and catch him.

To make sure that the disengagement is clean, a pilot must attempt to maintain visual contact with his opponent. Attempting to disengage while unsure of an opponent's position could easily result in the opponent gaining a position of advantage.

If a pilot loses sight of his opponent while in a turning contest (such as the *scissors*), he should continue turning until he regains contact. If seeking to disengage while under attack, the pilot should always turn toward the enemy. In this way, he can meet his assailant with the best chance of angling-off and escaping after the attacker has taken his shots. If the pilot flies away from his opponent, he risks allowing the opponent to get on his tail. This is doom.

## Rebel Starfighter Types

### The Z-95 Headhunter

At one time, the Z-95 was the most common starfighter in the galaxy. Though unable to compete with the newer 'fighters, it is still widely used by mercenaries, private corporations and planetary governments who cannot afford (or are forbidden to purchase) the latest generation of vessels. There are no Z-95s in the Alliance Fleet

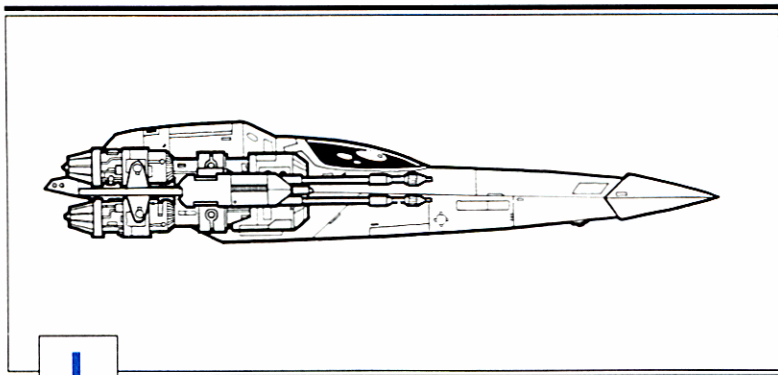

Rob Caswell



Incom/Subpro's Z-95 Headhunter.



**REBEL Z-95XT "TRAINER"**

**Craft:** Incom/Subpro Z-95XT  
**Type:** In-system courier/training vessel  
**Length:** 12.2 meters  
**Crew:** 1  
**Passengers:** 1  
**Cargo Capacity:** 200 kilograms  
**Consumables:** 1 week  
**Hyperdrive Multiplier:** None  
**Nav Computer:** None  
**Hyperdrive Backup:** None  
**Sublight Speed:** 3D  
**Maneuverability:** 1D  
**Hull:** 4D  
**Weapons:**  
**Two Triple Blasters** (fire linked)  
*Fire Control:* 1D  
*Combined Damage:* 3D  
**Shields:**  
*Rating:* 1D+2

(the Z-95 has no hyperdrive engines), but the Alliance still employs a few on defensive stations in low-risk sectors.

Although unable to compete with newer starfighters in performance or weaponry, the Z-95 is an extremely durable fighter, able to absorb damage with the best of them. In fact, Incom designers incorporated many of the Z-95's hull and ray-shielding features when creating the phenomenally successful X-wing starfighter.

Built with Incom's typical simplicity of design, the Z-95 is easily altered to suit different mission profiles. Typical modifications include additional weapons (usually ground-attack missiles), extended range, increased sublight speed, and better rear shielding. Attempts have been made to add hyperdrive engines, but that has been found to be entirely too costly to be worth the effort.

A two-seat training model of the Z-95 has been produced, as well. This lightly-armed craft is often used for ferrying runs in-system or between ships in a fleet.

**The Y-Wing Starfighter**

The Y-wing is perhaps the most versatile of all Rebel starfighters. With slight modifications or different model configurations, this ship is capable of handling virtually any mission. This flexibility is a valuable asset to the Rebellion, since they cannot afford to invest in many specialized ships. (The highly specialized A- and B-wing fighters are produced in quite limited numbers.)

The Alliance employs two basic Y-wing models, the BTL-A4 and the BTL-S3. The S3 is the two-man

**REBEL Y-WING LONGPROBE**

**Craft:** Koensayr BTL-A4 Y-wing  
**Type:** Long-range reconnaissance fighter  
**Length:** 16 meters  
**Crew:** 1 (plus 1 astromech Droid)  
**Passengers:** None  
**Cargo Capacity:** 80 kilograms  
**Consumables:** Three weeks  
**Hyperdrive Multiplier:** x1  
**Nav Computer:** Yes  
**Hyperdrive Backup:** Yes  
**Sublight Speed:** 3D+2  
**Maneuverability:** 2D  
**Hull:** 4D+1  
**Weapons:**  
**Two Laser Cannons** (fire linked)  
*Fire Control:* 2D  
*Combined Damage:* 5D  
**Two Proton Torpedo Launchers**  
*Fire Control:* 2D  
*Damage:* 9D  
**Two Light Ion Cannons** (fire linked)  
*Fire Control:* 1D  
*Combined Damage:* 4D  
**Shields:** 1D

**STANDARD REBEL Y-WING**

**Craft:** Koensayr BTL-S3 Y-wing  
**Type:** Attack fighter  
**Length:** 16 meters  
**Crew:** 2 (plus 1 astromech Droid)  
**Passengers:** None  
**Cargo Capacity:** 110 kilograms  
**Consumables:** One week  
**Hyperdrive Multiplier:** x1  
**Nav Computer:** None (Droid is preprogrammed for 10 jumps)  
**Hyperdrive Backup:** None  
**Sublight Speed:** 3D+2  
**Maneuverability:** 2D  
**Hull:** 4D  
**Weapons:**  
**Two Laser Cannons** (fire linked)  
*Fire Control:* 2D  
*Combined Damage:* 5D  
**Two Proton Torpedo Launchers**  
*Fire Control:* 2D  
*Damage:* 9D  
**Two Light Ion Cannons** (fire linked)  
*Fire Control:* 3D  
*Combined Damage:* 4D  
**Shields:** 1D+2

# Koenjarr Longprobe

## BTL-A4 Y-Wing Long-Range Reconnaissance Fighter

Side View — Cockpit

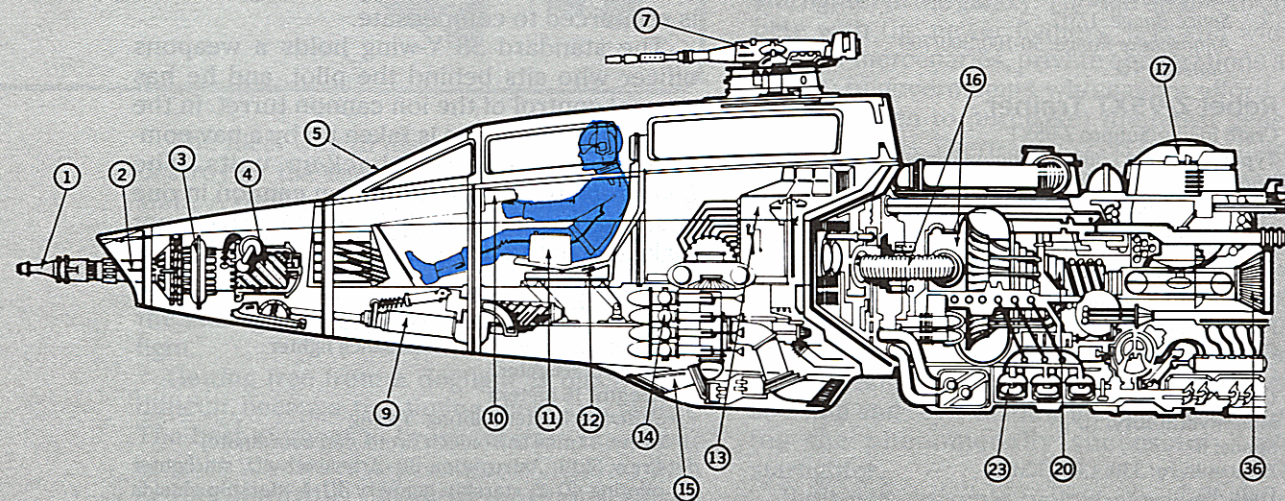

Primary Components List

- |                               |                                           |                                |
|-------------------------------|-------------------------------------------|--------------------------------|
| 1. Laser Tip                  | 13. Nav Computer & Hyperdrive Backup Unit | 25. Rear Sensor                |
| 2. Laser Barrel               | 14. Proton Torpedo Magazine               | 26. Hyperdrive Unit            |
| 3. Laser Actuator             | 15. Proton Torpedo Launcher               | 27. Power Coupling             |
| 4. Sensor Window              | 16. Life Support System                   | 28. Deflector Screen Projector |
| 5. Canopy                     | 17. R-2 Unit                              | 29. Long-Range Sensor Array    |
| 6. Primary Sensor Array       | 18. Novaldex Power Generator              | 30. Ion Fission Chamber        |
| 7. Ion Cannon                 | 19. Deflector Shield Generator            | 31. Turbo Impellor             |
| 8. Acceleration Compensators  | 20. Power Converter                       | 32. Turbo Generator            |
| 9. Landing Gear               | 21. Stabilizer                            | 33. Exhaust Nacelle            |
| 10. Tactical Control Console  | 22. Main Power Cells                      | 34. Support Pylons             |
| 11. Secondary Weapons Console | 23. Reserve Power Cells                   | 35. Disk Vectrals              |
| 12. Guidenhaus Ejection Seat  | 24. Deflector Ducts                       | 36. Alluvial Damper            |

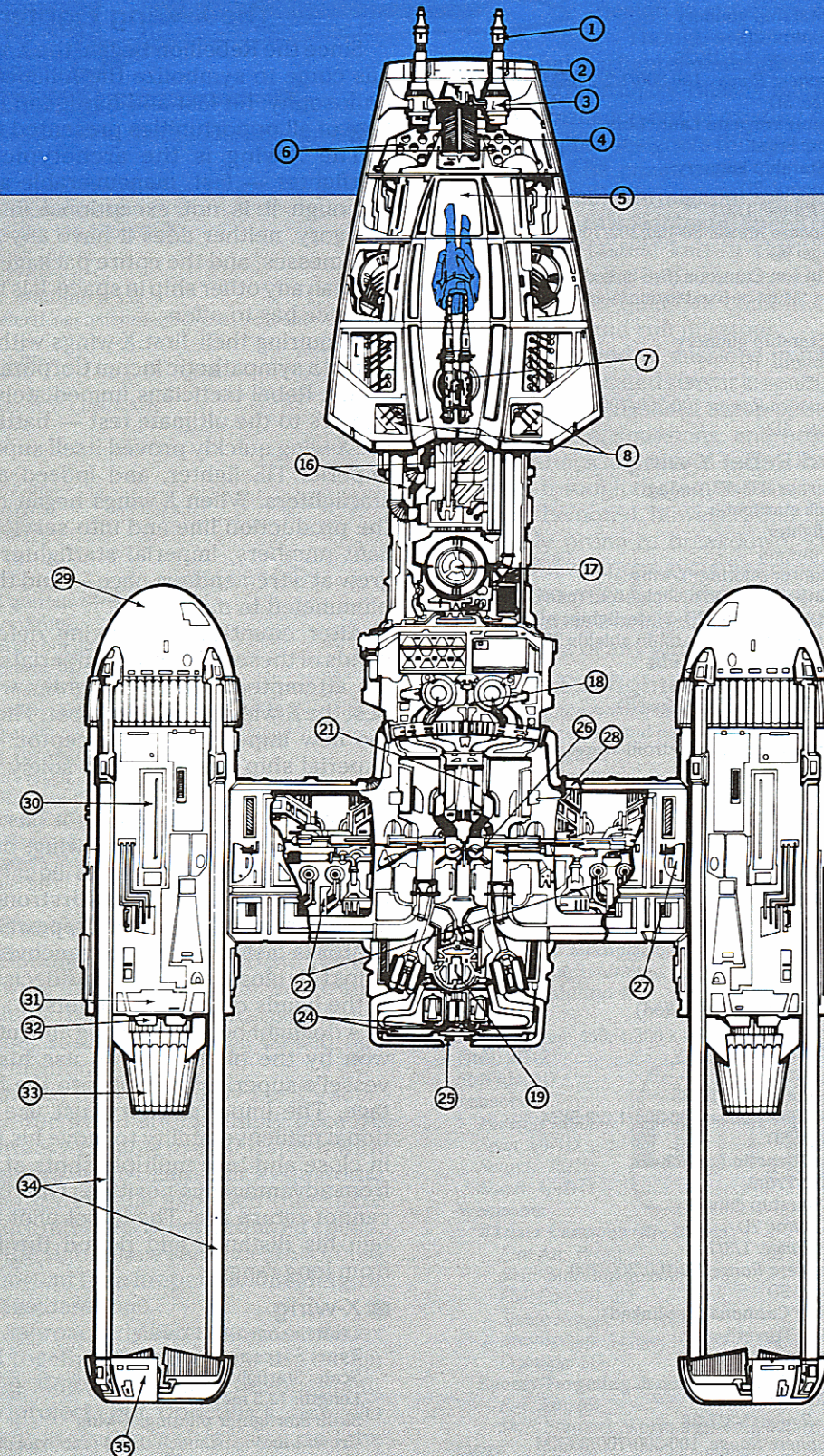

Top View

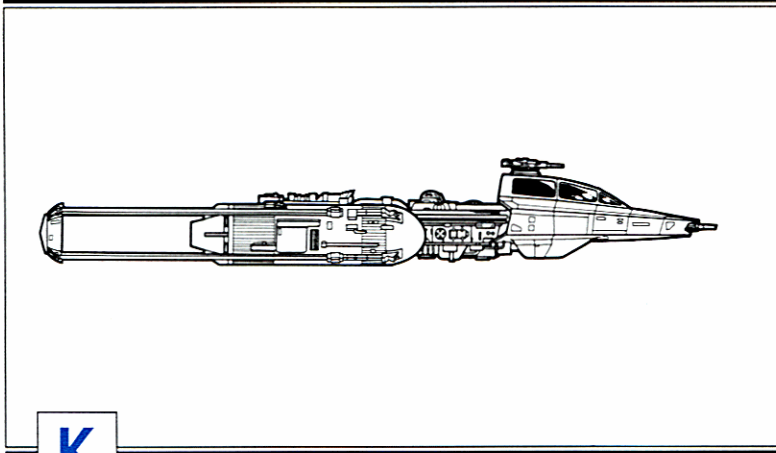

Rob Caswell

K

Keensayr's BTL-A4 Y-wing reconnaissance starfighter.

variant. It has superior shields to the A4, as well as better accuracy with its ion cannon (directly controlled by the gunner).

The A4 is also known as the *Y-wing Longprobe*. It is modified for deep-space missions with longer in-flight time. Whereas the S3 has no nav computer for making calculations for hyperspace (it uses a R2 unit with pre-set coordinates instead), the A4 is equipped with a sophisticated model capable of unlimited jumps.

Because of the power drain of its stronger hyperdrive engines, the A4 loses some of its deflector shield strength, though the hull is reinforced to compensate.

## REBEL X-WING FIGHTER

**Craft:** Incom T-65B X-wing  
**Type:** Space superiority starfighter  
**Length:** 12.5 meters  
**Crew:** 1 (plus astromech Droid)  
**Passengers:** None  
**Cargo Capacity:** 110 kilograms  
**Consumables:** 1 week  
**Hyperdrive Multiplier:** x1  
**Nav Computer:** None (uses astromech Droid)  
**Hyperdrive Backup:** None  
**Sublight Speed:** 4D  
**Maneuverability:** 3D  
**Hull:** 4D  
**Weapons:**  
**Four Laser Cannons** (fire linked)  
*Fire Control:* 3D  
*Combined Damage:* 6D  
**Two Proton Torpedo Launchers**  
*Fire Control:* 2D  
*Damage:* 9D  
**Shields:** 1D

The biggest difference between the two Y-wing models is the omission of the second crewman's station in the *Longprobe*. The standard Y-wing holds a weapons officer who sits behind the pilot, and he has manual control of the ion cannon turret. In the *Longprobe*, the space is taken up by a nav computer and hyperdrive back-up units. The A4 pilot must fix his ion cannon in one position (usually directly forward), and cannot make use of the turret's rotation capabilities.

## The X-Wing Fighter

Since the Rebellion began, the X-wing fighter has come to symbolize the Alliance's military philosophy: hit fast and hard, and take advantage of all opportunities presented to you.

The X-wing is the archetypal combat starfighter — fast, maneuverable and deadly.

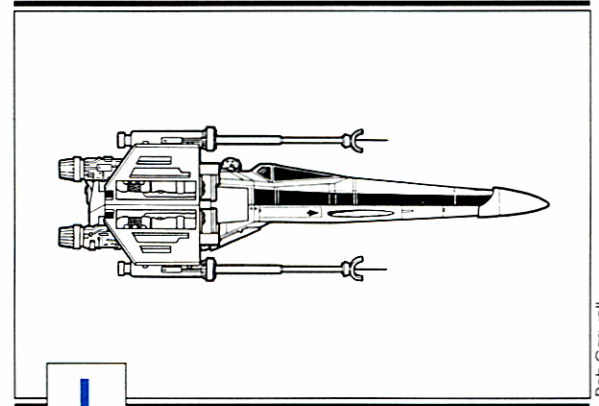

Rob Caswell

I

Incom's T-65B X-wing space superiority starfighter.

Although it is not exceptional in any single category, neither does it have any substantial weaknesses, and the entire package works better than any other ship in space. It is the best the Alliance has to offer.

Acquiring their first X-wings with the defection of a sympathetic Incom Corporation design group, Rebel tacticians immediately put these fighters to the ultimate test, battle, where the X-wing quickly proved itself superior to the Imperial TIE fighter, and indeed all Imperial starfighters. When X-wings began to come off the production line and into service in significant numbers, Imperial starfighter casualties grew at a tremendous pace — and their morale plummeted to match.

After countless frustrating defeats at the hands of these Rebel craft, Imperial ship designers attempted to build a fighter which could best the X-wing in single combat. The result was the new Imperial TIE Interceptor — the first Imperial ship ever designed solely to defeat a specific Rebel fighter.

In battle, the TIE Interceptor has not proven itself the superior of the X-wing, but it is distressingly close to being its equal. While the Rebel craft is still sturdier with stronger shields, and has marginally better firepower, the Interceptor is faster and more maneuverable. With ships this closely matched, the decision is firmly in the hands of the ship's pilots.

A dogfight between X-wing and Interceptor is won by the pilot who can use his particular vessel's superior attributes to the best advantage. The Imperial pilot must use his exceptional maneuverability to move his Interceptor in close and take multiple shots at the X-wing from advantageous positions where the X-wing cannot return fire. The Rebel pilot must maintain his distance and pound the Interceptor from long range.

### The A-Wing Fighter

General Dodonna conceived of the A-wing fighter following the Battle of Yavin. When analyzing that titanic battle, the General concluded that the Rebel starfighter arsenal lacked one essential element: Raw speed.

Three Imperial fighters, led by Lord Vader, almost foiled the Rebel attack simply because their TIE fighters were able to match speed with the Rebel fighters in the Death Star's equatorial trench. General Dodonna expected that there might be future missions which required speed, and that, in the right place and time, this could be more important than firepower, shielding, or any other considerations.

Dodonna approached Alliance engineer Walex Blissex, and together they drew up the design for the A-wing. Mon Mothma was dubious about

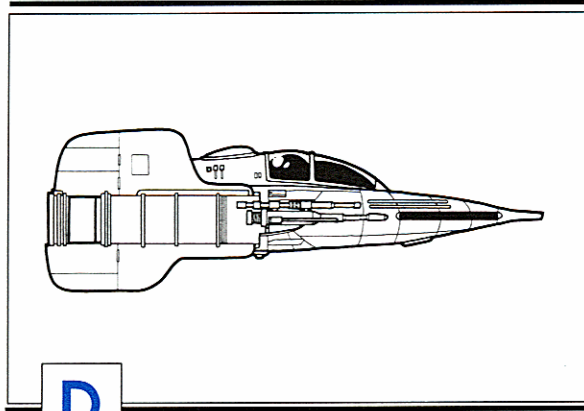

Rob Caswell

D

odonna/Blissex A-wing starfighter.

funding the project, but Dodonna's star was definitely in the ascendance after Yavin, and she eventually agreed, though she did not come up with as much money as Dodonna and Blissex wanted. They were forced to make some substantial modifications in their design to cut down on costs.

Though still extremely expensive, the final starfighter came in well under budget. The extraordinary Blissex managed to get better performance out of existing components than the original designers thought possible, and the ship can be constructed out of parts and material available throughout the galaxy.

In addition to its fantastic speed (to date, the A-wing is the fastest known starfighter in the galaxy), the A-wing is also extremely maneuverable. These two qualities combine to make it superb for hit and run missions.

With these kind of missions in mind, Blissex added a sophisticated sensor jamming unit to the vessel — the ship goes in at top speed, jamming the enemy's transmissions, and hopefully completes its attack and leaves before the defenders can break through the jam to summon help.

It must be noted, however, that the A-wing is notoriously prone to breakdown. The engines, chassis, and weapons systems are routinely subject to stresses far beyond design specifications, and the fighters' maintenance to flight ratio is the second worst of any Rebel starfighter in service.

### The B-Wing Fighter

As the A-wing was the brainchild of General Dodonna, the B-wing was conceived and built by Admiral (then Commander) Ackbar. Prior to the Battle of Yavin, Alliance starfighters had suffered considerable losses at the hands of Imperial Capital ships, specifically escort cruisers and corvettes. Star Destroyers were, of course, more dangerous vessels, but they were the responsibility of the Alliance Fleet — there was nothing that starfighters could do about them anyway. To

#### REBEL A-WING FIGHTER

**Craft:** Dodonna/Blissex A-wing starfighter

**Type:** Interceptor and multi-purpose fighter

**Length:** 9.6 meters

**Crew:** 1 pilot

**Passengers:** None

**Cargo Capacity:** 40 kilograms

**Consumables:** 1 week

**Hyperdrive Multiplier:** x1

**Nav Computer:** limited; two jumps

**Hyperdrive Backup:** None

**Sublight Speed:** 6D

**Maneuverability:** 4D

**Hull:** 2D+2

**Weapons:**

**Two Laser Cannons (fire linked)**

*Fire Control:* 3D

*Combined Damage:* 5D

**Shields:** 1D

**REBEL B-WING FIGHTER**

**Craft:** Slayn & Korpil B-wing  
**Type:** Heavy assault fighter  
**Length:** 16.9 meters  
**Crew:** 1 pilot  
**Passengers:** None  
**Cargo Capacity:** 45 kilograms  
**Consumables:** One week  
**Hyperdrive Multiplier:** x2  
**Nav Computer:** Limited; two jumps  
**Hyperdrive Backup:** None  
**Sublight Speed:** 3D  
**Maneuverability:** 1D+1  
**Hull:** 3D  
**Weapons:**  
**One Laser Cannon**  
*Fire Control:* 1D  
*Combined Damage:* 7D  
**Two Proton Torpedo Launchers**  
*Fire Control:* 3D  
*Damage:* 9D  
**Three Medium Ion Cannons (fire linked)**  
*Fire Control:* 4D  
*Combined Damage:* 4D  
**Two Auto-Blasters**  
*Fire Control:* 2D  
*Damage:* 3D  
**Shields:** 2D

complete their primary mission of space denial, Alliance starfighters had to be able to *at least* bloody the noses of the escort warships.

Commander Ackbar was commissioned to design a new Rebel fighter, a fighter which could conceivably go up against something as large and well-armed as a frigate, and, with luck, survive to get in close enough to make it nervous.

This was no easy task, but Ackbar rose to the challenge. The brilliant Mon Calamari enlisted the aid of the insectoid Verpine, a race of superb shipbuilders who lived deep within the Roche asteroid belt. There "Project Shantipole," as it came to be known, was begun and the B-wing fighter was born.

When the Shantipole Project was compromised by an Imperial spy working on Ackbar's staff, an independent Rebel unit performed heroically to keep Ackbar and the B-wing prototype from falling into Imperial hands. The Rebels were successful, and all that the Imperials managed to gain for their efforts was a healthy fear of going up against this new Rebel fighter in the future.

Following the Shantipole debacle, rumors of a powerful new Rebel fighter quickly spread through the Imperial fleet. By the time the first

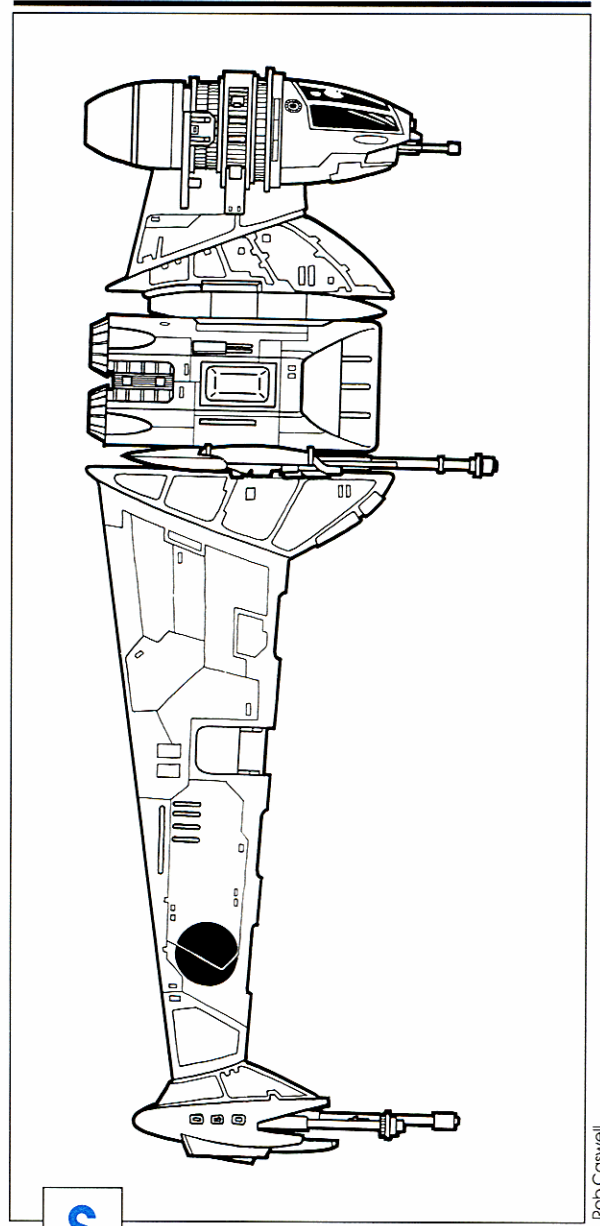

Rob Caswell

**S**layn and Korpil's B-wing heavy assault starfighter.

squadron of Rebel B-wings saw action against Imperial TIEs, the fear was so strong that the entire Imperial wing turned tail and ran at first sight of the strange new craft.

It wasn't until the disastrous raid on Fara's Belt that the Imperial Navy's fear of the B-wing was dispelled. During the massacre, it was found that despite the B-wing's powerful weaponry, the ship had exploitable flaws. Chief among these is a lack of maneuverability and speed, unimportant against the even-slower capital vessels, but a crippling liability against the new Imperial TIE Interceptor.



# Starfighter Recognition Guide

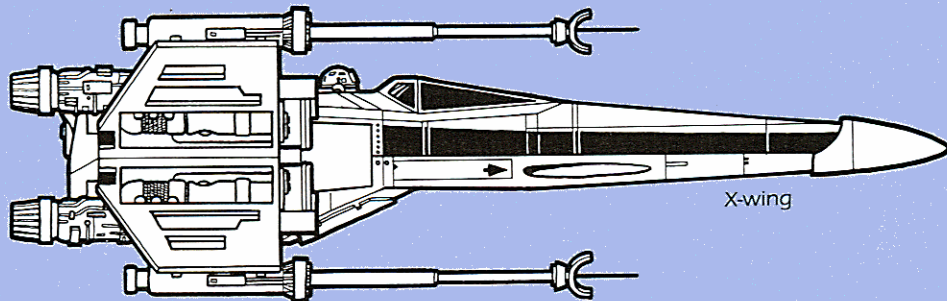

X-wing

B-wing

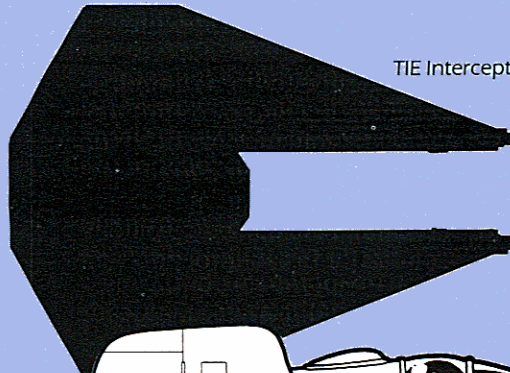
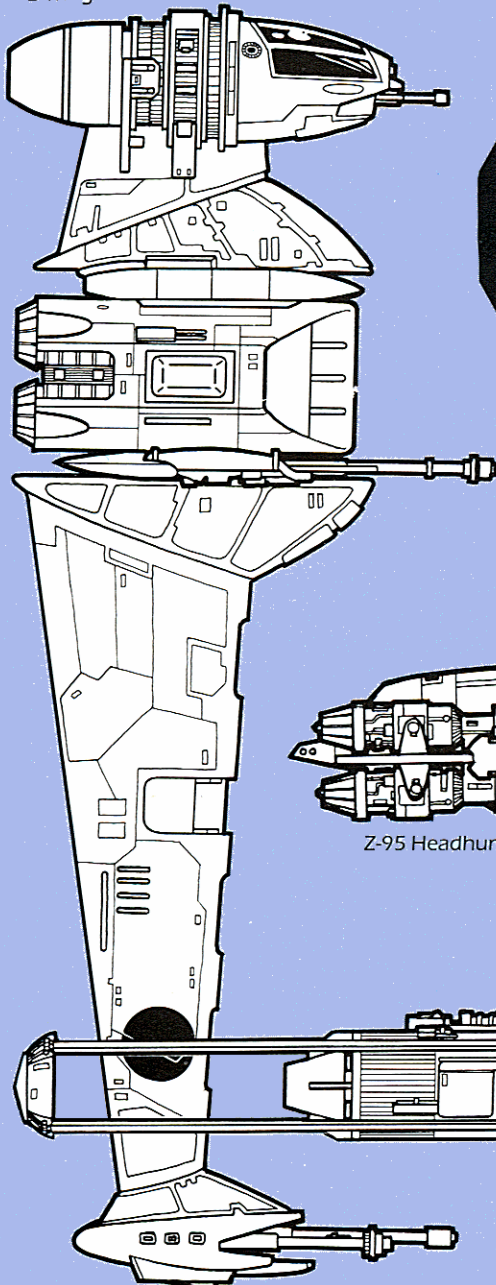

TIE Interceptor

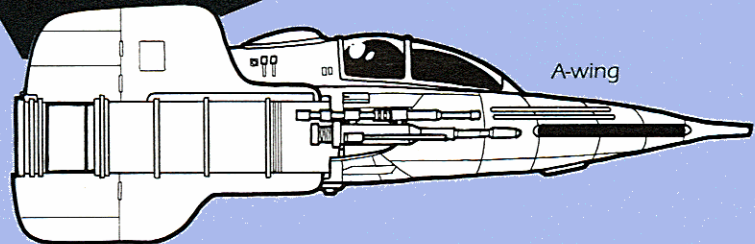

A-wing

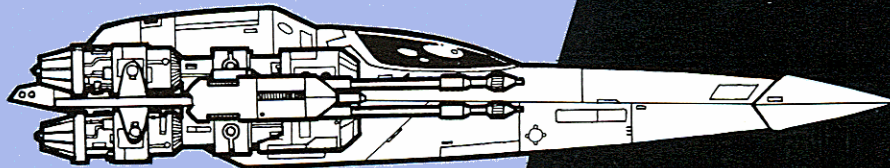

Z-95 Headhunter

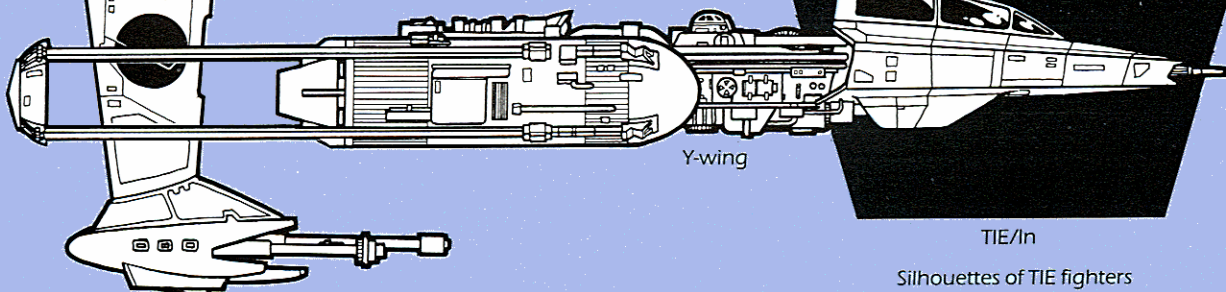

Y-wing

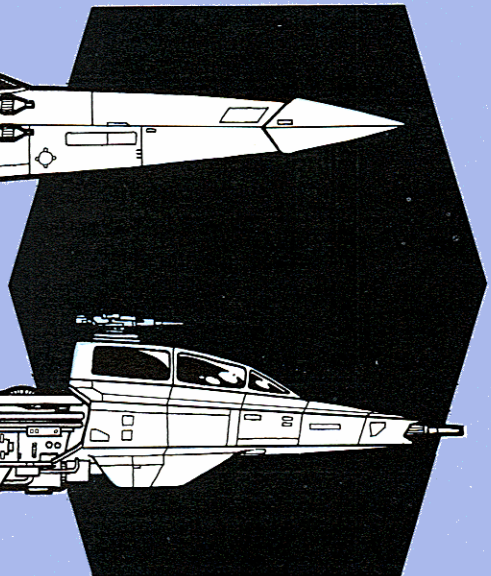

TIE/ln

Silhouettes of TIE fighters  
provided for comparison

**Note:** All vessels are shown to scale.



## Chapter Six Ground Combat

*The heat from the barrel of his blaster rifle warmed the hands of the Rebel soldier. When he set the rifle aside to use his macrobinoculars, his flesh retained the memory of the gun's trigger squeezing tightly against the inside of his first finger.*

*Through his macros, the soldier could see the thin black whiffs of smoke which marked the position of the downed snowspeeder just beyond the ridge ahead. He had seen a mighty Imperial walker shoot down the Rebel craft, dispatching the speeder with an effortless shrug of its head. The last walker behind him now, the soldier decided it was safe to double back and check the speeder for survivors.*

*As the advanced scout on Echo Base's North Ridge, he was the first to see the walkers. He was the first to feel the terrible thumping of their giant feet against the frozen Hoth tundra, and the first to come under their deadly guns. By all rights, he should have been the first killed. The speeders had saved him from that. He owed them.*

*Luckily, the speeder hadn't hit the ridge inverted. Judging by the deep trench stretching behind the craft, the pilot had enough control remaining after taking the hit to at least attempt a landing.*

*The soldier used the butt of his blaster rifle to smash open the canopy, and he lifted the unconscious pilot out of the cockpit. The gunner was gone. The after section of the craft had taken the full brunt of the walker's cannon shot — it probably ended quickly for him.*

*Slinging the pilot's harness straps over his shoulder, the soldier dragged the wounded man behind him as he crested the ridge. In the ravine below was the transportation he needed to get himself and the unconscious pilot to the evacuation staging area and off this frozen hell of a world.*

*Unfortunately, a squad of Imperial snowtroopers had just discovered his scouting buoy — and the tauntaun tethered to it. Following the conspicuous trail of footprints leading from the buoy, the nearest snowtrooper's gaze fell upon the Rebel soldier crouching on the ridge above. He pointed. His comrades opened fire.*

*Rolling back behind the cover of the icy crest, the Rebel soldier acted instinctively, reaching for the smooth cylinder at his belt. A flick of the detonator switch and the grenade was primed and ready.*

*"Have a nice day, boys," the soldier muttered, and shifted his body into throwing position, but he stopped just before tossing the explosive. He thumbed the "standby" key on the grenade's underside as he looked down at the snowtroopers diving for cover.*

*The explosion would probably take out the whole squad if he aimed the throw properly, but it would also take out the tauntaun. The soldier cursed softly. He needed that ride. He had to get the Imperials away from his mount before he could use the grenade. It was time to get creative.*

*The soldier quickly snapped off a few shots at the prone Imperials to keep them honest, then wedged his rifle in the snow, leaving the muzzle jutting out from the ridge crest in full view of the snowtroopers. He propped his hat and goggles up next to the rifle for effect, slung the pilot's limp form over his shoulder, and moved quickly down the ridge and circled back to his tauntaun.*

*Predictably, the Imperials advanced on the decoy, leaving one snowtrooper behind at the buoy. The soldier made short work of him, using his raynon scarf to muffle the 'trooper's scream. Still, he made enough of a sound while dying to catch the attention of his comrades. They turned, just in time to see the soldier's grenade landing at their feet.*

*The explosion left a deep pit of melted snow and ice where the Imperials once stood, and, as he slung the pilot onto the back of the tauntaun, the soldier grimly regarded the black, pitted rock at the bottom of the crater. He realized that this was the first time he had seen the actual surface of this forsaken planet.*

*The soldier rode off to the rendezvous point, the memory of his rifle trigger still pressing against his frozen finger. He wondered if it would ever go away.*

## The Role of Ground Forces

*“Battle platforms can destroy, starfleets can blockade, but only the army can take and hold the ground. Without the ground, all your fancy spaceships will wither and rot.”*

— General Madine

*“What’s the matter? You guys wanna live forever? Move it out!”*

—Unidentified Rebel Sergeant

## Excerpts from an Orientation Meeting Given by General Madine to New Alliance Ground Commanders

“Greetings, gentlebeings. Today we are going to discuss the role of the ground forces in the Rebellion, with particular attention to small-unit and operational tactics and strategies.

“First, however, it is necessary to look at the overall strategic picture.

“Put up holo one, please.”

### A Comparison of Alliance and Imperial Forces

“As you can see, by the numbers, the picture is pretty bleak. The Empire’s forces outnumber the Alliance forces by a factor of almost 30 to one in raw manpower, by better than 12 to one in equipment, and by about 15 to one in warships and transports. The numbers are equally grim when you compare weapons research, intelligence, and supplies.

“However, there are some extremely important mitigating factors which do much to offset these considerable disadvantages. First and foremost, we’re the good guys and our forces are strictly volunteer. Every man, woman and alien joins our cause because they want to be here, not because some corrupt recruiting agent dragooned them into service. It is impossible to measure morale with the same accuracy as numbers of troopers, but, from the evidence, because we want to fight, we fight much better than they do.

“Second, the Imperials have a lot more to lose than we do because we control few cities and we have limited manufacturing capacity. We also don’t have many training centers, and the ones we do have are well-hidden. The Imperials, on the other hand, have everything. *They* own the cities, the starship ports, the factories and the supply depots. And therefore, they are responsible for defending them.

“Of course, we realize that the value of this second point is rather debatable — claiming our extreme poverty as an asset. And I, for one, would

be happy to have even a quarter of their resources, even if it did mean that we had to defend them. However, it is indisputable that well over half of the Imperial troops in the galaxy are tied down defending their tremendous wealth. This leaves them inadequate forces with which to take the offensive, and that gives us the initiative. I’ll take the initiative over equipment any day.

“Third and finally, we have the edge in leadership. Unquestionably. The Emperor is a ruthless despot, and he’s cunning as hell. Vader is ... well, he’s the most frightening being it has ever been my misfortune to meet. He’s evil and smart. But the rest of the Imperials — the admirals, governors, Moffs and generals — for the most part, they’re pure scum. They are data-pushers, bootlickers and sycophants, and far better at bureaucratic in-fighting and backstabbing than at command.

“On the other hand, our leaders — including *you*, gentlebeings — are brilliant, dedicated, energetic, and willing to take risks. You’re not in it for the money nor do you crave the power for its own sake. If you wanted those things, you’d be working for the enemy now. You’re in the war because you love freedom and hate oppression. You’re in it because something deep inside you wouldn’t let you sit by and watch your planets, your friends and your family, be trampled under the unfeeling jackboots of those butchers. You’re in it because you’d rather die than submit.

“You, gentlebeings, are why we will win. Put up holo two, please.”

## Strategy

“We have discussed the relative strengths and weaknesses of Imperial and Alliance Forces. Now, we shall see how to use those to their best advantage in ground combat, maximizing our strengths and minimizing the enemy’s.”

### Madine’s Rules of War, #1: Hit ‘Em Where they Ain’t

“Never attempt to match strength against strength with the enemy. He’s probably got you outnumbered to begin with, and, because of his command of the sky and space, can call upon virtually unlimited reinforcements. You don’t want to get into a slugging match with the Imperials: they’ll win every time. If you can’t achieve your objectives quickly, against little opposition, you probably can’t achieve them at all.

“Speed and concentration are the keys. Bring all of your forces together and throw them against a fraction of his. Wipe ‘em out quickly, and then run like hell for the hills. If, once you have started an attack, you find out that your target is too tough for you, give it up. Do not keep up the fight



past the breaking point; this loses lives and wins nothing.”

### **Madine’s Rule of War, #2: Attack the Enemy’s Spirit**

“The object of warfare is to destroy the enemy’s will to resist. This is one of our strongest advantages because we fight for freedom and for our families; most of them fight for personal gain or because they’ve got a blaster at their backs. Our will to resist is —and *must be*— higher than theirs. Make sure that the enemy is aware of this.

“Make them fear you, gentlebeings. Make them fear your troops’ ferocity, cunning and unpredictability. In battle, there is nothing so frightening as knowing you face an enemy that has no fear and nothing to lose.

“If your opponent fears you, he’ll make mistakes. Bad ones. He’ll overreact to feints, and he’ll retreat when he could hold on. Eventually, his army will disintegrate around him, becoming nothing more than a mob of frightened men. An army that is afraid *cannot* win. Ever.”

### **Madine’s Rules of War, #3: Use Your Brains**

“You are our biggest advantage. You are not encumbered by out-of-date Academy training; you are not encumbered by fear of replacement if you screw up, and there is little chance of one of your subordinates deciding he wants your job enough to kill you for it. You can concentrate all of your energies upon the task at hand — victory. You can also afford to take chances. In fact, given the very real disadvantages under which you operate, you *have* to take chances.

“Do so.

“But do so in a smart manner. Keep one step ahead of the enemy. You and your troops have been specially trained to be flexible, to be smart, and to take advantage of any opportunity that arises.

“Learn how your enemy thinks. Though there are exceptions, most Imperial officers will do things ‘by the book’ because that’s how they are trained, and most of those who are smart enough to have overcome their training have defected to us. The ones who are left tend to stick to what they have been taught. Learn their book, and you’ll know what your enemy will do under any given circumstances.

“Present your enemy with the unexpected and try things that are not covered in his book. He may rise to the occasion and give you a bloody nose, but, chances are, if forced to think on his own, he’ll crack. And then you’ll have him.”

## **Tactics**

“I am not prepared at this time to go into a detailed discussion of tactics with all of you because you have very different situations facing you. General Martin’s command, for example, is a desert planet with a light population and virtually no heavy industry, while Lord Iuaway’s people live on an urbanized world, and, of course, General Throom’s planet is entirely water-covered. After the program, the class will break up into smaller groups according to planet-type, political situation and Imperial opposition. My assistants will discuss tactics with you then.

“There are, however, a few general tactical doctrines which are applicable to virtually all situations everywhere. We shall begin with the defensive, and then move to the offensive.

“Put up the next holo, please.”

### **The Mobile Defense**

“Under most circumstances, you will not be defending a specific point or line with the hope of holding onto it. As discussed above, the enemy can almost always eventually bring overwhelming force to bear against you. You usually go on the defensive because you haven’t got enough power to attack, or to buy time for your soldiers, supply trains and headquarters units to retreat and escape.

“Here, as in all of your military endeavors, do not match your strength against the enemy’s. Hit him where he is weak, make him attack you where you are strong. Give up ground when necessary; the enemy’s forward progress may give you the opportunity to launch a devastating counter-attack.

“Following is a classic defensive technique which will illustrate the point. The diagrams are taken from an After Action Report filed by General Rieekan after the Battle of Tiems.

“General Rieekan’s forces had successfully attacked the city of Tiems, destroying a power station and liberating several thousand Rebels incarcerated there. The Alliance transports scheduled to take his forces off-planet were delayed by enemy starfighter action; he had to defend the landing zone area from a heavy counter-attack by Imperial ground troopers until the transports could arrive.”

(See diagram, page 93.)

### **The Battle of Tiems**

“After the trap was sprung, the Imperial forces retreated in disorder to Tiems to regroup and await reinforcements. The reinforcements, an entire division of native troops, arrived 24 hours later, but the Imperials delayed their attack another 12 hours while waiting for the weather to

## Battle of Tiems

### The Situation: 1300 Hours

The Imperial force, consisting of four regiments of infantry, attacks the Alliance force of three regiments of infantry.

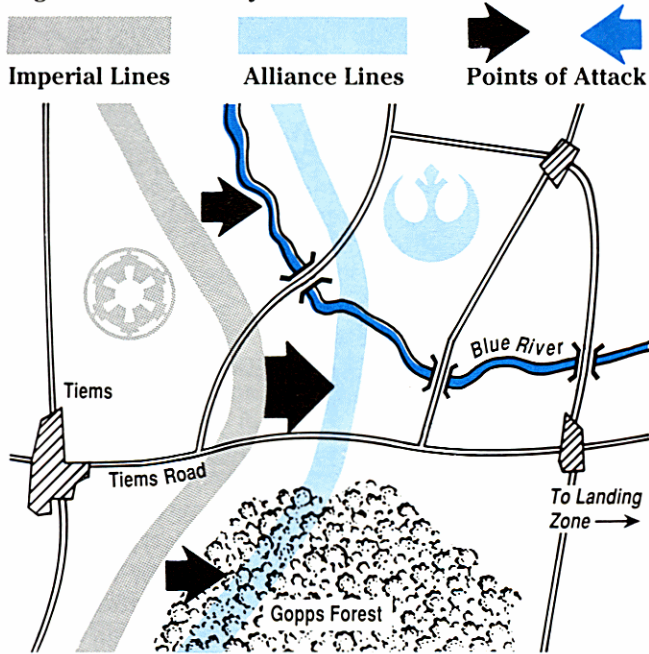

### The Attack: 1300 Hours

The Imperial forces attack: 1st and 3rd Regiments probe the Alliance lines, pinning the Alliance forces in position. 2nd Regiment assaults the weakest part of the line (without river or forest cover). 4th Regiment stands ready to exploit a breakthrough.

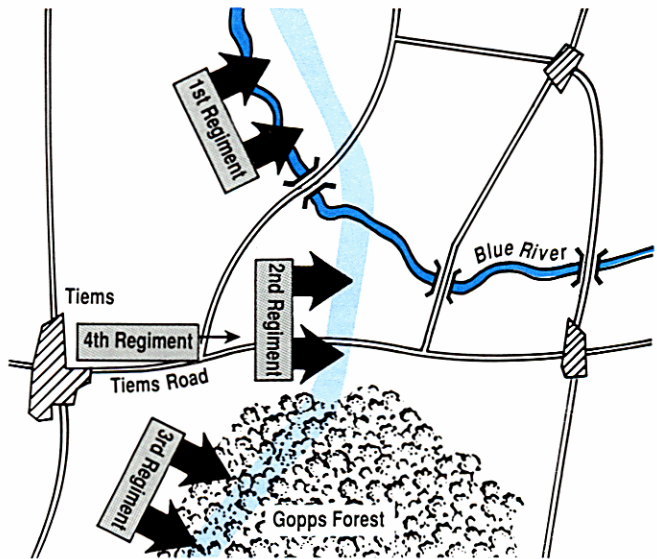

### The Trap

The Rebel front line is manned by only a single regiment. Two regiments have taken up defensive positions well to the rear of the line. The Rebels in the forest and behind the river have orders to stand firm; the Rebels in the center gap have orders to fall back when strongly attacked.

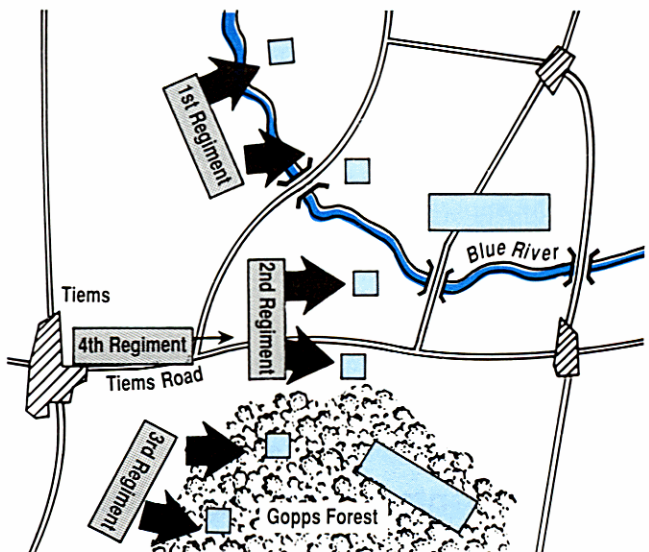

### The Execution

When the Imperials attack, the Rebels in the center flee to the town and dig in. The Imperial 2nd and 4th Regiments follow up. The two hidden Rebel regiments attack, hitting the Imperials in the flanks and rear, surrounding and nearly annihilating them.

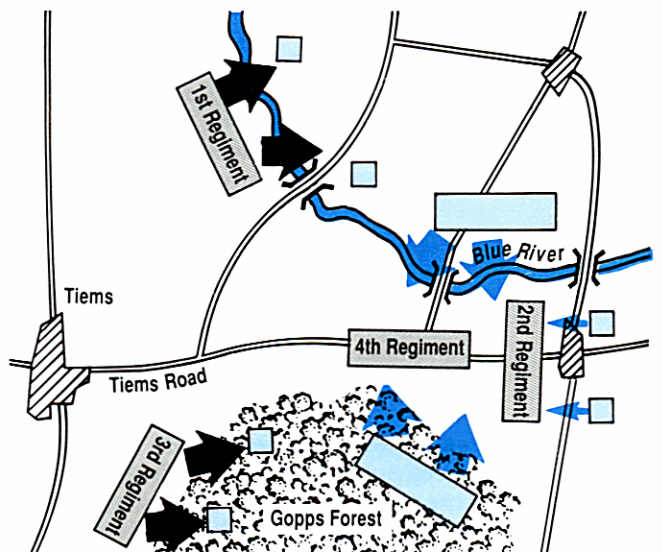



Allen Numis

clear up enough to allow them to call on air support from a nearby base. By the time they launched their attack, the Alliance forces were safely off-planet.

“These are the lessons of Tiems: first, General Rieekan knew his enemy. Imperial tactical doctrine requires commanders to ‘... concentrate the maximum force against the weakest part of the enemy’s line. Such attacks are likely to gain the highest benefits for the smallest cost.’ Rieekan knew that the weakest part of his line was its center; he had good reason to expect the Imperials to attack there.

“Similarly, he knew that, in the event they scored a breakthrough, the Imperials were likely to follow up hard and fast, attempting to get into the Alliance forces’ rear areas, cutting them off from retreat so that they could be destroyed in detail. With knowledge of how his opposing commander’s mind worked, he was able to tailor a trap that the enemy would find virtually irresistible.

“The second lesson of Tiems: training pays off. The Alliance troops performed brilliantly. The battalions on the left and right flank held their own against twice their number for over two hours, allowing time for the trap to develop. The battalions in the center put up a strong show of resistance to the main attack, taking tremendous casualties, and then, when the time was right, pulled out and fell back to the town in good order. This maneuver could only have been performed by highly-trained, highly-motivated, and well-led troops, others would have almost certainly disintegrated.

“The final lesson of Tiems is this: you don’t have to annihilate an enemy to beat him. The Imperials started out the campaign with four regiments. They lost two regiments in the battle. Shortly thereafter, they were reinforced by a full division of four more, giving them a total of six. The Alliance began the campaign with three regiments. They used up most of a regiment in the execution of the trap, leaving them two in any shape for further combat. Thus, when the battle opened, the Imperials had four regiments facing three. After they were reinforced, they had six regiments facing two. By all rights, the Alliance Forces should have been overwhelmed in short order. Instead, the Imperial commander delayed his attack until he had air support — which was too late.

“Rieekan had beaten the enemy commander’s spirit. By Rieekan’s brilliant tactics and his troopers’ flawless execution of those tactics, he had made his enemy doubt himself and his troops. The Imperial general did not attack — *at three to one odds* — because *he* was whipped.

“Whip your enemy, gentlebeings. Make him *fear* you and your soldiers. A frightened enemy is often of more use to us than a dead one.

“This concludes today’s lecture. My associates will organize you into smaller groups for further discussion.

“Thank you.”

## Elements of Ground Combat

A balanced ground combat force contains six major elements. The most basic of these is, of

course, the infantry. Next there is the artillery, the mechanized CAVs (Combat Assault Vehicles), scout units, ground transport and, finally, the airborne SAC (Sub-Atmospheric Craft).

All of these elements have important roles to play on the modern battlefield. Rebel commanders, usually forced to improvise and fight with whatever they have on hand, count themselves extremely lucky if they can muster four of the six elements in an engagement.

### The Rebel Infantryman

The job of the infantry soldier, or “dirtsider,” has changed very little throughout history. His job is to take and hold the ground. His is the least glamorous job in warfare — starfighter jocks and spies get most of the glory, while he does most of the dying.

Though his job has changed little over the centuries, the environment in which he must accomplish his job has changed enormously — and for him, changed much for the worse. Huge, terrible machines of war roam the battlefield, virtually invulnerable to his weapons. Supersonic aircraft scream overhead, killing him before he knows they are there. Laser artillery bombard him from kilometers away — or from orbit. Yet, despite these awesome technological advancements in the “art” of war, most specifically designed to kill him, the soldier is still king of the battlefield and the cornerstone of the Alliance’s ground combat doctrine.

To the Alliance strategists, there is nothing more flexible, practical or dangerous than a well-trained, reasonably-armed trooper, willing and able to operate alone or in small groups. The Imperials rely upon specialized heavy equipment; the Alliance counters with its best asset — the bravery and intelligence of its soldiers.

### Infantry Equipment

All infantry equipment performs one or more of the following functions: it kills the enemy, provides protection from the enemy’s weapons, aids in communication, nourishes the soldier or protects him from the environment, or it gives him information about the battlefield.

As a rule, Rebel equipment is somewhat clumsier than Imperial equipment. Much of the Imperial stormtroopers’ gear is built into their armor, while the Rebels’ equipment is external, and often improvised. The Imperial army can afford to expend lavish amounts upon each of their soldier’s equipment, while the Rebels must make do with whatever is available.

Following is a rundown of equipment carried by many Rebel soldiers:

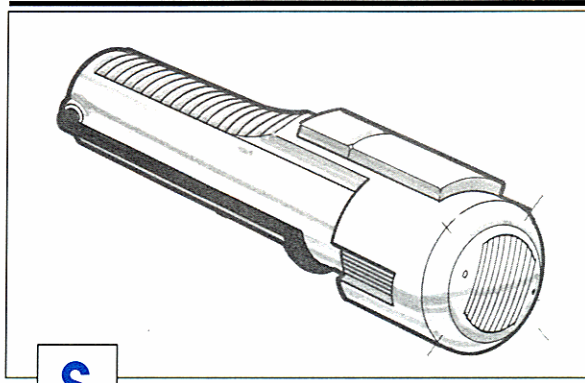

David Detrick

**S**tandard Alliance Comlink.

### Comlink

A good example of the difference in efficiency between Imperial and Rebel equipment is in their communications gear. A stormtrooper’s comlink is built into his helmet, accessible at the toggle of a tongue-switch, while a Rebel trooper’s comlink is shoved into a pouch or hung on his belt. It can take him precious seconds to find and activate his comlink — if he hasn’t dropped it somewhere in the heat of combat. On the modern battlefield, seconds can mean the difference between life and death, between victory and defeat.

To improve efficiency, Rebel techs are working on touchplate-activation comlinks which attach to the chest area of a soldier’s uniform, but they are quite expensive and have not been widely distributed as yet.

Rebel comlinks have an effective range of 50 kilometers and can, in fair weather, communicate with friendly ships in orbit.

Company commanders and higher-level officers are often equipped with larger and more powerful comlinks, either carried backpack-style or mounted on a command vehicle. These communicators have an effective ground range of over 200 kilometers, and can punch through the most inclement weather to communicate with ships in orbit. However, they also have a massive electromagnetic signature, making them stand out like beacons on the enemy’s sensors. Thus, they are never used when secrecy is important.

### Directional Transponder

The directional transponder is an extremely useful piece of equipment. It tells a soldier his exact location on the battlefield. The soldier can use the transponder to relay his precise location to other soldiers and his commanders, ensuring excellent coordination between soldiers not in sight of each other and also cutting down on the chances of the soldier being hit by friendly artillery fire. In addition, the transponder’s screen

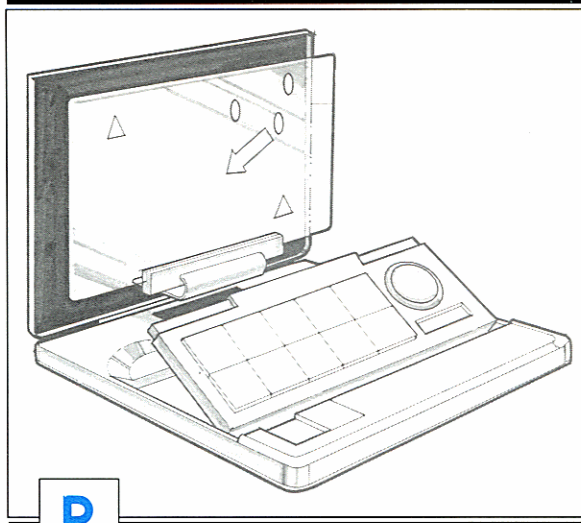

**P** ortable directional transponder.

David Deitrick

will display a map of several kilometers surrounding the soldier's present location.

The directional finder requires a significant amount of preparation to operate properly, making them impractical for all but important, well-planned operations or battles taking place on the Rebels' home territory.

The finder determines its present location by sending a signal to a satellite in geosynchronous orbit above the battlefield. The satellite notes the signal, determines the location of the sender, and transmits the information back down to the finder. For the system to work, the commander of the battle must have had the time and the equipment to launch the satellite.

In addition, these satellites are prime targets for enemy starfighters or hunter-killer satellites (who home in on their transmitted signals); in a major battle involving both land and space forces, they have a projected life span of about an hour — the commander better have several backups ready to deploy when the original is killed.

Also, in order for the map function of the transponder to be of much use, a detailed holo-reconnaissance of the battlefield must be made and the information programmed into the transponders. The transponders' maps are only as good as the information they are programmed with; they will not show any changes in the terrain since the last recon holos were made.

Finally, the entire system is rather delicate. The finders do not stand up well to the rigors of combat — for example, short immersion in mud can turn several hundred of credits worth of equipment into junk. As ground soldiers seem to spend quite a large portion of their time immersed in mud, the finders rarely operate as they should. Feeling them useless, and heavy to boot, many infantrymen refuse to carry them at all.

The finders have a much better performance rating when they are mounted on a vehicle which is somewhat protected from the elements. Mechanized troops and vehicle-equipped commanders swear by them.

## Survival Pack

The standard-issue survival pack includes two week's rations, three medpacs, a glowrod, two thermal flares, a single-person di-chrome shelter, a breath mask, six meters of syntherope, a knife (with self-sharpening sheath), and a small portable fusion power generator.

In addition to the standard pack, the following equipment may be available for special missions: vibropick, fusion cutter, pocket computer, recording rod, portable field scanner, macrobinoculars, standard explosive charge, exposure suit, portable moisture vaporator.

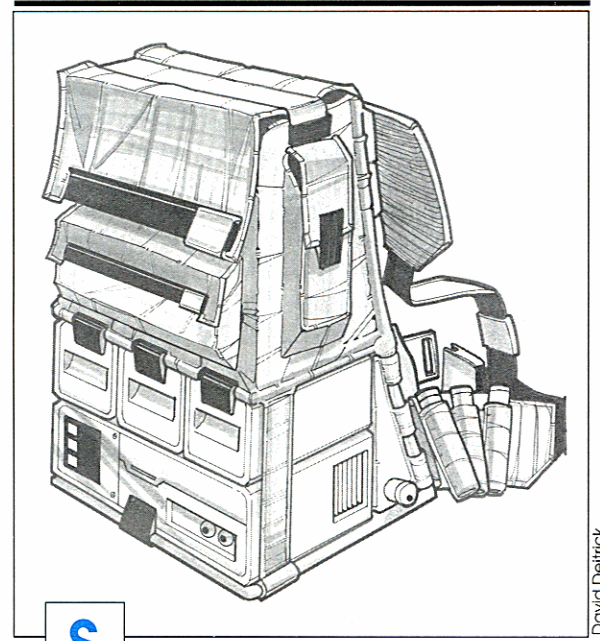

**S** tandard-issue survival pack.

David Deitrick

## Uniform and Armor

There is no standard uniform for the Rebel ground forces. An entire unit will wear the same uniform, perhaps even all units in a division, but there is not necessarily any continuity from sector to sector, planet to planet, or even division to division.

The Military Department of Ordnance and Supply has attempted to standardize the Rebel soldier's dress, but, as uniforms are almost always homemade or "requisitioned" (stolen, that is) from the enemy, OaS hasn't had much success. The troopers remain rag-tag, and, to a certain extent, this has become a source of pride to the soldiers of the Alliance.

## Representative Rebel Alliance Uniforms



Scout



Fleet Trooper

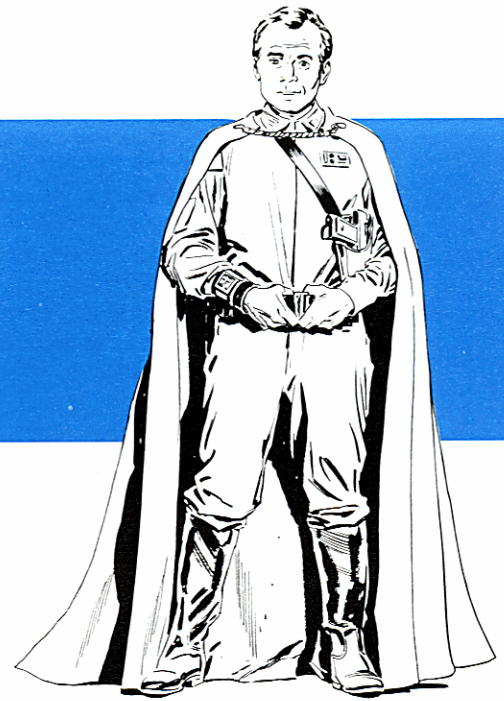

Fleet Officer



Commando

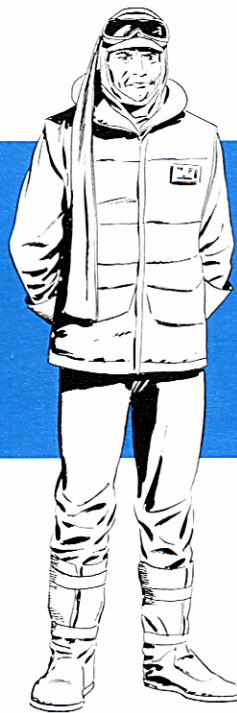

Echo Base Officer



Echo Base Trooper

Continued overleaf.

## Representative Rebel Alliance Uniforms (continued)

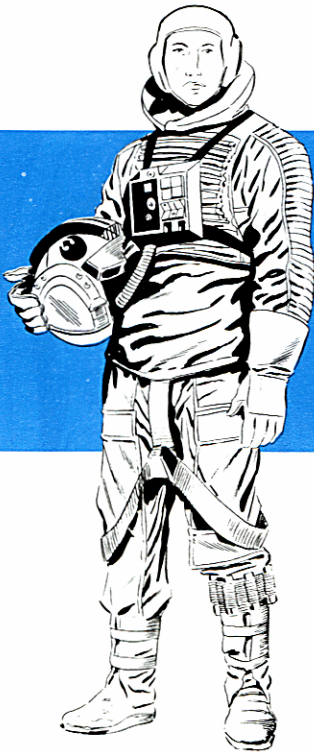

Pilot's Flight Suit



Pilot's Ground Uniform

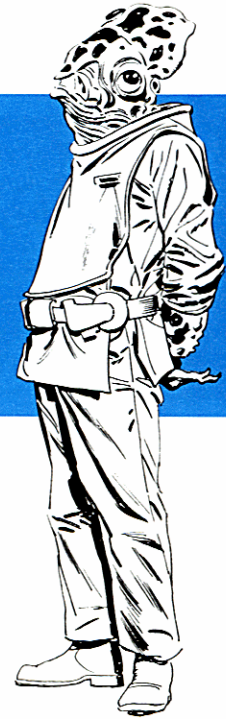

Mon Calamari  
Crewman

### Rebel Rank Insignia

(worn on uniform chest)

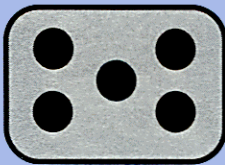

General

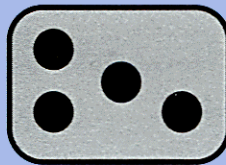

Colonel

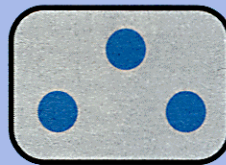

Commander

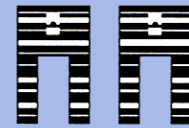

General's  
Collar Insignia

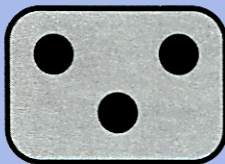

Major

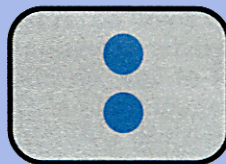

Captain

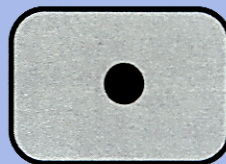

Lieutenant

- Army Designation
- Navy Designation

Even if issued “standard” Alliance gear, Rebel soldiers will customize their uniforms to suit their unit’s personality: dyeing it a different color, adding distinctive piping on the arms and shoulders, changing the cut of the trousers, and so forth.

In general, Rebel ground soldiers tend to wear uniforms in camouflage colors: khaki, brown, and olive drab. Soldiers serving aboard starships are most often outfitted in light blues and greys. Certain terrain types or planetary environments might dictate the use of climate acclimation garb, such as the thermal retention jumpsuits worn by the troops stationed on the ice planet Hoth. Special Forces units may have many different uniforms to cover a wide variety of mission profiles: camouflage gear, cold-weather gear, civilian dress (for infiltration missions) and so forth.

### Identification Plates

In addition to their rank insignia, Rebel base, outpost, safe world and Fleet personnel wear identification plates. ID plates are magnetically encoded with their wearer’s rank and clearance. Security door scanners read the ID plates and will deny access (and possibly sound an alarm) if the wearer attempts to enter an area he is not cleared for. The I.D. plate is usually worn on the chest, opposite the rank insignia.

### Armor

Rebel soldiers wear very little protective armor, typically a helmet at most, though some soldiers wear chest and abdomen plates. Alliance tacticians believe that complete freedom of movement is more useful than the dubious protection provided by armor — which rarely stops a blaster bolt anyway.

### Infantry Weapons

As does most of their equipment, the weaponry of the Rebel infantry varies greatly from unit to unit. Though Ordnance and Supply is working heroically to get all Rebel soldiers fully equipped, many soldiers are still armed with sub-standard civilian weaponry or Imperial weapons captured on the field of battle.

The weapons that Ordnance and Supply issues are chosen for cheapness and durability. The Alliance simply cannot afford the best weapons, and once in the field, maintenance and repair may be very hard to come by. It is an unfortunate fact of life that the Empire’s troopers are usually better-armed than the Rebels who face them.

### Blaster Rifles

Soldiers of the Alliance tend to use larger and more powerful rifles than those used by Imperial troops.

In general, long-barrelled rifles are preferred to the Imperials’ short-range assault weapons. Alliance infantry tactics stress remaining at maximum weapon range, where the Rebel troopers’ superior marksmanship can be used to its best advantage to counter Imperial assault tactics. Imperial doctrine stresses hitting the opponent with huge numbers and overwhelming him in the assault; the Rebels like to have as much time and space as they can to thin the advancing enemy’s ranks as they advance. Whenever possible, the Rebels equip their rifles with long-range sights to further increase range and accuracy.

Some typical Rebel blaster rifles include the SoroSuub “Heavy Tracker” 16, the Merr-Sonn G8, and the BlasTech A280\*. These are good, sturdy weapons, but much heavier than the rifles the Imperials carry. In campaigns where the infantry must march for long distances, the additional weight can be a significant hindrance.

### Blaster Pistol

Most Rebel troopers carry a blaster pistol in addition to their rifles. The pistols are used in close-quarters combat, when assaulting Imperial troopers, or, as is more likely, when receiving an assault from Imperial soldiers. Pistols are also used in combat aboard spacecraft, where misses from heavier weapons could breach the ship’s hull.

When they can get them, Rebel soldiers prefer powerful heavy blaster pistols such as the BlasTech DL-44 (made famous by the renowned smuggler Han Solo), and the Merr-Sonn “Flash” 4 (a knockoff of the BlasTech original).

Rebel Officers, on the other hand, tend to carry lighter, sleeker blaster pistols such as the BlasTech DL-18. The sporting blaster has come into fashion among officers as well, due primarily to Princess Leia’s preference for that weapon. The Princess uses a Merr-Sonn “Quick 6”. An additional advantage of these weapons is that they are available on the open market.

When undercover, Rebel spies carry hold-out blasters. The Czerka 411 is their weapon of choice.

Spare power packs for blaster pistols are commonly strapped to the gunbelt or holster for easy access.

---

\*This blaster is reputed to be the best armor-piercing rifle available anywhere in the galaxy. At medium range, it has been known to cut a fully-armored Imperial stormtrooper nearly in half. Still, when used during the Imperial assault on Hoth, the A280 failed to put more than a fist-sized dent in the armor of the Imperial walker.



## Some Typical Infantry Weapons

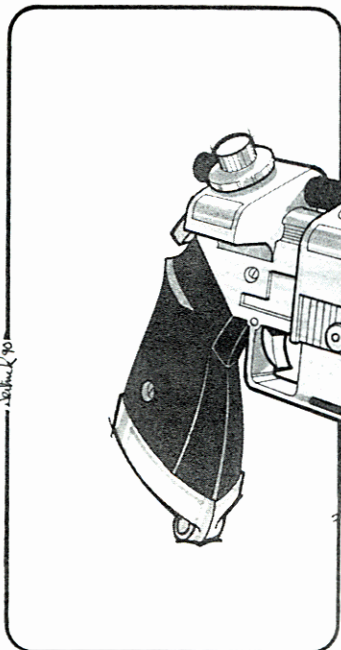

**BlasTech DL-18  
Blaster Pistol**

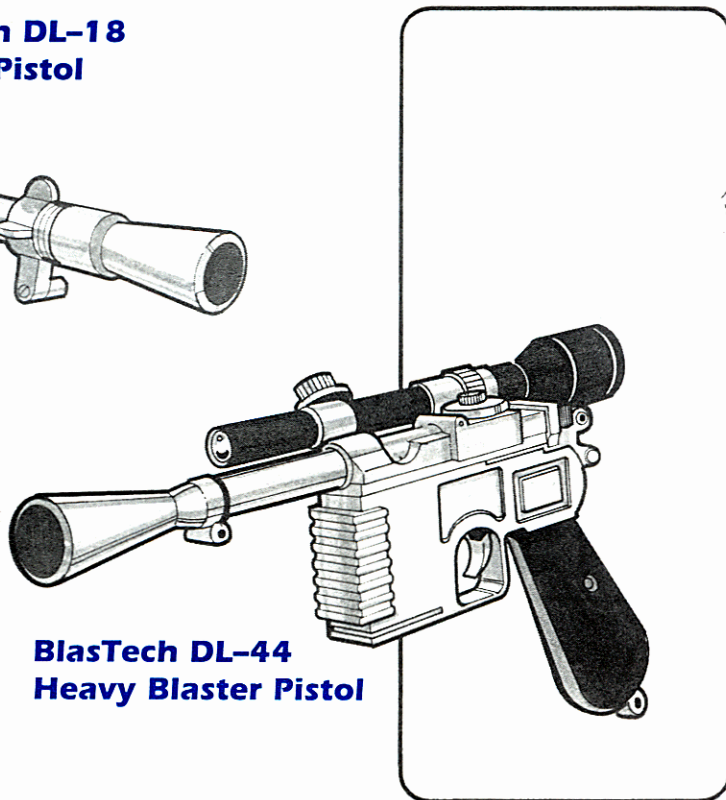

**BlasTech DL-44  
Heavy Blaster Pistol**

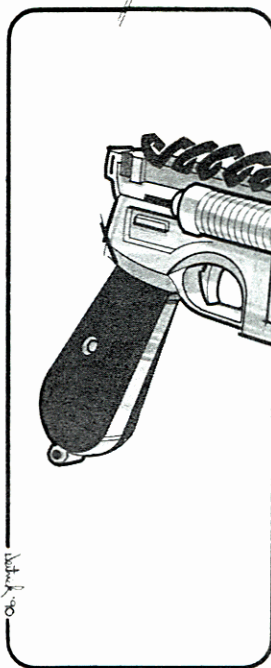

**Merr-Sonn Quick-Six  
Sporting Blaster**

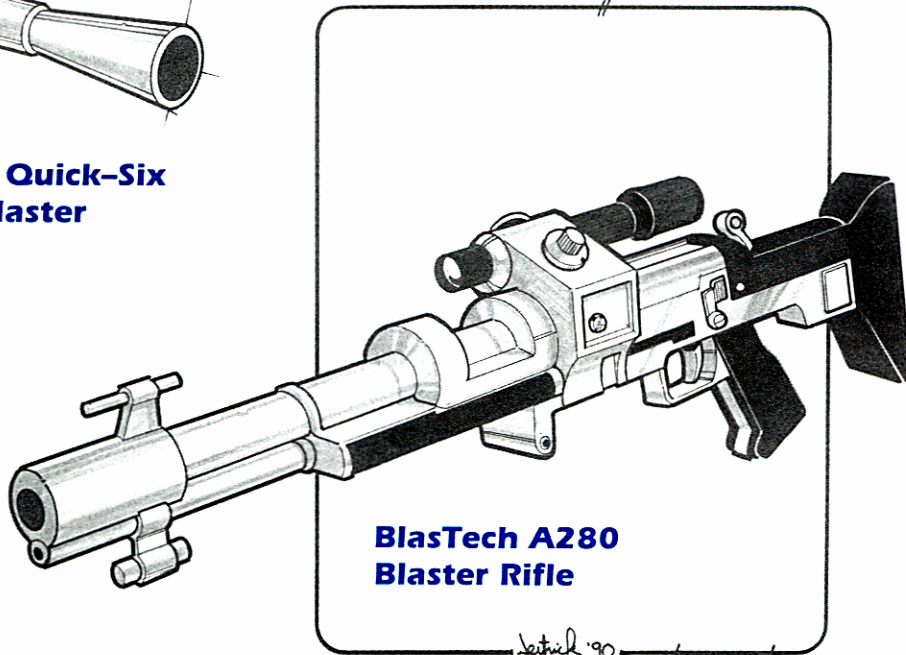

**BlasTech A280  
Blaster Rifle**

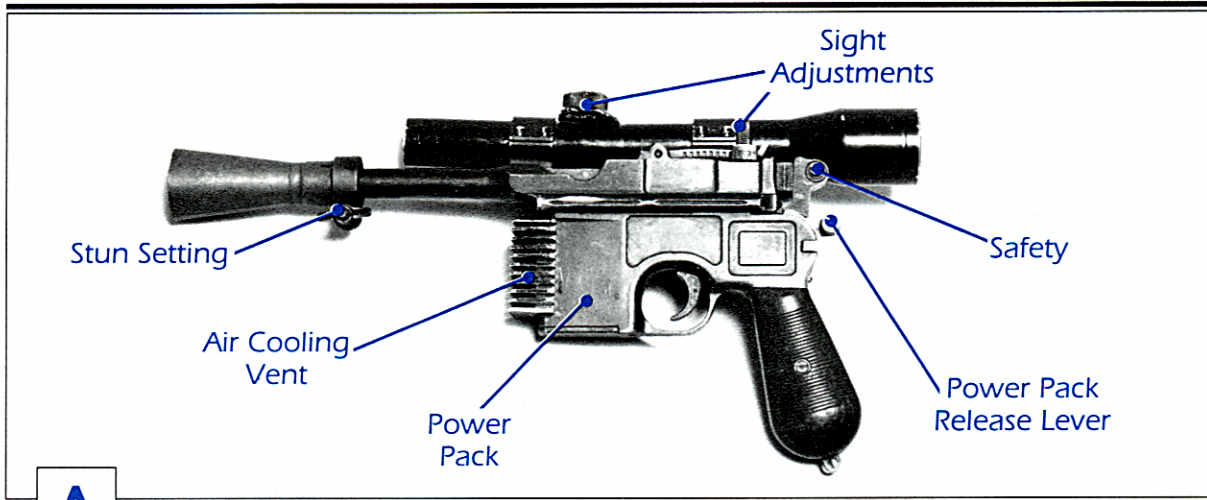

**A** anatomy of the Blastech DL-44.

**Personal Artillery**

“Personal Artillery” is Alliance military slang for grenades, thermal detonators and other hand-launched explosives. Personal artillery is useful when fighting at close quarters — within throwing range, that is.

Personal artillery is particularly effective in heavily-obstructed terrain such as that found within cities, bases, or aboard starships, where it is possible to get within throwing range without being seen. (On the plains, the enemy is quite likely to see and gun you down before you get nearly close enough to make your throw.)

Further, explosives are much more lethal in

enclosed areas than they are in the open. In open areas, the force of the explosion is dispersed over a wide area, greatly reducing its effect. In enclosed areas, however, the force of the explosion is concentrated and thus much more powerful.

The standard grenade used by Rebel troops is a fist-sized cube of detonite encased in a prestressed chrome shell. The grenade is armed by removing a restraining pin, and activated by flicking the detonator switch. Once the detonator switch is pressed, the grenade will explode after a pre-set amount of time, typically four seconds, though the soldier can alter this by turning a small dial inset on the bottom of the grenade. To abort detonation, the “standby” stud is depressed and the restraining pin reattached.

Thermal detonators are not usually used by standard Rebel troops in combat; they are too unstable and, if carelessly handled, may explode prematurely with potentially devastating effects. Rebel engineers and some Special Forces troopers, specially trained to work with explosives, will use thermal detonators to breach enemy defenses, blow up obstructions, sabotage equipment and the like.

Often inadequately supplied with the real thing, Rebel troopers employ a variety of makeshift explosives in emergencies. These might include a bundle of overloading blaster power packs strapped together, or the negative power coupling from a small starship fused with a positive flow detonator. These jury-rigged explosives are not at all safe to use, and can be as or more dangerous to their creators as they are to the enemy.

**R** ebel Infantry Weapons

Blaster Pistols	Cost	Damage
BlasTech DL-44	750	5D
Merr-Sonn “Flash” 4	695	4D+2
BlasTech DL-18	500	4D
Merr-Sonn “Quick” 6	325	3D+2
Czerka 411	300	3D+1
Blaster Rifles		
SoroSuub		
“H.Tracker” 16	1,000	5D
Merr-Sonn G8	1,250	5D+1
BlasTech A280	1,400	5D+2
Personal Artillery		
Anti-Personnel Grenade	175	4D+2
General Purpose Grenade	200	5D
Anti-Vehicle Grenade	250	5D+2
Thermal Detonator	2,000	10D
Infantry Support Weapons		
“E-Web” Hvy.		
Rep. Blast.	5,000	8D

**Infantry Support Weapons**

Infantry Support Weapons (ISWs) are defined as “crew weapons (requiring more than one per-

# Infantry Support and Personal Artillery

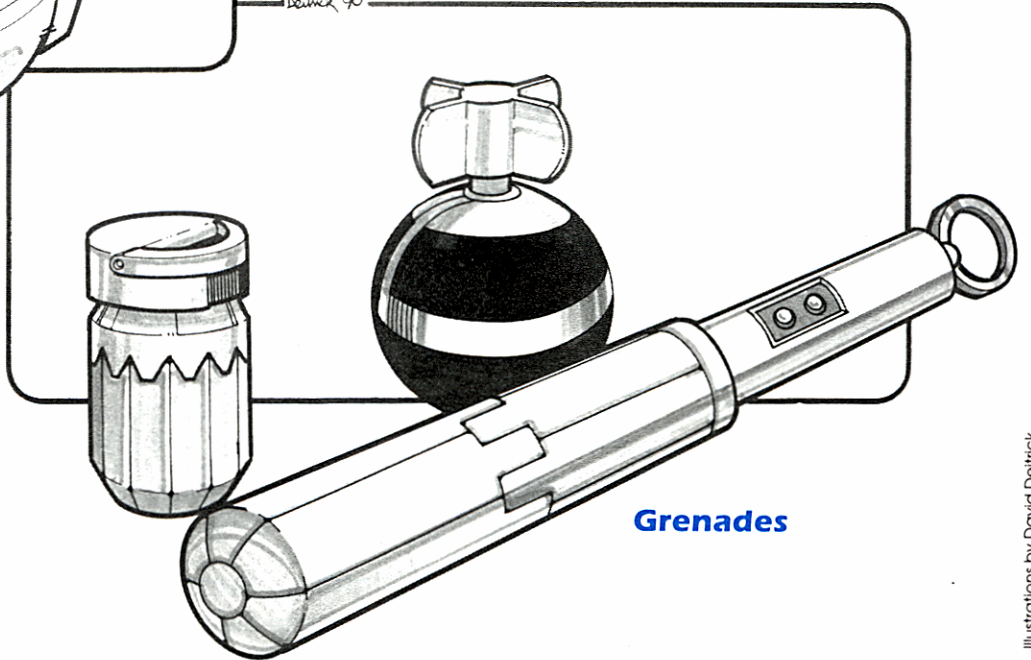
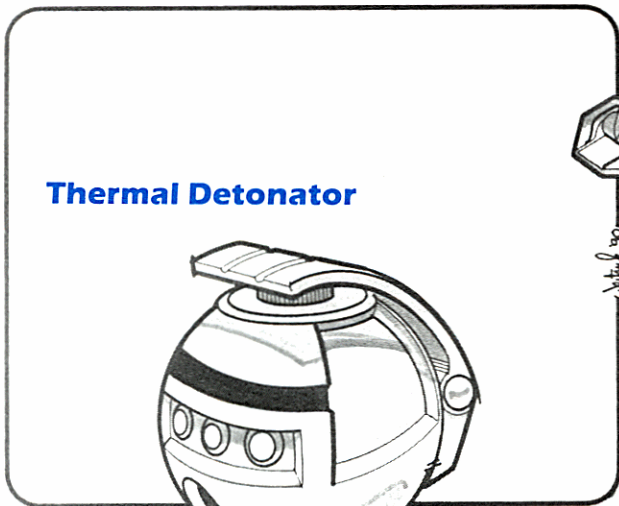
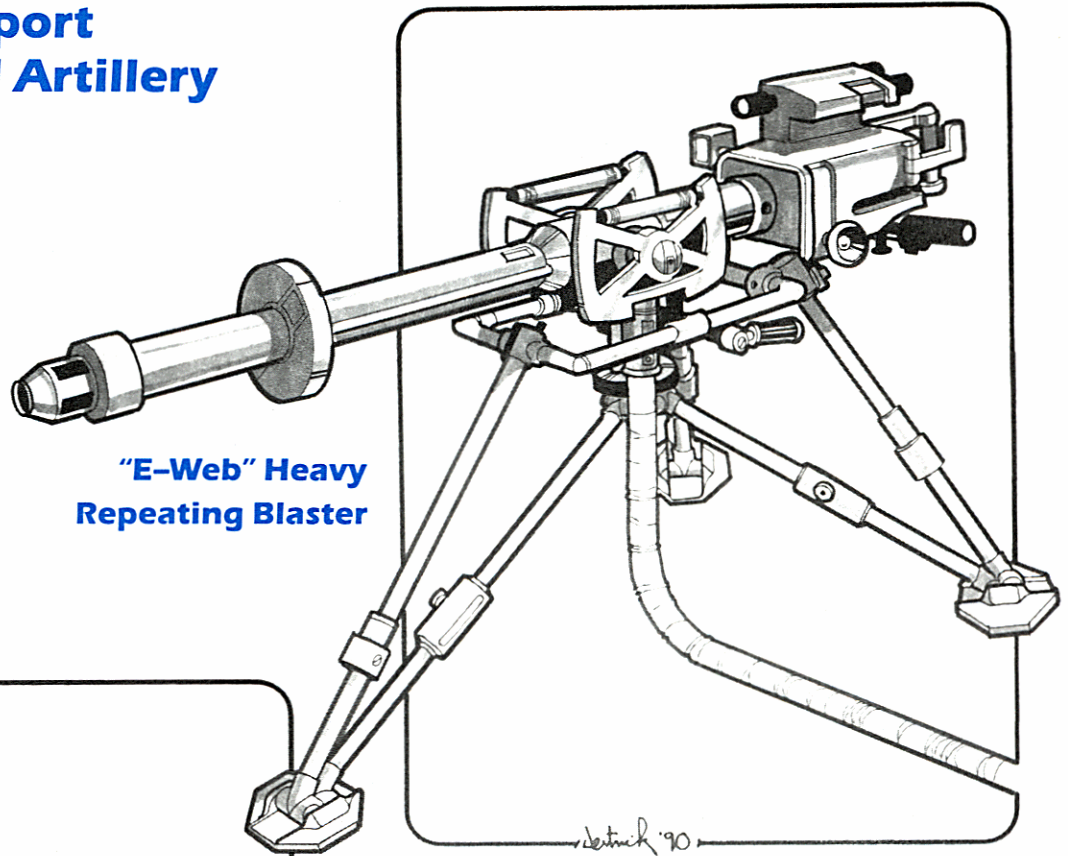

Illustrations by David Deltrick

son to operate), capable of being disassembled and carried by dismounted infantry." In short, ISWs are tripod-mounted blasters or very light artillery. If the weapon is mounted or transported on a vehicle, it is not classified as an ISW.

Unfortunately, the Alliance is critically undersupplied with this class of weapon – Alliance small-arms factories are barely able to keep up with the demand for rifles and blasters. Until the Alliance increases its factory output, most infantry units will be without the support of ISWs – unless, that is, they can acquire them on their own.

In battle, ISWs can be extremely lethal to unprotected infantry. They have extremely good range and very good power, able to punch through armor as though it was not there. They are, however, somewhat difficult to carry and require quite a bit of time to set up. Thus, they are more effective on the defensive — they can be placed in position and the enemy must come to them. When the infantry is on the move, which is usually the case when they are on the offensive, the weapons must be disassembled and carried to new positions. During that time, the weapons' crew are heavily encumbered, slow and unable to fire.

As mentioned above, most of the Alliance's ISWs have been captured from the enemy. Primarily, these have been "E-Web" Heavy Repeating Blasters. The Alliance has several hundred E-Webs in the Special Force's arsenal, and a handful of have been deployed at Echo base, Hoth.

## Artillery

There are two distinct types of artillery: anti-ground and anti-air/space artillery. Some artillery pieces perform both functions adequately, but most are much better suited for one or the other.

### Anti-Ground Artillery

Anti-ground artillery has three main assignments on the battlefield. Its first priority is to engage and destroy enemy artillery. Its second priority is to engage and destroy enemy vehicles. Finally, it is to engage and destroy enemy infantry. Typically, artillery is not self-propelled; it must be carried into position by a heavy vehicle. Once in position, it must be set up and readied to fire, a process which can take between five minutes and 10 hours.

And, for the Alliance, this is the rub. Alliance tactics are based upon the rapid movement of forces to offset the enemy's typical superior numbers and command of air and space. Usually, Alliance space transports do not have room to carry artillery, not to mention room to carry the vehicles necessary to tow the artillery on the



**A**

Atgar 1.4 FD P-Tower.

ground. And even if such space is available, if the enemy has any air vehicles at all, once the artillery has fired and revealed its position, it is a sitting duck.

The only places where artillery is really effective are in static positions, shielded areas or areas where the Alliance has superiority (or at least parity) in the air — that is, around permanent bases on Alliance-held planets. However, a new Imperial innovation — the heavily-armored AT-class of vehicles — renders them of questionable value even there.

### Light Anti-Vehicle Laser Cannon

The most common of the Alliance's anti-vehicle artillery is the Atgar 1.4 FD P-Tower, more because it is inexpensive than because it is particularly effective. The Atgar is readily available on the black market (which may give you an idea of

#### ANTI-VEHICLE LASER CANNON

**Weapon:** Atgar 1.4 FD P-Tower  
**Type:** Light Anti-Vehicle Laser Cannon  
**Scale:** Speeder  
**Crew:** 4  
**Body:** 2D  
**Range:**  
 Short: 10m to 500m  
 Medium: 501m to 2,000m  
 Long: 2,001m to 10,000m  
**Fire Rate:** 1/2  
**Fire Control:** 1D  
**Blast Radius:** Target  
**Damage:** 2D+2

its worth in battle).

The Atgar is cordially detested by most Alliance infantry commanders: it isn't powerful enough to damage heavy Imperial vehicles, it is difficult to move and it is too expensive to abandon when it is attacked. If, they ask, the weapons don't protect them from the enemy and severely limit their mobility, what good are they?

Making matters worse, the weapons' operators are quite vulnerable to attack, as all four of them must stand outside the body of the gun to fire it. The lead operator aims the weapon by manipulating a small joystick controller on a portable firing computer. The other three crewmen regulate the energy flow to the weapon and monitor the recharging energy cells between shots — and the Atgar takes roughly forever to recharge.

Given all of its deficits, it is easy to see why the Alliance is phasing the Atgar out. It is essentially its low price tag which keeps the light anti-vehicle cannon in operation at all.

### Anti-Infantry Battery

The standard Alliance anti-infantry battery is a more effective, if also more expensive, artillery piece than the anti-vehicle laser cannon. Developed by Golan Arms, this gun was originally designed to counter large-scale infantry attack against fixed defensive positions. In keeping with the Alliance's tactical doctrine, Alliance techs have modified the guns to be more effective against combat assault vehicles. Fortunately, little of the battery's rapid-fire capabilities were lost when its firepower was increased.

The Golan DF.9, the most common Rebel model, has a 180° rotation turret mounted atop a cylindrical control housing. The three-man crew remain within the control housing, which is proton-shielded against close combat blasters. Access to the control housing is gained through hatches on the turret top or on the side of the housing.

#### ANTI-INFANTRY BATTERY

**Weapon:** Golan Arms DF.9  
**Type:** Modified Anti-Infantry Battery  
**Scale:** Speeder  
**Crew:** 3  
**Body:** 3D  
**Range:**  
 Short: 20m to 600m  
 Medium: 601m to 3,000m  
 Long: 3,001m to 16,000m  
**Fire Rate:** 2/1  
**Fire Control:** 2D  
**Blast Radius:** 8m  
**Damage:** 4D

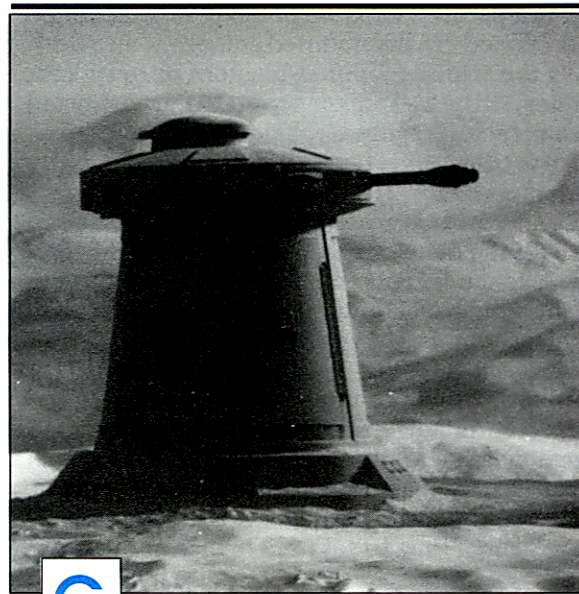

Golan Arms DF.9 Anti-Infantry battery.

### Anti-Air/Space Artillery

This class of weapon is designed to cover ground forces from air or space attack. Anti-air weapons tend to be rapid-firing, designed to put as much energy into the air as possible, hitting and bringing down enemy vehicles by sheer volume of fire rather than by the power or precision of individual shots.

Anti-space weapons, on the other hand, tend to be much more powerful and accurate, but with a much lower rate of fire. One hit from one of these weapons is usually enough to destroy most starfighters — particularly the unshielded Imperial starfighters — and at least put a dent in the far stronger cruisers, corvettes, and capital ships.

To provide space protection to its most important bases, the Alliance has been experimenting with a powerful new anti-space ion cannon. The ion cannon shoots a massive ionized energy charge. If it hits its target, the charge will ionize the ship's electronics, sending it completely out of control.

The loss of control is usually only temporary, leaving the attacked ship with only minimal permanent damage. Thus the ion cannon is useful only when there are Alliance vessels in the area to take advantage of the ship's paralysis.

The most powerful ion cannon in the Alliance's arsenal has been deployed with the Alliance base on the ice planet Hoth. In the event of attack, it is hoped that this cannon will disable enough of the enemy's ships so that the base can be evacuated. (However, most Alliance strategists are privately quite dubious about the weapon's chances against the powerful Imperial capital ships.)

## HEAVY ION CANNON

**Weapon:** KDY v-150 Planet Defender  
**Type:** Heavy Ion Surface-To-Space Cannon  
**Scale:** Capital Ship  
**Crew:** 27  
**Body:** 2D+2  
**Range:**  
 Short: Atmosphere  
 Medium: Near Space Orbit  
 Long: Outer Space Orbit  
**Fire Rate:** 1/1  
**Fire Control:** 4D  
**Blast Radius:** Target Vessel  
**Damage:** 6D Ionization

### Anti-Orbital Ion Cannon

The “150,” as it is affectionately referred to by Rebel personnel, is possibly the single most powerful weapon in the ground forces arsenal of the Alliance. But as powerful as it is, this massive battery is a disposable weapon, to be used once in desperate circumstances, and then abandoned. The 150 is deployed with the Alliance base on the planet Hoth. In the event of attack, the 150 will provide cover while the base is evacuated. There will almost certainly not be time to evacuate the 150 itself.

The crew of the 150 is composed entirely of Alliance soldiers from Alderaan. They are quite willing — eager, even — to die at their posts if it will aid the Rebellion and hurt the Empire.

### Combat Assault Vehicles

Combat Assault Vehicles (CAVs) are armored repulsorcraft equipped with medium or heavy weapons. Once again, this is an area of ground combat in which the Alliance is sadly deficient. Standard military doctrine suggests that every infantry division be supplied with at least a battalion of CAVs; only twenty-five percent of the Alliance’s infantry divisions are thus equipped. However, the Alliance Special Forces troopers have a much larger proportion of CAVs, giving that important arm of the Rebellion’s military some much-needed speed and striking power.

In general, the Alliance employs smaller, quicker assault vehicles than does the Empire (the Imperial military refers to its vehicles as Ground Assault Vehicles, or GAVs). The Alliance has neither the money, construction facilities or transport capabilities necessary to build, maintain and carry vehicles of the size of the Imperial Juggernauts, All-Terrain vehicles, and the like. Besides which, in keeping with its overall tactical philosophy, the Alliance prefers faster, more

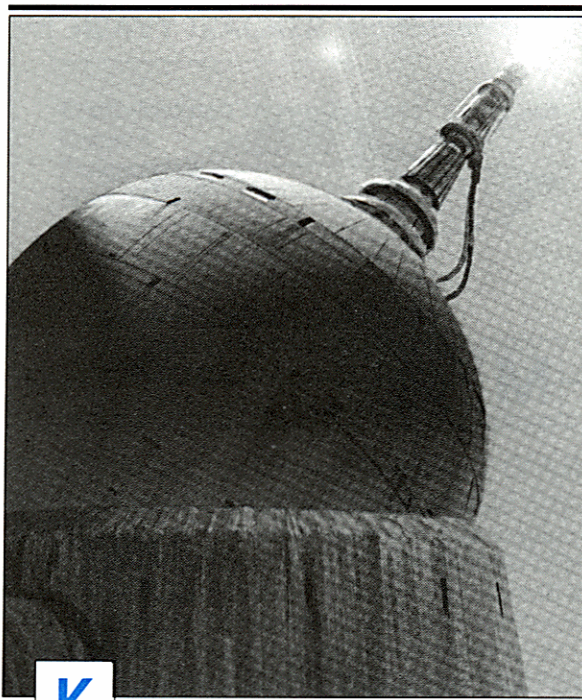

K

DY v-150 Planet defender.

maneuverable CAVs — even at the cost of firepower and armor.

The Rebellion acquires its CAVs in much the same way it acquires its fleets of starfighters, starships and other expensive equipment. Alliance agents purchase older, out-of-date vehicles on the black market or from sympathetic planetary governments; Alliance Techs then lovingly repair and modify the CAVs for superior performance. The result is a fleet of motley craft which looks as if they have been cobbled together from spare parts.

CAVs are the heavy cavalry of the modern battlefield. Their mobility allows them to scout terrain (though not as effectively as speeders); because they are heavily armed and armored, they can also range far beyond the front lines and strike the enemy’s flanks and rear with a good deal of hitting power.

Alliance CAVs do not have the power to stand up to Imperial armored vehicles in a knock-down, drag-out fight. The Imperial GAVs are tougher, better-armed and there are usually more of them. The Alliance CAVs must avoid direct conflict with equal numbers of the enemy’s vehicles. Instead, the Alliance vehicles use their superior mobility to hit the enemy on the flank and then escape in the confusion, gang up on isolated enemy GAVs or attack unsupported Imperial infantry.

The following are several of the more common CAVs in the Alliance arsenal:

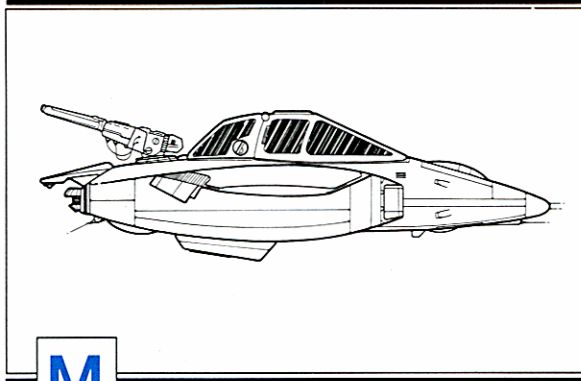

Karl Martin

**M**odified Imperial ULAV.

### ULAV

The ULAV (Ultra-Light Assault Vehicle) is the smallest and quickest of the Rebel CAVs. It was used extensively by the Empire in its early days of planetary conquest, but eventually was abandoned for larger, more powerful models.

After being de-commissioned by the Empire, the ULAV was nearly forgotten. It was too small and unimposing to be used by image-conscious planetary governments or private corporations. Huge stores of these antiquated vehicles sat in army storage facilities across the galaxy, waiting to be scrapped. Then the Alliance found them.

Stored with other outdated heavy equipment in a lightly-guarded Imperial warehouse on Hiffis, a huge fleet of ULAVs was stolen during an Alliance commando raid. Other forgotten equipment was also recovered, but the ULAVs were the gem of the find. Remarkably, many were in good shape. Aside from making a slight power flow increase and adding a bit of ray shielding, the Rebel techs

### REBEL ULAV

**Craft:** Modified Imperial Ultra-Light Assault Vehicle

**Crew:** 2

**Passengers:** None

**Speed Code:** 4D

**Scale:** Speeder

**Body Strength:** 2D+2

**Weapons:**

**Twin Light Laser Cannon** (fire linked)

*Fire Control:* 1D

*Damage:* 2D+2

**Concussion Grenade Launcher**

*Fire Control:* 1D

*Damage:* 3D+1

**Medium Blaster Cannon**

*Fire Control:* 2D

*Damage:* 5D

had to make very slight modifications to these sturdy old vehicles.

The ULAV seats two, a driver and a gunner. The driver controls the forward-facing blasters and grenade launcher, while the gunner operates the rear-mounted cannon.

The rear-mounted cannon is the ULAV's one major design flaw. It has a 180° firing arc, but it cannot fire at anything to the front of the vehicle. In assaults, the ULAV's driver must slew his vehicle around rapidly, giving the gunner a couple of quick forward shots, and then resume movement quickly, before he is targeted by the enemy's heavy weapons.

Another, though less critical, problem with the ULAV is the low efficiency of its elderly repulsor engines. The ULAV rides very low to the ground, skimming the earth at a height of 0.6 meters. This can cause problems when travelling through tangled underbrush or areas covered by jagged rock.

What the ULAV does have in abundance is speed and elusiveness. Its quickness and low profile make it an extremely difficult target for enemy gunners to hit. The ULAV's turning radius is particularly good, allowing for sharp handling on the battlefield — particularly the difficult maneuvering necessary to bring the rear laser cannon to bear.

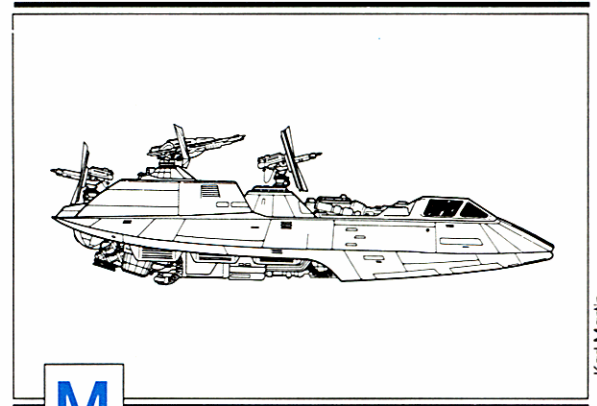

Karl Martin

**M**odified KAAC Freerunner.

### Rebel Armored Freerunner

The Freerunner is the next step up in the Rebel CAV arsenal. It is a bit larger and slower than the ULAV, but it possesses greater firepower.

The name "Freerunner" is derived from the vehicle's free-rotating gun platform which sits atop the main chassis. The platform was designed to accommodate various weapon types, according to the specific requirements of the owner. In its original advertising campaign, the Freerunner was said to be the "ultimate in fast, flexible firepower," allowing the owner the "freedom to meet any combat situation with the

appropriate countermeasure.”

Unfortunately for the designers, neither the vehicle nor the advertising campaign appealed to the Imperial Military. The now-defunct Kelliak Arms and Armor Company took a huge bath on the Freerunner and wound up unloading their entire advance stock to petty arms merchants and (unknown to them) Rebel agents.

The Rebel Freerunner is armed with stripped-down anti-vehicle and anti-personnel batteries. There are anywhere from two to four batteries mounted on a given vehicle, depending upon its specific battlefield assignment. Each gun is operated by an individual gunner, though they can be linked if necessary to save on manpower.

The Freerunner also features an open-air cockpit which, though it does increase the driver's visibility, is not entirely popular with CAV drivers or Rebel military leaders. This limits the vehicle's utility in certain atmospheric environments — it also makes the driver a prime target. Whenever possible, Rebel techs have enclosed the cockpit.

A modified Freerunner, specially fitted with heavy armor plating and deflector shields, serves as Mon Mothma's personal transport when she is traveling through potentially hostile environments.

### REBEL FREERUNNER

**Craft:** Modified KAAC “Freerunner”

**Crew:** 2-4

**Passengers:** None or two

**Speed Code:** 3D

**Scale:** Speeder

**Body Strength:** 3D

**Weapons:**

**1-2 Anti-Vehicle Laser Cannon**

*Fire Control:* 1D

*Damage:* 5D

**1-2 Anti-Infantry Batteries**

*Fire Control:* 2D

*Damage:* 3D+2

### HEAVY TRACKER

**Craft:** Mekuun Heavy Tracker

**Crew:** 6

**Passengers:** 5

**Speed Code:** 1D+1

**Scale:** Walker

**Body Strength:** 3D+2

**Weapons:**

**One Heavy Laser Cannon**

*Fire Control:* 2D (4D with Omniprobe)

*Damage:* 4D

literally “hugs” the ground, enabling it to scan even enemy movements which are out of direct sight.

The Tracker is the most heavily-armored Rebel CAV, although it has no deflector shields. It is also equipped with a single, massive laser cannon, operated by two gunners. Using data provided by the Omniprobe, these gunners can single out specific targets from extreme distances.

Because of the long-range targeting capabilities of the Omniprobe, as well as the vehicle's relatively slow speed and large target profile, the Tracker driver usually keeps his vehicle a good distance from the front lines. There is no need for it to enter into close combat situations when accurate shots can be made from long range.

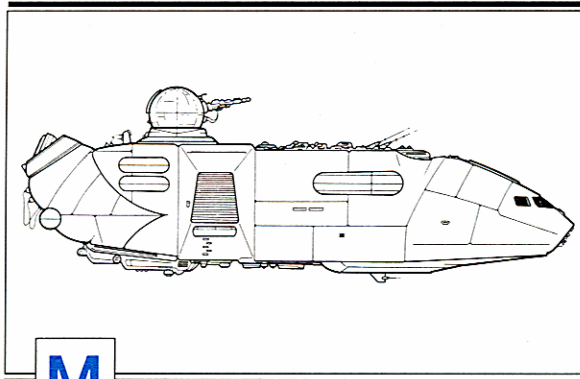

M

Mekuun Heavy Tracker.

Karl Martin

## Heavy Tracker

Although it is classified as a CAV, the Heavy Tracker is more of a mobile scanning unit than an assault vehicle. The Tracker is equipped with an advanced “Omniprobe” sensor array and long-range comlink for relaying enemy positions from the front lines. The Omniprobe is the Rebel answer to the Imperial “Target Identification Network” (TIN).

In operation, the Omniprobe makes low-level scans which are magnetically keyed to a planet's gravitational center. The Omniprobe sensor beam

## Scouting Vehicles

Scouting is an essential function in all combat. If you don't scout, you don't learn the terrain or the enemy's strength and disposition. In short, you lose.

Satellites and starships often perform the scouting function on the modern battlefield. Given the quality of modern sensor equipment, “high” scouting can give extremely precise information to a ground commander in a very rapid amount of time. However, bad weather, and/or enemy



starfighter or killsat activity may hinder or severely curtail space-based scouting — particularly for the Alliance. Rebel infantry commanders have learned that it is important to have ground-based scouts available at all times.

Imperial infantry commanders tend to rely heavily upon long-range ground-based scanning equipment to act as their “ground eyes,” with speeder bike scouts an important backup. Alliance Command goes the exact opposite way, with speeder (or animal) scouts their primary eyes and ears, and long-range sensors the backup. This is as much due to philosophical differences as it is due to the ever-present monetary constraints under which the Alliance operates.

When Infantry forces use long-range scanners, they often give away as much information about their own position as they learn about the enemy’s. Active scanners can be traced. If enough active sensors are in operation, the opposition can get a surprisingly accurate picture of the sensing side’s lines, numbers and disposition.

The only way to avoid this is to use passive sensors — which don’t tell you nearly as much as do active sensors. The Empire, working with overwhelming numbers and power, believes that it doesn’t matter much what your enemy knows about you — if you know where *he* is, you can paste him before he can do much of anything about it. Of necessity, the Alliance must be much more subtle in battle.

Alliance scouts range far and wide over the battlefield, passing through the enemy’s lines, probing his flanks and heading deep into his rear areas. If opportunity arises, they can launch small disruptive raids against weak points they discover. The scouts send back short, coded bursts of information to the Alliance command posts, detailing the enemy’s position, numbers, and movements. Unlike active sensor beams, these transmissions cannot be traced or decoded in time to be useful to the enemy. By the time Imperial techs have triangulated the transmitters’ positions, the scouts are probably kilometers away, making trouble in some other sector of the battlefield.

The only practical defense against this kind of scouting is for the enemy to deploy its own scout

troops against the Alliance scouts. Basically, no other troops on the battlefield are mobile enough to stop them. This can lead to exciting speeder versus speeder battles on the periphery of the main battlefield, with the winner gaining the edge in all further scouting of the battle.

## Speeder Bikes

Speeder bikes are the Alliance’s scouting vehicle of choice. They are extremely quick, very maneuverable, and, therefore, extremely difficult to hit. (To put it simply, they move too fast for the enemy’s heavy weapons to track.) Of course, speeders get their speed by sacrificing armor and weaponry, but their primary job is to scan and report; they are not meant to engage the enemy in battle.

Though some units have military-grade speeders, most Alliance speeders are modified civilian models. The Alliance techs have cut down on engine noise by adding passive sound dampers to the engines. There are radiostatic dampers which are more effective than the passives, but they also cut down on the engine’s power output and increase the bike’s electromagnetic signature.

The techs have made other modifications to the bikes to reduce their electromagnetic signatures (the energy they put out which can be picked up by the enemy’s sensors). The bikes have been stripped of all non-essential equipment: high-altitude lifters, civilian stabilizers, long-range receivers, and the like. The resulting streamlined vehicle is essentially a repulsorlift motor with a laser and comlink. Alliance scouts cheerfully refer to them as “flying rocks.”

### REBEL SPEEDER BIKE

**Craft:** Mobquet “OVERRACER”

**Crew:** 1

**Passengers:** None

**Speed Code:** 4D+1

**Maneuverability:** 3D+2

**Scale:** Speeder

**Body Strength:** 1D+2

**Weapons:**

**One Light Blaster Cannon**

*Fire Control:* 1D

*Damage:* 3D

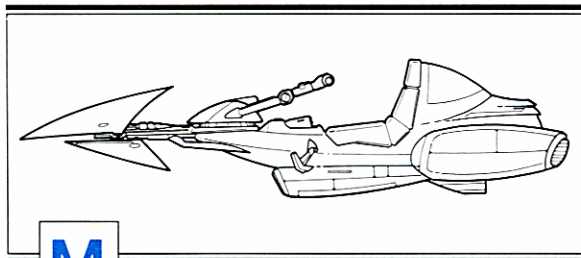

**M**

obquet OVERRACER

Keri Morfin

## Live Mount Scouting

Sometimes speed is less important than remaining invisible. Obviously, there are cases when it is of critical importance that information be gained without the enemy having even a clue that they have been scouted. Speeder bikes are likely

to obtain the information, but, despite their stealth technology, they are also likely to be spotted by the enemy's sensors while doing so. When it is critical that the enemy should not be aware of the fact that he has been scouted, the Alliance infantry uses live mount scouts to do the job.

Obviously, a beast is extremely difficult to sense — it is not built out of metal or plastic, and it gives off no electromagnetic energy to speak of. Radar or heat-sensitive systems might pick the beast up, but, if so, so what? It's just another animal wandering around, after all ...

The Alliance likes to use mounts which are indigenous to the world they occupy, to make their scouts even less conspicuous, but this is not always possible. Fortunately, a few popular riding beasts have been exported to many different worlds, and some of these have escaped and thrived in the wilderness areas on planets across the galaxy. Therefore, an Imperial would not necessarily be surprised to scan a tauntaun, dewback, fenwolf, or Cracian Thumper almost anywhere he was stationed. If the officer was lazy, the Rebel scout would have at least a fifty-fifty chance that he would not send out a patrol to check it out.

### CRACIAN THUMPER

**DEXTERITY:** 3D  
**PERCEPTION:** 3D+2  
**STRENGTH:** 3D  
**Orneriness:** 1D  
**Speed Code:** 3D+2

**Size:** Adults stand 1 to 1.8 meters at the shoulder.

**Combat:** The Thumper will claw (damage code 3D+1) and whip with its tail (damage code 4D+2). A herbivore, the Thumper has hard, fibrous, flat teeth, ineffective for biting an enemy.

**Skills:** *Move silently* 4D.

**Using Thumpers in the Roleplaying Game:** Players characters may find Thumpers used as mounts on many of the systems neighboring the Corporate Sector. They can carry up to 100 kilos of cargo, or one rider and up to 50 kilos.

### Cracian Thumpers

The Cracian Thumper gets its name not from the sound it makes as it runs, but rather the sound it should make. These remarkably agile beasts run with an extremely light touch upon the earth, making hardly a sound. They should "thump" when they run, but they don't.

The Cracian Thumper is an extremely loyal and obedient animal, with an intelligence equal to most domestic pets. They can be taught to follow verbal or touch commands; they can often distinguish between "friends" and "enemies" — particularly when the enemy wears a hard plastic shell. And they can also be taught to attack upon command.

The Thumper is a nasty beast in a fight. It has sharp foreclaws and a powerful whipping tail which is capable of removing the head from an Imperial stormtrooper with ease. Their hind legs are also clawed, and they can lash out backwards while at a full run.

The Thumper is found on each of the five planets of the Craci system, which is located just within the boundaries of the Corporate Sector. They have been domesticated for years; there are millions of them on human-populated planets across the galaxy.



**T**he Cracian Thumper, workbeast of the Rebel Alliance.

### Infantry Transport

This section discusses the more mundane transport vehicles — repulsor trucks, skiffs, and the like. These vehicles are designed to carry infantry troopers to the battlefield. They are not designed to get into battle themselves — they are usually inadequately armed and armored, for one thing, and they are driven by non-combatants, for another.

Still, they are of critical importance to the success or failure of an operation. Given the mobility of the armed force available to both sides — speeders, air vehicles, spacecraft, and the like — the front lines of a battle can shift several dozen

kilometers in a single day. The infantry must be equally mobile, or it will be bypassed, or surrounded and destroyed. On the offensive or in retreat, the infantry must be able to keep up with the rest of the army, or it is dead.

In addition to troops, the transport vehicles must carry ammunition, supplies, communications gear, medical equipment, and the myriad of other impedimenta necessary to keep the modern army in the field.

### Light Mechanized Vehicles

Rebel LMVs are usually civilian vehicles, with a bit of armor added for protection of the crew and passengers, and perhaps a small weapon mounted on the cab. Much lighter than their Imperial counterparts, which are often quite heavily armored, Rebel LMVs are faster, but cannot stand up to nearly as much damage. Therefore, the Rebel troopers must debark much further away from the front line than the Imperials. Nobody wants to be inside an LMV which is under fire; the term “deathtrap” could have been coined specifically for that situation.

### Speeder Truck

The speeder truck is basic battlefield transportation. It is essentially a civilian transport with modified repulsors and an oversized access ramp. This sort of vehicle is readily available on the open market, and the Alliance has little trouble acquiring and modifying them for carrying troops.

In general, speeder trucks remain unarmed, even when serving combat duty for the Alliance. They are not meant to engage in combat; if they do, somebody somewhere has fouled up, and badly. The Alliance doesn’t have weapons to spare, and those that they do possess are required for vehicles which are meant to participate in battle — CAVs, speeders, and the like.

Some truckers have “acquired” blaster rifles or even repeat blasters (never mind how) and hand-mounted them on their own vehicles. This practice is frowned upon by Alliance Command because it may give the truckers an unwarranted

### REBEL SPEEDER TRUCK

**Craft:** Modified Trast A-A5 Speeder Truck  
**Crew:** 3  
**Passengers:** 25 Troopers  
**Speed Code:** 1D+2  
**Scale:** Walker  
**Body Strength:** 1D+2  
**Weapons:** none

feeling of power and cause them to take risks they have no right to take.

### Tramp Shuttle

“Tramp shuttle” is a Rebel slang term for any beat-up, outdated landspeeder which has been souped-up, modified and equipped to serve as battle transport. Tramp shuttles come in all manner of size, shape and model— whatever the Alliance can get its hands on.

Although most tramp shuttles do not carry nearly as many troops as do speeder trucks, they are generally faster and better armed. Whereas the speeder truck is used around the perimeter of an engagement area, tramp shuttles often find themselves in the thick of things.

To be of use, a tramp shuttle must be capable of traversing a “hot” battle area. They are often called upon to go right to the front lines, carrying energy cells, ammunition and wounded men. Some tramp shuttles are modified to serve as emergency first aid stations, equipped with rudimentary medical facilities and a medic or medical Droid.

If armed, tramp shuttles are usually fitted with manual turret weapons, as the power drain required for automation tends to diminish the vehicle’s speed. Besides, in battle the driver cannot easily fire a weapon himself; he usually has his hands full simply steering the craft, avoiding craters, burning wreckage, strafing airspeeders and whatnot. A separate gunner is a clear necessity.

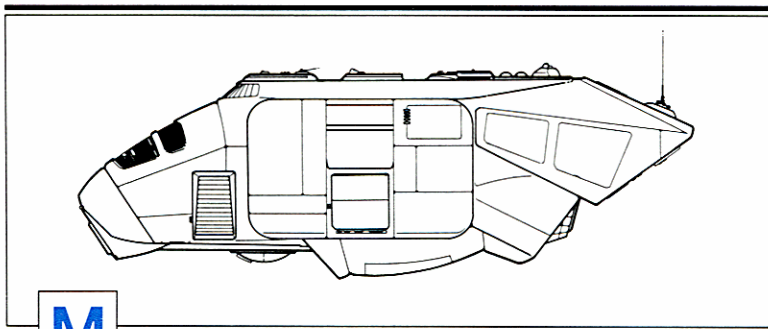

Kari Martin

**M** odified Trast A-A5 Speeder Truck.

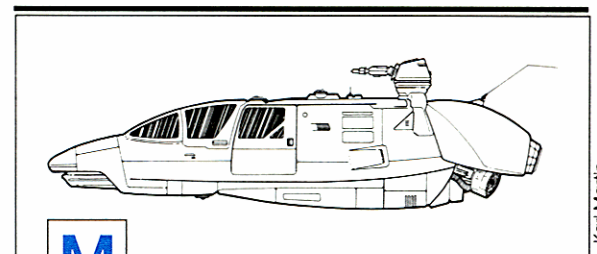

Kari Martin

**M** odified Aratech Arrow-23 Landspeeder

**TYPICAL TRAMP SHUTTLE**

**Craft:** Modified Aratech "Arrow-23"  
 Landspeeder  
**Crew:** 2  
**Passengers:** 5  
**Speed Code:** 4D  
**Maneuverability:** 2D+1  
**Scale:** Speeder  
**Body Strength:** 3D  
**Weapons:**  
**Laser Cannon**  
*Fire Control:* 1D  
*Damage:* 3D  
**Concussion Grenade Launcher**  
*Fire Control:* 1D  
*Damage:* 3D+1

**PERSONNEL SKIFF**

**Craft:** Repulsorlift transport skiff  
**Crew:** 1  
**Passengers:** 15  
**Speed Code:** 1D  
**Scale:** Speeder  
**Body Strength:** 1D  
**Weapons:** None

**Personnel Skiff**

The personnel skiff qualifies as an LMV, but it rarely, if ever, ventures into a hot combat area. These open-air repulsorlift transports are slow, unwieldy, and extremely vulnerable to almost any kind of attack.

The personnel skiff is most commonly used to transport personnel within the confines of a Rebel base, outpost, other installation or deep behind friendly lines, far from any chance of attack. They shuttle starfighter pilots and passengers to their ships in large hangar bays, move heavy equipment and supplies, and so forth.

Rebel skiffs tend to be slightly faster than their commercial counterparts, and each is equipped with a unichannel comlink. The driver sits in the left front corner of the skiff, controlling its speed and direction with a joystick/throttle assembly.

**Airspeeders**

Airspeeders are enclosed repulsorcraft designed to fly at heights in excess of 250 kilometers

and at speeds in excess of 800 kilometers an hour. They are much tougher than speeder bikes and capable of carrying much heavier loads — typically weaponry.

In battle, airspeeders perform much of the same function as jet fighter aircraft do on more primitive worlds — reconnaissance, air cover, anti-vehicle and anti-personnel attacks, and bombing runs. Their hard-hitting, quick-strike capabilities make them perfectly suited to the Alliance's style of combat.

Many Alliance airspeeders are built from the controls and chassis of starfighters no longer suitable for space combat, making them extremely durable. They are arguably the most powerful and survivable Alliance weapons on the battlefield. They are the only weapons in the Alliance's arsenal capable of stopping the Empire's new All-Terrain terror weapons.

**Airspeeder Tactics**

Stationed on Hoth's frozen Echo Base, Rogue Group was the first squadron of starfighter pilots anywhere in the Alliance to serve double-duty as airspeeder pilots. Together, Luke Skywalker, the squadron leader, and Beryl Chiffonage (a noted Rebel tactician), developed a series of tactical maneuvers to be flown by airspeeder squadrons in the event of attack by Imperial walkers.

Combining Skywalker's experience with airspeeder piloting and Chiffonage's intimate

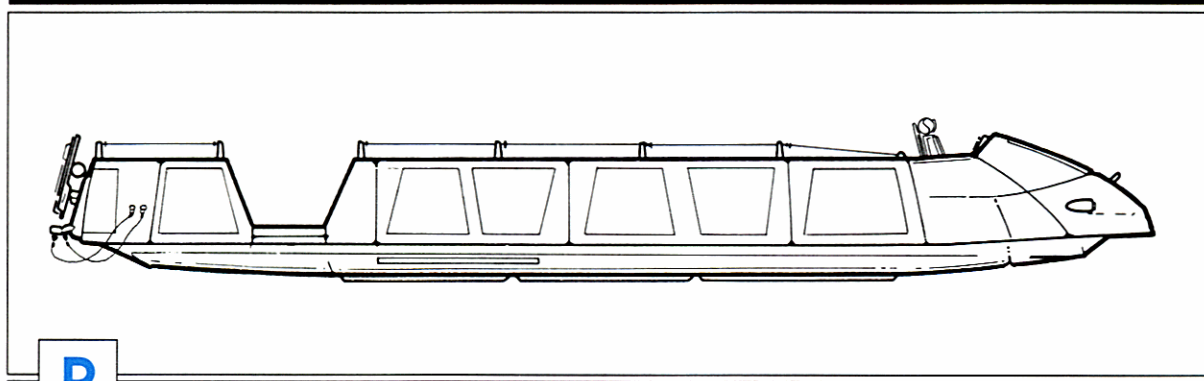

Karl Martin



repulsorlift transport skiff.

**A**bove-Ground Sensors

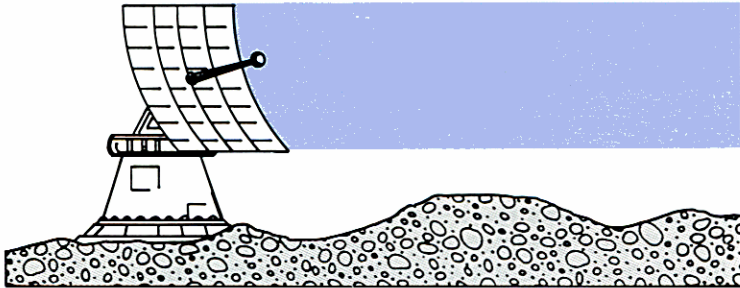

**Focused Uni-Directional Sensor Dish**

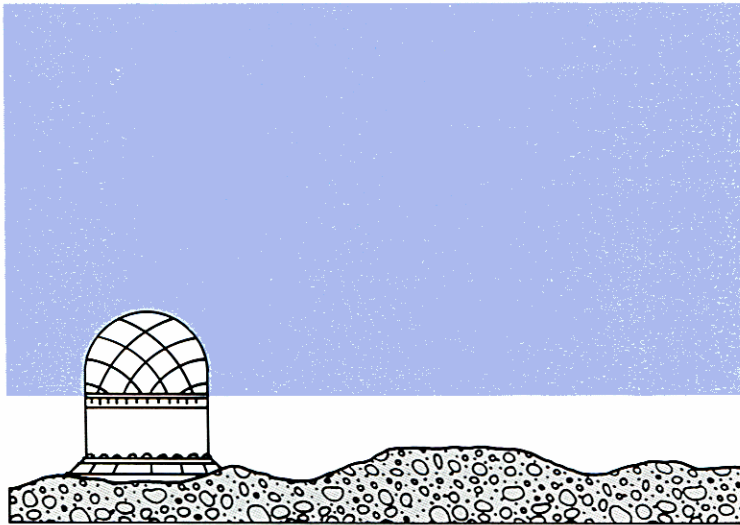

**Omni-Directional Sensor Globe**

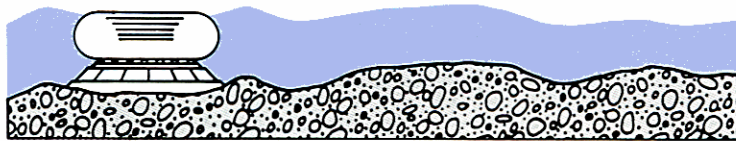

**Omniprobe Sensor Array**

The Alliance generally employs three types of above-ground sensors at its bases and outposts. Each type has its advantages and its weaknesses. Rebel military experts have found that the best coverage is provided by combining all three sensor types.

Focused Uni-Directional Sensor Dishes maintain a tight, focused beam. The technology used is similar to a starship's Dedicated Energy Receptor (DER). This type of sensor is excellent for relaying detailed, specific information on a previously detected target. It is almost completely useless as an early detection sensor because it covers so little territory.

The Omni-Directional Sensor Globe, a ground-based Full-Spectrum Transceiver (FST), is the ideal early detection sensor. It blanket-scans a large area around and above it, picking up any approaching space vessels as well as enemy ground forces. The problem with this sensor type is that it does not provide detailed information. Only the most basic contact information can be gleaned by this type of sensor.

The new Omniprobe Sensor Array solves a problem found in both of the previously-mentioned sensor types. Each of those sensors has "blind spots" below the arc of the scanning beam. On rough or jagged landscapes, these gaps in sensor coverage are particularly exploitable. The Omniprobe beam, on the other hand, uses a planet's magnetic gravitational forces to literally "hug" the ground, eliminating most blind spots altogether.

The Omniprobe relays far more accurate and detailed information than the Omni-Directional Globe, but only of ground-level targets. The beam stays extremely low to the ground, and anything above two meters remains undetectable.

Combining the three sensor types for complete blanket and focused coverage is obvious. The Omni-Directional Globe combined with the new Omniprobe can provide complete early warning detection coverage of both atmospheric and ground-based enemy attack, and once initial contact is made, a Focused Uni-Directional Dish can glean quite a lot of detailed information about specific targets.

**REBEL ALLIANCE AIRSPEEDER**

**Craft:** Rebel Alliance Combat Snowspeeder  
**Note:** These statistics replace those provided in the Star Wars Sourcebook.

- Crew:** 2
- Passengers:** None
- Cargo Capacity:** 10 kilograms
- Speed Code:** 5D+2
- Maneuverability:** 3D
- Scale:** Speeder
- Body Strength:** 3D
- Weapons:**
  - Double Laser Cannon** (fire linked)  
*Fire Control:* 2D  
*Combined Damage:* 4D+2
  - Power Harpoon:**  
*Fire Control:* 2D  
*Damage:* 3D (or none if tow cable and fusion disc is used)
- Flight Ceiling:** 175 kilometers

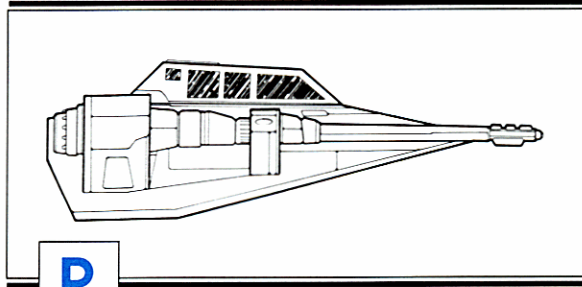

Karl Martin

**R** Rebel Alliance combat Snowspeeder.

(whether or not the speeder's blasters can penetrate the armor, nobody wants to have one crash into him at full speed). The speeders line themselves up in near single-file, so as to present the smallest target profile to the Imperial gunners.

Upon reaching optimal firing range, the walker is strafed with cannon fire by the speeder pilot, who then veers off. Each pilot veers off in a different direction, giving the head-mounted gunners only one target to fire on. Once out of range, the speeders regroup and make another run.

In effect, this is a game of "chicken" played on a larger scale. If the Imperials keep their nerve, they stand a good chance of doing serious damage to one of the speeders, while receiving minimal damage in return. If the Imperials flinch, the speeders will get off scot-free.

**Bantha Decoy**

This maneuver is a variation of a gag that Luke Skywalker used to pull in his old T-16 Skyhopper on his home world of Tatooine. Approaching an unsuspecting Bantha from behind, Luke's

knowledge of Imperial battle tactics, the maneuvers are both daring and innovative. Now known as the "Rogue Doctrine," this has set the standard for combat airspeeder tactics. Here are some excerpts:

**Attack Pattern Delta**

This is the standard front approach run by a squadron of airspeeders against an Imperial walker. The speeders approach head-on to take the heat off of other targets the walker may be firing on and to make the walker's pilot nervous

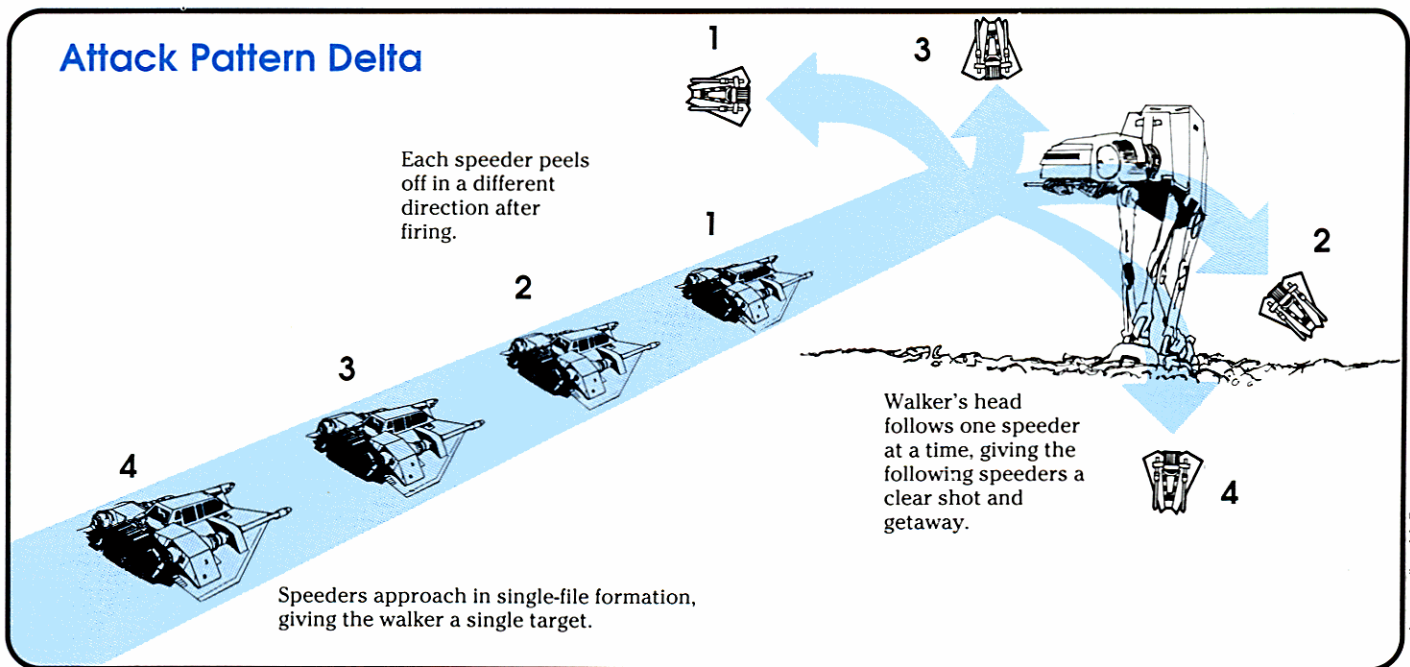

Jacqueline M. Evans

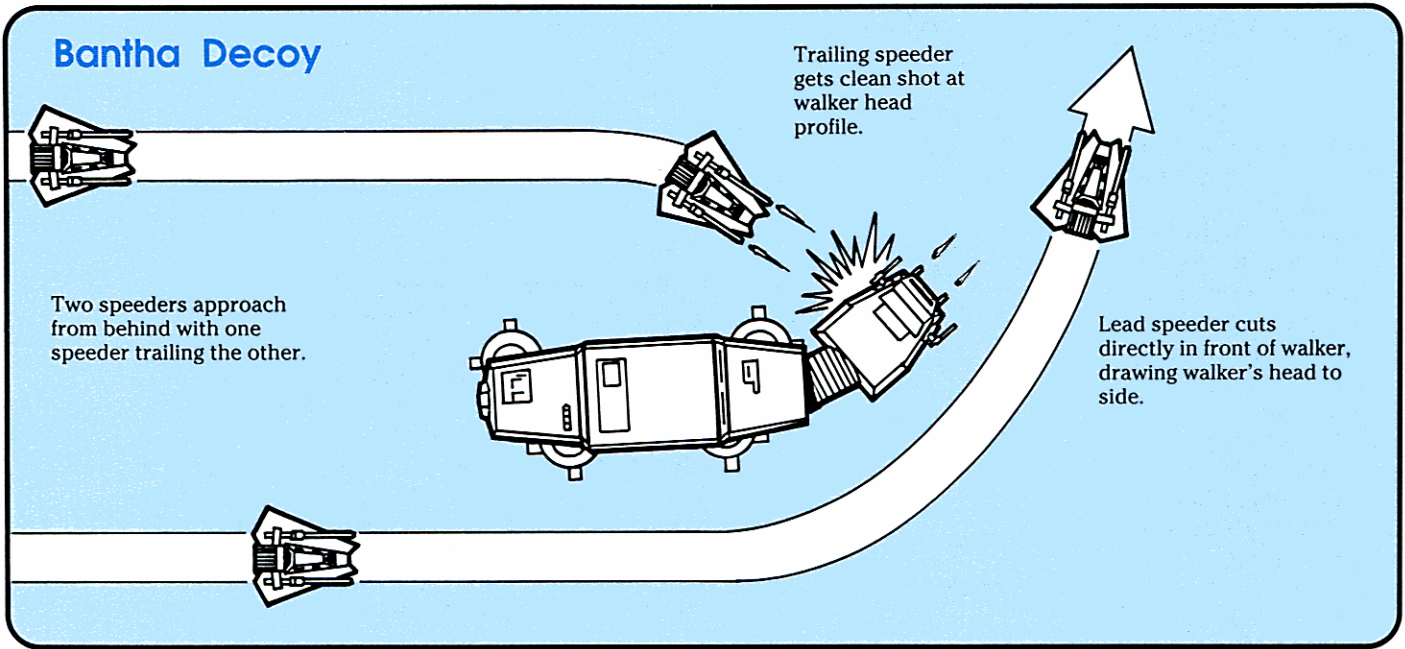

Stephen Crane

wingman would cut out in front of the beast. The annoyed Bantha would naturally turn its head in the direction of the Skyhopper, presenting a profile of its head to Luke, following behind in a second T-16.

Luke would then attempt to ping the Bantha in the ear with a sighting laser shot. The laser signals were very weak and (mostly) harmless. If the shot missed the ear, the Bantha wouldn't even notice it; if the shot was dead on target, the startled beast would buck and rear in a most gratifying fashion.

As an airspeeder combat maneuver performed against an Imperial walker, the Bantha Decoy stays pretty much true to form. A pair of airspeeders approach a walker from behind. The lead speeder shoots out in front of the walker, then banks sharply to the right, left, or straight up. The walker follows the lead speeder with its guns as the speeder banks, thus giving the trailing speeder a clear shot at the less-armored head and neck assembly.

**Harpoon and Tow Cable**

This is perhaps the most difficult and dangerous maneuver developed by Skywalker and Chifonage. However, it has the potential to do the most damage if it is successful. The maneuver

involves the use of a special high-powered harpoon attached to a flexi-steel tow cable and fusion disc, all of which were designed and built by Chifonage expressly for this purpose.

To use the harpoon and tow cable, the speeder pilot dives down at the legs of an Imperial walker. The gunner fires the harpoon at one of the walker's legs, hoping that the magnetic fusion disc on the end of the harpoon will affix itself firmly. Once the disc is secured, the pilot makes several circles around the legs of the walker.

The tow cable, which is attached to the end of the harpoon, wraps itself around the walker's legs as the speeder encircles them. Once the walker's legs are sufficiently entangled, the gunner releases the other end of the tow cable. This end has another magnetic fusion disc attached to it which fuses itself to the nearest section of entangled cable. Continuing its forward motion, the walker is brought to its knees by the force of its own weight.

Naturally, there are some problems with this maneuver. From a piloting standpoint, encircling the legs of a moving AT-AT is not the simplest of tasks. As far as the gunner is concerned, this is an extremely difficult shot. Combine these two elements, and the chance for success is rather low.



# Alliance Ground Assault Vehicle Recognition Guide

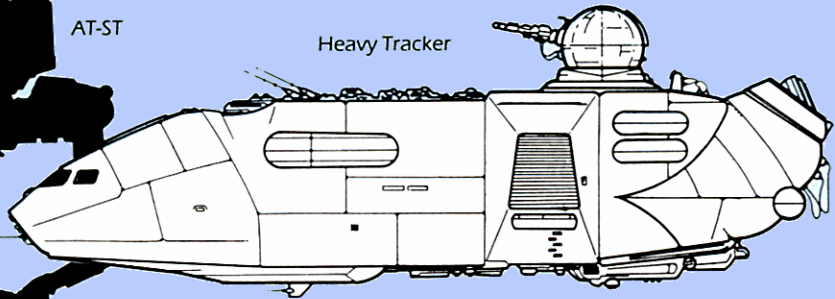
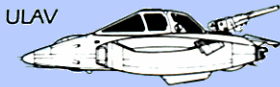
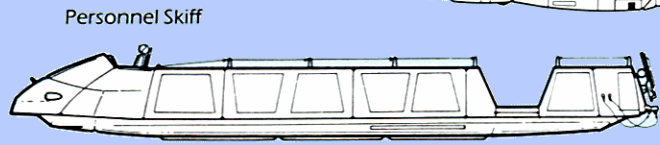
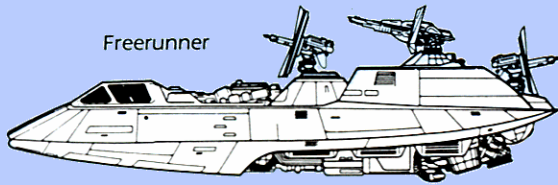

Silhouettes of AT-AT and AT-ST  
provided for comparison

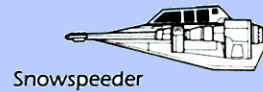
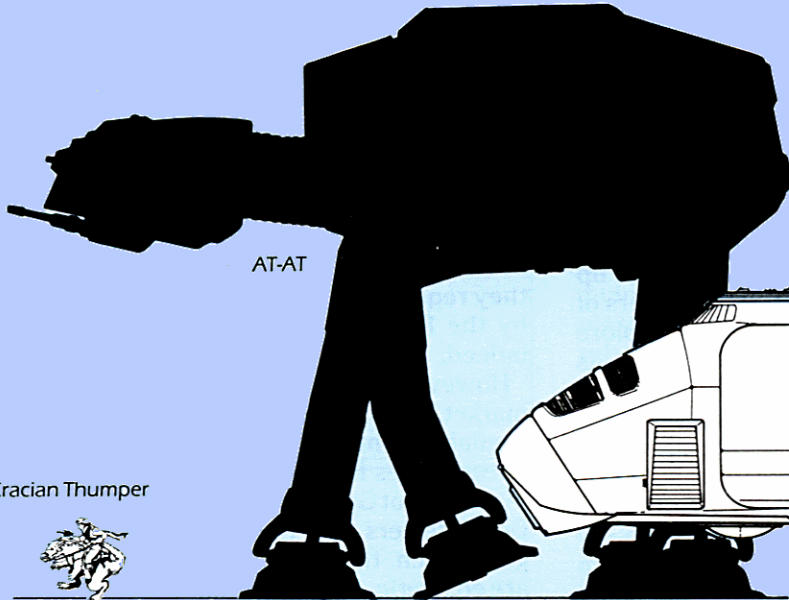

Cracian Thumper

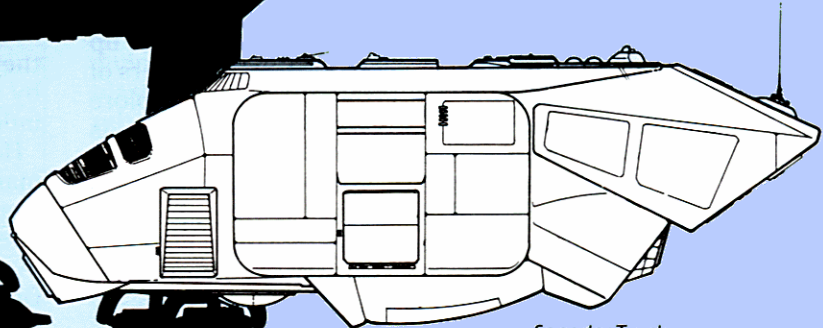

**Note:** All vehicles are shown to scale.







# Chapter Seven

## Droids

*“...The development and mass production of Droids has proven invaluable to all spacefaring cultures, and made possible great strides in science, engineering, and exploration, benefitting countless millions.*

*“The primary purpose of the Droid is to take on the tasks their creators cannot, or will not, do. It is the Droid who explores the trackless wastes on planets with fierce methane winds that would prove fatal to many species; it is the Droid who plunges into malfunctioning nuclear furnaces to effect repairs; it is the Droid who lifts and carries the precious cargo that fills thousands of container ships; it is the Droid who has brought to a myriad of species the freedom to focus on that which is truly important, secure in the knowledge that the menial tasks, the dangerous tasks and the labors that keep our societies moving forward will be accomplished.”*

—Anton Saar, *Of Droids and Men*

### Droids: An Overview

Droids are a critical component of the Alliance’s efforts, not only for the services they provide, but for the being-hours they save flight crews, ground staff, and administrators. These automatons, though rarely in position to commit heroic acts, make possible by their very existence the heroic acts of others.

Droids serve in all levels of the Alliance. Their duties range from navigational assistance and starfighter repair to acting as interpreters between the many different species that make up the forces of the Rebellion. Droids are healers of the wounded in battle, and scouts that can explore hostile worlds without risking adverse reactions to climatic conditions.

Droids also function as the eyes and ears of the Alliance on many worlds, storing information on Imperial activities and troop strengths and then retrieving it when ordered. Though limited by the difficulty they have telling lies, if properly programmed and placed in position, Droids can make excellent spies—in both directions.

Droids have been a boon to the Alliance in many

ways, and their importance can only be expected to grow as the struggle against the Empire continues.

### Acquisition and Development

Prior to the Rebellion, the Droid industry was largely dominated by two firms, Industrial Automaton and Cybot Galactica, with smaller fringe companies such as Arakyd and Geentech surviving by providing cheaper Droids or certain specialized Droid types. With the advent of the Rebellion and the disruption of normal trade and commerce in the galaxy, many of the smaller companies have been driven out of business altogether, leaving Automaton and Cybot in full control of the Droid market. Since both of these Corporate Sector giants are firmly in the Empire’s pocket, the Alliance has had to struggle to purchase Droids in the quantity it requires.

Fortunately, when the smaller Droid companies first began to go bankrupt, the Alliance was able to acquire a good deal of Droid manufacturing equipment quite inexpensively — at least until the Empire wised-up and banned the sale of the equipment. Before that occurred, however, the Alliance got enough equipment to set up complete Droid factories on several of its safe worlds.

However, the Alliance has yet to recruit or train enough of the specialized personnel — engineers, programmers, and the like — required to run their factories at peak efficiency. Until they do so, they will be forced to acquire the bulk of their Droids from the outside. And, in the quantities they require and the staggering inflation caused by the Rebellion, that can be quite expensive indeed.

However, there is a large used/damaged Droid market. Old, dinged-up, broken-down Droids are available in huge quantities and for remarkably cheap prices from numerous sources, including IA and Cybot Galactica’s remaindered stock, used Droid dealers, and the ubiquitous Jawa scavengers. Often, the problems with the used Droids are cosmetic, and they require few or no internal repairs to be fully functional.

Another source of Alliance Droids is the Empire, specifically Droids abandoned by Imperial forces or captured in battle. These are usually in good condition, but require significant reprogramming before they can be used in Rebellion outposts because special care must be taken to ensure that the abandoned Droids are not Imperial spies.

## New Droid Types

Following are some of the newer models of Droids which have begun to see extensive use in the Alliance's war effort:

### Explorer Droids

The LesTech Explorer Droid was designed with one major purpose in mind: to function in environments not conducive to organic life. It can travel through almost any sort of terrain and survive in almost any sort of atmosphere or climate, all the while recording data concerning the area's relief, geology, and the chemical composition of the water and air. Explorer Droids can also be used to gather preliminary data on a region's most defensible positions when planning base construction.

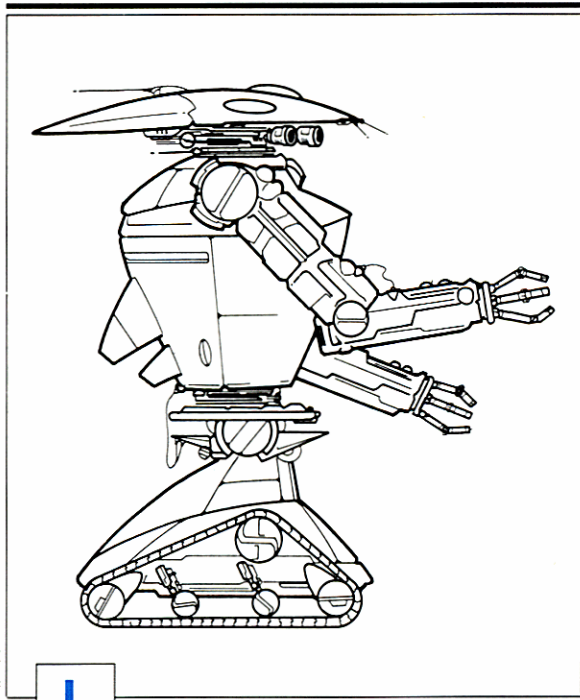

Karl Martin

L

Les Tech Explorer Droid.

## EXPLORER DROID

**Model:** LesTech Explorer Droid

**Height:** 1.3 meters

**Weight:** 165 kilograms

**Strength:** 5D

**Skills:**

*Planetary Systems:* 4D+2

*Survival (Droid):* 4D+2

*Search:* 4D+2

Equipped with:

- Seismic sensors
- Motive (movement) sensors
- Electromagnetic sensors
- Visual and infrared range sensors
- Radiation sensors
- Two arms: heavy grasper and fine manipulator
- Holocam
- Specimen hopper (holds 5 kilos)
- Treads

Explorer Droids are equipped with seismic, motive, and electromagnetic sensors, optical cameras with infrared scopes, and radiation meters. They normally stand 1.3 meters tall, with two articulated appendages for picking up soil and rock specimens and treaded rollers to enable them to travel over rocky or uneven ground.

The Explorer Droid can be programmed to seek out a specific mineral, or take general lifeform readings. The Droids have also been used on salvage missions, being sent into ships too highly radioactive for other beings to safely enter to ascertain if there was anything inside worth salvaging.

Despite some similarities in function with the Imperial Probot, the Explorer Droid is less sophisticated and lacks the versatility of that automaton. The most obvious difference between the two is that the Explorer Droid is not armed, and cannot defend itself against attack. The Droid's designers tried to compensate for this by giving it a thick outer casing that is resistant to blaster hits. The Droid's appendages are also relatively strong (to enable it to gather specimens and clear debris that might impede its travels), but if attacked, it is more likely to record data about its opponent than to actively engage in combat.

Explorer Droids are usually sent to a planet's surface in a small shuttle, either manned by a Pilot Droid or with a pre-programmed course laid in. If the shuttle is destroyed on the surface, a second ship must be sent to retrieve the Droid, or any data it has gathered will be lost.

Explorer Droids must be purchased new. Droids of this type tend to be worked until they break down — and as they usually break down in the most hostile of environments, it is often impossible or unreasonably expensive to retrieve and repair them. This means that the Alliance must be content with a limited supply, and use them wisely. Despite its limitations, the Explorer Droid is a valuable resource for the Rebels, particularly as they seek refuge from the Empire on forbidding worlds.

### Pilot Droid

For years, the popular R2 Astromech Droids have helped pilots navigate through strange systems and plan hyperjumps, performing almost as effectively as living copilots. In a few rare, but widely-reported incidents, R2s have even brought craft home on their own, after the pilot was disabled. Now, Industrial Automaton, manufacturer of the R2, has perfected a Pilot Droid capable of guiding even the most sophisticated ships from place to place.

Outwardly, the Pilot Droid resembles the Astromech Droid — cylindrical in shape and tripod-like, one meter in height, with the ability to interface with starship computers. But the Pilot Droid can use that interface to perform almost all of the functions of a pilot. The few the Alliance has managed to acquire have been most useful on cargo runs for which living personnel cannot be spared.

The Pilot Droid is connected to the helm of the ship through a special jack which takes the place of the ship's manual controls. It is capable of monitoring course and speed, making corrections when necessary, and providing the proper

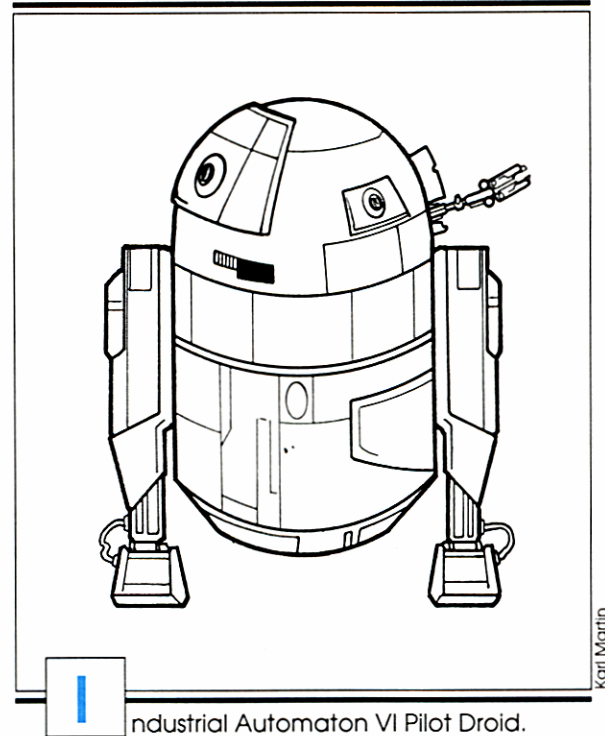

Karl Martin

Industrial Automaton VI Pilot Droid.

### PILOT DROID

**Model:** Industrial Automaton V1 Pilot Droid

**Height:** 1 meter

**Strength:** 2D

**Skills:**

*Astrogation:* 3D

*Starship Operation:* 5D

*Computer Programming and Repair:* 3D

*Starship Repair:* 3D

**Equipped with:**

- Three wheeled legs (one retractable)
- One retractable arm
- Visual range sensor
- Starship interface jack
- Video display screen
- Memory for three pre-programmed hyperspace jumps

astrogation charts have been programmed into it, the Droid can plot the safest course between stars. The Droid does not have the sophisticated starship repair capabilities of its Astromech Droid predecessor, but it can perform many minor repairs unassisted.

Both the Empire and the Alliance have Pilot Droids, and both sides have programmed enemy ship recognition into them. But efforts to turn the Droids into combat pilots have met with dismal failure — they can raise shields and perform some evasive maneuvers, but they cannot fight.

When attacked, their primary response is to flee. If that fails, they activate the ship's auto-destruct. Most Alliance Droids have been fitted with auto-destruct circuits to ensure that the Empire cannot capture a Droid and use its programming to discover the location of Rebel bases.

The technology to build Pilot Droids is new, and they are still extremely expensive (though the price will undoubtedly drop over the next few years). The Alliance does not consider them really worth their high price and does not buy them, but they are happy to receive Pilot Droids from Alliance sympathizers, and even happier to steal them from the Empire.

### Espionage Droid

The genesis of the Espionage Droid is an interesting one. A small Droid manufacturer called MerenData, working with remaindered Cybot Galactica 3PO Protocol Droids, experimented with the introduction of hidden files into its

**ESPIONAGE DROID**

**Model:** MerenData Espionage Droid (appears to be standard 3PO Human-Cyborg Relations Droid)

**Height:** 1.7 meters

**Strength:** 2D

**Skills:**

*Languages:* 10D

*Cultures:* 4D

**Equipped with:**

- **Secondary Programming:** Information recording and code-keyed retrieval/broadcast system
- Vocabulator speech/sound system
- Broad-band antenna receiver
- A-A-1 VerboBrain
- TranLang III Communication module (can access up to seven million different languages.)

programming. Eventually, this resulted in a Protocol Droid capable of recording everything that happened around it for a set period of time (at most a year), then transmitting that information on receipt of a high-frequency coded signal. The Droid itself would be unaware of the existence of the hidden programming, and would not recall making the transmission after it was completed.

MerenData had created the perfect spy — one which wasn't aware it was a spy.

The firm marketed the Droid very quietly, selling a few here and a few there, primarily because an Espionage Droid whose existence is known to everyone would be useless. (Another consideration was that Cybot Galactica's sales of 3POs would plummet if the news got out, which would make that large company very unhappy.)

The Espionage Droid is outwardly identical to a Protocol Droid. It is humanoid in shape, roughly 1.7 meters in height and weighing 50 kilograms. They are equipped with vocabulator speech units, microwave sensors, photoreceptors, and all the rest of the standard technology included in the 3PO units. The major difference is in the secondary programming, which contains a hidden command directing the Droid to record all that goes on around it.

The Droid will carry out its primary duties — language translation and storage and retrieval of etiquette practices — like a normal 3PO unit, completely unaware of its hidden programming. But upon receipt of a pre-arranged high-frequency signal, the Droid will download its information on a tight beam to the signal's source (usually a ship). If the Droid's owners have any kind of internal communications monitoring system, they

will be able to trace the broadcast back to the Droid and will probably destroy it, but by then, the damage is already done.

Espionage Droids are not available on the open market — a prospective purchaser must have the right connections to obtain one. And very few Espionage Droids survive to enter the used market. Since the Empire has made it illegal to possess them (although Imperial Intelligence has of course confiscated a number for their own use), the price is quite high. The Rebellion has one currently in service aboard the Imperial Star-Destroyer *Bombard*, but it has not yet been activated. Whether or not there are others planted in the Empire, and how the Empire uses its own Espionage Droids, are closely-guarded secrets.

**Game Notes:** It takes a Very Difficult *Droid programming and repair* roll to spot an Espionage Droid, and the programmer must specifically state that he is looking for hidden secondary programming.

An Espionage Droid's secondary programming will survive standard memory-wipe and reprogramming procedures; the Droid must be disas-

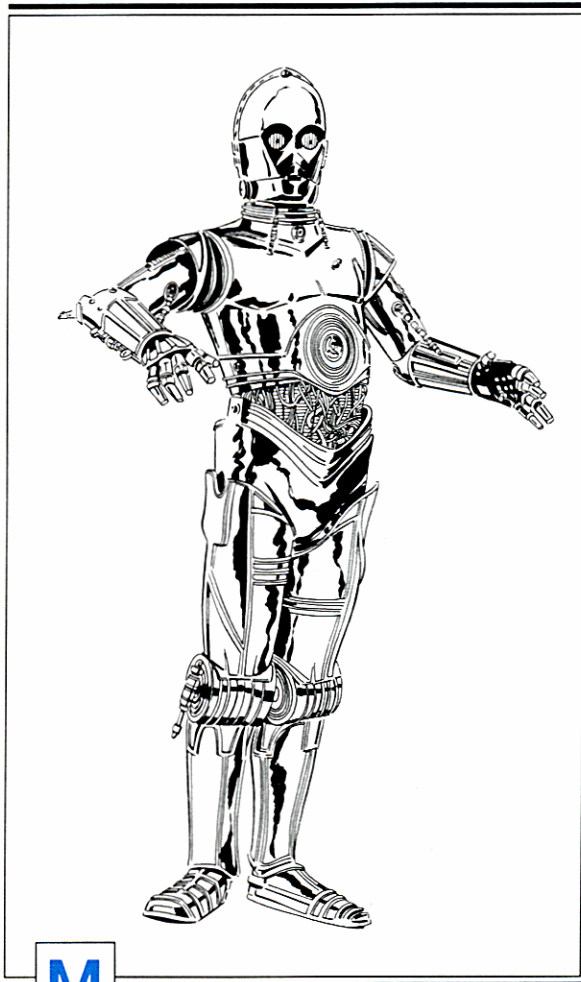

**M**

erenData Espionage Droid.

Mike Manley

sembled and the hidden chips physically removed before the Droid's secondary programming will be wiped out. Once the secondary programming is spotted, it requires a Moderate *Droid programming and repair* roll to remove the chips without damaging the Droid.

### B1 WORKER DROID

**Model:** AccuTronics B1 Worker Droid

**Height:** 1.5 meters

**Strength:** 8D

**Skills:**

*Lifting:* 10D

*Stamina:* 4D

**Equipped with:**

- Suction/magnetic-tipped digits
- Retractable third leg
- Visual spectrum scanners

## B1 Worker Droid

The B1-series Worker Droid serves in major spaceports all over the galaxy, loading and unloading bulk freighters, container ships, and other vessels and doing much of the purely physical labor that such facilities require.

The B1 Droid's manufacturer, AccuTronics, designed it with heavy work in mind. The interior of the Droid is a series of servo-motors, engineered to allow the automaton to lift objects without placing undue stress on its frame. When its power cells are fully charged, a B1-Worker Droid can lift three metric tons' worth of machinery. But due to the vast amount of energy it requires to do such work, B1s often need recharging.

The B1 is vaguely humanoid-shaped and bipedal, with two upper appendages. The tips of the Droid's digits are equipped with magnetic and suction devices which can adhere to virtually any metal surface, making it less likely the Droid will drop equipment it is handling. The B1 is also equipped with a retractable third leg, which emerges from the Droid's lower back and helps to brace it when it is lifting particularly heavy loads.

The B1 is the proverbial "all brawn and no brain" automaton. The Droid is programmed to respond to simple verbal commands (i.e., "Bring that box over here"), but has extremely limited memory capacity. The B1 is one of the few Droids that never requires a memory wipe, because it is incapable of learning new concepts. It has no loyalty programming and will follow orders from anyone.

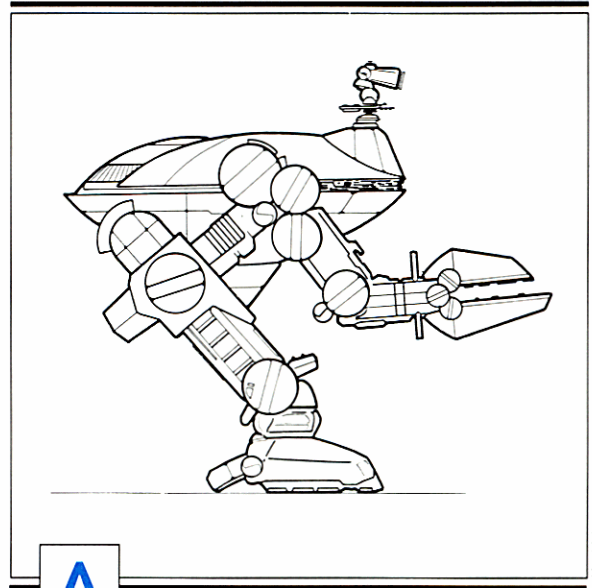

A

ccutronics B1 Worker droid.

Kari Martin

## SE4 Servant Droid

The SE4 Servant Droid is one of the oldest lines manufactured by Industrial Automaton, second only to early probots manufactured before the Clone Wars. For all intents and purposes, the SE4 put IA on the Droid technology map, as advanced science was used to create the perfect domestic help.

The Rebellion has found a few new tricks to teach the old SE4. While it still fulfills many of its traditional functions at Imperial bases and some Star Destroyers (i.e., overseeing the preparation of large banquets, housecleaning and light maintenance), on Alliance worlds, its duties tend to be a bit less genteel.

### SE4 SERVANT DROID

**Model:** Industrial Automaton SE4 Servant Droid

**Height:** 1.6 meters

**Strength:** 2D

**Skills:**

*Cultures:* 3D

*Languages:* 3D

*Culinary Arts:* 4D

*Home Economics:* 4D

**C** **look and Data**

**To:** Channe Dar, Alliance Intelligence, Gaulus Sector  
**From:** Mehar Grot, Commander, Alliance Base #16  
**Subject:** Espionage

Sir,

I regret to inform you of our recent discovery that an Espionage Droid has been operating within the confines of our base on Gaulus.

The Droid, which, according to the records, was purchased from Jawa traders four months ago on Tatooine, was believed to be a standard 3PO Protocol Droid. It has been present at a number of strategy meetings, serving as interpreter between the Gaulians and ourselves. We now believe that these meetings and this base have been compromised, and must assume the Empire is aware of all plans regarding this sector.

We first learned of the security breach two days ago, when our communications center picked up a tight-beam broadcast in Imperial code emanating from inside the base. We immediately triangulated to discover the source of the beam, and discovered it was coming from the quarters of my second-in-command, to whom the Protocol Droid was assigned. When we entered these quarters, we found only the Droid present.

The Droid denied knowledge of any message. Our techs ran a systems check on it, and it came up clean, but a second, more extensive check, turned up the hidden programming and transmitting equipment characteristic of Espionage Droids. When confronted, the Droid appeared to be completely bewildered, and subsequent memory disassembly proved that the Droid was in fact ignorant of its secondary programming.

This incident could well prove to be a disaster for Gaulus and the Alliance. I have already communicated with my superiors, requesting that the base be evacuated in anticipation of the Imperial attack that is sure to come, now that our location and defenses are known to the Empire. But we both know that we cannot evacuate an entire planet, and the natives of Gaulus will be made to pay for their cooperation with us.

This is an unfortunate situation which should never have been allowed to occur. I realize that Intelligence has a great many things to handle, but it was my understanding that greater care was to be taken in examining Droids, particularly those acquired from questionable sources such as the Jawas. The Espionage Droid problem is rapidly becoming a serious threat, and greater precautions must be taken when purchasing Droids in the future.

End transmission.

The SE4 is similar to the Protocol Droid in external design, and personality modules are available for this Droid, to enable it to function smoothly in its working environment. The SE4 is equipped with a Vocabulator speech/sound system to enable it to communicate with its owners, and its memory banks are crammed with recipes, dining etiquette, and various other bits of knowledge a domestic servant might need.

The SE4 can be found in the highest levels of the Empire, and a number of Imperial officials have grown quite attached to their Servant Droids, to the point of bringing them along on missions for the Emperor. The Droids bring an air of gracious living to many Imperial bases, acting as chefs and valets to higher-ranking officers.

Among the Alliance, much of the SE4's primary programming was considered useless and was stripped out, and the Droids converted into extremely inefficient laborers and maintenance personnel. But in time, the mistake was rectified,

and most of the Droids returned to their original programming.

Currently, SE4 Droids oversee Rebel mess halls, organize recreational facilities and control lesser Droids in many general maintenance duties that do not require a great deal of technical knowledge. On the surface, the SE4's duties are relatively trivial — but their contributions to the Alliance are invaluable when one considers the amount of time they save living staff, and the effect clean living quarters and edible rations can have on the morale of a fighting force.

Used SE4s are available in abundance on both the open and black market. Care must be taken with Droids purchased on the latter: it is possible that their previous owners had less than savory appetites, and they might have been programmed accordingly. Stories persist of one Alliance squadron which was fed werrjuice, an extremely powerful narcotic, by an SE4 who had been previously owned by a notorious crime boss.

There are rumors that the MerenData Corp. is

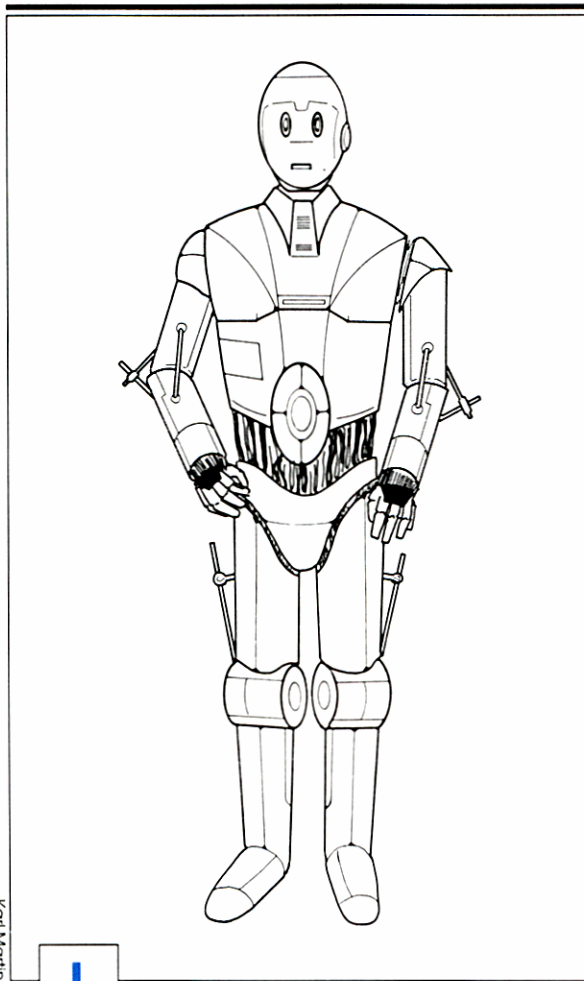

Karl Martin



Industrial Automaton SE4 Servant Droid.

looking into the possibility of turning SE4s into Espionage Droids, but no information is available as yet on their success or failure.

### AC1 Surveillance Droids

The AC1 Surveillance Droid is a direct descendant of the wall-mounted surveillance holocams found in countless security installations across the galaxy, the main difference being that the AC1 is mobile and semi-intelligent.

The AC1, or "spy-eye," as it is commonly referred to, is a spherical ball about .7 meters in diameter, with a 180 degree holocam mounted on a swivel joint at the bottom of the sphere. The Droid is equipped with a small, efficient repulsor-engine, allowing it to float up to three meters above a stable surface. AC1 Droids are not particularly fast, able to move about as rapidly as a running man.

The Droid is a mobile surveillance platform, programmed to silently wander the halls of bases and other security installations looking for in-

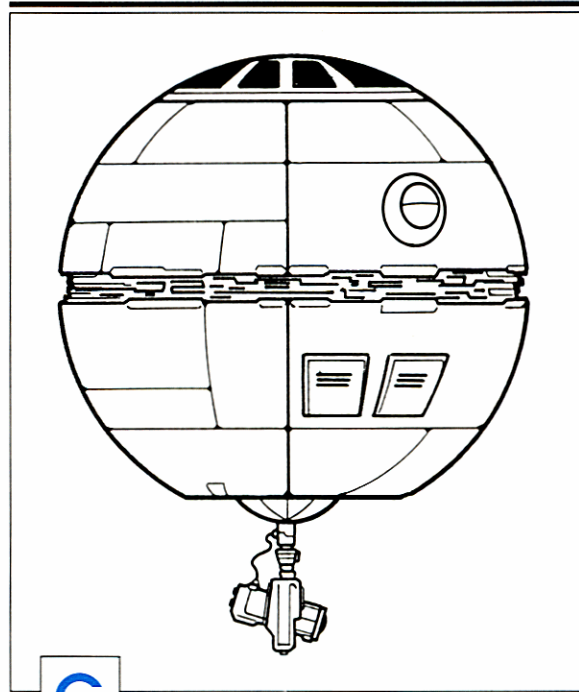

ybot Galactica AC1 Surveillance Droid.

truders. While it travels, the Droid transmits live images of what it sees back to a holo display (which is usually monitored by a security officer).

The Surveillance Droid is capable of at best limited intelligence. It will usually follow a pre-set course, scanning the base's hallways according to programming input by the security officers, though more sophisticated models have a randomization factor built in to make it impossible to know the Droid's route with certainty. The Droid can also be remotely-controlled by joystick, the controller being the security officer who is monitoring the Droid's transmissions.

In the event that the Droid spots an intruder or anything else which it does not recognize, it transmits a warning message back to its controller and retreats out of sight. The controller usually takes over operation of the Droid with the joystick. Depending upon the circumstances, the controller will send the AC1 in for a closer look or keep it well out of sight (possibly to avoid alerting the prey until a security team reaches the area).

AC1s are incapable of any tasks beyond scanning, and transmitting what they scan. They have no manipulators, no place to mount them, no power to spare for them if they could mount them, and no brain to control them if they could mount and power them. They are useless in combat, except as observers.

## **D**ining with Droids

Kredo Daar let his eyes feast on the sight before him — his first meal in a week that hadn't come out of a plasti-pak. He let the sweet aroma of the meat — he wasn't even sure what kind it was — float up his nostrils, and his mouth began to water as he dug his fork in...

"Excuse me, sir."

It was said in the quiet, perfectly-modulated tones of a Droid. Specifically, it was the SE4 that had served him the meal, which was now standing over him and shaking its metallic head.

"What is it?"

"I'm terribly sorry to interrupt your meal, sir, but you see ... you're eating with the wrong utensil," the Droid said.

The words didn't register with Daar for a moment. *No, I must have been on that ship too long ...*

"What are you talking about?" Daar said slowly, letting a hint of menace creep into his voice. Meanwhile, his food was growing cold.

"That fork, sir — it's for your salad, you see, and it shouldn't be used for consuming red meat. It's not done, sir."

"Of course it's done!" Daar snapped, gesturing toward the meat. "Hell, it's practically burnt!"

"And the gravy, sir, you're letting it spill all over the table. Here, let me wipe that up," the Droid said, reaching out a to rub the table with a damp cloth.

Daar found himself reaching for his blaster. "Somebody get this crazy Droid away from me!" he shouted.

Another pilot ambled over and gently led the Droid away. "Take it easy, Kredo. The last SE4 we had got blasted because somebody didn't like the food. This was the only other one around, and it hasn't been memory-wiped yet. It's not used to dealing with such rough customers."

Daar grumbled a little bit as he watched the other diners explaining to the Droid that there wasn't any salad to begin with, so it didn't matter what fork was used. He turned back to his food, now stone cold, and looked at the fork in his hand, then the one on the table.

He looked from one to the other for a very long time.

AC1s also have no personalities, and will cheerfully wander straight into the heart of a volcano if so ordered by their controller. They are also extremely inexpensive, and some Rebel teams have acquired their own spy-eyes, which they send ahead to scout unfamiliar terrain. The spy-eye's holotransmitter and joystick controller have an effective range of about 500 meters; its internal batteries are good for 24 hours' use before requiring recharging.

Surveillance Droids are readily available on the black market.

### **AC1 SURVEILLANCE DROID**

**Model:** Cybot Galactica's AC1 "Spy-Eye" Surveillance Droid

**Height:** .7 meters in diameter

**Strength:** 1D+1

**Skills:**

*Dodge:* 4D

*Sneak:* 4D

*Search:* 6D

**Equipped with:**

- Repulsor engine; max height 3 meters; speed code 4D
- Visual range holocam with simultaneous transmitter
- Holo receiver unit; maximum range, 500 meters
- Joystick controller; maximum range, 500 meters



## C

# Chapter Eight

## Alliance Bases

*Imperial Commander Harles, commanding Garrison Company 125a, walked around the late Alliance base on Gaulus, figuring out how to set up his men to protect the techs who were going to be dissecting the base to learn what they could about the Rebels.*

*As he walked, Harles idly wondered how Intell had discovered the base's location. Probably an informer; it usually was. In any event, the Rebels had not had time enough to destroy the base before they were overwhelmed. Harles bet they had found time to wipe the computer, though. They always did.*

*Courageous bastards. You had to give them that. Though not out loud, he reminded himself. He'd already been reprimanded once for that. Lost him any chance at a promotion, he'd figured.*

*Gaulus base was dug from the living rock, hidden high up in one of the planet's forbidding mountain ranges. His men were camped on the slopes outside. Access to the base was via hangar bay, the first area Harles examined.*

*Amazing. It looked as if it had been hand-dug, blasted from the rock with laser-beams and explosives. Made sense: fusion cutters would project an electromagnetic signal visible half-way around the world. Still, must have been a hell of a job.*

*The bay contained a couple of flights of starfighters. Most had taken some surface damage in the fighting but otherwise looked relatively intact. X-wings. The techs will love to get their hands on those babies; they've been playing merry hell with our TIEs. There also were a couple of dozen land- and airspeeders scattered around; local transport, nothing special. Maybe he could requisition two or three for surface patrols.*

*Hmm. No tractor beam generators. Guess you had to fly in here manually. Wouldn't enjoy that very much in the kind of weather you get up in these mountains. He wondered if his transport officers could manage it without getting themselves killed.*

*Harles stepped over a few bodies and headed down a hall into an area marked "Medical suite." More bodies. Looks as if the wounded fought to the death. Typical Rebel heroics; they don't know when to give up.*

*He turned to leave, paused, then bent to examine one body more closely. Officer. Woman. Pretty, too, or would be except for the damage a blaster shot had done.*

*Harles felt a vague regret. He hated a war in which you fought women. Something dirty about it. Though they were usually tougher and smarter than the men, come to think of it.*

*The officer moaned feebly. She's still alive! Harles pulled his comlink to call for a medic. Then he paused. They'll heal her, then Intell will peel her mind like a tockberry. Then they'll kill her. He grimaced and decided to let her die in peace.*

*Leaving her there, Harles went into an office area. More bodies. Non-combatants, by the looks of them. They'd died fighting too, though. The area looked as if it had been thoroughly ransacked; he wondered if the Rebels had done it before they left or the Imperial assault troops had after they'd taken the place.*

*He checked Life Support. It looked intact. Good. Save us the trouble of bringing in heating units.*

*Living quarters. More dead Rebels. God, some were just kids. A couple looked as if they'd been mutilated after they died. A soldier's vengeance against people who fought to the death for something they believed in. Harles sighed. He was getting too old for this.*

*Harles moved into the Command Center. Blaster holes in the computer banks. Just what he'd expected. Blood everywhere. More dead kids. How many was that now? 20? 30?*

*He rubbed his knuckles roughly across his mouth. Stop thinking, he commanded himself. Stop thinking and do your damn job.*

*He heard a noise coming from a hallway on the opposite side of the room. Probably a tech or a trooper looking for loot; still, he drew his blaster and went to check it out.*

*The Rebel had her back to him. She was doing something to the main power generator. Sensing his presence, she spun around.*

*Harles pointed his blaster at her. Their eyes locked. Hers showed no fear, only hate.*

*She was all of 16.*

*Harles swallowed. He remembered the carnage in the hallways, all the blood. What his people did*

to children like these. He began to shake.

*It was too much.*

*Dropping his blaster to his side, he jerked his head at the generator. "Finish it," he said in a harsh voice.*

*Looking at him first with distrust, then with something like wonder, the Rebel turned back to the generator. She worked quickly. In a few moments the generator began to whine, and red lights flashed on monitors. She nodded at him. "Three minutes," she said.*

*Harles activated his comlink. "Harles here. Code black! Main generator on overload. Detonation in 60 seconds. Will try to dump it. Evacuate base and perimeter immediately." He deactivated the comlink, cutting off the communications officer's startled reply.*

*Far away, he heard warning klaxons sound. His men, pulling back.*

*He turned to the Rebel. "You got a way out of here?" She nodded, and headed down toward the office area. She worked at a wall-panel, pulling it off, revealing a narrow corridor. She headed down the corridor at a trot. Harles began to follow, paused, cursed, then turned back to the base. The girl stopped and made as if to follow him.*

*"Keep moving," he called over his shoulder. "Got something to do. I'll catch up with you if I can." The Rebel knew how to follow orders. She left without a word.*

*The girl ran a long way down the corridor, through a blast door to a larger cavernous area, where a repulsorcraft waited. She started up the repulsorcraft, moved it out of direct sight of the blast door, and stopped.*

*A long minute passed.*

*A loud, dull "whuuuumpp" sounded, shaking the mountain. Dust and rocks fell on the repulsorcraft and the girl. The lights in the cavern died. Switching on the vehicle's lights, the girl turned it to leave.*

*Then the blast door opened. Out stumbled Harles, carrying the wounded Rebel officer. His uniform and hair were burning. But his body had protected the woman from the blast.*

*Helping Harles and her mother into the repulsorcraft, the girl drove off into the darkness. For the first time since the attack, she allowed herself to weep.*

## Overview of Alliance Bases

Across the galaxy, Alliance bases house starfighters, infantry units, command centers, communications facilities, weapons manufacturing, supply caches, and more. Few are single-purpose; most fulfill two or more of those functions.

An Alliance base can be anything from a small room in the basement of a building, to an un-

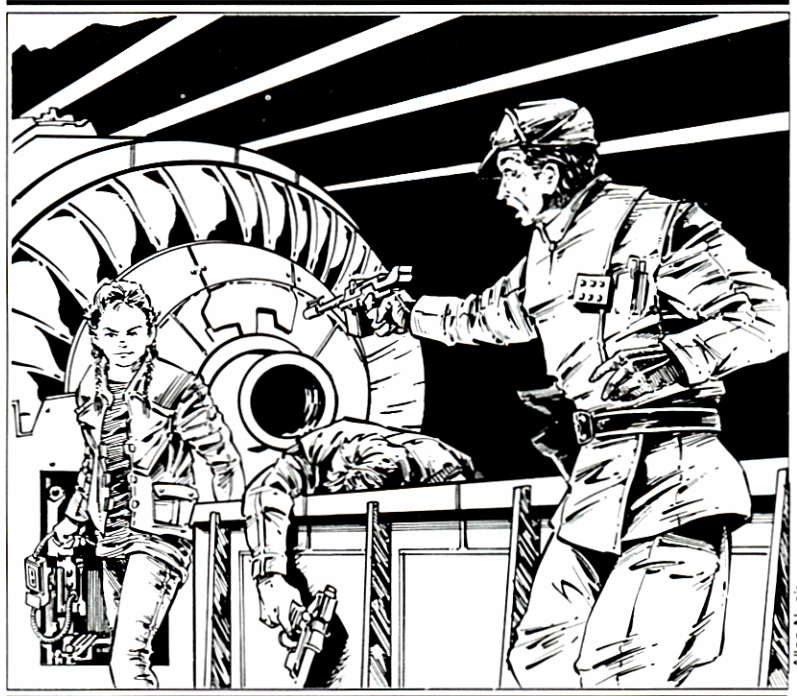

derground tunnel complex, to an entire city or planetoid. Virtually any place where Rebels are able to gather out of sight of the Empire's spies can house a Rebel base.

Most bases are primitive affairs, constructed of local materials, containing little more than a small comm receiver and a few crates of food and weapons. Some, though, are fully modern, complete with medical facilities, living and entertainment quarters, force shields and heavy weapon defenses, command centers, and the like.

On heavily-garrisoned worlds, where exposure is a constant threat, the base is likely to be simpler and more primitive, with all components easily transportable in the event of discovery; on worlds where the Alliance is stronger, the facilities are likely to be more extensive and permanent.

## Base Descriptions

### Alliance High Command

#### Function

Housing both the Civil and Military governments of the Alliance, High Command Base is the heart and brain of the forces united against the Empire. Along with the Fleet, HC Base is one of the two cornerstones of the Rebellion. Both are critical; the loss of either would be catastrophic.

From High Command Base, Mon Mothma and her hundreds of civilian and military assistants run the war effort. Dozens of starships and messenger Droids enter and leave HC Base every

bringing information to the Government and carrying the Government's orders to every corner of the galaxy.

In its short history, the Alliance has had a number of bases that have housed High Command. The first was on a small planetoid in the Chrellis system. Chrellis Base had to be abandoned, however, when the Empire moved one of its Sector Fleets uncomfortably close to that area — an unfortunate coincidence.

After Chrellis, HC Base was moved to Yavin. The Alliance had grown since Chrellis, and the base's facilities were much more extensive and modern (see *Galaxy Guide 2: Yavin and Bespin* for more details). However, the Empire eventually discovered (and came within seconds of destroying) Yavin Base at the Battle of Yavin, and High Command was forced to relocate once more, this time to the ice planet Hoth.

To many, Hoth is a questionable site to house the most important facility in the Alliance. It is in the far fringes of the Outer Rim Territories. This means that it takes days to communicate with Alliance forces in the Galactic Core, and weeks to communicate with those on the opposite side of the Empire.

In addition, the facilities themselves are uncomfortable, almost primitive. Hoth is an ice planet, with daylight temperatures averaging about -32 degrees Celsius, and nighttime a frigid -50. The temperatures in the base itself are not much higher; in fact, it is so cold that the Alliance engineers have been able to carve the base's corridors out of the snow itself.

While this has made construction extremely easy, these are not the best conditions under which to operate delicate electronic equipment — or delicate living beings.

However, Alliance High Command is willing to put up with these adverse conditions in return for peace and quiet. It is extremely unlikely that an Imperial vessel will stumble onto Hoth by accident, and, given the ice planet's lack of useful resources and general unpleasantness, even more unlikely that anyone would choose to go there on purpose.

### Personnel

Though not large when compared with heavy manufacturing bases or safe worlds, Echo Base Hoth is a busy place, teeming with representatives of most branches of both the Civil and Military Government. There are well over a thousand government officials on Hoth: high-level civil servants, their assistants, diplomats, planners, and the other functionaries crucial to the operation of a galaxy-spanning government in exile. There are almost as many high-level Military and Intelligence officers on Hoth, keeping the war on

track.

All of these beings are served by hundreds of maintenance personnel, cooks, technicians, medics, secretaries, communications specialists, supply clerks, Droids and others. Counting the infantry men and starfighter pilots, Hoth contains well over 4,000 beings — enough to populate a small city.

### Defenses

Echo Base Hoth is one of the most heavily-defended of all the Alliance bases; only the Mon Calamari starship construction facilities have better protection. Three squadrons of starfighters patrol the outer edges of the system. The base is protected from space attack by an energy field strong enough to deflect even the heaviest Imperial bombardment, and the space defenses are further bolstered by an anti-space Ion cannon, the single most powerful artillery piece in the Alliance's arsenal (see Chapter Six).

For ground defense, Echo Base contains 1,000 Special Forces troopers, equipped with several dozen anti-vehicle and anti-personnel artillery pieces. The Special Forces Scout Troops are supplied with over 30 tauntaun mounts, useful for both long-range recon missions and flanking attacks. A complete system of trenches, connected by underground tunnels, protects Echo Base from all possible avenues of assault. These formidable defenses are soon to be further strengthened by several flights of snowspeeders, once Alliance techs have modified them to work in the frigid temperatures on Hoth.

Alliance strategists believe Echo Base Hoth can stand up to virtually anything, including a standard Imperial Sector Fleet. In the unlikely event that they are attacked by a greater force — say, the Grand Fleet commanded by Darth Vader — it is hoped that the defenses will be at least strong enough to buy time to evacuate.

In the event that evacuation is necessary, six Alliance *Kleeque*-class transports, each capable of carrying approximately 1,000 passengers and many thousands of kilotons of equipment, stand fueled and ready to leave with an hour's notice.

### Equipment

Echo Base Hoth contains a staggering amount of equipment — communications equipment, medical facilities, infantry weapons, starfighter repair equipment, and at least samples of virtually everything else in the Alliance's stores. The Hoth machine shops can, given time, create anything from sophisticated microsurgery Droids to long-range communicators to snowspeeders.

With the exception of the bays designed to hold the evacuation transports, Echo Base does not have the facilities to dock or repair large starships.

## Sector Commands

### Function

As described elsewhere, Sector Commands control most of the Rebellion's activities within a sector. They are smaller versions of the High Command Base, with lower-level governmental and military officials performing for their sector what Alliance High Command does for the entire Alliance.

In addition, Sector Commands often house the sector's entire complement of starfighters. Thus, in addition to their heavy command and coordination responsibilities, these bases also serve as the Alliance's main offensive arm in the sectors.

Obviously, the loss of a Sector Command Base is a crushing blow to the Allied ground and intelligence forces in the sector, leaving them disorganized, cut off from communication with each other and the rest of the Alliance, and with virtually no space protection at all. If a Sector Command is destroyed, usually all the sector's forces can do is go into hiding and wait until Alliance High Command reestablishes contact.

### Personnel

Sector Command Bases are usually under the control of the Chief Executive of the sector. This person is the highest-ranking civilian official in the sector. He holds much of the same authority over his sector as does Mon Mothma over the Alliance (see Chapter One for more details). The Chief Executive is assisted by his Cabinet and a host of communications workers, secretaries, and other civilian functionaries.

The Chief Executive and Cabinet are not always stationed with the Sector Command. For example, when the Chief Executive of the Alliance forces is also a planetary or system leader, the Chief Exec may have his Alliance offices hidden within the planetary capital's government offices. In such cases, the Chief Exec would appoint a liaison to the Sector Command who would be empowered to act in his name in case of an emergency.

The Sector Command Base houses most of the Sector's high-level intelligence officials: senior case officers, intentions officers, cryptologists, and so forth. Field officers — agents — are usually not allowed to even know Sector Command's location. There is simply too great of a chance of capture, and, Imperial interrogation techniques being what they are, too great of a chance of the captured agent talking.

In addition to civilian and intelligence officers, many of the sector's highest-level military officers are stationed at the Sector Command. They include the Sector Military Commander and his staff, starfighter coordinator, supply chief, and other senior military officials who do not have field commands. These beings are responsible

for coordinating the sector's military efforts with other sectors and Alliance High Command.

In addition to the officials listed above, the Sector Command houses maintenance personnel, medical officers, communications specialists, servants, cooks and mechanics, along with the base's security personnel and military units assigned to its defense.

### Defenses

As mentioned above, the Sector Command base usually houses the sector's main complement of starfighters, and they are its most potent line of defense. Depending upon its location and the likelihood of Imperial attack, the base may also contain anywhere from 20 to 1,000, infantrymen, plus artillery, combat vehicles, and the like.

It must be remembered, however, that the base's primary defense is its invisibility. If its location is discovered, the most that the base's defenders can hope to accomplish is to delay the Imperials until the personnel evacuate. Though there have been occasions when a Sector Command base has been discovered and remained in existence (because the Imperials could not readily muster the forces necessary to wipe it out), these are the exceptions which prove the rule. In the majority of cases, once discovered, a Sector Command's days are severely numbered.

### Equipment

A Sector Command base is equipped with communications equipment allowing it to establish contact with Alliance units throughout the sector, as well as with other Sector Commands. In addition, the base will probably have starfighter repair equipment, a good supply of infantry weapons and gear — including speeders and speeder bikes, though probably *not* including artillery — and intelligence-gathering equipment and medical facilities.

## Starfighter Bases

### Function

The Alliance has built many small starfighter bases in systems across the galaxy. Though this information is classified, the number of bases is estimated at anywhere from 1,000 to 5,000. It should be noted, however, that only a fraction of these bases are operable; most are dormant, empty of starfighters, personnel, and equipment.

It is the nature of starfighter combat to be fluid. A system can be "cold," with little or no Imperial activity to speak of for months or years, and then suddenly turn "hot" as the Empire decides to increase its presence there — putting an orbital base up around an Alliance-friendly planet, moving a fleet into a nearby system, launching a ground campaign, and so forth. Conversely, the

Alliance may suddenly decide to increase its activities in a quiet sector, typically as part of a larger operation in that quadrant of space.

To use their starfighters to their best advantage, the Alliance must have facilities near to the action where they can fuel and repair their ships and rest their pilots. If not, if the starfighters must make a long journey through hyperspace to reach the battle, they are at a significant tactical disadvantage. The pilots arrive at the battle tired and worn, their ships low on fuel, and after the battle, damaged ships may not survive the long trip back through hyperspace. Thus, when a campaign is forthcoming, the Alliance always tries to have operational bases in the area.

When a system looks as if it is “heating up,” Alliance techs go to the dormant base and activate all of the power and life-support systems. The support team — medics, mechanics, security forces — arrives next, followed by the supply ships. Finally, the starfighters and their pilots arrive, and the base is fully operational.

After the campaign, the ships, personnel and equipment are removed to other bases, and the energy systems shut down, in order to make the base dormant once more.

Note that, in chronically hot systems, the base may be permanently functional. However, there may be other mothballed bases in these systems, in case the primary base is discovered and destroyed.

### **Personnel**

A starfighter base contains the base commander, typically an ex-fighter jock, and his staff, mechanics, medics, and various support personnel and Droids. There are usually a number of additional pilots at the base — ideally, 25 to 50 percent more than there are starfighters — to relieve tired or injured pilots.

### **Defenses**

Once again, the base’s primary defense is anonymity — if the enemy can’t find it, he cannot attack it. However, when a base is active, secrecy can be difficult to maintain. This is due to the fact that when returning to base, the starfighters are not jumping into hyperspace. Therefore, the enemy can, if he’s very skilled, follow ships — particularly if any are damaged — back to the base. Though they can attempt to evade and lose their pursuers, the Alliance pilots may not always be successful. Alliance tacticians assume that, for every sortie from a base, there is a cumulative two percent chance that the enemy will find the base. If there are five such sorties, there is a 20 percent chance that the base will have been discovered.

However, finding a base and putting it out of commission are two different things. Admittedly,

the Empire can muster enough forces to wipe out any Alliance base; the question is, can they do it before the base accomplishes its objectives? It can take weeks to assemble an Imperial battle fleet. By that time, the campaign may be over and the base evacuated. If the Empire wishes to hit the base in time to affect the campaign, they must do so with the forces in the immediate vicinity.

The Imperial Navy cannot hope to wipe out a base from air or space if they cannot overwhelm its starfighters. Indeed, they cannot safely launch a ground campaign against the base if they do not have at least parity in air or space — a starfighter can wreak havoc on unsupported infantry. Given that the battle is so close to the starfighters’ repair and replenishment facilities, they can stay in space for much longer periods, with much shorter resupply times, increasing their overall effectiveness possibly by as much as 30 percent.

However, though starfighters can play merry hell with ground forces for a while, they cannot stop them forever. If there are no infantry defenders, the enemy can split his forces into very small groups (which are difficult to spot or hit from the air); eventually, some of them will reach and take out the base. If threatened from the ground, the base must have some infantry support to pin down the enemy or force them to concentrate their forces to attack — and thus become juicy targets for the starfighters once more.

Depending upon the terrain and the likelihood of Imperial infantry attack, a starfighter base may contain between 50 and 1,000 infantrymen in support. If available, the infantrymen may be equipped with artillery, speeders, heavy weapons and the like.

### **Equipment**

The base is equipped with starfighter repair facilities, diagnostic equipment, spare parts, fuel, and so forth. It will also have good communications and medical equipment. It will probably have minimal weaponry and ground transport, though the infantry unit attached to the base may have brought some of its own.

A starfighter base rarely has spare starfighters around, unless its pilots have taken far higher casualties than the ships themselves. This is a fairly unusual occurrence.

### **Manufacturing Base**

#### **Function**

Manufacturing bases are, simply, places where Alliance personnel manufacture arms, ammunition, or other equipment. They range in size from the huge Mon Calamari starship facilities to tiny one-room hideouts where a few brave beings attempt to build homemade explosives.

Many manufacturing bases are located on Alliance safe worlds, where large number of families of Alliance personnel have been relocated to protect them from Imperial reprisals. These bases tend to be large, but they are often on newly colonized planets, without the equipment to manufacture sophisticated components. Instead, they concentrate upon labor-intensive, low-technology manufacturing — clothing, shelters, foodstuffs, and the like.

Alliance manufacturing bases on more developed worlds have the equipment and trained personnel on hand to manufacture more complex equipment — starfighters, blasters, communications gear, and medical equipment. However, these bases must be small and extremely well-hidden; the Empire's spies are everywhere, and punishment against cities (or entire worlds) with Alliance bases found upon them is swift and brutal.

### **Personnel**

Again, the number and type of personnel varies tremendously from base to base. The base will have a commander and, if large enough to warrant the need, he will have a staff. The base will, of course, also have workers. Larger bases will have security forces of some kind and possibly medics, mechanics, and so forth.

### **Defenses**

The Mon Calamari starship construction bases are defended by heavy cruisers, starfighters, anti-ship artillery, force shields, and the equivalent of a full division of Rebel infantry. The hidden Isis starfighter construction facility is defended by several squadrons of starfighters and some light ground security troops. The Sartoy weapons plant has two companies of militia and several beat-up speeder bikes.

### **Equipment**

For the most part, manufacturing bases will contain only equipment necessary to their manufacturing. They will have little in the way of communications equipment or weaponry, and extensive medical facilities only if the manufacturing process is inherently dangerous (explosives manufacturing, for example, can be quite risky).

## **Underground Base**

### **Function**

This is simply a place where members of an underground cell or larger unit meet and plan their strategy. It is often a weapons cache and holds the cell's communications equipment, as well.

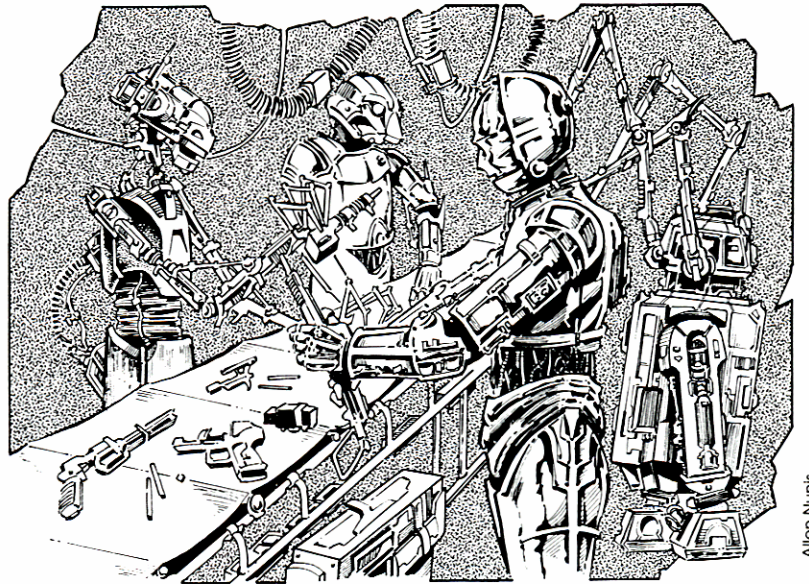

Allen Nurnis

Some underground bases serve as transit or collection points for Alliance pilots shot down on Imperial-held planets. When going into battle in the vicinity of such worlds, the pilots might be given rendezvous points which they should attempt to fly to if they are shot down. Underground agents would meet the pilots at those points, take them to their base, and hold them there until they could be shipped off-planet.

By definition, underground bases are secret bases on Imperial-held planets. Therefore, they must be extremely well-hidden, as exposure would mean their instant destruction and almost sure death or capture for the cell network.

The underground base might be located in an abandoned warehouse, a primitive cave, a cell-member's basement, an office-building (in which case all meetings would probably be held at night), the back-room of a pub, and so forth. Members must be able to enter and leave the base unseen, or they must have a good cover story to explain why they were going there.

### **Personnel**

The only people found at an underground base are members of the underground cell or unit, usually between three and 10 individuals. No one outside of the cell should even know where the base is, let alone be taken there. Other Alliance personnel would be taken to the base only rarely, in extreme emergencies.

### **Defenses**

Underground bases have no heavy defenses, only the cell-members' personal weapons and explosives. When cornered, underground members usually fight to the death.

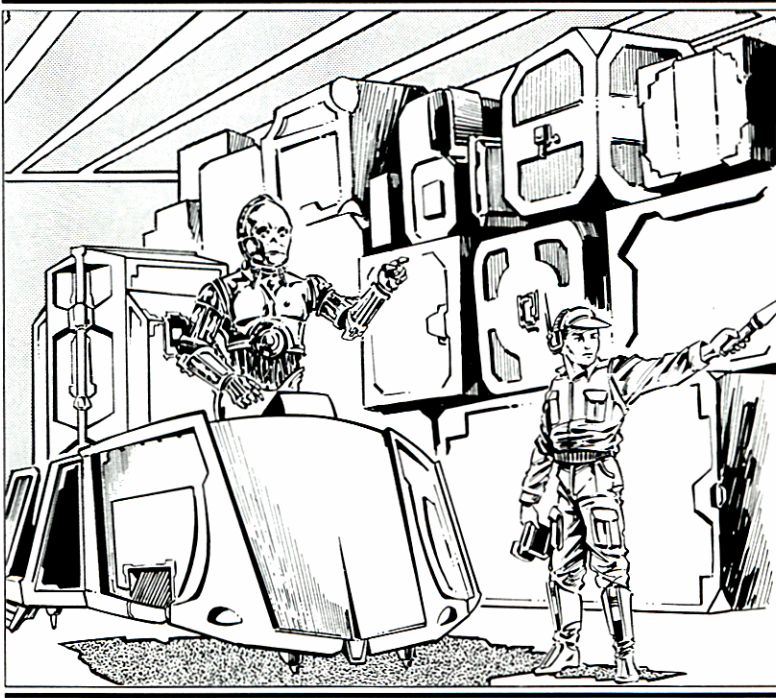

Allen Numis

**Equipment**

These bases have only what equipment the cell-members have scavenged — hand weapons, primitive explosives, crude medical supplies, and the like. The base might be equipped with a comlink for communication with other bases or with the cell leader or network officer.

**Supply Base**

**Function**

This is a hidden dump, holding equipment, ammunition, food, weapons, or any other materiel. These dumps are sometimes manned and sometimes unmanned, depending upon the size of the base, the maintenance requirements of the supplies, the security situation, and several other factors.

A supply base can be anything from a hole in the ground covered with a tarpaulin, to a factory warehouse, to an entire city complex, to an asteroid in deep space. The base can be temporary, set up to support one battle or campaign, or a permanent part of the Alliance's supply chain.

**Personnel**

Most smaller supply bases are temporary and either unmanned or staffed with a limited number of personnel. They are set up by Alliance Bureau of Supply personnel (with the assistance of Special Forces troopers), somewhere well out of Imperial sight. During the battle, the troopers or ships go to the dumps and take what they need. After the dump is depleted or the battle completed, the base is disbanded.

Larger, more permanent dumps may be staffed by up to hundreds of supply personnel. These beings organize the supplies, make sure that they go to the forces who need them most, maintain the facilities, and so forth. Additional personnel to assist in keeping the base operable — maintenance personnel, cooks, Droids, medics, security forces — will be stationed there as necessary.

**Defenses**

Smaller bases will be undefended or rely on security forces armed with hand weapons; larger bases can have any number of infantry and space defenses.

**Equipment**

The supply base will have (obviously) whatever kind of equipment it is storing. In addition, larger bases may have infantry weapons, medical facilities, communicators, and vehicles for their own uses.



## Chapter Nine Support Services

*Laser-fire, laid down by artillery and spacecraft, tore through the night air like lightning as the medic crouched in the ditch and worked on the wounded. When she first arrived, the smell of mud and fear and blood had nearly overwhelmed her, but she didn't notice it any more. She still flinched at the laser-fire, though. She just couldn't seem to get used to that.*

*"This one's patched up enough to move, I guess," she said to an aide. "Get him out of here."*

*The aide and an orderly gently lifted the man onto a stretcher and carried him to a waiting repulsorcraft 500 meters behind her position. They couldn't bring the 'craft any closer; there was no cover and the artillery would have murdered them.*

*The medic had been there for three days while the Alliance forces held off the Imperials' offensive, slapping on medpacs until they ran out, bandaging wounds, amputating limbs which were too far gone for reconstruction and getting the injured in shape for the dangerous trip back to the aid station.*

*She didn't feel tired any more, she had stopped feeling tired some time yesterday — she had gotten to a place beyond tiredness, a place where there was only the wounded, only their pain, only her devotion to the cause.*

*The medic washed the blood off of her hands and moved dully to the next patient. She smelt burned meat — blaster wound. The soldier made a sucking sound when she breathed — pierced lung. The medic mechanically inserted a drain and a plug, bandaged the whole thing into place, and motioned for the orderlies to remove her. She gave the soldier perhaps a one in three chance of survival.*

*Up ahead, toward the front lines, she heard shouting and blaster-fire. Heavy. Another attack. The medic didn't even look up. Maybe they'd hold; maybe not. Not her business.*

*Four days ago, when she came here, there had been three other medics with her. One had fallen within the first hour; another had died that night; the third was badly injured this morning. They had all trained together; she had been engaged to Kral. She didn't know if he was still alive. Now it was just her. She couldn't even weep; she couldn't seem to care. She swayed a bit, rubbed her eyes, and moved*

*onto the next patient.*

*Someone touched her arm. She looked up into the face of Lieutenant Reese, in charge of this sector of the field.*

*The Lieutenant spoke. "Ma'am, the enemy's broken through; we're retreating."*

*She nodded. "I'll need fifteen minutes to get the injured ready to travel —"*

*The Lieutenant was shaking his head. "No ma'am. You leave now. In five minutes this place will be crawling with Imperial assault vehicles. If you aren't out in two minutes, you won't get out."*

*For the first time, the medic heard the panic hovering in the Lieutenant's voice. Around them, soldiers were stumbling back through their position — the retreat was in imminent danger of becoming a rout.*

*The medic nodded sharply. "Two minutes. Aye sir."*

*The Lieutenant left without a reply and rushed toward the front, or what was left of it, to attempt to rally his men. The medic called to her orderlies.*

*"We're getting out of here! All equipment is to be abandoned; you are to assist the walking wounded to the rear. Make all of those too injured to walk as comfortable as possible; we haven't got time to save them. You've got two minutes — move!"*

*The orderlies were on their way, running to their tasks even before she completed the instructions — they were no strangers to retreat. The medic herself was moving in under a minute, half-carrying a blinded flashburn victim to the rear, when she came across Kral.*

*Her fiancée was lying on a stretcher, pale, heavily-bandaged. He smiled at her. "Go get 'em, kid," he whispered.*

*The medic stopped, horrified, the blind soldier at her side forgotten. "I can't leave you!" she cried.*

*"You damn well can," he replied. "I'm gut-shot. Can't walk; you can't spare the men to carry me. I'll be fine," he lied. "I've got a painkiller; I'll survive until the Imps come and get me. We'll meet after the war. Now move out soldier, before you're overrun."*

*The medic looked down at him, then looked up at the young man standing by her side. At last, she nodded. She kissed him goodbye, then stumbled off*



*with the wounded soldier.*

*Once she left, Kral sagged back into his stretcher, finally letting the agony show on his face. He had a painkiller; hadn't used it yet though.*

*He thought about his fiancée to take his mind off the pain. She was a great girl, and a fine soldier, too. He loved her very much; pity he would never see her again. Still, it was enough to get a chance to say goodbye— most didn't.*

*He listened: the sounds of firing were getting closer. Good. The enemy would be here in a couple of minutes. Fine. He hurt. A lot.*

*When the first Imperial soldier came, Kral smiled up at him. Then he pulled the pin on the grenade hidden under his blanket. The painkiller was extremely effective.*

## Alliance Support Services

Alliance Support Services are the unsung heroes of the Rebellion. They keep the soldiers supplied with food, clothing, and weapons. They run blockades in slow, old, dangerous and unarmed vessels, relying on stealth and (mostly) luck to keep from being spotted and blown out of space. They beg, borrow, steal or build all the starfighters, guns, medical equipment, and Droids that the Alliance cannot purchase. They offer aid and succor to the sick and injured.

With no fanfare, no recognition, no glory, they, daily, risk their lives in the name of freedom in the galaxy.

## Alliance Safe Worlds

Alliance Support Services sets up and operates a series of safe worlds on the fringes of known space. On these safe worlds, people connected with the Rebellion can live their lives without fear of the might of the Empire.

No relative of an Alliance warrior or government official is safe from Imperial reprisal. The single most potent weapon the Empire has in its battle against the Rebellion is terror. It is terror which keeps most planets in line — terror of the unimaginably harsh treatment which the Empire metes out against those who dare to stand up against it. Alderaan was a graphic lesson in the staggering strength and ruthlessness of the Empire — a lesson not easily forgotten. Though the Death Star is gone, the Empire still maintains fleets of vessels, each of which could easily destroy a city just as the Death Star destroyed a world.

The Empire's agents and informants are everywhere, practicing a more personalized kind of terror. When it is politically inexpedient to destroy a city or a planet, Imperial agents are able to slip onto a planet and destroy their enemies with surgical precision. They routinely kidnap, torture, or kill family-members of known Alliance personnel.

Unless gifted with the steel nerves and iron will of a Princess of Alderaan, it is the rare person who can continue to function effectively when he knows that his family is at grave risk. A man can look unflinching at his own death, but be unable to tolerate the idea of his wife, child, or parent's death — particularly if that death is the result of his actions. That's where safe worlds come in.

Safe worlds are planets where the families of Alliance personnel can live in peace, safe from the long, merciless arm of the Empire. In addition, once a safe world is established and viable, it may produce enough food or other raw material to help feed and supply the Alliance forces.

## Creating Safe Worlds

Select teams of Alliance scouts are constantly scouring the galactic fringe, looking for worlds which, as yet, have not been discovered by Imperial Survey Corps scouts. If the world is habitable by human (and alien) life but unpopulated, and light years from all space lanes, it may be suitable as a safe world.

Once a potential safe world has been discovered, Alliance scientists go to the planet, monitor the weather and catalog the natural perils — wild animals, diseases, and the like. If the risks are not too extensive, Alliance Support Services techs come to the planet and build primitive living quarters and put in a stock of foodstuffs, medicine, and other basic requirements for life. Once

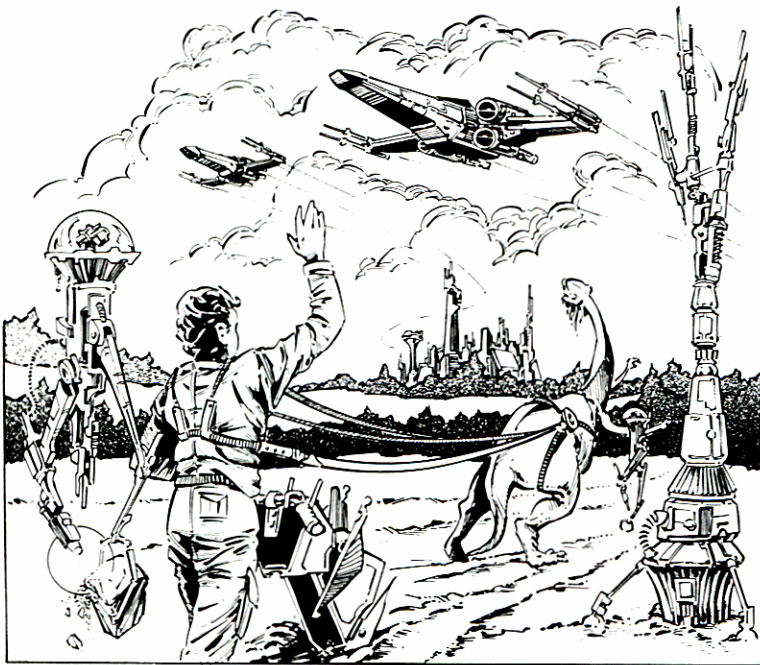

Allen Nurnis

## **S**ome Alliance Safe Worlds

### **New Alderaan**

**Population:** 13,000

**Goods Produced:** None.

**Tech Level:** Pre-steam; animal and water power.  
**Location:** Classified.

New Alderaan is a young safe world colony, established to hold the natives of Alderaan who were off-planet when Alderaan was destroyed. The colonists have yet to produce enough food to make exporting it to the Alliance fleet or armed forces practical.

New Alderaan is a pleasant world, with green fields, heavy woods, high mountains, and deep blue, almost purple, skies. The weather is rough, with long, cold winters, and long, dry, hot summers. Animal life is varied and hardy.

### **Sanctuary**

**Population:** 29,000

**Goods Produced:** Protein, vegetable fiber for cloth.

**Tech Level:** Steam.

**Location:** Classified.

Sanctuary is one of the oldest Alliance safe world colonies. In fact, it actually predates the Declaration of Rebellion. It was originally settled by religious pacifists attempting to escape enforced conscription. When the Rebellion began, Sanctuary agreed to join the Alliance, if its members did not have to take up arms. Mon Mothma agreed. Over the years, several thousand new refugees have come to swell the planet's population.

Sanctuary is a planet of small rocky islands and deep green seas. It has an abundance of fish life, which, along with seaweed, forms the staple diet of the planet's inhabitants. Using steam-driven wooden vessels and hand-woven nets,

Sanctuary's fishermen catch such an abundance of fish that they are able to export many tons a year to the Alliance. Also, it has been found that several varieties of seaweed can be made into quite serviceable cloth for uniforms (though some soldiers claim that they never quite get all the fishy smell out of it).

### **Flitter**

**Population:** 1,000

**Goods Produced:** None.

**Tech Level:** Primitive.

**Location:** Tierfon System

Flitter is a graphic example of exactly why the Alliance attempts to keep the location of its safe worlds secret. At one time, Flitter had a population of over 40,000 men, women, and children on it and was a major producer of ores for conversion into fuel. Tragically, a Support Services space transport was captured *en route* to Flitter, and the craft's pilot talked under Imperial interrogation. Within a month, Flitter's one major city was rubble and all of the land and forests nearby poisoned with air-dropped toxins.

It was in the dead of winter — and Flitter's winters are *cold*. The Imperials didn't even bother to send ground troops down to the planet; they merely posted a pair of corvettes in orbit above, and let the elements do their job for them. By the time spring arrived, over 95 percent of Flitter's population was dead of starvation or exposure, the rest scattered, hiding in caves, living on grubs and tree bark.

The Alliance desperately wants to rescue the survivors on Flitter, but, as yet, they have not been able to get enough firepower together to challenge the blockade.

this is done, the world is ready for its new inhabitants.

## **The Population of Safe Worlds**

Safe worlds are inhabited by all manner of Alliance sympathizers who cannot or will not fight but who also cannot risk living in Imperial-dominated space — injured or retired Alliance warriors, individualists who have spoken out against the Empire once too often, pacifists, dissidents, political leaders in exile, and the family-members of Alliance officials. They come from virtually every race known in the galaxy.

The population of a safe world averages between 5,000 and 20,000 beings. This number is

large enough to create a safe environment, but small enough to avoid undue attention.

## **Imperial Prisoners**

One other group of beings who occupy Alliance safe worlds are Imperial prisoners. The prisoners are dropped on a continent far from the Alliance settlements, given enough supplies and farming equipment to get them through the first year (if they work hard), and then, except for periodic visits by heavily-armed medical ships, the prisoners are left completely to their own devices.

Obviously, safe worlds are extremely difficult places from which to escape. First, the prison settlement is thousands of kilometers from the

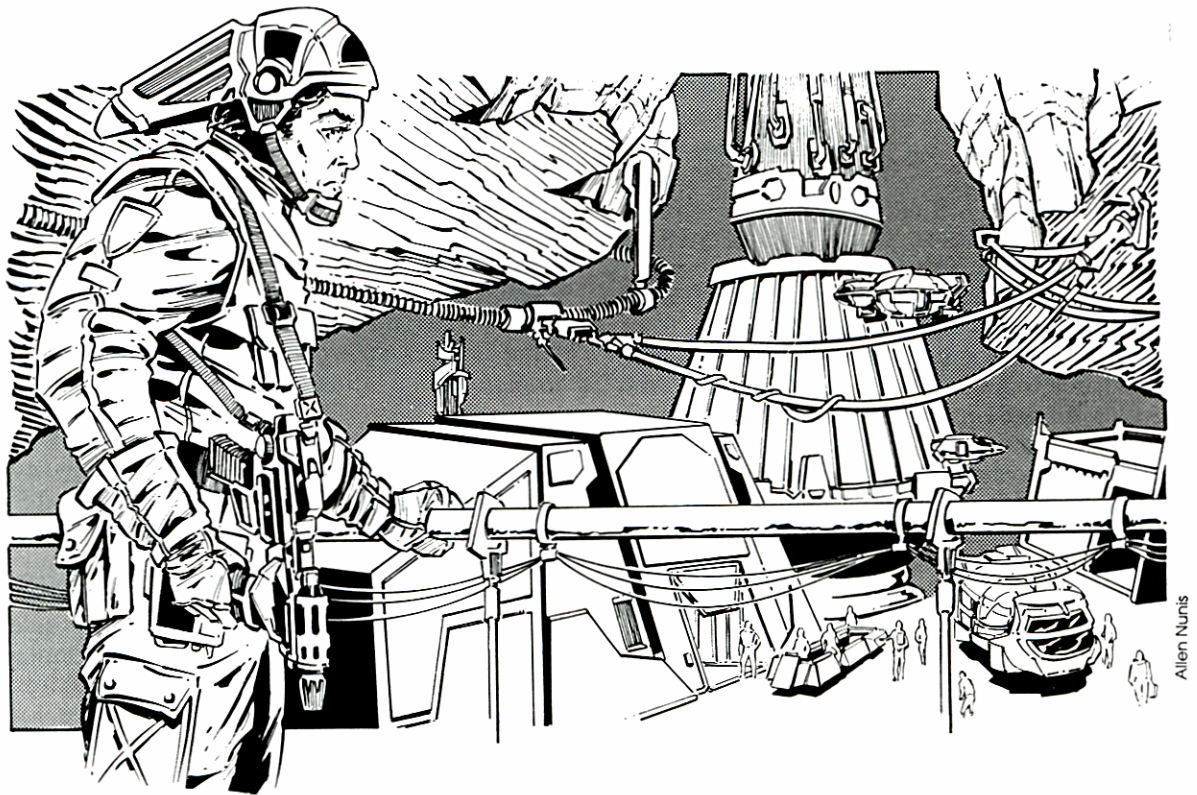

Alliance settlement, and the Imperials have no ground transport. If they somehow manage to cross the oceans, deserts, and mountains in order to reach the Alliance settlement, what then? There are no spacecraft there anyway (except for occasional visits by armed Support Services transports to drop off or pick up supplies), so the Imperials can't steal one to leave the planet.

As neither settlement has sophisticated electronic equipment, the Imperials can't steal or build long-range communicators to call for help, either.

### Life on a Safe World

Life on a safe world is primitive, harsh, and demanding. Inhabitants of safe worlds are pioneers, attempting to wrest subsistence from the planet without modern equipment. They live in rude dwellings created from local materials. They farm the land with animal-powered machinery, hunt the forests with bows, slings, and other easily-created weaponry. The inhabitants have few or no repulsortcraft, medical facilities, lasers, or other "luxuries." If they want these things, they must build them themselves.

The inhabitants tolerate this primitive existence for two reasons. First, as mentioned above, the Alliance simply cannot afford to feed and maintain them beyond the minimum level. Second, the more primitive the settlement, the smaller the chance of Imperial discovery.

ISC scouting ships are capable of picking up the signature of power generators, gravity anomalies caused by repulsortcraft, comlink communi-

cations, and so forth from the very edge of a planetary system. Settlements wealthy enough to afford these items are likely to be wealthy enough to be taxed, and thus ripe for Imperial conquest. If the settlement is poor, however, the ISC scouts may just ignore it as just another "two-credit ball of dirt."

### Space Transport

Support Services operates and maintains the Alliance's motley fleet of deep space supply craft. These vessels keep the Alliance's Fleet and ground forces supplied with the vital material necessary to stay in fighting trim, carrying cargo from the Alliance's vast hidden supply dumps to the very front lines of the war.

### Crew

The Alliance's space transport fleet is crewed by spacemen as diverse as the ships they fly. Old-time merchanters, born to space, flying the ships their families have operated for generations, ex-starfighter jocks who are too old or injured to fly 'fighters any more and raw kids fresh from the Alliance's training facilities on Mon Calamari — all of these people and more haul cargo for the Rebellion.

Support Services crews are fierce, proud beings. They face the enemy's elite forces in unarmed ships, pitting their skill and experience against his sensors in a deadly game of hide and seek. If spotted, they are doomed to death or capture. Most choose the former.

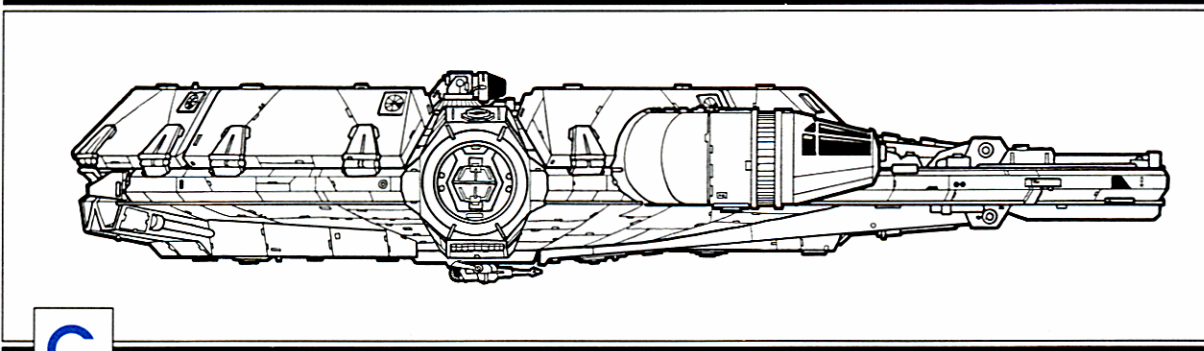

Rob Caswell



Corellian YT-1300 Transport with strap-on cargo pods.

## Alliance Transport Vessels

### Light Freighters

These vessels are among the smallest deep space transports in operation. Purchased or stolen from used spacecraft lots or dumpheaps across the galaxy, they receive just the minimal repairs necessary to make them operational and usually require a gifted (or lucky) mechanic on board to keep them from falling apart in space.

Too small to be useful in fleet replenishment, they are usually employed to supply individual ships deep behind enemy lines, where their small size is actually an asset (it helps them avoid detection).

Light freighters are also used to make stealth supply drops or pickups on Imperial planets. In some cases, the freighters are given forged documents declaring them to be tramp merchanters, in which case they land quite openly

at Imperial space ports. In others, the freighters attempt to land unseen on a planet, far away from the Empire's ground- and space-based sensor platforms.

The Alliance Supply Fleet has a large number of Corellian YT-1300 Transports (like Han Solo's *Millennium Falcon*, though of course without his extensive improvements) in service. These ships are cheap, hard-working, and refuse to die no matter how they are abused. Alliance techs have modified these ships somewhat to better suit their particular missions, adding cargo pods for additional carrying capacity.

### Medium Transports

These transports are just large enough to be useful for some Fleet replenishment tasks — medicine, clothing, small arms, light equipment, and so forth — though they are not big enough to economically transport bulk items such as food or fuel. Unfortunately, as the Alliance hasn't got

#### MODIFIED LIGHT FREIGHTER

**Craft:** Modified Corellian YT-1300 Transport  
**Type:** Modified light freighter  
**Length:** 26.7 meters  
**Scale:** Starfighter  
**Crew:** 2  
**Passengers:** 4  
**Cargo Capacity:** 200 metric tons  
**Consumables:** 2.5 months  
**Hyperdrive Multiplier:** x3  
**Nav Computer:** Yes  
**Hyperdrive Backup:** Yes  
**Sublight Speed:** 2D  
**Maneuverability:** Zero  
**Hull:** 4D  
**Weapons:**  
**Two Laser Cannon** (fire linked)  
*Fire Control:* 2D  
*Damage:* 3D  
**Shields:** 1D

#### MEDIUM TRANSPORT

**Craft:** Gallofree Yards Transport  
**Type:** Medium Transport  
**Length:** 90 meters  
**Scale:** Capital ship  
**Crew:** 6  
**Passengers:** None  
**Cargo Capacity:** 19,000 metric tons  
**Consumables:** 6 months  
**Hyperdrive Multiplier:** x4  
**Nav Computer:** No  
**Hyperdrive Backup:** No  
**Sublight Speed:** 1D  
**Maneuverability:** Zero  
**Hull:** 2D  
**Weapons:**  
**Four Twin Laser Cannon** (fire linked)  
*Fire Control:* 1D  
*Damage:* 4D  
**Shields:** 1D

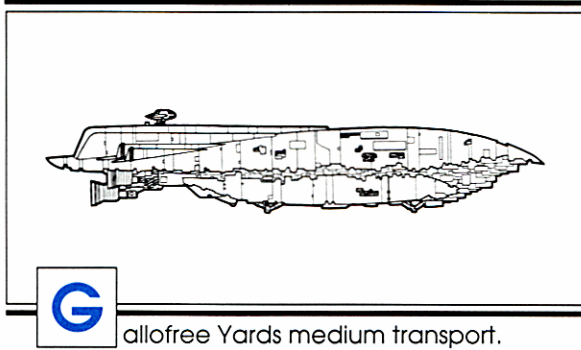

Rob Caswell



alofree Yards medium transport.

many large craft, they are forced to push these transports to their limits.

Though not specifically designed as such, medium transports can also carry passengers. A few have been converted into miniature hospitals, communications centers, and so forth.

Medium transports are virtually helpless in battle. They are slow, unwieldy, and very lightly armed and shielded. They are small enough to be vulnerable to starfighter attacks, but not so small that they aren't tempting targets for capital warships. The best thing that can be said about them is that they are cheap.

The Alliance got most of its medium transports direct from the manufacturer, Gallofree Yards, Inc., buying them through third-party agents for well below suggested retail price when Gallofree went bankrupt several years back. Rebel spacers insist that the Empire was fully aware the Alliance was buying the transports, but they let them purchase them anyway because they thought the ships would cause the Alliance more grief than good.

### Bulk Freighters

The Alliance has only a few bulk freighters, but those few they have are worth their weight in

### BULK FREIGHTER

**Craft:** Corellian Action VI Transport

**Type:** Medium bulk freighter

**Length:** 125 meters

**Scale:** Capital ship

**Crew:** 10

**Passengers:** None

**Cargo Capacity:** 90,000 metric tons

**Consumables:** 3 months

**Hyperdrive Multiplier:** x3

**Nav Computer:** No

**Hyperdrive Backup:** No

**Sublight Speed:** 1D

**Maneuverability:** Zero

**Hull:** 3D

**Weapons:**

None

**Shields:** 1D

gold. Though not much larger than medium transports, bulk freighters are designed to economically carry far more cargo. They are stronger, faster, and all-around better craft. (They are also about three times as expensive as medium transports, which is why the Alliance does not have very many of them.)

Most of the bulk freighters in the Alliance fleet have been involuntarily "donated" to the Alliance by the Empire — that is, captured in battle. This is actually quite difficult to accomplish.

Unless someone's nerve breaks, it is virtually impossible to capture a capital ship. As long as a ship's crew wishes to continue fighting, the ship can't be boarded. Even if it is being held by tractor beams, unless it is horribly outmatched (say, a Corellian corvette versus a Star Destroyer), even a tractor-beamed capital ship can maneu-

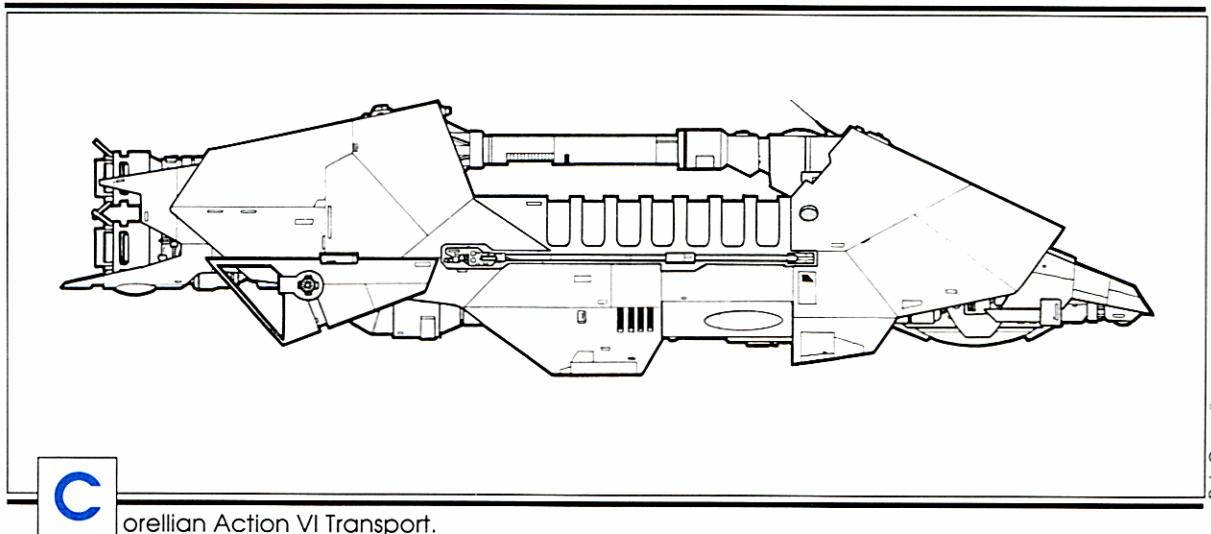

Rob Caswell



orellian Action VI Transport.

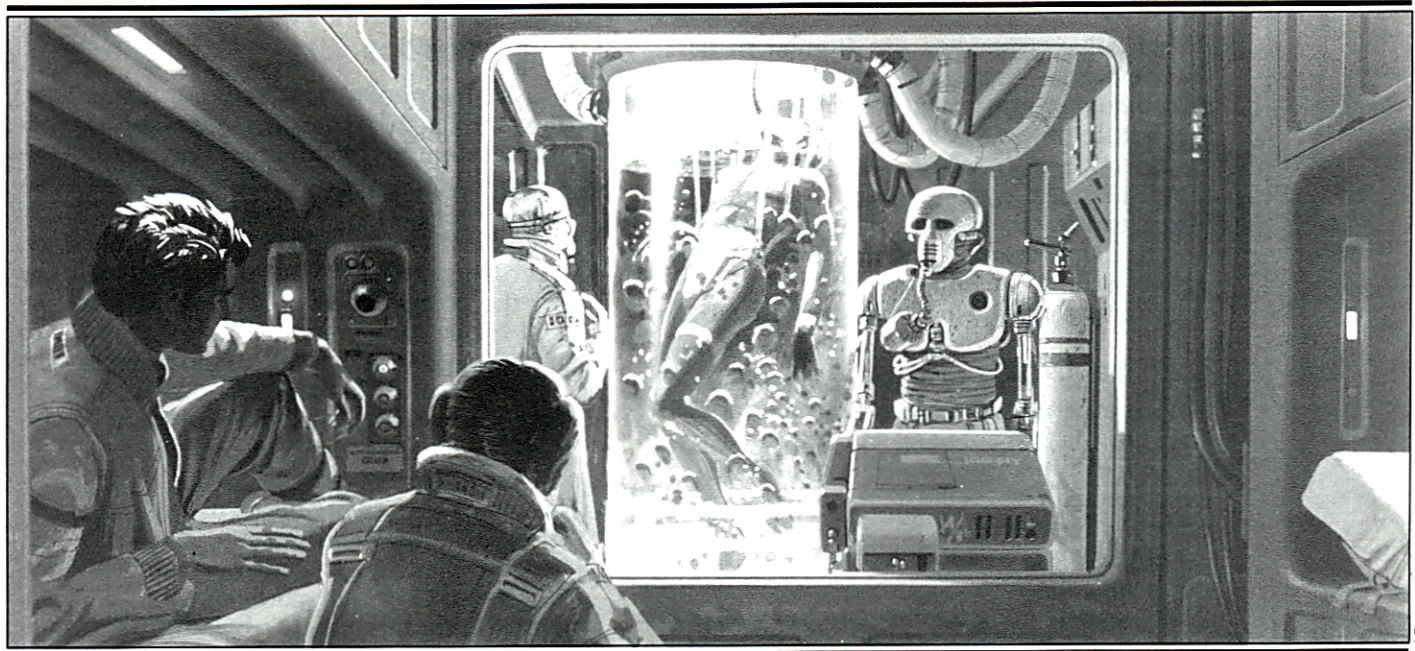

ver just enough to keep the enemy from getting any troopers aboard.

The only way to fully disable a ship is to take out its engines or blow up its bridge. However, it is difficult to do this without destroying the entire vessel. And even if the ship is disabled, it is useless to the men who captured it (who won't have time to sit around the scene of the battle while the ship is repaired).

Fortunately for the Alliance, some Imperial freighter captains and crew are not quite dedicated enough to be willing to fight to the death. When facing several B-wing fighters and with no

TIE support at hand, a number of bulk freighter crew have surrendered, preferring internment in an Alliance safe world prison to the honor of going down with their ship.

## Medical Services

Support Services is in charge of the Alliance's medical personnel, Droids, equipment and facilities. Support Services medics travel into battle with virtually every Alliance ground unit; medics or Droids can be found on almost all Alliance capital ships with crews of more than 20.

### MEDICAL FRIGATE

**Craft:** Modified Nebulon-B Frigate

**Type:** Medical starship

**Length:** 300 meters

**Scale:** Capital Ship

**Crew:** 850

**Passengers:** (see below)

**Cargo Capacity:** 1,000 metric tons

**Consumables:** 1 year

**Hyperdrive Multiplier:** x3

**Nav Computer:** Yes

**Hyperdrive Backup:** Yes

**Sublight Speed:** 2D

**Maneuverability:** 1D

**Hull:** 4D+2

**Weapons:**

**Six Turbolaser Batteries** (fire separately)

*Fire Control:* 3D

*Damage:* 4D

**Eight Laser Cannon** (fire separately)

*Fire Control:* 2D

*Damage:* 2D

**Two Tractor Beam Projectors**

*Fire Control:* 2D

*Damage:* None: target captured if hit

**Shields:** 2D

**Medical Facilities Aboard the Frigate**

The Alliance Medical Frigate has 745 beds. Eighty medics are stationed aboard the Frigate, plus 30 Medical Droids (a variety of Emdee and Two-Onebee models). The Frigate has 15 bacta tanks. It also has five operating theaters equipped to handle everything from microsurgery, to prosthetic replacement, to childbirth.

## Medics

Most Alliance medics are trained to handle battlewounds—blaster shots, explosive damage, gas poisoning, cuts, fractures, and so forth, with just a little training in more esoteric specialties such as disease control and long-term patient care. The medic's primary job is to get the patient into shape to get back into battle. If that is not possible, than the medic attempts to stabilize the patient so that he can survive until he can be treated by a fully-trained doctor or Droid.

## Medical Droids

Medical Droids are usually much better-skilled than medics and are used wherever possible — on board ship, in hospitals, and so forth. However, Medical Droids are a bit too fragile to stand up to the rigors of ground combat, which is why living medics are used in battle situations.

The most popular Medical Droids in both the Alliance and Imperial forces are the Emdee line, produced by Industrial Automaton. There are six Droids in the Emdee line: MD-0 is a diagnostic specialist; MD-1 is a lab tech; MD-2 an anesthesiologist; MD-3 a pharmacist; MD-4 microsurgeon; and MD-5 a general practitioner Droid. The older Geentech line of Too-Onebee Surgery Droids is also well-respected.

The Empire can, of course, purchase these Droids in the quantity they require; the Alliance is forced to get their Medical Droids second-hand, through third-party purchases, and by stealing them from the Empire.

## Medical Ships

Probably the best-known medical ship is the Hospital Frigate, which travels with the Alliance Fleet. However, a number of smaller craft also serve in this capacity as well, traveling the gal-

## **P**rosthethics

In war, people get injured. Sometimes, the injury is clean and the wound heals without leaving any disability. Other times, the wound is more grave and the victim loses an arm, or a leg, or an eye.

Fortunately, advances in biotechnology, microsurgery and robotic techniques allow for the construction of remarkably effective and lifelike prosthetics. Doctors are able to replace missing limbs, eyes, and major organs with mechanical or biomechanical substitutes virtually undetectable by the casual observer, and almost as good as the original.

The recipient can see through a replacement eye as if it were his own; he can feel and grip with an artificial arm; he can run and jump on prosthetic legs. Replacement heart and lungs and liver and skin can even be rapid-grown from the patient's own tissue culture, cutting down on the chance of rejection.

Though there remain — and will always remain — diseases and injuries which cannot be treated, for the majority of cases, if a patient still has the will to live when he reaches the hospital, he stands a very good chance of coming out whole or nearly whole.

axy, picking up very badly-wounded soldiers from planets which do not have the facilities to treat them and bringing them to one of the Alliance's hidden hospitals.

Hospital ships are fully-equipped with Medical Droids, bacta tanks, diagnostic equipment, and so forth. If a Rebel survives to reach a hospital ship, his chances of living are almost 98 percent.



# Chapter Ten

## Recruitment and Training

TATOOINE — ANCHORHEAD SETTLEMENT  
— POWER STATION — DAY

*Luke and Biggs are walking and drinking a malt brew. Other people can be heard working inside.*

**Biggs:** I've missed you, kid.

**Luke:** Well, things haven't been the same since you left, Biggs. It's been so ... quiet.

*Biggs looks around then leans close to Luke.*

**Biggs:** Luke, I didn't come back just to say goodbye ... I shouldn't tell you this, but you're the only one I can trust ... and if I don't come back, I want somebody to know.

*Luke's eyes are wide with Bigg's seriousness.*

**Luke:** What are you talking about?

**Biggs:** I made some friends at the Academy. (he whispers) ... when our frigate goes to one of the central systems, we're going to jump ship and join the Alliance ...

*Luke is amazed and stunned, almost speechless.*

**Luke:** Join the Rebellion?! Are you kidding! How?

**Biggs:** My friend has a friend on Bestine who might help us make contact.

**Luke:** You're crazy! You could wander

around forever trying to find them.

**Biggs:** I know it's a long shot, but if I don't find them I'll do what I can on my own ... It's what we always talked about. Luke, I'm not going to wait for the Empire to draft me into service. The Rebellion is spreading and I want to be on the right side — the side I believe in.

**Luke:** And I'm stuck here ...

**Biggs:** I thought you were going to the Academy next term. You'll get your chance to get off this rock.

**Luke:** Not likely! I had to cancel my application. There has been a lot of unrest among the Sand People since you left ... they've even raided the outskirts of Anchorhead.

**Biggs:** Your uncle could hold off a whole colony of Sand People with one blaster.

**Luke:** I know, but he's got enough vaporators going to make the place pay off. He needs me for just one more season. I can't leave him now.

**Biggs:** I feel for you. Luke, you're going to have to learn the difference between what seems to be important and what really is important. What good is all your uncle's work if it's taken over by the Empire? ... You know they're starting to nationalize commerce in the central systems ... it won't be long before your uncle is merely a tenant, slaving for the greater glory of the Empire.

\* \* \* \*



## Overview

Since its earliest beginnings, the Alliance has had extreme difficulty in gaining new recruits. The Empire is strong, and few are willing to risk their lives for what looks to be a lost cause. And of those who say that they are willing, more than a few are double agents — Imperial plants — enlisting to discover the location of secret Rebel bases, and deserting immediately once they do so to report to their Imperial superiors.

The first of the two problems has lessened somewhat since the destruction of the Death Star at Yavin. Since that great victory, the Alliance has gained new stature and respectability: the cause may be desperate, it may even be a very, *very* long shot, but it demonstrably is not a lost cause. For many people, this is enough. Since Yavin, recruits have been up nearly 23 percent.

The second problem remains very difficult to deal with even until this day. Imperial spies are highly-trained: It takes very sophisticated lie-detection equipment and deep background probes to spot them. The Alliance has neither the equipment nor the trained agents to scan each and every recruit. Officer candidates and high-level government recruits get scanned, probed, and background-checked to within a centimeter of their lives, but simple military recruits get the bare minimum.

However, there is a pretty good chance of spotting an agent when he is going through basic training. The Rebel training sergeants are specially trained to spot suspicious behavior among new recruits. If they have any doubts about a new

Rebel, Intelligence officials can quietly monitor him, and, if necessary, detain him for special interrogation. This is not 100 percent effective, but it's the best the Alliance can do.

## Sources of Personnel

The best sources of personnel for the Rebel Alliance remain those worlds which have openly declared themselves in Rebellion against the Empire. Mon Calamari provides a significant fraction of the Rebel Fleet's personnel; Alderaan citizens off-planet when the planet was destroyed fill both the Fleet and the Alliance Forces; and there are other friendly planets which supply a large number of personnel to the Alliance as well.

Sector Forces are recruited from the citizens of the sector themselves, usually by a friend or relative in the underground. Since the recruiter knows the candidate, there is a much smaller chance of the candidate being an Imperial plant.

In addition to these sources, the Alliance has other channels through which it gains recruits.

## The Imperial Naval Academy

At one time, when it was called the Navy of the Republic, the Imperial Navy was used for defense and to keep down piracy in the space lanes. It was known as the best place in the galaxy to learn the ways of space: a young being could join the Academy, see the galaxy, and serve his people all at once. When he retired in 20 or 30 years, still relatively young, he could find a job on any spacecraft in the galaxy. Over 14 percent of all the freighter captains in the galaxy had gone through Academy training.

Now, however, things are different. Now that the Emperor has come to power, the Navy has become a means for terrorizing millions of planets. The Imperial Academy has maintained its high standards in regards to training the young men in the ways of space, but, at the same time, it has also turned its efforts to brainwashing those same young men into believing that the brutality, corruption, and terror of the Empire is right, and that they should be willing — and eager — to die for the evil creature known as the Emperor.

Many young men are not aware of this until they enter the Academy. They join because their father, and their father's father were Academy men, because all their lives they have heard stories about the Academy. Others join simply to escape the tedium of their everyday lives — the lure of space is strong.

For the young idealists (there are still some left in the galaxy, even today), the shock of discovering what the Academy has become is tremendous. The physical brutality is expected — even



Allen Nunis

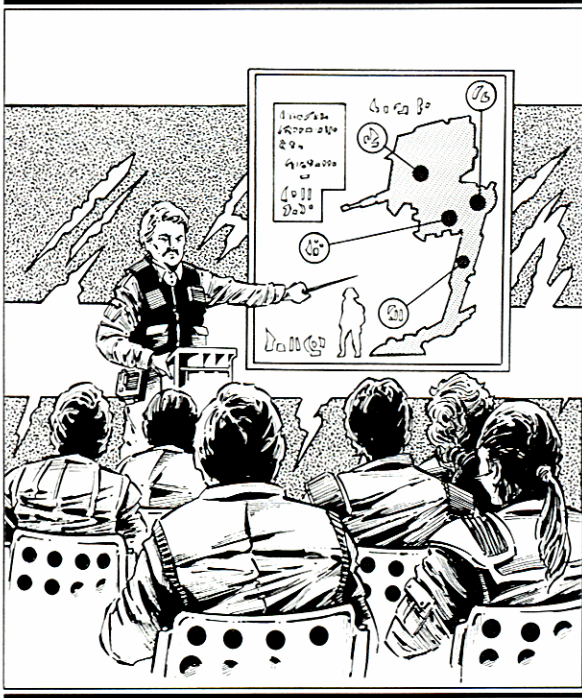

in the old days, recruits were worked to within an inch of their lives — but the mental oppression is completely unexpected. The recruits are told what to think, what to say, what to do. They are told that the Empire is the most important thing in the galaxy, and that the Emperor is almost a god. They are taught that oppression is right, that cruelty is pragmatism, that atrocity is acceptable when it is “for the good of the state.”

Sadly, many fall prey to the brainwashing techniques of the Academy, becoming willing tools of the Empire. However, a few refuse, determined to hold onto the values they learned from their parents, from the teachings of the Old Republic. These men have a cruelly hard time in the Academy — the instructors attempt to break their will; their fellow students haze them unmercifully. Many resign or are dismissed from the Academy; a few — the strongest — continue their training until the end.

The Alliance has one agent in the Academy, Greg Somax, a mathematics instructor. He is always on the lookout for new recruits to the Alliance. If a likely candidate is spotted, Somax informs another agent, who makes the contact with the likely recruit. Somax *never* contacts the potential recruit himself — he never does anything to risk his cover. He is one of the most valuable agents in the Alliance, and he knows it.

### Safe Worlds

These are worlds where the families of known Rebels have fled to evade Imperial capture. They are filled with the spouses, parents, siblings and

children of the Alliance. In time, the children grow up. Not unnaturally, many of these youngsters decide to join their parents and brothers and sisters in the struggle against the Empire. They are among the best soldiers in the Alliance's forces.

### Frontier Worlds

These are the recently-settled worlds of the Outer Rim Territories. Life is hard, and the people are in a constant day-to-day struggle to survive. The hand of the Empire is light on the Frontier Worlds — there's not much worth taxing on a Frontier World, and no industry worth stealing or protecting. However, they do have one very valuable resource: the young people of these planets tend to be sturdy, self-sufficient, and they make excellent warriors.

The Empire attempts to tap this resource by imposing mass troop levies on the planets: the planetary government is told to provide a certain number of troops per year for service to the Empire, and if they fail, the Imperial military will come and take them. This is bitterly resented by the population, many of whom moved to the Frontiers to avoid government interference in their lives in the first place.

To avoid sending their children into military service, some families head into the wilderness, living far away from the centers of population, making it extremely difficult for press gangs to track them down. Sometimes this tactic is successful, sometimes they are found and punished, their children taken from them anyway.

These planets provide a large number of recruits to the Alliance. After all, the young men and women reason, if they are going to have to

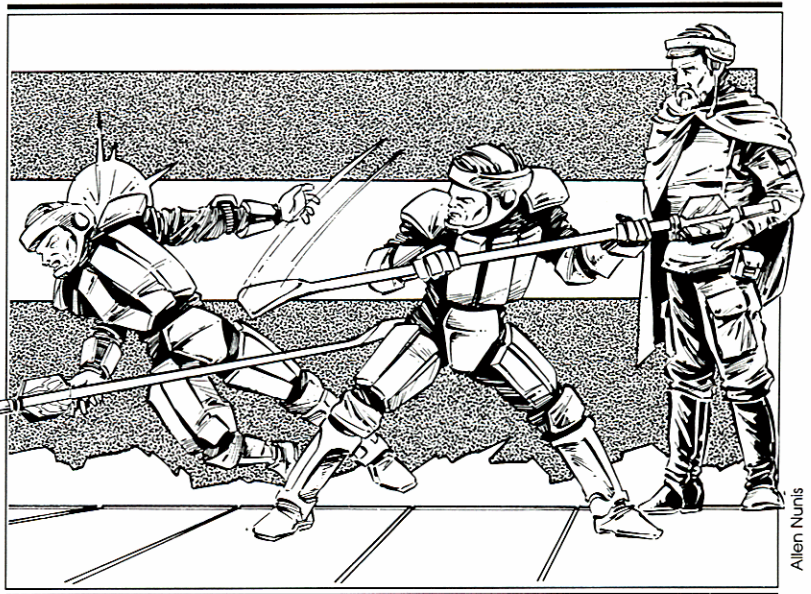



Allen Nunis

fight in the war anyway, they'd much rather fight on the side of right, of their own choice, then fight as slaves for a cruel and uncaring Empire.

### Imperial Survey Corps

As the Empire cuts back on the size of the Imperial Survey Corps, many fine spacefarers have suddenly found themselves out of a job. They are offered a chance to join the Imperial Naval Forces; however, the ISC tends to breed hardy individualists (one of the reasons the branch is being disbanded!), and these beings are completely unsuitable for the rigidly regimented life in the Navy. They may attempt to find themselves a career in the private sector, but the harsh new Imperial laws covering space travel make this very difficult to achieve, unless one is willing to work for one of the huge Corporate Sector giants — the small-time ship operator is all but gone from space.

Some of the ISC people join the Alliance because they have come to believe that the Empire is corrupt, is slowly stifling the last spark of freedom from the galaxy. Some join because they have rejected the harshness and cruelty of the Imperial Navy. Some join because they resent losing their jobs in the ISC and want to make someone pay. And some join because they're danger-junkies: the Alliance offers them a chance to risk their necks in space, just like their old job in the ISC.

The Alliance has found ex-Imperial Survey Corps agents to make good operatives in assignments

which require a lot of personal initiative, little coordination with others, and a high degree of personal risk.

### Underground Intelligence Networks

Underground Intelligence Networks provide the bulk of the recruits in Imperial-dominated sectors. These troopers rarely join the Fleet or the Alliance Forces; instead, they join the Sector Force in existence in that sector. These soldiers' training may not be up to the standards of the Alliance Forces; however, since these men and women were recruited by their family and friends in the underground, they have a very low rate of Imperial infiltration.

### Schools and Universities

Free thought is not encouraged in a totalitarian Empire. However, it's very hard to stamp out, particularly in places of learning, where young beings are expected to use their brains for something other than keeping their ears apart. Where there's free thought, the Empire is not popular.

There are many Alliance recruiters in universities and schools across the galaxy — and many Imperial agents looking for them.

### Basic Training

Alliance basic training follows the standard format created hundreds if not thousands of years ago. The recruits are put through a grueling eight weeks of physical training, during which they learn their bodies' strengths and weaknesses, learn the basic skills necessary to any soldier, learn to accept authority, and learn to



Allen Nunis

count on their comrades in all circumstances.

The recruits are broken down into squads of 20 soldiers, and each squad is assigned to a drill sergeant, who takes personal charge of the recruits throughout their training. The early stages of the course are not dissimilar to those found on this planet: each day the recruits endure long hikes with huge, heavy packs, painful calisthenics, and brutally rigorous weapons training. This is all under the watchful eye and scathing tongue of the drill sergeant, whom they learn to hate bitterly before the eight weeks is over — but remember with deep gratitude when the training saves their lives in combat.

As aliens' physical characteristics can vary wildly from the human norm, it is usual for the training squads to be segregated by race. Mon Calamaris simply are not physically designed to run as far as human beings do, and it would be cruel and foolish to force them to try. Similarly, a calisthenics course designed for a Wookiee would probably kill most humans. Naturally, all Alliance soldiers claim that the course designed for their species is the worst, and while away many off-duty hours making up lies about how hard their particular training was, how tough their drill sergeant was, and so forth — as soldiers have done since time immemorial.

## Officers' Training

After basic, the recruits are assigned to their permanent units; those going for advanced training are sent off to the appropriate school. Following is a description of the advanced training officers are required to take.

### Ground Officers

After basic training, officer candidates are sent to special tactical schools for an additional six months of training. There they continue their physical training, though at a less brutal pace than what they endured in basic, while at the same time studying how to command men in battle.

The officers take courses in tactics, communications, psychology, and strategy. They learn the objectives of the Rebel Alliance; they study the history of the Old Republic, paying particular attention to the battles of the Clone Wars. They form into combat squads and fight mock battles against each other. They are instructed by the best combat officers in the Alliance: to be asked to be a teacher at the Alliance Officers' Candidate School is considered to be one of the great honors of an Alliance officer's career.



Allen Nunis

When a candidate has completed the training course, he is as good an officer as it is possible to become from a classroom — that is to say, not very. The young officer must still command men in battle before he has proved his worth, and the examination on the battlefield is much more difficult than the one in the classroom could ever be. And if he fails *that* examination, not just he, but his men pay the price of his failure.

### Naval Officers

Once they have gone through naval basic training, naval officer candidates are assigned as midshipmen to Alliance vessels. Virtually all of their advanced training is of the “on the job” variety: the Alliance Fleet simply does not have the manpower necessary yet to maintain an Academy. Instead, the “middies” learn by doing, taking courses in navigation from the ship's navigator, learning tactics by reviewing battles their vessel actually engaged in and talking to the officers about the decisions they made in combat. They stand watches on the bridge; they help the engineers perform maintenance; they learn the ship from stem to stern.

When, in the ship's captain's opinion, the midshipman is ready, he is promoted to Lieutenant. However, his training is not over. It is never over. Aboard ship, it is said, you stop learning only when you are dead.

A

# fterword

## A Legacy for Our Children

**To:** Arhul Hextrophon  
**From:** Mon Mothma  
**Security Status:** Top Secret  
**Regarding:** Your magnificent Report on the Rebellion

My dear friend:

I thank you and your office for your brilliant efforts in compiling this Report. With few words, you have described our struggle in a way that takes my breath away, showing the great courage and determination of the free peoples of the galaxy for all to see.

You, Arhul, know how little I have to do with this Rebellion, and how much I owe to others, famed and unknown, living and dead. This great struggle is a people's struggle: a struggle between the strong and the weak, the rich and the poor, the cruel and the gentle. You have shown our struggle to everyone, and for that, I thank you. You have created a legacy for our children, so that, even if we fail, they too shall know.

As you (and few others!) know, I am not sanguine about the outcome of our Rebellion. We have hurt the Empire — and badly — at Yavin, and our organization is growing stronger everywhere. But the Emperor grows stronger too. Sometimes, when I cannot sleep, I can feel him out there in the night, brooding over his evil, feeding on the very life of the galaxy. He is terrible — malignant, cunning, and so strong! I fear him! I do not know if I have the power to beat him; I do not know if anyone can.

In my dreams, I see a young man — a boy, really — fighting the Emperor and Vader. He's alone, and in such pain! Somehow, I know that all of our efforts ride on his thin shoulders, and against those two, he cannot stand! He cannot! I wake from those dreams shaken, and very afraid.

Ah well. What will be will be. We will continue the fight, and, if mortal beings can, we will win. And if not — what did you tell me, so long ago, when it all began? You said, "If we fall, the galaxy will tremble at our passing." I've always liked that.

*And if we fall, the galaxy will tremble at our passing!*

The Force be with you, my friend.

Respectfully,



Mon Mothma

# The **STAR WARS**

## Rebel Alliance Sourcebook

by Paul Murphy

A terrible civil war burns throughout the galaxy. A rag-tag group of freedom fighters has risen from beneath the dark shadow of a tyrannical Empire: against all hope, they have dealt the oppressors a mighty blow.

But although the Death Star has been destroyed, Imperial troops have driven the freedom fighters from their hidden base and pursue them across the galaxy. The Emperor has turned his attention toward extinguishing this last spark of resistance, and everywhere the forces of the Empire have redoubled their efforts to seek out and destroy the elusive prey.

Throughout the vastness of space, heroic beings engage in a desperate struggle against the overwhelming might of the Empire. They are ill-equipped and pitifully few, but their courage and determination has fostered new hope for freedom in the galaxy. These are the men, women, and aliens of the Rebel Alliance.



### Companion to *Star Wars: The Roleplaying Game!*



Includes game statistics for the characters, Droids, weapons and equipment of the Rebel Alliance.

#### 144-page book features:

- In-depth examination of the birth and early growth of the Rebellion.
- Illustrations, photographs, maps and diagrams — some never before published!
- Detailed report of the Alliance military and political hierarchy since the destruction of the first Death Star.
- Data on Alliance Intelligence: operations, equipment and underground cell networks.
- Descriptions, diagrams and statistics for Rebel land vehicles, ships and equipment.
- Updated information on Rebel bases, plus recruitment and training protocol.
- Information for movie fans and game players alike on the heroes of the *Star Wars* galaxy — the Rebel Alliance.



West End Games  
RD 3 Box 2345  
Honesdale, PA 18431

40054

For ages 12 and up.

©, TM & © 1990 Lucasfilm, Ltd. (LFL). All Rights Reserved. Trademarks of LFL used by West End Games under authorization.

ISBN 0-87431-178-0



Science Fiction/Games/  
Reference