

STAR WARS[®]

Imperial Sourcebook

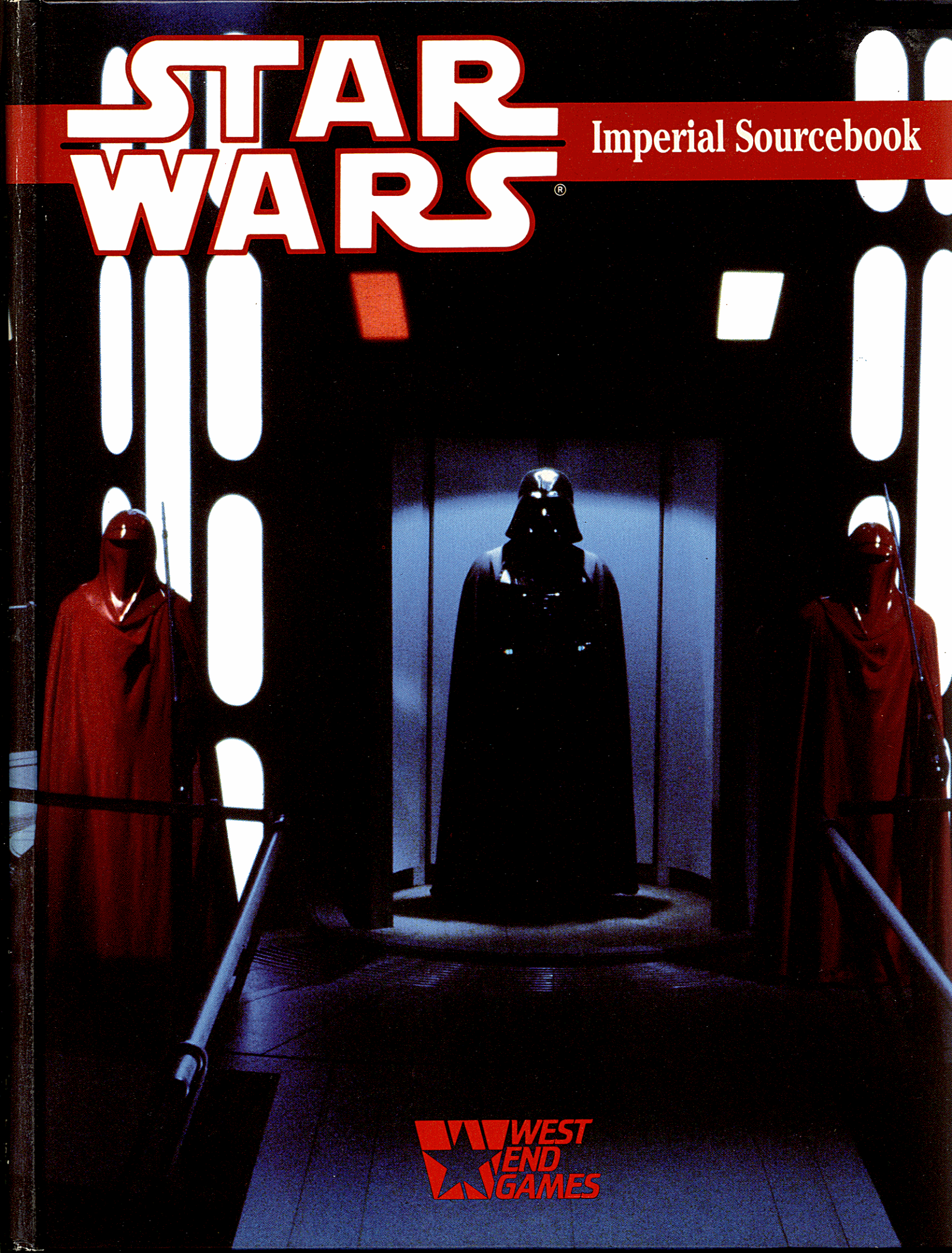

**WEST
END
GAMES**

A long time ago in a galaxy far, far away ...

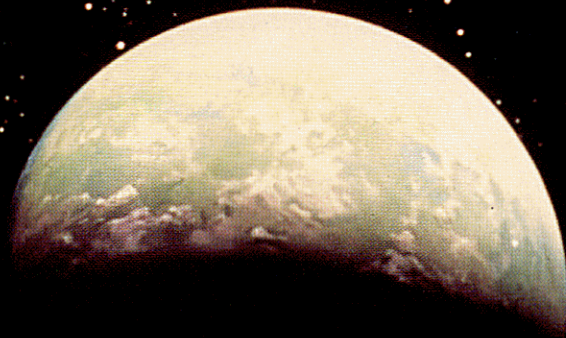

It is a dark time for the Rebellion. Although the Death Star has been destroyed, Imperial forces have instituted a reign of terror among the disheartened worlds of the Galactic Empire.

The Empire has many weapons in its arsenal, and every one of them has been turned upon the Rebels and their allies; tyranny, oppression, vast fleets, overwhelming armies, and fear. Fear keeps the individual systems in line, replacing the Imperial Senate and the Death Star as the prime motivator in the New Order.

The upstart Rebel Alliance has dared win a significant battle against the Empire at Yavin, but the war has really just begun. Outnumbered and outgunned, the Rebellion nevertheless burns across a thousand-thousand worlds, flaming into a fire of hope. But the Emperor has ordered this fire extinguished, setting the war machine he has constructed into motion.

This is the galaxy of ...

Development & Editing: **Bill Slavicsek**
Contributing Authors: **Jim Bamba, Grant Boucher, Deborah Christian, Steve Gilbert, Bill Slavicsek, Michael Stern, William Wenz**
Graphics: **Stephen Crane, Cathleen Hunter, Sharon Wyckoff**
Cover Illustration: **Lucasfilm, Ltd.**
Interior Illustrations: **Stephen Crane, David Deitrick, A. C. Farley, Lucasfilm, Ltd., Karl Martin**
Special Thanks To: **Anita Gross, Louise Riley**

Published by
West End Games
RD 3 Box 2345
Honesdale, PA 18431

Publisher: **Daniel Scott Palter** • Associate Publisher: **Richard Hawran** • Assistant Publisher: **Denise D. Palter** • Editorial Director: **Bill Slavicsek** • Associate Editors: **Greg Gorden, Douglas Kaufman** • Editors: **Jonatha Caspian, Michael Stern, C. J. Tramontana** • Art Director: **Stephen Crane** • Graphic Artists: **Rosaria Baldari, Bernadette Cahill, Jacqueline Evans, Cathleen Hunter, Sharon Wyckoff** • Production Manager: **Steve Porpora** • Sales Director: **Martin Wixted** • Sales Manager: **Fitzroy Bonterre** • Sales Assistant: **Maria Kammeier** • Special Projects Manager: **Ronald Seiden** • Treasurer: **Janet Riccio**

©, ™ & © 1989 Lucasfilm, Ltd. (LFL). All Rights Reserved. Trademarks of LFL used by West End Games under authorization.
First Printing: **October 1989**

The background of the cover is a dark blue, monochromatic illustration of a spaceship's interior. It features a large, curved structure on the left side, possibly a control panel or part of the hull, with several rectangular openings or windows. Through these openings, a starry space scene is visible. The lighting is dramatic, with highlights on the metallic surfaces and deep shadows in the recessed areas.

STAR WARS[®]

Imperial Sourcebook

by Greg Gorden

T A B L E O F C O N T E N T S

Introduction.....	5
Prologue	6
Chapter One: A Primer on Imperial Power	7
Chapter Two: Compnor	16
Chapter Three: Imperial Intelligence	24
Chapter Four: The Military	41
Chapter Five: Capital Ships	50
Chapter Six: Custom Ordnance	66
Chapter Seven: Land Vehicles	69
Chapter Eight: Sector Group Organization	81
Chapter Nine: Combat Artillery	112
Chapter Ten: Infantry Support Weapons	119
Chapter Eleven: Special Military Forces	129
Chapter Twelve: Recruitment, Training and Indoctrination	139

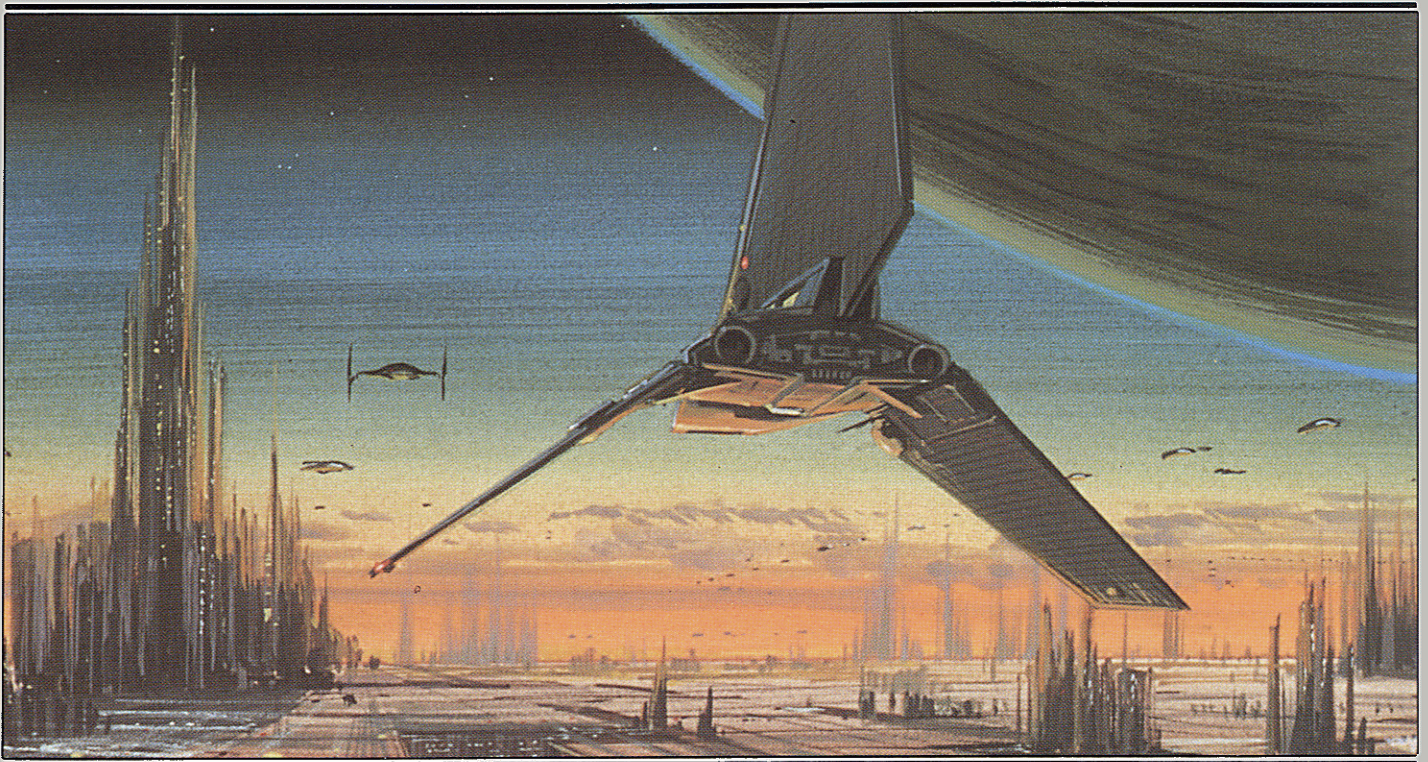

I ntroduction

The Empire

The Galactic Empire consists of a thousand-thousand worlds caught in the iron grip of tyranny. Using overwhelming armies and vast navies, the Empire instituted a reign of terror among the disheartened and enslaved planets. No world, no system, no race was immune to the terrible machinations of the New Order.

But the galaxy was not always such a dark and foreboding place. Once there was a good and pure government called the Old Republic, protected by the shining light of the Jedi Knights. Into this utopia, however, there appeared unscrupulous individuals who thirsted for wealth, power, and domination. Slowly, cunningly, they destroyed the Republic from within, creating the evil and corrupt Empire.

An ambitious senator named Palpatine, proponent of the New Order, declared himself Emperor and consolidated his power by destroying the Jedi Knights and disbanding the Imperial Senate.

But some worlds resisted. At first this rebellion was disorganized and ill-equipped, but as more planets joined against the tyranny the new Alliance became a force to be reckoned with.

In response, the Emperor ordered a military build-up unprecedented in galactic history. A terrible weapon was designed, a weapon powerful enough to destroy whole planets — the Death Star battle station. It became the cornerstone of the New Order's governing doctrine.

With the Senate dissolved, the Emperor gave his regional governors direct control and a free hand in administering their territories. From this point on, the Empire would be ruled by fear. Fear would keep local governments in line. Fear of the Imperial Fleet — and fear of the Death Star.

Recently, the Rebel Alliance won a significant battle at Yavin by destroying the Death Star. Enraged by this action, the Emperor has ordered the might of the Empire to crush the hated Alliance and its dream of a New Republic. Now the war has really begun ...

The Imperial Sourcebook

Perhaps nothing permeates the *Star Wars* galaxy more than the notion of the evil Galactic Empire. Ruled by the mysterious Emperor Palpatine and built upon the ruins of the fabled Old Republic, the Empire is the villain of the story. Even when the Alliance isn't directly fighting against the might of the Empire, the overwhelming presence of Darth Vader and the Imperial stormtroopers is never completely out of mind.

Star Wars: The Roleplaying Game is set in that turbulent time that begins with the destruction of the Death Star and ends with the establishment of the Rebel base on Hoth; that is, between the end of *Star Wars IV: A New Hope* and the start of *Star Wars V: The Empire Strikes Back*. This is a period that begins with high expectations and hope among the Alliance because of their stunning victory at the Battle of Yavin. But that hope must be quickly dealt with by the Empire or the New Order is lost.

What changes occurred in Imperial thinking when the Death Star exploded? What policies and tactics had to undergo drastic revisions to fill the hole the battle station left behind? *The Imperial Sourcebook* looks at the might of the Empire after the first *Star Wars* film and presents exciting new aspects of the galactic struggle for both players of the roleplaying game and fans of the movie mythos.

So come with us into the dark abyss that is the Imperial bureaucracy. Follow us as we examine the rumors concerning the very top of the Imperial power base, as we explore the inner workings of COMPNOR and Imperial Intelligence. Prepare to view the power of the Empire's military machine, from vast fleets to the order of battle of an entire sector.

The Imperial Sourcebook is packed full of descriptions, explanations, histories, photographs, illustrations and diagrams. It is an extensive look at many of the things that contribute to the unyielding might of the Galactic Empire, the greatest armed force ever detailed in fiction.

It is a dark time for the Rebel Alliance indeed.

P rologue

The Might of the Empire

To: Mon Mothma, Alliance Supreme Commander; other Alliance officers.

From: Major Arhul Hextrophon, Executive Secretary and Master Historian, Alliance High Command.

Regarding: The following Imperial data.

The research you have had my staff and I undertake concerning the events surrounding the Battle of Yavin has uncovered some startling information. I have compiled all of the intercepted communiques, technical readouts, holochips, and datapacks into one report.

Sources for this material include high-level communications, reports by various Imperial agencies, personal data logs, top-secret performance records, and other similar material.

While the information reveals much about the tactics and inner workings of our enemy, I must caution reading too much into this report at this time. None of the information contained herein has been confirmed or documented outside of the data presented here. Unlikely though it is, this could be an elaborate ruse to pass along false information to the Alliance.

I urge you and the rest of Alliance High Command to view this report in the proper perspective. Until collaborated, this report should be considered high level rumors at best. At worst, the Alliance is being fed half truths and lies for some unknown purpose, although I do not believe this to be the case.

No matter, for even in falsehoods can truths be found. And once you have studied this report, I believe that even if you read only between the lines you will uncover much to show you the nature of the Empire and its methods.

Consider this report a companion to our work in progress, *Official History of the Rebellion, Volume One*. We have thus far interviewed and documented the heroes of the Battle of Yavin, including Commander Luke Skywalker and Princess Leia Organa. But unlike that other work, this one — for obvious reasons — is not as well researched and established. The Empire just isn't as cooperative about revealing certain information. Be that as it may, I have included all of the data we have uncovered for the sake of completeness and further study.

When you read through the accompanying data files, you will see the Empire in its glory, its victories, and its failures. You will see its might and its power. You will see its deep, dark shadows that are quickly spreading throughout the Galaxy. And that is why, in the final analysis, I have sent this report to you. If the actual figures and divisions of forces are wrong, the spirit behind them ring true. This report shows the evil that has grown from the rotted corpse of the Old Republic, and that, we have already seen, cannot be exaggerated.

I remain your humble servant,

Major Arhul Hextrophon.

C

hapter One

A Primer on Imperial Power

There is a darkness in the galaxy. There is the Galactic Empire.

Where once peace held dominion over the countless planets of the Old Republic, now fear and terror hold sway. Planets set to defend themselves against any external menace were ill prepared to deal with threats from within. And so a galaxy was enslaved.

The idea of empire was old throughout the galaxy long before Palpatine ascended the throne and created his New Order. Hundreds upon hundreds of thousands of worlds have a history of empire, of rule by a single central authority, in their past.

Look at the Atrisi system, for example. The principle planet still recalls the Kiteel Phard Dynasty with pride. These rulers unified the entire homeworld, eliminating opposition and establishing a golden age.

This tale is typical of imperial legends and histories throughout the galaxy, containing those elements that are common to intergalactic memory. Few recall the negative aspects of imperial rule, preferring to remember the power and glory that comes from an overarching code of law and a common tongue.

None of these historical empires still stand. But their memories lingered, lying dormant in the minds of billions of beings who longed for a simpler galaxy, who sought certainty and order, who wanted to belong to the most powerful empire of all. These seeds of ideas were waiting for a more fertile time, for an ambitious leader to cultivate them once again.

The Old Republic Wanes

The galaxy was once a great Republic of stars. The thousand-thousand member worlds were governed fairly and efficiently by the Senate, and cared for and protected by the Jedi Knights. Inevitably, as the number of worlds increased, the Republic found itself saddled with too mas-

sive a bureaucracy. It had grown too large, gotten too old, and corruption had set in.

A few unscrupulous, greedy senators had started the destructive chain reaction of malaise. They saw the first lingering problems as cracks in the system of government which could be exploited for personal gain. These beings found that their colleagues were far too occupied by the day-to-day running of the Republic to monitor their activities adequately.

The corruption was too small to be noticed at first. But as the opportunities grew, so did the number of senators who were seduced by the lure of illegitimate power and wealth. These senators found an easy alliance with some of the mammoth corporate interests which constantly were on the lookout for easier ways to make a profit. A few arrogant, self-serving bureaucrats fell to seduction, and suddenly a virus was in the stars.

Every instance of instability, each uncertainty in government action, every wrinkle in senatorial policy and procedure became a means to foster larger opportunities. Senator turned on senator, values eroded, trusts were broken, and fear gripped the Republic. What was once thought to be immortal suddenly saw the approach of its own destruction, and the Old Republic was afraid.

Corruption and fear spread like a mutant disease, quickly reaching epidemic proportions without any visible cause. The Old Republic's troubles multiplied, and no one seemed to know what was happening — or why.

At last the Senate could no longer blind itself to the fact that the Old Republic was being devoured from within by those who had been entrusted with its care. During this time, the legitimate business of the Republic was neglected. Small, previously routine matters became insurmountable difficulties. The government became remote, unfathomable, often a

useless burden to tens of thousands of the governed races. The Republic was disintegrating, and it appeared that no one could hold it together.

The Rise of Senator Palpatine

Palpatine, an unassuming senator, began his road to power during this time of social injustice and rampant corruption. Palpatine was self-effacing and, despite a record showing promise, was mostly ineffective in the Senate. His plodding, methodical way seemed at odds with the mercurial shifts of power and agendas which were the reality of the collapsing Senate.

Palpatine failed to take advantage of opportunities for placement on important advisory boards and powerful committees. He was noted as a keen observer, but he was reluctant to present his observations unless pressed by his colleagues. The senator rose slowly, hampered by an apparent lack of ambition. His only notable achievement was a remarkable absence of enemies, attributed as much to his weakness within the Senate as to his unimposing personality.

But it was all a ruse, for Palpatine was more than he appeared to be. Much more.

The disintegration of the Senate continued, exhausting the entire Republic. On the constituent worlds civil unrest was now commonplace and crime blossomed. Some worlds threatened secession. Others pledged their loyalty over the hypermedia while doing what they pleased. The uncorrupt senators realized the danger to the Republic and all it stood for. The corrupt senators could see the need for stability, if only to preserve as much of the Republic as possible for future plundering. A void existed, and it demanded to be filled.

Senator Palpatine seized the moment. Through fraud, clever promises, and astute political maneuvering, Palpatine had himself elected head of the Senatorial Council — President of the Republic.

The loyalists were encouraged that Palpatine had not fallen in with the corrupt senators during his tenure, while the fallen senators took heart from Palpatine's apparent docility. Each side believed Palpatine would serve their needs. Each side could not have been more wrong.

The New Order

The new President exceeded everyone's expectations. In the midst of chaos, the previously underrated senator began the wheels of government turning again after too long a delay. He proved to be an efficient leader, restoring many

of the policies which had lapsed during the waning years. His power supplanted that of the Senate — in these policies only. But as the Senate turned a greater portion of its attention to its internecine struggle, more and more government functions were given over to Palpatine.

The senators of each faction found themselves establishing political debts to Palpatine. The President was the only being in the Republic who seemed capable of getting anything done. Palpatine's power grew. An ever greater number of worlds accepted the President as the voice of the Republic.

It was in this climate of trust that Palpatine declared his New Order and named himself Emperor. Skillfully evoking images of the glories of empires past, as well as promising to lead the Republic to a height unparalleled in galactic history, Palpatine gained ultimate power without any real opposition. When the senators realized what had transpired, they were too weak from their own in-fighting to mount an effective challenge. Those too vocal were silenced. Those considered dangerous were rendered harmless by whatever means were convenient. Darkness and tyranny spread slowly but continuously, entrenching itself across more and more worlds before anyone realized the danger.

The Empire was born.

Palpatine promised to eradicate the corruption and social injustice of the previous galactic government. Instead, he gave the people a program that's main goal was to subjugate as many planetary governments in the galaxy as possible for the personal benefit and glory of the Emperor. He reneged on his promises to the people and instituted a reign of terror and even greater social injustice.

The Old Republic was consumed, and out of that rotted body rose the New Order.

The Structure of the Empire

The Empire is still growing. Policies of expansion established by the Old Republic were never rescinded, and exploration — and now conquest — continues. The Imperial Survey Corps, scientists and scouts charged with exploring the galaxy, has seen its funds cut sharply over the years. Still, a new system is being catalogued for the Empire every 207 minutes by the understaffed ISC.

Most of the recently surveyed worlds have remained untouched by Imperial colonization. The Empire has little use for an expanding frontier. Frontier settlements offer greater freedom to Imperial citizens and stretch Imperial forces even further. That is not in the best interests of the Empire.

By His Own Hand

Look at the stars. They have been out there forever, hanging like diamonds upon the ebony velvet of space.

The stars were there when the Old Republic reached for glory. They waited, turning their sparkling lights inward when the Republic reached too far and collapsed from its own sanctimonious weight. They cheered when the Senate practically begged Palpatine to take control of the Council. Then the stars watched admiringly as the President used subterfuge, bribery and terror to name himself Emperor.

And I watched, too.

My name is not important, as all that I am is dwarfed by the bright darkness that is the Emperor. But I have always been near him, a servant, a happy slave. It is sufficient enough for me to be close to his power, to feel it reach out to me.

That is all I ask for. That is all I am granted.

The stars. I stare beyond the porthole and view their glory. They are all *his*. More glorious still, they are his by his own hand.

The Emperor.

It has a certain ring to it, that majestic title.

Emperor! The weak Republic had crumbled, but the Empire burns with a fire that will never be quenched. Nothing can destroy the Emperor's glory or his glorious reign.

The Emperor has taught me what others refuse to believe: the dark forces are strongest. He knew it all along, even back in those days when he was a lowly senator. And he has shared that knowledge with me.

Have you seen ambitious officers betray their superiors for inconsequential favors? Have you heard the secrets of local governments and how to bypass their defenses from the lips of weak-principled functionaries? Have you known sadistic gangsters, power-hungry politicians, greedy landlords? Then you know the truth, too — everyone craves the darkness.

The Emperor has simply recognized this truth. And with recognition comes utilization for his own aggrandizement. For he is the black center of the Empire.

He *is* the Emperor. He *is* the galaxy.

And I, like so many others, are content to serve in the shadow of his dark fire.

However, an ISC team occasionally turns up an inhabited world in the process of cataloging. Inhabited worlds mean taxes and other valuable resources for the Empire. These worlds are initially offered a place in the New Order, provided they agree to fall in line with the will of the Emperor. If a world refuses or reneges on its oath of allegiance, then the Empire resorts to military conquest.

Usually the threat implied by the massive Imperial war machine is enough to inspire unswerving fealty in even the most independent worlds.

Citizenry and Laws

All sapient inhabitants of the Empire — except Droids — are considered full citizens. Full citizens are accorded certain rights under Imperial law, namely, the right to follow the precepts of the New Order fully and without question. Other rights include certain freedoms that in no way interfere with Imperial doctrines and goals.

Where in the galaxy a citizen is determines the amount of prohibitions and restrictions governing his or her daily life. The least restrictive areas in the galaxy tend to be in the Galactic Core and in the Outer Rim Territories. Those areas in between find themselves under the greatest

amount of scrutiny and, therefore, face the brunt of Imperial authority.

All citizens are subject to the laws of the Empire, and all must pay some form of tribute to the New Order. Laws vary from system to system, but the most uniform are the Imperial Revenue Codes. Under these laws the burden of proof is upon the citizen to show that he has met all of his fiscal obligations to the Empire. Failure to provide adequate proof is considered an admission of guilt, penalties for which range from confiscation of goods to the increasingly common sentence to labor camps.

Planetary Governments

The Empire has not completely altered the governments of hundreds of thousands of worlds. Such a task would be impractical. The Emperor has left it to his advisors to modify the portions of a planetary government, be it government procedure or members of the ruling body, to conform to the will of the Empire. Less than one planet in 80 has been so modified.

The preferred option is to let a planet run itself much as it has for years, but maintaining a visible Imperial presence so that the rulers know who their ultimate master is. The Empire also encourages the constituent planets to reform their own

governments to conform to the Imperial method. In this way, individual worlds eliminate laws and freedoms, replacing them with doctrines and statutes more in line with Imperial edicts.

The Governors

Planetary governors are Imperial agents who represent the Empire's authority on a single world. Usually that representation extends to an entire system, giving him jurisdiction of all the planets orbiting a single star. A governor has command of all Imperial troops garrisoned on his planets.

This command extends only nominally to the political and intelligence arms of the military, which operate as if a governor's orders were well-intentioned suggestions. The Imperial Navy is supposed to consult with a governor whenever they are on maneuvers or engaging hostiles in his system, and to carefully consider the advice the governor can provide. The Navy routinely ignores this and most other forms of protocol when dealing with planetary governors, unless the governor is well supported by a Moff. The Navy considers governors to be too concerned with the welfare of their planet to be of much use in a crisis.

Governors are appointed by the Emperor's advisors, although a few are just holo-approvals of candidates the Emperor has chosen. Governors are rarely native to the planet or system which they govern. Rash appointments without regard for local sentiment can generate resentment. So instead an outsider is appointed to govern a world, thus bypassing local sentiment completely.

Governors are expected to let a planetary government run its own affairs unless the local course of action puts the planet in conflict with Imperial goals. The governor is then expected to step in and maneuver the policy back toward a direction more acceptable to the Empire.

Imperial policy exists in two different forms for a governor. There are the generally stated policy goals which are distributed by the Diplomatic Service, and there are direct orders received from the Moff. In case of a conflict, the Moff's orders are to be followed, as a Moff presumably has superior knowledge of the specific Imperial policy currently being employed in a particular sector.

Sectors

A sector is an economic and political division which originated in the early days of the Old Republic. Originally a cluster of star systems with approximately 50 inhabited planets, the definition of a sector became vague and the

average sector grew in size during the latter days of the Republic. Now unimaginably large sectors contain vast numbers of inhabited worlds with no regard to limiting factors.

Under the New Order, the Galactic Empire continues to grow and expand, and new sectors are being formed all the time.

The Moffs

A Moff is the being in charge of an entire sector. The planetary governors of a sector are under a Moff's control, and a Moff reports to an advisor, with duplicate reports being sent directly to the Emperor. A Moff has command over a military Sector Group, and is responsible for the security of the entire sector.

Being responsible for hundreds of systems, Moffs take a personal interest only in a handful of worlds. For the rest they first rely upon communications with their subordinate governors, and then upon reports from intelligence units within their Sector Group.

It is not unusual for a Moff to also serve as a governor of a particularly favored world within his sector.

Grand Moffs

There are planets in every sector in the Empire which cause more than their share of problems for the Emperor. Controlling these worlds is difficult, and the Moffs have found that the troubles are infectious, spreading from system to system from the source. The situation is made more difficult by the fact that the infection of freedom has no respect for sector boundaries; coordinating efforts between sectors is often impossible to accomplish in time to stop the spread of unrest. The Moffs have the resources to handle crises on a dozen or more worlds, but if the trouble cannot be contained to those planets the Empire's grasp on an entire sector may be weakened.

Taking the advice of one of his Moffs, Tarkin, the Emperor formed priority sectors. A priority sector is a sector consisting of systems on which signs of unrest have recently been detected, or systems which are in regular contact with systems in which unrest is chronic. A priority sector often crosses the boundaries of standard sectors, containing the worlds from a dozen or more sectors. The title of Grand Moff is granted to the being in charge of a priority sector.

The theory behind priority sectors, codified in the Tarkin Doctrine, is that Grand Moffs will be able to react quickly to problems when they are small, eliminating them before they have a chance to grow and spread. Grand Moffs are therefore given complete freedom to act as they see fit,

without giving advance warning to the Moffs or planetary governors of their actions.

The number of Grand Moffs is growing, and the resources given to each Grand Moff is also increasing. The Emperor personally appoints each Grand Moff, and they report directly to him. Each Grand Moff commands at least two Sector Groups, or the equivalent in other military resources. Some Grand Moffs are given even greater military strength if their priority sector is of crucial importance to the Empire.

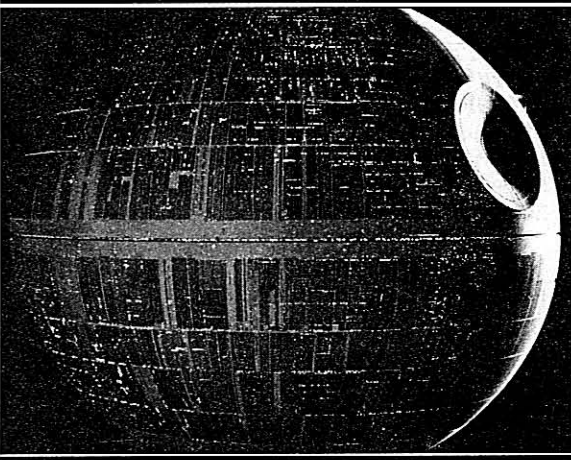

Priority sectors are the first to receive experimental equipment, and their's are the first to have losses replaced. Priority sectors are sometimes given special missions in which the Emperor has a personal interest. The Death Star Project is an example of a priority sector into which the Empire poured resources enough to have formed perhaps a score of Sector Groups.

The Moffs and planetary governors have politely complained about the favoritism shown Grand Moffs, arguing that the Grand Moffs are often completely unfamiliar with the systems in their jurisdiction and take actions which only work in the short run. The governors and the Moffs claim that they are then stuck with the problems and get fewer resources than they ought to have to implement a solution. The Moffs point specifically to the situation at Yavin as the prime example of a Grand Moff's failure. The Emperor, however, will hear none of it.

Servants of the Emperor

Advisors

The Emperor acknowledges that he alone cannot run the Galaxy. He needs advisors. Secure in the knowledge that an Empire founded through treachery cannot be run through trust, he has surrounded himself with advisors who owe all of their political

gains to the Emperor. He has made sure that each advisor has more enemies than allies among the other advisors. Fear and greed serve to bind each advisor to the Emperor. Palpatine finds this arrangement more satisfying than mere loyalty, an emotion on which he will depend only in the case of lower subordinates.

While there are hundreds of advisors, the Emperor rarely travels or consults with more than a few dozen at a time. He sends the others on missions to gather information or spread disinformation through appropriate channels. These missions serve a dual purpose; they do provide the Emperor with useful information. They also keep the advisors isolated from each other, a condition which assures their continued dependence on the Emperor.

Advisors perform many administrative functions for the Emperor. They usually appoint the planetary governors, as well as some of the Moffs, and oversee the political machinery of the Empire. To ensure that no advisor builds too large an enclave of political power, the Emperor has devised a system of adversarial administration for advisors.

An advisor is granted oversight of the administration of systems which are strongholds for one of his rivals. This makes possible deals between advisors more difficult by ensuring that no powerful rivals have oversight of each other's systems. Advisors with weaker political bases are granted a greater degree of oversight than are strong advisors. This system of checks and balances virtually guarantees the Emperor's hold on political power within the Empire, but the administration of the myriad worlds is not as efficient as it was during the better days of the Old Republic. This inefficiency is of no concern to the Emperor.

Advisors have taken to dressing in costumes derived from the histories of their home systems, drawn from the greatest empires of their pasts. Unlike the Emperor, many of the advisors wear lavish costumes as conspicuous badges of their status. Palpatine subtly encourages this form of rivalry, giving his advisors a sense of individuality and power which make them aware of their differences from the other advisors.

These displays are muted when in the Emperor's presence.

Imperial Royal Guard

The Imperial Royal Guard is a special detachment of hand-picked Imperial stormtroopers who serve as the Emperor's personal guards. Each of these soldiers is specially scrutinized

to fit select size, strength, intelligence and loyalty requirements, and equipment and training is lavished upon them.

No firm figures are available on the exact number of Royal Guards serving the Emperor, but speculation ranges from fewer than 50 to the tens of thousands. Whatever the case, the Royal Guard has become a formidable military sub-unit which is directly under the control of the Emperor.

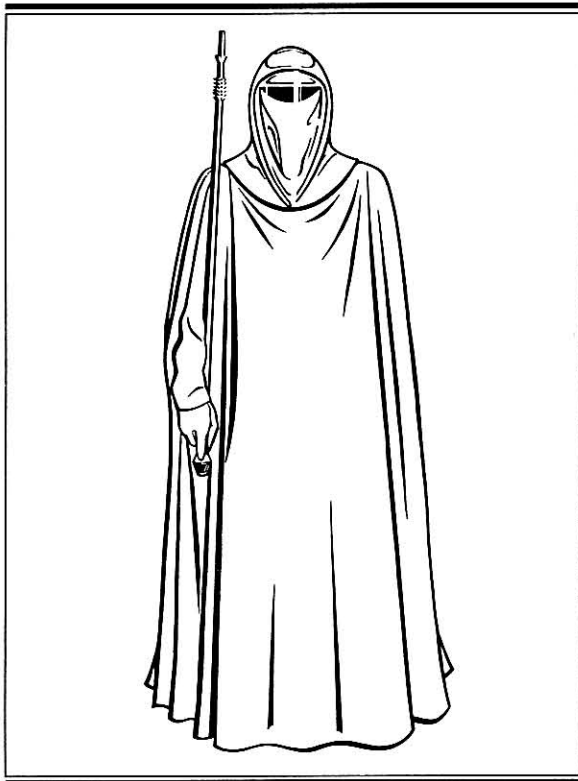

The entire Royal Guard is never sent on combat missions. A few small elements of the guard are sent into combat on a rotating basis, to keep them in fighting trim. On such missions, guard members usually dispense with their ceremonial uniform and don the armor worn by other stormtroopers in the operation. In such instances, the guard members are always part of the same unit. They are never dispersed among the ordinary Army units.

Rumors abound about this fierce fighting force. The legend is that no Royal Guard member has yet been killed in combat. Stories tell of their invincible fighting prowess — always in the service of the Emperor.

Royal Guards wear garb consisting of flowing red robes, red battle armor, and red helmets. Although ceremonial, the red armor does not hamper guardsmen in regards to movement or fighting. This armor is derived from a pair of similar designs, the uniforms of the

Death Watch of the Mandalore system and the Sun Guards of the Thyrsus system. That the armor resembles those of units with such ferocious reputations is no accident, and the red glint of the Imperial Royal Guard armor inspires fear in the hardest of men.

IMPERIAL ROYAL GUARD

<p>DEXTERITY: 5D Blaster: 7D Brawling Parry: 6D Dodge: 7D Heavy Weapons: 6D Melee Parry: 5D Melee: 6D KNOWLEDGE: 2D+1 Streetwise: 3D+1 Survival: 6D</p>	<p>PERCEPTION: 2D+2 Bargain: 3D+2 Command: 5D+2 Con: 3D+2 Hide/Sneak: 6D+2 Search: 6D+2</p> <p>STRENGTH: 3D Brawling: 6D Climbing/Jumping: 6D Lifting: 5D Stamina: 6D</p> <p>MECHANICAL: 2D+2 TECHNICAL: 2D+1 Demolition: 5D+1 Medicine: 3D Security: 4D+1</p>
----------------------------------------------------------------------------------------------------------------------------------------------------------------------------------------------------------------------------------------------------------------------------------------------------------------------------------------------------	-----------------------------------------------------------------------------------------------------------------------------------------------------------------------------------------------------------------------------------------------------------------------------------------------------------------------------------------------------------------------------------------------------------------------------------------------------------------------------------------------------------------------------------------------------------

The Royal Guard armor increases *Strength* code by 1D for damage purposes only. It does not reduce *Dexterity* code or skills.

There are specialists within the Royal Guard who are better at certain skills, particularly *heavy weapons*, *demolition*, *security*, and the combination of *hide/sneak* with *search*. These specialists usually have three more dice on their chosen skills, but lose a comparable total of dice from their *blaster*, *dodge*, *melee*, *melee parry*, *brawling*, and *brawling parry* skills.

The Emperor

The Emperor is a small man, clothed in robes intentionally reminiscent of harmless ascetics on scores of worlds. He walks with the aid of a gnarled walking stick. He appears old, fragile, entirely incapable of running the most ruthless Empire in the history of the Galaxy. This appearance is one of the Emperor's many masterful deceptions.

The Emperor's genius and strength with the Force give him unique insight into the governed races. He knows that the Old Republic was as much a symbol as a reality to many, just as he knows that the Jedi Knights were the remaining untarnished incarnation of that symbol. Working as he had in the Senate, he carefully cultivated the destruction of the Jedi. With the Jedi gone, all pretense for restoring the Republic was abandoned. The

Emperor's true ambition has finally been revealed — to be sole master of more than a thousand thousand worlds.

Under his guidance the Empire continues to grow in power, despite the momentary setback suffered at the Battle of Yavin.

THE EMPEROR

DEXTERITY: 2D+1	PERCEPTION: 4D+1
Dodge: 7D	Bargain: 10D
KNOWLEDGE: 4D+1	Command: 11D
Alien Races: 10D	Con: 8D
Bureaucracy: 12D	Search: 7D
Cultures: 9D	STRENGTH: 3D
Languages: 8D	Stamina: 6
Planetary Systems: 7D	
MECHANICAL: 2D	TECHNICAL: 2D
	FORCE SKILLS:
	Control: 13D
	Sense: 15D
	Alter: 14D

The Grasp of the Empire

The Empire has changed the ways systems interact with one another. It has taken a greater degree of control over information than the Old Republic ever did, and it intervenes in the politics of a single world with an arrogance new to the governed races. These changes have created resentment on some worlds, but the resentment is rarely cause enough for significant support of the Rebellion.

Control of Information

There was a free flow of information during the time of the Old Republic, an exchange of ideas and cultures which promoted rapid growth in almost every facet of the Republic. This flow of information also helped to hasten the decline of the Republic, as the constituent worlds were constantly and quickly updated on the state of the conflict in the Senate.

The environment of uncertainty was self-promoting. The Emperor and his advisors choose to avoid this consequence and forego the benefits the system had given the early Republic.

During the time of the Old Republic, there was a HoloNet which transmitted information throughout the constituent worlds. The HoloNet was extremely expensive to maintain, but it provided the Republic with a sophisticated, flex-

ible means of communication. Consisting of hundreds of thousands of non-mass transceivers connected through a vast matrix of coordinated hyperspace S-threads (popularly known as Simu-Tunnels), as well as the computing power to sort and decode all of the information, the HoloNet was the only method available for real-time holographic transmissions between worlds.

It was horrendously expensive to maintain, costing many thousands of credits per full-channel transmission second per transceiver. The HoloNet was used almost exclusively by the government and the larger commercial houses of the Old Republic. But it did connect the constituent worlds, giving a sense of belonging to the average citizen.

Smaller commercial concerns and individuals never used the HoloNet directly; they relied on the literally millions of traders who traveled the commerce corridors of the Old Republic.

Soon after Palpatine assumed the throne he dismantled the HoloNet, achieving two objectives. First, he made it difficult for any foes not in the Senate to coordinate any resistance to his designs. Any individual system, no matter how wealthy or influential, could easily be crushed by the Empire. Second, the constituent worlds were used to absorbing the cost of the HoloNet, even though most worlds received little benefit from the system during the final days of the Republic's collapse. This gave the Emperor an enormous flow of credits with which to initiate the rapid build up of Imperial forces, manning and outfitting more troops in the first six months of his reign than the Republic had ever mobilized at any one time.

Governor Tarkin urged the Emperor to reinstitute HoloNet technology on a much smaller scale, for use by the Imperial Navy only, and then only at the level of the Sector Group. This proposal was made in a transmission to the Emperor which outlined a plan for ruling the Empire with an economy of force. The Emperor approved of the plan, awarding Tarkin Grand Moff status for his efforts. The plan soon became known, unofficially, as the Tarkin Doctrine.

I mperial Communique #001044.92v

(This is the secret communique that began the policies adopted by the Empire and was later called the Tarkin Doctrine. While the official stance of the Empire presents itself as an enforcer of law and order, unofficially the doctrine of fear held sway. Even though the realization of this doctrine — the Death Star — has been destroyed, the policies are still in effect and are being modified in the wake of the Rebellion's apparent victory.)

To: His Imperial Majesty, Emperor Palpatine
From: Governor Tarkin, Seswenna Sector; Eriadu
Regarding: Increasing the Security of the Empire

Your Majesty:

It has recently come to my attention that what had previously been the quiet grumbling of malcontents on backwater worlds has become dissidence in more civilized systems. Your Majesty will forgive me if I am repeating foundless rumors, but I have heard there is even armed defiance in some sectors.

Coupled with increased resistance to your plans from hot-headed young senators, this has given me pause to think about our security arrangements. I myself have been frustrated chasing pirate bands in my sector, only to have them leap deep into another sector where my forces cannot follow without running into conflict with another moff and the advisor who supports him. If the scattered armed resistance should become organized, they will doubtless learn from the example of other criminal brethren. Granting any rebels the advantage of elusiveness is foolhardy.

I have also noticed that even the excellent pace with which Your Majesty is strengthening his fleets can scarcely provide security for the Empire should a significant number of planets begin to defy your will. We are many years away from a force vast enough to secure every system simultaneously.

I therefore wish that you would consider my recommendations on the following points:

- To provide a swift, systematic response to rebellion as it appears, rather than waiting until it is entrenched, I suggest the formation of Oversectors — sectors consisting of systems in which rebellion is newly born, or systems which maintain frequent contact with systems in chronic unrest. These Oversectors would be formed without regard for the boundaries of standard sectors. The forces of an Oversector would be able to respond to threats quickly, while the threats are small.

Liquidating a dozen small threats is easier than rooting out one well established center of defiance. As an Oversector is created only from problem worlds, they should be given a greater quantity of forces than an ordinary sector. I would think that three Sector Groups should be the average.

- Give the command of an Oversector to a single individual who reports directly to you. This will bypass any delays created by political opportunism in your advisors.

- Cannibalize existing HoloNet tranceivers, modify them for use and put them in the flagship of every Sector Group in an Oversector command. Place similar facilities within His Majesty's command ship and within Imperial City. This will enable your forces to respond to threats in minutes rather than hours or days after the fact. Imperial forces will be able to coordinate to a degree impossible among an enemy whose fastest means of communication is a rendezvous at a common system.

- Rule through the fear of force rather than force itself. If we use our strength wisely, we shall cow thousands of worlds which might otherwise consider rebellion to some degree. We can do this through superior coordination and manipulation of information. For example, Oversector groups could coordinate to make a series of devastating attacks upon known planets of resistance, taking care to eliminate any fleeing vessels capable of making hyper-

space. The operation would take several days in order to jump to all suspect planets in the area of operation.

After the operation, we could report to the media that a single Oversector group conducted a single day operation (without specifying the day) which was successful, eliminating resistance on each of the worlds included in the operation. Granting the citizens the impression of an overwhelming force, one against which resistance would be futile, would certainly reduce the chance of a citizen fostering such resistance.

• Your Majesty, it has long been my contention that the average citizen has no grasp of numbers nor a head for calculation. I maintain that one of the reasons for the effectiveness of the Star Destroyer is its size. When citizens look at a Star Destroyer and then look at the craft which might be made available to attack it, even the best mind among them wishes to reject the notion rather than approach the problem tactically.

I think this effect could be exploited to a far greater degree. The average citizen deals in symbols, not rational analysis. If we present the citizen with a weapon so powerful, so immense as to defy all conceivable attack against it, a weapon invulnerable and invincible in battle, that shall become the symbol for the Empire. We may need only a handful, perhaps only one of these weapons to subjugate thousands of thousands of worlds each containing millions upon millions of beings.

This single weapon must have force great enough to dispatch an entire system, and the fear it shall inspire will be great enough for you to rule the galaxy unchallenged. What do you need with the senatorial council when you can give direct control of territories to the regional governors? Sweep away the last remnants of the Old Republic and let fear keep the local systems in line — fear of our ultimate weapon.

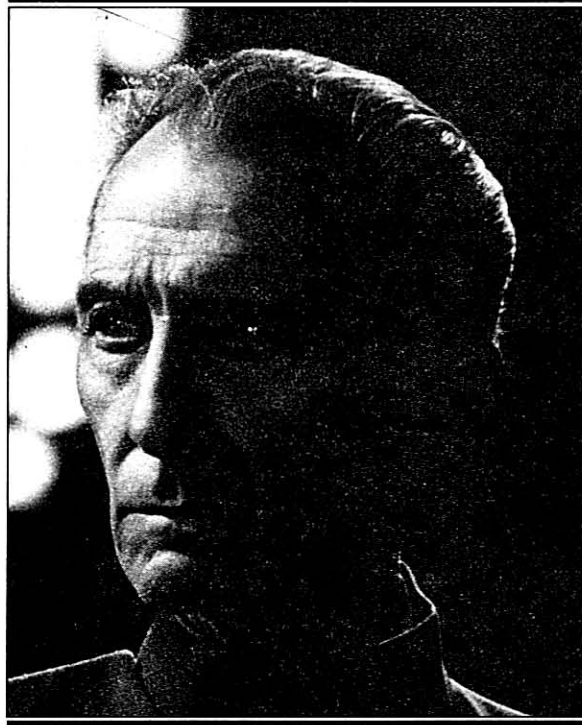

C

hapter Two
COMPNOR

(A report from Imperial Intelligence to an unnamed Grand Moff, prepared shortly after the Battle of Yavin.)

COMPNOR, the Commission for the Preservation of the New Order, was formed in Imperial City months after Palpatine assumed power. Initially COMPNOR was little more than a social gathering for idealistic young beings who saw in the New Order a deliverance from the chaos of the dying days of the Old Republic.

One of the Emperor's advisors, one Crueya Vandron, saw the potential worth of a populist

movement which could be molded into a useful political tool. Overt encouragement and discrete funding were provided, giving COMPNOR the appearance of a spontaneous organization enjoying phenomenal growth.

Crueya Vandron gave COMPNOR the resources to grow, but the Emperor took a hand in the shaping of the organization. His methods were patient, defeating his opponents within COMPNOR not through violence or threats, but with a hidden, gentle, consistent pressure which wore the opposition down. Those who opposed the change in COMPNOR never even knew the Emperor had done anything to instigate the changes. Most could not even explain how the nature of their organization differed from what they had envisioned.

Key members of the group were approved for the Select Committee, that part of COMPNOR that would oversee the rest of the organization, with implicit approval of the Emperor. Then the changes became more sweeping. The Emperor's peculiar genius was again demonstrated — he had succeeded in having his enemies unknowingly choose exactly the course of action he desired them to choose.

COMPNOR is no longer an innocuous social club. It has become a powerful tool for the New Order. COMPNOR actively attempts to build the ethic of the New Order into the life of the average galactic citizen. COMPNOR is also recruiting young beings in huge numbers in order to assure that future citizens will consider the Old Republic a relic of the past, committing their lives totally to the New Order.

Select Committee

The Select Committee is the ruling body for COMPNOR. The Select Committee has a variable number of members, and the COMPNOR charter provides for electoral and honorary

C OMPNOR

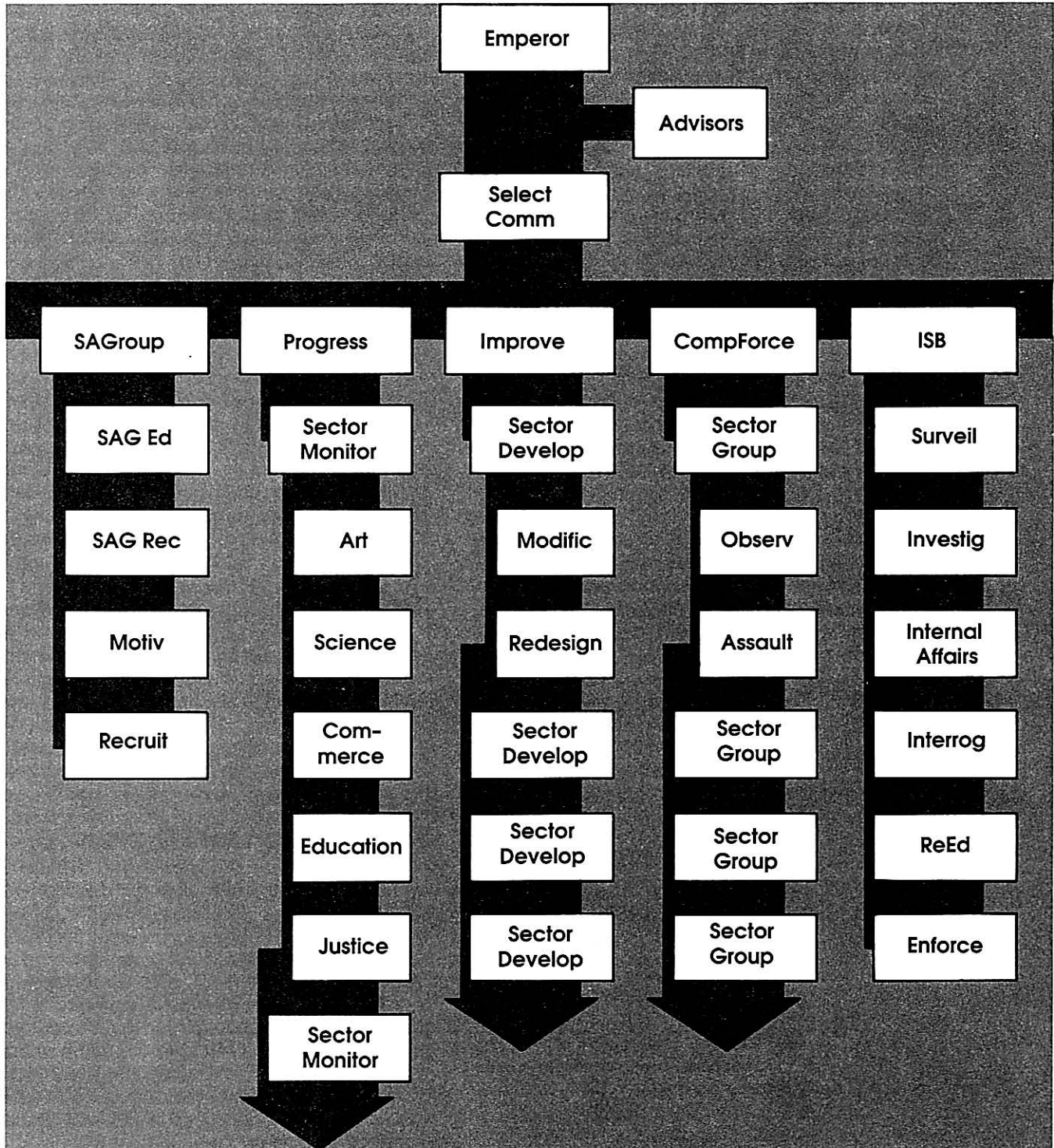

CATHLEEN HUNTER

means of being named a member of the Select Committee, but these are seldom invoked any more. At its height, the Select Committee contained over 25,000 members. The shadow of the Emperor then fell across the Committee, and membership declined precipitously.

No one knows exactly how many members there are now. Those in the lower echelons of COMPNOR believe there are still 15,000 or more members. Those who are higher up quietly guess that there are perhaps one hundredth that number. The Select Committee declines to dispel the confusion.

SAGroup

SAGroup is a contraction for Sub-Adult Group. SAGroup is the largest branch of COMPNOR. SAGroup has recently exceeded two trillion members, and it is still growing. SAGroup headquarters most resembles the original COMPNOR, an enthusiastic group who firmly believes the New Order is the best regime for the Galaxy.

Other branches of COMPNOR often recruit from SAGroup, but most other communication with the other branches is carefully screened by the Internal Affairs division of the Imperial Security Bureau (ISB). SAGroup is intentionally kept ignorant of most of the darker aspects of the Empire.

Those in SAGroup headquarters coordinate all of the communications for the divisions under them. They do the job but not very efficiently. There is a tradition of mishandled communications which are passed along as folklore to new members of SAGroup.

SAGEducation

The program which gained COMPNOR a positive reputation on thousands of worlds, SAGEducation succeeds in bringing learning to billions of young beings who had fallen into the cracks during the breakup of the Old Republic. It is largely unaffected by the changes in the rest of the organization, and continues to be popular on almost every world served by SAGroups.

The personnel of SAGEducation are as dedicated as those in SAGroupHQ, but they are better organized. They believe in the future of the New Order, and they believe in teaching their charges to become as well educated as they can in order to be better galactic citizens. Many of the educators have been surprised that this attitude has caused the occasional confrontation with the ISB. The continued popularity of SAGEducation has moderated the ISB reaction, but some of the educators are

emboldened to surreptitiously question the New Order. The ISB will respond.

SAGRecreation

SAGRecreation was created to provide wholesome activities for member beings. Wegsphere is there one real triumph, a competitive sport which has caught on in thousands of systems. Everything else suggested by SAGroupHQ is often ignored by the SAGRec personnel.

Some branches of SAGRec have been filled with future CompForce hopefuls. These SAGRecs engage in harsh physical training and wargames as an introduction to military training. Some have been reputed to hold exercises with blasters, casually ignoring the removal of the stunsafes which prevent lethal fire.

Motivation

Some of the SAGroup members fail to live up to the ideals of the New Order. If such behavior is persistent they are sent here to learn how to become useful citizens supportive of the New Order. The reported success rate of the motivation section at reforming recalcitrant SAGroupers is nearly a five-fold exaggeration. The motivation section's reputation for making sure no troublemakers are released before their compliance with the New Order is assured is not an exaggeration.

Recruitment

This group is gently wriggling from the control of SAGroupHQ, goaded by support from the ISB. Their activities are at an all-time high, sometimes offering impressive incentives to parents to have their offspring join SAGroup. The goals over the next five Standard Years is to have membership in SAGroup swell to 10 trillion.

The Coalition for Progress

The Coalition for Progress is the central authority and clearinghouse for the reports of all of the Sector Monitors. COMPNOR members inside and outside of the coalition simply refer to it as "Progress." Progress has grown from an understaffed and underwhelming authority on culture in the Empire to a large bureaucracy with surprising efficiency at gathering and analyzing the information which pours in from the Sector Monitors.

Recent events, however, have tied Progress much closer to the Imperial Security Bureau. They now gather low-level intelligence for the ISB, sifting through literally millions of reports on the chance of uncovering an as yet

undiscovered activity of the Rebellion. Any pattern of activity which strikes Progress as suspicious is analyzed, and the findings are passed on to the ISB.

Sector Monitor

A Sector Monitor is a collection of agencies which theoretically report on the cultural progress within a sector toward the perfection of the New Order. The Sector Monitor does rough sorting of data, largely by division type. If Progress considers data sensitive, they handle the encoding of the reports and update the COMPNOR members as to the security level of their reports to the Sector Monitor.

Below the Sector Monitor are collections of COMPNOR members dispersed throughout the systems of the sector. These collections are loosely grouped by the type of social activity on which they are reporting.

Art

The Art group is easily the most despised group within Progress by most of the citizens of the Empire. The Art group reports on the suitability of art forms within their sector, trying to apply the same austere tenets of the New Order to every art form within the Galaxy; sand-casting of Tatooine, transnovels of Cadomai, participlays of Besn, the dynamic holosculptures of Ediorung — all are judged by the same inflexible criteria.

To the thousands of sophisticated races who have developed their cultures over millennia, the Art group has as much right to pass judgment on art as an uneducated native has. Most would accept the native's view as more accurate.

When Art has something particularly scathing to say about a work, they attach a holopanel near the site which continuously replays their review. The intense red of the wavelength given the text in these holopanel has given the name "scarlet" to any particularly unfavorable review. "Drawing a scarlet" is now a guarantee of success on scores of worlds.

Science

The Science groups were originally their own group within COMPNOR. A political reshuffling landed them under the wing of Progress. Science does much more than report on the political acceptability of scientific research within their sector. They actively coordinate research and development efforts geared toward enhancing scientific progress in the New Order. Many of its members are scientists of firm conscience who have re-

sisted COMPNOR's pressure to concentrate on projects with direct military applications.

While the ISB keeps a close watch on the Science group, COMPNOR takes few reprisals against those scientists who continue to do basic research within their fields at the expense of weapons programs.

Commerce

In the early days COMPNOR used the Commerce agencies to work in conjunction with the large commercial houses to design programs for economic improvement on worlds within the Empire. Successes included the Corporate Sector System Development Programs, known as D-Progs. D-Progs gave crucial and effective aid to frontier worlds which had been neglected during the collapse of the Old Republic, making them economically self-sufficient. In return, the Corporate Sector secured profitable new markets.

Other programs were less worthwhile, including the well-publicized disaster of the Native Management and Industrialization Service (NAMIS) on Gamorr.

Now Commerce is an organ for industrial espionage against large commercial houses and political strong-arming of those smaller commercial interests which might have sympathies for the Rebellion.

Commerce wants to make certain that the Empire loses no more valuable technology to the Rebels. Commerce does pass on breakthroughs produced in the Science group to those corporations which have served the Empire well in the past.

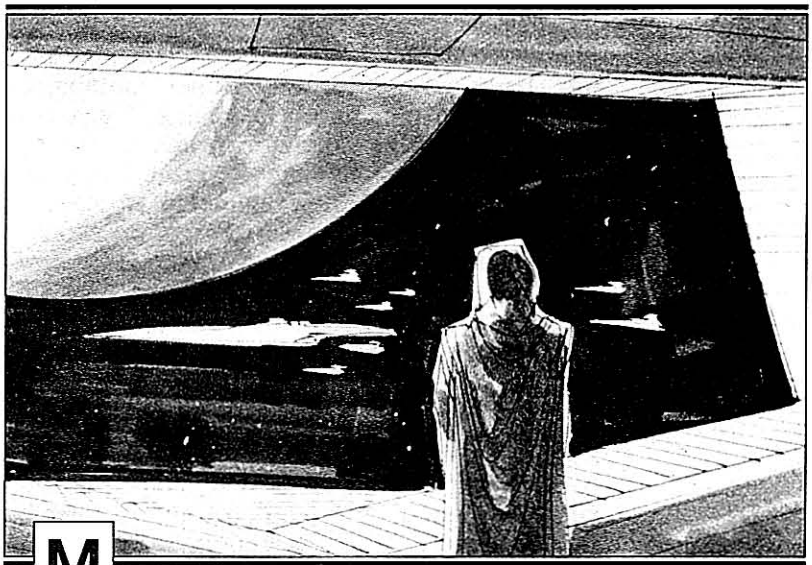
**M**

embers of COMPNOR can be found all over the Galaxy proclaiming the virtues of the New Order.

Education

The Education agencies were given the mandate to homogenize the level of education throughout the Empire, to place emphasis on the values cherished by the New Order. Unlike SAGEducation, the Education agencies actually do no teaching. Instead they generate data reports on how individual worlds should transform their educational system in order to conform with the dictates of the New Order. The Education agencies are now the subject of derision in a great majority of sectors in the Empire.

Consequently, the Select Committee uses the Education agencies as dumping grounds for incompetents who are politically useful to retain somewhere in COMPNOR. With the exception of SAGroup, the rest of COMPNOR knows this is the case. Being reassigned to an Education agency is called being "sent to the idea dusters."

Justice

The Senatorial struggle in the Old Republic left a legal legacy full of complications, problems of precedence and reflexivity, and inequities under the law. Justice agencies were given the job to produce a uniform legal code which would apply to the entire Empire. Unlike the Education agencies, the members of Justice realized that they would have to implement their ideas as well as present legal theories to the local systems. The legal system improved greatly with the fervent efforts of the members of Justice.

Recently, Crueya Vandron has been trying to work the idea of Imperial Infallibility into the code. His efforts have been resisted almost to a being within Justice. As a result, the ISB has been harrasing individual members, occasionally trumping up charges against less prominent members in order to intimidate the more politically powerful. Progress has been assigning new members to Justice who see things the way the Emperor would like them seen.

The Coalition for Improvements

Originally the Improvement Division of the Commerce agencies, Improvements became its own group when the Select Committee began reorganizing COMPNOR along the designs "suggested" by the Emperor. Improvements receives copies of Progress reports as forwarded by the ISB. Progress reports cases of system deviance from the ideals of the New Order to the ISB. The Imperial Security Bureau assigns Im-

provements those cases which will require long term solutions, especially when those solutions are best not associated with the Empire.

Sector Development

Resources available to each Sector Development agency vary greatly. While the Emperor personally approves of the methods of Sector Development, there are other short term projects which are given funding priority. Most Sector Development agencies have adapted by initiating low cost strategies, then pouring in precious funds to whichever strategies demonstrate the greatest promise.

Sector Development contains two departments, the Department of Modification and the Department of Redesign.

Modification

To the public, Modification is an association of technologists and system specialists who help local systems modify their technology to Imperial standards. While they do perform some of that, their primary and secret purpose is to slowly modify social conditions and institutions to cement a system's loyalty to the New Order.

Modification covertly promotes the careers of beings whose politics match the Empires more closely than their rivals. They create small perturbations which can interact to form social problems of bewildering complexity, and then help their chosen agents solve the problems. Their methods take a great deal of time and patience.

The Rebellion is, in the parlance of the members of Modification, a "site specific cause of negative feedback." Modification sees the Rebellion as too specific to regions within the Empire to ever have a lasting effect on the Empire as a whole, especially given that the Rebellion spends much of its time reacting to the activities of the Imperial Military. Modification is content to wait the Rebellion out.

Redesign

There are times when Improvements decides that a local system is virtually unsalvageable in its current form — no degree of small modifications will suffice to move it securely into the fold of the New Order. If a planet is deemed to be of marginal value, the problem is handed over to the Imperial Military. If a planet is considered to be of some value, Redesign will often augment the military's actions.

Redesign describes its works with the murky vocabulary of "state changes", "shock

vectors” and “bifurcation manifolds”. These neutral terms mask some of the most evil actions taken on behalf of the Empire. Redesign agencies rarely have the resources to handle more than one world in a sector at a time, a small mercy for the citizens of the Empire.

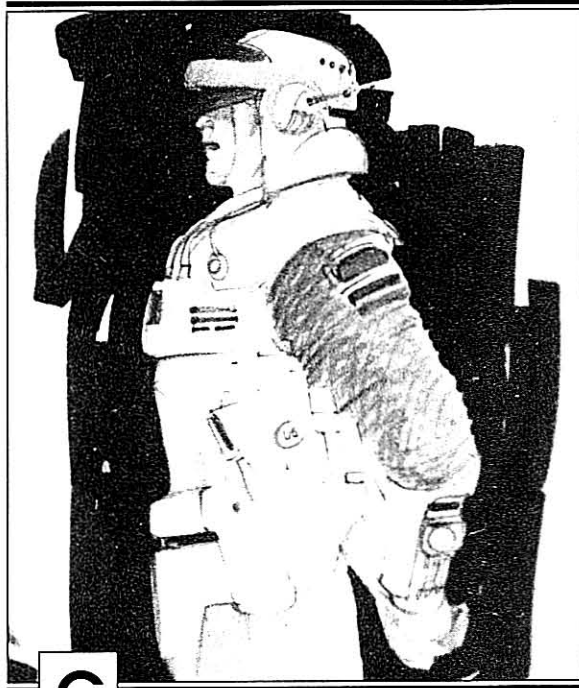

CompForce troopers receive priority treatment in the allocation of equipment, resources, and medical attention.

CompForce

CompForce is the military arm of COMPNOR. They were created to give the Emperor large forces other than stormtroopers on whose loyalty he could absolutely rely. They are carefully selected volunteers from SAGroup. Assault volunteers are given rigorous training, and then put nominally under the command of a Sector Group. Observation personnel are selected from a different pool of beings than Assault personnel.

Regular Army and Navy personnel have no love for CompForce. Regular troopers and deckmen feel that CompForcers are given priority when it comes to new equipment or the allocation of valuable resources, such as medical attention. In sectors where COMPNOR has a particularly strong influence this is true. Most of the dislike stems from CompForcers’ rabid adherence to the principles of the New Order. While the average deckman or trooper believes in the basics of the New Order, they believe they have better things to do with their spare time than self-examine their lives in excruciating detail to

see how they might better serve the New Order. CompForcers are treated coolly throughout the military.

Observation

Observation units are despised almost to a being by the regular military. Observation units are members of SAGroup selected for their political loyalty. In theory, they are then sent to observe the Imperial military in action so they might learn how the Imperial war machine works. In practice, they are spies who insure that the officers and enlisted folk of the Imperial military are acting with the proper respect for the New Order.

Everyone serving knows they are spies (with the possible exception of CompForce assault teams, who are pretty blind to the shortcomings of the New Order), and officers and enlisted personnel alike detest having to pretend otherwise. Acting in an insulting manner to an Observation officer is a good way to have a promising career cut short, and Observation knows this very well.

When their stint with Observation is up, most volunteers forgo joining the military but opt for the ISB or another COMPNOR group instead.

Assault

There is no branch of service which takes higher casualties in training than the Assault arm of CompForce. SAGroup has such a large supply of primed volunteers that the Assault arm can afford to train by attrition — if you make it through training you are combat ready. Of the 88 percent who fail to make it through training, nearly one quarter of these are combat fatalities. There is little exaggeration and a lot of perverse pride in Assault’s claim that “two die for every one that gets through.”

The ferocious training and indoctrination of Assault arm does provide strong unit cohesion for its troops, as well as instill a willingness to fight on despite heavy casualties. Training-by-attrition does have a serious defect in that it selects those who have been merely lucky, as well as those who have natural combat skills, and it processes so many volunteers through training that it does a mediocre job of teaching vital combat skills to its soldiers.

In the field, this lack of training shows in higher than necessary casualties and failure to succeed in objectives against well-trained troops. This deficiency is not seen as important for these reasons; the supply of volunteers is not large, but it is certainly larger than the

pool for the Rebellion, and training an Assault arm volunteer is cheaper than training the equivalent trooper in the regular Army.

Additionally, the Assault arm is a recent addition to the Imperial military. Some of the units are lasting long enough to train themselves and pass on the skill to the volunteers who replace casualties. These veteran units are gaining a fearsome reputation which is deserved.

Imperial Security Bureau

The ISB was created to increase the Emperor's knowledge of political events, and as an intentional rival to Imperial Intelligence. While the ISB does not have the quality of intelligence operatives that Imperial Intelligence does, it is now the larger organization and is staffed solely by those loyal to the New Order. The competition has also served to put a little fire under both organizations as they try to insure that their intelligence is as good or better than the rival's.

The ISB Central Office is a mammoth complex in Imperial City which handles all of the communications and coordination tasks for the whole of the ISB. The Commission of Operations transmits assignments through the Central Office directly to the Sector Officer for the branch in question; Surveillance, Investigations, Internal Affairs, Interrogation, Re-Education, and Enforcement. Any coordinated actions between the different branches within a sector, or between ISB resources in separate sectors, is dictated by the Commission and directed by the Central Office. Independent coordination by sector resources is strongly discouraged.

The ISB serves more of a police function than does the Ubiquitorate in Intelligence. The ISB has a more public presence. Its operatives, especially in Surveillance, will often identify themselves as members of ISB, the intimidation value being worth the loss of secrecy.

Surveillance

Surveillance is the largest branch of the ISB, containing nearly 35 percent of all personnel. The quality of recruit varies greatly within Surveillance. The spectrum includes promising, eager, but poorly trained candidates straight from SAGroup, CompForce Observers with better training, veteran officials from Progress's Sector Monitors or Improvement's Sector Development, to local contacts with an interest in subverting other local powers.

Surveillance's main purpose is to uncover beings or activities which *might* be helpful to

the Rebellion or otherwise obstruct the Empire's plans. If Surveillance has enough suspicions, they will turn the case over to Investigations so more thorough action can be taken.

The second purpose of Surveillance is putting the fear of the Empire into citizens who can be scared out of helping the Rebellion.

This is the use to which the rawer recruits and less skillful veterans are employed.

Investigations

Investigations draws its talent from proven agents in Surveillance, also drawing a substantial number from the Modification operatives who are looking to put their expertise to use in a new direction. Their professionalism and expertise is considerably higher than that of Surveillance.

Investigations agents have direct communication links to military forces in the area. These links are pre-approved by the Select Committee and the appropriate Moff or Grand Moff. Investigations individuals or teams may therefore call on a considerable degree of firepower if things become rough. This action was taken as a way of cutting down response times to legitimate Rebel threats which are too large to be handled even by a team of competent agents.

It is a measure of the success the ISB has enjoyed with this tactic that many Rebel bases were forced from heavily developed worlds, where ISB agents could operate unnoticed, to backwater worlds which deprive the ISB agents of convincing cover identities.

Investigations has developed a grudging respect for the Rebel Alliance and its agents. A body of lore surrounding the story of the hunter and hunted, and how quickly the distinction can turn, has grown quickly. A few, such as Mar Barez's continuing struggle against the Rebel spy Tiree, and Huorne and Parl's series of gambits against the Rebel Mon Cal Ackbar, have become legend.

Internal Affairs

Internal Affairs watches the rest of COMPNOR. Closely. Their agents pay special attention to Science, Commerce and Justice groups within Progress, and Enforcements in the ISB. Whether or not Internal Affairs has the authority to monitor the Select Committee is not clear; it is clear that Internal Affairs does not consider the Select Committee to be above suspicion. COMPNOR rules and procedures have always been pretty sloppy on the point of internal policing of their members. Internal Affairs takes advantage of every

ambiguity and gray area to expand their power.

The agents of Internal Affairs are isolated from the rest of COMPNOR. They have developed their own jargon, their own interpretation of the New Order, and have recently reorganized the agency to give lone agents greater authority to act on their own initiative. Other branches of COMPNOR have complained about the unusual autonomy of Internal Affairs. Crueya Vandron or the Emperor, perhaps both, must support this mode of operation, for nothing has been done to stop it.

Internal Affairs calls their field agents "keyns", after a renown tracking carnivore of the Gontzol system, while members of the investigative staff who go over all the information retrieved by the keyns are called "dirtbugs", a term they consider to be complimentary.

Internal Affairs has an amazing collection of terms to differentiate between the ways they conduct an investigation. To "audit" is to conduct an investigation in which the target and everyone around him knows the investigation is being conducted. "Finesse" is a way of investigating a person by asking their help in rooting out other traitors in the hopes they will give away incriminating evidence in their eagerness to finger others. "Scattering" is the technique of grabbing someone against whom you have no evidence, then watching the behavior of his associates to see if any react in suspicious ways.

"Crustbusting" is harrasing a suspect in the hopes he will do something criminal. "Cultivation" is allowing a suspect against whom you have evidence of minor wrongdoing to proceed unhindered so agents can catch the suspect and any associates in a larger crime, while "irrigation" is covertly staging events so a cultivated suspect has a greater opportunity to commit a larger crime.

To "Jabba" is to set a suspect up in a no-win situation in which he must, at least technically, commit a crime. Internal Affairs then promises to forgive the crime if the suspect does a few favors. Doing these favors inevitably causes the suspect to commit some other crime, which will be forgiven if the suspect

does these few other favors. There are over a hundred terms for the fine shadings of operations which Internal Affairs conducts.

Interrogation

Those beings caught by Investigations who are suspected of knowing more than they have been willing to divulge are sent to Interrogation. The information uncovered is sent back to Investigations. No one really knows what then happens to the suspects. No one really wants to know.

Re-Education

When Internal Affairs convicts a COMPNOR member of a crime, the member is sent to Re-Education. Many of these actually do return to COMPNOR, although they are always sent to a post of lower importance. Co-workers report that it is eerie working with the returnees. The returnees react strangely to the other workers, their conversation seems disjointed, their emotions out of phase with the situation. Officially, returnees are called "Graduates of Re-Education" or "Re-educated". Most COMPNOR members say the graduates have been "Re-brained".

Enforcement

Enforcement provides specialized muscle for the ISB, occasionally for Internal Affairs, but most often they lend their expertise to Investigations. Enforcement is the only division within all of COMPNOR which hires beings who are not COMPNOR members. Not only does this increase the amount of available talent, but Enforcement often has to take actions which the Select Committee would rather not be done by COMPNOR members.

Hiring outsiders causes Internal Affairs to take a keen interest in Enforcement. Internal Affairs considers the use of unindoctrinated personnel to be a bad risk, especially given the delicate nature of many of their missions. Enforcement tries to protect its operatives from unwarranted interference from Internal Affairs. The result has been a tension within the ISB as no one can avoid the conflict completely.

C

hapter Three Imperial Intelligence

(A report from the Imperial Security Bureau to the ISB Central Office, prepared shortly after the Battle of Yavin.)

Imperial Intelligence is one of the few New Order organizations which has remained largely unchanged since the days of the Old Republic. There were four organizations which gathered and analyzed intelligence for the Senate and other agencies of the Old Republic — the Republican Security Organization, the Senate Bureau of Intelligence, the Interstellar Consortium on Technology, and the euphemistically labeled Special Acquisitions Branch of the Library of the Republic.

As the Old Republic began to rot from within, the directors of the four agencies discovered that they were routinely being used by unscrupulous Senators who bribed lower level functionaries within the agencies to pass along misinformation through agency channels, in order to influence important intelligence reports which were presented to the Senate. The Senators' greed caught up with them; they often were too cheap to bribe operatives of all four agencies, relying on the innate distrust of the intelligence agencies toward each other to prevent them from comparing scandocs.

A number of directors met during the last days of the struggle for the Senate. The negotiations were unprecedented in their openness and willingness to compromise personal power in order to maintain an effective intelligence organization for the government. But which government? The directors felt the Republic to be unsalvageable. In their opinion, the rot had gone too far, and there were too many constituent worlds to install an effective new government based on elected representation. A strong central government was needed, exactly the sort of government which Palpatine and his New Order promised.

Next they agreed to quietly and unofficially merge their four organizations. Information would be shared and compared among the branches of the organizations in order to decrease the odds that the information was "contaminated." To oversee this process and the new intelligence organization, the Ubiquitorate was created. This was a governing body for all parts of the organization.

Once Palpatine was in power and the Empire was formed, the Ubiquitorate could operate with the Emperor's blessing, and the pretense of four distinct organizations was discarded. Imperial Intelligence was born.

There are indications that the efficiency, professionalism, and speed with which Imperial Intelligence was reorganized frightened some of the Emperor's advisors, quite a few of whom had used the Republican versions as they wished. Imperial Intelligence believes the flawless transition and expansion of capabilities are the reasons the advisors — through Crueya Vandron — created COMPNOR and the ISB.

The Ubiquitorate considers COMPNOR (especially the ISB) to at best be a misuse of valuable resources. At worst COMPNOR is a case of arming and authorizing talented but untested amateurs to defend the Empire, the entire basis of their strategies and tactics being a few holos of political aphorisms on the New Order. Imperial Intelligence has cautiously presented evidence to the Moff's and Grand Moff's to whom they report, as well as the Emperor himself, that COMPNOR has often incited as much rebellion as COMPNOR has been able to squelch. The Grand Moff's are the only ones who give this information a positive reception, and even then it is mild. Imperial Intelligence is therefore resolutely determined to do the whole job themselves, even if it means cleaning up "the muck left behind by COMPNOR."

Imperial Intelligence

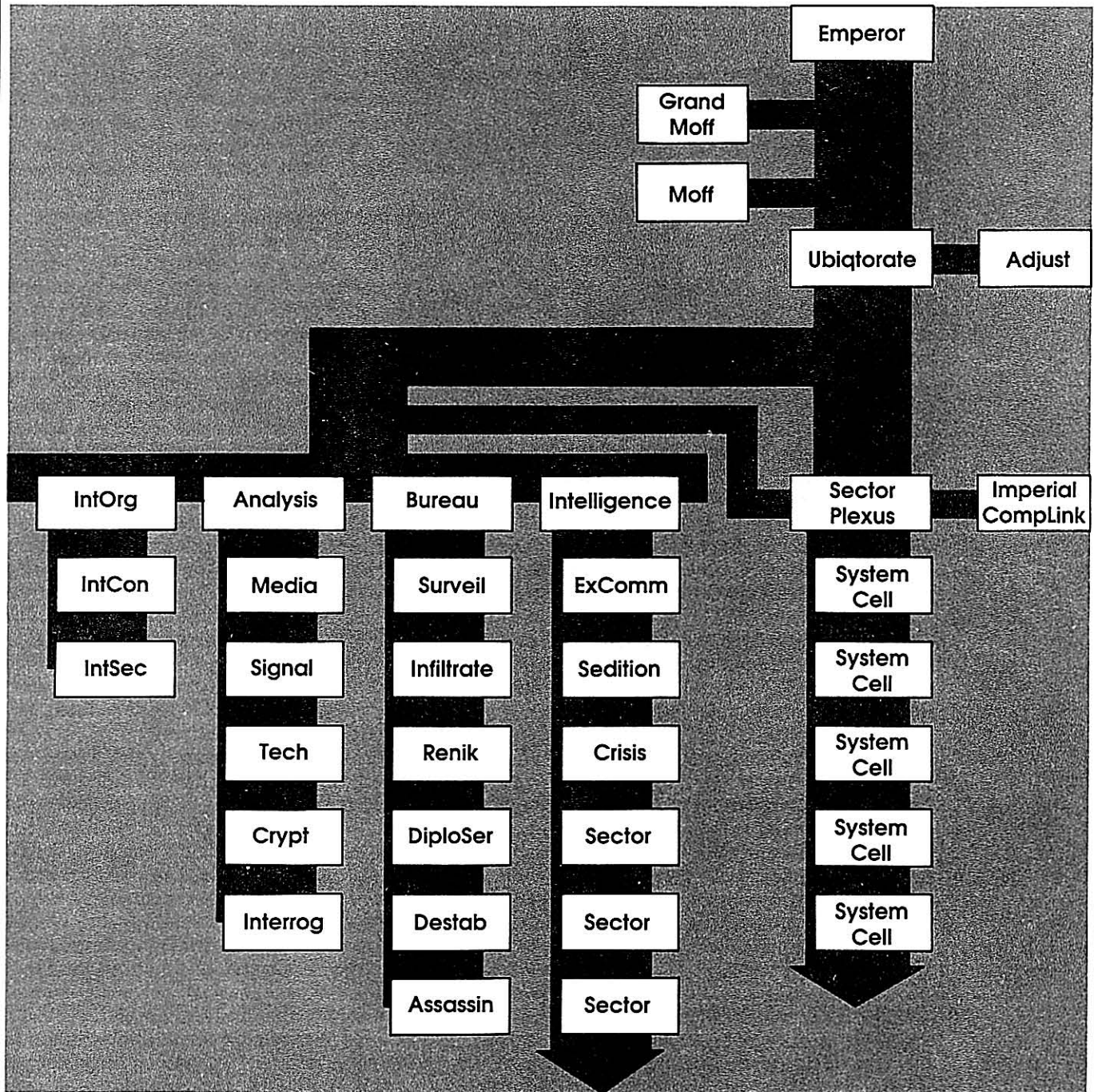

CATHLEEN HUNTER

How to Read an Imperial Intelligence Scandoc

Imperial Intelligence is famous for the security of its scandocs, as well the structure which often baffles new recruits. To help test the security of its communications, Imperial Intelligence often sends sample communications to the Navy or to COMPNOR, challenging them to break the security of the scandoc. No one has yet broken a completely encoded communications.

A fully secured scandoc will look like this when decoded:

From: Pouquor Elegin, Intelligence: Sedition
To: Murtan Andes, Tatooine/3
Subject: Reallocation of Efforts
Confirmed: SEND; TRAN59/64; RECV
Context: 6E6; AMAN; IMMD; ROPT;
Phasecycle: PSEG144513567390290; ICON; 00.12BMUT; 00.30RMUT

Murtan,

Now that the Rebels have fled their base on Tatooine, we feel you should dismantle the Tatooine/3 operation and take any essential personnel with you to the Al'Nasrl Sector. There are strong indications that there is a nascent Rebel movement in that sector.

Murtan, we must deny you permission to continue your contacts with the underworld lord, Jabba the Hutt. The Bureau has had dealings with him before, and despite Jabba's antipathy toward certain Rebel Alliance personnel, he can scarcely be said to have any interest in the New Order other than as a new source of revenue.

To explain ...

From: The sender's name is always a pseudonym. Each sender will have better than a dozen personal code names, as well as several hundred "pool" names which may be used by any member of the sender's branch. Once a code name is used in a particular transmission, Sector Plexus will keep the names and destinations straight for future use.

The next designation is the bureau of the sender, followed by the sender's branch within the bureau. If the sender is from a system cell, the cell designation is the only information given.

To: If the recipient is not in a system cell,

the recipient's name is also a pseudonym. In a system cell the recipient's name is often a pseudonym, but Imperial Intelligence chooses these names with particular care. A random percentage of a system cell's agents are assigned their own names. The remaining agents are given a pseudonym which is the name of some poor citizen who is not connected with Imperial Intelligence in any way.

Murtan is a member of the system cell "Tatooine/3". If he had been a member of a bureau, the designation would be his bureau and branch names.

Subject: When transmitting to system cells the subject is usually plaintext. When transmitting to other branches, code phrases are often substituted for plaintext, just in case. In such cases the majority of the message is embedded in the subject, and the main body of the text will make no sense without the necessary context of the encoded subject.

Confirmed: This status line tells the recipient which send and receive codes were acknowledged and matched without any error. "SEND" indicates the send code was confirmed and matched, while the "RECV" means the receive code was also confirmed. If either code is not confirmed, the message is aborted or altered. "TRAN" indicates how many of the information conduits in Sector Plexus have transmitted the message with all the appropriate codes and the content completely intact and error free. There are several reasons why these numbers rarely match (see "Sector Plexus"). In this scandoc 59 of 64 information conduits have transmitted perfectly.

Context: The first item in this status line is the authenticity of the message. "6E6" is standard notation for 6,000,000; the odds that the message has been faked or tampered with are 6,000,000 to 1 against. 100,000 to 1, or E5 is usually the lowest acceptable security level for field agents. Levels of secrecy in Imperial Intelligence directly correspond to the authenticity level necessary to act upon the information. Bureau-to-branch communications has a minimum authenticity of E8, often rising to E18, while branch-to-branch or bureau-to-bureau communications have a minimum authenticity of E25. Ubiquitorate communications can have an authenticity no lower than E50.

The next item is the action code. "AOPT"

tells the agent that the action described in the text is optional, and the sender expects the recipient to use his best judgment in deciding whether or not to undertake the task. "AADV" says the actions are "advised", which is an Imperial Intelligence euphemism; the sender believes the action should be optional but there is considerable political pressure from above for this operation. An agent must factor these risks in addition to the risks inherent in the mission. "AMAN" means the actions described in the text are mandatory. In case of contradictions, the more recent mandatory action takes precedence. "AEXC" is an exclusive action. The agent is expected to execute this action to the exclusion of everything else.

The security item is next. "PERS" indicates the information is restricted to the recipient. He may inform no one of the message. "IMMD" security means the information is restricted to the immediate peers of the agent and necessary subordinates. This can mean different things to different agents, depending on how Imperial Intelligence is structured around them. "USYS" means the message may be relayed by the agent to any of his superiors in Imperial Intelligence; "DSYS" means he may inform any subordinates; "ASYS" tells an agent he may contact any level of Imperial Intelligence which needs this information. The "SYS" levels are generally reserved for bureau and branch level communications, as field agents have little use for those classifications.

The response item lets the agent know if he must acknowledge receiving the message. "ROPT" indicates an optional response, while "RMAN" means the agent must acknowledge receipt of the message as soon as possible.

Phasecycle: The messages which Imperial Intelligence sends are dynamic, which means software which modifies the scandoc is embedded within the scandoc itself. The scandoc is continually regenerating itself, recoding itself according to a deterministic sequence. This coding will change word order, sentence order, paragraph structure, as well as individual ciphers for words or characters. This technique makes breaking the code of an Intelligence scandoc nearly impossible.

The "PSEG" item is a contraction for product segment. When Imperial Intelligence

codes messages it uses "prime product matching" in which the coding sequence is related to the product of two huge prime numbers (200 to 5,000 digits long), one assigned to the sender and one to the recipient. The actual numbers are kept in Sector Plexus and are unknown to both the sending and receiving agent. The recipient is given a list of PSEGs, digits which come from some segment of the product of the primes. PSEGs are from five to 25 digits in length. If an agent's PSEG matches the PSEG of the message, the agent knows that his SOF (security and operations file) is current with Sector Plexus. If there is a discrepancy, then the agent is out of date. The greater the discrepancy the more out of date his SOF. The agent must contact Sector Plexus for an update.

The next item is the message packet. "ICON" means the smallest message packet with which the scandoc works is a single graphic icon or text character. The other possible choices are "WORD", "LINE" and "SCAN". The size of a message packet relates to the sensitivity of the message as well as the size of the main body of the message; a very large, very sensitive message will almost always be set at SCAN.

An Imperial Intelligence scandoc is constantly regenerating itself. Initially this reproduction is absolutely accurate. After a time the message will mutate, changing about one of every 1,000 of the individual message packets. When these mutant packets are reproduced, some of the message packets sequenced after them will mutate as well. After a while the message is altered to incomprehensible gibberish.

As the mutations are basically random and there is no record of any intermediate scans, there is no hope of reconstructing the original message from sufficiently mutated descendents. The numbers before "BMUT" tells the agent how long before the mutations begin, given in the form days, hours and minutes. The number before "RMUT" tells the agent approximately how often a mutation occurs, given in hours and minutes. For every minute of RMUT, an agent has one hour of time before the message degrades significantly; if a day has passed for every two minutes of RMUT, the agent can forget about retrieving any useful information from the message.

Ubiqtorate

On many worlds "Ubiqtorate" has come to be the name for the whole of Imperial Intelligence. The name came to light in several COMPNOR scandocs which were accidentally transmitted to a media beamcast in the Qeimat system. The scandocs themselves indicated that the authors were not aware of the real role of the Ubiqtorate, and Imperial Intelligence saw no reason to correct their error. From the beamcast the name caught on, as the Ubiqtorate sounded more mysterious, omnipresent and threatening than "Imperial Intelligence".

The Ubiqtorate oversees all of the activities of Imperial Intelligence at the highest levels. Details and tactical considerations are decided by the appropriate bureau or branch of Imperial Intelligence. The Ubiqtorate never concerns itself with those. The Ubiqtorate formulates strategies for the bureaus of Imperial Intelligence or, as has recently become common, presents the bureaus with a set of goals and very broad grand strategic considerations and asks them to plan an effective strategy. With the exception of Adjustments, members of the Ubiqtorate never have any communication with personnel at the sector or system level. They would certainly never deal with an individual field agent.

The members of the Ubiqtorate are anonymous. They are unknown to their subordinates; a member of the Ubiqtorate is likely to be acquainted with the identities of perhaps a third of the members, and to have personal contact with only a handful. When communicating to the rest of Imperial Intelligence, the members of the Ubiqtorate identify the originator as "Ubiqtorate", never an individual. This practice has been imitated by other organizations, most notably the Select Committee of COMPNOR.

Created through a compromise, the Ubiqtorate has become an organization of surprising thoroughness and effectiveness. It continues to improve.

Internal Organization Bureau

Called IntOrg by those within Imperial Intelligence, this bureau's mandate is to protect Imperial Security from outside threats and those which might be generated from within. As IntOrg must deal with the rest of Imperial Intelligence, its agents have cultivated a highly civil manner and a strong sense of political etiquette, and then combined those with complete ruthlessness when the stakes are high and the threat is real.

IntOrg is committed to the security of Imperial Intelligence, but rarely abuses its authority or

conducts political witch-hunts. As a result, IntOrg enjoys a good reputation among the agents of other bureaus.

IntSec

Internal Security Branch (IntSec) is responsible for the physical security of the personnel, materiel and facilities of Imperial Intelligence. Originally considered a branch for the unambitious (especially by members of IntCon), IntSec has upgraded its personnel and procedures in response to bolder attacks by forces of the Rebellion. Their abilities have improved faster than their image; there is still a huge body of IntSec jokes making the rounds of the bureaus and branches.

IntSec officers are the only Imperial Intelligence personnel to obviously carry weapons while within intelligence facilities. They have a great many plainclothes agents who will operate outside the facilities, trying to spot and stop potential trouble before it is realized.

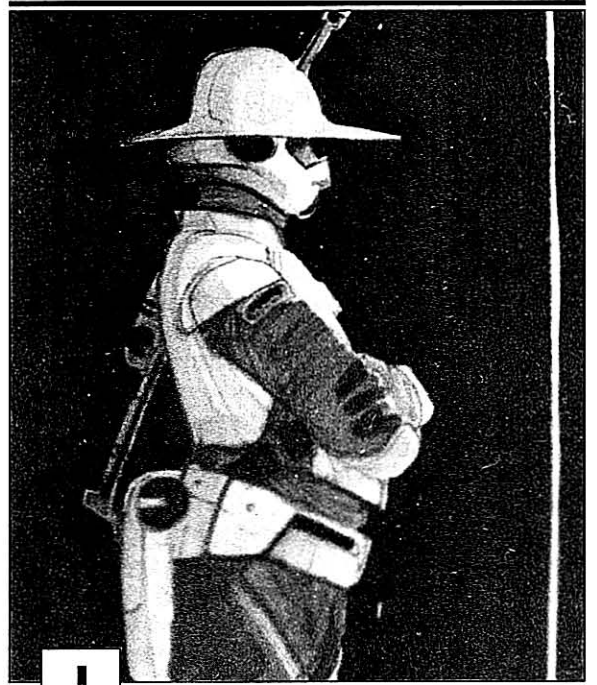

IntSec personnel provide security for Imperial Intelligence.

IntCon

Internal Counterintelligence Branch (IntCon) looks for enemy agents or spy rings which may have been implanted in Imperial Intelligence by the Rebellion or other forces inimical to the New Order. Through Sector Plexus they have an extraordinary freedom to access any data they may

consider useful, in many cases obtaining the information more readily than would a member of the Ubiqtorate. IntCon deals with all levels of Imperial Intelligence, but recently they have begun to devote a greater proportion of their resources to personnel at the bureau level of Imperial Intelligence.

IntCon almost resembles Imperial Intelligence in miniature, with its own sections for Analysis, Operations and Intelligence. The boundaries between these sections often blur, and IntOrg is renown for its loose structure and the informal environment in which its agents work. Information inside IntOrg is heavily secured against access by parties outside IntOrg, but there is literally no information security from other members of IntOrg. This openness is how IntOrg monitors itself — every decision, action, or piece of data generated by a member of IntOrg is available to any other member of IntOrg who chooses to examine it. This lack of secrecy, and often privacy, makes it almost impossible for an enemy spy to operate within IntCon.

Analysis Bureau

This bureau handles gargantuan amounts of data from tens of millions of sources. In addition to looking for enemy activity, it looks for patterns or trends in social data which might be useful to the agents over in Intelligence. Analysis also handles, examines and copies useful technologies, even developing a few of their own.

Media

Media branch pores over public scandocs, newsdocs, holos, comlinks, beamcasts, every form of media in the Empire, looking for patterns or hidden meanings which might betray a clue as to an enemy's plans and operations. Media can, with substantial assistance from Sector Plexus and the Imperial Complink, give at least a cursory examination of all media in the Empire simultaneously. While they regularly concentrate on a significantly smaller portion of the Empire, they do cast their net wide often enough to make a professional judgment as to whether or not a new media source should be monitored on a more regular basis.

Signal

Signal has a saying; "Media examines every media message in the Galaxy. We handle everything else so they can have the easy stuff." This is probably an exaggeration, but the job done by Signal is indeed enormous. While Media monitors the intended message, Signal examines the channel through which the information was transmitted.

Signal samples and checks carrierwave codes and Complink protocols, scan rates on scandocs and imagepacks on holos to see if any information is being squeezed into the space between what a citizen would ordinarily sense. Signal examines line noise to see if it might contain a pattern rather than random error. Broadcasts and beamcasts are examined to see if the backup information sent with the primary information actually matches and, if not, how they differ.

The agents in Media sarcastically refer to Signal as "a group of beings who sort through the garbage in order to discover what a family said to each other at breakfast." Signal does occasionally overreach itself, applying blindingly sophisticated mathematical techniques to squeeze nonexistent meanings from chaotic data. However, it was Signal which discovered that Leia Organa had the plans to the Death Star through the analysis of unshielded ELEL (Extremely Low Energy Level) transmissions from her ship.

Cryptanalysis

When Media or Signal finds evidence of coded communication, they give it to the Crypt. Those who work in Cryptanalysis call themselves "lignyots". Why they call themselves lignyots, and if the word has any meaning independent of Cryptanalysis, is not known by anyone in the other branches. This is as intended.

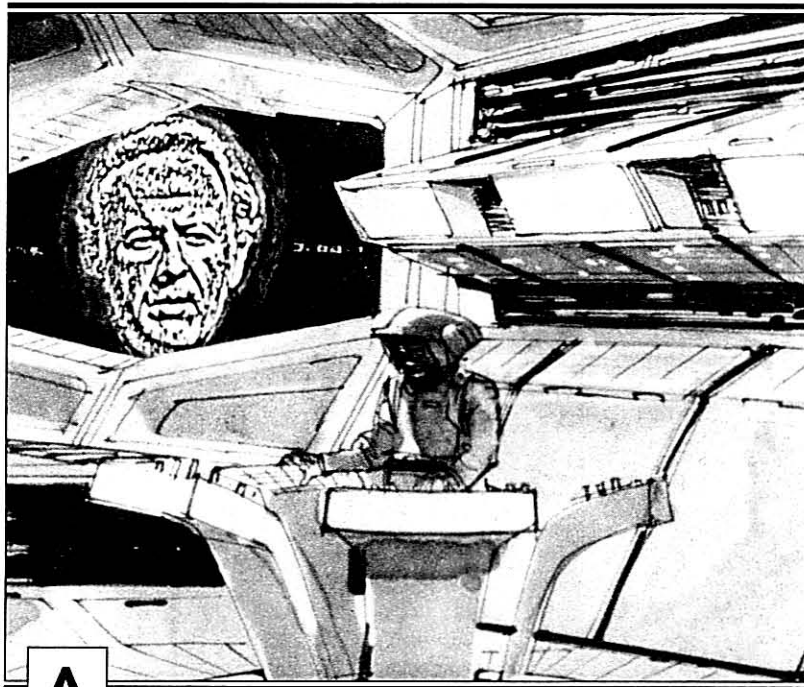

A Analysis Bureau checks sources from all over the Empire in its search for enemy activity.

Lignyots have gone out of their way to create a bizarre reputation for Crypt. They have sent scandocs to other branches in simple codes, which mutate into an unflattering holo if not broken quickly enough. They try to break the security of the communications between branches, forging inflammatory messages on a secure channel when they succeed.

They will often move the entrance to their offices or relocate their facilities entirely, leaving only a puzzling scandoc as to their new location. All communication to the Sector Plexus from the new branch office have invariably been relayed through thousands of points before reaching Sector Plexus, making successful tracing almost impossible.

The bureaus have complained to the Ubiquitorate about the unprofessional behavior of Crypt. Lignyots have always defended themselves by saying the relentless, time-critical nature of their responsibilities entitles them to be a bit crazy. The Ubiquitorate decided that Crypt's behavior was an opportunity rather than a problem. Whenever a Crypt office does something off-beat, another branch is assigned to deal with the problem as if it were an example of enemy-generated activity. The lignyots have calmed down quite a bit since the time one of their branch offices relocated, and within eight days Assassination had found and liquidated it.

Tech

Tech has two jobs — to figure out how an enemy's hardware works, and to provide Imperial Intelligence with hardware which is superior to that. Tech has a lavish budget and a number of highly skilled personnel whose moments of brilliant inspiration can translate into innovative technology. Unfortunately the administration, chosen from

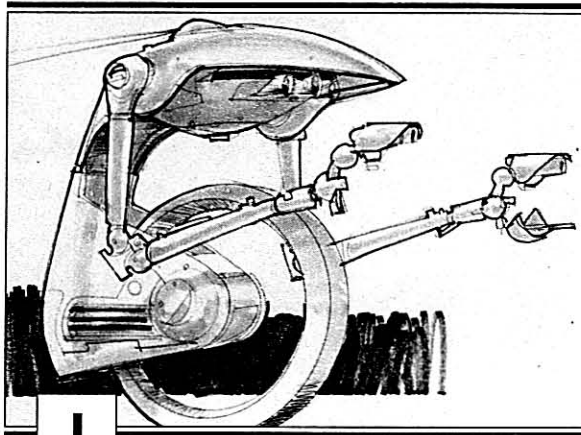

Intelligence uses various interrogator Droids to gather information.

scientists and technologists within the branch, are often lost when having to decide upon the proper priorities for projects which lie outside their area of expertise.

Consequently, Tech does a better job analyzing enemy gear than in producing their own. With the hardware in front of them and orders to figure out how it works, Tech does the job better than anyone else in the Galaxy. It is when they must set their own goals and criteria for project success that the process goes off kilter.

From: Dr. Tobias, Analysis: Tech
To: Hyndis Kogler, Bureau: Infiltration
Subject: Superior Utilization of 3PO Human-Cyborg Relations Droids
Confirmed: SEND; TRAN9/9; RECV
Context: 4E16; AOPT; ASYS; ROPT;
Phasecycle: PSEG388893131;ICON;
 02.00BMUT;01.00RMUT

Hyndis,

I am dismayed that you have not seen fit to reply to my request of an evaluation of our scheme for using 3PO Human-Cyborg Relations Droids for infiltration of enemy facilities. In order to refresh your memory of my previous communication, I herein summarize my important points:

1. 3PO Droids are nearly universal. They could be inserted virtually unnoticed into any Rebel camp, having unquestioned access to most areas. The Rebels would never suspect such a low-cost piece of hardware as being an integral part of Imperial Intelligence.

2. Dr. Lucien guarantees me that only minor modifications are necessary to a 3PO's already impressive array of sensors in order to make it a first-class intelligence-gathering Droid, costing thousands less than the Akrayd Viper Probe Droid.

3. A 3PO unit has built-in hardware, the TranLang III Communications module, which allows it to speak millions of languages. Given that the Rebellion recruits scum from anywhere they can find it, a facile ability with a great many tongues could be a significant advantage, allowing a few 3POs to replace hundreds of less linguistically adept agents. Just think of the savings to the New Order!

4. I can arrange for an impressive demonstration for you if you would like. I am sure the results would surprise you.

Interrogation

When Rebels or other enemy agents are captured by Imperial Intelligence, they are usually sent to Interrogation. Interrogation is not as bloodthirsty as its counterpart in COMPNOR, and it is slightly less effective in cracking Rebels. Interrogation often has a larger purpose, working on the assumption that the Rebellion will work as hard as possible to render any divulged information useless. Unless the Rebel is believed to hold vital information, interrogation will be light. However, a larger number of psychological probes will be made of the prisoner, and direct neuroprogramming of susceptible prisoners will result. The results of their novel techniques are undetectable by everything but the most advanced medical probes, of which there are very few and every one of which is under Imperial control. While expensive, reprogrammed Rebels have a high reliability as double-agents, and have provided Infiltration with some of their best agents.

As the Rebellion is slowly becoming aware of this tactic, Interrogation has modified its approach to stay one step ahead of the Rebels. They now release more Rebels than they once did, including some fairly valuable to the Rebellion. They only reprogram a few. As suspicion falls on all of the released prisoners, the Rebellion is torn whether or not to accept any, all or none of the prisoners. The doubt and debate has been enough to significantly lower the morale at some Rebel bases.

The second modification is to use image surgery on a reprogrammed agent, have Infiltration brief him, and then have him join the Rebel Alliance as an unknown recruit. While this method takes considerable time, no agent who has been infiltrated in this way has yet been discovered.

Bureau of Operations

Of all the bureaus in Imperial Intelligence, this is the one which is called the "Bureau"; no one in Imperial Intelligence for more than a few days would call it anything else. The Bureau handles the covert operations which are beyond the scope or require greater resources than those of the average system cell. The Bureau may send in a team of specialists to a sector, in effect creating an at-large system cell, or they may send a few agents to augment an existing system cell for a single mission.

Surveillance

A point of pride with Surveillance is their small size, especially in comparison with the huge organization maintained by COMPNOR through

the ISB. Imperial Intelligence has less the one agent in Surveillance for every 70 so dedicated in the ISB, yet Surveillance successfully keeps watch on more serious threats to the Empire than does the ISB.

Intelligence gives Surveillance megascandocs of material on potential enemies of the New Order; the genius of Surveillance is the ability to sort through the information and unerringly select suspects who are currently involved in anti-Imperial activity. Surveillance agents are thoroughly briefed on everything which is known about the suspect. Often more than one agent is selected for an important case, and Surveillance actively solicits the help of any available system cells.

Surveillance agents are well trained in a broad variety of skills, including combat skills. They are expected to handle situations by themselves in the field — there is not likely to be enough time to call in backups. Surveillance agents are expected to make arrests if the suspects will get away with a critical crime, and if arrest looks untenable, stop the suspects in any way the agent can.

Infiltration

"There are three ways to defeat your enemy. The first, and most obvious, is to better him in a trial of force. The best way is to have him destroy himself; few enemies are so obliging. The middle way is to destroy your enemy from within. Judicious application of the middle way shall make your blows more effective if you later take the way of force. From the middle way it is also possible to push your enemy onto the path of self-destruction."

— Uueg Tching of Kitel Phard, 54th Emperor of Atrisia

When they join Infiltration, every agent is told the legends of Uueg Tching. The ancient emperor's success against the peoples and nations of the newly-discovered continents was spectacular; of greater interest to Infiltration is the manner in which Uueg Tching managed to subvert no fewer than 30 separate rebellions against his tyrannical rule.

After indoctrination, Infiltration agents are often reassigned to Intelligence, assigned as assistants to a few sector branches, and then assigned to Sedition. The agents learn vast amounts during this period. Many agents have to be released because of overuse of the Mnemiotic drugs given agents to enhance their learning. Those who survive with minds intact know a great deal.

From: Hyndis Kogler, Bureau: Infiltration
To: Dr. Tobias, Analysis: Tech
Subject: Your Droid Scheme
Confirmed: SEND; TRAN9/9; RECV
Context: 5E13; AOPT; DSYS; ROPT;
Phasecycle: PSEG 7519285763950326; LINE;
00.06BMUT; 00.15RMUT

Dr. Tobias,

I have received all of your communications on the use of 3PO Droids for infiltration. We have given it a great deal of consideration. I am responding in sufficient detail to each of your points that you might understand our point of view.

1. 3PO Droids are indeed nearly universal throughout the Galaxy, being one of the 20 most popular Droid models of all time, with more still being produced. This means that if the Rebels have any need for a 3PO they could have easily picked up whatever quantity they need. We suspect their need is minimal. As for the ease of infiltration, the most difficult thing about infiltrating the Rebels is finding some Rebels to infiltrate. Our agents have to be in place for months or years before getting a chance to join the Rebel Alliance. We cannot just ship 3POs to them.

Additionally, it is easier to scan Droids than living beings, as Droids are still simpler constructs and they are far more uniform than any single race in the Empire.

2. I have seen Dr. Lucien's modifications. The Dedicated Energy Receptor is covered with a translucent membrane which from certain angles gives the 3PO the appearance of a third eye, something which will undoubtedly raise suspicions among observant Rebels.

3. I am sure the Ubiquitorate appreciates your efforts to save the New Order a few credits by replacing agents with Droids. I certainly do not appreciate the prospect of being replaced by some mobile garbage compactor from Astromech. I feel Infiltration is best staffed by beings rather than

Droids; we are still more effective than any Droid yet invented.

4. All of this can be summed up by our response to your last point.

Read this part carefully, Tobias. I am extremely angry over your demonstration. On Stensen's Colony there are Ghothian Slime pools which display a greater degree of intelligence than you did when you initiated this project.

I was scanning by my terminal when the security system notified me that a Droid with an improperly coded ID chip had entered the perimeter office a split-second before. I notified IntSec personnel and then grabbed a few men from Infiltration to try and head it off before it reached any sensitive areas within the office. As I rounded the corner I spotted a 3PO waddling casually toward a sector office. It was then I spotted Dr. Lucien's modification. Your Droid had time to say, "Oh dear, there must be some mistake," before we blasted its legs off. Satisfied that the Droid had no weaponry, we interrogated it. I have had no more than the standard course on interrogation given by your bureau, but I had the 3PO spilling its chips before I had holstered my blaster.

Cute idea, trying to insert a 3PO into Infiltration. It was a stupid idea having the 3PO transmit its findings directly to your office for two reasons. First, any unsecured transmissions in our office will be detected — not might be, will be. Second, for direct transmission you had to give the Droid exact coordinates to your office. If we hadn't known where your office was, we would now.

So Tobias, it was a stupid idea to send those eight other 3POs out to find Rebel bases to infiltrate. The Bureau has managed to recover seven of them, but one of them is still out there. If we don't find that last Droid before the Rebels do, you may get a close up opportunity to see how Rebel equipment works.

Once they have finished their stint with Intelligence, agents are then tested to see for what sort of missions they are best suited — double-agents, moles, or "polwocz".

Double-agents are active operatives, taking part in enemy actions against the Empire. Their job is to give Imperial Intelligence good enough information to allow the Empire to do

greater damage to the Rebellion than the double-agent's operations do to the Empire.

A mole is inserted behind the lines, to transfer important intelligence about enemy activities when the opportunities arise.

A polwocz is a type of creature located in the Spinward Sector. Their spawn lay underground, undetected for years or even decades.

Once hatched, the larvae initiate a feeding frenzy which is reputed to destroy entire cities. A polwocz is therefore an agent who is to be used just once, at a critical moment when his use can be devastating to the enemy.

Renik

Renik is the branch in charge of counterintelligence, which is the art of identifying and dismantling enemy spy operations. If a particular spy operation is considered to be potentially useful, Renik hands over all information on the enemy operation to Infiltration, which takes it from there. If the enemy group is considered insignificant or too dangerous to allow continued operations, Renik destroys it.

The branch has built a considerable myth about where the name Renik came from. They now claim an ancient race existed in the Galactic Core called the Delorf. The Delorf were a pastoral race, one which never aspired to technological achievements. But many among them had an innate sense which allowed them to feel treachery and animosity in another being, Delorf or not. Upon sensing animosity in another, the Delorf sensitives would gather and pool their energies into a ritual called "Renik". Renik would cleanse the hostility and treachery from the target being, making him one of the Delorf in mind if not in body.

It is far more likely that the term Renik is derived from the last respected counterintelligence officer in the Old Republic, Admiral Kiner. Being counterintelligence, the name was reversed.

DiploSer

Diplomatic Services is the catch-all branch of the Bureau. It provides a sizable portion of the personnel for trade and diplomatic missions found in Imperial garrisons, as well as political experts for planetary governments and Moff's. Many of these personnel are well trained and expected to perform only their overt duties, with the exception of reporting their action to Imperial Intelligence. Others are more clandestine agents, some sent on specific anti-Rebel missions, but most sent to establish and organize system cells within their area of influence.

Destabilization

Referred to as "the quiet branch", no one hears much about Destabilization. Part of the reason is that Destab keeps its operations very quiet. The rest of it is the fact that Destab operations make a large number of Imperial Intelligence agents queasy. Destab has been known to move from what agents consider legitimate intelligence operations into full-fledged atrocities. Given the

shadowy ethics of Imperial Intelligence, this says quite a bit about Destab.

Officially, Destabilization is the branch which specializes in "taking the fabric which holds a people, society or government together and unraveling it." Agents from other branches suggest Destab's methods more closely resemble shredding.

Assassination

Unlike Destabilization, Assassination is a branch which is wholeheartedly embraced by the agents of other branches; assassination has long been a legitimate means of removal of key members of the opposition for intelligence agencies. The ban on assassin Droids has enhanced the image of assassination being a fair contest between the hunter and the hunted. While Assassination is careful not to unnecessarily dilute this image, its agents are trained to take every advantage, to use every trick and subterfuge possible; in short to weight the contest as much in the favor of the assassin as possible.

Assassination has been careful to select only those targets for which mission success is probable. It is a tribute to their highly trained agents that the actual success ratio is higher than the theoretical one. This has only served to enhance the mystique of Assassination within Imperial Intelligence.

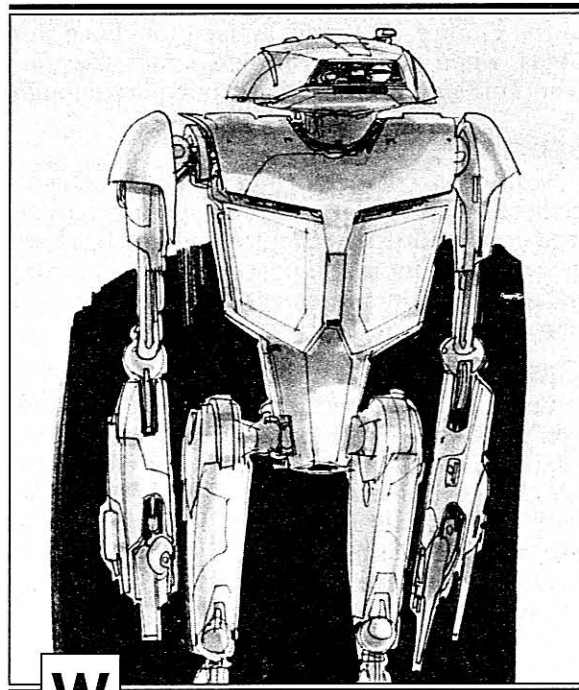

While technically illegal, assassin Droids are still used for certain choice assignments by Intelligence.

Intelligence

When Analysis finishes sorting, cleaning, decoding, or otherwise manipulating the data sent to them, they pass it on to Intelligence. Intelligence has culled experts from all over the Empire. They have recruited military experts, cultural experts, experts in politics, economics, science and technology, experts in almost every possible field of endeavor. Intelligence has plucked experts from universities, the Corporate Sector, planetary governments, artistic movements, religious movements, the media, the underworld — they have pulled in experts from nearly every conceivable place or organization, including some turncoats from the Rebellion.

Intelligence combines the vast knowledge of its agents with the most sophisticated computer models in the Galaxy to predict trends or future actions of the enemies of the New Order. These predictions are refined into reports transmitted to the Ubiquitorate. From these reports the Ubiquitorate establishes priorities and sets strategies for the whole of Imperial Intelligence.

External Communications

Sector Plexus has the normal conduits for information between the Bureaus and the system cells. Ex Comm is a branch with its own communications equipment. While much smaller than Sector Plexus, Ex Comm is used for emergency communication with system cells, or for priority communications with the military forces of the Empire. Ex Comm is used for those rare times when the labyrinthine communication works of Sector Plexus are just not quick enough.

Sedition

Sedition is a branch of Intelligence which specializes in knowledge and predictions on organized opposition to the Empire. Sedition has been growing rapidly in the past few years, keeping pace with the increased resentment to the Emperor's rule.

Crisis

Crisis is not a permanent branch of Intelligence. It is created as need arises, a Crisis branch for each active hot spot within the Empire. A Crisis branch is in constant contact with the Ubiquitorate, and Ex Comm facilities are at their disposal for direct contacts with Grand Moffs, even the Emperor if the situation is dire enough.

Sector

The sector branches are the basic divisions of Intelligence. There is a sector branch for each sector in the Empire, and each sector branch has scores or hundreds of experts

within it. Sedition and Crisis draw from the sector branches as is appropriate for the situation currently under consideration.

Sector Plexus

Sector Plexus is the heart of the information system for Imperial Intelligence. While none of the bureaus are completely centralized, Sector Plexus is the most dispersed. Equipped with the most advanced communication computers and equipment in the Galaxy, Sector Plexus conduits handle better than 99.95 percent of all Imperial Intelligence communications. The Plexus encodes, categorizes, transmits, stores, receives and decodes more messages in a single Standard Day than most planetary communications nets will transmit in over 800 Standard Years.

Sector Plexus assigns each agent or branch office its code number and sequence, and Plexus computers compute and send agents the PSEGs they are most likely to need (see "How to Read an Imperial Intelligence Scandoc"). There are typically half a dozen PSEGs for a field agent, 5,000 for a typical branch office agent, and better than a million for a high ranking official of a bureau. Sector Plexus records and updates all PSEGs according to a complicated security algorithm. If a transmitting agent's PSEG is sufficiently out of date, even if the message is encoded properly, the computers will transfer the message to a Plexus officer who decides whether or not to authorize the sending of the message. These officers will often route copies of messages which are the slightest bit suspicious to IntCon, Renik and the Ubiquitorate.

When a message is sent through the Plexus, it is copied and transmitted to at least two different conduits at each link along the way. Each Sector Plexus station is a surprisingly small affair, and while they are well hidden, their security is far from guaranteed. If enemy forces destroy a few Plexus conduits, parallel transmission will allow the message to get through despite the loss. Lower priority messages are sent on less secure channels, and only two copies of each message are transmitted from each conduit. But there are five or more links along the message path before transmission to the final destination, and the message is transmitted to additional conduits even after the message has been received at the final destination. This means the message is routed to thousands of places, only one of which is the actual destination. Even if a message is intercepted, enemy agents have a slim chance of discovering the location of the initial sender or the recipient; the chain is too long.

Sending messages over many links takes time, so higher priority messages are sent over more secure channels and fewer links, but three copies of each message is sent from a single conduit to better protect against the destruction of Plexus conduits.

When copies of a message are transmitted, there can be many reasons for errors — power fluctuations during transmission, signal degradation over long range, interference from other beamcasts or star activity. The message may have been interrupted by a message of higher priority. The computer may receive readings which indicate enemy sensors are sweeping the area for evidence of transmissions, and quickly stop transmissions.

When the message reaches its final conduit, the Plexus computer assembles and compares all received versions of the message, synthesizing them into the message most likely to be an exact copy of the original. The computer then generates the authenticity code for the message — the more secure the channel and the fewer the deviations between copies of the message, the higher the authenticity code.

Plexus Droid Vessels

Sector Plexus has access to portions of the HoloNet, but most of their information is carried from system to system on Droid Vessels. These are small, extremely fast starships run strictly by CNLinked Droids and computers. The ship has a nav computer, a storage/transceiving I2-CG Droid (based on Cybot Galactica's ED4 model), a "ship's captain" R2-M3 Droid (based on the R2 Astromech Droid), and an analysis/encoding computer equipped with the TranLang III Communication module. These ships contain no accommodations or space for living beings, nor do they have life support systems.

Essentially the PDV is a fuel source and engine, with supporting electronics and Droids attached. It is built strictly to send and receive Plexus conduit transmissions within a system and then jump to the next system on its route. A combination of PDV speed, programmed skills and efficient route algorithms guarantee that a PDV never has a jump duration greater than one Standard Day, except in extreme emergencies.

The PDV has the ability to avoid detection by long range sensors. PDV's are often given minimal camouflage to make them look like mining probes or scavenger Droids to casual observers.

PLEXUS DROID VESSEL

Craft: Imperial Intelligence Tech 4 PDV
Type: Unmanned Messenger Pod
Length: 9 meters
Crew: I2CG, I2AM 3-Droid, A/E Computer integrated into ship
Passengers: None
Cargo Capacity: None
Consumables: None
Hyperdrive Multiplier: [x 1/2]
Nav Computer: [Yes]
Hyperdrive Backup: [None]
Sublight Speed: [7D]
Maneuverability: [5D]
Hull: [2D]
Weapons: [None]
Shields: [None]
Skills:
 Languages: 9D
 Hide/Sneak: 7D
 Planetary Systems: 5D
 Search: 5D
 Astrogation: 13D
 Computer Prog/Repair: 6D
 Starship Piloting: 4D
 Starship Repair: 7D

Imperial ComLink

When the New Order was declared there arose an ambitious group of scientists eager to free research from the parochial power struggles which typified the latter days of the Old Republic. They proposed a vast computer network connected to the HoloNets, giving scientists on any of thousands of worlds instant access to information vital to their research. These scientists designed and wrote much of the software necessary to support such a system, presenting the entire package to Palpatine and his advisors.

The idea was rejected, ostensibly for the tremendous additional funds needed to upgrade the HoloNet to handle the increased flow of information. The costs were real, and Palpatine needed the tens of trillions of credits elsewhere, but he also feared a system which would allow such an instantaneous and complete exchange of information between citizens of the New Order.

Imperial Intelligence managed to retrieve almost all of the documentation and software, and recruited a number of the scientists who proposed the Imperial ComLink. Using the PDVs and Plexus conduits to link the computers, rather than HoloNet technology, reduced the costs more than ten thou-

sandfold. The prospect of having access to every computer bank in the Galaxy, with the nearly inconceivable wealth of information such a system would provide, was too tempting to ignore.

With the help of system cells throughout the Galaxy, as well as a massive effort by virtually every talented individual within Tech, the necessary software was installed in computer networks in hundreds of sectors. Still, less than six percent of the planetary networks had been tapped; many of the rest had security which was too difficult to penetrate to make it worth the risk.

The Ubiqtorate considered cancelling the project as too expensive for the benefits it accrued. It was then that a Plexus technician, Geothray Camber, sent Dr. Lindu Sencker a series of scandocs with preliminary specifications for a new eavesdropping device which would circumvent the security systems in virtually every computer system in existence. Sencker's team conquered the formidable theoretical and technical problems poised by Camber's plan.

With this device, the Hyperspace Orbiting Scanner, Imperial Intelligence has been able to tap into the computer networks on more than 470,000 worlds, and the number is increasing every day.

Left in hyperspace orbit around a planet, the HOS sensors do not pick up the signals from the computer directly. They monitor the hyperspace shadows left by streaking particles inside a computer.

Careful and systematic matching of the shadows of known computer languages to the shadows produced by the target system have produced data which is better than 78 percent reliable. Imperial science is not likely to produce an improvement over this phenomenal performance any time in the near future.

An HOS is placed and serviced by modified PDVs. PDVs enter hyperspace and then cycle through various triangulations on possible positions of the HOS (whose hyperspace shadow is lost against the shadow of the planet and other, larger space vehicles) until the orbiter is located. This process can take hours. It would be impossible if the searching craft did not already have an idea of where the HOS was. The PDV then links with the HOS in orbit.

To transfer large amounts of data, or to effect any repairs on the HOS, the PDV must temporarily pull out of hyperspace. It is vulnerable during this period, and so stays in realspace only for the minimum possible time. Once repairs are made or information is transferred, the PDV and HOS return to hyperspace — the HOS to its

orbit and the PDV to its rendezvous with the Plexus conduit.

System Cell

Imperial Intelligence has placed millions of system cells throughout the Galaxy. They exist on every inhabited world, and even on a few uninhabited ones which prove to be convenient jump sites or listening posts. While a system cell can theoretically be of any size from a single being to hundreds, they usually range from four to 20 beings. Imperial Intelligence often recruits agents from the worlds on which they are going to serve, training them off-world only if absolutely necessary.

A system cell is the basic unit of Imperial Intelligence. When the Ubiqtorate plans strategy it thinks in terms of operations which could be conducted independently by system cells, with all coordination coming from the bureau. System cells are aware of the command structure immediately above them, but are allowed to know very little else about Imperial Intelligence. They are most emphatically not allowed to know of the existence or operations of other system cells.

Imperial Intelligence gives system cells rudimentary logistic support. The only standard piece of equipment is the RWStar A/P Transceiver, with expanded memory and processing capabilities, which communicates with Plexus Droid Vehicles or Plexus conduits. Other equipment is to be obtained by the system cell itself, or is provided on a mission basis only. This lack of equipment occasionally hampers a cell, but the ingenuity of cell agents usually makes up for the lack of sophisticated gear.

A cell can increase its status within Imperial Intelligence by equipping itself from hostile sources. This includes not only the Rebellion, but often the underworld and sometimes even COMPNOR.

Adjustments

Adjustments is the most elite branch of Imperial Intelligence. It consists of agents who receive their orders directly and in person from the Ubiqtorate. No record of their orders is ever kept, and no mission files exist within Sector Plexus for these agents.

Whenever the Ubiqtorate feels a critical situation has slipped from the control of Intelligence, and that the situation is beyond the normal capabilities of the bureaus but not yet completely hopeless, Adjustments is called in to restore order. The Ubiqtorate briefs the Adjustment agent or team on the problem and what resources are available to solve it. Adjustments then solves the problem.

IMPERIAL RANK INSIGNIAS

Rank badges and cylinders are combined to determine the hierarchy of the Imperial military. These examples can be considered interim insignias until the reorganization prompted by the Battle of Yavin is concluded.

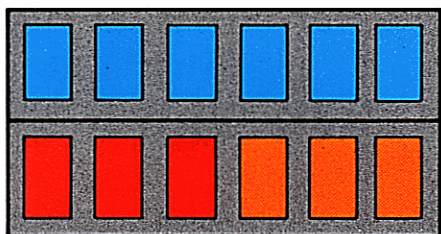

Priority Sector
High Commander

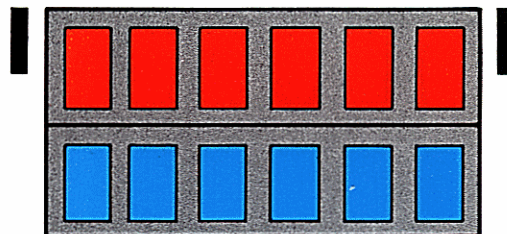

Admiral

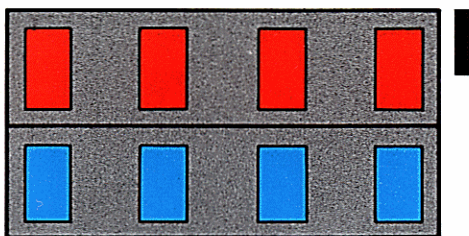

General

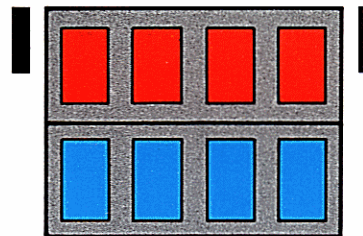

Colonel

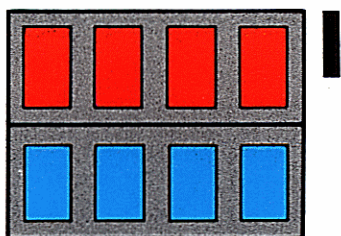

Major

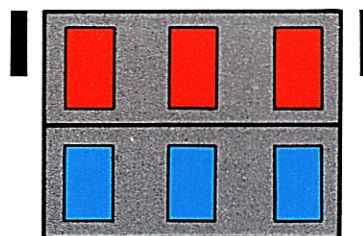

Commander

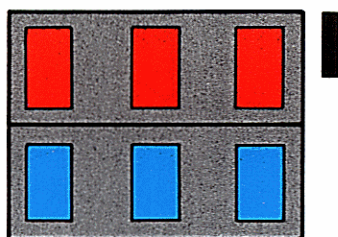

Captain

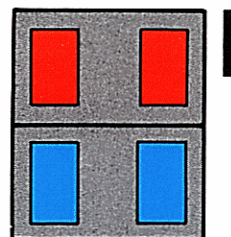

Lieutenant

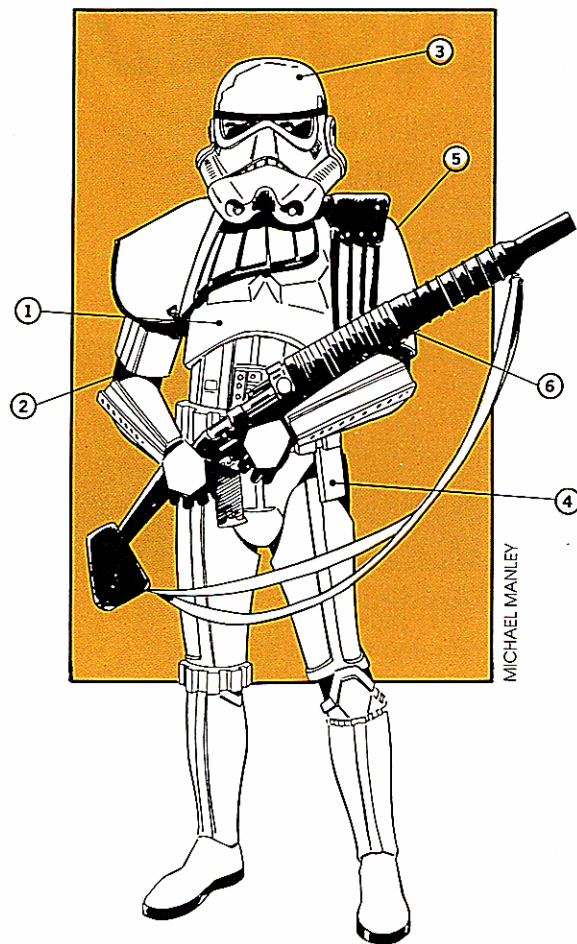

MICHAEL MANLEY

◀ **Sandtrooper**
(Desert Terrain Stormtrooper)

1. 18-piece anti-blaster cocoon shell with heat-reflective coating.
2. Temperature-control body glove.
3. Helmet with automatic polarized lenses, comlink, and breathing filters.
4. Utility belt with standard gear, long-range comlink, and food/water pack.
5. Energy source and portable environment unit (on back).
6. Concussion grenade launcher.

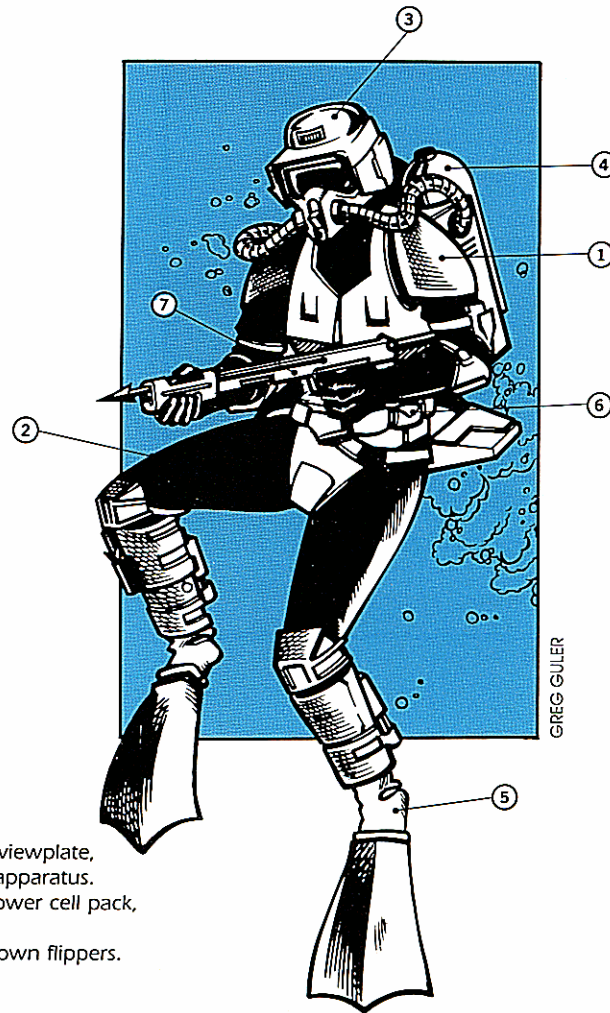

GREG GULER

▶ **Seatrooper**
(Aquatic Assault Stormtrooper)

1. Lightweight armor.
2. Two-piece environment suit.
3. Helmet with macrobinocular viewplate, sensor array, and breathing apparatus.
4. Portable environment unit, power cell pack, and propulsion unit.
5. Propulsion boots with snap-down flippers.
6. Standard utility belt.
7. Blaster spear gun.

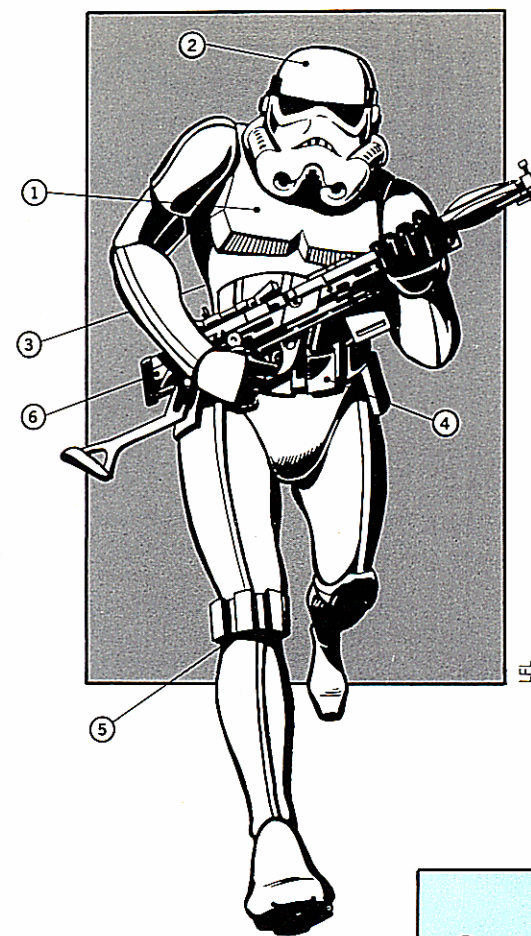

LFL

◀ **Stormtrooper**
(Standard Shock Trooper)

1. 18-piece anti-blaster cocoon shell.
2. Helmet with automatic polarized lenses and communication unit.
3. Energy source and portable environment unit (on back).
4. Utility belt with specialized survival equipment, concentrated rations, emergency power cells, and spare comlink.
5. Black, two-piece temperature-control body glove.
6. Heavy blaster rifle.

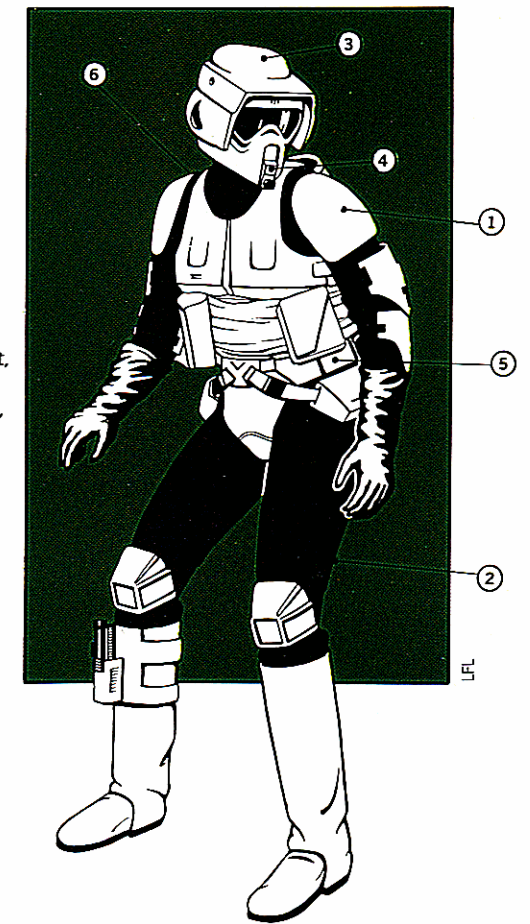

LFL

▲ **Scout Trooper**
(Stormtrooper Scout)

1. Lightweight armor.
2. Two-piece black body glove.
3. Helmet with macrobinocular viewplate and sensor array.
4. Breathing apparatus.
5. Utility belt and pouches with flares, concussion grenades, survival kit, and blaster packs.
6. Energy source, environment unit, and computer storage pack (on back).

▶ **Snowtrooper**
(Cold Assault Stormtrooper)

1. 18-piece outer shell.
2. Powerful heating and personal environment unit.
3. Airtight fabric oversuit for additional protection from cold.
4. Breather hood envelops face plate and feeds into suit liner.
5. Utility pouches include high-tension wire, grappling hooks, ion flares, blaster packs, and survival kit.
6. Blaster pistol.
7. Terrain grip boots.

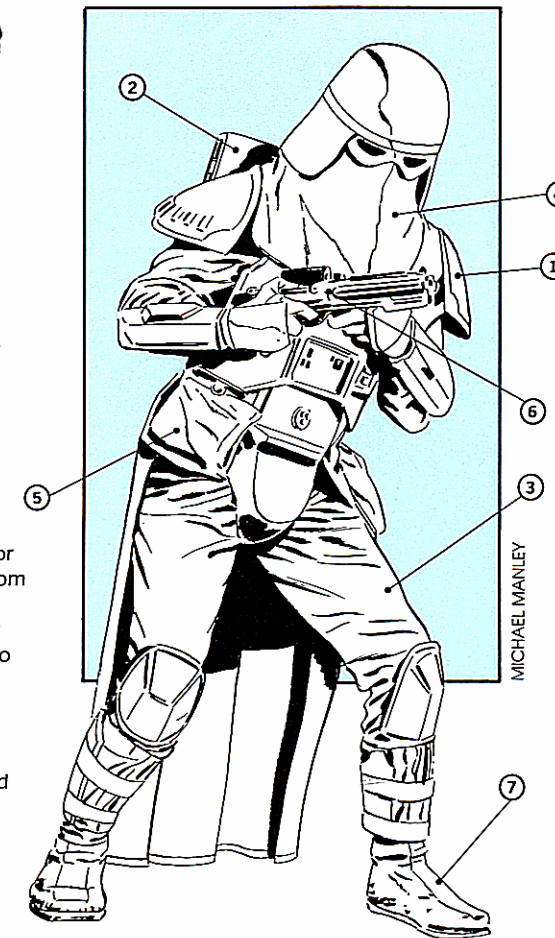

MICHAEL MANLEY

STORMTROOPER ARMOR

ZERO G STORMTROOPER

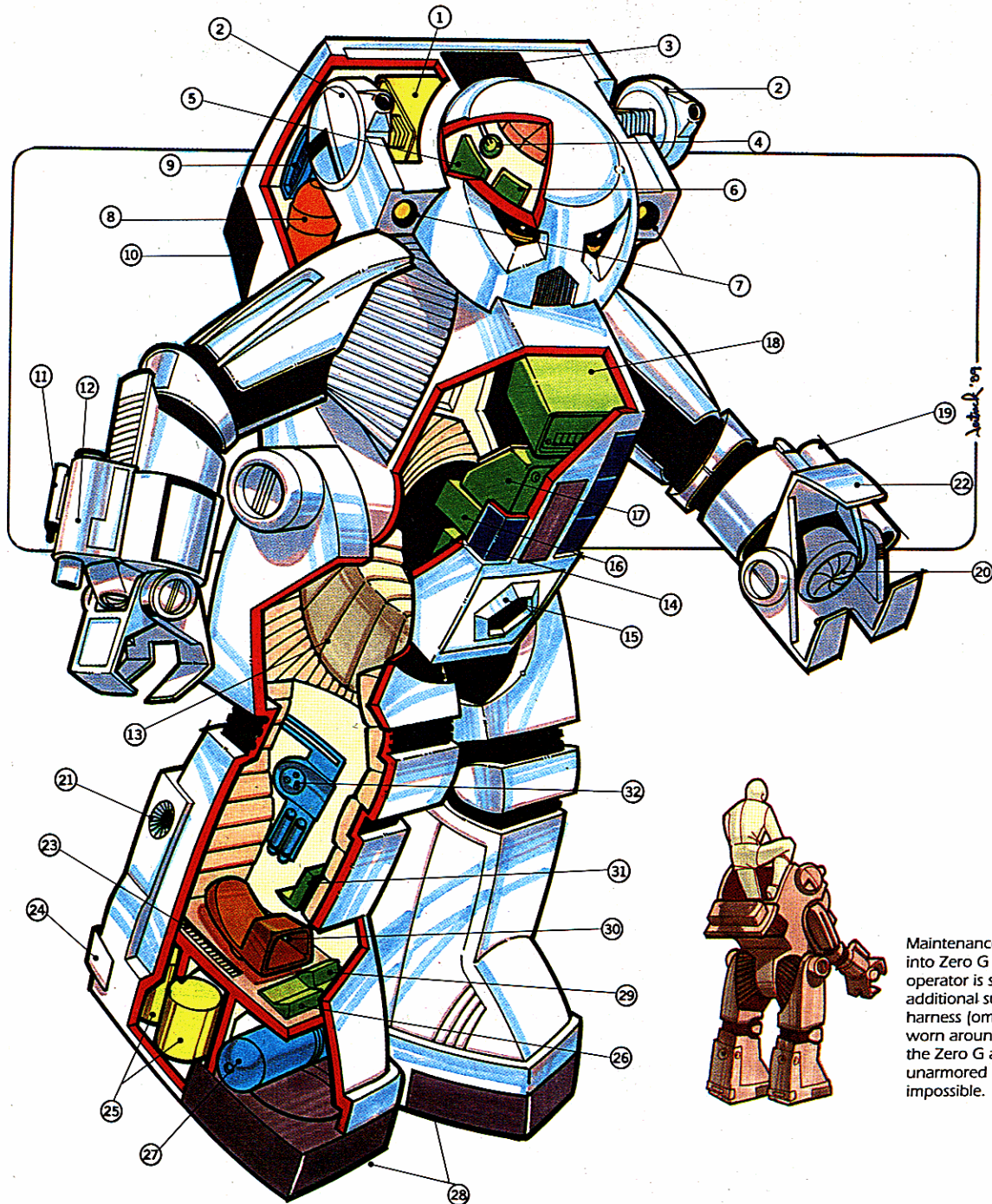

1. Magazine for grenade launchers (holds concussion, gas, and stun projectiles)
2. Grenade launcher
3. Communications antenna
4. Comlink
5. Suit status board
6. Rear-view viewscreen
7. Light
8. Fire extinguisher
9. Environmental control apparatus
10. Main repulsorlift propulsion unit (RPU)
11. Laser cutter

12. Blaster Cannon
13. Saddle
14. Main sensor unit
15. Main sensor array
16. Extended-range comlink
17. Integrated tactical display
18. Active sensor package
19. Miniature proton torpedo hurler
20. Iris valve opens when cuff is fully retracted, allowing the stormtrooper to use his hands
21. Attitude control thruster
22. Cuffs move up and down forearm

23. Vent
24. Recharging power coupler
25. Auxiliary RPUs
26. RPU switch
27. Breathing gas/life support
28. Primary magnetic couplers
29. Coupler activator switch
30. Stirrup
31. Function switch — toggles the stirrup in and out of attitude thruster control
32. Automated injector

C

Chapter Four The Military

(Compiled from various sources, including scan-docs, datareports, and communiques.)

The might of the Empire has not arisen overnight, although years of planning and preparation by the Emperor allowed the military to expand at a nearly inconceivable rate. From the time of the Old Republic to the opening years of the New Order was a period of rapid change and expansion for the Imperial forces. With the Empire's loss at the Battle of Yavin, even more changes have taken place — some not even yet announced to the various branches.

The Navy

The Navy has grown enormously since the decline of the Old Republic, but its mission has largely stayed the same: to free the system space of member worlds from hazards to profitable commerce, to assure the safety of member worlds from attack from outside forces, and to bolster the planetary governments in times of crisis. This last mission has grown more difficult since the rise of the New Order.

Under the Republic, the Navy could move in and put down unrest in a system, secure in the knowledge that the majority of the governed races welcomed their intervention. The New Order has changed the attitudes on many of the constituent worlds. While the vastly increased firepower available to the Navy has so far been more than adequate to compensate for any increase in hostilities, the willingness of member worlds to resist the New Order is expected to be a greater problem in the future.

Changes in Civilian Command Structure

Planetary governments had the right to call upon the Navy of the Old Republic in emergen-

cies. They would simultaneously petition the Senate if the forces were to be engaged for more than seven Standard Days, but most actions could be concluded within a week. The only lengthy campaigns were against the pirates located on the fringe worlds, and these were the concerted efforts of several hundred worlds who at one time or another had found themselves prey for pirates.

Since the disbanding of the Senate, the Navy is no longer required to respond to requests from planetary governments, including the planetary governors appointed by the Empire. Under new doctrine, individual planets are too insignificant to allow them direct control over an asset as important as the Imperial Navy, even for short periods of time.

Civilian orders are now transmitted at the level of the Sector Group, from regional Moff, Grand Moff, or the Emperor himself. Smaller units are to receive their orders only from



officers in the proper chain of command. This is a definite change from the Republican Navy, when Senators or other politically powerful beings could directly commandeer naval vessels — sometimes entire squadrons — for missions without having the order come down through the chain of command.

This change has greatly boosted the morale of naval personnel. The officers now know that the strategy is being set at a level of authority which is best suited for seeing the whole picture. Naval commanders have the authority and responsibility to execute their orders in the best manner possible, and they know they shall be free from political interference while doing so.

Naval Command Structure

The Navy has responded to its rapid growth by changing its command structure, introducing intermediate levels of command which did not exist in the Republican Navy. Most of the junior level officers were promoted to these intermediate levels, while the senior officers kept their ranks but had the scope of their command enlarged. An admiral in the Imperial Navy commands forces over 10 times as great as an admiral did during the Old Republic.

Naval Personnel

All vessels serving in the Imperial fleets have varying numbers of the following personnel.

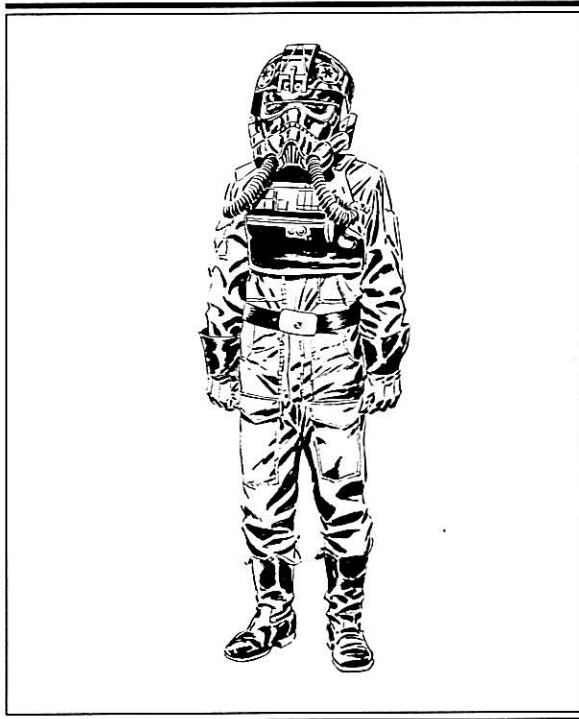

Pilots

From the men who fly the capital ships to the men who leap into the cockpits of the TIE fighters, Imperial pilots are the mainstay of the Imperial Navy. They are the necessary element in the military branch charged with protecting the space lanes from pirates, smugglers, alien invaders, and Rebels.

The top pilots in the Galaxy are found in the Imperial Navy. These pilots, following the glorious and time-honored allure established during the Republic, attend the premier Academies throughout the Empire. Within these fine institutions the Empire teaches these men duty and promotes the idea of maintaining order, as opposed to defending against aggression.

As the civil war grows more violent and both sides experience rapid depletion of able pilots, the Empire has begun to offer incentives to civilian merchant pilots and others with some flying experience until more crops of Academy graduates can be produced.

TIE pilots form an elite corps within the Imperial Navy. Each candidate for admission into the rigorous TIE training program must undergo a strenuous screening and testing process. After all, they are being prepared to fly the best starfighters the Empire has to offer.

IMPERIAL PILOT

DEXTERITY: 2D+1	PERCEPTION: 2D
Blaster: 3D+1	Search: 3D
Dodge: 3D+1	STRENGTH: 2D
KNOWLEDGE: 1D+1	TECHNICAL: 1D+1
Planetary Systems: 2D	Computer
MECHANICAL: 3D	Programming: 2D+1
Starship Gunnery: 4D	Starship Repair: 3D+1
Starship Piloting: 5D	

Gunners

Gunners are a special sub-unit of the Imperial pilot corp. Any Imperial military vessel larger than a one-man TIE starfighter makes use of these trained weapons masters to handle the high-tech arms employed by the Empire.

Most gunners are either pilots in training or pilots who failed to make the grade in all the skills necessary to fly a vessel. Nonetheless, a gunner must have a keen eye, superior reflexes, and a rapport with the specialized equipment.

Gunners are trained to handle everything from a single-light laser cannon up to turbolaser battery emplacements and even the now-destroyed



These troopers wear the distinctive uniform and helmet once only the province of the Death Star troopers. These soldiers dressed in all black are deadly warriors, but they all serve other functions aboard Imperial ships. They act as security, handle hangar traffic control, monitor sensor arrays, and other duties when their combat skills aren't required.

IMPERIAL NAVAL TROOPER

DEXTERITY: 2D+1	PERCEPTION: 3D
Blaster: 3D+1	Search: 4D
Dodge: 3D+1	STRENGTH: 2D+2
Grenade: 3D+1	Brawling: 4D+2
KNOWLEDGE: 1D+1	TECHNICAL: 1D
Streetwise: 2D+1	
MECHANICAL: 1D+2	

superlaser that was the main weapon of the Death Star battle station. In addition to their hands-on training, gunners learn to work with specialized computer helmets that not only offer protection but are equipped with macrobinocular viewplates and sensor arrays to assist with targeting fast-moving fighter craft.

IMPERIAL GUNNERS

DEXTERITY: 2D+2	PERCEPTION: 1D+1
Blaster: 3D+2	STRENGTH: 1D+1
Heavy Weapons: 4D+2	TECHNICAL: 2D+1
KNOWLEDGE: 1D+1	Gunnery Repair: 4D
MECHANICAL: 3D	
Starship Gunnery: 5D	
Starship Shields: 4D	



Naval Troopers

To protect its vast number of capital ships without relying on the help of the Army, the Navy has created a corps of troopers to act as Naval soldiers. These men, trained in traditional combat skills, also learn skills needed to survive aboard the mighty vessels that patrol the Galaxy in the name of the Emperor.

Equipment

Equipment designs proliferated under the Old Republic to the extent that the odds of a cadet training on equipment and serving with units which used anything which bore a passing resemblance to said equipment was often remote.

With the New Order, and especially since the massive build up orders issued after the Battle of Yavin, the Navy has received top-of-the-line equipment throughout the upper ranks of the Imperial fleet. Only in the lower, system-level units does the older, less-standardized equipment appear in large quantities.

The Army

If the Navy was rejuvenated since the rise of the New Order, the Army was revived from the dead. During the days of the Old Republic the Army degenerated into a poorly trained police force with fancy uniforms. They performed garrison duty on member worlds, often as a barrier between squabbling locals. The Navy was responsible for getting the Army to its destination and for picking up what was left. There was lip service paid to the concept of orbital support, but the Navy was stretched too thinly to afford sitting in stationary orbit for the duration of a surface campaign. The Navy jealously guarded its starfighters, so the Army was denied any effective means of maintaining an orbit free of enemy spacecraft once the Navy departed. Morale was often low and the quality of Army personnel bordered on non-existent.

With the New Order the Army was completely overhauled. Rigorous training and recruitment programs were re-established, and the missions of the Army were expanded. Drop missions into hostile territory were considered to be routine for normal troopers rather than the province of a few elite units. Training for complex assaults was the norm, and Imperial doctrine specified the Navy's mission to be support for surface forces during critical phases of an operation.

Doctrine further specified that permanent garrisons or units expecting surface cam-

paigns of significant duration would have significant Naval assets, such as TIE fighters, attached to the Army units for the whole of the mission. These assets were determined well in advance of the mission and soon standardized so an Army officer could know what he had to work with for a particular type of mission.

Changes in the Civilian Command Structure

The Army used to be almost exclusively under the command of the planetary governments of the worlds on which they served.

Admiral Jerjerrod's Testimony

(From the days of the Old Republic, a holorecording of Senate Security Hearings, Naval Subcommittee, Procurement Panel: Document #RS.SS. 225863a.NS.1771.PP.24)

Senator Gopple: Admiral Jerjerrod, you have indicated to this panel that you have certain misgivings concerning the procurement procedure of our fair Republic. Could you explain why you insist on undermining the Republic's confidence in her Navy with your public statements, rather than going through the chain of command as is proper for a military officer?

Admiral Jerjerrod: The Senator from Erigorm has not scanned my reports very thoroughly. I have reported to the proper people above me and to my peers within the Naval Command. My public statements, as you choose to call them Senator, were taken from those reports I so filed. I had nothing to do with their dissemination.

Senator V'troren: But if you did not leak these reports to the media, who did? Who else would have had the motivation to promulgate your particular point of view?

Admiral Jerjerrod: Senator V'troren, every being serving knows that the weapons he uses, the ships on which he serves, the Droids and computers on which his life depends, every piece of equipment which he will expect to use, was designed as a result of a Senate compromise to keep each constituent commercial interest happy. Upon entering combat with such equipment a crewman's sole consolation is a grim satisfaction that our enemies probably stole their equipment from us.

During This Time of Crisis ...

(A holomessage to the citizens of the Galactic Empire from Ars Dangor, advisor to the Emperor.)

Loyal subjects,

These are dangerous times. Our grand Empire of united star systems now faces a threat that could destroy us if action is not taken quickly.

As always, we shall act quickly.

The rebellion against the Emperor's fair and just rule has flared into a flame greater than we anticipated. It threatens to become a civil war, and as such we have declared it an emergency situation.

To better protect our citizens and our member worlds, the Emperor has superseded and suspended the Imperial Senate for the duration of this emergency. The Grand Moffs will now have direct control of their systems until such time as the danger has passed.

We are sure you shall all do everything in your power to assist us during this time of crisis.

Your servant,

Ars Dangor, Imperial Advisor

This was due to necessity more than anything else; most worlds had an arrangement whereby they paid half the expenses and provided half the materiel of any Army unit engaged in operations on their world, unlike the Navy whose expenses were paid for by the Republic as a whole. This one difference was perhaps the major cause for the decline of the Army. The worlds which needed help from the Republic and were not among the wealthiest continually complained about the cost of surface forces deployed on their planets. The average amount spent on the Army plummeted while the Navy's expenditures remained constant.

With the New Order, and especially since the abolishment of the Senate, the Army has become the physical manifestation of the Empire throughout the Galaxy. Whether black-clad Imperial soldiers or white-armored stormtroopers, the Imperial Army has grown into the mailed fist that pounds the thousand-thousand worlds of the Galactic Empire into submission.

The Army Command Structure

The Army took a different tack from the Navy when it experienced its phenomenal growth. The army kept its ranks the same, but increased the number of subordinate officers for each rank above. This decreased the ratio of officers to troops and gave the Imperial Army a very lean fighting force.

The establishment of the New Order gave the Army the opportunity to clear out its deadwood as well as remove those officers who might be ideologically opposed to the new regime. Over three quarters of the Army's officers were weeded out during the first days of the New Order.

Since the Battle of Yavin, the two forces have been moved closer together as regular Army detachments have been assigned to Navy vessels to create more complete combat units.

Army Personnel

The personnel that make up the Imperial Army include many specialized soldiers. However, most of these men can be classified under the following types.

Army Troopers

Army troopers make up a vast number of the Empire's planet-bound fighting forces. These soldiers wear similar uniforms to the Naval trooper, complete with helmet. But the Army wears a gray-colored uniform and partial armor for protection.

These soldiers are trained only to fight, and they do it very well. They are taught all man-

ner of combat techniques. Hand-to-hand, blaster pistol, grenade, and heavy weapons training are just some of the areas these soldiers are expected to excel in.

IMPERIAL ARMY TROOPER

<p>DEXTERITY: 3D Blaster: 4D+1 Dodge: 4D+1 Grenade: 3D+2 Heavy Weapons: 3D+2 KNOWLEDGE: 1D+1 MECHANICAL: 1D+1</p>	<p>PERCEPTION: 2D STRENGTH: 3D+1 Brawling: 3D+1 TECHNICAL: 1D</p>
----------------------------------------------------------------------------------------------------------------------------------------------------------------	----------------------------------------------------------------------------------------------------

Army Assault Crews

The Imperial Army uses surface attack vehicles such as AT-AT and AT-ST walkers to equal the fury of their assault troopers. These vehicles are all heavily armed and armored to provide maximum fire power and protection to the units they are assigned to.

The crews that service these war machines are soldiers with training in the operation of a variety of ground assault vehicles. Most of these machines are crewed by a pilot, a gunner, and a

No Longer of Any Concern ...

(A holomessage to the Grand Moffs of the Galactic Empire from Ars Dangor, advisor to the Emperor.)

Loyal subjects,

We understand that you have been concerned of late about this "growing" rebellion. I have even heard concern about the support this rebellion has been gaining in the Imperial Senate.

Listen well. The Imperial Senate will no longer be of any concern to us. The Emperor has permanently dissolved that misguided body. The last remnants of the Old Republic have now been swept away.

Senatorial representation has not been formally abolished, you must understand. It has merely been superseded for the duration of the emergency. If that duration remains a permanent fixture, so be it. You, the Emperor's regional governors, will now have direct control and a free hand in administering your territories. This means that the Imperial presence can at last be brought to bear properly on the vacillating worlds of the Empire.

From now on, fear will keep potentially traitorous local governments in line. Fear of the Imperial fleet — and fear of the new Death Star battle station.

Have I made the Emperor's will clear?

For the Emperor,
Imperial Advisor Ars Dangor

combat coordinator (or commander). Depending on the size and type of vehicle, there may be additional crew members or fewer crew handling multiple roles.

Like the normal Army trooper, assault crewmen wear gray uniforms and partial body armor. They receive all the combat training given the trooper, as well as the training needed to operate the ground assault vehicles. They also learn how to best apply the Imperial mindset of rule by fear through the use of their war machines.

**IMPERIAL ARMY
ASSAULT CREW**

<p>DEXTERITY: 2D+2 Blaster: 4D+2 KNOWLEDGE: 1D MECHANICAL: 3D+2 Vehicle Gunnery: 5D+2 Vehicle Piloting: 5D+2</p>	<p>PERCEPTION: 2D+1 Search: 3D+1 STRENGTH: 1D+1 TECHNICAL: 1D</p>
-----------------------------------------------------------------------------------------------------------------------------------------------------------------------	----------------------------------------------------------------------------------------------------

Equipment

While the Army suffered financially under the Old Republic, one benefit to less money was less of a squabble in the Senate over procurement of equipment; the contracts were less lucrative and therefore subject to fewer predations by greedy commercial interests. This is particularly true of the personal weapons and equipment of the average trooper, which was built to last with a minimum of maintenance. The budgetary wrangle over more expensive pieces of equipment, such as surface war vehicles, was sufficient to ensure that the Army suffered problems similar to those of the Navy, only on a smaller scale.

Since the disbanding of the Senate and the Battle of Yavin, no expense has been too great for the Empire. The Emperor has ordered the pace of military build up — already staggering since the start of the New Order — increased even more. He does not want his forces even lacking when the next battle takes place.

Stormtroopers

Encased in protective armor and wielding the most powerful personal weapons available, Imperial stormtroopers form the Empire's elite shock troops and are feared throughout the

Galaxy. Stormtroopers support the two arms of the military — assisting the ground forces and the Imperial fleets — but remain apart and separate from these organizations.

Imperial Command assigns stormtroopers wherever they are needed to crush resistance and neutralize opposition to the will of the Emperor. They are totally loyal and cannot be bribed, seduced or blackmailed into betraying the New Order. They live in a totally disciplined militaristic world where obedience is paramount and the will of the Empire is unquestioned.

Where the men who wear the armor of the stormtroopers are recruited from is unknown, just another part of the mystery that adds to the aura of fear and secrecy that surrounds these soldiers.

Some say the stormtroopers were created to provide the Emperor with an obedient force that was loyal to no one save him. Others note that these specialized warriors were designed to provide adequate protection to the varied worlds of the Galactic Empire with little preparation time. Whether one or both of these are true, it remains that the stormtroopers fit the doctrine of rule through fear very well indeed.

In addition to the core stormtrooper forces (which some reports indicate is greater than the number of regular Army and Naval forces combined), a number of elite divisions have been established to move into a specialized environment at a moment's notice. These units are equipped with particularly designed armor, weapons, and gear created for use in specific environments.

STANDARD STORMTROOPER

DEXTERITY: 2D (reduced to 1D by armor)
Blaster: 4D (reduced to 3D by armor)
Brawling Parry: 4D (reduced to 3D by armor)
Dodge: 4D (reduced to 3D by armor)
STRENGTH: 2D (increased to 3D by armor for damage purposes)
Brawling: 3D
All other Attributes and Skills: 2D
Stormtrooper Armor: Adds 1D to *Strength* code for damage purposes only. Reduces *Dexterity* code and all *Dexterity* skills by 1D.
Stormtrooper Weapons: Blaster pistol (damage 4D), blaster rifle (damage 5D).

Cold Assault Stormtroopers

The polar regions of most worlds remain frozen, inaccessible wastelands — the perfect hiding place for rebel outposts, smuggler ports and pirate coves. In response, the Empire has established a special corps of elite stormtroopers trained and equipped to operate in these environs. These are the stormtroopers of the Blizzard Force Cold Assault units.

Blizzard Force snowtroopers (as they are called) work in tandem with AT-AT walkers. These vehicles are ideally suited for the extreme temperatures and icy terrain where snowtroopers are deployed.

There is no stealth involved in snowtrooper combat tactics. They hit planets fast and hard, like the blizzard they are named for, crushing opposition quickly and completely. Efficient, fast and deadly, snowtroopers are one of the most feared combat units in the Imperial military.

COLD ASSAULT STORMTROOPER

DEXTERITY: 2D (reduced to 1D by armor)

Blaster: 5D (reduced to 4D by armor)

Brawling Parry: 4D (reduced to 3D by armor)

Dodge: 3D (reduced to 2D by armor)

STRENGTH: 3D (increased to 4D by armor for damage purposes)

Brawling: 3D

All other Attributes and Skills: 2D

Snowtrooper Armor: Adds 1D to *Strength* code for damage purposes only. Reduces *Dexterity* code and all *Dexterity* skills by 1D.

Stormtrooper Weapons: Blaster pistol (damage 4D), blaster rifle (damage 5D), concussion grenades (damage 5D), tripod-mounted automatic blaster cannon (damage 6D).

Aquatic Assault Stormtroopers

Another special unit of stormtroopers has been established to handle another prominent environment throughout the Empire. The Aquatic Assault stormtroopers—or seatroopers—are trained and equipped to operate below the seas of the thousand-thousand worlds.

Sea troopers can be deployed quickly via dropships, but are most often assigned to aquatic garrisons where they enjoy the support of a fully loaded base, special water craft (including modified TIE fighters), and powerful AT-AT swimmers.

The Empire Strikes Back

(A holomessage to the military hierarchy and Grand Moffs of the Galactic Empire from the Emperor's advisor, Ars Dangor.)

Loyal subjects,

The recent setback at the Battle of Yavin has resulted in a few changes to Imperial doctrine. As you are aware, we have lost both the Death Star and its commander, Grand Moff Tarkin. But the doctrine of fear has not been rescinded because of this minor victory for the insignificant rebellion.

Instead, the doctrine of fear must be broadened and upgraded. It is time to let that fear spread, time for the Empire to strike back at its enemies and destroy them once and for all. That is why the Emperor has placed his servant, Lord Darth Vader, in command of a special Imperial fleet. This fleet, led by Lord Vader's new *Super-class Star Destroyer Executor*, has been charged with the mission to hunt down the rebel command base and those rebels that escaped us at Yavin.

You are to bow to Lord Vader's wishes as though they were the Emperor's own, extending him every possible assistance he may require in the completion of his task. Soon, nothing will remain to threaten the Emperor's rule.

For the Emperor,
Imperial Advisor Ars Dangor

AQUATIC ASSAULT STORMTROOPER

DEXTERITY: 2D

Blaster: 4D

Brawling Parry: 4D

MECHANICAL: 3D

Waveskimmer Operation: 3D+2

STRENGTH: 2D+2 (increased by 3 pips by armor for damage purposes)

Brawling: 3D+2

Swimming: 4D+2 (increased to 6D+2 by armor)

All other Attributes and Skills: 2D

Seatrooper Armor: Adds 3 pips to *Strength* code for damage purposes only. Does not reduce *Dexterity* codes. Increases swimming code by 2D.

Seatrooper Weapons: Blaster spear gun (blaster damage 5D, spear damage 4D), concussion grenades (damage 5D).

Zero G Assault Stormtroopers

While all stormtrooper armor provides limited protection against hard vacuum, one elite division has been trained to operate exclusively in outer space. Zero G Assault stormtroopers — or

spacetroopers — are deadly commandos of the highest order, second only to the Imperial Royal Guard in training, loyalty, and destructive capability. When it is necessary to capture a freighter, space station, or other spacefaring vehicle, spacetroopers are deployed to handle the job.

A spacetrooper platoon uses a refitted and heavily armored assault shuttle to stage its operations from. A five-man command crew pilots the shuttle. All communication devices are patched through the platoon commander's station so that the commander can monitor the entire team's activities. He issues orders from on board the shuttle, directing his troopers from within the flying fortress.

The assault shuttle is a formidable attack vehicle in its own right, but the 40 spacetroopers it carries are walking arsenals. Each trooper wears a standard stormtrooper shell, but then plugs into a full body armor encasing that performs as a personal spacecraft and attack vehicle. Spacetroopers are limited by the amount of power their armor can store, but they are trained to employ their armament effectively and complete their specified mission within a limited period of time. If unable to complete their mission within the time limit, spacetroopers have standing orders to return to their shuttle for recharging.

Because of their fearsome yet bulky outfits, spacetroopers perform best in no-gravity environments such as deep space and non-atmosphere worlds.

ZERO G ASSAULT STORMTROOPER

DEXTERITY: 2D (reduced to 1D by armor)

Blaster: 4D (reduced to 3D by armor)

MECHANICAL: 3D

Starship Piloting: 4D

Starship Gunnery: 4D

STRENGTH: 2D (increased to 5D by armor for damage purposes)

Brawling: 3D

All other Attributes and Skills: 2D

Spacetrooper Armor: Adds 3D to *Strength* code for damage purposes only. Reduces *Dexterity* code and all *Dexterity* skills by 1D.

Stormtrooper Weapons: Concussion grenades (damage 5D), gas/stun grenades (stun damage 5D), mini-proton torpedoes (damage 6D), blaster cannon (damage 6D), laser cutters (damage 3D).

Scout Stormtroopers

Scout stormtroopers are assigned to garrison posts. At a typical garrison, scout speeder bike squadrons perform reconnaissance and patrol missions in cooperation with AT-ST walkers. Imperial doctrine dictates that garrisons remain active and aggressive, performing continuous patrols to establish a tangible presence, even on "pacified" worlds.

Scouts use the explosively fast Aratech 74-Z speeder bike to perform their missions. Because speeder bikes require sensitive handling, Imperial scouts wear highly specialized light-weight armor. This armor includes macrobinocular viewplates and full sensor array, as well as a built-in computer to analyze incoming data quickly. Without such aid, even the best scouts would be hard pressed to operate speeder bikes at full speed.

SCOUT STORMTROOPER

DEXTERITY: 2D

Blaster: 4D

Brawling Parry: 4D

Dodge: 4D

MECHANICAL: 3D

Speeder Bike Operation: 3D+2

STRENGTH: 2D (increased to 2D+2 by armor for damage purposes)

Brawling: 3D

All other Attributes and Skills: 2D

Scout Armor: Adds 2 pips to *Strength* code for damage purposes only. Does not reduce *Dexterity* codes.

Scout Weapons: Blaster pistol (damage 4D), blaster rifle (damage 5D), concussion grenades (damage 5D).

The Effect of Stormtroopers

When stormtroopers were first assigned to Army and Navy units everyone questioned who they were and where they had come from. Stormtroopers stayed to themselves and always referred to themselves by number or rank rather than by name.

The early successes of the stormtroopers, combined with their fearsome appearance, soon made the stormtrooper a symbol of the New Order. Their fearless dedication set an example which was enthusiastically followed by many troops and junior officers eager to move up in the Army and Navy. The elite attitude of the stormtroopers has now firmly entrenched itself throughout the Imperial forces.

C hapter Five Capital Ships

(From a report by the Imperial Navy to the Emperor's advisors on budgetary affairs.)

While starfighters took a premier role in the recent Battle of Yavin, capital ships remain the heart of the Imperial Navy. Capital ships conduct battles on a grand scale. They do not engage in common dogfights — that is the province of small one- and two-man starfighters. When capital ships meet, they engage in a war between spacefaring cities and the outcome could result in thousands of deaths.

These combat starships measure over 100 meters, require large crews to operate, use massive power cells and generators, and are heavily armed and armored. Under the New Order, many of these vessels have been commissioned. But since the emphasis of Imperial doctrine has again turned toward the use of the Imperial fleet, even more of these ships of the line are needed.

Examine the following reports. You will find a variety of vessels currently in at least limited use. Any or all of them can be put into mass production with a simple word from your office. Remember, we will not crush this rebellion by tying our hands in bureaucratic datatape. We need resources made available to increase our galactic might a thousandfold. With such resources, nothing will be beyond the reach of our Emperor.

Assault Shuttle

Not technically a capital ship, Imperial assault shuttles regularly engage capital ships in combat or are used to ferry Zero G stormtroopers aboard an engaged vessel. These heavily-armored vehicles come complete with tractor beam generators, full sensor suites, power harpoon guns, concussion missile launchers, and automatic blaster cannons.

Assault shuttles are divided into three sections. The first section contains the command crew cockpit. Here the five-man crew can monitor the actions of the spacetroopers as well as handle the operation of the shuttle and all its systems. The second section of the craft is the main body. In this section, 40 spacetrooper armor shells are stored until the troopers plug into them. The armor is constantly being recharged and powered up while in its place in the shuttle. This compartment is lined with fold-away launch doors that swing open to disgorge the spacetroopers. The rear portion of the craft houses the engines and power generators.

In a standard operation, an assault shuttle will hold a given target in a tractor beam or with magnetic harpoons. Sometimes it will also cripple the target with a few well-placed blaster cannon shots. Then it will open up and let its spacetrooper platoon loose.

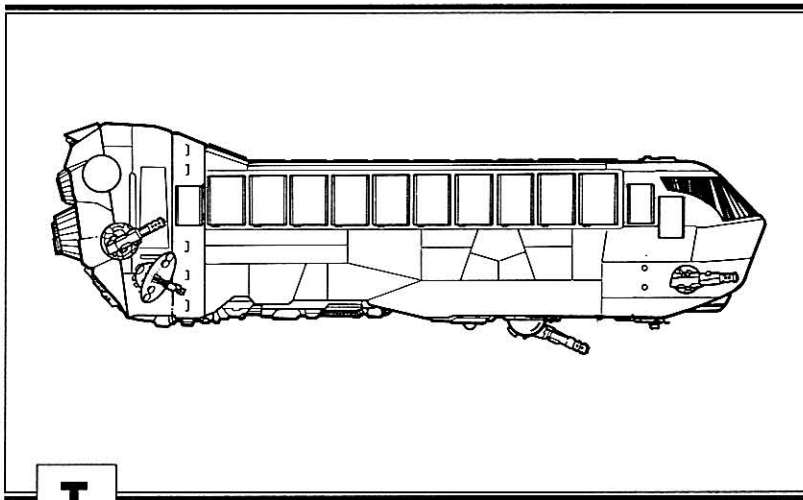

T

elgorn Corp. *Gamma-class Assault Shuttle.*

SHIP ILLUSTRATIONS BY KARL MARTIN

Assault shuttles are among the most-heavily shielded vessels in the Imperial fleet. Most combat starships funnel approximately 25 percent of their total power through the shield generators. An assault shuttle uses up to 62 percent power on shields, and over half of that power is channeled into the front arc. This allows the shuttle to withstand even the most concentrated barrage of fire for at least a short time.

These craft are both atmospheric and space capable, and have limited capacity for hyperspace travel (their onboard nav computers can hold up to three jumps). Most Imperial-class Star Destroyers carry an assault shuttle, along with the necessary spacetrooper platoon. Other ships are supplied with these units as needed and available.

ASSAULT SHUTTLE

Craft: Telgorn Corp Assault Shuttle
Type: *Gamma-class Assault Shuttle*
Length: 30 meters
Scale: Capital Ship (due to power output)
Crew: 5
Passengers: 40
Hyperdrive Multiplier: x2
Nav Computer: Yes (3 jump limit)
Hyperdrive Backup: No
Sublight Speed: 4D
Maneuverability: 2D
Hull: 3D+2
Weapons:
Four Laser Cannon (fire separately)
Fire Control: 3D
Damage: 2D
Tractor Beam
Fire Control: 4D
Damage: 5D+2
Concussion Missiles
Fire Control: 2D+1
Damage: 4D
Shields: 4D+2

Skipray Blastboats

Blastboats fill the gap between speedy, maneuverable starfighter designs and the slower, more heavily-armed capital ships. They are swift enough to overhaul most system intruders, and strong enough to deliver — and survive — blows from powerful weapons. They operate equally well in atmosphere, on patrol in the far reaches of a star system,

or performing fleet point duties with or without starfighter support.

Sienar's GAT Blastboat series is the Empire's standard gunship for demanding point missions and patrol assignments. To take advantage of its exceptional armament, it is deployed in trouble spots where conflict is likely and the combat risk is high. The GAT is the smallest Imperial Naval vessel to be equipped with hyperdrive engines. Although these craft are usually planet- or space station-based, they routinely patrol entire sectors.

Different configurations have been employed as ground support or missile launch platforms, but the most popular version is the GAT-12h "Skipray", a power-boosted refinement over slower, less combat oriented models. As with the assault shuttle, blastboats are lumped in with capital ships because of the missions they undertake and the firepower they are able to deliver. In addition to patrol duties, the Skipray is commonly used for planetary defense and interdictive actions.

The aerodynamic Skipray performs exceptionally well in atmospheric flight, easily executing maneuvers normally possible only by high-performance air speeders. In space combat, the GAT-12h is not especially maneuverable. It relies instead on its speed to approach with surprise and get in a devastating first attack. When engaged in extended combat, the Skipray coordinates its attack with TIE fighters whenever possible, or uses wingman tactics if there are more blastboats in the area.

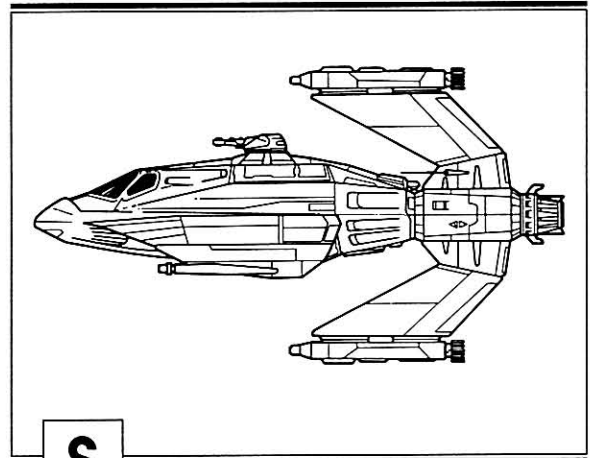

S

Sienar Fleet Systems GAT-12h Blastboat.

SKIPRAY BLASTBOAT

Craft: Sienar Fleet Systems' GAT-12h
Type: Defense and Patrol Skipray Blastboat
Length: 25 meters
Scale: Capital Ship (due to power output)
Crew: 4
Passengers: None
Hyperdrive Multiplier: x2
Nav Computer: Yes (4 jump limit)
Hyperdrive Backup: No
Sublight Speed: 4D
Maneuverability: 1D+2 (2D+2 in atmosphere)
Hull: 2D+1
Weapons:
Three Medium Ion Cannons
 (fire linked)
Fire Control: 3D
Combined Damage: 4D
Proton Torpedo Launcher
Fire Control: 2D
Damage: 9D
Two Laser Cannons (fire linked)
Fire Control: 1D
Combined Damage: 5D
Concussion Missiles
Fire Control: 1D
Damage: 6D
Shields: 2D

system with stolen or smuggled goods, so the crews must be constantly on watch for threats from within their system as well as those from beyond.

SYSTEM PATROL CRAFT

Craft: Sienar Fleet Systems' IPV 1
Type: Inter-system patrol/customs craft
Length: 120 meters
Scale: Capital Ship
Crew: 12
Troops: 10
Hyperdrive Multiplier: None
Nav Computer: No
Hyperdrive Backup: No
Sublight Speed: 3D+2
Maneuverability: 2D+1
Hull: 3D+1
Weapons:
Four Laser Cannons (fire separately)
Fire Control: 2D
Damage: 4D
Shields: 3D

System Patrol Craft

System patrol craft are any of a number of capital ship designs that fall between the 100 meter minimum and 250 meters, although some larger ships are relegated to this duty due to lack of available vessels. System patrol craft follow the primary directive to apprehend smuggling vessels, but they also serve as a star system's first line of defense against pirates, rebels, and hostile aliens as well.

Most of the vessels that fall into this class are either designed or modified for speed and fire power. Built to engage in "pre-jump" combat, patrol craft make maximum use of speed and maneuverability to catch fleeing vessels before they can escape to hyperspace. System patrol craft contain no hyperdrive engines, instead relying on powerful sublight engines to make their way within a system.

Often, the crew of a system patrol craft spends long periods off-world in their vessel, patrolling the borders of their star system. They are called upon to respond quickly to any ships leaving the

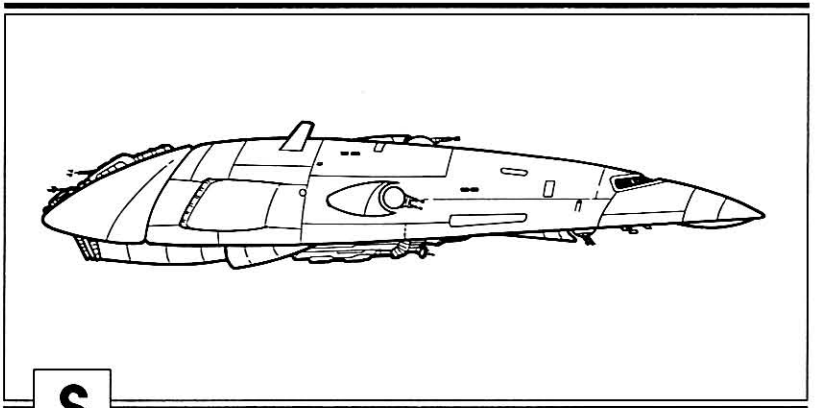

S

Sienar Fleet Systems IPV 1 Inter-system Patrol Craft.

Strike Cruisers

Loronar's *Strike*-class Cruiser has been called the fleet's best kept secret. While every smuggler and Rebel knows to avoid Star Destroyers, the fighting capacity of the Strike Cruiser comes as quite a surprise to many.

Loronar has designed a vessel that can be mass produced in a limited amount of time, due to the prefabricated nature of its component sections. Not only does this procedure reduce construction time, it also dramatically lowers the cost of each vessel.

Each Strike Cruiser can carry a company of

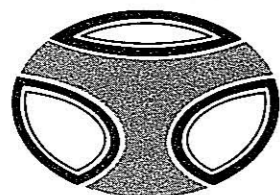

TELGORN CORP



Gamma-Class Assault Shuttle

Taim & Bak KT6
Heavy Blaster Cannon

Nordoxicon
Wavefront-active
Tractor Beam Projector

Zero-G stormtrooper
boarding hatch

Telgorn corp tri-level
armor plate hull

Zero-G stormtrooper
launch ports
(10 port, 10 starboard, 20
overhead)

Zero-G stormtrooper
boarding hatch

Command crew
boarding hatch

Armored
transparisteel
viewport

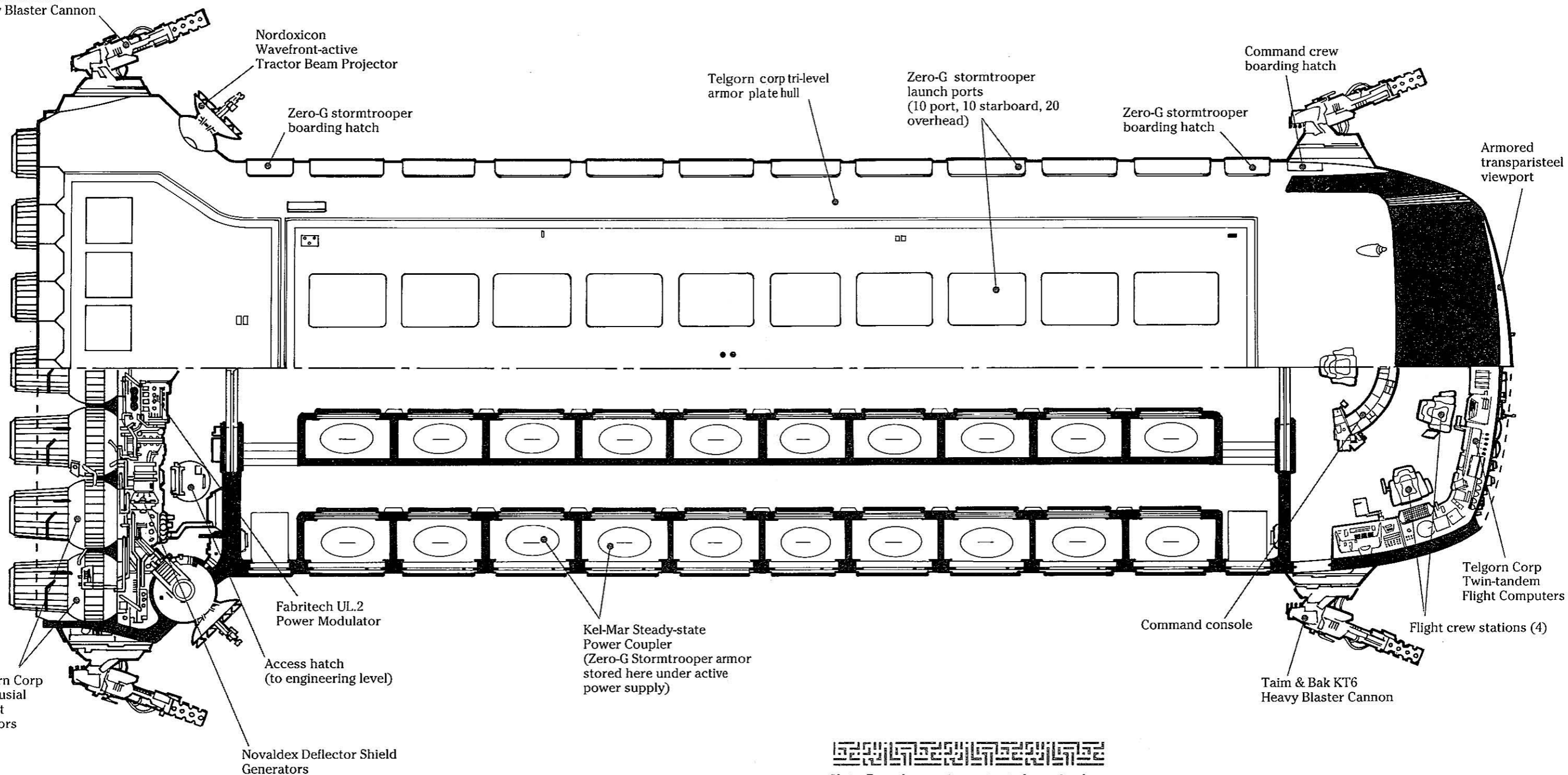

Telgorn Corp
IA/4 Fusial
Thrust
Reactors

Fabritech UL.2
Power Modulator

Access hatch
(to engineering level)

Novaldex Deflector Shield
Generators

Kel-Mar Steady-state
Power Coupler
(Zero-G Stormtrooper armor
stored here under active
power supply)

Command console

Taim & Bak KT6
Heavy Blaster Cannon

Flight crew stations (4)

Telgorn Corp
Twin-tandem
Flight Computers



Note: For other equipment not shown in plane
of this readout refer to appropriate plans.

troops, two AT-STs, and one AT-AT walker for ground assault missions. Its small but functional hangar bay houses one squadron of TIE fighters.

Because of its modular design, a Strike Cruiser can be easily modified for specific missions. Those specialized vessels currently in service include prefab garrison deployers, troop transports, TIE launch platforms, heavy vehicle recovery, and planet assault vessels that can carry up to five walkers.

While the benefits of its design are obvious, the Strike Cruiser has some glaring weaknesses. The modular design means that entire systems or weapons batteries can be knocked out by a single, well-placed hit.

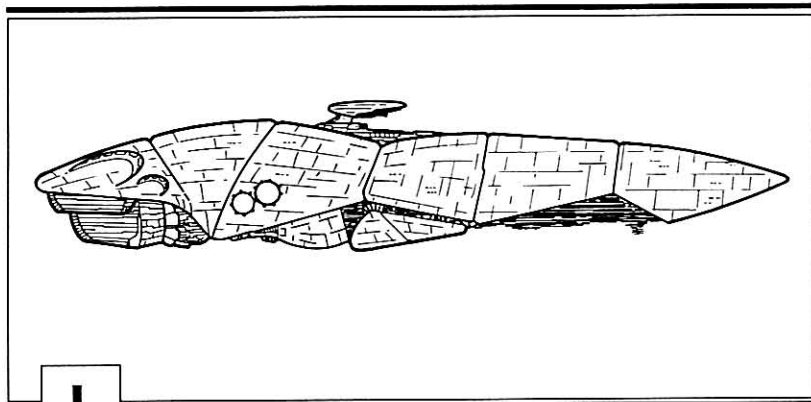

L

Loronar's *Strike-class* Medium Cruiser.

Escort Carrier

The need for an Escort TIE Carrier became apparent after the Battle of Ton-Falk. In that battle, two Imperial Frigates and a Dreadnaught were lost due to, as Naval Command reported, "inadequate TIE support." So the Navy commissioned Kuat Drive Yards to construct a vessel that would serve the specific function of carrying TIE fighters into battle.

The main duties of Escort Carriers are to augment the starfighter strength of the fleet they are attached to, and to transport non-hyperspace support shuttles from system to system. Box-like and inelegant in appearance, KDY's Escort Carrier performs these missions admirably.

Each Carrier bases an entire TIE wing in its cavernous bays. Imperial policy mandates that at least one squadron of TIE Interceptors be included in the mix. Additional bays can carry up to six shuttles.

While Carriers are equipped with protective weaponry, they are not considered combat ves-

STRIKE CRUISER

Craft: Loronar Strike Cruiser
Type: *Strike-class* Medium Cruiser
Length: 450 meters
Scale: Capital Ship
Crew: 2,112
Troops: 340
Hyperdrive Multiplier: x2
Nav Computer: Yes
Hyperdrive Backup: Yes
Sublight Speed: 3D
Maneuverability: 2D
Hull: 6D
Weapons:
20 Turbolasers (fire separately)
Fire Control: 2D
Damage: 5D
10 Turbolaser Batteries (fire separately)
Fire Control: 1D
Damage: 7D
10 Ion Cannons (fire separately)
Fire Control: 4D
Damage: 4D
10 Tractor Beams
Fire Control: 2D
Damage: 4D
Shields: 2D+2

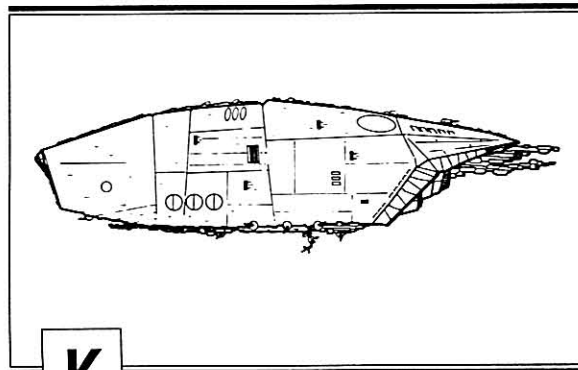

K

Kuat Drive Yards' Escort Carrier.

sels. They do not engage enemy targets and try to stay as far from the actual battle as possible.

Other missions that Carriers regularly perform include augmenting the power of Imperial garrison bases. While the garrison quells planetary problems, the Carrier assumes a stationary position in orbit over the planet. From this position, the Carrier's TIEs can blanket the world to provide support from above.

ESCORT CARRIER

Craft: Kuat Drive Yards' Escort Carrier
Type: Heavy starfighter/shuttle carrier
Length: 500 meters
Scale: Capital Ship
Crew: 3,505
Troops: 800
Hyperdrive Multiplier: x1
Nav Computer: Yes
Hyperdrive Backup: Yes
Sublight Speed: 2D
Maneuverability: 1D
Hull: 7D+1
Weapons:
 10 Twin Laser Cannons (fire separately)
 Fire Control: 3D
 Combined Damage: 3D
Shields: 2D

Lancer-Class Frigates

Following the Battle of Yavin, Naval Command experienced an exaggerated but understandable case of phobia concerning Rebel starfighters. One group of senior admirals, led by the vocal Admiral Drez, argued that the Death Star's destruction was due to the lack of anti-starfighter screening vessels. Drez stated that "until an anti-starfighter screening vessel is brought into service, every capital ship in the fleet is in imminent danger." Naval Command authorized the construction of Kuat Drive Yard's *Lancer*-class Frigate — but only a limited number to serve as test vessels.

Gun for gun, Lancers are the best anti-starfighter ships currently in service — at least according to their initial tests. The main and only armament the ship carries is 20 quad-firing laser cannons. Each cannon is equipped with a targeting mechanism adapted from the one used in Sienar Fleet Systems' TIE bomber craft. This produces multi-fire cover with superb fire control. In addition, each gun is mounted on its own tower to provide an increased fire arc.

For all its fire power, the *Lancer*-class Frigate could be shaping up as a failure. The Lancer is comparable in price to a cruiser, without the added benefits of the larger vessel. Also, the predicted starfighter attacks on capital ships never materialized — at least not at the level feared. Admiral Drez and others claim that this is due to the appearance of the Lancer, but others point out that there are not enough Lancers in service to make so bold an assumption.

Those Lancers currently in use have not lived up to expectations. While they perform exceptionally when engaging starfighters, Lancers have done very poorly in the few fleet engagements they have participated in. To function as screening vessels, Lancers must be placed on the outer perimeter of the fleet, but without turbolasers these ships are easy prey for Rebel cruisers. In addition, the modified targeting systems still need work, resulting in less than half of each Lancer's weapons operating perfectly on any given day.

Intended as stationary screening ships, Lancers cannot match starfighters for speed or maneuverability. But when their weapons are operational, they are more than a match for Rebel starfighters.

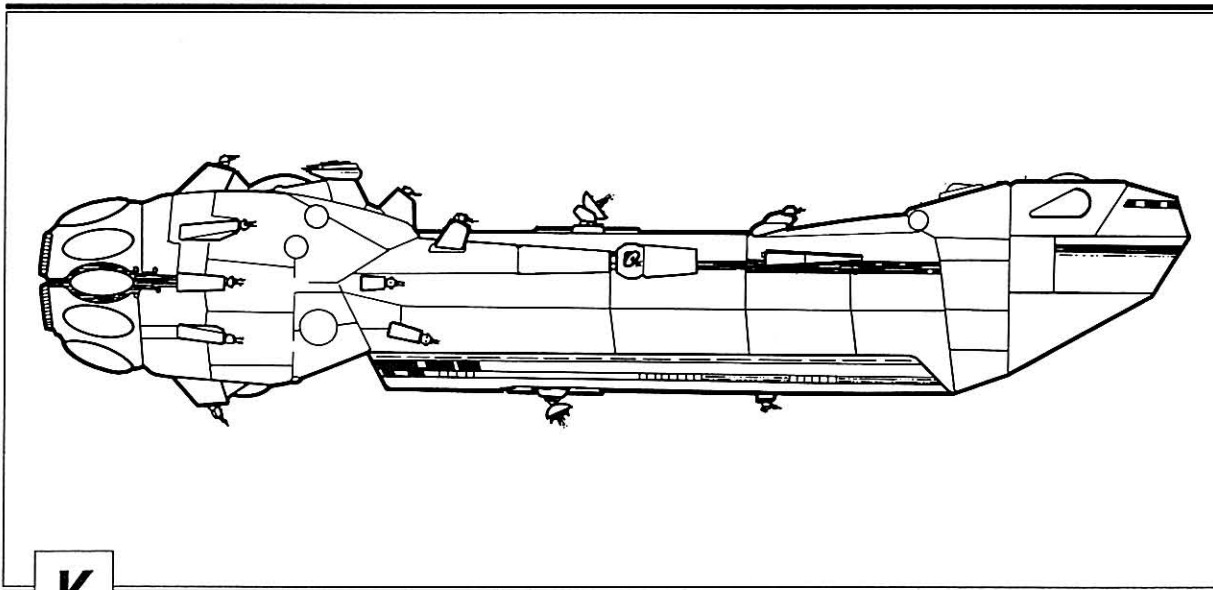

K uat Drive Yards' *Lancer*-class Frigate.

LANCER-CLASS FRIGATE

Craft: KDY's *Lancer*-class Frigate
Type: Anti-Starfighter Screening Vessel
Length: 250 meters
Scale: Capital Ship
Crew: 850
Troops: 40
Hyperdrive Multiplier: x2
Nav Computer: Yes
Hyperdrive Backup: Yes
Sublight Speed: 2D
Maneuverability: 1D
Hull: 4D
Weapons:
20 Quad Laser Cannon (fire separately)
Fire Control: 4D
Damage: 4D
Shields: 2D+2

so much mass prevents ships in the area from engaging their hyperdrives, and it also drops ships already in hyperspace back into realspace.

The Interdictor Cruiser serves as an escape cut-off, strategically stationed out of direct combat but in a position that provides a maximum fire arc. It projects fields of gravity throughout a battle zone, rendering all hyperdrives inoperable. This greatly reduces the chances of Rebel ships, which normally survive by using quick hit-and-run tactics and then escape into lightspeed.

These Heavy Cruisers also perform as ambush vessels, hiding along a known hyperspace lane and projecting gravity fields that produce mass shadows. Any ships traveling along the hyper route must slip back into realspace when confronted with gravity projections. Once in realspace, other Imperial vessels can engage them in direct combat or board them for customs inspection.

INTERDICTOR CRUISER

Craft: Sienar Fleet Systems' Immobilizer 418
Type: *Interdictor*-class Heavy Cruiser
Length: 600 meters
Scale: Capital Ship
Crew: 2,807
Troops: 80
Hyperdrive Multiplier: x2
Nav Computer: Yes
Hyperdrive Backup: Yes
Sublight Speed: 3D
Maneuverability: 1D
Hull: 5D
Weapons:
20 Quad Laser Cannons (fire separately)
Fire Control: 2D
Damage: 4D
Four Gravity Well Projectors
Fire Control: 6D
Damage: Blocks Hyperspace Travel
Shields: 3D

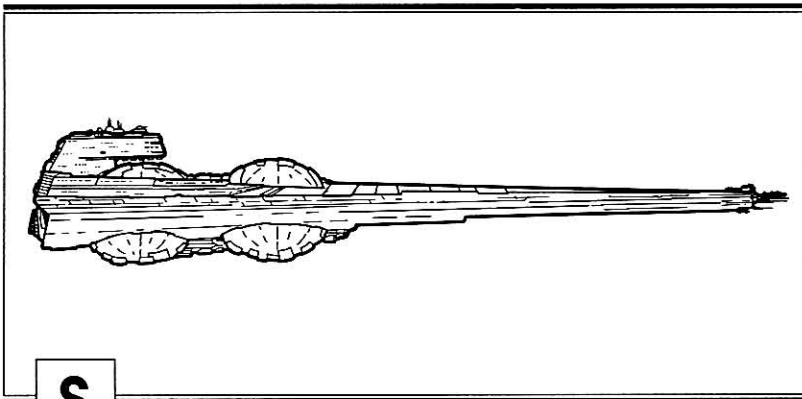

Sienar Fleet Systems Immobilizer 418 *Interdictor*-class Heavy Cruiser.

Interdictor Cruisers

When the Empire developed a working gravity well projector, it was determined that a special vessel would need to be constructed to provide the necessary power output the device required. So the Interdictor-class Heavy Cruiser was designed by Sienar Fleet Systems.

The gravity well generator works on a simple principle. When focused, it sends out waves of energy that disrupt mass lines in space, thereby simulating the presence of a large stellar body such as an asteroid or planetoid. The presence of

Imperial Star Galleon

As more and more cargo freighters suffer capture and destruction at the hands of pirates and rebels, the Empire decided to experiment with a new class of capital ship. This new vessel contains enough storage capacity to make it function as a transport ship, but also has the added benefit of sophisticated weaponry and shielding. In essence, this vessel can serve as both transport and escort — simultaneously.

The *Star Galleon*-class Frigate takes the place of two ships, thus saving the Empire credits. Previous Imperial transports were unarmed or lightly armed cargo ships that could not compete against starfighters or powerful capital ships. They needed the protection of Escort Frigates or some other type of combat craft.

However, the new Star Galleons can carry equivalent amounts of goods while protecting themselves from the ravagers of the space lanes. A combination of concussion missiles and turbolasers creates a decent fire perimeter. In addition, the vessels are designed to repel invaders intent on capturing their store of goods.

Up to 300 troopers are stationed aboard a Star Galleon. The interior of these ships bristle with anti-intruder defenses. The troopers, for example, can make use of fortress-like emplacements that line the inner hallways and corridors from which to defend their ship. Individual sections can be sealed and held by the defenders, creating pockets within a Star Galleon.

One of the more interesting features of a Star Galleon is the cargo hold. Placed in the very center of the craft, the hold is actually a separate vessel that can detach and be jettisoned into hyperspace for collection at a later time. A built-in homing device allows Imperial agents to track the hold as it randomly jumps across the hyperlanes.

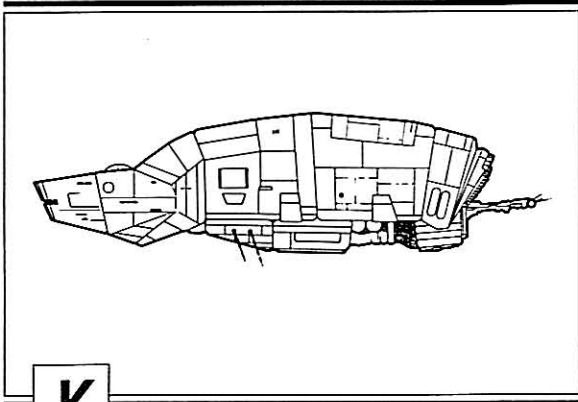

K

Kuat Drive Yards' Star Galleon.

IMPERIAL STAR GALLEON

Craft: Kuat Drive Yards' Star Galleon

Type: Cargo/escort frigate

Length: 300 meters

Scale: Capital Ship

Crew: 150

Troops: 300

Hyperdrive Multiplier: x2

Nav Computer: Yes

Hyperdrive Backup: Yes

Sublight Speed: 1D+2

Maneuverability: 1D

Hull: 5D+2

Weapons:

10 Turbolasers (fire separately)

Fire Control: 3D

Damage: 4D

Concussion Missiles

Fire Control: 5D

Damage: 5D

Shields: 2D

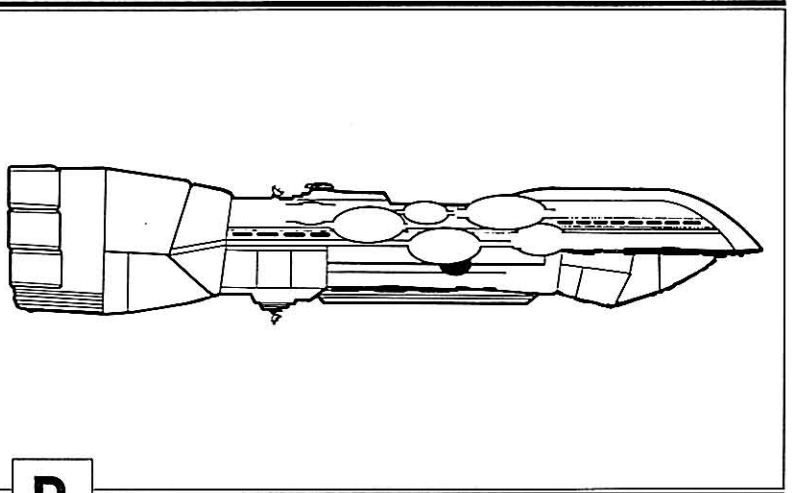

R

Rendili Star Drive's Dreadnaught Heavy Cruiser.

Dreadnaughts

Introduced to the Galaxy before the Clone Wars, the *Dreadnaught*-class Heavy Cruiser was the largest vessel of its time. In fact, these are among the oldest ships still seeing active service in some parts of the Empire.

Originally, the Navy had planned to phase out the Dreadnaught. Critics pointed out such flaws as slow speeds, weak shielding, inefficient power generators, low fire power, and high crew needs. Economics has won out though, so far, as the

Navy has found it more cost-effective to refit these ships than to build totally new vessels.

Because of their slower speeds, these ships were originally equipped with an enormous amount of cargo space for food and supplies during long missions. As technology improved, faster hyperdrive engines made most of this space unnecessary. Now these areas have been converted into TIE hangar bays. Dreadnaughts typically carry a full squadron of TIE starfighters.

Dreadnaughts perform a number of duties within the Empire. They are used to maintain an Imperial presence in the Outer Rim Territories, as convoy escort vessels, and in the pacification of low technology worlds.

The biggest drawback for this class of Heavy Cruiser is its reliance on manual technology. While the newer vessels have minimal crews supported by a heavy concentration of Droid technology, even the refitted Dreadnaughts need more actual crewmen than any other vessel currently in Imperial service.

DREADNAUGHT CRUISER

Craft: Rendili StarDrive's Dreadnaught
Type: Heavy Cruiser
Length: 600 meters
Scale: Capital Ship
Crew: 16,204
Troops: 3,000
Hyperdrive Multiplier: x2
Nav Computer: Yes
Hyperdrive Backup: Yes
Sublight Speed: 2D
Maneuverability: 1D
Hull: 5D+2
Weapons:
 10 Laser Cannons (fire separately)
 Fire Control: 3D
 Damage: 2D
 20 Quad Laser Cannons (fire separately)
 Fire Control: 2D
 Damage: 4D
 10 Turbolaser Batteries (fire separately)
 Fire Control: 1D
 Damage: 7D
Shields: 2D+1

Carrack-Class Light Cruiser

An old yet reliable ship in the Imperial fleet is the Damorian Manufacturing Corporation's *Carrack-class* Light Cruiser. This vessel's 10 turbo-

CARRACK-CLASS LIGHT CRUISER

Craft: Damorian Manufacturing's Carrack
Type: Light Cruiser
Length: 350 meters
Scale: Capital Ship
Crew: 1,092
Troops: 142
Hyperdrive Multiplier: x1
Nav Computer: Yes
Hyperdrive Backup: Yes
Sublight Speed: 4D
Maneuverability: 2D
Hull: 5D
Weapons:
 10 Heavy Turbolasers (fire separately)
 Fire Control: 1D
 Damage: 7D
 Five Tractor Beam Projectors
 Fire Control: 2D
 Damage: 4D
 20 Laser Cannons (fire separately)
 Fire Control: 3D
 Damage: 2D
Shields: 2D+2

laser batteries allow the Carrack to engage larger opponents with a reasonable chance of success. Backing up the heavy guns are a number of smaller laser cannons for point defense against starfighters and missiles. Refitted vessels have also been equipped with tractor beam projectors.

Layered bulkheads and compartmentalization, combined with a unique modular life support system, assures maximum crew survival in case of hull breachings. On numerous occasions, Imperial salvage craft have retrieved Carrack debris and found live crew members on board. These bulkheads also lend strength to the hull, allowing a Carrack to survive an attack that would destroy a similarly-sized vessel.

Compartmentalization does have one major drawback, though. Such a defense system takes up an inordinate amount of space. As a result, the *Carrack-class* is one of the largest light cruisers not equipped with internal hangar bays. Instead, each Carrack carries four TIE recon starfighters docked on an external rack. These small ships are used for courier missions and scouting duty.

To compensate for the lack of starfighter support, Carrack cruisers are equipped with powerful engines that make them among the fastest of

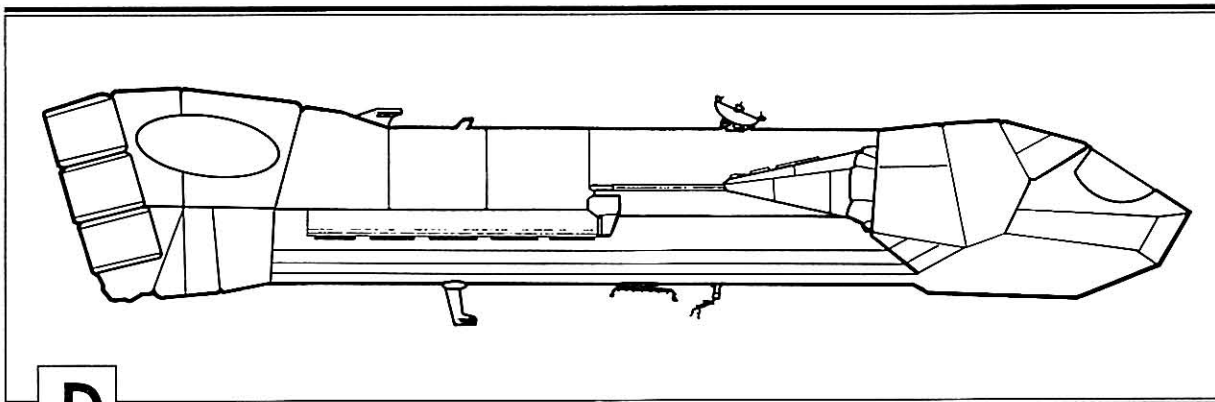

D

amorian Manufacturing's Carrack Light Cruiser.

the Empire's capital ships.

Current doctrine teams these cruisers with smaller vessels and assigns them to patrol duty in pacified or semi-pacified sectors. They also serve as personal transports for important planetary governors and Moffs.

Torpedo Spheres

The dedicated siege platform, the Torpedo Sphere, is designed to accomplish one mission — to knock out a planet's shields. Planetary shields, whether full or partial, protect a world from orbital bombardment. It takes a lot of troops to assault a planet. It is easier and far less expensive to simply pound a planet into submission with the weapons of a Star Destroyer. But planetary shields prevent this.

The Torpedo Sphere is a miniature Death Star, covered with thousands of dedicated energy receptors (DERs) designed to analyze shield emissions. Planetary shields are never uniformly even. They experience power anomalies and energy fluctuations just like other mechanical devices. The Torpedo Sphere parks in orbit around a planet and trains its DERs upon the world to search for weak points in the shielding. These weak points rarely exceed more than a 20 percent power drop, but this is enough for the Torpedo Sphere to bring down the shields.

The Sphere contains 500 proton torpedo tubes arranged in an inverted conical formation. Surrounding these tubes are 10 heavy turbolaser batteries. The actual destruction of a planet's shields is simple. The Torpedo Sphere arrives and analyzes the shields. It finds both the weak points and the location of the planet-bound shield generators. The Sphere then fires a salvo of torpedoes that knock a hole in the shield (at a weak point), followed by blasts from the turbolasers to destroy the generators. Then the bombardment of the planet can begin.

That is the quick version. In reality, it takes almost a hundred heavy weapons technicians to coordinate the tube launches. The target area rarely exceeds a six meter square. The hole this produces is actually a power surge that only lasts a few microseconds. If the turbolasers have not made their shots in this time, the process must start all over again.

The most difficult part of the entire process is determining exactly where the shield generators lie. Sensors cannot penetrate full planetary shields, so the crew of the Sphere must study the power waves within the shield to determine where the initial power is coming from.

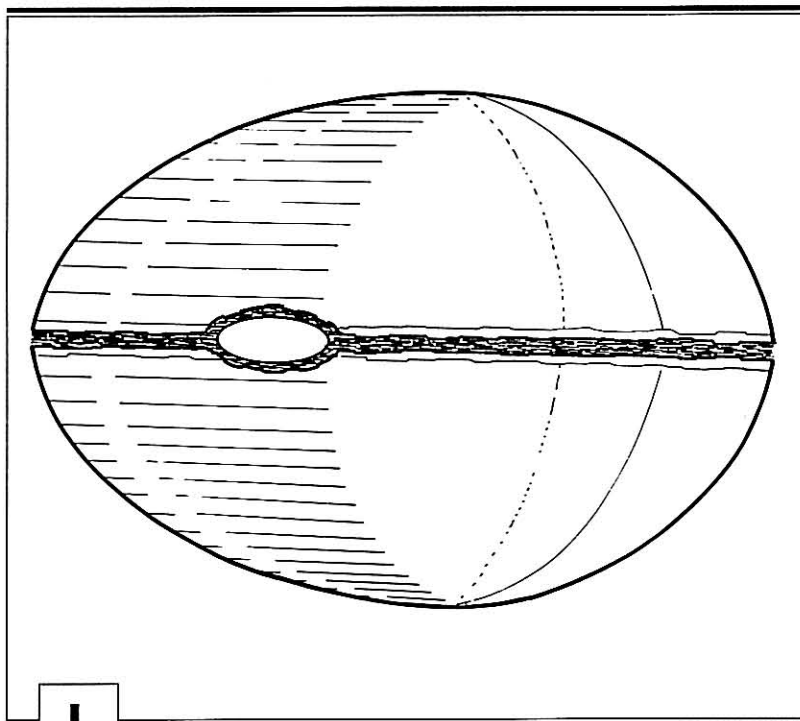

L

ronar's Torpedo Sphere Dedicated Siege Platform.

There are only six Torpedo Spheres currently in service. They perform only one function, but it is an important one in these times of open rebellion.

TORPEDO SPHERE

Craft: Loronar's Torpedo Sphere
Type: Dedicated Siege Platform
Length: 1,900 meters
Scale: Capital Ship
Crew: 63,275
Troops: 8,540
Hyperdrive Multiplier: x3
Nav Computer: Yes
Hyperdrive Backup: Yes
Sublight Speed: 1D
Maneuverability: zero
Hull: 9D+2
Weapons:
10 Turbolaser Batteries (fire linked)
Fire Control: 0D
Damage: 9D
500 Proton Torpedo Tubes (fire linked)
Fire Control: 2D
Damage: Knock out planet shield (9D)
Shields: 2D

Victory-Class Destroyers

Technological advancement is a byproduct of war. The battle-marred era marked by the Clone Wars saw the creation of bigger, faster, more heavily armed and armored combat vessels. The best of this bumper crop was the *Victory*-class Star Destroyer.

Designed by Republic engineer Walex Blissex, the *Victory* was commissioned into service as the wars were drawing to a close. Consequently, though these ships saw little action during the wars, they formed the bulk of the Republic Navy for years following. For a time it seemed these vessels would be replaced by the larger, newer *Imperial*-class Destroyers, but since the Rebellion moved into full swing the *Victory* has served in the defense of the Empire.

The *Victory* Star Destroyer carries out three standard mission types: planetary defense, planetary assault and troop support, and ship-to-ship combat. It is much better at the first two than at the latter. One of this vessel's most powerful advantages is its ability to enter the upper levels of a planet's atmosphere — something the newer Star Destroyers cannot do. This

permits precision ground attacks and the pursuit of smaller craft hoping to escape by diving toward planet.

The *Victory*-class vessel's main deficiency is its slow sublight speed. However, it does have rapid hyperspace capabilities and can make jumps quickly. To augment its slow speed, the *Victory* carries two TIE fighter squadrons.

VICTORY-CLASS DESTROYER

Craft: Rendili StarDrive's *Victory I*
Type: *Victory*-class Star Destroyer
Length: 900 meters
Scale: Capital Ship
Crew: 5,200
Troops: 2,040
Hyperdrive Multiplier: x1
Nav Computer: Yes
Hyperdrive Backup: Yes
Sublight Speed: 2D
Maneuverability: 1D
Hull: 4D
Weapons:
10 Quad Turbolaser Batteries
 (fire separately)
Fire Control: 4D
Damage: 5D
40 Double Turbolaser Batteries
 (fire separately)
Fire Control: 3D
Damage: 2D+2
Concussion Missiles
Fire Control: 2D
Damage: 9D
10 Tractor Beam Projectors
Fire Control: 3D
Damage: 5D
Shields: 3D+1

Victory II

It did not come off the production line until the Clone Wars had ended, and consequently only a handful ever saw completion. Yet Rendili StarDrive's *Victory II* Star Destroyer has made an impact in this age of *Imperial*- and *Super*-class Star Destroyers. While the *Victory I* is primarily a planetary assault vessel, the *Victory II* was designed with space combat in mind.

The *Victory II* is fitted with powerful Hoersch-Kessel engines that add significantly to the Destroyer's sublight speed and maneuverability. In addition to its normal armament, the *Victory II* is equipped with ion cannons and enhanced tractor beam projectors. In combination, these weap-

ons regularly disrupt the usual performance of an enemy ship, leaving it vulnerable to the Victory II's destructive weaponry.

Victory II Destroyers are designed with hangar bays large enough for two squadrons of TIE fighters. A recent shortage and high demand for the starfighters has seen the mothballing of several hangars, or the use of non-combat craft as battle platforms.

The main duty of the small number of these Star Destroyers is sector patrol. In pairs, or with other ships, Victory IIs regularly move into suspected hot spots and areas of Rebel or pirate activity with orders to pacify the sector.

VICTORY II STAR DESTROYER

Craft: Rendili StarDrive's Victory II

Type: *Victory-class* Star Destroyer

Length: 900 meters

Scale: Capital Ship

Crew: 6,107

Troops: 1,600

Hyperdrive Multiplier: x1

Nav Computer: Yes

Hyperdrive Backup: Yes

Sublight Speed: 3D

Maneuverability: 1D

Hull: 4D+2

Weapons:

20 Turbolaser Batteries (fire separately)

Fire Control: 1D

Damage: 7D

20 Double Turbolaser Cannons (fire separately)

Fire Control: 2D

Damage: 5D

10 Ion Cannons (fire separately)

Fire Control: 4D

Damage: 4D

10 Tractor Beam Projectors

Fire Control: 2D

Damage: 6D

Shields: 3D

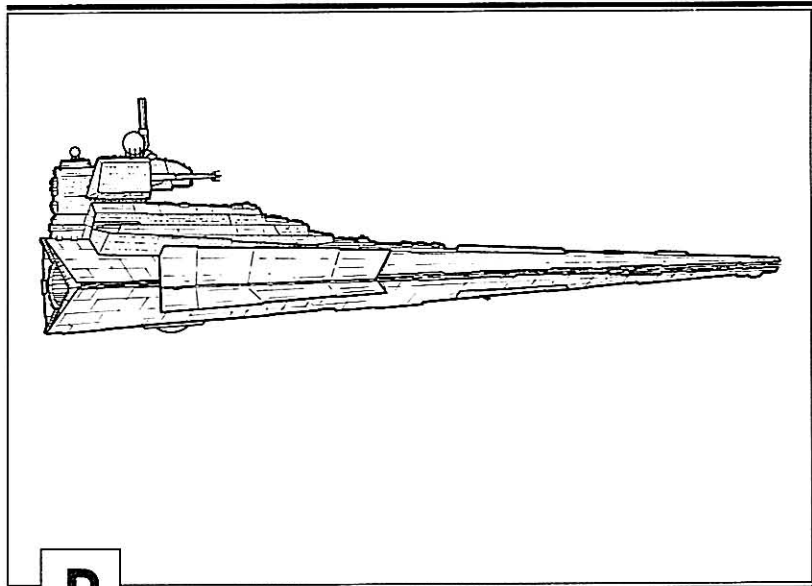

R

endilli Star Drive's *Victory-class* Star Destroyer.

on a fleet of lesser enemy vessels. Each carries a full stormtrooper division, complete with assault craft and ablative heat shields for orbital drops, 20 AT-AT and 30 AT-ST walkers for ground assault, and six TIE fighter squadrons for escort and patrol.

There are whole star systems whose gross domestic product is less than the cost of a single Imperial Destroyer. There are whole nations which, throughout their entire history, do not use as much energy as an Imperial expends to make a single hyperspace jump.

To carry out the Emperor's mandate of rule through fear and the swift destruction of opposition, the *Imperial-class* Star Destroyer is the weapon of choice. By deploying a Star Destroyer and support ships to a system, the Empire can destroy virtually any foe.

It is impossible to garrison every world in every system in the Empire, but the Imperial Star Destroyers give the Emperor the ability to project his power anywhere he wishes in a short period of time. These vessels are more than weapons platforms. They also act as space stations, repair docks, and heavy transports for smaller craft.

An *Imperial-class* vessel usually carries combat craft, shuttles, repair and recovery vehicles, landing barges, drop ships, ground assault vehicles, and pre-fabricated garrison bases for immediate deployment.

Since its introduction, an improved version of the Star Destroyer has begun to see action. The Imperial II is an upgraded model featuring increased shielding and heavier firepower.

Imperial Star Destroyers

Designed by Lira Wessex, daughter of the man who designed the *Victory-class* Star Destroyer, the *Imperial-class* Star Destroyer was an engineering and budget-planning nightmare. But the Navy pushed for it and the Emperor demanded it, so the standard Star Destroyer was built.

The Imperial Star Destroyer has enough firepower to reduce a civilized world to slag or take

IMPERIAL STAR DESTROYER

Craft: KDY's Imperial I
Type: *Imperial-class* Star Destroyer
Length: 1,600 meters
Scale: Capital Ship
Crew: 37,085
Troops: 9,700
Hyperdrive Multiplier: x2
Nav Computer: Yes
Hyperdrive Backup: Yes
Sublight Speed: 3D
Maneuverability: 1D
Hull: 7D
Weapons:
60 Turbolaser Batteries (fire separately)
Fire Control: 4D
Damage: 5D
60 Ion Cannons (fire separately)
Fire Control: 2D+2
Damage: 3D
10 Tractor Beam Projectors
Fire Control: 4D
Damage: 6D
Shields: 3D

IMPERIAL II STAR DESTROYER

Craft: KDY's Imperial II
Type: *Imperial-class* Star Destroyer
Length: 1,600 meters
Scale: Capital Ship
Crew: 37,085
Troops: 9,700
Hyperdrive Multiplier: x1
Nav Computer: Yes
Hyperdrive Backup: Yes
Sublight Speed: 3D
Maneuverability: 1D
Hull: 7D+1
Weapons:
50 Heavy Turbolaser Batteries (fire separately)
Fire Control: 0D
Damage: 10D
50 Heavy Turbolaser Cannons (fire separately)
Fire Control: 1D
Damage: 7D
20 Ion Cannons (fire separately)
Fire Control: 4D
Damage: 4D
10 Tractor Beam Projectors
Fire Control: 4D
Damage: 6D
Shields: 2D+2

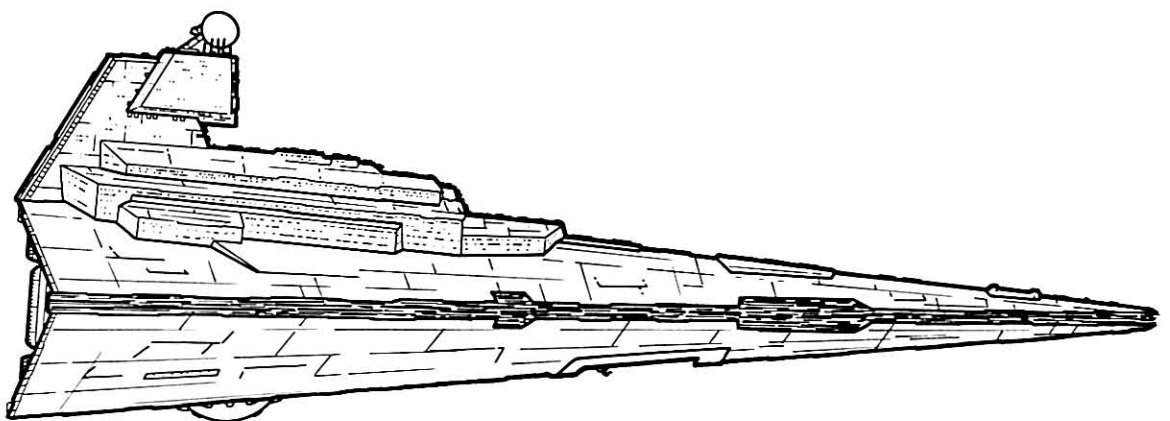

K

uat Drive Yards' *Imperial-class* Star Destroyer.

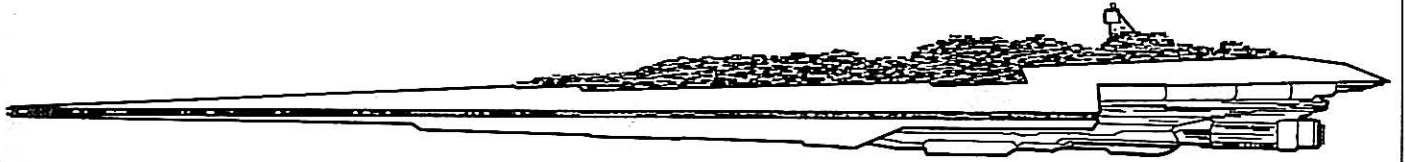

K

uat Drive Yards' *Super-class* Star Destroyer.

Super Star Destroyers

Except for the Death Star battle station, the *Super-class* Star Destroyer is the largest warship ever constructed. Five times the length of an Imperial Star Destroyer, each carries more than a quarter million troops and crew.

Over 1,000 turbolaser batteries, ion cannons, and tractor beam emplacements dot the eight kilometer length. These vessels are like a fleet unto themselves. Twelve squadrons of TIE fighters await within the huge confines of the massive ship, including two squadrons made up of the new TIE Interceptor model. Other carried vessels bring the total aboard the *Super Star Destroyer* to over 200 ships.

Even more weapons of destruction are within the *Super Star Destroyer*, including a full corp of stormtroopers and other soldiers, 25 AT-AT walkers, 50 AT-STs, and various other ground assault vehicles. In addition, the ship carries three pre-fabricated garrison bases for immediate deployment.

The *Super-class* Star Destroyer is the dream of the Emperor and the epitome of his new navy. It represents the best and newest vessel available in the Imperial inventory. It is a command ship, a spacegoing headquarters from which to guide planetary invasions, space battles, and the like.

Four of these massive vessels are now in service. The first, *Executor*, was presented to Lord Darth Vader by the Emperor to serve as his personal flagship from which to lead the fleet charged with the eradication of the Rebel Alliance.

SUPER STAR DESTROYER

Craft: KDY's *Executor*
Type: *Super-class* Star Destroyer
Length: 8,000 meters
Scale: Capital Ship
Crew: 280,734
Troops: 38,000
Hyperdrive Multiplier: x2
Nav Computer: Yes
Hyperdrive Backup: Yes
Sublight Speed: 2D
Maneuverability: zero
Hull: 10D
Weapons:
250 Turbolaser Batteries (fire separately)
Fire Control: 1D
Damage: 7D
250 Heavy Turbolaser Batteries (fire separately)
Fire Control: 0D
Damage: 10D
250 Concussion Missiles Tubes
Fire Control: 2D
Damage: 9D
250 Ion Cannons (fire separately)
Fire Control: 4D
Damage: 4D
40 Tractor Beam Emplacements
Fire Control: 4D
Damage: 9D
Shields: 8D

Imperial Capital Ship Recognition Guide

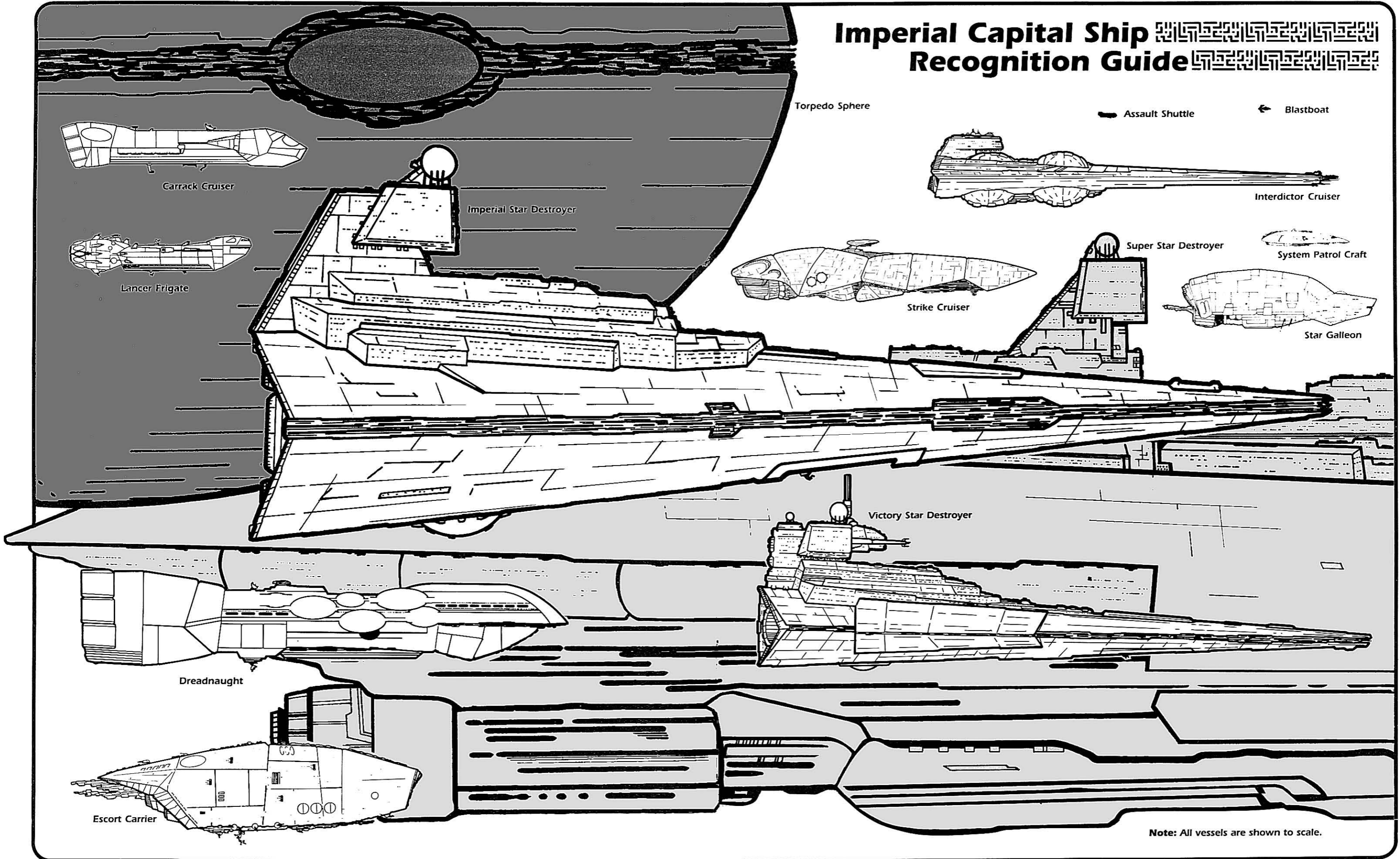

Torpedo Sphere

Assault Shuttle

Blastboat

Carrack Cruiser

Imperial Star Destroyer

Interdictor Cruiser

Lancer Frigate

Strike Cruiser

Super Star Destroyer

System Patrol Craft

Star Galleon

Victory Star Destroyer

Dreadnaught

Escort Carrier

Note: All vessels are shown to scale.

C

hapter Six
Custom Ordnance

Silhouette of
Super Star
Destroyer
continued
from previous
page.

(The following report was presented to the Emperor's Advisory Committee on Military Affairs by the senior officers of the Department of Military Research.)

Some military missions require special weapons. The following report outlines some of the newest innovations to come out of the DMR. Many of these custom ordnance are still in the planning stages, but these few are the closest to operational deployment.

Cloaking Fields

A fully-operational cloaking device has always been the ultimate dream of Naval commanders since before the most primitive sensors were developed. The idea of cloaking or hiding a vessel from either visual or sensor pickup has been a goal of everyone who designs space vehicles. Unfortunately, as newer and more sophisticated sensor systems were developed, true "cloaking" became more difficult.

Recently, the Empire's highly funded and very controversial research into sensor cloaking paid off. A multi-talented team of scientists and engineers were collected to begin final construction on a working cloaking device.

Many rumors have been circulated concerning cloaking fields and their existence. Some have come from the Empire in an attempt to frighten and confuse those who would test its abilities. Others have come from those so frightened, permitting the disinformation to expand. In fact, it was determined that a singular breakthrough in cloaking technology was highly unlikely, and the Empire has pursued a combined approach ever since.

The current test model is a device comprised of a number of inter-related systems and technologies, specifically designed to

provide total protection. The "cape," as the complete system is referred to, is a double-blind device. This means the protection from sensor transmissions works both ways.

The cloaking field obscures all types of electromagnetic sensors by absorbing the beams instead of reflecting them. Since most sensor radiation never returns to the originating source but usually disappears into the void of space, the protected vessel is effectively cloaked. The field protects against highly limited EPRs (electrophoto receptors), insensitive FSTs (full-spectrum transceivers), and computerized LFI (lifeform indicators).

A cloaked vessel is virtually immune to DER (dedicated energy receptor) scanning by all but the most powerful systems manned by the most expert technicians. DERs can only locate cloaked vessels by picking up ion engine heat. The Empire has developed a method for successfully baffling this heat via another phase of this project, and this phase is currently being studied for other military applications.

Cloaking fields, as they are developing now, cannot protect against CGTs (crystal gravitational traps) since the mass of the protected vessel is not affected by the field. As most of these expensive sensors are Imperial property, the need for mass baffling seems unnecessary.

The main drawback to the cloaking field project is that the cloak works both ways. A cloaked vessel cannot use its sensors either, as the field absorbs the beams before they can register any information. These ships would be blind in space, as well as invisible.

With these problems in mind, the Department of Military Research decided to narrow the cloaking project's goals. Under the new scheme, a vessel with a specific search-and-destroy or deep-space patrol mission would be

equipped with the new technology. This ship would use visual navigation in realspace and minimum sensors when in hyperspace. As combat would remain a low priority of this type of mission, the need for extensive computerized weapons systems which rely on sensor feedback would be eliminated.

As more details and reports are forthcoming, they will be passed along to the Advisory Committee.

Hyperspace Pulsemass Generators

Certain leaders within the DMR have a tendency to overlabel everything. The hyperspace pulsemass generator is an example of this, as the ordnance is simply a huge "pebble spreader" in space. The generator produces tiny spheres of hyperenergy that are shot out into an area of space. When ships traveling through hyperspace cross the equivalent area of realspace, they come in contact with the hyperenergy spheres. These spheres overwhelm the blocking capacity of the ship's shields and shred the craft.

These hyperenergy spheres do not affect ships in realspace, but if a ship enters a field of spheres and then jumps to lightspeed it comes in contact with the deadly pulses. A region mined with hyperenergy spheres is dangerous for only a few minutes, for then the energy dissipates.

This weapon can be devastating to large fleets, but the luck involved in successfully employing the pulsemass generator is enormous. You literally have to catch your opponent napping to mine a region of space and have him hyperspace through it before the energy spheres fade.

Now in experimental and limited use, the Empire is working to make this form of attack more profitable and more exacting. If it does succeed in improving the versatility of the hyperspace pulsemass generator, then fleets of enemy ships quickly escaping into hyperspace will become a threat of the past.

Magnetic Bombards

High tech worlds where the new magnepulse custom ordnance have been tested showed an immediate cessation of hostile and rebellious activity. A magnetic bombard delivered above cities or technological installations can send a civilization literally back into its dark ages.

These weapons take two forms, both delivering a magnetic pulse that shorts out most technological equipment, computers, communication units, and Droids. The first method

delivers the pulse via a cannon blast delivered by a ship of medium cruiser level or above. This blast, however, can be reflected back on the firer, causing the attacking vessel to "blink out" and become a desolate, powerless hulk. The second method delivers its pulse via a cluster bomb, but these bombs can be destroyed before they reach detonation.

Now being designed to include shields and evasive computers, the magnepulse bomb is gaining acceptance within the Empire. It is a clean weapon that simply prevents a world from retaliating with modern weaponry. The bombs can be carried by any vessel capable of supporting TIE bays, as these weapons are approximately the size of a fighter when the thrusters, evasive computers, shield generator, and power cells are in place.

The sophisticated technology that goes into creating a magnepulse bomb, and its one-shot delivery, make this ordnance very mission expensive. For now, DMR has chosen to spend the extra credits to obtain maximum flexibility. But new technologies, like interchangeable cannon-mounted weapons, might see this change in the near future.

Remember, these weapons do nothing against planets without a level of technology that includes computers and electromagnetic communications. But as most worlds the Empire wishes to pacify fall into this category, the use of magnepulse ordnance may increase as the civil war rages on.

Two-Wave Gravshock Devices

Housed within the shell of a Torpedo Sphere, the two-wave gravshock — or planetbuster — is designed to do terrible damage on a near-planetary scale.

By localizing a planet's gravity, the gravshock waves can simulate earthquakes, floods, and other natural disasters. Unfortunately, time and power make this weapon somewhat impractical on the everyday scale. The *Super-class* Star Destroyer, for example, is the only ship with engines powerful enough to pump the massive amounts of energy necessary for a full planetary disruption, but it has no need of such a weapon considering the armaments it packs.

The localization effect of the gravwave is not without problems either. As a planet's gravitational field is altered, any vessels navigating in near-space (including the attacker) are subject to rapid and unpredictable orbital shifts.

However, successful tests make this ordnance worth exploring. Crushing cities in upon them-

selves, shaking them to pieces, redirecting waterways to make the most of their destructive power — the gravshock device is worthy of Imperial thinking and use.

One new concept for the gravshock technology involves asteroid mining and surveying. Imperial engineers theorize that by studying the effects of a weak gravwave attack on a small body, like a moon or asteroid, they can learn information about its interior. Thus, the weapon can be used to find important ores and metals for making even more weapons.

Orbital Nightcloaks and Visual Electromagnetic Intensifiers

The experimental orbital nightcloak and visual electromagnetic intensifier are simply huge nets of linked satellites which intercept energy traveling to or from a planetary body.

The orbital nightcloak satellites prevent visible light from reaching a planet, immersing sections of the world in utter night. The visual electromagnetic intensifier net enhances and focus visible light onto a planet, effectively cooking the world.

Obviously, time is a drawback when using these ordnances. Time is needed to deploy and set up the satellite network, and because of the large amount of satellites needed to blanket a world nothing smaller than a Star Destroyer can be used to deliver them. As the network is susceptible to linkage detachment, a prolonged seige with these weapons can be cut short by fighter craft or anti-orbital defenses.

To combat some of these failings, technicians are working to introduce "dummy" satellites into the net that can be removed without halting the rest of the process. They are also working to design modular nets that can continue to work even though a section has been destroyed.

Silhouette of Super Star Destroyer continued from previous page.

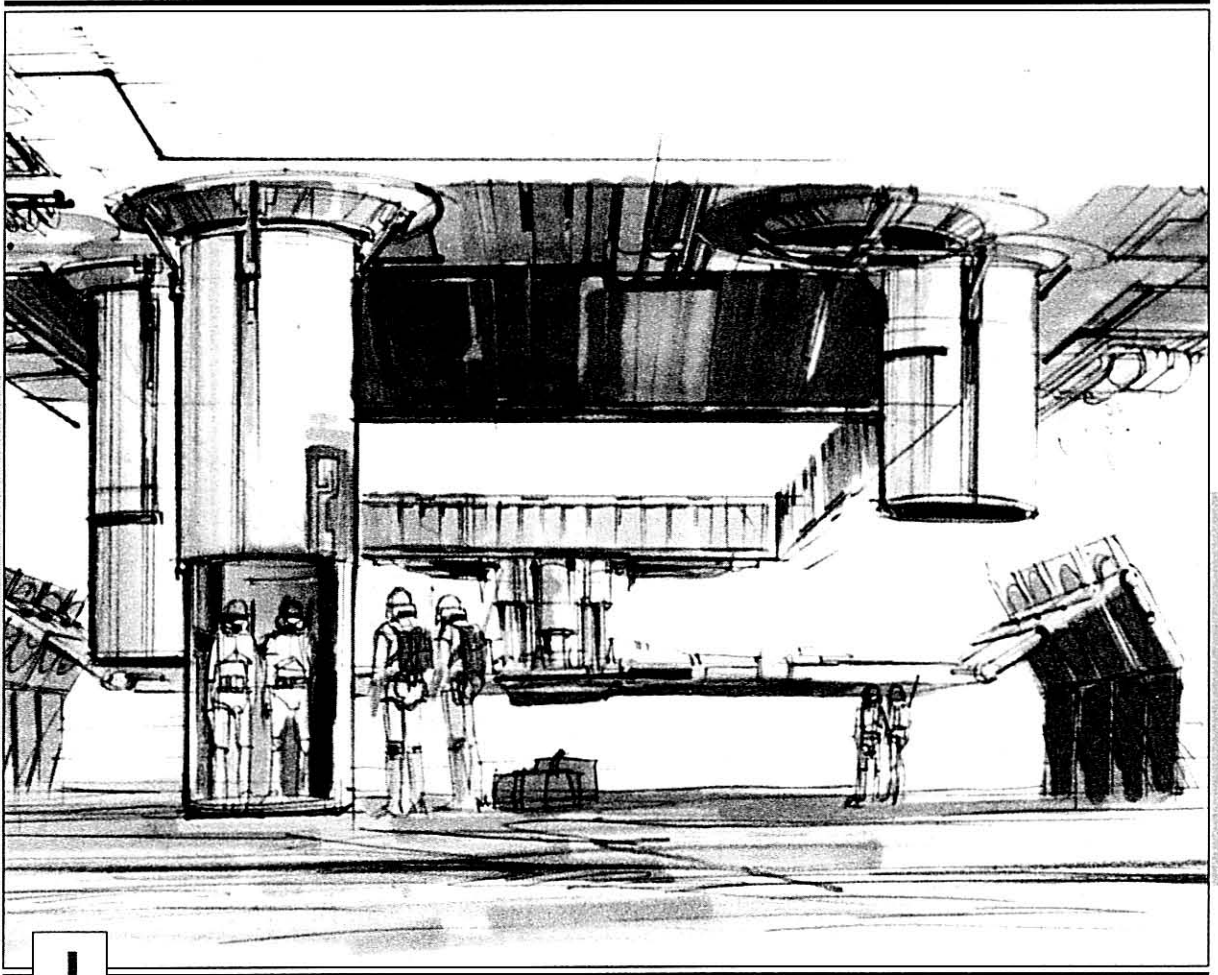

I

f deemed necessary to enforce galactic law and order, the Empire can use custom ordnance including magnetic bombard, gravshocks, orbital nightcloaks and visual electromagnetic intensifiers to bring planets in line with the New Order.

C

hapter Seven Land Vehicles

(Various reports from Army Command to Grand Moff Selit in response to the Grand Moff's request for suggestions on dealing with rebellious elements entrenched upon worlds in his sector of influence.)

The Empire consists of land, an incalculable amount of rock and soil and varied terrain. The space lanes are merely the paths between the land. The Navy has the massive Imperial fleet to control the space lanes, but the Army has a fleet of its own to control the land — a fleet of ground assault vehicles.

The Imperial fleet has been called “the Empire’s long arm,” but the Army and its assault vehicles are its crushing fist. Here are those members of the GAV (ground assault vehicle) fleet best suited to the subjugation of rebellious worlds. These craft, along with the mighty AT-AT and AT-ST walkers, make up the most powerful GAVs currently available to the Empire.

Juggernaut

While newer, sleeker GAVs can be found in service throughout the Galactic Core, older, less than perfect vehicles still see action throughout the Outer Rim Territories. The Juggernaut, called “rolling slabs” by troopers the galaxy over, is a hulking, cumbersome assault vehicle that nevertheless inspires fear in its opponents.

Dangerous and powerful looking, the Juggernaut has some design problems that make it less than perfect. But it is available and does serve an adequate function. Moving across terrain on massive wheels, these huge vehicles can be awkward to operate. The wheels on both ends of the Juggernaut turn independently to navigate unusual terrain, and either end may serve as the front. The coordination between the pilots in both cockpits must be

precise in order to keep the wheels from taking contradictory angles. If this occurs, the vehicle can “lock up” and become immobile. This has been known to happen during the confusion of battle.

The reason for the dual steering stems from the amount of time needed to turn the huge vehicle around. The Juggernaut can reach respectable speeds when moving in a straight line, but it is extremely slow to turn. Although a bit faster than the newer AT-AT walker (which drew some design elements from the earlier Juggernaut), the Juggernaut has little of the walker’s flexibility. Its huge bump flexors provide adequate shock support for the wheels, but a lack of traction and independent drive units leave the Juggernaut without maneuverability or momentum enough to manage certain terrain types.

The most unenviable assignment aboard a Juggernaut is the lookout post. A trooper must stand atop the huge machine in a scanning

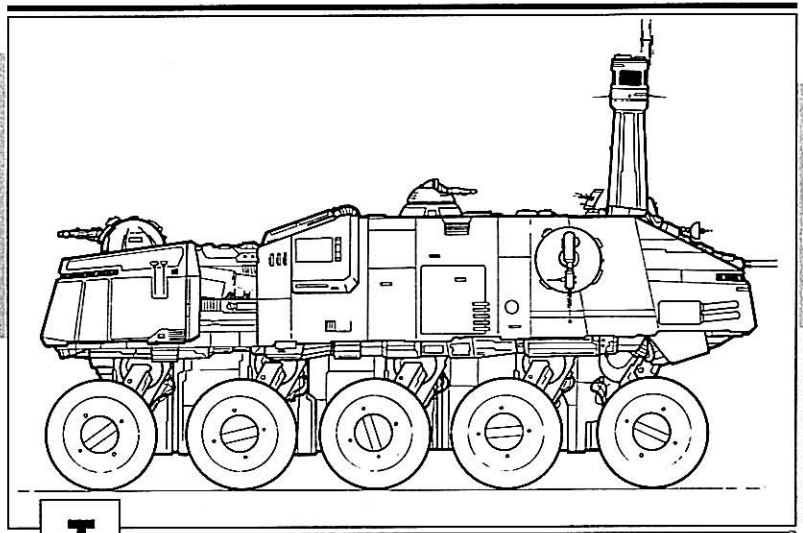

VEHICLE ILLUSTRATIONS BY KARL MARTIN

The Juggernaut heavy assault vehicle.

tower, operating the sensor array that needs the added height to be effective. While highly important to the pilots within the main body, the scanning tower is the most vulnerable spot on the rolling slab. Without the information relayed from the tower, the Juggernaut must rely on only the information and scanning it can perform from ground level, leaving it susceptible to air strikes and forces hidden behind hills and other terrain obstacles.

A Juggernaut's armor is its strongest point, along with the weapons that jut from its surface. It has firepower equivalent to a walker, and armor nearly as impenetrable.

While this vehicle is the predecessor to the AT-AT, it was not commissioned by the Empire. These ground craft were originally purchased by planetary governments and crimelords during the waning days of the Republic to provide the protection that was lacking at the time. They have since been commandeered by the Empire for use in the Outer Rim Territories.

JUGGERNAUT

Craft: Kuat Drive Yards' HAVw A5 Juggernaut

Crew: 8

Passengers: 50

Speed Code: 2D+2

Scale: Walker

Body Strength: 5D

Weapons:

Three Heavy Laser Cannons
(fire separately)

Fire Control: 2D

Damage: 6D

One Medium Blaster Cannon

Fire Control: 1D

Damage: 4D

Two Concussion Grenade Launchers

Fire Control: 1D

Damage: 3D+1

Compact Assault Vehicle

The Compact Assault Vehicle, or CAV, transforms a single trooper into a formidable assault force. This valuable piece of equipment addresses the problem of spreading the Empire's forces too thin throughout the vast expanse of the Galaxy. With it, a single trooper can generate the firepower of an entire squad.

There are worlds scattered throughout the Galaxy that are too remote to warrant a full-

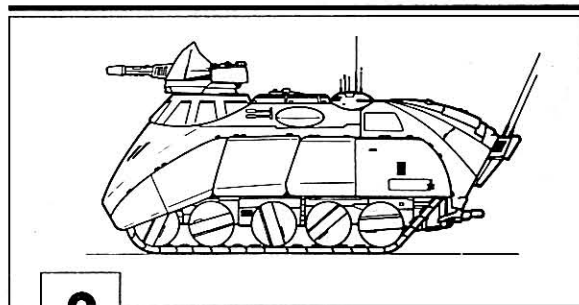

S

ingle trooper Compact Assault Vehicle.

scale occupational force, and yet demand a substantial Imperial presence because of their value to the Empire. The CAV was created for precisely this situation. A small force, equipped with CAVs, can hold and control an impressive amount of territory — provided the opposition does not have extensive firepower of its own to call on.

Controlled entirely by one trooper, a CAV combines sophisticated transportation, communications, and combat equipment into one compact unit. Fast, well armored, and equipped with sensors that allow the CAV to drive itself so that the trooper can concentrate on combat, this vehicle also has surprisingly powerful weapons for such a small machine.

The primary rule for CAV operators is never, under any circumstances, get out of the vehicle. The CAV is their weapon, their fort. If separated from the unit, the solitary trooper is probably doomed.

Opponents have discovered that the intricate computer technology that assists the CAV soldier can be jammed. This causes a breakdown in sensory input, confusing the pilot and rendering the CAV assistance programs inoperable. This makes the CAV less useful against high-tech foes, but more than adequate for dealing with the primitive worlds throughout the Empire.

COMPACT ASSAULT VEHICLE

Craft: Nen-Carvon CAVw PX-10

Crew: 1

Passengers: zero

Speed Code: 3D+2

Scale: Speeder

Body Strength: 3D+2

Weapons:

One Medium Blaster Cannon

Fire Control: 2D

Damage: 5D

Silhouette of Super Star Destroyer continued from previous page.

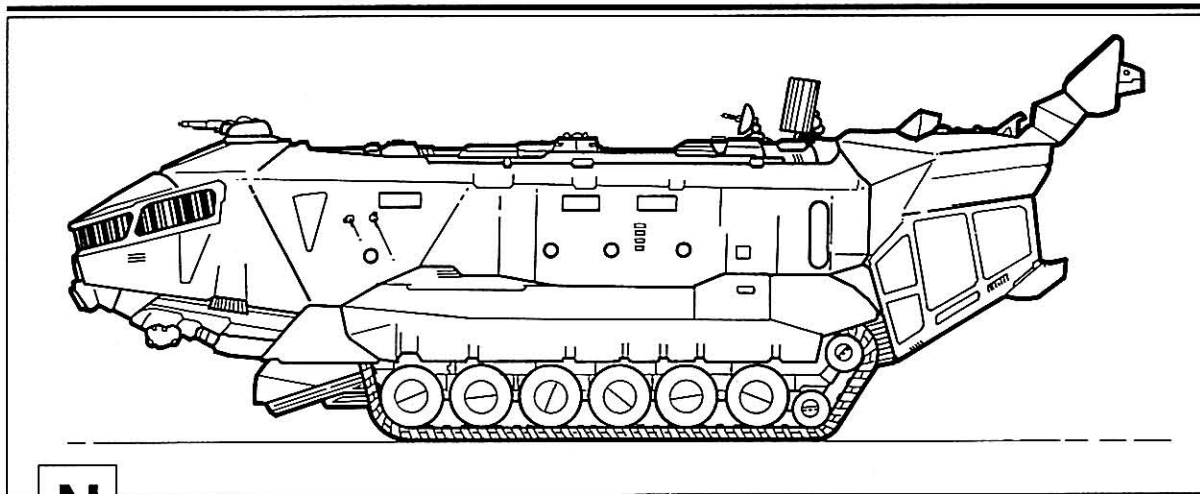

N

en-Carvon Mobile Command Base.

Mobile Command Base

The Mobile Command Base provides field combat commanders with transportation, protection, and a mobile headquarters that can move as their troops do. The heavily armed and armored vehicle permits safe passage to hostile battle sites for on the spot observation — a condition where commanders were once not permitted to enter.

These vehicles are also used by some planetary prefects and governors upon openly hostile worlds. Some of these leaders have come to rely so heavily upon the Mobile Command Base that they rarely travel without it. There are even a few who live inside these vehicles, never leaving the protection offered by the armored confines.

Designed for protection, the Mobile Command Base is built within a protective metallic shell almost a half a meter thick. The command pod at the center of the vehicle is encased within a shell of its own, adding to the protective thickness. Reflective shielding covers the outer hull, giving a final touch to this security cocoon.

Sophisticated sensors and computers monitor and analyze an entire battle as it progresses, giving the commander and his advisors up-to-the-minute data and suggestions. The sensors also monitor enemy communications, and incoming Imperial communications.

One heavy laser cannon provides offensive punch for the Mobile Command Base, but in normal operation the vehicle does not engage in actual battle. It is an observer and command post, designed to provide security to important individuals. It is not, in the strictest sense, a weapon of war, but wars are fought more effectively because of their presence.

MOBILE COMMAND BASE

Craft: Nen-Carvon PX-4 Mobile Command Base

Crew: 3

Passengers: 7

Speed Code: 2D

Scale: Speeder

Body Strength: 7D

Weapons:

One Heavy Laser Cannon

Fire Control: 2D

Damage: 4D+2

Repulsorlift Sled

The swoop gangs of the Outer Rim Territories have long been trouble for the Empire. Planetary governments have petitioned for protection from these roving pirates. Initially, Imperial scout troopers were deployed, but the more powerful swoops easily outmatched the scouts' speeder bikes.

Frustrated by these outlaws and angered by their increasing boldness, Army Command commissioned a new vehicle to deal with the menace. The Swift 3 Repulsor Sled is fast, light, and is capable of out-racing anything short of an air speeder when it comes to sheer surface speed.

But catching the outlaws is only the first step. Stopping them is another matter. To accomplish this, the repulsor sled is equipped with tangle nets that drop from bottom compartments. These nets, in addition to tangling around a swoop, give off short pulses that disrupt the repulsor fields that carry the craft. Once

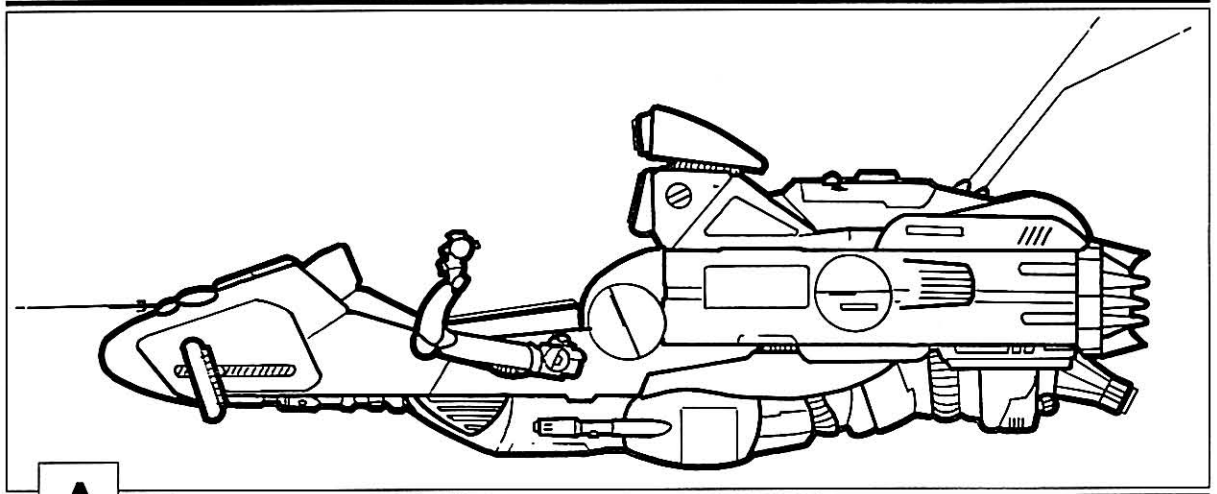

A

Aratech's Swift 3 Repulsorlift Sled.

in place, the net draws off the field and causes the craft to plummet toward the surface.

Other features include a clamping hook launcher, a front-mounted blaster cannon, and the newest scanning and communications jamming equipment. A modular design allows engineers to refit a repulsor sled according to a mission or particular situation.

The basic "engine with a seat" approach that goes into the swoop is employed for this craft. But updated engineering has eliminated the need for protruding directional vanes that mark the older swoops. Handlebar and foot pedal controls are still required, but with more comfortable body positioning.

As the success rate of the repulsor sled increases, these vehicles will see more and more service. They have already begun to appear in tandem with speeder bike and AT-ST teams, rounding out effective ground assault units.

REPULSORLIFT SLED

Craft: Aratech 64-Y Swift 3 Repulsorlift Sled
Crew: 1
Passengers: none
Speed Code: 6D
Scale: Speeder
Body Strength: 1D+2
Weapons:
One Medium Blaster Cannon
Fire Control: 2D
Damage: 3D

Floating Fortress

The scourge of any Imperial occupation force, the Floating Fortress repulsorlift vehicle has a reputation for being mercilessly thorough. Primarily used to extinguish uprisings in occupied urban areas, the Floating Fortress addresses some of the logistic problems faced by the cumbersome AT-AT walker. This vehicle is compact enough to glide easily between the buildings of a crowded inner-core city, yet it generates as much fear and terror as its four-legged counterpart.

The Floating Fortress is roughly cylindrical in shape, with a distinctive twin-turret blaster cannon resting atop its well-armored body. These formidable guns move independently of each other, swinging in a slow and determined arc, until finally "locking in" on an intended target. In the dark of night, the cannon follows the path of two piercing search beams, targeting whatever the beams focus upon.

The armored shell of the Floating Fortress allows the vehicle to go through obstacles as opposed to around them, obliterating all in their path with a casual effortlessness. Whole cities have been leveled by Floating Fortresses in search of Rebels or other enemies of the Empire.

Many of the psychological weapons of war necessary for urban suppression are also employed by the Floating Fortress. Chief among these is a highly sophisticated audio-visual surveillance system. Projecting out in a 30 meter bubble around the vehicle, this system combines a sensitive listening device with a heat sensing probe to create an intensive

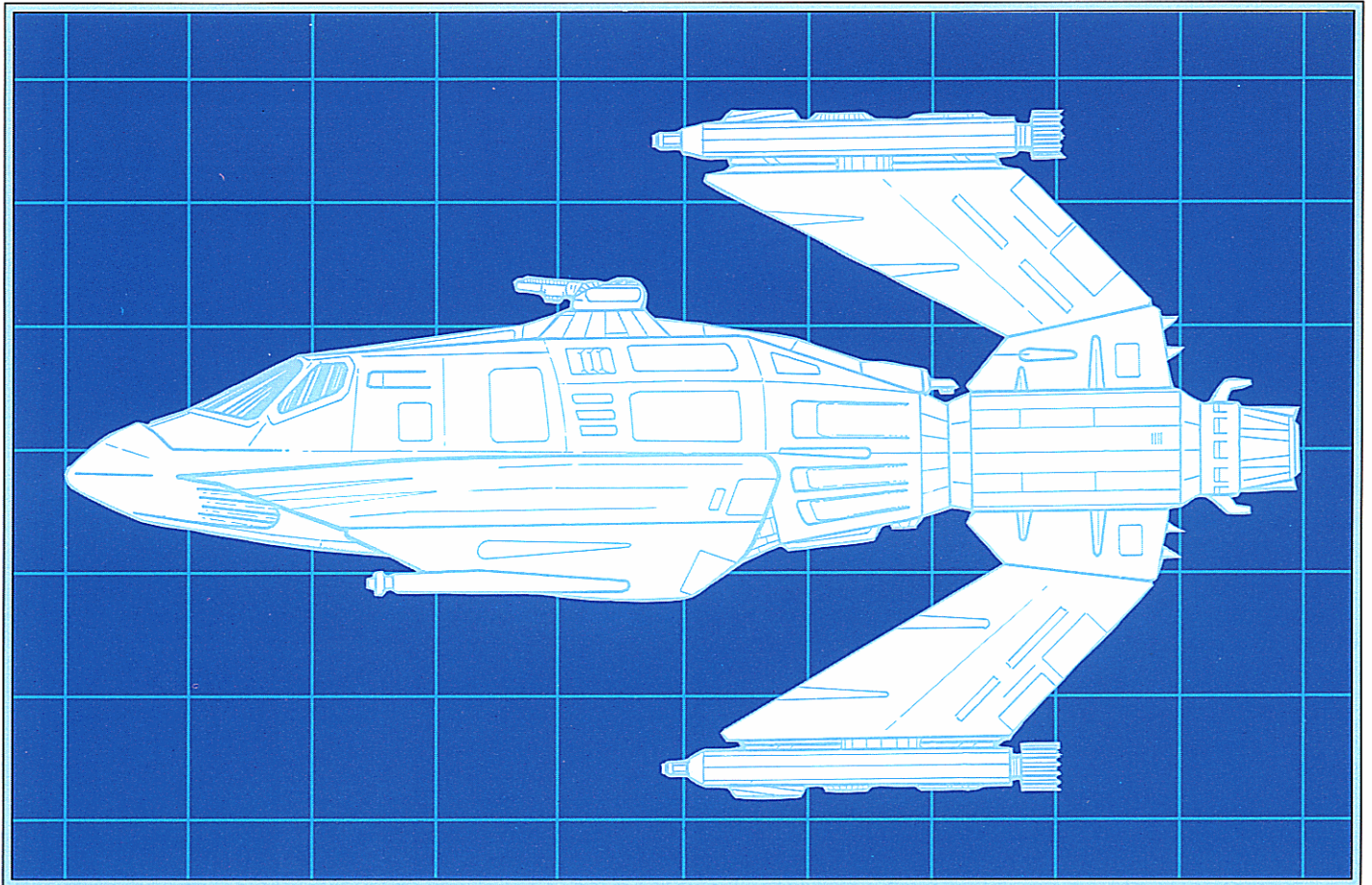

GAT

We're Ready for the Toughest Competition

Engineered to support system patrol/point defense requirements at the highest level, this upgraded combat veteran sets new standards in meeting multi-role mission integration and intersystem jump needs.

From the expertise developed in the successful and popular series of TIE starfighters comes the new generation in blastboat technology.

The GAT-12h "Skipray" delivers the performance edge needed for greater tactical response. We've boosted its power systems and reconfigured its weapon systems. Result: the GAT-12h is faster, tougher, more capable. Skipray

demonstrates a new degree of combat effectiveness, making it ideally suited for multiple mission profiles — equally at home fulfilling system patrol, point defense, planetary defense and interdiction requirements.

Hyperdrive capability enhances this versatility, making Skipray an integral part of your strategic overview.

Ready. Willing. Able. Skipray.

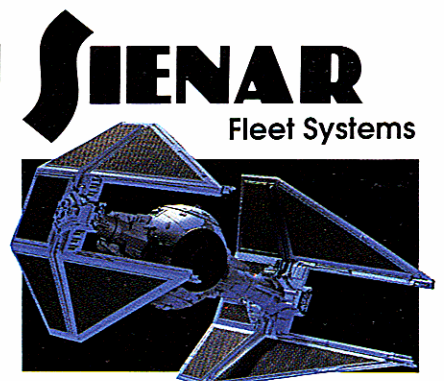

A Record of Excellence

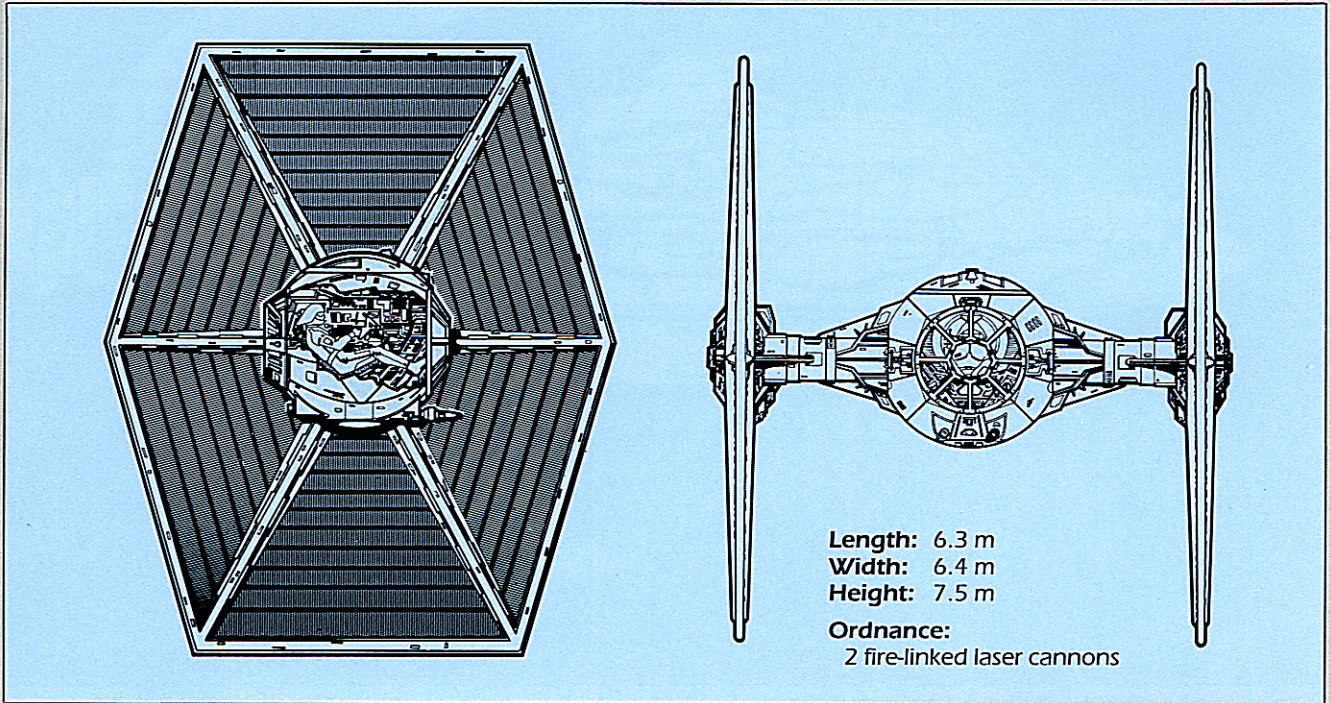

TIE/ln
Space Superiority Starfighter

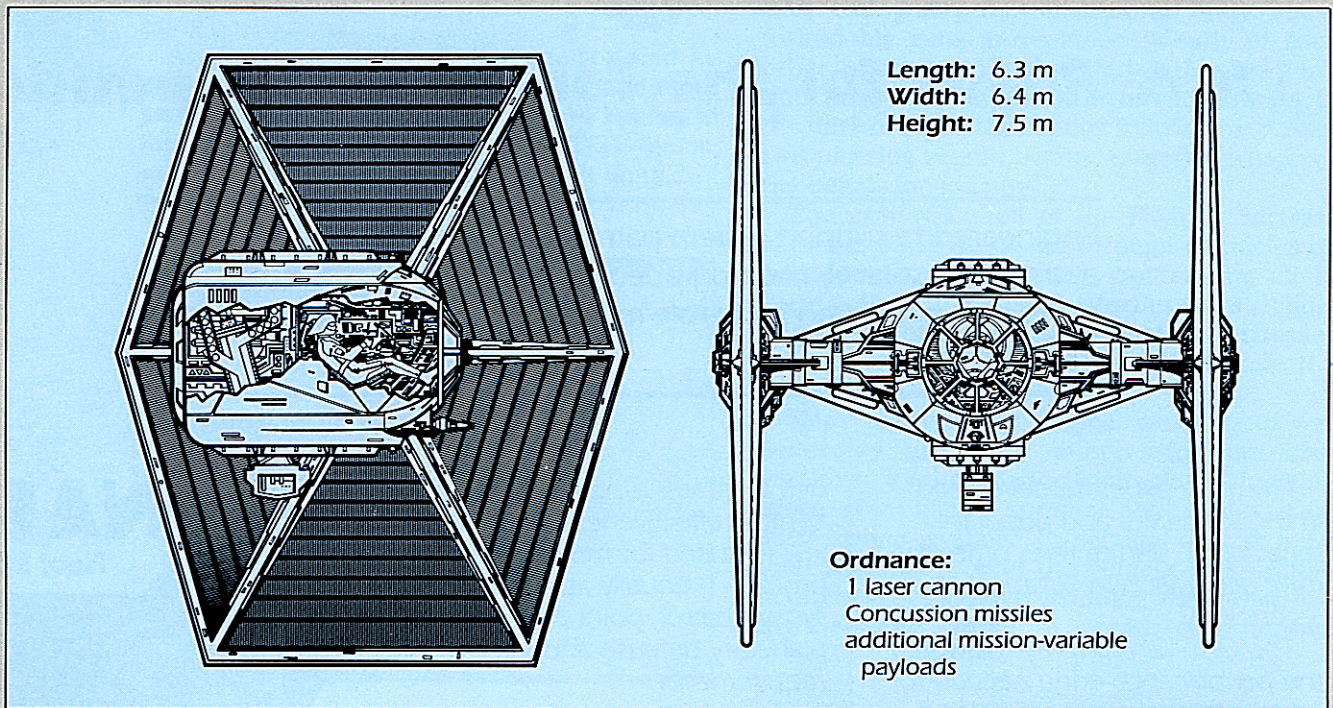
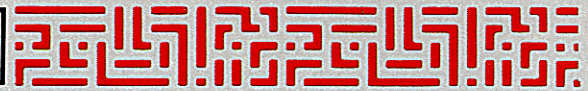

TIE/gt
Ground Support Starfighter



GENERAL SPECIFICATIONS

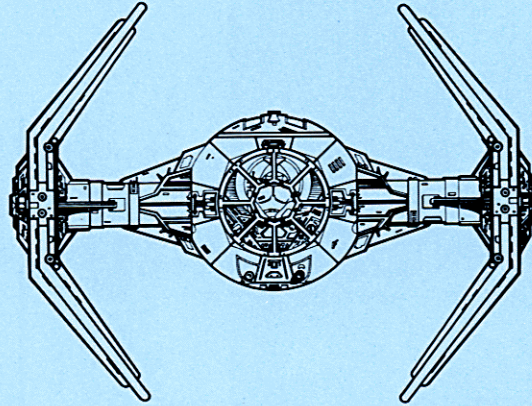
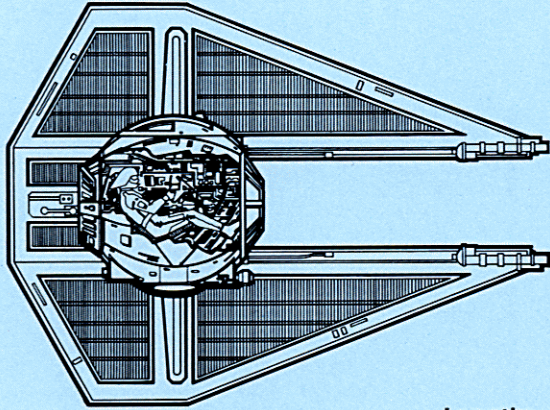

Length: 6.6 m
Width: 6.4 m
Height: 4.9 m

Ordnance:
4 fire-linked laser cannons

TIE Interceptor
Space Superiority Starfighter

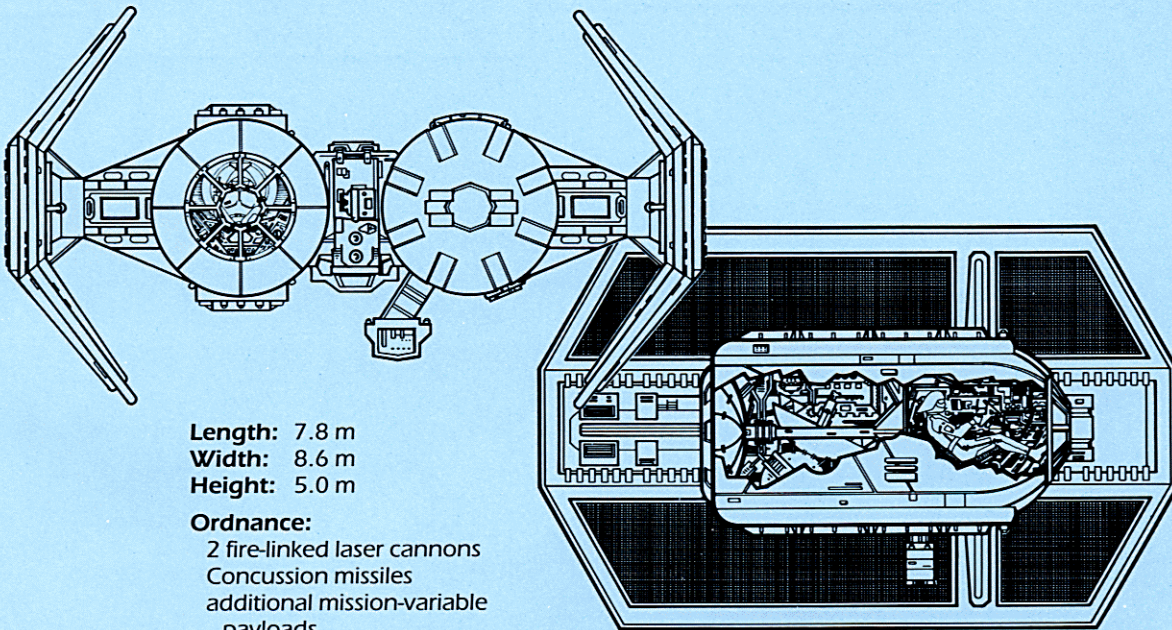

Length: 7.8 m
Width: 8.6 m
Height: 5.0 m

Ordnance:
2 fire-linked laser cannons
Concussion missiles
additional mission-variable
payloads

TIE Bomber
Light Space Bomber

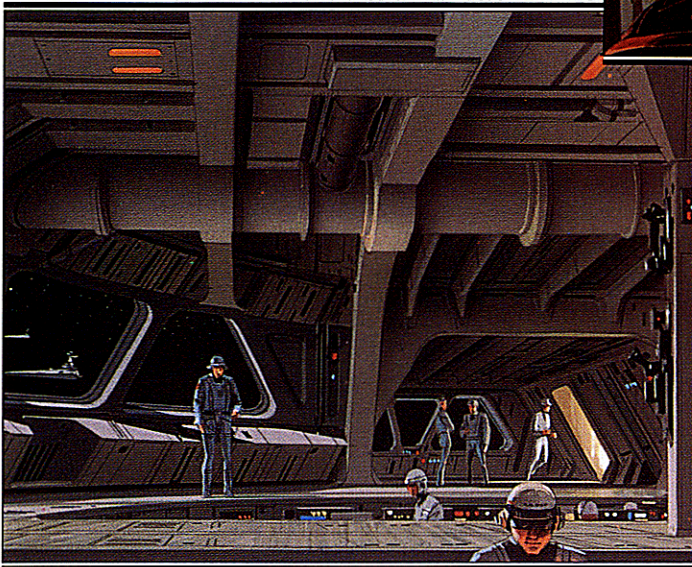
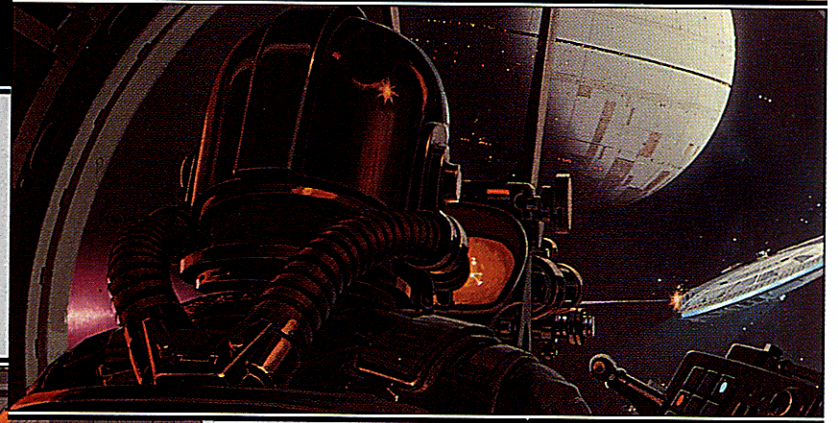
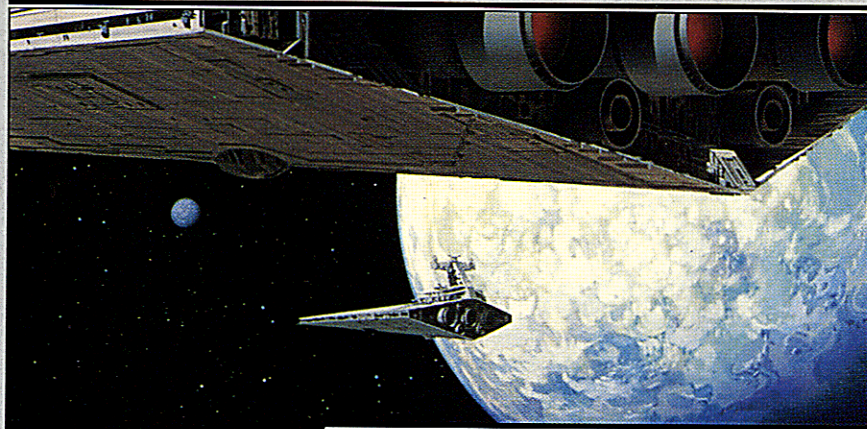

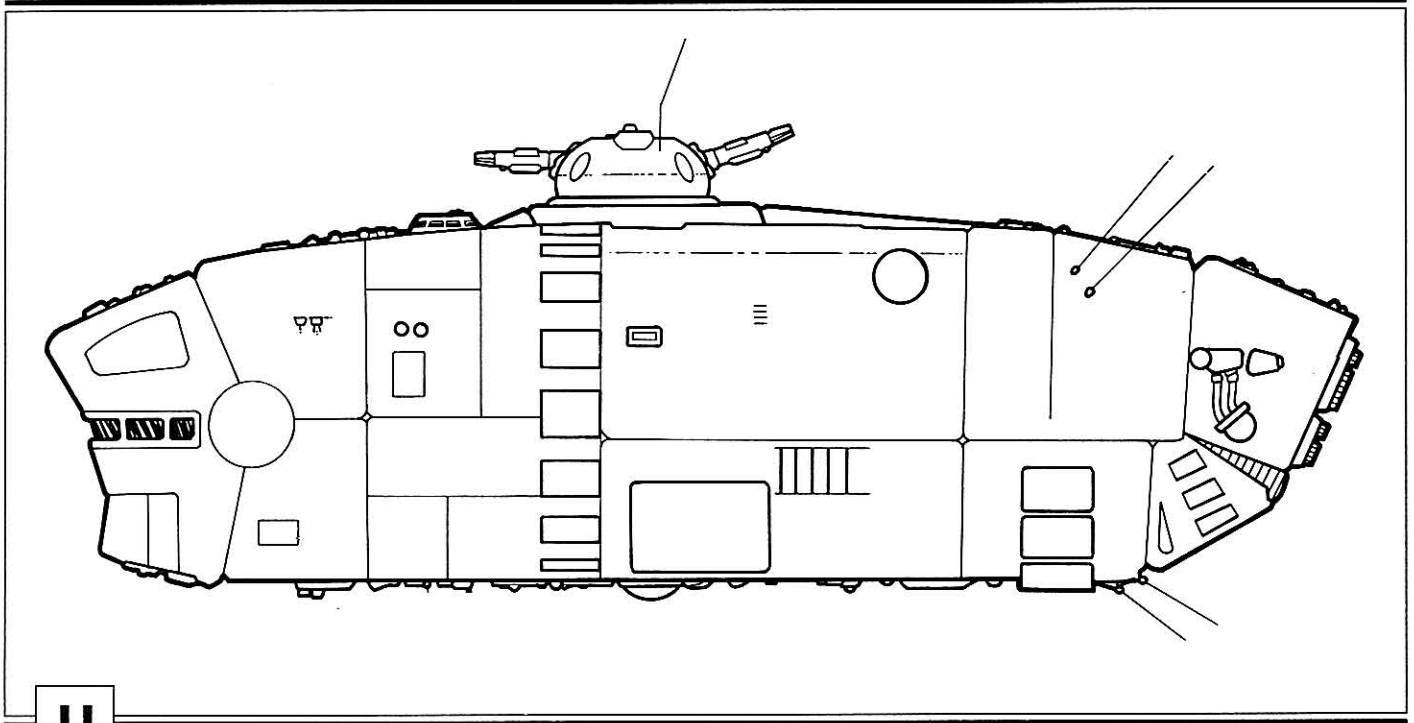

U brikian's HAVr A9 Floating Fortress.

"Target Identification Network," or TIN. This system is modeled after a sensor package once employed by assassin Droids.

The TIN system is not used exclusively to locate enemies, however. Often a mission will call for a simple display of power with a minimum of actual destruction. In these cases, the TIN system can be used to pinpoint an exact target without causing undo havoc.

A crew for the Floating Fortress consists of a pilot, two gunners, and a sensor coordinator who monitor the TIN. The repulsorlift craft also carries a small number of troops if deployment is needed. A rivalry of sorts exists

between the crews of these vehicles and the AT-AT walkers. While Army Command prefers the walker, occupational commanders constantly demand Floating Fortresses when garrisoning a world.

Command Speeder

The Chariot light assault vehicle is a modified military land speeder used by Imperial command personnel during routine occupations and assignments where proximity to actual combat is not a threat. It is more heavily armored than the usual military land speeder, but it is slower and more lightly armed. This reflects the need to protect important supervising command personnel rather than to lead attacking forces.

The command speeder has only one forward-mounted laser cannon that can fire only in the direction the vehicle is facing. As these craft are rarely unescorted, the cannon rarely fires a shot.

Like the Mobile Command Base, the command speeder possesses superior on-board computer battle-assistance programs, as well as complete up-link communications facilities. These critical units are shielded and back up systems exist in case of failure.

A little-known feature of this speeder is the self-destruct timer, activated by throwing a

FLOATING FORTRESS

Craft: Ubrikkian HAVr A9 Floating Fortress

Crew: 4

Passengers: 10

Speed Code: 2D

Scale: Walker

Body Strength: 5D

Weapons:

Two Heavy Blaster Cannons

(fire separately)

Fire Control: 2D

Damage: 5

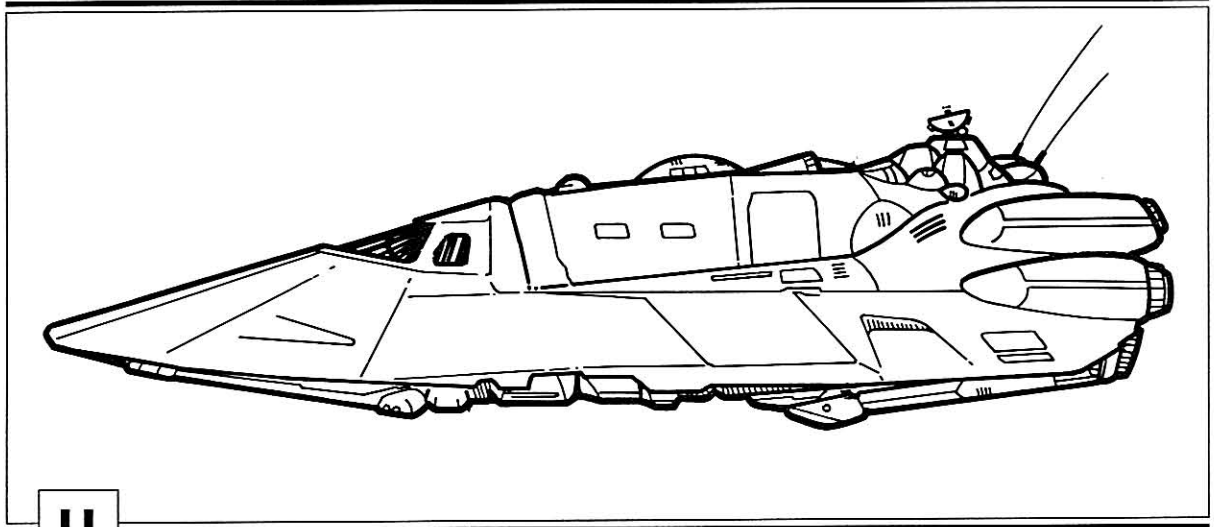

U

Uulshos's LAVr QH-7 Chariot Command Speeder.

switch beneath the command chair. It can be set to destruct as long as 10 minutes from the time it is thrown. This provides a last-ditch failsafe if a command team is captured or in risk of imminent capture. The computer monitors that record and analyze battles are not to fall into Rebel hands.

The vessel is outfitted for three men: the commander, his driver, and a guard who also serves as aide to the senior officer.

COMMAND SPEEDER

Craft: Uulshos LAVr QH-7 Chariot
Crew: 3
Passengers: none
Speed Code: 1D
Scale: Speeder
Body Strength: 4D
Weapons:
One Laser Cannon
Fire Control: 1D
Damage: 3D

Hoverscout

The Mekuun Hoverscout has proven itself on a number of worlds in a variety of ground forces and combat conditions. Intended for use in small unit reconnaissance and offensive point operations, the craft works well independently or with infantry or armor support. It is often deployed with several other hoverscouts in raids or rear-guard actions.

Although its speed and maneuverability cannot compete with those of repulsor-driven scout craft, there are many points in favor of the Mekuun design. It boasts a maintenance and failure rate better than most competitive floater scouts. It is easier and cheaper to maintain. Hovercraft require less training to operate than do repulsorlift vehicles. Finally, there are some worlds and terrain type that make repulsorlifts behave erratically. On these planets the hoverscout is the vehicle of choice.

The hoverscout uses a Gurian S87 "perpetual charge" power plant dynamo. A power capacitor initiates blower rotation, then back-blast impellers recycle energy from the vehicle's air cushion to supplement power generation. This efficient use of energy gives the hoverscout a longer range than most vehicles of its size and type.

The standard hovercraft ground effects design has been modified to meet the demands of military use in rigorous terrain. The vehicle's air cushion is generated by four three-cycle Kasmin turbopumps, the most refined heavy-duty blower unit of its type. The Kasmin pump permits extra elevation and float when needed, easily surmounting terrain that forms formidable obstacles for more conventional repulsorlift craft.

Several military specifications were designed into the hoverscout. It is armored enough to withstand a direct hit, but is not so heavy that its maneuverability is impaired. Sealed doors and weapon ports support a closed and recycleable environment.

A minimum crew of one is required to operate the hoverscout. The ceraglass windscreens, made from a ceramic alloy that is transparent and tough as armor, offer an exceptionally wide field of vision. With an optimal crew of four, all of the weapons systems can be operated while the vehicle is moving.

A variety of sensors and communications packages can be installed as custom-ordered devices, particular to a given mission. Standard equipment consists of weapon-linked EPR sensors at each crew position, and long-range communications.

HOVERSCOUT

Craft: Mekuun Hoverscout

Crew: 4

Passengers: 6

Speed Code: 3D

Scale: Speeder

Body Strength: 3D

Weapons:

Heavy Blaster Cannon

Fire Control: 1D

Damage: 6D

Laser Cannon

Fire Control: 1D

Damage: 2D

Concussion Missile Launcher

Fire Control: 2D

Damage: 4D

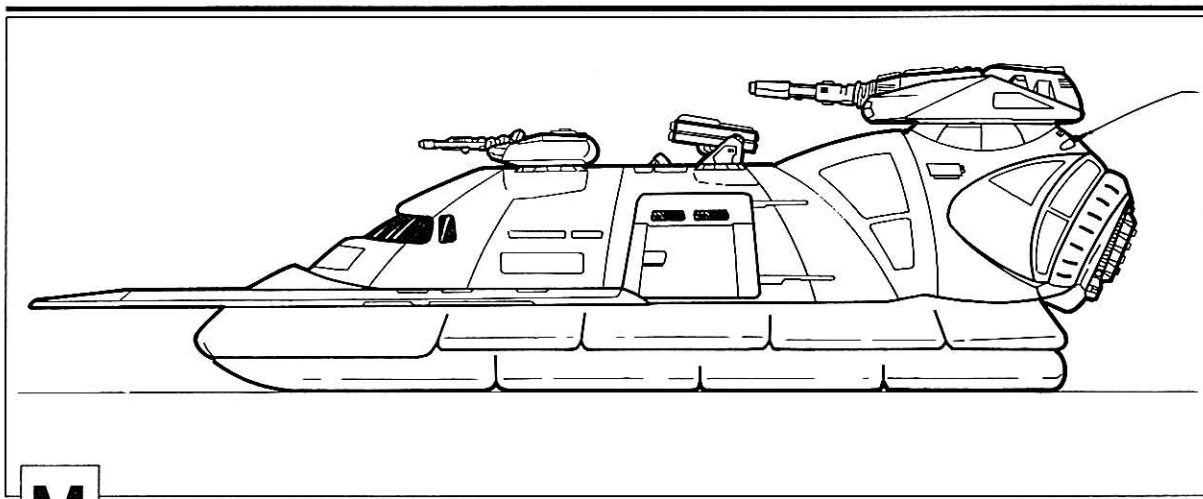

M

ekuun's Hoverscout repulsorlift craft is designed for reconnaissance missions and offensive point operations.

Imperial Land Vehicle Recognition Guide

Mobile Command Base

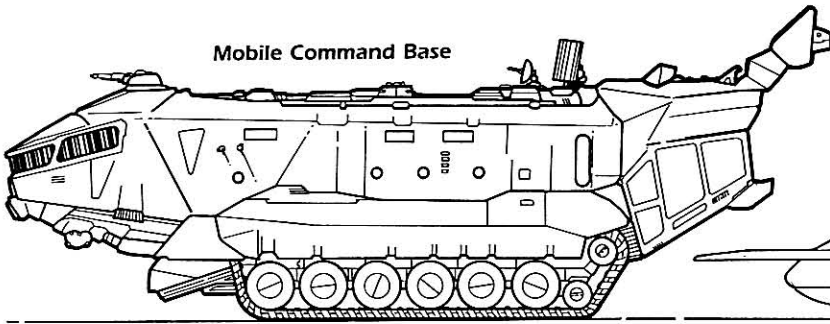

Hoverscout

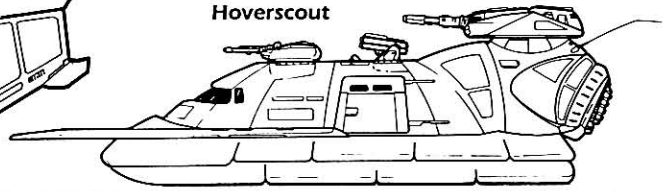

Command Speeder

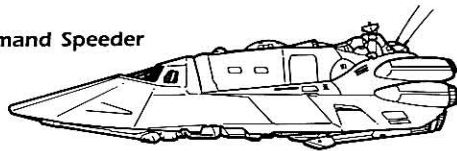

Juggernaut

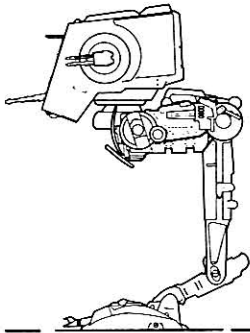
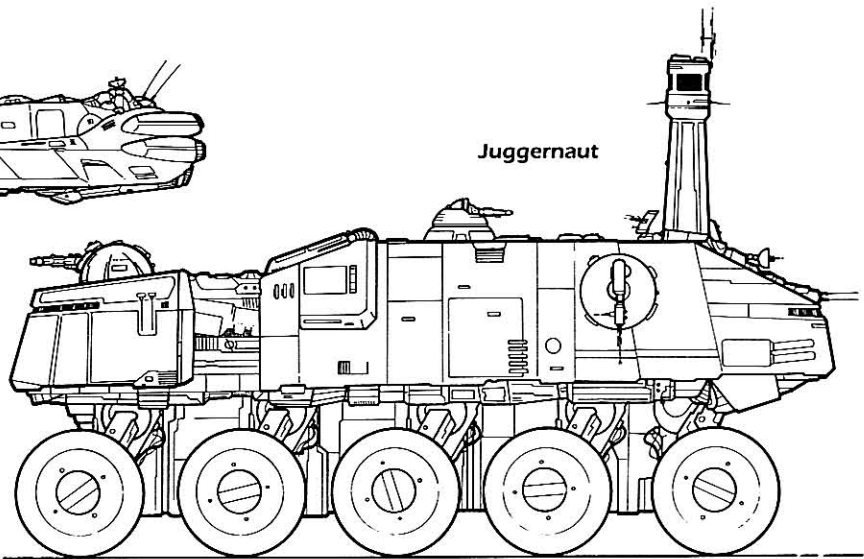

AT-ST

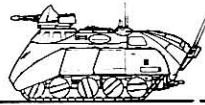

Compact Assault Vehicle



Repulsorlift Sled

AT-AT

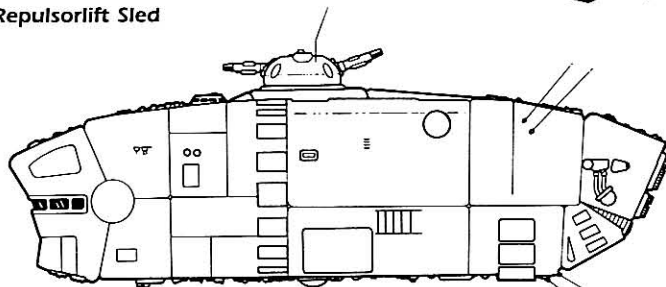
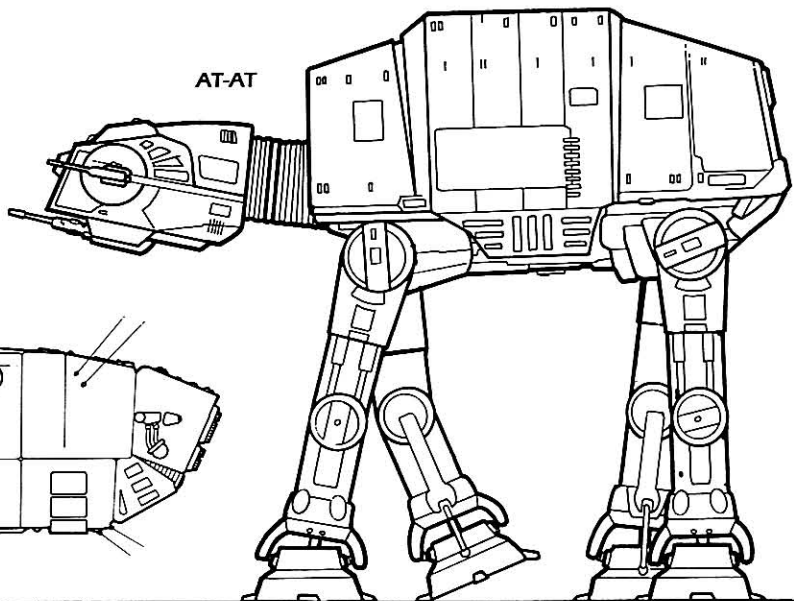

Floating Fortress

Note: All vehicles are shown to scale.



C

Chapter Eight Sector Group Organization

A Sector Group is a huge gathering of Imperial military might. A Sector Group is a flexible organization, one which is readily reinforced to many times its original strength while retaining essentially the same command structure at all times. This flexibility is an integral part of the Emperor's plan to fully arm the Empire.

While the organization and Order of Battle of a Sector Group—all the military might assigned to an average sector—has been outlined according to the numbers in these reports, these numbers can at best be considered averages. And in the wake of the Emperor's command to mobilize the Imperial war machine, they may even be considered minimum levels of force. Also, the forces deployed in a given sector will depend upon the importance, size, and location of that sector.

The Roles of the Army and Navy within a Sector Group

One of the Emperor's first actions was to refurbish the structure and personnel of the Army, establishing it as a branch equal to the Navy. This equality is still part theory, as the Navy is reluctant to give up its position of pre-eminence. Old line officers fought bitterly against designing Star Destroyers to carry and deploy drop-qualified combat elements under the command of the Army. The officers correctly saw this as a sign of an increase in support activities for the Navy—they incorrectly believed naval prestige could slow the will of the Emperor. The military was transformed according to the Emperor's wishes.

One of the results of this transformation was the creation of the Sector Group, an organization with greater flexibility and accountability than the military of the Old Republic. The roles of the Army and Navy were meshed more closely. No longer is the Navy able to ignore the Army because it is "groundstuck ... and proud of it," and the Army is no longer able to neglect events in

nearby systems as "the Navy's problem." Each branch is expected to pool its resources in order to achieve a common goal, maintaining Imperial rule within a sector.

The Role of the Army

The Army's mandate is to eliminate military threats to the established Imperial political order on the planetary surface (or other inhabited complex). If the planet is not under Imperial control, the Army is to engage and defeat any local military force capable of resistance in order to facilitate the transition of control of the planet to the Empire.

When engaged in operations, the Army can expect support from the Navy during the initial drop phase. During this phase the Navy will provide suppressing fire against particularly hard and/or well armed targets, and "force reduction attacks" to destroy enemy assets capable of interfering with reorganization after the drop. The Army is also allowed to pre-plan for from-orbit fire on specific targets during later stages of the operation. If the operation is important enough, naval units may be dedicated to certain ground elements to provide fire support whenever they are called upon.

When on garrison duty the Army's mission is essentially unchanged, except they are expected to provide firepower and backup to COMPNOR and Intelligence operatives when such actions have been cleared with the garrison commander.

When aboard a naval vessel, their primary duty is to stay clear of naval personnel who are doing their duty, and to see that their equipment is properly maintained. However, the Army is responsible for the defense of the vessel should enemy units attempt to board her. In this event, Army officers have authority to coordinate the crew of the vessel with their own men in order to defeat the enemy. With an increasing number of daring raids by Rebel elements, Army units are

now more active in maintaining day-to-day security. This causes friction between the crew of the vessel and Army troops.

The Role of the Navy

The Navy's mandate is to secure orbital space around inhabited planets, to investigate any vessels which in the opinion of the commanding officer appear capable of disrupting the security of orbital space, and to engage hostile vessels, destroying or seizing them as deemed necessary. In addition, the Navy is to establish patrols within a sector to locate known enemies or for the early detection of patterns of space activity which could indicate a hostile presence. Space superiority is clearly the Navy's most important mission, and the one which generates the most enthusiasm from crew and officers.

A mission which has been de-emphasized is the protection of scientific missions, as well as acting as the official clearinghouse for information on new worlds. As the Empire has practically ceased to sponsor exploration, this mission has atrophied to the point that many of the newer commanders are not even aware that such missions are part of the Navy doctrine.

If the Army is to be deployed on the surface of a world, the Navy is to provide combat support as soon as the orbital space is secured. Support for Army operations is to take precedence over establishing patrols until such time as the commander of surface operations indicates he has the situation under control, although such support operations are not expected to be exclusive of patrol activities.

If Army commanders deem the surface situation to be beyond hope of victory, or if the proper political authorities directly command it, the Navy is to execute a series of punitive attacks upon the target. The attacks are given code names which vary according to the mission and change frequently. The only code name which has not yet changed is "Base Delta Zero", the code for complete destruction of all "assets of production", including factories, arable land, mines, fisheries, and all sentient beings and Droids. The code name has not yet changed so there can be no possibility of confusion when a Base Delta Zero is ordered.

Organization of the Army

There was a clear-cut distinction in the army of the Old Republic between troops (those who could be expected to see combat) and support personnel and command elements, who usually stayed as far away from the action as they could and still stand a reasonable chance of performing their duty. In the twilight of the Old Republic the

probability of anyone over the rank of Lieutenant landing in a blasterblaze was virtually zero. This distinction still remains in the New Order, even though support personnel are more closely integrated with their units, are given combat training, and are expected to (and do) fight when confronted with the enemy.

Even though it is no longer unusual for captains and other ranking officers to participate directly in combat, they are still considered command elements rather than troopers. When a typical Imperial source lists a number of troops, they are counting traditional combat personnel only and not including the support or command elements.

Information on all the elements in the Army's order of battle is included below.

Squad

The eight-man line squad is the basic unit of the Imperial Army. The Imperial squad is smaller than the old 10- and 12-man squads common in the Old Republic, but superior training and more thorough use of coordinated small-unit tactics have resulted in no reduction in squad firepower. Additionally, a large number of new squads were created from the available manpower. The Empire has been experimenting with still smaller squads, particularly with elite or Stormtrooper units, but these are still rare. The eight-man squad remains the backbone of the Imperial Army.

A squad is commanded by a sergeant. The sergeant makes recommendations to his superiors for a brevet list, a list of the order of succession of chain of command. The first man on the list (once approved) is automatically given the rank of corporal. While the other troopers are not given ranks, each man knows what his number in the line of command succession is. While not a really accurate indicator of a man's value to his squad, succession numbers are often taken as a measure of a trooper's worth. This belief has led to the expressions "Lower than the eight-man" and "Certain as the one-man's mind."

The Empire spends a great deal of time selecting and training its sergeants. The sergeant is the man who has train, evaluate, and command the recruits. The sergeants build the squads, and the squad is what the Army is built upon. The common wisdom is that it is more difficult to make it to sergeant than to lieutenant or even captain.

Recent setbacks against the Rebellion have prompted the Empire to see how they might increase the firepower of a basic squad as cost effectively as possible. A leading effort is to give each squad a light repeating blaster. The repeating blaster is carried and operated by one man. Light repeating blasters have been added to

squads in almost every sector, but the rearming effort has been sporadic everywhere but in three sectors where better than half of the line squads have been re-equipped: Shwuy, Harron and Nembus. On heavily populated worlds in those sectors, such as Uviuy Exen in Shwuy and Trammen in Harron, every single line squad has been completely armed with light repeating blasters.

Sharpshooter squads are indeed filled with troopers whose accuracy with blasters is greater than the standard trooper. Sharpshooter squads also differ in that the brevet list is largely discarded. While every elite trooper is given at least the basics of demolitions, each man is trained in several different skills, and before each mission the sergeant appoints the trooper with the most pertinent skills as brevet corporal. Each trooper is briefed as to what is expected of him during the mission, and these soldiers are expected to be good enough to decide how best to improvise should the sergeant and corporal be eliminated from the mission profile.

While not officially on the order of battle, light repeating blasters have found their way into just about every sharpshooter squad. The troopers' belief that these weapons greatly increase the effectiveness of their units is a prime factor in issuing the weapons to line squads.

Engineering squads contain specialists in non-combat skills who have some combat training, mixed with combat experts who have been given intensive training in other useful skills.

Engineering squads are designed to get into, go through, go around, or go over just about anything. They are also expected to be able to operate, repair or dismantle any piece of equipment they come across. Each squad contains a demolitions expert who has proven his ability in the field with sharpshooter squads. His mixture of skills often makes him the most dangerous man in the engineering squad.

There is no such thing as standard equipment for an engineering squad. They usually have an ample supply of explosives and thermal detonators, as well as medpacs and a variety of SAPs (Sensor Array, Portable units). In terms of weaponry, an engineering squad has standard-issue blasters and as much interesting hardware as they have been able to build, requisition or steal in the field and still carry.

Standard repulsorlift squads have eight troopers, a sergeant, and two light transport vehicles. Each vehicle has a four-man crew, including a trooper mechanic, a driver, a tech/sensor officer, and a commander, who usually doubles as the gunner. Most sergeants' vehicles have a Dedicated Energy Receptor built into the transport compartment where a second tech/sensor officer sits. This officer looks for signs of hostile

communications in an attempt to gain a jump of the enemy.

Heavy weapons repulsorlift squads are those which have additional armaments built into their vehicles, most often dismount weapons such as a heavy repeating blaster, a Merr-Sonn 4.4 grenade launcher or even a light laser cannon, which may be dismounted by infantry and used when really heavy firepower is needed.

Scout troopers are organized differently. This is due to two factors; the difficulty of training the scouts against their high rate of loss, and their heritage. Most scout troopers come from systems which have a strong tradition of mounted warriors, cavalry or knights of some kind. The Empire culled what was useful from the varied doctrines, and left as much of the traditions intact as possible in order to foster esprit d'corps. One of the useful parts of this tradition is caring for ones own mount; scout troopers are trained to maintain and repair their own vehicles, greatly reducing the support personnel necessary to run such a mobile unit. Fierce unit pride and high standards have filtered through to manufacturers, and Aratech and Mobquet military bikes are the most reliable repulsorcraft built.

A scout trooper squad is called a lance. Each lance contains five scouts (including the sergeant) and their vehicles. Most scout lances use speeder bikes with one scout per bike, although a few use a speeder bike and a pair of two-man vehicles.

Augmenting Squads

Line squads are not often augmented, but when they are up to a second full squad is assigned to the squad to be augmented. The sergeant of the first squad is given a brevet rank of "lead sergeant," while command of his squad is directed by the corporal in his absence. More commonly, squads are augmented by the addition of a heavy weapons detail, usually a three-man detail with a medium repeating blaster.

Platoon

There are four squads in a line platoon, a lieutenant in command and a sergeant major as platoon adjutant, for a total of 38 troops in a basic platoon. A platoon is the smallest unit which can request fire support from other units. Fire requests are made of the battalion headquarters, which then assigns an appropriate unit to respond or screens and relays appropriate requests to a higher command if it lacks support resources within the battalion.

If Imperial commanders have time to develop a plan of attack, they often assign an artillery section to a platoon. Troopers refer to this prac-

tice as "grafting". Sometimes battalion commanders will graft a large number of platoons to a single artillery or armor company, letting the company captain allocate fire support requests as the battlefield situation dictates.

Before entering a combat situation, a lieutenant usually sends his sergeant major to the squad which he believes will come under the most pressure. If possible the lieutenant does not stay with any one squad but tries to go where he is most needed on the battlefield. This tends to give lieutenants a very short life span. Those lieutenants who survive their first encounter are one of two types.

The first type is a pragmatic individual who realizes the limitation of the doctrine and sticks with one squad when the blaster bolts get thick. They maintain command control through the headcomm connection to their sergeant major, waving of hands, and occasionally screaming at the top of their lungs. The second type is one tough trooper.

An assault platoon contains two line squads and two heavy weapons squads. The heavy weapons squads are usually armed with heavy repeating blasters. Additional heavy weapons details are often assigned, usually one three-man medium repeating blaster detail, but sometimes up to three medium repeating blaster details or two heavy repeating blaster details. The standard assault platoon can have from 38 to 47 men, 41 being the most common.

An artillery platoon is called a line, and contains four artillery sections, with the standard complement of 38 men. An artillery line has either four heavy or medium artillery tubes, or eight light artillery pieces.

A repulsorlift platoon contains 56 men in four repulsorlift squads (heavy weapons repulsorlift squads if the platoon is a heavy weapons platoon) and a command element. The command element contains two light transport vehicles modified with heavier armor and greater repulsor power to compensate. In combat the lieutenant's command vehicle usually operates from a point where he can effectively direct the actions of his entire platoon, while his sergeant major is assigned to one of the squads, most often the lead squad. There is also a support vehicle, with a crew of four (who double as mechanics) and eight technicians. The support vehicle also carries a limited number of spare parts for repairing damaged or otherwise disabled repulsorcraft.

A standard armor platoon has from 34 to 42 men, with either four heavy vehicles, each with four- or five-man crews, or eight medium or light vehicles with three-man crews. The heavy-vehicle platoons are the more common. Armor platoons also have a fifth vehicle, the command

vehicle, which is usually a medium vehicle (modified to carry an extra man in a secondary gun cupola mounting a heavy repeating blaster) with superior visibility to that of the heavy vehicles. The lieutenant is always in the command vehicle in combat, while the sergeant major can be assigned to another vehicle or even the support element if defense of that element is in question.

These vehicles are usually repulsorlift tanks or their equivalent. Additionally, armor platoons can be made up of walkers or other heavily armored combat vehicles.

Armor platoons are accompanied by two heavy transport vehicles which carry the necessary spare parts and resupply components for the unit. These HTV have three crewmen each, doubling as general mechanics for the armored vehicles, and four additional technicians. Every technician is familiar with all the operating systems of a tank, but each specializes in one of four areas: weapons systems, armor maintenance, control circuits, or engine/power transmission.

Special missions platoons have the standard 38 men, but that is the only thing standard about them. They have four squads: two sharpshooter squads, a heavy weapons squad, and a squad of engineers. These squads cross-attach, often breaking up into about three more equal groups each containing engineers and/or a heavy weapons detail.

The platoon is the basic unit of operation for special missions. When the Imperial military thinks of special missions, it thinks in terms of the number of platoons needed to accomplish the mission. As this indicates, special missions are those operations which a few elite men can accomplish, rather than standard military maneuvers.

Special missions forces have been pressed into "political gain operations" (PGOs) with increasing frequency. Special mission troopers call them "straw man" operations. PGOs are terrorist missions held on worlds where native sympathies vacillate between the Empire and the Rebellion. In a typical PGO, the special missions troops stage several terrorist attacks, executed in a manner which would suggest that political factions native to the world could have produced the attacks.

Eventually some political faction will appeal to the planetary governor for help. The governor will declare martial law, asking for help from the fleet. The help arrives in the form of hundreds or thousands of additional troops. These troops operate on "new intelligence", rounding up scores of suspected or known Rebel sympathizers for imprisonment or execution. Once the Rebels are out of the way the attacks cease, reinforcing the

impression that the Rebellion indeed sponsored the attacks. The special missions force then moves on to another world.

A scout platoon has 29 men with two line squads commanded by a sergeant major and a scout squadron commanded by a lieutenant.

A squadron consists of two lances of five scouts each, a lieutenant replacing the sergeant in the command lance. While the lieutenant is officially in charge of the entire platoon, tradition leaves the "grunts" almost exclusively to the sergeant major, while the lieutenant handles the squadron.

Augmenting Platoons

Platoons are the most flexible units in the Army. This is not true in doctrine, but it is certainly true in practice. The organizational chart tells commanders that platoons may be augmented by adding complete squads, and this is done whenever possible.

But commanders of infantry platoons also swap equipment and personnel with heavy weapons platoons, repulsoircraft platoons, even armor platoons. Equipment is over-ordered at the company level; many platoons are walking around with an extra light repeating blaster or even a medium repeating blaster. Reinforcements occasionally are assigned to the wrong units, who decide to keep the extra men and materiel. The platoon is the least standardized of all the Army units, occasionally packing as much firepower as a line company.

Company

A line company is the smallest unit which is capable of extended operations on its own. It has four platoons for 152 troops, with command elements and support personnel raising the total to 180 men. A company is commanded by a captain who is served by four staff officers, all of whom are the equivalent of a lieutenant in rank. SC1 is the company lieutenant, the captain's second-in-command. SC2 is the logistics officer, SC3 is the medical officer, and SC4 is the technical officer. In addition, there are 23 support personnel; eight in logistics, 11 in technical, and four in medical. Each support person is aided by two (in medical) to 11 (in logistics) Droids, for an average of 118 Droids per company. If the mission is to be of a longer than usual duration, or if the company is to be completely isolated from all other support, the support personnel will be augmented with additional Droids. Droids are almost never accounted for in Imperial scandocs on organization and equipment, forming an almost invisible support network within the military.

Staying in Touch

The need for reliable, lightweight communications gear to keep platoon commanders in touch with other units provides work for a number of companies' R&D sections. Soro-Suub's initial success with the DH77 headcomm led to issuing hundreds of thousands of sets before a serious flaw was discovered: the sets are easily jammed by high energy particle emissions. Such emissions could result from normal battlefield conditions; near misses from artillery could create dead zones through which DH77 transmissions were lost. The ionic contrail from a single TIE fighter attack run could temporarily knock out DH77s up to three kilometers away!

The Herzfall Corporation, a little known company from the Senex sector, developed the DH107 which rectified this mistake and was less susceptible to signal interception. DH107s have been issued to every platoon formed since the Battle of Yavin, and most platoons have been retrofitted. Still, thousands of platoons are using the old DH77s, a situation which does not look likely to change as the Empire finds more crucial uses for its resources.

A drop company can be orbit-loaded for missions of up to six weeks duration, although two weeks is the Imperial standard. Support staff are trained for survival in a variety of environments, and they in turn instruct individual platoons on what they can expect when they reach the surface — what the atmosphere is like, what the environment can be expected to do to the troopers equipment, what biological hazards they face, what they might be able to eat if rations get low, etc. Ideally a support staff can keep a company functioning independently until all of the blaster packs have given out. Realistically a support staff has done well if they have kept every unwounded trooper and piece of equipment not damaged by enemy fire fit for combat after a month on the surface.

Artillery companies, known as batteries, have 152 troops, 23 support personnel and either 16 heavy or medium artillery tubes, or 32 light artillery pieces. They have fewer Droids than other companies, about 70 Droids with the support personnel.

Heavy weapons companies have two assault platoons, two line platoons and the usual command and support elements for a total of from 152 to 170 troopers, depending on the configuration of the assault platoons, giving the company from 180 to 198 men. In the standard assault

platoon, the line platoons equip their squads with light repeating blasters. Recent upgrades in many companies have substituted a medium repeating blaster for a light repeater in each platoon, giving assault companies an extremely flexible mix of firepower.

An attack armor company has either 200 men (for a heavy tank company) or 232 men (for a company with light tanks). There are four platoons, three tank platoons and a heavy weapons repulsorlift platoon, as well as the command and support element, containing 16 tanks if a heavy tank company or 28 light tanks if a light tank company, and nine heavy weapons repulsorlifts. The captain commands from a modified heavy tank. This tank is noticeable because of the large number of heat extractors necessary to deal with the waste heat from all of the extra power the command tank consumes. Unlike the medium command tank, a heavy command tank is expected to perform all functions simultaneously, and uses power accordingly.

A breakthrough armor company is the leanest of the armor companies. Its support element is attached to battalion headquarters and does not travel with the company. A breakthrough company is nothing but four tank platoons and a command tank, a total of 21 or 37 tanks depending on tank types. Breakthrough armor companies are designed to bust through enemy lines and to wreak havoc. Their missions are to destroy enemy assets or seize lightly contested assets and holding them until more balanced forces arrive. The lack of a support element puts a great deal of pressure on the company.

These units are equipped for short combat operations. But "short combat operations" are a training document fiction. Supplies are never used up at average rates and parts neglect to break down in average ways; after 72 hours a breakthrough company usually has developed some problem which hampers its combat effectiveness. Commanders know this, and consequently breakthrough operations are rarely planned to be more the 72 hours in duration.

A repulsorlift company has 188 troops, 220 men total including the command element and support personnel. There are a total of 31 repulsorlift vehicles in the company, eight dedicated to the support element and the command vehicle, in addition to 22 combat vehicles divided into two platoons. Each repulsorlift platoon carries a line platoon for deployment in combat. Special missions companies consist of three special missions platoons and an augmented scout platoon, plus the command and support element — 136 troopers out of a total of 164 men. If the mission is to be of short duration the support element is omitted. An augmented scout platoon is actually smaller than a normal scout platoon, having 22 men. However all of them are speeder bike scouts, having four lances, a lieutenant and a sergeant major. The 22 scout bikes are often modified to carry additional spare parts and munitions as special missions companies often operate in "zones of increased hostility density". They are involved in far more combats than a scout platoon is designed to be; special missions scouts greatly enjoy the increased action.

Rebaxan Colmuni MSE-6 General Purpose Droid

This Droid was introduced as a low cost commercial model with a 400-sector promotional support campaign with 85 percent media saturation. Trillions were sold. Hundreds of billions were returned. While being extremely versatile, the MSE-6 had motile and audiocast patterns which reminded dozens of separate sentient species of some native pest; and it was certainly nothing to look at.

To stave off bankruptcy Rebaxan turned to the military, offering a great deal on a few hundred billion slightly used Droids. The military purchased them as a temporary stopgap to accommodate the huge increased need for Droids occasioned by the spectacular growth of the Army and Navy.

In the military the Droids were as de-

tested as they had been in civilian life. But they were effective, reliable, and cheap. Nicknamed "mouse Droids," they became a fixture in Imperial installations from the most makeshift company camp to the most secret project.

Mouse Droids are class three Droids with modular knowledge C-matrices. Each matrix holds one skill, and each Droid can only hold one matrix. But the matrices are cheap and very compact, and are easily emplaced and removed from the Droid. Imperial technical officers no longer emplace the matrices themselves; they issue orders to mouse Droids with the Droid Programming/Repair matrix, and the Droids then make all the necessary changes.

When operating on a planet considered hostile to the Empire (including hundreds of planets nominally part of the Empire), special missions companies are drop-supplied directly from naval vessels. A force of at least line size flashes in from hyperspace, launching scores of containers varying in size from a probe Droid to a life pod. These take erratic paths to the surface, impacting all over the planet. No more than five of these are genuine resupply pods; the rest are decoys to dilute the effectiveness of enemy tracking measures. Frequently the appearance of naval vessels is enough to occupy the attention of the enemy. Once the resupply effort is complete, the starships jump into hyperspace unless they have been ordered on a surface support mission for ground forces. Naval support missions for special missions companies are rare as such elite units are expected to do without them.

Scout companies are called troops. They contain four scout platoons and the command and support elements — a total of 116 troopers and 40 speeder bikes. The command element travels in a high powered command speeder rather than a speeder bike, and the support element is mobile as well. Scout companies are assigned far fewer Droids than usual units because the platoons are expected to operate independently from the support element, and because of the scout doctrine of “fast and lean”, but largely due to the lack of room in the support vehicles.

Augmenting Companies and Larger Units

Any unit from company size on up is almost always augmented in the manner dictated by

doctrine; adding whole subordinate units to the base unit, usually in the order outlined by the Order of Battle (OB). For example, if a line company were to be augmented, the first unit added would ordinarily be a heavy weapons platoon, the next unit added would be another heavy weapons platoon, and the third and fourth units which could be added would be line platoons. Units which augment a base company or larger unit are to be commanded by the unit's second in command. This rule is violated by particularly strong-willed commanders, or commanders of above average ability. The Empire seems to overlook these violations.

There are a few times when a large unit may be augmented in ways other than as dictated by the OB. The most common is when a commander forms groups from the survivors of a battle, attaching these units to his own. These units rarely conform to anything resembling the OB. The second is when Imperial troops are working with auxiliaries local to the planet of operation. The Imperial commander is expected to allow the native units to operate in unit sizes most closely matching the Imperial Army equivalent, but not completely force the Imperial method of operation upon allies. As fewer planets are currently providing auxiliaries, this method is rapidly decreasing in importance. A third method is when a unit commander decides special augmentation is crucial to an operation. If he succeeds, his superiors will try to quietly cover up the violation. If he fails, he faces the harsh justice of the Imperial military.

ARMY: COMPANY LEVEL

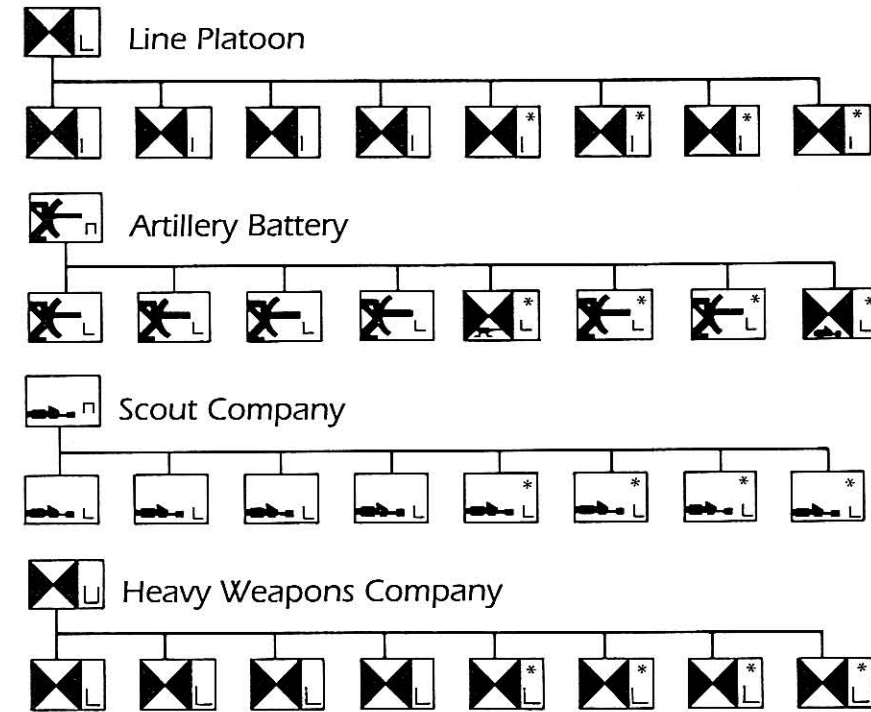
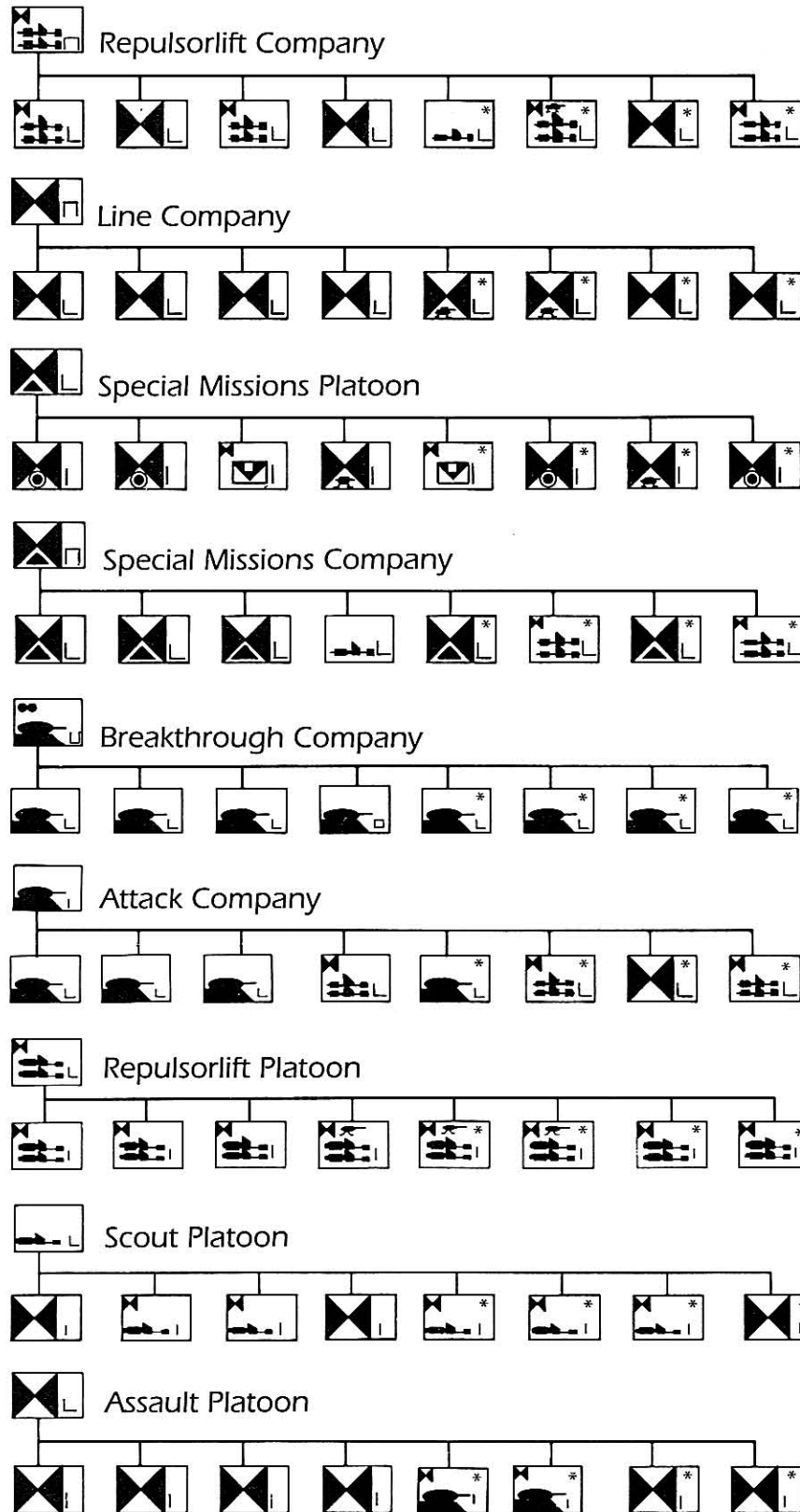

ORGANIZATIONAL SIZE SYMBOL

- Squad I
- Platoon L
- Company □
- Battalion □
- Regiment □
- Battlegroup □
- Corps □
- Army □
- Systems Group □
- Sector Army □



Infantry



Armor



Sharpshooter



Repulsorlift Infantry



Artillery



Heavy Weapons Infantry



Scouts



Engineers



Special Missions

●● - Heavy Unit Designation
 * - Expanded Unit Designation

A - Auxiliary
 N - COMPNOR Unit

Battalion

On the battalion level the organization makes a large change at the level of the command and support elements, which are now pooled together into the battalion headquarters. Unlike company command elements, which are expected to be close to and often involved with the combat actions, battalion HQs are expected to be relatively secure.

Battalion HQ is headed by a major, with five staff officers whose ranks are the equivalents of captains. SB1 is the battalion captain. In addition to duties as the second in command, SB1 is responsible for gathering and assimilating intelligence for the unit. SB2 is the logistics officer, SB3 the medical officer, and SB4 is the technical officer. A staff officer without a counterpart at the company level is SB5, the headquarters officer, responsible for the coordination of all the support elements, headquarters security, and to a lesser extent order within the battalion.

The number of support personnel is 47 (which includes the SB5). There is a security platoon of 38 men commanded by the SB5 under normal circumstances, and by the major in the event of an attack upon the headquarters. A security platoon is listed as a support unit even though it consists of troopers. This is because security platoons are not considered combat units; they maintain order within their unit. Ranking Imperial commanders have been able to pull themselves out of some tricky situations by creating units from the security platoons available to them. This is not a common enough practice that security platoons are considered troopers in the OB count.

The standard complement of Droids is 145, over two thirds of them MSE-6 Droids. The rest vary from sector to sector, depending on which Droids are locally popular. The standard battalion HQ therefore has 90 men and 145 Droids.

Line battalions have four companies including a heavy weapons company and an HQ, for a total of 608 troopers out of 810 men. A fully equipped heavy weapons company raises these totals to 626 and 828. Line battalions are committed to more ground combats than any other type of unit in the galaxy, as a battalion is the usual minimum Imperial commanders will consider dropping for a surface operation, and line battalions are more common than any other type.

Assault battalions consist of one line company, two heavy weapons companies, a repulsorlift company and the HQ. One of the assault companies is always fully equipped, giving the average assault battalion 662 troopers of 868 men, and 31 repulsorlift vehicles. The repulsorlift company is occasionally reorganized so that

it carries units from the fully equipped heavy weapons company. Assault battalions are most often used in urban areas or for attacking a single enemy stronghold. Assault battalions are given priority over line battalions when requesting fire support from artillery or naval units. Assault battalions are the most common battalion to bust dirt first as the vanguard battalion for large surface operations.

Repulsorlift battalions are made up of three repulsorlift companies, one scout company and the HQ. Repulsorlift HQ has 18 repulsorlifts to move everyone in HQ, one of which is crewed by the major and staff officers, another by the battalion captain and staff officers plus a sergeant driver. The rest have three-man crews which add to the size of HQ. A repulsorlift battalion has 680 troopers from a total strength of 952 men, with 115 repulsorcraft and 40 speeder bikes. Repulsorlift battalions are most commonly used to gather information on the enemy's movements, cut off enemy retreats, disrupt supply lines, harass enemy movement, and take lightly defended resources away from the main theater of operations. They are committed to a frontal assault only if the Imperial commander needs to use every single trooper he has, a piece of doctrine which makes repulsorlift battalions a popular assignment.

Artillery battalions have three batteries plus a normal heavy weapons company to provide protection, giving the artillery an opportunity to retreat and set up elsewhere if necessary. Artillery battalions have 608 troopers out of 810 men, and either 48 heavy or medium artillery tubes, or 96 light tubes, plus the attendant vehicles necessary to move the artillery.

Consisting of a breakthrough company, two armor attack companies, and a repulsorlift company, an armor battalion represents a near optimum combination of combined arms firepower and mobility. What they lack is staying power — they have too few troops to set up adequate defensive positions. Armor battalions are used primarily for attacks or mobile defenses.

The HQ has 23 additional support personnel to help maintain all of the equipment, and the HQ is mobilized to travel in 24 HTVs, one of which is crewed by the major and staff officers, another by the battalion captain and staff officers plus a sergeant driver; the rest have three-man crews which are part of HQ. The total HQ size for an armor battalion is 180 men plus Droids. An armor battalion of heavy tanks has 601 troopers out of 1,000 men, 53 tanks, and 55 repulsorlift vehicles.

An armor battalion of light tanks has 695 troops out of a total of 1,096 men, 93 light tanks and 55 repulsorlift vehicles. Light tank battalions are

ARMY LEVEL

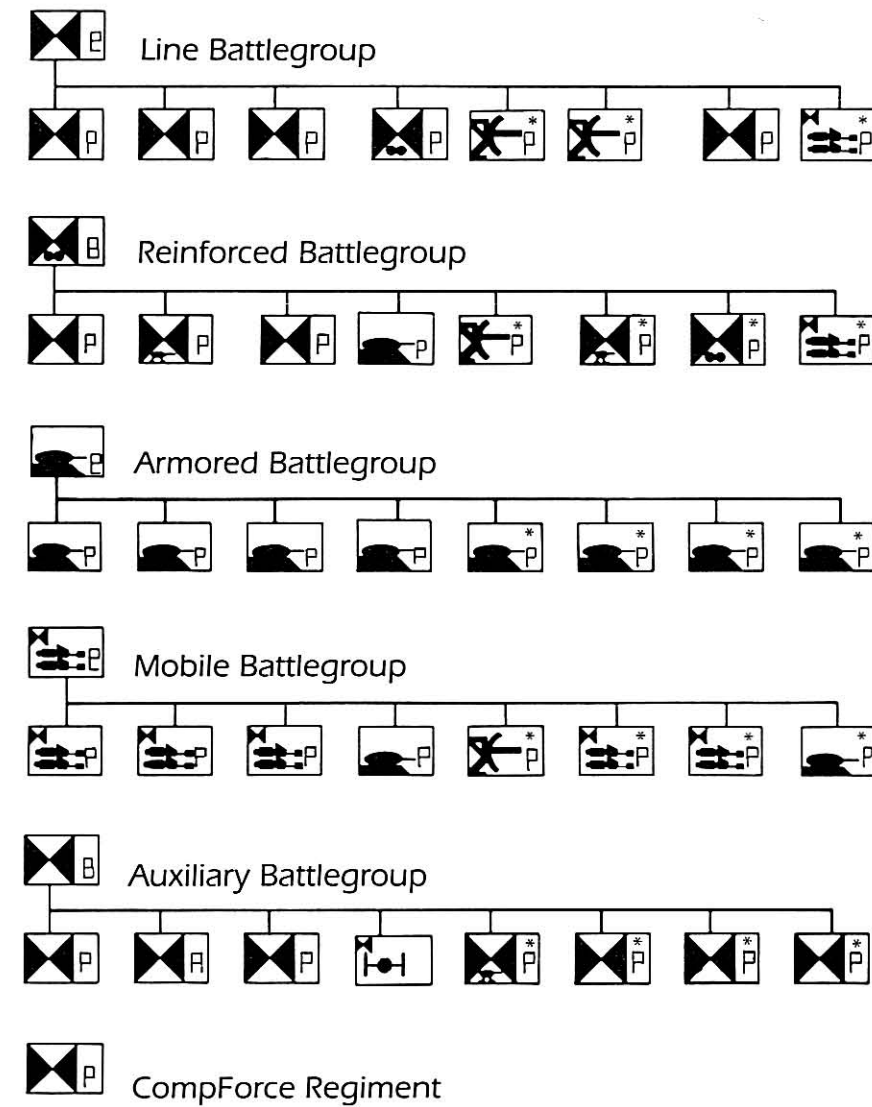
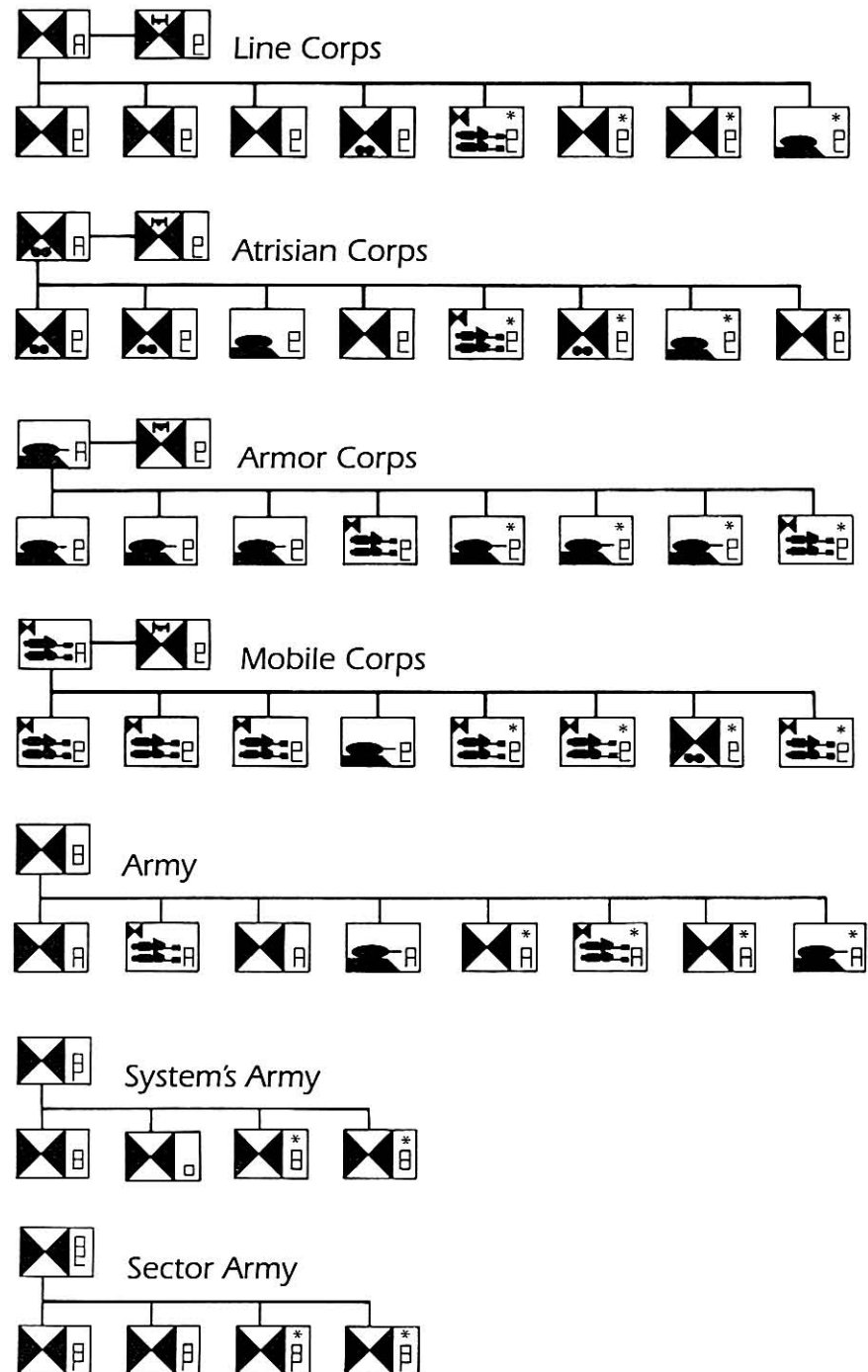

See OB Key on page 89.

ideal for situations where the opponent is not heavily armed, nor has time to construct fortified defenses — situations which the Empire often confronts when fighting the Rebellion. The Empire designed light armor battalions as a response to Rebel actions on dozens of backwater planets. But light armor battalions have a drawback — the entire unit does not fit into an Imperial landing barge.

Special missions battalions are the largest special missions units recognized in the OB of the Imperial Army. They consist of four special missions companies and an HQ element, a total of 544 troops out of 746 men, and a total of 88 speeder bikes, more than in a many Army corps! Special missions HQ is an exception to the rule — they are expected to be directly involved with the combat operation. In place of the standard support personnel are engineers who double as support when things calm down; the security platoon is made of the absolutely finest troopers the Army can find, and the major and his staff are hardened combat veterans.

A special missions HQ is used to action. This approach leads to high morale among troopers, knowing that they are not being asked to do something which the major isn't actually doing himself. It also leads to ample opportunity for promotion into the HQ unit as attrition wears the HQ down.

Regiment

Regiments are commanded by a lieutenant colonel who runs an HQ identical in structure to that of a battalion with the exception of a larger compliment of Droids, usually upwards of 200. Regimental HQ is where the most extensive repairs are performed, and some HQs even have a capacity to machine or nanomanufacture precise spare parts from very basic components. Regimental HQs often stay aboard the mother vessel, as orbital command control is as good in most instances as control on the ground. If orbital command is disrupted the HQ can be quickly dropped (there is a record of at least one conflict where the regimental HQ was dropped in life pods as landing barges were unavailable). If regimental HQ is dropped with the attacking forces, it is an indication that the Empire expects to maintain a ground force for at least a month and that the naval presence will be not be continual.

Line regiment contains two line battalions, one assault battalion, and one repulsorlift battalion. The unit contains 2,558 troopers in a total force size of 3,530 men, with 130 repulsorlift vehicles. A line regiment is most commonly deployed on worlds with low level resistance. A line regiment is capable of massing troops (usually by combining the repulsorlift and assault battalions) for a

"For every problem a solution must be found. It is the commander's duty to see that the objectives of the mission are obtained. He is personally responsible should the mission fail. If the objective is of importance, he is to succeed regardless of method needed to obtain success. It is the commander's duty to see that success is obtained in accordance with the directives of the New Order."

— First axiom from Surface Operation Training Document 89, Officers' Section.

major battle without having to commit the entire unit to the conflict.

Assault regiments are deployed when intelligence sources can define areas of limited size on the surface that are under the control of Rebels or Rebel sympathizers. The assault regiment is dropped to retake those areas. Assault regiments are not usually deployed for any length of time. Once Rebel strongholds have been cleared, a line regiment replaces the assault regiment. The assault regiment is then dropped into another hot zone. An assault regiment comprises 2,545 troopers in a force of 3,546 men, with 121 repulsorlift vehicles and 53 heavy tanks.

Repulsorlift regiments are put down on worlds where Rebel activity is light but spread out across a vast area. The repulsorlift regimental HQ is dropped more frequently with the regiment than other regimental HQs. This is not for any command control reason, but for a bit of psychological warfare. By dropping the HQ the Army provides the Rebels with a tempting target — destroy the HQ and the unit fails to function effectively, if at all. But the HQ is mobile, and competent Imperial commanders can lay traps with the regiment, engaging and destroying Rebel units which attempt to strike at the HQ.

An artillery regiment is an anomaly. The Imperial military has been slow to recognize that artillery still has a useful role to play on the battlefield, and the doctrine and support given to the artillery arm has been lacking. The general buildup of Imperial might has largely passed the artillery arm by. A hasty attempt to revitalize this arm is now being made after belated recognition that artillery has been an effective tool for the Rebellion.

Artillery regiments are being formed as quickly as possible and then attached to battlegroups which use them as a single unit. Junior officers are making official complaints about this policy despite the risks of those complaints. The response has been lukewarm, and some Sector Groups are assigning smaller artillery units at the

regimental or battalion level. There are unofficial reports, nowhere reflected in the official OB, of assigning batteries to line battalions. The most frequent deployment of artillery remains a massed regiment containing either 144 or 288 artillery tubes, with attendant vehicles for a minimum of 199 repulsorlift vehicles and 53 tanks. The regiment has 2,425 troopers out of a regimental total of 3,520.

Armor regiments are not to be deployed alone. They are to be deployed only as part of a battlegroup. The Imperial military considers an armor regiment to have too much firepower for the normal regimental engagement. They do not have enough infantry to hold any ground they might take which would justify using an armor regiment. There are no official records of the deployment of a lone armor regiment. A line armor regiment contains 2,562 troopers out of a total of 3,994 men, with 304 repulsorlift vehicles and 106 heavy tanks. A vanguard armor regiment has 2,483 troopers out of 4,042 men, with 262 repulsorlift vehicles.

A COMPNOR Regiment (CompForce) has a structure like a line regiment with the exception of the lack of security platoons. COMPNOR volunteers are fanatical, and their loyalty is unshakable under every condition yet faced. CompForce commanders have dispensed with the security platoons as unnecessary to a well run unit, a notion which does not endear them to commanders in the regular army. Very little about CompForce endears itself to the regular army.

Battlegroup

Battlegroups are a recent addition to the Army, replacing divisions, which were common in the Old Republic. The change was made because divisions were commonly commanded by planetary governors or used as honor guards for ambitious senators. Divisions were associated with a particular planet or being, a detrimental attribute that was hard to shake. Army planners reorganized the OB and eliminated the division, replacing it with the battlegroup. As usual, the Empire kept a few elite divisions where unit identification was strong and useful, both from a military and a propaganda standpoint.

Battlegroups are commanded by a high colonel, five staff officers (SG1 through SG5), four substaff officers with the rank of major who serve the SG5 (SG51 to SG54), 188 support personnel, and 76 troopers in two security platoons for a total of 274 men in HQ.

Battlegroups are committed to major offensives against known concentrations of resistance. The Empire doesn't drop a battlegroup on a world just to take a look around — a battlegroup

drops when the Empire knows it has a tough fight on its hands.

Line battlegroups have 10,219 troopers in a force of 14,410, with 511 repulsorlift vehicles and 53 heavy tanks. Line battlegroups are now considered to be underpowered given the increase in Rebel strength. The military is debating trying to upgrade all line battlegroups to reinforced battlegroups, but the required resources and the reorganizational difficulties have prevented the idea from taking hold.

A reinforced battlegroup has 10,210 troopers from a total strength of 14,890, with 676 repulsorlift vehicles and 212 heavy tanks. They are considered the most versatile battlegroup, with a good mix of firepower and staying power.

Armored battlegroups are dropped into missions where the enemy has several concentrations of strength in an area of moderate size. The armored battlegroup is designed to quickly hit these concentrations in succession, one or two enemy strongholds at a time. An armored battlegroup has 10,090 troopers out of a unit strength of 16,346, with 1,132 repulsorlift vehicles and 318 tanks.

Mobile battlegroups are deployed on worlds where there are Rebel held or sympathetic areas adjacent to areas loyal to the Empire. Mobile battlegroups are used to shift quickly in response to Rebel incursions, and to make lightning strikes into enemy territory.

1,342 repulsorlift vehicles make sure the battlegroup get where it is going quickly, while 265 heavy tanks give it some punch. 10,248 troopers form the fighting force for the unit of 16,106 men.

Auxiliary battlegroups are not at all traditional battlegroups. They have no commander, and never operate as a battlegroup. They are merely an organizational convenience for grouping resources available to a corps commander. An auxiliary battlegroup has three CompForce regiments, and a ground support wing of TIE fighters. In the continuing struggle between the Army and the Navy, the ground support wing is one of the casualties. The Navy wanted to retain control of the TIEs, but the Army insisted upon its own starfighters so they could primarily be dedicated to ground support missions. The resulting wing has 40 TIE fighters rather than the 72 as is standard in the Navy.

The ground support wing has 40 TIE fighters organized into 10 flights. Three flights are organized into a TIE bomber squadron, six flights into two squadrons of TIE/ln, and one flight of TIE/fc for use as spotters. A ground support wing has 40 pilots, 25 sensor techs, 25 controllers, and 60 ground crew personnel for a total of 110 men. An auxiliary battlegroup has a total of 7,674 troopers from a total of 10,130. There are also 390 repulsorlift attached to the unit.

P icutorion Viewed From the Top

Commodore Bevven and High Colonel Drost were viewing the progress of the battle on Picutorion, engaged in a strained discussion about whether to deploy TIE fighters in support of the surface action. Elements of the armor battalion of Tensiger's 6th regiment had penetrated the perimeter of a tracking station, but the Rebels were still giving heated resistance, and nearly every Y-wing flying was attacking in support of the tracking station.

Bevven, fearing that the Y-wings might decide to attack the fleet, wanted to send the TIEs in waves which would engage a few Y-wings quickly and then return, holding the majority of the TIEs in reserve. Drost knew that picking off just a few Y-wings at a time would doom the troopers making the assault, probably causing the failure of the attack.

Bevven turned away from Drost, facing his lead controller squarely. "Lieutenant, order all squadrons to attack along the parabola programmed in. They are to stay in tight formation during the initial attack, and to return to the fleet as soon we have pulled within four arc seconds of the return path. Release on my mark."

"Yes sir!"

"May I interrupt for a moment, Commodore?" Bevven turned to face the man who had been watching him on the bridge. Bevven could not remember his name. Barezz, perhaps? The one from ISB.

"If you must," said the Commodore.

"This is for your ears also, colonel," said the man. "We have been monitoring the progress of the offensive and have noted the elements which have actually penetrated the tracking station include two tagged as sensitive."

Colonel Drost moved closer, stepping within a polite distance. He eyed the ISB man cautiously.

"The two, a Captain Ganig and a Sergeant Stecker, are both inside the station. COMPNOR made each famous after the Battle of Sagma, but since then their casual observation of doctrine has come to light. If they take this station, COMPNOR will again make them heroes."

"What is your point, Barezz?" asked the colonel. The ISB man snapped his eyes toward him. The colonel met the gaze.

"My point, colonel, is that for propaganda purposes, dead heroes are nearly as good live ones. And dead heroes cannot defect to the Rebellion."

"Do your sources indicate that they are thinking of defecting?"

"No," admitted Barezz, "but we are certain that a trooper named Linds is a Rebel sympathizer. He has been in contact with each man. I do not know if we can take such a risk. Delay the starfighter support until the Rebels have killed Ganig and Stecker. Then send in the support needed to dispose of the Y-wings."

Bevven looked at Drost. They were his TIE fighters, but they were Drost's men. The colonel nodded curtly.

"How long could your men hold out in their present position, colonel?" Bevven asked.

"Normally I would say less than three minutes. They are good. I would guess seven," said Drost.

"Controller, widen the parabola for 10 minutes to target. On my mark."

"Yes sir!"

ARMY: BATTALION LEVEL

Special Missions Battalion

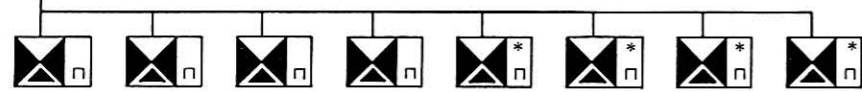

Armor Battalion

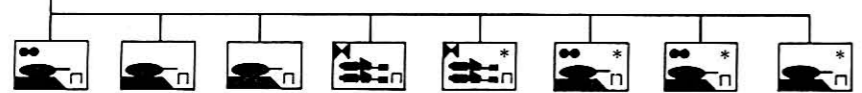

Artillery Battalion

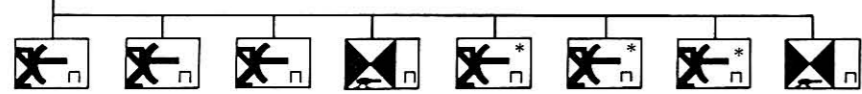

Line Regiment



Assault Regiment

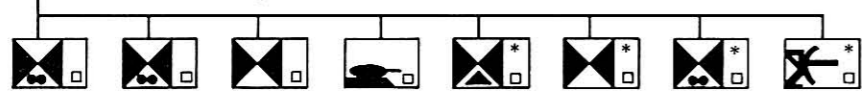

Repulsorlift Regiment

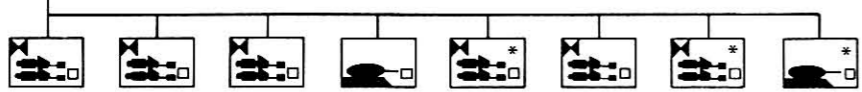

Artillery Regiment

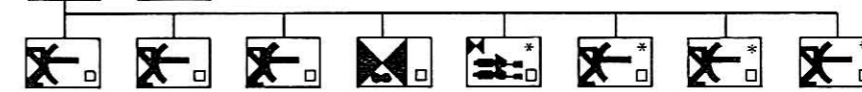

Repulsorlift Battalion

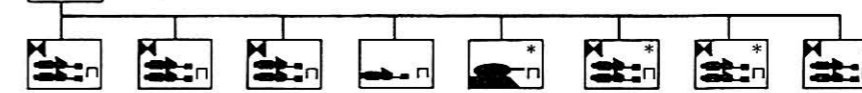

Assault Battalion



Line Battalion

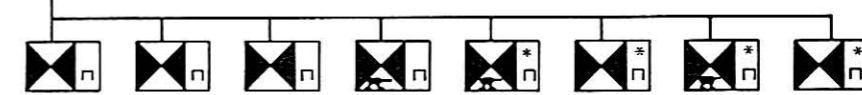

Vanguard Armor Regiment

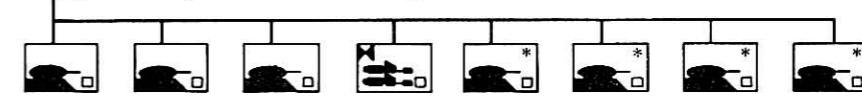

Line Armor Regiment

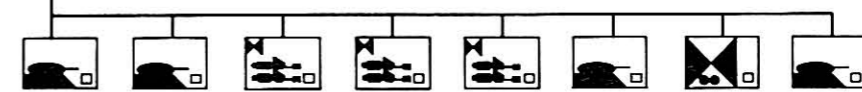

See OB Key on page 89.

Corps

The corps is one of the few instances of real cooperation between the Army and the Navy. Imperial military planners from each branch designed the transport ship to hold all corps types, building in the possibility for expansion into both the starship and the unit. The fact that the corps transport ships are among the newer model of ships in the fleet is perhaps a sign that the two branches are ready to cooperate more closely so that the New Order may expand.

When the Empire deploys a corps onto a world, it is retaking that world, regardless of the propaganda beamcasts. The military consider a corps to be a sufficient force to retake a world which has only recently slipped from the grasp of the Empire. Such a world would still contain a significant number of loyalists, and would not have had time to build up an organized defense. This does not mean that the corps outnumbers its opponents; usually the opposite is true by a factor of at least four to one. What is true is that the opposition is not organized enough to coordinate all of the military power available to it. Moving quickly the Empire can destroy each opposition element in turn.

A corps is led by a major general who has five staff officers (SP1 through SP5), each staff officer having two staff officers of their own (SP11 through SP52). There is a company of 152 troopers to provide security for the HQ, and there are six perimeter platoons which are under direct command of the general or his SP1. Fifty ISB agents are assigned to a corps, to help with intelligence and to assure loyalty. There are also 388 support personnel and 114 CompForce support personnel organized into three platoons whose job it is to support the CompForce regiments assigned to the auxiliary battlegroup. The CompForce support is usually inadequate.

There is also a single officer from Imperial Intelligence (the Ubiquitorate, not the ISB) who provides supplementary aid to that provided by the ISB. Typically this officer provides 15 to 20 percent of the intelligence used by the corps.

Corps HQ is often augmented with a huge number of MSE-6, I2F-5 and I2F-73 industrial Droids — as many as 2,000 in some instances. These Droids serve as a mobile processing and manufacturing plant, particularly with the introduction of repulsorlift-enabled models of the I2F-73 which acts as transport for most of the other Droids. Such a complex can manufacture everything from glow rods to blaster packs to repulsorlift engines upon demand, using the crudest and most impure raw materials. If the corps can keep the complex producing, it can operate without Imperial resupply indefinitely.

Line corps have 48,541 troopers in a unit of 69,199 men. It comes equipped with 2,599 repulsorlift vehicles and at least 371 heavy repulsor-tanks.

Mobile corps have 48,508 troops from 71,615 men, with 5,548 repulsorlift vehicles and 1,113 heavy tanks. Armor corps have 48,192 troops from 74,794 men, 5,128 repulsorlifts and 1,219 heavy tanks. The distinction is important in Surface Operations Training Documents, and mobile corps are organized for maneuver operations better than armor corps. However, the average Rebel is not going to care what sort of corps just overran his position.

Army

An army is commanded by a general. An army HQ is larger than two full battalions, containing five staff officers (SA1 through SA5) and their 10 subordinate officers (SA11 through SA52), a

Major Generals are Everywhere

There are far more corps HQ than there are corps. This represents an abundance of more than pleasant jobs for less than brilliant officers — the corps HQ is the basis for the Imperial garrison. The Empire wants garrisons to be organizing points for rapid mobilization. Realizing that in a crisis units may have to be sent from many parts of a sector, the Army wanted HQs in place which could take command of all the parts.

As Imperial doctrine currently holds that a corps is a sufficient force to retake any planet, corps HQ are set up as the basis of Imperial garrisons. As the garrisons also have diplomatic, trade and research functions, additional tech, medical, science and diplomatic service personnel are assigned. These are nominally outside of the major generals command, but reality often puts the general in charge.

The typical military contingent is at the battalion level, most often four battalions mixed in a way which is optimum for the world on which the base is situated rather than following the OB and constructing a regiment. A battalion of stormtroopers, one of AT-STs, and two battalions of AT-ATs is a popular configuration. In addition, the ground support wing of the auxiliary battlegroup is almost always present. TIE fighters are a rare enough resource that any wise commander will take all he is entitled to as soon as he can get them.

security company of 152 troops, six perimeter patrol platoons of 228 troops who report directly to the general or the SB1, 200 ISB agents, 784 support personnel, three COMPNOR observer companies of 152 plus a command element of five (captain and staff) each for a total of 471 men.

Four Ubiquitate agents are available to provide additional intelligence to the general, should he so desire. The total number of people in HQ is 1,855. There are at least twice as many Droids.

An army consists of one each of the four different corps, line, Atrisian, armor and mobile. This gives an army 193,644 troops, 293,686 total personnel, 16,660 repulsorlift vehicles and at least 3,498 heavy tanks. An army is built to be transported by a naval troop squadron.

Armies rarely see action in the field as a coordinated unit. Increased success by the Rebellion has led to a revival and redevelopment of doctrine concerning the use of an entire army in the field.

Systems Army

The systems army is more of a bookkeeping level of organization rather than a unit that ever sees action in the field. The HQ is the same size as that of the army. It is commanded by a high general. The primary function of the HQ is to make sure that all of the subordinate commanders know where all of the other military resources in the sector are — if a major general needs naval support for his unit greater than what is available in his drop line, system HQ will try to find the nearest naval support units and relay the information to the major general.

Sector Army

A surface marshal commands the sector army, although more often than not this is merely an additional title bestowed onto the Moff or Grand Moff who commands the Sector Group. The sector army includes every single army trooper in an assault fleet. This is 774,576 troops and 1,180,309 personnel in total. 66,640 repulsorcraft are in service with the sector army, as well as 13,992 heavy tanks.

The Organization of the Navy

The ship is the building block of Navy organization, much as the squad is for the Army. The problems each branch has in organizing these building blocks is quite different. The Army has millions upon tens of millions of squads, and its chief difficulty is in organizing these parts into an effective whole. The Navy has far fewer ships than the Army has squads, but the difference between ships is enormous. There is a greater difference in overall effectiveness between a Star Destroyer and a system patrol craft than there is between a squad and a regiment.

Organize 300 squads with a command and a support element and you have a regiment. Organize 300 system patrol craft and you still do not have the equal of a Star Destroyer. In some instances the 300 system patrol craft might be better than a single Star Destroyer. Usually they would not be.

Compounding the problem is the plethora of ship types, the variations by model within a single type, and the customization or modifications of individual ships throughout a Standard Year. Again in comparison, a squad is composed largely of young adults who have been trained so as to become more uniform, while a naval squadron may be composed of ships two years, 60 years, and 210 years old.

The key organizational problem for the Navy then is to create units which are consistent enough from fleet to fleet that general tactical theories can be applied, while recognizing the great difference in ship type and quality throughout the Empire.

The Mission Detail

The heart of Navy doctrine is the mission detail. The commander at every level can create temporary organizations called "mission details" which violate the standard OB.

The concept behind the mission detail is simple for a commander to carry through:

1. Evaluate the mission.
2. Assign a detail which would best accomplish the mission.
3. Retain sufficient ship strength to meet other expected obligations.

There is a saying among Navy staff officers and commanders: "The first step leads to work, the second to promotion, the third to court martial." While extensive training docs exist to teach commanders how to perform these three steps, the third step remains as much a product of instinct as training. With increased Rebel activity, those officers who act in strict accordance with doctrine often fall short of expectations. Naval discipline is such that officers rarely repeat their mistakes.

Ship Command

Attaining the rank of ship's captain is considered the culmination of a naval career. When a person earns command of a ship, he has attained a position of honor, regardless of the size of the ship. There is a certain amount of chauvinism on the basis of ship size and power, but being the captain of a KDY Lancer often carries more prestige than being a staff officer of any rank. For this

S tormtroopers and the Order of Battle

Stormtroopers technically do fit into the Order of Battle. But these elite troops continue to be a source of mystery to the regular Army, even at the level of their organization. The major difference seems to be the complete lack of support personnel. It is known that the stormtroopers do siphon off some supplies from the normal chain of logistics, but not nearly enough to support a force as large as the stormtroopers appear to be. Whether they can somehow "live off the land", have a shadow network which resupplies them in order to enhance their mystery, or really not be in need of resupply is simply not known.

The end result is that a stormtrooper unit is a pure combat unit.

A stormtrooper battalion has 820 men, just like any other battalion. But every single individual is either combat command or a trooper — there is even a complete absence of staff officers.

Other differences, although minor, do appear. Stormtrooper squads vary in number of men to a greater degree than in the regular Army. The level of organization corresponding to a battlegroup is called a legion. While there is no larger unit of stormtrooper organization than the legion, legions have been known to appear from other sectors to join in a major offensive with legions which belong to the Sector Group.

reason the Navy often understands if a ship's captain will turn down a promotion to a staff position, or even turn down a transfer to the command of a more modern or more capable ship.

The Navy honors these men rather than viewing them with suspicion. It benefits the Navy to have men who intimately understand their ship and crew in order to gain the greatest possible performance from them.

Line

Commanded by a captain of the line, the line is the most amorphous level of organization in the Navy. In theory a line should have four ships, but the percentage of lines which actually have four ships is about seven percent. Lines vary from as few as one ship to 20 or even more if circumstances warrant.

An attack line has from three to six ships; fewer ships if the line consists of heavy cruisers or larger ships, six if the line consists of light cruisers or frigates. An attack line's purpose is to engage enemy combat starships of equivalent size. If Star Destroyers or other top capital ships are present the attack line is to engage the enemy within range of the Star Destroyer, making sure that the Star Destroyer is out of effective range of the enemy ships. If a Star Destroyer does not have to concentrate on its own defense it can make short work of virtually any enemy starship.

A heavy attack line has from four to eight ships, none smaller than a light cruiser. A heavy attack line is designed to come out even against any like number of enemy combat starships. The heavy attack line is an independent element of maneuver, one which an Imperial commander would be unafraid to commit to a conflict which was out of range of his sensors.

A pursuit line has four to 10 ships, usually light cruisers or occasionally lighter ships such as corvettes. Their mission is to maintain contact with a retreating enemy. As virtually every combat starship has hyperdrive, pursuit lines are most often employed against starfighters which are not hyperspace capable, or to follow escaping craft long enough to calculate their jump coordinates.

Pursuit lines are also commonly used on missions which the crews call "beambaiting." Pursuit lines track Rebel starships to a base or a planet known to house well-organized Rebel sympathizers. They engage the starships and see if any Rebel units come to their aid. Then they employ a fighting retreat to a point where a heavier element of the fleet can jump in from hyperspace. The Empire enhances this tactic by sending pursuit lines on such missions without

Military Folklore

There is a bit of military folklore about the difference between the structure of the Army and the Navy. An admiral had just finished listening to a general explain the OB for a Sector Group, including virtually every conceivable configuration by mission type. This general concluded proudly by calling up numerics which showed that every unit deviated less than two percent from the projected strength on the OB.

The admiral took the podium and holoviewed the naval plan for a Sector Group. After a brief explanation of the theory, the admiral then used his Sector Group as an example of how the naval theory was modified in practice. The general became increasingly impatient as the admiral listed exception after exception. Finally the general interrupted the admiral.

"You don't have an organization, admiral! What you have is nothing like the Army!"

"Yes, general, the Army has its organization. We in the Navy must content ourselves with the control of all known space."

any backup, so the Rebels can never be sure whether or not the line is part of a trap.

Recon lines contain two to four ships, operating in pairs or individually. Reconnaissance ships are usually light cruisers modified for even greater sublight speed, trading in about half of their laser cannons for a full complement of sensors with greater range and sensitivity than the Imperial average. Recon lines are to find the enemy, retreat without engaging in combat, and return to report on the disposition of the enemy.

Recon lines are more common now as the Empire equips more of its large capital ships with improved Hyperwave Signal Interceptors capable of detecting flux shift. This technology allows the Imperial Navy to actually project a ship's destination once it jumps to hyperspace with greater accuracy than the old method. Enemy ships can no longer just jump out of trouble; the odds that the fleet will follow are getting better. So enemy ships often try to lie quietly in the sensor penumbra of an asteroid or similar body in order to avoid detection. Recon lines are sent into the dark places of a system to see what they can find.

Skirmish lines contain four to 20 small combat starships, corvettes being the most common sort of ship. Skirmish lines are meant to harass larger starships or else engage in a coordinated action against enemystarfighters. The emergence and prevalence of TIE fighters temporarily diminished the role of skirmish lines, but they have regained favor as the Rebellion has become better armed. TIE fighters often use available skirmish lines as mobile cover, and skirmish lines try to provide cover fire for the TIEs.

Torpedo lines usually have two torpedo spheres. The cumbersome nature of the spheres

makes them useful only for their primary mission of planet bombardment. The dream of a more mobile platform with even greater firepower has tantalized Imperial planners for years, but the torpedo line remains a staple of the Navy.

A troop line consists of two Evakmar-KDY transport vessels and two escort vessels — frequently two strike cruisers. As a troop line's function is intimately connected with that of the Army, troop lines vary less than other lines. The Army considers consistency a virtue. A single transport is designed to carry a corps, but often carries less than a full corps as subordinate elements are assigned to other vessels. It is not unusual for a ranking admiral to oversee an important surface operation, as captains of the line are accused by Army officers of being far too concerned with just the safety of their line rather than with the success of the mission. There are other types of transports, most of them left over from the days

of the Old Republic. Some, such as the Delta-class troop transport, have been converted from true transports to glorified attack shuttles, but many remain in service as intersystem transports as the Army grows.

A Star Destroyer is considered a line in itself. A naval staff study concluded that a Star Destroyer was the equivalent of at least the squadrons of the time, and would be more properly categorized as such. The Admiralty agreed with the analysis, but disagreed with the conclusion. The Admiralty felt that as there were more lines than squadrons, designating the Star Destroyer as a line unit would get them more Star Destroyers. The Admiralty's thinking prevailed.

Squadron

An admiral runs a squadron, which has from 14 to 60 ships on average, depending upon the composition of the lines in the squadron. The

A Salvager's Run

Kanda Farral watched through the viewscreen as the last of the Imperial warships made the jump to lightspeed. Captain Sreethyn had *The Lucky Find's* engines at full as the ship pulled away from Jerijador. Kanda absent-mindedly checked a few of the sensor banks. She glanced again when she saw indicator pulsions approximating the locations of better than a dozen ships, all on roughly the same vector as *The Lucky Find*. All were making like the last bolt from a busted blaster toward the Imperial jump point.

"Suit up woman! I didn't hire you to look at colored lights all day," growled Sreethyn, "and it looks like some of the left-goods are larger than usual. Adjust the programming on the retrieval Droids."

Kanda deftly reprogrammed each of the four Droids, but had more difficulty than she would have liked getting into her suit. She checked to see if Sreethyn had noticed. His forced grin and slightly shaking head said he had. Okay, now he knew for certain that she had lied about her zero-G experience. The Droids were going to do most of the work, so taking care of them was more important.

"Remember to lock in before you lock out." Kanda found herself nodding, a clumsy motion inside of a work suit, in response to the thin-sounding voice over her comlink. She stepped into the airlock, making sure the frequency of the T-beam actuator and her tractor beacons were the same. She then by-the-booked the depressurization sequence, and vacced with the Droids. Kanda was pleased to see the Droids scan and maneuver immediately in an optimum search pattern. She began inspecting the refuse from the Imperial fleet.

"There is a Treson cluster, a third full, of KDY Servo Circuit surfaces, OP configuration ... they just jettisoned them!"

"That's the kind of stuff we're after Farral." Sreethyn's voice carried excitement over her comlink. Kanda began to tag containers and activate the beacons. Immediately the containers lurched toward the hull of *The Lucky Find*.

"Why would they just throw the good out with the bad?" Kanda asked as she slowburst to avoid a compacted piece of trash.

"Because they're the Empire. They got more money than ships, see? So when it comes to allocating cargo space before a jump, they fill themselves to the gunnels. If they rush they just replace half-empty containers with full ones."

"But you can't sell a lot of this stuff on the market, Sreethyn. It's illegal tech ..." Kanda stopped herself, realizing that Sreethyn could very well sell that sort of hardware as long as no one knew about it. And Sreethyn was inside the ship, Kanda outside. Sreethyn's laugh was unreadable through the comlink.

"I'm no smuggler, Farral. I'm a licensed salvager. I pick the stuff up, sell what's legal on the open market, and sell the rest back to the Navy."

"The Navy buys back its garbage?"

"If I package all the partials into standard units they do. They pay full price. I like to think of it as getting some of my taxes back."

Kanda tagged another container. She laughed as she watched two of the Droids struggle with a WD condenser pod, as the entire unit and the Droids slowly tumbled toward *The Lucky Find*. This was absurd, but it paid well. She could come to like this.

admiral is served by an adjutant who holds the rank of captain of the line. The adjutant acts as liaison with the other staff officers and is the admiral's second-in-command. A squadron is the largest concentration of ships which is normally assigned to a single system. A direct order from a Moff, Grand Moff or the Emperor is necessary to gather more ships in a single system.

A measure of the extent of Imperial military growth is the squadron. Under the Old Republic, units of identical configuration were called fleets, and were sometimes the total Naval presence in a sector. The usage "fleet" is still common among senior officers for ship groups of squadron size and up. Recent recruits and junior officers are more likely to use the terms listed in the OB.

A full troop or battle squadron packs enough firepower to subjugate any system not protected by an equivalent fleet; no ground defense yet devised is sufficient to hold off a determined attack from these elements of the Navy.

The average sizes below assume the average size for the lines which make up the squadron. Larger than normal lines or more lines than normal can easily double the size of a squadron.

Light squadrons consist of at least two attack lines, a skirmish line and a recon line, averaging 20 to 30 vessels of all types. A second common configuration of a light squadron is two recon lines, a skirmish line and a pursuit line, averaging 25 to 35 vessels. Both are deployed in areas where it is believed there are no enemy capital ships. With the first squadron configuration the Navy is playing it safe; such a light squadron can survive more punishment should the intelligence estimates prove to be wrong.

Heavy squadrons are made up of at least two heavy lines, an attack line, and a recon line for an average of 18 to 24 ships. Alternate configurations include at least three heavy lines and a skirmish line for an average of 28 to 36 ships. The first type of heavy squadron is employed when the enemy is known to be in a system, but his

exact location and force composition is unknown. The second is employed when enemy ships are in a system defending an asset, so a fight is expected rather than Rebel flight. It is common to assign *Victory*-class Star Destroyers to the latter type of heavy squadron.

Battle squadrons contain an *Imperial*-class Star Destroyer. There are other ships, but they matter little in the configuration. In addition to the Star Destroyer there are at least three lines, two attack and one pursuit line, for an average of 18 ships. If there is some system in the Empire that must be repressed, some force which must be run down, a battle squadron is the force of choice. Sending a battle squadron on a mission is the Navy's way of showing that the job is of utmost importance.

Troop squadrons have two troop lines, an attack line, and a skirmish line for an average of 25 to 30 vessels. A troop squadron is most often used as a transfer point for Army units, reinforcing or reorganizing the Army complement of other squadrons. These transfers are usually conducted in deep space where there is little chance of interference. If a troop squadron shows up within a system, there is certainly something big happening.

Bombard squadrons have two torpedo lines, a skirmish line, and a pursuit line, for an average of 20 to 28 vessels. Bombard squadrons are assigned to worlds which have rebelled successfully and have organized a large surface military which would take far too long to defeat. Imperial commanders, pressed on so many planets, often deploy bombard squadrons in less severe circumstances.

The vessels which escort the bombard squadron are considered sufficient to deal with any starships which might resist. Any force larger than what a bombard squadron can handle would draw the attention of the Imperial Navy, who would deal with it prior to the appearance of the bombard squadron.

SECTOR GROUP: SQUADRON LEVEL

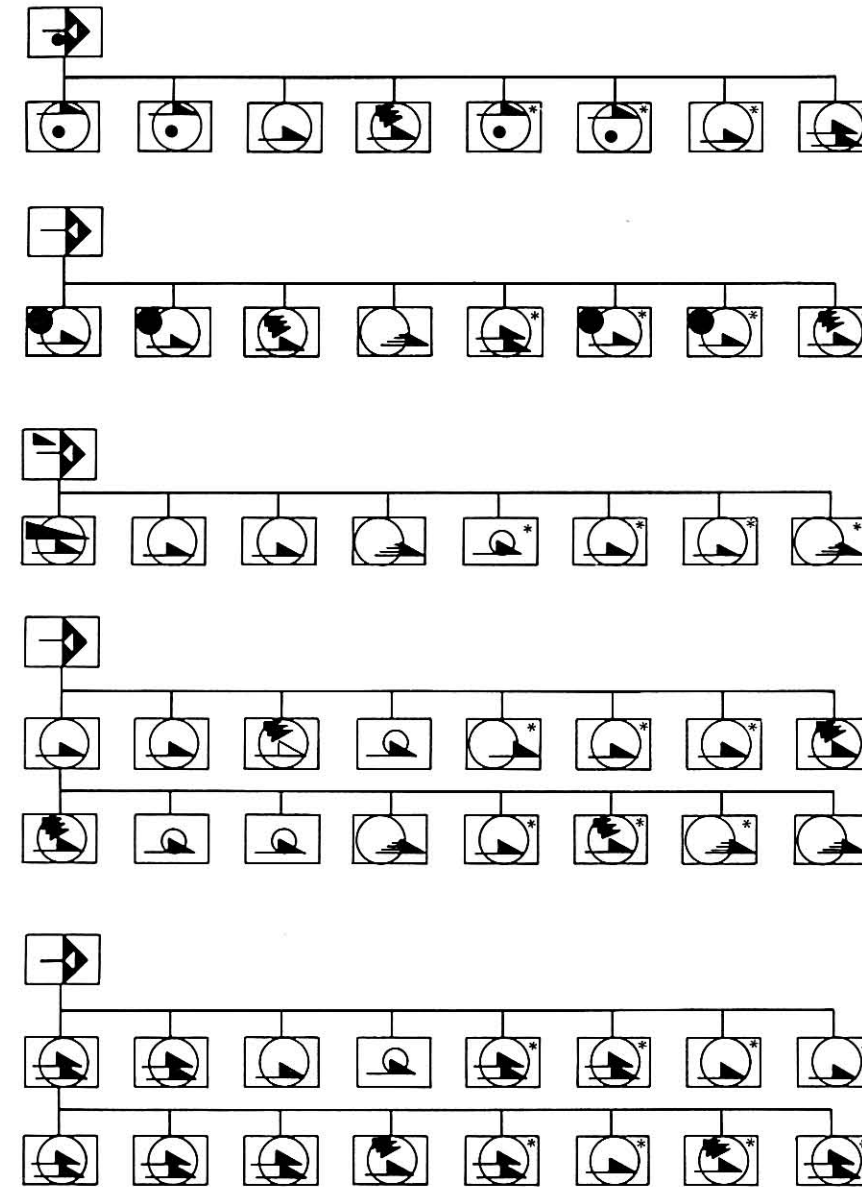
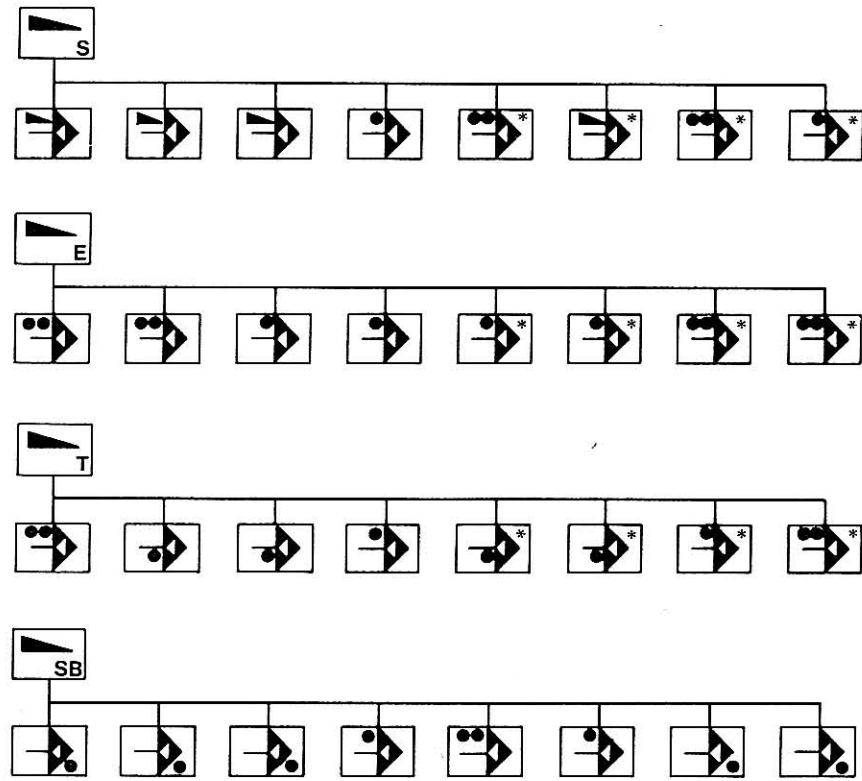

SQUADRON KEY



LINE KEY



Units designated with an asterisk are not available in all squadrons or lines

Systems Force

A systems force is commanded by a systems admiral, also known as a commodore. A systems force is responsible for several systems, the admiral being in charge of organizing and coordinating all of his ships throughout a sphere of command spanning hundreds of light years and dozens of worlds, the normal method of communications being no faster than the ships themselves. It requires extensive planning and preparation. It often goes wrong.

It is a tribute to the staff officers that things do not go wrong more often. The commodore is left to manage by exception, to handle those situations which have gone wrong or which have the greatest potential for going wrong.

A systems force is organized along force pools, available resources categorized by general mission type. While they have a set organization on the OB, a commodore is expected to reform the constituent elements of a pool to tailor the detail to the mission.

Force superiority contains ships expected to perform space superiority missions, which the

Navy still considers to be its primary objective. Space superiority is defined as "the complete absence of hostile craft within the orbital space of controlled worlds, and no chronic enemy ship activity within the entire system." The Navy has striven for that goal ever since the inception of the Empire. The goal is even farther away now than it was at the beginning, but the gigantic increase in Naval resources is expected to reverse the trend. Force superiority, at a minimum, has three battle squadrons and a full-strength light squadron, with total ship strength around 90 (three of which are Imperial Star Destroyers). A commodore will make some attempt to use force superiority in squadron increments as these missions assume stiff resistance or urgent importance.

Force escort always has at least two heavy squadrons and two light squadrons, for an average of 108 ships. Force escort has the job of protecting commercially valuable orbital spaces or installations, as well as tracking down pirates or small bands of renegades. The Navy considers force escort to be a malleable organization, and

The Full Might of the Empire

Captain Oweg marched smartly to the head of the bridge. A few of the pit crew smirked as he went by, noticing the captain's distinctive walk. Oweg's gait meant he had good news for which he personally wished to take credit. Moff Vensell, standing at the viewport, was looking at nothing in particular. He acknowledged Oweg's crisp salute with a desultory nod, continuing to look at nothing in particular.

"We have an update from astrogation," said the captain. "Hypersignal sensor data and recalculation indicates that all ships shall emerge from hyperspace in formation. Only the Strike Cruiser *Shador* is anticipated to have deviated more than an arc second since we left Jerijador."

The captain waited, standing at attention. Vensell did not dismiss him. Oweg began to look uncomfortable. The pit crew looked up, aware of the silence. Oweg glanced at the pit crew. Vensell made a slow quarter turn, examining the comp centers. Oweg stiffened to full attention again as he inferred Vensell's meaning.

"Astrogation assured me that the data has less than a fourth factor expected delta," the captain called out. Vensell nodded as Oweg snapped another salute. He made another

slight change in facing as the captain gratefully withdrew.

The pit crew, alert to the Moff's posture, began running test charges through all of the *Valiant's* weapons systems. As the gaze of the Moff meandered over parts of the bridge the crew leapt to life. The comm-pit began preprogramming fire command messages to the other ships for all of the exigencies for which they had planned. Controllers began the launch drill with the TIE pilots. Sensor crews began zero basing their instruments, fine tuning them to squelch any noise. Shield loads were tested, compared with standard energy draws on the engines. The helm worked through all of the emergency simulations with techs in the engine room. All sections reported to the staff lieutenant. When the row went green, the lieutenant looked up at the Moff.

"We are set to exit in 45. We shall proceed on the attack vectors unless you alter the plan, sir." Vensell nodded, turned and faced the helm.

"Lieutenant ..."

Pit Lieutenant Hast saluted faster than he ever had at the Academy when he heard Vensell's voice.

"Yes, sir?"

"Let us show these Rebels what we mean when we say 'the full might of the Empire'."

the admiral and his staff create mission details which fit the known mission as precisely as possible. Force superiority is given the maxim "always send enough." Force escort is given the maxim "never send too much."

Transport force contains two troop squadrons, a heavy and a light squadron, for an average of 80 ships. Troops and ships are assigned to mission details as needed, the troop squadrons being used as a command center for coordinating ongoing surface operations.

System bombard contains an average of 100 ships divided between three bombard squadrons and a light squadron. If an admiral feels that force superiority has done less than a thorough job of removing hostile craft from the system, a system bombard squadron will be augmented with ships from the light squadron. The new unit will still be called a bombard squadron to avoid the need to consult with a Moff or higher authority. Such actions are not approved of when they are discovered.

Force Technical Services contains technical and mechanical specialists who are organized by single ships. FTS has eight vessels (often EvakmarkDY transports) devoted to getting the techs where they are needed the most. Two escort frigates accompany each FTS ship. While Naval vessels have a large number of competent specialists aboard, these are trained and equipped to maintain existing ships' systems. If a system needs to be completely replaced, or a significant modification needs to be done, FTS is called in.

FTS cannot repair hulks which are dead in space, but they are equipped with tractor beams to return such vessels to deepdocks where they can be repaired. If the techs believe the vessel to be a complete wreck, FTS has salvaging equipment on most vessels.

Each force support has over 100 vessels of all sizes, and maintains depots on a handful of worlds. Munitions, consumables, spare parts and equipment for FTS, medical ships, and Droid services are all handled by force support. Unlike FTS, force support has no escort vessels dedicated to it. If the vessel is traveling into a combat zone it is given an escort, otherwise it usually must go it alone. As the Rebels have gotten bolder, the Navy has gone to elaborate Rancor-and-Sath games in which force support vessels are the bait.

Fleet

"Fleet admirals have it made. They only have to worry about the success of their subordinates, their Moff, and guys whose name begins with Lord."

— Captain Seledrood (deceased)

A fleet is designated as a "sector resource," which means it should be available for action anywhere within the sector. A fleet is the small-

est unit transferred between sectors. All fleets have a force technical service and force support under their command.

Superiority fleets comprise at least four system forces, two force superiority and two force escort. With six Star Destroyers and an average of 390 other combat starships, a superiority fleet is presumed to be a sufficient force to maintain space superiority in calm sectors (those with four or fewer worlds confirmed hostile to the New Order, with no more than 16 additional worlds with confirmed significant hostile elements).

Assault fleets comprise at least two transport forces and two force escorts, an average of 376 ships. Assault fleets are built to sustain what is called the "1/4/16/64 Plan". The fleet is expected to be coordinating and sustaining four types of efforts: one corps-level continuous mission on a surface, four continuous operations at the battle-group level (occasionally shifting troops from other theaters to temporarily reinforce one mission to corps level), 16 continuous missions of regimental level (with potential for shifting troops to temporarily reinforce one area to a battle-group), and 64 missions of irregular duration at the battalion level or lower. The ability to sustain these missions is predicated upon absolute space superiority. If superiority is contested in many systems within the sector, the number of missions for which an assault fleet is responsible is reduced in direct proportion to the percentage of contested systems.

Bombard fleets contain an average of 416 ships, allocated between two system bombards and two force escorts. Bombard fleets are assigned to sectors where the Empire has determined the probability of repressing the Rebellion in the sector to be less than even. System bombards are used when the Empire would rather completely destroy a world rather than see it fall into Rebel hands.

Deepdock fleet has a average of 280 support vessels, plus a force escort to protect the deepdock assets. Deepdock contains two deepdock complexes, the engineering corps, plus two force technical services.

Deepdock complexes are huge structures, and the ones planned are becoming larger all the time. Deepdocks are floating shipyards, able to make extensive repairs and modifications. When not repairing vessels they are building new ones to join the fleet. The smallest deepdock complex still in service has three work bays, the largest of which can hold a Victory Star Destroyer with the other two able to accommodate any ship smaller than a carrier. Such deepdocks have huge tractor beam generators which put up to eight damaged ships on hold while waiting for a work bay to open.

The largest deepdock now in operation is the Rendili R/M Facility Number Four, currently in the Mahrusha sector. It has 125 work bays, each of which is large enough to hold a strike cruiser. These work bays are modular, each segment joined to the other by attraction-variable Akinetic fields produced by Voorson generators larger than the drives on most combat starships.

This allows the work bays to be combined to form larger work bays; four work bays can be joined to repair or manufacture a Victory-class Star Destroyer, 15 can be combined to work on an Imperial Star Destroyer, and 18 can be reconfigured to produce a torpedo sphere. Work bays are being added as quickly as Rendili can manufacture them.

Deepdock facilities, while not as efficient as the shipyards of the major starship manufacturers, have the advantage of being hyperspace capable. This not only shortens the time required to get damaged combat starships repaired, but makes deepdocks more difficult targets for Rebel attacks.

Engineering corps is the research and development arm of the fleet, as well as the branch containing the most esoteric technical specialists. Engineering works on construction projects involving unproven technology, develops and refines new manufacturing processes (such as deepdocks), and works feverishly to keep Imperial starship technology on par with or ahead of that of the Rebellion.

Support fleet has at least 500 vessels, a quarter of which are corvette class or smaller, while a quarter of them are the huge Loronar FSCVs (Field Secured Container Vessels). FSCVs always travel in pairs, their main ion engines faced in opposite directions. On the side opposite the ion engines are gargantuan Prexton doublefield generators; these create force fields which are then surrounded by a hyperspace field when the ships make the jump to lightspeed. Each force field sphere is about 800 meters in diameter for over 250 million cubic meters of cargo space. Cargo containers are held in place by the force fields. The force fields may be bubblechained if enough power is available, and 20 or more field spheres are not uncommon.

As the vast majority of an FSCV's power is going through the Prexton, it is no surprise that the ion engines are underpowered. FSCVs at full throttle can take 35 hours and over 600,000,000 kilometers to come to a stop from normal sublight speed, and a like time to accelerate the ships again. FSCVs are therefore flown on paths tangent to the orbits of planets whose depots are being resupplied. Smaller ships unload and reload the cargo as the FSCV flies by, never losing more than a third of their sublight velocity.

Fleet ordnance is responsible for equipping all Navy and Army units with needed weapons and ammunition. Ordnance will use a ship as dangerously insecure as the FSCV only if a huge operation has been ordered suddenly by High Command, not giving ordnance sufficient time to resupply ships and depots. Ordnance usually conducts resupply operations by using available cargo space on more secure vessels, and has priority of the use of such space.

Biological section does medical research for the Navy and Army. Maintaining a presence on tens of thousands of different ecosystems exposes troops and crews to millions of microbes to which their bodies are not accustomed. Biological tries to assess the danger, prevent the transmission, cure or remedy the symptoms of all of these. In addition they experiment with new methods of wound treatment and rehabilitation. They are directly responsible for the health of stormtrooper units.

Every starship in the fleet has navigational computers which plot coordinates for a safe jump to lightspeed. Astrogation's job is to coordinate these jumps in as advantageous a way as possible, plotting arrival times in myriad systems for strategic advantage, and even plotting the arrival of mission details for tactical advantage. Astrogation does as close to a flawless job as possible with fleets so large.

Sector Group

A Sector Group is the sum total of Naval strength which the Empire expects to commit to a normal sector. A Sector Group is commanded by a high admiral, usually a title granted to the Moff who heads the sector. If the sector is involved in constant and severe naval actions, the high admiral is a man distinct from the Moff, so the Moff does not have devote all of his time to the naval conflict.

A Sector Group HQ always has a squadron under the personal command of the Moff. If the Moff is particularly competent or politically well connected, they can have many more squadrons at their disposal. Men such as Grand Moff Tarkin and Moff Carlinson could easily have 15 additional squadrons attached to their Sector Group HQ.

A Sector Group can be expected to contain at least 2,400 ships, 24 of which are Star Destroyers, and another 1,600 combat starships. Thousands of Sector Groups are at the Emperor's command as he seeks to bring the Galaxy firmly under his control.

The Order of Battle and Future Growth of the Army

When viewing the Order of Battle (OB), it is important to realize that this represents a baseline, a starting point for Imperial military ambitions. Only eight percent of Army units are below their OB strength for reasons other than combat attrition, while nearly 15 percent are above the baseline as given by the OB.

The OB is built upon the assumption of continued explosive growth in the military. Every unit from a platoon up is expected to undergo an "upgrade" to its full OB strength. The exception to this rule are the scouts, which are difficult to man with qualified troops even at current levels.

This buildup will filter up through the ranks — larger platoons joining larger companies which are a part of larger battalions. The process is exponential.

For example, a baseline armored battlegroup has 10,090 troopers out of a unit strength of 16,346, with 1,132 repulsorlift vehicles and 318 tanks. If every unit were augmented in accordance with the planned growth of the OB, a full strength battlegroup would have 318,062 troops in a unit total 324,318, as many support Droids as troops, 36,084 repulsorcraft and 14,480 heavy tanks.

The limiting factor is not a lack of resources in the Army, but limited expansion of the Navy. The Army cannot expand faster than the fleets which are designed to carry them, and the fleets cannot be built any faster than they

are now. For the present, expansion will be limited to those sectors with heavy recurrent fighting where the need for a large land-based force, regardless of naval support or transport, is evident. Such forces can be built, but are then bound to the planet.

Another point to be made is that the OB represents the ideal organization of the Army. Mistakes and inaccuracies in upper level HQs can result in a skewed organization of the actual unit in the field. As the war against the Rebellion heats up, a substantial part of the organization is improvised by field commanders who are trying to combat a foe who gains strength with each encounter. Old line commanders and COMPNOR officials do not approve of such initiative on the parts of local commanders, and these officers are often punished even if the results prove successful. It is not unknown for a commander to be summarily executed for his violation of Surface Operations Training Doctrine, and then have his methods evaluated and subsequently adopted as new doctrine.

Such pioneers are obviously a rarity in the Empire.

SECTOR GROUP: HQ LEVEL

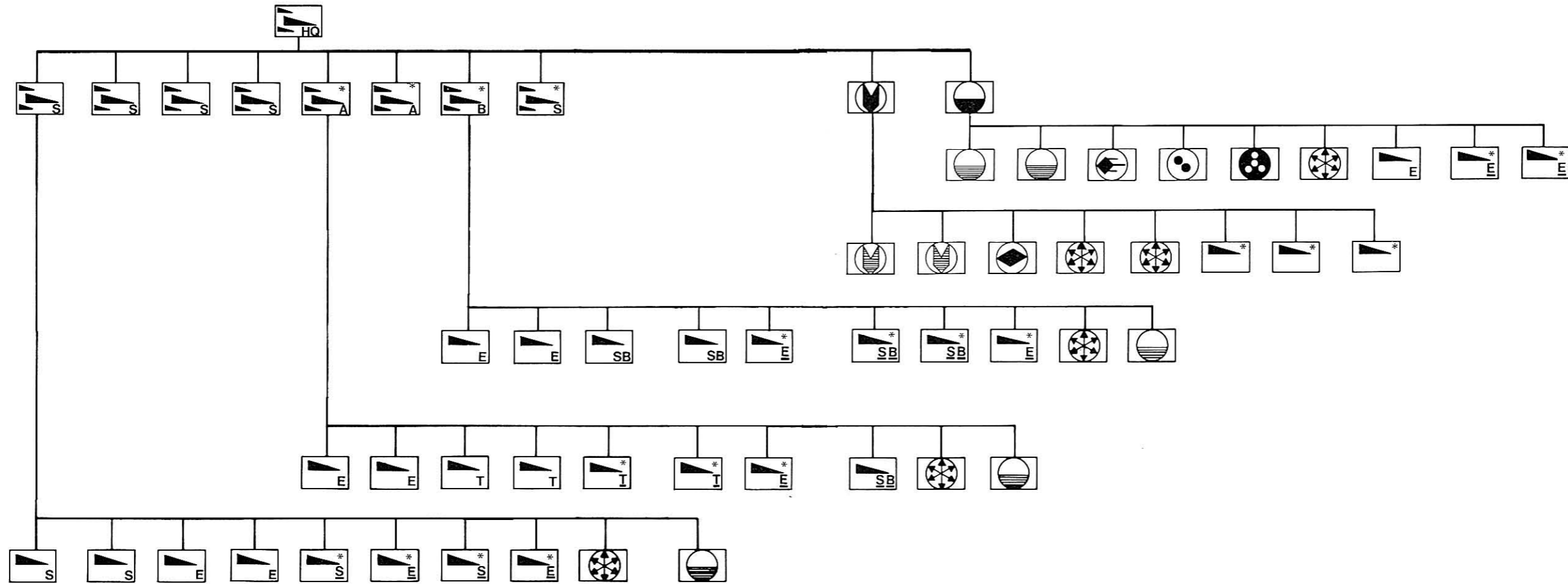

FLEET KEY

Sector Group Headquarters	Superiority Fleet	Assault fleet	Bombard Fleet	Deepdock Fleet	Support Fleet

SYSTEMS FORCE KEY

Force Superiority	Force Escort	Force Transport	System Bombard	Force Tech Services	Force Support

FLEET SUPPORT KEY

Deepdock Complex	Engineering	Fleet Ordnance	Biological	Astrogation

Units with underlined designations are not available in all groups

C

Chapter Nine Combat Artillery

To survive on the modern battlefield, artillery must either be very mobile, or have heavy enough FPR (Fire Position Relative) shielding to protect it against orbital bombardment and fighter attack. Hence, because of this vulnerability problem, actual use of artillery formations in the Empire is on the decline. Most modern guns are now mounted on vehicles of one sort or another and are classified as armored fighting vehicles (AFV).

The artillery units currently in service primarily work in conjunction with fixed defensive points, or to protect static strategic points. A profusion of artillery rankings exists within the Imperial military, a situation resulting from the de-emphasis of this arm within the inner circles of Imperial strategists. The three most common ways of categorizing

artillery are by FD, v-, and Df. Below are brief descriptions what these systems represent.

1. FD number. The FD (Fire/Disable) number is a ratio of the amount of time during which an artillery tube fires over the amount of time a tube is disabled for cooling and recharging. A more powerful weapon usually has a lower FD. The FD number system rose to prominence in the Artisian system and is used by both Atgar Corp. and CoMar Combat Systems (a member of the Corporate Sector).

2. v-. "v-" is a measure of deliverable energy in a single artillery tube charge, an approximation of a single shot. The units are obscure, developed by Republic Sienar Systems (now Sienar Fleet Systems) based on the amount of



Using Artillery in the Roleplaying Game

Artillery is designed to function against targets at a particular range. To represent this in *Star Wars: The Roleplaying Game*, all artillery units have three ranges listed: short, medium, and long. Artillery may only use its fire control at targets in the medium range, which is the optimal distance at which these weapons work. As with all RPG combat, hitting a target at short range requires an Easy skill roll, medium is a Moderate skill roll, and long is Difficult.

All artillery operates on the Walker Scale. See *The Star Wars Rules Companion* for more information on how scaling works in the roleplaying game.

Characters use their *heavy weapons* skill code to fire artillery. Skill codes for Imperial artillery gunners range from 4D to 7D.

In addition to their range rate, all guns come with a Fire Rate. These two numbers indicate the shots per round. For example: the 1.4 PD P-Tower has a fire rate of 1/2. This translates to one shot every two combat rounds. A few artillery units can fire more than once per round. As with all actions, for each shot above one subtract a die from the firing crews roll. (Note: firing more than once per round is optional.)

Each gun has a crew number listed. This number is the number of bodies needed to fully man the gun. When firing a fully-manned gun, designate one of the crew as chief gunner. Use the chief gunner's *heavy weapons* skill when firing the gun. When firing an under-manned gun (i.e., not enough bodies for a full crew) subtract two dice from the chief gunner's skill roll.

energy required to excite a double-packed particle emission of approximately 10^{24} g²-ions in a coherent beam from a 400 cm. by 8.5 cm. rod of vacierite (standard purity).

3. Df. "Df" is the range, in kilometers, over which a single tube-charge loses eight percent of its energy. At eight times this range the charge has lost about half its punch. The eight-base measure was developed by the Sumrias of the Lol system; members of the Sumrian thought-caste have four digits on each hand.

All three of these systems are in wide usage at this time, and translation between them is literally impossible. Each measures the relative strength of an artillery piece in its own manner.

Light Anti-Vehicle Laser Cannon

The Atgar 1.4 FD P-Tower, a light laser cannon, was first introduced in the Clone Wars as an anti-vehicle weapon. Primarily used by the Rebellion now, a few ancient Atgar 1.4 FD P-Towers still see service on the Empire's lower-tech Outer Rim worlds. The main problem with the Atgar 1.4 is its low fire rate. This is due to the weapon's power system.

The Atgar 1.4 uses an energy dish with micro-power routers spaced evenly along the dish's outer edge. When firing, energy is fed directly to all 16 power-routers. These hold their charge

until the computer registers that the ECP (Energy Conversion Point) has been reached. At that instant, the firing computer simultaneously channels the energy from all 16 routers into the main power converter in the center of the dish. This fires the laser cannon.

This system has a number of drawbacks besides the low fire rate. First, the main converter has very precise energy needs. If even a single power-router malfunctions the entire system goes down. Second, the high-profile 2.8 meter energy dish provides attackers with an easy target. Third, the battery which feeds the power routers is fairly bulky and must be replaced after just eight shots. Even with these drawbacks, though, the Atgar 1.4 is considered a viable (if not preferable) weapon by the military establishment.

Atgar 1.4s pack a punch equal to many standard artillery units, and on occasion have taken down vehicles as large as AT-ST walkers. In addition, these are true all-terrain weapons, capable of functioning in temperatures from minus 100 degrees Standard to plus 120 degrees Standard. Finally, and most importantly, the Atgar 1.4 is inexpensive by any standards, costing less than half as much as similar powered weapons. Hence, even though the Atgar 1.4 has all but vanished from standard issue, its continued use by merc units and Rebel units is assured. For this reason, Army Command is reviewing this weapon for inclusion on the updated standard issue list.

**ANTI-VEHICLE
LASER CANNON**

Weapon: Atgar 1.4 FD P-Tower
Type: Light Anti-Vehicle Laser Cannon
Crew: 4
Body: 1D
Range:
Short: 10m to 500m
Medium: 501m to 2,000m
Long: 2,001m to 10,000m
Fire Rate: 1/2
Fire Control: 1D
Blast Radius: Target
Damage: 2D

Comar Tri-Tracker

Military crafts designed for atmospheric attacks are swift and deadly, capable of bypassing common air defense systems. To meet the anti-atmospheric needs of today's Imperial military, CoMar has combined their most innovative tracking system with proven Star Destroyer weapons technology. The result is the CoMar Tri-Tracker, one of the most accurate surface-to-air defense systems used in the Empire.

The Tri-Tracker's advanced Target Acquisition and Tracking (TAT) system uses a triple-array sensor and computing package to accomplish three essential tasks.

First, the Tri-Tracker acquires a signature lock on targets registering in the operator-designated vector of interest. The weapons computer or the operator then selects a primary target of interest, while the signature library of suitable alternate targets continues to be updated.

A second sensor system records and tracks relative position and physical evasive maneuvers of the target. It feeds this data to the C3 unit, the heart of the Tri-Tracker.

The Countermeasures Compensation Computer (C3) is a unique sensor/brain combination. The C3 unit analyses and tracks target countermeasures — such as jamming, dropping chaff, or flying with drones, as well as evasive flight maneuvers — extrapolates and predicts the target's continuing true flight path, and compensates for this when the Tri-Tracker is fired.

The Tri-Tracker continues to extrapolate the position of receding targets even at long range. The fire control operator can shoot at a departing target even when at extreme ranges with exceptional accuracy. This long-distance "parting shot" has accounted for many downed

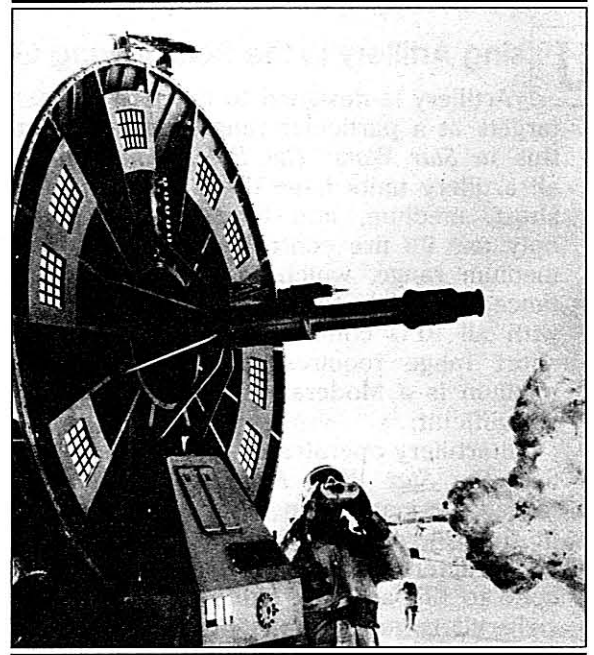

craft whose pilots thought they were safely out of range.

Firing accuracy is improved by the use of a tri-beam burst which brackets the target's predicted location. The C3 unit handles minor adjustments in beam angle up to the microsecond before firing. The destructive power delivered by the Tri-Tracker is comparable to that of a Star Destroyer turbolaser hardpoint.

Specially programmed Droids are capable of operating a Tri-Tracker in lieu of a qualified crewmember.

Because of the complexity of the Tri-Tracker system, the weapon's rate of fire is relatively slow. The weapon needs three times longer to reset than it does to fire. With this in mind, it is especially easy for a concentrated air attack to overwhelm isolated Tri-Trackers. Therefore, the Tri-Tracker is commonly used as an interlinked series of air defense emplacements. An optional network fire control unit is available to coordinate TAT activities for optimum target coverage.

A two-man crew is needed for the most accurate weapon performance. One fires the weapon, while the other selects priorities among TAT functions. When one man operates the Tri-Tracker, its target acquisition process is 40 percent less accurate.

Due to design limitations, the complex and very accurate Tri-Tracker sensors also have a relatively short range of operation. Unlike other sensor-assisted artillery, the sensor range falls short of the effective firing range of the weapon. This is compensated for by the

Tri-Tracker's ability to extrapolate a flight path beyond sensor limits.

The Tri-Tracker runs with land-line power, a generator or a battery reserve option. The battery option looks appealing for portable operations, but it is seldom employed since it is inadequate for the immense power requirements of a turbolaser weapons system. Land-based power lines and high-demand generators are more popular.

The Tri-Tracker is designed for use in permanent emplacements, or for mobile deployment with a heavy-duty repulsor sled. However, a long set-up and calibration time is needed to ready the Tri-Tracker for operation when it is newly installed. For this reason, it is not very popular as a portable air defense system. It is used on mobile platforms and field emplacements only when these occupy long-term defensive positions.

COMAR TRI-TRACKER

Weapon: Comar G-003 Tri-Tracker
Type: Medium Surface-To-Air Defense, Anti-Atmospheric Gun
Crew: 2
Body: 1D
Range:
Short: 20m to 600m
Medium: 601m to 3,000m
Long: 3,001m to 16,000m
Fire Rate: 1/3
Fire Control: 4D
Blast Radius: 10m
Damage: 5D

Speizoc "Grandfather Gun"

When shield technology was less refined than it is today, siege warfare and bombardment remained effective strategies to use against cities. At that time, Speizoc Arms created the "ultimate answer" in siege warfare: the C-136, perhaps the largest land-based ion cannon ever built. Popularly called the "Grandfather Gun," it was a refinement of ion cannon technology built to penetrate the primitive urban shields of the time.

Massive and unwieldy, the C-136 was designed for line-of-sight attack against large scale targets. It was used predominantly against cities, but has also been applied creatively to bridges, dams, other engineered structures, and stationary low-orbit targets. With its extremely long range it can be deployed well behind friendly lines, where it delivers

devastating blows to the target seemingly out of nowhere.

"Grandfather Guns" quickly became obsolete with improvements in shield and laser weapons systems. However, the C-136 remains in use on former frontier worlds and less advanced planets where ground-based bombardment remains a practical tactic. It is most popular because of the psychological appeal of pin-point long-range destruction. This is especially true of worlds where atmospheric, gravity, or other circumstances limit the use of air-borne or orbital bombardment systems.

The C-136 is difficult to transport and takes six to 12 Standard Hours to set up or disassemble. A forward observer is required for accurate medium- and long-range fire. The weapon is no longer in production, so spare and replacement parts are increasingly difficult to locate or produce. Its power drain is enormous, and a reliable power supply is always a critical issue when a "Grandfather Gun" is used. The energy blast from the cannon is of such magnitude that unusual atmospheric effects are commonly reported all along the path of energy discharge, and sometimes create ionization hazards for friendly troops.

SPEIZOC "GRANDFATHER GUN"

Weapon: Speizoc C-136
Type: Heavy Surface-To-Surface Bombardment Cannon
Crew: 7
Body: 3D
Range:
Short: 50m to 600m
Medium: 601m to 5,000m
Long: 5,001m to 25,000m
Fire Rate: 1/10
Fire Control: 3D
Blast Radius: 100m
Damage: 9D

Anti-Orbital Ion Cannon

First proposed by Can Lar, a Gathi working for Comar Weapons, the v-150 planet defender was initially rejected by Comar as "militarily useless and an engineering impossibility." Not to be deterred, Can Lar quit Comar and took his design to Kuat Drive Yards. There he found a more receptive audience.

The v-150 is a massive independently powered

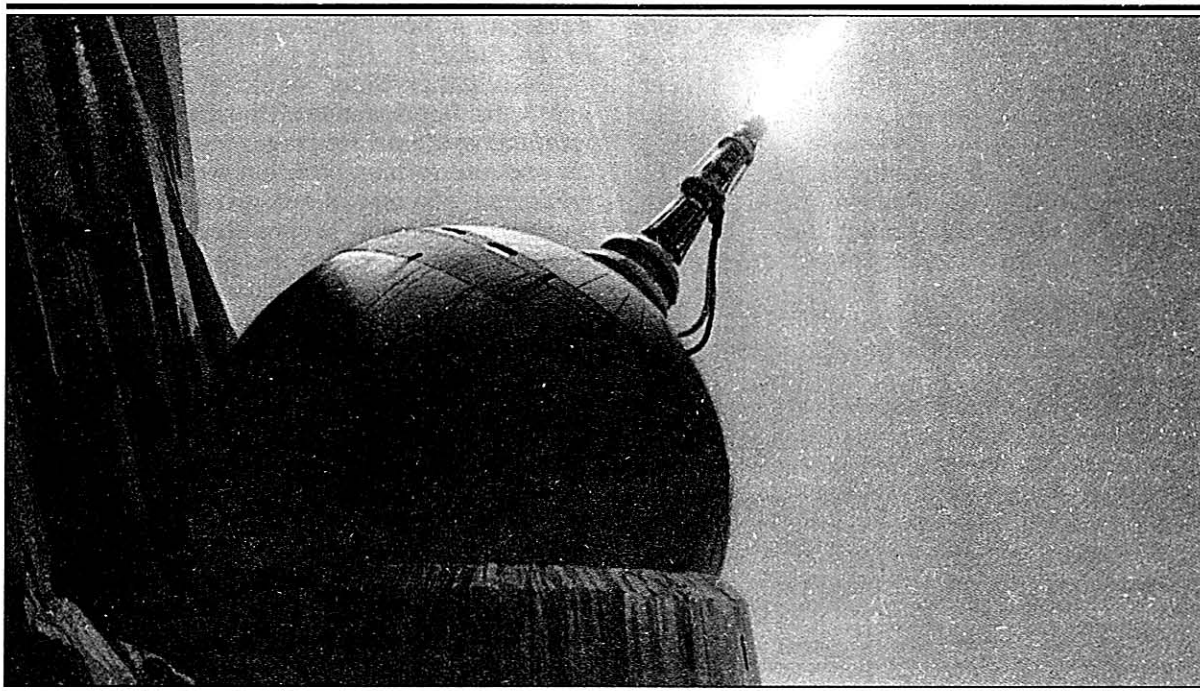

ion cannon, specifically designed for use against orbital and super-orbital space craft. V-150s are strictly fixed-placement guns, typically mounted on a rotating base covered by a semi-circular, reinforced permacite shell. These emplacements are modular, designed to be installed within a matter of hours. Each gun comes with its own reactor, which is then buried 40 meters beneath the actual emplacement. Between the reactor and the gun are three levels of crew quarters and storage space. A v-150 emplacement holds about three months of supplies.

V-150s are often used in conjunction with planetary shields. These shields are extremely expensive to maintain, so systems typically leave them down until hostiles arrive. To further complicate matters, most large shields take several minutes to reach full power. It is during these critical minutes, between an attacker coming out of hyperspace and the shields reaching full strength, that the v-150 is expected to perform.

Shield generators are always the first target of orbital bombardments. V-150s are designed to disrupt attackers until the shields reach full strength. The v-150 is well designed for this mission. Superb fire control allows the v-150 to hit orbital ships almost at will, and a single ion bolt from the gun can disrupt even Imperial Star Destroyers for short periods.

The biggest draw back to the v-150 is its extremely high price, nearly one-quarter the price of a full planet shield. Still, many Imperial planets have elected to buy 150s as an alternative to keeping shields on full power.

HEAVY ION CANNON

Weapon: KDY v-150 Planet Defender

Type: Heavy Ion Surface-To-Space Cannon

Crew: 27

Body: 5D

Range:

Short: Atmosphere

Medium: Near Space Orbit

Long: Outer Space Orbit

Fire Rate: 1/1

Fire Control: 5D

Blast Radius: Target Vessel

Damage: 12D Ionization

Anti-infantry Battery

Originally designed for the suppression of native populations on low-tech worlds, the self-propelled Golon DF .9 (also called the SP .9) is standard issue to Imperial garrison units. Based on the successful SoroSuub Corporation heavy repeating blaster, the twin guns on this weapon can fire extremely fast and, when turret-mounted, has a 180 degree arc of fire.

Powering the guns is a specially designed light ion unit, which also feeds energy to the repulsorlift chassis the guns are mounted upon. Surrounding the entire unit is a one-inch thick hull.

The main role of the SP .9 is long range anti-personnel support, although it also performs

ANTI-INFANTRY BATTERY

Weapon: Golon Arms Twin DF .9 (SP .9)
Type: Medium Anti-Infantry Battery
Crew: 3
Body: 3D (4D for fixed version)
Range:
Short: 20m to 600m
Medium: 601m to 3,000m
Long: 3,001m to 16,000m
Fire Rate: 6/1
Fire Control: 2D
Blast Radius: 5m
Damage: 4D

very well against medium and even heavy fighting vehicles. The rapid fire capability gives SP .9 a considerable edge on the battlefield, and its internal engine can supply its guns with virtually unlimited power. Critics of the SP .9 point to its vulnerability in close combat (the SP .9 has an open-top gun turret), and its awkward mechanics (to do engine repairs the entire gun turret must be removed). Proponents argue that the SP .9 was never intended for close combat against modern opponents, and that the gun has the lowest mechanical failure rate of any self-propelled gun in service.

A fixed-installation version, called the DF .9/B, is also in production. Mounted atop a heavily

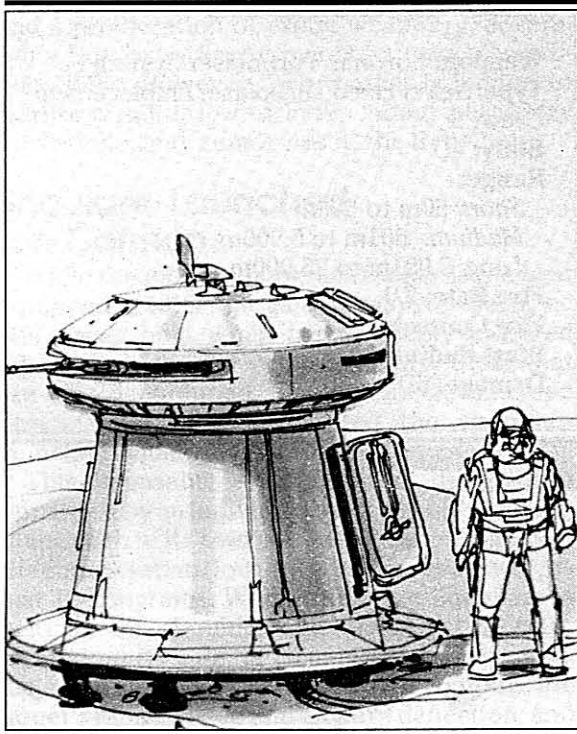

armored four-meter tower, .9/B features a full 360 degree firing arc, and comes equipped with a closed canopy. The fixed version only requires two crew to operate, both of whom are encased in the four-meter tower. The .9/B is rapidly gaining in popularity with Imperial governors, particularly for defense against dissatisfied (and unarmed) civilian populations.

Field Missile Launcher

The Leveler I self-propelled concussion missile launcher was developed by Bryn and Gweith, a subdivision of Comar, as a hardened fortification and long range siege weapon. Each Leveler I carries 28 concussion missile tubes mounted atop a heavy-track chassis in a four tube by seven tube formation. These tubes can be fired individually, in salvos of seven, or all 28 at once for maximum effect.

Reloading time is two combat rounds per tube, during which no firing can be conducted. Leveler Is carry no additional ammo themselves, and are instead usually accompanied by a repulsorlift ammo wagon. These vehicles are strictly designed for artillery support, being equipped with only the lightest shielding and no defensive weapons.

For spotting over-the-horizon targets, Levelers are equipped with DER (dedicated energy receptors). These receptors feed target information to the gunner's holo-display who then programs what salvo pattern to fire — narrow, medium, or wide.

Presently, the Leveler I is standard issue to Imperial assault forces, although there have been some complaints about their tracked chassis's inability to deal with weather extremes.

FIELD MISSILE LAUNCHER

Weapon: Bryn & Gweith Leveler I
Type: Medium Concussion Missile Launcher
Crew: 6
Body: 2D
Range:
Short: 20m to 600m
Medium: 601m to 3,000m
Long: 3,001m to 16,000m
Fire Rate: Variable
Fire Control: 2D
Blast Radius: 20m

Heavy Anti-Vehicle Weapon

The Speizoc v-188 Penetrator, a heavy anti-vehicle weapon, was first introduced during the Clone War. These are among the heaviest energy cannons ever to see field combat. Due to the massive size and excessive energy requirements, most of these weapons are placed inside fixed fortifications. There, hooked directly into a power converter, a single gun can dominate an entire battlefield.

On today's battlefield, these guns are mounted atop Aratech's 440 Super-Heavy Armored Chassis. These chassis's give the v-188 some mobility and offer a limited amount of protection against enemy fire. For power, mounted guns either carry their own energy cell, which gives them six shots before recharging, or tow along an energy trailer. Guns towing a trailer can fire as many as 50 times before stopping to recharge.

The biggest drawback to the v-188 is its low Df ratio. Shots from a Penetrator disintegrate rapidly, falling below 50 percent power at long range. Still, even with the rapid energy dispersal, few vehicles can withstand the punishing power of the Penetrator.

The arrival of the longer ranged turbolasers may doom the Penetrator to extinction. But for the time being, these monstrous weapons are still used by Imperial ground assault forces.

Rumors persist that some Rebel units are equipped with v-188s mounted atop modern repulsorlift vehicles. If true, these guns could pose a serious threat to even the heaviest of Imperial vehicles, including AT-AT walkers.

HEAVY ANTI-VEHICLE GUN

Weapon: Speizoc v-188 Penetrator
Type: Heavy Anti-Vehicle Gun
Crew: 8
Body: 3D+1
Range:
Short: 50m to 600m
Medium: 601m to 5,000m
Long: 5,001m to 25,000m
Fire Rate: 1/3
Fire Control: 1D
Blast Radius: 20m
Damage: 7D

Turbolaser Emplacements

Turbolasers are the queen of the modern battlefield, with more range, more firepower, and better fire control than any other gun in service. Turbolasers are typically classified as either medium or heavy. The Turbolaser System I is actually a single heavy turbolaser with independent range gear and fire control.

Ground installed System Is are usually encased in pure permacite and powered by a boron fission reactor. Each reactor is capable of powering a number of guns, so a single reactor is usually connected to multiple turbolaser emplacements. These multiple emplacements, called "hives" often share an underground system of living quarters or at the very least have a tunnel network leading back to the main base or city they are protecting.

The biggest drawback to the System I is its tendency to overheat. Poor coolant restrictor circuits allow gunners to fire up to 20 rapid shots using sustained fire. However, at this rate most gun batteries experience emergency shutdown after just five or six shots. Green gunners, in battle for the first time, often lose sight of their thermal monitors with predictable, but often tragic results. A gun which experiences emergency shutdown can be out of service indefinitely, depending on the external weather conditions.

TURBOLASER BATTERY

Weapon: Loronar Turbolaser System I
Type: Heavy Fixed Turbolaser Emplacement
Crew: 5
Body: 4D
Range:
Short: 50m to 600m
Medium: 601m to 5,000m
Long: 5,001m to 25,000m
Fire Rate: 2/1
Fire Control: 1D
Blast Radius: 10m
Damage: 6D

C hapter Ten Infantry Support Weapons

In addition to blaster rifles and pistols, thousands of other non-standard infantry weapons exist. Some of these, such as repeating blasters, are common and carried by the majority of Imperial trooper and stormtrooper formations. Others are only issued to specially trained trooper units. All of these weapons, classified as Infantry Support Weapons (ISW), are designed to be carried, emplaced, and fired by four or fewer men.

Three companies, Merr-Sonn Munition, Inc., BlasTech Industries and SoroSuub Corporation, exclusively manufacture ISWs for the Imperial military. The competition between these three has led to an expensive game of one-upmanship and a proliferation of exotic weaponry. Several other Corporate Sector manufacturers also produce ISWs. However their market is limited to territorial militia forces, independent mercenary formations, and, rumor has it, the Rebellion.

Shoulder-Launched Ion Cannons

While the modern Imperial trooper is the best equipped soldier the galaxy has ever seen, he still needs help when facing enemy armored fighting vehicles (AFVs), particularly those that are shield equipped. To immobilize shielded opponents, SoroSuub created the shoulder-launched Equalizer.

This disposable weapon system, designed to be carried by an individual soldier, holds four ion bolts, each in its own two-meter tube. Together, the entire system (four bolts in four tubes) weighs just 12 kilograms. When firing, the Equalizer is held on the shoulder and the targeting gear, located on its side, is aligned on the target vehicle. The Equalizer's sensors then compute the target's range, speed and angle of deflection, and

feed this data into a microcomputer which adjusts each bolt's flight angle accordingly.

Each ion bolt is launched individually. Once all four tubes have fired, the empty casing is discarded. Vehicles struck by the Equalizer's highly charged ion bolts experience power shortages (particularly to their shield power converters), leaving them vulnerable to attack by more standard weapons, like blasters. Smaller vehicles may have their entire electronic system fused by a single Equalizer bolt.

While the primary mission of the Equalizer is anti-vehicle duty, it also proves to be highly effective against low flying ground assault craft. More than one Rebel fighter has crashed after having its flight controls shorted.

Use of the Equalizer is widespread, especially among garrison forces. Garrison soldiers are often more concerned with repelling attackers than in launching massive offensives.

SHOULDER-LAUNCHED ION CANNON

Weapon: SoroSuub Equalizer
Type: Personal Ion Cannon, Disposable
Scale: Character
Skill Code: Heavy Weapon
Range:
Short: 3m to 50m
Medium: 51m to 120m
Long: 121m to 300m
Damage: 3D Ionization Damage

Portable Missile Launcher

The PLX-2 — or “Plex” — combination missile and rocket launcher is the newest standard-issue weapon for rapid, high-powered response. It is used against vehicles, fortifications, atmospheric craft and other projectiles. It is especially suitable as an anti-repulsorcraft weapon.

The launcher is an over-the-shoulder device operated by one person. It fires “dumb” rockets in a line-of-sight attack, or can program and fire the smart GAM guided missile designed for use with this weapon. The Plex chambers one projectile and holds a second in reserve.

Guided missile tracking modes are selected with the push of a firing stud on the launcher housing. Two different modes are supported. In EPR mode, the GAM homes on intense IR sources such as vehicle or missile exhaust. In the Gravity-Activated Mode for which the missile is named, its onboard computer first records the target’s silhouette. It pursues that image until it is close enough to lock onto the gravity-wave anomalies that are the signature of repulsorlift propulsion. The GAM missile can pursue a target for 40 kilometers before its fuel expires.

PORTABLE MISSILE LAUNCHER

Weapon: MerrSonn PLX2 “Plex”

Type: Launcher, Disposable

Scale: Character

Skill Code: Heavy Weapon

Range:

Short: 25m to 100m

Medium: 101m to 300m

Long: 301m to 500m

Damage: 6D

Merr-Sonn DEMP Gun

Sometimes it is desirable to neutralize Droids without permanently damaging or destroying them. Because of design requirements, these constructs are vulnerable to the effects of an electromagnetic pulse, a burst of energy which destroys electromagnetic pathways in mechanical and computerized devices.

Internal components are hardened against EMP effects as a matter of course in manufacturing, to

C omments by Imperial Trooper Kosk

“The Plex is lightweight, a nice change from other systems. But it can’t take rough handling or the targeting system falls apart. Oh, you can fix it all right with regular maintenance tools, but that takes about an hour. And there’s no time for that if you’re in the middle of action.

“You can override a broken targeting system and fire it anyway, but there’s no guarantee you’ll hit anything. If you fire a rocket, you’re all right — that’s line of sight. But if it’s a GAM, one or the other of the tracking systems kick in and there’s no telling which.

“A small problem for careless troopers is the firing stud. You have to tap it twice — once to set the guidance system and a second time to fire. I’ve seen troopers in a hurry press it only once, then wonder why the missile didn’t fire.

“Aside from those things, a Plex-fired GAM is the best seek-and-destroy weapon I’ve seen for use against repulsorcraft. It’s fast, and almost impossible to shake once it locks onto a target. I admit the GAM’s visual tracking system can be confused by other images in the sky. Good evasive maneuvers can lose the missile, too. But once it’s caught a repulsor signature, that craft is gone.”

enable devices to withstand the rigors of space and unpredictable alien environments. However, a modified-frequency pulse effect developed by Merr-Sonn is capable of penetrating shielding and hardened circuitry. The DEMP gun incorporates this technology. It is the only weapon capable of “stunning” a Droid as an alternative to damaging it.

The DEMP gun is available in a handgun or carbine configuration with adjustable power settings. Setting one does one-half the normal stun damage of a blaster pistol. Setting two inflicts the stun damage indicated in the weapon specifications. Setting three inflicts physical damage to internal components. A Droid damaged by setting three cannot be repaired, but must have its components completely replaced.

DEMP GUN

Weapon: Merr-Sonn DEMP Gun
Type: Personal Anti-Droid Electromagnetic Pulse Weapon
Scale: Character
Skill Code: Variable
Handgun Range:
Short: 3m to 10m
Medium: 11m to 30m
Long: 31m to 120m
Handgun Damage: 3D
Carbine Range:
Short: 3m to 25m
Medium: 26m to 60m
Long: 61m to 250m
Carbine Damage: 4D

Comments on the DEMP Gun from Imperial Trooper Dokus

"We were on Tatooine during a routine shakedown. In one place out in the desert, some moisture farmer's work Droids wouldn't let us in to search his evaporation station. Our senior officer didn't take that too well. The Droids wouldn't move aside, so he turned to me — I'm the DEMP gunner — and told me to juice 'em.

"The first setting ionizes a Droid's systems. It sparks a bit, but can operate normally in a moment. We never use that setting. If you need to stop a Droid, that doesn't put him out of the action. It only makes him pause for a bit.

"The second setting's more useful. It stuns a Droid, like a blaster set on stun does to a human. Knocks 'em out for quite some time — long enough to do whatever we came for.

"The third setting is the fun one. It blows 'em completely. Not only does it short their power plant, but it gets the motivator and burns the memory too. It's supposed to be used to stun heavily-armored Droids, and stop ones that are obviously threatening.

"Well, I felt so threatened by those work Droids I set the DEMP on "fry" and let them have it. It stopped them, all right, and something burned out so badly in one it actually caught fire.

"I'd never seen that happen before. A burning Droid is pretty spectacular, I found out."

Projectile Launcher

The CSPL ("Caspel") Projectile Launcher fires canister projectiles containing smoke, gas, and chemical agents as needed in tactical combat situations. Canisters containing the desired agent are mounted in the projectile launcher or stored in the weapon's four-canister magazine. An adapter for launching grenades, the PL/1G, is available as optional equipment.

Canister effects vary depending on the load fired. When undisturbed by wind, gas clouds affect all within a 30-meter radius after impact.

PROJECTILE LAUNCHER

Weapon: BlasTech CSPL-12 "Caspel"
Type: Personal Projectile Launcher, Disposable
Scale: Character
Skill Code: Heavy Weapon
Range:
Short: 5m to 50m
Medium: 51m to 100m
Long: 101m to 250m
Damage: Variable, see "Standard Cannister Effects"

Standard Canisters Effects

Load	Effects	Damage
Dye	Marks terrain, 10-meter radius	—
Smoke	Marks terrain, obscures vision	—
T-238	Nausea, incapacity	1D
CryoBan	Freeze damage, incapacity	2D
Plank Gas	Corrosive, incapacity	3D
Spore/B	Bothan stun spores, unconsciousness	4D (stun)
Fex-M3	Nerve Gas, death	5D

Comments on the CSPL from Lt. Harburik

“The Caspel has a bad reputation in certain circles, but only among troops that don’t keep their weapons clean. They claim that it jams and ignites the canister while it’s in the launcher.

“True, that’s happened once or twice. The most notorious time was the accident that killed Imperial General Azarin on Lafra. But the investigation proved it was a trooper’s negligence, not his weapon, that was at fault.

“No, the Caspel isn’t such a sensitive piece of equipment. Just watch out for dirt caught around the canister priming pin, and make sure it’s kept clean. That’s what can cause the launcher to jam. Then, sure, the canister’s been primed and it’ll go off if it’s jarred.

“Basically, though, the weapon is simple and reliable. It’s not as flashy as a blaster, but it fills a big need in small unit tactics. And the Caspel doesn’t have as many quirks as other projectile launchers I’ve seen. It seems like it takes forever to affix the grenade adapter, but it always feels that way when you need grenade fire quick. Of course, when a fire team takes a Caspel on a mission, you have to plan smoke or chemical support ahead of time. It takes only the special canisters designed for it and standard-issue grenades — nothing else. So if you didn’t bring the CSPL load you need, you can’t substitute ammo from other weapons.”

Thermal Detonators

Thermal detonators are small grenade-sized explosives, manufactured by Merr-Sonn Munitions for use by Imperial Combat Engineers. These bombs produce an extremely powerful but tightly contained explosion capable of blasting through two meters of pure permacite. Operation of a thermal detonator is fairly simple; slide the thumb guard out of the way and activate the detonator. From that point, there are six seconds to either clear the area or switch the detonator off.

Thermal detonators are packed with baradium, a powerful but unstable synthetic element. Once detonated, baradium generates a particle field which contains the “exploding” baradium inside it. As the baradium reaction continues, internal

pressure causes the particle field to rapidly expand until the energy being consumed by the field surpasses the energy within the sphere. At that point the sphere collapses in upon itself, consuming the last of the baradium. The end result is that anything outside the sphere is undamaged, anything inside is exposed to a concentrated baradium explosion (consisting mainly of heat).

Thermal detonators carry enough baradium to create a five-meter sphere. One disadvantage to thermal detonators is the instability of baradium. Detonators have been known to explode after being dropped or, occasionally, for no reason at all. Thermal detonators rarely function as grenades or projectiles, since the harsh motion could activate the baradium. Instead, Imperial engineers use thermal detonators to destroy fixed targets, attaching a bomb with magnetic cupplers and then detonating it via remote control or with the six second delay.

Distribution of thermal detonators is extremely limited, although some stolen detonators are available on the black market. Illegal possession of a thermal detonator is a capital offense.

THERMAL DETONATOR

Weapon: Merr-Sonn Thermal Detonator

Type: Personal Concentrated Heat Explosive

Scale: Character

Skill Code: Grenade

Range:

Short: 3m to 4m

Medium: 5m to 7m

Long: 8m to 12m

Damage: 10D (at point-blank range)

Heavy Repeating Blaster

The “E-Web” heavy repeating blaster takes its name from “Emplacement Weapon, Heavy Blaster,” with a number designator for its rate of fire. As indicated by its name, the E-Web was designed for use in small- and medium-sized unit gun emplacements. Heavy enough to provide devastating fire, the EWHB-10 can also be carried on maneuvers by its two-man crew. It can be set-up as needed in temporary emplacements by an experienced crew in 15 minutes. It can be moved already assembled on its tripod mount, although this is not recommended procedure.

The weapon comes with a high-demand portable Eksoan power unit and is fitted with the Gk3 Cryocooler for continuous fire capability. The limited fire control system includes Starvision and IR sensing for night targeting and unusual environments. A built-in com unit enables the crew to coordinate fire with other E-Web emplacements if command communication channels should become disabled.

Comments on the E-Web by Imperial Trooper Reydon

"The E-Web's a good gun, but it's not built to be fired by one man. Oh, you can do it. But you'll wish you could do it better.

"That happened to me when we were at Keskin. We fell back after our last firefight and took up a position outside of town. Ohvan and I set up the E-Web and settled in for the night. We were waiting for our scouts to report back, until a nightfire went off and lit us up. Ohvan was hit and fell against the Eksoan. I dived for the power unit to keep it from tumbling down the hill. That power pack is heavy, and if it goes it rips the power couplers out with it.

"A few shots winged the E-Web, but couldn't knock it out. The Rebels ran past and saw me down over the power pack. They thought I was hit, and kept going. The other E-Web, somewhere off to my right, exploded a minute later. It's real dangerous when the cryocooler gets hit. Rebels were pouring out of the jungle by the time I got the power couplings straightened out and opened fire.

"Without a second man it's very hard to shoot an E-Web. There's no fire control, you can't nurse your power supply or watch the cooler, and the gun is awkward to aim. My shooting accuracy was cut in half, and I barely took out enough Rebels to chase 'em under cover.

"I never want to try to fire an E-Web by myself again if I can help it. Especially not in a firefight."

HEAVY REPEATING BLASTER

Weapon: Merr-Sonn EWHB-10 "E-Web"
Type: Two-man Heavy Repeating Blaster
Scale: Character
Skill Code: Heavy Weapons
Fire Control: 1D
Range:
Short: 3m to 75m
Medium: 76m to 200m
Long: 201m to 500m
Damage: 8D

Force Pikes

Force pikes are two-meter long poles topped with power tips and made of very strong spun graphite which bends, rather than breaks, when put under pressure. A two-setting power panel is located on the base of each pike. The settings available are "stun" and "lethal."

First introduced during the Begali Uprising, force pikes are primarily used by planetary patrols and local military units to stun opponents or disperse crowds. However, they are also used by Imperial troops to eliminate opponents in situations where blaster fire is inappropriate or unavailable. Personal bodyguards to high officials also carry force pikes, although these pikes are primarily ceremonial (except in the case of the Royal Guard, in whose hands a pike is more dangerous than anyone would care to find out).

FORCE PIKE

Weapon: SoroSuub Controller FP
Type: Personal Force Pike
Scale: Character
Skill Code: Melee, Moderate difficulty
Damage: STR+2D

Proton Mines

The main purpose of a proton mine is to establish a defensive perimeter. To do this effectively, a mine must be deadly against both enemy soldiers and vehicles. Such a weapon is Merr-Sonn Munition's LX-4 Proton Mine.

Typically buried about half-a-meter beneath the surface, the LX-4 is actually a refitted proton torpedo warhead attached to two sensors. The first, a gravity-sensitive sensor, scans for magnetic disturbances (such as those created by a large vehicle). The second, a thermal sensor, searches for body heat. Both sensors are programmed to detonate the LX-4 if they detect an intruder within five meters.

The biggest drawback to the LX-4 is it cannot be disarmed. Once implanted, an LX-4 can only be removed via detonation. The reasoning behind this traces back to the old LX-2 comlink mines. Originally thought of as impregnable, a spot inspection on Calonica found that fewer than 10 percent of the 50,000 LX-2 mines, buried around the Imperial capital, contained explosive charges. A follow-up investigation revealed that Rebel spys had somehow discovered the mine's secret com code, and were using it to deactivate the mines. Once deactivated, the Rebels dug them up, stole their charges, and then buried the mines back in the ground.

PROTON MINE

Weapon: Merr-Sonn LX-4
Type: Self-detonating Perimeter Mine
Scale: Character
Skill Code: Demolitions (Moderate difficulty to set sensors; failure causes premature detonation)
Blast Radius: 20m
Damage: 6D

Sharpshooter's Blaster

BlasTech's Sharpshooter V is actually a modified blaster carbine fitted with a multi-spectrum targeting sight for increased accuracy. This sight, equipped with infrared enhancers for night battles, magnifies the target image while its micro-computer clears the scene of any haze or smoke. The Sharpshooter V fires a smaller, tighter energy bolt than other blasters, which dissipates less rapidly, giving the Sharpshooter V a range advantage over most other light weapons. But this sacrifices some of the power.

Imperial orders for the Sharpshooter V are kept at a modest level because of the weapon's high price tag. Instead of being standard equipment, these blasters are issued to special commando units. They are assigned to regular formations sparingly.

Surprisingly, the military establishment allows BlasTech to manufacture a weaker (and less expensive) civilian model for commercial distribution, called the Hunter V. Marketed as a sporting blaster, this weapon is widely used by urban security forces who often need the higher accuracy for inner-city fighting.

SHARPSHOOTER V

Weapon: BlasTech Sharpshooter V
Type: Blaster Carbine
Scale: Character
Skill Code: Blaster
Range:
Short: 3m to 30m
Medium: 31m to 80m
Long: 81m to 350m
Damage: 4D+1

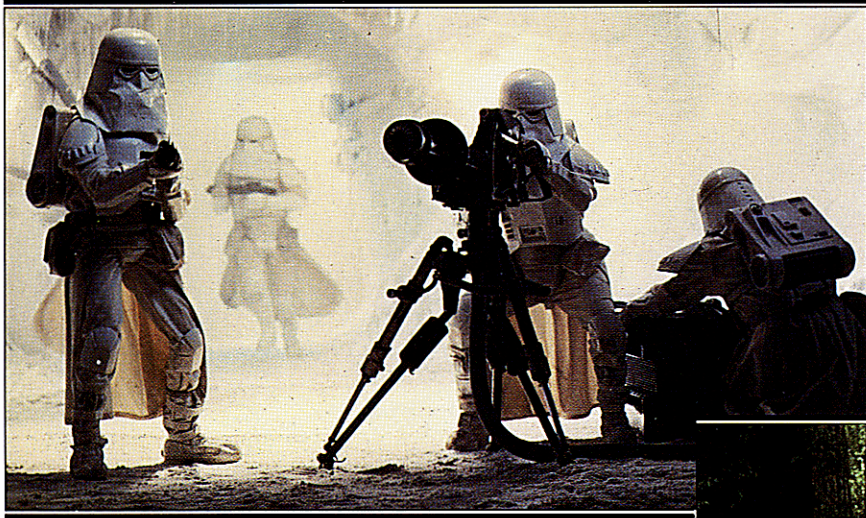

Feared throughout the Galaxy, stormtroopers support the two arms of the Imperial military as the Empire's elite shock troops.



LFL



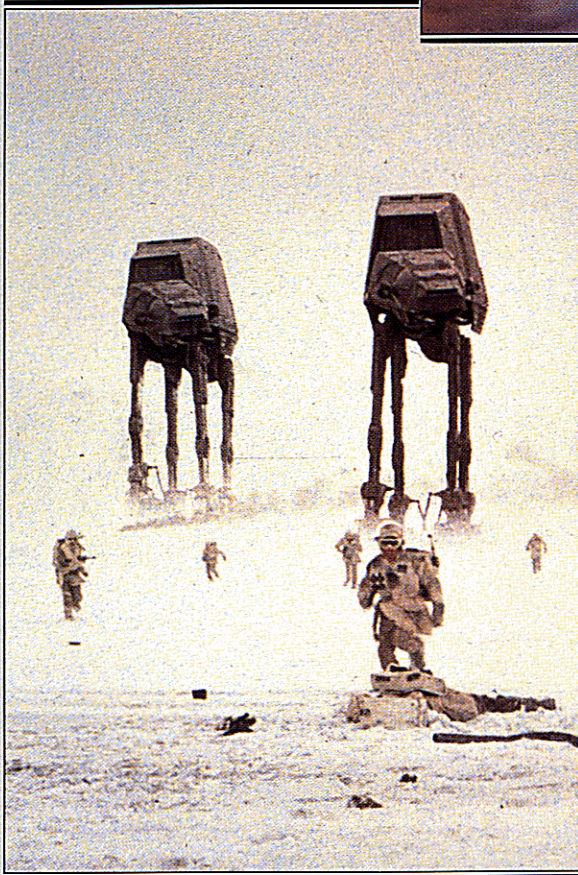
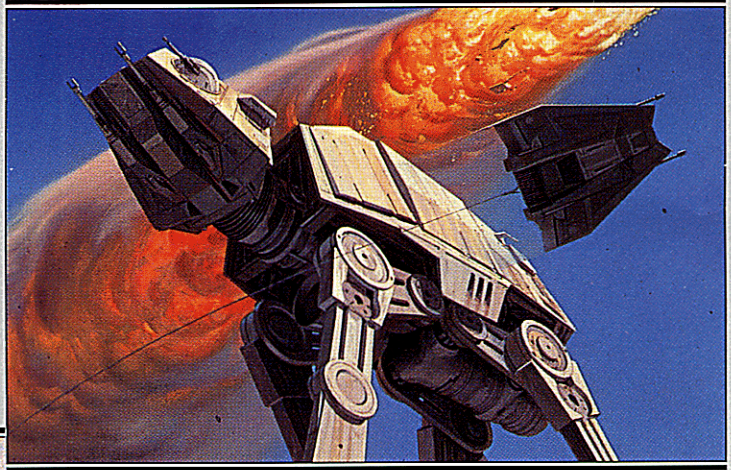

ne example of the might of the Empire is the dread AT-AT walker, over 15 meters of armored ferocity and terrible firepower.



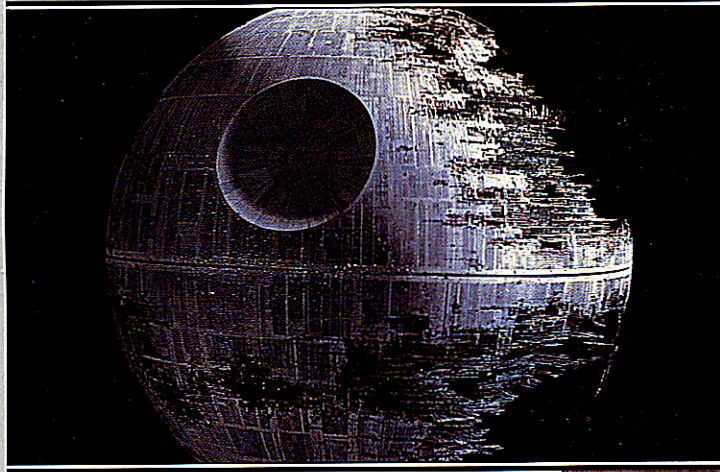

Before the Battle of Yavin, the Death Star battle station was scheduled to be the weapon by which the Emperor ruled. Rumors that a new Death Star is under construction are unconfirmed.

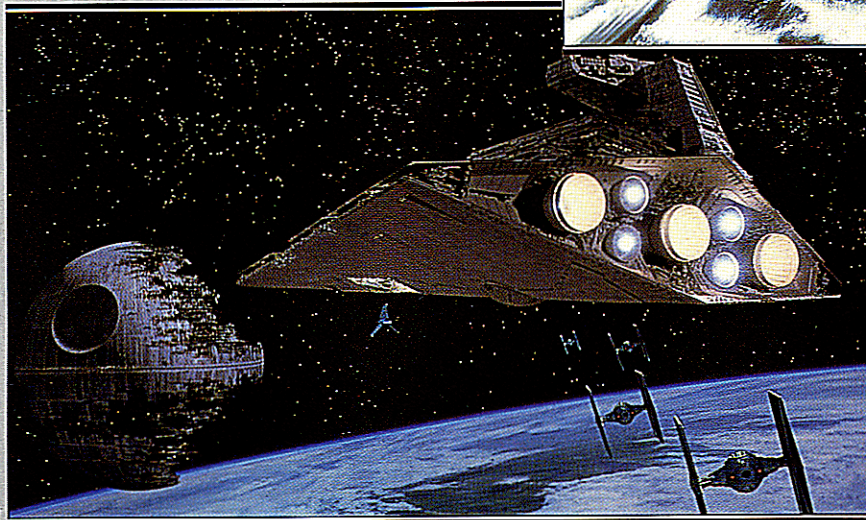

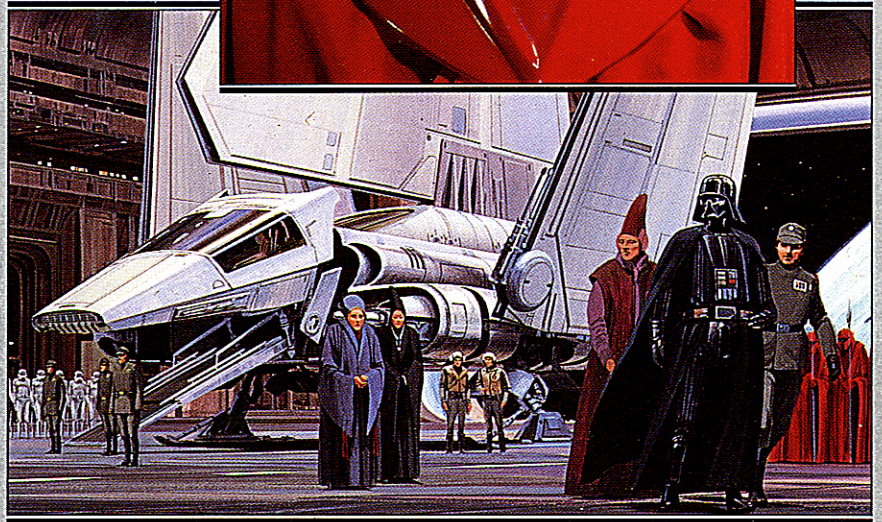
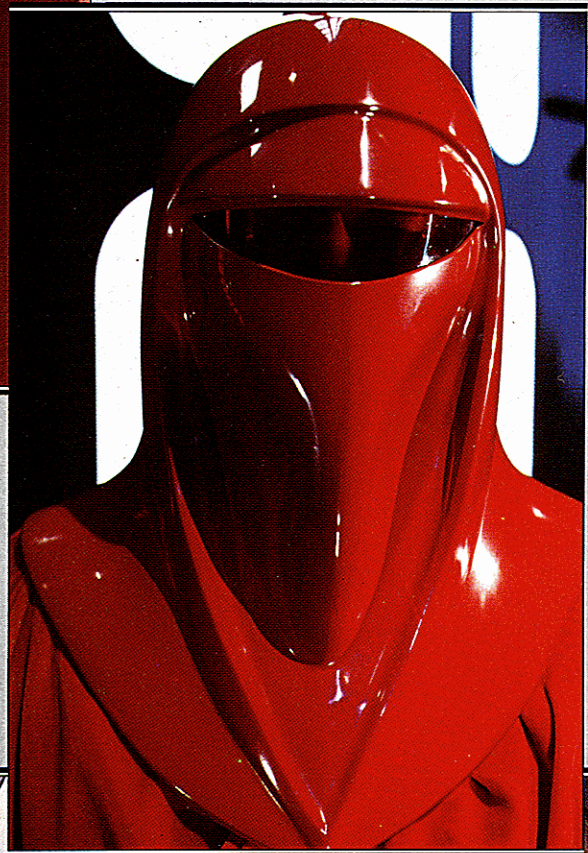

C

Chapter Eleven

Special Military Forces

The Empire employs a number of special military units throughout the various branches that perform specialized tasks. Stormtroopers fall into this category by their very nature, as do others. The following reports describe what has been documented concerning some of these units.

Standard Stormtrooper Unit

Stormtroopers are the elite of the Empire's military machine. Trained in a wide variety of roles, stormtroopers carry out any task quickly and effectively. They provide support for the two arms of the Empire's military establishment — the ground forces and the Imperial Fleet.

Stormtroopers are highly trained and highly motivated. Knowing no fear, they surrender only when faced with impossible odds, and then only once they have secured their primary objective. If ordered to hold at all costs, stormtroopers will willingly give their lives, rather than fail in their task. And yet they are not suicidal, because they know that to die without due cause is to betray the Empire. A dead stormtrooper is of no use to the Empire, unless he dies in furthering the Emperor's wishes.

While members of the Imperial Army and Navy have been known to accept bribes, or even defect to the Rebel Alliance, no stormtrooper has ever done so. They live only to serve, and nothing can ever cause them to do otherwise. It is no wonder that the Emperor trusts his stormtroopers implicitly, and that they look only to their superiors for direction. To die for the Empire is the highest honor they seek, and they do so without hesitation.

The white and black armored forms of Imperial stormtroopers strike fear into all who face them. Stormtroopers lie at the core of the Emperor's aggressive policies. Without

his legions of stormtroopers, the Emperor would not be able to maintain his firm grip on the Empire. While stormtroopers continue to do his bidding, no decree passed by the Emperor will ever fail to be implemented. Contingents of stormtroopers aboard Imperial Navy vessels ensure that no Navy captain or admiral will actively disobey the Emperor's wishes.

Deployment

Stormtroopers are the Empire's calling card. Wherever the Empire goes, stormtroopers will be found, acting as ship's troops aboard Star Destroyers, accompanying visiting dignitaries to outlying worlds, and maintaining garrisons on trouble-torn worlds. Working in conjunction with the Imperial fleets, stormtroopers enforce the Emperor's will in an effective and brutal manner.

Unlike the Imperial Army which is entirely geared toward ground operations, stormtroopers function equally well in space and on the ground. Trained to quickly seize ground installations during planetary assaults and to act as security troops on starships and battle stations, stormtroopers are far more flexible than regular army units.

As assault troops working in conjunction with Imperial Navy and Imperial Army armored units, stormtroopers are second to none. Their ability to rapidly overwhelm and capture enemy positions makes them the first choice for leading assaults on important worlds. Often stormtroopers are used to clear away the enemy's first line of defense and establish a ground base to allow the unopposed landing of transports carrying regular Army units. The Army, in these situations, is used to mop up resistance and maintain an Imperial presence.

Except in systems where prolonged struggles

threaten to disrupt the Empire's industrial capacity or weaken its strategic positions, stormtroopers will be withdrawn once they have secured a landing zone. The complete subjugation of a world is left to the Imperial Army. Where a quick victory is essential, large numbers of stormtroopers will be deployed to crush the opposition as quickly as possible. On worlds where the Empire has established important military bases or research establishments, units of stormtroopers are used to stiffen regular Army units.

Stormtroopers can be transported and deployed far more rapidly than regular Army units, who rely on large transport ships or the Navy for interplanetary travel. Huge Imperial Star Destroyers can carry battle ready stormtroopers into even the most heavily defended planetary system. The sheer size and firepower of the Star Destroyers allows them to brave planetary defense fires and land stormtroopers from orbit in a matter of minutes.

Every Star Destroyer carries a full division of combat-ready stormtroopers. On arriving in a system, stormtroopers and their vehicles are carried to a world's surface in heavily armed and armored assault craft. Stormtroopers hit hard and fast, and the presence of an orbiting Star Destroyer and its TIE fighters protects the landing stormtroopers from attacks by enemy starships. Once on a planet, stormtroopers move rapidly into the attack.

In situations where Imperial Command expects heavy opposition, task forces of three Star Destroyers, accompanied by huge transports carrying extra stormtrooper divisions, are dispatched. This is, of course, on worlds the Empire wishes to preserve either as forward bases, for their natural resources, or for their industrial capacity. On worlds of no strategic importance to the Empire, stormtroopers are rarely landed. Imperial Command will instead land Army units, or even resort to reducing the planets to piles of smoking rubble using the devastating power of the Star Destroyers.

In addition to being used as ground assault and garrison forces, stormtroopers are used by the Imperial Navy to enter and secure starships which have been captured by an Imperial ship's tractor beams. Even when pulled into the expansive landing bays of a Star Destroyer, many Rebel and pirate crews refuse to surrender.

Stormtroopers use high energy blasters to cut through a captured vessel's airlocks or hull, and then storm the interior of the vessel.

D eath of a Rebel Base

The armored compartment swayed rhythmically from side to side as the AT-AT walker crashed through the bushes and scrub surrounding the Rebel base. Inside, the stormtroopers clutched their blaster rifles and calmly waited for the walker to reach its position. Outside, blaster fire filled the air. Occasionally, a bolt found its mark, sending echoes through the giant mechanical beast before bouncing heavily off its armored sides.

The giant walker shuddered, the rhythm of its stride momentarily broken as its huge leg crashed through a low lying building. Abandoning their medium repeating blaster, a group of Rebel defenders desperately flung themselves out of the way as the walker continued its advance. Most didn't get very far as the walker's head spat brilliant orange and yellow death onto them.

From the cockpit of the Imperial walker, Commander Hayvlin surveyed the fleeing Rebels and thumbed open the comlink. "Commence ground assault."

Slowly the walker came to a halt. Its head turning from side to side as it continued to fire at the Rebel troops. With a grating of gears, it lurched slightly as its legs bent, lowering its huge body onto the ground. Its rear hatch shot open and a ramp sped down to the ground.

Armored feet clattered against the metal ramp as stormtroopers rushed out of the walker.

Rebel blaster fire lifted the first three stormtroopers into the air and flung them against the sides of the walker. But it did nothing to slow the stormtroopers behind them. They charged down the ramp, their blaster fire scattering the Rebels before more shots could be exchanged. One Rebel

Moving quickly and laying down devastating fields of fire, stormtroopers move steadily into the interior of a ship.

Caring little for their own losses, stormtroopers advance relentlessly through enemy ships. Stepping over fallen comrades, stormtroopers cut down the defenders and drive them back to the inner reaches of the vessel. No matter how many stormtroopers the defenders kill, there are always more ready to step in and take their place. Stormtroopers are well drilled in this style of combat and, unless instructed

attempted to toss a grenade into the advancing armored figures. Before he could throw it, his body lay smoking on the ground.

The stormtroopers spread out. Groups moved to the front of the walker to form a perimeter with other stormtroopers dismounting from nearby walkers. Other groups moved toward the entrance to the underground base. Using destroyed blaster cannons, rocks and brush for cover, the stormtroopers advanced, driving the Rebels before them.

Before long, no Rebels remained alive above the ground. Only white and black armored figures moved next to the base's metal doors. "They've closed the blast doors. Send in a cutting team," ordered the assault commander.

Inside the base, Rebels crouched nervously in the corridor, their blasters held ready to fire. Lights blazed over the armored doors as the stormtroopers cut their way in. A loud clang echoed through the corridor as the blast doors fell inward. Silence, and then searing beams of light sped down the corridor.

Chunks of rock and metal shot through the air as blaster bolts hit walls and machinery. Six stormtroopers were cut down as they rushed through the freshly-sliced opening. But their bodies were crushed underfoot as more stormtroopers poured into the base. They began to inexorably move down the corridor. Rebel blaster bolts found their marks, scattering stormtroopers right and left, but the Rebel defenders were not escaping unscathed.

Even though their dead were beginning to pile high in the corridors, the stormtroopers rapidly pushed the defenders back. The Rebels moved deeper into the base's tun-

nels, heading for their only hope of escape — a concealed hangar exit at the rear of the base.

The stormtroopers followed, spreading quickly through the base, taking no prisoners. The Empire was involved in a punitive strike, and the stormtroopers had their orders: reach the shield generator and destroy it, then form a perimeter around the area to contain Rebel troops while the Star Destroyer *Avenger* obliterates the base from the face of the planet.

A heavy repeat blaster fired down the corridor, pinning the crouching stormtroopers and buying the Rebel technicians time to maneuver the remaining airspeeders into position. The blast doors opened as the Rebels abandoned the heavy blaster and ran for the rising speeders. The first airspeeder shot out of the base, only to instantly explode. The other airspeeders were already on their way out. Unable to stop in the confines of the exit, they ran right into the combined firepower of the four AT-ATs and their stormtrooper contingents waiting outside. As the last speeder erupted into flame, the stormtroopers rushed into the base and joined with those inside.

High above the planet, the Star Destroyer *Avenger* was turning the Rebel base into slag metal. Blasts of high powered laser energy leapt from the vessel to the planet's surface. As the bombardment subsided, a gray-uniformed figure strode confidently onto *Avenger's* bridge. Captain Ferdas looked up from his instruments and acknowledged the newcomer's presence. "You have done well, Commander Hayvlin. Lord Vader will be pleased."

otherwise, they are likely to kill any who do not surrender immediately.

Units of stormtroopers are also used as honor guards to protect influential Imperial personages. No Imperial Ambassador, Grand Moff, Moff, Admiral or Governor General goes anywhere in public without an honor guard of at least 10 stormtroopers. While Rebels, bellicose natives, smugglers, pirates and assorted lowlifes may have no respect for Imperial officials, it is hard not to show some respect for the armed and armored forms which constantly surround them. It is al-

ways wise to be polite when you are looking down the muzzle of a stormtrooper's blaster rifle.

Stormtroopers are deployed in areas vital to the Imperial war machine. Industrial plants and mining facilities, which have been identified as high risk attack points by Rebels or pirates, are constantly manned and patrolled by stormtroopers. Their very presence often acts as sufficient deterrent to all but the most motivated of saboteurs and aggressors.

Elite Armor Unit

Formed during the closing stages of the Clone Wars from armor units of the Old Republic, Hell's Hammers have served the Empire in a large number of actions in the Outer Rim Territories. Used initially to crush opposition to the New Order, Hell's Hammers are now engaged in eradicating Rebel Outposts, subjugating planets with Rebel sympathies, and in forcibly bringing reluctant worlds into the Empire.

Originally created as a regiment, losses suffered in countless campaigns have reduced the unit's strength to little more than a battalion. Even so, Hell's Hammers continues to strike fear into all who oppose the Emperor's will.

Often working in tandem with stormtrooper strike teams, the Hammers are frequently deployed to crack open the outer defenses of Rebel Outposts. They clear a path into a base by brushing aside Rebel ground troops, eradicating gun emplacements, and shooting down enemy airspeeders and low flying starfighters. Stormtroopers or regular Army troops are then able to enter the confines of a base directly from their transports.

The Hammers have also seen action in more traditional armor engagements, where

they are used to spearhead assaults into enemy-held territory. Equipped with the most powerful repulsortanks in the Empire, the Hammers are capable of destroying or overpowering most of the ground-based opposition they encounter.

Being able to travel fast, the Hammers are a hard-hitting assault force with a reputation for getting results at any cost — a reputation that they well deserve, for their long history is not free from the taste of defeat.

On more than one occasion the Hammers have been thrown against superior forces without effective backup. In all of these cases the Hammers achieved their initial objective, but the lack of adequate infantry support made it impossible for them to maintain their position.

The action on Turak IV, while being marked as the Hammers' worst defeat, is also a great source of pride to the unit. Here two battalions of the Hammers' tanks swept across the lava plains to capture the Rebel Army's forward positions. But, because of the incompetence of General Maltaz, commander of the Imperial Army on Turak IV, they were cut off by Rebel forces counter-attacking from hidden bases high in the volcanic Hitak mountains.

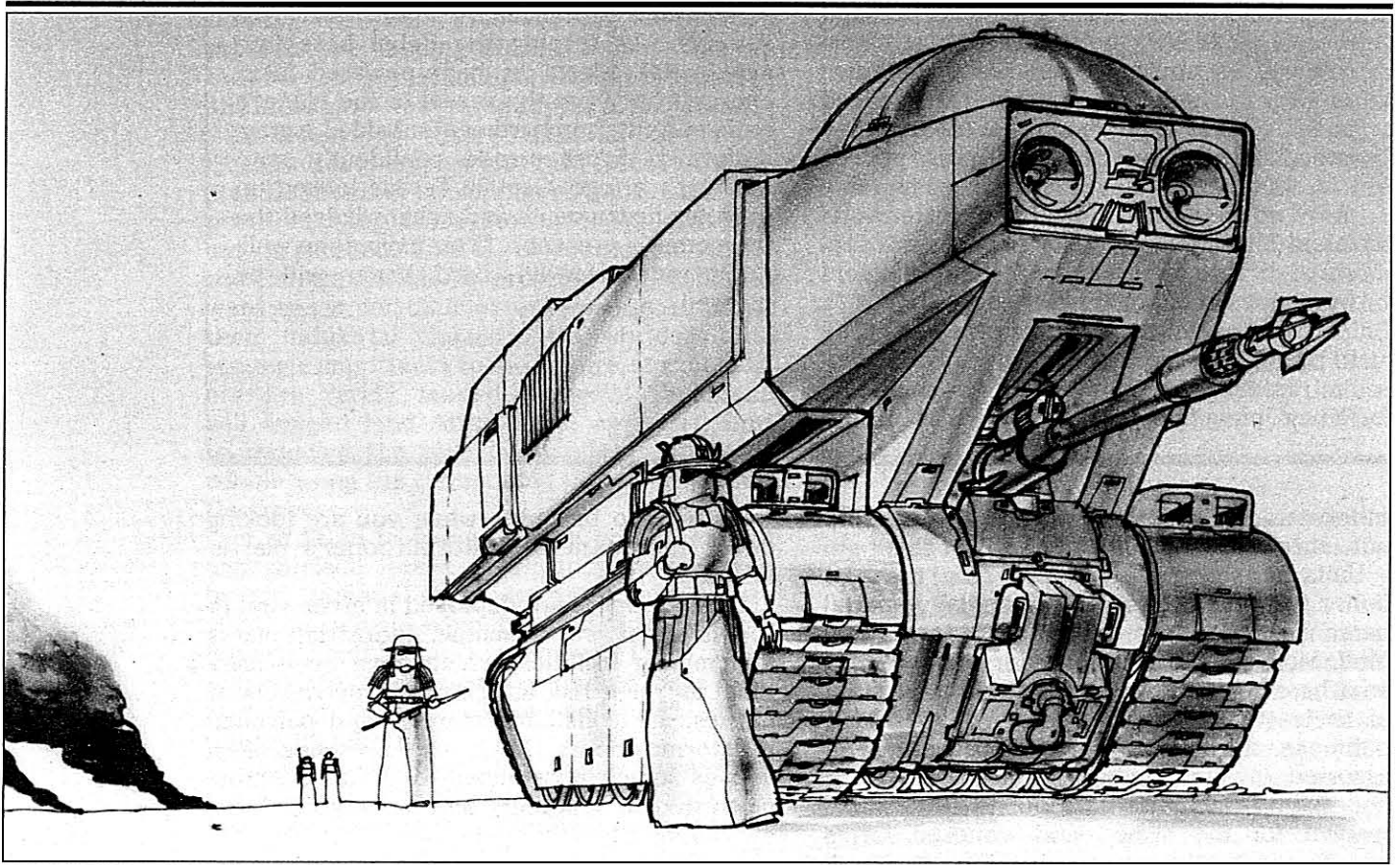

General Maltaz ordered the Hammers to hold their position, and attempted to halt the Rebel advance with the remainder of his command. Heavily outnumbered and subject to concentrated attacks by armored Rebel speeders, starfighters and ground forces, the Hammers' suffered heavy losses. Even though their tanks were soon burning fiercely in the hot sulphurous air, the Hammers refused to give ground. By the time the order came to withdraw, there were few Hammers left to receive it. All that remained were three tanks. The rest of the once-mighty force had been turned into smoldering hulks. The two battalions had almost ceased to exist.

Even though two battalions were effectively destroyed, their tank crews did not die in vain. TIE fighter patrols, which flew over the area in the closing stages of the campaign, reported large numbers of Rebel vehicles and starfighters lying strewn across the plains in front of the Hammers' position. The Hammers had paid a high price, but the cost to the Rebel Alliance was even higher. The Hammers had indeed lived up to their motto of "Strike To Kill".

Since that fateful day, the Hammers have operated under strength, with only one battalion able to take the field. While this has reduced the fighting ability of the unit, it has also served to increase its morale. The remaining troops of the unit have an uncanny knack for surviving engagement after engagement. Always bearing the brunt of the assaults, the Hammers have surprised Imperial Command with their ability to keep on going in the face of overwhelming odds.

Once considered an expendable force, the Hammers are now viewed as an essential part of Imperial Command's strategy in the Outer Rim Territories. This position has been attained at a high price as the blood of the unit's tankers has often been spilt unnecessarily by incompetent Imperial officers.

The unit's commander, Colonel "Rancor" Johans, is using the growing prominence of the Hammers to further increase his standing in the Imperial Army. Colonel Johans's proven tactical ability, and the complete devotion of his troops, has enabled him to persuade Imperial command that the Hammers should be allowed more freedom when it comes to campaigns.

Following the successful subjugation of the Yatir, a humanoid race indigenous to Absit and sympathetic to the Rebel Alliance, Johans has been able to convince Imperial Command that the Hammers would be of far more use to the Empire if they were again restored to

regimental strength. To this end, intensive training of recruits is now taking place on Brintooin to build the Hammers back up to regimental strength.

Hell's Hammers are destined to play a major role in the Empire's war against the Rebel Alliance.

Organization

Hell's Hammers form an elite force within the Imperial Army. When at full strength, the regiment consists of three battalions and a regimental command group. Two battalions are used to spearhead assaults, with the third battalion being held in reserve to reinforce the front line units as required, or be deployed as the situation warrants.

As the unit is currently under strength, it operates without a reserve, relying on the abilities of its troopers to gain its objectives quickly and effectively. This self-reliance and the growing autonomy of the unit within the Imperial command structure has helped maintain the unit's already high morale. The troopers look to each other and to Colonel "Rancor" Johans, rather than to other Imperial units, for support in times of need.

The experience on Turak IV has led the unit to act independently whenever possible, preferring to plan its own actions rather than catering to the logistical concerns of Imperial Command. If the Hammers were not so successful, this attitude would not be tolerated. But Johans's inspired leadership has led the unit to victory after victory, a state of affairs which Imperial Command is only too happy to accept.

Battalion Organization

The battalion consists of the battalion command and three armor troops, backed up by a reconnaissance troop. The three armor troops are employed to break through and capture enemy positions, relying on the mighty repulsorlift tanks to achieve their objectives. The reconnaissance troop serves a dual role: to probe enemy positions, and to protect the flanks of the armor troops during advances.

Each armor troop is led by a captain and consists of four squadrons. A squadron contains four repulsortanks led by a lieutenant and is the smallest unit employed by the Hammers. Depending on the situation, squadrons may operate independently of their troops or be massed together with other troops to literally "hammer" through enemy defenses.

The tanks are crewed by highly-trained troopers led by a sergeant. The crew is equipped with helmets containing wide-spectrum viewfinders, passive infrared sensors, and

computer-linked fire control targeting sensors. Although the tank crews are not expected to fight outside of their tanks, they are equipped with blaster carbines and pistols for defense in the event of a breakdown or being knocked out by enemy fire.

The reconnaissance troop comprises three squadrons of heavily armored airspeeders, and one squadron of fast moving but lightly armored speeder bikes. The reconnaissance squadrons operate independently of each other, allowing them to cover a wider area. The repulsorlift bikes are equipped with a single laser cannon for defense purposes. Their riders are expected to retreat in the face of enemy fire.

Before the armor advances, the reconnaissance troop explores the area ahead reporting on the difficulty of the terrain to be traversed

by the tanks, probing enemy positions, and noting the strengths and weaknesses of the enemy. The reconnaissance units are not designed to capture and hold ground. In the event of concerted opposition they are instructed to report on enemy positions and return to the main unit.

When the armor advances, the reconnaissance unit is positioned on the flanks and slightly to the rear of the attack force. In this formation the reconnaissance squadrons are able to keep the armored attack force informed of any enemy troop movements which threaten to cut off the unit or otherwise endanger its advance. In the event of an enemy attack on the flanks, the reconnaissance troop's airspeeder squadrons fight to protect the exposed tanks, but fall back as soon as the

The Assault on Protazk

The mighty repulsortank slid down the ramp of the landing barge, sending dust plumes high into the air.

Gortz peered through his viewport and cursed. "Another dirt ball world. Hey, sarge! How come we get all the good jobs?"

Sergeant Arbmab flicked a few switches on the command console and leaned over the turret to speak to his driver. "We're expendable, that's why. You don't think they'd send in the white armor boys while they've got us do ya? Besides, it'll be a push over, Rancor's leading us himself. Okay, let's roll, we've got a job to do."

The huge metal tank thrummed as Gortz cut in the repulsorlift drives. The tank hung there, momentarily suspended above the flat landscape before shooting forward in formation with the other tanks in the squadron. "Keep your eyes peeled, this place is crawling with Rebel scum."

Sergeant Arbmab powered up the main blaster cannon and kicked his panic bar, dropping him into the body of the tank. Around him holo screens flickered to life, providing a view of the surrounding terrain.

The comlink crackled as the calm, commanding voice of Colonel Johans came on the air. "Welcome to Spuma. I trust you enjoyed the ride. The Rebel forces are at grid reference 678/446. You all know what you have to do. Good luck and good hunting."

The battalion raced across the flat, dusty plain. Ahead, heavy blaster bolts began to

fill the air as the Rebel defenders opened up from their hidden positions. "Left 12 degrees Gortz, full speed." Sergeant Arbmab barked out his orders and spun the blaster cannon onto a now visible Rebel gun tower. Spraying the area, he watched with satisfaction as the tower erupted into searing, blue flames.

The command comlink again came to life. "Rebel airspeeders approaching in attack formation. Squad three, peel off and intercept."

As one, four huge tanks spun round and headed toward the Rebel speeders. Blaster bolts impacted on the lead tanks, causing Arbmab's vehicle to lurch sickeningly to the left.

Clutching onto the gun's controls, Arbmab demanded a damage report. Gortz glanced briefly at the monitor on his left and flicked a switch. "Slight damage to the port repulsorlift units. Nothing I can't compensate for."

"Okay, hold us steady." Arbmab studied the sky through his targeting computer and rapidly traversed the turret. A blip on the screen indicated the speeder was in his sights. He thumbed the firing switch and blue blaster bolts shot out from the tank to explode against the lead speeder. It lifted into the air and then hurtled toward the ground. Around it other speeders were suffering the same fate as the rest of the squadron's guns found their marks.

The remaining two speeders attempted to fly over the tanks' positions, but were cut

armor is able to bring its heavy weapons to bear.

Until the unit is returned to full regimental strength, "Rancor" Johans personally commands the battalion. His command group is therefore larger than would be normally found in a tank battalion. It consists of his personal tank squadron of four vehicles, a communications wagon, and a gun battery.

The gun battery contains four Golon Arms Df .9 Mobile Emplacement Guns, and two Golon Arms Df .1 Spray Blasters. The battery provides fire support and air defense fire for the battalion. The mobile repulsorlift-mounted guns can be rapidly moved into position to protect the battalion during enemy counterattacks, or to add their firepower to the battalion's tanks during advances. The gun battery is a recent addition to the unit, and is indica-

down by concentrated fire from the tanks' rapidly traversing turrets.

"Squad three, rejoin main attack formation. Recon 1, resume flanking patrol."

"You heard the man, Gortz. Take us in."

The repulsortanks rapidly approached the Rebels' main positions. Heavy repeat blaster fire spattered against the hull as Gortz zoomed up on the first trench. Sergeant Arbmab fired blast after blast at the Rebel defenders. Within seconds the trench was clear. As the heavy armored vehicles crossed the trench one of the tanks erupted in flame as a laser tower scored a direct hit.

As one, the three remaining tanks of the squadron turned their weapons on the offending tower, blowing it and its crew across the dusty plain.

As the Rebels fled in disorder, armored Imperial transports brought up infantry who poured into the trenches to begin mopping up hidden Rebels.

Sergeant Arbmab removed his helmet, wiped the sweat from his brow and opened up the comlink to base. "This is Hammer 3:2. We require a tech team up here as quickly as possible. Nothing major, but our port repulsors need looking at." He acknowledged the response and turned to Gortz. "You can rely on Rancor. Those Rebel scum didn't even know what hit 'em. They'll be looking forward to facing stormtroopers after this!"

tive of the more independent role that the unit has gained under Johans's leadership.

In addition to the combat troops, the battalion contains 40 support personnel responsible for supplying the unit in the field and for maintaining its equipment. Thirty technicians work on the unit's vehicles, keeping them functioning and repairing battle damage. A group of 10 engineers, equipped with heavy repulsorlift barges, recover disabled and damaged tanks and carry out any field fortifications required.

The unit relies on Imperial starships to carry it from world to world. On arriving in a system, the unit is transported to the planet's surface in armored and shielded landing barges. After landing, the unit quickly moves out to begin its attacks. Usually one of the first units in, the Hammers are also one of the first units to be withdrawn once victory has been assured. This unit, however, gets little rest as it is soon enroute to its next assignment.

Scimitar Assault Wing

The Scimitar assault wing, "White Death", is the best-known wing of the Qeimet fleet. Its battle name refers to the light-colored bodies of their TIE bombers, difficult to spot by ground observers until death and devastation strike the target.

The Qeimet fleet, led by the flagship *Victorious*, is based near the Hook Nebula, a strategic rimward sector. In spite of its distance from more famous areas of rebellion, the region is vital for the resource worlds located there. Already Rebel factions have gained control of manufacturing centers and have resupplied their forces through these means.

The Qeimet fleet is tasked not only with eliminating the Rebel presence in the Hook Nebula, but with punishing the resource worlds that allowed them free reign there. The Scimitar assault wing, aboard the Star Destroyer *Retribution*, plays a vital role in this mission. Before a military presence moves in on the ground to reassert Imperial control, the "White Death" wing subjects worlds to extensive bombardment and retaliatory measures — taking care, of course, not to harm manufacturing facilities that will be of use to the Empire.

Scimitar and other assault wings have seen plenty of action in the Hook, but only Scimitar has the record of excellence which others try to beat.

Scimitar History

The Scimitar assault wing was formed when TIE bombers were initially released to the Imperial Navy. Captain Tomax Bren was placed in charge of this, the first bomber-assault wing in the Qeimet fleet. Bren set the

unit on its ear with radical alterations in tactics, deployment, and assault priorities.

Unpopular among the older pilots, the commander's changes first proved their effectiveness at the siege of Nulan VI, where Scimitar's deep-atmospheric precision bombing forced the capitulation of the rebellious capital. His tactical innovation has continued ever since. Most recently, Scimitar's new "vertical swoop" tactics proved especially useful in the assault of the Aturi Cluster, where Rebels had set up powerful anti-atmospheric defenses.

Since the wing's inception, "White Death" bombers have continually set the fleet standard for performance in planetary assaults and orbital support. Though much of this success is owed to their commander's brilliance, the Scimitar wing has become the shock unit of choice for difficult assaults by the Qeimet fleet. Not only are their tactics and performance superior, but the officers of the wing, following Bren's lead, seem more politically trustworthy as a whole. White Death officers are more dedicated to the higher ideals of the New Order than most of their peers.

A high degree of discipline is demanded from "White Death" pilots. Precisely-coordinated maneuvers and split-second timing are essential for successful bombing runs. Working under unpredictable atmospheric conditions increases the difficulty of this considerably, yet "White Death" pilots do so often, and are constantly striving to better their already outstanding performance.

The Scimitar wing consists of three squadrons of TIE bombers, and two squadrons of TIE

starfighters for escort and interception duties. The sixth squadron is a specialty unit, comprised of recon vessels and drop-ships. Pilots in each squadron complete 50 combat missions, and then are rotated to training duties, mission planning staff, and other critical support positions. Officers freed from support duties by this rotation return to combat.

The primary mission of the "White Death" wing is planetary assault and low-level atmosphere bombing strikes. Although bombardment is often done in support of ground troops, the Scimitar wing is also capable of independent assault bombardment. Such attacks enforce psychological intimidation and neutralize strategic targets. The TIE's precision bombing capabilities are used in pinpoint strikes to achieve tactical or strategic effects: bombing a single house where Rebel leaders are believed to reside, or destroying a recalcitrant governing body as they convene in their regular place of government business.

Such extensive work in atmosphere requires techniques different from those utilized in space. Bomber pilots in an assault wing like "White Death" become more skilled in atmospheric flight than any other type of TIE pilot.

The Scimitar assault wing routinely sends one or more squadrons to lay down strategic or tactical bombing, either from orbit or atmosphere, in support of ground operations. Single bomber elements and flights tackle smaller targets of importance in the battle zone itself. When not needed as bomber escorts, TIE fighters are deployed for ground strafing in an effort to harass convoys or enemy troops.

Recon Flight

One flight in the Special Unit squadron consists of equal numbers of TIE fighter escorts and TIE/rc reconnaissance craft. The recon ships contain specialized equipment packages with extra-sensitive sensors and long-range communication gear. They gather intelligence for the fleet, going where ship-board sensor arrays cannot go.

Not all recon vessels need escort protection on every mission, but those that do usually need it badly. The starfighters in this flight protect the slower recon TIEs as necessary, and sometimes perform detached duty with one of the escort squadrons.

Drop-Ship Flights

The Special Unit squadron includes two flights of drop-ships. The ships are used for rapid transport of ground troops from ship to planet during combined assaults. They serve double duty as cargo vessels and shuttlecraft

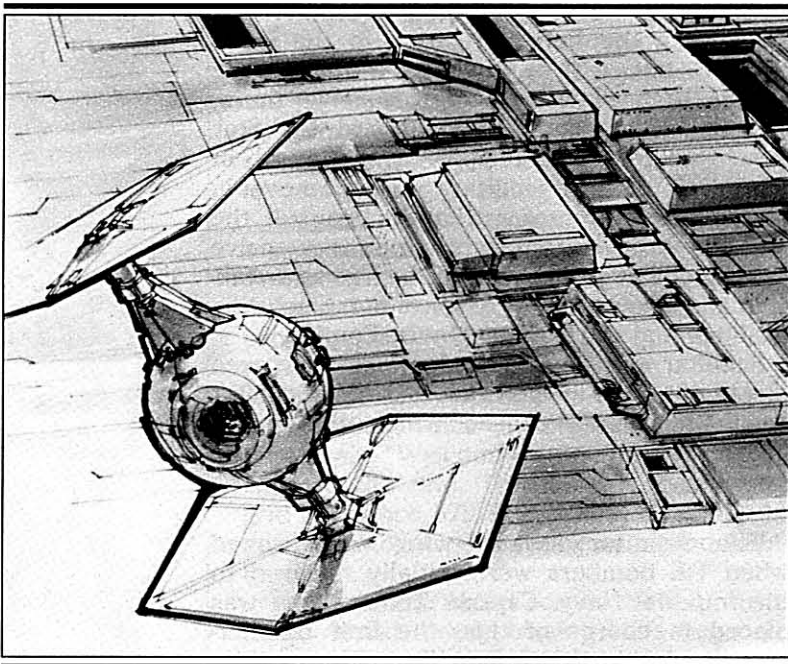

when not in service as transports for assault troops.

Because drop-ships participate directly in assault support under combat conditions, they are part of the Scimitar wing's combat squadrons, and are not counted among shuttles, launches and other utility craft in the wing.

Although the MT/191 can approach a planet normally, it is designed to drop in a rapid powerdive to a planet's surface, landing in a controlled manner at the end of the fall. Before drop, the ship is covered with VACX, an ablative coating which raises the hull rating. By planetfall, the VACX has burned off and the hull value is reduced to its normal rating.

The laser cannon is located directly above the cockpit. It is functional only when extruded from the ship's body. The cannon is intended only to be a mild deterrent if needed during shuttle runs in combat zones, and is never in a ready position during drops.

DROP-SHIP

Craft: Meller & Dax MT/191 Drop-Ship
Type: Special-purpose shuttle and troop transport
Length: 52.5 Meters
Crew: 1
Passengers: 160
Hyperdrive Multiplier: none
Nav Computer: no
Hyperdrive Backup: no
Sublight Speed: 5D (during drop); 1D (during flight)
Maneuverability: 0
Hull: 4D
Weapons:
 One Light Laser Cannon
 Fire Control: 1D
 Damage: 1D
Shields: 1D

Datamemo

From: Commander, Scimitar Wing
To: Squadron Commanders
Re: New TIE bomber pilots

Heavy losses sustained in the ongoing assault of U'Dray have put us understrength. We are receiving a replacement complement of new TIE pilots from the training squadron of the *Victorious*.

These pilots will complete their bomber training exclusively on actual combat mission. Since they will not have time to undergo standard wing indoctrination, it is imperative to brief them on the requirements of service with the Scimitar assault wing. Include these points:

- Mission timing is always critical; some are planned down to the second. Each element, flight and squadron is relied upon by others to be in its designated place at a precise time.
- Mission success and personal survival hinge on each member of the wing doing as expected when it is expected of him. Failure to do so through negligence, poor timing, or exercise of personal initiative is inexcusable.
- Missions are carried out exactly as planned. Individuals who deviate consistently from mission assignments will be demoted to drop-ships.

C

Chapter Twelve Recruitment, Training and Indoctrination

To: All Sector Commanders
From: General Nasda, ISB
Subject: Imperial Recruitment

Following the defection of the Imperial Army infantry units of Wazta (see Imperial Communique #2734.19g), an unspecified number of Imperial Navy vessels and their crews have deserted. This spate of defections to the Rebellion must stop. We cannot continue to allow Rebel sympathizers to enter Imperial Service for the sole purpose of undermining morale.

At the same time, unexpected losses suffered by Imperial forces engaged against Rebels in the Yavin system have highlighted the need to increase the rate of Imperial recruitment. You will personally ensure that your recruitment and training procedures are brought into line with the following directives.

Recruiting: Recruits for any section of the Imperial services must have a high loyalty to the Empire. In light of recent desertions, we can no longer rely on troops or officers whose loyalty is in any way questionable.

You will therefore cease to recruit on worlds which have been subject to Imperial bombardment or planetary assault in the last 10 Standard Years. Worlds which have a history of liberal or independent traditions are also to be avoided as these worlds are known to be breeding grounds for the Rebellion.

Recruiting drives shall be directed on worlds known to be loyal to our glorious Emperor. The worlds forming the Imperial Core still provide the best and most able recruits. These shall continue to form the majority of our officer pool, their beliefs in genetic superiority making them ideally suited for command.

The next recruiting area is those worlds which border the Imperial Core, and which are not proscribed under the directives above. Here a life in the Imperial Services can be presented as

glamorous and exciting. A chance for candidates to improve themselves and develop long and full careers in the Imperial Forces. Emphasis will continue to be placed on the benefits to be gained from the services: travel and adventure, learning valuable skills, opportunities for promotion and command, and the respect to be gained from serving the Empire.

Other valid areas for recruitment drives are the frontier worlds. These worlds should be carefully scrutinized prior to recruitment, as a small number of them are known to be sympathetic to the Rebel cause. Do not overlook these systems as a source of officer cadets.

Primitive worlds should continue to be scoured for recruits as these people make excellent assault soldiers. Their lack of technological knowledge is more than offset by the ease with which they can be indoctrinated. These troops are highly expendable, and this should color your recruitment accordingly.

Screening: In order to ensure that only the best are recruited, you shall continue to maintain stringent entry requirements. The need to find more recruits is not an acceptable reason for lowering the quality of those recruited. Recruits must be physically fit, brave, intelligent (may be waived in the case of certain infantry regiments), and loyal.

Initial screening will continue to be carried out by Screening Officers at Imperial Recruitment Offices. Checks will be conducted into potential recruits' background, school reports and home life. Screening Officers should determine why candidates wish to join, and if they wish to apply for officer training.

Instruct your personnel to watch for Rebel connections or family members with known Rebel sympathies. Candidates who fail to match preliminary requirements should be rejected. However, suspected Rebel spies should be encouraged to join and the ISB informed immediately.

Those candidates who pass initial screening (including suspected Rebels) will be sent to training centers where the candidates will be given further medical examinations and assessed for their intellectual capacity. Retina scans will be carried out and matched against available records.

Policy of Assignment: Initial procedures will have determined which services and branches applicants wish to join. Where possible, recruits should be posted to their chosen positions. Where screening tests show that recruits would be better suited to another branch, this should be implemented as soon as possible. Remember that personnel cannot leave the service before their contract is fulfilled, but dissatisfaction with an assignment has been shown to have a detrimental effect upon morale.

To the less intelligent recruits, the infantry divisions should appear to be glamorous, making their transfer to the infantry seem a logical and beneficial progression.

Stormtrooper units will continue to be formed in the standard manner, and therefore fall outside of your jurisdiction. However, the Empire is always looking for people with high aptitudes and initiatives to undergo specialist training. The files of any recruits who match this criteria should be forwarded to Imperial Command.

Indoctrination: While the loyalty of our recruits should be high, initial training shall serve to further increase this loyalty. The anarchic viewpoint of the Rebel Alliance shall be stressed along with the Rebels' disregard for law and order. The Empire is the only force in the galaxy which actively promotes stability and peace. Our troops are engaged in a noble crusade against the forces of disorder, and every trooper should be aware of this. By the end of basic training, recruits should willingly die for the Empire.

The great size and strength of the Imperial war machine should also be stressed, along with the belief that each recruit has an important contribution to make. Unit morale is very important, and personnel should feel that their individual unit is the best there is.

Any inquiries regarding this communique should be addressed to the ISB.

The Imperial Army

(The following is extracted from "The Imperial Army — A Guide to Army Training for New Recruits".)

The Imperial Army is vast. It is the largest army that the Galaxy has ever seen. Our forces can be found protecting law and order and righting

wrongs on thousands of planets. We maintain peace on countless worlds threatened by Rebel terrorists. No matter what branch of the Imperial Army you join, you will be serving the many and diverse sentient life-forms of our glorious Empire. You'll be in the forefront of the New Order. You can be proud to serve the Emperor and make the Empire a safe place to live.

Basic Training

When you join the Imperial Army you'll find it hard to begin with. You most likely won't be used to sharing your room with six or seven other people. You won't be used to taking orders, and you'll probably find that drill is something you hate.

You may find it a pain to look after your equipment and weapons. The effort you have to spend maintaining your blaster may seem like a waste of time. But the discipline you undergo now will prove to be very beneficial in the long term.

It will help you to remember that everything we teach you during basic training is done for a reason. Drill builds up team spirit, and trains you to act quickly and effectively in times of need. And when you're on active service, you'll be glad of the time you spent learning to maintain your equipment.

We'll make you fitter and healthier than you've ever been. You'll spend hours building up your stamina and strength. We'll take you on long marches to ensure that you are up to the rigors of army life. By the end of it you'll be tired, but fit: ready for anything the Galaxy can throw against you.

The Imperial Army is the best in the Galaxy, and that means that every soldier is highly trained to carry out the various jobs demanded of him. In the Imperial Army we don't send you into battle half-trained. That would cost us and you dearly. We have a galaxy to protect and dead soldiers are of no use to us. That's why we take the time to teach you how to handle your blaster and yourself.

We also show you how the Imperial Army is organized and your role within it. So, whether you're a member of an armored unit, an infantry regiment, the artillery, the engineers, or the communications corp, we ensure that your basic training is second to none.

When you're on active service with your unit operating thousands of kilometers from base, life can be very hard. At drop camp we aim to prepare you for every situation that you're every likely to face.

Your basic training is conducted at one of the thousands of drop camps throughout the Empire. Drop camps vary greatly, depending on your unit and its intended sphere of operations. The

Imperial Army operates all around the Galaxy, and its soldiers must be prepared to operate under many different conditions.

We train you in the types of environments that you will be seeing the most action in. For most regiments this will be on standard worlds with a wide mix of terrain types. We'll teach you to survive and operate in jungles, deserts, swamps, arctic regions, forests, and how to handle yourself under different planetary gravities.

There are many specialist units within the Imperial Army, units which are trained to deal with specific terrain and atmosphere types. While we normally rely on recruits who come from exotic worlds to form the main bulk of our special operations forces, you may find yourself posted to one of these units. If that's the case, we'll ensure that you can handle yourself, so there's nothing to worry about. Every soldier needs to have some familiarity with the diverse worlds of the Empire because, in times of need, you may find yourself posted to some very strange places indeed. At drop camp we can't guarantee to give you first-hand experience of these worlds, but we'll do our best to prepare you.

The Navy

While the Imperial Navy provides us with interplanetary transport and ground support in the form of TIE fighters, bombers, and the massed batteries of the fleets, it is the Army which really wins the wars. We are the ones who go in and capture ground, garrison troublesome systems, and deal with the Rebels face to face. The Army forms the cutting edge of the Imperial Services, and we do so by getting results.

The Army is for beings who seek excitement and travel. The Navy rarely sets foot upon the worlds which it patrols. For them warfare is an exercise in logistics and computer programming. How many Navy personnel ever get to see the people they fight? Very few. Only the TIE fighter pilots ever see any real action, and they make up a very small fraction of the Imperial Navy's personnel. While the Navy is not composed entirely of "vachheads," it is often remote from the worlds and peoples of the Empire.

Raithal Academy

Of all the Imperial Army Officer Training Academies, Raithal Academy is renowned for producing the best officers in the Army. Here young hopefuls receive a year's training designed to turn them into the competent officers that the Imperial Army needs for its regiments. The training is hard and intense, aimed at turning out officers who can confidently lead troops even under the most gruelling of conditions.

At this Academy young officers undergo rigor-

ous psychological examinations designed to test their mettle and turn them into hardened soldiers. Loyalty to the Empire is deeply instilled, ensuring that the young officers always place the Empire before their personal safety. The need to balance self-sacrifice with self-preservation is an essential part of this training, as the empire requires officers who know when to fight to the end, and when to surrender in the hopes of serving the Emperor another day.

The training is hard and intensive, involving gruelling physical and military exercises. Every Imperial Army Officer is expected to be able to survive in the field along with the men under his command, and to gain their respect by doing so. There is no room for students who have taken the army life in hopes of a cushy career.

Survival forms an important part of each officers training, as does the ability to resist interrogation. Every officer spends a week or more in an interrogation center which simulates the type of treatment they will receive at the hands of the enemy. While not all officers survive this training, those who do emerge with a greatly strengthened character and a healthy hatred of the Rebel Alliance.

Great emphasis is placed on an officer's ability to lead men in the most adverse of conditions. Officers are taught the two-fold method of leadership—fear and respect. They are trained to draw on common soldier's fear of disobeying orders which is disciplined into all troops. While hard discipline and fear of their officers, form an integral part of every soldier's outlook, the Academy also aims to teach its officers to lead by respect and example.

Officers from Raithal Academy are strong, confident, capable and loyal, making them a valuable asset in the Empire's struggle to maintain law, order and peace in these times of bloody rebellion.

See your local recruiter today to find out more about the Imperial Army.

Imperial Navy

"...You are part of the greatest navy ever assembled. The might of the Empire rests on the military — and the Imperial Navy embodies the most elite and trusted segment of that power. Only the best, the most disciplined, are admitted to our ranks. We who serve the Emperor in the Imperial Navy have made this Empire the irresistible, galaxy-spanning force it is today."

— excerpt from Academy cadet indoctrination speech delivered by Fleet Admiral Holt.

The Imperial Navy has grown from a peace-keeping and defensive force under the old Republic into an aggressive tool for the unification

and control of the Empire. Although the Army provides the Empire's obvious physical presence on subject worlds, they reach their objective through the vehicle of Navy ships, often maintaining position only with naval interdiction and ground support. It is the Navy which has mastery of imperial space, giving the Emperor the means with which to bind his vast realm into one whole. And it is the Navy, with its mighty vessels and valliant TIE starfighter pilots, which offers the most awe-inspiring and appealing image of military prowess under the New Order.

"Very often mission requirements compel us to work closely with the Army. It is counterproductive to let a negative attitude toward ground troops interfere with the accomplishment of mission objectives."

— from a lecture on inter-service cooperation by Training Lieutenant Danos.

"I don't take any smart talk from treads. If they get in my way, I offer them a quick trip out the nearest airlock. They have to back off. They got no thrust on shipboard, and no vector to use it in."

— unofficial comments on soldiers by Training Lieutenant Danos.

The demands of service in the Imperial Navy are unique and not always appreciated by outsiders. This lack of appreciation comes to a head in the rivalry between Army and Navy. Most Navy men regard soldiering as an uninspired profession, a physically taxing occupation requiring only brainless obedience at most levels. Ground strategy and tactics are simple two-dimensional problems using predictable formulae.

Army troops can never maintain close unit-level teamwork for extended periods in the heat of a battle, when individual initiative becomes paramount for survival. And even in the worst of situations, a trooper knows the odds are with him: a soldier in combat is far more likely to be injured than killed.

In contrast, naval crewmen know that, in the worst situation, not only will one die but every one in his section or ship is likely to die along with him. Exposure to vacuum is a very real consequence of battle; there are very few injured crewmen in space, only dead ones. Yet even under the most stressful circumstances of combat, crewmen live, eat and breath teamwork. A ship's crew must function as a single entity in order to accomplish its mission, and this frictionless interaction is a high ideal among crews. Any cretin can sweat on the ground and shoot a blaster rifle, but it takes a large degree of discipline, intelligence and training to execute the technical specialities demanded of Navy crews. Even naval strategy

and tactics are far more challenging and exiting than their ground-based parallel, for naval problems take place in a three-dimensional arena where it is commonplace and necessary to cope with tens or hundreds of complicating factors.

Joining the Imperial Navy

Naval service attracts a different sort of personality type than does the Army. Qualified recruits with the right personality profile are eagerly accepted into its ranks. Many with officer potential come from regional or sector military schools, where the best of a world's inhabitants are groomed for local and imperial military careers. Highly-rated recruits who already have their pilot's certification are of special interest as potential candidates for starfighter training.

Naval training is decentralized and conducted at designated sector locations called fleet camps. After completion of fleet camp, they attend advanced schools for further education in the technical specialties of their assigned branches.

Beingss chosen for officer training are selected both from recruits new to the military, and from active duty crewmen recommended by their superiors. These Crewmen-Cadets attend one of many naval academies located throughout the sectors. Although often called an "Imperial Naval Academy," such institutions are more properly termed Sector Naval Academies, to differentiate them from the original Imperial Naval Academy after which they are modeled.

Each Sector Naval Academy is an Imperial institution which shares a uniform training program and curriculum with others of its kind. Officer training occupies one Standard Year. It includes military indoctrination, education in technical specialties, and training cruises. When a Crewman-Cadet graduates he is commissioned as a Lieutenant, and often goes on to advanced technical training.

Officer candidates who rate in the top two percent of their qualifying tests have the opportunity to attend the Imperial Naval Academy, the original and oldest of the academies. An applicant must receive the endorsement of his Moff, and undergo a more thorough background investigation than other officer candidates. If accepted, he is inducted as a Cadet and boards a transport bound for the Academy.

"The time you spend at this Academy is the longest period of officer's training in the Empire. At the end of 30 months of rigorous physical and academic training, you will receive a commission as Lieutenant in the Imperial Navy. You will know more than your peers, and have greater responsibilities than your peers. If you perform your duties well, they will not remain your equals for long."

Officers from this Academy — and only this Academy — are recognized as the very best the Emperor has to command.

“You will serve the Emperor best by mastering everything you have come here to learn: the behavior and standards expected of an officer of the Imperial Navy. If you are selected for flight school, you have even more demanding training ahead after your graduation. You are expected to complete it with the same degree of excellence you will show in your Academy studies.

“Our credo is ‘Service. Fealty. Fidelity.’ This may be the first time you have heard it. By the time you graduate, it is one you will never forget.”

— excerpt from Academy cadet indoctrination speech delivered by Fleet Admiral Holt.

The epitome of officer training is the Imperial Naval Academy. Its academic standards are stringent and its training methods are the most advanced of their kind. The Academy system is designed to instill loyalty, build discipline, and develop team interdependence. The greatest of naval commanders and fighter pilots have come from the Academy. Graduation from it is almost essential for promotion to the very highest echelons of Naval Command.

The exact location of the Imperial Naval Academy is unknown to most who study there. Cadets board a transport and disembark on the grounds of the institution ignorant of which world they are on. Only in this way can the wealth of highly classified information and equipment at the Academy be protected from Rebels, other insurgents, and the politically questionable who cannot be trusted with the secrets of the Empire.

Flight Training

The highest aspiration of most young naval officers is to become a starfighter pilot. It is the single most dangerous, demanding, and prestigious job in the Imperial Navy. Only officers who graduate in the top five percent of their class qualify for flight training. The remaining top third of their class qualifies for flight-related specialties such as astrogation, weapons systems, and other support skills. Because of the tough entrance requirements and extensive training offered at the Imperial Naval Academy, all officers in the top third of the Academy qualify for flight.

Before instruction is half over, pilots begin to fly training missions under actual combat conditions. This trial by combat policy swiftly adapts

the trainee to combat, culling those who are unfit and teaching the rest things they could never learn under peaceful training conditions. By the time a pilot is certified for combat, he flies missions as regularly as other starfighter pilots. The new pilots are then transferred to the wing which is their permanent duty station.

Branches

The Imperial Navy is divided into four branches.

Line Branch handles strategy, tactics, and administrative functions primarily through its Deck, Logistics, and Administration Divisions, its three largest specialties.

Flight Branch oversees flight operations of combat vessels. It consists of Flight Division, and several smaller support specialties.

Fleet Support Branch maintains vessels in operating condition. Its Engineering Division handles structural and drive-related matters, while Technical Services deals with power distribution, environment, and other specialties that do not fall under the Engineering Division's purview.

The Support Service Branch provides services which help the men and machines of the Navy accomplish their mission. Its major divisions are Ordnance, which uses the armament; Communications, which handles information systems and traffic; Biological, which performs medical services and research; and Astrogation, which handles hyperspace and navigation-related tasks.

“...In this time of rebellion and turmoil, most of you can expect to be stationed aboard vessels which will see action, or at bases which assist those ships. Others will be placed on picket in remote star systems, or be assigned planet-side to ordnance dumps, research stations, or other support duties.

“I cannot disguise the fact that some of these are unexciting missions, galling to the crewman anxious to prove himself in service to the Empire. I can encourage you to take heart, for your duty assignment is re-evaluated bi-annually. If there is need, and your performance warrants it, you will be transferred to a more vital assignment. In the same way, those who have seen combat for more than two Standard Years are rotated out to less taxing duties, allowing fresh vessels and crews to take their place. At least, that is the ideal the Navy strives for.”

— Excerpt from crew graduation speech at Prefsbelt Fleet Camp, delivered by Moff Gaaqu.

First Flight

The cockpit wraps around you, snug like the bodysuit you wear. Your feet slip into the control yokes automatically as techs fasten your flight webbing. Polyweave presses you into the shock couch. It molds against your back with a familiar grip.

The hatch snicks shut, and you are alone in the cockpit of your TIE. Comlink checks are an unnoticed routine, for your mind already clicks away — out there, where the skirmish has already begun. Your hands locked on the control rods are your only sign of battle nerves. You breathe deeply and relax them, trying for the gentle grip the TIE demands.

You're not a combat-rated pilot. Yet. There's only one way to get that square: by flying training missions under combat conditions. And this is your first time.

Your flight swoops from the *Victorious* as it has on every other training run. But this time it's different. Outside, starfighters swirl near a yellow-green planet. Lasers flash and blossoming explosions litter your flight path with flying debris. There's no time to move into a reserve position like the training officer had planned. Your TIE fighters are needed now. Your flight descends into the chaos of battle.

You snap-roll to stay with your leader, then slide right to bracket an X-wing with cross-fire. You shoot and miss, rolling left to stay with the evading Rebel. The third salvo does it. You smile tightly as you evade the X-wing's debris.

Then, as suddenly as it started, the skirmish is over, Rebels escaping back to atmosphere. There are no orders to pursue, not this time. As you turn back to *Victorious*, you once again force yourself to relax an over-tense grip. There's no need for nerves, now. Your first combat training mission is over.

You survived.

Imperial Sourcebook

Designed by Greg Gorden

Introduction by Greg Gorden

Prologue by Bill Slavicsek

Chapter One: A Primer on Imperial Power
by Greg Gorden

Chapter Two: COMPNOR
by Greg Gorden

Chapter Three: Imperial Intelligence
by Greg Gorden

Chapter Four: The Military
by Greg Gorden

Chapter Five: Capital Ships
Assault Shuttle by Bill Slavicsek and Stephen Crane
Victory I, Imperial I by Bill Slavicsek
Blastboats by Deborah Christian
System Patrol Craft, Star Galleons by Michael Stern
Lancers, Carracks, Strike Cruisers, Escort Carriers, Dreadnoughts, Intradictors, Victory II, Torpedo Spheres, Super Star Destroyers by Steve Gilbert

Chapter Six: Custom Ordnance
by Grant Boucher

Chapter Seven: Land Vehicles

Juggernaut, Compact Assault Vehicle, Mobile Command Base, Repulsor Sled, Floating Fortress
by Michael Stern

Command Speeder by Grant Boucher and William Wenz

Hoverscout by Deborah Christian

Chapter Eight: Sector Group Organization
by Greg Gorden

Chapter Nine: Combat Artillery
by Steve Gilbert and Deborah Christian

Chapter Ten: Infantry Support Weapons
by Deborah Christian and Steve Gilbert

Chapter Eleven: Special Military Forces
Standard Stormtrooper Unit, Elite Armor Unit
by Jim Bambra
Scimitar Assault Wing by Deborah Christian

Chapter Twelve: Recruitment, Training and Indoctrination
Imperial Recruitment, Imperial Army by Jim Bambra
Imperial Navy by Deborah Christian

STAR WARS®

The Galaxy Keeps Getting Bigger...

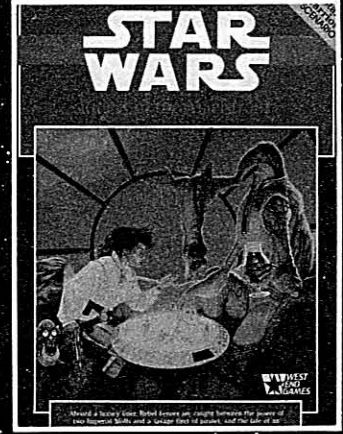
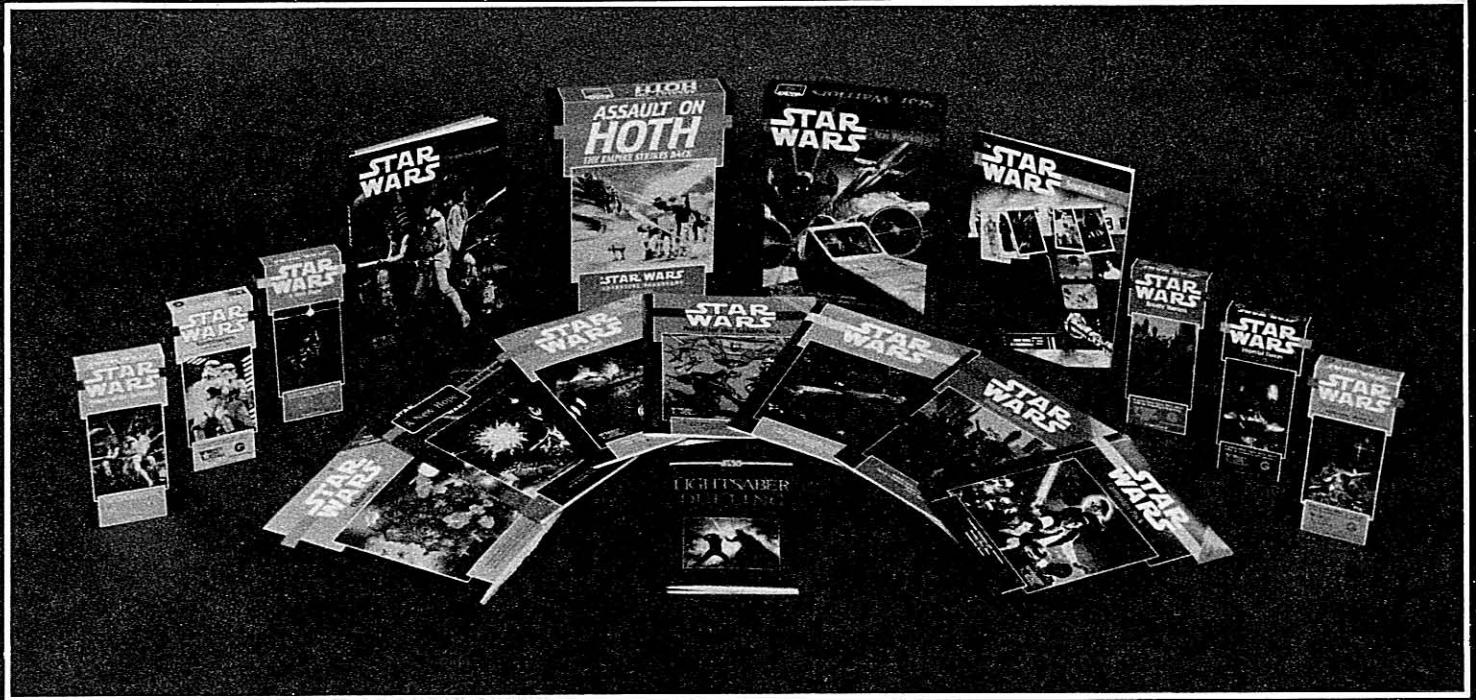

Star Wars Product Checklist

Adventures

- Tatooine Manhunt
- Strike Force: Shantipole
- Battle for the Golden Sun
- Starfall
- Otherspace
- Scavenger Hunt
- Riders of the Maelstrom
- Crisis on Cloud City

Games

- Star Warriors
- Assault On Hoth
- Lightsaber Dueling Pack
- Starfighter Battle Book
- Battle for Endor

Hardcovers

- Star Wars: The Roleplaying Game
- The Star Wars Sourcebook
- Imperial Sourcebook

Supplements

- Star Wars Campaign Pack
- Galaxy Guide 1: A New Hope™
- The Star Wars Rules Companion
- Galaxy Guide 2: Yavin™ & Bespin™
- Galaxy Guide 3: The Empire Strikes Back™
- Galaxy Guide 4: Alien Races

Miniatures

- Heroes of the Rebellion
- Imperial Forces
- Bounty Hunters
- A New Hope™ Movie Set
- Stormtroopers
- The Empire Strikes Back™ Movie Set
- Rebel Characters
- Mos Eisley™
- Cantina Aliens Set
- Return of the Jedi™ Movie Set
- Jabba's Palace

STAR WARS®

Available Now From



RD 3 Box 2345
Honesdale, PA 18431

STAR WARS

Imperial Sourcebook

by Greg Gorden

It is a dark time for the Rebellion. Although the original Death Star has been destroyed, Imperial forces have instituted a reign of terror throughout the galaxy.

The Galactic Empire has many weapons in its arsenal, and every one of them has been turned upon the Rebels: tyranny, oppression, vast fleets, overwhelming armies and fear, the prime motivator in the New Order.

The upstart Rebel Alliance has dared win a significant battle against the Empire at Yavin, but the war has only begun. Outnumbered and outgunned, the Rebellion nevertheless burns across a thousand-thousand worlds, flaming into a fire of hope.

But the Emperor has ordered this fire extinguished, setting the massive war machine he has constructed into motion ...

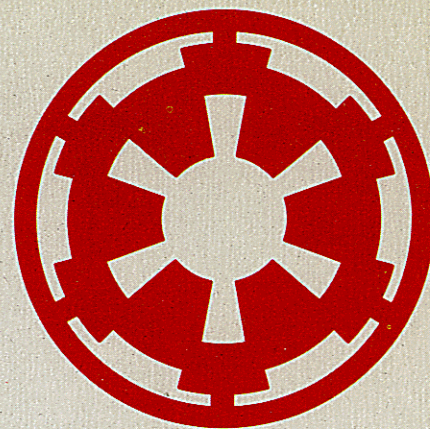

Companion to *Star Wars: The Roleplaying Game!*

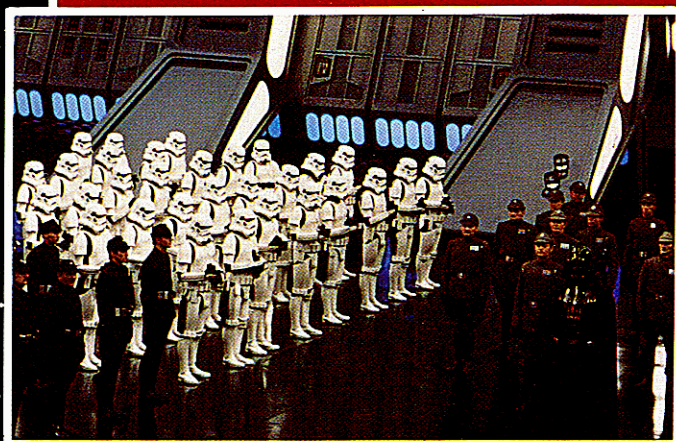

Includes all the game statistics needed to use the might of the Empire in the roleplaying game.

144-page book features:

- Illustrations, photographs, maps and diagrams — some never published before!
- A look at the Imperial power structure since the Battle of Yavin, concentrating on the time period between *Star Wars* and *The Empire Strikes Back*.
- Details on COMPNOR and Imperial Intelligence — the organizations that keep the war machine moving.
- Descriptions, illustrations and statistics for new capital ships, custom ordnance, and land vehicles.
- Data on support weapons, special Imperial units, and training techniques.
- Information for movie fans and game players alike on one of the most evil institutions ever portrayed in heroic fiction.
- The massive Order of Battle of a typical sector, detailing the true military might of the Galactic Empire.

With Additional Material by:

Jim Bamba, Grant Boucher,
Deborah Christian, Stephen Crane,
Steve Gilbert, Bill Slavicsek,
Michael Stern, and William Wenz.

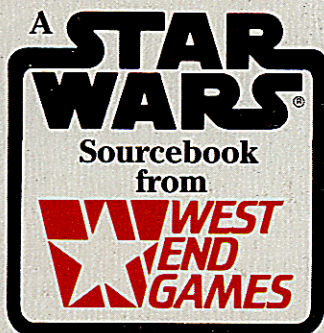

West End Games
RD3 Box 2345
Honesdale, PA 18431

40006

For ages 12 and up.

®, TM & © 1989 Lucasfilm, Ltd. (LFL).
All Rights Reserved. Trademarks of
LFL used by West End Games
under authorization.

ISBN 0-87431-135-7



Science Fiction/Games/
Reference