

STAR WARS
THE NEW REPUBLIC

GALAXY GUIDE 8
SCOUTS

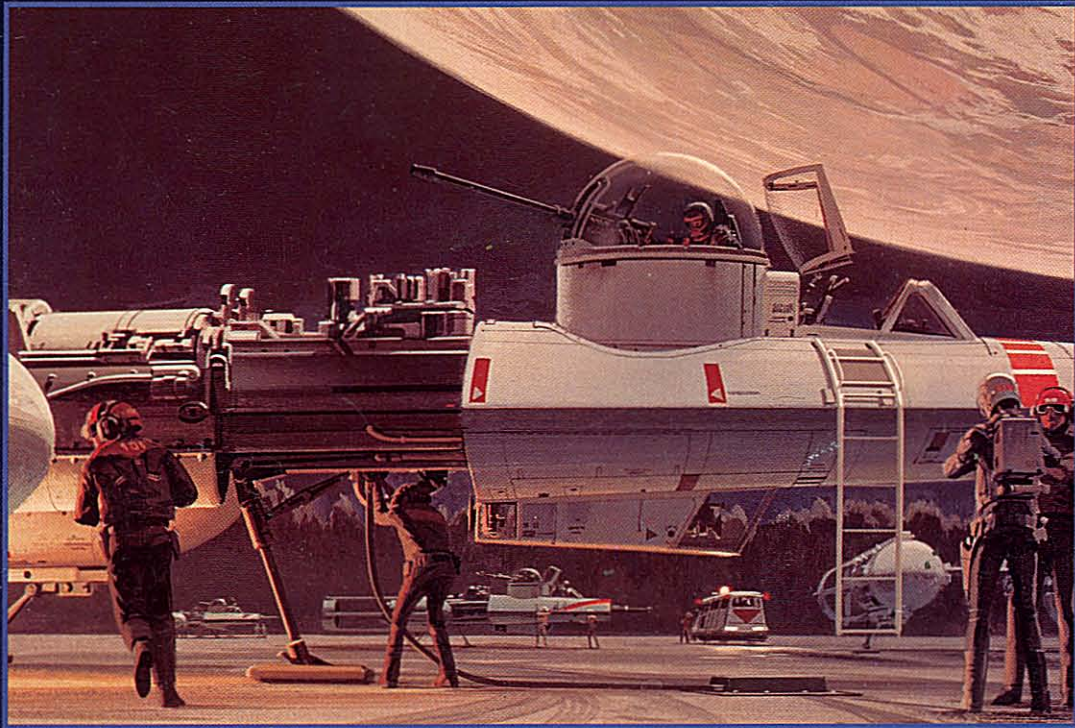

STAR WARS®

THE NEW REPUBLIC

G A L A X Y G U I D E 8

SCOUTS

by Bill Olmesdahl & Bill Smith

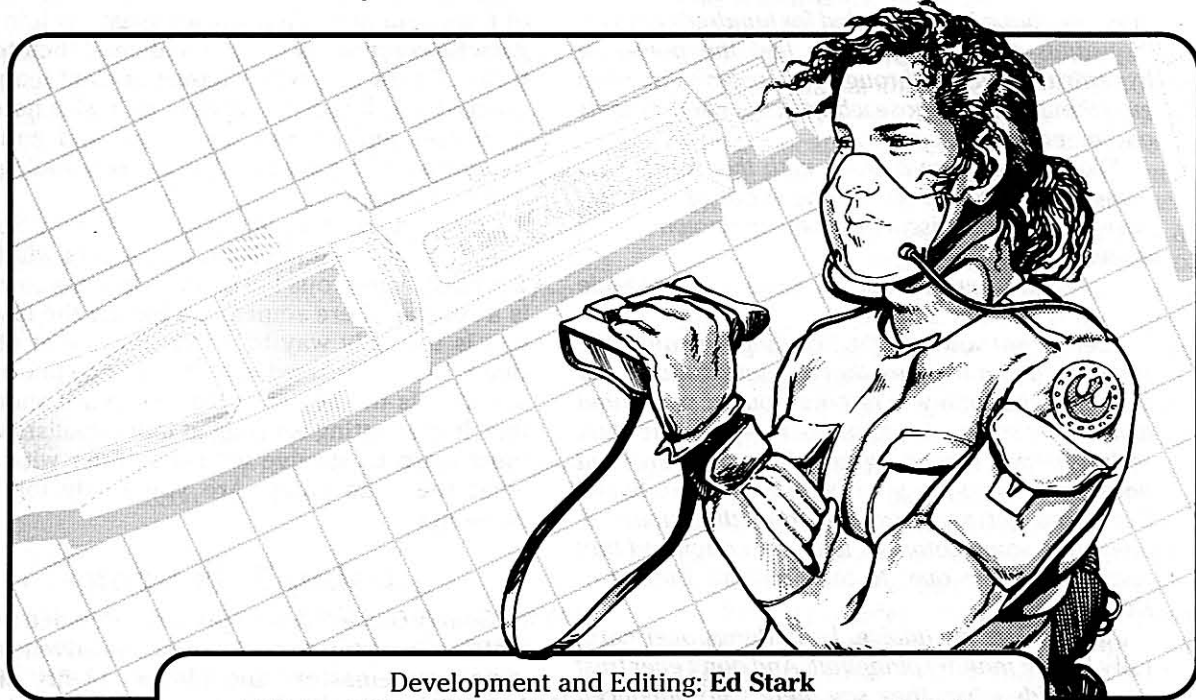

Development and Editing: **Ed Stark**
Additional Material: **Dr. Michael R. Fortner, Rebecca C. Hall**
Graphics: **John Paul Lona** • Cover Art: **Lucasfilm Ltd.**
Interior Art: **Mike Vilardi**

Publisher: **Daniel Scott Palter** • Associate Publisher/Treasurer: **Denise Palter**
Associate Publisher/Sales Manager: **Richard Hawran**
Senior Editor: **Greg Farshtey** • Editors: **Bill Smith, Ed Stark** • Art Director: **Stephen Crane**
Graphic Artists: **Cathleen Hunter, John Paul Lona** • Sales Assistant: **Bill Olmesdahl**
Licensing Manager: **Ron Seiden** • Warehouse Manager: **Ed Hill**

Published by



RR 3 Box 2345
Honesdale PA 18431

40061

Introduction

“Have you ever dreamed of exploring the paths between stars? Of traveling over routes which might not have been traveled for hundreds or even thousands of years? Do you feel the power of hyperdrives pulsing through your veins? Have you ever thought about those who discover new planets and meet new species?”

“You share these dreams with thousands who came before you. You are the scout of the New Republic and the discovery of the unknown is your domain.”

— New Republic Scout Service *Spaceguide*

“Let me set you straight. Scouting isn’t all of the romance and adventure that the datamanuals say it is. Half the time you’re bored out of your mind waiting for something to happen — the other half of the time you’re running away from some enraged natives ready to put your head on a pike. Sometimes you get more trouble from the ‘civilized’ ones, like some colonists who are convinced that you’ll turn them over to the Empire’s Bureau of Revenue.”

“Just follow my advice. Look things over carefully before making planetfall. And don’t ever trust your Droids when they say there’s no advanced technology or weapons on the planet.”

“Trust me.”

— Glaennor, Eighth Nebulan Scout Corps

The galaxy of the *Star Wars* universe is vast, exciting, and, to scouts, waiting to be explored. Typical *Star Wars* adventures involve the Known Galaxy, and the understood foes are the Empire or bounty hunters. In *Galaxy Guide 8: Scouts*, characters get to tackle the unknown and explore a part of the galaxy where there are no maps, where the villains are unfamiliar or may not be villains at all, and where nothing can be taken for granted. The potential for excitement and adventure is virtually unlimited.

A scout’s missions will take him to unknown systems with primitive civilizations, lost colonies that haven’t been visited by spacecraft since

before the Clone Wars, ancient temples hidden on distant worlds and forgotten in the antiquity of time, and new alien worlds eager to join the galactic community or fight to defend their territories. Characters will discover ancient temples erected and forgotten, worlds rich with natural resources and bizarre life forms, and entities beyond anything imagined by the xenobiologists of the Republic.

Out in the frontier of the galaxy, in Wild Space and the Unknown Regions, characters will face the most dangerous foe of all — the unknown! It is a setting where sometimes having the fastest gun is the only way to survive, while at other times, being a shrewd negotiator or an informed scientist is the key to living to explore another day. It is a setting for rugged individualists who must learn to survive with only their wits and what they can carry. Are you ready for this challenge?

Using This Book

Galaxy Guide 8: Scouts provides detailed information on many aspects of scout adventures, giving gamemasters and players plenty of information to get started. For players, this book offers an overview of the scout services, discussion of where scouts come from and what they are like, as well as several new templates. There are detailed explanations of the equipment, starships and Droids scouts have at their disposal.

For gamemasters, this book covers the story and practical elements of scouts adventures, including hints on how to design new planets and civilizations, natural hazards, and interesting gamemaster characters suitable for a scout setting. This book also has a detailed alien species generation system so gamemasters can “build” fun and exciting new alien species. Finally, this book offers a mini-campaign for new scouts, with adventure hooks, locations, and gamemaster characters to get things rolling right away.

A Typical Survey

Deeve finally reached the top of the ridge. With a sigh, he looked over the edge — and into the heart of a planet. His aching arms and legs were forgotten in that split second, as he peered down into the swirling mists thousands of meters below. They looked like clouds, but he knew that they were hot enough that taking one breathful of those vapors would kill him instantly.

He tugged at his face breather again, making sure it was snug. He tried to wipe away some of the sweat that had built up near his eyes, but his hand was stopped by a thick piece of transglass.

"Never get used to seeing things like this," he muttered to himself. "What a marvelous view, and I'm the first person to have ever seen it." He searched for a comfortable seat in the loose, rocky soil. He had long ago gotten over his fear of heights as he sat less than a meter from the edge of the cliff. "There are other things *worth* fearing out here." Small chunks of bluish-purple soil tumbled down into the abyss.

He pulled his datapad from its molecular hooks at his waist, flipping the power switch. As he waited for the datapad's basic operating programs to engage, he flicked his tongue over to the monitor pads inside his breather mask. As his breather's internal analysis computer ran a quick diagnostic, it played the results across his face plate:

2:14:48 Air Remains
Respiration Acceptable
Potential Energy Acceptable
Outside Climate Hostile But Within Sealsuit Specifications
Recommendation: No Advisory; Proceed

"Good. I'm set for this one."

He flicked his comlink tongue-toggle.

"NRSS *Founder*, this is Deeve. I'm at the edge of the canyon, about five minutes ahead of schedule. Anything new I should be aware of?"

An electronic but distinctly female voice replied. "Go ahead, Deeve, baby. Nothing new to report. Temperature'll fry you without that suit, atmosphere's a killer. A few decades of terraforming and this place will be a good home for ... something."

"Effcee — where's Jarsa?" Deeve held back a comment about the Droid's behavior. He'd thought he'd had her reprogrammed not to be so annoyingly affectionate.

"Jarsa's down working on the solar fin. We had more mynocks — this time they chewed through the fin shield capacitors, and a speck of dust shattered the fin before we found out the particle shielding was down."

"Wonderful. Make sure she's back up there soon. If I call for help, get *her* to fly down here; I don't want you trying to land that thing. You'd end up burying the *Founder* in a mountain or something."

"Honey, that makes me want to try. Just to prove

you wrong —"

CLICK!

"Deeve out," he muttered to himself as he tongue-toggled the comlink off. This was going to be hard enough without a lovesick pile of circuits jabbering at him.

Turning his attention to the datapad, he pulled the backpack off his aching shoulder and opened one of the large pockets. Pulling out a small, roughly rectangular device, he pressed a power stud. Spectrameters, raddetects, mineral spotters, temp monitors and a dozen other gauges and gadgets hummed to life as his enviro-analyzer powered up. Pulling out a complink, he pressed one connector into the enviro-analyzer's port and attached the other end to his datapad. Tongue-toggling his comlink to "Audio Mode" he announced aloud, "Resource remote scan: commence."

Dials, gauges and other monitors warbled as the enviro-analyzer gathered what data it could from this remote locale. He took another look around.

The canyon stretched to the northern and southern horizons, appearing to be roughly crescent shaped from his vantage point. It was probably a good ten kilometers across and who knew how deep. With the side of the canyon exposed he could see seven distinct types of soils — first, that top layer of bluish rock; then a deeper blue and seemingly more solid rock; as the canyon stretched further down, the color of the soils got steadily darker, until the mists of the swirling lava flows far below obscured his view.

He thought to himself, "There's got to be some good mineral deposits down there. Otherwise, this'll be the fifth barren, worthless planet in a row." Three more systems and they were to return to the Outer Region Foxar Scout Base, and so far they were coming back empty-handed. They would barely have earned enough to cover their operating expenses, but one big mineral strike — then this trip would pay off.

He opened up the largest compartment in his backpack and pulled out a box about half a meter square. He examined tiny repulsor nodules on the bottom surface.

"AreeEm-OhToo, how ya doin'? Ready to do the job?"

A number of cheerful chirps emerged from a side speaker. REM-02 saved a lot of trouble in these planet-bound surveys. He could hover down, closer to the lava than Deeve dared to go. The plucky little Droid could run a complete analysis of the soil and air and broadcast it back up to the receiver sensor on the enviro-analyzer. Granted, the unit wasn't smart enough to figure out anything on his own (that's what the enviro-analyzer was for) because most of his programming concentrated on self-preservation.

Continued on Page 4

There was only so much the Industrial Automoton technicians could pack into that small body.

"Here you go!"

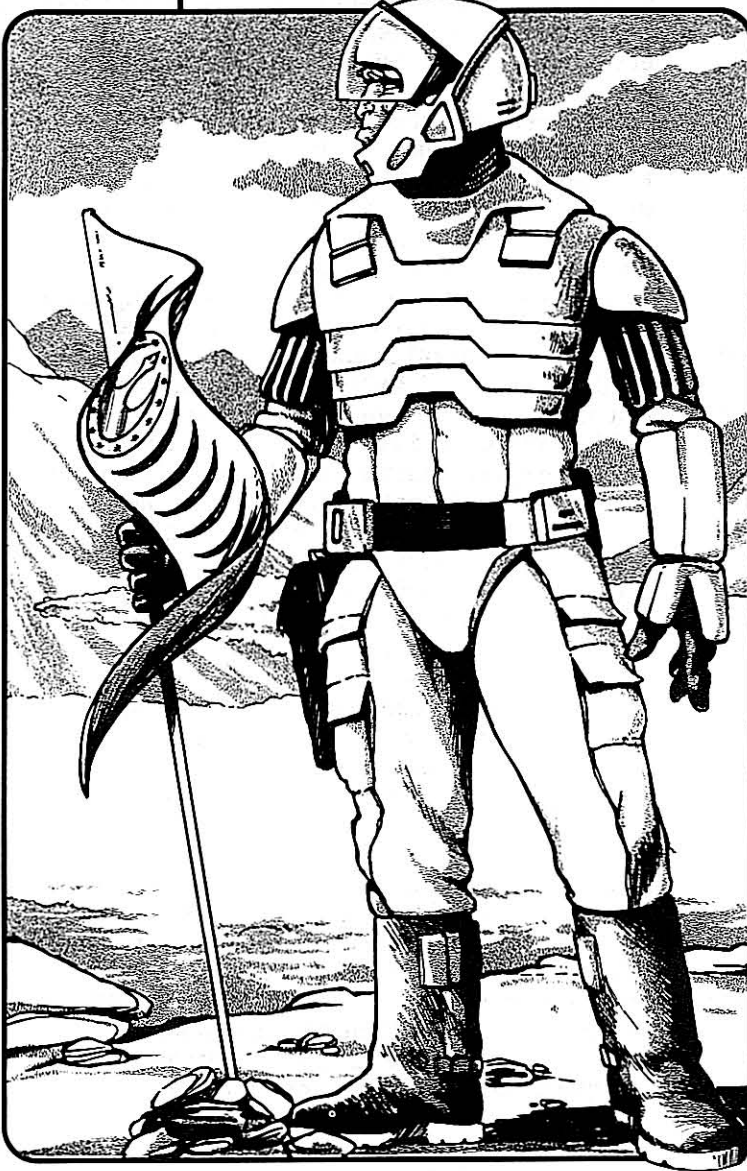

With a heave, he sent the little Droid over the edge of the cliff and the repulsors clicked in with a steady humming sound. Soon the hum was gone, but data started trailing across the screen of his datapad. He figured in ten or fifteen minutes he could make the quick jaunt down to his skyhopper and move on to the next survey spot.

Then, he heard a dull roar mixed with several muted crunches like ... footsteps. Whirling around, he saw what looked like a four meter high, four limbed creature covered in that bluish rock. From underneath its body, a tentacle touched the ground and snaked along the rock toward him.

Deeve instinctively pulled his blaster pistol and tried to back away. When his left foot traced the edge of the cliff, he remembered his predicament. "*Something* to the front, nothing to the back. This is a bad spot."

As the tentacle slid closer, he fired into the ground, more out of fear than anything. The tentacle stopped when it reached the edge of the blast point. He immediately pulled his datapad, ordering the program to stop its remote sensor run and telling it to examine whatever it was standing less than five meters away.

The thing backed up a meter or two, making what Humans might interpret as a "relaxed motion"—it reclined, resting on its rear legs. Of course, the thing could also be readying to pounce on him.

It sat there, doing nothing. The tentacle pulled back up under a plate of rock that seemed to part for it. "If only it had a head. I'd at least be able to tell if it was staring at me." Deeve figured that, for the moment, it wasn't interested in combat. Always a good sign.

"Effcee, get down here NOW! We've got something worth looking into."

Just another ordinary day in the scout service.

Chapter One

The Scout Service

"The Scout Service is the way to test the true mettle of a being. Scouts on the frontier face challenges that require them to draw upon every resource — and those who are successful experience the exhilaration of a mission well done. This type of job isn't for everyone, but for some people, it's the only job."

— New Republic Scout Service *Spaceguide*

"There are happy scouts. There are sad scouts. Then there's me: I'm in it for the money."

— Curlin, Independent Scout

Scout characters in a *Star Wars* campaign will inevitably deal with the New Republic Scout Service, either as a staff scout, a corporate scout or an independent.

The Modern Scout Service

The New Republic Scout Service was founded shortly after the formal declaration of the New Republic. Mon Mothma ordered the creation of the new service, despite strong opposition from some on the New Republic's Provisional Council, who felt that the new government would be best served pouring its resources into rebuilding systems that had been decimated under the rule of Palpatine. Mothma, instead, declared that the service was to go into the Unknown Regions and Wild Space and make contact with worlds that had been lost in the confusion of the war and the horror of Palpatine's rule.

She hoped that scouts would be able to con-

The New Republic Scout Service: Mission Statement

The Republic is dedicated to bringing freedom of thought, choice and action to the many and diverse peoples of the galaxy. Just as diplomats represent the Republic to the known worlds, so will the New Republic Scout Service seek out lost and undiscovered worlds, presenting to the peoples of these planets the promise and hope of the Republic.

The missions of the Republic's scouts are outlined below, in order of priority:

- Reestablish contact with worlds which were lost during the reign of the Empire and the civil war.
- Discover worlds which are home to sapient beings.
- Catalog unregistered settlements.
- Catalog worlds which offer valuable resources or have colonization potential. Provide the most detailed information possible on the flora, fauna, minerals and civilizations of new worlds.
- Explain the benefits of Republic membership to worlds which are willing to uphold the laws of the Republic. Planets which accept will be contacted by formal Republic ambassadors.
- Catalog worlds currently enslaved by the Empire so that Republic military forces may bring freedom to these worlds.
- Completely survey systems for Republic star libraries.
- Provide complete calculations for hyperspace paths to new systems.

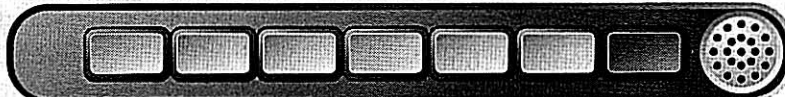

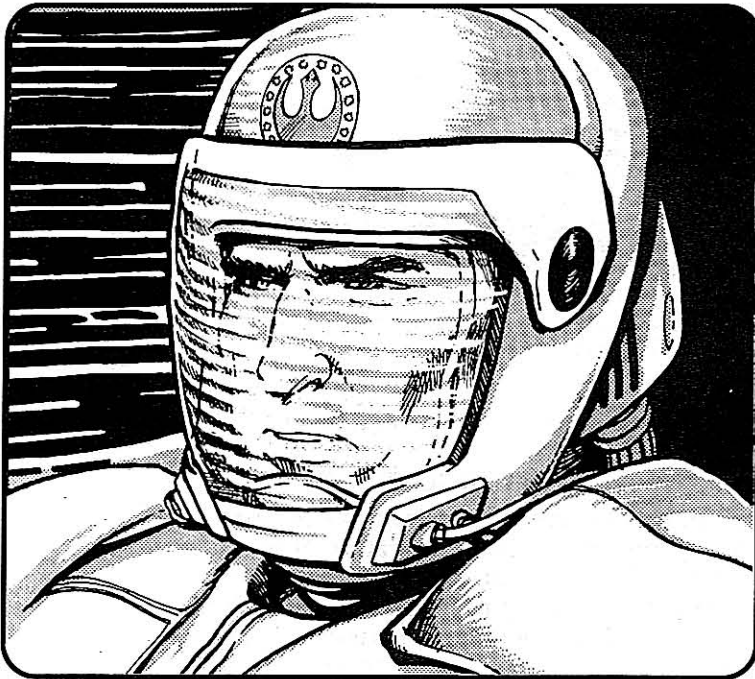

tact worlds that would join with the Republic, giving the new government powerful and reliable allies. At the very least, the scouts would open up new systems to colonization, giving species that were enslaved and transported away from their destroyed homeworlds by the Empire the opportunity to make a better life on new worlds.

While each individual scout has his or her own reasons for venturing into the unknown, the service itself expects its scouts to abide by the service's guidelines and to accept, if not embrace, its mission statement.

Types Of Scouts

There are three major types of scouts affiliated with the New Republic Scout Service. Scouts employed directly by the Republic are called "service scouts," and this route is normally the only way for a young scout with no experience to get his first tour. It is also a favorite choice of many ex-Alliance fighter and transport pilots.

The second type of scouts are the "corporates": they are employed directly by one of the countless mega-corporations of the Known Galaxy. The corporate scouts answer directly to their companies, and are normally provided ships, Droids, support crew and whatever else is necessary for their missions. Corporate scouts are traditionally well funded and well paid. They are the most numerous of scouts.

The final group of scouts are the "independents": they work freelance, selling what information they can to the New Republic, but also are free to sell their findings to any other entity, whether it be the sovereign government of a

Republic member world, a corporation, or even the Empire itself. Often operating in quasi-legal areas, independent scouts often double as smugglers, gunrunners, and spies. The only generality that applies to all independent scouts is that they cannot be defined by generalities.

Service Scouts

Service scouts work, as scouts, exclusively for the New Republic. They are provided a set salary for their services, normally over a specified term-contract (ranging from a few weeks to years). They normally can also earn bonuses for finding advanced civilizations or worlds rich with valuable resources. Depending upon the terms of the contract, the Republic may provide ships, Droids or equipment.

Service scouts are given a set schedule, with orders to investigate specific systems on a predetermined time-table. These scouts are answerable directly to the Under Minister of Scout Services, higher ranking Scout Service members and the New Republic military.

However, the life of a service scout can have many of the hassles of the "civilized world" — endless datawork, answering to superiors, taking orders that seem to be contradictory and all of the other negative aspects associated with the military and corporate environments.

Those new to the scouting "industry," with little experience and almost no money, often opt to begin their careers with the New Republic Scout Service. A tour of service gives a young scout valuable experience, an opportunity to make contacts with other scouts and potential employers, and if all goes well, some savings at the end of the tour.

Long-time New Republic scouts seldom stay for the pay. They usually enjoy being part of something "larger than themselves." Among the active members of the New Republic, the service scouts are respected members of the organization. As a result, some veteran service scouts have found ways to legally "supplement" their incomes — they take courier jobs and "mail runs" to the frontier. As long as these extra activities do not conflict with their normal duties, the bureaucracy of the New Republic does not care.

Corporate Scouts

Corporate scouts are hired full-time by one or a group of corporations. Much like the arrangement that New Republic scouts have, they are hired for a set term, with a salary (normally, this is a sliding salary scale, based upon the value of a scout's discoveries and claims), and are often provided equipment, personnel and ships by the company.

Corporate-sponsored scouts often have to

adhere to the same kinds of schedules and record-keeping that those in the New Republic Scout Service face. The pay is often better, but geared toward results: scouts who make no large finds often end up with little or nothing to show for their efforts.

Likewise, the term of service is on a sliding scale. The most common agreement involves the scout finding a set number of “valuable prospects” for the company and then “mustering out” with a cash bonus and, sometimes, a scout ship as reward (more on this in later chapters).

The scouts must also check in with the company they are working for periodically — and much more frequently than most New Republic scouts do. While most established companies deal with their employees in a reputable manner, naive individuals may be defrauded by some companies, never seeing compensation for their efforts. Many new companies specializing in exploration have been started since the overthrow of the Empire, and not all of them are reputable or solvent.

The scouts answer directly to the company (and only to the company), giving the corporate sponsor exclusive decision-making power: the company can then report to the New Republic whatever it wants to and withhold whatever it feels is necessary. While there are strict laws about this kind of conduct, but with the spotty law enforcement of the fledgling New Republic, companies find it fairly simple to act without fear of penalty.

Independent Scouts

The final type of scout is the independent: this scout sells what information he can to the New Republic or the companies (or whoever else wants to pay), but he is by no means guaranteed a regular income, as the service scout is.

Independent scouts seem to be even more hardy and disrespectful of authority than the average scout. The independent, in all likelihood, despises schedules, taking orders, keeping records and all of the other duties of service scouts. Instead, the independent often uses scouting as a way to get away from the civilized galaxy to see what is “out there.”

Independent scouts may own their own ships, or have taken to the unknown regions to hide from creditors because they’ve skipped out on payments — most likely, *ship* payments. Independents make their living by selling information regarding resources, civilizations and hyperspace coordinates about the systems they have explored. Some independents even strike it rich as traditional prospectors; if they can find an uninhabited world or asteroid rich in resources and register it with the New Republic Claims Office

before anyone else, the place becomes “theirs,” offering potentially generations of unbelievable wealth. Of course, there are some scouts who make a living trying to “jump claims,” registering a world in their name before the discoverer can.

New Republic laws also hinder the sole “claiming” of a world by an independent scout — or a corporation, for that matter. Part of the procedure involves “improving and developing” the planet within a set period of time. Corporations have little trouble with this, setting up “company towns” that evolve into colonies or disappear when the wealth dries up, but the independent scout seldom has the resources (or the desire) for such long term commitment. Most take what they can from a planet and move on. For this reason, most independent scouts focus on asteroid belts and uninhabitable planets — they have less competition and regulation if the area *cannot* be “improved and developed.”

Dealing With The Scout Service

Those among the brotherhood of scouts perceive themselves as survivors, and in some ways superior to those who don’t live among the stars. This kind of arrogance runs headlong into the wall that is the bureaucracy of the New Republic Scout Service, which tends to annoy anyone who comes into contact with it. While the Service is intended to be efficient and make everyone’s life easy, the Scout Service is filled with mediocre administrators who are more concerned with pleasing upper-level administration than providing assistance to scouts in the field. Scouts use the term “mud ballers” for anyone who lives on the surface of a planet, and while many of the bureaucrats are permanently based on scouting space stations, the term (and many other more vulgar ones) is cheerfully extended to them as well.

Scouts try to take advantage of the service whenever possible because they never know when it is going to mess up their lives. The first time a scout receives a crate full of tongue-depressors instead of a half dozen survey drones, it is the last time he will be inclined to listen to speeches about procedures and doing things according to regulations. Scouts try to make contacts in the lower levels of the Scout Service so that they can go directly to their sources and procure what they need for a mission — having the necessary supplies on hand can mean the difference between life and death during a mission.

For non-scouts, the Scout Service can often be a source of employment as well. Often, a scout will want to temporarily hire “extra help” for a

mission—whether it is extra hands, extra muscle, or extra company he needs. During these missions, the scout and the non-scouts can learn the meaning of “expense accounts.” And how to justify those pesky receipts ...

The Organization

The New Republic Scout Service’s organization is supposed to provide quick and efficient support for the scouts. While the structure is simple in practice, a lack of resources, communication lag-times and other problems have made the service less than a model of efficiency.

Running the overall organization is the Under Secretary of Scout Services, who serves under the Minister of State of the New Republic. The

Scout Service is technically known as the “Bureau of Scouting and Exploration Services.” The Scout Service is responsible for almost all New Republic star patrols, as well as many other governmental duties, beyond the boundaries of New Republic space.

There are four main departments in the scout service: supply, information, military and personnel. A sister bureau is the Colony Authority, which is responsible for establishing and supporting new colonies, and often calls upon the Scout Service for assistance and cooperative efforts. While their relationship is close, there is definitely an air of competitiveness between the two branches.

Department of Supply

The Department of Supply is responsible for providing Droids, ships, weapons, survival gear and any other equipment necessary for the scouts to complete their missions. Unfortunately, due to the under-financed nature of the New Republic, the D of S has very little “on hand” equipment to supply its scouts with, beyond what is considered “standard.” When a requisition comes through to the D of S, they must first approve the requisition and then turn it over to the New Republic’s purchasing agents, who must then prioritize it and find a way to purchase it. As a result, getting something from the D of S when you need it right away is almost impossible.

Department of Information

The Department of Information, or DI, registers all claims by New Republic, corporate and independent scouts. When a world or system is registered, that information is distributed to the general public and corporations for moderate fees, unless the claimant registers and is granted a Request For Privacy (this is normally reserved for systems that will host military research bases or other types of top-secret facilities). The Department of Information is responsible for the Library of Systems, a comprehensive catalogue of all systems and worlds that the New Republic is affiliated with. The Department of Information turns duplicate copies of all information over to

The Legal System

The New Republic drew upon the tradition of Old Republic law when outlining the legal rights and responsibilities of scouts. The laws were written to encourage rapid expansion, but not at the expense of developing civilizations. Of course, the enforcement of these laws is another matter: the New Republic is continually facing a manpower shortage, and therefore inaccurate information that is intentionally reported to the Republic might never be checked.

- Exploration requires no permits or fees of any kind. Scouts are free to come and go into most sectors of space as they please — just like anyone else. However, if a section of space is placed under quarantine, which is rare, anyone wishing to enter that area of space must seek permission first. Sometimes there are expensive permits that are required for such a process. Also, since the scouts are not technically part of the military, areas the New Republic has classified as “hostile” are also off-limits.

- Planets, in their entirety, are property. When someone purchases or gains claim to a planet, they normally also purchase exclusive rights to all space within a certain radius of the world as well. Planetary governments typically purchase entire systems just so they can keep a tight rein on activities in a given system. Scouts in the service register their claim to and for the New Republic. They cede all rights in exchange for their employment. Independent and corporate scouts often have similar agreements with their employers and, even if they don’t, have limited “possession and occupation” rights under New Republic laws.

- Planets with native sapient species become the property of that (or those) species. Once the New Republic has recognized a species as sapient, no

activity can be undertaken on a world by any corporation, government or other world without the authorized — and legally represented — permission of the species. The New Republic has the exclusive right to assert authority on planets in times of crisis.

This law was also in use by the Empire, but the Empire’s definition of “crisis” was much more liberal than the New Republic’s, enabling the Empire to steamroll a population into submission without technically violating their own laws. The Empire also delayed or completely avoided declaring some species sapient for the sole purpose of exploiting the world, or allowing it to be exploited by a corporation or other supporter of the Empire.

Predictably, in cases where worlds have competing factions or multiple sapient species, each legal ruling is made on a case-by-case basis for a true hodge-podge of laws. Many times, corporations or groups are able to get the case caught in the legal system and then claim “prior use” so that they receive permission to continue their activities.

Independent scouts seldom worry about the sapient species of the planet. If they are under contract with someone, their contract usually covers this contingency. If not, or if they are prospector-scouts, the independents tend to make their finds pay off before they report them — if they bother to do so at all.

- Planets without sapient species may be claimed, and thus become the property, of any person, corporation, group or New Republic affiliated government. Normally, an entire system is claimed. The claimant has one standard year to establish a permanent facility on the planet in question, or ownership reverts to the government of the New Republic. If the entire system was claimed, one facility on one world is sufficient to keep the entire system.

The definition of “facility” varies depending upon the size (and, unofficially) value of the claim. A habitable planet, for example, needs to have a city or collection of towns operating on it to be considered duly claimed and developed. Likewise, a system that is uninhabitable but has tremendous mineral or strategic wealth must have a space station or habitation dome somewhere inside it to be claimed. Small, relatively poor planets and asteroid belts with mineral resources seldom need more than the scout and the scout’s associates operating within the claim area to establish the claim.

The New Republic is exempt from this law, and may claim any planet or system in its entirety. Coincidentally, this is why the New Republic maintains the Scout Service: while it is expensive to operate, once newly discovered planets are sold off to corporations, groups and other governments, the profits can be immense.

- The property of a planet or system may be leased or sold at the discretion of the owner. This includes planets that have been developed. For example, if a corporately owned planet has been “developed” for any amount of time — say, fifty standard years — it can still be sold ... even if the population of the planet has grown up into the millions or billions! New Republic laws are being made to protect the inhabitants of “owned” planets from the results of these sales, but the legal process is slow. Under some circumstances, it would be legal for an inhabited planet to be purchased by an individual who then chooses to evict the inhabitants! This happens seldom, as evicting a planetary population almost certainly would result in bloodshed, but, on a smaller scale, there have been many recorded occurrences.

- All New Republic citizens and organizations are required to uphold the general laws of the New Republic. Of course, these laws typically apply to trade and military activities, and thus owners of systems and worlds have

the advantage of being able to conduct their activities as they see fit.

In practice, these legal principles ensure that if someone is going to claim a planet, it will be used. It also gives a tremendous advantage to governments and corporations over independent prospectors.

In addition, any planetary owner or government with a population over ten thousand (less, in some cases, often depending on the species) has a right to independent representation under New Republic laws. But this right is also a responsibility. The owner or government must send a representative to the New Republic and must pay taxes according to its size, income, and other factors. Often, small populations forgo representation to avoid taxation (and notice) by the New Republic.

- Scouts in service to the New Republic are required to uphold the laws of the New Republic. They may not bring harm to sapient beings except in self-defense. They may not deliberately harm or injure a culture. Scouts are required to report any illegal transgressions by New Republic individuals, groups or companies against members or non-members (thus, if a scout learns that a company has built a factory on a planet with a sapient population without first getting their permission, he is required to report the incident to his superiors). In practice, these laws are difficult to investigate and enforce.

Also, scouts who operate on the frontier of New Republic control — but within the bounds of Empire or Pre-Empire space — often run into trouble because of this rule. There are many people in the Known Galaxy who do not welcome the New Republic and their laws, and they are operating outside its legal boundaries for this reason. They see New Republic scouts as threats to their security and anonymity.

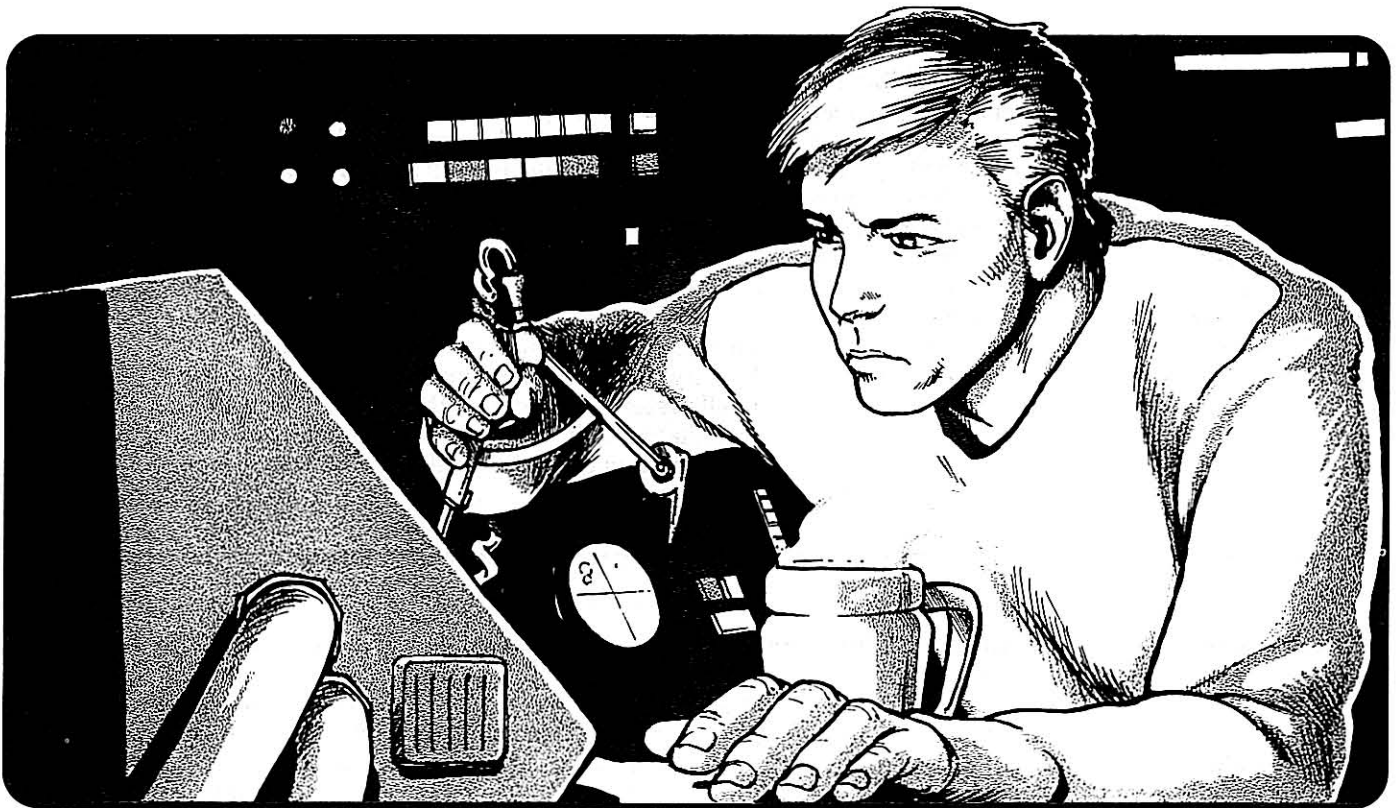

the New Republic's Under Minister of Information, which is responsible for tracking ownership of worlds and other valuable data that the government or member worlds might need.

The DI has been manned, since the success of the Rebellion, almost exclusively by intelligence personnel from the Rebel Alliance who served in the intelligence branch during the war and who have tired of military service. This is only logical, as most of the scouts were warriors of the Alliance before becoming scouts. As a result, the DI does have a tendency to follow up "suspicious leads" that do not necessarily fall within their jurisdiction — even when they should be turning over their information to the New Republic's Secretary of Intelligence. They prefer to "handle things" on their own quite often, and this has put them into conflict with the military and the bureaucracy.

Department of Personnel

The Department of Personnel is responsible for keeping track of active and inactive service members, paying employees on time, deciding assignments of exploration for scouts in the field and keeping track and filing all of the miscellaneous data that comes into the Scout Service.

This is the one department of the Scout Service that is run almost exactly like its bureaucratic and military counterparts. It is an established, efficient bureaucracy that is almost impossible to penetrate when it feels like being

obstinate. More than one request for information on an individual, unit, or population has gotten "lost between offices" by the DP. Usually, this is a response to the New Republic bureaucracy losing scout requests for information, equipment, or financial support.

Department of the Military

The Scout Service has a small military arm for contending with small-scale engagements. It has approximately 50,000 soldiers, all of whom receive training with the New Republic military. These individuals are officially attached to the Scout Service, but may be called upon for duty by the New Republic military in times of crisis. The Scout Service must get permission from the Minister of State to send troops to a given world, so sometimes military assistance can take several months to deploy.

In reality, the military arm of the Scout Service serves a "bodyguard" function almost all of the time. The Scout Service will use its military "force" to set up secure areas on frontier worlds, man remote space stations, and safeguard couriers and scouts on dangerous missions. Many of the military personnel assigned to the Scout Service resent their "demotion" from line troops (though most of the line troops actually see less action), while others wouldn't have it any other way. The "Scout Soldiers" are incredibly mobile and active and are beginning to gain a reputation as an "elite service" within the New Republic.

Many military personnel also begin to learn scouting — intentionally or through necessity. A scout crew may be assigned a squad of marines while exploring on the frontier and, unless armed conflict happens with prohibitive frequency, the marines are likely to be bored out of their skulls most of the time. They will probably be taught certain scouting procedures and duties as a cure for boredom — and because scouts love having other people take over the “drudge work” associated with their profession. Many “scout teams” have been formed this way, with one or two “official” scouts sharing their ship with four or five marines, and the entire team sharing the work and the rewards.

Other Support Services

In the interests of the economy, the New Republic has chosen to streamline the Scout Service as much as possible. Many support services are not covered by the four departments, and the Scout Service must “farm out” a lot of those

chores to other government services and even independent contractors.

Some examples of these services include ship building and repair, food service, and communication services. While most scout bases have their own permanent personnel to handle these chores, very few of these people are actually scout personnel. Most often, they are military or bureaucratic personnel assigned on “detached duty” to the scouts, and sometimes, especially on the larger but less centrally located bases, they are independent businesses and contractors that have arranged service agreements with the Scout Service.

The Department of Supply and the Department of Personnel oversee most of these extra services and, in the case of New Republic personnel, the extra services only require a little extra book-keeping. But independent services are obtained almost always on a cash-for-service basis and, in some outlying regions, scout bases have become the basis of some settlements’ economies.

Chapter Two

Inside the Scout Mind

"The Men and Women of the scout branch of the service represent the finest qualities that humanity has to offer. A scout is brave, honest and trustworthy."

—Spaceguide

"It takes a certain mindset to become a scout. You have to love space and the spaceways, solitude and adventure. Just remember when you're running from a pack of savage cannibal headhunters on some backwater planet with no name but the one you've given it, that there's no other job in the world like the one you've got, and you love it."

— Brut Jaxton, Nova scout (retired)

What makes a man want to give up the modern conveniences that we all take for granted to spend his days on the fringe of the known galaxy? The scout is a rare breed. Not many individuals could spend their lives on the edge, with the pressure and the solitude of long periods in hyperspace. There are several traits that most of these remarkable men and women share.

Traits of the scout

Love of the Unknown: This is perhaps the most important trait a scout can possess. A scout has to be dedicated to the pursuit of knowledge. A scout who doesn't have a driving urge to find answers to the unanswered is best suited for another line of work. It is this drive for knowledge that burns in most scouts and drives them on, further and further from the known and into the depths of space.

Need for Adventure: The life of a scout is full of adventure and intrigue. Undiscovered planets and strange new races are the bread and butter of the scout. Who knows what curious creatures lurk in the mysterious primordial seas of a new world? A scout who shrinks from the face of danger won't get very far in the Scout Service.

Self-reliance: A scout has only himself and his ship, and perhaps a small crew to rely on. There is no law or corner market outside the frontier. A scout must be able to make, trade or ... creatively

acquire any supplies that he needs. And if there is justice to be meted out, it is up to the scout to act as judge, jury and jailer. A scout who can't take care of himself won't make it for long.

The Corporate Scout

The many galactic corporations employ a large and active scouting branch. There is a need for the large companies to find worlds that can provide them with the raw materials that they turn into the many modern conveniences that citizens of the galaxy enjoy and take for granted every day of their lives. Planets rich in these materials are of top priority for the corporate scout. Uninhabited planets, mineral-rich asteroids and moons are a treasure trove for the corporate scout.

Of course, many of the richest planets available are already claimed — by their inhabitants. While this is inconvenient to the corporate scout, it is not an insurmountable obstacle. While both the Empire and the Rebel Alliance/New Republic have their own laws and regulations regarding the exploitation of inhabited worlds by outside interests, the corporate scout and his employers have their own ways of dealing with this difficulty. Negotiation is the primary, and recognizably acceptable, means, but there are other ways to work a deal.

Another valuable service of the scout, from the corporate point of view, is the discovery of new species and cultures. Each new species is another potential market for the goods and services that the company provides. Several species that were barely above a prehistoric level soon found themselves rushed to the level of galactic citizen by overzealous company executives. Their new planetary governments were plunged into bankruptcy by the the purchase of thousands of previously unknown "necessities" that their population suddenly had to have. It is rumored that more than a few of the most underhanded companies introduced their products to



newfound species in the hopes of turning entire populations into virtual “wage slaves” by building a need for products and then setting up vast factories. Once the factories are established, the population is then put to work, in exchange for credits that the workers can spend in company owned-stores.

Corporate scouts have brought several new and valuable devices into common use in the galaxy. Several advanced civilizations have been discovered and brought into the galactic league by corporate sponsored expeditions. Rumors of espionage and the theft of new technologies by these expeditions is most likely exaggerated by the companies’ jealous rivals.

Benefits of being a Corporate Scout

The benefits of becoming a corporate scout are many and varied. The pay scale for a beginning scout is generally very high, the risks are moderate to low and, in many cases, equipment and a ship are provided.

Pay for a corporate scout is, of course, dependent on the company. The average monthly pay is around 1,000 credits per month with bonuses paid for especially valuable discoveries. A discovery bonus can be as high as .01% of the market value of a planet.

The corporate scout can expect the finest in rest and relaxation when off duty. Although off-duty time does not come as often for the busy company employee as for the New Republic scout,

The Karflo Corporation

The Karflo Corporation manufactures hyperdrive engines for a substantial number of ship companies throughout the Known Galaxy. The company maintains a large scouting branch which provides the company with the raw materials and manufacturing sites that the expanding company needs to continue its reign as top producer in the field.

Karflo is also one of the companies rumored to have the most disreputable practices — especially in regards to the discovery of new species. The need for raw materials in their manufacturing plants is great, and rather than hire workers, they actively seek low-tech planets with high mineral content to exploit. Company representatives establish “development colonies” on these new worlds and hire natives to labor in mine facilities for low wages.

This practice was illegal, but mostly ignored, under Imperial law — the right grease in the right palm opens doors. But the New Republic shows no such leniency. However, with the state of the New Republic at present, there is almost no way for the new government to discover these illicit activities. Woe to the independent scout that discovers one of Karflo’s colonies, since the company really doesn’t want its business practices to be made known to the general public.

he can expect to be given first class accommodations at one of his company’s many executive resorts, with all of his creature comforts seen to.

Leave time is accrued according to the number of useful planets or technologies discovered, generally to the order of two weeks per find. The scout may either use his leave as it is accrued or trade it in for a larger credit bonus. The bottom line is, if a scout is successful, the company will do almost anything to ensure that he continues to work for them.

This can become a problem when the retirement question rolls around.

Equipment

The larger companies usually provide their scouts with the finest equipment available. The companies have found, after many years, that if they invest in their employees and equipment, morale is high and subsequently, so is their return. That old adage, "It takes money to make money," is held in high regard by most successful company officials.

But, in a Known Galaxy as large as this one, there are more than a few companies that violate what others take as common sense. In many areas of the universe, scouts are treated as the low end of the corporate ladder. They find credits are cheated out from under them, their equipment is substandard, and their superiors make certain that their only options lie along the corporation's plan. Many of these scouts stay with their companies only out of ignorance or fear ... or because they have nowhere else to go.

Getting Out

The last major benefit of working as a scout for one of the many galactic corps is their liberal retirement benefits. After fifty successful missions (the usual standard), the corporate scout is given full and legal ownership of his scoutship and gains an "associate" status. The scout still receives a small monthly stipend from the company as his retirement pay, but is now free to work on his own; the only stipulation is that the scout may not work for a direct competitor while collecting this stipend. Many scouts continue to do freelance work for their former employers, many years after their formal retirement.

This is the most liberally "interpreted" corporate rule of scouting. Fifty *successful* missions can take a long time to come, and it is quite likely that the ship a scout uses most of his career will not be the one he uses on his corporately-recognized fiftieth mission. Again, most of the larger, more successful corporations muster their scouts out fairly, but there are thousands of examples in the Known Galaxy of "liberal interpretations" of the scout contracts.

Receiving the stipend can also be a problem. Most corporations prefer to turn the credits into trade. This means they are really only paying

about forty percent of the scouts' stipend in credits, the other sixty percent being what they save wholesale. The scouts who retire from large corporations make out best on this deal — they are entitled to their stipend's worth of goods and services from the corporation's company and sub-companies every month. A scout whose MOBs ("mustering-out benefits") come from a company the size of, say, Sienar, doesn't have to worry about expenses for the rest of his life. But scouts who end service in small, two- or three-system corporate services find it difficult to collect their benefits — in cash or trade.

In addition, scout retirement options can be sold from corporation to corporation. One corporation may decide it needs a "freelancer" in its "stable" and will pick up the commitment from another corporation. This means the new corporation is now responsible for the MOBs, but the scout is also bound to honor his retirement contract with the new corporation.

New Republic Scouts

The Scout Service has had a long and complicated history since its founding under the Old Republic. Originally, it was established as a means of stabilizing and charting the expansion of the peoples of the Known Galaxy. During the years of the Emperor Palpatine and the Empire, the service was split between those loyal to the ideals of the service and those loyal to the current government. That split has left scars on the service that are still in the process of healing.

During the reign of Palpatine, the scouts were primarily used to search for Rebel bases, important sources of raw materials for the war effort, and new races that could be used as warriors or slaves at the Emperor's dark whim.

The scouts proved to be a double-edged weapon for the Emperor, because the service was filled with members loyal to the Old Republic (and sympathetic to the Rebel Alliance) and those old spacers that really didn't care for politics, but strove to uphold the basic tenets of the Scout Service. For every victory Palpatine claimed with his scouts, the members cost him two battles elsewhere. They used their freedom of movement to run information to the Rebel cells and became the information net of the Rebellion.

When it became apparent to the Emperor that he couldn't control his exploration arm, he shut it down. Scouting duties were then taken over by his already overtaxed Imperial Fleet. Many of the scouts left to join corporate scout services, the Rebel Alliance, or both.

The destruction of the Scout Service during the Empire caused many of the Service's best and brightest to continue "scouting" on their own — exploring for fun and profit, and as a way to avoid

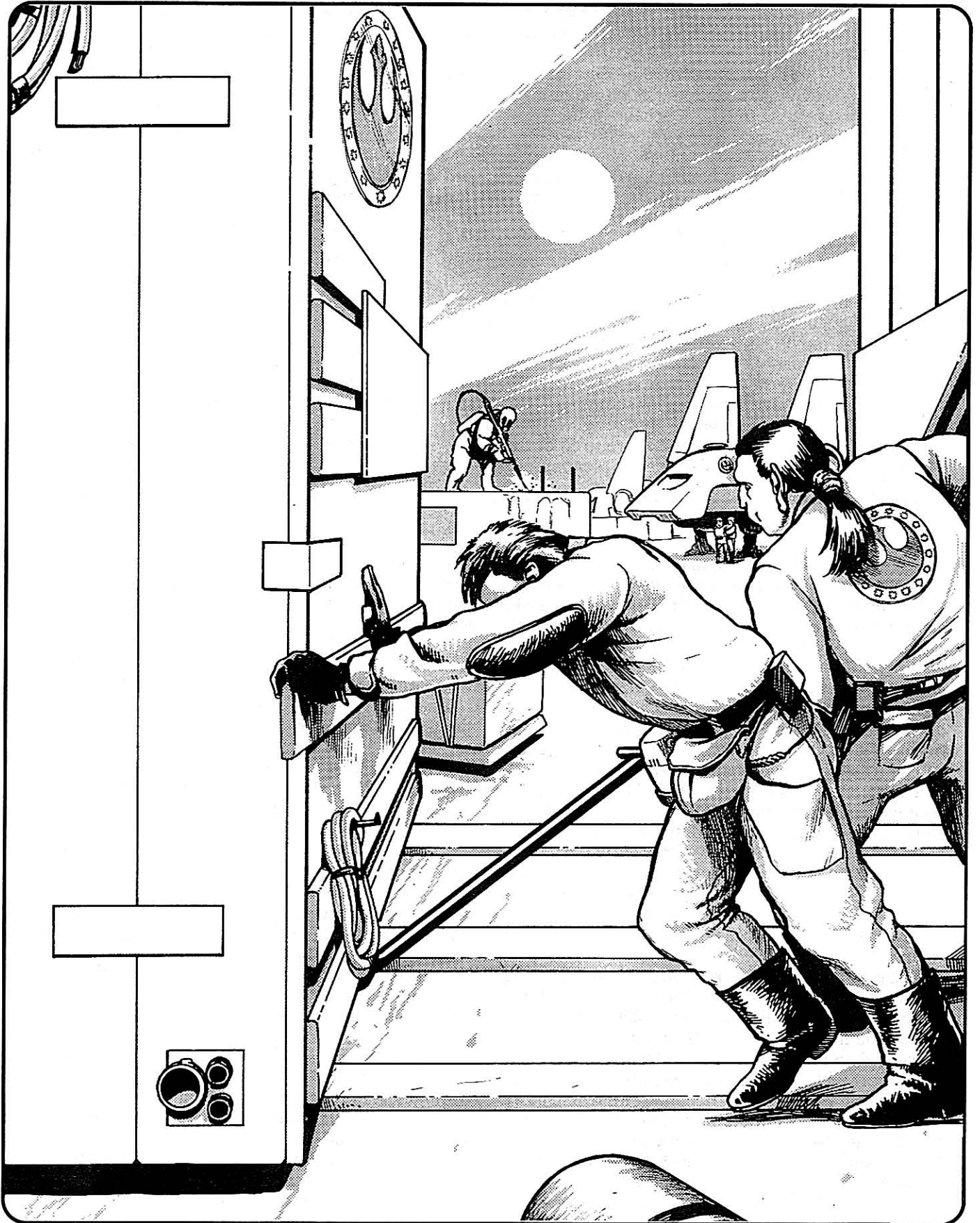

"Imperial entanglements." These men and women have become the core of the independent scout movement.

This is not to say that the New Republic scout branch is in a decline. The returning scouts have something that they believe in, for the first time in years, and the "newbies" are already the converted. The basic ideals of the New Republic have fired the imaginations of a generation, and these new scouts are some of the most promising the service has ever seen.

The Scout Service is the perfect place for a youngster to earn his wings. The hours are long and often lonely, but a stint in the service will prepare him for anything the galaxy has to throw at him. Skills in communication, first contact, geology, astrogation and piloting are just a few of the skills that a new scout will learn.

Many of the Rebellion's hottest pilots and crews have signed on for scouting as well. While nearly all of them are tired of fighting and watching friends die, very few are tired of the excitement. The Scout Service has plenty of adrenaline

for those hotshots, and it allows them to recover from their years of war.

The service provides a comprehensive training program for the prospective scout. Raw recruits are transformed into self-reliant, skilled pilots or crews in a few short months. After the nine month training, the scout is either sent to one of the many scout bases to serve an apprenticeship, or, if he or she is exceptional, directly assigned as a junior mate on a training ship.

The First Cruise

Training ships are manned by a crew of six scouts, normally four recruits and two veterans. This part of the training period is normally six months long, during which the young scout may visit anywhere from one to ten new worlds. The trainees are left to make all decisions and perform all the actual piloting, sensor readings, and exploration, guided by their older brothers and sisters. After this training period, the scout is graded on his performance and either assigned to a scout ship or base as an apprentice, or sent

The Training Mission

The six-month-long mission is a sham. This fact is carefully guarded by the trainers and every member of the "Scouts' Organization." The entire exercise is carefully constructed to test the young scouts in all aspects of their new environment. Care is taken that no one actually gets hurt, but accidents do happen and a trainee that dies during this mission is given posthumous honors and the cadet's family receives one-half of the cadet's monthly wage over the next twenty years.

The training mission usually contains a first contact mission, to evaluate the cadet's knowledge of contact regulations and practices. This contact mission is considered the most difficult of all the tests. More than one young scout has cracked when face to face with an unknown creature. Luckily for both the aliens and the new scouts, they are not issued genuine weapons for their mission, but their trainers have the real article and occasionally have had to use them.

The next standard test mission is the discovery of a mock Imperial Base or "Hostile World." This tests the cadets' stealth and subterfuge skills. The objective in the Imperial mission is to get into the base, download computer information from it and get out and report its location to New Republic authorities. The "Hostile World" test — becoming more and more used with the dissolution of the Empire's remaining bureaucracy — is a little more involved. The scouts have to sneak into a (predetermined) village, gauge the natives' fighting abilities, tech levels, and relative threat to the New Republic, and get out alive.

One of the more famous training mission stories is that a group *did* actually find a *real* Imperial base. The truth became apparent after three of the trainees were wounded by hostile gunfire. Talek Var, the cadet leader, fled the base while his veteran commanders were trying to salvage the wounded crew. But Var returned. Using his small scout vessel as a manned missile, he rammed the base headquarters, killing over eighty percent of the Imperials and causing the rest to scatter. The wounded scout cadets and the veterans were saved hours later when their survival beacon's signal was picked up by a New Republic ship sent to check on the group's success or failure. When the disaster was sorted out, Talek Var became the youngest scout ever to be inducted into the Nova Scout "Hall of Fame." Unfortunately, he was also the first scout of the New Republic to ever be given this honor posthumously.

The final test occurs while in deep space. During the cadets' rest period, the trainers sabotage the ship's hyperdrive, sensors, and communications. The cadets must jury-rig repairs from the odds and ends in the craft's stores, as the veterans have taken the escape pods and fled to a waiting rendezvous.

This last test may be the most vital, as many young men and women have proved to be unable to hold up under the strain. The prospect of years in space at normal speeds and possibly even starving to death before ever seeing another planet has shattered even veteran spacefarers.

It is this training that prepares the young scout for the trials that lie ahead, and it takes a special man to earn his scout stripes.



back for more training.

The Benefits of the Scout Service

While the Service is not the most glamorous job in the world, it provides the beginning pilot with a stable source of income, experience in all aspects of space flight and exploration. It prepares him for any path he may later choose; independent scouting, working for a corporation, private sector employment or even another branch of the New Republic's extensive services.

The pay scale for a New Republic scout is 500 credits per month with bonuses earned for the discovery of an uninhabited planet capable of supporting life, and more for the discovery of inhabited worlds interested in joining the New Republic. This bonus is paid by the Colony Authority, which purchases rights to exploitation or induction of the planet from the Service. Bonuses can range from as little as 1,000 credits to as much as .005% of the planet's net value.

The only drawback to the Scout Service's bonus system is that only a small percentage of a large reward can be drawn on immediately. The New Republic is loathe to admit it, but they are strapped for cash. Any reward over 1,000 credits is almost always served out in several installments. There are a very few scouts who need never work again — as long as they can survive on their monthly bonus payments of 1,000 credits apiece for the next twenty or thirty years.

But New Republic scouts seldom join the service for money — though they recognize its value later on. Most are in it for the adventure and the novelty, or even the high-class training. A few have their own reasons, not so noble, for joining the Scout Service, and those men and women have given the Service a dubious reputation in some systems.

Other Compensation

Although the pay is rather low, the Service supplies the finest ships the New Republic has available. But *available* is the key word. Currently, the Service is searching for independent scouts and small-ship captains who wish to sign on and use their *own* vessels for exploration. Regardless, the Service scout is supplied with fuel and consumables for each mission and may purchase additional equipment at a considerable discount at frontier bases. Those who sign on and use their own vessels also get lines of credit open to them ... within certain bounds.

Free room and board are available at any of the thousands of service run bases located throughout the galaxy, with more being established every day. Some independent hostels have been set up to cater to the Scout service and other New Republic official travellers (such as the Courier Service), and they receive special considerations from the New Republic as far as patronage and recommendations go — for discounted rates.

Finally, the New Republic Scout Service has

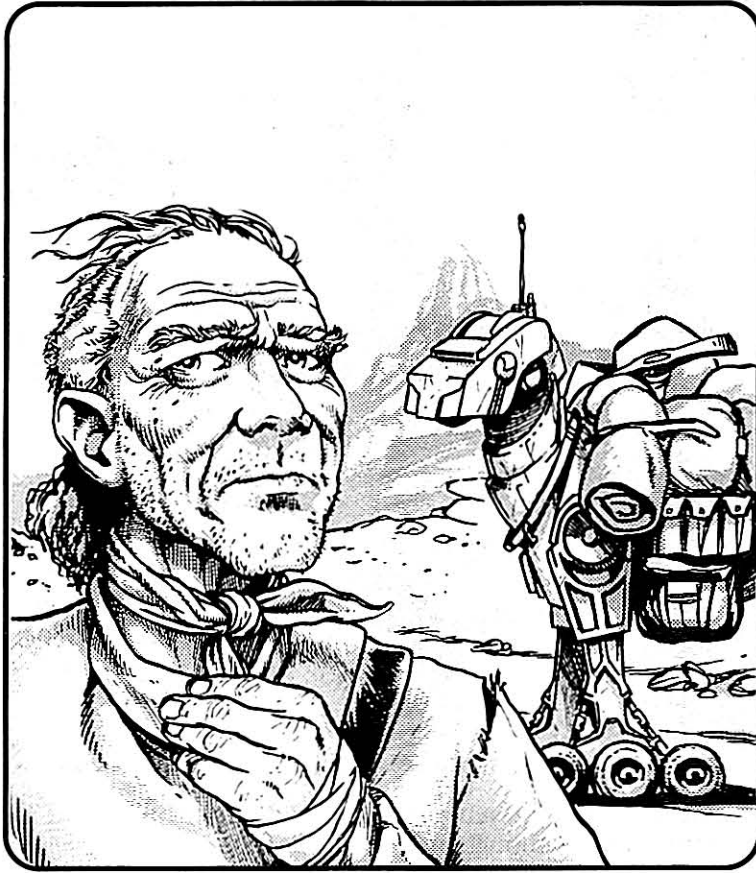

garnered a reputation among the bureaucrats and officials of the New Republic nearly equal to that of the front line troops and fighter pilots during the Rebellion. They are often looked at as daring heroes who have found a way to avoid the

humdrum nature of day-to-day life. The worst reputation a New Republic scout needs to worry about (in non-Imperial controlled areas) is that of a shady daredevil or ne'er-do-well. And those systems are few and far between.

The Independent Scouts

The galaxy is made up of millions of inhabited planets, but with the advent of the hyperdrive engines, millennia ago, this huge galaxy was made much smaller — too small for some individuals. What makes a man live his life on the edge of the galaxy, constantly trying to stay one step ahead of the masses of humanity expanding outwards? To most independents, it is the love of the galaxy in its raw, undeveloped form. How many people get to make their own rules and live their lives as they see fit? No one moreso than the Independent Scout. Out in Wild Space, a man lives as he wishes, with no higher authority to bow to and no time clock to punch.

Many of the current independents out in Wild Space right now were members of the Scout Service during the time of the Empire. When Palpatine closed the service, many members ran with their ships, searching for a new place to call home, but not a new cause to fight for. Even now, years after the Emperor's defeat, there are countless Independents out there who believe that the Empire still exists, and these lonely, desperate men continue to flee from a spectre out of the past. Even those that know of the Empire's fall are somewhat skeptical of the New Republic's idealistic bent. After all, it is a bureaucracy, and bureaucracies live to chain people to routines

Safe Home

A small number of the members of the old Scout Service have formed a collective order. This order has established a secret planetary home for their kind which they call Safe Home. The existence of this planet is the most closely guarded secret that the Independent scouts possess.

Safe Home has been carved, over many years, into the bedrock of a huge asteroid, hidden among countless others in a belt beyond the known reaches of the galaxy. This base serves as a jumping off point for Independents, where they swap stories over drinks and unwind with their own kind.

This base is kept supplied by a group of friendly pirates that prowl the area. This pirate group has managed to convince the scouts that the Empire still exists and has stamped out all traces of the Rebellion. They have done this to enable them to use the inhabitants of Safe Home. When the pirates need a bit of added muscle on a mission, they convince the scouts that Imperial scoutships, posing as civilians, are in

the area. Using the scouts as disposable muscle, they crush their chosen prey and split the booty with the Independents.

Safe Home is terrified of outsiders, as the pirates have persuaded the scouts into believing that the Empire is searching for them as galactic criminals.

This may seem overly simplistic and, in truth, it is. Many of the older scouts who know of Safe Home know about the pirates and their scheming ways — they just don't care. Or, rather, they are too *tired* to care. They take jobs as scouts because it is all they know, and they ignore the rest.

The younger, newer, scouts of Safe Home are of a different, darker bent. They look on themselves as new "rogues" and "swashbucklers" of a too-civilized era. Many of them may have worked for the Empire in the "old days," but have hidden their past to enlist in the scout organization. They willingly play this masquerade with the pirates, allowing the fiction to salve what conscience they have.

and rules, right?

The motivations of these proud explorers are as diverse as the stars themselves. Most have simply found a way to make their dreams and desires — and lifestyles — pay for them (at least as far as keeping their ships running). They go from one job to the next, farther and farther out, working alone or in small groups, and keeping one step ahead of civilization.

The Benefits of the Independent Scout

Freedom. There is no authority telling you where to explore or how long to stay on a new planet. Many independents simply spend their days flitting from planet to planet, poking about, enjoying themselves, meeting new races, taking new husbands or wives. It is the ultimate lifestyle for the dreamer or the pleasure seeker — and responsibility avoider. When you get tired of your current lifestyle, you leave.

One way in which many Independent Scouts make money is selling rights to a planet they have discovered to either a galactic corporation or to the New Republic. Although neither will give the scout full market value for a discovery, it is easy to make a living at it.

Unfortunately, several unscrupulous scouts have made *too* easy a living at it. Duplicate reports have been sold to several corporations, the scout playing the odds, figuring that the confirmation teams won't run into each other, and some scouts have managed to blindside particularly naive or gullible New Republic or corporate officials — by selling rights to little known, but explored and catalogued, worlds and systems. It is becoming more and more difficult for Independent Scouts to get quick credit for discoveries ... without proof in hand.

Organizations

Independent Scouts have formed brotherhoods, sisterhoods, and integrated orders and there are dozens in existence. These organizations help to provide the scouts with outpost bases where they can go for ship repair, fuel and supplies. Generally, these bases are privately owned and operated by retired scouts, scout families, or those friendly to the independents, and they charge stiff fees to scouts not of the organization, and others, that need their services.

The Independents must manage to find sponsors and have to bear the burden of purchasing and maintaining a ship on their own. Consequently, Independent Scouts are known for purchasing and operating any ship that still runs. It is not unusual to find an Independent prowling the spaceways in a ship that was considered a piece of junk thirty years ago. Don't be fooled by

Claim Jumping

The main problem that the Independent Scout has to deal with is claim jumping. All a scout can do when he has discovered a new planet is set up a marker buoy in orbit and hope that others respect it. By the time the scout races back to "civilization," it could be weeks or months later. There is very little that the scout can do to preserve his claim *in absentia*.

A favorite trick for disreputable scouts of all loyalties is to scan a new system for a marker buoy signal and replace it with one of his own. Once this is done, the claim jumper goes directly to the nearest Scout Services base, where he registers the planet as his own. This ensures that he has laid claim to the best planet in the system, wither for valuable mineral content or for colonization purposes.

Of course, since the original scout probably made a beeline for the scout base as well, this will lead to a conflict that can be near unresolvable. According to Imperial and New Republic laws, the first scout to report a system or world is the one who wins the claim. But, in the case of a contest or claim jumping report, the credit reward is stalled pending an "investigation." In Imperial terms, this meant the greater kickback and/or influence won. Sadly, in New Republic terminology, this is often the same result — the most loyal bureaucrats of the New Republic do not work on the frontier.

The Independent Scouts have, therefore, developed a "Code of the Claim" that resolves the situation. If the second (or third, or fourth) claim contest is offered before the credit has been paid and claim established, the scouts will resolve the situation by declaring "Mutual Claim Registration" and splitting the reward. This cuts out the bribes and red tape and, while it does not salve all egos or cater to very many scouts' "sense of justice," it makes sure everyone gets something.

Oddly, among many Independent Scouts, claim jumping has become more prevalent *because* of this code. Many independents feel that they are *entitled* to jump a claim because either they have had to settle for an MCR before or may sometime in the future. The New Republic has tried to cut down on MCR fraud, but it has become ingrained into the code of the Independent Scouts.

There are many scouts who will fight for their claims, however. Some work in partnerships, one partner guarding the claim and the other going to report it. Others set devious traps in the system or on the planet for claim jumpers. Fake or rigged marker buoys, decoy signals, and firing up the natives are all tools of the scouting trade.

Finally, it has also become very popular for Independent Scouts to go into business for themselves. Modifying and equipping their old scout vessels with mining or hunting equipment, the Independent Scout relies on his and his crew's abilities to get what they can from a claim and leaving. These "prospector scouts" have abandoned the original intent behind the scouting service — to expand the universe for everyone — but many have made a good profit at it.



these appearances! Most of those ships have been heavily modified over their century in service and are a challenge for the newest ship in any lot.

... And other Jobs

As has been mentioned before, freedom is the most precious commodity a scout — Independent, Corporate, or New Republic — possesses. No matter who the scout works for, the choices and decisions made are nearly all his own. Bureaucracies have little time to waste on scouts, and both sides like it that way.

As a result, most scouts “supplement” their incomes by taking side jobs. It is not unusual to find a New Republic scout hauling foodstuffs between a frontier world and an orbital base, or a Corporate Scout ferrying a courier Droid to a

distant local. Independent Scouts are the least choosy about these “moonlighting” jobs, as they have only their own standards to live up to. Smuggling, theft, and high adventure often become means to an end — keeping your ship running — when you are an Independent Scout.

The one sidebar profession most scouts will shrink from is bounty hunting. While that is, in the most basic sense, what their job actually is (they get “bounties” for finding prime planets or finds), most hesitate to rely on hunting people for money. Scouts prize their own freedoms, and even the most loyal New Republic scout has a measure of contempt for the existing bureaucracies. Bounty hunters — the scouts’ shadowy reflection on the frontier — are not well respected by most scouts.

Chapter Three

The Frontier

"The galaxy is more vast than most people will ever be able to comprehend. No matter how far civilization has spread, there is still more that must be explored and catalogued. Billions of stars have never been visited by our civilization.

"Members of the New Republic Scout Service have the unique privilege of bringing new systems into the Known Galaxy."

— New Republic Scout Service *Spaceguide*

Revitalizing The Scouts

The Old Republic ruled over millions of individual systems. The legacy of Republic rule lasted for a thousand generations, and in that time, there was much emphasis placed on exploration and colonization. Yet, the galaxy has over one hundred billion stars. As the Empire arose, there was still much that wasn't known.

When Palpatine came to power, he realized that in order for him to retain his throne he needed control over the people of the galaxy. An expanding population, discovering and colonizing worlds, is difficult to dominate. Colonies, far from the guiding hand of the Imperial star fleet, get dangerous ideas about freedom and self-determination. Thus, Emperor Palpatine choked off exploration — the Imperial Survey Corps still catalogued new systems, but the emphasis was on discovering new civilizations that could be conquered and forced to join the Empire.

In the death throes of the Empire, there was the fire of hope. Hope for a New Republic, founded on the principles of peace and equality for all people.

One of the priorities of the New Republic is to contact the many lost worlds: some were completely subjugated by the Empire, while others were simply forgotten. Since some of this information is known only by the Empire, it is vital to the New Republic to discover these worlds before the Empire brings them under its control.

Many millions of systems in the galaxy lie unclaimed by the Empire or the New Republic.

Some of these systems are truly unexplored, and any accounts about them are from remote sensors or hearsay. It is up to the scouts to discover these new civilizations, chart new star paths, to spread word of freedom to those worlds lost in the chaos of the past, and to offer the hand of friendship to the new worlds that will be discovered.

The New Republic has restarted the Scout Service as a way of exploring and making contact with these lost and unknown worlds. While the soldiers of the New Republic fight to free those worlds still held in slavery by the Empire, the New Republic Scout Service is bringing word of the Republic to worlds that have been uninvolved in galactic affairs for decades, or even centuries.

The Scout's Domain

The politics and conflicts of the Known Galaxy seldom intrude upon the life of a scout. While the Republic struggles to defeat the Empire, the scout knows only that he is often beyond help and assistance. The scout is charged with venturing to the areas of space that are unexplored or only dimly known, and then mapping and exploring those areas, paving the way for colonization. The scout has entered "the frontier."

The "frontier regions" of space are simply those areas beyond the direct rule of the Empire or the New Republic. Many of the systems closest to the borders of Republic or Imperial space have been thoroughly explored and settled — some have been independently established, others are sponsored by corporations, and still others are founded by Republic or Imperial member worlds.

These worlds are as variable as the people who inhabit them. The "personality" of each of these worlds is unique, a mixture of the temperament of the settlers, the beliefs of native inhabitants (if any) and even the world itself contributes much to the flavor of a frontier world.

Cultures can be wildly variable. Worlds founded by Republic, New Republic, and Impe-

Lost Worlds

From The New Republic Scout Service Spaceguide:

In our galaxy, where hyperspace makes rocketing between stars easier than crossing the surface of many worlds, one might wonder how entire planets and cultures could have been lost. Perhaps it is because, during periods of great chaos, such as during the rise and fall of the Empire, only vital interests are protected. Or, as some are fond of saying, "Entropy requires no maintenance."

Prior to the Empire, the Old Republic expanded, adding countless colonies to its benevolent, though often inattentive, catalogue of worlds. Many of these new worlds were found in areas of space that were poorly explored. These worlds relied upon scouts for contact with civilization and for maintaining viable trade routes.

Then came the Empire. Emperor Palpatine used his military forces and influence to close off exploration and colonization, drastically reducing scout services. Aside from exploration, the scouts provide other valuable services: relaying information, pioneering trade routes, providing disaster relief, law enforcement and a myriad of other tasks. As scout services were reduced, many distant colonies were simply ignored and, eventually, forgotten.

As Palpatine's rule became more despotic, some people realized the danger of the Empire and fled to the stars. Often, they told no one where they were headed — they simply stocked a ship with as much survival gear as it could hold, and headed into unknown space, hoping to live free of Imperial influence. Now, there are countless unregistered settlements out in space, unaware that the Empire has fallen.

Many of these worlds were lost because of the disturbance in trade during the war. As the Empire was forced to commit more resources to fight the Rebel Alliance, piracy increased on the poorly defended trade routes leading to these distant worlds. Companies that did trade with uncontrolled colonies faced increasing harassment from the Empire. Eventually, the corporations left the worlds to fend for themselves, and the tramp freighters, while still numerous, found the going tougher and tougher, so that in time, many worlds were forgotten.

rial settlers are often remarkably similar, culturally, to their parent worlds. On the other hand, a planet founded by disgruntled refugees may have decided to build laws and start traditions around completely alien concepts. Often, the culture of any alien inhabitants alters the culture of a new settlement — often subtly, but on some worlds the changes are dramatic.

Some of the worlds feature all of the comforts and technologies of the Core Worlds, while others, poor in resources, far from trade routes or without many credits to spend, may rely upon a combination of modern repulsorlift technology and primitive propulsion, such as burning petroleum fuels, solar power, steam generation, or

even animal power.

In the frontier regions, the military forces of the New Republic and the Empire are rarely encountered or are low in number. Instead, the planets establish their own armies and police forces, or, as on many isolated worlds, justice is settled by individuals who have the guts — and the firepower — to make their personal laws stick.

On some of these worlds, outdated technology, such as blaster carbines, slug throwers, primitive Droids and ancient computers, may be the norm. These worlds may be rarely visited, perhaps by a few small traders every year, or, in some cases, years may pass between visits by starships.

As one ventures further and further from the boundaries of Imperial and New Republic space, worlds become more individualized and more isolated. Some worlds may have colonies that were established decades, or perhaps millennia, ago and then forgotten. Those who wish to be forgotten — criminals or dissidents who have managed to slip through the various legal and political nets — may be found in greater numbers, living new lives where no one knows their background. Technology is less and less common, and often local primitive constructs are developed as reminders of — but not always replacements for galactic standards.

In some cases, advanced and unknown alien civilizations can be found, with their own starships, weapons, robotics and other artifacts of a unique culture. The further one goes, the less likely one is to encounter aliens that are aware of the New Republic and the Empire — some scouts have even reported coming across alien civilizations that have spread out, forming trade empires spanning scores of systems, yet totally unaware of the Known Galaxy.

These areas await the brave and noble, the adventurous and daring. The scout must be ready for the unexpected and unknown, but if he is smart and adaptable, he will survive, and enhance the knowledge of the New Republic and those new civilizations he meets.

Wild Space

Wild Space was the last region of space officially opened to exploration before Emperor Palpatine's death. Wild Space encompasses thousands of stars and systems. Under the guidance of the Empire, miners, farmers, families and soldiers have ventured to this region, eager to make their fortune or begin new lives. Others have come by themselves, motivated only by the desire to wring profit from the natural resources and return back to civilization for the good life.

Since the region was opened, the battle fleet of

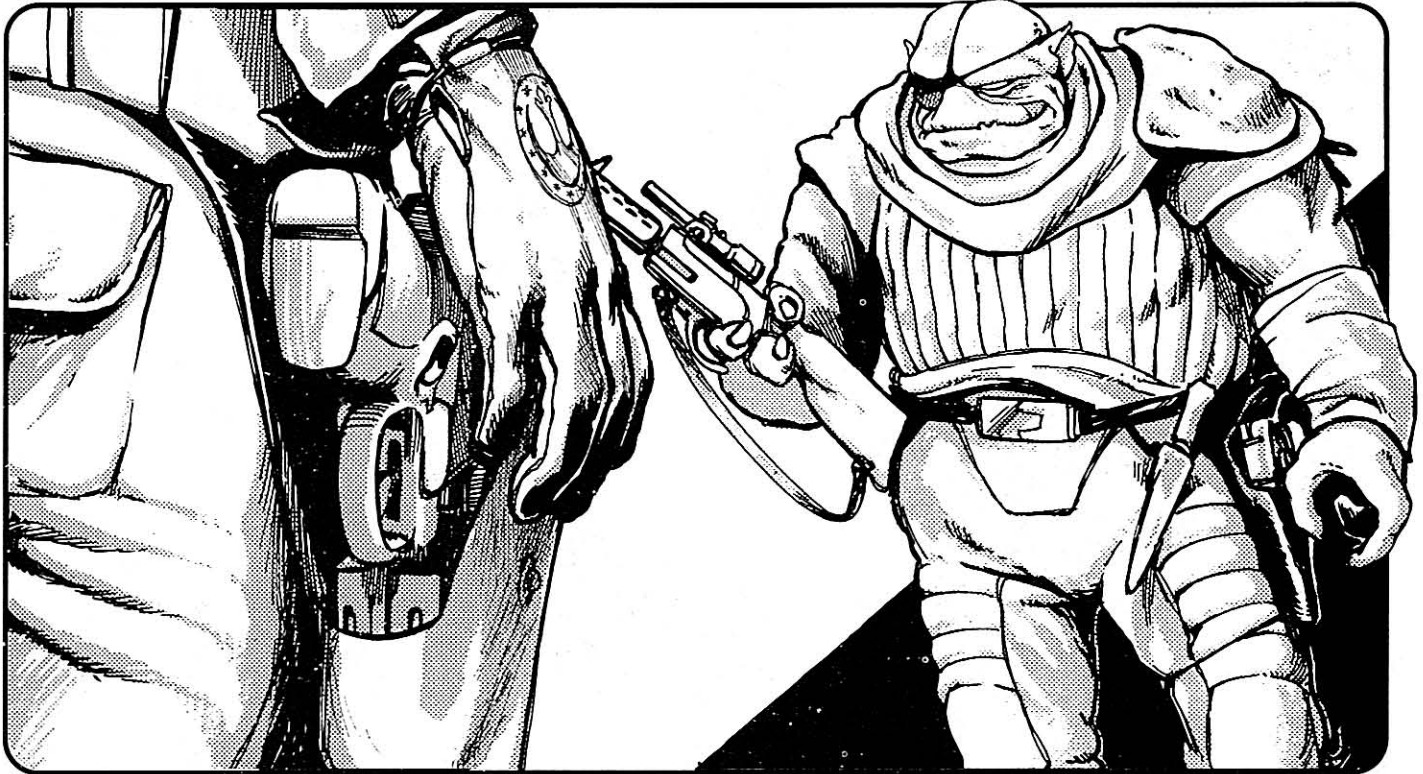

Grand Admiral Thrawn has been charged with taming the region. There are those within the Imperial military who question Thrawn's appointment, for he is part-alien, but after the initial engagements under his command, Thrawn has demonstrated his phenomenal tactical skill, erasing all doubt regarding his abilities. The New Republic will remain ignorant of Thrawn until he begins his offensive against the government two years from now, a total of five years after Palpatine's death.

Currently, despite Thrawn's best efforts, Wild Space is still a largely uncivilized region. The main settled worlds have fallen under the complete control of the Empire, but the outlying colonies, normally with small populations and plenty of unexplored territory, are normally freer, giving small traders opportunity to come and go without much scrutiny. Many new alien civilizations have been discovered and subjugated by Thrawn, but others still resist the might of the Empire. The outlying worlds often have to defend themselves because Thrawn's fleet cannot be everywhere at once. Calls for help may go unanswered for months.

Gamemaster Note: If player characters are operating in Wild Space during the time of the New Republic (post-*Jedi*, pre-*Heir*), then it is possible they will run into Imperial star fleet vessels, and may learn that there is an organized force to be reckoned with outside of New Republic con-

trol. If this happens, Grand Admiral Thrawn and his minions will no doubt take great interest in ... containing this knowledge. Appearances by Thrawn's fleet should be cloaked in mystery prior to the beginning of the *Heir to the Empire* period.

If the player characters are operating during a pre-*Jedi* period, during the Rebellion, but have occasion to operate in Wild Space, they may run into Thrawn's fleet with more regularity — originally, he had quite a large command. It was only during the years between *Jedi* and *Heir* that it was paired down.

Life in Wild Space is rough and tumble, but the mere threat of the Empire's steady hand has been enough to dissuade large-scale conflicts. The Empire has been known to exact punitive measures on individuals or groups that have disrupted trade or other colonies. Groups which seem to be more tractable may be relocated to new colony sites (sometimes these groups are placed on especially inhospitable worlds, particularly if the group has caused much trouble). Sometimes colonies are simply eradicated, with the world quarantined from future exploration and settlement, or with the records simply classified so that civilians are unable to find out what has happened.

There are few records regarding the inhabitants and systems of Wild Space. A few trade routes between the major settled worlds are

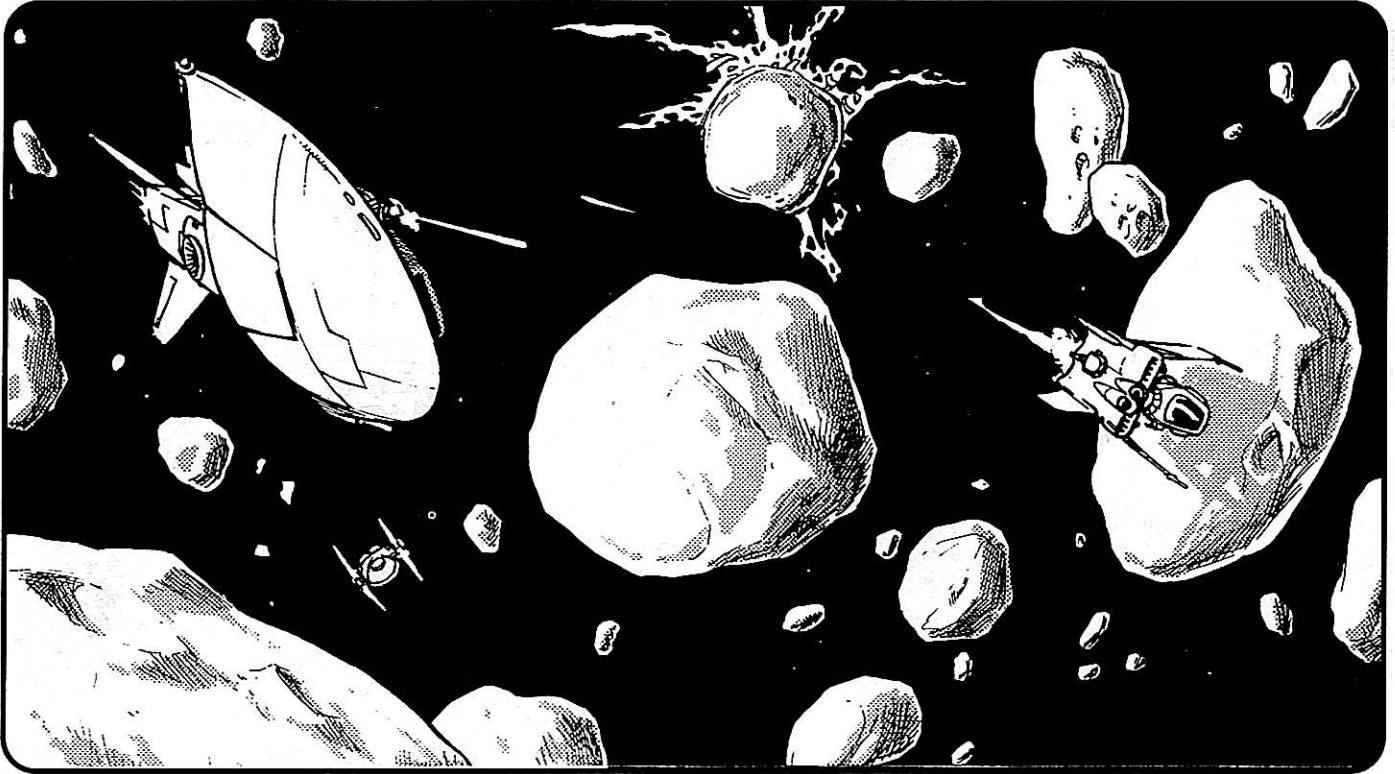

known, but the outlying colonies are unknown to all but the Imperial military forces. There are stories from traders and wanderers of lush worlds, and aliens, and rich treasures, but the truth of these rumors remains unconfirmed.

Unknown Regions

The term "Unknown Region" is a general term for any sector of space which is officially unexplored. Covering literally billions of stars, most of these areas are thousands of light years from the Core Worlds, in the most distant areas of the galaxy. Most of these areas of space remain mysterious and unexplored, and are one of the prime subjects of Scout Service scrutiny. There are also several areas within the boundaries of New Republic and Imperial space which remain "unknown" as far as the general public is concerned. Many of these regions have been explored, but for some reason remain restricted to civilian travel.

The Unknown Regions are the most dangerous because they are farthest from aid and least understood. Of course, that is the appeal to the scout — to venture into the unknown and make it known!

Much of what is known of these areas of space comes from deep space scans conducted by New Republic and Imperial scientists. Making use of visible light, x-rays, neutrino and other forms of radiation, scientists can form a composite picture of these areas of space, at least as they stood

thousands of years ago, since that information only travels at the speed of light. However, there is limited information that can be gleaned from this type of observation.

Star types can be determined (orange, yellow, red, white, blue or another less common type), as can information about particular clusters of stars, nebulas and other cosmic curiosities. Seldom can these scans provide information on the number or type of planets in a given system.

Most of the systems in the Unknown Regions have never been visited by representatives of the New Republic, and a prospective scout can face anything. The scout may have limited information from travellers or aliens in the region. As the scout approaches the world, the ship's sensors must do all of the work, scanning for atmosphere components, communications broadcasts, and other possible indicators of life.

Sometimes a scout will discover that he or she isn't the first visitor to a given world. Perhaps traders have visited in recent memory. Few records remain regarding how far the explorers of the New Republic ventured, although the Outbound Flight project was supposed to send several Jedi to the nearest galaxy — certainly, smaller scale exploration efforts were mounted in the past. Sometimes, these expeditions would even establish colonies if a particularly hospitable world were encountered.

What makes colonies in the Unknown Regions unique is that they have had little or no contact

Adventure Themes

The types of adventures scouts are likely to have depends largely upon what kinds of space they are in. Scouts close to the borders of settled space (Imperial or New Republic) are much more likely to come across a colony than an unknown alien species. Likewise, if the scout is far from settled space, the scout is more likely to come across a rich, unsettled world than a thriving colony.

Some of the adventure types overlap with others to a certain degree. This was intentionally done in order to give the gamemaster maximum latitude when rolling up a category. As any fan of science fiction literature knows, seldom are stories about one central theme: often, novels are a mixture of different themes, for a story that is interesting on many levels. As a gamemaster, you might want to roll up two or three themes and then create a story with two central themes or devise one central story with two or three subplots.

When choosing to randomly roll up an adventure theme, select the classification that best fits and roll on the appropriate column of the chart below:

- *Frontier* — Space on or near the edge of settled space. Technically, not part of the Empire or the New Republic, but not too far removed from their influence either. Independent tramp freighters, pirates, outlaws and other fringe elements of galactic society are fairly common. Resource-rich worlds likely to have

already been colonized. Many known hyperspace routes, although they may require slow travel due to navigational hazards.

- *Semi-Wilderness* — Space that is partially settled and somewhat explored. There are many systems that aren't well known or explored, but there are many small colonies as well. Advanced, but unknown alien civilizations are unlikely. Area may have been previously settled by Old New Republic or alien colonists, so lost civilizations and worlds are quite possible. Freighters and pirates are less likely. Resource-rich worlds may still lie undiscovered. Fewer hyperspace routes, and most have navigational hazards.

- *Wilderness* — Space that has been minimally explored. Recently established and unregistered colonies are less likely, although colonies established during the Old New Republic and then forgotten are possible. Freighters, pirates and others unlikely. Encounters with primitive and advanced aliens quite likely. Resource-rich worlds most likely to be unsettled. Almost all hyperspace routes will have to be plotted based only on astronomical data — time-consuming and dangerous.

To randomly determine an adventure theme, roll two six-sided dice. Read one die as the "tens" die, while the other die is the "ones" die. For example, if the tens die comes up as a 5 and the ones die comes up as a 6, look up "56" on the chart below.

Frontier	Semi-Wilderness	Wilderness	Result
11-12	11	—	Diplomatic
13-15	12-13	13	Imperials
16-23	14-15	14	Known Colony
24-26	16	—	Law Enforcement
31-34	21-22	15	Pirates/Criminals
35-36	23-24	16	Traders
41-42	25-26	21-22	Disaster
43-45	31-33	23-24	Unregistered Settlement
46	34-36	25-31	Lost Colony
51-52	41-43	33-34	Equipment Failure/Accident
53	44-45	35-36	Space Hazard
54-55	46-51	41-42	Life Forms
56	53	43	Lost Treasure
61-62	54-55	44-46	Primitive Culture
63	56	51-52	Aliens
64	61-62	53-54	Survival
65	63	55-56	Resource World
66	64	61-62	Unknown Artifact
—	65	63-64	Exploration/Survey
—	66	65-66	Navigate Hyperspace Route

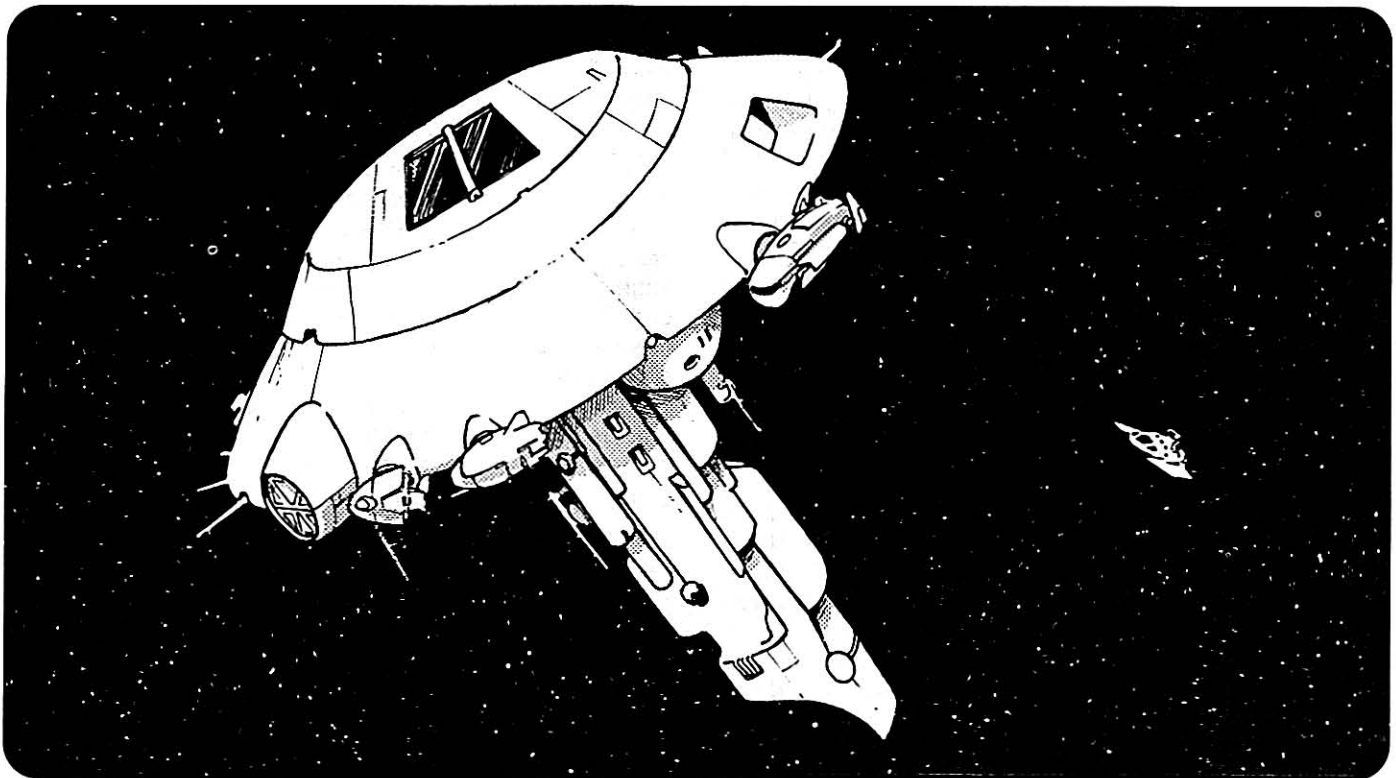

with the Empire, and usually very little with the Old Republic. They might have been alone for thousands of years, leading to unique languages, customs and cultures.

The most fascinating, and rare, worlds are those that never heard of the Empire but *did* have extensive contact with the Old Republic. For some reason, they were spared contact with Emperor Palpatine, they never heard of Darth Vader or the Death Star, and are blissfully unaware of the galactic conflict that raged throughout the Core Worlds. These worlds can be bizarre and strange to those scouts born in conflict and mistrust; many of them are havens of peace and prosperity. Still others have strange secrets yet to be discovered by visitors from the great unknown.

A Call To Adventure

"For the scout, there is the need for adventure. Not just the stories on the newsnets, but the need to be doing the exploration. The scout lives for the thrill of circling dead stars, weaving through asteroid fields, landing on undiscovered planets, and meeting new species."

— New Republic Scout Service *Spaceguide*

"And if you score, the money's not bad either."

— Glaennor, Eighth Nebulan Scout Corps

The stories scouts tell are not like the stories of other adventurers. The scout's love is explo-

ration, filled with mystery, the unknown and wonder at the vastness of the galaxy.

Getting Involved

Scouts are more than explorers — they are messengers, diplomats, cargo haulers, lawmen, traders and information brokers. A scout takes on many tasks — thus his duties can be highly varied and seldom predictable.

Becoming involved in adventures for a variety of reasons, the scout leads an exciting life. The simplest way to get a scout involved is to customize the mission profile given to a scout when he is assigned to explore a system, sector, or region. What is the scout going to encounter "out there?" What are his standing orders on this mission? What is he most likely to *want* to do? Answer these questions, and the adventure can come easily.

Scouts often venture to partially explored worlds for more extensive research, often in the company of highly skilled scientists. Scouts are sometimes ordered to visit colonies, to deliver medicines, help bring about law and order, or do some other good deed. They might also find themselves in a system due to some accident or mechanical failure, such as a failed hyperdrive, a miscalculation in navigation, or a quick "blind jump" into hyperspace while fleeing combat.

Diplomatic

Diplomatic missions involve the scout conducting official business on behalf of the New Republic, or, in the case of a corporate scout, his employer. Independent scouts may be hired to undertake diplomatic missions as well.

The mission orders might require the scout to negotiate a trade agreement, or make first contact with a new civilization and ask them to join the New Republic, or convince them to sell mineral resources to the company. The scout might have to negotiate for the release of political prisoners, or arrange to exchange one type of good or technology for another (for example, trading the secret of fusion technology for large quantities of crystals). The scout might also be asked to defuse tensions — for example, a particular colony or world has been attacking a company's freighters, and the colony wants to negotiate a peace agreement.

The scout might also be merely a courier for other diplomats. The diplomats have to travel to a distant world, and the scout's ship is the only one available for the trip. In this case, the scout may become embroiled in a secondary story — perhaps there is some court intrigue that the scout has to avoid or manipulate to his advantage, or perhaps he finds out about an assassination planned against the diplomats, or the scout visits the "common people" of the world and finds out a horrible secret about the government.

Imperials

In this type of scenario, the Empire figures prominently, although not necessarily as the antagonist. The most straightforward type of scenario involves the scout, as a New Republic representative, coming into conflict with the military. Perhaps the scout is attacked by army troops, runs across an Imperial scout, or makes the mistake of entering an Imperial-controlled system.

Another option is that the scout has come across valuable information that the Empire is willing to kill for, and the scout must race to report the information and save his life. The Empire's xenophobia is well known: maybe Imperial forces have come across an alien star fleet and they are preparing to wipe it out, and the scout is the only one who can warn the aliens (of course, the aliens might present a greater threat than the scout realizes). Perhaps the Empire is actually helpful, and ends up saving the scout from dangerous pirates, aliens or some other force that is determined to kill the scout. Since many scouts are not actually affiliated with the New Republic (or Rebel Alliance, depending upon

who you are talking to), the Empire might even be a source of employment or protection for some.

Known Colony

The scout is asked to investigate a known colony, possibly a world held by the Empire or the New Republic, or even an independent world. The scout's mission might be as simple as updating current files regarding population, government, industry, trade and so forth. The scout might also be asked to lend assistance or aid — perhaps the world has become embroiled in some sort of civil war, it is suffering from a plague, it is facing constant attacks from pirates or the Empire, or it is having problems with natural predators.

The scout might also have stopped on the world for supplies or a brief vacation and become embroiled in more personal problems. He might be charged with a crime, or pick a fight with the wrong group of bullies, or have agents that have been tracking him finally catch up with him.

Colony worlds can run the gamut of galactic civilization, from industrialized worlds with a population in the billions to planets with only one settlement, with a population in the hundreds. Worlds might be regional trade centers, mining colonies, agricultural worlds, or simple subsistence planets, where the people are surviving, but just barely.

Law Enforcement

In this case, the scout is asked to use his authority as a New Republic official to stop disorder or bring criminals to justice. While the Scout Service normally only asks scouts to do what is reasonable (such as capturing a murderer, bounty hunter or smuggler), occasionally scouts are asked to directly intervene in wars, long-running feuds, and other major conflicts.

The amount of respect and cooperation scouts receive depends upon the world and its proximity to New Republic space. Citizens of worlds close to the New Republic will be more likely to do as a scout orders, and while local police and military forces may be resentful about being ordered around, they will frequently provide whatever assistance they can. Worlds far from the boundaries of New Republic space (especially those close to the Empire) may completely disregard the scout's badge. The scout may be stonewalled by local officials, or may even be attacked or imprisoned by them. On true frontier worlds with minimal law enforcement, flashing a scout badge in a bar is an invitation to a shoot-out in the town's streets.

Pirates/Criminals

The scout is attacked by or sent to capture pirates, bounty hunters or other criminals. The pirates might be attacking and disrupting shipping to distant worlds that can hardly afford to lose supplies. The pirates might also be attacking aliens that the New Republic is hoping to open trade with. The pirates might simply force the scout's ship out of hyperspace and strip it of all valuable equipment, leaving the scout adrift in space.

The frontier regions of space are perfect hiding spots for criminals hoping to hide from bounty hunters and the law. These criminals may have taken up a new identity on a colony world, or simply live as a hermit on a distant and lightly settled world.

Traders

The focus of the adventure is interaction with traders of some kind. The scout might meet the traders (or smugglers) in open space, in the landing field of a distant frontier town, or in a crowded space station. Traders, because of the nature of the business, travel throughout the galaxy, swapping stories, venturing to new worlds, and making deals. As a result, traders might have information about new and valuable worlds, alien species, or new hyperspace routes. Traders are also one of the most effective conduits for rumors of all kinds — from the outlandish, to the reliable, to outright distortions planted by the Empire to frighten members of the New Republic. As a result, traders can be a valuable source of leads for prospecting scouts looking for a “big strike.” Of course, traders are businessmen, and will try to get as much as they can for their information — scouts often end up paying top credit for information that is only marginally reliable.

If a scout has to perform a law enforcement task and is lacking manpower, traders might hire on for a few credits or give the scout information on mercenaries that are for hire.

Disaster

The world the scout is visiting has been the site of a disaster of some kind, or soon will be the victim of one. The disaster might be ecological, cosmic or man-made. Likely events include a planet's sun about to go nova, an imminent asteroid collision, plagues sweeping a world, industrial accidents, massive earthquakes and tidal waves, worlds that have irregular orbits and devastating seasonal changes, a war, or an ancient ship that ruptured, spilling deadly chemicals into the atmosphere, as happened on Honoghr (shown in *Heir to the Empire* and *Dark*

Force Rising). For primitive worlds, the people of the planet might face invasion and extermination at the hands of mercenaries or aliens with advanced weapons.

The scout will probably have to help out, such as arrange an evacuation, provide disaster relief supplies (food, medicine and technology), or become caught in a personal story set during the disaster (such as coming across an orphaned child who needs to be saved). The scout might also be the only person capable of preventing the disaster, providing an opportunity for real heroism.

Unregistered Settlement

The scout comes across a settlement that was never authorized by the Old Republic or the Empire. While the Empire often deals harshly with such planets, the New Republic is often content simply to bring the world under its blanket of galactic government. The settlers might be criminals seeking escape, families and communities who simply wanted to get away from the war, secret corporate, private or government research facilities, or playgrounds for wealthy and eccentric individuals. Some worlds may have been recently established and hidden for the protection of the residents, such as in the case of Rebel Alliance safe worlds like New Alderaan, or have top secret facilities, such as Wayland, with Mount Tantiss, the Emperor's secret weapons storehouse.

These worlds frequently have access to some modern equipment and technology, although if the world is poor or distant, technology may be in short supply or have fallen into disrepair. Often, the worlds present a mystery, and the fun is investigating and finding out exactly what is on the world. Sometimes, the scout will find that he is not welcome, and may have to fight or quietly make his escape.

Lost Colony

Lost colonies are worlds that were forgotten during the war or deliberately hidden from the Old Republic. These colonies may have been isolated for a few years, decades, centuries, or even millennia — their isolation is typically much greater than that found on “Unregistered Settlement” worlds.

Such worlds are likely to have unique cultures, language, religion, and art. Such worlds, if isolated for long, may have slipped to a more primitive level of technology, as shown on Jomark in *Heir to the Empire*. The people may have taken to dabbling in mysticism, have developed a unique way of using the Force, have slipped to barbarism, or have unique cults and groups built around portions of the Old Republic's culture (for ex-

ample, built around honoring the activities of the Jedi Knights). Such worlds are likely to be completely ignorant of galactic affairs, and may greet visitors with hostility.

Equipment Failure/Accident

The adventure revolves around the failure of some essential piece of equipment or an accident that befalls the scout. Typical equipment failures include hyperspace drives blowing out or problems with life support systems. This type of failure requires the scout to act immediately, often venturing to a hostile settlement undercover to acquire replacement parts or to jury-rig a temporary fix until the scout can perform adequate repairs. Accidents are great ways to force a scout to explore nearby worlds in hopes of finding help or parts, and often leading to a larger adventure.

If the accident or failure occurs between systems, the scout may have to struggle for mere survival — if an asteroid has put a hole in the hull, the scout must struggle to place a temporary patch on the hull so that he can then concentrate on limping to a starport.

Space Hazard

A space hazard is any type of natural or artificial object or entity which might impede a scout's progress or endanger his ship. When plotting new hyperspace routes, scouts have to deal with asteroid belts, rogue planets, gas clouds, radiation pockets and other hazards. The scout may find that weird energy fluctuations are fouling his sensors, or have to contend with bizarre hyperspace or otherspace vortexes.

The vacuum of space also holds sentient dangers. Mynocks will suck energy from a ship's power cells, leaving it helpless in space. Giant space slugs, believed by most to be only legends, do exist (as shown in *The Empire Strikes Back*) and can destroy small ships. Completely alien forms of life might also lurk in the void of space — it is known that the Star Dragons, or Duinuogwain, can fly in open space; gaseous intelligences, hyperdimensional beings or other exotic life forms are certainly possible and might be encountered in unknown space.

Life Forms

Dangerous life forms are encountered during routine exploration of unknown or lightly settled worlds. The life form might be a predatory animal, a plant or even a virus. It might attack with claws, horns, talons, or a poisonous bite, or the life form may be more subtle or insidious: perhaps it has limited intelligence and is able to possess those unlucky enough to venture too

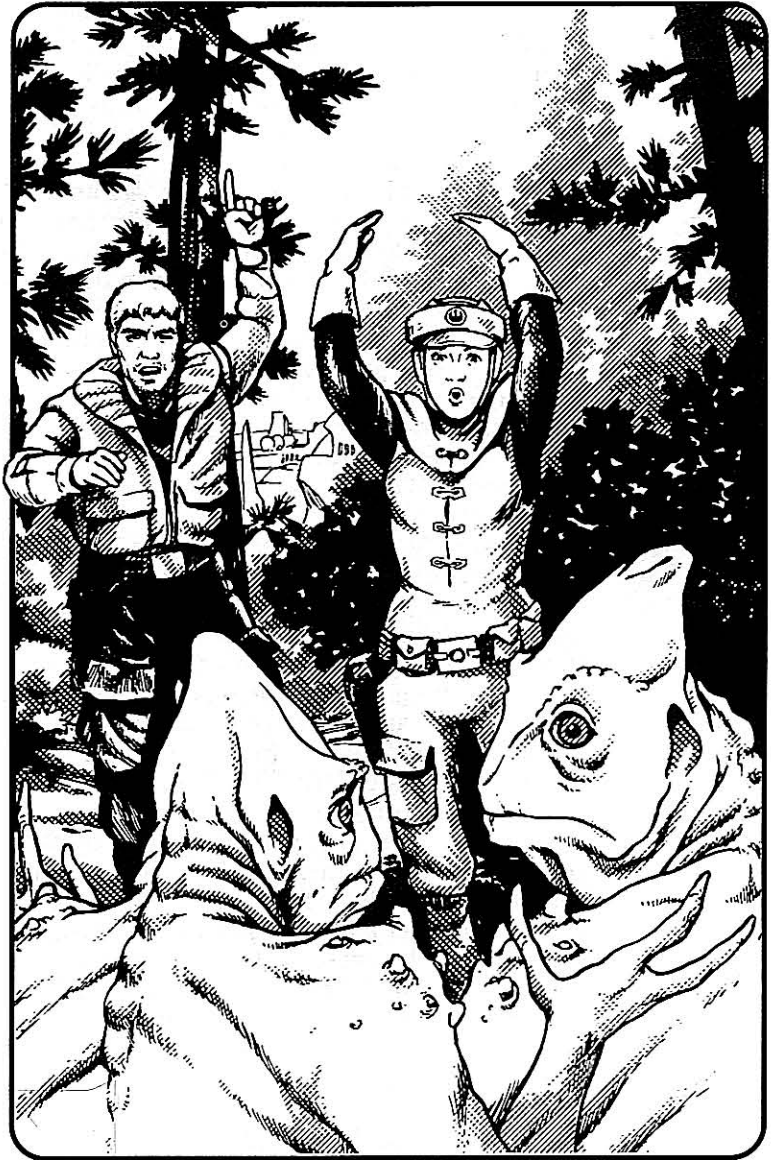

close to it. Perhaps the life form has a contact neural poison that causes great pain, hallucinations, paranoid delusions or some other nasty side effect. The life form might also be indirectly dangerous — creatures that are able to drain power generators of their power won't physically harm the scout, but may leave him stranded on a planet indefinitely.

The scout may be sent to capture a sample of the life form, or might run across it during the course of routine explorations and then have to find some way to escape. The life form might not be immediately apparent, and like many diseases, might require a long-period of incubation or go into hibernation so the scout brings in onto his ship. See Chapter Seven, "Aliens, Creatures and Planetary Features" for more information on creating alien life forms.

Life forms might also be merely intriguing or

have some economic value, instead of being dangerous. An example is the ysalamiri, a creature explained in *Heir to the Empire*. The docile creatures can push the Force away from them. Unfortunately, the creatures' limbs grow into the bark of the trees they inhabit, so they can't be removed without killing the creature. A complication with these particular creatures is that any Force-user on board a scout ship will have difficulty using his or her abilities while in the presence of the creature.

Life forms might provide food, or produce beneficial side products, such as spices, solvents, medicines and other substances that can be of use to the galaxy. Biochemicals and plants are particularly noteworthy for their utility in these areas. Biochemicals are the result of animal, plant or geologic processes. Plants can take the form of grasses, trees, shrubs, fungi and other, more exotic structures. Some plants, such as fungi, can have extensive structures underground with very little on the surface marking them. Animals can range in size from microscopic to the gigantic space slug in the Anoat asteroid field, and can have countless uses. Animals, when transported from their homeworld, often require special food, lighting, temperature conditions, or atmosphere or vital gases.

Often, a scout is expected to take detailed readings of lush worlds and collect as many samples as possible. Readings include sensor scans, chemical analysis, and holo-recordings. Samples may be preserved live, flash frozen, or even analyzed and dissected by the scout. When the scout returns, New Republic and corporate scientists will study the biochemicals, plants and animals for commercial applications.

Lost Treasures

The scout will come upon lost treasures that are of value to him, his employers or competitors. Often, these types of treasures are hidden on a world, so the scout might be led to the planet by outlandish stories, or might not even know that such a treasure is present on the world. The scout might come across individuals who possess the treasure, offer to lead him to it, or accidentally stumble across it. Normally this type of adventure works best if the quest for the treasure is perilous, with many natural dangers, as well as competitors (from the Empire or another company or independent mercenaries) who are willing to do whatever it takes to get their hands on the treasure.

Appropriate treasures include warehouses full of valuable weapons (perhaps even abandoned technologies, such as personal mechanized battle suits, which were the forerunners of walker vehicles), fleets of starships (such as the *Katana*

fleet in *Heir to the Empire* and *Dark Force Rising*), symbolic possessions (such as the crown jewels of the ruling house of Alderaan, or a lightsaber of a legendary Jedi Knight) or jewels, or valuable coins, minerals or crystals. The adventure is often more interesting if the treasure has a mythic quality about it, or if the story behind the treasure personally involves one of the characters (perhaps a certain item will prove that a character's ancestor wasn't guilty of a hideous crime, allowing the character to clear his family name).

Primitive Cultures

Primitive worlds are those on which pre-space technology civilizations exist. Typically, these worlds are home to indigenous alien species which have yet to achieve advanced technology for spaceflight, but sometimes the worlds are effectively lost colonies, seeded by other alien civilizations or the New Republic hundreds or thousands of years ago. The dominant factor is that these worlds have little, if any, advanced technology — what does exist is likely to have come from visiting traders, as opposed to discovery by the natives.

Very primitive worlds might have low technology goods for trade, including crafts, furniture, cloth, simple metalware and low technology weapons. However, the word primitive can be deceptive — such worlds might have developed inter-system space travel, nuclear power, advanced alloys, plastics and primitive robotics. They simply lack hyperspace, Droids, blasters and other advanced technologies and are ignorant of the larger galactic community.

Almost all cultures keep records of their past, and these might prove most interesting to scouts. Depending upon the technology, these records can take the form of tablets, books, sound recordings, movies, holograms, data chips, molecular memory storage devices, or imprints in the Force. Understanding the records can lead to the discovery of new technological items, an understanding of the world upon which the civilization was based, or the culture itself. By examining records, scouts can determine vital facts about a species, possibly making the difference between understanding and needless conflict.

Because these worlds are in unexplored space, they are unlikely to have any advanced settlements or bases, and thus the scouts might be the first representatives of the Known Galaxy to have ever visited the world.

The scout will probably be required by his mission profile to observe any primitive civilizations and gather complete information about the species, and their tech level and culture. If the scout is likely to be peacefully received and, in



his opinion, the civilization is capable of handling relations with advanced civilizations, the scout will make first contact with such a culture in the interest of opening trade and simply finding out information about the people of the world.

An example of a primitive civilization world is Duroon in *Han Solo At Stars' End* or Baralou in *Planets of the Galaxy, Volume One*.

Aliens

In this type of adventure, the scout will encounter an unknown alien species, either by coming across a homeworld, a colony, one of their broadcasts or one of their starships. The aliens are likely to be completely unaware of the New Republic and the Empire, and have been only concerned with their "local" area of space (perhaps a few hundred or thousand stars, if that).

The aliens may be nearly as advanced as the New Republic, or more advanced. In this case, they might not be interested in trade, but they are probably very curious. They probably have adequate defenses for intruders intent upon hostility or conquest. More advanced species might have teleporters, self-replicating machines, dimensional warps, machines that allow thought to take physical form and other items that are only dreamed of by most engineers. However, when introducing this level of technology, game balance must be carefully maintained — these items cannot permanently fall into the hands of

the characters, and likewise, they cannot be introduced to the Empire or the New Republic or they would destroy the balance of power. However, if the aliens are powerful enough to have these devices, they are probably able to control who does and doesn't receive this technology.

Their reaction can be mixed, depending upon the outlook and beliefs of the aliens and the behavior of the scout. This type of situation is especially sensitive, as the outcome may set the tone for relations with the aliens for a very long time. For information on creating alien species, see Chapter Seven, "Aliens, Creatures and Planetary Features."

Survival

In this adventure situation, the scout is confronted with a hostile environment and his main objective is to survive long enough to escape. Typically, the scout is stranded on a hostile world with a poisonous atmosphere or dangerous weather patterns, and for some reason is forced to brave the wilderness in order to find safety. For example, the scout's survey vehicle may malfunction, and may have to cross several kilometers of hostile terrain to reach a suitable landing site for his ship. The scout will have to rely on his brains and whatever tools he has on hand, and hope to reach a safe settlement, an abandoned ship, a subspace radio or some other device or location that will allow him to reach safety.

Resource World

Valuable resources can take many forms, from extremely valuable ores and crystals, to vast deposits of raw metals or unusual gases that are useful in large scale manufacturing. Resource worlds are incredibly important to large companies, such as mining and manufacturing companies. These worlds are important to scouts since companies will pay generous bonuses for information and coordinates on such worlds, but often the resource is in an unrefined, natural form. With the exception of some crystals, these resources are often too bulky to be profitably transported in small scout ships.

Mineral deposits can take the form of valuable metal ores that are difficult to find, large deposits of raw materials or common ores for construction or production, or high-energy combustibles such as fuel sources, natural high energy plasmas and fusible materials. Young and hot planets, asteroid belts and other inhospitable worlds often have high levels of mineral deposits, as shown on the planet Nkllon in *Heir to the Empire*.

On some planets, the mineral deposits are found in a pure state, in the form of large crystals. These crystal deposits are quite rare and normally more valuable than standard ore and mineral deposits.

The rare naturally-occurring heavy elements of the universe are formed in the intense blasts of supernova explosions. From these explosions, these elements are dispersed throughout the galaxy, and sometimes, one or more of these trace elements will accumulate on a planet in measurable amounts.

Rare gases may also be a rich resource for a world, and can be used in manufacturing, specialized medicines, or be used in weaponry, such as spin-sealed tibanna gas, which powers blasters. The gas may be trapped in unusual rock formations, the result of the natural processes of the geology, plants and animals of the world, or be naturally occurring in the atmosphere of the planet. Rare gases can frequently be found on gas giants. Rare gases can be poisonous or corrosive, sometimes causing damage immediately; some gases require substantial exposure before they pose a danger.

To be usable, the resources should be readily accessible, such as near the surface, or easily isolated from other materials in the natural environment.

Unknown Artifact

Unknown artifact adventures revolve around the scout coming across or hearing about a mysterious alien artifact. The major difference between these adventures and "Lost Treasures" adventures is that the powers of the artifact and its history are unknown. The artifact was constructed by aliens long ago, and its intended use was lost in the mists of time — however, there may be some, such as Jedi, who will be able to decipher the workings of the artifact.

Exploration/Survey

In these missions, the scout is simply assigned to thoroughly explore a system. The scout must log the star type, number and types of planets, any potential resources on planets or in asteroids, make note of any significant life forms on worlds and explore anything deemed "unusual." In other words, a "typical" mission as far as a scout is concerned. The details of creating a system are discussed in Chapter Nine, "System Generation" and the details of conducting such an exploration are explained in Chapter Eight, "The Survey."

Stories that feature star systems may never require the scouts to leave their ship, especially if there are no habitable worlds. Often, each world is surveyed by remote probes and sensor scans. Sometimes, even inhospitable worlds require scouts to personally investigate (perhaps there is sensor interference, requiring a surface level investigation). In such cases, scouts will often venture forth in an environment suit because of a lack of atmosphere or hostile environment that could harm the scout.

Navigate Hyperspace Route

As scouts venture further and further into unknown space, they are required to plot new hyperspace routes, rather than using known routes. These adventures revolve around the dangers, hazards and challenges of such tasks — characters may run across natural hazards, aliens or traders, or rogue planetoids or ships adrift in space.

Since a scout has to make many micro-jumps in hyperspace to plot a completely new course, there are ample opportunities to drop tantalizing adventure hooks into this type of task — if the scout picks up broadcasts from a nearby system, he will be encouraged to investigate.

Chapter Four Scout Ships

“No one ever said that piloting a starship would be easy. But with a little bit of effort you can be jumping between stars.”

— *Spaceguide*

Hyperspace

Hyperspace is an alternate dimension to realspace. It coexists with realspace so that every point in hyperspace has an equivalent point in realspace. Hyperspace is essential to space travel because it permits travel at faster than light speed as perceived by residents of realspace. In addition, travel through hyperspace eliminates the time distorting effects of relativity, so that a space traveller spends as much time in hyperspace as passes in the real universe.

The effect of hyperspace travel is that distances that would take years to travel in realspace take hours in hyperspace, and one can cross the galaxy in a matter of months. There is no exact correlation between realspace distances and hyperspace distances due to hyperspace shadows, but in general the distance in realspace is related to the apparent distance in hyperspace.

Hyperspace travel has some limitations. Objects in realspace exert gravity, and that gravitational field acts as a blockade in hyperspace, called a shadow. Objects in hyperspace create a shadow in realspace. The more massive the object in realspace, the larger the shadow. The blocking effect of hyperspace shadows is greatest when entering or leaving hyperspace. A starship must be far from stars and planets to enter hyperspace. Starships emerging from hyperspace also will be far from stars and planets.

Microjumps are used to maneuver near large bodies. A collision with a shadow in hyperspace can cause great damage or destroy an object in hyperspace. A direct collision between a scoutship and a star will do nothing to the star, but it will vaporize the ship. When realspace objects collide with a shadow in hyperspace, the object in hyperspace emerges from hyperspace.

Hyperspace travel requires the unique tech-

nology of the hyperdrive. The hyperdrive can take a ship into hyperspace, make a journey through hyperspace, and bring the ship back into realspace again. The path through hyperspace must be determined before entering hyperspace. A starship must leave hyperspace then reenter after a new course is determined. Plotting a hyperspace course is difficult, and most ships use either a navigation computer or an astromech Droid to perform the calculations.

In game terms, plotting a hyperspace course requires an *astrogation* check. The difficulty for a standard journey is typically from Very Easy to Moderate. The difficulty for new exploration will typically range from Moderate to Heroic. A normal *astrogation* check for a navigation computer takes as little as a couple of minutes if the path is well established, or up to several hours for unexplored hyperspace paths. *Astrogation* checks can be cut short, but with an increase in difficulty. The difficulty is also increased when attempting a faster speed on a course, reducing the length of the standard journey. Likewise, the difficulty can be decreased by planning a slower and longer trip. Use the “*Astrogation Difficulty Table*” to get the correct factor.

If an *astrogation* check fails the difficulty by ten or more points, the entry to hyperspace fails. The *astrogator* will have to try something different, like a new route or a modification to the power converter to make another attempt into hyperspace. If the *astrogation* check fails by 1 to 9 points, roll 2D on the “*Astrogation Mishap Table*.”

Astrogation Duration Table

Pick a duration for the trip, from hours to weeks.

Type of hyperspace trip	Duration change
Major trade route	No change
Minor trade route	+25%
Rarely travelled route	+50%
Route unused in years	+100%
Unexplored route	+200%

Astrogation Difficulty Table

Standard journey — Very Easy to Heroic difficulty

Condition	Modifiers to difficulty	Duration
No Navigation computer or astromech Droid	+30	Double
Hasty entry	Double difficulty	Double
Lightly damaged ship	+5	+5 hours
Heavily damaged ship	+10	+10 hours
Each extra hour taken	-1	+1 hour
Each hour saved	+1	-1 hour
Obstacles	+1-30 or more	—

Astrogation Mishap Table

2 — Hyperdrive Cut-out And Damage. The ship's hyperdrive cuts out, avoiding a collision with a stellar body. Unfortunately, the cut-out damaged the hyperdrive engines. A Moderate repair total (*capital ship repair, space transports repair or starfighter repair*) is necessary to repair the main hyperdrive; otherwise the ship will have to use its backup hyperdrive to limp to a nearby system. This can be a good excuse to introduce the characters to a new system, ship, alien species, or other adventure.

3-4 — Radiation Fluctuations. Radiation surges affect the hyperdrive's performance, randomly increasing or decreasing the journey's duration. Suggested change of +1D or -1D in hours for each point the roll was missed by — if the astrogator missed by 3, the journey might be increased by 3D hours.

5-6 — Hyperdrive Cut-out. The ship's navigation computers detected a mass shadow (a rogue planet, for example), throwing the ship into realspace. The pilot must now calculate a new hyperspace journey from wherever they are in realspace. This is also a good excuse for introducing an adventure.

7-8 — Off Course. The ship is completely off-course. The ship emerges in the wrong system and an entirely new path must be plotted. The system they have arrived in may be settled or unsettled. Yet another good excuse to introduce an adventure.

9 — Mynocks. Mynocks somehow attached themselves to the ship's power cables prior to jumping into hyperspace. The duration of the journey is increased by 1D days.

10 — Close Call. Some other ship's system, such as the sublight drives, nav computer, escape pods or weapons are damaged due to any number of factors. The ship completes its journey, but the system will have to be fixed upon arrival at their destination.

11-12 — Collision, Heavy Damage. The ship actually collides with an object. The ship drops to realspace, heavily damaged and with a ruptured hull. The ship is no longer spaceworthy, and it must be abandoned.

Scout Ships

There are, literally, thousands of different types of scout ships, and millions of "modified" vessels in the *Star Wars* universe. Following are some of the more common types. They are listed either because they are the most numerous, or because of special features unavailable in standard vessels.

The Ships of the Independent Scouts

Beginning on page 40 are some of the ships used by independent scouts.

Unlike their more prosperous cousins, the independent scouts are not provided with cutting-edge ships and equipment. The independent scout must make due with the hand-me-downs of the brethren that have gone before him. Indeed over 90% of the independent scout ships in service today have been roaming the spaceways for more than 50 years. What this means to the unincorporated scout is a serious technological gap, which while not an insurmountable problem for the free scouts, has given a distinct advantage to their corporate brothers.

Lone Scout

One of the standard scout ships in the Imperial Scout Corps is the Lone Scout by Siemar. The Lone Scout uses many of the basic technologies in Siemar's popular TIE line of starfighter, but adds substantial room for passengers and cargo. The LSA-2 is an advance on the original Lone Scout and features an improved hyperdrive backup and new deep scan sensor array.

The popularity of the Lone Scout has brought it into service in the New Republic Scout Service. The New Republic uses the Lone Scout for many of the standard exploration missions into the Wild Space. In the Scout Service the Lone Scout will usually have a pilot and specialist, but the extra passenger space permits this vessel to perform a wide variety of missions.

■ **Lone Scout**

- Craft:** Siemar Fleet Systems LSA-2
- Type:** Stock scout vessel
- Scale:** Starfighter
- Length:** 24 meters
- Skill:** Space transports: LSA-2
- Crew:** 1
- Passengers:** 3
- Cargo Capacity:** 125 metric tons; 50 cubic meters
- Consumables:** 1 year
- Hyperdrive Multiplier:** x2
- Hyperdrive Backup:** x12
- Nav Computer:** Yes
- Maneuverability:** 0D
- Space:** 5
- Atmosphere:** 295; 850 kmh
- Hull:** 4D
- Shields:** 1D
- Sensors:**
 - Passive:* 30 / 0D
 - Scan:* 50 / 2D
 - Search:* 75 / 2D+2
 - Focus:* 5 / 3D+2
- Weapons:**
 - One Laser Cannon**
 - Scale:* Starfighter
 - Fire Arc:* Front
 - Crew:* Pilot
 - Skill:* Starship gunnery
 - Fire control:* 0D
 - Space range:* 1-3 / 12 / 25
 - Atmosphere rng:* 100-300 m / 1.2 km / 2.5 km
 - Damage:* 4D

FORWARD VIEW

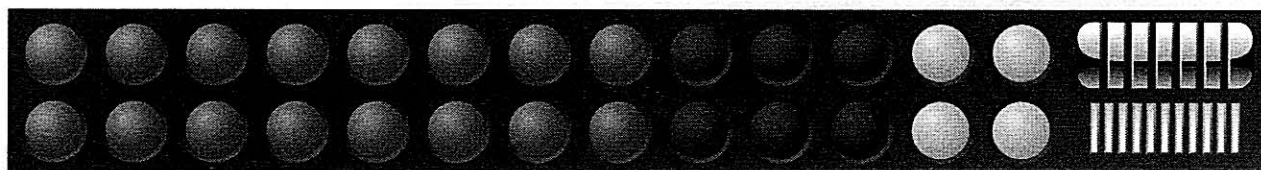
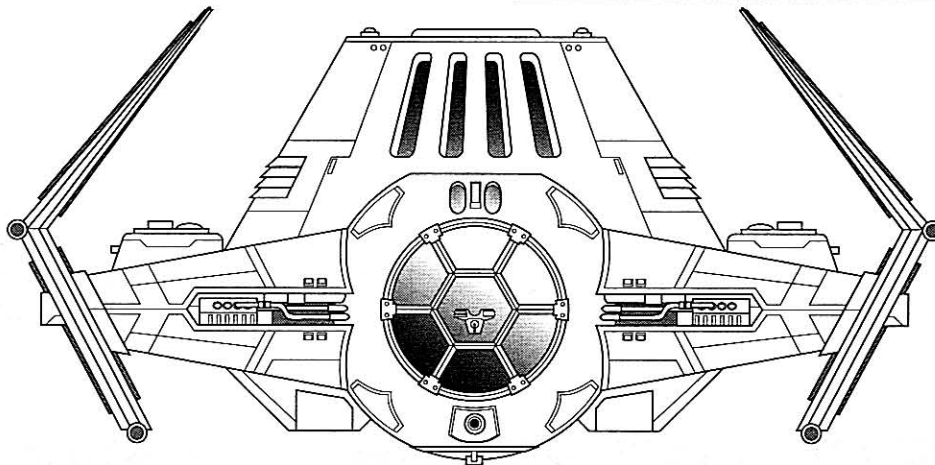

Deep-X Explorer

Many ships not originally intended for scout duty have been converted to the Service. One of the most successful conversions is the Deep-X "Explorer." The DP-X is the top of the line small yacht from Uulshos Manufacturing. The original design utilizes a dual-engine configuration for power with a delta-wing body for maneuverability and atmospheric handling.

In the Explorer, the DP-X engine compartments have been fully utilized to give maximum engine performance. The engine truly has two hyperdrives to make it one of the fastest and most reliable deep space vessels in the galaxy. The sub-light engines are also of superior quality for speeds associated with starfighters. Two blaster cannons give the Deep-X limited firepower when a crew is available to operate them.

■ Deep-X Explorer

Craft: Uulshos DPx Yacht
Type: Modified space yacht
Scale: Starfighter
Length: 12 meters
Skill: Space transports: DPx
Crew: 1
Passengers: 5 (including two to operate blaster cannons)
Cargo Capacity: 50 metric tons; 20 cubic meters
Consumables: 6 months
Hyperdrive Multiplier: x1
Hyperdrive Backup: x8
Nav Computer: Yes
Maneuverability: 2D
Space: 7
Atmosphere: 350; 1000 kmh
Hull: 2D
Shields: 0D
Sensors:
Passive: 20 / 0D
Scan: 30 / 1D
Search: 50 / 2D
Focus: 3 / 3D
Weapons:
Two Blaster Cannons (fire separately)
Scale: Starfighter
Fire Arc: Front
Crew: 1 per gun
Skill: Starship gunnery
Fire control: 0D
Space range: 1-2 / 8 / 15
Atmosphere rng: 100-200 m / 800 m / 1.5 km
Damage: 1D

TOP VIEW

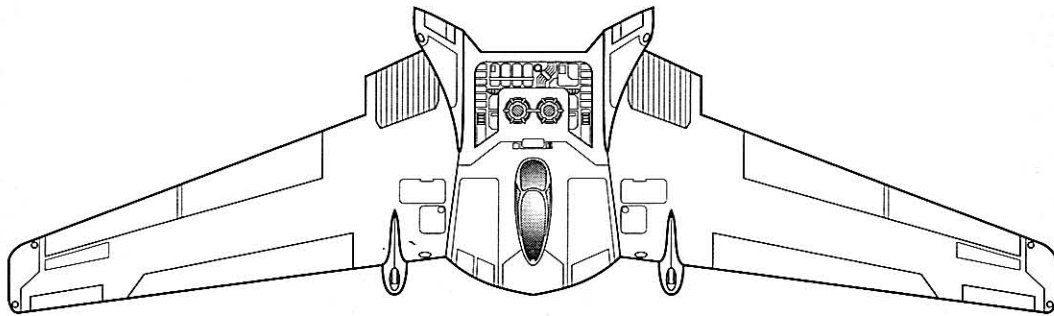

FORWARD
▼

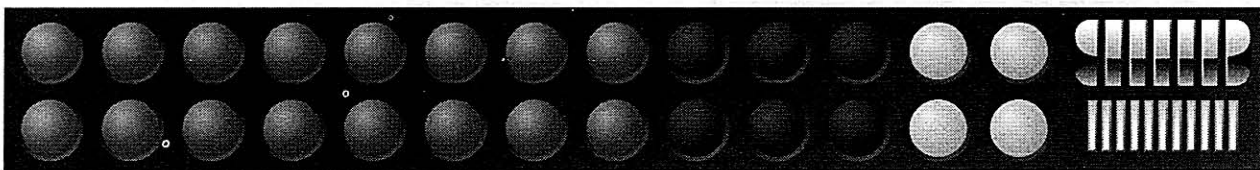

Scout Shuttle

Based on the success of the *Lambda*-class shuttle established among Imperial outposts, Sienar Fleet Systems designed the *Mu*-class shuttle for long range applications. The exterior is quite similar to the *Lambda*, using two fold out lower stabilizers for maneuverability, though the single tall central fin has been replaced by two shorter sensor arrays. On the interior, the cockpit has been reduced to two seats and some weaponry has been eliminated to permit expansion of the passenger space and hold.

The *Mu*-class shuttle comes in two models. Model 1 has limited sleeping space, but seats 24 passengers. Model 2 meets the demands of the

comfort-minded long-range traveler by including four small enclosed cabins. The *Mu-2* also has a small galley at the rear with plenty of food storage.

Though it was originally designed for Imperial Scout platoons, the *Mu-2* is finding wider service with New Republic Scouts. Sienar Fleet Systems is continually improving their line of shuttles, and they are able to customize the *Mu-2* by trading cargo space for cabins, or vice-versa. The ability to ferry a large group to distant points makes the *Mu-2* the shuttle of choice for outpost resupply.

■ **Scout Shuttle**

Craft: Sienar Fleet Systems *Mu-2* long range shuttle

Type: *Mu*-class shuttle

Scale: Starfighter

Length: 20 meters

Skill: Space transports: *Lambda-C*

Crew: 2

Passengers: 14

Cargo Capacity: 100 metric tons; 40 cubic meters

Consumables: 6 months

Hyperdrive Multiplier: x2

Hyperdrive Backup: x20

Nav Computer: Yes

Maneuverability: 1D

Space: 5

Atmosphere: 295; 850 kmh

Hull: 4D

Shields: 1D+2

Sensors:

Passive: 25 / 1D

Scan: 50 / 2D

Search: 60 / 2D

Focus: 3 / 3D

Weapons:

Two Laser Cannons (fire-linked)

Scale: Starfighter

Fire Arc: Front

Crew: 1 (copilot)

Skill: Starship gunnery

Fire control: 2D

Space range: 1-2 / 12 / 25

Atmosphere rng: 100-300 m / 1.2 km / 2.5 km

Damage: 4D+1

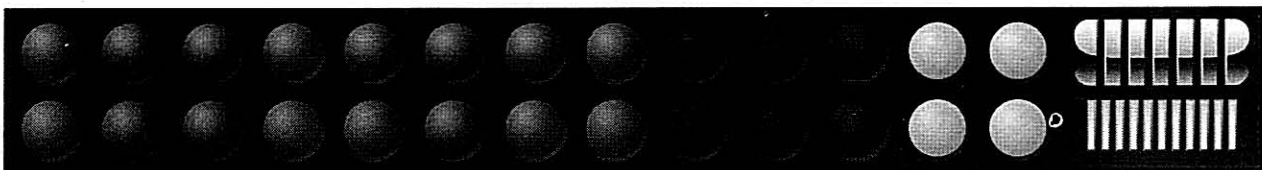
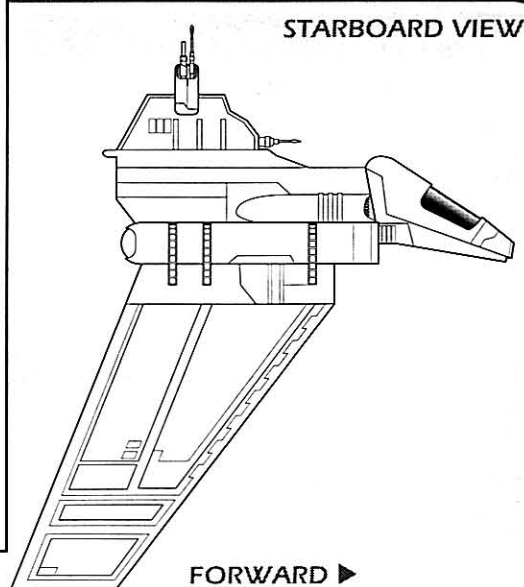

SkyBlind

Reconnaissance is one of the most important tasks for a scout. When dealing with a strange and potentially hostile world, stealth is the best policy. To meet the needs of concealed exploration of planetary systems Loronar has designed the SkyBlind. The SkyBlind has been used successfully for both military and civilian operations.

The secret to the SkyBlind is the round profile it presents to all viewing angles. The SkyBlind uses sensor masks to block active and passive sensors, electromagnetic shields to further deflect sensors and optical shields to distort visual observation. To a ground observer, the SkyBlind will appear as a discoloration in the atmosphere or a shimmering patch, easily confused with natural phenomena.

The small cargo space is enhanced by the inclusion of a small landing sphere. The landing sphere is powered by repulsorlift technology and is air- and watertight, but cannot travel far from a source of gravity such as a planet. If the landing sphere is not carried, the cargo space is doubled.

■ SkyBlind

Craft: Loronar SkyBlind Recon Ship
Type: Reconnaissance scoutship
Scale: Starfighter
Length: 21 meters
Skill: Space transports: SkyBlind
Crew: 1
Passengers: 7
Cargo Capacity: 50 metric tons; 20 cubic meters
Consumables: 6 months
Hyperdrive Multiplier: x3
Hyperdrive Backup: x20
Nav Computer: Yes
Maneuverability: 0D
Space: 2
Atmosphere: 225; 650 kmh
Hull: 6D
Shields: 3D (shields apply to defense against sensors as well)

Sensors:

Passive: 50 / 2D
Scan: 30 / 1D
Search: 50 / 2D
Focus: 3 / 3D

Weapons:

One Proton Torpedo Launcher

Scale: Starfighter
Fire Arc: All
Crew: Pilot
Skill: Starship gunnery
Fire control: 0D
Space range: 1 / 3 / 7
Atmosphere mg: 50-100 m / 300 m / 700 m
Damage: 7D

■ Landing Sphere

Craft: Loronar Landing Sphere
Type: Surface to starship transport
Scale: Speeder
Length: 6 meters
Skill: Repulsorlift operation: SkyBlind landing sphere
Crew: 1
Passengers: 7
Cover: Full
Cargo Capacity: 5 metric tons; 2 cubic meters
Consumables: 1 week
Move: 225; 650 kmh
Maneuverability: 0D
Body Strength: 5D
Shields: 1D (shields apply only against sensors)

Sensors:

Passive: 5 / 0D
Scan: 10 / 1D
Search: 15 / 2D
Focus: 1 / 2D

Weapons: none

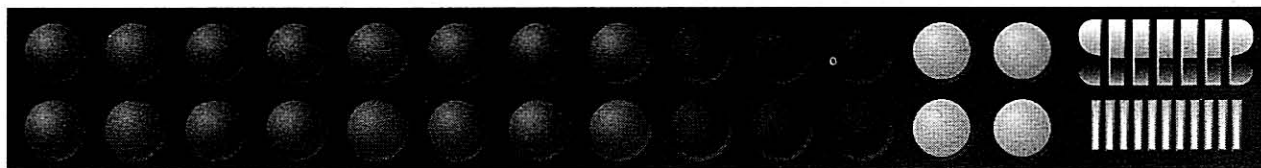
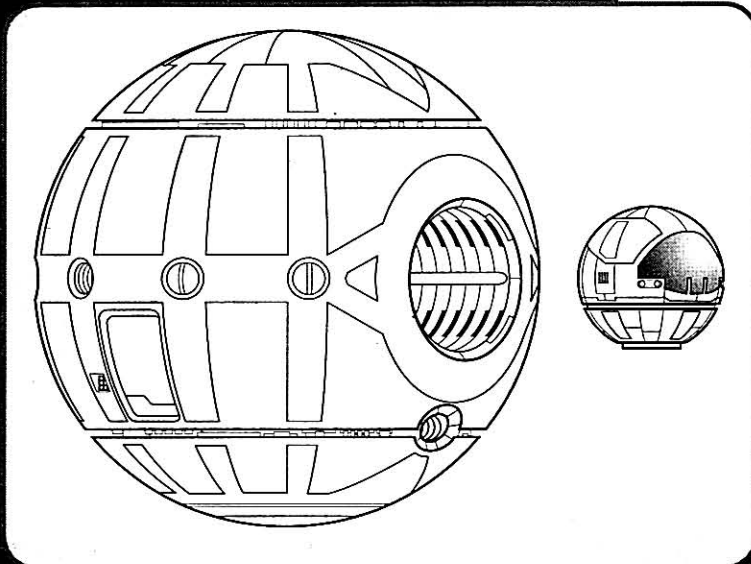

Star Seeder

Scouts are commonly used to accompany colony ships to new worlds. On these missions, scouts are essential for their knowledge and experience when dealing with new worlds. Scouts may travel in their own ship alongside a colony vessel, or may be employed as part of the colony ship's crew. Any scouts in the crew of a colony ship are treated with great respect by the colonists, since they know that without the scout the colony may be doomed from the start.

The KDY Star Seeder has been a popular choice for groups of between 200 and 800 colonists. The Seeder can run with a small crew for its size and has ample space for cargo. The cargo area has been adapted to the needs of colonists by use of compartmentalized space for plants, livestock, building material, Droids, etc. The hangar bay of the Star Seeder comes complete with a small shuttle, air speeders, underwater speeders and land tractors. Walkers can be added as needed to fit the needs of the colony.

■ Star Seeder

- Craft:** Kuat Drive Yards Star Seeder
- Type:** Colony ship
- Scale:** Capital ship
- Length:** 250 meters
- Skill:** Capital ship piloting: KDY Seedship
- Crew:** Skeleton: 143, with Command 4D+2; Total: 550
- Crew Skill:** Capital ship piloting 3D+2, starship shields 3D, starship sensors 3D+2, scanning planets 4D+1, astrogation 4D, capital ship gunnery 3D, survival 4D, medicine 4D+2
- Passengers:** 800
- Cargo Capacity:** 7500 metric tons; 3000 cubic meters
- Consumables:** 5 years
- Hyperdrive Multiplier:** x3
- Hyperdrive Backup:** x15
- Nav Computer:** Yes
- Maneuverability:** 1D
- Space:** 4
- Atmosphere:** 280; 800 kmh
- Hull:** 2D
- Shields:** 1D
- Sensors:**
 - Passive:* 40 / 0D
 - Scan:* 75 / 1D
 - Search:* 250 / 4D
 - Focus:* 5 / 5D
- Weapons:**
 - Six Turbolaser Batteries**
 - Fire Arc:* 2 front, 2 back, 1 left, 1 right
 - Crew:* 1 per gun
 - Skill:* Starship gunnery
 - Fire control:* 0D
 - Space range:* 3-15/35/75
 - Atmosphere mg:* 6-30/70/150 km
 - Damage:* 3D
 - Tractor beam projector**
 - Scale:* Starfighter
 - Fire Arc:* Front and down
 - Crew:* 2
 - Skill:* Capital ship gunnery
 - Fire control:* 1D
 - Space range:* 1-5/15/30
 - Atmosphere mg:* 2-10/30/60 km
 - Damage:* 4D

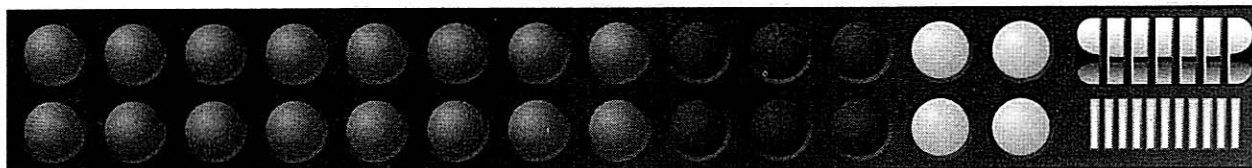
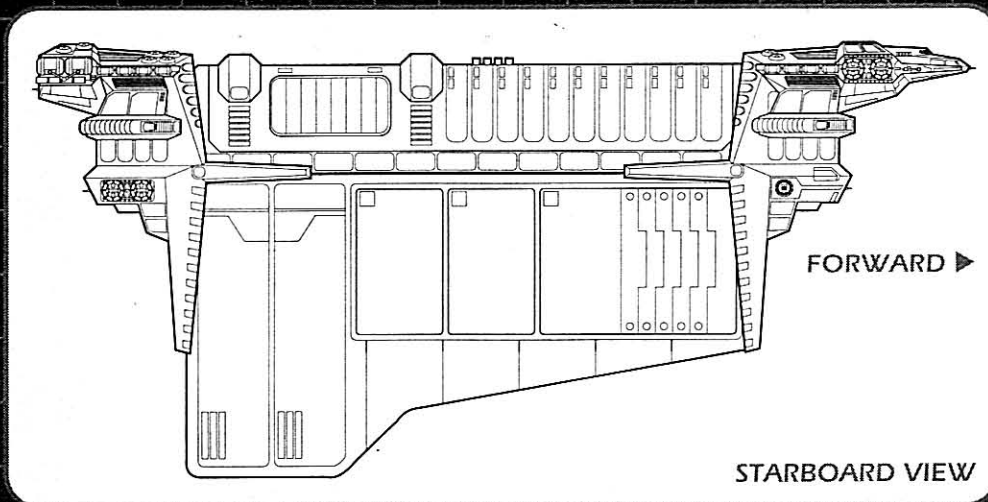

Vangaard Pathfinder

One of the most successful of all the privately owned ships still in service is the Pathfinder, originally designed and produced by Vangaard Industries as a cutting edge, one-man scout. Needless to say, since the Pathfinder was introduced 63 years ago, some technological advances have been made. The Pathfinder was one of the first ships of its size to include both a hyperdrive generator and computer-assisted weapons.

The reason that the Vangaard corporation stopped production of the Pathfinder model was that several ships were lost due to explosions in their power supplies caused by shield overloads. The original design idea was to create shields that would absorb damage and channel the energy back into the weapon systems. This worked to a point. If the shields were hit with enough energy, the ship's power system overloads and drops the shields.

Aside from that slight flaw, the Pathfinder is still a top choice for independent scouts. It is a cheap, reliable ship. Easily handled by a crew of one or two. It has ample room for either passengers or cargo.

■ Vangaard Pathfinder

- Craft:** Vangaard Pathfinder
- Type:** Small fighter/Scoutship
- Scale:** Starfighter
- Length:** 36 meters
- Skill:** Space transports
- Crew:** 1
- Passengers:** 2
- Cargo Capacity:** 100 metric tons; 40 cubic meters
- Consumables:** Six months
- Hyperdrive Multiplier:** x3
- Hyperdrive Backup:** x15
- Nav Computer:** Yes
- Maneuverability:** 1D
- Space:** 4
- Atmosphere:** 350; 950 kmh
- Hull:** 3D
- Shields:** 3D
- Sensors:**
 - Passive:* 30/0D
 - Scan:* 45/1D
 - Search:* 60/2D
 - Focus:* 5/3D
- Weapons:**
 - One Laser Cannon**
 - Scale:* Starfighter
 - Fire Arc:* Turret
 - Crew:* Pilot
 - Skill:* Starship gunnery
 - Fire Control:* 0D
 - Space Range:* 1-5/15/20
 - Atmosphere Range:* 2-10 /30/60 km
 - Damage:* 3D (special)

Notes: The Laser cannon's special damage is that for each shot absorbed by the shields, the damage of the gun goes up by +1. When the shields absorb 3 hits, the generator overloads and shuts down for 3 rounds while it recalibrates. Both the +1 and the overload effect reset to zero after ten rounds automatically. The generator can be replaced at a cost of 10,000 credits, but it then loses its additive damage value.

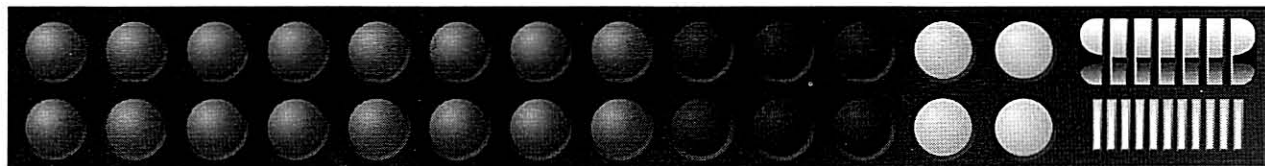
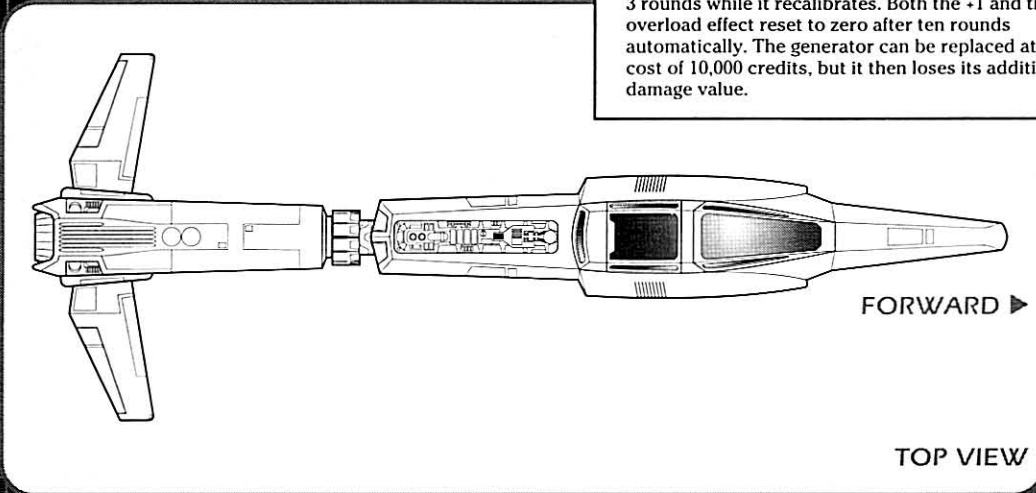

Star Cab

The Star Cab is easily *the* oldest ship still in service. It dates back to the time before hyperdrive units were totally reliable. While the vast majority of modern-day scouts employ ships with current hyperdrive units, every so often an old timer will turn up in one of these ships. These ships put across the void between the stars, pausing only to refuel and log another world. While this lifestyle may not be to everyone's liking, there are some out there who know no more of the modern universe than their ships.

The Star Cabs include a full complement of Droids that handle the day-to-day operation of the ship, including a Droid which may well be the ancient predecessor of the R2 unit that handles all navigation. The Star Cabs are equipped with an enormous complement of weapons. More than may seem necessary in this more enlightened day and age, but we must remember, the galaxy was a much wilder place back in the Star Cab's heyday.

An interesting side note: many of the old-time scouts who man these ships *hate* the Droids often necessary for their continued operation. This "personality conflict" makes for less-than-stellar performance from these Droid crews, and a high rate of Droid turnover should be expected.

■ **Star Cab**

- Craft:** Orlean Star Explorer
- Type:** Ancient Exploration Vessel
- Scale:** Starfighter
- Length:** 70 meters
- Skill:** Space Transports
- Crew:** 1 Human, 3 Droid
- Passengers:** 11
- Cargo Capacity:** 100 metric tons; 40 cubic meters
- Consumables:** 5 years
- Hyperdrive Multiplier:** x10
- Hyperdrive Backup:** NA
- Nav Computer:** None (astromech Droid)
- Maneuverability:** 1D
- Space:** 8
- Atmosphere:** 365; 1050 kmh
- Hull:** 4D
- Shields:** 0D
- Sensors:**
 - Passive:* 10 / 1D
 - Scan:* 15 / 2D
 - Search:* 25 / 3D
 - Focus:* 3 / 3D+3
- Weapons:**
 - Four Blaster Cannons**
 - Scale:* Starfighter
 - Fire Arc:* 2 Front, 2 Rear
 - Crew:* 1 per Gun (usually Droids)
 - Skill:* Starship gunnery
 - Fire Control:* 0D
 - Space Range:* 1-4 / 15 / 20
 - Atmosphere Range:* 100-400 m / 1.5 km / 2 km
 - Damage:* 2D

STARBOARD VIEW

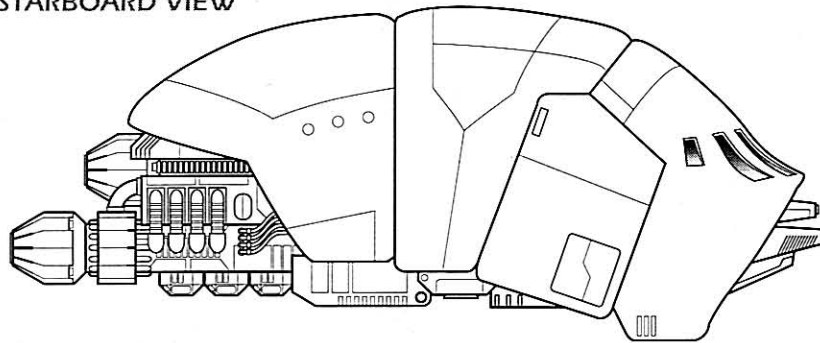

FORWARD ►

John Paul Lona

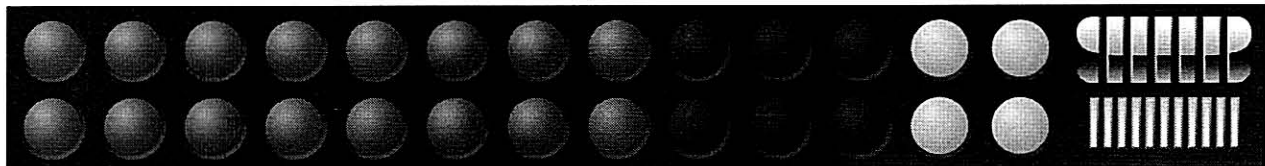

MRX-BR Pacifier

Back before the galaxy reached its current, enlightened state, some members of the Scout Corps had a less politically correct view on contact with new races, this is where the MRX-BR Pacifier comes in. The Pacifier is designed to act as either a high-tech contact vessel or as a powerful assault vessel. It is equally adept at either. Equipped with some of the most powerful sensor arrays built in its time, the Pacifier is able to count the leaves on a particular tree from

orbit. Its powerful weapons are computer controlled to enable maximum carnage with minimal effort.

Due to the recent change in public mood (the New Republic), MRX-BR Pacifiers are seeing less use in recent months and are making their way to used ship lots in droves.

The Pacifier was the scout vessel of choice for the Empire.

TOP VIEW

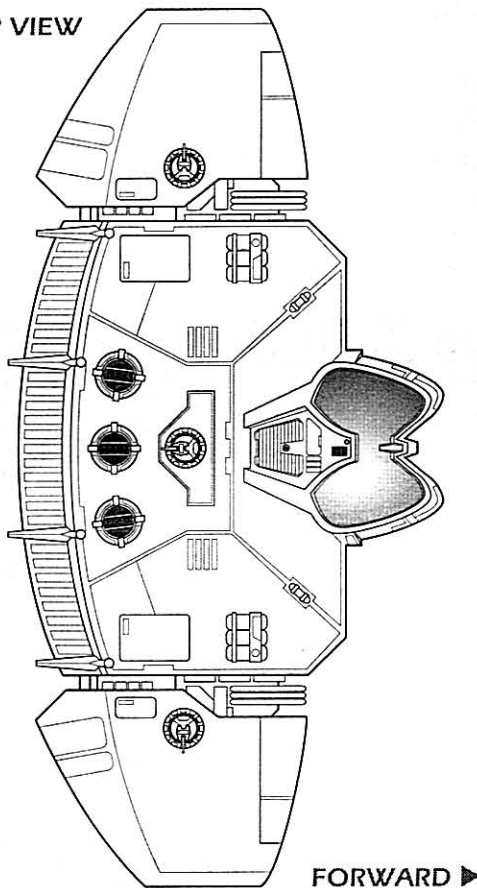

■ **MRX-BR Pacifier**

Craft: Sydon Vehicle Works MRX-BR Pacifier combat/contact vessel

Type: Exploration Fighter

Scale: Starfighter

Length: 25 meters

Skill: Space transports

Crew: 1

Passengers: 3

Cargo Capacity: 25 metric tons; 10 cubic meters

Consumables: 1 year

Hyperdrive Multiplier: x1

Hyperdrive Backup: x8

Nav Computer: Yes

Maneuverability: 1D

Space: 7

Atmosphere: 600; 1200 kmh

Hull: 2D

Shields: 2D

Sensors:

Passive: 30 / 1D

Scan: 60 / 2D

Search: 120 / 3D

Focus: 10 / 3D+2

Weapons:

Two Proton Torpedo Launchers

Scale: Starfighter

Fire Arc: Front

Crew: 1 (Gunner)

Skill: Starship gunnery

Fire Control: 2D

Space Range: 1/3/7

Atmosphere Range: 50-100/300/700m

Damage: 9D

Three Laser Cannons

Scale: Starfighter

Fire Arc: One Rear, One each side

Crew: One Each (Gunner)

Skill: Starship gunnery

Fire control: 3D

Space Range: 1-3/12/25

Atmosphere Range: 100-300/1.2km/2.5km

Damage: 3D

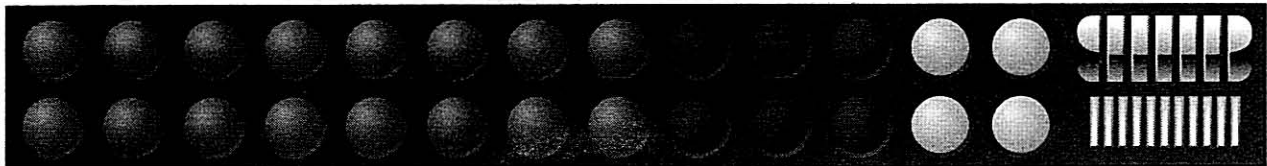

Trilon Mining Barque

Scouts have often supplemented their incomes through various side enterprises. One of the most popular is mining. The risk is minimal and the chance for reward great. This is why the Trilon Mining Barque is such a common ship.

The Trilon Barque is equipped with an enormous cargo hold and contains complete equipment for testing and processing various ores and valuable metals. The Mining Barque has a specialized sensor array, used to detect precious and semi-precious metals and minerals. The ship can then be parked over the mineral vein, where the automated mining equipment built into the underside of the hull can be employed. Organized in a tight ring formation, there are several small, but powerful, cutting blasters on the barque's underside that can be used to methodically and surgically strip away rock and dirt to get to the rich mineral rewards below.

Some less reputable scouts have found that the ship is also ideally suited for the pillaging of low-tech worlds. The underbelly lasers can cut through some of the hardest substances known in the galaxy and can carve through the average bank vault in nanoseconds.

■ **Trilon Mining Barque**

Craft: Trilon Inc. Mobile Mining Vehicle
Type: Work Ship **Scale:** Starfighter
Length: 80 meters **Skill:** Space Transports
Crew: 3 **Passengers:** 6
Cargo Capacity: 3000 metric tons;
 1000 cubic meters
Consumables: 4 months
Hyperdrive Multiplier: x4
Hyperdrive Backup: x9
Nav Computer: Yes **Maneuverability:** 0D
Space: 2 **Atmosphere:** 100; 400 kmh
Hull: 3D **Shields:** 1D
Sensors:
 Passive: 100 / 1D *Scan:* 200 / 2D
 Search: 400 / 3D *Focus:* 50 / 4D

Weapons:

Turbolaser

Scale: Starfighter
Fire Arc: Front
Crew: 1 (Pilot or Gunner)
Skill: Starship gunnery
Fire Control: 1D
Space Range: 3-15/35/75
Atmosphere Range: 300-1.5km/3.5km/7.5km
Damage: 2D

Heavy Mining Laser*

Scale: Capital
Fire Arc: Bottom
Crew: 1 (Gunner)
Skill: Starship gunnery
Fire Control: 0D
Space Range: 1/3/7
Atmosphere Range: 30-100/300/700m
Damage: 3D

*Note: While the Heavy Mining Laser was designed for strip mining on planets, it has occasionally been adapted by daring and unscrupulous scouts and pirates as a deadly ship-destroying weapon. If a pilot can "land" it on top of another vessel — or fly right above it — the laser can cut through the hull of most small ships quite easily.

STARBOARD VIEW

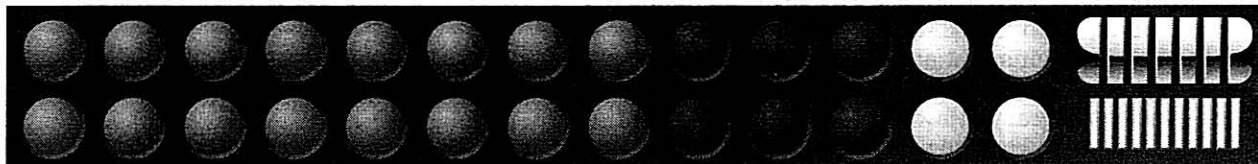
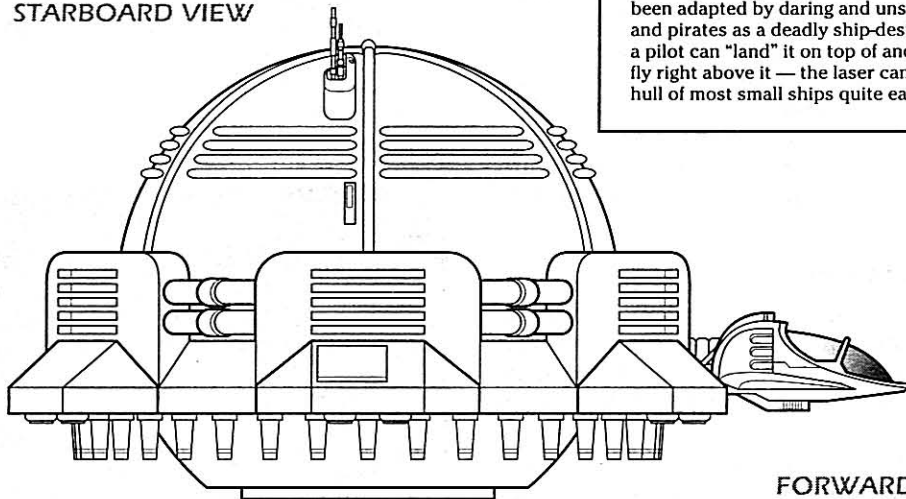

Chapter Five Equipment

"A scout can make herself at home with a breather, blaster and repulsor hitch as her only tools. They are your friends and should always be treated kindly."

— Spaceguide

"Remember what Burt Jaxton says, kid. A scout is only as good as his equipment. Take care of it like it was your own mother and it'll treat you right. Why, one time I can remember ..."

— Burt Jaxton to an unwilling listener

Corporate Scout Equipment

Just as there is a disparity in the type of ship used by the two common classes of scouts, so it is with equipment. The common equipment available has been separated into two distinct groups.

Keep in mind that the equipment presented for the corporate scout is the finest available in the galaxy. It is not normally obtainable by any but a handful of the galaxy's richest citizens. It is often used on the most important missions by agents of the galactic mega-corporations, with very stiff fines levied against those who damage or lose it.

Scout Companion Droid

Scout Companion Droids are designed to accompany a scout during the exploration of new territory. These Droids have extensive sensor capabilities in odor, hearing, infrared, and vision for detecting the presence of approaching objects or life forms, and provide an alternate method of communications to the scout's ship. They use four-legged walker technology for locomotion, and have specially adapted "jaws" that allow them to lift or drag their Scout when necessary. Their ability to *hide* and *search*, combined with their *security* skill allows them to locate their scout and attempt a rescue if necessary. The extensive sensor capabilities along with the grasper jaw limit verbal communication to a narrow range of warning sounds.

Exploration Droid

Model: Cybot Galactica F1 Exploration Droid

Height: 1 meter

Move: 10

DEXTERITY 2D

KNOWLEDGE 1D

Survival 4D

MECHANICAL 2D

Communications 2D, Sensors 5D

PERCEPTION 1D

Hide 2D, Sneak 2D, Search 3D

STRENGTH 1D

Lifting 2D

TECHNICAL 1D

Security 2D

Standard Equipment: Four legs, Heavy grasper jaw, designed for holding without crushing, Video, hearing, and odor sensor arrays attached to a "head," Movement sensor, Communications link to the ship computer extending from the rear of the body.

Companion Droid

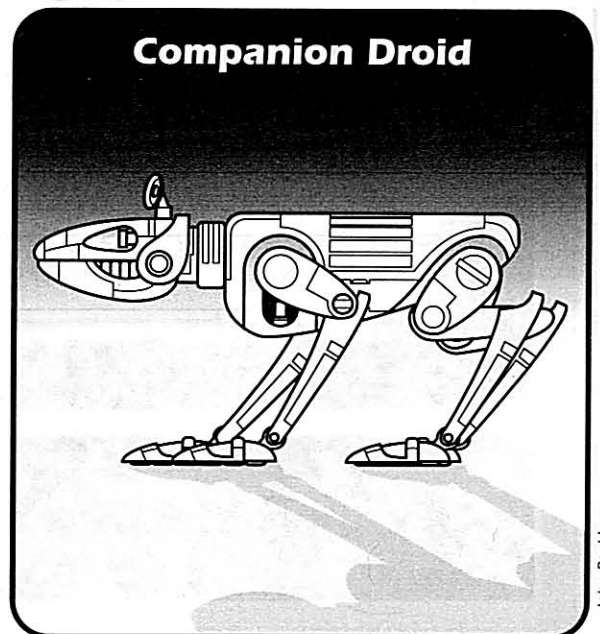

John Paul Lona

MULE Droid

The Mechanical Universal Labor Eliminating Droid, or MULE as it is more commonly known, is used to pack and carry personal equipment, supplies, and more. The mule uses a strong, steady — but slow — repulsorlift to move over rough or even terrain with equal ability.

The MULE was also designed with a self-repair feature. While the Droid itself cannot effect repairs, it can use its *Droid programming* and *Droid repair* skills to help a scout perform the repairs (use the “Combined Actions” rules in *Star Wars: The Roleplaying Game, Second Edition*, pages 68–70).

Model: Mechanical Universal Labor Eliminating Droid, PackTack 41LT-R

Height: 1.5 meters

Move: 7

DEXTERITY 1D

KNOWLEDGE 1D

MECHANICAL 3D

Repulsorlift operation 4D+1*

PERCEPTION 3D

Search 3D+2

STRENGTH 6D

Lifting 7D

TECHNICAL 2D

Droid Programming 4D, Droid Repair 5D

Equipped With:

- One heavy lifting claw
- One large storage bay (2 cubic meters) protected by +1D armor
- One repulsorlift, max altitude one meter

Armor

Designed both for protection against the environment and fellow stellar adventurers, armor worn by scout personnel tends to be eclectic and versatile. It isn't the best armor available, but it is often the best available for certain situations.

Scout Armor

Worn when exploring environments where life forms have been detected. Adds 2 pips against damage, but does not affect *Dexterity*. It is usually sold with breather and heater units, so it can be used in areas of little or no atmosphere ... but not the vacuum of space.

Lightweight armor

Made from two body-glove sections of camouflage cloth, this armor is used for reconnaissance and light survival missions. The helmet contains a Breath Mask with extended filter (lasts up to 6 hours) and Macrobinoculars have been fitted into the visor. There is a utility belt with several pouches and it is usually worn with an integrated version of the Multipack (described below). Add

one die to all *sneak* actions while in natural terrain, and +1 pip to the character's armor value.

Thinsuit

Used for protection against potentially hazardous atmospheres, the thinsuit provides limited protection against chemical exposure, good for up to 18 hours against most known atmosphere types. Includes a Breath Mask with extended filter (lasts up to 6 hours), with easy access storage for up to five more filters. Provides no protection against blaster damage, but resists tearing, slashing, and puncturing to the extent of +1 pip against such attacks. The thinsuit can actually be worn in space, providing heat and protection for nearly one hour — of course breathing is a problem.

Bulk Exploratory Armor

A model seldom worn by the scouts, the BEA is designed to stand up to the harshest weather or atmosphere any person would need to interact with. Complete with rebreather and oxygen cylinders, the BEA is often worn in place of the standard space suit when a scout needs to perform EVA. The bulky suit has a *Dexterity* penalty of one die, but also an armor bonus of one die. It is equipped with removable weight boots and magnetic soles, and most BEAs have small tool and utility belts. The helmets have comlinks built in, as well as overhead flashlights.

Miscellaneous Equipment

Survey Datapad

A datapad especially adapted to recording survey data, including mapping, the survey datapad is a flat computer with a variety of uses. A special sensor array is available that attaches to the survey datapad to record accurate mapping information based on movement computed by actual motion as measured by bouncing electromagnetic rays off of the Scout ship in orbit. Alternatively, the scout can have the datapad's sensors track his progress for a point of reference — or several points of reference. The scout can also enter data without interfering with this mapping, and call up preloaded encyclopedia information. While the memory on the datapad is small, it can store basic language functions, notes, and mapping software with ease.

Cutting Blaster

Used for creating trails in densely overgrown environments, the cutting blaster is not designed for accuracy, and is therefore not as strictly restricted as weapons-quality blasters. However, when in need, anything a Scout carries can be used in any way necessary to ensure survival.



The cutting blaster produces a "cold blast"; a prolonged burst that can be used to cut down brush or even small trees. The pulse lasts nearly a second and a half. The burst is labelled "cold" because it is very unlikely the pulse will start a fire or throw sparks. Unfortunately, the weapon's magazine requires nearly four hours to recharge off a typical ship's power system, or three hours at a commercial recharger. This is not due to the amount of energy stored, but the way it is contained.

Model: BlasTech DL-68 Cutting Blaster

Scale: Character

Skill: Blaster: Cutting blaster (-1D due to inaccuracy)

Ranges: 2-4/7/10

Damage: 5D

Ammo: 50

ThinHut

The ThinHut is made of a slightly thicker version of the material used in the Thinsuit, but with a 30-hour exposure time to most alien atmospheres. The ThinHut provides a small, three cubic meter shelter against cold and atmosphere. Like the thinsuit, it is resistant to tearing, slashing, and punctures. The ThinHut can be folded by an experienced scout into a packet no larger than a datapad, and considerably lighter. While it is no good in a vacuum, it is a great relief to scouts operating on hostile worlds.

Portable Heater

A thin square of specially formulated ceramic, the portable heater can provide enough heat to keep a scout alive within an enclosed area of a maximum of 3 cubic meters in temperatures down to -75 degrees C for several days, perhaps a week or two with careful regulation.

Universal Recharger

This special recharger has been built to endure the hardships of the scouting life, and is adapted to charge most of the special tools carried by a scout. These include the Cutting Blaster (recharge time 4 hours), the heaters on the BEA (about 20 minutes) and the Portable Heater (recharge time 3 hours if not in use, 5 hours if recharged while in use). A special interface allows the scout to plug in all three at once, and program charging priorities through a simple keypad. The UR has enough energy to recharge twenty hours worth of power. It takes twenty hours to recharge the UR from a spaceship or 18 from a commercial recharger.

Rations

Dehydrated and specially formulated for complete nutrition, with an emphasis on protein, carbohydrates, and the vitamins and minerals most rapidly depleted under adrenaline surges, the scout's rations are not very tasty. They are very compact, however, and every scout keeps several days' worth available at all times. The rations do not deteriorate as long as the original wrapping is intact, and some scout ships have been found to have nearly all of their original supply even decades after their commissioning run. Many scouts would rather go hungry than eat this nourishment, but none will die of starvation.

HydroExtractor

The hydroextractor is a necessary companion in inhospitable climates. It is capable of extracting a liter of nearly 100% pure water from most local alien water in 5 minutes or from a dry atmosphere in 4 to 12 hours. Less time is needed to

extract water from a humid atmosphere. The only problem with the hydroextractor is that it needs to be recharged after each use — about one hour using the recharger.

MiniLab

The minilab is capable of a wide range of chemical and biological analyses, but with far less accuracy than the shipboard lab facilities. The minilab allows a rough determination of the elemental structure of a substance, its relative age, and an analysis of secondary compounds. The minilab is very good for storing samples in laboratory conditions as well, and its pack can carry one liter (in volume) of most substances — liquid, gaseous, or solid.

Repulsor Hitch

Attached to an object weighing up to 200 kilos, the repulsor hitch allows the scout to transport otherwise immovable objects. This is especially useful when capturing alien animal species for inclusion in the survey. There is a special attachment on the MULE Droid (see above) for hookup to a hitch as well.

Multipack

An essential element of any scout's outfit, the multipack is designed to have a place for everything the scout needs to carry. Standard equipment includes the following:

- 3 Medpacs
- 2 Glow Rods
- 2 Breath Masks
- 24 Breath Mask Filters
- 1 Week's Rations

Special pockets and/or attachment points are included for the following:

- Survey Datapad
- Cutting Blaster
- Vibroblade
- ThinHut
- Portable Heater
- Universal Recharger
- HydroExtractor
- Thinsuit/Thinhut Patching Kit

Mechgill

This device resembles a rebreather unit, but enables oxygen to be extracted from most liquid mediums. Operates for six hours on a full charge at depths of up to 10,000 meters.

Claim Beacon

The auto beacon is useful to the frontier scout. The beacon is able to be quickly set up on the site of a newly discovered planet and beams a continuous message of ownership into the system. This message of ownership is recognized by all members of the Brotherhood of Independent Scouts. This device allows a scout to protect his claim on a world while traveling back to register it.

Unfortunately, the beacon is also recognized by the unscrupulous. As a result, many scouts have finally found a use for the thermal detonator. Hooked into the beacon's stabilization mechanism, the thermal detonator can be rigged to explode if someone is so rude as to take the beacon or try to download system information from it. This is not a standard option for the claim beacon, but it is so commonly done as to necessitate listing.

Chapter Six

Scout Bases

"Even the most hardened scout needs a break from the action."

— *Spaceguide*

The New Republic Scout Service maintains two headquarters: one is primarily political and the other is for normal operations. Both headquarters facilities have complete data base records for the Scout Service, and can serve as starting points for missions.

The Core Post is the official headquarters for the Scouts and is located at the New Republic capital world of Coruscant. The scout headquarters is located near the spaceport in Imperial City, away from most of the other government buildings. Associate Councilor Miwa Oyev, in charge of exploration, has her offices at scout headquarters. The Coruscant headquarters employs about 2000 people including librarians, map makers and data analysts, as well as a number of government bureaucrats to keep the Scout Service funded by the New Republic. The Core Post offers complete food, drink and lodging to any scouts who are on the capital world.

The Core Post is also home to the main offices of the Nova Core. Among the scouts there are individuals who are known for amazing feats for the service. Amazing feats include heroic deeds, fantastic discoveries and extended missions to the Unknown Regions. As a reward for outstanding performance the New Republic Scout Service has set up an organization called the Nova Core. The members of Nova come from all parts of the Scout Service. All members have at least two years working for the Scout Service and visits to

Miwa Oyev

The second headquarters is Ops Post on Xoemefel. Ops Post is the biggest home base for scouts. Captain Hug'rer is in charge of Ops Post and directs the day to day activities of the Service. Hug'rer is also the head of the Survey and Ops Post usually has new information well before it reaches Core Post. The Ops Post complex covers 20 square kilometers.

at least five new worlds. A new world is one which has no record of a visit by the Survey. New worlds can include visits to old, but forgotten colonies, secret Imperial bases in the Wild Space, or home worlds of alien species that have not been catalogued by the New Republic. Of course, a brand new discovery also counts.

To become a member, a character must meet the service requirements and get an invitation from an existing Nova member. There is a four person limit on the number of new members that come from any one sector in one year, so the member must have obtained approval from the Nova central office. After invitation, there is an initiation for potential members. The initiation is usually a set Survey mission to a strange world, or a mission to retrieve some life form from the Unknown Regions or Wild Space. These initiations are set up on a sector-by-sector basis and held only once a year with all new members in that sector participating.

Members of Nova represent the best qualities that scouts are known for. The legendary deeds of the scouts are usually told at a cantina and not in the official Survey report.

Frontier Posts

The Scout Services maintain small facilities on nearly five thousand worlds. The frontier posts are usually automated affairs, maintaining only a skeletal crew of three or four. Frontier posts provide food, drink, lodging, equipment, ship repair, and all other vital services to the scout on the go.

Due to the vast numbers of these small scout posts, the main service has quite a problem with regulating them. Because of this, there is a problem with disreputable men using these posts to take advantage of the system. There are reports of some frontier posts marking up their goods as much as one thousand percent over their actual market value. As much as this is a problem, there is little that the scout can do when he needs tools

other than pay, and pay well. He can report them to Scout Main at a later date and hope that some day, something will get done.

These Frontier Posts are the main clearing house for up to date information of nearby systems. Scout Main has more info, but since several of the more active scouts never get back to Main Base, most of their data on the fringe is years out of date.

The Frontier Posts are where scouts on the move go for their mission assignments and for rest and relaxation when not on the job.

Mission Assignments come from Core Post directly, it is then up to the individual Post commander to assign a crew. It is rumored that graft and blackmail are the two most common tools used by Post commanders to hand out the plum assignments. Whether or not this is true is a matter of speculation, although it is odd the way certain scouts get the highest paying and lowest risk jobs.

Rest and relaxation is of great importance on the frontier. Space madness caused by thousands of hours in unexplored space is the primary foe of the Service. Frontier bases have some of the most advanced entertainment facilities in the galaxy, with holoivid theatres, computerized libraries and other entertainments. Some of the larger ports have even brought back the custom of live entertainment tours which are sponsored by the Scout Service.

Colony Bases

Once a system has been thoroughly explored by the Scout Service, its brother branch, the Colony Authority moves in. The demand for habitable worlds has grown enormously since the dawn of the New Republic. Entire races of beings were dispossessed by the Empire and now it is up to the Colony Authority to provide new, safe homes for them.

Colony bases are constructed on newfound worlds, generally within 6-8 months of their discovery and investigation. These bases take the form of a small spaceport and prefab living quarters for five to ten thousand settlers. Businesses



are encouraged to settle on the new world by the New Republic with offers of tax credits and other inducements.

The Colony Authority provides raw supplies and monetary support for the colony during the first three years, as well as a small police force. At the end of the three years, the colony should be self sufficient. It is then expected to join the New Republic as a full member.

Military Attachments

The New Republic provides military support for the scouts and the Colony Authority. Occasionally, the Scouts will run across an alien race that is either too aggressive or too primitive to be brought into the galactic brotherhood. When this happens the scouts call on the Military.

The Scout Service has over 5,000 military ships and 50,000 men at its disposal. The troops are kept at combat ready at all times, with good reason. There has not yet been a month when the Scout Service has not had to deploy troops.

Chapter Seven

Aliens, Creatures and Planetary Features

"Observing unusual life forms is the highlight of any survey mission. Experienced scouts often can determine the role of a life form in its local ecosystem with some careful examination."

— New Republic Scout Service *Spaceguide*

"Exotic life forms are interesting, provided they don't try to eat you. Or bury you. Or keep you as a pet. Always keep your distance until you've figured

out how the thing is likely to react to you or you may end up being dinner."

— Cavaaks, Independent Scout

Life Forms

If there is one thing that never ceases to amaze most scouts, it is the diversity of life in the galaxy. Life forms take all manner of shapes, sizes and

From the Catalog of Intelligent Life in the Galaxy ...

Life possesses certain characteristics. These are:

- **Organization:** Every living organism has a distinct form and appearance.
- **Irritability:** Living things respond to stimuli, such as physical or chemical changes in their environment.
- **Metabolism:** All organisms harness and utilize energy in order to stay alive. This process usually takes the form of chemical reactions.
- **Reproduction:** As a species, living organisms create more living organisms (via a series of chemical reactions).
- **Adaptation:** Organisms adapt to changes in their environment. Some even cause the changes to which they must adapt.

Life forms, when found in their natural habitat, existing alongside other creatures in that habitat, are part of an ecosystem. As each scout ventures to a new world and a new climate, the scout is going to come across a few ecosystem

that should be examined, analyzed and hopefully understood.

Each life form exists for one reason: survival of the species. Each life form's genetic programming forces it to undertake certain activities which will lead to the continued survival of that species, while individual life forms have to contend with predators, diseases and changing environments (some creatures significantly change the environment themselves).

The pinnacle of achievement for a life form is to evolve intelligence. As a result of various environmental factors, some species follow the path not of physical advantages, but of cunning and the capacity for abstract thought. It is intelligent life forms that are of the greatest interest to scouts and the Known Galaxy. Intelligent life can make major changes to the environment that will make intelligent life easy to spot. Finding an intelligent life form is not enough. The scout is expected to make contact and determine something about the culture of the intelligent life.

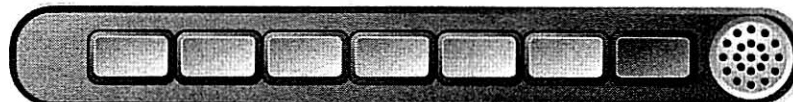

appearance, all of it for the sake of survival, and indeed, all life forms seem to tenaciously cling to survival as a species.

This chapter reviews some of the basic factors involved in designing believable creatures and new alien species, allowing the gamemaster to breathe life into the many worlds a scouts campaign will require him to create.

The famous sentientologist Obo Rin has formulated his so-called "universal definition of life," which helps identify the difference between the living and the unliving.

Niches In Ecosystems

In each type of terrain, one will encounter life forms that have evolved to deal with the special conditions of that terrain, including adaptability to common weather fluctuations, ability to deal with predators or prey, ability to find food, as well as birth, mating and sleep cycles that take advantage of the benefits of a given terrain.

Life forms of all type will exist in most environments, from simple plants to carnivores and omnivores. In each ecosystem there are a number of niches that are invariably filled. These niches are based on a food chain starting with plants and rising up to the high level carnivores. The number of creatures in a niche depends on where in the food chain that niche is. The higher the creature is in the food chain, the fewer creatures there will be occupying the niche. The basic niches are outlined below:

Plants

Plants are distinguished from animals because they synthesize energy from water, nutrients in soil and sunlight. Plants are the lowest and most common niche in an ecosystem.

Plants tend to be unintelligent, immobile and typically possess only passive defenses, such as burrs. Certain plants will dominate an ecosystem, such as trees in a forest, but many other plants will also exist. Some general types of plants include trees, shrubs, succulents (like cacti), small flowering plants, and ground cover (like grass). Many plants produce seeds, fruits or berries, which are spread around the environment by the activities of animals.

Herbivores

Herbivores are creatures which derive their nourishment by eating plants, and are the next step up the food chain from plants. They are far more common than carnivores, since they tend to be prey for carnivores. Sizes can range immensely, from microscopic, to only a few centimeters long, to several meters tall. Defenses can include acute senses, high movement speeds,

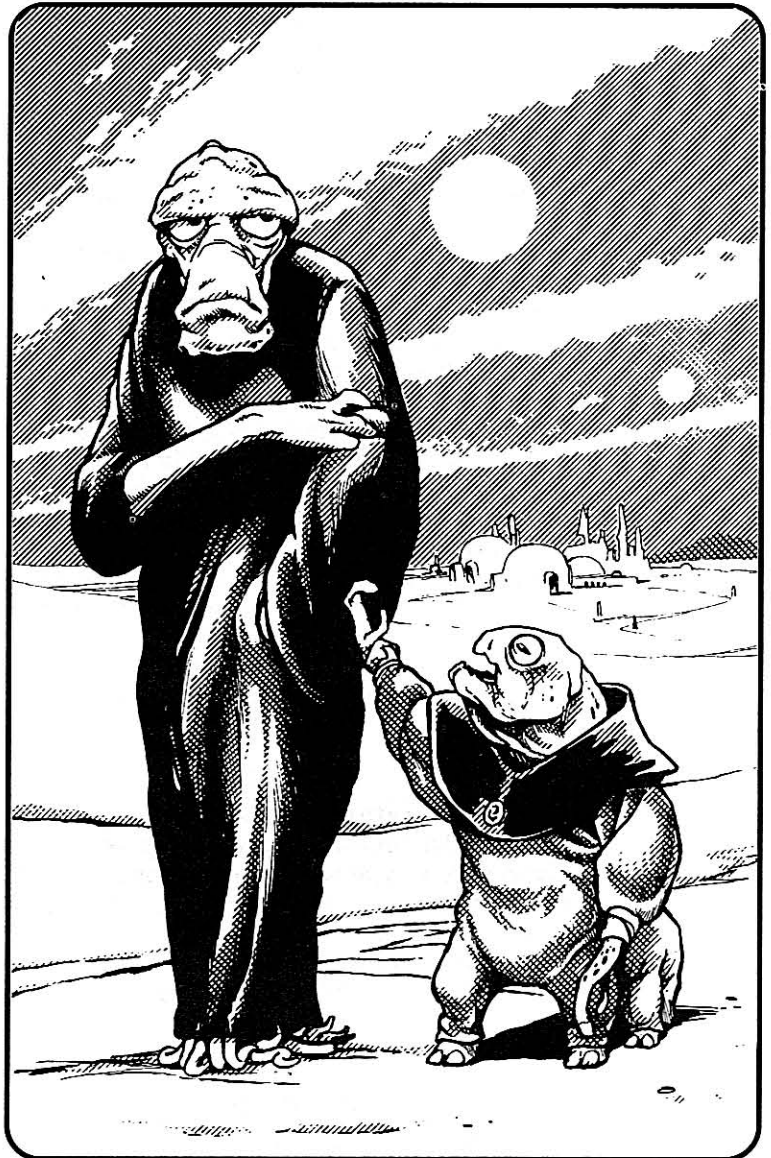

armor, and natural weapons that can be used in combat.

Most herbivores are selective in the plants they consume — very few indiscriminately eat any kind of plant. Some tend to eat only grasses, others eat fruits and berries, others thrive on roots and fungi, and still others exist only on the leaves of some plants.

Few herbivores evolve intelligence, although some of the creatures may be very clever at hiding and otherwise avoiding becoming a meal.

Carnivores

Carnivores are meat eaters, normally preying on herbivores or smaller and weaker carnivores. These creatures tend to be hunters, although there are also clever creatures which lure potential food into traps.

Each ecosystem normally has several levels of

carnivores (just as there are many kinds of herbivores), with the weakest preying on the weakest herbivores. More powerful carnivores may prey on weak and strong herbivores, as well as weaker carnivores. High level carnivores represent the top of the food chain and are few in number compared to lower level carnivores and herbivores: they require many creatures beneath them in the food chain to sustain the ecosystem's balance.

Carnivores often compete with each other, although carnivores in the same ecosystem will often evolve unique abilities that differentiate them from other carnivore species. There are few standard characteristics of carnivores: some are solitary, other animal members are highly social and hunt in packs. Some carnivores are active only during daytime, others only at night; some are highly territorial, while others are migratory. In general, like most animals, carnivores will adopt behaviors most likely to preserve and continue the species.

Carnivores can evolve intelligence as a result of the pressures of surviving in a hostile environment.

Omnivores

Omnivores are creatures that can and will eat plants and animals, and often compete with carnivores for prey, as well as preying on some of the carnivores themselves. These creatures are also highly variable, adopting whatever behaviors and evolving whatever traits are most likely to enable them to survive (those that don't evolve die out). Omnivores can often evolve into intelligent creatures.

Scavengers

Scavengers are the final primary niche in ecosystems. Scavengers survive by feeding off the remains of animals or plants after they have been killed. They are seldom as strong or dangerous as the hunters that made the kill, but do often have formidable defenses.

Devising Creatures

When devising creatures, the gamemaster must start with a creature that is to be used in the adventure. Often, a gamemaster will only have to create one or two creatures for a given adventure and not really worry about the larger ecosystem that it fits into. The gamemaster should assign die codes that he feels are appropriate to the creature in light of its environment and role in the planetary ecosystem. Because some worlds are more hostile than others, and there are countless niches that can be selected, the gamemaster's decision regarding die codes can be fairly arbitrary.

All creatures need *Dexterity*, *Perception* and *Strength* die codes. If the creature can be ridden, an *Orneriness Code* should be assigned to the creature (riders roll their *beastriding* skill against the code). The gamemaster might also elect to give the creatures extra skill dice in areas like *brawling parry*, *brawling*, *search*, *sneak* or other skills relevant to the survival of the creature.

Adaptations

The gamemaster may also choose one of several adaptations that creatures have evolved. This should be done with careful consideration for the ecosystem that the creature is to inhabit. This is only a partial list of possible factors, presented in terms of suggestions rather than specific mechanics, enabling the gamemaster to devise creatures to fit the specific needs of the adventure.

Sense: The creature has highly developed senses such as sight, smell, hearing, taste and touch (which can detect ground vibrations). The senses can be used to detect predators coming after the creature, or be used to aid it in hunting. The creature should receive bonus to *Perception* under specific conditions or with the specific sense.

Speed: The creature has great speed compared to other creatures in the ecosystem. The creature might have great endurance, and be capable of sustaining the speed for a long time, or might only be able to move at this high speed in short bursts. This ability is reflected by a high Move score relative to other creatures in the area.

Claws: The creature has claws, talons or other hard and sharp weapons on the end of its paws or other appendages. This should be reflected as a separate die code for damage, normally higher than the creature's *Strength*.

Armor: The creature has armor that can absorb physical and/or energy attacks. The armor might be in the form of hardened skin, a hard exoskeleton, a reflective skin that helps deflect energy bolts, a flexible body structure that can absorb shocks with minimal damage, or some other unusual way of absorbing damage without inflicting injury. The armor adds extra die codes to the creature's ability to resist damage without adding to its raw *Strength*.

Camouflage: The creature is colored so that it can blend into the surroundings of its natural environment. The creature might also have learned behaviors so that when it is trying to hide it is even tougher to spot than when it is going about its natural activities. Some creatures blend into the surroundings through their permanent coloration, others have coloration that changes with seasons, and still others can change color within a few seconds or minutes. Creatures with

this ability receive extra dice to their *sneak* skill.

Poison: The creature produces venom that helps kill prey or helps to protect the creature from hunters and predators. The poison may be delivered through a bite, claws, quills, or a stinger. The poison may also be on the outer surface of the creature (secreted by glands, or in the skin and fur of the creature) so that when a predator attempts to bite or eat the creature it receives the poison. The effects of the poison can vary, from mild illness, to nausea, to a potent neural toxin that can kill.

Odors: Some creatures produce offensive odors as a defense mechanism to scare away predators. The odor is normally strong enough to overpower the senses of the predator, allowing the odor-producing creature to escape. Another adaptation is for the creature to produce an odor so strong that it masks the trail of the creature, so hunters cannot track the creature. Another common adaptation is for the creature to produce enzymes and scents so that it “tastes bad” to any creature that attempts to eat it — while an individual of the species will die, predators will learn to leave the species as a whole alone. With such attacks, victimized creatures may have to make *willpower* rolls to be able to act against the odor-producing animal, or make more difficult *search* totals to track and follow the animal.

Quills: Some creatures have sharp or barbed quills on the outer surfaces of their bodies. The quills may hook themselves into another creature when it attacks the quill-bearing animal, or in rare cases, the creature may be able to hurl the quills for ranged attacks. Aside from the base damage, the quills may continue to produce damage if they aren't removed from the victim, or even be coated with poison. Some creatures might have “quill sacs” inside their mouths, so that they could “spit” the quills at distances as well. Normally the creature should have a skill relevant to throwing the quills, and the quills should have a base damage value.

Reproduction: The creatures can reproduce rapidly, so that they survive not due to the strength of an individual, but through strength of numbers. The creatures may produce great numbers of young, or mate several times in a season, producing many more litters than other types of creatures. This is a common tactic for herbivores, since they tend to lack effective attacks and defenses against predators.

Large Communities: Some animals are helpless in small numbers, but when in large groups, they are excellent survivors. In large groups, the creatures might have excellent combat tactics, or as with many herd members, when predators attack one member of a herd, the rest of the herd flees, assuring the continued survival of the species.

Homes: Some creatures build complex and confusing home areas, such as underground burrows or warrens, tree cities, or aquatic structures. In this case, when predators attack, they often get confused in the natural maze of the home, while the creature flees, retreats to a defensible location, or readies an attack on the invader. Such types of homes are excellent to protect helpless young.

Energy Projection: Some creatures may be able to absorb or produce certain types of energy, such as heat, light, sound or radiation. These can be used as an attack form, causing damage to attackers or targets. The gamemaster simply needs to determine the ranges (if any) and damage of such attack forms. The creature may need a recuperation period between uses, so that it might be helpless or unable to use the defense more than once in a certain span of time.

Migratory: The creatures migrate great distances to seek food, avoid devastating climate changes, or even have a pre-programmed urge to return to traditional mating or young rearing areas.

Hibernation: During times of limited food or dangerous natural conditions, such as seasonal extremes, creatures may be able to go into hibernation. During these times, the creature can survive on very limited air and gets all of its energy from stored layers of fat. Hibernation periods may last a few days, weeks, months, or even years, depending upon the nature of the planet and the metabolism of the creature.

Blubber: Many creatures store excess energy as fat, able to break the fat back down into energy when food is scarce, or the creature can't take the time to hunt, such as in migrations. Likewise the creature may also have the ability to store water or other vital fluids, so that it can go a long time without stopping to drink, or can survive temperature extremes in relative comfort.

Play Dead: A very bizarre form of natural defense; when confronted by a more powerful predator, the creature pretends to be dead in the hopes that the predator will pass it by. This tactic works best against creatures that eat only live prey.

Non-Essential Parts: The creature can shed portions of its body when attacked. Often, the tail is one such appendage: the attacker is often content to let the creature scamper to safety because it can at least make a meal out of its tail.

Digging: The creature digs quickly, so that it can build underground structures or can travel underground in relative secrecy. Some creatures tunnel under potential prey, and then burst from the ground, attacking and killing the target before it has a chance to react. To determine game



effects, simply give the creature a Move for tunneling.

Flying: The creature can fly or glide in atmospheres. The most common ways of doing this are through wings or air bladders. Most creatures can climb, dive and maneuver at will, but some creatures are helpless in the air, and thus glide along air currents. Many flying creatures can make nests and homes in isolated locations where ground-based predators cannot reach them. Assign a flight speed to the creature.

Amphibious: The creature can survive, and probably hunt as well, on land and in water, possibly breathing both water and air.

Leaper: The creature can jump or leap great distances. This can be used for high speed movement across the surface of a world, or the creature may use this ability to leap from trees in movement or during an attack. This type of movement can also conceivably hide the trail of a creature, so there is no continuous contact with a surface to hold scent.

Confuse Senses: The creature has the ability to mask its presence by other than visual means. The creature can disperse its heat so that it doesn't stand out to infrared vision, can make sounds like other creatures or has some other ability so that it isn't easily detected or is mistaken for some other type of creature. Creatures with this ability often also have camouflage.

Dexterity: The creature is extremely dextrous, and talented at dodging attacks using the *brawling parry* and *dodge* skills. The creature does this by jumping, moving quickly and making other feints that make it difficult to catch or hit in combat.

Tail: The creature has a tail, which can be used to aid in balance, or to cause damage in combat.

Antlers/horns/tusks: The creature has antlers, horns or tusks which aid it in combat, doing more damage than a simple *Strength* attack.

Communication: The creature has an unusual form of communication, including echo-location, using feet to make sounds on the ground, communication by releasing scents, or by touching. The complexity, range and reliability of the communication varies by creature.

Cold-Blooded: The creature is cold-blooded, and thus is very susceptible to temperature changes. When it gets too hot or cold, the creature may become lethargic or be unable to hunt or move; severe extremes may kill the creature. The advantage of this adaptation is that, in general, the creature needs to eat much less food than similarly-sized warm-blooded creatures.

Independent Young: Young are fully capable of taking care of themselves from birth — they can find food, defend themselves, and are in no way dependent upon the parent for care or nurturing.

After the gamemaster has devised a base creature, he should determine the creature's social habits and behaviors. Are the creatures solitary, or do they hunt in packs? Do they try to surround opponents, or simply charge when prey is spotted? Are they stealthy enough to sneak up on opponents without being spotted? Often, a creature with mediocre abilities can become a devastating foe if it is cunning enough to confuse and surprise prey.

Encounters

When scouts survey new worlds they will inevitably encounter the native life forms. The reaction of these forms depends upon how familiar the scouts are to the creatures: if the scouts are similar to predators, herbivores are likely to flee. If the scouts appear similar to the prey of a predator, they may be attacked. Particularly territorial or brutal predators might attack the scouts simply for being in their territory. Some life forms will ignore the scouts completely.

Intelligent Life

The process of creating a new alien species should be done with great care: the gamemaster should take the time to think most of the aspects of the species through thoroughly to assure that the creature is balanced, reasonable and interesting. Of course, there are times when a new alien is needed *immediately*. Hence, this system for randomly rolling up some creatures. However, to preserve play balance, this system is geared to produce fairly "average" species that will not overpower a *Star Wars* game.

Evolutionary Stock

All intelligent life evolved from non-intelligent species. Any major biological form can develop consciousness and intelligence. Roll 2D to get the basic biological form.

2: Plant

This category includes creatures that get their nourishment from light and soil. Plants usually stay in one place, but they can move about in search of better soil or light. Intelligent plants can be very difficult to communicate with since their entire existence is based upon a life where food is present every day and they lack many concepts Humans and other animals find natural.

3: Soft Invertebrate

This category includes species descended from soft bodied creatures without bones, such as worms, slugs or snails, or octopi. These creatures may eat either plants or animals and can

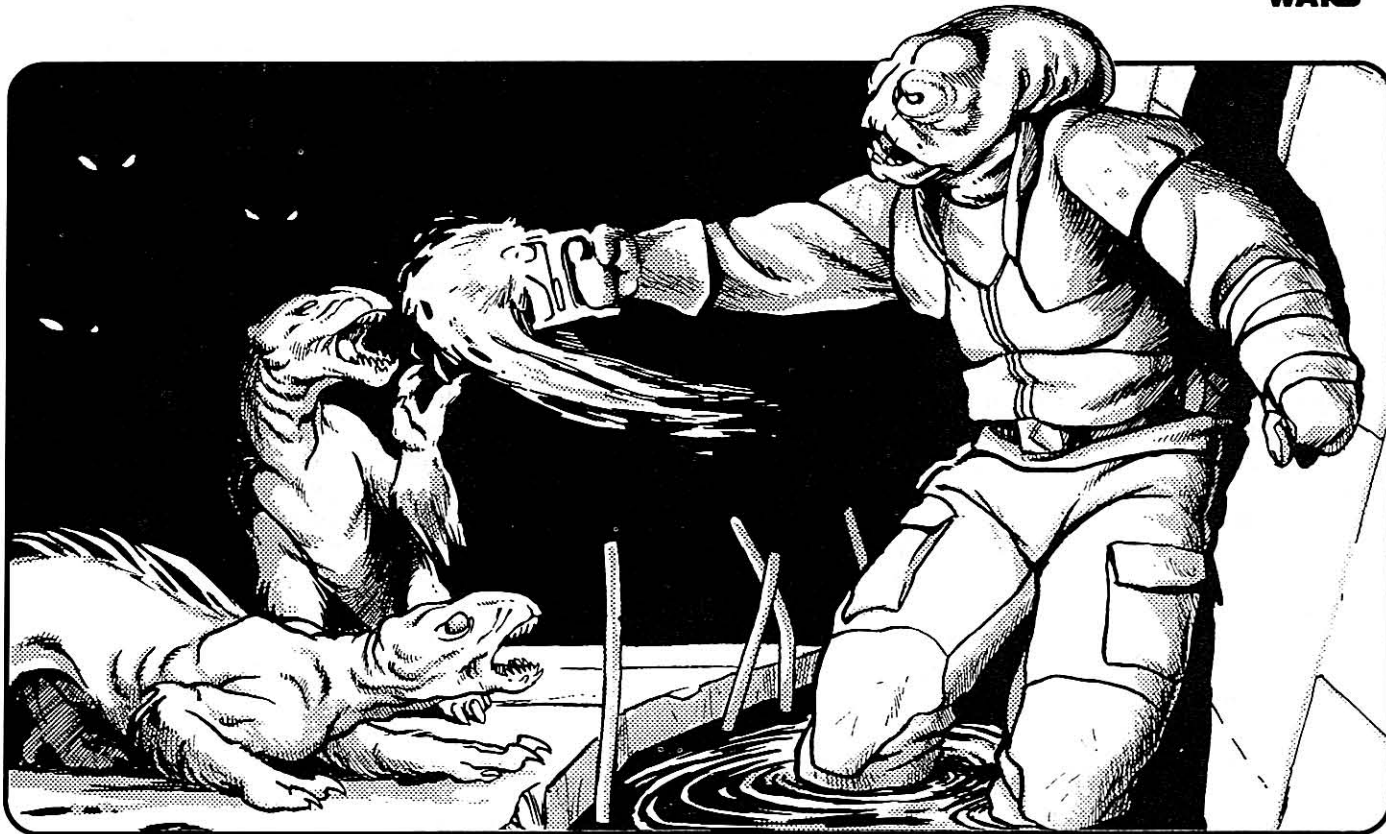

form colonies or stay independent. They can take many forms, and some species are able to change form as necessary. They usually move about through muscles and some creatures have very unusual internal structures that give them some of the rigidity necessary to enable swift movement.

4: Hard Invertebrate

This category includes species that have hard outer bodies and no internal skeleton. They often have jointed legs. Examples include insects, some flying creatures, and crustaceans. These species can be very diverse.

5: Aquatic

This category includes species descended from creatures that need to exist in water for part of their life, like fish, sharks or frogs. Some species will breathe water, while others may rely on air. These species may be carnivores, omnivores, herbivores or scavengers. Aquatic creatures can automatically breathe air instead of water if desired; if the creator wants to make the species able to breathe both water and air, the species must lose -1D on the attribute dice roll below.

6: Avian

This category includes species descended from winged creatures — the species may still be able to fly, or might have evolved to live on the ground. Fliers normally have light bones or incredibly

powerful muscles, so that they can fly. These species may be carnivores, omnivores, herbivores or scavengers. Avians can automatically have wings if desired, but the species must lose 1D from the attribute dice roll below.

7-8: Land Carnivore

The species is descended from hunters, and will tend to be cunning, aggressive and violent. The species may have special adaptations, such as claws, poisonous bites or other items that enable it to attack and kill prey. Since the species has evolved intelligence and has probably begun using tools, the species may have lost these adaptations. Carnivores may pick one non-ranged attack form (such as claws or poisonous bite) at a cost of 1D of attribute dice; the attack does STR+2D damage. Carnivores may increase the Move by 2/2 for 1D of beginning attribute dice, up to a maximum of 2D.

9-10: Land Omnivore

The species is descended from omnivores and lives on a diet of plants and animals. Species descended from this type of creature can be competitive and aggressive, but may also be curious, eager for contact with new and unknown beings and cultures. Omnivores may choose to have one non-ranged attack form, doing STR+1D damage, and increase their Move by 1/1 for a cost of 1D of attribute dice or they may elect to have armor at *Strength*+1D+2 at a cost of 1D of attribute dice.

11: Land Scavenger

The species is descended from scavengers. Because of the varied nature of homeworlds, there are no hard and fast characteristics of this species, except that because it is evolved from a scavenger, it is clearly not the most dangerous or powerful form of life on the planet.

12: Land Herbivore

The species is descended from herbivores. As such, the species may be skittish, oriented toward large groups and not as aggressive as species descended from carnivores and omnivores. Herbivores may choose to increase their move by 3/3 or they may elect to have armor at *Strength* +2D+2 for a cost of 1D of attribute dice.

Attribute Dice

Each species has a set number of attribute dice, which are then broken up into the six basic attributes. Roll 2D to determine the number of attribute dice.

Roll	Attribute Dice
2	8D
3	9D
4	10D
5-6	11D
7-9	12D
10-11	13D
12	14D

Size, Move And Attributes

For purposes of this system, it is assumed that most aliens will be humanoid in form. Roll once for the size of the creature, once for its move, and once for each attribute: *Dexterity*, *Knowledge*, *Mechanical*, *Perception*, *Strength* and *Technical*. The numbers listed under the attribute column represent the attribute minimums and maximums (see pages 133 to 138 of *Star Wars: The Roleplaying Game, Second Edition* for a complete explanation of these terms).

If, after special abilities, there are not enough attribute dice remaining to meet minimum attribute dice scores, reduce the *highest* attribute minimum and maximum in 1D increments until the creature's minimums are equal to or less than the creature's attribute dice.

Roll	Height (in meters)	Move	Attribute
3	0.8	4/5	1D/2D
4	0.9	5/6	1D/2D+1
5	1.0	7/9	1D/2D+2
6	1.2	8/10	1D+1/3D
7	1.4	9/11	1D+1/3D
8	1.6	10/12	1D+1/3D+1
9	1.6	10/12	1D+2/3D+1

10	1.8	10/13	1D+2/3D+2
11	1.8	10/13	1D+2/3D+2
12	2.0	11/14	2D/4D
13	2.2	11/14	2D/4D
14	2.4	11/14	2D/4D
15	2.6	12/15	2D+1/4D+1
16	2.8	12/16	2D+2/4D+2
17	3.0	13/17	3D/5D
18	3.2	14/18	4D/6D

Technological Development

As intelligent species begin to develop, they form societies with a distinct culture. One measure of the development is the technological level achieved by the most advanced group of the species. Most newly discovered species in the frontier region will have low technology levels; as one ventures further into the wilderness, the probability of discovering a high technology species, while not great, does increase. This is because as a species' technology improves, the species is more likely to have already contacted galactic civilization.

Bear in mind that these are general guidelines, and individual cultures may exceed in one or two areas far beyond their general technological capacity, or lag behind in a few fields.

Optional Modifiers: Apply only to "first contact" types of missions. Frontier space: -3 to roll. Semi-wilderness: -1 to roll. Wilderness: no modifier.

2-5: Stone

Stone level civilizations are marked by small social groups, the use of simple tools and primitive agriculture. The tools are usually able to be made by anyone in the society and there is little need for trade. Food can be provided through hunting (if carnivorous) or gathering wild foods (if herbivorous) or through early methods of cultivation. Transportation is by foot, with no organized road network. Communication is by storytelling and pictures.

6-8: Feudal

Feudal level civilizations are distinguished by extensive social contact on a regional basis and simple manufactured goods. The most advanced tools must be made by specialized workers and factories. Agriculture occupies most of the society and consists of herding bred animals or farming planted crops. Transportation is by harnessing animal, wind or water power; road networks do exist. Communication includes the use of a hand-written language.

9: Industrial

Industrial level civilizations have the population split between agriculture and manufacturing, as

society interacts at a continental level. Mass production is used to create the most advanced tools. Transportation and agriculture become motorized and electricity from burning fuels is the common source of power. Communication includes the mass production of written text and simple electrical messages like the telegraph.

10: Atomic

Atomic level civilizations see more efficient mass production, and manufactured goods become available on almost all societal levels. Advanced alloys and plastics are produced, space travel begins, and transportation, communication, medicine and business fields continue to grow.

11: Information

Information level civilizations have a global community, marked by rapid dispersal of information to all inhabited parts of the world. Automation dramatically increases efficiency in factories and agriculture. Atomic power and solar power are understood and used for large energy demands, while more advanced energy sources are being explored. In-system space travel is common and colony ships are possible. Early Droids and energy weapons appear; repulsorlift is likely to be discovered soon.

12: Space

The Republic and Empire are both Space level civilizations. These civilizations are characterized by extra-system colonization, hyperspace travel, Droids, personal energy weapons and very efficient industry. Multiple planets may be economically interdependent.

Special Abilities

Most species have abilities that make them well suited to their environment. Those abilities can be divided into physical, sensory and mental abilities. Roll 3D to determine the number and type of special abilities creatures have.

Roll	Number Of Special Abilities
3	4
4-6	3
7-9	2
10-14	1
15-18	0

For each ability, roll 1D to determine whether the ability is physical, sensory or mental, and then roll for the corresponding category.

- 1-2: Physical
- 3-4: Mental
- 5-6: Sensory

Stacking

When generating alien characters, it is possible to “stack” special abilities. If the special abilities are being generated randomly, when one is rolled more than once, the gamemaster may choose to just increase the ability again, if possible (for example, a species has two special Physical Abilities. *Strength* is rolled twice. The species can have an increase of 2D in *Strength*). When picking special abilities, the same ability can be picked more than once — thus, again, “stacking” the abilities.

Note: stacking can get out of hand quickly if not monitored by the gamemaster. For example, if a species has an attribute increase of more than 3D in any one attribute, it can become prohibitive to gaming with characters of that species. Some of these characters might be used by the gamemaster only, but it is a good idea not to generate sapient species that the players “aren’t allowed” to play.

Physical Abilities

These are abilities that came from the evolutionary stock and environment of the species. To select a special physical ability choose one of the following or roll 1D and use the table below. If the physical ability is incompatible with the background of the species, ignore the result or roll again.

3-4: Strength

Species with extra strength should increase *Strength* by 1-2D, and should not be small creatures. Some species will have specialized strength that does not affect the attribute but increases one of the following skills by 1-2D: *brawling, climbing/jumping, lifting, stamina or swimming*.

5-6: Extra Limb(s)

The species has either one or two extra limbs (gamemasters’ choice) for each time this is rolled/picked. The species receives no bonuses for any attributes, but may perform one extra action with that limb at no penalty — the total number of actions that may be performed is equal to the total number of limbs divided by two, rounded up. This only works for skill uses that specifically use the extra limbs. For example, a character with three arms could perform two actions a round without sacrificing a die — as long as both actions used the character’s arms. Running, for example, would not count.

7-8: Speed

These species are good at sprinting at high speeds. Species with extra speed should increase their minimum Move by 1 and their maximum Move by 2.

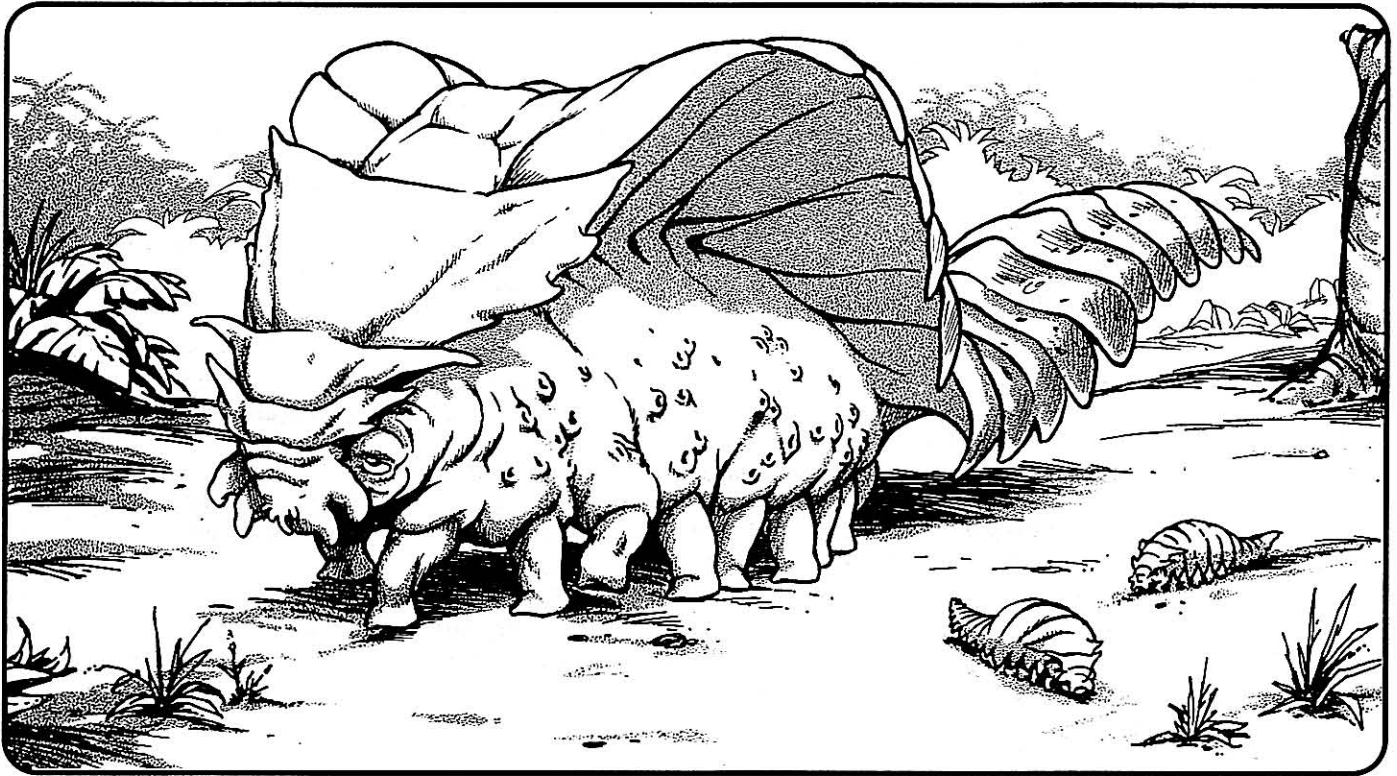

9-10: Natural Weapons

Species with natural weapons have body parts that can be used offensively, such as claws, teeth, a tail or horns, doing *Strength* +2D damage.

11-12: Natural Armor

Species with natural armor have thickened skin, hard scales or plates to protect themselves. Carnivores rarely have natural armor since they are in need of speed to attack and are less likely to be concerned about attack from another creature. Natural armor usually counts as 1D, but may protect as much as 3D. If, when generating the species, armor is rolled (or selected) more than once, it is stackable. However, creatures with more than 1D of natural armor have a cumulative -1D penalty to all *Dexterity* skills.

13-14: Wings

Species with wings may evolve from any evolutionary stock and in any ecosystem except water (treat this as flippers in water.) Species with wings have a *Dexterity*-based skill called *flight* (or *swimming* in water) with an additional 1D in the skill. Creatures with wings sacrifice some *Strength* to the wing muscles and the *Strength* should be reduced by 1D.

15-16: Tail/tentacles

Species that have evolved prehensile tails or tentacles usually come from a forest or water ecosystem. These species have an additional 1D on the *climbing/jumping* skill and 1D added to any *brawling* skill when the species is trying to

hold its opponent. If this option is picked/rolled twice, the benefits can be “stacked” (the species has two tails, or one big one), or the tail can be prehensile and the species also receives the “extra limb” (above) bonuses.

17-18: Reflexes

The species has quick reflexes, and all of them get *one* of the following skills at +1D for free: *brawling parry*, *dodge*, *running* or *thrown weapons*.

Mental Abilities

These are abilities that came from development of the intelligent species. To select a special mental ability, choose one of the following or roll 1D and use the table below. If the mental ability is incompatible with the background of the species, ignore the result or roll again.

1: Memory

Species with enhanced memory come from an environment with a great deal of detail to be remembered. Some of the modifications coming from enhanced memory include 1D added to the *Knowledge* attribute. If the type of memory is specific there may be a 1D addition to any specific *Knowledge* skill.

2: Learning

Species with enhanced learning abilities came from a rapidly changing environment. These species have the training time for any skill decreased such that the training time is halved.

3: Spatial

Spatial aptitude arises in species that were nomadic and travelled a great deal. These aliens make excellent pilots. The improved spatial aptitude increases the *Mechanical* attribute by 1D.

4: Mathematical

Enhanced mathematical reasoning may arise in species that needed to understand how the world operated to survive. Species that are mathematically adept are often excellent tool designers. These species will have their *Technical* attribute increased by 1D.

5: Social

Enhanced social skills arise in species that operate best in large groups. These species are able to better understand what other characters are feeling. Skills that would be improved 1D by enhanced social ability include *alien species, bureaucracy, business, cultures, languages, law enforcement, streetwise, command, or persuasion*.

6: Force

As with species whose senses are naturally attuned to the force, some species' minds naturally work with the Force. These species begin with one attribute point as 1D in *Force control*. All control powers are one level easier to perform.

Sensory Abilities

These are abilities that came from the environment of the species as a precursor to intelligence. Species with enhanced vision may be susceptible to an overload of that sense. To select a special sensory ability, choose one of the following or roll 1D and use the table below. If the sensory ability is incompatible with the background of the species, ignore the result or roll again.

1: Vision

Enhanced vision includes improved distance vision, night vision, vision into the infrared or ultraviolet spectra or increased depth perception. Some of the modifications from improved vision are an additional 1D to *Dexterity* (using certain skills only) due to better aim, or 1D to *Perception*, or 1D to a specific skill such as *forgery, hide, search or sneak*.

2: Hearing

Enhanced hearing includes the ability to hear faint sounds, sounds at high or low frequency or to use sonar as a means to locate objects. Enhanced hearing may improve *Perception* or *Knowledge* by 1D or add 1D to a specific skill such as *language, streetwise, survival or sneak*.

3: Smell/Taste

Smell and taste are the senses that allow a species to identify chemicals in the environment. Enhanced smell may increase *Perception* or *Tech-*

nical attributes by 1D by increasing the ability to sense chemical changes in characters, environments, or equipment.

4: Touch

Heightened touch includes greater sensitivity on the skin, better temperature judgement or the ability to feel electrical and magnetic fields. A special ability in touch may boost *Mechanical* or *Technical* attributes by 1D, or certain *Perception* skills like *gambling* or *pickpocket*.

5: Speech

The improved ability of speech gives characters better control over communication or some other aspect of communication such as music. Some modifications to the template for improved speech include 1D added to knowledge or 1D added to such skills as *intimidation, language, bargain, command, con or persuasion*.

6: Force

Some species in the galaxy are naturally attuned to the force. These species begin with 1D in the *sense* ability, taken from their attribute points. Any *sense* powers used have the difficulty reduced one level.

Weakness

Just as some species have unique abilities, many species also have unusual weaknesses. As a species evolved and there was no need for a particular trait, that trait would diminish. This is especially true if another trait served to replace the lost trait in the species. When designing an alien species, base any weaknesses on the environment and special abilities the species has. As a rule, every species with more than one special ability (and this includes "stacked" abilities) should have at least one weakness for every extra ability. Sometimes, species have weaknesses even when they *don't* have special abilities. Roll 1D to generate random weaknesses, or pick them as appropriate.

1: Temperature Sensitivity

If the species is from an ecosystem that is hot or searing, the species will be susceptible to cold. Similarly, if the species is from an ecosystem that is cool or frigid, the species will be susceptible to heat. Species that are temperature sensitive will take 1D damage for the first hour exposed to the wrong extreme in temperature and an additional, cumulative 1D in damage every hour thereafter.

2: Requires Water

If the species comes from a water-saturated ecosystem, the species will be at risk in a dry or arid environment. The time that a species requiring water can be comfortable in dry air varies, but is usually 2D hours — rolled each time the

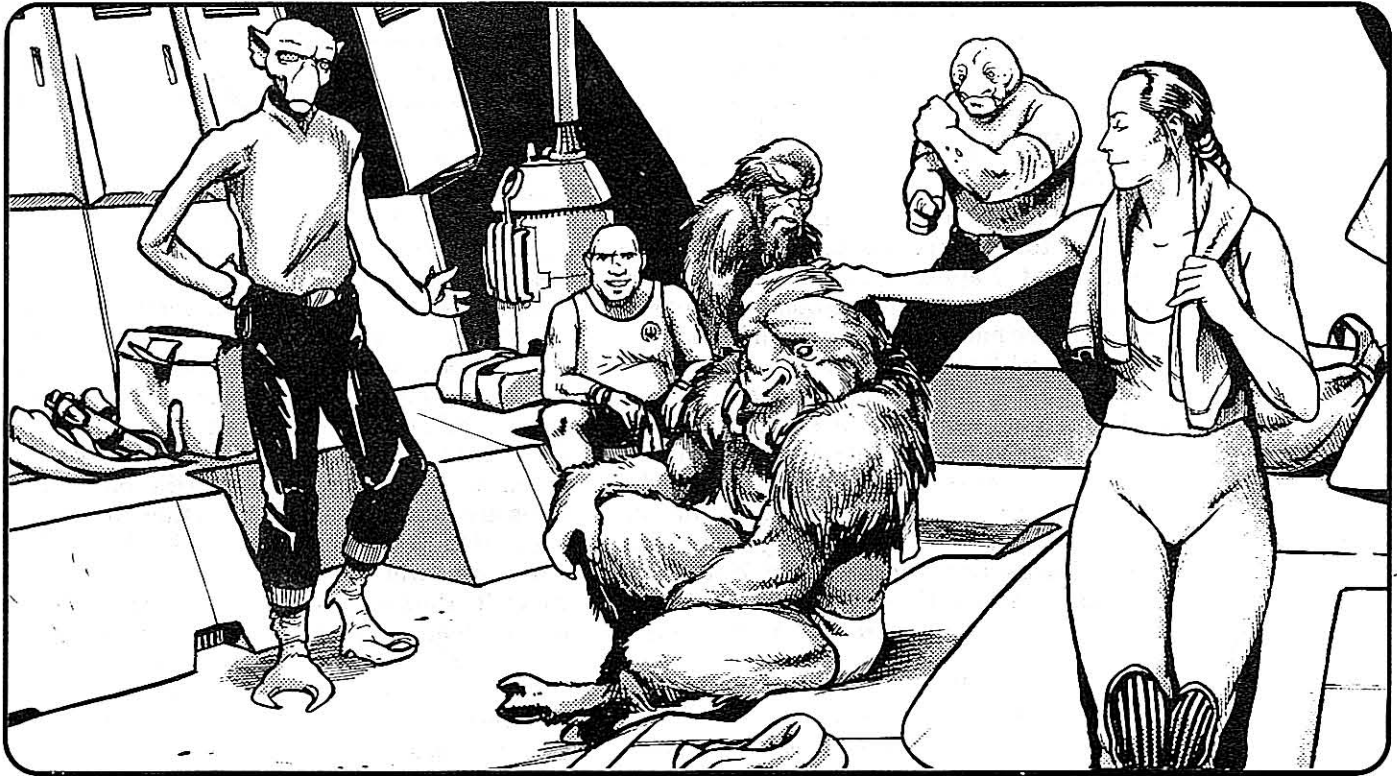

individual leaves the water. Species that need a moist environment will take 1D damage after that time away from water, and an additional, cumulative 1D in damage each additional period thereafter.

3: Limited Physical Abilities

If the species has a special mental or sensory ability, then the species may have evolved without some physical abilities. Limited physical abilities affect the basic template for the species by reducing *Dexterity*, *Strength* or both by 1D (depending on how many times this is picked/rolled). To the alien this will not seem like a disadvantage, since it is “natural.”

4: Limited Sensory Abilities

An overall weakness in sensory abilities is reflected by reducing the *Perception* attribute by 1D in the species template. Sometimes the sensory weakness affects only one sense. This is particularly true for species that have a special sensory ability that replaces another sense. Specific sensory weaknesses will be proportional to the ability that compensates for them. Examples include weak vision, deafness, or limited sense of smell. It is up to the gamemaster how severe each individual limitation is.

5: Unusual Weaknesses

Due to a lack of some factor in the environment, species can have peculiar weaknesses. Unusual weaknesses are often unnoticed until the weakness occurs. When the weakness does

occur, it is usually devastating to the species. An example of an unusual weakness is the Wookiee reaction to certain high-pitched sounds, which cause great pain, preventing any action but doing little real damage.

6: “Linked” Weakness

A “linked” weakness is one that is joined either to another weakness or a special ability. For example, a species that has gas bladders that allow it to fly might also have the disadvantage that those gas bladders, when punctured, do an extra 1D of damage to the character from combustion. Or, a species with an unusual weakness — maybe the species has an allergic reaction to salt — may also have an additional problem. That species may also take damage from the allergic reaction. Another example might be of a species with limited sensory abilities — a straight minus one die to every *Perception* roll. The reason the species has that -1D might be because its eyes do not see in the same spectrum of light as most Humans and aliens do.

Appearance and Attitude

The appearance of an alien will follow directly from the environment, evolutionary stock and special abilities. A reptilian with exceptional vision will be scaly and have big eyes. To manipulate the environment most intelligent species will have evolved appendages like hands or tentacles and most of the senses like sight and hearing will be

near the brain. The other features of an intelligent species are open to the imagination. If a species does not have a special need for camouflage they can be any color the gamemaster wants.

Likewise most facial features, numbers of arms and legs, and other details are up to the whim of the designer. Keep in mind that most creatures evolve towards efficiency not away from it, so there shouldn't be too many contrasting features on one creature. Like the appearance the attitude of the alien will follow from the background. Carnivores will generally be more aggressive than herbivores when dealing with other species.

Species that come from ecosystems with a changing climate will also have behavioral patterns that differ with the season. A completely passive species is not likely to have survived the evolutionary process and wouldn't be that interesting to encounter. An overly aggressive species that distrusts all others will also be difficult for scouts to deal with. Between those limits, there is a lot of possibility for alien adventures.

Ecosystem Generation

Either roll 1D or pick one of the following ecosystems as the predominant one on the planet:

1: Complex

The ecosystem on the planet is made up of several different kinds of smaller ecosystems. Most planets have this "type" of ecosystem. Roll again for a "predominant" ecosystem, ignoring this result, and roll again for secondary, tertiary, and more ecosystems.

2: Water

These ecosystems are based on a watery surface. The plant life will be dominated by microscopic plankton and algae, though sometimes there will be larger growths of seaweed and possibly sapient life forms. Most of the simpler life forms will be near the surface, where light provides energy for plants to grow. If there is any land, there will be amphibious creatures and different development on or near the land. Water ecosystems tend to have relatively uniform temperatures with minor seasonal variations. There are a number of distinct ecosystems based on water. Open ocean is characterized by the lack of any land nearby; the creatures in the open ocean will all be free moving. Ocean depths are sparsely inhabited and will have strange creatures unused to any light, living off the heat of volcanic vents. Coastal waters are the richest ecosystems with plenty of light and minerals and many forms of plant and animal life. On worlds with a large moon or circling a gas giant coastal areas will be subject to tides that leave some land exposed part of the day.

3: Forest

Forests have trees that grow to be many times the size of any animal. Forests occur where the trees dominate the land with their tops interconnecting and little light reaching the ground. These ecosystems are interesting because there will be different subsystems at different heights in the trees. These may be so separated that there is no contact between the creatures in the treetops and those on the forest floor. Forests tend to have variations in temperature, but the variations are not extreme. The predominant type of tree found in the ecosystem will vary with the temperature. Frigid areas cannot support trees at all and forests will not be able to exist. Cold areas of the world will tend to have evergreen coniferous forests, where the leaves of the trees are hard or waxy to keep them from freezing, and there are relatively few life forms. Moderate areas will have deciduous woodlands that vary with the seasons. Hot areas will have jungles that are teeming with many different types of life. Particularly wet areas will form swamps.

In great forest ecosystems, the trees will probably be the most prevalent forms of life — or at least the most obvious. Small plants do not survive well in large forests, though tiny ones thrive by living off the decay and the refuse of the trees. Animals flourish in forests, and most of them are herbivores that subsist on the trees almost entirely. Carnivores keep the population of the herbivores under control, and they tend to be larger and stronger than carnivores in other areas.

4: Grassland

Grasslands get less rainfall than forests and this keeps the plants from reaching great heights. Grassland ecosystems will only have one main level of activity. There may be some trees in a grassland ecosystem, but they are few in number with a lot of space in between. The animals in these ecosystems will frequently travel great distances in search of food or water. Grasslands will often look similar over a wide range of temperatures. However, like the forests, grasslands with warmer temperatures will have more types of life forms than cool grasslands. The weather can change quickly in the grasslands and temperatures can vary from day to day and season to season.

Herbivores and insects live in grasslands, and the carnivores that prey on them tend to be speed-oriented. There aren't as many places to hide in the grasslands, so the animal life must be fast and/or strong.

5: Desert

Deserts are marked by a lack of complete plant cover with large stretches of bare ground. These

are harsh dry ecosystems and both the plants and animals found here will be very hardy and able to survive a long time without food or water. The ground on the desert may be rocky or sandy. Mountaintops can also be deserts due to the cold temperatures and lack of rain. Temperatures in the desert are not moderated by any humidity and will be hot in the day and cold at night. Very cold deserts are called *tundras* and the ground stays frozen all year long, although the surface may thaw during the warm season to permit plants to grow.

6: Alien

The ecosystem is unlike anything "natural." Pure mercury oceans, with creatures that live in them; or hydrogen atmospheres mixing with hard metal landscapes. Roll on the table again, ignoring this result. Use whatever is rolled as a "basis" for an alien ecosystem, then go from there. For example, if you roll "Forest," the forest might be made of magnesium and heavy metal "trees" and have animals that feed on these compounds in it.

Chapter Eight

The Survey

"The survey is the heart of a scout's job. Upon entering the outer periphery of a new system, the scout must scan the vicinity of the star, attempting to discover all of the worlds and determine their basic characteristics. After that, it is time to investigate any curiosities about the system or explore any potentially habitable worlds. In short, the scout has to learn anything worth knowing and find anything worth discovering — all in the span of a few weeks."

— *Spaceguide*

Gamemastering The Survey

Scouting missions often rely on a sense of mystery. The scouts almost never know exactly what type of situation they are facing — after all, if the situation was well known and completely understood, there would be no reason to send a scout there!

The gamemaster can purposely limit the amount of information available to the players and justify it in a game context. For story purposes, the available information should be limited and enticing — enough to elicit interest. This makes sense, since the New Republic will rarely be sending scouts to systems on which they have complete information. Of course, they may also have the scouts conducting "system check-ups."

The process of conducting a system survey is tedious and time-consuming, at least to the scout character. However, the game should play quickly, so the gamemaster is encouraged to gloss over the periods during which scouts are gathering information (possibly summing things up with a couple of appropriate die rolls, explaining that "during the next few days, you take sensor readings, perform computer mapping," etc.) and cut to scenes where the scout discovers something amiss or a world that demands investigation.

The gamemaster should control the scout's access to equipment so that the character has no choice but to personally investigate the situation at hand. During the investigation, the scout can be drawn into the story — sometimes the story simply involves figuring out a mystery, or proving that there is indeed something valuable on the planet. In other words, as with other *Star Wars* adventures, concentrate on the story and action and don't get bogged down in technical and scientific details.

"Don't let this fool you. Sure, catalog a system, check any worlds for life and see if any are habitable. If it's clear that the world isn't particularly valuable, move on! Time is wasting! Let the staff scouts come by later and do all of the hard work ..."

— *Curlin, Independent Scout*

Often, a scout's primary mission consists of surveying systems and worlds to discover what is there, gather as much information as possible within the allotted time constraints, and then passing that information on to the Scout Service's Department of Information or the scout's employers.

As that information is disseminated to experts in various fields, corporations and other interested parties, the original scout or a new group of individuals may be ordered to the system to investigate further, gather and experiment with samples, or establish colonies or manufacturing facilities.

Mission Orders

Scouts are often given specific mission orders from either the Scout Service or the corporation they are employed by. The orders will tell the scout what systems to explore, how much time to allot for each phase of a survey, and under what conditions the scout may alter those orders for further investigation (for example, when the scout discovers a world rich in mineral resources). Scouts may have the latitude to investigate interesting rumors that they hear from traders or aliens.

Prior to undertaking a mission, the scout is given whatever information his employer has and deems "useful" to the scout (while the Scout Service wants its scouts to know exactly what they are getting into, some corporations and private employers do choose to withhold information). This information could have been pulled from a variety of sources (including Old Republic and Imperial databanks, corporations, planets, and individuals), and some of them inaccurate. New Republic scouts are often assigned the task of updating these databanks.



Plotting Hyperspace Paths

When scouts venture to new systems, they often have to plot new hyperspace routes, which can be time-consuming and dangerous.

The first trip to a new system requires the scout to make several small “micro-jumps.” At the end of each jump, the scout must make sensor sweeps to look for debris and other possible navigational hazards. Because the route is completely unknown, the journey through hyperspace must be slow so that the ship’s sensors have plenty of time to detect debris in the path of a ship and drop the vessel into realspace before it smashes into the obstacle.

Once the scout has completed the trip to the new system, the scout can string together the path of the various jumps for a new hyperspace route. This new route can be used for travel between the two systems, although at fairly slow speeds.

As ships increase the speed at which a hyperspace route is traveled, the possibility of an error in calculating the hyperspace route becomes greater. In game terms, if an astrogator is willing to accept a longer travel time, the difficulty for the journey becomes lower. This reflects the fact that at slower speeds, minor errors in astrogation calculations or minor deviations in the drive itself are tolerable, but at very high speeds, exacting precision is needed to make a safe journey.

Therefore, as a route and its navigational haz-

ards are better known, ships can travel the route at higher and higher speeds. While it may take several weeks to make that initial journey to a new system, after years of trade the path may be so well known that ships can make the journey in a few hours.

Playing it Out

Again, performing these microjumps and mapping out a hyperspace route is boring in gameplay terms. Either resolve the situation with a few die rolls — “It takes you ...” (clatter, clatter) “four weeks to plot the hyperspace route” — or arrange for an event during the mapping:

“After returning to the nearest established hyperspace route, you begin plotting the new map areas in a slow and painstaking manner. Since you are taking your time, this shouldn’t be too dangerous or difficult. Unless, of course, something unexpected shows up.

“After a week of this tedious duty, you notice a light blinking on your sensor panel. It takes you a moment to realize that the light is a proximity sensor signal — perhaps the tedium has worn down your reflexes — but you suddenly know the tedium is over. Something is coming ...”

What’s coming? Another ship? A group of pirates or hostile aliens? Maybe your scouts have stumbled onto some ancient relic or hidden base. Whatever it is, the adventure begins *here*.



The System

Once the scout enters a system, he will want to make complete sensor scans to determine the type and number of stars and planets. This whole process can take anywhere from a few hours to several days. If a system is clogged with debris or the planets are in irregular orbits, the process takes much longer than if the system is fairly "average."

At this time, the scout will look for indications of valuable worlds: terrestrial worlds that might support life or have valuable mineral resources, asteroid belts with valuable minerals and ores, and gas giants that have unusual gases. In each case, the scouts will have been trained to look for certain kinds of indicators of these materials, and upon detecting appropriate indicators, they are to further investigate the world with detailed sensor scans and personal observation. In game terms, it is enough for the gamemaster to give the players a casual "system summary."

Sample System Summary

The system seems fairly ordinary. There are two stars, a moderate sized yellow class G star and a small red dwarf. There are six planets:

- The innermost is a small terrestrial world with a very thin atmosphere. It has almost no metals and seems mostly useless.
- The second planet is a terrestrial world, but with a poisonous atmosphere, possibly small mineral deposits.
- The third planet is a terrestrial world, again probably worthless.

- The fourth planet is a gas giant, but it has no indications of anything but average gases.
- The fifth planet has promise: it is a terrestrial world. Sensors scans indicate a low metal content, but the composition of the crust suggests that it might have significant deposits of rare elements. This planet could be worth some money to a corporation. Atmosphere is breathable, indicating life. Temperature is cool. Worth investigating.
- The sixth planet is a frozen ball of rock. Nothing of interest.

Investigating A Planet

Once a potentially interesting planet has been discovered, the scout will often have to proceed with a personal investigation of the world. First, the scout's ship will pull into close orbit around the world, scanning for more detailed information about atmosphere and the planet's composition.

Sensors can determine with near perfect accuracy the basic atmosphere type (I, II, III or IV) of a planet, although trace elements may be missed, so there is no guarantee that an atmosphere is completely safe even if it isn't immediately dangerous. Ships can also determine the dominant terrains of the world, probably weather and temperature conditions, moisture content, length of day and year, and any satellites.

The ship's sensors are very likely to pick up any communications broadcasts that intelligent inhabitants may be making, as well as detect large cities that cover several square kilometers, and detect clear signs of heavy industrialization.

Tighter focus scans will be able to get a better fix on locations of potential ore deposits or other points of interest, so the scout can land his ship or atmospheric vessel near the suspected deposit.

Once a probable landing site has been determined, the scout can proceed with direct investigation. The scout will commence investigating what drew him to the world originally: if the world might have resources, the scout will take several soil samples to determine whether or not the sensors were accurate and the extent of the deposits. If the scouts came here to investigate life forms, the scout will collect plant or animal samples for return to civilization so that scientists may study them in laboratories. In both cases, the scout will take detailed air, soil and water samples for further analysis. Most scouts will have computers that can direct the scout's activities — the computers normally have sensors so that if a small sample is placed on the sensors, the computer determines whether or not the item in question is worth further study and a sample is needed. Since these computers are truly intelligent, they can make educated guesses about planets, so they may be able to

suggest alternate samples that might be needed, or other areas or types of investigation that might be needed for complete information.

Encountering Life Forms

Scouts who encounter life forms on a world are advised to proceed with caution: often, things are not as they seem. That pleasant looking herbivore may be territorial and have a poisonous bite that can kill in seconds. Scouts are encouraged to look for creatures and plants with very unusual properties, since they are most likely to be of interest to researchers.

In all cases, the scout's best approach is to proceed with caution and never take anything for granted. Observe, make notes, and collect as much data as possible. Scouts venturing to worlds with life will want to try and determine as much about the local ecosystems and the behavior of creatures as possible.

First Contact

Meeting a new form of intelligent life is a dramatic experience. During a scout's survey, he may learn of an intelligent species from near-orbit scans (especially if the species has a high tech level), or come across the life form during his journeys.

Ideally, the scout will come across signs of intelligent life, such as artificial constructions or tools. Then, the scout should attempt to track the life form and find one for observation. Smart scouts spend a great deal of time observing new life forms in secret, so that the scout can learn as much as possible about their behavior before approaching them. If the scout is lucky enough to have a Droid with language capabilities with him, it may be able to learn the language of the beings, although this is likely only for beings who use variants on known languages. Fortunately, beings that are similar in structure often have similar concepts (for example, humanoids tend to conceptualize ideas like "life, death, hunger") — by observing the aliens, Droids may be able to piece together a few words, phrases and concepts, and then hope that there is enough information available to figure out more detailed levels of communication. At this stage, the potential for misunderstanding is enormous.

Finally, the first contact should be carefully planned. The scout should attempt to determine and use behavior that the aliens will recognize and accept — and always have someone watching your back from a distance, just in case.

Of course, this is the textfile manner of dealing with life forms. In practice, the scout and the unknown life form will simply stumble across each other, or the new life form may have noticed the scout and decided to investigate further. In many

cases, the course of future relations with intelligent species is determined by the split-second reaction of the scout and the member of the new species. Things can get off to a rocky start ...

The Report

Once the scout has completed his initial survey, it is time to prepare a report to be delivered to the Scout Service or the scout's employer. The report is a summary of important and interesting information about the world. In the report, the scout must be very careful to make a distinction between proven fact and speculation. Reports discuss the outstanding characteristics of worlds (summarized through a "World Log"), natural inhabitants, and sometimes even contain the scout's personal diaries. Reports are normally filed with the samples the scout has recorded. In the report, the scout must also decide whether to recommend a travelers' advisory or quarantine for the system, based on how dangerous it seems to be or if the presence of visitors would be dangerous to the planet's ecosphere or inhabitants.

Playing the Scout Survey for Fun and Profit

All right. Now you know the basics of the scout survey. Sound fun? Well, probably not. Lots of bookkeeping, die rolling, and description. That's the way life *is*.

But that *isn't* the way *Star Wars* is. A scout may work his entire career without getting into an armed conflict, finding an alien relic, or discovering a lost civilization. *We aren't telling stories about those scouts!* We're telling stories about scouts that fight monsters, pirates, Imperials, and claim jumpers. The survey is a means to an end: it keeps the scout in food and fuel money, while getting the *character* into situations that will be fun to play.

At *any time* during a scout survey, something interesting could happen. The players should know this. It heightens the tension, while at the same time, lulling them into a sense of "oh, well; nothing is *actually* going to happen — the gamemaster just wants us to map another system." That way, when the aliens, or the Imperials, or whatever the adventure is really about shows up, there are "I-told-you-sos" and "what-do-we-do-nows" fired across the table.

The *Star Wars* movies have a few examples of how this works. In the beginning of *The Empire Strikes Back*, Luke and Han are out looking around the frozen surface of Hoth. They've done it before; they expect to do it again. *No big deal*. Then, suddenly, Luke gets jumped by a snow beast. If he was in "combat readiness," that whole scene wouldn't have happened. If Luke was *ready* for trouble, he could have avoided or shot the snow



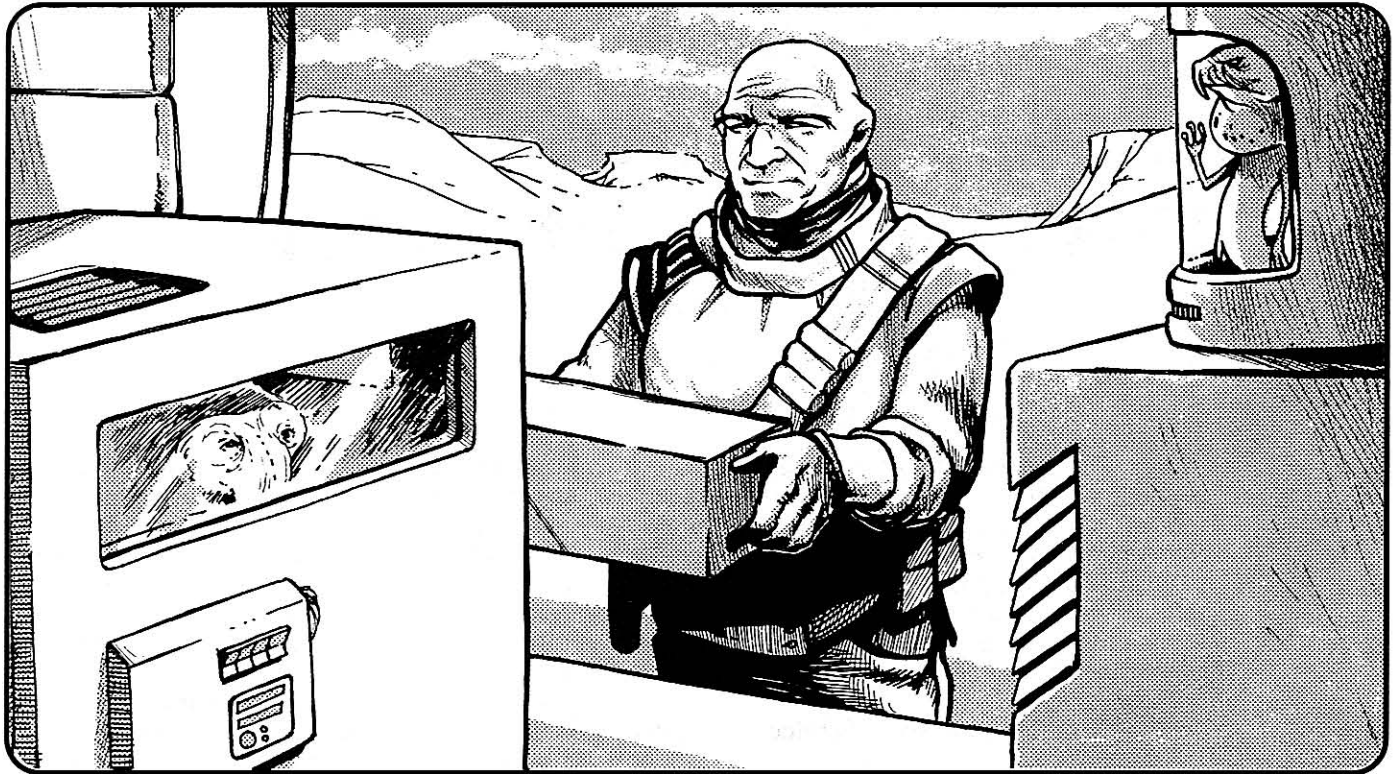

beast — or carved it into little snow beast patties with his lightsaber. But he wasn't. He was "on another *boring* scout mission," and he got careless.

The scout mission is a great way to introduce new settings, gamemaster characters, and technology into the game. It is also a terrific springboard to adventure.

A few more tips ...

Here are a few things to keep in mind when running scout adventures:

• **What type of players do you gamemaster for?** Are they "commandos" and "warriors" who like to fight the Empire/Alien Monsters/Anything Handy all the time? If so, you'll want to have these elements in your scout adventures. A survey probably won't go by without them running into Imperials/Alien Monsters/Anything *Nasty* at some point. The way you introduce these elements should vary, though. Sometimes, the scouts find them on a world or base. Other times, the "bad guys" find *them*. On occasion, the "bad guys" actually *hire* them. There are lots of interesting possibilities ...

• **Are your players more interested in finding out new things about the *Star Wars* universe?** Maybe they've gotten *tired* of battling the Empire — much like many of the veteran scouts mentioned in this book — and want to seek out and discover new people, places, and things. In that case, the scout survey is the "meat" of the adventure. You'll need to create these elements *in*

depth instead of as a background setting for an adventure. Use Chapter Seven and Chapter Nine as a beginning, but drag out your old comic books, SF movies, and books for new and exciting elements. Make the climax of the adventure the discovery or realization of what they've just found, and the events leading up to that climax as building blocks of hints, teasers, and clues to be put together in solving a grand puzzle.

• **Do your players have *no idea* what they want to do?** Either in a new campaign, or one that has been running for a long time, it is important that the players (and their characters) develop a sense of *purpose* to their gameplay. Roleplaying is much easier when the character your player is playing has a goal — even if it is a short-term one. For campaigns that lack overall goals, or that have tired of the old one, scouting can bring in new life. Send the characters into situations they have never encountered before if they are veterans, and give them some things to think about. If you are beginning a new campaign, then use the Scout Service as a way to introduce the players and their characters to the *Star Wars* universe. Send them hopping about from one world to another, from one situation to another, trying out new stories and subplots as you go. The new player characters probably won't have to worry about money or equipment that much — they've been provided those things by the New Republic or their employer — so they can concentrate on learning about the setting they're going to play in.

Chapter Nine

System Generation

"If you were to describe an 'average' planet, you would get a rocky world, with little or no atmosphere, and either too hot or too cold to support Human life. The second most common type of planet are huge gas giants, with poisonous atmospheres at pressures so great that starships are easily crushed. It is those few worlds capable of supporting Human life that are most important to the scout service."

— New Republic Scout Service *Spaceguide*

"Average planets are useless. Look for the unusual and find your fortune."

— Marrsel, Independent Scout

Most of the adventures in a *Star Wars* role-playing game session will take place on terrestrial worlds since they offer those elements which make *Star Wars* so exciting — exotic and unusual life forms, strange environments, and plenty of places to go and see. Of course, there are exciting stories to be told in strange and hostile environments, but the majority of stories take place on worlds where characters don't have to spend every minute worrying about having their environment suit punctured or checking the amount of oxygen they have left.

When a gamemaster decides to design a world for a *Star Wars* adventure, it is important to make sure that the world fits the story to be told. The following system can be used to completely flesh out a world for an adventure. While scouts often survey entire systems, seldom do the gamemaster or players really need to know every detail about a given system; it's enough to tell the players the survey is complete and give them a quick listing of any points of interest. For those who feel the need to completely detail a star system, this chapter includes a discussion of what is and isn't likely when it comes to generating systems and uninhabitable worlds.

This system is also geared toward generating interesting and "gameable" planets. According to current scientific theory, most planets are likely to be useless balls of rock with poisonous

atmosphere or none at all, or gas giants, which are similarly inhospitable. This system concentrates on worlds where there are interesting life forms and exciting things to do — and as gamemaster, feel free to gloss over the "boring" systems and cut to the action.

It is important to note that you don't have to detail every aspect of a world. Instead, define the planet through a number of characteristics (explained below) and then determine the major points of interest that the characters are likely to visit during their adventure.

Example: *In Star Wars IV: A New Hope, the Droids are stranded on the desert world of Tatooine. If this was run as an adventure, the only areas that needed to be mapped out and thought about were Uncle Owen's farm, the Jawa sandcrawlers, Ben Kenobi's house, and Mos Eisley spaceport. There are many other points of interest on the planet — for example, wherever the Tusken Raiders live or Jabba the Hutt's palace, but none of them matter for this adventure, so they can be detailed when needed, if ever.*

This System

This system was first introduced in *Planets of the Galaxy, Volume One*. It is designed to provide inspiration for worlds, in addition to allowing the gamemaster to randomly roll up planets.

When generating worlds, the gamemaster should keep in mind what area of space the scout is in, and discard unsuitable die rolls as necessary.

Civilized systems are part of the Known Galaxy and are generally ruled by either the Empire or the Republic. These planets are typically involved in galactic trade, have visiting starships and are fairly aware of what is going on in the galaxy as a whole.

Frontier systems are those on the edges of the Republic and the Empire, and tend to be more isolated than civilized areas. Only about half of the

settled systems in these areas are directly controlled by the Empire or the Republic, although many of the independent worlds swear allegiance to one of the two. Frontier systems are unlikely to have seen heavy combat between Imperial and Republic forces, although small skirmishes are common as the civil war drags on. Populations tend to be smaller and technology less readily available, and trade is more often conducted by small tramp freighters, such as the *Millennium Falcon*, than by large galactic transports.

Semi-wilderness systems are even more isolated than frontier worlds, and only a small percentage swear allegiance to either the Republic or the Empire. Formal colonies are less likely the further one ventures from the Known Galaxy, but unregistered settlements are more plentiful; those that do exist are likely to have a lower tech level since there is very little trade from the Known Galaxy in this type of area. Scouts are more likely to come across unknown primitive alien cultures that have not yet come into contact with the Known Galaxy. Traders are less frequently encountered, and the scout may find himself isolated from all assistance. Information on systems in these areas is more sketchy, and the scout will find much of it is exaggerated or fabricated.

Wilderness areas are the true unknown sectors of space. Lost colonies, possibly established thousands of years ago, are more common than known colonies and unregistered settlements (even the bravest individuals don't want to venture this far into unknown space). The scout is very likely to come across primitive alien civilizations, and even advanced, starfaring aliens can be encountered (their technology tends to be limited to short range faster-than-light drives, or even sublight drive only). This region of space is so far removed that the scout ship is probably

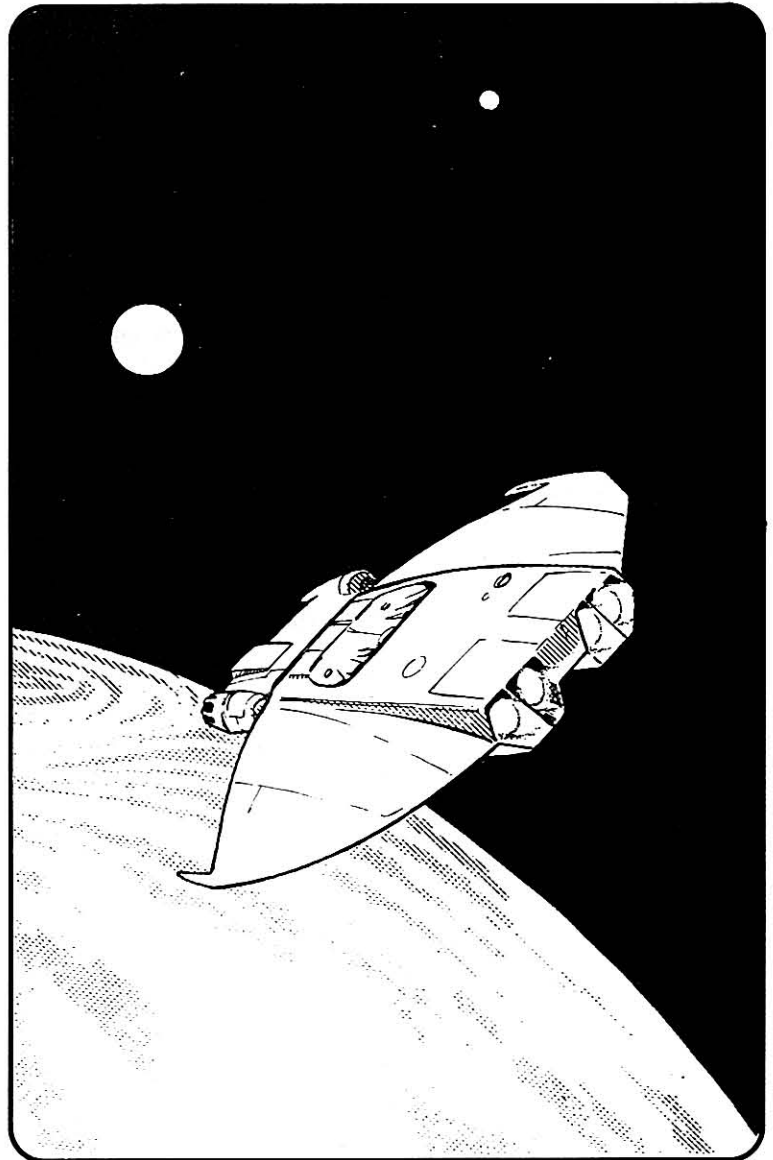

Government

Roll D6%

- 11 Alliance/Federation
- 12 Anarchy
- 13-16 Competing States
- 21-22 Corporate Owned (+3 Starport, +2 Tech Level)
- 23-24 Dictatorship
- 25 Family
- 26-31 Feudalism
- 32 Guild/Professional Organization
- 33-42 Imperial Governor

Roll D6%

- 43-45 Military
- 46-52 Monarchy
- 53 Organized Crime
- 54 Rebel Alliance/New Republic
- 55 Participating Democracy
- 56 Representative Democracy
- 61 Ruler By Selection/Rite
- 62 Theocracy
- 63-66 Tribal

the first vessel from the Known Galaxy to have visited the area in centuries, if ever. There are many undiscovered life forms and resource worlds waiting to be found and claimed.

For complete explanations of the results, refer to *Planets of the Galaxy, Volume One*. This system appears in abbreviated form due to space considerations — we felt that it was inappropriate to take up over 20 pages reprinting existing material when there were so many other essential topics to discuss in this book.

Some charts have the reference “Roll D6%” in front of them: this means roll six-sided percentile dice, counting one die as the tens die and one die as the ones die, as used in Chapter Seven, “The Frontier.”

Planet Type

Roll 2D	Planet Type
2-9	Terrestrial
10	Satellite (Normally Gas Giant)
11	Asteroid Belt (-2 Population; Incompatible: Agriculture, Homeworld Planet Function)
12	Artificial (-2 Population)

Temperature

Roll 2D	Temperature
2	Searing
3-4	Hot
5-9	Temperate
10-11	Cool
12	Frigid

Gravity

Roll 2D	Gravity
2-4	Light (+2 Atmosphere)
5-11	Standard
12	Heavy (+2 Atmosphere)

Length of Day

Roll 1D	Length of Day
1-2	Roll 2D +10 hours.
3-4	Roll 1D+20 hours.
5	Roll 1D+25 hours.
6	Roll 1D+30 hours.

Terrain

Roll D6%

11	Barren (Compatible: Arid, Dry Hydrosphere; Incompatible: Moist, Saturated; -2 Population, +3 Atmosphere)
12-13	Cave (+2 Atmosphere, -2 Population)
14	Crater Field (Incompatible: Thick Atmosphere)
15-16	Desert (Compatible: Arid, Dry Hydrosphere; Incompatible: Moist, Saturated Hydrosphere)
21-24	Forest (Compatible: Moderate, Moist Hydrosphere; Hot, Temperate, Cool Temperature; Incompatible: Arid Hydrosphere; Frigid, Searing Temperature)
25-26	Glacier (Compatible: Moist, Saturated Hydrosphere; Cool, Frigid Temperature; Incompatible: Arid, Dry Hydrosphere; Searing, Hot, Temperate Temperature)
31-32	Jungle (Compatible: Moderate, Moist, Saturated Hydrosphere; Searing, Hot, Temperate Temperature; Incompatible: Arid, Dry Hydrosphere; Cool, Frigid Temperature)
33-34	Mountain (Incompatible: Saturated Hydrosphere)
35-41	Ocean (Compatible: Moderate, Moist, Saturated Hydrosphere; Incompatible: Arid, Dry Hydrosphere; -1 Population)
42-44	Plain (Compatible: Dry, Moderate, Moist Hydrosphere; Hot, Temperate, Cool Temperature; Incompatible: Arid, Saturated Hydrosphere; Searing, Frigid Temperature)
45-46	Plateau (Incompatible: Saturated Hydrosphere)
51-52	Urban (+1 Population)
53-61	Wetlands (Incompatible: Arid, Dry Hydrosphere; Frigid, Searing Temperature)
62-63	Volcanic (Incompatible: Type I Atmosphere; -2 Population; +3 Atmosphere)
64-66	Special Terrain

Atmosphere

Roll 2D

- 2-9 Type I (Breathable)
- 10 Type II (Breath Mask Suggested)
- 11 Type III (Breath Mask Required)
- 12 Type IV (Environment Suit Required)

Length of Year

Roll 1D. Multiply roll x15.

Roll 1D

- 1 75 local days
- 2 150 local days
- 3-4 225 local days
- 5 300 local days
- 6 375 local days.

Add both totals.

Starport

Note: Gamemasters are encouraged to add negative modifiers to this roll to reflect the primitive nature of frontier and wilderness worlds. The more isolated the world, the higher the modifier. Suggested modifiers range from -1, for worlds on the edge of the Known Galaxy, to -8, for very isolated worlds in the wilderness.

Roll 2D

- 2 Landing Field
- 3-5 Limited Services
- 6-8 Standard Class
- 9-11 Stellar Class
- 12 Imperial Class

Tech Level

Note: Due to the primitive nature of frontier and wilderness regions, gamemasters are encouraged to apply a modifier of -1 to -7 to this roll.

Roll 2D

- 2 Stone
- 3 Feudal
- 4 Industrial
- 5 Atomic
- 6-7 Information
- 8-12 Space

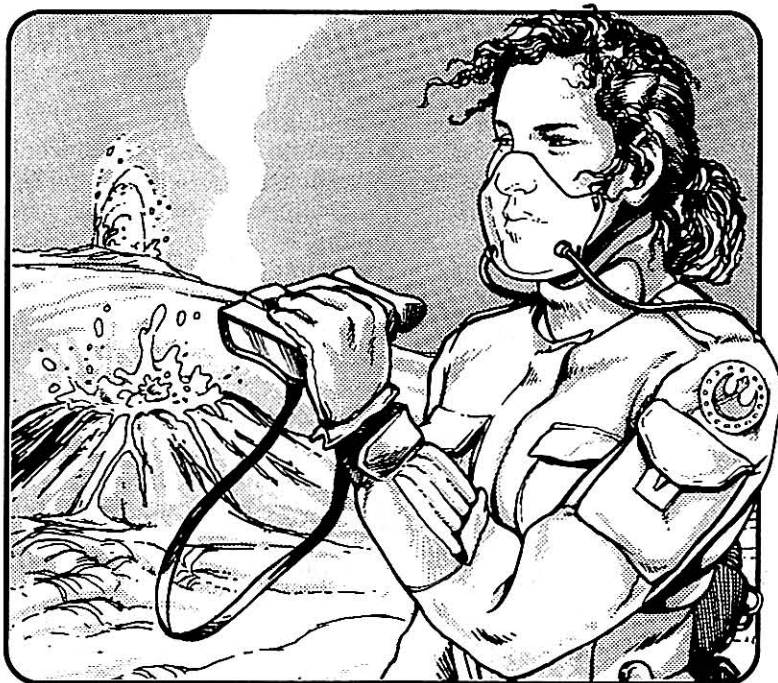

Population

Note: Populations in frontier and wilderness sections of space tend to be lower. Gamemasters are encouraged to apply a modifier of -1 to the population roll.

Roll 1D.

- 1 Population is 1-999
- 2-3 Population is in the thousands
- 4-5 Population is in the millions
- 6 Population is in the billions.

Roll 1D to determine whether in the singles, tens or hundreds of thousands, millions or billions. If the population of a planet is in either the tens or hundreds of billions, the system must either be multi-planetary in its inhabitants or have a sapient population that takes up *very* little space.

- 1-2: Population is in singles.
- 3-4: Population is in tens.
- 5-6: Population is in hundreds.

Roll 1D. Determine population to two significant figures.

- 1-3: Number is 1-5: roll 1D, ignoring 6.
- 4-6: Number is 6-9: roll 1D, ignoring 5 and 6, and add five.

Hydrosphere

Roll 2D

- 2 Arid
- 3-4 Dry
- 5-9 Moderate
- 10-11 Moist
- 12 Saturated

Planet Function

Roll D6%

11	Abandoned Colony
12	Academic (+1 Starport, +1 Tech Level)
13	Administrative/Government (+1 Starport, +1 Tech Level)
14-21	Agriculture (Incompatible: Asteroid Belt, Artificial Planet Type, Barren Terrain)
22	Colony
23	Disaster (-3 Spaceport, -2 Tech Level, +3 Atmosphere)
24	Entertainment
25-26	Exploration (-2 Starport, -2 Tech Level)
31	Hidden Base
32-33	Homeworld
34	Luxury Goods
35-41	Manufacturing/Processing: Low Tech, Mid Tech, High Tech (Mid Tech: +2 Starport, +2 Tech Level; High Tech: +3 Starport, +4 Tech Level)
42	Military (+3 Starport, +2 Tech Level)
43-46	Mining (+2 Starport, +1 Tech Level)
51-55	Natural Resources
56	Research
61	Service (+1 Starport, +2 Tech Level)
62-63	Subsistence
64-66	Trade (+3 Starport, +2 Tech Level)

Planet Function

This characteristic explains why the planet is inhabited. Determine the basis of the economy, why people live here, and other things that are essential to understanding the planet.

Please note that many of these planet functions can still be explained with primitive tech levels. In these cases, the planet's entire economy is driven by the industry in question, even if the world has little or no trade with outside planets.

Abandoned Colony: The colony was abandoned by its sponsor, and may have slipped into barbarism. These worlds are common in frontier and wilderness space.

Academic: The planet is a center of learning.

Administrative/Government: The world's prime function is bureaucracy. Usually reserved for capitals of trade empires and governments, and these worlds typically have a high tech level. Low-tech worlds with economies centrally directed by the government also qualify.

Agriculture: The world is dedicated to the production of food.

Colony: This is or was a colony world (it may currently be independent).

Disaster: Disaster planets have been the victims of one of a number of possible cataclysms.

Entertainment: The world specializes in providing entertainment.

Exploration: The planet and system have seldom, if ever, been visited. They often have primitive tech levels.

Hidden Base: There is a secret base on the world, such as a military, corporate or pirate base.

Homeworld: This planet is the homeworld for an alien species.

Luxury Goods: The world produces luxury goods, such as liquor, gems, art or other goods.

Manufacturing/Processing: The planet processes raw materials or manufactures finished goods.

Military: The planet has important military facilities, often Imperial or New Republic bases.

Mining: The world thrives on mining the rich mineral resources.

Natural Resources: The world depends upon naturally occurring resources, like crystals, wood products, pelts, biochemicals and plants.

Research: The planet is home to scientific research facilities.

Service: These planets specialize in advanced services, such as banking, medicine, or financial markets.

Subsistence: Very common in frontier space, these worlds are struggling simply to survive.

Trade: The planet is a center of trade and commerce.

Government

This explains the type of government that the planet has. During the reign of Emperor Palpatine, most planets were under his control, however, this control was normally in the form of a planetary governor and whatever Imperial troops were necessary to keep order: the vast majority of planets, even if controlled by the Empire, retained their native form of government provided it supported the Empire.

Now, only about one-quarter of the Known Galaxy is controlled by the Empire. The rest are non-aligned or part of the New Republic, although most of these, too, retain their native form of government — there is not nearly as great a fear of repression or violent reprisal.

Alliance/Federation: Several different groups have allied together for mutual defense, trade or any number of other reasons.

Anarchy: No central government, or a government whose only concern is preserving individual freedoms.

Competing States: Several competing factions vying for power. The factions can be tribes, nations or companies. The competition may take the form of open warfare.

Corporate Owned: One company owns the entire planet.

Dictatorship: A dictator or absolute ruler has complete control. The planet is probably very

intolerant of individual differences or beliefs.

Family: The family is the most important social organization on the planet, or a group of elite families rules the world.

Feudalism: A multi-level social system in which nobles or royalty are entrusted with territory and required to generate tax revenue for higher-level officials.

Guild/Professional Organization: A particular guild or profession controls the planet. Possibilities include trade or mining guilds.

Imperial Governor: An Imperial official has assumed direct control.

Military: The planet is directly run by the military, possibly the Empire or a local army.

Monarchy: A ruling family, normally led by a king or queen, has complete, or near-complete control.

Organized Crime: Crime gangs own and control this planet.

Participatory Democracy: Citizens vote directly on important issues.

Rebel Alliance/New Republic: This world is run directly by the Republic, or the planet is an open supporter of the new government. Planet may be a protectorate, under the supervision of the Republic.

Representative Democracy: Citizens choose



officials, who then vote on important issues.

Ruler By Selection/Rite: The ruler is chosen by a series of mental and/or physical trials.

Theocracy: The government is run by a religious organization.

Tribal: The planet is ruled by tribes. Such planets are often technologically primitive.

Planet Type

Terrestrial: typically a ball of rock and metals, with an atmosphere, orbiting a star. Most habitable planets are terrestrial (but not all terrestrial planets are habitable).

Satellite: moons of a larger planet. For moons to be habitable, they normally have to orbit a large gas giant.

Asteroid Belt: a collection of settlements built into an asteroid belt. These settlements will normally be mining or industrial in nature, or may be the location of hidden military bases.

Artificial: constructed worlds, normally in the form of giant starships or space stations.

Terrain

This category is simply the dominant terrain type that the characters will interact with. It is important to note that most worlds will have water covering a majority of its surface; unless the settlements are aquatic by nature, "ocean" is seldom listed with terrains since characters will seldom venture to these areas. Most worlds feature a variety of terrains, but not all types are listed for brevity.

Barren: Little or no life, probably with an inhospitable atmosphere.

Cave: Immense network of caves is where most civilization or points of interest are found.

Crater Field: Meteorites continually assault the planet's surface.

Desert: Found on dry, arid planets, with minimal plant life and moisture.

Forest: Land covered by thick trees or other large plants.

Glacier: The world is covered by glaciers and snow.

Jungle: Areas overgrown by plant life, typically warm and moist.

Mountain: Geologically active worlds. Mountains can be small hills to huge peaks several kilometers tall.

Ocean: Ocean covers almost all of the world, or civilization is centered upon oceans.

Plain: Huge, flat expanses of grassland.

Plateau: Large sections of elevated land, typically in the interior of continents.

Urban: The planet is largely covered by cities and other artificial constructions.

Wetlands: Low-lying wet areas, including ponds, marshes, and swamps.

Volcanic: Volcanoes and lava pools cover most of the planet. These worlds often have harsh atmospheres.

Special Terrain: A very unusual type of terrain is found on this planet.

Temperature

This classification represents the average temperature on the planet's surface. Most planets have several distinct temperature bands, and if they have an unusual orbit or other odd physical feature, temperature changes can be dramatic over even short periods of time.

Searing: Average temperature 60 degrees Celsius or more. Almost too hot to support known life.

Hot: Average temperature 30 and 59 degrees Celsius. Most often considered "uncomfortably hot" by Humans.

Temperate: Average temperature from -5 to 29 degrees Celsius on average, and are most comfortable for Human and similar life forms.

Cool: While often habitable, still fairly cold, averaging -6 to -20 degrees Celsius.

Frigid: Planet averages -21 degrees Celsius or lower, and very inhospitable.

Gravity

This is a reflection of the gravity of the planet. While not an exact measurement, and certainly not including all the possible gravity types found, it is a guideline.

Standard: Gravity is the range at which Humans and most aliens are most comfortable.

Zero: Gravity locations are normally found only in artificial locations, such as space stations, and most of them will have a repulsor and gravitic generator providing artificial gravity.

Light: Gravity is much lighter, and usually makes characters from standard rules seem stronger — though some problems with over-compensation usually need to be accounted for.

Heavy: The gravity is much stronger than most other worlds, and it is harder to lift objects and move; characters will also take more damage from falls on heavy gravity planets.

Atmosphere

There are only five basic atmosphere classifications used in *Star Wars*:

None: The planet has no appreciable atmosphere, and a space suit is required simply to survive on the world.

Type I (Breathable): There is a proper mixture of gases and pressure so that Humans and comparable aliens species can breathe the atmosphere safely and with no discomfort. These atmospheres may have contaminants that pose long-term health threats, but they are generally safe.

Type II (Breath Mask Suggested): These atmospheres can support Humans without a breath mask, but they are strongly suggested due to the presence of dangerous gases or contaminants. Many alien species have evolved in Type II atmospheres.

Type III (Breath Mask Required): Unbreathable without a breath mask, again due to a number of possible characteristics. The atmosphere might be poisonous or too thin — however, they are safe enough that a space suit isn't required.

Type IV (Environment Suit Required): Poisonous, corrosive or dangerous atmospheric conditions require the use of a full space or environment suit by most inhabitants of the Known Galaxy.

Hydrosphere

This represents the amount of moisture on or near the surface of the planet. The moisture may be water or some other liquid.

Arid: These worlds are very dry, typically desert planets, and are 85 to 100 percent covered by land.

Dry: These worlds are dry, but can have oceans and seas, and are typically dominated by arid plains, deserts, or similar terrain, and are 50 to 84 percent covered by land.

Moderate: Most of these planets are covered anywhere from fifteen to forty-five percent by land, and probably have large oceans and a variety of terrain types.

Moist: These planets only have five to fourteen percent of their surface covered by land, and those few land masses are probably bogs, swamps or other very moist terrain.

Saturated: These planets have less than five percent of their surface covered by land. They are most often ocean worlds.

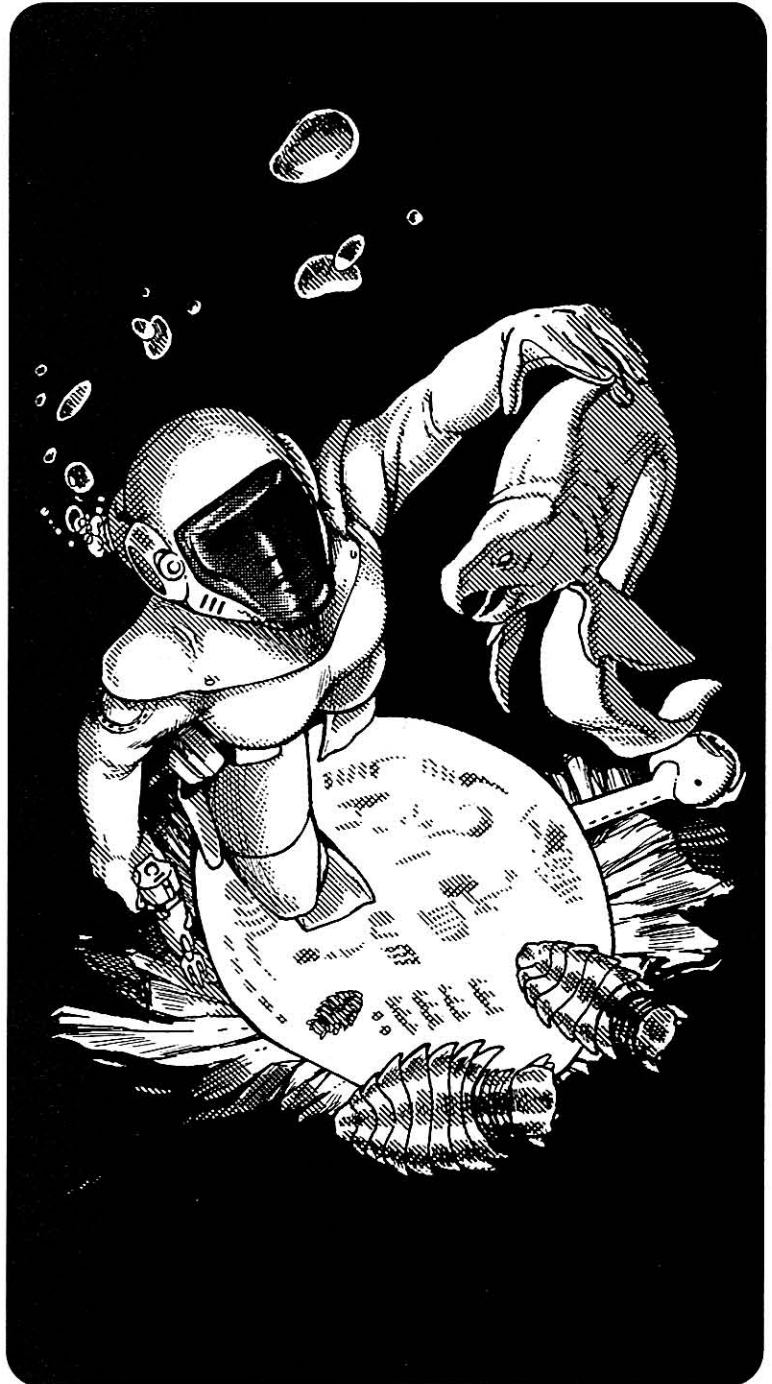

Length of Day

This is the length of day in Standard Hours. Typical habitable worlds will have a day of 12 to 36 Standard Hours. Twenty-four hours is the galactic standard (both the New Republic and the Empire usually function on a twenty-four hour day schedule in space).

Length of Year

This is the length of the planet's year in local days. The standard year is 368 days but this varies widely from planet to planet.

Sapient Species

These are the sapient (intelligent) species that live on the planet, both natural (those who evolved there, indicated by an (N)) and those who emigrated there from other planets. Only species who make up a significant percentage of the population are indicated.

Starport

The type of starport available on a planet. This ranking is normally for the *best* starport or starports on a planet; planets will often have several starports of lesser quality as well.

Landing fields: These are simply flat areas for ships to land. There is no control tower, and probably no fueling or repair services.

Limited services: The starports have a control tower, and possibly refueling and repair services, but very limited facilities at best. Mos Eisley had limited services.

Standard class: These planets have starports that are fully staffed and equipped, and will have refueling and resupply services, as well as a small shipyard for at least minor repairs. Bespin had a standard starport.

Stellar class: These starports can dock almost all classes and sizes of ships, and probably have several shipyards in the immediate area for major repairs and modifications. Yavin, during the beginning of the Rebellion, had a stellar class starport ... but it was only available to members of the Alliance.

Imperial class: starports are large and luxurious, with complete storage and repair facilities. These are normally major trade centers. Naturally, Coruscant has several Imperial class starports. Even in the time of the New Republic, this classification has yet to be changed.

Population

Indicate the planet or system's sapient population, which may range from single numbers to the billions. Indicate the total to two significant figures (such as 69 million, or 1.2 billion, or 25,000). The average "settled," industrial system in the *Star Wars* universe would have about four or five billion inhabitants — if the main planet was of standard size and had a standard hydrosphere.

Tech Level

There are several standard tech levels, which a planet generally falls into. A planet's tech level is defined as what is *typically* available on the world, but some areas may be more or less advanced, depending upon whether an area has been isolated, contacted by space explorers or affected by some other factor. When generating random planets, take into consideration population and other factors when determining tech level and cast out results that make no sense at all.

Stone: Technology on these worlds is very primitive, with loosely-knit cultures, probably tribal in nature. The society uses stone tools and probably has primitive agriculture. The people probably only trade by barter and don't understand money. Low populations are also common in stone technology systems/worlds.

Feudal: The technology on these planets has developed into primitive manufacturing and metal-working, and they have more advanced social structures. Travel is normally by ship or caravan. Again, the population on these planets is almost always fairly low.

Industrial: These planets are beginning to understand mass production, and use windmills, waterwheels, wood or coal furnaces for energy generation. Mass communications, motorized transportation and projectile weapons are developing. Population varies on these planets, but actually tends toward the high side.

Atomic: Here, the technology exists on these planets to have large-scale production of goods, atomic energy as a power source. Advanced alloys and plastics are available. Space travel is in its infancy.

Information: The technology on these planets allows advanced computers and satellites. Industry is much more efficient, mechanization is very common and the precursors of Droids have appeared. Energy weapons are beginning to be developed. Inter-system space travel is likely to be common. Fusion is likely; repulsorlift may have been developed.

Space: These planets are at the pinnacle of known development, and are characterized by hyperspace technology, Droids, blasters and highly efficient industry.

Major Exports/Imports

There are several broad trade categories: low technology, mid technology, high technology, metals, minerals, luxury goods, foodstuffs and medicinal goods. If you like, you may list imports and exports more specifically.

Astronomical Data

This includes the name of the system (often the name of the most developed planet in the system) and the star type. You may choose to quickly define other planets in the system with one or two word descriptions. See the section "Star Systems" for suggestions on how to finish this section.

Planet Summary

Now that all of the stats for the planet have been summed up, this area is a good place to breathe life into the world. Describe the world in general terms, listing points of interest and other factors that are necessary to know when setting adventures on this planet.

Planet Summary

Planet Name: _____

Planet Function: _____

Government: _____

Planet Type: _____

Terrain: _____

Temperature: _____

Gravity: _____

Atmosphere: _____

Hydrosphere: _____

Length of Day: _____

Length of Year: _____

Sapient Species: _____

Starport: _____

Population: _____

Tech Level: _____

Major Exports: _____

Major Imports: _____

System Name: _____

Star Name: _____

Star Type: _____

Sector: _____

Region: _____

Name	Type	Moons

Planet Summary: _____

Normal Stars

The type of star in a system determines a great deal about the worlds that circle it. Most inhabitable worlds will be around the so-called normal, or "main sequence" stars. Stars are classified by type, indicating color, the amount of light produced and temperature (based on an absolute zero scale). Human habitable worlds may be found around any of these type of stars, although the distance they must be from the star to support life depends upon the temperature of the star.

Star	Type	Temperature
(N)	Brown	2,500 or less
(M)	Red	2,500-3,500
(K)	Orange	3,500-5,000
(G)	Yellow	5,000-6,000
(F)	Yellow-White	6,000-7,500
(A)	Blue-White, White	7,500-11,000
(B)	Blue	11,000-28,000
(O)	Blue	28,000-40,000

Binary Stars

Two stars in close proximity to form one star system are quite likely. Unfortunately, these systems are unlikely to support habitable worlds, as the planets would have to form a stable orbit in the constantly variable gravitational force of the system.

If the two stars are close to each other, it is possible that worlds could be distant enough to orbit the dual stars as if they were only one, although unless the stars are very hot, the worlds would be too frigid to be hospitable. Another possibility is if the stars are very far apart — planets could orbit just one of the stars, while the companion could provide light during what would normally be "night."

Gas Giants

Gas giants may form in the interior, moderate or outer orbits of a system, although interior gas giants close to very hot stars will tend to boil away to only their rocky cores.

If there is a gas giant in a star system, it will be the first planet a scout will see upon entry. Gas giants typically have no solid surface to land on, but often have many satellite moons. Sometimes these moons are habitable, such as the moons of Endor and Yavin.

It is possible to build enclosed mining posts and other structures in the upper atmosphere of a gas giant, but most will have to be fully enclosed because most gas giants have poisonous atmospheres. A few notable exceptions include Cloud City on Bespin and the Gas Vortex of Yhifar. Their

“atmospheric pockets” are filled mainly with nitrogen, hydrogen, oxygen and other gases that Humans and most aliens are able to breathe. The bizarre structure of the gas giant also forms a “pressure bubble” where settlements can be built — though the Gas Vortex has a pressure-per-square-centimeter that is uncomfortable for all but the most resilient Humans and aliens.

Gas giants are simply huge balls of gas centered around a small rocky — or icy — core. The atmosphere of most gas giants is poisonous to Humans, but other forms of life may evolve on such worlds (they are prone to having multiple bladders and wings for movement, and inhabit a small zone of the gas giant’s atmosphere). At lower levels, gas giants exert tremendous atmospheric pressure, capable of squashing people or ships that aren’t specially reinforced for such tasks.

Terrestrial Worlds

Terrestrial worlds can be found in any orbit of a system, from interior to exterior, although the “zone of habitability” can limit whether or not a terrestrial world is inhabitable. If the planet is too close to its sun, it will be too hot to support life, possibly boiling away most of the atmosphere and water. If the planet is too far from the sun, the world won’t receive enough heat and light to support life. These ranges vary greatly, depending upon the star’s temperature. Even worlds which are in the appropriate orbits may

prove inhospitable due to atmospheric components — worlds with too much carbon dioxide will eventually be overwhelmed by the “greenhouse effect” and the planet will become too hot to support life, complete with a poisonous atmosphere.

Asteroids

Asteroid fields are often found in star systems with many large planets — the force of gravity from the large planets prevented a smaller planet from forming, leaving the raw rock spread in a ring around the star. Because the raw materials of planets are exposed in asteroids, there are valuable minerals that can be easily mined from these rocks.

Asteroids may also be what is left of a world after a collision with a massive stellar body (such as a large asteroid smashing into a planet).

Comets

Small comets far from a star are very common and usually not worth noting by scouts, except as potential navigational hazards. Large comets that pass near stars are less common, but may have mineral resources or even support life. Comets are made up of ice and frozen gas and become unstable with quakes as they approach a star. As the comet thaws, ice and frozen gas trail away from the star, forming a bright tail. Comets may be important to a story simply because they are going to collide with a planet that supports life.

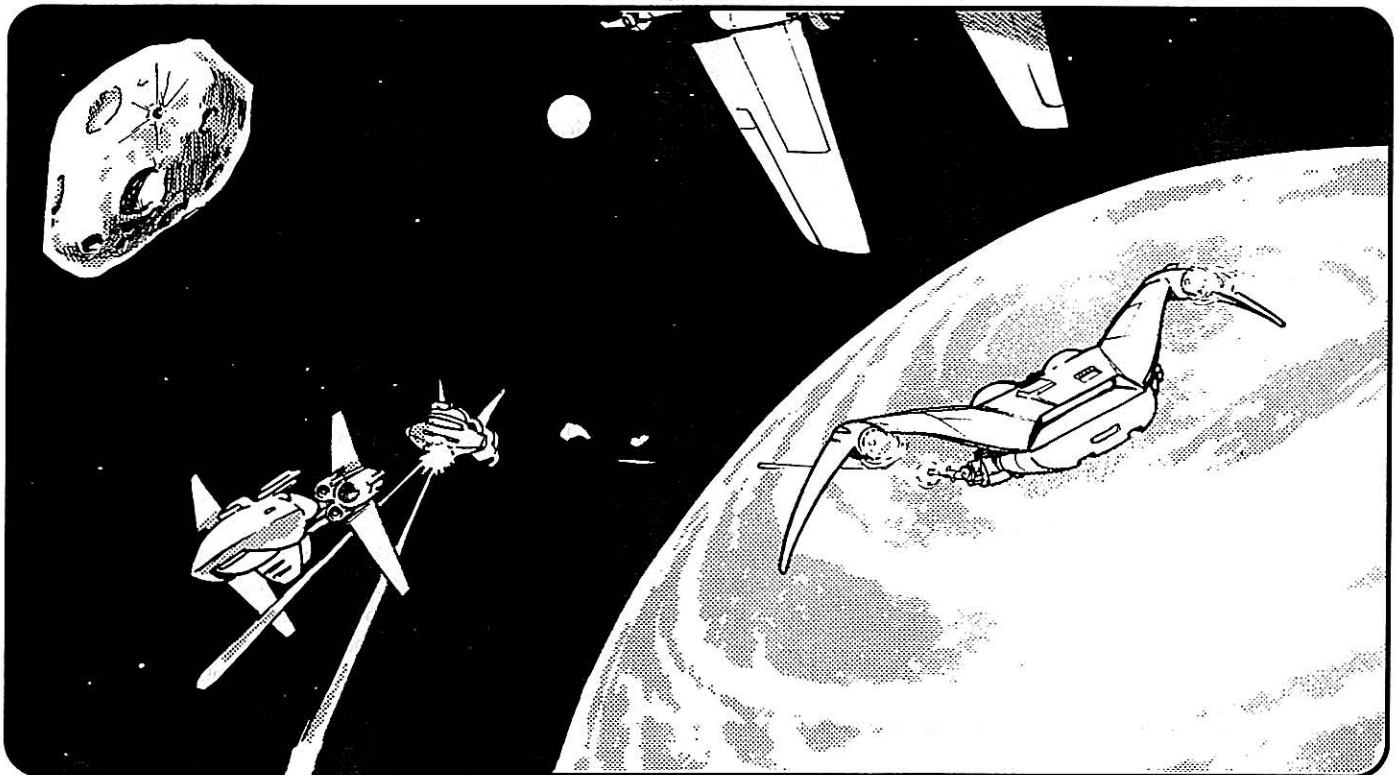

Abnormal Stars

There are several types of abnormal stars, including red giants, supergiants, novas, supernovas, white dwarfs, neutron stars and black holes.

Giant Stars

Systems may be dominated by a giant star, probably red in color. Giant stars put out much less heat than smaller stars, and a well shielded scout ship might be able to explore the outer atmosphere, possibly investigating unusual energy readings.

A giant star occurs when the hydrogen fuel of a star has been entirely consumed, and the star balloons out to a huge size, possibly enveloping the innermost planets of the system. These stars may have stable terrestrial planets that can be home to advanced or primitive civilizations. As the star ages, it might become variable, changing in size and brightness many times within a few months or years.

As the star continues to burn, it will produce heavier and heavier elements. When the star finally exhausts all of its fuel, the star will collapse into a white dwarf or tiny neutron star. The star might also explode its outer layers in a spectacular supernova. In very rare instances, the core of the star might become a black dwarf.

Dwarf Star

Red and brown dwarf stars began with insufficient fuel to become large. These stars are often the companion of another star. The planets around a red dwarf are also likely to be small, favoring terrestrial worlds with only trace atmospheres, but possibly with valuable mineral deposits or unusual minerals and ores.

White dwarf stars are the remains of stars that have collapsed as they have exhausted all of their fuel. As the white dwarfs cool, they eventually turn yellow, then red, and then finally become black dwarfs. There may be remnant dust clouds in the area of the star with unusual chemical elements. The dust clouds serve as excellent hiding places for pirates and others who desire privacy. Planets around white dwarfs were probably destroyed in the explosion, although if the dwarf is old enough, it may have captured a rogue planet or two, which might have had time to evolve life or be settled.

Neutron Star

A neutron star is what remains of an exploded star. Neutron stars have extremely strong gravitational pulls and are so dense that a spoonful of material from a neutron star weighs tons. The stars are only about ten or twenty kilometers across, and don't produce light like other stars.

However, the gravitational pull of a neutron star is so strong that nearby companion stars and gas clouds may have material drawn to the neutron star. When the particles impact against the surface of the neutron star, they give off blinding bursts of light and intense radiation in a "cosmic fireworks display." Neutron stars can rotate very rapidly, seeming to pulse at a rate of about once a second, leading to the name "pulsar."

Normal ships will avoid these areas due to the difficulty of navigation in the intense gravity. Any planets in the system are very likely to have been blown away when the star exploded.

Planets in close systems (typically, less than a year away) will be subjected to very strong gravity, and thus have astounding tides. The worlds will be constantly bathed in very high levels of x-ray and gamma radiation. Life on the surface of the world would have to be hardy indeed to survive such radiation, but if the world is covered by water, marine life could be plentiful, since water will act as a shield against much of the radiation. Due to the intense radiation, such worlds may be a rich source of unique minerals and crystals with unusual capabilities. The items will have had their structure altered by the radiation, and they might be quite good for retaining or focusing energy, such as the crystals used to fashion lightsabers.

Black Hole

The final collapse of some giant stars form black holes. This is a pocket of gravity so intense that nothing, not even light, can escape the black hole's grip. A ship that is caught in the pull of a black hole faces certain destruction.

Ships stay well away from these objects, and scouts will want to post navigational warning beacons to warn ships away from these areas. The locations of such areas is of prime interest to New Republic Scout Service libraries, so this information can be made available to all ships requesting navigational information on that sector of space.

Black holes cannot be seen, but they can be detected by how they affect items in their environment. Like a neutron star, a black hole can draw gases from nearby stars and release bursts of radiation all across the spectrum, for a light show marking the boundary of the stellar troublemaker.

Black holes will not have "systems" per se, but they may be affecting nearby stars and worlds, slowly drawing systems to their death. Also, it is quite possible that ships with more primitive drives may be caught on the edge of a black hole's grip — close enough to be dangerous, but far enough out that the scout ship could conceivably mount a rescue operation. Likewise, scien-

tific research space stations may be in the same kind of situation.

Nebula

A nebula is an extensive dust cloud that, normally, is in the process of becoming a system. Nebulae can hold one or more proto-stars, or conceivably a star and its companion planets. From a distance, the nebula is almost impenetrable, and the dust obscures and alters sensor readings: the only way to find out what is *really* inside a nebula is to investigate it directly.

Nebulae are unlikely to have habitable worlds, although primitive worlds rich in minerals and with high temperature are quite possible. Such places would be appropriate to self-contained mining cities, such as Lando Calrissian's Nomad City, shown in *Heir to the Empire*.

As shown in the *Star Wars* adventure *Planet of the Mists*, a nebula can hide many things, such as pirate bases, secret weapons facilities and any-

thing else that someone wants hidden from prying eyes.

Nova

A nova is a star that is exploding. Large stars will die this way, giving off a great deal of light and gas. The explosion of a star can take many years, but the high levels of radiation makes the entire area dangerous.

A supernova occurs when the largest giant stars explode. These explosions are only a few days long and can be seen by much of the galaxy (at least eventually; bear in mind that the light might take centuries to cross the galaxy). The explosion will destroy anything in the vicinity of the star.

People on planets around such stars will have to be evacuated or face certain death. Stars that have gone nova or supernova may have dead worlds around them, but some civilizations may have left behind records or artifacts.

Chapter Ten

The Prize: A Scout Adventure

Introduction

Far, far out beyond the fringes of the known universe, there are countless inhabited planets which have either never been discovered or have been found and lost in the relentless passage of eons. These planets can be a bottomless font of exciting adventures. This adventure will take your characters beyond the fringe of the known, to a legendary planet and a fabulous prize waiting for those brave enough to grasp it.

Along the way, they will overcome overwhelming odds and battle against a being of vast, dark power. They will explore new worlds and ancient civilizations. They will expand the *Star Wars* universe in their own unique fashion.

The Setup

The characters are refueling and stocking up for a journey into the fringe on the planet Vengler. Vengler is a quaint, rustic world. Discovered by the Empire only a few years ago, Vengler has only the most primitive of spaceports. The majority of the population of the planet work on small farms, barely existing at subsistence level. More cosmopolitan characters will probably sum up Vengler with one word:

Dirtball.

The Marketplace

The only point of interest on the whole planet is the Varno Market, which surrounds the area of the spaceport. Since alcoholic beverages are illegal on Vengler, nearly all the business on the planet is transacted in this one square kilometer area.

The Varno Market contains treasures and trinkets that find their way there from all sections of the galaxy. Most scouts wandering through the area barter the interesting trash they've picked up on their travels here and there for food and fuel. Nearly anything imaginable can be found in one of the murky booths, if one is lucky and patient.

The feel for the area is similar to that of an exotic open-air marketplace. Beggars swarm af-

ter offworlders, courtesans beckon, prestidigitators amaze the tourists with feats of skill and pickpockets lurk in every shadow. The scene opens with the following exchange ...

Adventure Script for "The Prize"

Gamemaster: You've just finished bartering for fuel and supplies in the open-air markets of Vengler. Hundreds of Humans and aliens mill about, each conducting their own business transactions. You gather near the path back to the spaceport, ready to get off this ball of mud and back into open space.

First character: That was strange. I traded a dozen of those old Holoreels we had back on the ship for some food and the proprietor insisted I take this. Some kind of medallion. He seemed like he was glad to get rid of it.

Second character: Let me see it. Hmmm, it feels like it's made of platinum. I wonder what it's worth. Maybe we can hang it over the dashboard.

Gamemaster: You notice that when you take the medallion out and hold it up for a better view, a hush falls over the throng of people. A circle begins to form around you. *Hundreds* of the market's patrons and vendors. The silence is deafening. Just when you feel you can stand the silence no longer, a single thin voice rises out from the crowd.

"The Eye!! He has the Eye!"

The crowd scrambles madly away, looks of fear frozen on their faces. As the dust settles, only seven figures remain. Six robed warriors and one other, darkly hooded, with a tiny winged creature on his shoulder.

"Kill them and bring me the Eye." the hooded stranger rumbles as he turns and strides away.

The six warriors begin to advance, unsheathing wicked looking bronze Scitroks.

First character: I have a bad feeling about this...

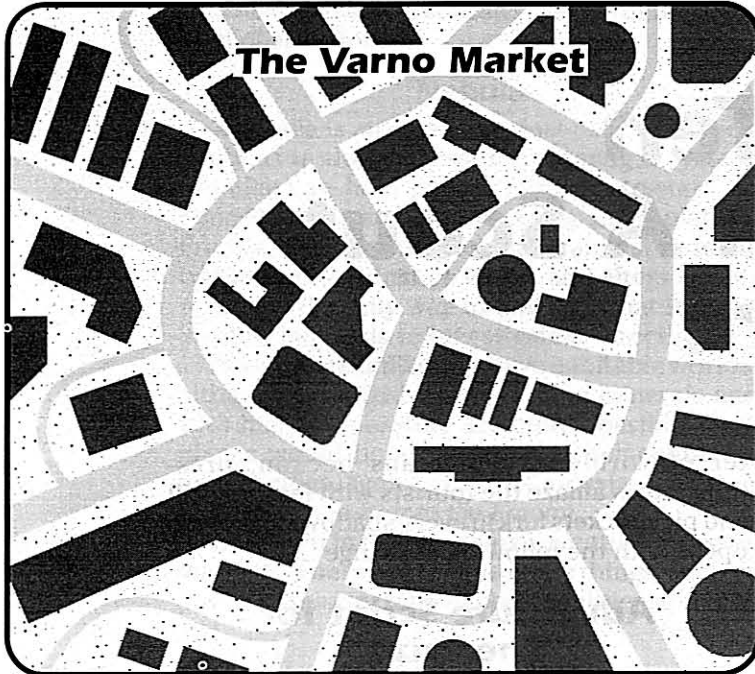

Second character: I wish you would stop saying that!

Encounter: Fight or Flight

The Scitrok Warriors will advance with their Scitroks at the ready. The battle should be fast-paced and exciting. If the characters attempt to run, the warriors will break into pursuit teams of two per player character and try to run down the group.

Once the characters have dispatched the warriors, chances are good that they will try to get off the planet and find out more about the strange medallion they have in their possession. If they try to ignore the attack or tarry too long in the marketplace, they will have repeated encounters with the warrior-monks. The rest of the natives won't be very friendly to them either.

What's going on?

The mysterious robed figure is Dhar Bullwin, a student of the Dark Arts. He has searched for over twenty-five years for the Eye of Koda. He was finally able to trace it to the Varno market on Vengler. Dhar Bullwin made his way to the market section and began extracting information from the inhabitants.

The shopkeeper who gave the characters the Amulet is unsure of what it is that he had, but was desperate to get rid of the amulet. He knew that those pursuing the treasure would stop at nothing to get it. When he heard the player characters were heading off planet, that seemed like the best way to steer trouble away from Vengler.

The Scitrok Warriors

DEXTERITY 3D

Dodge 5D, melee parry 5D, melee 6D

KNOWLEDGE 2D

Streetwise 3D, survival 3D, religion 3D

MECHANICAL 1D

PERCEPTION 2D

Hide/sneak 4D, search 5D

STRENGTH 3D

Brawling 7D, stamina 7D

TECHNICAL 1D

Security 5D

The Scitrok Warriors are a strange monastic brotherhood of warrior-monks that live in a monastery far off in the barren hills outside of the city of Vengler.

Life for the monks is made up of equal portions of religious teachings and combat training. They spend an average of ten years mastering the Scitrok, which most closely resembles an eight-foot-long scimitar, with vicious barbed spikes lining the inside cutting edge.

Once the Scitrok Monks have mastered both their religious teachings and weapon studies, they are then sent into the world to sell their services, in exchange for gold to support the monastery. The Monks will accept any commission, and have no loyalties to any, save for their current master and their church.

Scitrok

Scale: Character

Skill: Melee Combat: Scitrok

Difficulty: Difficult

Damage: STR+3D (Max. 6D+2)

Cost: unavailable for purchase

Note: A character who fails a *melee combat* skill total with a Scitrok weapon may injure himself. If he rolls ten or more less than the difficulty number of the weapon (not the defensive skill of the target), then he does the damage to himself.

Dhar Bullwin has spies and hirelings throughout the Varno Market; when the eye was found, he wanted to know immediately. He will spare no expense or effort in gaining the item. Besides his many Human and alien spies, Dhar also has other servants in his thrall.

Once the amulet turns up, Dhar plans to let the characters lead him to the treasure. He orders his servants to harass the characters and keep them busy while he plants another servant on the characters' ship.

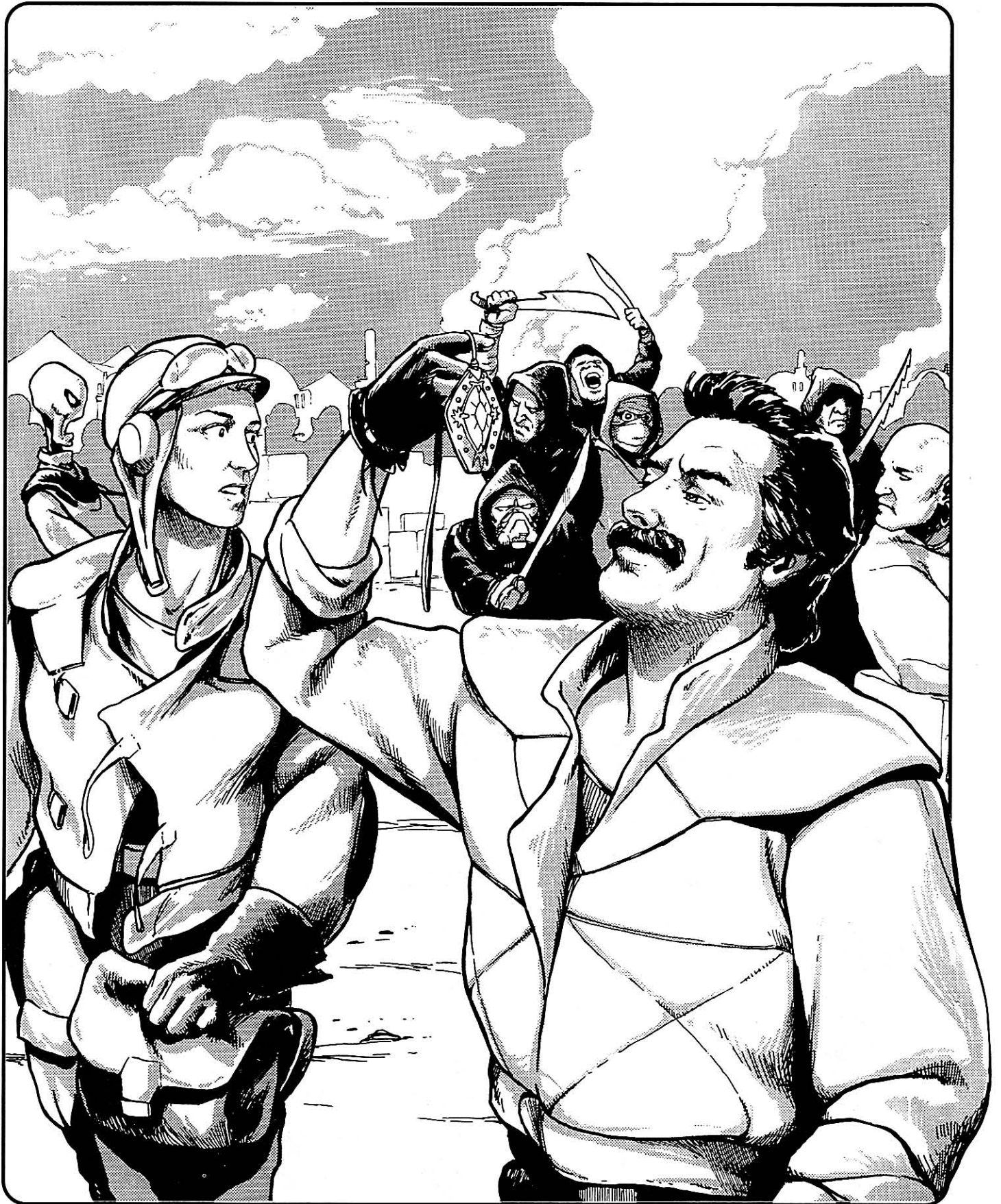

So What's So Special About the Amulet?

This information can be gathered through talk with locals in the market or from scanning the

The Homonculous

DEXTERITY 3D+2

Dodge 5D, Melee Combat 4D+1

PERCEPTION 2D

KNOWLEDGE 1D

STRENGTH 2D

MECHANICAL 1D

TECHNICAL 1D

Description: The Homonculous is a magical construct, the secret of which has been lost by almost everyone in the galaxy. The creature is mottled green and stands 50 centimeters tall, with large bat-like wings growing from its upper shoulders. The Homonculous has wicked claws which secrete a powerful toxin. If the creature hits with a melee attack, roll 2D against the character's *Strength* score. If the player's total is higher, nothing happens and there is no damage from the attack. If the Homonculous' roll is higher, the player temporarily subtracts 1D per each pip difference from each of his stats. If any stat falls to 0D, the player character falls unconscious. The toxin and all its effects lasts for three hours.

The creator of a Homonculous is able to use any of the creature's senses as his own; thus, by concentrating, he can communicate over vast distances through the beast.

ship's data banks. Information from the locals requires that the player character make a *difficult con* or *intimidation* roll against his target. Failure means that the target either knows nothing or is too terrified to speak. After a certain amount of questioning, the villagers will become nervous and ask the player characters to leave—or more monks will show up.

Gaining information from the ship's computer is less complicated, but the player character must spend four hours in pursuit of the knowledge before the tidbits below are revealed:

The Eye of Koda

The amulet is called the Eye of Koda, named after the scout who found it. Krin Koda was a legendary scout who flew the spaceways in the early years of the Empire. He claimed that the Eye was the map to a planet where ultimate power and wealth could be obtained.

Somewhere during that time, however, Koda disappeared. But the Eye has turned up every few years and passed through many hands. It has a history of bringing misfortune and death to those who possess it.

The Eye is a map, and the tiny particles within the gem, when viewed through a magnification device, represent stars and planets. If a character can make his Very Difficult *astrogation* roll, the system represented can be identified. Any scout vessel has the appropriate magnification apparatus in its locker.

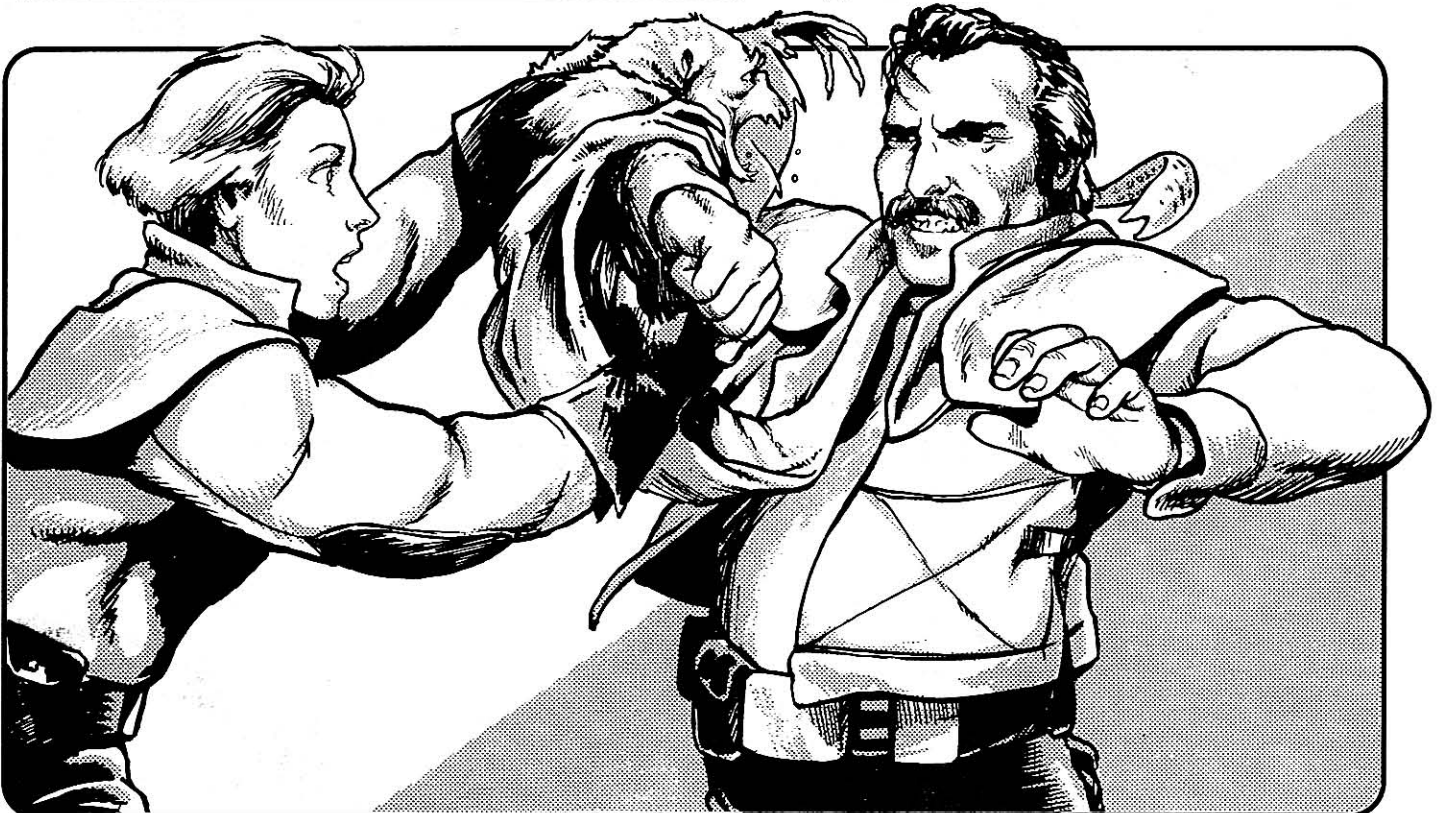

A little-known legend says that the Eye leads to a temple, built by an ancient and powerful race as a repository for all their knowledge and might. According to the legend, if a being gains entrance to the temple and stands on the altar within, he will be gifted with mastery over his fellow man and the ability to move among them unseen. There are other legends about the Eye, but this is the most detailed and concrete.

Encounter Two: A Race in Space

In this scene, the characters will make their way to the mysterious planet of Krin Koda — named, appropriately, after the scout who “discovered” it. They will have to survive an unexpected attack from both within and without their ship to continue their quest.

Once the characters make it to their ship, read the following aloud or paraphrase:

You find your ship much as you left it and quickly board and make ready for the journey ahead of you. Glad to be away from the homicidal fanatics, you quickly plot your course outsystem.

Your ships zips out of the atmosphere of the planet Vengler. The serenity of space overtakes you and you set your course for the jump into hyperspace. It is a jump which will lead you to the mysterious planet of Krin Koda. But questions nag at you: Who was that mysterious figure at the market? What is the secret that the planet of Krin Koda holds? You contemplate these mysteries as the stars around you blur and flash. Hyperspace! You are on your way.

Allow the characters time to do more research or prepare for their upcoming adventure in any way that they wish. Occasionally drop hints that they are feeling uncomfortable, like they are being watched.

A few moments after the characters’ ship drops out of hyperspace, read the following aloud or paraphrase:

You drop back into real space and find yourselves in a new and unknown system. According to what you’ve been able to determine from the Eye, you should be in the correct system. The treasure of Krin Koda awaits you!

You are preparing to steer your ship into orbit when a slight movement from a cabinet in the back of the cockpit captures your attention. The door swings open and a small winged creature is revealed. The creature leaps with a piercing screech from the cabinet and launches itself into the air.

Almost directly next to you, another craft comes out of hyperspace. It is a small assault

The Logrus

Craft: ExcelStar “Lone Scout-A”
Type: Modified Scout Vessel
Scale: Starfighter
Length: 24 meters
Skill: Space Transports: scout ship
Crew: 1
Passengers: 3
Cargo Capacity: 150 metric tons; 60 cubic meters
Consumables: 1 year
Hyperdrive Multiplier: x2
Hyperdrive Backup: x15
Nav Computer: Yes
Maneuverability: 1D
Space: 6
Atmosphere: 295; 850 kmh
Hull: 3D
Shields: 1D
Sensors:
Passive: 30/0D
Scan: 50/1D
Search: 75/2D
Focus: 5/3D

Weapons:

Four Laser Cannons (fire linked)

Scale: Starfighter
Fire Arc: Front
Skill: Starship gunnery
Fire Control: 3D
Space Range: 1-3/12/25
Atmosphere Range: 100-300m/1.2km/2.5km
Damage: 6D

The *Logrus* would look like a standard Lone Scout ship, save for the added quad turret mounted above the cockpit and some external hull modifications. The ship is flat black, making its shape difficult to discern when moving. Modified engines give the ship added speed and maneuverability. The ship has one emergency escape pod mounted on the vehicles’ bottom. It is enough to get the occupant into a planet in the system if necessary.

ship of unknown design. The assault ship begins an attack pass on your ship as the tiny creature in the cockpit sails at you, clawing and rending at your eyes.

The ship is being piloted by a servant of Dhar Bullwin. The ship, the *Logrus*, is a modified and disguised scout ship. It will use the distraction created by the Homonculous to attack the characters’ ship and attempt to either destroy it outright or force a landing.

When the characters manage to defeat the Homonculous read the following aloud or paraphrase:

The creature hisses and its mottled green skin begins to boil and melt from its bones. A

The Tempestro

The forests of Koda's World hide the planet's only sapient lifeform, the Tempestro. They are the warlike remnants of a once gentle and proud race. Millennia ago, the Tempestro had achieved a great civilization. While they never mastered technology, they had vast control over the spiritual world and were great natural Force users. This emphasis on the spiritual was the cause of their eventual downfall. The planet was struck by a meteor, and because the Tempestro had turned so far within, they were caught unprepared. Most of the population were destroyed in the dust cloud caused by the impact. The survivors of the cataclysm spent years erecting a huge stone edifice, where they stored the collected knowledge of their once-proud civilization.

The Tempestro that survive to this day are pale reflections of their proud ancestors. They are reduced to living in the trees surrounding the great stone edifice their forefathers built. They no longer remember the purpose of the building or its significance. They merely protect it and wait.

The Tempestro are large winged reptiles and are able to glide great distances. Their wings have sharp serrated edges which the Tempestro use in combat to great effect.

Tempestro

Attribute Dice: 12D

Attribute

Minimum/Maximums:

DEXTERITY 2D/4D

KNOWLEDGE 1D/2D

MECHANICAL 1D/3D

PERCEPTION 1D/6D

STRENGTH 3D/5D

TECHNICAL 1D

Height: 1.9-2.5 meters

Move: 8/10 walking or 13/18 gliding

Quote: "You seek entrance to the place of stone, it is forbidden."

Special Skills:

Strength Skills:

Gliding: Tempestro are able to use this skill to move through the great forests of the planet, much like Humans and other characters use running. Their speed is 13/18, or 37/52 kmh.

Special Abilities:

Telepathic Communication: Tempestro characters receive +3D when attempting to communicate with a sentient creature or use *con*, *bargain* or any other communication skills, due to their innate telepathic abilities.

greasy brown mist surrounds it. Within seconds, there is nothing left of the strange entity, other than a fragile framework of bone.

The ghastly skeleton twitches and the empty eye sockets glow with an amber light.

"The prize is mine, turn back and spare your

Koda's World

Planet Type: Jungle

Type: Terrestrial

Temperature: Temperate

Atmosphere: Type I (Breathable)

Hydrosphere: Moist

Gravity: Standard

Terrain: Ocean, forest, mountain

Length of Day: 14 hours

Length of Year: 502 Local Days

Sapient Races: Tempestro

Starport: none

Population: 100,000

Government: Tribal leaders

Tech level: Primitive

Major Exports: none

Major imports: none

The hot sun Tarin has five planets orbiting around it. Only Koda's World, the fourth planet, supports life. The others have potential for corporate use, as they have abundant natural minerals and other resources.

Koda's World resembles the forest moon of Endor in several ways. Vast forests cover both and the trees that grow on each are very similar. The trees reach several hundred meters into the air and are covered with a shaggy rust colored bark. They rise as straight as columns. The leaves of the trees are wide fronds the shape of a Human hand. Sparse foliage covers the lower portions of the forest.

lives!" croaks the hideous mockery. The framework of bone and sinew collapses and nothing but dust is left.

If the characters manage to defeat the *Logrus*, read the following or paraphrase:

Your last shot seems to have scored on a vital system. The *Logrus* shakes and crackling bits of blue energy run along the ship as it buckles and shakes. The out of control ship hurtles into the atmosphere of the planet, where it begins to breakup. At the last moment, an emergency pod launches from the belly of the black ship, it slips into the atmosphere just as the *Logrus* explodes in a brilliant pyrotechnic display.

It is important to the next scene that Dhar escape. If your characters are the type that will try to control everything, and are unlikely to "let" the escape pod reach the planet, don't tell them about it. When they enter the atmosphere, their sensors tell them that an escape pod has just landed on the surface.

If the characters are defeated, Dhar will not

deal the final death blow, he will allow the characters the chance to escape. He is in much too big a hurry to deal with the likes of them; he has a greater mission! He will assume that the characters will give up now that he has beaten them.

The last thing that the characters will see is the Homonculous melting away, as described above. Allow the characters to form their own plans about how to proceed from here.

Encounter Three: Alliance and Betrayal

In this scene, the characters should come face to face with the villain of the piece. Soon after they land, they will be able to trace Dhar Bullwin to a vast ancient temple complex by either his ship or his escape pod. There they will begin to battle, only to find that their struggles have awakened old horrors. A gigantic guardian beast is awakened, and the two sides have no choice but to stop their struggles in an attempt to overcome the horror.

Read aloud or paraphrase:

You manage to track Dhar Bullwin's ship/escape pod through the heavy moist atmosphere of Krin Koda's planet. As you initiate planetfall, you take in the breathtaking splendor of the planet below.

Koda's planet has a breathable atmosphere and is a warm lush world, filled with gigantic forests and deep green seas. Your sensors indicate that the world is teeming with life, from insects to large mammals and reptiles. You don't detect any signs of civilization, at least nothing modern.

Bullwin's ship/pod has made a landing at the edge of one of the planet's largest forests, and now that you are closer, your sensors do indicate some sort of large stone edifice some 20 kilometers within.

The characters can make an easy landing on the edge of the forest, landing within is not possible due to the size and density of the trees. The remains of an ancient brick pathway lead into the deep wood. From all indications, one lone man made his way down this pathway within the last several minutes, although no one can be seen in the darkness of the forest.

Read aloud or paraphrase:

The trees are ancient and huge, standing thousands of meters tall, like silent guardians. Their thick, heavy fronds blot out most of the available light. Sap runs from many of the trees filling the air with a heady, spicy odor.

It will take anywhere from several hours to several days to reach the dark stone temple, depending upon where the characters land in

Dhar Bullwin

Template Type: Dark Magician

Loyalty: To Himself

Height: 1.8 meters

Species: Human

Homeworld: Unknown

Age: 62 Standard Years

DEXTERITY 3D+2

Dodge 6D+2, melee combat

5D+2, melee parry 6D+2

KNOWLEDGE 4D+1

Alien species 5D+1, cultures

5D+1, intimidation 7D+1, lan-

guages 6D+1, survival 5D+1,

willpower 8D+1

MECHANICAL 2D

Astrogation 3D, beast riding

4D

PERCEPTION 3D

Bargain 5D, command 7D, con 6D, hide 5D, persuasion

7D, search 6D, sneak 5D

STRENGTH 3D

Brawling 4D, climbing/jumping 5D, stamina 6D

TECHNICAL 2D+1

First aid 5D+1, security 5D+1

Special Abilities:

Force skills: Control 5D, Sense 6D, Alter 7D

Force Powers:

Control: Absorb/Dissipate Energy, Control Pain, Reduce Injury, Enhance Attribute

Sense: Danger Sense, Magnify Senses, Receptive Telepathy

Alter: Injure/Kill, Telekinesis

Control and Sense: Projective Telepathy

Control and Alter: Force Lightning, Inflict Pain

Control, Sense and Alter: Affect Mind, Control Mind, Telekinetic Kill

Force sensitive?: Yes

Force Points: 12

Dark Side Points: 10

Character Points: 8

Description: Dhar Bullwin is not a Jedi, nor even a Dark Jedi. He is one of an ancient order of dark magicians who tap into and use the Force without actually understanding what it is.

Dhar studied under a master of these dark arts for nearly thirty years, until he felt he could learn no more. He then tested his powers by betraying and destroying his former master.

Dhar now uses his vast powers in a quest for ultimate power. He believes that with the treasures of Koda's planet, he can begin building a powerbase to achieve domination over the entire Galaxy.

Quote: "You cannot hope to stop me, my powers are beyond your comprehension."



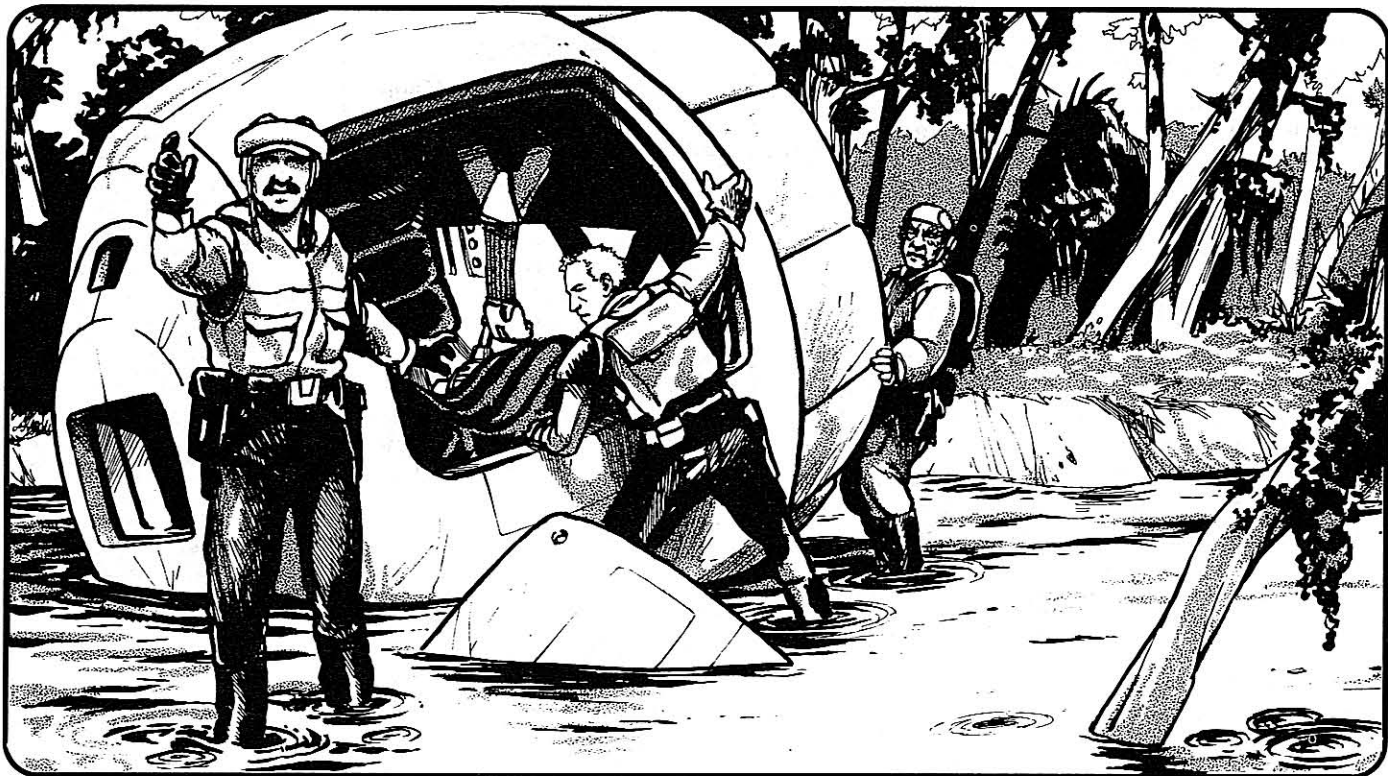

relation to Dhal and how much difficulty they run into. After several hours, the foliage begins to thin and a silence falls over the area. The constant calls and chirping of the local wildlife had been around for hours, but have suddenly become conspicuously absent. Tell the players this and continue reading aloud:

Up ahead in a thinly wooded clearing, you can just make out a solitary figure swathed in dark robes. Almost as though he possesses some sixth sense, the figure turns and, spying you, redoubles his efforts.

Suddenly, the ground begins to shake, dust and rock blast into the air and a fissure begins to open. The fierce cry of a savage guardian shatters the stillness of the day. The ground stops its rumbling, the dust begins to clear, revealing an enormous reptilian creature.

The monster is 20 meters long. It resembles a Star Dragon but looks more fierce, less intelligent. It turns its attention toward the robed figure and breathes a gout of fire at the fleeing man.

The flames lick the dark magician, but seem to do no harm. He responds with a blue ribbon of electricity.

The rear section of the creature pulls free from the ground, revealing ANOTHER HEAD! The newly revealed monster spouts a great rush of flames at you and your group!

The Garagon

DEXTERITY 3D

PERCEPTION 3D

STRENGTH 7D

Stamina 8D

Move: 10

Size: 8 meters tall, 20 meters long

Scale: Creature

Attacks:

Teeth: 8D

Claws: 5D

Special Abilities:

Breath Attack: breathes fire in a 25-meter x 10-meter cone. Does 7D damage and ignites flammable objects. Can breathe fire with a head once every other combat round. The head that is going to breathe the next round can do nothing else during the preparatory round (except dodge).

Dhar will stand his ground and attempt to use his powers to overcome the Garagon. The characters should do their part to help overcome the beast or it may well stop them all.

The magician will use his *control mind* power against the creature to turn it against the player group in order to slow them down, while he escapes into the forest. If the characters try to flee, the Garagon will pursue them (there are more of them, after all).

Encounter Four: A Tempest in a Temple

The characters make their way to the ancient stone fortress only to find that their foe has gotten there before them. He has made contact with the planet's inhabitants and bent them to his dark will. The characters must try to win past the primitive beings and stop the dark mage before he gains the great prize they are competing for.

Read aloud or paraphrase:

You have just defeated the strange draconic creature and head through the forest, trying to make up the time that you have lost. The path becomes harder, less well traveled and dense underbrush clogs the way. Each step becomes a battle as the thorns and brambles clutch at your feet.

After an eternity of this, you can see a great stone building before you. The monolith is made from giant blocks of stones, cut and transported from mountains thousands of kilometers away. Its twisting spires of pale gray stone reach above even the tops of the huge trees. There is no entrance that you can see from your vantage point and neither do you see any signs of the dark mage. As you continue nearer, you spy a movement on the side of the great central tower of the citadel. It is Dhar, climbing lizard-like up the slender spire toward a tiny opening in the wall.

You rush forward in a vain attempt to slow your foe, when the air is alive with hurtling shapes. Strange flying reptiles with stone axes and crude wooden spears surround you. What you assume to be an elder moves toward you. The brute is dressed in a rough loincloth made of uncured skins and wears a headpiece of dried flowers.

The Tempestro have already made contact with Dhar. He has used his dark powers to convince the gentle creatures that he was their friend and protector and warned them of the evil, unscrupulous beings that were chasing him. The Tempestro have promised to try to detain Dhar's enemies while he pushes on.

The characters will have quite a fight on their hands, if this is the course they wish to take. There are ten Tempestro warriors in this small hunting band and they will try to capture and detain the characters, causing them as little damage as possible. They are masters of woodcraft and adept at setting traps and using snares, nets and bolos to bring down prey. If the fight begins to go badly against the Tempestro, or if the characters are bloodthirsty, they will begin to employ their natural and lethal weapons. The Tempestro are naturally peaceful, and, even in their controlled state, do not wish to harm the player characters.

If the characters defeat the hunting party, they will then be able to follow the dark magician unopposed. But if the characters have slaugh-



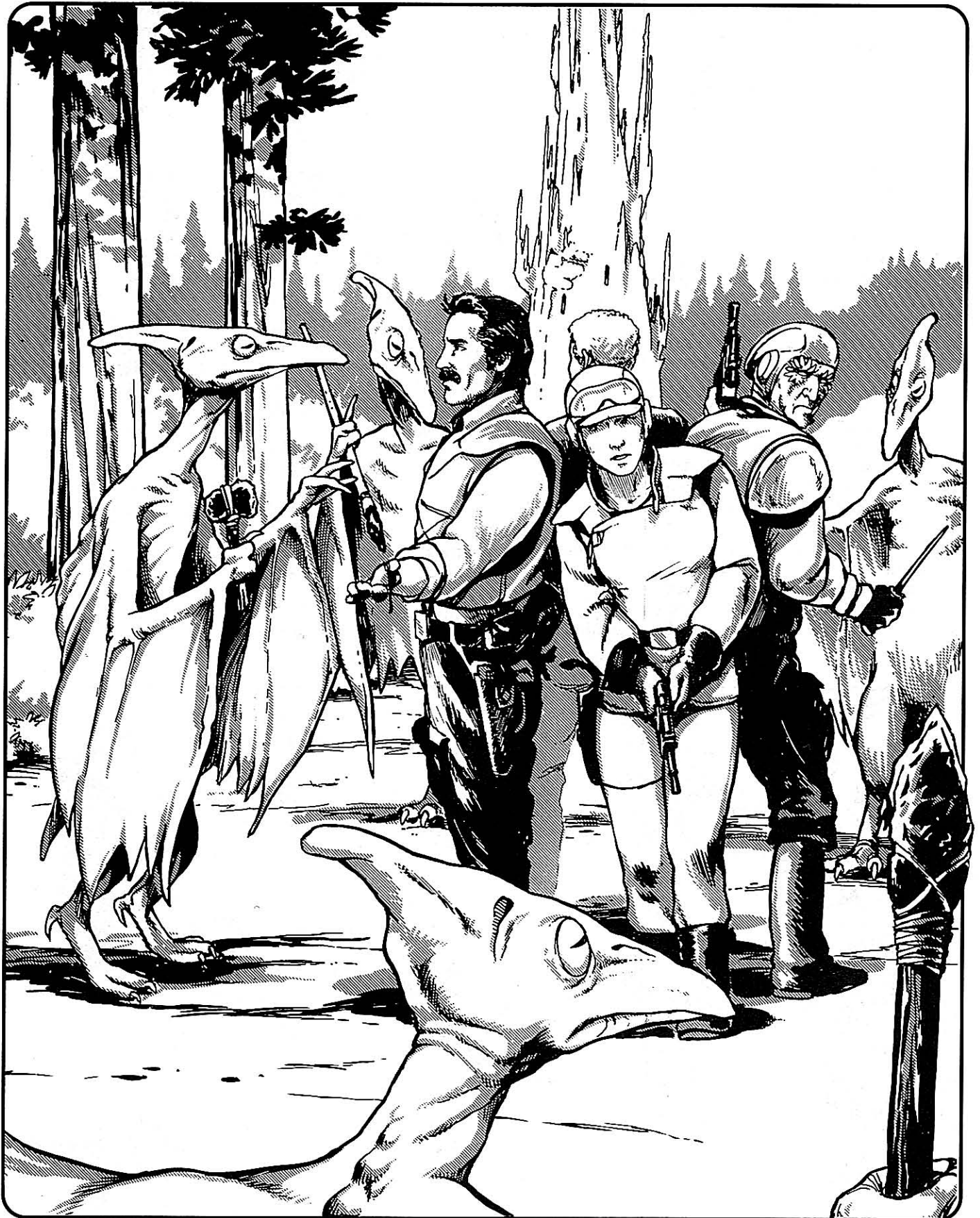

tered the Tempestros under Dhal's control, they will probably meet with vengeance by the other members of the species soon.

The other option open to the characters is to try to communicate with the natives and convince them of their good intentions. The easiest way for them to do this is to show the Tempestro the Eye of Koda. They were the ones who gave it to Krin Koda when he saved the population of the planet from a ravaging disease. This will shock the Tempestro out of Dhal's control, and the primitive beings will help the player characters any way they can (short of violence).

If the characters don't think to show the warriors the Eye, they must convince the primitives in another way, perhaps through a stirring soliloquy on the beliefs of the New Republic, in any event it will take a Difficult *con* roll to change their minds about the characters. Language shouldn't be a problem (at least on the Tempestro's side).

Once the characters either defeat or befriend the Tempestro, they can continue into the stone castle. The characters may try to climb the outside of the tallest tower and follow Dhar or they can search the base of the structure for another way in.

If the characters try to climb the outside of the tower, read the following aloud or paraphrase:

The outside of the tower has numerous hand and footholds and should prove easy enough to climb. The first several hundred meters are quickly conquered, but as you continue higher,

you see that the sections of the wall that extend beyond the tops of the trees have suffered from exposure to the elements and have been worn nearly smooth from a thousand generations of wind and rain. There is no way to continue past this point, you must climb down and look for another means of entry.

When the characters search the base of the structure, read the following aloud:

The stone structure is one hundred meters square and several hundred meters tall. The huge blocks of stone from which it has been constructed have been carved into elaborate patterns and shapes. The only spot on the outside that is remarkable is a section on the north side of the structure. One entire thirty meter wall section has been carved into a representation of the Tarin system.

A character making a *Perception* difficulty of Moderate will notice that this planet, Koda's World, is not represented on the wall. If the Eye is placed in the correct position on the carving (requiring a Moderate *astrogation* roll to place it in the correct position in regards to the other planets), a section of wall will swing open noiselessly. Read aloud or paraphrase:

The area beyond the door is dimly lit by some sort of natural phosphorescent fungus or lichen that grows on the walls. The room beyond is immense, taking up the entire space

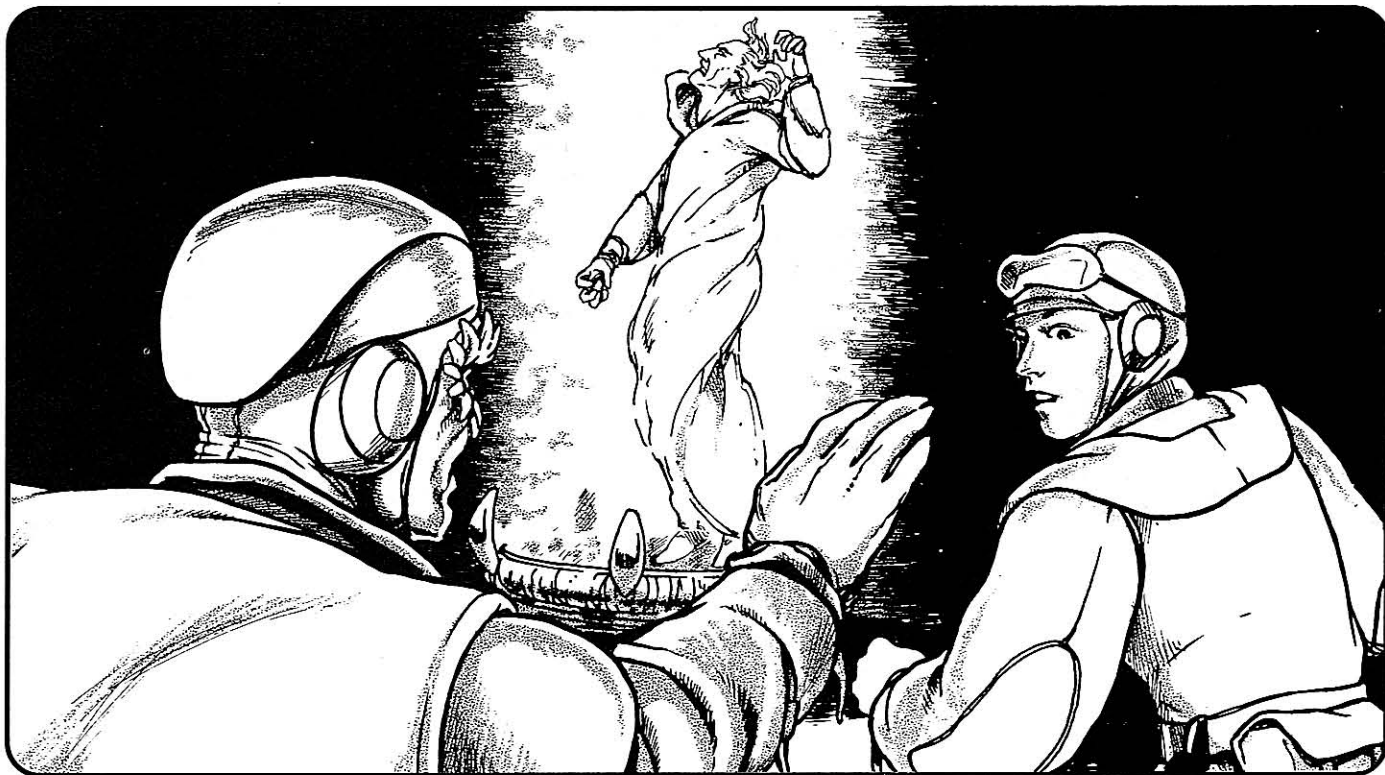

within the monolith. In the center of the space is a raised platform with a softly glowing energy nimbus surrounding it. Standing in the center of the swirling maelstrom is your foe, the dark magician, Dhar Bullwin. Flashes of energy strike his body and he reels from the shock.

The dark mage turns and his eyes flash with anger at you. His voice rings out, "The power is amazing! I can feel it flowing through me, coursing through my veins. I am in touch with the whole of the cosmos, and it shall be mine! Now fools, prepare to face the wrath of Dhar Bullwin, prepare to die!"

Before your eyes, the magician seems to fade from view, his outline only barely visible in the swirling energy nimbus.

The dark magician will use his powers against the group; it is vital that they somehow stop the evil here. The energy field that Dhar is standing in is made up of the spiritual energy of the Tempestro that gave up their lives to preserve the knowledge and power of their culture. As long as Dhar stands in the energy field he may add an additional 1D to all rolls that he makes and all difficulties for manipulation of Force powers are reduced by one level.

Because Dhar is invisible, all attacks against him are at minus 1D.

If things go poorly for the characters, you can have the Tempestro come to their aid in an attempt to turn the tide of the battle. When things seem their darkest read the following aloud:

The evil magician seems unstoppable. He hurls bolts of energy with reckless ease, causing frightful destruction at will. The energy field that surrounds him continues to feed raw might to the wizard. Suddenly, Dhar begins to shake, seemingly unable to control his actions. The light from the energy reaches a blinding intensity. The mage screams in torment and then is seemingly devoured from within.

A voice rings out from the energy whirl, "The power devoured him because he was not worthy to receive it. Will you attempt to gain the power for yourselves?"

The shimmering form of an elderly Tempestro begins to manifest at the base of the pedestal.

"I am the last of the Tempestro of old, guardian of this repository of knowledge and power. For your part in the defense of this temple you

shall be rewarded. Step onto the pedestal and receive your reward."

When the characters stand in the energy whirl they will gain an additional 1D in any one of their skills (their choice). If, however, the characters slaughtered the Tempestros under Dhal's control, this bonus will go away after twenty-four hours. Otherwise, it is permanent.

The spectral form speaks again, "You must leave now; we were wrong to attempt to retain our powers and live beyond our allotted time. Our time is past and we must prepare our end. Leave this place, leave before you are destroyed."

The energy pool flares with a new brilliance, shooting forth like a beacon. Cracks appear in the stonework and an ominous rumbling can be heard. Chunks of masonry rain down from the tall spires and within minutes the entire temple collapses in upon itself.

Aftermath

The player characters are able to escape the destruction of the temple if they do not delay. Any character that does not immediately decide to flee the ruin must make an Easy *Dexterity* roll to get out in time or be crushed to death by the falling rubble. For every round the characters delay further, the difficulty number rises by one level.

After escaping the ruin, the characters again encounter the Tempestro. If they convinced the Tempestro that they were friendly before, then the primitives take them back to their village for a celebration — and reward them with artifacts and trinkets as friends of the tribe. Because of the unique nature of the artifacts, the characters can get 10,000 credits for them on any specialized market.

If, however, the characters slaughtered the Tempestros, they will get a very different welcome. The primitives will harry and attack them all the way back to their ship, throwing spears and rocks, but keeping their distance. More and more Tempestros will attack, unless the characters repent and try to reason with the primitives. The best they can hope for here is to be left alone to flee the planet.

Corporate Scout

Character Name: _____



Player: _____
 Species: Human
 Sex: _____ Age: _____
 Height: _____ Weight: _____
 Physical Description: _____

Background: You found a way to the fast track in the Karflo Corporation as a corporate scout. You fly the spaceways searching for readily exploitable worlds. A couple of big discoveries and before you know it, you'll be a junior V.P. in the exploration division.

Personality: You are a little new at this scouting thing, but how hard can it be? You've seen those other scouts and

you know you're smarter and luckier than those losers.

Objectives: Be involved in a *big* discovery, and get yourself noticed by your bosses.

A Quote: "So there are natives; if they don't want to live next to a Tiroxin processing plant, I guess they'll have to move."

Connection With Other Characters: _____

DEXTERITY	3D	STRENGTH	2D
Blaster	_____	Climbing/Jumping	_____
Dodge	_____	Stamina	_____
Running	_____	Swimming	_____
Melee Parry	_____		_____

PERCEPTION	3D	MECHANICAL	3D+2
Bargain	_____	Astrogation	_____
Con	_____	Sensors	_____
Hide	_____	Space transports	_____
Persuasion	_____	Starship gunnery	_____
Search	_____		_____

KNOWLEDGE	3D+2	TECHNICAL	2D+2
Alien Species	_____	Computer Prog/Rpr	_____
Business	_____	Droid Programming	_____
Languages	_____	First Aid	_____
Planetary Systems	_____	Space Transports Rpr	_____
Survival	_____	Starship/Weapon Rpr	_____

Special Abilities: None.

Move: 10

Force Points:

Force Sensitive: Yes No

Dark Side Points:

Character Points: 5

Wounded

Incapacitated

Mortally Wounded

Equipment: Karflo Corporate Scoutship (Gamemaster assigns ship similar to Stenar's Lone Scout), comlink, 250 credits, 2000 credits in snappy wardrobe and scout equipment.

Prospector

Character Name: _____



Player: _____
 Species: Near-Human
 Sex: _____ Age: _____
 Height: _____ Weight: _____
 Physical Description: _____

Background: Making a fortune in the human-dominated Known Galaxy has never been easy for an alien, but you've earned and spent more money than most people will ever see. Searching out and finding the claim's the fun; taking the rewards and living high is the gravy.

Personality: You've been called an old coot, a lunatic, and a fool, but you don't value

what "civilized" people think. All you care about is the *claim*. Just you and your old mule Droid against the galaxy.

Objectives: To live out life searching for that one "big score."

A Quote: "Lotta 'spectors crack up, can't handle the loneliness. But not me. Heh, heh, heh. Nope, not me. Hee, hee."

Connection With Other Characters: _____

DEXTERITY	2D+2	STRENGTH	2D
Blaster	_____	Brawling	_____
Brawling Parry	_____	Climbing/Jumping	_____
Dodge	_____	Lifting	_____
Pick Pocket	_____		_____

PERCEPTION	3D+1	MECHANICAL	3D+1
Bargain	_____	Astrogation	_____
Con	_____	Powersuit Operation	_____
Hide	_____	Sensors	_____
Investigation	_____	Space Transports	_____
Search	_____	Starship Gunnery	_____

KNOWLEDGE	3D+1	TECHNICAL	3D+1
Alien Species	_____	Demolition	_____
Languages	_____	Droid Programming	_____
Planetary Systems	_____	Droid Repair	_____
Streetwise	_____	Space Transports Rpr	_____
Survival	_____		_____
Value	_____		_____

Special Abilities: None

Move: 10

Force Points:

Force Sensitive: Yes No

Dark Side Points:

Character Points: 5

Wounded

Incapacitated

Mortally Wounded

Equipment: Vangaard Pathfinder (*very* old); datapad, comlink; prospector equipment; MULE Droid on which you owe 500 credits; 300 credits in negotiable minerals

Scout Droid

Character Name: _____

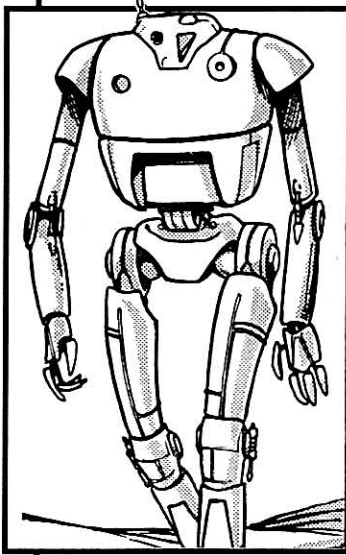

Player: _____

Model: Smitroo Industries Explorer Mk. V

Height: 1.8m **Weight:** _____

Physical Description: Bigger and more resilient than other Droids, you have a pacifying effect on those who don't know you. Your master finds this useful; you find it interesting.

Background: Only 500 of your model were created and sent out with scouts to find new worlds for the Smitroo Corporation before it fell into bankruptcy. Since then, you have passed from owner to owner, hoping to find a scout who will help you fulfill your primary mission (the Smitroo Board of Directors *must* be out there).

Personality: You are program-

med for exploration and loyalty — to the Smitroo Corporation.

Objectives: To seek out new worlds and new civilizations ... and find out what rathole your creators ran down..

A Quote: "Greetings primitive organic lifeforms, I contact you as a representative of the... Put down that jawbone!"

Connection With Other Characters: _____

DEXTERITY	1D	STRENGTH	3D
Brawling Parry	_____	Lifting	_____
Dodge	_____	Stamina	_____
_____	_____	_____	_____
_____	_____	_____	_____

PERCEPTION	2D	MECHANICAL	2D
Bargain	_____	Astrogation	_____
Investigation	_____	Communications	_____
Persuasion	_____	Repulsorlift Ops	_____
Search	_____	Sensors	_____
_____	_____	Starship Shields	_____

KNOWLEDGE	2D	TECHNICAL	2D
Alien Species	_____	Computer Prog/Rpr	_____
Bureaucracy	_____	First aid	_____
Business	_____	Starship repair	_____
Cultures	_____	Security	_____
Languages	_____	_____	_____
Planetary Systems	_____	_____	_____

Special Abilities: Due to the nature of your programming, you have some skills or abilities that you are unaware of and unable to use ... until the proper time.

Skills: You start with 10D to allocate to skills

Story Factors: See section 8.2 in Star Wars 2nd edition.

Equipped With: Chest Storage Case (.5 cu meter), analysis kit (internal; used with storage case — +2D to *investigation* and *value* of minerals only), long-range sensor (+2D to *search* for objects 25–30 meters away), atmosphere sensor determines air content in 1 hr. and type (I, II, III, or IV) in 5 minutes.

Move: 7

Force Points:

Force Sensitive: Yes No

Dark Side Points:

Character Points: 5

Wounded

Incapacitated

Mortally Wounded

Ex-Imperial Scout

Character Name: _____



Player: _____

Species: Human

Sex: _____ **Age:** _____

Height: _____ **Weight:** _____

Physical Description: _____

Background: You were taken from your home and forced into life as an Imperial conscript. Managing your way into scouting, it never satisfied your need for freedom. Now that the Empire has fallen you can do as you wish, and what you want to do now is spend time on the fringe exploring the wonders of nature and making peace with yourself.

Personality: You were forced to work for the wrong side most of your life, but you're too sick of conflict to "atone."

Objectives: Find peace within yourself.

A Quote: "I'll never forget what they did to me, or what they made me do. But I'm sure gonna try."

Connection With Other Characters: _____

DEXTERITY	3D	STRENGTH	2D+1
Blaster	_____	Brawling	_____
Brawling Parry	_____	Climbing/Jumping	_____
Dodge	_____	Swimming	_____
Melee Combat	_____	_____	_____
Vehicle Blaster	_____	_____	_____

PERCEPTION	3D+2	MECHANICAL	3D+1
Command	_____	Astrogation	_____
Hide	_____	Communications	_____
Investigation	_____	Sensors	_____
_____	_____	Space Transports	_____
_____	_____	Starship Shields	_____

KNOWLEDGE	3D+1	TECHNICAL	2D+1
Alien Species	_____	Blaster Repair	_____
Bureaucracy	_____	Droid Programming	_____
Intimidation	_____	Droid Repair	_____
Planetary Systems	_____	Space Transports Rpr	_____
_____	_____	_____	_____

Special Abilities: None

Move: 10

Force Points:

Force Sensitive: Yes No

Dark Side Points:

Character Points: 5

Wounded

Incapacitated

Mortally Wounded

Equipment: Modified Senar Lone Scout (LSA-1) — use stats for two, but the LSA-1 is much more recognizable as an Imperial craft; Imperial service uniform (stashed away); heavy blaster pistol

STAR WARS

THE NEW REPUBLIC

GALAXY GUIDE 8

SCOUTS

by Bill Olmesdahl and Bill Smith

In the days of the Old Republic, exploration was the key to adventure. New worlds lay beyond the next star, and high adventure lived along the spaceways. The scout was a free spirit; an adrenaline jockey eager to plumb the depths of his own curiosity.

And then came Imperial Rule and the iron grip of Emperor Palpatine. He, and his Imperial Moffs and governors, turned the scout service to ... other purposes. Seeking out Rebel Bases and hunting the heroes of the Alliance, the scouts became dark shadows of themselves — spies and infiltrators under the control of the Imperial Fleet.

Now, the New Republic holds sway in most of the “civilized” portions of the old Empire, and the Scout Service has been renewed. Seeking out cultures and worlds lost or abandoned during the dark time of the Empire, the scouts are a new breed of hero facing a new kind of danger ...

A STAR WARS

S U P P L E M E N T

For gamemaster and one or more players.
For ages 12 and up.

©, ™ & © 1993 Lucasfilm, Ltd. (LFL). All Rights Reserved.
Trademarks of LFL used by West End Games under authorization.



40061

ISBN 0-87431-188-8



0 18874 40061 1