

STAR WARS®

THE  
KATHOL  
OUTBACK



THE  
DARKSTRYDER  
CAMPAIGN

**A long time ago in a galaxy far, far away ...**

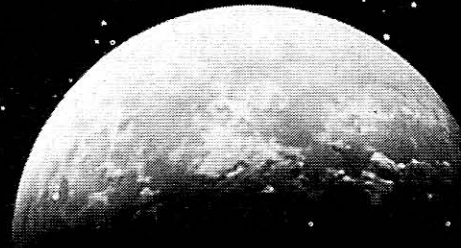

The New Republic ship *FarStar*, manned by a motley crew of New Republic personnel, outcasts, and misfits, is in hot pursuit of rogue Imperial Moff Sarne.

Sarne commands his fleet and controls strange, mystical artifacts known only as "DarkStryder technology." The captain of the *FarStar*, Kaiya Adrimetrum, has been charged with apprehending him at all costs.

With every passing day, the *FarStar* travels farther and farther from the settled worlds of the galaxy, and farther into the isolated, unsettled void of deep space ...

**C O N T E N T S**

**Introduction** ..... 3  
**The Kathol Outback** ..... 4  
**Denizens of the Outback** ..... 14  
**Plant Food** ..... 22  
**Little Empires** ..... 38  
**Wildfire** ..... 50  
**The Masters of Exocron** ..... 66  
**Galaxy's Edge** ..... 80

**C R E D I T S**

"Introduction" by Paul Sudlow  
"The Kathol Outback" by Paul Sudlow  
"Denizens of the Outback" by Paul Sudlow  
"Plant Food" by Chris Doyle  
"Little Empires" by Lisa Smedman  
"Wildfire" by George R. Strayton  
"The Masters of Exocron" by Anthony P. Russo  
"Galaxy's Edge" by George R. Strayton

*Development and Editing:* Paul Sudlow

*Additional Editing:* Bill Smith, Eric S. Trautmann

*Project Coordination:* Paul Sudlow

*Graphics:* Brian Schomburg

*Maps and Diagrams:* Stephen Crane, Tom O'Neill

*Cover Illustration:* Gábor Szikszai and Zoltán Boros

*Interior Illustrations:* Storn Cook, Dan and David Day, Tim Eldred, Ray Lederer, Christopher Trevas, Mike Vilardi

*Special thanks to:* Timothy Zahn

# INTRODUCTION

"Score another one for the 'Queen of Sabacc!'" Gorjaye crowed, as she raked in the credit chips. "Guess you just aren't having a good day, Thyte."

Darryn Thyte glowered as he regarded the sabacc cards which had betrayed him at the last moment. "I'm not having a particularly good *decade*," he said, flexing his mechanical arm with a whirl of servomotors.

Gorjaye snorted, and threw a card at Thyte. "Aw, stop being such a wet blanket. You think you're the only ex-Rebel who's had a setback? I can think of a couple of X-wing pilots who've had worse luck than you, fact is."

"Oh, for pity's sake, will you two shut it down?" called Dajus from the other side of the officers' lounge, where she sat at a holographic gameboard across from Lofryyhn. "I can barely think over here!"

"I guess it wouldn't be too sporting to touch *that* one, Imperial," Gorjaye said with a nasty smile. "Tempting, though."

Dajus glared at Gorjaye a long moment, and Gorjaye glared right back. Lofryyhn woofed impatiently, and Dajus turned back to the game with a guilty glance at the Wookiee engineer. She looked down at the gameboard and sighed with frustration. Lofryyhn's holographic gundark had made an alarming foray into her primary defense group. She glared up at Lofryyhn across the table. He snuffed with laughter and leaned back.

"Heading into this Void thing ... I hear it'll be 14 days — *at least* — before we hit a system, even an undeveloped one," Thyte remarked. "It's a good thing we got the engines upgraded, or we'd be out in the middle of nowhere for nearly a month."

"It's going to be bad enough as it is," Gorjaye said, gathering the cards. "You bridge types can drill your crews silly to keep them busy,

but our mighty captain refuses to stop every few days so my pilots can log some flight time. She may catch us up to Sarne quick, but it won't buy a nerf's tail if we can't fight when we get there."

Lofryyhn growled angrily.

"I don't think the Wookiee cared for your tone, there, Gorjaye," Dajus said. She paused. "I don't think I particularly care for it either. Bad-mouthing the captain is bad form."

"Oh, what would you know about it. Little Miss Jackboots? At least *I'm* not chasing around after *my* last boss!"

"What's *that* supposed to mean?" Dajus said, flushing.

"You heard me!"

At that moment, alarm klaxons began wailing throughout the ship. The hull gave a little shudder through the deck plates. Dajus stared up at the ceiling. "Hey! Do you feel that? We're reverting to realspace."

"All hands clear for action!" called First Officer Khzam's voice over the intercom. "Repeat, all hands clear for action!"

"This had *better* be a drill," Gorjaye muttered as she grabbed her flight jacket and ran for the door, followed by Lofryyhn.

"I thought you wanted action, Wing-Ripper!" Thyte called merrily after them. He sat back down, chuckling.

"Um, shouldn't we be going, too?" Dajus said, standing.

Thyte looked up. "Eh? In a minute." He winked. "Actually, this is a drill. Ordered up special for our bored pilots." He leaned back with a chuckle. "Apparently Captain Adrimetrum has her own sense of humor, as well as better ears than Gorjaye gives her credit for. She specifically told me not to tell Gorjaye about this drill ..."

The adventures of the *FarStar* have thus far taken place in the frontier planets of Kathol sector. But the Kathol region of space is comprised of more than the area claimed by the Empire and ruled by Moff Sarne.

Beyond the limits of the Kathol sector itself lies a large area of space largely unexplored and uncharted — an area of space known as the

Kathol Outback. The settlements in the Outback are as isolated and insular as can be imagined (some haven't had contact with the Core in centuries). Life in the Outback is hard, and often dangerous. In the Outback, a man's blaster cells are sometimes valued more than his life. Even this far out in space, there's seldom a dull moment ...



# THE KATHOL OUTBACK

## WELCOME TO THE OUTBACK

The portion of Kathol sector claimed by the Empire is much bigger than the area actually *controlled* by Moff Sarne. Sarne, when his military might was at its pinnacle, could only project his power over about a quarter of the sector.

The rest of the sector lies beyond a very long stretch of empty space called the Marcol Void. Beyond the Void lies the Kathol Outback, a stretch of stars with many small settlements. These settlements include subsistence colonies and worlds populated by refugees, criminals, penal colony convicts, and religious cults.

The starfields of the Outback are dominated by an enormous backdrop of glowing dust, milky-white tendrils of burning gas, and the glowing

nimbuses of coalescing solar systems. This majestic cloud, blazing with the light of thousands of young suns, is the Kathol Rift.

The Rift forms the far border of the Outback. As far as is known, no one from civilized space has passed through it and returned. There isn't much interest in doing so, either. The people who live in its shadow are more concerned with the demands of day-to-day living and staying out of the way of the mysterious Aing-Tii monks, strange aliens who take a dim view to anyone interfering in their unknowable affairs.

## THE MARCOL VOID

The Marcol Void is a stretch of empty space which cuts through the sector, separating the Imperial region — dominated by Kal'Shebbol — from the independent wilds of the Outback.

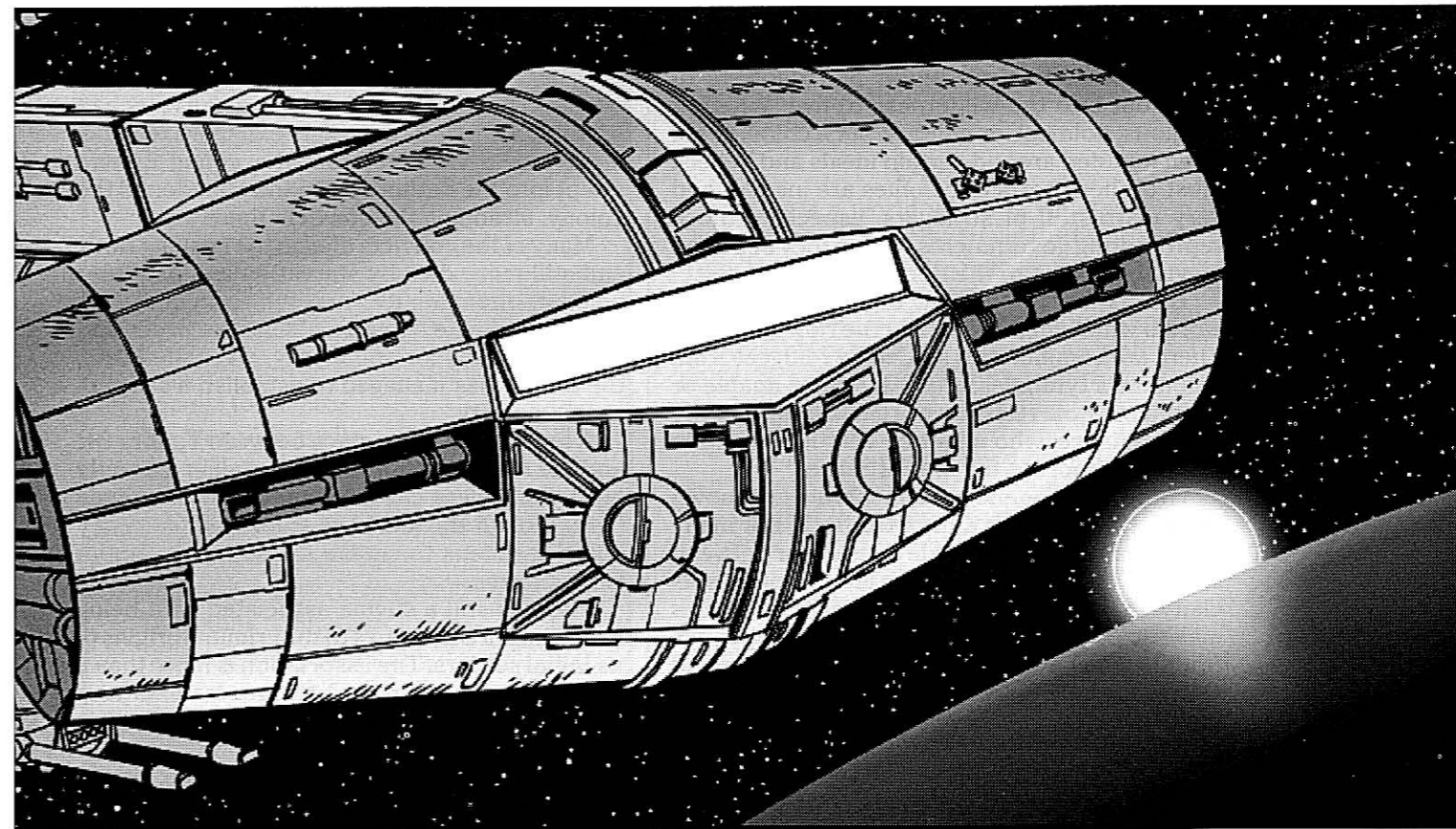

Tim Eldred

The Imperial-dominated portion of the Kathol sector ends, for all practical purposes, at the Void. Sarne occasionally sent ships on patrol in the Void and out into the Outback. Now, of course, these excursions have stopped altogether with the New Republic's take-over of the sector, though Sarne's fleet crossed the Void as it fled the sector.

The Void is roughly 30 light years across, with no known fast hyperdrive routes. A ship with a hyperdrive multiplier of x1 takes over 14 days to cross the Void; it is not an idle undertaking.

There are no systems within the Void, and very little space debris. Because of this, blind jumps into the Void are relatively safe. Many of the pirates in the area blind-jump into the Void when pursued, since they know the chances of hitting something are vanishingly small — about as small as the chances that their pursuers can track a blind jump.

## THE NEW REPUBLIC AND THE OUTBACK

There are many settlements in the Outback, most of them settled by those hiding from something or someone. Other settlers are simply unin-

terested in dealing with outsiders.

Most of these settlers never gave Sarne and the Empire much thought. Some of the more prominent trading settlements closest to Gandle Ott received occasional visits from Sarne's revenuers to collect taxes and ensure they were complying with Imperial law. Beyond that, Imperial ships were rare sights indeed.

Many of the settlements in the most remote areas of the Outback escaped Kal'Shebbol's notice altogether. These settlements are in varying stages of isolation. Some worlds don't know that Sarne has fled his capital. Some still suppose Palpatine rules the Empire from his throne on Coruscant. Still others are unaware there ever *was* an Empire — the Old Republic was in full swing when their ancestors left settled space, and "everyone knows that the Republic will never die."

Many of the Outback's settlements won't be very impressed by the arrival of a New Republic ship. Most of the people settled out here because they didn't much care for galactic government, democratic or not. To the Outbackers, any external political force greater than their own is to be viewed with suspicion.

Many of the newer settlements are colonies forged by a charismatic leader — for only such a leader could convince his or her followers to come out into the wilderness to live. Whether religious, political, or military, such colonies are often founded around certain ideals and beliefs. Most of these sorts of colonies are insular, and very distrustful of strangers, especially those representing governments, which they see as an inevitable threat to their autonomy.

That is not to say that there are not some worlds which might welcome the New Republic. There are communities settled by refugees from Palpatine's tyrannies, either by those unable or unwilling to join resistance organizations like the Rebel Alliance, who might be very interested in lending support to the foes of Sarne.

These colonies and settlements are not known to many outside the Kathol Outback, but many know of one another. Trade does occur between some of these worlds, and a few produce specialty export items. Some few of these items make it back to the Kathol sector proper via traders who have set up networks of buyers and sellers in the Outback. Other worlds are absolutely isolated, and have not been disturbed in hundreds of years.

## **WORLDS OF THE OUTBACK**

Here is a listing of some of the worlds and colonies in the Outback. Additional worlds are covered in the adventures themselves.

The settlements listed here appear on the star map and tend to fall between the adventures included in this book. They may be customized and adapted for your own adventures. There is also plenty of room on the star map for worlds of your own invention should you wish to customize the Outback for your campaign.

### **TIMBRA OTT**

Timbra Ott, at the end of the Galtea Run, is the one planet of the Outback known to most people — even if they're not quite sure how to get there. Originally, it was a sister colony of Gandle Ott, for those who *really* wanted to get away from their neighbors.

Like Gandle Ott, Timbra Ott was a very nice planet upon which to settle. That is, before the quakes sundered the planet's mantle and caused huge tidal waves to sweep away the coastal colonies.

The planet never really recovered, and was converted to a penal colony by Kal'Shebbol's

government in the days of the Old Republic. For many years, convicts labored in camps to rebuild the infrastructure sufficiently to allow resettlement. However, some years before the work had progressed to the point where extensive resettlement was a viable option, the young Empire swept into the Kathol sector and abandoned the colony, stranding the convicts there.

Many of the convicts died in the ensuing riots, and still more died by starvation and exposure before the community's new self-appointed leaders could create some semblance of order and lay down plans for sufficiency. Over the years, the colony has managed to establish a self-subsistent society.

A lot of trade takes place between Timbra Ott and the rest of Kathol sector, not all of it exactly legal. Smugglers can do their business openly here, though the local law enforcement agency still takes steps to ensure the safety of Timbra Ott's citizens.

There is still a stigma associated with being from Timbra Ott, thanks to the criminal origins of its initial settlers. The association is more than a little unfair, however, since two generations have now been born since the last batch of criminals landed on the planet's surface.

A small but growing number of people, mostly the adult children of the original criminals, are lobbying to boot the smugglers out and forge a more lawful society. Thus far, they lack the clout to make an impact, but they would make natural allies of the New Republic.

### **THE PIMBRELLAN LEAGUE**

The Pimbrellan League is a three-system network of colonies which lies at the end of the Sebiris Run across the Marcol Void. It was settled many decades ago. The colonists are religious adherents to Pinacism, the belief that those who sit out the grand events of history will eventually emerge to pick up the pieces.

The three worlds of the League — Dolstan, Swedlan, and Bresan — are located within a cluster of star systems. Each world is located in a separate system, each of which is located some distance from the others. There are numerous smaller systems between them, but the three main colonies are the only worlds capable of supporting human life.

Dolstan, as the original settlement, is still dominant in League politics. It is a dry world of savannas and deserts, and large, land-locked salt lakes. However, the soil is very fertile when irrigated, and provides most of the food for the colonies of the League. Swedlan and Bresan are less hospitable worlds. The atmospheres cannot directly

## ASTROGATION DIFFICULTY CHART

The following difficulties apply for *astrogation* rolls for routes between the following systems.

Galtea to Timbra Ott	14
Sebiris to Dolstan	12
Dolstan to Bresan	5
Bresan to Timbra Ott	11
Timbra Ott to Sapella	16
Timbra Ott to Jangelle	12
Sapella to Binaros	13
Binaros to Jangelle	8
Jangelle to Dayark	10
Dayark to Pitann	9
Pitann to Ehjenla	16
Ehjenla to Uukaablis	15
Uukaablis to Shatuun	15
Shatuun to Exocron	19
Shatuun to Nah'Malis	14

support human life, and the settlers must wear breath masks. The settlements consist of sealed domes and underground "warrens," and a large percentage of local resources are poured into maintaining the life support facilities.

The settlers of the three worlds have done a very good job of establishing self-reliant nation-states, and each world also has a few dozen towns and villages. Life is relatively rustic and low-tech, but the League does have small industries which produce such items as comlinks, satellites, hover vehicles, and droids. The Pinacist leaders are highly-educated people, and education is important in Pimbrellan society.

The three worlds jointly maintain a small navy of corvettes which range throughout the holdings of the League, protecting its assets and people from pirate and slaver raids.

Unlike many settlements in the Outback, the Pinacists keep careful tabs on events all the way back to the Core, and have arranged through agents living on Gandle Ott to have a courier droid sent out to them once a week to deliver information from the newsnets. They do not share this information with other settlements, however. Indeed, they are reluctant to even suggest that they keep tabs on happenings in the New Republic and Empire.

There is an ongoing debate among the Pinacists as to whether the fall of the Empire is "The Event" they have been waiting for to return to settled space and fulfill their destiny, or merely a small "hiccup" in galactic affairs.

### SAPELLA

Sapella is a world which is isolated even by Outback standards. Few travel the five-day route from Timbra Ott out to Sapella, since there is a main route running directly to Jangelle and the more profitable trading in the Kathol Republic.

Sapella is in the early stages of an ice age. The polar caps cover most of the northern and southern hemispheres, and the temperatures range from chilly to frigid.

There is a temperate band near the equator, and the Sapella colony is settled in this region. The weather is milder — merely cold — and the terrain is made up of hilly coastland islands.

The colony raises hindian pears, sihan peaches, a variety of grains, and several types of livestock. Its vineyards produce a very tasty wine which its merchants trade for needed supplies from other colonies, most commonly Timbra Ott and Jangelle.

Sapella has a mutual defense pact with Timbra Ott. Though its navy consists of only two vessels, they are large (though dated) capital ships capable of taking on most pirate forces operating in the Outback. They had a third capital ship, but it was lost with all hands after an unfortunate brush with a Aing-Tii ship (this was an accidental collision rather than a purposeful ramming, but Sapella's government doesn't know that).

### BINAROS

Binaros is a young planet, rich in vegetation and wildlife, and devoid of sentient life forms.

This wild, untamed world is home to a variety of species of plant life, many of which are edible and can augment the *FarStar's* food stores.

(See "Plant Food" for more information on Binaros.)

### JANGELLE

Jangelle is a warm world of sandy lowlands. Large bodies of water are rare, though the surface of the planet is covered in a complex network of rivers, streams, and deltas.

The world was settled by a colony of refugees who fled there soon after the Empire came to the Kathol sector. The inhabitants are aware of Sarne's activities, since they send carefully disguised cargo ships on supply runs all the way back to Gandle Ott and Pembric II a few times a year. They do not yet know that Sarne has fled the

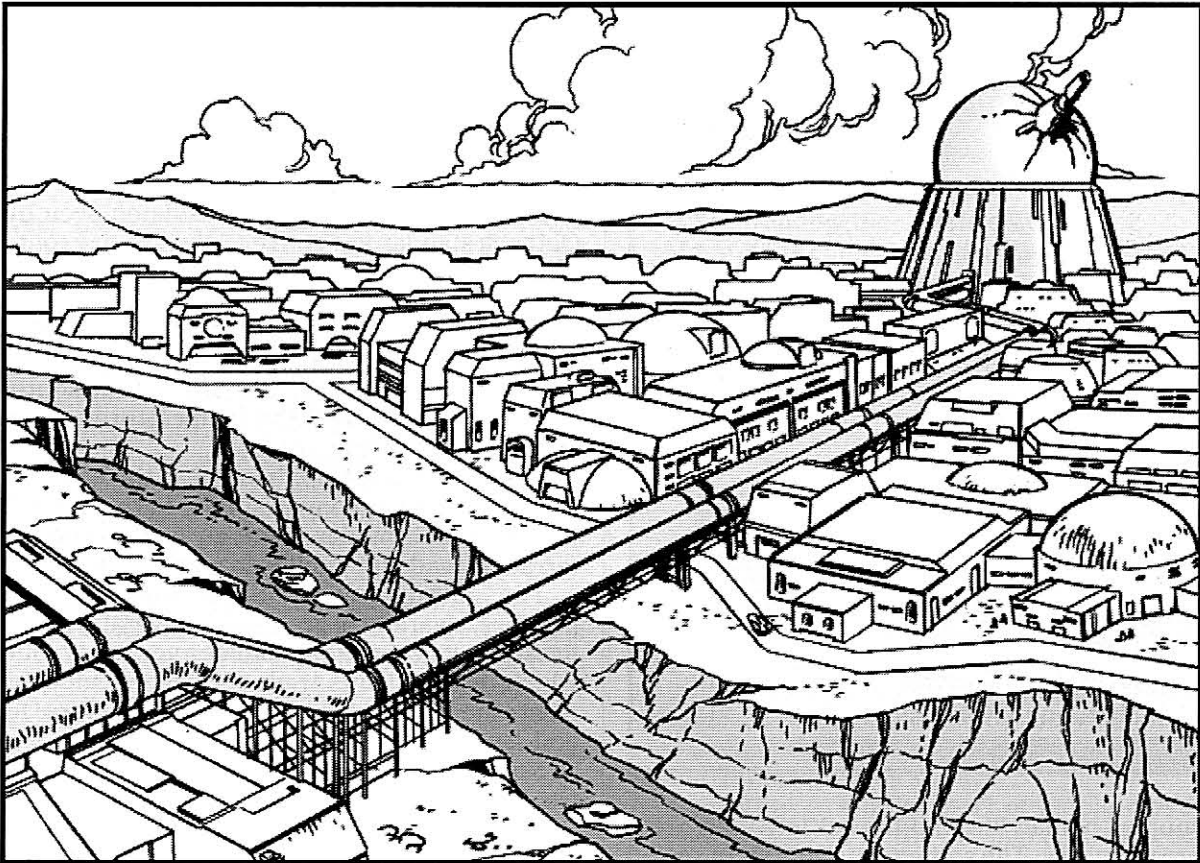

Tim Eldred

capital — the next scheduled supply run isn't for two months.

The settlers know next to nothing about the New Republic — they have not spent enough time in settled space on supply runs to hear anything but the Imperial propaganda. They have heard that the Emperor has fallen, but assume it was due to some sort of internal power struggle. They will be somewhat skeptical about the New Republic to say the least.

The colony is relatively low-tech, but its inhabitants are largely self-sufficient. The colony does have several armed freighters, two ion cannons (positioned near the settlement for orbital defense), a few dozen droids, three orbital satellites (to aid weather forecasting and communications), and a host of power generators.

These machines are deemed essential to the survival of the colony. They also require maintenance and replacement parts, hence the supply runs.

Jangelle has a mutual defense pact with the Kathol Republic. The Kathol Republic's many corvettes complement Jangelle's two capital ships.

## DAYARK

Dayark is the most populous world in the Kathol Republic, a governing body that has banded a number of planets together for mutual protection. Because of its relatively high population, this agricultural world serves as the Kathol Republic's seat of government.

(See "Little Empires" for more information on Dayark.)

## PITANN

Pitann is a harsh desert world in the Kathol Republic. Primarily, Pitann's economy is based on the planet's extensive mining operations. Its inhabitants are stern, tight-lipped people who have very low regard for outsiders.

(See "Little Empires" for more information on Pitann.)

## EHJENLA

Ehjenla is a small planet located toward the center of the Outback. It is a world just emerging from an extended ice age. The polar ice caps are huge, the oceans are large and deep, and fertile plains are scarred with fjords, the rutted tracks of glaciers now vanished.



Ehjenla is home to a species which call themselves the Tuhgri. The Tuhgri believe that the Great Creator provides everything that allows them to survive on their world and in space. The rule that underlies their entire culture, therefore, states that no one may own anything.

Any Tuhgri in need of some object may borrow it until she or he no longer has use for it. Unfortunately, this "custom" has caused problems between the Tuhgri and other species of the sector, and many planets have banned their presence.

(See "Edge of the Galaxy" for more details on the Tuhgri.)

## UUKAABLIS

The planet Uukaablis is the home of an extremely friendly people who live in the shadow of the "Qektoth Confederation," a menacing group of criminals. The Uukaablians are technologically primitive — they have not yet developed hyperdrives and other such advanced devices — although they do possess medical knowledge and skills that may prove quite useful to the New Republic.

(See "Wildfire" for more information on Uukaablis.)

## SHATUUN

Shatuun is a wild world of towering mountains beset by fierce electrical storms. Those traveling to Danoor (Nah'Malis system) seldom stop here any more than they do the hundreds of other systems which lie on the passage between the Uukaablis and Nah'Malis systems.

Shatuun does have one interesting feature: a mated pair of Duinuogwuins (also known as "Star Dragons") who have come to this isolated system to reproduce. They are still settling in — after a mere six decades — and are only now getting around to their task. They are somewhat shy about receiving visitors, since they don't want word getting out that they are there.

Should they be assured of their privacy, however, they would be glad of having guests.

(See pages 36 — 38 of *Galaxy Guide 4: Alien Races* for more details on Duinuogwuins.)

## EXOCRON

Exocron is a fabulous world hidden inside the sensor interference of a nebula. The general populace of the Kathol Outback is not aware that Exocron even exists, and the planet does not appear on any map fragment that the *FarStar* obtains.

(See "The Masters of Exocron" for more information.)

## DANOOR

Danoor was colonized a century ago as a scientific outpost dedicated to the study of the Kathol Rift. As word spread of Danoor's beauty and rich natural resources, others came to the colony seeking to survive on what the land provided.

Thirty years ago, a stray asteroid smashed into the planet, killing hundreds of thousands of people. Today, Danoor's inhabitants are struggling to rebuild their society and their world. There has been little contact with Danoor since the disaster, and information about the planet is hard to come by.

(For more information on Danoor, see "Galaxy's Edge.")

## SUPPLIES

Keeping the *FarStar* running is no simple task in the depths of unsettled space, where even the most routine maintenance procedures can be impossible if replacement parts are scarce, or worse, unavailable.

Restocking the *FarStar's* supplies is going to be a major, *major* headache once beyond the Void. Foodstuffs can come out of ship's stores if need be, but Adrimetrum prefers to stop and investigate planets in hopes of replenishing supplies whenever possible. Water is available on most worlds that produce safe food or it can be forced out of ice comets in just about any system — however, careful filtration is always necessary and there is always the possibility that there may be something dangerous in the water that the *FarStar's* sensors and labs cannot detect.

Machined parts and high-tech replacement parts for failing engines, however, are quite another matter. Even locating supplies of raw materials for Lofryhn's machine shop might be a challenge.

Most colonies have little in the way of parts for capital ships, and will likely jealously guard what they do have for their own vessels. If the *FarStar* crew does manage to locate someone willing to part with a scarce item (even blaster cells are precious to a colony which only gets a new supply every three years), it will likely cost a great deal.

While the quest for mundane supplies should not come to dominate the campaign, the importance of allocating resources and time to locating these supplies should be emphasized early on. Shipboard shortages can require significant detours, leading to interesting adventures. The needs of the *FarStar* can lure characters toward systems and planets they might not ordinarily be interested in exploring.

Note that, in many cases, the travel time between settled systems is longer than an X-wing can travel without exhausting its own fuel and supplies. This is not an accident, and can be used to great advantage by sufficiently devious gamemasters.

## KEEPING UP WITH NAVIGATION CHARTS

As was emphasized in *The DarkStryder Campaign* boxed set, the *FarStar* crew lacks astrogation charts for most of the Kathol sector, mainly because none are available. This is especially true of the Outback, parts of which have never been surveyed and logged by Imperial or Old Republic scouts.

A gamemaster's map of the Outback appears in this chapter. It contains all of the worlds mentioned in this supplement.

The hyperspace routes depicted are not known by all travelers or inhabitants of the Outback, nor are those listed the only systems and hyperlanes that exist — some may be closely guarded secrets. Feel free to develop more of the sector as the opportunity presents itself.

Ideally, the characters should have just enough of the map to lead them to the next adventure, be it one of the adventures in this book or one developed by the gamemaster. Since the adventures in this book are not as closely linked as those in the boxed set, the task of getting the maps into the hands of the characters is left largely to the gamemaster (although there are one or two exceptions).

The worlds and societies detailed in this chapter mainly fall between the worlds developed in the adventures that follow. This affords the gamemaster plenty of opportunities to develop original adventures as necessary. Since the characters may receive astrogation maps which are in error (or outright fraudulent), there is plenty of room for the *FarStar* to wander into dangerous and interesting situations. Gamemasters are encouraged to give the players a bogus map early on to hammer this point home.

### THE ASTROGATION CHARTS

Astrogation charts detailing the Kathol Outback are presented on the next three pages. The three maps overlap at the edges, so that they can be taped together to provide one overall chart to the entire Outback. The adjoining diagram shows how they fit together.

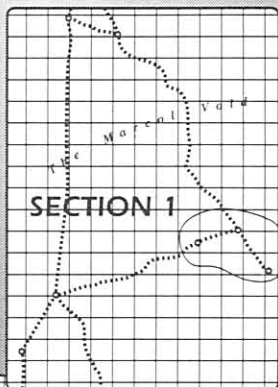

Remember that characters will not have access to this information at the beginning of the campaign, and will only discover parts of the route through the course of play. If necessary, make copies of the maps and black out the portions that the characters have not yet discovered.

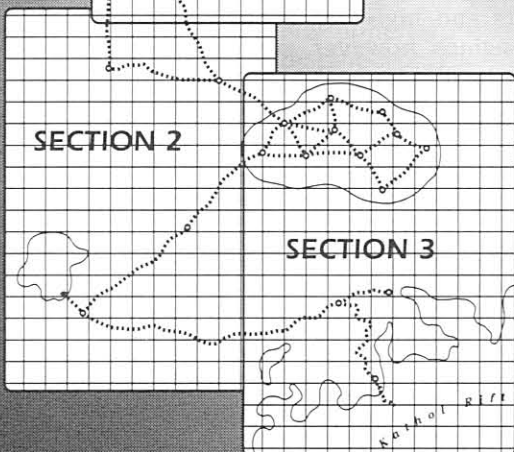

### NOTES TO THE ASTROGATION CHARTS

- Numbers alongside routes represent standard hyperspace durations with Class 1 hyperdrive (x1). Travel times subject to local conditions.
- d = standard 24-hour days. h = hours.
- Local referent grid centered on Kathol sector capital (Kal'Shebbol).
- Minor systems omitted for clarity.

#### KEY

- ..... lesser known route (known to other groups and which *FarStar* may later acquire)
- ⊕ Space station or other artificial construct

NOT TO SCALE

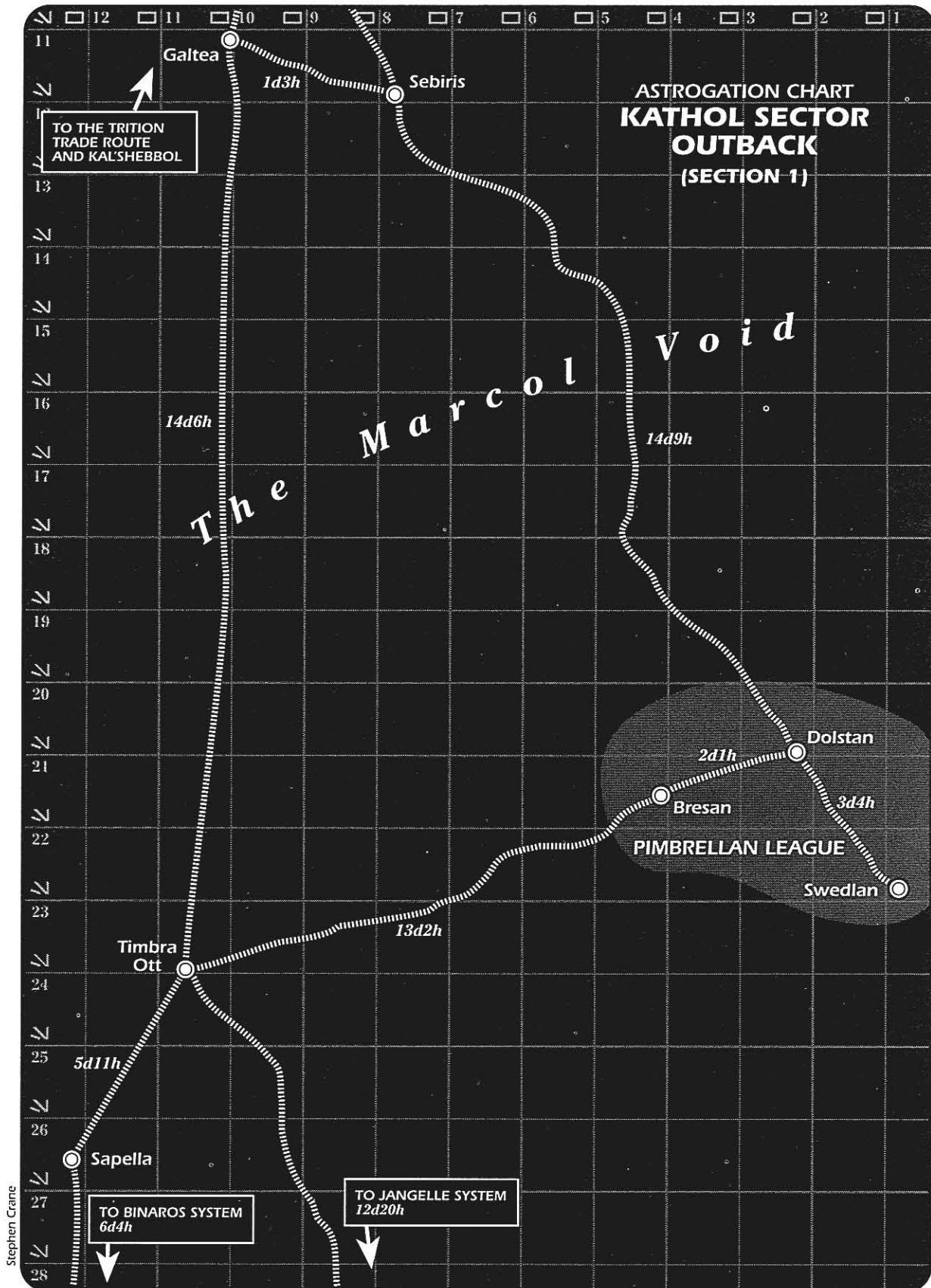

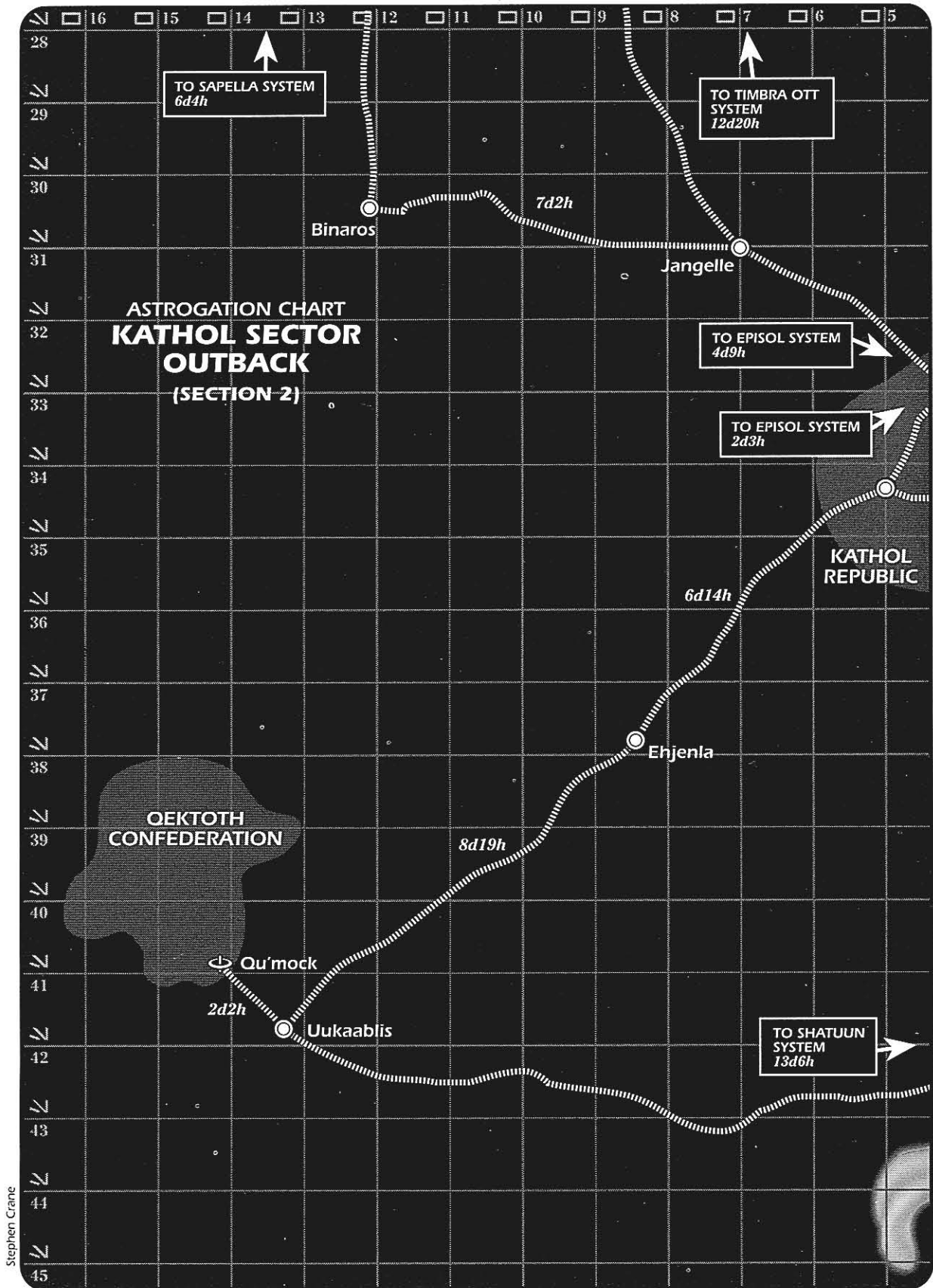

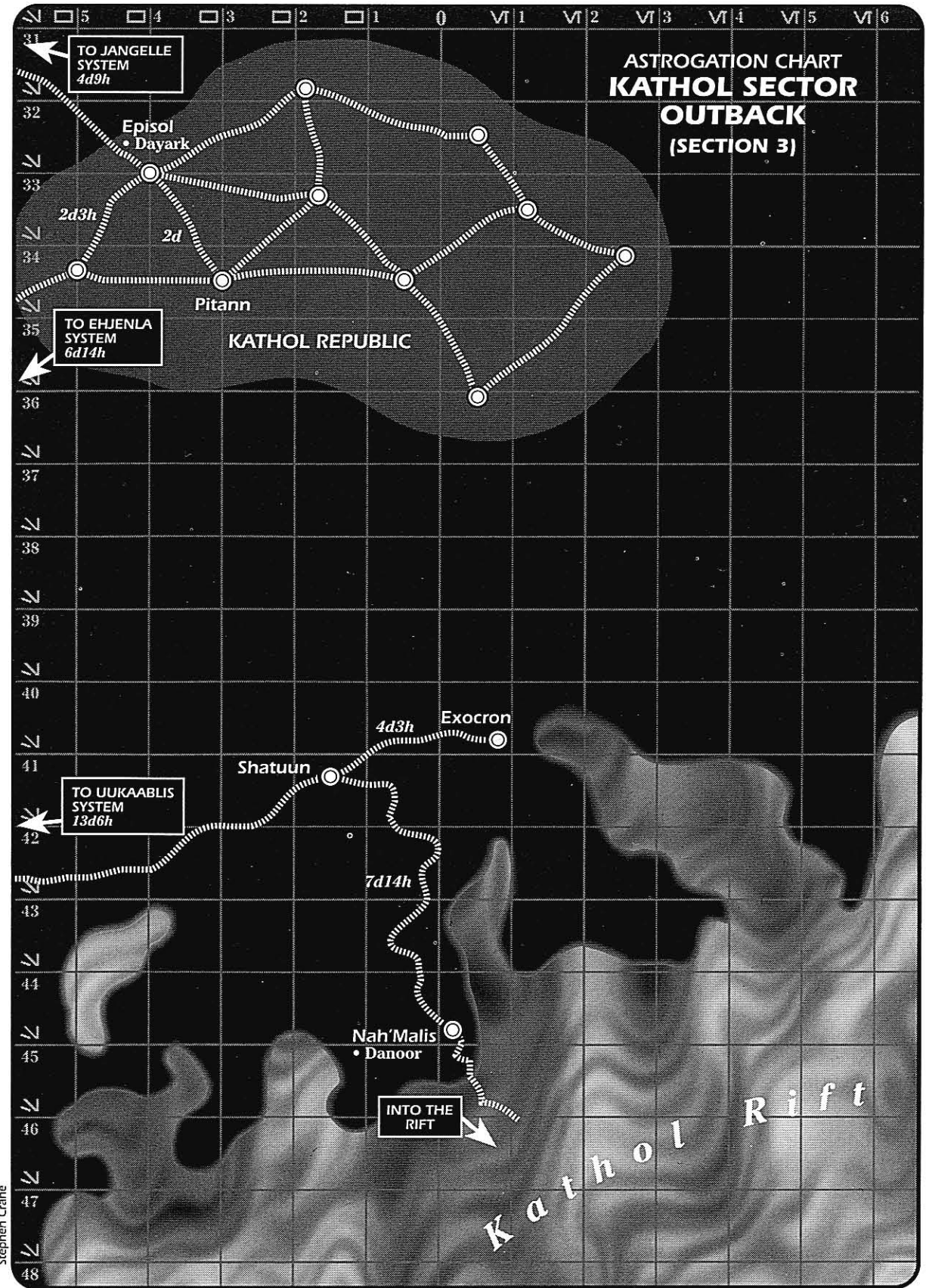



## DENIZENS OF THE OUTBACK

There are plenty of dangerous and mysterious (and occasionally downright *bizarre*) characters wandering the Outback, and the crew of the *FarStar* will likely encounter a fair number of them. This chapter details a few groups and individuals that the characters might encounter, and suggests ways they might be used to good effect in introducing adventures, imparting information, and saving the characters if they get in over their heads.

### THE AING-TII MONKS

The Aing-Tii monks are a mysterious species of aliens who haunt the outer fringes of the Outback near the Kathol Rift. No one knows much about them for the simple fact that the Aing-Tii keep to themselves, and are powerful

enough to discourage casual attempts by other species to contact them.

They have been cruising the Outback on unknowable errands for as long as other species can remember, and seem to pass in and out of the Rift from time to time. They seldom allow the curious to shadow them for long, however. Those who have tried report that, after a time, the Aing-Tii ship suddenly turns on the pursuing vessel and bathes it in a strange beam — which so bedazzles its crew that they lose complete track of time. When they return to their senses some hours later, the Aing-Tii craft is long gone.

That the Aing-Tii value their privacy does not mean they have managed to keep all information regarding their species from others. Though one would have to search long and hard to find someone who has seen an Aing-Tii with his or her

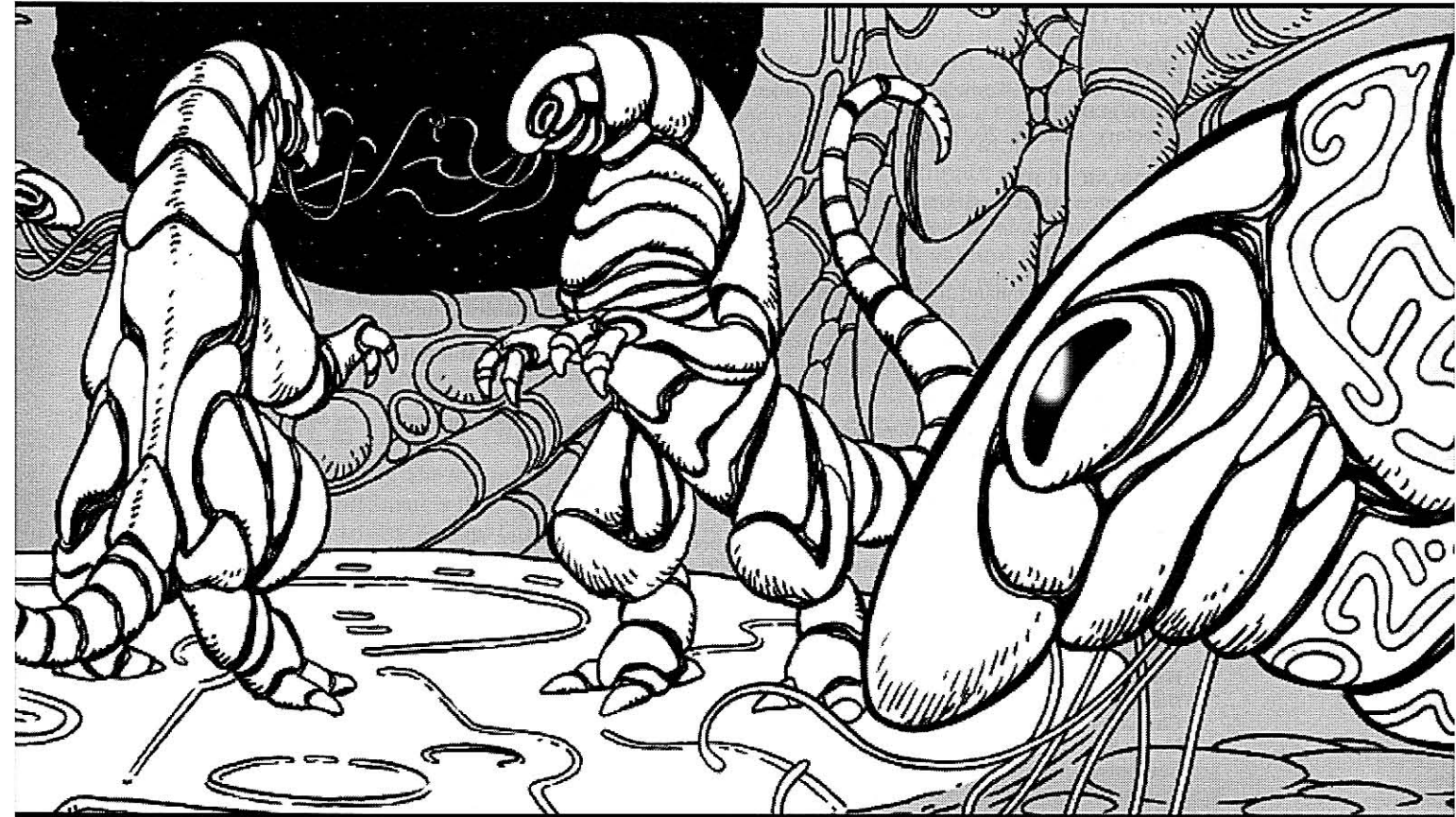

Tim Eldred

own eyes, images do exist. Most came from a survey of an Aing-Tii ship which crashed on a remote planet some decades ago, while another series of holoclips are from a micro-espionage droid which managed to steal aboard one of their mighty ships a few years ago.

Physically, the Aing-Tii are two-meter tall edentate mammals which are covered in jointed protective coverings of bony plates. They stand erect, and have large claws, and long, armored tails. Their heads are protected by bony plates which resemble helmets, and sweep back to protect the neck. They do not speak, but seem to communicate by flickering, touching, and tasting one another's long, thin tongues.

All of the Aing-Tii seen thus far are similarly decorated with painted symbols all over their bodies, which resemble markings appearing on the hulls of their ships. What little is known about their culture suggests that they are warrior monks of some sort, though no one can say what their beliefs are, why they drift endlessly around the Outback, where they come from, or even what fuels their ships.

Some settlers say they are waiting for an answer from the "Ones Who Dwell Beyond the Veil,"

(by which they presumably mean the Kathol Rift, but no one knows for sure). Not many people feel like asking, either — the monks *hate* being bothered by lesser creatures, and express their displeasure in the most destructive manner available. The few travelers who claim to have met an Aing-Tii face-to-face report that they tend to react violently to newcomers; often, these strange aliens attack with their tails and with odd wooden sticks wrapped in silvery wire. These "sticks" deliver a powerful energy charge that renders the victim unconscious.

Travelers encountering an Aing-Tii ship are well-advised to steer clear of it. Occasionally, an Aing-Tii vessel cruising serenely along will suddenly change vectors and smash another craft across its bow. Fortunately, they don't do this very often.

The Aing-Tii seem to be the only ones who know how to pass through the Rift unharmed. How Sarne discovered their secret method of travelling through the region is unknown. There are others rumored to be connected with the Aing-Tii in some manner, though finding such an individual will likely prove an arduous task.

## ■ Aing-Tii Monk

**Type:** Alien Mystic

**DEXTERITY 1D**

Blaster 4D, dodge 4D, melee combat 4D, melee parry 4D

**KNOWLEDGE 3D**

Planetary systems 2D, planetary systems: Kathol Rift 5D+2

**MECHANICAL 1D**

Astrogation 3D, astrogation: Kathol Rift 7D, capital ship gunnery 5D, capital ship piloting 4D+2, capital ship shields 4D+1, sensors 6D

**PERCEPTION 3D**

Bargain 3D+1, command 3D+1, con 4D, hide 4D, sneak 5D

**STRENGTH 2D**

Climbing/jumping 4D

**TECHNICAL 2D**

Capital ship repair 3D

**Special Abilities:**

*Armor:* The thick plates of armor afford an Aing-Tii monk +2 against physical attacks.

*Tail Slap:* The mighty tail of a Aing-Tii can deliver a powerful blow (STR+2D), though a monk may only use this attack every other turn.

*Hyperspatial Perception:* Aing-Tii monks have special talents which allow them to navigate a ship. They receive an additional 1D to any *astrogation* rolls in the Marcol Void and Kathol Outback, and an additional +2D to *astrogation* rolls in the Kathol Rift.

**This character is Force-sensitive**

**Force Points:** 1

**Dark Side Points:** 2

**Character Points:** Varies, typically 1 — 3

**Move:** 8

**Equipment:** *Vor'cha* stun stick (4D stun)

**Capsule:** This is a typical Aing-Tii monk and the stats shown can be considered to have the minimum die codes for a member of this species. There are exceptional Aing-Tii with 18D attribute dice and

significantly higher skills, Force Points and Character Points.

## ■ Aing-Tii Sanhedrim Ship

**Craft:** Aing-Tii Pilgrimage Vessel

**Type:** Heavy Cruiser

**Scale:** Capital

**Length:** 300 meters

**Skill:** Capital ship piloting: Aing-Tii vessel

**Crew:** 150, gunners: 66, skeleton: 75/+10

**Crew Skill:** Capital ship gunnery 5D, capital ship piloting 4D+2, capital ship shields 4D+1, sensors 6D

**Cargo Capacity:** 900 metric tons

**Consumables:** 1 month

**Cost:** Not available for sale

**Hyperdrive Multiplier:** x2

**Hyperdrive Backup:** x5

**Nav Computer:** Yes

**Maneuverability:** 2D

**Space:** 4

**Hull:** 5D

**Shields:** 1D+2

**Sensors:**

*Passive:* 60/0D

*Scan:* 100/1D

*Search:* 200/2D

*Focus:* 6/3D

**Weapons:**

**30 Aing-Tii Energy Web Generators**

*Fire Arc:* 5 front, 10 left, 10 right, 5 back

*Crew:* 2

*Skill:* Capital ship gunnery

*Fire Control:* 2D

*Space Range:* 1-3/7/10

*Damage:* 7D/6D/5D

**6 Null-Burst Projectors**

*Fire Arc:* 1 front, 2 left, 2 right, 1 back

*Crew:* 1

*Skill:* Capital ship gunnery

## GAMEMASTER NOTES

The Aing-Tii are a force to be encountered intermittently by the characters as the *FarStar* makes its way through the Outback. The characters will be unable to make direct contact with the Aing-Tii in this book, though they should meet people who can gradually reveal the information imparted above.

There is indeed a pattern behind the ships the Aing-Tii ram, though few have realized what it is — each target vessel is a slave ship. The monks abhor slavery, and destroy every vessel they encounter which traffics in other sentient beings. The Aing-Tii do not venture any closer to settled space than the Marcol Void.

This aspect of the Aing-Tii monks suggests a number of dramatic scenes involving the *FarStar*. Perhaps a slaver fleet attacks the *FarStar*, only to be thrown into disarray by the arrival of an Aing-Tii ship in its midst.

The stats above are for typical Aing-Tii monks only, not average members of the spe-

cies (who never venture into space). To date, all Aing-Tii monks that have been encountered in the Kathol Outback are Force-sensitive. Force-sensitive characters may therefore be able to detect a faint presence aboard the alien ships, but no more.

The Aing-Tii are unaware of other Force-users, and have not developed these unusual abilities to any great effect; they refer to this unseen energy field simply as “Gifts From Those Who Dwell Beyond The Veil,” and generally avoid using these abilities. (The Aing-Tii feel that this power is a gift from some form of deity, and should not be meddled with.) It is not known how they might react when faced with others who can use the Force. This theme, along with the Aing-Tii species, will be further developed in the next *DarkStryder* supplement. For now, the Aing-Tii should remain enigmatic, mysterious and unpredictable.

*Fire Control:* 4D

*Space Range:* 1-40/50/75

*Damage:* all aboard target vessel are stunned for 1D hours, and can take no actions during that period.

**Capsule:** The ships of the Aing-Tii are huge, cigar-shaped craft, organic in appearance, and etched with millions of glyphs and symbols. They have a split-shell design, with exhaust ports and thruster pods emerging from all sides in no particular symmetrical order.

Aing-Tii ships employ a great deal of organic technology, and are unlike anything seen in the Empire. Each ship is slightly different from the others, but all share a similar look.

## CAPTAIN TREIDUM AND THE LANCE OF ENDOR

Captain Rolf Treidum is the skipper of the *Lialic II*, a corvette in Moff Sarne's fleet. Sarne has ordered him to return to the Kathol Outback to delay the progress of the *FarStar*, as well as turn local populations against the New Republic.

Treidum has decided to do this by posing as a New Republic vessel, and has accordingly renamed his ship the *Lance of Endor*. He plans to approach the various settlements and colonies scattered throughout the Outback, welcome them

into the "wondrous New Republic," make several impossible demands, and then blast them when they refuse to comply with the bogus "New Republic" edicts. By turning these normally neutral settlements against the New Republic, Sarne and Treidum hope to rob the *FarStar* of any allies in the region. Sarne's ultimate objective is to lure the *FarStar* through the Rift, but he has no intention of letting them have an easy time of it.

Rolf Treidum is a loyal and talented Imperial officer who threw in his lot with Moff Sarne years ago while both served in the Deep Core. He is a no-nonsense officer in the traditional Imperial mold—the ends justify the means. He can present a warm and affable front when it serves his purposes, however. He lost his only son at the Battle of Endor, and relishes the irony of his present task.

Treidum is a tall man in his early 60s. He has dark hair graying at the temples and down his sideburns.

### ■ Captain Rolf Treidum

Type: Imperial Navy Captain

DEXTERITY 2D+2

Blaster 7D, blaster: blaster pistol 8D, dodge 4D+1, grenade 4D, melee combat 5D+1, melee parry 4D+2, missile weapons 3D+2

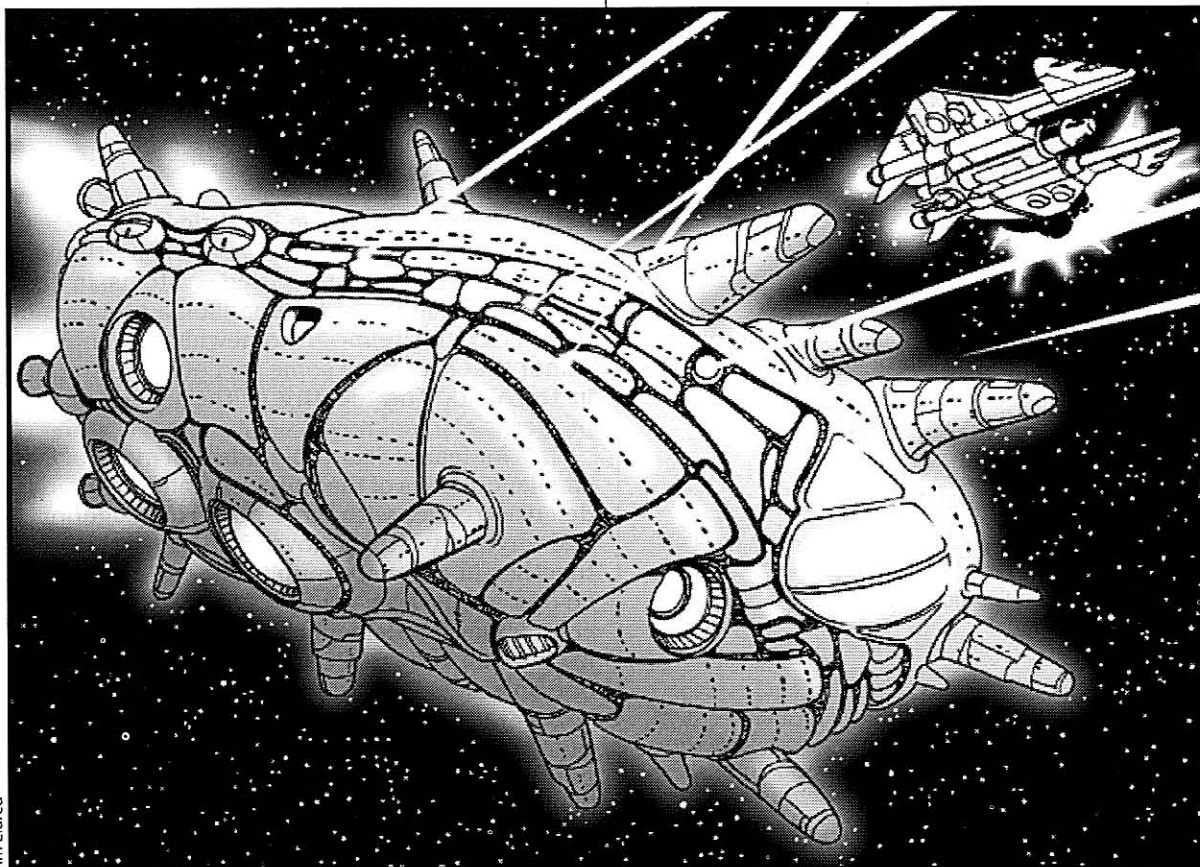

Tim Eldred



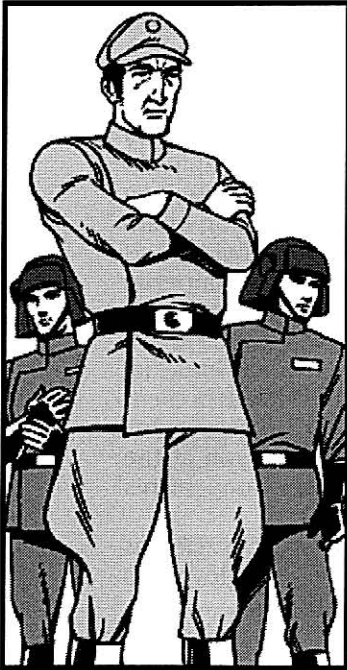

Tim Eldred

## KNOWLEDGE 3D

Alien species 4D+1, bureaucracy 7D, business 5D+2, cultures 4D+1, intimidation 6D, languages 3D+2, law enforcement 3D+1, law enforcement: Imperial law 5D, planetary systems 5D, tactics: capital ships 6D, value 6D+1, willpower 4D+2

## MECHANICAL 3D+2

Astrogation 4D+1, capital ship gunnery 4D+2, capital ship gunnery: concussion missiles 6D+2, capital ship piloting 5D, capital ship piloting: Corellian corvette 6D, capital ship shields 5D+1, repulsorlift operation 4D, sensors 5D+1, space transports 4D+1

## PERCEPTION 3D+1

Bargain 5D, command 4D+2, command: Imperial Navy officers 6D, command: *Lialic II* crew 6D+1, con 4D+2, hide 4D, investigation 4D+1, persuasion 6D, search 4D, sneak 4D+1

## STRENGTH 2D+1

Brawling 4D+2, stamina 4D

## TECHNICAL 3D

Capital ship repair 5D, capital ship weapon repair 4D+2, computer programming/repair 4D, demolitions 4D+2, droid programming 5D, droid repair 3D+1, first aid 4D+2, repulsorlift repair 4D, security 6D+2

**Force Points:** 2

**Dark Side Points:** 6

**Character Points:** 22

**Move:** 10

**Equipment:** Imperial Munitions heavy blaster pistol (5D+1), Imperial uniform, New Republic uniform, comlink, datapad

## ■ Lance of Endor

**Craft:** Corellian Engineering Corporation Corvette

**Type:** Multi-purpose mid-sized vessel

**Scale:** Capital

**Length:** 150 meters

**Skill:** Capital ship piloting: Corellian corvette

**Crew:** 85, gunners: 12, skeleton: 65/+10

**Crew Skill:** Astrogation 3D, capital ship gunnery 4D+1, capital ship piloting 3D+2, capital ship shields 3D, sensors 3D+1

**Passengers:** 90

**Cargo Capacity:** 2,500 metric tons

**Consumables:** 1 year

**Hyperdrive Multiplier:** x2

**Hyperdrive Backup:** x10

**Nav Computer:** Yes

**Maneuverability:** 2D

**Space:** 6

**Atmosphere:** 330; 950 kmh

**Hull:** 4D

**Shields:** 2D

**Sensors:**

*Passive:* 40/1D

*Scan:* 80/2D

*Search:* 100/3D

*Focus:* 5/4D

**Weapons:**

**6 Double Turbolaser Cannon**

*Fire Arc:* 3 front, 1 left, 1 right, 1 back

*Crew:* 1 (3), 3(3)

*Skill:* Capital ship gunnery

*Fire Control:* 3D

*Space Range:* 3-15/35/75

*Atmosphere Range:* 6-30/70/150 km

*Damage:* 4D+2

**Capsule:** Moff Sarne had several Corellian corvettes in his fleet besides the *FarStar*, and several escaped with him when the New Republic invaded the sector. Captain Treidum commands one of these vessels, the *Lialic II*, renamed the *Lance of Endor*.

This ship is outfitted with decades-old equipment. It was due to be refurbished a few months after the *FarStar* was completed.

## SKANDREI BANDIT'S

The Skandrei Bandits are a cutthroat gang of pirates who prey on the colonies and settlements of the Outback, with astounding success.

With a fleet of six or seven small capital ships and several supporting starfighters, the Skandrei Bandits are *not* to be trifled with by anything less than a navy. Fortunately for the Outback's settlers, the pirate fleet seldom travels together, preferring to travel in smaller roving bands of two to three ships. However, the fleet can unite to hit a particularly well-defended target (though this is a relatively rare occurrence).

The pirates hit one or two settlements a month, stealing what high-tech equipment they can (from droids to ships to power cells), plus foodstuffs for their own consumption. Their raids follow no discernible pattern, and they seldom hit settlements known to have heavy firepower. They sell their booty to other colonies through middlemen, or send their two transports back to the Kathol sector to sell it on Pembric II.

They have no known permanent base, though there are plenty of unsettled systems in the Outback which might harbor such a group, and there is a persistent — if somewhat romantic — rumor that they have some sort of space station in the Void. The identity of the leader of the pirates is also unknown.

It is for fear of Skandrei raids that many of the smaller colonies of the Outback maintain mutual defense treaties with more powerful neighbors, and why many of these powerful neighbors joined together in unions, republics, federations, and co-ops in the first place. Though many of the colonies and settlements do not have a great deal in common, they realize that they will fall one by one unless they stand together.

Several settlements have banded together and pooled their military resources to protect their populations and resources. Their roving defense fleets patrol their territories, and have *very* itchy trigger fingers when faced with unknown and heavily-armed vessels.



43:6:2

To: Captain Rolf Treidum, CO *Lialic II*

From: Moff Kentor Sarne, Kathol Sector Imperial Fleet

Regarding: *Lialic II* Mission Profile

## MISSION OBJECTIVES

You are ordered to return to the Kathol Outback region and locate the New Republic ship *FarStar*. Intelligence indicates that the *FarStar* means to pursue our fleet into the Void. This is according to my design. You are ordered to slow the enemy's progress through the Kathol Outback. This will provide ample time for the bulk of my fleet to complete preparations for the *FarStar*'s eventual reception, and that of the New Republic regional fleet.

- You shall delay the *FarStar* using any means at your disposal.
- You shall deny the New Republic potential allies in the Outback by stirring up resentment towards the New Republic; again, use any means at your disposal.
- You shall not destroy the *FarStar*, or in any way cripple it so that it cannot follow our fleet into the Void at a time of my choosing. Should it come to harm through no fault of your own, I will expect a full report proving your innocence in the matter.

**SKANDREI**

Sarne



### ■ Typical Skandrei Gunship

**Craft:** Modified CSA Etti Light Transport

**Type:** Modified medium freighter

**Scale:** Capital

**Length:** 125 meters

**Skill:** Space transports: Etti Lighter

**Crew:** 30, gunners: 14, skeleton: 15/+5

**Crew Skill:** Capital ship gunnery 4D, capital ship shields 3D+2, space transports 3D+2, starship gunnery 4D

**Passengers:** 15

**Cargo Capacity:** 400 metric tons

**Consumables:** 3 days

**Cost:** Not available

**Hyperdrive Multiplier:** x2

**Hyperdrive Backup:** x6

**Nav Computer:** Yes

**Maneuverability:** 1D

**Space:** 4

**Atmosphere:** 280; 800 kmh

**Hull:** 3D

**Shields:** 2D

**Sensors:**

*Passive:* 30/1D

*Scan:* 60/2D

*Search:* 90/3D+2

*Focus:* 6/4D

### Weapons:

#### 4 Double Turbolaser Cannon

*Fire Arc:* 1 front, 1 left, 1 right, 1 back

*Crew:* 2

*Skill:* Capital ship gunnery

*Fire Control:* 3D

*Space Range:* 3–15/35/75

*Atmosphere Range:* 300–1.5/3.5/7.5 km

*Damage:* 4D+2

#### 6 Quad Laser Cannon

*Fire Arc:* 2 front, 1 left, 1 right, 2 back

*Crew:* 1

*Scale:* Starfighter

*Skill:* Starship gunnery

*Fire Control:* 1D

*Space Range:* 1–5/10/20

*Atmosphere Range:* 100–500/1/2 km

*Damage:* 5D

**Capsule:** This is one of the smaller ships employed by the Skandrei Bandits. It was obtained from an arms dealer operating out of the Corporate Sector, and retooled to suit its new mission — piracy and raids. It is now well-armed, and, like most of the Skandrei vessels, can also carry quite a bit of cargo.

## MIST THE BOUNTY HUNTER

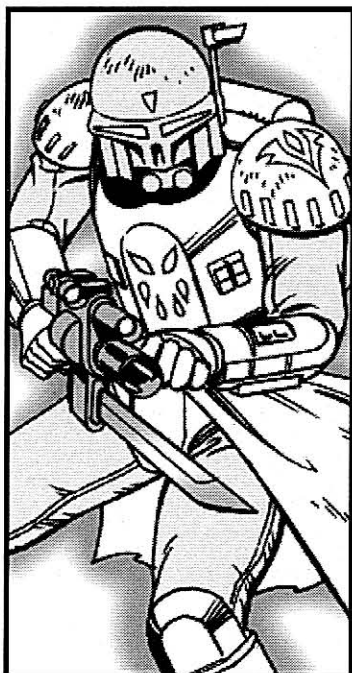

Tim Eldred

The bounty hunter known as Mist is an enigma: a violent, capable individual who appeared in the Kathol region several years ago and has since built up an impressive reputation. During the reign of Moff Sarne, Mist seldom appeared in public (though word of a shadowy bounty hunter's exploits began to spread through the underworld of Kathol sector).

The Moff's departure seems to have relaxed Mist somewhat; the bounty hunter has returned to more traditional bounty hunting activities, frequently appearing in unlikely places performing... *questionable* activities.

Mist speaks only infrequently — usually in curt, clipped phrases — and the hunter's voice is disguised by a voice amplification system.

Mist stands just shy of two meters tall, lean and fit. Mist's exact build is difficult to determine due to the bulky armor the bounty hunter favors.

### ■ Mist

**Type:** Bounty Hunter

#### DEXTERITY 3D

Blaster 9D, blaster: blaster rifle 9D+1, brawling parry 6D+2, grenade 5D, melee combat 5D+2, melee parry 5D+1, missile weapons 5D+2

#### KNOWLEDGE 2D

Alien species 5D, bureaucracy 5D, languages 7D, planetary systems 6D+2, streetwise 8D, survival 5D+2, value 7D

#### MECHANICAL 3D

Astrogation 6D, jet pack operation 5D+2, powersuit operation 7D+1, repulsorlift operation 7D, space transports 6D, starship gunnery 6D+2, starship shields 6D+2

#### PERCEPTION 4D

Bargain 7D, command 4D+2, con 5D, hide 5D, search 7D+2, search: tracking 8D, sneak 6D+1

#### STRENGTH 3D

Brawling 5D+1, climbing/jumping 5D

#### TECHNICAL 3D

Armor repair 4D, armor repair: photo-reactive armor 7D+2, blaster repair 6D+2, security 8D

**Character Points:** 12

**Move:** 10

**Equipment:** Heavy blaster pistol (5D), blaster rifle (5D), hold-out blaster (3D+2), 2 smoke grenades, 2 paralysis canisters (20 meter radius, instant paralysis for 1D rounds for opponents who do not make a successful Difficult

*Strength* roll), thermal flare, medpac, modified Krail Photo-reactive Armor (see below), binders, datapad, Imperial Peacekeeping Certification, man trap (see *Galaxy Guide 10: Bounty Hunters*, page 90)

### ■ Mist's Bounty Hunter Armor

**Model:** Modified Krail Armory Model 1010 Photo-reactive Personal Armor

**Type:** Modified personal battle armor

**Skill:** Powersuit operation: Krail 1010 armor

**Cost:** 80,000 (with all modifications)

**Availability:** Basic suit is "X" (illegal) on most planets; modified suit is unique

#### Game Effect:

**Basic Suit:** Protection +2D to *Strength* for energy attacks, +2D+1 for physical attacks; -1D to *Dexterity* and related skills. Suit has a Move of 15, with movement rolled on *powersuit operation* skill.

**Power Suit:** +1D to *lifting*

**Sensor Pod:** +1D+1 to *search*

**Integral Flechette Launcher:** 20-meter range, rolled on *missile weapons* skill. (Causes 3D stun).

**Jet Pack:** Has a Move of 100 meters horizontally, 65 meters vertically. Uses *jet pack operation* skill, base difficulty is Easy, modified by obstacles. Has 16 charges, two of which can be expended per round.

**Sealed Enviro Filter:** Filter system can block out harmful molecules, or in case of insufficient or deadly air supply, the unit can completely seal, drawing upon a three hour supply of oxygen. In addition, the filter on the armor's blast helmet contains a voice disguiser, rendering attempts at voiceprint identification futile.

**Photo-reactive Coating:** The armor has been treated with a coating of photosensitive, microscopic crystals that reflect the ambient colors in a given area, making the armor difficult to see in virtually any situation. This modifications adds +2D to *sneak*.

**Reflec Plating:** In addition to enhanced camouflage, the armor has been covered in a fine mesh of *reflec*, a storm-absorbing material favored by the Imperial Storm Commandos. This adds an additional +1D to *sneak*.

**Capsule:** Mist's armor makes the bounty hunter nearly invisible in most situations, providing an undeniable edge over most opponents. In addition, the armor still provides ample protection from most attacks without sacrificing stealth.

### GAMEMASTER NOTES

The *FarStar* should cross paths with Mist once or twice (and definitely shall in the last adventure in this book, *Galaxy's Edge*). They might witness Mist making a collar, tracking a fugitive, or otherwise pursuing the trade of a bounty hunter.

However, such encounters should be very brief and inconclusive; Mist should be treated as a fleeting, mysterious character foil. The characters must not be permitted to kill, capture or unmask this enigmatic figure. Mist has a major role to play in the next *DarkStryder* supplement, and will be further developed at that time.

## MADDIE MACATTEN

Maddie Macatten is a crazy coot. She's a very old Bith trader who putters around the Outback, selling replacement machinery parts and luxury items to the various colonies and settlements. She can be found literally anywhere in the Outback in her battered ship, the *Scupper Bantoo*.

Maddie is somewhat senile. She talks to herself constantly (though she seldom finishes a sentence), and is forever humming Bith folk tunes.

She has a personal quest to occupy her copious free time: looking for the secret Aing-Tii homeworld. She was once a slave on Kal'Shebbol, and was freed when her master was slain by a Aing-Tii ship while on a trading junket. She has become obsessed with locating the Aing-Tii ever since, so she can thank them properly. In her travels she has amassed a lot of information about the Aing-Tii, which she may be willing to share with those with a sympathetic ear. A lot of her information is plain wrong, but a speck of truth is buried in some of her rambling dialogs.

Maddie actually knows about the world sheltering the Star Dragons (Shatuun), but probably won't mention it until she's been babbling for an hour and everyone has long since stopped believing anything she says.

### ■ Maddie Macatten

**Type:** Bith Trader

**DEXTERITY 3D**

Blaster 3D+2, dodge 4D, pickpocket 4D+2

**KNOWLEDGE 4D+2**

Alien species 5D, business 5D+2, cultures 5D+1, languages 5D, streetwise 6D+2, value 5D+2

**MECHANICAL 2D+1**

Astrogation 3D+2, space transports 4D+1, repulsorlift operation 3D+1

**PERCEPTION 3D**

Bargain 4D+1, con 3D+2, gambling 4D, hide 4D+2, sneak 4D+1

**STRENGTH 1D+2**

Climbing/Jumping 2D+1, stamina 3D

**TECHNICAL 3D+1**

Computer programming/repair 4D+1, droid programming 3D+2, droid repair 4D, first aid 3D+1, space transports repair 5D

**Special Abilities:**

*Vision:* +1D bonus to *Perception* skills with objects less than 30 centimeters. -1D penalty for visual based actions more than 20 meters away. Cannot see more than 40 meters away.

*Scent:* +1D bonus to all *Perception* skills when pertaining to actions and people within three meters.

*Manual Dexterity:* +1D to performance of fine motor skills (such as *pick pockets*, *surgery*, *fine tool operation*, etc.), but not to gross motor skills such as *blaster* and *dodge*.

**Move:** 8

**Force Points:** 1

**Character Points:** 11

**Equipment:** Datapad, sporting blaster (3D+1), comlink, random tools, 250 credits

### ■ Scupper Bantoo

**Craft:** Modified CorelliSpace

Gymsnor-2 Freighter

**Type:** Modified light freighter

**Scale:** Starfighter

**Length:** 31.7 meters

**Skill:** Space transports: Gymsnor-2

**Crew:** 1

**Crew Skill:** See Maddie Macatten

**Passengers:** 4

**Cargo Capacity:** 82 metric tons

**Consumables:** 2 months

**Cost:** Not available for sale

**Hyperdrive Multiplier:** x3

**Hyperdrive Backup:** x14

**Nav Computer:** Yes

**Space:** 3

**Atmosphere:** 260; 750 kmh

**Hull:** 5D

**Shields:** 1D+2

**Sensors:**

*Passive:* 15/0D

*Scan:* 30/1D

*Search:* 45/2D

*Focus:* 3/3D

**Weapons:**

**1 Heavy Blaster Cannon**

*Fire Arc:* Turret

*Skill:* Starship gunnery

*Fire Control:* 2D

*Space Range:* 1-5/10/17

*Atmosphere Range:* 100-500/1/1.7 km

*Damage:* 4D+2

**Capsule:** The *Scupper Bantoo* is a very old and battered CorelliSpace model, which was obsolete 20 years ago. Both Maddie and her former master have made extensive modifications to keep it moderately up to date technologically, but there is only so much one can do with such an old ship.

Maddie simply flew the ship from her master's docking bays on Kal'Shebbol when she heard of his death. She has all the papers, so the ship is legally hers.



Tim Eldred

### GAMEMASTER NOTES

Maddie is obviously a good source for introducing lore concerning the Aing-Tii. Rather than having one or two scenes in which Maddie tells all about the Aing-Tii, make her a recurring character who turns up again and again at odd junctures, each time revealing a bit more in her aimless dialogs. Mix in a great many frustrating digressions and even more misinformation with the accurate information.

Maddie can be used to lead in to some of the adventures in this book. She may also join the *FarStar* crew at some point, if the gamemaster so desires.



## PLANT FOOD

Amidst the bustling movements of the command crew and the constant warbling of droids, First Officer Khzam looked over the motley assortment of personnel assembled in the command center. A few tense moments passed as the Rodian paced back and forth without a word. He returned to his seat and glanced again at the schematics of the small world they were orbiting; Binaros, according to their astrogation charts. A nice little unsettled planet ... just the sort Khzam liked.

Captain Adrimetrum appeared, and gave the security droid by the door an annoyed glance when it failed to announce the presence of the Captain on the bridge. Khzam noted her glance and grimaced inwardly. He had ordered it to ignore naval protocol when he had the conn. It was Dajus and Thyte who insisted on following all that "naval tradition" nonsense, and Khzam resented the fact that

Adrimetrum had followed their lead rather than his suggestion that a more casual atmosphere made for a more relaxed crew — as a former ground pounder, and therefore ignorant of naval protocol, he had fully expected his captain to lean more in his direction. No matter, as long as Adrimetrum let him run his bridge as he liked on the night shift. This arrangement wouldn't last forever.

Adrimetrum sat down in the captain's chair. "The lab boys and girls seem to think the planet below has some resources to offer us, especially around the equator. Plenty of food-stuffs to replenish our supply, and maybe even water we don't have to boil out of space rocks." A wave of murmuring swept through the room. This was good news. Adrimetrum let it go on for a moment. "Sensors detect no sentient life, but we can't take any chances. Security Officer Khzam will lead this recon-

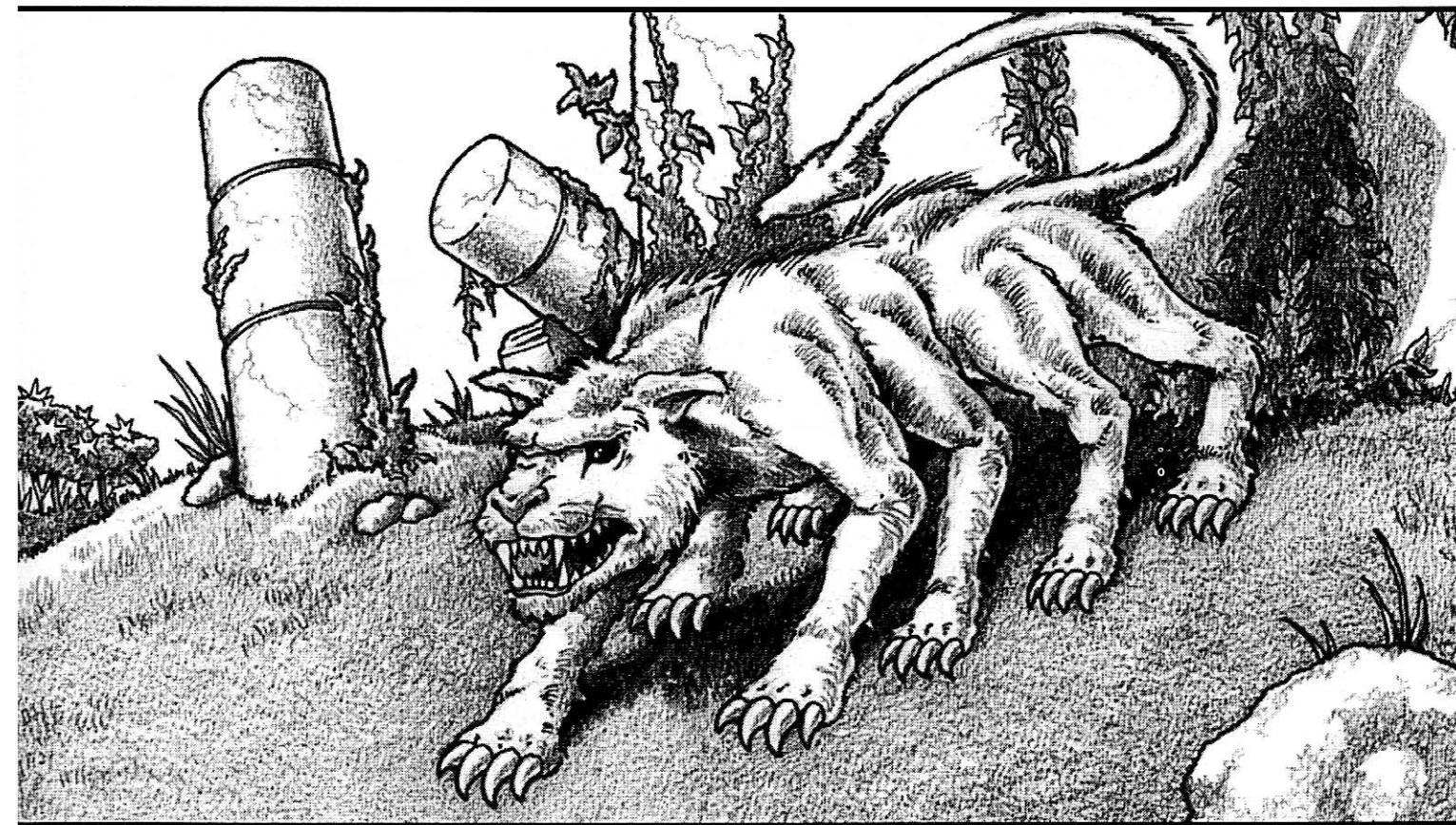

Christopher Trevas

naissance mission." She nodded to the Rodian as he stepped forward with a jaunty air. Down below, *he* would be in command.

"Captain, I feel Kl'aal should also come along," Khzam said. "His skills are suitable for such a mission."

Adrimetrum smiled. "Agreed. I assume you heard that, Kl'aal?" she asked as she glanced about the bridge. Sure enough, the inky form of the Defel emerged from a recessed computer terminal. She nodded. "Good. Brophar is prepping the shuttle as we speak. Assemble your team as you feel fit. Dr. DeVay will be accompanying you."

"Captain?" Adrimetrum turned to face the speaker, a young female human clad in a jumpsuit. It was Varel DeVay, the ship's xenobiologist. Khzam didn't care for her. Too meek to be a survivor.

"I would have thought you might have had more pressing business below decks, Dr. DeVay, since the shuttle is leaving soon. What are you

doing on the bridge?"

DeVay pushed her lanky brown hair away from her eyes and stared at the floor. "Um, I'm not sure that I'm suited to accompany the exploration team. I'm a scientist and not very useful in dangerous situations."

Adrimetrum looked coolly at the young woman for a moment, an eyebrow raised. She glanced about the bridge, but no one met her stare. Except Dajus. Khzam snorted to himself. For all the military pomp, the captain still managed to find people who questioned her orders on her own bridge.

Adrimetrum was visibly annoyed. "Your concern is noted, Doctor, but it saves both time and resources if you are present when potential food sources are located. We can't afford to shuttle potential supplies back to the ship if we're not positive they are useful." She paused, sizing up the girl. "Just make sure you get a blaster before you leave..."

**BACKGROUND**

Moff Sarne could not extend his control over the entire Kathol sector, but he did his best to place a presence where it was important. Scattered about the Kathol Outback are several supply depots, research facilities, and secret bases. One of these research facilities is located on the lush planet of Binaros.

While chasing Moff Sarne and charting the Outback, the *FarStar* discovers Binaros. Sensor scans reveal the planet is teeming with non-sentient life, especially vegetation. Captain Adrimetrum feels a small reconnaissance party should be sent to the surface to collect food and other useful resources. What they discover is much more interesting ...

■ **Binaros**

- Type:** Terrestrial
- Temperature:** Hot
- Atmosphere:** Type I (breathable)
- Hydrosphere:** Moist
- Gravity:** Standard
- Terrain:** Early succession tropical forests, oceans
- Length of Day:** 32 hour
- Length of Year:** 110 standard days
- Starport:** Landing field
- Planet Function:** Natural resources
- Capsule:** Binaros is a young planet. It is largely ocean, with a few land masses clustered around the equator. Its atmosphere is very hot and humid, due to the high level of volcanic activity and the planet's close proximity to its sun.

The land masses are rich in vegetation and animal life. There are a few scattered grasslands, but most of the land is covered in thick growth, mostly bushes and shrubs, none growing much higher than two meters. The animals are an even mix between docile herbivores and fierce predators.

■ **Varel DeVay**

- Type:** Xenobiologist
- DEXTERITY** 2D+1
- Dodge 4D, running 4D+2
- KNOWLEDGE** 3D+2
- Alien species 8D, languages 5D+1, survival: forests 6D+1, science: xenobiology 7D+1, value: natural resources 7D+1
- MECHANICAL** 3D+1
- Beast riding 4D, sensors 4D+1
- PERCEPTION** 3D+2
- Bargain 3D+2, hide 4D, persuasion 5D+1, search 4D
- STRENGTH** 2D+1
- Stamina 3D+1
- TECHNICAL** 2D+2
- Computer programming/repair 5D+2, first aid 5D
- Force Points:** 1
- Character Points:** 11
- Move:** 10



Christopher Trevas

**PREPPING THE TEAM**

The team has about an hour to prepare. Gorak Khzam leads the expedition and Kl'aal comes for support. If Kl'aal resists, Captain Adrimetrum insists that the Defel go to let off some steam — he has recently caused a few scuffles with the crew. Brophar pilots his shuttle and DeVay, the xenobiologist, is the mission's chief scientist.

The players can choose the rest of the team as they desire. Reasonable equipment requests are fulfilled, including blasters, survival gear, and scanning equipment, but heavy weapons and thermal detonators are not available. The *FarStar's* stores of these items are extremely limited and Captain Adrimetrum does not want these resources squandered. (DD-19, the *FarStar's* overseer droid, is in one of his moods about issuing supplies anyway).

**Equipment:** 4 datapads (contain information on plants and animals), comlink, glow rod, recording rod, hand microscope, hand vibro-hoe (STR+1)

**Capsule:** Varel DeVay grew up on a small planet in the Core. She led a pampered life and attended the finest universities. She could have chosen any career, but her fascination with alien species and creatures led her into the field of xenobiology.

DeVay has worked for several different research corporations, but she never stayed at one place too long. She is obsessed with climbing the corporate ladder in an effort to achieve financial security. In the five years since graduating, she's had four jobs on three different planets.

The last opportunity seemed too good to be true. A small company on Kal'Shebbol offered twice her current salary. As usual, she jumped at it, and in a month reported for work. Only when she arrived did she discover that the company did not exist — it was a ploy to lure scientists to the capital by Moff Sarne. She was forced to work for Sarne developing biological weapons. DeVay was alone, out of touch with family and far from home.

Then the New Republic liberated the capital and set her free. Her father begged her to return home while she still could. Too proud to admit he was right, she signed on with the *FarStar*.

DeVay spends most of her time in the hydroponics labs overseeing the

droid workers. She can't stand machines and is constantly verifying that their work is done to her high standards. She whines for more human help, but no one has paid her any attention.

Devay stands 1.8 meters tall and typically wears formfitting jumpsuits of neutral colors. She has large brown eyes and thick brown hair that falls to her mid-back.

## EPISODE ONE: EXPLORATION

Read aloud:

**The cramped quarters of Brophar's freighter, the *Muvon*, are as uncomfortable as they are cluttered. Spare parts, ration wrappers, plus the stench of sweat and spoiled food choke the tiny cabin. Through the viewport, you gaze upon your destination. The islands of the small blue planet are vibrant with vegetation.**

**Brophar wrenches the controls, arcing the shuttle toward one of the planet's larger land masses. Winging his way down, he grazes the belly of the shuttle on the vegetation while searching for a suitable landing spot. Several clearings streak past, but Brophar's breakneck speed brings you by them as soon as they become visible. Finally, he spots a location on a patch of grassy plain and sets her down gingerly.**

Binaros' forested landscapes are quite an impressive sight. With the exception of a few clearings that dot the landscape, the entire area is covered with thick leafy vegetation. Countless species of plants are present, mostly grasses, bushes, shrubs, and a few young trees. With an *Easy Knowledge* roll, DeVay can determine that the plants are types that grow rapidly, require few nutrients (early succession growth) and all

### MISSION ACTIVITIES

The landing team partakes in several actions while exploring. Khzam curtly orders DeVay and the other characters to begin procuring possible food sources. Meanwhile, he scouts around, alert for any signs of danger. Actually, the Rodian hopes to find a few targets for blaster practice. Kl'aal sneaks off to do some of his own hunting. It is important to the progression of the adventure that the Defel hunt alone, and the gamemaster should suggest that a player use Kl'aal during the hunt. Brophar pokes about, but stays in sight of his beloved shuttle at all times.

are about 10 years old. It is apparent from soil deposits and plant growth patterns that the island is periodically flooded every decade or so.

There are no paths through the undergrowth, so all movement is difficult and time consuming. Insects and smaller mammals are plentiful, but large predators seem rare.

### COLLECTING FOOD

For each hour a character looks for food, a *Moderate search* roll reveals a possible food source. Any character may search for plant samples, but DeVay will probably be the only person qualified to analyze them. Given a choice, she will stay in the main camp area at her portable science station, and wait for others to bring her samples.

Below are a number of plants which might be located. Keep in mind that a great many other plants are to be found which are inedible, but not dangerous. Create additional edible (or dangerous) plants as needed:

**A long yellow tuber.** A *Moderate science: xenobiology* or *Difficult Knowledge* total is necessary to prove that it is harmless. The plant is bland and crunchy, rather like chewing on duroplastic, but nutritious nonetheless.

**Small pink-tinted capless mushrooms.** A *Difficult science: xenobiology* or *Very Difficult Knowledge* total is needed to determine that these are poisonous. If consumed, the victim develops acute stomach pains and dizziness in about 12 hours. At this time, a *Moderate stamina* roll is required. If failed, the victim is incapacitated. If successful, the victim is only wounded. (The effects of this poisonous plant can be cured with a medpac, but the stomach cramps will persist for 1D hours, causing a -1D penalty to all actions during that time.) The mushroom stalks taste sugary and pleasant.

**Large one meter long oval leaves from a thin barkless tree.** An *Easy science: xenobiology* or *Moderate Knowledge* roll is needed to prove that they are edible. These plentiful leaves have a mint flavor but are very stringy with a slightly bitter aftertaste. The leaves don't provide a well rounded meal but are suitable roughage.

**A round succulent blue fruit encased in a thick leathery hide.** A *Difficult science: xenobiology* or *Very Difficult Knowledge* roll is needed to prove that these are harmless. This delicious fruit tastes sour but pleasantly tart. It is very watery and messy to remove from its hide.

**A patch of small white berries.** A *Difficult science: xenobiology* or *Very Difficult Knowledge*

roll is required to determine that these berries are mildly poisonous. Consuming these berries clouds thought processes for six hours. During this time, any *Knowledge* skill checks are made at a -1D penalty.

**Long filamentous strands of red-brown algae.** A Very Difficult *science: xenobiology* roll reveals that this algae, found in a shallow, slow-moving stream, is mildly poisonous and will cause a wound to the eater. Although inedible, applying a moist mat of the algae over a wound aids healing. When used with a medpac, the user adds +2 to the *first aid* roll. A Moderate *first aid* or Easy *medicine* roll can reveal the useful properties of this algae.

## THE HUNT

Being cooped up on the *FarStar* often wears Kl'aal's patience thin, especially when he doesn't have scouting to keep him busy. Therefore, he hunts to satisfy his natural urge. Before long, he spots his prey: a Binarian sabercat.

During the hunt, it is vital that Kl'aal be affected by the spore cloud and that he locate the ruins. If at any point Kl'aal loses his prey, a Difficult *search* roll means he can pick its trail back up. While the hunt is on, Kl'aal encounters the following obstacles:

- While pursuing his prey through underbrush, Kl'aal bursts into a plant that releases a cloud of yellow spores. Kl'aal needs to make a Moderate *stamina* roll or lose sight of his prey. Regardless of the roll, the spores become embedded in his fur. These spores will appear totally innocuous, releasing a mildly pleasant odor.

- The prey crosses a shallow stream filled with rocks. Kl'aal needs to make two Moderate *climbing/jumping* rolls to follow at top speed. Failure results in a slip and fall on the jagged rocks (damage 1D+2), and he loses his prey.

- The prey deftly passes through a briar patch. At normal speed, Kl'aal needs to make three Moderate *Dexterity* or *running* rolls to avoid taking 3D damage. If he tries to pass through at top speed, two Difficult rolls are needed. Any missed roll means that the sabercat has pulled ahead.

- The prey bursts into a clearing with Kl'aal a step behind. The sabercat, cornered against a rocky outcropping, turns and fights to the death. After the fight, Kl'aal realizes that the rocky outcropping is actually an ancient wall, built by some species long ago. After a brief investigation, the vine-crusted wall proves to be but one side of a ruined building partially buried in the side of a hill.

## ■ Binarian Sabercat

**Type:** Jungle predator

**DEXTERITY** 3D

Brawling parry 4D

**PERCEPTION** 3D+1

Search 4D+1, sneak 5D

**STRENGTH** 3D+2

Brawling 4D

**Special Abilities:**

**Claws:** Can attack with two claw attacks a round without penalty. Additional attacks cause penalties (i.e., using a third paw means -1D to all actions, fourth is -2D, etc.). Claws do STR+1D damage.

**Bite:** Huge teeth do STR+2D damage.

**Move:** 12

**Size:** 1 meter at shoulder, 2-3 meters long

**Capsule:** Binarian sabercats are huge feline predators that search the undergrowth for small prey. They have eight powerful paws, ending in razor sharp claws. The sabercat can bring four of these to bear on an opponent including a rear raking attack.

The creature has a two meter long tail that ends in a bony bulbous protrusion. This is not used to attack but is instead part of the animal's mating rituals. Sabercats possess huge incisor teeth and have thick brown-tan fur speckled with green splotches (providing this lie-in-wait predator with natural camouflage).

## EPISODE TWO: THE RUINS

This episode details the ruined building Kl'aal discovers during his hunt. There are also several clues present, betraying the actual function of the ruins (agents of Moff Sarne modified it a few months ago).

### THE LANDING FIELD

Approximately 175 meters to the northeast of the ruins is a peculiar patch of land. The soil in this 25-meter semi-circular area has been repeatedly charred to a crisp. Jungle vegetation has already begun reclaiming the area, but anyone investigating the soil and making an Easy *search* or *Perception* roll can discern the blast area. The vegetation cloaks this site from the air. The Imperials used this area as a landing field for their shuttles and cargo vessels.

### THE DEAD ZONE

About 150 meters due east of the ruins is a disturbed area of vegetation. This clearing is 100 meters in diameter and is covered with gray lifeless soil. No vegetation intrudes on the perfectly symmetrical area, nor do any insects crawl through the soil. Force-sensitive characters feel a strange twinge here. This area is the result of an experiment with a piece of DarkStryder technology.



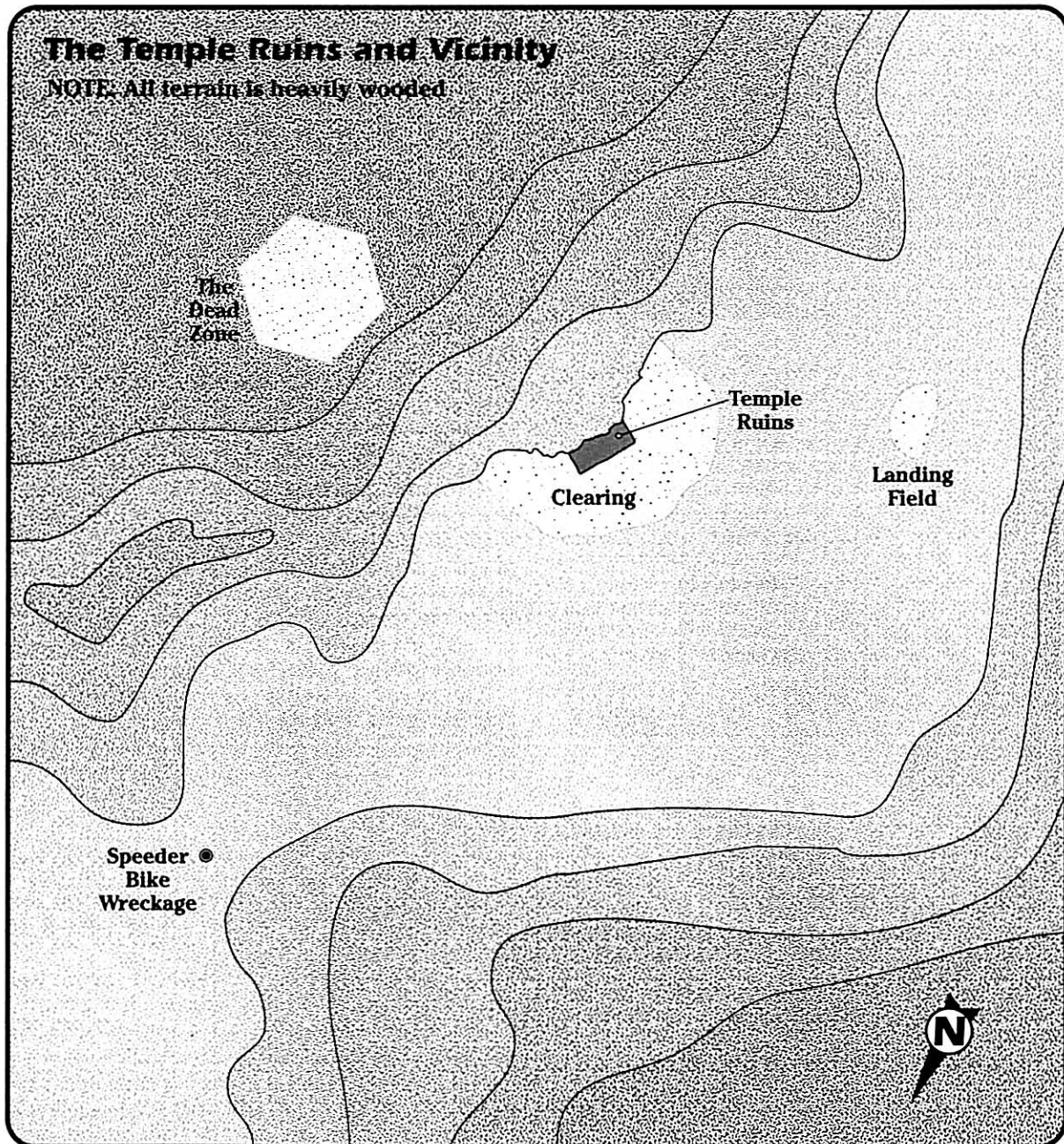

## The Temple Ruins and Vicinity

NOTE: All terrain is heavily wooded

Speeder ●  
Bike  
Wreckage

The  
Dead  
Zone

Temple  
Ruins

Landing  
Field

Clearing



Stephen Crane

### SPEEDER BIKE WRECKAGE

Any character who makes a Difficult *search* or *Perception* roll while exploring to the north of the ruins finds the wreckage of an Aratech 74-Z military speeder bike. This model is typically used by Imperial scout troopers and a character familiar with Imperial vehicles can determine this with an *Easy Knowledge*, *repulsorlift repair*, *Technical*, or *value* roll.

This particular speeder bike needs a new power stabilizer. With proper parts, a day's work, and a

Difficult *repulsorlift repair* or *Technical* roll, the bike can be salvaged.

Unfortunately, this clue resides next to the lair of a Binarian carnivorous plant. The plant attacks anyone who investigates the wreckage and fights to the death.

### ■ Binarian Carnivorous Plant

Type: Carnivorous plant

DEXTERITY 1D

Missile weapons: tendrils 3D+1

PERCEPTION 1D

Hide 4D

## STRENGTH 4D

Brawling 5D

### Special Abilities:

**Tendrils:** If these three-meter-long tendrils strike a victim, he becomes entangled. No damage occurs, but the victim is now at -1D for all *Dexterity* rolls and the plant gets a +1D to *brawling* with the next bite attack. Entangled characters must make an opposed *Strength* roll or be drawn closer to the carnivorous plant. The plant has six tendrils.

**Bite:** The plant can move its mouth in a two meter radius. A successful bite (using *brawling*) causes 4D+1 damage from the plant's digestive juices every other round. On an incapacitated result, the victim is swallowed. Only one victim can be entrapped in this manner at a time.

**Move:** 0 (but mouth can move anywhere within a 2 meter radius of main stalk)

**Size:** 3 meters tall

**Capsule:** This huge plant preys on small animals for sustenance. It is capable of feeding on creatures up to two meters long and it is not selective of its prey. It can go months between feedings.

The plant uses simple tactics to capture food. It lies still until prey comes within reach of its three-meter-long tendrils. The tendrils snake out and entangle the prey, drawing it to its maw. The maw contains digestive juices which dissolve struggling prey in a matter of minutes. Its mouth is made up of three modified leaves shaped like a bulbous oval, mounted on a half meter thick stalk adorned with an alternating pattern of orange and red leaves.

## THE RUINS

The ruined building stands 25 meters tall and is constructed of weathered stone blocks. The windowless structure is covered with all manner of creeping vines and leafy vegetation. A single arched doorway — supported by stone pillars — provides the only entrance.

About three centuries ago, a small cult venerating a solemn, hermitic deity established a small settlement on Binaros. Here the cult worshipped their god, secluded from the rest of the galaxy. They imported building materials and set up a self-sustaining colony, dedicated to worship.

Within 20 years, a deadly disease wiped out the colony. Over time, the jungle destroyed all signs of the colony, save the temple.

One of Moff Sarne's recon teams discovered the temple while exploring Binaros. The team established a research base near the temple in order to research possible biological weapon resources. However, the station was abandoned about a year ago when Sarne recalled his research teams to Kal'Shebbol.

**The Main Temple.** The entrance to the temple is an archway supported by two thick square pillars. Vines have twisted and wended their way into the darkened interior. A Moderate *Perception* roll reveals that the vines must have been cleared away within the last year, for they are only just beginning to work themselves back

inside. Blast scars on the walls where the vines were burned away appear fairly recent.

The chamber beyond is 25 by 40 meters in size with an ornate cathedral ceiling. The walls are covered with alien mosaics and pictographs. At the center of the room is a round flat stone table roughly knee-high which might have served as an altar of some sort. Two rows of simple stone pews flank the altar. A single door leads to another chamber.

This room is dark, so the characters must provide a light source. The only clue present can be found with a Difficult *search* roll: discarded near the southwest corner is a small piece of durable black fabric. A Moderate *Knowledge* roll reveals that this bit of cloth is the remains of a stormtrooper's body glove, apparently overlooked when the Imperials left.

**The Crypt.** The outer chamber leads to an inner one, which is a burial crypt. The walls are covered with full color murals depicting an interpretation of afterlife, and feature small, shaggy simian beings engaged in primitive activities such as bow hunting, gathering berries, warring with spear and buckler, and so on. Whether these depict the original builders or their gods is not known.

The chamber contains five hexagonal stone sarcophagi partially inset in the flagstone floor. Otherwise the chamber is empty. None of the sarcophagi, which are roughly one meter wide, contain any bodies, though a fine powder coats the inner surface of each.

An Easy *search* or *Perception* roll reveals a door set in the rear wall behind one of the sarcophagi, partially hidden in the shadows at the back of the chamber. The small door panel next to it is of Imperial design.

The power which allows the door to operate is out, but if a droid or generator patches into the power unit, the door may be opened with an Moderate *security* roll. The door slides open to reveal the interior of a compact turbolift. The turbolift is operational, and drops a single level. (If the players fail the *security* roll, a Moderate *lifting* or *Strength* roll will open the door.)

## THE IMPERIAL RESEARCH STATION

The Imperial segment of the temple consists of a number of portable units which were buried in the hill behind the temple and concealed as an added measure of security. The interior is dimly lit by low-powered emergency lamps which have not yet drained their power cells. The interior is clean but stuffy.

Due to the bad lighting, the characters incur a +1D to the difficulty of all *Perception* checks while in the research facility.

### The Temple Ruins and the Hidden Research Facility

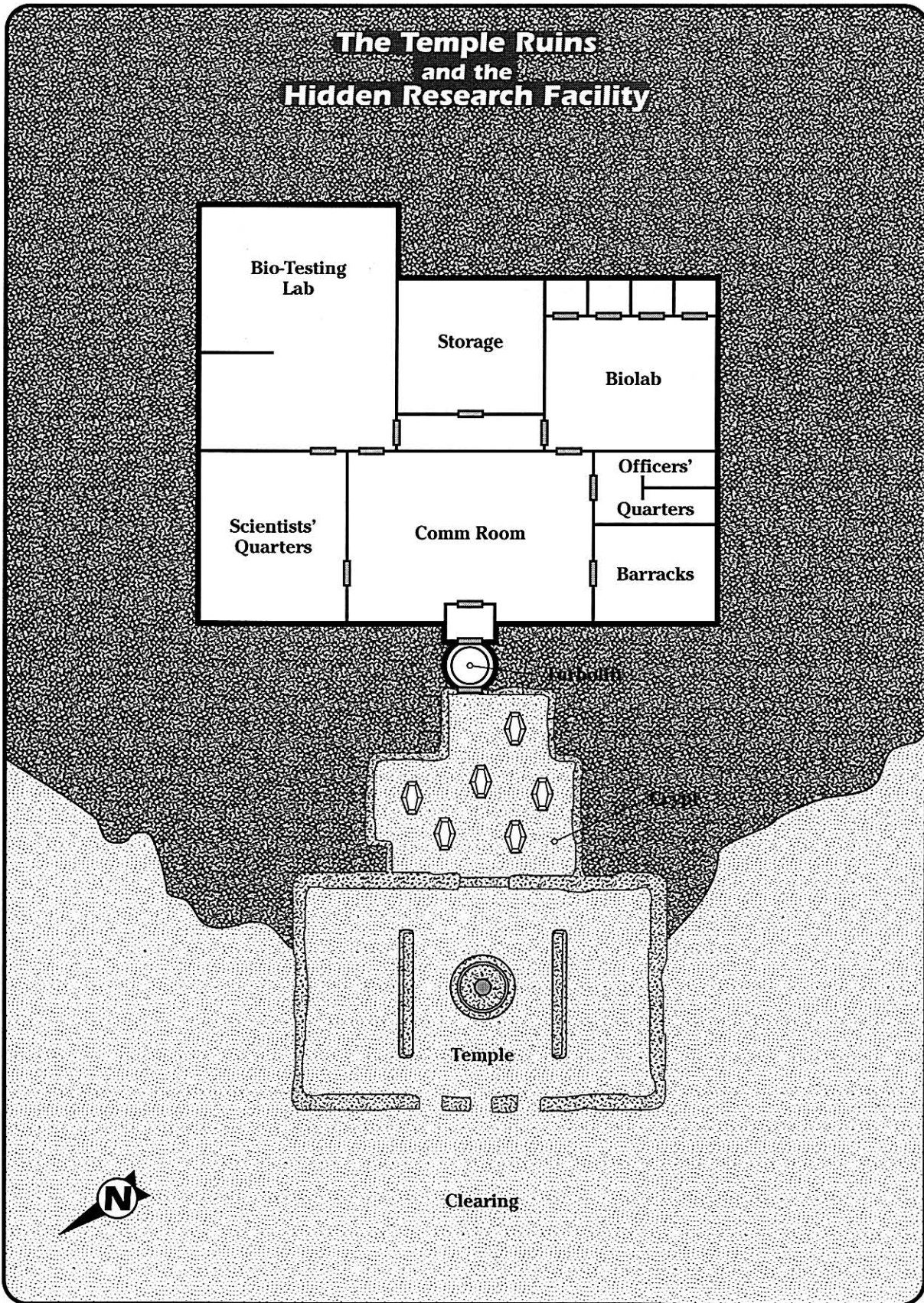

Stephen Crane

**Comm Room.** The turbolift leads to a sealed blast door. A computer access panel is set into the wall, on the right. A Moderate *security* roll can open the door or a Difficult *computer programming/repair* roll can override the lock.

Inside the comm room, a BlasTech T-21 light repeating blaster is mounted on a tripod facing the door. The blaster is connected to the door's opening routine via a computer jack. When the door opens, the blaster fires once per round into the turboshaft; the blaster does 6D damage. Unless the first person opening the turbolift door makes a Very Difficult *Perception* roll, the victims cannot *dodge* the first round.

This large chamber is a communications room and contains three computer terminals and nine chairs. Except for the terminals, the room is barren. All of the terminals have been flash-erased and no useful information can be located.

**Barracks.** This chamber is empty save for eight folding cots. Four line each wall and they appear to be standard Imperial issue.

**Officers' Quarters.** This room is partitioned into two sub-rooms. Each of these contains a folding cot, a small chair, and an empty foot locker. A discarded broken datapad lies under one of the cots. A Moderate *computer programming/repair* roll yields the datapad's file: astrogation coordinates to several nearby systems in the Outback, including the Episol system (see "Little Empires").

**Scientists' Quarters.** This room is similar to the barracks except that it contains only six folding cots. The opposite wall has an inset computer terminal. This terminal has also been flash-erased.

**Biolab.** The Imperials left possible intruders a little surprise in this room: four Arakyd G-2RD guard droids! As soon as the door slides open, the droids activate. The four tables in the room can provide partial cover for either the player characters or the droids, depending on who reaches them first. Using the tables as cover increases the difficulty to hit by one difficulty level. The tables have a *Strength* of 2D to resist damage.

**G-2RD Guard Droids.** All stats are 2D except: *Dexterity* 3D, *blaster* 5D, *dodge* 4D, *melee combat* 4D+1, *bureaucracy* 3D, *intimidation* 4D, *intimidation: interrogation* 5D, *languages* 3D, *law enforcement* 3D+2, *repulsorlift operation* 4D, *sensors* 5D, *Perception* 4D, *command* 5D, *investigation* 5D,

*search* 7D, *Strength* 4D+1, *first aid* 3D, *security* 5D. Equipped with a repulsorlift engine, visual/sound sensor package, stun appendage (stun damage 6D), blaster appendage (damage 5D, range 3-7/25/50), grasping claw (+1D to *lifting*). Move: 10.

This spacious chamber contains four large work tables in the center of the room, which are probably now on their sides. A few empty packing crates are on the floor nearby.

There is a small computer terminal set in the east wall, and the north wall is lined with four doors. Each door leads to a separate mini-lab capable of maintaining different ambient conditions. Climate control panels are set in the wall next to each door. The labs themselves are empty.

**Biotesting Lab.** This huge open chamber was once used to test various substances and biological agents. Equipment was moved in and out as needed, but currently two partitions and four work tables occupy the chamber.

The room reeks of sweet honey and the moisture content of the air is high. Unlike the other rooms, this area is brightly lit by light panels on the ceilings and walls. A green filamentous vegetation covers the floor, walls, ceiling, and tables. The algae-like vegetation is highly corrosive to flesh and exposed body parts immediately suffer 3D from acid burns.

**Storeroom.** This small room is piled high with junk. Extra chairs, broken computer parts, and lab equipment all lie heaped in a mess. A careful search reveals a few spare computer parts, two crates of standard rations, and a blaster power pack. Those searching also discover an eccentric mouse droid named MSE-X-PR6.

### ■ MSE-X-PR6

**Type:** Modified Rebaxan Colmuni MSE-6

**DEXTERITY** 2D

**KNOWLEDGE** 1D

**MECHANICAL** 1D

**PERCEPTION** 1D

**STRENGTH** 1D

**TECHNICAL** 1D

**Equipped with:**

- Electro-photoreceptor
- Auditory sensor
- Vocabulor speech system
- Treads
- Storage area (0.1 meter cube)
- Retractable fine manipulator arm (+1D to *lifting*)

**Equipment:** thermal detonator in storage area (10D) a small flat metal object (in skill matrix slot — see sidebar)

**Move:** 5

**Size:** 0.3 meters

**Cost:** Not for sale



Christopher Trevas

**Capsule:** MSE-X-PR6 used to be a standard mouse droid serving the research team assigned to this station. His responsibility was to act as a messenger between the personnel. Therefore, his skill matrix was removed and a vocabulator speech system was installed. They also removed his holocam and heavy manipulator to give him a small storage space to carry datapads or other objects.

Unfortunately, MSE-X-PR6 developed an unusual programming "glitch." The diminutive droid enjoys petty theft, swiping interesting objects and keeping them for himself. He used to hide his "stash" of stolen items in the storeroom. He carries his two most prized items at all times: a thermal detonator and an unidentifiable metal object (see sidebar).

When the science team abandoned the station, the small droid was left behind. MSE-X-PR6 is now lonely and wants to leave this boring place. When he encounters the characters, he pleads with them to join the crew of the *FarStar*, offering to serve as a messenger. If necessary, he threatens them with the thermal detonator. While he will not intentionally detonate the explosive, the device is likely to explode anyway under MSE-X-PR6's inept control. (Obviously, this unusual mouse droid's programming is more than a little ... *erratic*.)

## MSE-X-PR6'S CARGO

MSE-X-PR6 carries a piece of DarkStryder technology in his skill matrix slot. The piece is 10 centimeters wide by 16 centimeters long (and only a few centimeters thick), colored a deep crimson. MSE-X-PR6 swiped it from a scientist during the final evacuation of the station; the theft was never discovered. He knows that the artifact is important, but does not know its function. If he loses his thermal detonator, he offers to trade the DarkStryder item for passage aboard the *FarStar*.

A Very Difficult *Perception* roll reveals an activation panel on the device. When pressed, the device causes all plant and insect life in a circle to wither and die (a similar artifact caused the dead zone outside the ruins). The dead zone has a diameter of exactly 50 meters. Higher life-forms in this area automatically suffer a wound. All of this life energy is absorbed by the wielder of the device. For the next 10 minutes, the wielder's *Strength* (and all related skills) is doubled. The device can only be used once, after which it turns black and useless. If there are no living beings within 20 meters, there is no apparent effect, but the device is still drained and rendered inoperative.

## DAJUS' VISION

Read this sidebar to the player playing Dajus if MSE-X-PR6 is brought aboard the *FarStar*. The presence of the droid triggers a dream:

The shadowy form lumbers into view from the dark recesses of the room. You stand defenseless, a mere spectator in the events about to unfold. The black hairy arachnid writhes its appendages in the air as if sensing your presence.

In a flurry of movement, the huge beast is gone, disappearing into the shroud of darkness. You try to follow, but something weighs down your approach, as if you were running through water. Ponderously you push through the darkness, arms outstretched.

Finally, you pass through the darkness as if it was a doorway. You stand in brightly lit chamber, empty save for a small box-like droid perhaps half a meter long.

## EPISODE THREE: OH, NO ...

The *FarStar* will need to gather food for two more days to completely replenish ship's stores. Once the vessel's stores are restocked with new supplies, the *FarStar* presumably leaves the system and continues the pursuit of Moff Sarne.

One of Sarne's patrols, meanwhile, has been alerted to the *FarStar*'s location, thanks to a beacon which activated when the characters entered the Imperial research labs. Sarne left this small flotilla to lurk in the area and delay the *FarStar* should it pass this way (the personnel aboard this ships are not people Sarne wanted to take with him beyond the Rift).

The patrol vessels have traveled to Binaros to investigate the disturbance. However, they arrived to discover that they missed the *FarStar* by some hours.

### NOT THIS AGAIN ...

Over the course of the next few days, minor malfunctions occur throughout the ship. The *FarStar* crew will likely attribute these problems to Sarne's booby traps in light of past experience. After a time, it will certainly become apparent that the continuing malfunctions are *not* coincidental.

A brief list of ideas follows, but feel free to create more. The hyperdrive malfunction should be used last to lead into "Target Practice."

- A blast door shuts and seals several crew members in a particular chamber. A Moderate *security* or a Difficult *computer programming/repair*

*pair* roll is needed to open the door normally. A Difficult *Strength* roll allows the characters to force open the door.

- The climate control malfunctions, plunging the command center and adjacent levels to near-freezing temperatures. An Easy *computer programming/repair* roll can fix the problem, but it takes 6D hours to locate the problem in the environmental control room.

- The hologram projector in the communications room randomly flips on and off. No communications can be received or sent until a Moderate *communications* or Very Difficult *computer programming/repair* roll is made. The projector requires 1D hours to repair.

The malfunction has triggered a message from Moff Sarne, hidden in the communications array subroutine. The Moff placed this message as a warning to any of his captains who might have thoughts of disobeying orders.

Read the following:

**The hologram projector flickers, sputters, and finally snaps to life. The image of an imposing Imperial officer appears, although the color of the image is distorted. In a rush of emotion you realize that the officer is Moff Sarne.**

**"Greetings, Captain. Don't be so surprised to see me. After all, I always know the location of my ship. Remember that little fact and be warned that I will hunt you and your crew down if..."**

The image disappears as the generator squawks and sputters before shorting out completely.

During the communication, the *FarStar* emits a transmission via hyperspace. This transmission is detected by Sarne's patrol, still in orbit around Binaros. This signal alerts the patrol to the *FarStar*'s present location. A Difficult *communications* or *Mechanical* roll can detect this transmission. The Imperial patrol sets out on an intercept route. See Episode Five for details on the composition and arrival time of this patrol.

- The hyperdrive cuts out, returning the *FarStar* to realspace with a lurch. No reason for the abrupt stop can be found and it takes about a day to fix the hyperdrive with a Moderate *capital starship repair* roll.

### TARGET PRACTICE

After the hyperdrive cuts out, a sensor scan reveals a nearby asteroid field. The *FarStar* limps to the field on sublight engines and Captain Adrimetrum orders the gunners to the turbolaser bays for some target practice, while the engines are being repaired. Not wanting to be outdone,



Christopher Trevas

Ranna Gorjaye orders her pilots to participate in some maneuvers and target practice. After an hour of game time, continue with the following announcement.

Read the following:

**The ship's com system sputters and crackles, spitting static as it comes alive. "Attention all crew members, this is the Captain. At 1700 hours, there will be a turbolaser targeting contest open to all crew members. The top gunner will receive an extended leave pass at our next friendly port. Good luck!"**

This is an attempt by Captain Adrimetrum to improve morale, but it may have the opposite effect. While the competition occurs, the turbolaser Krudar is using malfunctions in a shower of sparks. Although just another mysterious malfunction, Krudar believes that one of the characters has sabotaged his turbolaser. Krudar refuses to complete the contest and will further spark the antagonistic feelings the Duros is harboring.

## THE COMPETITION

Any of the characters can participate and several gamemaster characters should also enter the contest. Suitable participants include Ranna Gorjaye, Dasha Defano, Krudar, and Tanner Carzyn as well as any other gunners the gamemaster creates. Even gamemaster characters unskilled with *capital ship gunnery* can participate in an attempt to net the prize.

Each contestant is given five shots. The contestant can choose the size of the asteroid being targeted: large, medium, small, or tiny. A successful hit nets a set amount of points as shown below. A miss doesn't provide any points, regardless of how close. The point values for all five shots are added together and the highest total is the gunnery winner. Consult the table below for the *capital ship gunnery* (or *Mechanical*) difficulties and the respective point totals.

Asteroid Size	Difficulty	Point Value
Large	Easy	5
Medium	Moderate	7
Small	Difficult	10
Tiny	Very Difficult	15

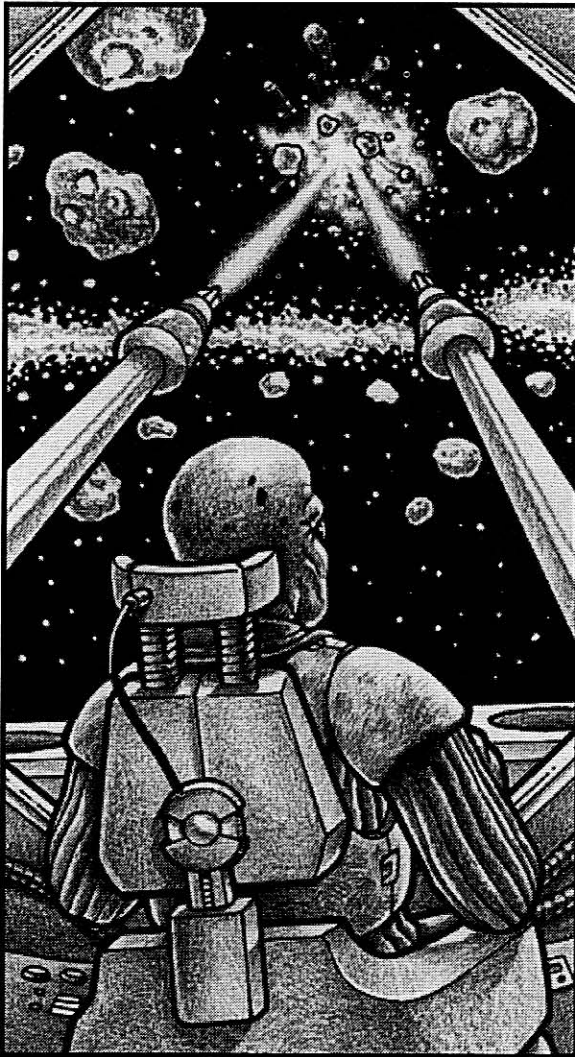

Christopher Trevas

## EPISODE FOUR: THE ENEMY WITHIN

While on his hunt on Binaros, Kl'aal disturbed a curious plant in its dormant state. It spewed a cloud of tiny spores which lodged themselves in his fur. When he returned to the ship, the spores came with him. When he groomed himself, the spores broke free, and drifted about the ship on eddies of air. Most landed in the sterile hallways and perished, but a few landed in the forward lower hold. The presence of hydroponic nutrients, metal, and darkness were all conducive to the plant's growing cycle, and the spores became active and began growing almost immediately.

Over the next few days, the plant grew in the darkness, unobserved by the lone SE-4 droid keeping watch over the hold, feeding itself from the bags of nutrients kept here for the hydroponics labs. After a week, small pods popped open,

### GAMEMASTER NOTE: THE GALAXY'S SMALLEST ASSASSIN DROID

Here's a nasty idea to further complicate matters on board the *FarStar*, particularly if the players are moving too quickly through the adventures for the gamemaster's taste.

Perhaps MSE-X-PR6's story is all just a front and he was programmed to sabotage his "rescuer's" ship. In this case he sneaks to a vulnerable part of the ship, probably the engine room, and sets off his thermal detonator after he's a safe distance away. Of course, if he can frame a crew member, all the better!

To make the situation even more difficult for players, the sabotage can occur during the Imperial attack in Episode Five. Please note that this is an optional route for the gamemaster to take. MSE-X-PR6 is equally useful as comic relief and roleplaying interaction. The final decision on how to use the small droid rests solely with the gamemaster.

ejecting small mobile "feeder" plants which began to roam the area looking for additional food, water, and metals to bring the mother plant. Some have begun to forage beyond the hold, either by using the ventilation ducts, or slipping out of the hold door when someone comes down to get supplies. The malfunctions have occurred as feeders of various sizes scampered through the maintenance ducts and internal systems, tugging at wires and dislodging electronic components.

Thus far, they have escaped detection mainly by favoring the darkened corridors and sections of the ship. However, they are growing larger, and the mother plant more demanding. Soon they will become bolder as well.

### FIRST SIGHT OF THE ENEMY

Late one evening, "Gammer" Firdaaz, the drunken scout, bursts onto the bridge blabbering about short plant-like creatures poking at him while he was sleeping in one of the ship's alcoves. He creates quite a scene but provides little information regarding details or even a description. He's quite drunk, but insists that the captain take action to prevent these "beasties" from taking over the ship.

Despite his seemingly mad ravings, "Gammer," really did see "plant things." However, if the characters investigate, they discover no signs of the mysterious creatures.



## WATER SHORTAGE

The following day, the xenobiologist DeVay reports a theft from hydroponics lab A. A Moderate *investigation* total reveals that approximately 75 liters of water have been extracted from an open tank feeding the irrigation system.

Khzam does not take the theft seriously, but DeVay does. She needs every drop of water not used by the crew to keep her operation running at peak efficiency. The J9 Roche droids, who were all in lab B at the time, are even more upset at this disruption of their efficient labs, and spend the interview bickering and complaining. Other than some spilled water on the floor, no clues are found.

A few hours later, an alarm signals a leak in one of the water tanks in the water storage area on Deck Four. The leak is coming from a row of neat holes which run down the tank about half a meter off the ground. The holes were evidently punched in the metal by metal rods, a dagger, or something similar. Around the foot of the tank, a series of wet prints can be seen, which look like ropes or hoses were dragged around in the puddles of water. They fade some meters away from the tank, as evaporation takes effect.

The leaks are readily patched. A Moderate *Perception* roll reveals that almost 100 liters of water has been removed from the tank, far more than actually spilled on the floor.

## ESCALATION

A crewmember who went down to the belly hold for supplies fails to return. When his superior officer goes looking for him, she discovers his lifeless body sprawled on the floor, next to the smashed remains of the SE-4 droid stationed here. By all appearances, the crewman was repeatedly stabbed by a knife. Bloody rope-like prints lead toward the door, but fade as the blood wears off whatever made the prints.

After a quick examination, Dr. Akanseh (or another medical officer), reports that the crewmember's body has been drained of blood.

## HYDROPONICS LAB ATTACK

Minutes after this, the command center receives a desperate transmission from DeVay. She is begging for help, claiming she is under attack by mobile plant creatures. The transmission ends abruptly with static. Khzam puts an alert to all personnel near the hydroponics labs and orders them to respond. The gamemaster (and the players) can determine who reaches the labs. Read aloud:

**Hastily you pound the command code into**

**the panel to gain access to the hydroponics labs. An audible click, followed by the grinding of the blast door, precedes the opening of the door. Bright lights bathe the shadowy corridor, causing you to shield your eyes from its intense rays.**

**In a moment your vision clears, but you still blink to ensure that your eyes aren't playing tricks on you. At least 10 half-meter-tall mobile plants are scrambling about the spacious bay, moving about on fleshy root-like tentacles. Several have thrust needle-like proboscides into plastic containers of water, and are sucking the contents into rapidly distending sacks on their underbellies. Another four of the creatures have DeVay cornered on the far side of the room. Feebly she swings a hand-held vibrospade in a vain effort to keep the little horrors at bay.**

DeVay is being attacked by feeders, the small plant-creatures which have been causing all the trouble. The immobile mother plant requires water, metal, and nitrogen to complete all of its life stages. The feeders are spawned to collect these resources. They have only collected water and metals thus far, but since the mother plant has just entered a stage requiring more nitrogen, the mindless feeders have entered a phase where they will attack any animal (including intelligent ones), in an attempt to obtain nitrogen by ingesting blood.

The four feeders grapple with DeVay, attempting to stab her with their proboscides, while the remaining eight withdraw from the water jugs and engage the characters. If the characters seem to be winning, the feeders flee toward the mother plant. During the withdrawal, one character manages to wound a feeder in its water sac, causing it to leak ichor and water all the way back to its refuge. The characters can follow this leak back to the forward lower hold for a nasty surprise.

### ■ Feeders

**Type:** Mobile plant

**DEXTERITY** 2D+2

Brawling parry 3D+2, running 4D+1

**PERCEPTION** 1D

Search 2D+1, sneak 4D, hide 4D

**STRENGTH** 1D+1

Brawling 2D

**Special Abilities:**

*Proboscis:* The needle-like proboscis of the feeder can stab an opponent for STR+1D damage. If it remains attached for more than one turn, it begins to suck blood, causing an additional 1D damage per turn.

*Brawling:* Feeders are adept at overwhelming opponents with large numbers. For each feeder that attacks an opponent in addition to the first, add +1D to all attackers' brawling rolls. (Example: three feeders attack a smuggler, so all the brawling skills are effectively 4D.) Up to five feeders can attack a human-sized creature in this manner.

**Move:** 15

**Size:** 0.5 meters tall

**Capsule:** Feeders are mobile hunter vegetables which bring food to the mother plant which spawned them. They are not intelligent, but respond to a number of environmental cues which trigger hunting, fleeing, and feeding behaviors.

A feeder stands about half a meter tall, supported by four thick fleshy vine-like legs, which

sprout out of a soft underbelly of lichen-encrusted vegetable matter. Atop this mass is a carapace of tough layered shells which protect the upper body of the feeder from predators. Spiny thorns protrude from the joints of the shells. A thin bony proboscis protrudes from the front of the upper body, which the feeder uses to feed on water and other nutrients. It stores these nutrients in sacs in its underbelly for transportation back to the mother plant.

Feeders prefer to attack en masse, swarming their prey. They can be dangerous in large numbers.

## THE PROBLEM IS BIGGER THAN WE THOUGHT

The trail left by the injured feeder leads to the darkened interior of the forward lower hold. The hold is huge, so searching it will take some time. It won't be a boring activity, however, since 10 feeders will attack characters entering the hold, leaping from shadowed spaces between crates in an attempt to gore and bring down the intruders. All around the large bay, the faint skitterings of feeders can be heard.

Secluded in a well-hidden recess of the cargo hold, behind and partially inside of a huge crate of water pumps, is the mother plant. Its roots are entwined about machinery and have penetrated the deck plating below it. This plant is the cause of all the malfunctions, and eliminating it will eventually bring to a stop the *FarStar's* infestation problems, since the feeders have short life spans and will soon die.

There are eight feeders defending the mother plant and tending to its needs. Any feeders that survived the hydroponics labs attack and the defense of the hold will also be here. They all attempt to overwhelm the intruders en masse.

Since the mother plant can't move, grenades or other heavy equipment could be used to facilitate the attack. Characters should be warned that such devices might breach the outer hull of the *FarStar*, which is only mere centimeters below the deck plating. If DeVay makes a Very Difficult *science: xenobiology* roll after observing the creature for a few rounds, she can concoct a gaseous poison which can kill it. This takes several hours to concoct.

Meanwhile, Sarne's patrol has found the *FarStar*.

### ■ Mother Plant

**Type:** Huge spawning plant

**STRENGTH** 5D+1

**Special Abilities:**

**Maw:** Maw does STR+1D damage but feeders must place victim inside for the attack to be made.

**Size:** Due to its immense size, all to hit rolls incur a +10 penalty to hit a vital part of the plant. Otherwise the attack



Dan and David Day

does not harm the plant.

**Weakness:** Energy weapons inflict an additional +1D of damage on the mother plant.

**Move:** 0

**Size:** 10 meters in diameter

**Scale:** Speeder

**Capsule:** The mother plant is an immense, non-sentient plant. It is round in shape, dominated by a huge maw lined with thorn-like teeth used to rend prey (this plant has nearly reached maturity). The maw is hidden by many leafy stalks situated on the creature's body. Its roots consist of six short tap roots and a dense mat of secondary roots. The entire creature is shaded in different shades of green, save for the brown roots. The creature emits a mild odor of sweet honey intermixed with an organic earthy scent.

In its natural habitat on Binaros, the adult plant is dormant in the daylight hours and folds back in on itself, which is why the ground crew did not encounter others of the species while on Binaros. It unfurls itself when darkness falls, and becomes more active.

The plant has several life stages. When growing from a spore, it generates feeders to bring it nutrients and water for rapid growth. To grow, the plant needs abundant minerals and metals. On Binaros, these are trapped in the vegetation, not in the soil. When it reaches adulthood after a week or two (the plant grows very rapidly due to the frequent flooding which occurs on Binaros in the wet season), the mother plant begins to send out spores. To do this, it needs a large amount of nitrogen. To fulfill this need, the feeders begin gathering nitrogen by internally distilling the blood from living or recently killed creatures to feed to the mother plant. In optimal conditions, it can complete its life cycle in two weeks.

The *FarStar* is an even better environment than Binaros. The hold is warm and the ship's hull is rich in metals and minerals providing a fertile substrate. Lack of water is the main limitation, which the feeders solved by collecting it from the hydroponics labs and water tanks.

## IMPERIAL COMPLICATIONS

While the *FarStar* crew is dealing with its parasite problem, Sarne's patrol arrives, and moves in on the *FarStar*. The patrol fleet consists of a modified *Lancer*-class frigate, the *Pulsar*, and three Skipray GAT-12g blastboats. The *Lancer* slowly approaches the *FarStar* and attempts to open communications.

Meanwhile, the blastboats circle behind the *FarStar* and position themselves for a surprise attack run. A Difficult *sensor* or *Mechanical* roll can unveil this tactic. The *Pulsar* then orders the *FarStar* to surrender in the name of the Empire. If the *FarStar* refuses to surrender, the blastboats attack, with the *Pulsar* providing cover if any starfighters are launched.

## COMPLICATIONS

Each round of the space battle that the mother plant is still alive, roll a d6. On a result of a 1 or 2, a malfunction occurs for the next round only. Roll 1D to determine the malfunction. The system is restored the next round.

Roll	Effect
1-2	Maneuverability reduced to 0D
3-5	One turbolaser doesn't function
6	Shields reduced to 0D

Run this episode at the most inconvenient and dramatic moment, probably while the crew is frantically dealing with the mother plant. If the crew doesn't find and destroy the mother plant soon, the malfunctions continue during the space battle. Be prepared to run the episode in a fast and furious manner, cutting away between the battle with the plant in the hold and the space battle. Until the mother plant is destroyed, use the rules presented in the sidebar "Complications."

**The *Pulsar*.** Capital, *astrogation* 4D, *capital ship piloting* 3D, *capital ship shields* 3D, *starship sensors* 3D+1, *starship gunnery* 3D+1, maneuverability 1D, space 4, hull 4D, shields 1D+2. Weapons: 10 quad laser cannons (fire control 3D, damage 4D).

**Outdated Skipray Blastboats.** Capital (due to power output), *astrogation* 4D, *capital ship gunnery* 5D, *starfighter piloting* 4D, *starship gunnery* 5D+1, *starship shields* 4D+1, maneuverability 1D+2 (2D+2 in atmosphere), space 8, atmosphere 415; 1,200 kmh, hull 3D+2, shields 2D. Weapons: 2 medium laser cannons (fire-linked, fire control 1D, damage 5D), 2 laser cannons (fire-linked, fire control 2D, damage 5D)

## REWARDS

Each character should receive two to four Character Points. One to two additional Character Points may be in order if additional supplies were obtained, aside from the food and medicinal herbs gathered on Binaros. These include the speeder bike, any guard droids, the light repeating blaster, the DarkStryder artifact, or any Blastboats captured.

These items will be used in the service of the *FarStar* and her crew. It is unlikely that specific characters will be able to keep anything to themselves.



## LITTLE EMPIRES

The insistent beeping of the comm alarm gradually brought Kaiya Adrimetrum out of an exhausted slumber. Groaning, she pulled her pillow over her head, wishing a thousand deaths on the comm unit. When the alarm showed no signs of ceasing, she rolled over with a curse and slapped the comm. "Yeah. What?"

"Sorry to disturb you, Captain," said the Rodian first mate Khzam, not sounding the least bit sorry, "but we've just intercepted a transmission from Sarne to one of his cronies. We're getting it ready for decryption and playback now."

Adrimetrum sat up in her narrow bunk, suddenly very much awake. "I'll be right there."

Adrimetrum appeared on the bridge moments later, a tunic hastily pulled over her nightdress and hair flailing wildly about her head.

Kaiya sighed as the security droids ignored her presence in cee-cee.

Adrimetrum took one look around the room, crowded with people who had suddenly found pressing business in the command center. Apparently news of the message had spread fast. "Officer Khzam, I want cee-cee cleared of non-essential personnel *immediately*," she said, pushing her way to the captain's chair.

"You heard her," Khzam growled. "If you aren't on duty, get out of here. Right now." He stabbed a rubbery finger at one of the crewers — also a Rodian — rising from a console next to Thyte's station. "You, slicer! You stay."

The Rodian slicer sank back into his seat, as the room cleared. Adrimetrum seated herself. "Report," Adrimetrum ordered.

Thyte looked up from his position behind the slicer. "While recalibrating the subspace transceiver, we did some testing in some fre-

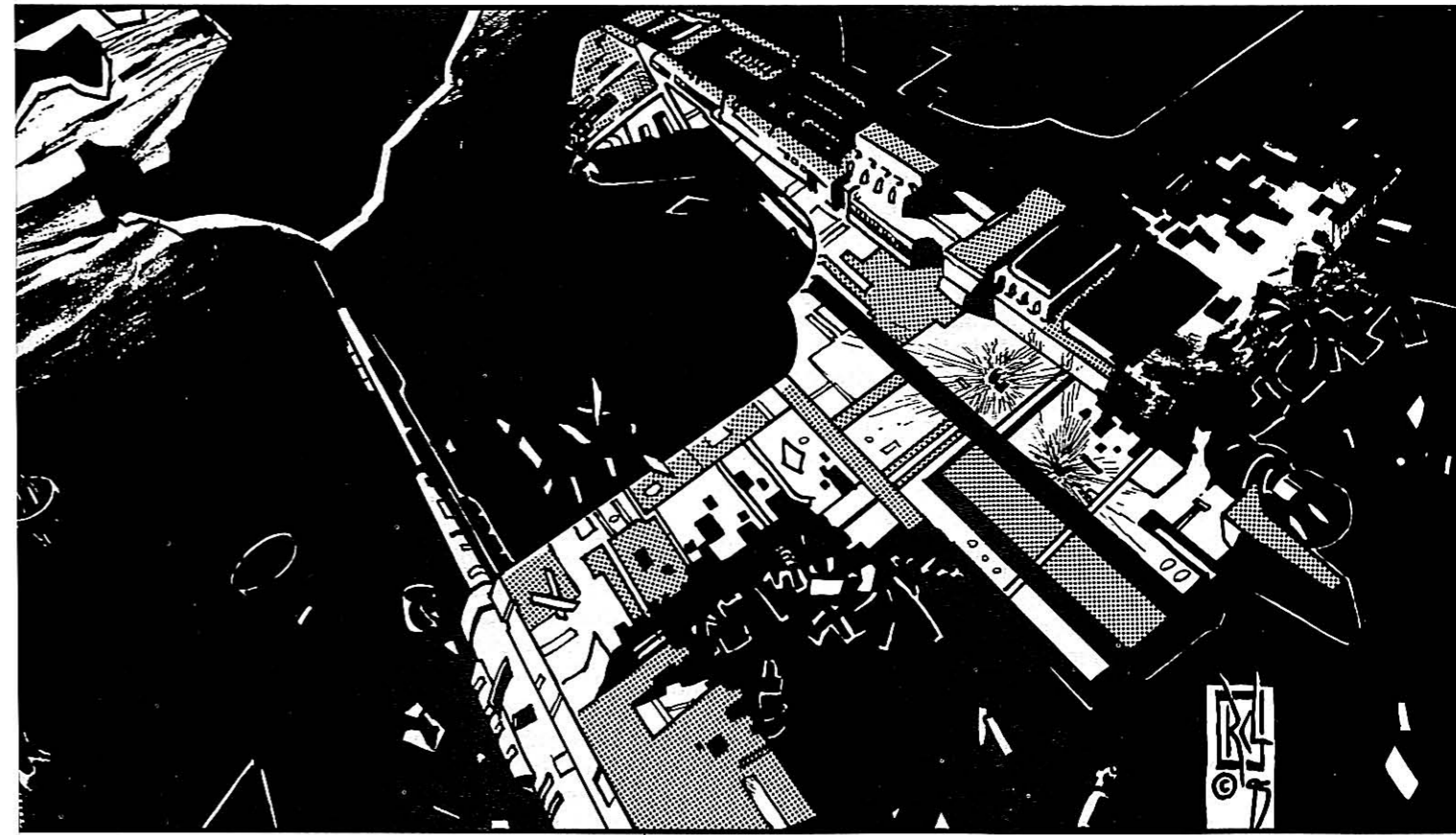

Ray Lederer

quencies we don't normally use. Anyway, we picked up a holo-transmission ID coded from Sarne. We ought to have it decrypted soon if Hydan here can slice as good as he can talk."

"Working on it, sir," the slicer said, snorting disdainfully at Imperial encryption procedures. "They got part of decrypt hardwired into the system, otherwise it'd be impossible to hit the right logarithmic sequence."

"Spare us the details, Hydan," Adrimetrum said dryly. "Just crack it."

Hydan nodded absently, and continued work. The moments passed. The bridge was silent save for the background humming of the life support systems and the faint clacking of Hydan's fingers on the comm-system keypad.

Finally Hydan squinted, then chuckled. "Hold it. Got 'im." He punched a final sequence with a long, thin finger. A small form appeared in the hologram board set near Adrimetrum's chair. It was Sarne, frozen in the position he had assumed at the onset of his transmission.

"The image is a bit grainy and we'll get some dropout in the audio," Hydan said almost apologetically. "but I think we got most of it."

"Play the blasted message, Hydan!" Adrimetrum snapped. Hydan pushed another button, and the image sprang to life.

"... will be pleased, Captain Treidum, with the results. I suspect your idea of ... shall yield us handsome dividends. Pray continue to encourage the belief that ... will be joining you in the Episol system shortly to observe your handiwork first-hand as planned. Sarne out."

The hologram then dissolved into static. Hydan hit a button and the holofield winked out.

Jessa Dajus, the only off-duty officer who had ignored Khzam's order to vacate the bridge, stared for a long moment at the space vacated by Sarne's small image. "Episol ... Maybe we finally have the break we need." Her feral grin faded. "Or maybe this is a trap ..."

## INTRODUCTION

Moff Sarne's elaborate schemes once again plague the *FarStar*. Not quite prepared to receive the New Republic vessel beyond the Kathol Rift, he has instructed Captain Treidum and the *Lance of Endor* to delay the *FarStar* at the isolated Kathol Republic, a "pocket empire" centered in the Episol star system.

Treidum's cursory recon revealed that the Kathol Republic's navy consists only of obsolete capital ships — no match for Sarne's fleet, but more than adequate to threaten a lone Corellian corvette. He decided to turn the system's fleet against the *FarStar*.

Treidum arrived in the Episol system, announcing that he was in command of the New Republic's envoy ship in the Kathol sector. He made a number of extremely unreasonable "demands" on behalf of the "New Republic," included the annexation of all Kathol Republic worlds, a 50 percent tax on their products and resources, the forcible sterilization of all colonists, and the replacement of elected senators with appointed New Republic functionaries. He gave them an impossible deadline to meet.

Having stirred up the little empire against the New Republic, Treidum reported his plan to Moff Sarne. Sarne, to lure the *FarStar* into the Episol system, sent his response to Treidum deliberately on a wide beam transmission he was sure the *FarStar* would be able to pick up and decrypt.

When the *FarStar* arrives in the Episol system, Treidum has just destroyed his first target and damaged a second, in "retaliation" for the Kathol Republic's "failure to promptly comply" to New Republic demands. He had planned to strike three or four more targets before vanishing into hyperspace, but the arrival of the *FarStar* cuts that action short.

### GETTING TO EPISOL

The *FarStar*'s most recently acquired astrogation charts (those found in the abandoned Imperial base in the Binaros ruins) contain coordinates to the Episol system. The charts note that the system contains human settlements, but does not offer specific details.

## EPISODE ONE: A CASE OF MISTAKEN IDENTITY

When the *FarStar* emerges from hyperspace, it does so at the outer fringes of the Episol system.

This four-planet system features two radiation-blasted, rocky planets, a semi-habitable desert world that supports mining colonies, and a gas giant orbited by Dayark (a temperate moon that is widely settled).

Alert to the possibility that Moff Sarne may be in this system, the crew of the *FarStar* is likely to scan for signs of hostile ships. An Easy sensors roll provides assurance that no ships are in the immediate area — but it does detect the distinctive gravitational signatures left by a capital ship that has just departed via hyperspace. There is no way of determining where this ship is now.

The *FarStar* picks up a distress signal on its subspace transceiver. The signal is quite weak, and is on the verge of breaking up altogether.

**"Emergency! Emergency! This is Captain Willa Udine of the frigate *Bravado III*, calling all ships of the Kathol Republic. We have been attacked and are badly damaged ... less than a tenth of our crew ... rapidly losing power ... attacker was a corvette of the new ... urgently in need of evacuation and medical ... currently drifting at coordinates three zero nine fi ..."**

The *Bravado III*'s location can be pin-pointed by scanning for the source of the signal; the ship was not immediately detected by the *FarStar*'s sensors because it is disabled and thus not giving off a readily detectable energy signature.

If the *FarStar*'s crew believes the distress signal to be a trap and refuses to approach the vessel, skip ahead to the next section, and the arrival of the Kathol Republic navy (which picks up the *FarStar* on its sensors). Otherwise, the *FarStar* can move in and observe the crippled ship — a *Marauder*-class corvette. Its shields are down and the control centers for its turbolasers and laser cannons have been destroyed. Entire chunks of the ship have been blasted off, and tumble in space beside the frigate. Supplies, bodies, and other debris are also drifting off into space. Of its skeleton crew (which did not include troops), only about 40 are still alive.

If the *FarStar* establishes comm contact with the *Bravado III*, the characters will be asked to identify themselves. Captain Udine expresses relief and gratitude for any assistance offered — until the *FarStar* identifies itself as a ship of the New Republic. Then her manner suddenly changes. Read aloud:

**"So you've come back to finish what your friends started," she says bitterly. "Well go ahead then, finish us off. But just remember that there's more to the Kathol Republic than just one ship. Our navy will make you pay for this."**

No matter what the characters say, Captain Udine believes the *FarStar* to be the *Lance of*

*Endor* — which she considers a legitimate representative of the “brutal and imperialistic” New Republic. But she continues talking to them over her comm, knowing that other ships of the Kathol Republic navy are approaching in response to her distress signal. She sends a coded message to these ships, urging them to come quickly while the “enemy” is distracted and destroy the *FarStar*. The *FarStar* crew can intercept and decode this message on a Difficult *communications* or *Mechanical* roll.

In the meantime, Captain Udine diverts the last of her ship’s power into its remaining tractor beam projector. The beam is at half range (1-3/7/15) and strength (2D) but it may be enough to hold the *FarStar* in place until the other ships arrive.

If the *FarStar* has offered to send over a medical team, Captain Udine instead uses the tractor beam on the shuttle, holding those inside it as hostages.

### THE CAVALRY ARRIVES

Drawn by the *Bravado III*’s distress signal, six more *Marauder*-class corvettes of the Kathol Republic’s navy arrive to avenge the two damaged or destroyed ships. The ships are the *Quillion*, *Mirandine*, *Triumph*, *Juno II*, *Siroma*, and *Solidarity*. They close in rapidly, mistaking, as Udine has, the *FarStar* for the *Lance of Endor*. Fortunately for the *FarStar*, the navy prefers capturing the ship, and making an example of its crew, to blowing it to pieces.

The fleet commander, Hendric Faile, hails the *FarStar* as the *Lance of Endor* and announces that its officers are charged with war crimes for their unprovoked attack on Republican vessels. He demands to talk to Captain Rolf Treidum, diplomatic representative of the New Republic.

Regardless of the *FarStar*’s response or activities, Faile has orders to bring the corvette in, preferably intact, but as a lifeless hulk if need be. He tells Adrimetrum that he intends to let the politicians sort out the truth from the lies, and he will do no more talking: Captain Kaiya Adrimetrum must appear with her officers before the senatorial council on Dayark to defend the deeds of the New Republic and the *Lance of Endor*.

Faile orders the *FarStar* to remain stationary and allow itself to be boarded by a squad of marines. The ships position themselves in a loose sphere around the *FarStar* (to its right, left, front, back, and above), attempting to hold the cor-

vette in place with their tractor beams while Faile’s vessel, the *Triumph*, moves in to dock.

If the *FarStar* resists, the *Triumph* uses its turbolaser batteries. It is slower but more maneuverable than the *FarStar*, and a few salvos from its multiple weapons should convince the characters that they are outmatched by its firepower. If necessary, the other ships join in, adding their turbolasers and laser cannons to harry the *FarStar* while the *Triumph* switches to tractor beams.

Remember that this attack (if things get this far) is designed to persuade the *FarStar* crew to surrender — it is intended to disable the corvette, not destroy it. The attack ceases once the *FarStar*’s controls are frozen or when it is lightly damaged, and the crew is given another chance to comply with the Kathol Republic’s demands.

### ■ Kathol Republic Corvettes

**Craft:** Republic Sienar Systems *Marauder*-class Corvette

**Type:** Combat cruiser

**Scale:** Capital

**Length:** 195 meters

**Skill:** Capital ship piloting: *Marauder*

**Crew:** 129, gunners: 48, skeleton: 52/+10

**Crew Skill:** Astrogation 2D+2, capital ship gunnery 3D+2, capital ship piloting 3D+2, capital ship shields 3D, sensors 3D+1

**Passengers:** 40 (troops)

**Cargo Capacity:** 300 metric tons

**Consumables:** 3 months

**Cost:** Not available for sale

**Hyperdrive Multiplier:** x2

**Nav Computer:** Yes

**Maneuverability:** 2D+1

**Space:** 5

**Atmosphere:** 295; 850 kmh

**Hull:** 3D+2

**Shields:** 2D+1

**Sensors:**

*Passive:* 40/1D

*Scan:* 80/1D+2

*Search:* 100/2D+2

*Focus:* 5/3D+1

**Weapons:**

#### 8 Double Turbolaser Cannons

*Fire Arc:* 2 front, 2 left, 2 right, 2 back

*Crew:* 3

*Skill:* Capital ship gunnery

*Fire Control:* 3D

*Space Range:* 3-15/35/7

*Atmosphere Range:* 300-1.5/3.5/7 km

*Damage:* 5D

#### 3 Tractor Beam Projectors

*Fire Arc:* 2 front, 1 back

*Crew:* 8

*Skill:* Capital ship gunnery

*Fire Control:* 2D

*Space Range:* 1-5/15/30

*Atmosphere Range:* 2-10/30/60 km

*Damage:* 4D

## ■ Kathol Republic Marines (20 per squad).

**DEXTERITY** 3D

Blaster 4D+1, blaster artillery 3D+2, dodge 4D

**KNOWLEDGE** 1D+1

**MECHANICAL** 1D+1

**PERCEPTION** 2D

**STRENGTH** 3D+1

Brawling 4D

**TECHNICAL** 1D

**Character Points:** 2

**Equipment:** Blast helmet and blast vest (+1 energy, +1D physical), blaster pistol (4D), comlink.

## EPISODE TWO: POLITICAL PROBLEMS

### THE KATHOL REPUBLIC

Episol is one of 10 star systems that were settled decades ago, when a number of maverick politicians chose to flee the crumbling Old Republic and start anew. Their exodus eventually brought them to the Kathol Outback.

Here, the colonists settled on 14 worlds in 10 neighboring star systems. Only two of the planets were readily suitable to support the settlers without terraforming. Some were so harsh that colonization was only possible using biospheres. But the colonists were willing to look to the future — to make do with what they had and build a better life for their grandchildren.

Ironically, while the colonies that make up the Kathol Republic started out as a cohesive political unit, in-fighting now dominates the union, as the children and grandchildren of the colonists have begun taking over leadership roles. Many of these descendants had been born in the Outback and did not experience the chaos of the waning days of the Old Republic. Unwittingly, some began to use the very same methods that their ancestors despised, using underhanded tactics in their struggle to become the next president and to make their planet the center of the Kathol Republic's government.

Each of the 14 planets, regardless of its population size, elects 11 senators to a body known as the senatorial council. One of these 11 senators is nominated to be that planet's presidential candidate. The president is chosen from among the 14 candidates by a majority vote of the inhabitants of all of the worlds.

The official seat of government is always on the president's homeworld. The president acts as moderator of the senatorial council (which has a veto power over his or her actions). He or she also serves as the titular head of the Kathol Republic's military forces, which consist of a handful of obsolete capital ships.

Currently, the presidency is held by Chandra Hobat, an Ithorian living on Dayark, one of the two colonized worlds in the Episol star system. Her chief rival is the near-human Sho'ban Do, a senator of Pitann, a settled planet in a neighboring system. Sho'ban was a close runner-up in the most recent presidential race, and believes that Chandra's style of governing the Kathol Republic is not only wrong, but dangerous.

The government of the Kathol Republic is vaguely aware that the Empire has risen out of the Old Republic, and that it is involved in a civil war with a group calling itself the New Republic. They are fairly ill-disposed towards Palpatine (at least the original settlers are), but do not have any opinion of the New Republic. Few concern themselves with such petty details as who the Empire has appointed as head of the Kathol sector — Kal'Shebbol is some six weeks away, and local politics are more than eventful enough to keep everyone occupied.

### ■ Dayark

**Type:** Satellite

**Temperature:** Temperate

**Atmosphere:** Type I (breathable)

**Hydrosphere:** Moist

**Gravity:** Standard

**Terrain:** Wetlands

**Length of Day:** 84 standard hours

**Length of Year:** 196 local days

**Sapient Species:** Humans, Ithorians

**Starports:** 1 standard class

**Population:** 2 million

**Planet Function:** Colony

**Government:** Member of Kathol Republic

**Tech Level:** Space

**Major Exports:** Medicinal goods, foodstuffs

**Major Imports:** Metals

**Capsule:** Dayark is a satellite of the gas giant Nepe, and always keeps the same face toward this parent planet. Thus only the sunward side of the moon is habitable; "day" occurs when Dayark passes out of the shadow of Nepe, and "night" occurs when it once again falls in Nepe's shadow.

The planet's wetlands are ideal for growing rice and other food crops (which are harvested by agricultural droids), making Dayark the bread basket of the Kathol Republic. Because the moon's orbit lies within the outermost fringes of the gas giant's atmosphere, the skies are always cloudy and a light rain is constantly falling.

Dayark is the most heavily populated world in the Kathol Republic. It has also been the seat of government for many years; the Dayark vote alone is usually enough to ensure that Dayark's presidential candidate is elected.

### THE COUNCIL MEETING

The Kathol Republic navy escorts the *FarStar* to the moon Dayark, and directs it to land at the spaceport in Dayark's capital city of Rytal Prime,

where it is immediately impounded. All crews and droids are ordered to debark, and are taken to detention centers around the city to be processed. Captain Adrimetrum and her officers (as well as any of the other characters who can justify coming along) are escorted by a squad of troopers to the senatorial chambers, where a meeting of the council is hastily being convened.

The senatorial council meets in a vast hall covered by a glass dome. The faint hiss of rain striking the dome can be heard in the chambers below. The chambers are filled with the senators, who are somewhat disgruntled at having been summoned to an important meeting in the middle of the night.

The characters are lined up before the center dais, and greeted coolly by President Hobat. She informs them that the government has already determined that the *FarStar* is not the same ship that called itself the *Lance on Endor*. She asks if the *FarStar* represents the New Republic. There really isn't a way for Adrimetrum to deny this (though Khzam would love to do so at this point), since doing so would contravene her orders to establish the New Republic's presence in the Kathol sector.

Hobat announces that according to Kathol Republic proxy law, the *FarStar* crew must stand trial for the deeds of her fellow New Republic vessel, the *Lance of Endor*. The officers of the ship are now permitted to make a case in their defense. They are told that if they are found guilty, they will be executed, and in any case, their ship is being confiscated and given to the Kathol Republic's navy to replace the lost ship.

## IN THE DOCK

Obviously, the characters must convince the senators that the *Lance of Endor* is *not* a New Republic ship, rendering the proxy law inapplicable. This will save their necks, but will not do much for the *FarStar* itself, which is being stripped of supplies by the shipyard. In order to have their ship restored to them, they must also turn the senators actively against Sarne, and convince them to join the New Republic.

Alienating the senators from Sarne shouldn't be that difficult. The hologram message that was intercepted earlier can be used to prove that Treidum received his orders from someone called Sarne. Unfortunately, the senators have never heard of Moff Sarne and certainly don't recognize him from the hologram image. However, a thorough check of transit records within the last three decades will turn up the record of a young Imperial officer named Sarne who passed through the sector years ago. This holovid recording,

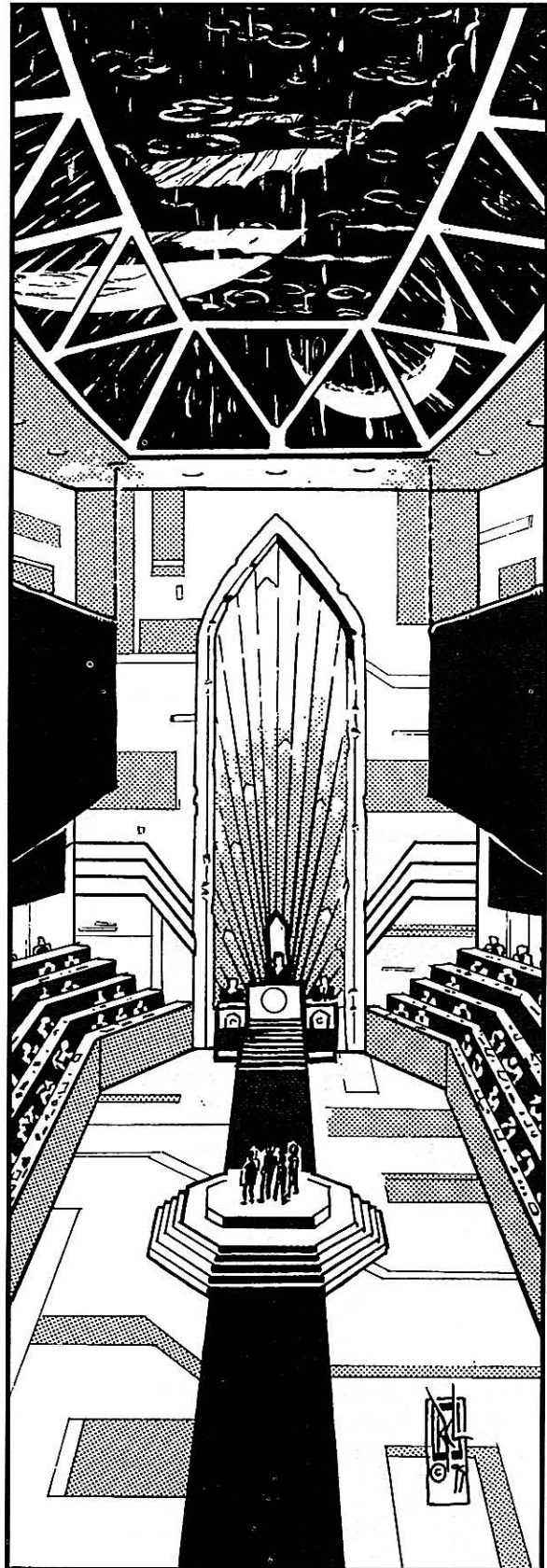

Ray Lederer



when paired with the holovid in which Treidum makes his demands to the Kathol Republic, goes a long way towards linking the *Lance of Endor* with the Empire. Gamemasters should note that this is also an important clue as to why Sarne is headed into seemingly "unexplored" space.

The senators frequently interrupt with shouted questions, and Hobat does her best to keep all doors open. Treidum's recent visit has given them the impression that the New Republic is a fascist state, and that the Empire is a beleaguered force for good in the galaxy — the true representative of the Old Republic.

At some point during the debate, one of the senators from Dayark, a near-human named Sal Olbeg, rises to his feet and insists that the council deal with "the important matter that was tabled at our last meeting." He is shouted down by other senators — most of them from Do's faction — who say that the matter currently before the council is more pressing. Olbeg tries again: "I insist that we deal with the matter of the droid gladiators on Pitann immediately, while the council is in session." Once more he is shouted down, and this time receives a furious look from Senator Do. Olbeg returns the glare, then stalks angrily out of the senatorial chambers. The debate on the *FarStar* then resumes.

Continue the politicking for as long as it maintains the players' interest before moving on to the next episode.

## ■ Chandra Hobat

Type: Kathol Republic President

**DEXTERITY 1D**  
**KNOWLEDGE 4D**  
 Agriculture 8D, alien species 5D, bureaucracy 6D, business 4D+2, ecology 7D, planetary systems: Kathol Republic 8D  
**MECHANICAL 1D**  
**PERCEPTION 4D**  
 Bargain 5D, persuasion 6D  
**STRENGTH 1D**  
**TECHNICAL 1D**  
 Force Points: 1  
 Character Points: 5  
 Move: 10

**Capsule:** Like most Ithorians, Chandra Hobat is a skilled agriculturist and ecologist. This is her second three-year term as president; she has concentrated the Kathol Republic's resources into terraforming and farming operations. Unfortunately, these are long-term projects, and some of the worlds will not see any benefits for decades. Enthusiasm and support for Hobat's "Ithorian ex-

travagances" is gradually falling away.

If she can persuade the populace that joining forces with the New Republic will provide an immediate influx of expertise and wealth, support will rally around her once more. But she'll probably have to provide concrete proof of the benefits to be gained.

## ■ Sho'ban Do

Type: Pitann Senator

**DEXTERITY 2D**

Blaster 2D+2, dodge 3D, melee combat 5D

**KNOWLEDGE 3D**

Alien species 4D, bureaucracy 3D+2, intimidation 4D, planetary systems: Kathol Republic 5D

## PLOTS AND FACTIONS

There are dozens of factions operating behind the scenes at the hearing, but they gradually fall behind two leaders with regard to the *FarStar/Lance of Endor* issue.

President Chandra Hobat, an Ithorian, is inclined to embrace the New Republic. She is a consensus-builder, and can normally count on a number of factions to back her up. However, she can no longer rely on her coalition to back her up, since the attack on the Kathol Republic navy has stirred up a lot of resentment regarding outsiders. Her coalition threatens to crumble if she publicly embraces the New Republic as represented by the *FarStar*.

To give her political cover, she needs proof that the Empire is as evil as the characters make it out to be, and that it was the driving force behind the *Lance of Endor* attack. Only then can she publicly support the *FarStar*. Even so, the conflict has shifted many senators away from taking any stand, and thus even if the characters can convince her, they won't be much further ahead.

The larger faction is led by Senator Sho'ban Do of Pitann, a staunch isolationist. He adamantly opposes any ties to outside forces. He is extremely critical of Hobat's presidency, and blames her lack of support for the military for the loss of the navy's two corvettes. He insists that military spending be increased immediately to beef up what he freely admits is an obsolete fighting force. This conflict has pulled many former Hobat supporters into Do's political camp.

Since Do isn't about to change his policy of isolationism, the characters' best chance at swaying the council lies in discrediting him. Hopefully, his supporters will then move back to Hobat's faction in an effort to distance themselves from him.



**MECHANICAL 1D**

**PERCEPTION 2D**

Command 7D, persuasion 5D+1

**STRENGTH 2D**

Brawling 5D+1

**TECHNICAL 2D**

**Character Points:** 4

**Move:** 10 (on Pitann), 12 (on Dayark)

**Capsule:** Sho'ban Do is human, but shows several of the peculiarities of those born and raised on Pitann. He is barrel-chested, short in stature, has dark leathery skin, and has enormously muscular arms and legs. He is used to a higher gravity, and thus all but bounces along the streets of Dayark. He is secretly plotting to stage a coup and declare himself tyrant of the "Kathol Tyranny."



Ray Lederer

## EPISODE THREE: ECHOES OF EMPIRE

The negotiations with the senatorial council are likely to have ended in a stalemate. The characters should be able to convince the senators that they are indeed the true representatives of the New Republic, and not to be held responsible for the actions of the *Lance of Endor*. But getting the senators to agree to an alliance with the New Republic (and to release the *FarStar* from its impoundment) is another matter.

If the characters don't think of it themselves, Loh'khar suggests that they look into the background of Senator Do for anything they can use to discredit him, in an effort to reduce support for his isolationist policies. The characters have already been given a clue as to the best place to start — it was clear that Senator Do and Senator Sal Olbeg are political opponents, if not enemies.

Unless the characters were antagonistic and threatening during their appearance before the senatorial council, they will be free to move about Rytal Prime without a squad of troopers escorting them everywhere they go. The *FarStar*, however, remains impounded in the city's spaceport, under the watchful eyes of several squads of troopers. Depending upon whether the encounter with the Kathol Republic's ships escalated into battle, it may be undergoing much-needed repairs.

Olbeg insists that any meetings occur at his home. The senator lives on a large estate on the outskirts of Rytal Prime. Its marshy ground is divided by dikes into neat squares in which crops

are tended by a number of insect-like agricultural droids. His home is a glass-domed structure, raised on elaborately sculpted pilings. An ornate stone wall encloses the water around and under the building; this water is filtered and heated, turning it into a swimming pool. Olbeg offers the characters a tour of the estate's farming operations, then a relaxing dip in the outdoor pool, where water-proofed repulsor-droids bring drinks and other refreshments.

The characters should be the ones to direct the course of the interview, and should coax the following information out of Olbeg.

During the meeting, Olbeg refers back to the matter he tried to raise in the chambers, which is the source of Do's animosity toward him.

It seems that, on Pitann, Do's home planet, a new form of "entertainment" has sprung up in the past year. The miners are modifying their heavy-duty digging droids and pitting them against one another in gladiatorial contests.

Olbeg has heard rumors that Do plans some sort of coup attempt, and that the first blow in this bid for control of the senate will be staged on Dayark. His theory is that the gladiatorial contests are a front for the development of an army of armed droids that will be imported to Dayark and used in some sort of violent attack against the senatorial chambers.

Olbeg's interests and those of the characters are similar: discrediting Senator Do, and preventing the coup (doing so would provide fertile ground in which to plant a lasting New Republic-Kathol Sector treaty). Olbeg suggests a place to start their investigations: with a droid programmer and repair mechanic on Pitann by the name of Uta T'cha who lives in a mining town named Ghaz Kul IV. Olbeg's inquiries have suggested that this woman may be involved in the plans to create a droid army, and that she may be willing to accept bribes and to tell what she knows. Olbeg was planning on questioning Uta himself, but had not yet done so, due to his fear that an "accident" would claim his life if he visited Pitann in person. But perhaps the characters could conduct the investigation for him and bring back proof of Do's plans.

Characters who make a Moderate *search* or *Perception* roll can notice that Khzam visibly

starts at the mention of Uta's name. Khzam will deny knowing this woman, however, saying that he misheard the name and thought that the speaker was referring to someone else. However, he does know her as a former comrade of his slaver gang.

## ■ Sal Olbeg

Type: Dayark Senator

DEXTERITY 1D

KNOWLEDGE 2D+1

Agriculture 4D, bureaucracy 3D+2, business 3D+1

MECHANICAL 1D

PERCEPTION 2D

Persuasion 5D+1

STRENGTH 5D

Swimming 6D

TECHNICAL 1D+2

Droid repair 2D+2

Character Points: 8

Move: 10 (running), 14 (swimming)

Special Abilities:

*Genetic Alterations:* Olbeg gains a +1D to *swimming* rolls due to the minor alterations to his physique.

**Capsule:** Sal Olbeg is human, but has been genetically engineered for life on Dayark. The changes are subtle: nostrils that he can close at will, wide feet, short downy hair, and webbed fingers. Otherwise he looks like a normal human male in his early 30s. Olbeg is one of the youngest senators in the council. He is the grandchild of some of the original colonists to the Kathol Outback, and is fiercely protective of

Dayark's traditional role as the center of government.

## OFF TO PITANN

To interview Uta, the characters will need to travel to Pitann, which is a barren desert world in another system of the Kathol Republic. Since the *FarStar* remains impounded in Rytal Prime's spaceport, they'll be forced to travel there by shuttle — either one of the commercial services that links the planets of Dayark and Pitann, or one of the *FarStar's* own landing craft. Getting permission to use the latter will involve another appearance before the senatorial council.

Since the bulk of the *FarStar's* crew will be remaining on Dayark (and are thus potential hostages), permission will be granted. But the characters will have to come up with a good excuse for traveling to that planet — one that won't arouse the suspicions of Senator Do. Khzam

avoids the trip if possible. If he must go, he goes sullenly and keeps to himself. He will not explain his behavior.

The trip to Pitann takes two standard days. As their craft orbits Pitann, the characters can observe its many strip mining operations (which have left large scars on the planet's surface), and the smoke rising from its refineries. Once they have landed and disembarked, they are struck by this world's searingly hot, tainted atmosphere and its heavy gravity. Breathing masks aren't necessary to survive — but they're certainly a welcome relief.

Ghaz Kul IV is one of four mining towns that are connected by repulsorlift barge to one of Pitann's limited-services landing fields. Its buildings are grimy and mainly industrial, and the landscape around the town is a bleak plain of slag heaps and open pit mines. There are fewer droids here than in Rytal Prime; most are kept busy in the mines and ore refineries.

## MOVING AROUND ON PITANN

Characters will find moving about in Pitann's heavier gravity tiring. Walking counts as an action (it is not a free movement). Characters incur a -1D penalty to all *Strength* and *Dexterity* actions (except for resisting damage). They must make a minimum of a Moderate *stamina* check after every minute of heavy exertion, although checks may be made more difficult or frequent at the gamemaster's discretion. Characters who fail these *stamina* checks must rest for double the amount of time they were active or suffer a -3D penalty to all actions except resisting damage in combat. Additionally, when the character suffers damage from collisions or falling, increase the damage by a minimum of 1D

## THE WORD ON THE STREET

If the characters ask around, an *Easy streetwise* roll can give them a bit of background on Uta T'cha. She's a newcomer to the Pitann system who arrived on a small tramp freighter about 22 months ago. She is rumored to have a somewhat shadowy past, but is known to be one of the best droid repair mechanics and programmers in the Kathol Republic. When she first arrived, she worked on the colony's mining droids. But now she specializes in modifying and reprogramming these droids for the gladiatorial games.



If any of the characters' make a Moderate *streetwise* roll, they learn that the games originated in Ghaz Kul IV, and that Uta was one of the driving forces in setting them up. (The other was Senator Do, if anyone thinks to ask.) She arrived virtually creditless on Pitann, and hopes to one day make her fortune by fighting some of the droids she's modified.

If any character makes a Difficult *streetwise* roll, they learn that Uta is rumored to be a former member of a group of slavers. The droid gladiatorial contests were modeled after games that the slavers used to supply captives for another part of the Kathol Sector.

The one thing the characters will *not* be able to learn (at least, not yet) is what Uta is really up to. Senator Olbeg's guess was close, but not quite on target. Rather than assembling a droid army to attack Dayark, Uta is hard at work on a program that will override a droid's usual command sequence, allowing it to be remotely controlled.

Senator Do plans to use the program Uta is developing to create "assassins" from Dayark's own droid population. These will be used to quietly eliminate any who oppose his bid to name himself ruler. The droids will be the ultimate stealth weapon, since they operate inside the homes of almost every senator on Dayark.

Allow the player characters to move about Ghaz Kul IV and interact with the locals. This is an ideal time to encourage roleplaying in the session. Individual encounters with Pitann's gruff natives are excellent opportunities to allow players to more fully flesh out their characters.

## STUMBLING IN THE DARK

As the player characters move about Pitann gathering information, it is likely that a player will botch a *streetwise* or *investigation* roll. If this is the case, gamemasters can indicate that the character has offended a Pitann resident with impertinent questions. In this situation, the player will have to placate an angry local who is yelling for assistance.

If the players fail in their attempts to calm the angered citizen (which requires a Difficult *persuasion* roll), trouble arrives; six tough miners (paid by Do to create problems for the characters at the earliest opportunity) come to the aid of the local and attempt to "persuade" the *FarStar* crew to go home. They are not armed; these miners are simply "leg-breakers" who will try to beat the player characters into submission. However, if the characters draw their weapons during the fight, all future attempts to gather information from the locals will increase one level in difficulty for the duration of the adventure.

If three of the miners are downed, the rest will flee or give up; when interrogated they will only reveal that "some big shot paid them off to rough up the newcomers."

If the miners win the fight, they will simply knock the player characters unconscious and steal all their possessions.

### ■ Pitann

Type: Terrestrial  
 Temperature: Hot  
 Atmosphere: Type II (breath mask suggested)  
 Hydrosphere: Arid  
 Gravity: Heavy  
 Terrain: Desert  
 Length of Day: 12 standard hours  
 Length of Year: 841 local days  
 Sapient Species: Humans, Near-humans, Sullustans  
 Starports: 5 limited services  
 Population: 20,000  
 Planet Function: Mining  
 Government: Member of Kathol Republic

Tech Level: Space

Major Exports: Metals

Major Imports: Foodstuffs

**Capsule:** Pitann is a harsh desert world, inhabited by colonists who wanted to make a living mining and smelting its rich ores. The rocky planet's high gravity reduces the economic value of these metals, which are expensive to lift out of the planet's gravity well.

Life is hard and uncomfortable on Pitann, but its colonists believe that this makes them tougher than anyone else in the Kathol Republic. The populace is fervently behind Senator Sho'ban Do, whom they see as having the strength to fight back against the bullying tactics of the "New Republic."

**Pitann miners.** All stats 2D except: *dodge* 4D+2, *Strength* 3D+2, *brawling* 6D. Move: 10. Equipped with miners' coveralls, toolbelt, vibropick (STR+1D).

## NEGOTIATING WITH UTA

Uta can be found in a workshop near the center of Ghaz Kul IV. The workshop is next to a large arena with seating for several thousand and a dusty, oil-stained floor. Here, droids are pitted against one another in gladiatorial contests that are much like demolition derbies. Any droid modification goes, as long as the droid is armed only with melee weapons (no built-in blasters or other sophisticated ranged weapons are permitted.) The last droid still functional is the winner. The elite of Pitann — its senators and mining managers — rarely miss a contest.

Should the gamemaster wish, a gladiatorial

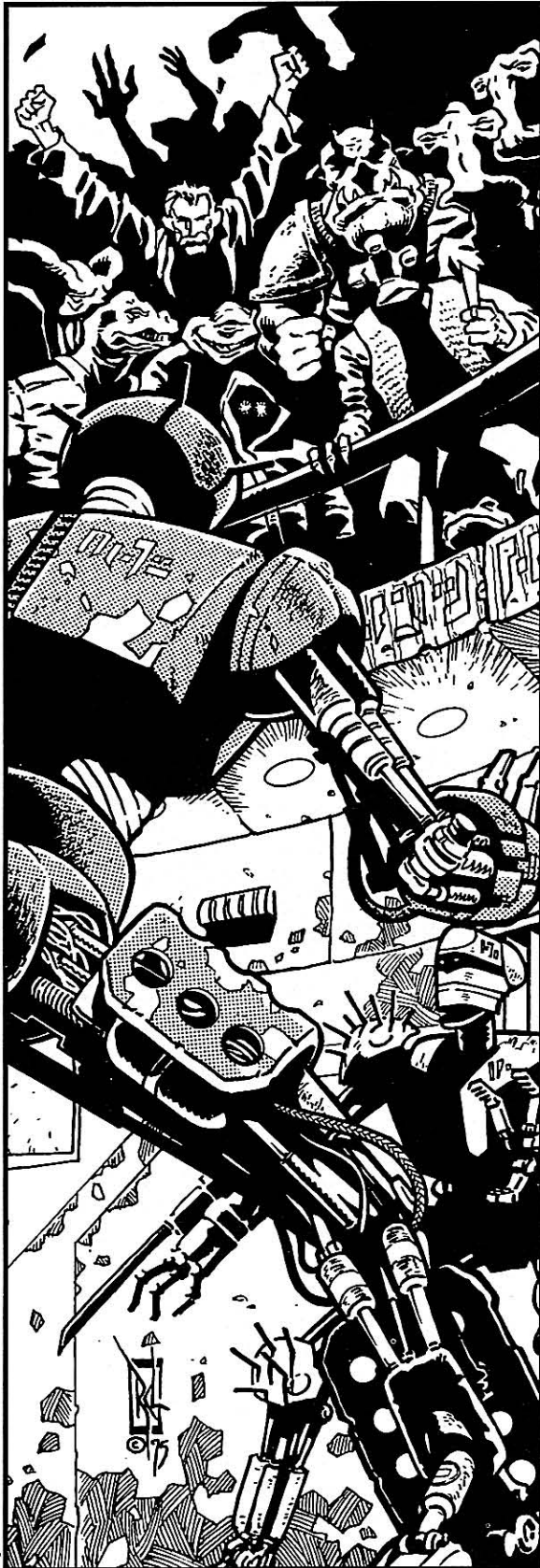

Ray Lederer

contest might be in progress at the time the characters arrive at Ghaz Kul IV. It involves four droids (of the gamemaster's choice, but *not* any security droids), and has drawn a crowd of nearly 3,000 "bloodthirsty spectators." If any players are running droids, these characters may be tempted to enter the contest, which has a purse of 15,000 credits. Any winnings go to the droid's human "owner" — not to the droid itself.

## GAMEMASTER NOTES

If Cobb Unser is with the characters, he expresses disgust and sorrow at the way the droids are forced to fight one another. The gamemaster might like to develop a subplot in which Cobb tries to "rescue" one or more droids.

If either Gunthar or Qesya Vth'naar are along, the contests bring back unpleasant memories of their own gladiatorial bouts.

Olbeg's information was right: Uta can be bribed. Her only allegiance is to the person or faction with the most credits to offer. She's willing to sell a hologram recording she made secretly, when Senator Do hired her to work on a computer program that would turn ordinary droids into covert assassins. In this recording, Do mentions that these droids would be used against rival senators — and even names his next victim (Uta doesn't say who, but it's Senator Hobat).

Uta demands the exorbitant fee of 50,000 credits for her evidence and cooperation. With clever bargaining (or good role-playing), she can be talked down to 8,000 credits, but will insist on passage out of the Kathol Republic. She knows that once she's sold Do out, she won't be safe anywhere in the Kathol Republic, even if Do himself is dealt with — he has many allies who are not directly connected with the droid plot. She is not concerned with the destination of the *FarStar*, or where it might drop her off, as long as it is a settlement several jumps away from the outermost Kathol Republic system. Her talents as a droid programmer would certainly come in handy aboard the *FarStar*, though her loyalty remains uncertain.

Uta is aware that the *FarStar* crew is without its ship, and knows that she is the means for getting it back. She will use this knowledge shrewdly to enhance her bargaining position.

She insists on accompanying the characters

back to Rytal Prime. Once there, she will turn over the recording (which she has hidden inside a secret pocket in one of her tool gauntlets, and which requires a Very Difficult *search* or *Perception* roll to find).

Uta does have one additional reason for choosing to accompany the *FarStar*. She recognizes Khzam (if not in person, then from newscasts of the *FarStar's* arrival on Dayark), and realizes that he hasn't told anyone of his slaver past. She is sure she can blackmail him for favors once aboard.

## ■ Uta T'Cha

**Type:** Ex-Sabiador Slaver

**DEXTERITY 2D**

Blaster 3D, melee combat 4D

**KNOWLEDGE 4D**

Alien species 7D, intimidation 4D+1, languages: droid 4D+1, streetwise 5D+1

**MECHANICAL 2D**

Astrogation 3D+2, communications 2D+1

**PERCEPTION 3D**

Bargain 4D, gambling 3D+2

**STRENGTH 2D**

Brawling 2D+2

**TECHNICAL 5D**

Computer programming/repair 9D, droid programming 9D, droid repair 8D

**Character Points:** 4

**Move:** 8

**Equipment:** Droid tool kit, datapad, miscellaneous spare parts.

**Capsule:** Uta is a short woman with close-cropped brown hair and cold blue eyes. She wears casual clothing and has two leather tool "gauntlets" attached to her forearms; these bristle with the delicate tools used in maintaining a droid's internal hardware.

She has a brusque manner that seems to be a carry-over from the sharp commands she barks at the droids under her control. Her dialogue is peppered with incomprehensible computer terminology and acronyms.

Uta was a member of the Sabiador Slaver gang along with Khzam. They were casual acquaintances at best, and she left the gang some time before he did. She prefers buying and selling droids to sentient species. The loyalty of droids can, at least, be assured. She arrived in the Kathol Republic dirt poor, and would like nothing more than to leave.

She only thinks of herself, and will use Khzam's past against him to get what she wants (out of the Kathol Republic, for now, but the list might grow, depending on how pliable Khzam proves to be).

## REGAINING THE FARSTAR

Upon arrival at Rytal Prime, Uta hands over the hologram of Senator Do, then requests protection from Do's factions from the *FarStar* crew until the *FarStar* leaves the system.

Once Chandra Hobat sees the hologram, she reconvenes the senatorial council, and shows

them the hologram recording that implicates Senator Do. The result should be explosive — lots of shouting, angry protests by Do that the recording is a fake, and the eventual arrival of a squad of troopers to arrest the senator.

Now that Hobat has positive proof of a plot against the Kathol Republic, she is able to restore her coalition and restore the *FarStar* to its crew. In addition, she offers a tentative alliance with the New Republic.

## DEALING WITH UTA

The ultimate fate of Uta depends largely on the desires of the gamemaster. She should be aboard the *FarStar* at least through "Wildfire," the next adventure in this book. This is the adventure in which Khzam abandons the *FarStar* to pursue his own goals.

Bear in mind that if she squeezes Khzam too hard, he may well decide to kill her in some sort of "accident." This would not at all be out of character for him. Fortunately, Uta knows just how far she can push Khzam without losing control of him. (The gamemaster may wish to work out some sort of understanding with the player running Khzam about how the situation should be handled prior to beginning play.)

If the *FarStar* has lost a few of the more prominent crewmembers, she might serve as a permanent addition to the crew. Khzam's defection will create some voids in the crew roster which need to be filled.

## SKILL AWARDS

Characters receive three Character Points for participation. Characters who helped to persuade the Kathol Republic navy not to attack the *FarStar*, or who roleplayed well in the meeting with the senators receive an additional two Character Points. Characters who conducted the negotiations with Uta or who otherwise helped to expose Sho'ban Do's coup plans receive an additional two Character Points.

## FURTHER ADVENTURES

The Kathol Republic covers 10 star systems and includes 12 additional worlds that were not detailed in this adventure. Further adventures may lie in wait on any of these planets. The characters may be pitted against more of Sarne's operatives — or may be caught up in the political infighting of the senators. By exposing Senator Do's plans, they have made a powerful enemy. Perhaps he will one day seek revenge ...

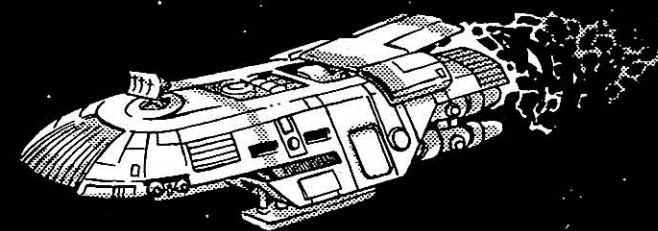
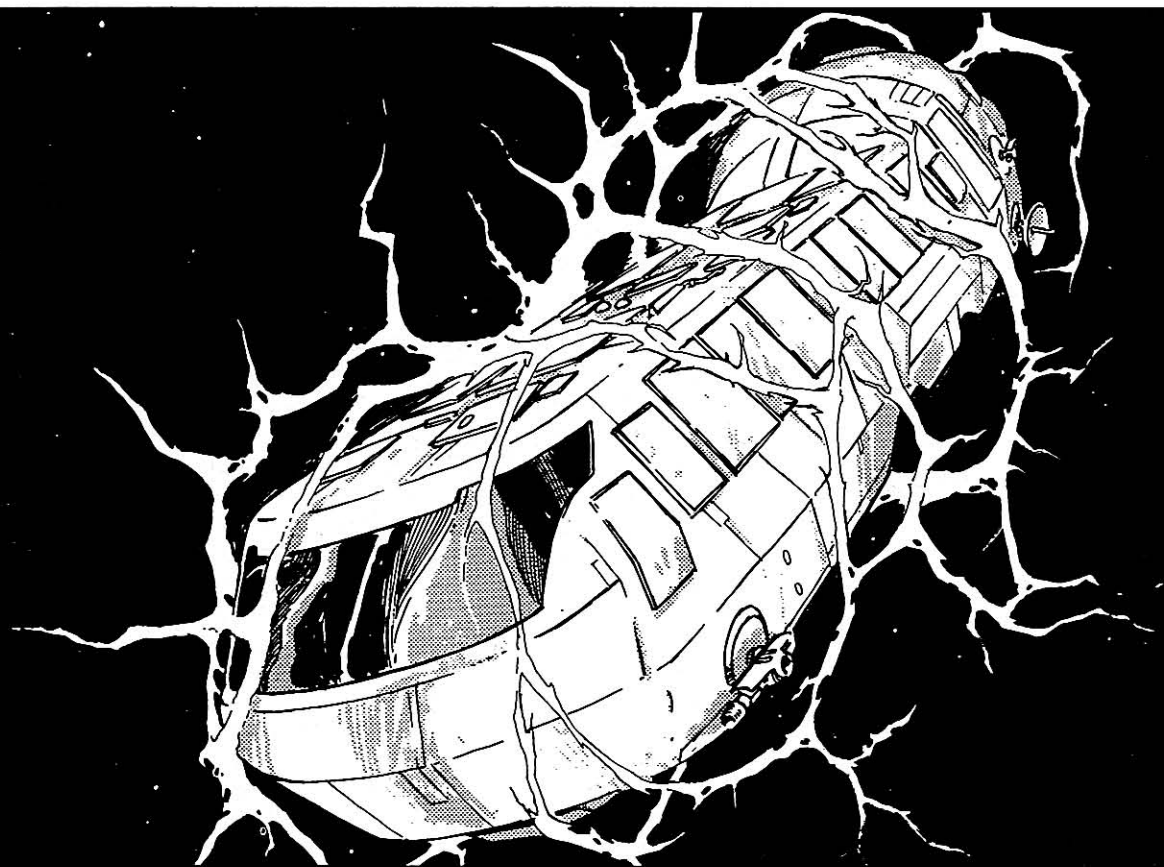

## WILDFIRE

Dim crimson light spilled over the command center's durasteel stations and deckplates in the sluggish hours after midnight, highlighting everything in an eerie red glow. Captain Kaiya Adrimetrum stood on the main floor of the bridge lost in thought, her hands clasped behind her.

She stared out the main viewport at the Kathol Rift — a mass of red-tinged stardust and bright primordial gases that spread outward like an enormous cloud against the star-filled backdrop. Lieutenant Thyte had determined that the Rift spanned several parsecs, and in taking sensor readings to calculate that distance, he had also discovered massive energy storms tearing through the nebula at incredible speeds.

As Adrimetrum continued to gaze at the Rift she decided it looked more like an explosion frozen nanoseconds after its birth. Wispy ten-

drils of blue, red, white, and black snaked outward into space like veils shrouding the glittering starpoints behind them. But for all its internal fury — the storms, the creation of new stars, the whipping currents of primary gases — the Rift seemed peaceful and beautiful from this far distance.

"Captain?" Lieutenant Thyte called in his slightly tensed, nasal voice. He always kept his tone somewhere between annoyance and shock so that Adrimetrum never knew what words to expect from him, nor what true feelings lay behind those words.

She stepped out from behind the bank of R3 units that assisted the navigator. "Yes, Lieutenant?"

Thyte stared at a read-out screen at the sensor station, the multi-colored light from the monitor glowing on his pale face. "Captain, I've discovered an unknown ship approxi-

mately 1,500 kilometers from our current position. I cannot determine its type or pick-up its transponder codes, and it hasn't moved since it appeared on my sensors."

*Strange*, she thought, *but not too strange*. The *FarStar* itself had been holding its present position for several hours now while the crew attended to routine hull maintenance and the R3s processed astrogation data. This vessel could be in the midst of similar procedures. No reason to look into—

"What was that?" Thyte said, louder than usual.

Adrimetrum hurried down the few steps to Thyte's station and peered over his shoulder as he stared wide-eyed at the screen.

"Lieutenant?" she prompted.

"Some kind of energy surge," he said without taking his eyes from the monitor. "It exceeded every sensor range limit. I've never seen anything like it."

Adrimetrum read the data and confirmed Thyte's determination. A massive energy disturbance erupting and dissipating into the

vacuum of space ...

A single thought charged forward from the back of her mind — *DarkStryder*.

Could they have stumbled upon an experimental Imperial mission? Or some other sector force that possessed DarkStryder technology? If there was a chance of either one, Adrimetrum thought as she looked up to the main viewport, they had to investigate.

"Lieutenant, take us in until we have visual contact." As she gave the order she wondered what Page or Ciro would have done. They had always told her she was too aggressive, too eager to leap head-long into a mission. Could they be right? Should she keep to the safe path, act and think cautiously rather than charge ahead? Maybe she should wait until the crew finished repairs on the *FarStar*.

No, she decided, in this case there was no decision to be made. She had no way of knowing how much longer the vessel would remain, and she couldn't pass up the opportunity to capture DarkStryder technology. This time she had made the right decision ... she hoped.

Mike Vliardi

## EPISODE ONE: AFTERBURN

Read aloud:

Every crewer in cee-cee stares slack-jawed at the sight. An Imperial assault shuttle, dark and lifeless against the star-filled space-scape, tumbles slowly about an oblique axis as it drifts along a vector that will eventually — in a few thousand years — take it into the empty reaches of the Kathol sector. Without warning, blue tendrils of lightning erupt across the ship's hull, wrap about the vessel in a lattice-work of energy, and then fizzle away to nothingness.

Lieutenant Thyte punches at his sensor controls with more vigor than usual, his eyes tracing the data that spills across the screens. "Captain," he says, "I can't determine what has happened to the vessel. Its systems have apparently malfunctioned, and even the backup life support is failing." Thyte flips a switch and adjusts the sensor sweep focus knob. "I also detect an unspecified number of life forms gathered at the rear of the ship."

He turns toward Captain Adrimetrum, taking his gaze away from his station for the first time in more than an hour. "Captain, if we don't rescue whoever is trapped aboard that ship —"

"I'm way ahead of you, Lieutenant." A blue glow highlights her face as another energy surge envelops the assault shuttle. She turns to Khzam, standing at her side. "I want a team aboard that vessel in three minutes. If you come across anything that might be DarkStryder technology, do your best to retrieve it — but not at the cost of lives."

The characters may either take Brophar's light freighter or the *Aegis*-class combat shuttle over to the Imperial vessel and attach to its hull above one of the zero-g stormtrooper boarding hatches. (In any event, Brophar will pilot his ship, refusing to ride aboard the *Aegis*.) Since the assault shuttle continues to tumble, the character piloting the docking vessel must maneuver carefully to get in sync before joining. This action requires a Moderate *space transports* roll.

As the ship nears the Imperial vessel, several still zero-G suited figures can be seen hanging in space. Closer examination reveals that the people inside the suits are dead. The suits themselves have been severely scorched by the strange energy tendrils that dance about the ship.

The team must move quickly to enter the boarding hatch — or else get caught in the strange energy emission. Each member of the group must make a Moderate *Dexterity* roll. If more than half

### RECOMMENDED CHARACTERS

Khzam leads a team consisting of at least one member of the medical staff, a slicer, and several troopers capable of carrying heavy objects. Brophar insists he pilot his Loronar B-7 freighter, the *Muvon*, and after a brief argument, Khzam gives in.

Khzam himself seems somewhat preoccupied throughout the mission. If asked about it, he curtly responds that he's tired. The reality is that he is uneasy with the fact that Uta T'Cha (from "Little Empires") knows of his secret past.

The characters have yet to fully awaken from their interrupted sleep and therefore suffer a -1D penalty to their attributes and skill rolls for the duration of the first episode.

of the team fails, the last person through the hatch takes 3D in energy damage as blue lightning crackles across the assault shuttle's dark gray hull, grazing the *FarStar* crewmember.

Read aloud:

Dim glowpanels flicker as you step into the main stormtrooper bay of the assault shuttle. At least the artificial grav-generators seem to be working (for the time being).

In the brief moments of full light created by the energy discharges you can see that this section — which accounts for a majority of the ship's interior — appears to be abandoned. Shadows expand and contract with the flickering of the overhead glowpanels, distorting the view of the forward and aft sections. A slight hissing is audible in the background.

Characters who actively examine the vessel's interior and make an Easy *search* or *Perception* roll notice strange grooves running in wild arcs across the walls, floor, and ceiling of the assault shuttle. Near the center of the stormtrooper transport chamber, the port wall bears a series of indecipherable markings drawn in a thick, green-gray substance.

All of the vessel's main systems are down. If characters attempt repairs to the craft, their efforts succeed only on Heroic *space transports repair* rolls. The only valuable information aboard lies in the computer core — the senior officer's last log entry. Apparently, Captain Treidum ordered the assault shuttle's commander to proceed to these coordinates and then await a Kathol sector force calling itself the Qektoth Confedera-



tion. That entry was made approximately 21 hours ago. There are also navigational maps to nearby systems, though larger scale maps have already been erased.

According to Thyte, the life forms were detected near the engineering section at the rear of the vessel. A Moderate *security* or Difficult *computer programming/repair* roll allows the characters to bypass the security lockout on the access hatchway that blocks entrance to that area.

Once inside the engineering section, the characters notice movement along the shadowed back wall. Huddled in a nook between the deflector shield generators and the power modulator, two Imperial officers whimper incoherently. The characters must either use *persuasion* (on a Moderate roll), *con* (on a Difficult roll), or use their blasters to stun the officers to extricate them from their cramped location.

Five minutes after the characters board the assault shuttle (or just after they manage to remove the Imperials), the *FarStar* contacts them on the comm.

Read aloud:

**Thyte's static-riddled voice filters through your comlink: "The energy surges ... to fluctuate, becoming more ... unstable ... unpredictable ... out now."**

**Short streaks of blue-white energy suddenly crackle like forked lightning from one wall to another. The hissing that had until now lain in the background has grown louder and more insistent, as if it is unable to contain itself any longer.**

The unleashed energy now crackling thought the vessel interferes with communication signals, making contact with the *FarStar* impossible. The assault shuttle's systems have been completely ionized and have begun to discharge energy in random fits of feedback. The charac-

ters must drag the Imperial officers — who flail wildly throughout — to the boarding hatch and return to their own shuttle. Characters carrying the Imperials must make Easy *Strength* rolls to keep a hold on the men.

Just before the lead character reaches the zero-g stormtrooper hatch, an energy dispersion melts the hatch power controls as well as the struts on a metal ceiling brace, causing a durasteel beam to crash to the deck plates. The lead character must make a Moderate *Perception* roll to have enough time to attempt to *dodge* the falling beam, which inflicts 2D damage.

With the hatchway controls irrevocably destroyed, the characters have little chance to escape. They may choose to exit in vacc suits via the zero-g stormtrooper launch ports, but the floating bodies outside attest to what a bad idea this is.

They may also jack into another computer terminal, either in the engineering section or in the cockpit, and access the hatch subroutines on two successful Moderate *computer programming/repair* rolls or they may attempt to cut through the durasteel hatch itself, which has a *Strength* of 5D. But as they work to free themselves, their time quickly slips away.

Meanwhile, Brophar must make a Moderate *space transports* roll to align his freighter with the Imperial vessel between the energy discharges.

When the characters manage to clear a path to the hatch, a Moderate *Dexterity* check allows each of them to exit the assault shuttle without incident. Those who fail suffer 3D of damage as they accidentally bump into the side of the assault shuttle and are engulfed by an energy flare.

Once the characters have returned to Brophar's ship, read the following aloud:

**Just as you detach from the assault shuttle, tendrils of blue-white energy arc outward again,**

## KHZAM'S SORDID PAST REVEALED!

Uta T'Cha has had a change of heart. She has decided she likes being a *FarStar* crewer, and wants to bring Khzam around. She does this by engaging Khzam in a very public conversation, probably in the training room or officers' lounge. She tells the panicked Rodian that she plans to reveal her past and come clean with the crew, and asks Khzam to do the same.

Regardless of what Khzam does, she presses on, stating that she feels that the crew will forgive them their past misdeeds if they confess. The upshot of this "little talk" is that Khzam's secret comes out in a very public

way. Some of the ex-slaves start howling for Khzam's blood, and the whole mess lands in Adrimetrum's lap just as the *FarStar* reverts from hyperspace in the Uukaablis system.

The end result is that Khzam is relieved from duty and told to remain in his quarters until the *FarStar* finishes its business in the system and Adrimetrum has time to deal with it. Khzam's quarters are not guarded, though they are locked from the exterior, and Adrimetrum leaves strict orders that anyone who harms him will be left in the system.

Play this scene out at some point before Episode Two.

swallowing the ship in a lattice of destruction. But this time the energy does not disperse; it just continues to grow brighter. Suddenly, the entire ship explodes in a ball of flame and gas. But this explosion is like none you've ever seen. Jets of green, blue and purple fire lash out like whipping tentacles, flailing as they try to embrace your own shuttle.

Brophar must make a Moderate *space transports* roll to evade the jets of superheated gas. Otherwise, the characters' shuttle takes 2D damage from the blast. Either way, the force of the explosion knocks the shuttle away in a slow spin for almost a half a kilometer.

Back aboard the *FarStar*, anyone who examines the Imperial officers and makes a Difficult *first aid* roll discovers that the men have been infected by some sort of biochemical agent. A search of the medical computer's records turns up no known cure. The medical staff informs Adrimetrum of the diagnosis and recommends that the *FarStar* seek help at the next inhabited system. According to the Imperial navigational

charts, that is the Uukaablis system, which is two days closer to the Kathol Rift.

## EPISODE TWO: SUMMIT

The peaceful aliens who live on the fourth planet of the Uukaablis system greet the crew with open arms and, before Adrimetrum can get a word in, invite a diplomatic team to rendezvous with planetary officials at their capital city.

Adrimetrum assembles a group consisting of Brophar, at least one member of the medical staff, and four others, and immediately heads to the planet. Nizzal insists on coming along, saying that she hasn't had a chance to search for supplies in a long while. Khzam, in light of recent revelations, is told to stay in his quarters.

Read aloud:

**You disembark from your shuttle onto a small landing pad, which is atop a large stone pillar towering over the forest. A group of pale, green-skinned aliens wearing baggy robes that look two sizes too big are making their way towards you.**

### ■ The Paravacc

For generations war raged across Uukaablis, eventually threatening the continued existence of all of its creatures. At the brink of world-wide biological disaster, the ministers from the warring factions met, and after a three-day summit, agreed to end the aggression that had plagued their species for as long as anyone could remember. Weaponry of every kind was loaded onto a giant space barge and launched into the system's sun.

One local year later, the Uukaablians began to suffer from a strange, incurable disease never before seen on the planet. After a decade of research, the leading medical authorities announced that the cause of the fatal illness was a microscopic parasite that had been developed by one of the factions as a weapon. Even though they had abandoned their belligerent ways, a specter from all those years of war had returned to haunt them once again.

From that point on, the Uukaablians have dedicated all of their technology to medical research. Now, almost a millennium later, the world boasts several large medical complexes and an enormous, planet-wide database filled with information on every illness encountered by the Uukaablians.

Within recent months, one team of researchers developed a vaccine that helps the body

repel parasites. The government has since voiced its interest in trading this new vaccine to other worlds in exchange for more advanced technologies.

### ■ Paravacc

**Model:** Uukaablian MedCorp Paravacc 1.X

**Type:** Parasite-repelling vaccine

**Skill:** Medicine

**Cost:** 1,000

**Availability:** 2

**Game Notes:** Use of the paravacc requires an Easy *medicine* roll. If successful, the vaccinated character's *Strength* is treated as 1D higher for rolls to resist diseases caused by parasites for the next 20 hours. Each paravacc holds enough medicine for 10 vaccinations. Characters using the vaccine for more than three days begin to suffer from what seems like utter exhaustion, losing one pip from each attribute for each day thereafter until the paravacc's use is ended. Each day without injection returns one pip to each attribute.

**Capsule:** The paravacc looks like a long, narrow cylinder of polished metal. The person administering the vaccine places one end against the back of the target's neck, and then depresses the stud on the opposite end. The injection causes a slight headache, but no other ill effects. Uukaablian MedCorp has placed one warning on the use of its product: prolonged use of the vaccine (exceeding three days at a time) has been known to cause deleterious effects to the nervous system.



Mike Vitarci

As you look around, you see that the city is actually a network of wide, sweeping skyways suspended above the planet by massive stone columns. Thin, gleaming poles spaced every dozen meters along the skyways bear rectangles of multicolored cloth that snap merrily in the brisk breeze.

As your gaze falls to the huge columns holding up the entire affair, you realize you are about 100 meters above the thick, dark green canopy of forest that covers this region of the world.

It's a long way down.

The group of four aliens comes to a halt barely a meter away from you. They stand over two meters tall, but have small features — elliptical eyes, a pair of nasal passages just above their slim mouths, and slender, four-fingered hands. One steps forward, bowing slowly as his wide robes ripple in the wind.

“Chee danada, tok jin,” he says in a deep, throaty voice.

The characters must translate the Uukaablian language, which seems to derive from a dialect of Huttese. The attempt requires a Moderate *languages* roll to succeed.

With the language barrier broken the Uukaablians begin to inundate the characters with pleasantries and diplomatic rhetoric.

But once Adrimetrum or one of her crew gets a word in and informs them of their quandary, they offer as much help as the characters request, although their technology is limited to planet-bound transportation and medical services.

The four diplomats go wide-eyed at the description of the medical emergency aboard the *FarStar*, and turn slowly to one another, but utter not a word. They know who is responsible: the Qektoth Confederation.

They begin by stating that they have no cure for the disease. They do have certain stop-gap measures that might dampen the symptoms of the disease, but lack a real cure. This measure is the paravacc (see below for details), a drug which immensely boosts the body's ability to repel parasitic invasion.

Though they have no cure for the infection, they can provide information on the Qektoth Confederation, a group of aliens from all over the sector who have decided to abandon inanimate technology in favor of a biological sort. The

**THE QEKTOH CONFEDERATION**

The Confederation was founded almost 25 years ago when a group of scientists from a small colony in the Kathol sector banded together to promote the use of biological technology. They believed that traditional technologies gradually sapped away a being's spirit, weakened the immune system, and caused premature death. Although the scientists performed a series of experiments to verify their claims, no one wanted to believe them, especially those corporations developing and manufacturing non-biological technology.

For the next few years, the Confederation drew more scientists to its cause. Eventually the goal of the group changed, turning it into a militant crusade against those who wished to keep the beings of the galaxy in this weakened condition. Many of the founders of the Confed-

eration left, appalled at what it had become.

Since then, the Qektoth Confederation has continued its biological research, expanding to include chemical technologies as well. The current leader, Trann Shoame, plans to begin the Confederation's full-scale war against its enemies as soon as it perfects its newest weapon: a biochemical agent mated with an unknown technology discovered by an expedition sent into the Kathol Rift.

Recently, the Confederation encountered a group that wished to trade for this unknown technology. Shoame negotiated a deal that provided the Confederation with several new ships which it would convert to biological systems. Now the war can begin sooner than Shoame had planned.

Confederation has grown steadily in power since its formation two dozen years ago. The Uukaablians suggest the characters visit a human by the name of Drigor Tarrens — a former member of the Confederation who sought political asylum when he left the organization several years ago.

At some point in the dialogue, Nizzal scampers off to tend to her own errand. She intends to defect with Khzam, and has come down to the planet to acquire something of value so they might escape with a means to further themselves. After hearing about the paravacc, she decides that is her best option.

**KHZAM'S DEFECTION**

As the characters leave with the coordinates of Tarrens' home, Lieutenant Thyte contacts Adrimetrum, informing her that an unidentified person has hijacked an X-wing and headed for the planet's surface. After a short pause he gives her the X-wing's precise landing coordinates, which is somewhere in the city.

If asked, the Uukaablian diplomats tell the characters that that location does not have enough room to accommodate their shuttle. They instead offer the use of several light swoops parked nearby and give directions to the coordinates provided by Thyte.

**Uukaablis Trans-Systems Light Swoops.** Speeder, maneuverability 4D, move: 175; 500 kmh, body strength 1D. Weapons: 2 light laser cannons (fire-linked) (fire control 2D, damage 3D).

After three minutes of speeding along the curv-

ing skyways of the city, the character reach the touchdown site. Read aloud:

**As you swing into view of the X-wing, a small reptilian form freezes in the act of handing a small metallic cylinder to a figure inside. Pausing a moment, it gestures to the figure in the X-wing, and then leaps onto a nearby swoop, which is loaded down with more of the cylinders. As the lizard fires up the swoop, the X-wing lifts on its repulsor engines and hovers about two dozen meters above the skyway. You can vaguely make out a humanoid seated in the cockpit.**

The figure on the swoop is Nizzal. She has located and stolen a supply of paravacc cylinders. She and Khzam had originally planned to load them aboard the X-wing and fly back to the pad and steal the *Muvon*, but that plan was scrapped when the characters arrived. Now she plans to head back to the pad by land while Khzam flies back to secure the *Muvon*.

With an Easy *Perception* roll, the characters may readily identify Nizzal as being one of the three Turazza. Though she is too far away to identify specifically, it will be rather obvious who it is unless all three sisters came planetside. The characters may or may not deduce that the figure in the X-wing is Khzam, but they won't be able to get a positive identification there, either.

Once the characters come within medium range of Nizzal, she engages the swoop's engines and zooms into the open archway of a large, cylindrical building topped by a shallow dome — one of the Uukaablians' enormous medical re-

search facilities. She is obviously having trouble getting the hang of the craft, which is a bit too large for her, but she is agile and a fast learner, and has already had a little practice.

As they near the point where the errant Turazza disappeared, the X-wing opens fire on the characters. The X-wing has the characters in range for only two rounds before it banks and heads back toward the landing site where the *Muvon* is parked.

Nizzal leads the characters on a merry chase through the twisting hallways of the complex, gradually making her way back to the landing site. Allow the characters to damage the fleeing swoop, but not destroy it.

As the characters maneuver through the twisting hallways of the complex, have them make *swoop operation* or *Mechanical* checks every round. Rolls of less than 10 indicate that the character's swoop has clipped a corner and suffers 2D damage. On the fourth combat round, the characters enter a more crowded section of the complex. The piloting difficulty rises to 15, and rolls of less than four indicate that the character has slammed into a pedestrian, inflicting 3D damage to the unfortunate person.

Meanwhile, Khzam returns to the pad, and orders any guards or pilots (probably Brophar) to exit, and get away from the craft or be fired upon. He lands the X-wing just as Nizzal roars right up to the ramp and drives in without stopping. She immediately fires at anyone still aboard with her hold-out blaster.

Khzam leaps from the X-wing, and turns to face the characters. With a click and whine of servomotors, the *Muvon's* laser cannon rotates to cover Khzam. Anyone who thinks to look can see Nizzal's form in the cockpit.

Read aloud:

**Khzam's Rodian face betrays no emotion as he stares at you. "I think this is where we say farewell," he says, taking a step back onto the *Muvon's* landing ramp. "I have enjoyed our little jour-**

**ney, but I've decided that I have better opportunities elsewhere.**

**"And now that we've aired my little secrets, why don't you ask *Colonel Dajus* about hers? A simple shuttle pilot?" He chuckles and bows low, and then suddenly straightens up, displaying a fat, cylindrical object. "A little going away present from Nizzal," he says.**

**Looking in the window of the *Muvon's* cockpit, you see the Turazza give you a merry wave as her reptilian face contorts into a wicked grin, her reddish tongue darting out in laughter. At the same moment, the drone of the *Muvon's* engines drowns out everything else as she powers up the ship. Khzam gives a final, flippant salute, and tosses the little globe at the characters. He turns and runs up the ramp as the shuttle lifts off the pad.**



Mike Vilardi

Khzam just tossed a low-grade thermal detonator (blast radius 0–2/8/12/20, 5D/4D/3D/2D damage) toward the characters. Within 15 seconds it explodes, destroying a portion of the landing pad and sending several hunks of white-yellow stone to the forest floor far below. As the *Muvon* vaults toward space, Khzam jams all communications. Anyone wishing to contact the *FarStar* may only do so on a Difficult *communications* roll.

Nizzal and Khzam, plus the *Muvon*, disappear into the Kathol sector. The characters can learn from the staff of the medical complex that at some time that afternoon, someone had broken into a locked storage bay and stolen about three dozen paravaccs. One of these cylinders is still sitting in the cockpit of the abandoned X-wing.

## ■ Uukaablians

**Attribute Dice:** 12D  
**DEXTERITY** 1D/2D+2  
**KNOWLEDGE** 2D/4D+2  
**MECHANICAL** 1D+2/4D  
**PERCEPTION** 2D/4D+2



**STRENGTH** 1D/3D  
**TECHNICAL** 2D/4D

### Special Abilities:

**Medical Aptitude:** Uukaablians receive an extra 2D for beginning skill dice which must be applied to the *first aid* skill.

### Story Factors:

**Social Graces:** Uukaablians have mastered the art of conversation, learning to let not a silent moment slip by. Politeness and diplomacy, they believe, count above all, and they therefore work wonders at political summits, although even after an agreement has been reached, no one can get them to shut up.

**Move:** 10/14

**Size:** 2.0-2.5 meters tall

**Capsule:** The Uukaablians have evolved from a species of aggressive, warring factions into a peaceful worldwide community determined to better the lives of its members through medical technology. They have heard mention of the Galactic Civil War, but they have yet to

encounter anyone from either side of the conflict this far into the Kathol sector. The government leaders, however, are anxious for contact with other species, especially those closer to the Core worlds, for they hope to strike trade agreements, mostly in an effort to spread their medical technology across the galaxy.

## FALLOUT FROM THE DEFECTION

Several of the crew members aboard the *FarStar* will have strong reactions regarding the defection of Khzam and Nizzal.

Most affected are Loh'khar and the two remaining Turazza sisters. Loh'khar is crushed at Nizzal's betrayal, and Rizzal and Vizzal go on a two day mourning spree in which they sit, curled in a tight ball together, and keen loudly, refusing to sleep or take food and water.

Naturally, most of the crew bear Khzam considerable enmity for abandoning them and stealing away one of their prized assets, the *Muvon*. Brophar, of course, is in a nearly-berserk state at the loss of "his baby," and has to be forcibly restrained when Adrimetrum refuses to turn around and pursue Khzam. Needless to say, Khzam has acquired a mortal enemy.

Oddly, few hold any grudge against Uta, though some resent the fact that she held what she knew of Khzam secret for so long. Others may be interested in pursuing Khzam's parting remark about Dajus.

## ■ Uukaablis

**Type:** Terrestrial

**Temperature:** Temperate

**Atmosphere:** Type I (breathable)

**Hydrosphere:** Moderate

**Gravity:** Standard

**Terrain:** Forested mountains

**Length of Day:** 28 standard hours

**Length of Year:** 427 local days

**Sapient Species:** Uukaablians

**Starport:** Limited services

**Population:** 100 million

**Planet Function:** Homeworld

**Government:** Representative democracy

**Tech Level:** Information

**Major Exports:** Medical supplies, ground-based transport

**Major Imports:** Foodstuffs, high technology

## EPISODE THREE: ONE MAN'S FOLLY

Read aloud:

**Less than 20 minutes after Khzam's apparent desertion, you set down in a small clearing bordered by short, thickly branched trees. Since forested mountains cover most of the planet, the freighter rests on a steep slope. Brophar glances over his shoulder several times as you head for Tarrens' home, apparently afraid the ship's landing struts might slip on the loose dirt**

and slide into the wall of trees below.

You follow a narrow trail along the mountain for more than 15 minutes, taking it slowly through the steeper sections. But for some reason, you seem to have become winded quickly, and you begin to wonder whether you need to step up your exercise regimen.

The trail ends at a shelf of stone the color of desert sand. It juts out from the mountain several meters, angling slightly upward toward the twin moons glowing softly against the fading afternoon sky.

"Drop your weapons," a hollow voice calls from a shadowed cave near the back of the stone shelf. The words echo from one jagged peak to another, sounding more empty with each reverberation.

There are very few things Drigor Tarrens hates more than trespassers. The characters have exactly one minute before he lets loose a volley of energy bursts from his heavy blaster rifle. If the characters *con* (on a Difficult roll) or use *persuasion* (on a Moderate roll), he does not fire, but he also does not offer any useful information.

He just steps out from the cave and stares at the characters. His reply to any question regarding the Qektoth Confederation is to look away from the character speaking. If pressed, he merely says, "I won't involve myself with them again. For now I think they've forgotten me, and I want to keep it that way. Now get off my land!"

When the situation seems hopeless, read the following aloud:

**A soft beep from your comlink draws your attention. You flick the on-switch and hear Lieutenant Jessa Dajus' voice addressing you, "The medical staff reports that the disease is spreading. They're saying that it is highly contagious."**

Dajus first asks whether the team has managed to discover a cure for the biochemical agent, and gives a dejected "oh" at their negative response. She then says that the characters should probably alert those they have come in contact with since arriving on the planet about the contagion.

If the characters mention to Tarrens that he may have been exposed to the agent, he exhales sharply, shakes his head, and offers them the coordinates of a small Confederation outpost less than a day's hyperspace travel away. He warns them that they will most likely not find an actual cure, but that they should be able to download the computer files regarding the bio-agent's design and thereby, with the help of the Uukaablians, develop their own antidote.

When he finishes, he glares at Adrimetrum, his cybernetic eye staring off toward the darkening sky, and says, "Come back for me." He turns and heads back toward his cave without another word.

## ■ Drigor Tarrens

Type: Hermit  
**DEXTERITY 4D**  
 Blaster 5D+2, dodge 5D, melee combat 5D, vehicle blasters 4D+2

**KNOWLEDGE 2D+2**  
 Bureaucracy 3D, cultures 3D+1, languages 3D+1, languages: Uukaablian 4D, planetary systems 4D

**MECHANICAL 3D+2**  
 Astrogation 4D, repulsorlift operation 4D+2, space transports 6D, starship gunnery 4D

**PERCEPTION 2D+1**  
 Bargain 4D+2, con 3D+1, persuasion 3D

**STRENGTH 3D**  
 Swimming 3D+2

**TECHNICAL 2D+1**  
 Blaster repair 2D+2, droid programming 3D, droid repair 2D+2

Force Points: 1  
 Dark Side Points: 2  
 Character Points: 7  
 Move: 10

**Equipment:** Heavy blaster rifle (5D), hold-out blaster (3D), comlink, blast vest (+1 energy, +1D physical)

**Capsule:** Drigor Tarrens, born on one of the colonies along the edge of the Kathol Rift, joined the Qektoth Confederation over a decade and a half ago. For some unknown reason, he abruptly left that organization five years later.

Tarrens seems constantly preoccupied, as if his thoughts remain locked on a single image and manage to break away for only brief moments. He stands just under one and three-quarter meters tall, and has grown somewhat larger in girth since his younger days. Now, at the age of 42, his brown hair, which hangs from his head in thick braids, has begun to gray and his skin has become wrinkled about his mouth and his right eye. His left eye has been replaced by a gleaming cybernetic version that stares straight ahead no matter which direction his other eye seems to be directed.

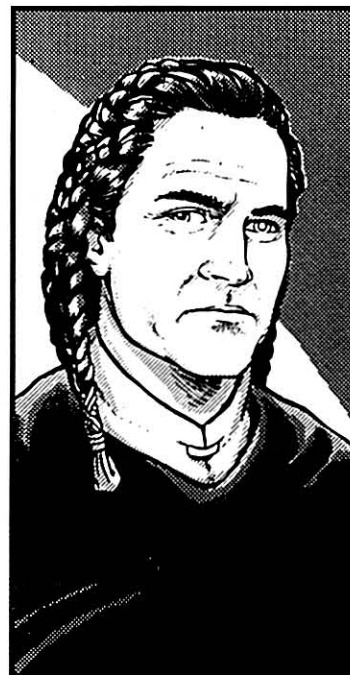

Mike Vliardi

## EPISODE FOUR: THE HEART OF THE MATTER

The player characters should return to the *FarStar* after their encounter with Drigor Tarrens. As they initiate the docking procedure, they can hear a great deal of frantic activity in the background when they establish communications with

the bridge. If the shuttle crew ask the bridge officer about the situation, they will receive the curt reply, "We're a little busy here; you'll be briefed when you're aboard."

When the shuttle is docked aboard the *FarStar*, read the following aloud:

**As you exit the shuttle, you notice that a general alert has been called. Crewmembers are frantically moving about the docking bay; there does not appear to be an immediate threat, but the hangar bay seems to be operating with half of its regular crew complement.**

Lt. Thyte is waiting for you with a nervous and worried expression on his face. "This doesn't look good, folks," he grimaces.

"More than a dozen crewers have reported to the sickbay with everything from intense headaches to full-blown delusions, and that number just keeps going up, Captain," he continues, pausing for a moment. The cynical ex-pilot looks even more distressed than normal as he adds, "and three crewmen died from their symptoms about half an hour ago."

Captain Adrimetrum will order the landing party to return to the command center. Gamemasters should allow the players a chance to roleplay on the way to the bridge. The corridors aboard the ship, normally crowded with on-duty personnel are virtually empty.

Read the following aloud:

**Your team remains in cee-cee at the captain's request. But aside from necessary snippets of conversation, the crew goes about their work in silence. In the main viewport streaks of gray like the dark underbellies of rain clouds stream by as the *FarStar* vaults through hyperspace.**

As your gaze wanders across the various stations, sudden movement from your left calls your attention. Krudar — the surly Duros gunner — and one of the bridge officers stagger away from each other as if they'd just crashed into one another. Krudar's datapad goes spinning out of his hands and drops to the deckplates with a clatter. "Why don't you watch where you're going, human?" he snarls.

"Me?" the officer, Ensign Colton, says, pointing to himself. "Watch yourself, green-skin!"

As the insult registers, Krudar's eyes flare open and his face tightens, and then he rushes forward, throwing his arms out wide to tackle his crewmate.

Two characters may pull the gunner and the human away from each other on Moderate *Strength* rolls. Alternately, a Moderate *command* roll will convince the two to stop fighting.

After the brawl, Adrimetrum immediately confines the involved crewers to two days in their quarters, ignoring their protests. She cannot afford to let this dissension get out of hand at this crucial time.

The biochemical agent has begun to fester in the host life forms. Characters who fail a Moderate *Strength* check take on various symptoms including involuntary shaking, severe headaches, fever, profuse sweating, and delusional episodes. Until cured, their attributes and skills all drop by -1D.

Read aloud:

**With a sudden flicker, the *FarStar* drops into realspace. Ahead, a red, pockmarked moon hangs above its immense white-and-blue swirled mother planet.**

"The space station is currently on the opposite side of the moon, Captain," Lieutenant Thyte says as he continuously adjusts his sensors.

"Good," Adrimetrum says, turning to your group. "Take the shuttle. We're going for stealth this time around. Just get in, download the files, and get out as quick as you can."

She starts to turn toward Thyte again, but glances back over her shoulder. "Hit the armory before you go; we can't afford to play around with this."

The characters selected for the landing party can stock up on weapons before heading to the station. They will be issued a pair of blaster rifles (5D) and each character will also be issued a glowrod and a heavy blaster pistol (5D). In addition, one character will be issued a thermal detonator (10D). When the characters' shuttle slips around the moon, read the following aloud:

**As Brophar skirts the red moon's equatorial region, the Aegis shuttle falls into its monstrous shadow. Then, on the crimson sliver of the moon's horizon, you see the flicker of blue, green, and white lights, like tiny stars just beyond your reach. The cylindrical silhouette of the space station takes form as you get closer, but no one bothers to hail you.**

A long cylinder accounts for a majority of the station's bulk, with a cone-like module protruding from each end. Slim, lighted antennae jut from the tips of the cones, and at the top edge of the central cylinder four arms of durasteel alloy stretch outward with hexagonal solar energy arrays.

Unless the characters initiate a conversation with the station, the communications transceiver remains silent. The Confederation members aboard are rushing about trying to ready for their



impending escape, and have no time to deal with the incoming vessel. The characters may therefore attempt to use *con* or *persuasion*; an Easy roll indicates success. If they make the roll, they are allowed to land in the docking bay at the center of the station.

## ■ Confederation Space Station

**System:** Qu'mock

**Starport Type:** Limited Services

**Traffic:** Rare

**Control:** Controller

**Landing:** None

**Docking Areas:** Docking bays

**Capsule:** Developers commissioned this space station to study the Gandle Ott region over 100 years ago. But only months after entering the region, it disappeared, its entire crew lost in the unexplored reaches of space.

Records aboard the station indicate that a group of colonists consisting of several crimelords and hundreds of escaped criminals raided and hijacked the orbiter. They used their strike craft to tow it back to their hidden base and modified it for use as a communications center so that they might monitor the happenings of the Known Galaxy as well as the sub-space communications of their new home.

Thirty-four years later a massive quake destroyed everything on the planet, leaving the station in orbit around a dead world. Just 26 years ago a man named Drigor Tarrens discovered the station and brought it to the attention of the Qektoth Confederation, who restored it to its original scientific design. It was then transported and deployed in an abandoned system where the Confederation could conduct its research in secret.

### THE HANGAR BAY

Read aloud:

**Your shuttle turns in a wide arc as it nears the station, vectoring toward the center point of the cylinder where a gaping square of bright light marks the en-**

**trance to the bays.**

**The atmospheric magnetic field defending the interior of the station from the vacuum of space drops as you near, and immediately re-engages as you pass the threshold. Shadows blanket the rear half of the bay, and no vessels rest on the dark gray, grid-like deckplates.**

The characters find no one in any of the bays, which account for the majority of this level of the station. A thin, film-like grime covers everything,

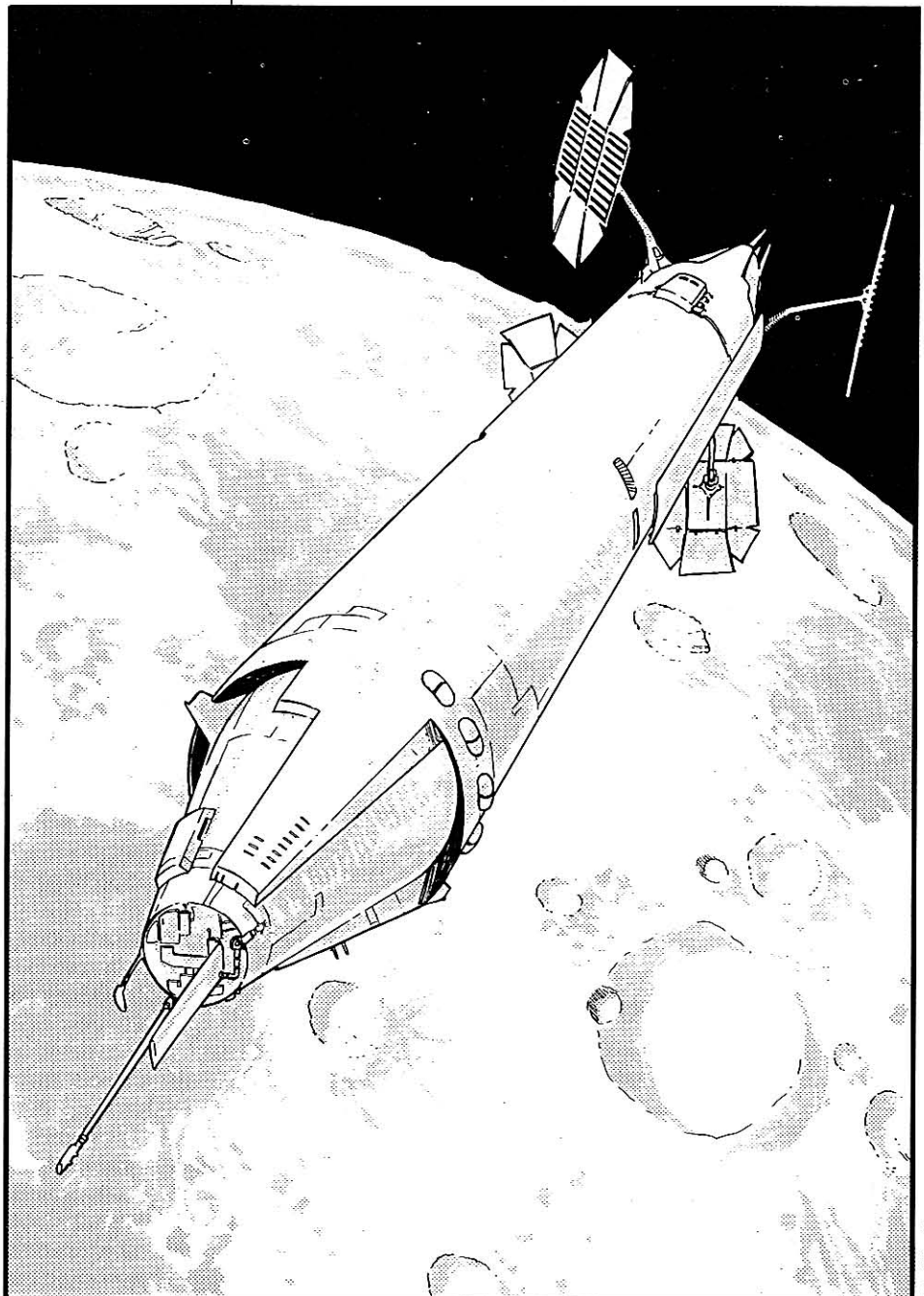

**Oektoth Confederation  
Space Station**

**Hangar Bay**

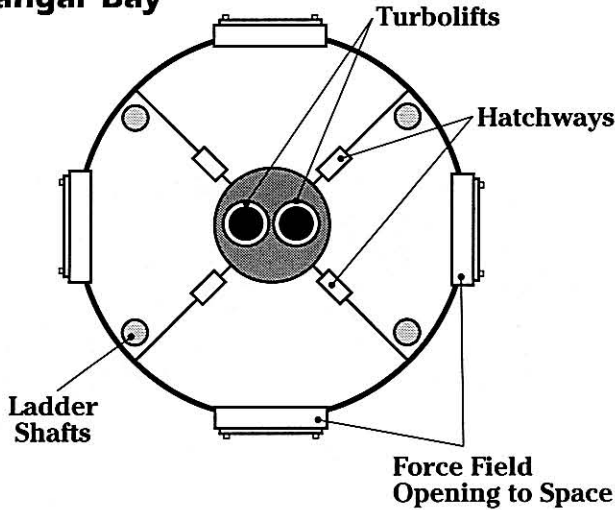

**Storage Area**

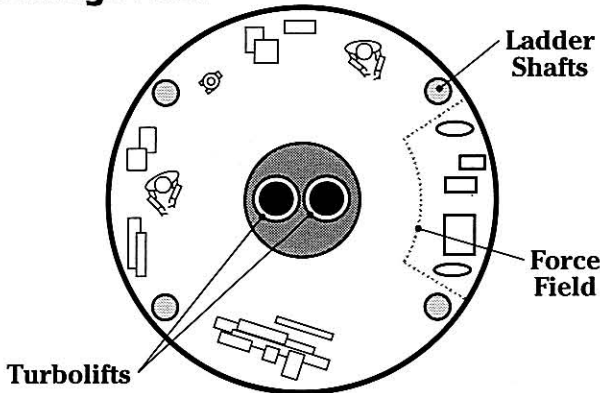

**Typical Science Lab**

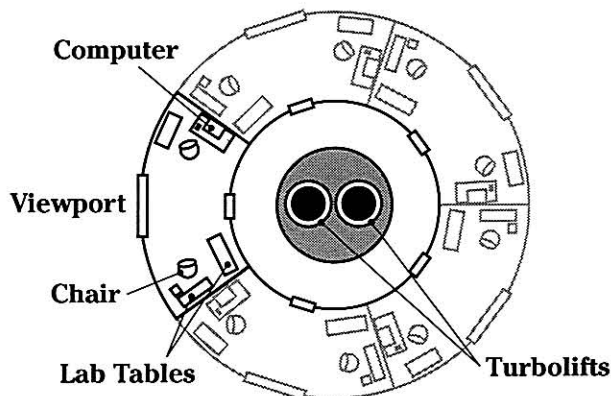

making the durasteel look dark and worn. In one of the shadowy areas near the exit sits a computer terminal. Unfortunately, this computer is jacked in only to the station's main systems: life support, lighting, security, and shields. It holds no scientific or other auxiliary files. To adjust any of the systems the terminal does have access to requires a *Moderate computer programming/repair* roll.

**Lifts and Shafts.** Two turbolifts at the center of the station provide access to all levels: hangars, crew decks, storage, computer core, command center, and science lab. Also, four narrow ladder shafts spaced every 90 degrees along the outer edge of the central cylinder run the length of the station.

**Crew Decks.** The characters find that most crew quarters lie in disarray overturned plasteel trunks, stripped bunks, dried puddles of unknown liquids. The other quarters appear untouched, as if no one has ever used them.

**Storage.** The storage bay is a single massive chamber four levels high. Tons of metallic debris — transponders, hyperdrive casings, durasteel ceiling struts, ancient droid circuitry — rest in precarious piles throughout the place, reminiscent of a Squib used-parts brokerage.

The characters may *search* for useful equipment. For each *Moderate* roll they make, the gamemaster should provide that characters with a repairable piece of technology. On each attempt, however, characters must make an *Easy Dexterity* roll or else send a pile tumbling down upon themselves and anyone else in the area for 1D damage.

A force field encases one section of the cavernous storage bay. Blue glowpanels above the area highlight oval cases and large, rectangular containers, glinting off the thin layer of frost that seems to cover everything. An encrypted keypad controls the force field, which requires a *Moderate computer programming/repair* roll to operate.

An *Easy Strength* roll allows a character to pry open the lids of the containers. Inside, frozen solid, hundreds of alien and human bodies lie in various states of mutilation — the remnants of Oektoth Confederation experiments.

On a careful inspection and a *Moderate search* roll, the characters discover the latest victim; her skin has taken on a blue-gray tone, but otherwise she seems uninjured. On a *Difficult first aid* roll, a character may revive the human woman, though a quick examination (an *Easy first aid* roll) reveals that she cannot be healed past wounded without immersion in a bacta tank.

The woman cannot speak for 10 minutes after

her return to consciousness. She just stares at the characters with wide eyes, cringing at any sudden movement. When she can speak, she introduces herself as Fasha.

**The Science Lab.** The science lab fills the entire bottom cone of the station. Each room houses elaborate experimental equipment, from bacta tanks filled with greenish liquid to wire frameworks used in hydroponics bays. A small computer terminal occupies a shelf in each lab.

As soon as the characters enter this area of the station, a group of humans – Qektoth Confederation guards – wearing black tunics and carrying blaster rifles leap up from behind tables and large pieces of equipment and begin firing. When the guard force is reduced to three or fewer, those remaining flee toward the command center at the top of the station.

**Confederation Guards.** All stats are 2D except: *Dexterity 3D, blaster 4D, brawling parry 4D, dodge 4D, brawling 3D.* Move: 10. Blaster rifle (5D).

On an *Easy computer programming/repair* roll the characters may access the computer and begin to download the files, which will take a total of two minutes. But as they start the transfer, a *Moderate search* or *Perception* roll alerts the character at the console to a file called “Sarne” just as it slips from the screen into virtual space.

From what the characters can gather from the remaining files, Sarne traded several vessels and accompanying crew for unspecified information regarding the Qektoth Confederation’s biochemical technology. The Confederation then tested one of their latest weapons on one of the Imperial vessels, an assault shuttle, and have just begun to analyze the data from the experiment. They have found that a single substance, which they have stored in containers on the far side of the room, has the ability to repel this particular biochemical agent that has infected the *FarStar*.

Twenty seconds before the files finish downloading, a buzzing alarm suddenly erupts throughout the station. Anyone looking out the single viewport of the lab sees another vessel drop out of hyperspace — a Qektoth Confederation warship! If the characters rescued Fasha from the storage bay, she stares out the viewport and says, “Oh, no! That’s the vessel that destroyed my ship! It’s got some kind of biological weaponry that bypassed our shields.”

The Qektoth war vessel moves to attack. The Confederation vessel immediately initiates its jamming routines. The characters may only contact the *FarStar* on a *Difficult communications* roll.

As the *FarStar* battles the vessel, the characters aboard the station trip a recorded holographic message from the Confederation. Read aloud:

**The holographic image of a giant cybernetic eye implant appears, and a mechanical-sounding voice begins speaking, echoing throughout the station.**

**“Thank you for volunteering for the final test of our latest weapon. You should feel honored, as you will be the first of millions to be eradicated by the Qektoth Confederation.”**

**The image flickers and then disappears. Somewhere at the very edge of your hearing a slight hiss slowly builds. Then, in a series of hollow thuds, the exit hatchways to the lab magnetically seal themselves.**

## ABOARD THE FARSTAR

The battle between the Confederation ship and the *FarStar* erupts immediately. The *FarStar*’s shields seem to be ineffective against the Confederation’s strange weaponry, but the *FarStar*’s weapons systems appear to inflict normal damage on the prototype craft.

During the first two combat rounds, the Confederation vessel uses only its plasma burst cannons. On an *Easy Perception* roll, any gunner aboard the *FarStar* notices a circular hatchway on the enemy ship begin to slide open. As the second round ends, a tangled mass of dark green sinew spotted with beige ovals glides out from the opening on a mounting platform, like a biological version of a sensor array. Tendrils of blue electricity leap from one sinew to another, and Lieutenant Thyte, on a *Very Easy sensors* roll, detects a massive energy buildup from the living weapon.

At this point, cut back to the characters aboard the space station.

### ■ The Scourge

**Craft:** Qektoth Attack Cruiser  
**Type:** Modified strike cruiser  
**Scale:** Starfighter  
**Length:** 103 meters  
**Crew:** 30, gunners: 10, skeleton 5/+10  
**Passengers:** 50  
**Cargo Capacity:** 100 metric tons  
**Consumables:** 1 year  
**Hyperdrive Multiplier:** x3  
**Hyperdrive Backup:** x12  
**Nav Computer:** Yes  
**Maneuverability:** 1D  
**Space:** 3  
**Atmosphere:** 260; 750 kmh  
**Hull:** 5D  
**Shields:** 2D+1 (can only be focused in one direction)  
**Sensors:**  
*Passive:* 40/2D

Scan: 55/2D+1  
 Search: 100/2D+2  
 Focus: 4/3D+1

**Weapons:**

**4 Plasma Cannons**

Fire Arc: Turret  
 Crew: 1  
 Skill: Starship gunnery  
 Fire Control: 2D+2  
 Space Range: 1-7/20/35  
 Atmosphere Range: 100—700/2/3.5 km  
 Damage: 5D\*

**1 Bio-Energy Array**

Fire Arc: Forward  
 Crew: 6  
 Scale: Capital  
 Skill: Capital Ship Gunnery  
 Fire Rate: 1/4  
 Fire Control: 1D+1  
 Space Range: 1-30/55/75  
 Atmosphere Range: 2—60/110/150 km  
 Damage: 4D+1\*

\*These weapons pass through conventional shielding. Target vessels lose the protection of their shields when rolling to resist damage in space combat.

## BACK ON THE SPACE STATION ...

An Easy *security* or Moderate *computer programming/repair* roll allows a character to open the locked hatchway blocking their escape. Should the characters remain in the science lab for more than one minute, grooves begin to appear in the walls and floor, racing toward their location in an erratic pattern; it is the biochemical weapon used aboard the Imperial shuttle. The characters have only moments to act. They must either cover themselves in the green-gray "goo" (which looks very similar to the sludge they discovered aboard the assault shuttle) stored in the containers near the back of the lab and hope they reach the shuttle before the muck wears off, or else just race desperately back to the hangar bay before the arcing grooves catch up with them.

The sludge/repellent lasts for 2D minutes and allows that characters to ward off the biochemical agent with an Easy *Strength* roll. Any character caught in the biochemical field without such protection must make a Very Difficult *Strength* roll, or be infected by the disease, which lowers attributes and skills by -1D and causes death within 42 hours. The biochemical agent was released from the science lab and takes six minutes to reach the hangar bay.

The characters discover to their dismay that the turbolifts have been locked in emergency position, rendering them inoperative. By tapping into the computer, the characters can locate the four ladder shafts in the station schematics on a Moderate *computer programming/repair* roll.

As the characters make their way up the shafts,

an explosion rocks through the station, throwing anyone who does not make a Moderate *Strength* roll down the shaft into the depths of the station. It takes four minutes to climb to the hangar bay, leaving just under a minute before the biochemical agent reaches this area.

After the characters board their shuttle, they discover that the heavy, magnetically-sealed blast doors have closed, blocking off any escape from the docking bay. Luckily the shuttle's shields will protect them from the biochemical weapon.

With a sudden beeping, the sensors detect a massive energy surge in the station's computer core; the characters have only moments before the entire complex explodes. After the characters sweat for a moment and make at least an attempt to save themselves, read the following aloud:

**"Power down the station's shields," comes a voice over the comm. "Power 'em down now!"**

At this point the erratic grooves of the biochemical agent hiss across the entire docking bay. The biochemical field strikes all the characters leaving the shuttle. A Very Difficult *Strength* roll is necessary to avoid being stunned. A Moderate *computer programming/repair* roll allows a character to shut down the shields through the terminal near the exit.

Read aloud:

**Suddenly, the blast doors slide open, revealing the sleek, shadowed form of an Arakyd Helix starfighter. The comm crackles to life. "There's no time to explain."**

**You stare at the comm as Drigor continues. "Let's just say I still know some of the Confederation's codes. But your vessel's in trouble. We have to hurry."**

**As your shuttle follows Drigor's starfighter, he explains that the Confederation ship battling the FarStar can strike only when it has surprise and only against a single opponent. Apparently the massive energy drain from the biological weaponry prevents them from shielding more than one fire arc of the vessel at a time. If you each attack from a different side...**

Drigor has had a change of heart as the illness takes hold of him. He now believes that the FarStar crew are his best chance of survival.

**Arakyd Helix Light Interceptor.** Starfighter, space transports 5D, starship gunnery 5D+1, starship shields 4D, maneuverability 2D+1, space 7, hull 3D+2, shields 1D+2. Weapons: 2 plasburst laser cannons (fire-linked, fire control 2D+2, damage 6D), 2 ion cannons (fire-linked, fire control 1D, damage 4D), 1 proton torpedo launcher (fire control 1D, damage 9D).

## ■ Fasha Dansun

Type: Xenarchaeologist

### DEXTERITY 3D

Brawling parry 3D+2, dodge 4D, running 3D+2

### KNOWLEDGE 4D

Alien species 5D, cultures 5D, languages 5D+1, planetary systems 4D+2, scholar: xenarchaeology 6D, scholar: Kathol sector history 6D

### MECHANICAL 2D+2

Repulsorlift operation 3D, sensors 4D+2, space transports 4D

### PERCEPTION 3D+1

Bargain 4D, investigation 4D+2, persuasion 4D

### STRENGTH 3D

Brawling 3D+1, climbing/jumping 4D+1, stamina 3D+2

### TECHNICAL 2D

Computer programming/repair 3D+2, droid programming 3D+2, first aid 3D

Move: 10

Character Points: 8

**Capsule:** Fasha Dansun spent several years in the Kathol sector studying its cultures before venturing out beyond the Void to explore the Outback. She stopped off on many of the same settled worlds the characters have, before running afoul of the Confederation.

Fasha is a sunny woman in her early 30s, who regularly cracks jokes, even when in distress. She is eager to join the *FarStar* crew once restored to health, and is a veritable font of information regarding the Kathol sector, though she hasn't been any further out in the Outback than the characters.

She has shoulder-length blonde hair, freckles, and the faintest hint of age lines around her eyes. To judge from her complexion, she has spent a great deal of time outdoors.

## THE FINAL CONFRONTATION

Combat round three begins with Drigor's interceptor and the characters' shuttle joining the battle. The Confederation ship lets loose vicious streaks of ragged, forked lightning from their bio-energy super-weapon. They continue the barrage each round hereafter.

At the beginning of round four, another ship, originally from the space station, drops from hyperspace and enters the fray. The blocky Corellian HT-2200 medium freighter focuses its fire on the characters' shuttle.

On round five, the orbiting space station explodes in a fiery torrent of snaking purple, green, and black gas jets. Debris batters all four ships,



Mike Vilardi

inflicting 6D starfighter scale damage on each unless the pilot succeeds at a Difficult roll on the appropriate piloting skill roll, which reduces the damage to 3D.

**Corellian HT-2200.** Starfighter, space transports 4D+2, starship gunnery 4D, starship shields 3D, maneuverability 1D+1, space 3, hull 5D, shields 1D. Weapons: 2 pulse laser cannons (fire control 2D, damage 4D).

## EPISODE FIVE: TREATMENT

The *FarStar* returns to Uukaablis with the downloaded files from the Confederation space station. The Qektoth Cónfederacion bears all responsibility for this abominable crime against sentient life. Less than a day passes before the brilliant

Uukaablian scientists and the *FarStar*'s medical staff develop a cure for the agent. The New Republic crew was hailed as heroes by the Uukaablians.

Drigor Tarrens explains that about a decade ago the leaders of the Confederation took cell samples from all of its members and secretly began to grow new life-forms with enhanced capabilities. Drigor learned of this and was about to report it to the rest of the Confederation when his Y-wing starfighter exploded just after taking off from a secret base near the Kathol Rift. Without his knowledge or approval, Confederation medics repaired his body with cybernetic implants. When he awoke from the surgery he was immediately issued a summons to appear before the Confederation court for treason, a sentence punishable by death. He fled to Uukaablis and requested "political asylum" hoping to hide from his former brethren until his life ended. Now, he hopes to atone for his past crimes.

## CHARACTER POINTS

Participating characters gain one to three Character Points for completing the adventure. Award an additional point to those who rescued Fasha.

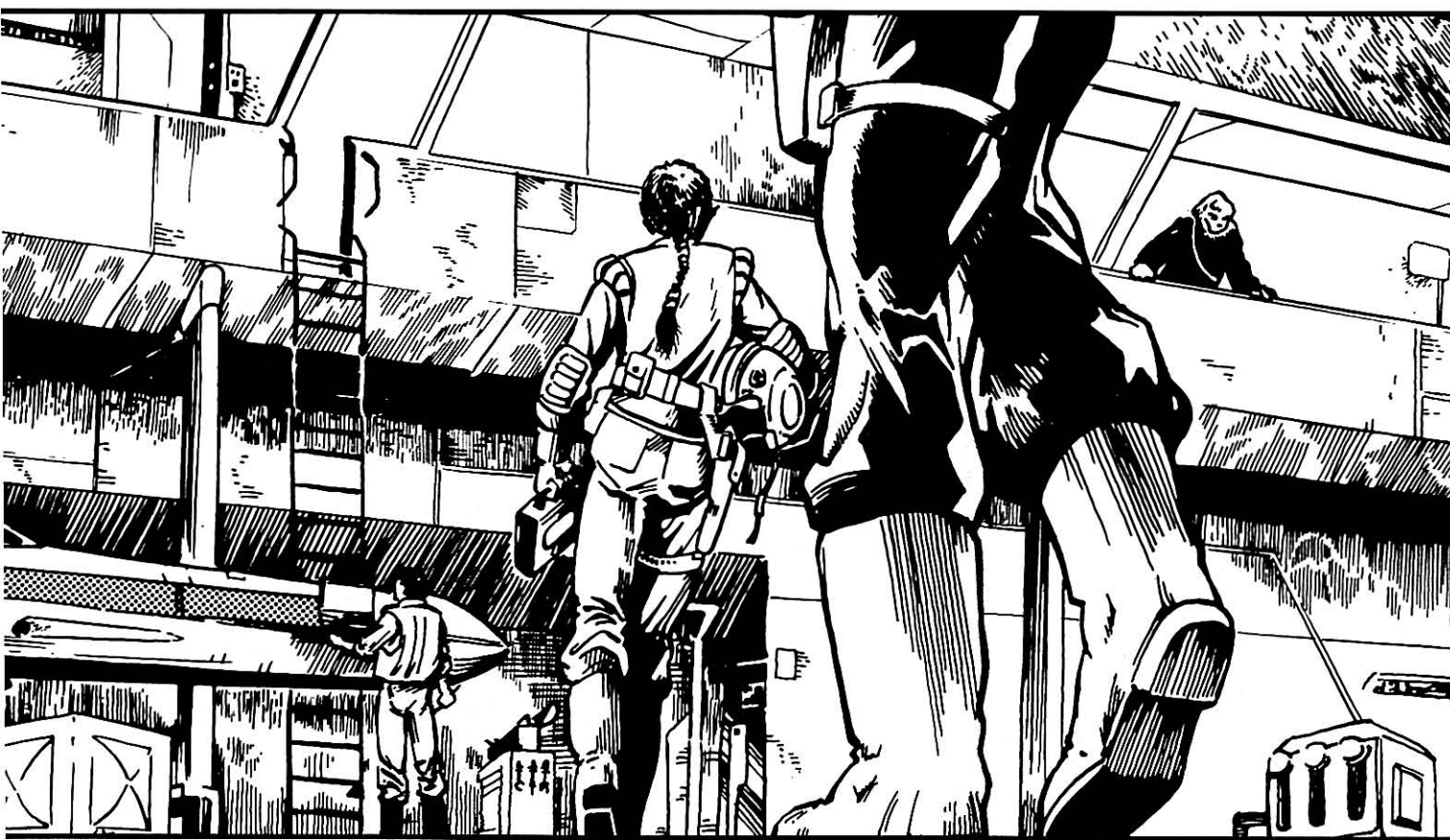

## THE MASTERS OF EXOCRON

Loh'khar the Finder watched with interest as Lofryyhn and Brophar Tofarain lowered the probe droid into its launch pod.

"That's got it, Lofryyhn!" Brophar shouted as the droid seated itself in the pod with the heavy mechanical *chunk* of deadbolts locking. The Wookiee gave an assenting grunt, and pulled the winch away. The two mechanics leaned over the pod to inspect their work.

Brophar rapped the droid's outer shell smartly with his knuckles. "All ready to go in there?" he called. The probot growled back an answer in its Imperial electronic language. "I guess that's a 'yes,'" he said, wiping his brow with a greasy rag. "Awright, lads, patch it up!"

Loh'khar chuckled and idly re-adjusted his

headtails as he watched the techs swarm about the pod, prepping it for its flight. The droid's reply hadn't been 'yes,' actually, but best the rotund human not know that.

It wasn't often that Adrimetrum ordered a precious probot shot out into the void, and Loh'khar had not actually ever seen one launched, so he was keen to see how the thing was done. One never knew, after all, when it might be necessary to repeat the process for one's *own* purposes.

Besides, he was curious to see what it might find. The *FarStar's* long range sensors had detected the presence of a star system lurking behind the gaseous web of a failed, ancient protostar, which was at present dominating

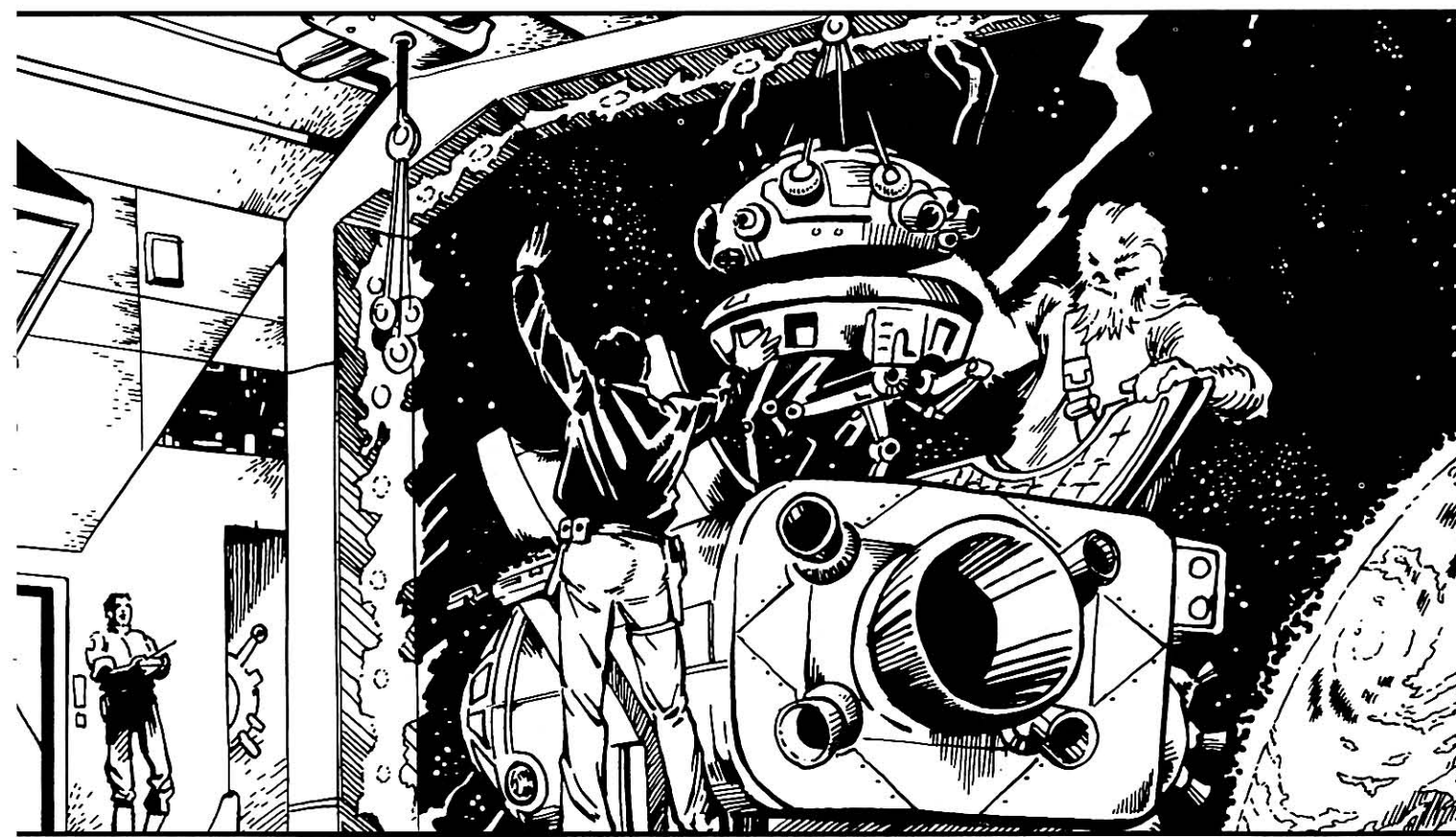

Storn Cook

the starfield outside the ship, overpowering even the majestic maelstrom of the ever-nearing Kathol Rift.

The officers of the ship were of the opinion that Moff Sarne might be lurking within the clouded interior of the protostar, and had decided to send a probot in to take a look. Loh'khar supposed there was a possibility that Sarne's fleet might be found within, but he wasn't much taken with that theory. There were plenty of other things the gas clouds might be hiding, however, and Loh'khar's nose fairly twitched at the thought of the finds that might be hidden within for the taking.

He allowed himself to be shooed from the hangar as the techs cleared the area for the launch. He turned to watch from a window overlooking the bay as the probot drifted out of the main bay, then fired its thrusters and

shot away into hyperspace.

It would have a very short trip, Loh'khar reflected. It should even now be dropping out of hyperspace within the cloud, even now beginning its survey. He was filled with a sudden feeling of urgency as he realized he was missing the preliminary reports.

Loh'khar gathered his robes up around his knees and trotted toward the command center. Several crewers chuckled as he passed them, but he paid them no mind. Sluggard Twi'leks, *weak* Twi'leks, had reason to fear the opinions of others. Wealthy Twi'leks, on the other hand, were those who moved with haste when following their hunches. Loh'khar didn't know exactly what this particular hunch was trying to tell him, except that he had best hurry ...

## EPISODE ONE: THE HIDDEN WORLD

As the *FarStar* draws closer to the Kathol Rift, gas offshoots and mini-nebulae are becoming increasingly common. This protostar is the first which completely hides its contents behind a cloak of radiation and sensor-jamming static, and Adrimetrum wants to be sure nothing threatening lurks within before moving on.

Adrimetrum has ordered the launch of a probe droid; since it cannot send back reports while within the cloud, it has orders to pop back out of the area with preliminary images and scan data, then go back in for a more in-depth survey. It is to return to the *FarStar* in five hours.

The initial report comes in right on schedule. The images are not clear, and simply show a cobalt-blue cloudscape tinged with bright white tendrils of super-charged gaseous matter. The limited data indicates that a small yellow star is within the cloud, orbited by a planet of unknown composition. The droid announces it is going in for a closer look.

### EXPEDITION INTO THE CLOUD

Unfortunately, the probe droid does not return. Not liking this turn of events, Captain Adrimetrum orders Gorjaye to send some X-wing fighters in to retrieve the probe droid and investigate the mysterious planet. She is extremely reluctant to send her precious X-wings and pilots to face an unknown danger, but wants an unknown threat at her back even less.

The starfighters time their mini-hyperspace jumps accordingly and enter the system. Once past the outer wall of the bluish cloud, the starfighters come upon a solitary, garden-like world circling a yellow star.

Local interference from the gaseous cloud that encircles this system makes long range sensor checks and communications nearly impossible. If any of the pilots make a Moderate *sensors* roll, the characters are able to locate the ion exhaust trail of the probe droid leading into the planet's atmosphere. Unable to pick up the probe's transponder, the starfighters will have to enter the planet's atmosphere and perform a search.

Breaks in the clouds reveal long stretches of beautiful forests and distant mountain ranges. The planet certainly fits any character's notion of what a garden world would look like. Unfortunately, the interference from the gas cloud surrounding the system disrupts sensor checks even within the planet's atmosphere. This does not

prevent characters from making direct, line-of-sight observations. A Difficult *Perception* roll reveals that there are scattered population centers on the surface.

### ■ Exocron

**Type:** Terrestrial  
**Temperature:** Temperate  
**Atmosphere:** Type I (breathable)  
**Hydrosphere:** Moist  
**Gravity:** Standard  
**Terrain:** Plains, ocean, mountains  
**Length of Day:** 26 standard hours  
**Length of Year:** 388 local days  
**Sapient Species:** Human  
**Starports:** Landing field  
**Population:** 20 million  
**Planet Function:** Colony  
**Government:** Technocracy  
**Tech Level:** Information

**Capsule:** The planet Exocron was settled by the inhabitants of an ancient colony ship which left the Core Worlds during the days of the Old Republic to escape the high-tech "plastic societies" which were flowering at that time.

The colonists destroyed their colony ship upon arrival, and established a corps of engineers to guard the advanced technological knowledge against the day the society might need it. The rest of the settlers reverted to an industrial tech level.

Over time, the corps of engineers evolved into a secretive technocracy known as The Devisors. The Devisors have come to view most technological advancements as being evil and forbid space travel from Exocron.

Exocron society has effectively split into a two-tiered caste system with the Devisors controlling the direction of development; in short, any new technological development is given to the people of Exocron only after the Devisors ensure it poses no threat to their rule.

### WELCOME TO EXOCRON

As the X-wings wheel around a particularly large cloud, a gray shadow suddenly looms up beneath them. A majestic flying vessel breaks through the cloud, whipping it into a froth.

The vessel is of tremendous proportions, consisting of a central, airfoil-shaped spar connected to two huge, finned cylinders. The snouts of huge projectile cannon emerge from bulbous turrets. Bizarre, winged aircraft leap from the central spar to intercept the X-wings.

The characters' first reaction may be to fight, but an Easy *communications* roll reveals that the characters are being contacted by a primitive form of wave-form communication. Modifying an X-wing's comm unit to transmit using the older frequencies requires an Easy *communications*, *starfighter repair* or *Mechanical* roll (the X-wing's R2 unit can assist, or even perform the task if the characters lack the skill.)

Once the characters transmit back and identify themselves, the voice on the other end is at first surprised, then highly suspicious. The six winged vessels — which identify themselves as Skylarks — assume an escort formation around the X-wings. Read the following:

**“This is the Airfleet sky-dreadnought *Maxion*. You are to land aboard this vessel for inquiry. Do not attempt to deviate from your assigned landing pattern. Our weapons and Skylarks are tracking you.”**

The voice will not answer any questions about the probe droid or this planet, but repeats the order to land on board the *Maxion*. If the X-wings turn to flee, the *Maxion* discharges an ion-charge within the cloud which automatically hits all of the X-wings. One round prior to firing the ion charge, the Skylarks pull out of range. The *Maxion* continues firing ion charges into the clouds until the X-wings comply and land on the ship.

The top of the air vehicle’s spar serves as a landing platform. As the characters disembark from their ships, a procession consisting of an officer and 15 armed troops approach.

The officer is dressed in a rather ostentatious uniform, with gold braids and wildly-colored shoulder boards. The troopers’ uniforms are olive-colored and very functional. They are carrying percussion rifles, archaic guns that fire explosive projectiles.

On a Difficult *cultures* roll, the characters might deduce that such weapons, and even technology like the airship and the Skylarks, have not been in common use since the days of the Old Republic.

### ■ Sky-Dreadnaught *Maxion*

**Craft:** Exocron Airfleet battleship  
**Type:** Airspeeder  
**Scale:** Walker  
**Length:** 200 meters  
**Skill:** Repulsorlift operation: archaic airspeeder (unskilled -2D)  
**Crew:** 340, gunners: 120, skeleton: 280/+10  
**Crew Skill:** Varies dramatically  
**Passengers:** 150 (troops)  
**Cargo Capacity:** 880 metric tons  
**Cover:** Full  
**Altitude Range:** Ground level–10 kilometers  
**Cost:** Not available for sale  
**Move:** 21; 60 kmh  
**Body Strength:** 5D+2  
**Weapons:**

**18 Large Bore Projectile Cannons**  
*Fire Arc:* 3 front, 6 left, 6 right, 3 back  
*Crew:* 4  
*Skill:* Archaic guns: projectile cannon  
*Fire Control:* 1D  
*Atmospheric Range:* 6–25/250/20 km  
*Damage:* 6D

**38 Percussion Repeater Cannons**  
*Fire Arc:* 5 front, 14 left, 14 right, 5 back

*Crew:* 1  
*Scale:* Starfighter  
*Skill:* Archaic guns: percussion weapons  
*Fire Control:* 1D  
*Atmospheric Range:* 2–10/250/1 km  
*Damage:* 3D

### 2 Static Ion Field Dischargers

*Fire Arc:* Turret  
*Crew:* 5  
*Scale:* Starfighter  
*Skill:* Archaic guns: ion field discharger  
*Fire Control:* 1D  
*Range:* 1 km (Moderate difficulty)  
*Damage:* 4D ion damage

**Skylarks.** Airspeeder. Maneuverability 2D+1, move 70; 200 kmh, body strength 3D+2. Weapons: 1 projectile cannon (fire control 1D, 6-25/250/20 km, damage 3D), 2 percussion cannons (fire control 1D, 2-10/250/1000, damage 3D).

**Airfleet Guards.** All stats are 2D except: *Dexterity* 3D, *archaic guns* 5D, *melee combat* 4D, *Strength* 2D+2, *brawling* 3D+2. Move: 10. Percussion rifle (4D+2 damage), bayonet blade (STR+1D+2), protective helmet (+1D physical, +1 energy).

### INTERVIEW ABOARD THE MAXION

The characters are led to a luxuriously-decorated state room and told to wait there. Two guards remain inside as the characters look around. Sculptures of other intriguing-looking aircraft and various sky vehicles are mounted on the walls. A heroic painting of the *Maxion* dominates one wall. The furniture consists of light metal chairs with comfortable cushions and back rests surrounding a large map table. Everything is very light, yet surprisingly strong. All the furniture is bolted to the floor.

The map table should be of some interest to the characters. The map displays the major continents, highlighting the eastern coast of the largest continent and the western mountain region. The words are old and hard to understand. A Moderate *languages* roll reveals the language as an unusual derivative of early Basic.

A door slides open. The guards snap to attention as a gray-haired, older human strides inside, followed by the officer who first met the characters. The older officer’s uniform is in the same style as the first, except there is more decoration on the shoulder boards as well as additional rank and sleeve markings. Unlike the first officer, who looked a little silly wearing such a gaudy outfit, this man looks like he was born to wear this uniform. A sword and some sort of pistol sit at his hip, and he looks like he knows how to use both. He identifies himself as Captain Horzao Darr.

Sitting in his chair at the head of the map table, Captain Darr listens intently to the characters’



explanation. He draws out a steam pipe from inside his uniform tunic and puffs on it, nodding as the characters' talk. He seems to weigh their words with great conviction. Removing the pipe from his mouth and extinguishing it, he leans forward, folding his hands on the table as he speaks to the characters:

**"I apologize for the rather abrupt manner you were brought aboard. At first, I believed you to be corsairs from the western canyons. Examination of your unique machines proved this to be an incorrect assumption. This world is called Exocron. You are welcome here, as are others of your kind."**

Captain Darr has been instructed to bring the characters and their X-wings to Caballa City, the capital of Exocron. The missing probe droid vessel was seized by another Airfleet vessel and is on its way to Caballa City for examination. Apparently the probe droid has raised many questions and the council is quite eager for answers. Darr mentions in passing that space travel among his people is strictly forbidden, but he will not elaborate.

The captain permits one of the characters to return to *FarStar* to report what has taken place, and invite Captain Adrimetrum to the capital. He requests that the representatives from the *FarStar* rendezvous with the *Maxion* before heading for Caballa City, and gives the coordinates where the *Maxion* can be expected to be (translating between two different mapping systems takes a few minutes). He explains that this is an ancient diplomatic protocol which must be observed.

The characters have no problem reaching the *FarStar* and forwarding Exocron's invitation. Captain Adrimetrum will be very excited when she hears that Exocron harbors a settled, inhabitable planet that Sarne has possibly overlooked. Contact with these people might provide the beginnings of a safe haven for the New Republic deep in the Kathol sector. She orders the astrogators to plot a course for Exocron.

### ■ Captain Horzao Darr

Type: Sky-Dreadnought Captain  
DEXTERITY 3D

Archaic guns 6D+2, dodge 4D, melee combat 5D, melee parry 4D+1, missile weapons 5D  
KNOWLEDGE 4D



Storn Cook

Bureaucracy: Exocron 8D, cultures 6D, planetary systems: Exocron 6D, tactics: air combat 7D

#### MECHANICAL 2D+1

Communications: archaic 4D+1, hover vehicle operation 6D+1, repulsorlift operation 6D+1

#### PERCEPTION 3D+2

Command 8D+2, persuasion 4D+2

#### STRENGTH 2D

Brawling 3D+2

#### TECHNICAL 3D

Archaic gun repair 4D, first aid 4D, repulsorlift repair 4D, security 5D+2

Force Points: 1

Character Points: 10

Move: 9

Equipment: Ornate uniform, comlink, slugthrower pistol (3D), ceremonial sword (STR+1D)

**Capsule:** Darr's service career began at the tender age of twelve when he stowed away aboard a sky transport. Indentured to the captain to pay for his voyage, Darr quickly learned what it took to be a sky-sailor.

He served aboard the private vessel for several years before enlisting in the Airfleet Academy. He passed with honors, eventually graduating with an officer's commission and a ship of his own.

Those were dark days in Exocron's past, when the world had splintered into squabbling regimes. The Airfleet was desperately needed to keep the government unified. Darr's ship, the air-cutter *Loristar*, fought its way to bring relief supplies to surrounded council forces. Afterwards he received command of the flagship *Maxion*, and has been embroiled in political intrigue and controversy ever since.

Military insiders want to appoint Darr as Supreme Admiral of the Airfleet, where he can be in a position to take power. Still Darr resists their efforts to promote him, preferring to be among the clouds and not in some dank council office.

## EPISODE TWO: ON TO CABALLA CITY

The *FarStar* achieves a close orbit around the planet and launches a shuttle and a small escort of X-wing fighters. They are directed to a landing platform aboard the *Maxion*.

Captain Darr greets Captain Adrimetrum and her crew with a full honor guard. After the welcoming and introductions, the *Maxion* turns its bow north and cruises towards Caballa City.

Darr is immediately impressed with Captain Adrimetrum. He does notice that Dajus' uniform is different from the other characters and makes an inquiry. Darr has no idea what the Galactic

Empire is, which annoys Dajus to no end.

Captain Darr asks if Adrimetrum and the other characters would like to enjoy a light meal in his dining quarters. Adrimetrum, understanding that protocol is very important to these people, graciously accepts. Other characters may attend the meal as Adrimetrum and her command crew, security guards, or as the starfighter pilots who first encountered the *Maxion*.

The “light meal” proves to be a feast. Platters of delicious and unusual foods line the tables. Darr, his officers, and the *FarStar* crew dine in splendor. After months of rations and droid-inspired cooking, even Captain Adrimetrum is a bit overwhelmed at the elaborateness of the food. As Airfleet flagship, the *Maxion* often transports many important council members and high-ranking military representatives.

Discussions at the tables eventually lead to current history and events. Captain Adrimetrum will try to explain the ascension of Senator

Palpatine as Emperor, the galactic civil war, and the birth of the New Republic. Dajus broods and appears as if she wants to say something, but holds her tongue.

Instead, she brings up Moff Sarne. The name, and the man, are unfamiliar to Darr or his other officers. She mentions several local systems to him, but to the same result. Even Captain Adrimetrum is surprised. Given the extent of technology that Exocron seems to possess, she reasons that hyperspace travel would seem a natural part of life here. Although Darr hides his feelings well, his younger officers’ faces turn red with astonishment.

Darr explains that any mention of the “beyond” or space travel is considered a punishable offense. At Adrimetrum’s insistence, Darr will try his best to describe the history of his people and world, which is related in the sidebars “The Exocros Cabal” and “The Devisors.”

## THE EXOCROS CABAL

During the time of the Old Republic, an ex-slave, soldier, general, writer, philosopher, and dreamer named Deamos Na-Coth believed in the existence of a fabulous ancient world called Exo. Hailed as a prophet, Na-Coth founded a series of explorations beyond the Outer Rim Territories known as The Cabal. These explorations, conducted using massive colony ships with primitive hyperdrives, stretched beyond the then-known limits of the galaxy.

Many of the Cabal expeditions ended in disaster, with colony ships succumbing to mutinies, pirates, ion storms, hyperdrive malfunctions, or simply disappearing among the thousands of stars.

The *Exocros Cabal*, as Darr explains, was one of these vessels. The original colony ship population consisted of over 2,000 beings, families who deeply believed in Na-Coth’s prophecies. The vessel had not traveled far past the Outer Rim when an uncharted asteroid storm struck the ship and destroyed much of the bridge, killing the captain and seriously damaging the navigational computers used to plot hyperspace jumps.

A mutiny broke out across the vast ship, with many family leaders making their own interpretations of Na-Coth’s writings so to find their way to Exo. The ship traveled aimlessly for years as the warring families occupied various parts of the ship. Over time, different

families had control of the wrecked bridge and they sent the ship in dozens of foolishly-inspired directions.

Finally, several starship engineers took control of the ship. With the damaged colony ship pursued by pirates, the engineers realized that a world had to be found — a place hidden away from the pirates, yet suitable enough to support a colony. Such a world was found, quite accidentally, within a massive gas cloud, and their new home was named Exocron in honor of their vessel. Captain Darr will remark about the great blue “wall” which is visible in the night sky, protecting their world from the prying eyes of invaders.

The colony’s early years were not peaceful. Many of the families wanted to take the colony ship and continue the search for Exo. Several families formed rival factions who have been rivals to the ruling council ever since; the strongest being the corsairs from the western canyons. To prevent any further squabbling and keep the colony intact, the engineers deliberately destroyed the downed ship’s hyperdrives and struck the first of the many Laws of the Devisors: travel beyond our home is forbidden.

Thus was established a two-tiered caste system — with the Devisors and military commanders ruling over the technologically-ignorant commoners.

## THE DEVISORS

The Devisors are the descendants of the original colony ship's engineers. They are the undisputed masters of Exocron, and hold the secrets of technology like the airship *Maxion*. The Devisors introduce new technology slowly and only after great deliberation. To them, space travel is a "great magic" that will only destroy Exocron and its noble civilization.

To insure that their codes are upheld, only the chief engineer and apprentices aboard ships like the *Maxion* are trusted with the knowledge to repair the vessel.

**Note:** The Chief Engineer is pointedly boycotting the banquet. He is apparently upset and has noted to Darr, for the record, his disapproval of this encounter between the *FarStar* and the people of Exocron.

## SKY BATTLE

During the banquet, a communications officer strides in and whispers something to Captain Darr. Darr's expression turns into one of surprise. Corsairs from the west are attacking the *Desaclates*, the Airfleet cruiser which captured the probe droid vessel and is transporting it to Caballa City. The *Desaclates* is requesting assistance.

Though he is obviously loathe to do so, Captain Darr requests Adrimetrum's help, noting that he has observed that her X-wing craft can travel many times faster than his own Skylarks. The following narrative assumes that she agrees to dispatch the X-wings into the fray, perhaps as a gesture of good will.

After a few tense minutes of flight, the X-wings come upon a raging sky battle. The *Desaclates* is limping along slowly on its repulsorlifts, with several of its engines damaged and smoking. The corsairs' ships are winged, torpedo-shaped gunships, each carrying several crewmembers and gunners. They make hit-and-run passes at the weakened *Desaclates*; the cruiser's cannons are too slow to track the rapidly-moving ships.

**Airfleet Cruiser *Desaclates*.** Walker. Maneuverability 1D, move 25; 75 kmh, body strength 3D. Weapons: 10 projectile cannons (Capital, fire control 1D, 6–25/250/20 km, damage 3D), 18 percussion cannons (Starfighter, fire control 1D, 2–10/250/1 km, damage 3D.)

**Corsair Raiders.** Airspeeder. Maneuverability 2D+1, move 70; 200 kmh, body strength 4D+2.

Weapons: 1 projectile cannon (fire control 1D, 6–25/250/20 km, damage 3D), 4 percussion cannons (fire control 1D, 2–10/250/1 km, damage 3D), 12 air-to-air rockets (fire control 1D, 50–75/300/750, damage 6D.)

During the pitched battle, characters making an Easy *Perception* roll notice that several raiders have lashed themselves beside the beleaguered air cruiser and have boarded it. Airfleet soldiers and corsairs can be seen fighting on the decks with percussion weapons and bayonets. Explosions belch from the interior superstructure. The *Desaclates* is going down.

The characters can land on the ship's aft deck (there is room for three X-wings at the most) with a Moderate *starfighter piloting* result. The ship is noticeably listing to one side. On an Easy *repulsorlift repair* or *Technical* roll, the characters realize that the ship's repulsorlift pods are failing — the ship won't remain airborne for long.

Working their way down the length of the ship, 12 corsairs appear and open fire on the characters.

**Corsairs.** All stats are 2D except: *Dexterity* 3D, *archaic guns* 4D+2, *melee combat* 5D, *Strength* 3D, *brawling* 4D+2. Move: 10. Percussion rifle (4D+2), percussion pistol (3D+2), bayonet blade (STR+1D+2), sword (STR+2D), protective vest (+1D physical, +1 energy).

The fight pushes inside the ship. Dead Airfleet troops and crew are sprawled throughout the corridors. A semi-conscious officer points in the direction where the raiders went — towards the cargo hold.

As soon as the characters reach the cargo hold, a tremendous shudder shakes the ship's bulkheads. They are going down in this flaming deathtrap! In the cargo hold, the characters can see that the ship's underbelly cargo doors are open. Beyond the loading cranes are the lapping waters of the ocean coast below. The sky pirates are hauling the probe droid vessel aboard one of their ships. The corsair leader spies the characters and yells at his comrades to fight them off until they can get underway.

Before the characters can reach the raider ship, a violent explosion destroys one of *Desaclates*' remaining repulsorlift pods. The characters will need to make a Difficult *dodge* or *Dexterity* roll to avoid falling to the deck (or worse, out of the cargo hold) as the ship shakes violently.

The raider ship suddenly pulls away. But the wounded *Desaclates*, pitching down, smashes it. The destroyed craft falls to the ocean below, taking the probe droid vessel with it. The charac-

ters are either going to have to try to reach the engineering section to stop the ship from falling or return to their X-wings and abandon the doomed ship.

Fixing the remaining repulsorlifts will require a Difficult *repulsorlift repair* attempt and a Very Difficult *repulsorlift operations* attempt. Even if the characters succeed, the *Desaclates* will land on the ocean surface hard, knocking everyone to the deck.

Everyone on board must make a *Strength* roll to resist 3D impact damage. If the characters decide not to try and head back to their X-wings, the remaining corsairs will have already escaped. The *Desaclates* plunges into the water and shatters into several large pieces.

Sometime later, the *Maxion* and other air ships come to the rescue. If the characters tried to save the ship, they will be personally commended by Captain Darr. With the corsairs out of range and the probe droid vessel lost, Captain Darr has been ordered to bring the *Maxion* directly to Caballa City.

## EPISODE THREE: CABALLA CITY INTRIGUES

The *Maxion* glides over the high spires of gleaming, bustling Caballa City, situated beside a protective harbor on the coast. The metropolis is a testament to the amazing ingenuity of the Devisors and just how well-developed Exocron is, despite its technological restrictions.

Strange, winged aircraft zoom among the structures. Along the ground, hover vehicles and transports zip through tunnels and across bridges. Because it serves as both a water and air port, Caballa City is dedicated to commerce.

Captain Darr informs Captain Adrimetrum that he is to accompany her and the characters to their meeting with the ruling council. The characters' shuttle lifts off and heads down towards the heart of the city with an escort of Skylarks (and possibly X-wings, depending on Adrimetrum's orders).

Along the way, Captain Darr describes many points of interest, including the huge, protective hangars where *Maxion* and her sister warships are maintained along the outskirts of the city, the busy harbor port, the council chambers, and the flag-adorned towers of the Ministry of Technology where the Devisors meet.

### A SUDDEN REVERSAL

When the shuttle lands in the huge courtyard

before the council chamber building, there is even more pageantry. Crowds of curious onlookers can be seen outside the courtyard fences, held back by guards.

A high-ranking officer strides forward from the ranks of assembled guards and gestures for the two captains to follow him inside the council chambers. The other characters will have to wait outside the great hall.

The characters remain for some time before the doors of the great hallway. There is no news about what is transpiring inside the hall, and any passersby comment that it is rare when the council chambers are completely sealed.

One of the characters' comlinks beeps for attention. The *FarStar* is trying to contact them, but the message is garbled and filled with static. No matter how the characters adjust their comlinks, the message is no clearer. One thing is certain, whoever is sending the message is definitely excited.

Suddenly, the doors to the council chamber unbolt and the guards allow a regally-dressed man and a somewhat tight-lipped Captain Darr to exit. The councilor steps forward and introduces himself to the characters as Pagda Gevtes, Master Devisor and Council Adjunct.

Captain Darr stands stiffly at attention, a slight frown on his face, as Gevtes makes the following pronouncement:

**"Exocron has always enjoyed prosperity in its seclusion. However, if knowledge of Exocron's existence should be made, pirates, slavers or even this 'Moff Sarne' would ravage our world.**

**"Therefore, it is the judgment of the Council that your vessel be brought down to Exocron and studied so that a proper defense can be created. For the protection of Exocron, you and the rest of your crew are to remain here ... for the remainder of your lives."**

Pagda Gevtes offers no chance for recourse or reply from the characters and strides off. If the characters demand to know what happened to Captain Adrimetrum, Captain Darr (who is plainly angered by the council's reaction) will explain that she is being held responsible for the *FarStar*'s arrival and is to be locked up. Their X-wings and shuttle have been placed under protective guard.

### ■ Pagda Gevtes

Type: Master Devisor and Council Adjunct

DEXTERITY 2D+2

Archaic guns 6D+2, dodge 5D+2, missile weapons 4D+2, vehicle blasters 4D+2

KNOWLEDGE 4D

Bureaucracy: Exocron 10D, planetary systems: Exocron 10D



Stern Cook

## MECHANICAL 3D+1

Archaic starship piloting 5D, communications: archaic 6D+1, hover vehicle operation 6D+1, repulsorlift operation 6D+1, walker operation: archaic 4D+1

## PERCEPTION 2D

Command 8D, con 3D, intimidation 5D, persuasion 5D

## STRENGTH 2D

## TECHNICAL 4D

Archaic starship repair 7D+2, computer programming/repair: archaic 6D, repulsorlift repair 6D, security 6D+2, walker repair: archaic 5D

**Force Points:** 1

**Dark Side Points:** 1

**Character Points:** 10

**Move:** 10

**Equipment:** Ornate robes, comlink

**Capsule:** Pagda Gevtes' interests lie in maintaining the Devisors' hold over the ruling council. Stored in the Ministry of Technology are thousands of data tapes and records about space flight

and navigation which were carried aboard the *Exocros Cabal*, not to mention powerful weapons and technology.

Gevtes and the Devisors understand that knowledge is power. The *FarStar* and its people represent a level of knowledge superior to that of the Devisors; such knowledge would undermine the Devisors' authority. Secretly, he hopes to examine the characters' X-wings and the *FarStar* itself. The technology aboard these ships will increase the Devisors' power tenfold.

## ABOARD THE FARSTAR ...

Meanwhile, high above the clouds of Exocron, the *FarStar* has been engulfed in a shimmering red beam — an archaic but powerful tractor beam. Lieutenant Darryn Thyte gets a growling report from Lofryyhn. The ship's drive systems are starting to overload and fail.

Panels along the bridge pop and explode as secondary shields systems start to collapse. The main weapons battery is off-line. An engineer rushes up to Thyte. The ship is being pulled down to the planet.

Because of the effects of the beam, the hangar doors have been yanked out of alignment. Additional fighters or other craft cannot be launched until the doors are repaired (at least two to three hours).

The characters may attempt to rock the ship from the beam's grip, but trying to accelerate only damages the ship further. Communications from the ship down to the planet consists only of static.

Unless the *FarStar* crew can figure out a way to break the tractor beam, their ship is heading straight down to the planet's surface.

## THE CAPTAIN'S PLAN

Back on the planet's surface, Captain Adrimetrum is escorted from the council chambers, flanked by council guards. Before the characters can think of a rescue attempt, dozens of troops level their percussion rifles at them. Captain Adrimetrum orders the characters to comply with the council's decision and not to resist.

As she is led away, Adrimetrum and Darr exchange glances. The council guards take the characters' weapons, but Captain Darr suddenly orders his own Airfleet troops to surround the characters and to follow him. The 10 council guards are surprised, but they do not question the captain's authority. Darr summons an airspeeder shuttle to transport them back to the sky-dreadnought. He dismisses the pilot and personally takes over the controls.

**Council Guards.** All stats are 2D except: *Dexterity 3D, archaic guns 5D, melee combat 6D, Strength 3D, brawling 4D.* Move: 10. Percussion rifle (4D+2 damage), bayonet blade (STR+1D+2), protective helmet (+1D physical attacks, +1 energy).

## SHARDEN'S REBELS

Captain Darr and the characters do not travel back to the *Maxion*. Instead, their airspeeder leaves the city and flies low over the coast. Clearly angry at the council's decision, he turns to the characters:

**"Your captain will not be harmed. The Devisors will take your ship and learn more about it, but not for creating any defense. By frightening the council, Gevtes will once again deny our heritage. The Devisors have always had the knowledge of space travel and other advanced technology. If the Devisors should ever lose control of this knowledge, they will lose control of the council."**

The airspeeder lands at the estate of a wealthy commerce maker at the outskirts of Caballa City. Darr explains that there are a few who believe that the Devisors have abused their power for too long. He has always kept himself at arm's length to these insurgents, believing their views too radical. But he thinks they might be able to help the characters rescue Captain Adrimetrum and the *FarStar*.

Captain Darr and the characters enter the house of Eida Sharden. An old friend of Captain Darr, Sharden is a wealthy, influential entrepreneur.

neur. She invites the characters to sit down, asks them if they are hungry, and tells her servants to attend to their needs as other members of her group start to arrive.

The insurgents represent a cross-section of the intellectual, political and financial elite from many regions on Exocron. They eye the characters with some awe and fear. With them here, many believe that the council will send troops to arrest them. Sharden does her best to console them.

Sharden informs the characters that her people are willing to help the characters rescue Captain Adrimetrum and the *FarStar*. Her contacts know the location of the tractor beam projector being used to drag the *FarStar* down from orbit. More importantly, she knows how the characters can get their X-wing fighters back.

Captain Darr adds that the tractor beam projector will be heavily defended by council forces. It is located within a massive bunker, and will take more than the starfighter's laser cannons to pierce its thick hide. The X-wings still have their proton torpedoes though, which should prove sufficient to destroy the device.

Rescuing Captain Adrimetrum will be more difficult. The captain is being held inside the Ministry of Technology in Caballa City. There are rumors that the Devisors have unique protective measures in the building. Sharden also warns that the Devisors themselves might be armed. What the characters do not know is that the Ministry is a stronghold where the Devisors keep their secret (and their most powerful) weapons.

In return for their help, Sharden proposes that the *FarStar* supply her people with enough technical data to build modern hyperdrives and navigational computers. The final decision will have to come from Captain Adrimetrum herself.

## ■ Eida Sharden

**Type:** Commerce Maker

**DEXTERITY 2D**

Archaic guns 6D+2, dodge 4D+2

**KNOWLEDGE 4D+2**

Bureaucracy: Exocron 9D+2, business 8D+2

**MECHANICAL 2D+1**

Communications: archaic 5D+1, hover vehicle operation 4D+1, repulsorlift operation 4D+1

**PERCEPTION 4D**

Bargain 6D, con 7D+2, persuasion 5D, sneak 5D, streetwise 5D, value 5D

**STRENGTH 2D**

Brawling 2D+2

## TECHNICAL 3D

Computer programming/repair: archaic 4D+2, first aid 4D, repulsorlift repair 4D, security 5D

**Character Points:** 10

**Move:** 8

**Equipment:** Slugthrower (3D)

**Capsule:** Unknown to her old friend Captain Darr, Eida Sharden is an agent for the western corsairs. She has been carefully using her group of insurgents to attack the Devisors, whom she hates with a vengeance. The ruling council, manipulated by the Devisors, have made the decisions far too long for Exocron.

The western corsairs almost came to possess the probe droid vessel. But now that Captain Darr has brought the characters to her, she sees an opportunity to destroy not only one of the Devisor's principal secret weapons (the tractor beam) but to invade the Ministry of Technology.

## EPISODE FOUR: REVOLUTION

There are two approaches to take in running the coming battles. The first method is to run the attack against the tractor beam projector and then the attack against the stronghold as separate incidents. The second choice is to allow the players to play two different sets of characters — one group attacking the gravity projector in X-wings while the other group attacks the Ministry.

Under each section, the *FarStar* insignia will appear where it is dramatically appropriate for the gamemaster to cut the scene and proceed to the other conflict.

## GETTING THE X-WINGS

Through her contacts, Eida Sharden directs the characters who will be piloting the X-wings to head for a military landing field not far outside the city. The X-wings have been placed inside a locked hangar there. Using his authority, Captain Darr will have no problem landing his airspeeder at the field.

Only a few troops are stationed around the locked hangar. When he is challenged by the guards, Sharden claims that the characters are with him to inspect the starfighters. The guards do not suspect duplicity, until another airspeeder arrives with a Devisor and several military officers. They too are here to inspect the starfighters. The characters are going to have to fight their way to their ships.



Storn Cook

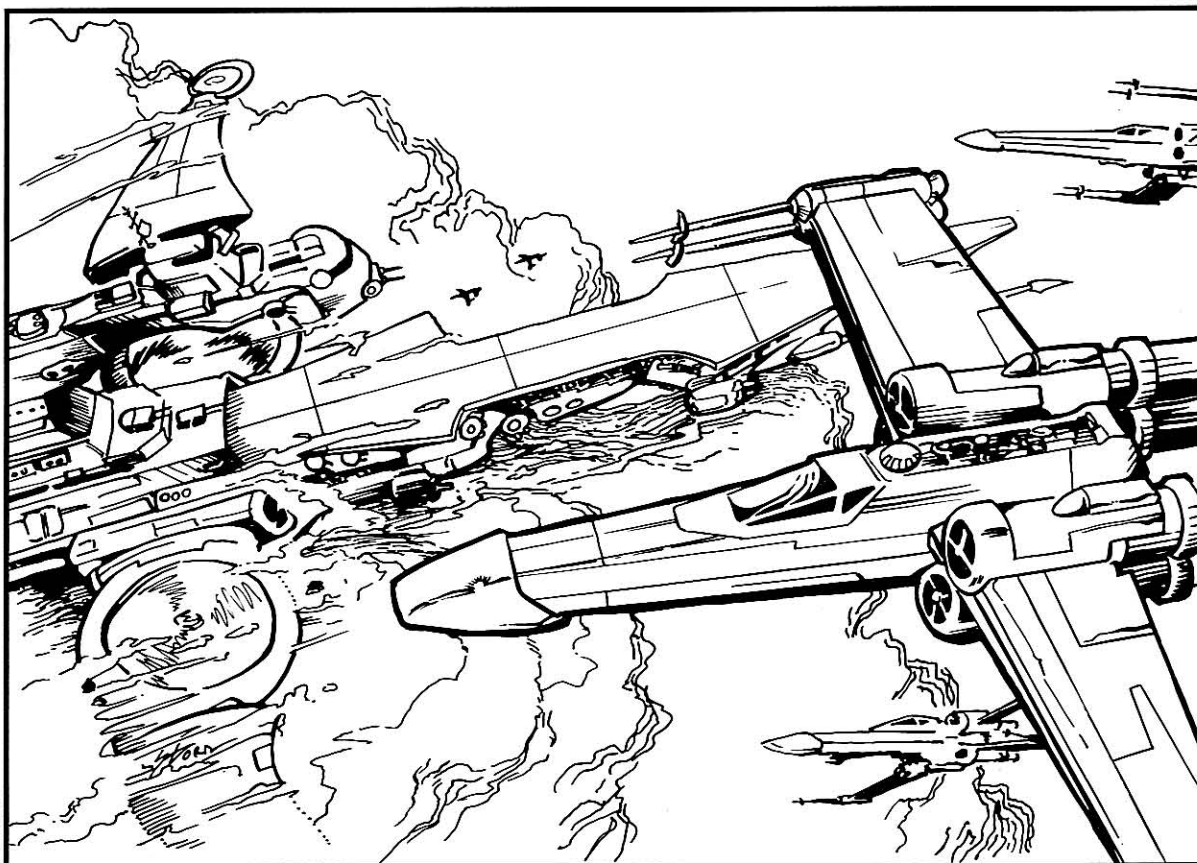

Storn Cook

**Six Hangar Guards.** All stats are 2D except: *Dexterity 3D*, *archaic guns 4D*, *melee combat 4D*, *Strength 3D*, *brawling 4D*. Move: 10. Percussion rifle (4D+2 damage), bayonet blade (STR+1D+2), protective helmet (+1D physical, +1 energy).

**Airfleet Officer.** All stats are 2D except: *Dexterity 3D+2*, *archaic guns 5D+2*, *dodge 4D+2*, *melee combat 4D+2*, *Strength 3*, *brawling 4D*. Move: 10. Percussion pistol (3D+2 damage), officer's short sword (STR+2D).



## CLOUD JUMPERS

Before helping the first group retrieve the X-wings, Captain Darr signals the *Maxion* to a rendezvous point near Eida Sharden's home. Darr gives specific instructions for the ship's "cloud-jumpers" to prepare.

Once aboard, the characters are introduced, rather quickly, to the Master Sergeant of the *Maxion's* cloud-jumper regiment. He explains the fundamentals of using a personal repulsorlift jump pack, (which looks a lot like a popular

model of rug-cleaning droid).

As the characters get into the jump packs, the *Maxion* heads toward the Ministry of Technology. The plan is for the characters to land atop the castle-like Ministry, locate and then free Captain Adrimetrum before the Devisors can sound an alert.

One of the characters must also carry a spare repulsorlift pack for Captain Adrimetrum. Any character trying to carry another pack or another person while using a jump pack must make any *repulsorlift operation* rolls at a -1D penalty.

Once the *Maxion* is in position, the characters must make Difficult *repulsorlift operation* rolls to leap to the spires of the Ministry without being detected. On any roll that fails, that character did not time his or her leap properly and either lands too hard on a roof, falls into the main courtyard of the structure, or suffers any other inventive mishap the gamemaster can think of.

In secret, the gamemaster should make a Difficult *search* check (*search 4D*) for the watchtower guards to detect the characters. The guards will immediately sound the alarm if they make the roll or if any of the characters fail to make their skill rolls.

**Repulsorlift personal jump pack.** Skill: *Repulsorlift operation*. Cost: Not available for sale. Availability: 3, R. Game Notes: The pack is not a true rocket pack in the sense that the wearer can “fly.” Instead, the pack allows the wearer to make incredible leaps, over 200 meters at a time, from point to point (hence the nickname, “Cloud Jumper”). The pack can also be used to slow the descent of a person who is free-falling, allowing a soft landing in most cases.



## ROCKET BARRAGE AND SKY FIGHTER ATTACK

The X-wings take to the sky, traveling quickly to the location of the tractor beam projector. In the failing light of day, they see the red beam jutting from a narrow slit in the observatory-like bunker. The bunker is protected by eight Skyraptors and a large rocket cruiser.

**Airfleet Rocket Cruiser *Bremarc*.** Walker. Maneuverability 1D, move 25; 70 kmh, body strength 3D. Weapons: 6 projectile cannons (fire control 1D, 6-25/250/20 km, damage 3D), 14 percussion cannons (Starfighter, fire control 1D, 2-10/250/1 km, damage 3D), 24 air-to-air rockets (Starfighter, fire control 1D, 50-75/300/750, damage 6D.)

**Skyraptors.** Starfighter. Maneuverability 3D, move 350; 1,000 kmh, body strength 1D+2. Weapons: 2 percussion cannons (fire control 1D, 2-10/250/1 km, damage 3D), 4 air-to-air rockets (fire control 1D, 50-75/300/750, damage 6D.)

Before they even get a chance to open fire at the bunker, the X-wings must first avoid an incoming barrage of rocket fire (two rockets per X-wing) launched from the cruiser.

After dodging the rocket barrage, the X-wings must then fight their way through the first swarm of Skyraptors before trying to make an attack run at the bunker.



## BATTLE FOR THE TOWER

Once the characters have landed on or near the battlements of the Ministry using their jump packs, they must search the towers where Eida Sharden believes Captain Adrimetrum is being held.

Make *sneak* rolls for the characters moving through the corridors. A revolving patrol of four

guards moves across the ramparts that connect the towers. Make a *search* roll to determine if the characters are spotted by the guards.

**Ministry Guards.** All stats are 2D except: *Dexterity 3D+2, archaic guns 5D, melee combat 5D, Perception 3D, search 3D+2, Strength 3D, brawling 5D*. Percussion rifle (4D+2 damage), bayonet blade (STR+1D+2), protective armor (+1D physical attacks, +2 energy).

If the guards do not discover the characters, the characters can check the first tower. The first tower consists of an observatory where the Devisors make astronomical calculations.

A Devisor is working intently at the telescopes. Hearing the characters enter, he believes them to be a colleague. Imagine his surprise when he turns and finds himself confronted by the characters armed with percussion pistols and wearing jump packs! He immediately fumbles for a pendant he wears around his neck and twists it. Alarms bellow throughout the Ministry.

**Devisor.** All stats are 2D except: *Dexterity 2D+2, archaic guns: flash pistol 4D+2, dodge 4D+2*. Pendant communicator. Flash pistol (does no damage; target must make a Moderate *Perception* roll or be blinded for 1D rounds).



## FIRST TORPEDO RUN

After dealing with the rockets and the Skyraptors, the X-wings can now make their torpedo attack runs against the hardened outer shell of the tractor beam projector. The X-wings line up for their attack runs — the characters must make an *Easy starship gunnery: proton torpedoes* roll to release the torpedoes correctly.

It sounds simple enough. But as the blast from the torpedoes subsides, it becomes apparent that the outer shell is hardly scratched. The characters are going to have to fire their torpedoes through the narrow slit where the tractor beam projector is beaming through, barely four meters across! Before they can, a second wave of Skyraptors rushes forward to attack the X-wings.



## THE DEVISORS RETALIATE

The characters fight their way to a second tower. There are a series of locked doors which can be opened on a Moderate *security* roll. These rooms are empty. Eventually the characters hear





Stern Cook

Captain Adrimetrum's voice shouting from one of the rooms. Once the characters open the door, she can finally warn them about the ancient walker coming their way.

Just as she mentions it, a clanking shape fills the wide tower corridors — and the only way out of the holding rooms. Pagda Gevtes can be seen inside the cockpit of an ancient personal walker, all rivets and bolts; this model has been out of service in Imperial space for decades. The blaster cannon mounted beneath it is definitely *not* all that old-fashioned, however.

His voice comes from a speaker system. "I do not wish to destroy you," he cries as the walker's blasters take aim. "But for the sake of Exocron, I shall!"

**Personal Walker.** Walker. Move 21; 60 kmh, maneuverability 2D, body strength 1D+2. Weapons: 1 blaster cannon (fire control 1D, damage 4D), concussion grenade launcher (fire control 1D, damage 2D).



## SECOND TORPEDO RUN

After fighting the second wave of skyfighters, the X-wings must now make a Very Difficult *starship gunnery* roll to release the torpedoes correctly at the slit where the gravity projector beam is coming from. Now is the time for Force Points.

If the characters are successful, the gravity beam projector explodes inside its protective shell. Volumes of black smoke belch from the slit in the bunker dome. The *FarStar* is freed. The characters are also now able to communicate with the *FarStar*.

## BACK ON THE FARSTAR

The crew and officers on the bridge let out a shout of triumph as the red beam finally disappears. Communications between the ship and the X-wings are restored.

As news of Captain Adrimetrum's imprisonment is finally relayed, Lieutenant Thyte orders repairs to the shields and weapon systems. Now that the ship is this close to the planet, no one is going to mind if they decide to make an appearance over Caballa City ... and demand Captain Adrimetrum's immediate release!



## BLINDED BY THE LIGHT

Pagda's walker clanks forward, firing its blaster cannons. The characters cannot leap off the tower because there are no available windows on this level. There are windows on the next level down.

One or more of the characters must distract Gevtes. Their percussion weapons may not be strong enough to damage the vehicle. However, if one of the characters is smart enough to have picked up the flash pistol from the other Devisor, he or she can use it to blind Gevtes.

If the characters manage to distract or blind Gevtes, the others can run past the walker, which cannot turn around in the corridor very quickly. Once the characters head down the spiral staircase, the walker cannot climb down the stairs as fast as it can climb up.

If Gevtes fails his *walker operations: archaic* roll, the walker loses its balance and starts to roll down the staircase. The characters have little time to use their repulsorlift packs to get to safety.

The walker stumbles down the staircase, with Gevtes trapped inside. When the vehicle finally comes to a rest, ministry guards rush forward to get the stunned Master Devisor extracted from the battered walker. Council troops and forces from the *Maxion* arrive to place the Master Devisor in custody until the council completely reviews the situation.



## RESOLUTION

With the destruction of the tractor beam projector and the defeat of the Devisors, Captain Adrimetrum thanks Captain Darr for his assistance and trust. She promises to provide infor-

mation about hyperdrives and interstellar navigation systems to anyone on Exocron who wants them.

After the invasion of the Ministry of Technology, Eida Sharden has enough evidence to prove that the Devisors know how to build powerful weapon systems like tractor beam projectors and blaster cannons — Exocron should be able to defend itself from most invaders. The New Republic will be pleased and grateful to have Exocron join its ranks.

## CHARACTER POINTS

The characters should receive four Character Points for this adventure, plus one additional Character Point for those who performed each of the following actions: saving the *Desaclates*, destroying the tractor beam projector, and using the flash pistol to blind Gevtes at the controls of the walker.

## FURTHER ADVENTURES ON EXOCRON

Since Exocron is now considered friendly to the New Republic, the *FarStar* will be able to return there to obtain fresh supplies and make light repairs to their vessel. The gamemaster is welcome to continue the political and social changes happening there as the ruling council agrees to build starships and become a space-faring world once again.

### ALTERNATE ENDING

If the player characters cannot damage or distract Gevtes in the walker and he pursues them into the courtyard of the Ministry of Technology, the gamemaster is encouraged to have the *FarStar* appear at the last possible moment, weapons systems operational and firing!



## GALAXY'S EDGE

Lieutenant Jessa Dajus sat at the nav console programming the coordinates for the *FarStar's* next micro-jump. As she finished, she glanced up to the main viewport and stared at the massive nebula cloud that filled the entire screen.

The Kathol Rift was one of the many wonders of the galaxy. Huge fields of multi-colored stardust spread out like splatters against the star-filled backdrop. This turbulent cloud marked the edge of Kathol sector, separating it from the wild, unexplored reaches of unknown space. It was enchanting and seductive, a cauldron of galactic power, Dajus mused.

The colonies the *FarStar* had visited on its journey so far had all warned of the Rift's twisting passageways. One slight deviation could send a ship into the writhing streams of raw gases that would instantly tear the vessel into a thousand shards of worthless durasteel.

Captain Adrimetrum had therefore decided that they needed a navigator familiar with the Rift to lead them safely into the nebula after Sarne. And Jessa could not have agreed more; she did not want the responsibility of maneuvering the *FarStar* through such unstable pathways.

Suddenly, a searing pain lanced through her temple, driving into her right eye. She reached up instantly to press against the bony bridge just below her forehead, a technique she had quickly mastered since the headaches began a week ago. But this time the pain dissipated as suddenly as it had appeared.

She breathed out slowly and took her hand away, relieved that for once she had been spared... and then she saw them thousands of spiders crawling over her console. Black, brown, and beige creatures the size of her hand swarmed over every knob and switch,

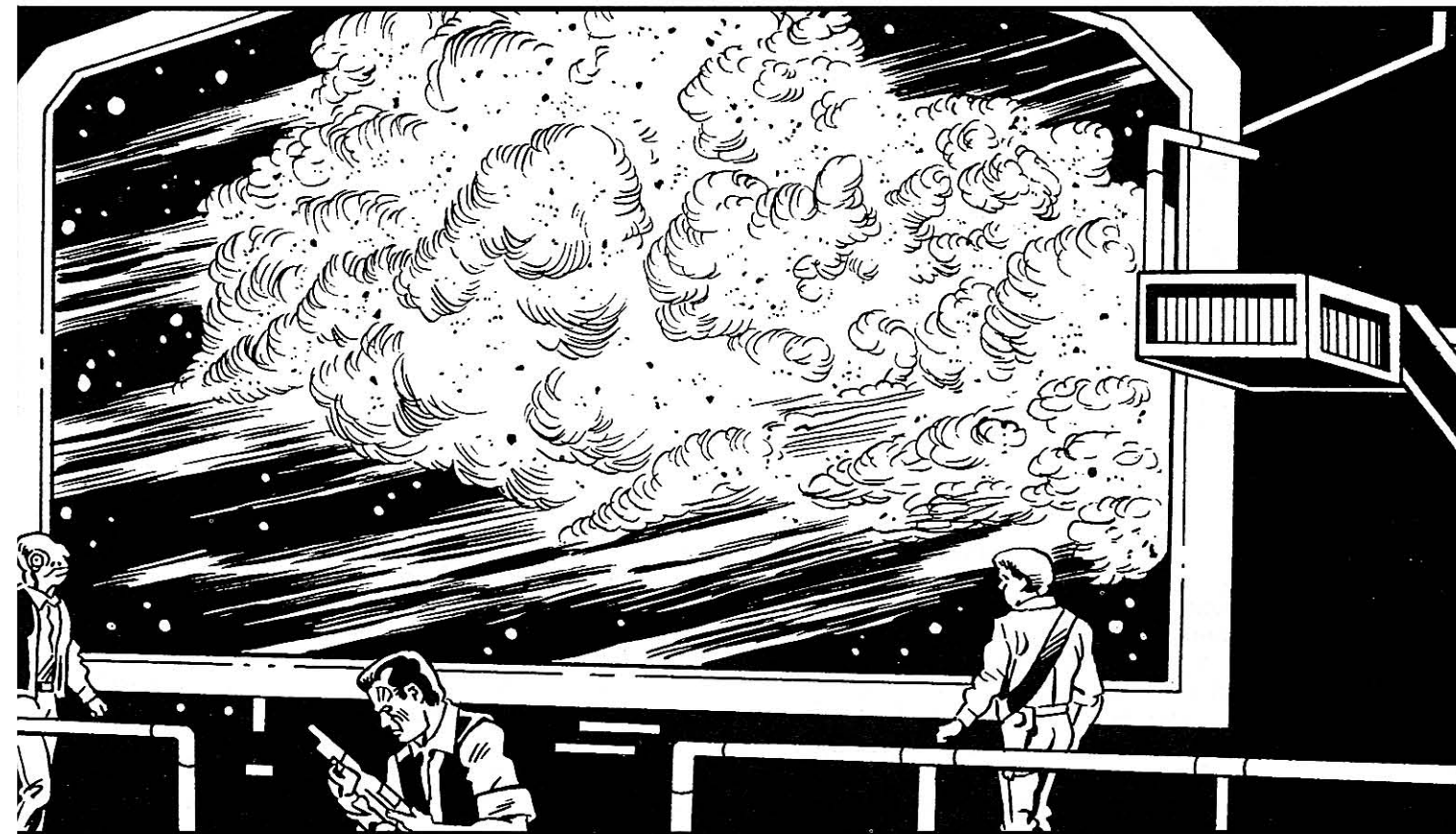

Dan and David Day

filled every niche of the panel. They were covered in coarse hair, reaching out with twitching legs, coming for her.

She screamed as she leaped up. Her leg tangled with the console's chair and she fell backward, slamming into the deckplates with a thud. The back of her head throbbed wildly and her vision sizzled with a million colors as she dug her boots into the floor and pushed herself away from the army of spiders.

"... Lieutenant," some faceless voice was saying. "Are you all right?"

Her vision began to clear, and she pointed to the nav console which was now clear and quiet, free of the swarm of arachnids.

She pushed herself into a sitting position and rubbed her temples, for the headache had returned, more intense than any that had come before.

"Lieutenant, what's wrong with you?" the voice, which she now recognized as Thyte's,

asked in a concerned, (though slightly annoyed) tone.

Jessa rose, bracing herself on her console's chair. "I'm ... I'm okay. I'm just tired." She could not allow them to know of the madness that had suddenly come upon her. The *FarStar* had limited crew capacity and could not burden itself with useless passengers. She didn't want them to drop her off at the next outlying colony. She had to find Sarne. She had to catch up with, to look him in the eye, to face him down one last time. She only wished she knew why she wanted it so much.

She gazed up to the Kathol Rift again. She could feel the danger of the place, but she knew that somewhere within it, or perhaps beyond it, her destiny awaited.

Millions of colored dots suddenly erupted across her vision and she felt herself begin to fall ...

## EPISODE ONE: RIFT WORLD

The *FarStar* arrives at Danoor in the Nah'Malis system, a colony at the very edge of the Kathol Rift. It is a beautiful world, covered by swathes of green, blue, brown, and red, with white and gray trails of clouds spiraling around the planet from the northern to the southern pole.

Adrimetrum hopes to find a navigator willing to take the *FarStar* into the Rift. Though she realizes the danger looming in the nebula, she knows she cannot abandon their pursuit of Sarne. Should he return with more DarkStryder technology ... she cannot even contemplate the devastation.

Read aloud:

**The streaming gray splotches of light speed suddenly give way to the stillness of realspace. Ahead hangs the immense world of Danoor. Dark-blue oceans surround the green, brown, and red landmasses of the planet as wisps of gray and white clouds slowly circumnavigate the brilliant sphere.**

**And behind Danoor the Kathol Rift spreads out against the space-scape in billowing clouds, wispy tendrils, and dark patches.**

**The comm panel lights up. "Incoming ship, this is Danoor System Control, please state your affiliations and intentions."**

**Just before you respond, a massive ship about half the size of a *Victory*-class Star Destroyer drops out of hyperspace on a collision course with the *FarStar*.**

The *FarStar*'s navigator must struggle to alter course before the corvette slams into the dark-gray hull of the strange vessel. A Moderate *capitol ship piloting* roll allows Lieutenant Dajus, or whoever currently sits at the ship's controls, to avoid the incoming vessel, although just barely.

The recently-arrived ship neither hails nor makes any aggressive moves against the *FarStar*. It just heads off toward the Rift with a flare of its massive sublight engines.

A small freighter swoops over the *FarStar* at that moment, and its pilot hails the New Republic vessel, telling them to stay clear of the Aing-Tii Sanhedrim ship they just dodged, noting that it would be the last mistake they ever made. The freighter then disappears into Danoor's thick atmosphere.

Danoor System Control contacts the *FarStar* again, this time in a somewhat insistent tone.

If the characters mention that they hail from the New Republic, the speaker on the other side of the channel tells them to wait a moment. Two

minutes pass. Suddenly, a new voice erupts in a fury of accusations.

Read aloud:

**"New Republic vessel," a new, strained voice begins. "I am Minister Waric Nane. We are shocked and dismayed that you have returned to our planet so soon after your last visit. We are not threatened by your new warship. Our military has already begun to deploy its defense forces. We will resist you until no one is left on Danoor."**

The comm clicks off abruptly.

Less than one week ago, Captain Treidum arrived here with the *Lance of Endor* posing as a New Republic envoy and demanded the complete submission of Danoor's government, annual tithes equal to half the colony's income, and 10 percent of the population for use as slave labor. With the sudden return of the New Republic, Nane fears the worst for his world.

Only through quick thinking, and an *Easy persuasion* roll, can the characters get Minister Nane back on the comm. He seems wary, even suspicious of the characters' attempts to convince him of their benign intentions. On a Moderate *persuasion* roll (with bonuses given for good roleplaying), he agrees to halt the deployment of his forces and to meet with a small diplomatic team on the planet's surface to discuss the matter.

### ON THE PLANET

Nane provides the *FarStar* with the coordinates of a private landing pad on the outskirts of Eror Zeen, the capital city of Danoor. Adrimetrum heads to the planet to meet with Minister Nane, accompanied by Dajus, Brophar, any characters with diplomatic skills, and at least two troopers.

The characters set down in a circular pad of gray duracrete amidst a ring of armed military personnel. Two soldiers stride up to the characters in precise military fashion as the characters depart their shuttle. They stop barely a meter away from the characters, turn, and head toward a squat, domed building at the edge of the landing pad.

The characters find themselves in a wide chamber with an arched ceiling, its walls covered in dramatic scenes of battle. A triangular table made of some dark stone sits in the center of the room surrounded by a half dozen chairs. Four well-groomed men wearing uniforms similar to the guards outside stand just behind the table, watching the characters enter.

Nane quickly introduces Ministers Opodim, Durhant, and Mooren. The diplomats sit down

without any exchange of pleasantries. Nane asks the characters to tell their side of the story in detail.

Should the characters mention the Empire or Moff Sarne anytime during the conversation, the ministers look to each other wide-eyed as if sharing some secret fear. If the characters explain that the New Republic does not stand for the atrocities demanded by the *Lance of Endor*, and that they have come here seeking only to hire a navigator to take them into the Rift, Nane thinks for a moment, and then decides they must undergo a test to prove their claims.

A mining drone has been lost in the Duhrib Belt, a swath of rust-colored asteroids orbiting the system's sun between the fourth and fifth planets. And, just to show that he and his populace are honorable people, he offers to provide the services of a navigator in exchange for the retrieval of the lost miner.

## ■ Danoor

**Type:** Terrestrial

**Temperature:** Temperate

**Atmosphere:** Type I (breathable)

**Hydrosphere:** Moderate

**Gravity:** Standard

**Terrain:** Forests, mountains, hills, plains

**Length of Day:** 25 standard hours

**Length of Year:** 201 local days

**Sapient Species:** Humans

**Starport:** Limited services

**Population:** Two million

**Planet Function:** Colony

**Government:** Representative democracy

**Tech Level:** Space

**Major Exports:** Scientific research

**Major Imports:** High and low technology

**Capsule:** Danoor was colonized a century ago as a scientific outpost dedicated to the study of the Kathol Rift. The scientists had no affiliations with any specific groups; they had come only in hopes of understanding the glorious wonder of the galaxy that was the Rift.

As word spread of Danoor's beauty and rich natural resources, others arrived to the colony seeking to survive on what the land provided without industry, without government. The first influx of new colonists consisted mostly of farmers. As the years passed, however, small businesses began to appear, and eventually towns groups of buildings clumped together, but still without a governing body.

Thirty years ago, however, a stray asteroid from the Duhrib Belt careered into the planet, killing a half of a million people and causing world-wide devastation: quakes, floods, and ash clouds. In the aftermath of the disaster, the people called for a central government to protect them and help them rebuild after such calamities. After a brief political struggle, the first government of Danoor formed. One Minister from each grouping of 500,000 people would sit at the head of this body and be responsible primarily for planetary defense, police forces, tax collecting, and financial aid needed by the citizens.

The ministers of the new government realized that it did not have the funds to handle any of its charges, and therefore, as their first formal act, they invited commercial

ventures from all over the sector to come to Danoor, where they would receive special concessions not available elsewhere. The tax revenues from the businesses that flocked to Danoor provided enough credits to get the government off to a good beginning. Unfortunately, the concession the ministers made would allow the newly arrived companies to operate in whatever manner they chose, without restriction.

## EPISODE TWO: DRONE

Read aloud:

**You begin the search for the mining drone at its last known coordinates, which Minister Nane provided before you left Danoor. The rust-colored asteroid belt arcs across space between the system's fourth and fifth planets. Luckily, the asteroids themselves seem to tumble slowly along their paths, with each one a fair distance from the next. Maneuvering through the field shouldn't pose too many problems. But first you have to find the drone.**

Lieutenant Thyte (or whichever character currently has sensor duty) may attempt to locate the drone every fifteen minutes of game time, succeeding on a Difficult *sensors* roll. Some strange signal traveling into the Rift seems to have created a field of interference, making detection of the drone much more difficult than normal. A Very Difficult *sensors* roll allows a character to determine that the signal emanates from Danoor's surface.

The drone has become trapped within a massive asteroid near the middle of the belt. Should the characters decide to fly the *FarStar* to the asteroid, the navigator must make three Moderate *capital ships piloting* rolls to avoid the tumbling rocks. Each failed roll causes the navigator to miscalculate, thrusting the *FarStar* into the path of an oncoming hunk of space rock, which causes 4D damage. If the characters instead make the trip in the Aegis shuttle, the same rules apply, except that the piloting difficulty drops to Easy.

No matter which vessel they use to approach the asteroid, the characters quickly realize that only the shuttle can fit into the narrow crevasse within which the miner drone has become trapped.

Read aloud:

**As you descend into the sharp-edged crevasse, the pilot begins to sweat. The gap that the ship can pass through continues to narrow, and the ship must be handled with extreme precision to avoid the jagged protrusions that threaten to tear into the hull.**

The pilot must make an Easy *space transports* roll to reach the bottom of the crevasse without

damaging his ship. Failure results in 2D hull damage.

The chasm ends at a wide chamber where the characters immediately spot the drone on the rocky floor, its tentacle-like mining arms spread out across a large, flat stone. Characters who make an Easy *search* roll discover the remains of a small escape pod hidden behind an outcropping of stone.

Characters exiting the shuttle must wear vacc suits. The rust-colored rock of the chamber's floor, walls, and ceiling seems hard and unbreakable, and the whole area appears devoid of smaller stones or chips. As they move about, the characters can feel slight tremors beneath them. Apparently, this asteroid is none too stable.

Characters inspecting the miner drone discover on an Easy *droid repair* roll that its repulsor power modulator has shorted out. An hour's worth of time and some rewiring, along with a Moderate *droid repair* roll, returns the drone to working condition.

About 15 minutes after the characters begin their repairs, read the following aloud:

**Work continues on the drone's repulsor power modulator. You have started to adjust to the strange buoyant feeling caused by the asteroid's weak gravimetric force, but an even more odd sensation taps at the back of your mind.**

**A flash of movement calls your attention to the back of the cave where the ceiling drops toward the floor. You turn to see eight waist-high aliens charging toward you waving long shards of durasteel apparently scavenged from the mining drone. They are wearing dirty orange vacc suits, and they seem to be yelling at you through their masks.**

If the characters take any aggressive actions against the aliens, a group of Tuhgri, a battle immediately commences.

The Tuhgri speak a dialect of Huttese. If the characters touch helmets with the aliens, they can make out the words. Characters making Moderate *languages* rolls understand basic words and can derive the gist of the Tuhgri's yells. They claim that the mining drone belongs to them, and that the characters have trespassed on their territory.

If the characters explain their presence here at the request of Danoor's government, Jutka, the leader of the Tuhgri, strides forward, telling the rest of his group to stay back. The remainder of the aliens comply, but keep their weapons in hand.

Jutka explains that his vessel was heading

toward Danoor along the edge of the Kathol Rift when a strange, hulking ship dropped out of hyperspace directly in front of them, forcing them to take sudden evasive maneuvers. Unfortunately, their ship skimmed one of the Rift's wispy tendrils, which completely ionized their primary and secondary systems. With their ship in shoddy condition to begin with, and navigation now inoperable, the aliens abandoned the vessel before it fell deeper into the Rift.

Their escape pod jettisoned with enough thrust to take it away from the Rift, but not far enough to reach Danoor. Their sensors detected a tiny flicker of energy at the edge of the Duhrib Belt, and they followed it as it proceeded farther into the asteroid field. Just as they caught up to it, the flicker disappeared from their sensors, and they had to readjust the sweep to pick up signs of durasteel rather than energy readings.

Within an hour they had located the drone inside this asteroid and had set down next to it to begin repairs. If they could get it running, they could send home a message. Unfortunately, their escape pod lacked the proper tools necessary for fixing the power modulator and so they had to strip the ship to create makeshift versions.

The Tuhgri want only to travel to an inhabited planet so they might contact their colleagues and arrange for transportation back to their homeworld. Jutka shows the characters the repairs they have already made to the drone. If the two groups work together, they can make the drone spaceworthy within 10 minutes.

As the repairs on the mining drone come to end, the entire asteroid shudders violently. Anyone failing a Moderate *Dexterity* roll is thrown to the floor. Jutka says that they have experienced similar quakes since they arrived and believe them to occur when smaller asteroids collide with this one. But he also notes that this tremor is the worst yet.

Read aloud:

**Cracks split open in jagged lines across the walls, floor, and ceiling of the chamber. The upheaval releases slabs of stone that crash into the ground and sends shock waves that you can feel through your vacc suits. The violent tremor continues, threatening to throw you to the rocky ground as you scramble to avoid the falling debris.**

The characters have only a few moments before the entire chamber topples down on top of them. Each time a character wishes to undertake an action, he or she must make an Easy *Dexterity* check or be hit by a falling piece of stone causing 3D damage.

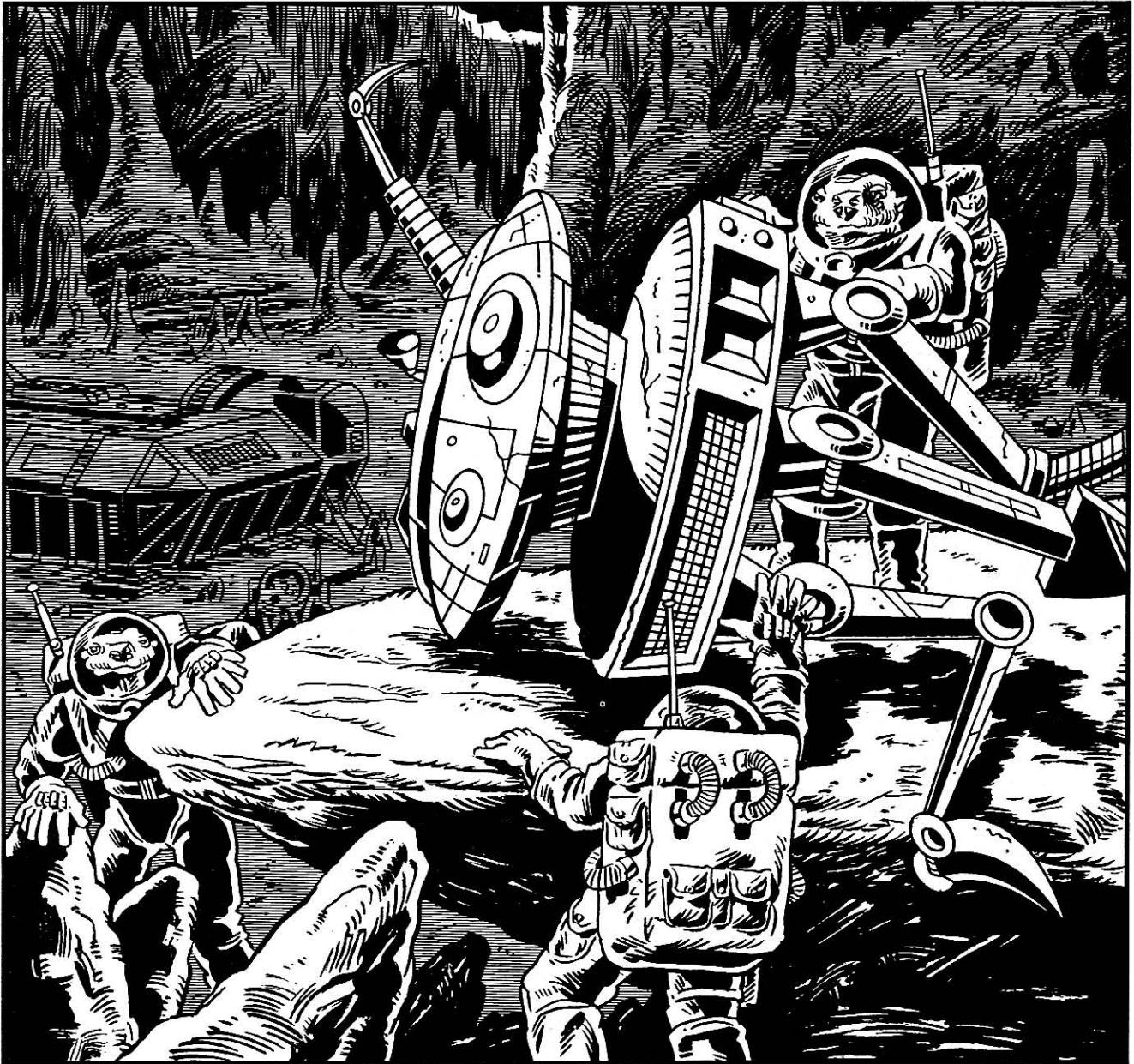

Dan and David Day

The shuttle pilot must make three *space transports* rolls to avoid large chunks of stone that tumble down the crevasse and are too big to be deflected by the particle shields. Each failure causes 2D damage to the shuttle.

The mouth of the crevasse has begun to fall in upon itself. Only two well-placed blaster shots can clear enough space to allow the vessel to escape the narrowing chasm. The characters must make two Moderate *starship gunnery* rolls consecutively to succeed. If they make one and then miss the next, they need to make two more shots. Unfortunately, the characters have time

for only five attempts before the stone walls collapse and smash the ship into scrap.

## ■ Tuhgri

Attribute Dice: 11D  
 DEXTERITY 1D/4D  
 KNOWLEDGE 1D/3D  
 MECHANICAL 2D+2/4D  
 PERCEPTION 1D/4D  
 STRENGTH 1D/3D  
 TECHNICAL 1D+2/4D

### Special Abilities:

*Leap:* Tuhgri can leap up to four meters high and eight meters forward.

### Story Factors:

*Sharing:* Tuhgri take any object they require at the time with or without permission. Many species find this

behavior disconcerting at best, and many battles have broken out in the aftermath.

**Move:** 8/10

**Size:** 1.0-1.25 meters tall

**Capsule:** The Tuhgri come from a moon-sized planet called Ehjenla located somewhere in the middle of the Kathol Outback. Their government works on a tribal basis, with each *Gaawan*, or chieftain, maintaining control over his or her tribe. The Gaawans all meet once per year at the House of Balance, the place where each tribe holds the same power no matter their military or political strength, to settle disputes and enact any planet-wide policies.

The Tuhgri believe that the Great Creator has provided everything that allows them to survive on their world and in space. The rule that underlies their entire culture, therefore, states that no one may own anything. Any Tuhgri in need of some object may borrow it until she no longer has use for it. Unfortunately, this *custom* has caused problems between the Tuhgri and other species of the sector, and many planets have banned their presence.

But the Tuhgri also maintain a strong sense of tribal unity, and this feeling translates to anyone of any species with whom they spend at least three months as allies. The Tuhgri offer the use of anything they currently possess, and they expect the same from their tribe-mates.

Tuhgri typically stand roughly 1.25 meters tall, and have wrinkled, mottled-red skin. They have no hair on any parts of their bodies, and have small circular eyes and ears. Their gangly arms end in six-fingered hands, and their noses look like elongated diamonds and have four nostrils, one on each side. Bony ridges criss-cross the Tuhgri's scalp in wild patterns, forming a tight net of protection for their brain.

## EPISODE THREE: CONSPIRACY

Read aloud:

**You return to the circular landing pad on Danoor's surface, anxious to find the promised navigator and to resume your pursuit of Moff Sarne.**

**Upon landing, you immediately notice the soldiers marching along the perimeter. Each carries a blaster rifle diagonally against his**

**chest, ready to bring it to bear in an instant. As they walk along the edge of the duracrete, they seem to be alert and nervous, as if expecting a full-fledged assault to leap out of nowhere.**

**Your group follows the strip of duracrete that leads from the landing pad to the domed building where you first met the governmental ministers. As you pass through a gaping archway into the central meeting chamber, you see the ministers huddled together at the far side of the triangular table, whispering heatedly at one another. They look up as you enter.**

**"Please, sit," Nane says as the other ministers take their seats.**

**Nane continues to stand, his face tight and serious. "Tell me, why are you really here?"**

**Before you can get a word out, Nane raises his palm to you, closes his eyes, and shakes his head slowly. "Spare me your lies," he says, dropping his arm and opening his eyes again. "All the navigators capable of charting a course through the Rift are dead. We have tried to help you, and *this* is the reward for our efforts? Well, now it seems we couldn't offer you any assistance even if we wished to do so."**

**Minister Mooren stands. "What about Makezh?" he says to the other ministers.**

**Nane turns slowly to Mooren. "I thought we had agreed not to mention him."**

### ■ Waric Nane

**Type:** Minister of Danoor

**DEXTERITY** 2D

Blaster 3D+2, dodge 3D

**KNOWLEDGE** 4D

Bureaucracy 6D, languages 4D+1, planetary systems 4D+2

**MECHANICAL** 1D+2

**PERCEPTION** 3D+1

Bargain 4D+2, con 3D+1, persuasion 4D

**STRENGTH** 3D+1

**TECHNICAL** 3D+2

Droid programming 4D, droid repair 4D+2

**Force Points:** 1

**Dark Side Points:** 2

**Character Points:** 7

**Move:** 10

**Equipment:** Heavy blaster rifle (5D), hold-out blaster (3D), comlink, blast vest

**Capsule:** Nane has proposed a new form a government, which many call totalitarian. He believes in a strong military and police presence, curfews, and strict control over anything that falls within the government's borders. Over the past two years, Nane has coerced two of the other ministers of the soundness of his plan, and he feels its institution is imminent.

After receiving several death threats from what he called "insurgents," he decided he needed a personal protection force and purchased assassin droids on the black market.

When Captain Treidum arrived posing as a New Republic emissary, Nane, along with the other min-



Dan and David Day



isters, completely fell for the ruse. Several hours later, however, Treidum appeared in Nane's private study, having somehow bypassed all of Nane's defensive measures. Treidum offered his true identity and explained the benefits of joining the Empire and the reckless insurgency of the New Republic. Nane saw the Imperial government as one dedicated to order, much like the one he hopes to bring to Danoor and told Treidum that he would put serious thought into the offer.

Treidum provided Nane with a strange trapezoidal device which he could use to summon the Empire in case of an emergency. Transmissions from the device would alert Treidum and one other Imperial vessel, who would both arrive as soon as possible. Treidum asked only one favor: should the New Republic arrive on Danoor, Nane was to activate the device and occupy the New Republic vessel until the Empire could return.

Nane has long, gray sideburns, and short gray-white hair. He stands almost two meters tall, and has a slight, almost sickly frame. He has the habit of clasping his hands in front of him and constantly adjusting their interlocked positions.

Any characters making a *Moderate Perception* check notice an old humanoid-like droid hidden in the shadows at the back of the meeting chamber. On a *Very Difficult law enforcement* roll, a character may recognize the droid as an ancient assassin model that supposedly went out of production some 26 years ago. The nicks, dents, and carbon-scoring along the droid's exoskeleton hint at its age as well as its frequent and recent use.

While the characters retrieved the mining drone, Nane initiated a coded subspace signal that would penetrate the massive energy fields of the Kathol Rift. He cannot allow the *FarStar* to leave the planet before the Empire arrives.

Unfortunately, Nane has run out of ideas for keeping the characters on Danoor, though Minister Mooren has just given him an idea. If the characters make a *Very Easy persuasion* roll, he agrees to provide them with Makezh's address in Eror Zeen, as well as military identification that will allow them to walk the city streets. But he warns them to be cautious when approaching Makezh. The man has an unstable personality and often suffers from delusional episodes. Nane takes no responsibility for the *FarStar's* crew should they decide to contact the crazed navigator.



Dan and David Day

Minister Mooren, who brought up Makezh's name, secretly belongs to Danoor's Resistance force and hopes to convince the characters to help his cause. He knows that Nane has had contact with the Empire and fears that the minister has enacted some plan to crush the Resistance in a single blow.

Just after Nane offers Makezh's address, a government courier arrives. The thin woman marches rigidly as if she were a soldier, though she wears the dignified garb of a government official. She whispers to Nane, who then abruptly calls an end to the meeting. He apologizes as the four ministers leave the chamber.

But as Minister Mooren leaves, he attempts to make eye contact with one of the characters. Which ever character rolls the highest

*Perception* total notices Mooren, who then shifts his gaze to a datapad he left on his chair. He looks back to the character, nods almost imperceptibly, and then exits the chamber after the other ministers.

At that moment a soldier carrying enough ident-tags for the entire team arrives. Should any character attempt to pick up the datapad left by Mooren, the soldier immediately questions that character. He knows the value of government secrets and does not wish to chance being responsible for a security breach. The characters may use *persuasion* on him on a *Very Difficult* roll, *con* him on a *Difficult* roll, or somehow distract him and grab the datapad without his noticing.

Mooren has encrypted the datapad in case it fell into the wrong hands. A *Moderate computer programming/repair* roll allows a character to uncover the cipher and decode the information.

According to the information contained in the datapad, Mooren believes that Nane has secretly had contact with a group calling itself the Empire. Knowing Nane's policies and personal beliefs, Mooren fears the worst for his people. He knows some of the history of the New Republic, and sees the *FarStar* crew as his last hope before civil war erupts across his planet.

He asks that after the characters locate Makezh and ready to enter the Rift, that they position the *FarStar* at coordinates which he has provided and then send the message he has appended to the end of this file into the Rift on channel gamma-gamma-eleven. He hopes that the single ally of



Dan and David Day

the Danoor Resistance will receive his message and arrive to protect them from this so-called Empire. In the meantime, he will monitor the characters' progress in their search for Makezh and offer any help they might require.

## EPISODE FOUR: MAKEZH

The characters must leave their shuttle behind and head into the heart of Eror Zeen on foot. Twilight has just settled over the city, signaling the nightly planet-wide curfew. Only squads of 10 soldiers appear on the streets as the characters continue toward Makezh's residence. Twice along the way a squad approaches the characters and asks to see their identification.

Read aloud:

**Blue-white glowlamps at the top of thin durasteel poles light your way as you head toward Makezh's residence. Squat buildings no more than four stories high line the streets, casting long moon-shadows across your path. The city seems quiet, almost dead, and you notice several window shutters close as you pass.**

**After about 15 minutes you finally reach the two-storied structure where Makezh apparently lives on the top floor. A set of stairs leads from the street to a landing on the second level.**

**At the top of the stairway four battered durasteel doors along the walls of the hallway bear address codes, and you find Makezh's apartment easily.**

*Any character making an Easy search or Perception check notices a fifth door at the end of the hallway suddenly slide shut.*

Knocking on Makezh's door provokes no response for the man is not at home. Having heard about the sudden deaths of navigators across the planet, he has become suspicious of everyone. When he saw the characters turn into his building he hid in the stairwell leading to the roof. As soon as they approached the door, he closed and sealed the door to the stairway and headed up to the roof, where he intends to wait until the characters leave.

To unseal the stairway doors requires a Very Easy *security* roll. The door hisses upward loudly, alerting Makezh to the characters' imminent arrival, and he dashes toward the edge of the roof.

Read aloud:

**You climb the dozen steps through the narrow stairwell to the roof and step out just as a strong gust of wind blusters through the area. Across the rooftop thin antennae jut toward the graying sky from amid rectangular, hexagonal,**

and octagonal protrusions of various sizes. Suddenly, near the edge of the roof, a shadow slips past, a humanoid silhouette against the pink and gold cluster of clouds at the horizon.

Makezh does not want his life to end anytime soon, so he has no choice but to flee. He leaps across the two meter space between his building and the next, and then sprints across that rooftop. Jumping across the chasm requires an Easy *climbing/jumping* or *Strength* roll.

Use the table below to determine what obstacles confront Makezh and the characters.

Any character who fails to make the indicated skill or attribute checks plummets to the street (2D meters below) and takes the requisite damage (see page 97 of *Star Wars: The Roleplaying Game, Second Edition*). If the character makes a Difficult *Dexterity* roll, however, they can grab an outcropping from the building — an antenna, balcony, or ledge — and only suffers 2D damage.

After four rounds, or just as the characters catch up to Makezh, he leaps across a five-meter gap. Exhaustion has finally affected him and he misses his target, crashing into the building's face, falling to a ledge below, and tumbling over, just managing to grab hold of the ledge's lip before he falls to his death. But Makezh considers letting himself fall, denying his assassins the pleasure of killing him. The characters must convince Makezh to allow them to rescue him, which requires a Moderate *persuasion* roll (with bonuses for good roleplaying).

When Makezh agrees to their offer of help, he suddenly realizes the danger of the situation as his hands begin to slip. In two rounds, one hand loses its grip, and Makezh dangles precariously in the gusts that have begun to whip between the buildings. After another two rounds, and every

Die Roll	Obstacle	Required Roll
1	Two-meter gap, straight across	Easy <i>Strength</i>
2	Durasteel beam straddling two buildings	Moderate <i>Dexterity</i>
3	Three-meter gap, upward incline	Moderate <i>Strength</i>
4	Local transmission cable, four meters across	Easy <i>Dexterity</i>
5	Three-and-a-half meter gap, downward incline	Difficult <i>Strength</i>
6	Crumbling edge of building, one-meter gap	Moderate <i>Dexterity</i>



Dan and David Day

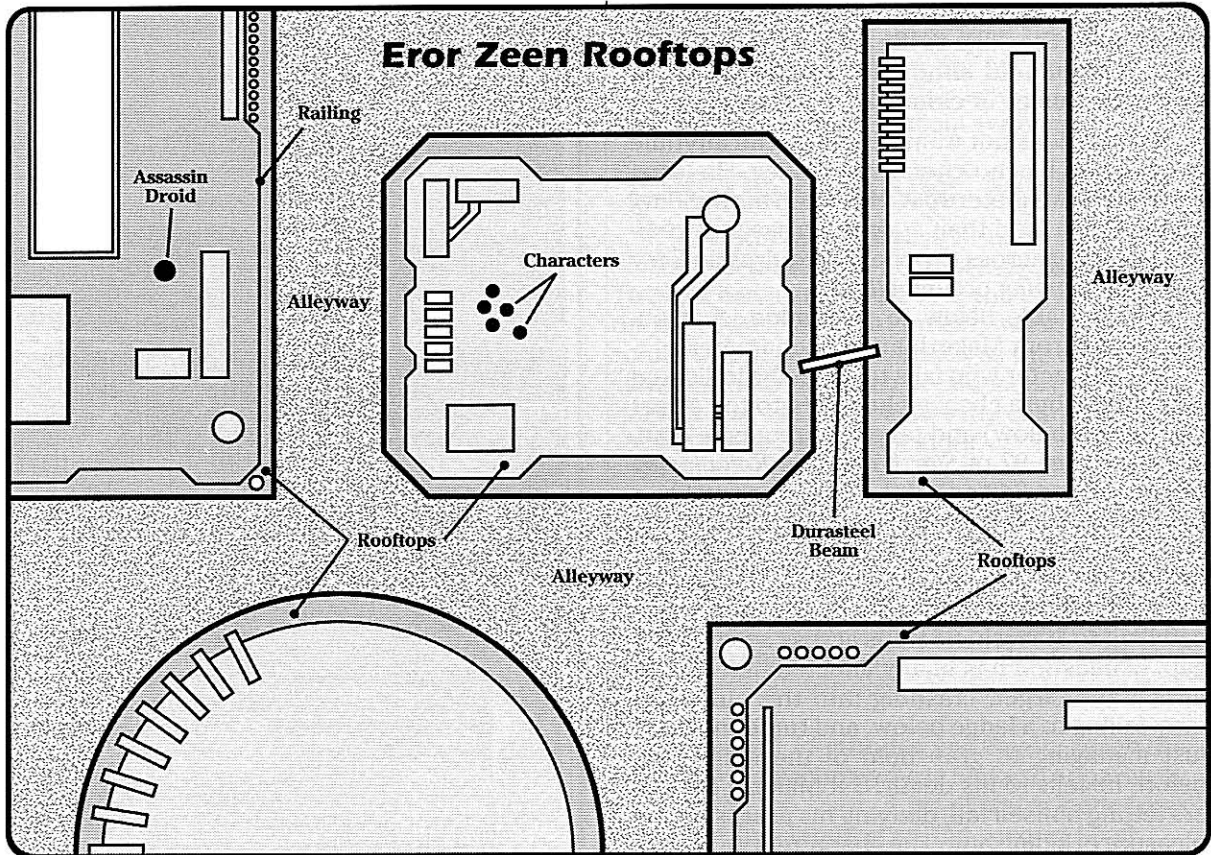

round thereafter, Makezh must make a Moderate *Strength* roll to keep himself from falling.

As the characters begin their rescue attempts, however, blaster fire erupts from a neighboring rooftop. The first two bolts explode against the building just above Makezh's head, tearing a ragged hole in the duracrete wall.

The attacker — an assassin droid — concentrates its attack on the hanging navigator, but takes one shot per round at a random character.

**Assassin Droid.** All stats are 2D except: *Dexterity* 3D, *blaster* 5D. Humanoid body, reinforced durasteel frame (+2D against energy attacks), dual photoreceptors, auditory sensors, heavy blaster (5D). Move: 10.

Characters who noticed the droid at the meeting with the ministers recognize this one, though they cannot tell whether it is the same droid or just another of the same type.

Once the characters destroy the droid, two figures bolt from a hiding place just behind the droid's position, taking wild shots at the characters as they race toward a ladder that leads to the street. But before the two can take five steps (one round), another figure, leaps onto the top of the building from a rooftop diagonal to the charac-

ters. Before the characters can react, the new arrival — who carries a heavy blaster in each hand — fires twice at each fleeing figure, knocking them off their feet and backward almost four meters.

The mysterious benefactor glances toward the characters for a moment. A full suit of body armor covers his frame, including a helmet similar in appearance to Mandalorian battle armor.

As the characters begin to make a move to engage the armored figure, whether in parlay or in battle, he suddenly fades into the darkness. On a Heroic *Perception* roll, a character notices a flash of motion as the figure, Mist, leaps over the side of the building and disappears.

Makezh thanks the characters and agrees to help them on one condition: that they take him with them.

### ■ Makezh

**Type:** Rift Navigator

**DEXTERITY** 3D+1

Blaster 4D, dodge 4D+1

**KNOWLEDGE** 2D+2

Planetary systems 3D+1, planetary systems: Kathol Rift 5D

**MECHANICAL** 3D+2

Astrogation 4D+2, astrogation: Kathol Rift 8D, capital ship piloting 4D+1, repulsorlift operation 3D+2, space transports

## MIST APPEARS

Mist's stats are listed on page 20. The bounty hunter's sudden attack on the Imperials should cause the characters to believe that Mist is on "their side."

They couldn't be more wrong.

Mist enjoyed working for Sarne; the money was good, the job, interesting and challenging. While Mist was off-planet on a mission for Sarne, the New Republic took Kal'Shebbol, and the bounty hunter was left behind. Mist is currently searching for Sarne and is gathering clues from Imperial sources, hoping to track down the elusive Moff.

Mist will appear in later supplements as a major adversary to the player characters. Do not allow any interaction other than that described in this adventure.

5D+2, starship gunnery 4D

PERCEPTION 2D+1

Persuasion 3D

STRENGTH 3D+2

TECHNICAL 2D+1

Capital starship repair 2D+2, ground vehicle repair 3D,

space transports repair 2D+2

This character is Force-sensitive.

Force Points: 2

Character Points: 5

Move: 10

**Capsule:** Makezh cannot remember much of his life before a year ago. His first memory is a confused scene of strange aliens calling themselves the Aing-Tii Sanhedrim. He entered a light transport ship, sat at the controls, and powered up. Within moments, the ship vaulted through a twisting passageway of billowing gases, and then exited into open space.

Makezh set down on the planet Danoor, the first inhabited world he came across. With no other method for earning credits, he rented his services for travel into the Rift. At first no one believed he could pilot through the cauldron of seething protomatter, but he quickly proved his abilities. Somehow even he didn't know he could navigate through the passageways without charts or astrogation coordinates.

Unfortunately, few people other than scientists bothered to take advantage of Makezh's talent. With money running out, and nowhere to turn, he stole a basket of fruit from a local market. Government forces caught and arrested him the same day.

During his stay in jail, several government scientists took a particular interest in him, though he did not know why. And soon afterward, the headaches began.

Makezh returned to his apartment. He could not eat or sleep with the constant pounding, and he decided he needed to get some help soon. But without credits, medical treatment would have to

wait. At the same time, he started to notice government agents patrolling about his building more frequently than usual. With the sudden rash of navigator murders, Makezh knows he must flee soon.

Makezh's dark, curly hair has begun to recede from his forehead back across the middle of his scalp, leaving the sides as full as ever. Dark circles hang beneath his eyes, and graying stubble covers his chin. He has a swarthy complexion, short arms and legs, and darting eyes.

## EPISODE FIVE: THE UNDERWORLD

Read aloud:

**You head back through Eror Zeen's shadowed streets with Makezh in tow, anxious to finally leave Danoor. After crossing several side streets you turn onto a wide avenue to see a squad of soldiers marching toward you. One of the troopers in the front rank stares at your group for a moment, and then points, shouting, "That's them!"**

**As one, the soldiers bring their blaster rifles to bear and charge toward you.**

When the assassin droid was destroyed, Nane realized the characters had found Makezh first. Nane had no choice but to set his soldiers after the group, although he gave them explicit instructions not to harm any of the characters. Nane plans to hold the group until the Empire arrives, since he believes the Imperials will appreciate and reward him for New Republic captives.

The squad of troopers fires at the characters, purposely missing (though the gamemaster should roll dice so as not to alert the players). On a Very Difficult *Perception* roll, a character may realize that the soldiers are not aiming directly at them.

Makezh asks the characters where their ship is located. He thinks for a moment, and then runs into a narrow alleyway a few meters away, yelling, "Follow me!"

In the middle of the alley he drops to his knees and begins to pry open a square grating in the street. The sound of booted feet grows louder, and Makezh asks for help in removing the grate, which requires a combined Very Difficult *Strength* roll. Makezh then leaps down and lands with a splash.

Read aloud:

**You hit ground with a hollow thud and a splash. The durasteel tunnel you stand in continues as far as you can see in both directions, with connecting corridors intersecting at vary-**

ing intervals. A faint, greenish light pervades the area, and after a moment you realize it emanates from a strange fungus that has taken root in the seams of the durasteel.

The last member of your team leaps down and fits the grating back into place as the clacking of the soldiers' boots suddenly grows louder.

Every character must make an Easy *sneak* roll to avoid alerting the soldiers to their presence in the ancient irrigation canal. If the characters remain quiet, the squad charges through the alley and out onto the next intersecting street.

Makezh tells his newfound companions that this irrigation system once provided water to the farms that covered the lands where Eror Zeen now stands. The tunnels have remained empty aside from the murky stream of rainwater that continues to collect as years pass for almost two decades. Makezh's father worked the irrigation system, and Makezh still remembers its basic layout. He believes he can lead the characters to a point somewhere near their ship in less than 20 minutes.

At this point, gamemasters can panic the player characters a bit. Makezh can make a wrong turn that leads them into a dead end, or a sudden downward-slope in the tunnel plunges everyone who fails a Moderate *Dexterity* roll into the murky water. The atmosphere of the tunnel is claustrophobic and oppressive, and the opportunity for players to roleplay their characters in these unpleasant conditions should be explored.

As the characters reach the approximate half-way point in their journey, read the following aloud:

**The cloudy, brown rainwater running through the center of the tunnel deepens as you make your way through the underground complex, and the luminescent fungus has grown thinner, allowing darkness to gradually consume everything around you.**

**A splash suddenly echoes down the corridor, but you can't tell which direction it came from.**

Everything goes quiet again. If the characters stand completely still and silent, they hear only the soft plopping of muck-filled water somewhere along the tunnel.

A minute passes, and then suddenly, a huge creature leaps up from the water and lashes at the characters with wicked claws and crooked, razor-sharp teeth. The dim light does not fully illuminate the beast, and the characters only catch glimpses of slick, reptilian skin and thick, four-clawed hands.



Dan and David Day

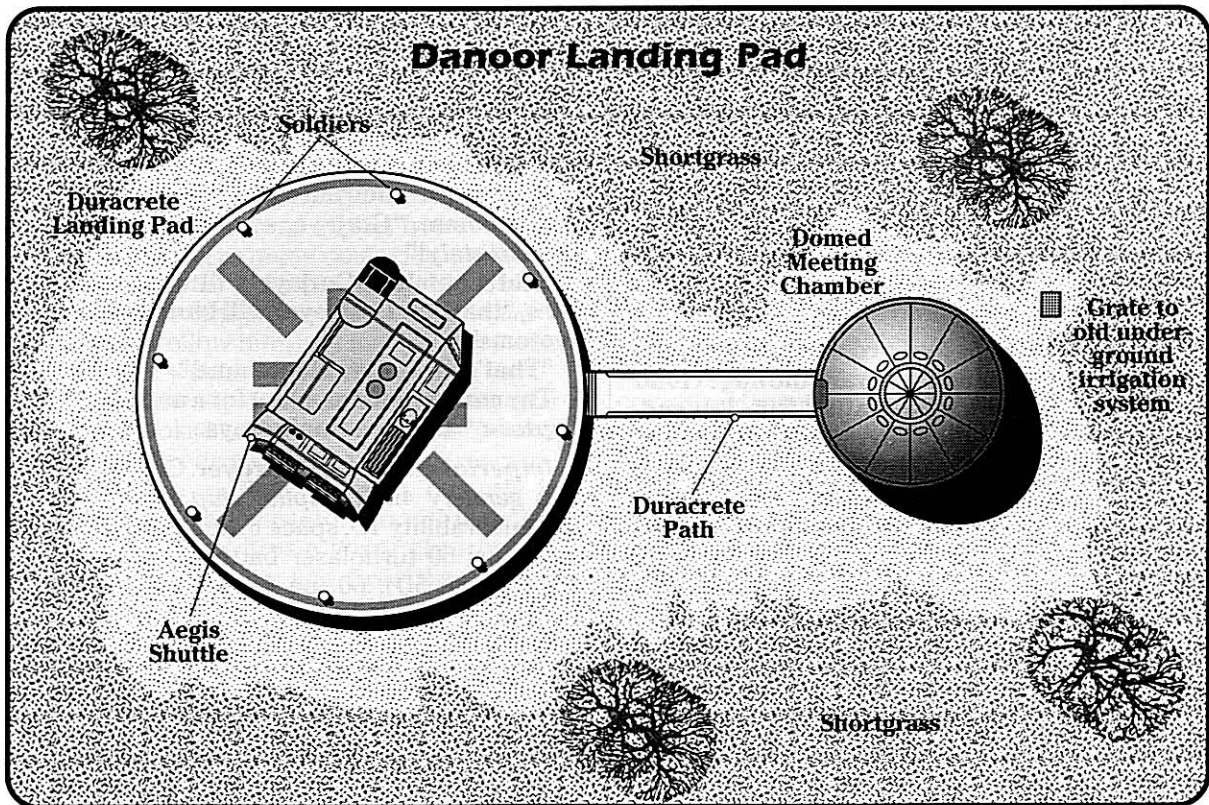

Stephen Crane

## ■ Ghest

**Type:** Cartilaginous reptile

**DEXTERITY** 1D

**PERCEPTION** 2D

**STRENGTH** 7D

**Special Abilities:**

*Teeth:* Do STR+2D damage.

*Claws:* Do STR+1D damage.

**Move:** 15 (swimming), 8 (walking)

**Size:** 6 meters long

Once the characters evade or defeat the ghest (a creature native to Rodia that has been somehow transplanted to Danoor), they can complete their trek without further hindrance. After a few more minutes of travel, they arrive at a plant-covered grating that allows thin shafts of moonlight to filter into the tunnel. Removing the grate (which has a 3D *Strength* to resist damage) requires a Moderate *Strength* roll.

The square hole leads out onto a plain of short, yellow-green grass just behind the squat chamber where the characters met with the ministers of state. A Moderate *sneak* roll allows each character to crawl out of the tunnel and hide behind the building unnoticed.

Twenty soldiers march around the perimeter of the landing pad, guarding the characters' ship. They have instructions to prevent the New Republic team from leaving the planet at all costs.

The troopers do not fall under the sway of persuasion techniques, though they may be conned, or occupied by some type of diversion. (Two guards always remain at the boarding ramp to the character's shuttle.)

Should the characters manage to board their ship and take off, two old Z-95 Headhunters, modified by Danoor's military, quickly fall behind them in pursuit.

**Variant Z-95 Headhunters.** Starfighter, *starfighter piloting* 4D, *starship gunnery* 3D+1, maneuverability 1D, space 5, atmosphere 365; 1,050 kmh, hull 4D, shields 1D. Weapons: 2 triple blasters (fire-linked) (fire control 1D+2, damage 4D), concussion missile launcher (fire control 1D+1, damage 7D).

## EPISODE SIX: REINFORCEMENTS

The characters arrive back at the *FarStar* to find the crew in a state of confusion. Apparently, Nane had contacted them with news that the characters had been taken hostage by a group of insurgents calling themselves the Resistance. He had asked the *FarStar* to send down another team to aid his troops in rescuing the captives before anything "unfortunate" happened to them.

Makezh seems anxious to get moving into the Rift, and he immediately locates the nav station and begins to familiarize himself with the controls. If asked about piloting through the Rift, he cryptically says that he “just knows when to turn.”

If no one else brings it up, Brophar asks about sending Minister Mooren’s message into the Rift. The entire task takes less than three minutes to complete.

Read aloud:

**The *FarStar* leaps forward with a surge of its sublight engines, heading toward the huge cloud of stardust that forms the Kathol Rift. But suddenly another Corellian corvette slips out from behind the system’s third planet, vectoring straight toward you on an attack run.**

**A filtered voice comes over the comm. “Greetings. I am Captain Treidum of the New Republic vessel *Lance of Endor*. We’ve come from the Galactic Core to eradicate your people.”**

*Lance of Endor*. See Chapter Two, page 18 for stats.

Within 30 seconds the *Lance of Endor* comes within medium range and fires at the *FarStar* with a barrage of laser fire.

During the second round of combat, six new Headhunter variant starfighters approach from Danoor’s atmosphere, joining the battle in round three. Minister Mooren, an impressive pilot in his own right, hails the *FarStar*, and says in a determined tone, “Let’s end this now.”

On round five, read the following aloud:

**Thyte’s sensor read-out, already jammed with blips of light, suddenly gets more crowded.**

**“I’ve got a squadron of TIE fighters — correction, TIE interceptors — coming in fast on an attack run,” Thyte says anxiously.**

**In the blackness of space behind the Imperial Corvette you see nothing but glittering starpoints beyond the rust-colored line of the Duhrib Belt and the snaking tendrils of the Kathol Rift. And then, suddenly, six TIEs swoop into view and bear down on the *FarStar* and its newfound allies.**

Any character who makes a Moderate *Perception* or Easy *tactics* roll realizes that, unless these interceptors were redesigned to accommodate hyperdrives, they couldn’t have made it this far into space *alone*. In any event, after two rounds, read the following aloud:

**Thyte’s eyes leap up from his sensor screens to the main viewport, and his jaw drops. The flattened pyramid-shape of an Imperial Star**

**Destroyer fills the transparisteel window and tactical screens, growing larger with each passing moment. The sheer size of the monstrous vessel awes you, and you feel tendrils of fear slither past your hearts. “This is bad,” he mutters, “this is very, very bad.”**

**Captain Adrimetrum calls Lieutenant Gorjaye on the comm. “Gorjaye, scramble the X-wings immediately!”**

**“But Captain,” Gorjaye’s filtered voice replies, “that Star Destroyer will blow our fighters to atoms!”**

**“That’s an order, Lieutenant!”**

**The comm remains silent for a moment. “Yes, Captain,” Gorjaye finally says.**

*Imperial-class Star Destroyer*. Capital, *capital ship gunnery* 4D+2, *capital ship piloting* 5D+1, *maneuverability* 1D, *space* 6, *hull* 7D, *shields* 3D. *Weapons*: 60 turbolaser batteries (fire control 4D, damage 5D), 60 ion cannons (fire control

## GAMEMASTER NOTES

The devastator torpedo should not actually strike the *FarStar*. The captain of the Star Destroyer would not waste the torpedo on such small game; besides, this would violate his orders concerning the *FarStar*’s survival.

Instead, the torpedo is targeted on Danoor, which lies directly behind the *FarStar*. This scene’s impact hinges on convincing the players that the torpedo is fired at them, not the planet. Gamemasters should encourage the players to react to the threat of the torpedo *immediately*, limiting the amount of time they have to declare responses. This will help the gamemaster steer the course of the battle in the desired direction.

As soon as the devastator torpedo is launched, the gamemaster can abruptly point at the players in turn and demand to know what they are doing. If they pause, begin counting backwards from five to zero, and if the player has not declared an action, simply shrug, say “Next!” and move on to the next player. By putting the players on the spot, it lets them know that their actions at this moment are *pivotal*.

By putting the group under this kind of pressure, you can make the characters react to the immediate threat without worrying about long-term consequences of their actions. This is precisely what you want.



2D+2, damage 3D), 10 tractor beam projectors (fire control 4D, damage 6D), devastator torpedo launcher (fire control 1D+1, damage 10D).

Sarne, fearing that the *FarStar* might not follow his carefully laid trail of clues, has detached one of his prized Star Destroyers from his main fleet and sent it to lure the New Republic ship into the Rift. He doesn't play very gently, however, and has been throwing as many obstacles in the New Republic's path as he can. All would be lost should the New Republic suspect that he *wants* the *FarStar* to follow him, and making it too easy to pursue him would do just that.

At a dramatically appropriate moment (particularly if it looks like the crew of the *FarStar* may actually win the engagement or effect an escape), the Star Destroyer fires its most recently installed weapon—a devastator torpedo launcher. The Imperial vessel fires a flurry of turbolaser blasts as covering fire and fires the torpedo directly at the *FarStar* (or so it appears; see the gamemaster note below). On a Moderate *capital ship piloting* roll, the navigator of the *FarStar* can avoid the relatively slow-moving torpedo.

Read aloud:

**The *FarStar* lurches as it evades the incoming torpedo, and you all breath a sigh of relief as its passes within meters of the hull. The slim missile screams past, streaking toward Danoor, and within a half-second it disappears into the atmosphere.**

**But before you can even wonder at the effect of the torpedo, a massive gray cloud erupts from the collision point on the planet and spreads outward, shrouding everything in a thick, churning sea of smoke.**

**Lieutenant Thyte is the first to speak. "Everything within ten kilometers of the blast point is ... Captain, its been obliterated."**

Luckily for the *FarStar*, the Star Destroyer cannot fire another devastator torpedo for three combat rounds. During this time, the Imperial vessel concentrates its fire on the Resistance's Headhunters. The Resistance fighters, horrified by the carnage on the planet, are beginning to withdraw. They will provide no further assistance and will not answer any hails.

Characters who make an Easy *Perception* check notice that there is a five-meter-wide hole from which the devastator torpedo was launched. If the end of that tube collapsed and another torpedo is fired ...

A Moderate *sensors* roll allows Thyte to pick up the slight energy surge that occurs just before

the launching of the torpedo. To hit the torpedo tube requires a Difficult *starship gunnery* or Very Difficult *capital ship gunnery* roll, depending on the weapon being used. Unfortunately, Gorjaye realizes that no fighter can get close enough to make the shot through the Star Destroyer's covering turbolaser fire.

If the characters sent Minister Mooren's message, on the next combat round a new vessel appears from the Rift. The Aing-Tii Sanhedrim have arrived to answer Mooren's plea for help. The grooved and pitted craft accelerates and heads right for the *Lance of Endor*. The Imperial corvette attempts to make a desperate evasive maneuver, but the Aing-Tii ship is too quick for it, and plows right into Treidum's ship without slowing. As the corvette erupts in a shower of sparks across the grooved bow of the Aing-Tii ship, the amazed characters can see that it wasn't even damaged by the encounter.

**Aing-Tii Sanhedrim vessel.** See Chapter Two, page 16—17 for stats.

Even as the Aing-Tii open fire on the Star Destroyer, the massive Imperial warship slowly comes about to face this new threat, and diverts most of its turbolaser batteries to deal with the massive fire power of the incoming vessel. Gorjaye and her fighters now have a three-round window of opportunity to damage the torpedo launcher.

If the players fail to damage the launcher, all will appear lost. At this last second, the Aing-Tii ship lurches forward and rams the section of the ship that contains the launcher, just as the Imperials fire the massive weapon. The pair of ships explode spectacularly. Proceed to Episode Seven.

Should the characters manage to destroy the tube opening during that interval, read the following aloud:

**Everything seems to go silent for a moment, and then suddenly the area around the torpedo tube explodes in a torrent of sparks, gas, and orange and yellow fire. More explosions propagate outward, blasting away huge portions of the Star Destroyer. The monstrous ship lists to its port side, and then its pointed nose drops.**

**A final eruption sends out shock waves as a huge ball of bright flame and gas explodes, rivaling the brilliance of the Kathol Rift behind it. You shield your eyes for a moment, until the last sparks of the explosion spread outward and fade into the blackness of space. Hunks of debris tumble and spin as they speed away in every direction.**

## EPISODE SEVEN: RIFTBOUND

Read aloud if the Aing-Tii ship survived the encounter with the Imperials:

The Aing-Tii vessel was reluctant to allow the *FarStar* to enter the Rift, but they seemed somewhat pacified when they learned of Makezh's presence on the ship. Makezh explains that the Sanhedrim — a powerful race of warrior-monks — sees the Rift as a holy site, and has just returned from a recent pilgrimage.

If the player characters managed to destroy the launcher (and the Star Destroyer in the process) continue reading the following text:

**Makezh breathes out sharply, and says, "Ready when you are, Captain."**

**Adrimetrum looks to each crewer in cee-cee. "We have been lucky so far. And now the most difficult part of our journey begins. Let's hope**

**the Force guides us through."**

**She nods to Makezh, and he faces forward, gripping the controls as he closes his eyes.**

**The *FarStar*'s sublight engines surge with a blue flare, and the ship disappears into the writhing tendrils of the Kathol Rift, leaving the known galaxy behind.**

## CHARACTER POINTS

Note that the citizens of Danoor, shattered by yet another disaster, will no longer provide assistance to the New Republic. If asked, they will respond: "We will no longer become a bargaining chip or potential victim to your war." The New Republic has lost a potential ally.

The characters receive three Character Points for completing the adventure. Give them one additional point for rescuing the Tuhgri from the asteroid, and three for defeating the Star Destroyer by collapsing its devastator torpedo tube.

# STAR WARS®

## THE KATHOL OUTBACK

by Chris Doyle, Tony Russo, Lisa Smedman,  
George R. Strayton, and Paul Sudlow

The epic adventure that began in the *DarkStryder Campaign* Boxed Set continues!

The New Republic vessel *FarStar* has pursued the renegade Imperial Moff Sarne into the uncharted reaches of the Kathol Outback. Join the intrepid *FarStar* crew as they track Sarne's forces through this isolated and dangerous region of space.

A strange alien species with a mysterious hidden agenda menaces the *FarStar* as it ventures further into the unknown ...

Lost colonies on the verge of civil war move to protect themselves from New Republic and Imperial incursion ...

Hostile creatures invade the *FarStar* as the forces of Moff Sarne strike back at the New Republic ...

This book features five adventures that continue the *DarkStryder* saga as well as extensive source material on the Kathol Outback, allowing gamemasters to expand the scope of the *DarkStryder Campaign*!

## A STAR WARS® SUPPLEMENT

For ages 12 and up.

©, TM & © 1996 Lucasfilm Ltd. (LFL). All Rights Reserved.  
Trademarks of LFL used by West End Games under authorization.

A supplement for use with *Star Wars: The Roleplaying Game*



40118

