

STAR WARS®

• CLASSIC •
ADVENTURES
VOLUME TWO



 WEST
END
GAMES®

STAR WARS®

CLASSIC ADVENTURES

VOLUME TWO

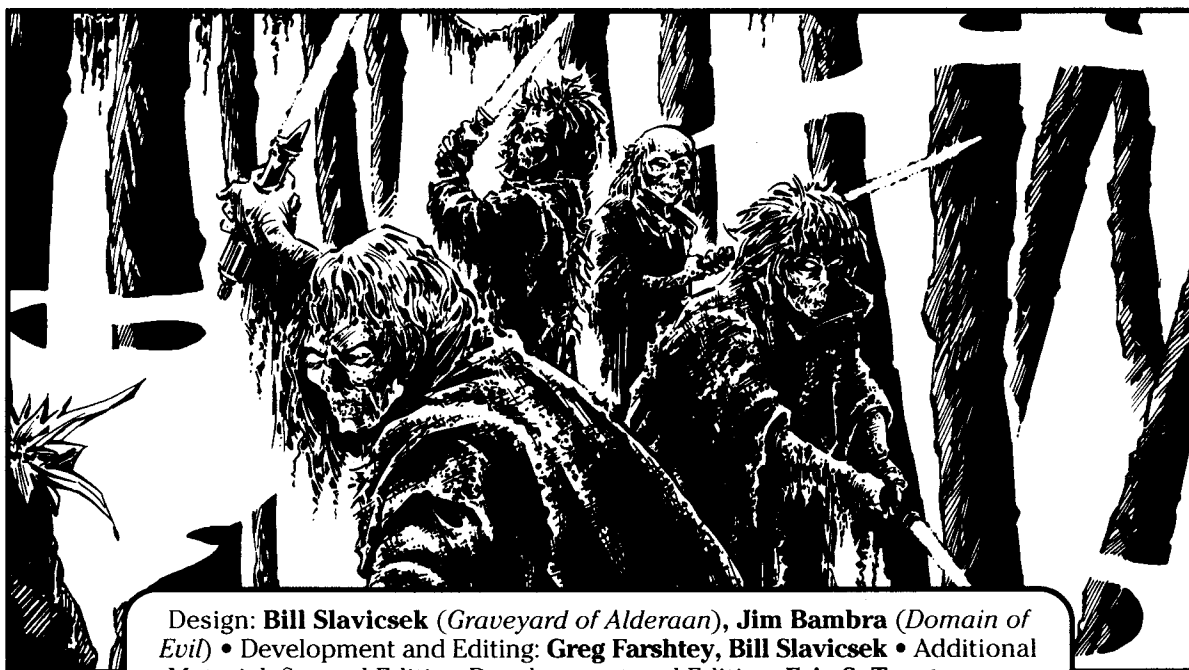

Allen Nunis

Design: **Bill Slavicsek** (*Graveyard of Alderaan*), **Jim Bambra** (*Domain of Evil*) • Development and Editing: **Greg Farshtey**, **Bill Slavicsek** • Additional Material, Second Edition Development and Editing: **Eric S. Trautmann** • Cover Design: **Brian Schomburg** • Graphics: **Stephen Crane**, **Richard Hawran**, **Cathleen Hunter**, **Brian Schomburg** • Cover Photo: **Lucasfilm Ltd.** • Interior Art: **Allen Nunis** with **Carlos Garzon**, **Gray Morrow**, **Alan Jude Summa**, **Al Williamson** • Additional Material: **Greg Farshtey**

Publisher: **Daniel Scott Palter** • Associate Publisher/Treasurer: **Denise Palter** • Associate Publisher: **Richard Hawran** • Senior Editor: **Greg Farshtey** • Editors: **Peter Schweighofer**, **Bill Smith**, **George Strayton**, **Paul Sudlow**, **Eric S. Trautmann** • Art Director: **Stephen Crane** • Graphic Artists: **Tim Bobko**, **Steven Brown**, **Tom O'Neill**, **Brian Schomburg** • Sales Manager: **Jeff Kent** • Licensing Manager: **Ron Seiden** • Warehouse Manager: **Ed Hill** • Accounting: **Karen Bayly**, **Wendy Lord** • Billing: **Amy Giacobbe**

Published by



RR 3 Box 2345
Honesdale PA 18431

40128

TABLE OF CONTENTS

Introduction to Classic Adventures, Volume Two 3

Graveyard of Alderaan

Introduction: Graveyard
of Alderaan 7

Episode One: Bazaar 10

Episode Two: Walking in
the Graveyard 26

Episode Three: The Secret
of Alderaan 39

Episode Four: Another Chance 50

Graveyard of Alderaan
Character Templates 62

Domain of Evil

Introduction: Domain of Evil 69

Episode One: Crash Landing 73

Episode Two: Mists of the Mind 81

Episode Three: The Nightmare
Begins 89

Episode Four: A Disturbance
in the Force 95

Episode Five: Ambush 107

Episode Six: The Dark Side 115

Domain of Evil
Character Templates 126



Introduction

Classic Adventures: Volume Two is a compilation of two previously published *Star Wars* role-playing adventures: *Graveyard of Alderaan* and *Domain of Evil*.

Graveyard of Alderaan is set in the classic *Star Wars* time period, between *Star Wars: A New Hope* and *The Empire Strikes Back*. The Empire still rules the galaxy with an iron hand, and Darth Vader and the Emperor are moving against the Rebellion with renewed vigor, following the destruction of the Death Star at Yavin.

In *Graveyard of Alderaan*, forces of the Rebel Alliance stumble onto a staggering piece of information while on a routine assignment: a fragment of the Royal Palace of Alderaan has survived destruction after a “visit” from the Death Star. And even more startling: there is a possibility that Bail Organa, leader of the now-destroyed planet and father of Princess Leia Organa, may still be alive in the ruins!

The players must match wits with corrupt miners, ruthless assassin droids and the master plan of Darth Vader himself to solve the secret buried in the *Graveyard of Alderaan*.

Domain of Evil is also set in the classic *Star Wars* era, and can be used with Rebel or non-aligned characters with ease. (Bounty hunter and smuggler characters are recommended for *Domain of Evil* but are not required.)

After a series of misadventures with stolen freighters and dangerous bounty hunters, the player characters crash their commandeered ship on the swampy planet Trinta. There, they must battle the bounty hunters tracking them and the dangers of the planet itself. These dangers include murderous flora and fauna and a nexus of evil Force energy that has been harnessed by Halagad Ventor, hero of the Clone Wars, now fallen prey to the dark side of the Force!

Using These Adventures

Each adventure in this volume is a stand-alone game, designed to be long enough to fill three to five hours of play. *Graveyard of Alderaan* makes an excellent starting point for new players and new characters, allowing them to gain some much needed experience before tackling hostile terrain and the dark side of the Force in *Domain of Evil*. It is also recommended that these adventures be spaced apart in a campaign, rather than being run consecutively.

Classic Adventures: Volume Two has been completely revised to conform with *Star Wars: The Roleplaying Game, Second Edition*. Character backgrounds have been expanded and supplementary information has been added to widen the scope of these adventures.

Graveyard of Alderaan, the first adventure in this volume, is designed for members of the Rebellion, rather than independent types like smugglers and pirates. While it is possible to “retrofit” the adventure to suit fringers and their ilk, it is recommended that the player characters be affiliated with the Rebel Alliance in some capacity.

In addition, the ending of *Graveyard of Alderaan* has been substantially revised to more accurately reflect the current tone of the *Star Wars* universe.

Domain of Evil features expanded information about the native creatures of Trinta, as well as updated information about Halagad Ventor.

Difficulty Numbers and Game Balance

As gamemaster, it's your job to modify this adventure to suit the abilities of your players' characters. The “Difficulty Numbers Scale” presented here lets you adjust the adventure according to the level of skill of the player characters.

Difficulty Number Scale

| Task | Difficulty Range |
|----------------|------------------|
| Very Easy | 3-5 |
| Easy | 6-10 |
| Moderate | 11-15 |
| Difficult | 16-20 |
| Very Difficult | 21-30 |

As this adventure is designed for more proficient characters, you should concentrate on the higher end of the scale, but you may wish to modify the difficulty numbers for certain tasks depending on the skills of the player characters.

For example, if the text calls for a Rebel to make a Difficult *starship piloting* roll to accomplish a given task, you would assign a number between 16 and 20, depending on the level of skill of the player character.

Both adventures are designed for four to six experienced characters. If you are playing with fewer than four characters, you should scale the difficulty of the encounters down.

Domain of Evil in particular is meant to be a challenge for the player characters. The players should feel that their characters are facing a powerful evil that is intent on destroying them, but there should always be a chance for them to succeed. If the player characters get badly mauled in one encounter, either reduce the difficulty of the next, or give them time to heal before you present the next encounter.

Keep the player characters under pressure, but remember that you're playing for fun. Give them a few breaks here and there.



A long time ago in a galaxy far, far away ...

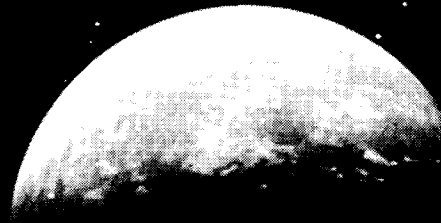

Spacers call it the Graveyard. It is an asteroid field, the shattered remains of the once-great planet called Alderaan. It had been a paradise, a planet where peace was the rule and violence was unheard of. Then the evil GALACTIC EMPIRE came, with its terrible Death Star battlestation. Alderaan became an example for the rest of the galaxy. It was obliterated as a warning to the growing Rebellion and all who would support it.

But that was not the last the galaxy heard of Alderaan. Rumors fill the idle gossip of spacers and free-traders in ports and cantinas from the Outer Rim to the Core worlds, tales of strange happenings in the Graveyard.

The wildest tale yet has just surfaced, a story claiming that the Royal Palace itself has been found mostly intact among the shattered ruins of the planet. It is a story that has attracted much attention, from the Rebel Alliance, the Empire, and the galactic underworld. But the truth that haunts the Graveyard could turn the tide of battle in the Galactic Civil War ...

Graveyard of Alderaan

As Princess Leia Organa watched, her adoptive homeworld was destroyed. It became the first test — and a significant demonstration to the galaxy — of the power of the Death Star battlestation. But that was the past. Now all that remains in the orbit once occupied by the planet Alderaan is a field of shattered rock. This is the area spacers call “The Graveyard,” and it contains a secret that the Rebel Alliance must have and the Galactic Empire will stop at nothing to protect.

Graveyard of Alderaan is an adventure for use with *Star Wars: The Roleplaying Game*. It is designed for a group of six Rebel player characters and a gamemaster, but can be easily adapted for use with groups of different sizes.

If you want to be a player in this adventure, stop reading now. This book contains information for the gamemaster only. Reading the material before you play will only ruin the adventure for you and for everyone involved.

In this Adventure ...

... a group of Rebels intercepts a message meant for Princess Leia Organa and her companions, the Heroes of Yavin. The message tells of a new discovery in the Alderaan system — in the ruins of the planet itself! The Royal Palace of Alderaan has been found within a huge asteroid, still mostly intact, and its as-yet-unopened interior may hold the fate of the Royal Household, Leia’s adopted family.

So the Rebels head for Alderaan, unaware that the entire story has been staged by the Empire as a trap for Leia and her friends. But more than just the Rebels and Leia’s group are flying blindly into the Graveyard. Others want the treasures rumored to be stored in the Palace, including a group of persistent salvagers.

However, there is another secret waiting to be discovered in the depths of the Royal Palace. It is a secret that none of the involved parties even suspect, not the Rebels, not Leia, not the salvag-

ers, not even the Imperials. And the secret, once revealed, could change the direction of the Galactic Civil War for all time!

Preparing to Play

Before the opening credits roll and this session of *Star Wars: The Roleplaying Game, Second Edition* gets underway, there are a few things the gamemaster must do. First, the gamemaster (who should be the only one currently reading these words) should read through the entire adventure. By being familiar with all of the material included, the gamemaster will be able to handle most of the twists and turns the players will throw at him. Pay particular attention to the episodes on the schedule for tonight’s gaming session, but be ready for any unexpected paths the player characters may decide to wander by reading all the way through.

Second, make sure that all of the players have characters. Those who don’t will need to spend a few minutes with the rulebook to select and customize character templates.

When the gamemaster has finished reading through the material and the players have all created characters, then the game can begin.

Adventure Materials

This book contains the *Star Wars* adventure *Graveyard of Alderaan*. It is a full-length adventure that comes complete with an adventure script to start the action, maps and diagrams of major locations the player characters will visit, gamemaster template profiles of recurring or important characters, and a mini-game which simulates a flight through an asteroid field. It is a good idea to photocopy the script so that each player can have one, and we suggest you also make copies of any maps or diagrams you plan to display to the players.

In addition to this book, you will need *Star Wars: The Roleplaying Game, Second Edition*, pen-

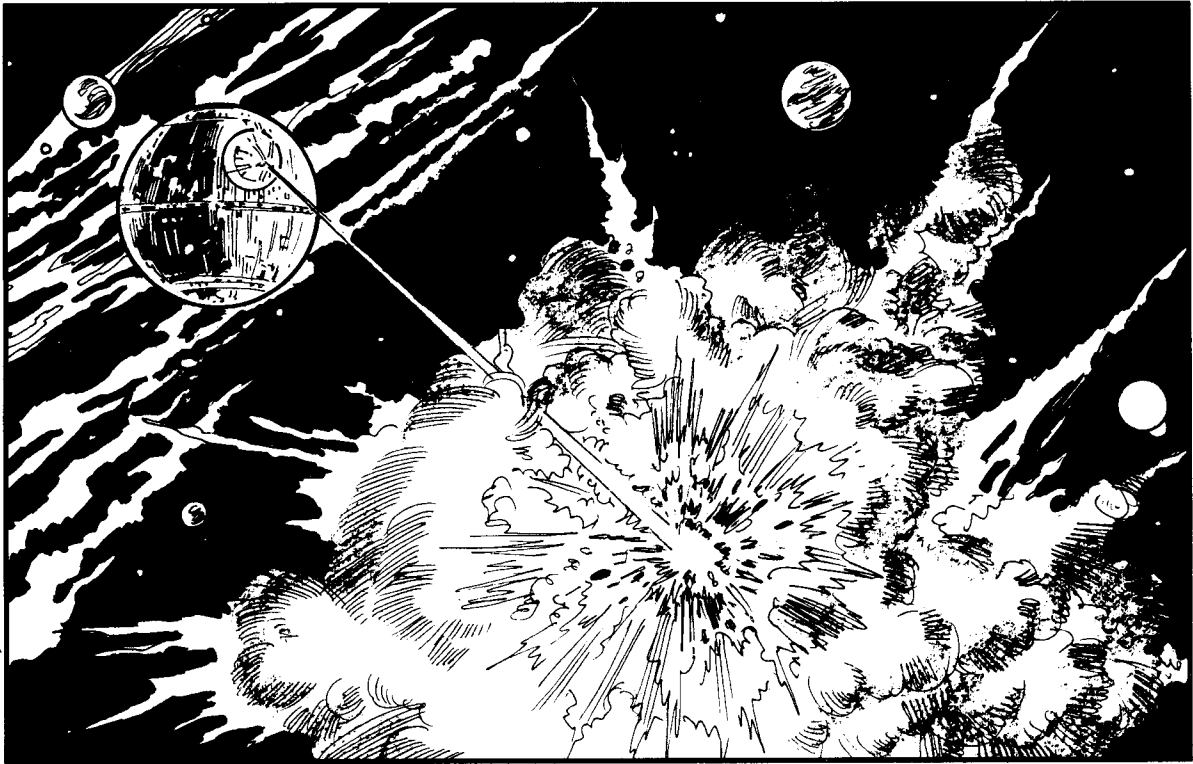

Allen Numis/Gray Morrow

cils, paper, and lots of six-sided dice to play this adventure.

The Star Wars Sourcebook, *The Imperial Sourcebook*, *The Rebel Alliance Sourcebook*, and *Star Wars* miniatures sets are all recommended accessories but are not necessary for play.

Adventure Background

Once Alderaan was a paradise of freedom and peace. After the Clone Wars, the entire world turned away from violence and dedicated itself to pacifism. Weapons were abolished and outlawed, and even planetary defenses were discarded as a show of the new philosophy. But with the increasingly disturbing changes in the New Order, certain factions on Alderaan began to rethink their non-violent position.

Chief among this new breed of thinkers was Princess Leia Organa, adopted daughter of Viceroy and First Chairman of Alderaan, Bail Organa. She was also one of Alderaan's representatives to the Imperial Senate, and a secret friend to the growing Rebellion. Eventually, as rumors of further atrocities by the New Order spread, even Bail Organa became concerned. He sent Leia on an important mission to find a hero of the Clone Wars and return him to Alderaan. Then the planet would openly cast its lot with the fledgling Rebellion. That hero was none other than General Obi-Wan Kenobi, Jedi Knight.

But events did not go as Leia and her father

had planned. Her ship intercepted a transmission from Rebel spies just before it reached Tatooine, the Outer Rim world where Bail told her to search for Kenobi. That transmission also brought her under the scrutiny of the Empire and its terrible servant, Lord Darth Vader. Captured by Vader and imprisoned aboard the Death Star, Leia was forced to face Governor Tarkin, the Grand Moff in charge of the battle station. Tarkin decided to demonstrate the power of his fully-functional Death Star on the defenseless world of Alderaan. The battlestation's super laser destroyed the planet with one terrible blast.

Before it could throw its resources and support against the evil Empire as it had done against the enemies of the Old Republic during the Clone Wars, Alderaan was obliterated. Of course, Leia and the companions she met through Obi-Wan Kenobi went on to become the heroes of the Battle of Yavin. They, in turn, destroyed the Death Star. But nothing could bring back the only home Leia remembered. All that remained of the once-great Alderaan was an asteroid field called "The Graveyard."

In the months since Alderaan's destruction, the Graveyard has become the subject of tall tales and wild rumors whispered in cantinas and spaceports the galaxy over. Some scouts claim to have been chased out of the field by a "ghost ship" that appeared without warning, then disappeared as quickly and quietly as it arrived. Others tell of fabulous treasure, including Jedi arti-

facts, buried within the asteroids. And, of course, there are more than enough stories of strange monsters, weird aliens, and the ghosts of Alderaan's dead haunting the floating debris.

There is a kernel of truth buried amid these tales, and that is the basis for this adventure. After the Clone Wars, after Alderaan accepted its new pacifist policies, the Council of Elders had to decide what to do with the stockpile of weapons Alderaan had built during the time of conflict. While the public believed that the massive armament was destroyed, the Elders feared that someday they would again need to defend their world and their galaxy from some as-yet-unnamed evil. They reconstructed one of the huge Alderaan war ships, turning much of its interior into an armory. Then they placed droids within the vessel to maintain it, and programmed its nav computers to constantly jump through hyperspace until called to return to Alderaan.

But this is a secret that no one alive knows, not even Princess Leia. All knowledge of the ship and its precious cargo died with the Council of Elders when Alderaan exploded. Still, the Graveyard remains a lure with which the Empire can hook Leia and her companions — if the proper bait can be found. And that is where this adventure begins ...

Adventure Synopsis

The adventure starts with the Rebels enjoying a relaxing break aboard the Ithorian herd ship, *Bazaar*. But the restful period is cut short when they stumble upon a miner being executed by an unknown assassin. The remainder of their time on *Bazaar* is occupied trying to stop another

murder — if they can locate the dead miner's companion before the remaining assassin does. It is from this miner that they learn of the newest tale to emerge from the Graveyard of Alderaan — the Royal Palace has been discovered, and within it lies the fate of Bail Organa and the Royal Family!

Now the heroes must rush toward the Alderaan system to check out the story that the miners died to bring them. In the asteroid field, the Rebels find the mining outpost, learn of the new discovery, and take a hazardous journey through a portion of the field thick with asteroids. Here they learn that others are after the new discovery, and a contest of wits and skills begins with an unscrupulous gang of salvagers.

At the asteroid marked as 7785, the Rebels find the entrance into the remains of the Royal Palace. But they also find that they have blundered into a trap! A platoon of stormtroopers force them into the Palace, where they are to be held until Lord Vader arrives. A series of traps designed to break their spirits follows, with the Rebels finally finding Alderaan's greatest secret. They stumble upon the command chamber for the armory ship, *Another Chance*.

The climax of the adventure takes place aboard the damaged ship as it continues to leap into and out of hyperspace at an alarming rate. The Rebels must take control of the vessel and bring it safely into realspace before Leia and her companions unwittingly fall into Vader's clutches. If they can succeed, then the Alliance will finally receive Alderaan's gift — weapons with which to wage civil war and restore freedom to the galaxy.

Episode One Bazaar

Summary

The adventure begins aboard the Ithorian herd ship, *Bazaar*. The Rebel heroes find that their restful visit has been cut short by a pair of assassins out to murder two miners with a message for Princess Leia Organa. On the way to Isttu Village, the Rebels witness the attack of an assassin droid upon one of the miners. From there, they explore the merchant village and learn many rumors concerning a place called "The Graveyard of Alderaan." During the interactions with merchants and visitors, the Rebels are mistaken for Leia and the Heroes of Yavin. This case of mistaken identity, which will haunt them throughout the adventure, allows the message for Leia to fall into their hands. "We've found the Palace," one of the miners tells them. "It's in the Graveyard."

Read Aloud

A long time ago in a galaxy far, far away ...

It is a time of civil war. A small but growing Rebel Alliance has dared to challenge the evil Galactic Empire, winning a few major battles — most recently the Battle of Yavin — as the war rages on.

But even in the midst of war, there is time for peace. A group of Rebel heroes takes a break aboard the Ithorian herd ship, *Bazaar*, enjoying the exotic wares of its merchant crew and the idyllic nature of the vessel.

Now, as they stroll down a jungle-filled corridor, the Rebels are about to find that even a place of peaceful beauty can house terrible evil. And evil rarely cares what it destroys ...

Start the Adventure

Hand out copies of the adventure script and assign each player a part. The parts are labelled as "1st" through "6th" Rebel. Assign multiple parts if there are fewer than six players. Begin by reading the narrative introduction provided in the "Read Aloud" box and then cue the players to start reading their parts from the script. The script leads directly into "The Assassin Droid" encounter below.

Encounter: The Assassin Droid

As the adventure opens, the Rebels find themselves on the verge of being pulled into a battle between a frightened, fleeing man and his as-yet-unseen assailant. They are approaching Isttu, one of the many merchant villages which dot the herd ship's upper-level jungle. They are on the way to meet their Alliance contact, thinking that their mission is a simple cargo pick-up. They are about to find out that they are very wrong. Give the Rebels a moment to decide what they want to do with the little information that has been placed before them through the script, then reveal the assassin droid that is currently lurking "off-camera."

The Rebels have whatever equipment they normally carry, keeping in mind that they are on board a ship where violence is frowned upon. If they decide to help the fleeing man, continue with the bold face descriptive text. If they decide that this is none of their business and leave the area, then they will find out what happened to the fleeing man later in this episode.

The jungle falls silent, and only the smell of charred vegetation reminds you of the destructive blasts you just saw. Then a droid floats out of the brush. It is larger than an astromech, floating above the ground on a repulsor field.

GRAVEYARD OF ALDERAAN ADVENTURE SCRIPT

Use the following script to start the adventure.
Your gamemaster will tell you what part (or parts) to read.

1st Rebel: This place is great! I almost believe I'm in a real jungle! I'm glad they sent us on this run and not one of the other teams.

2nd Rebel: You make it sound like you've never been on an Ithorian herd ship before.

3rd Rebel: And you have?

4th Rebel: I have. One arrived in my home system the summer before I joined the Alliance. It's like the Hammerheads gathered up a piece of their planet and launched it into space.

5th Rebel: Not just their planet, though. There are more shops and merchants set up here than I've ever seen in one place, with merchandise from all over the galaxy.

6th Rebel: I don't know what they call it in Ithorian, but the Basic translation sure fits this ship — *Bazaar*.

1st Rebel: Still, what a mission!

2nd Rebel: Yeah, all we have to do is pick up a cargo of Droid parts from a merchant named Poliss. We just have to say, "Yavin sends greetings," give him the 700 credits, and the cargo is ours.

3rd Rebel: Better yet, we don't have to have the cargo back for two weeks, which gives us a couple of days to enjoy the scenery.

4th Rebel: It's almost like a vacation.

5th Rebel: There are a lot of merchants on this ship, and they're all Hammerheads. How are we supposed to find Poliss?

6th Rebel: He runs a Droid shop over in Isttu, one of the merchant villages on this level. The village should be around the next bend.

1st Rebel: Do you think our ship is okay? I don't like leaving it unattended.

2nd Rebel: If you want, we can send you back down to the hangar to watch it.

3rd Rebel: Don't worry. This is an Ithorian ship. They're some of the most peaceful and friendly beings in the galaxy. And everyone is welcome here, so no one starts any trouble.

GM: *Suddenly a man emerges from the foliage ahead of you. He looks frightened. He stares at you briefly with large, worried eyes, then glances back the way he came. Without a word, he dodges into the foliage on the other side of the path, disappearing from view.*

4th Rebel: What in the world was that ...?

5th Rebel: It looked like a man. He seemed nervous.

GM: *Blaster fire cuts through the jungle, slicing a path toward the fleeing man.*

6th Rebel: So much for a peaceful vacation ...

From its spherical body rises a black curved neck which ends in a head of lights and blinking sensors. Two arms extend from its head, tipped with deadly blaster pistols. It regards you with a quick scan, then turns away, intent on following its prey.

This is the assassin droid XS3. It is hunting the man the Rebels briefly met, a miner from an outpost stationed in Alderaan system (see the sidebar, "How the Miners Fit In"). It is out to kill the miner, and that is its primary objective. While it will defend itself, it will not turn its full attention on the Rebels until it has dealt with the miner.

The miner is Hanos Darr, one of two miners from the Alderaan outpost who are currently enjoying a restful break aboard *Bazaar*. He has already received a *wound* from XS3, and he is hurt and tired.

If the Rebels manage to save Darr from the assassin droid, he thanks them and disappears down a jungle path at his earliest opportunity.

The Rebels will learn more about him later. If they fail to stop the droid from killing Darr, he relates a brief message to them before he dies. See "Hanos Darr's Message" for more details.

Once Darr has been taken care of, the assassin droid turns its attention on the Rebels. It battles until destroyed, and is programmed to self-destruct if it takes enough damage to *incapacitate* it.

Hanos Darr, Miner: All stats are 2D except: *Dexterity 2D+2, blaster 3D+2, melee combat 3D, melee parry 3D, Knowledge 3D, planetary systems 3D+1, planetary systems: geology 4D, Mechanical 2D+1, mine drill operation 3D+1, con 2D+2, gambling 2D+1, search 3D+1, lifting 3D, demolitions 3D, mining 3D+1.* Move: 10. Blaster pistol (4D), comlink, mining permit.

Hanos has black hair, a pale complexion and a thin, angular face. He wears old, sweat-stained coveralls and sports a two-day growth of beard.

How the Miners Fit In

The Empire discovered the location of the Royal Palace of Alderaan a few weeks prior to the start of this adventure. It was found by an Imperial scouting unit assigned to explore the shattered ruins of the planet. Once Lord Darth Vader was informed of the find, he set the current plan into motion.

First, he had the scouts leak the discovery of asteroid 7785 to the miners of Outpost 11. It was generally believed that if there weren't any Rebel agents working in the outpost, there were at least a few miners with Alliance sympathies. Then, once the information had a chance to make the rounds, all of the miners were ordered to leave the outpost. This was not unusual, as the Empire often cleared areas of civilians for limited times, and the miners looked at it as a forced vacation. Only Kathos Loof, the mining chief, remained behind (see his template profile in the "Character Templates" section). The rest went in all directions to spread the news of the Alderaan find.

Once the outpost was cleared, Vader replaced the mining crew with a crew totally loyal to the Empire — men whose loyalty was bought with credits, commissions, or lethal threats. He also stationed two platoons of stormtroopers to act as an advance guard under the command of Captain Janus Bonn. Vader would arrive personally once he was certain his trap had been sprung. So, with little thought to what the palace ruins might actually contain, Captain Bonn and his men

went about establishing the trap for Princess Leia and her companions.

The "vacationing" miners, meanwhile, went about unwittingly spreading the bait. At every cantina and space port they visited, the miners told the tale of the discovery of the Royal Palace of Alderaan. To make the story seem more important, Vader dispatched bounty hunters and assassins after the miners to silence them — once they were able to spread their tales, of course.

Six miners, however, were unusually silent. Instead of telling the story to everyone they met, they contacted old friends and acquaintances, dropping the news that they were back in town and had to see their "cousins from Yavin." These six were Rebel agents, and the code phrase they passed around would get them an audience with Princess Leia as soon as she could be relayed the message. Hanos Darr and Zaz Kamiroz arrived on *Bazaar* two days before the Rebel player characters and gave the code to the merchant, Poliss. Now they are waiting for Leia and her companions to contact them so they can complete their mission.

Unknown to the miners or the Rebels, another Rebel miner is going to rendezvous with Princess Leia at Kwenn Space Station in six hours. Kwenn is seven hours from Bazaar by light speed travel. That gives the Rebel player characters a head start over the Heroes of Yavin.



Allen Numts/Carlos Garzon

XS3, Assassin Droid. All stats 1D except: *Dexterity 2D, blaster 4D+1, dodge 3D+1, grenade 2D+2, Perception 3D, hide 4D, search 4D, sneak 4D, Strength 4D, droid repair: self-repair 3D.* Move: 10. Internal blaster pistols (4D, two shots per round with no penalty), grenade launcher (5D), internal repair unit (can repair one wound per round with Moderate *droid repair: self-repair* roll, *incapacitate* result destroys repair unit).

XS3 is a black mechanical made up of a large spherical body and a smaller spherical head connected by a curved metal arm. It uses repulsorlift engines to move, and it has two thin arms extending from its head which have built-in blasters, as well as a grenade launcher built into its body. It is — like most assassin droids — cold, calculating and totally devoid of emotion.

Hanos Darr's Message

If XS3 manages to deliver a *mortal wound* to Hanos Darr, the Rebels have three rounds from that moment to attend to him or he will die. That's just the way it is. Try to keep the battle with the assassin droid going long enough for this to occur. Even though Darr dies, he is able to leave a brief message for the Rebels etched in the packed dirt of the path. It says, "Kamiroz."

Kamiroz is the name of the second miner from the Alderaan outpost. He is somewhere aboard *Bazaar*, unaware that his life is in danger from either the assassin droid or its partner. Kamiroz also has a message for the Rebels — the message that should eventually lead them to the Graveyard.

The Herd Ship Bazaar

Bazaar is an Ithorian herd ship, hailing from the home planet of the beings often called "Hammerheads" because of their most prominent physical feature. Ithorians have a long neck which curls forward and ends in a T-shaped dome. The Ithorians are peaceful, ecologically-minded beings content to wander the galaxy in their herd ships.

Ithorians speak Basic, the common language of the galaxy, but with an accent that can be disconcerting to those who have never heard it before. Hammerheads have two mouths, one on each side of their long, curved necks, which operate at the same time when they are speaking. One is used to produce the lower range of sounds, the other to produce the higher range. This stereo effect is fully employed when they speak their native tongue, but even Basic emerges as music from the mouths of Ithorians.

Bazaar, like all Ithorian herd vessels, travels

the spaceways like a caravan, bringing unusual merchandise from one end of the galaxy to the other. It is designed for Ithorian comfort, built to mimic their home world's tropical environment. As such, the ship is made up of indoor jungles complete with artificial storms, wildlife, and vast expanses of lush vegetation.

The gentle Ithorians manifest great respect for all life forms, and their curiosity is only matched by their gregarious natures. They are extremely religious, and *Bazaar* has a section devoted to the worship of the Mother Jungle. While the species has taken no official stance regarding the galactic civil war, and while they will trade with anyone who comes to their herd in peace, many Ithorians secretly support the Rebel Alliance.

Bazaar is currently in orbit around the main planet in the Lusdu system. It is only one hour from the Alderaan system by light speed travel.

Bazaar, Exterior

The great floating disk is a welcome sight in many of the more out-of-the-way parts of the galaxy, for its arrival signals the coming of the Ithorian merchants. The ship's smooth surface is interrupted by many plastisteel viewports that look in upon the vast interior jungle. Large openings ring the equator of the herd ship, leading to the huge hangar bays that can handle ships as large as small transports. There is also evidence of powerful deflector shields and low-powered weaponry for driving off pirates and smugglers.

Bazaar, Upper Level

The upper level of the herd ship is a vast, seemingly wild jungle that is actually well cultivated. The jungle is divided into a number of sections, each with its own village. Villages contain the famed markets of *Bazaar*, as well as inns, cantinas, holothaters, and other types of businesses. This is the level of most activity when a herd ship comes to a system. But the number of guests at any given time is strictly regulated by the Ithorians. Too many people tend to crowd and ruin the environment, so guests and the length of their visits are monitored and determined by the merchant council at the time a guest arrives. When the lights dim each evening, guests can look up to see the stars or their home planet through the many domes that cover the roof of the ship.

Bazaar, Middle Level

Huge space doors, protected from vacuum by magnetic fields, line the walls of this level of the herd ship. Observers within the many control towers that oversee space traffic into and out of

Bazaar regulate visits. Powerful scanners check for hidden cargo, undeclared weapons, or anything else that could endanger the herd or its guests. However, with great effort, certain unscrupulous visitors have managed to slip contraband and even powerful weapons past the sometimes-lax observers.

The floor of the hangar is a vast plain of soft grass that sways in the artificial breeze. After registering with the observers, guests are free to leave their ships and wander about *Bazaar* until their time is up. Most visits last anywhere from two days to two weeks, depending on the crowds and the schedule the herd ship is keeping.

A modern ship repair facility fills the center of the hangar. It can handle most repairs short of those which require a full space dock, and its tractor beams can even pull disabled ships in to work on.

Bazaar, Lower Level

Bazaar's lower level is divided into a number of distinct sections, all built around the Dome of the Mother Jungle. The dome is a plastisteel bubble into which an island has been suspended, floating freely with only the transparent walls separating it from deep space. This island is a piece of the Mother Jungle of Ithor, grown from a small bit of the land so that the home world and its life-giving goddess would always be with the space travelers. It is tended by a small group of priests dedicated to the Mother Jungle, and is usually off-limits to visitors.

Three huge repulsorlift engines take up much of the room on this level. These are used to move the herd ship through normal space. The hyperdrive engines are only used to jump into and out of light speed. Another chamber full of machinery controls and monitors life support and power throughout the herd ship, including the regulation of storms in the jungles and on the hangar plains. Finally, a vast storage facility holds the ship's supplies. As with the Mother Jungle, this entire level is restricted to visitors and is only open to *Bazaar's* crew.

Using Bazaar in this and Other Adventures

An Ithorian herd ship can serve as a wonderful stopping point between adventures. The merchant villages contain everything the Rebels need to rest, stock up on supplies, and receive new missions from Alliance High Command. Any conceivable merchandise is available at any given time at the merchant stalls (including the occasional illegal item or two). The inns and cantinas serve up the best food and drink, and gossip and

rumor gathering is second to none. Many wealthy or needy individuals come to these dens to find the right people to help them, and that is often the Rebel player characters. Doctors, ship repair facilities, and even droid specialists can be found here, and more than one merchant could be an Alliance contact.

There is the added bonus of danger and subterfuge that comes with any large gathering of beings. Imperial agents come and go as they please, as do all manner of underworld figures. As long as they keep their business to a minimum and don't bother the other guests, the Ithorians tolerate their presences. Of course, while the Rebels are looking for new adventures and news of the galaxy, so are all types of bounty hunters, salvagers, mercenaries, pirates and smugglers. Competition can be fierce — and it can come from the least likely source.

In this adventure, the herd ship and its occupants should be used to introduce the Rebels to the vital information that drives the rest of this adventure, namely, the rumors concerning the Graveyard of Alderaan. Most of these rumors are transmitted via the interaction between the merchants and their customers which takes place in the Isttu Village. Let the Rebels examine the map of the village and wander where they will. All encounters are marked in the text, but they can occur in any order. We suggest you save the confrontation between the remaining assassin(s) and Kamiroz until after the Rebels have had a chance to look around a bit. As long as they are having fun interacting with the villagers, keep the scene going. When things begin to slow down, pick up the pace with "Finding Kamiroz."

Isttu Village

The merchant village of Isttu is built around Isttu Lake, which is just a wider branch of the Great Mother River that runs through *Bazaar's* upper level jungle. The only break in the illusion that this is a village in a jungle clearing is the dome above that looks out into space, and the turbolift banks that jut from the floor. The following descriptions are keyed to the accompanying map and explain what the various structures are, but only areas that have major encounters are described in detail. Gamemasters are urged to flesh out the rest of the village to best reflect their current campaign setting. Note that Belinda Vog and her crew are in the village, as is the ISB agent, Dal Rogos. Use them according to their backgrounds and objectives, but avoid any overly-suspicious confrontations (see the gamemaster templates in the "Character Templates" section for more information).

GAMEMASTER DIAGRAM: Bazaar Herd Ship

Herd Ship Exterior Side View Schematic

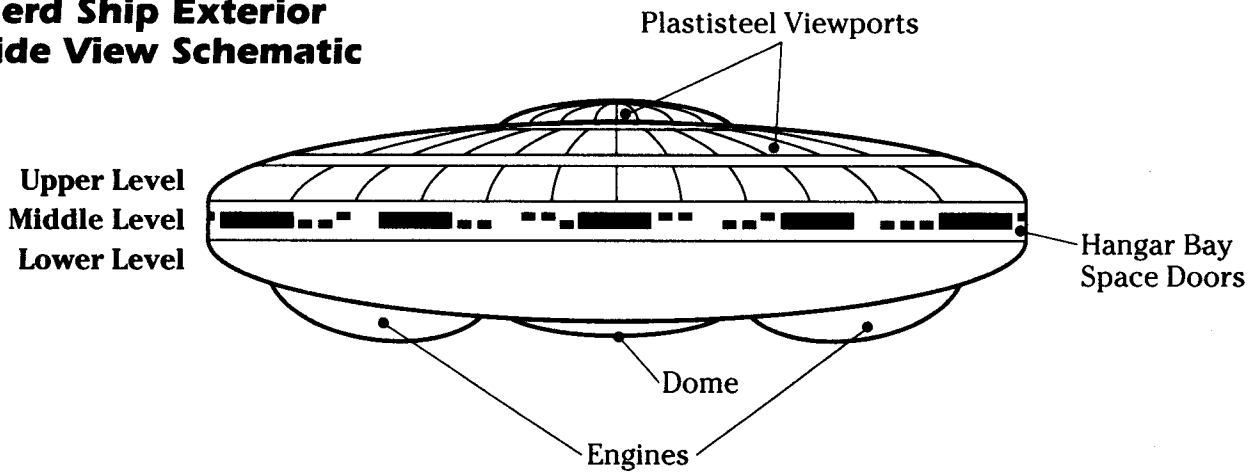

Middle Level

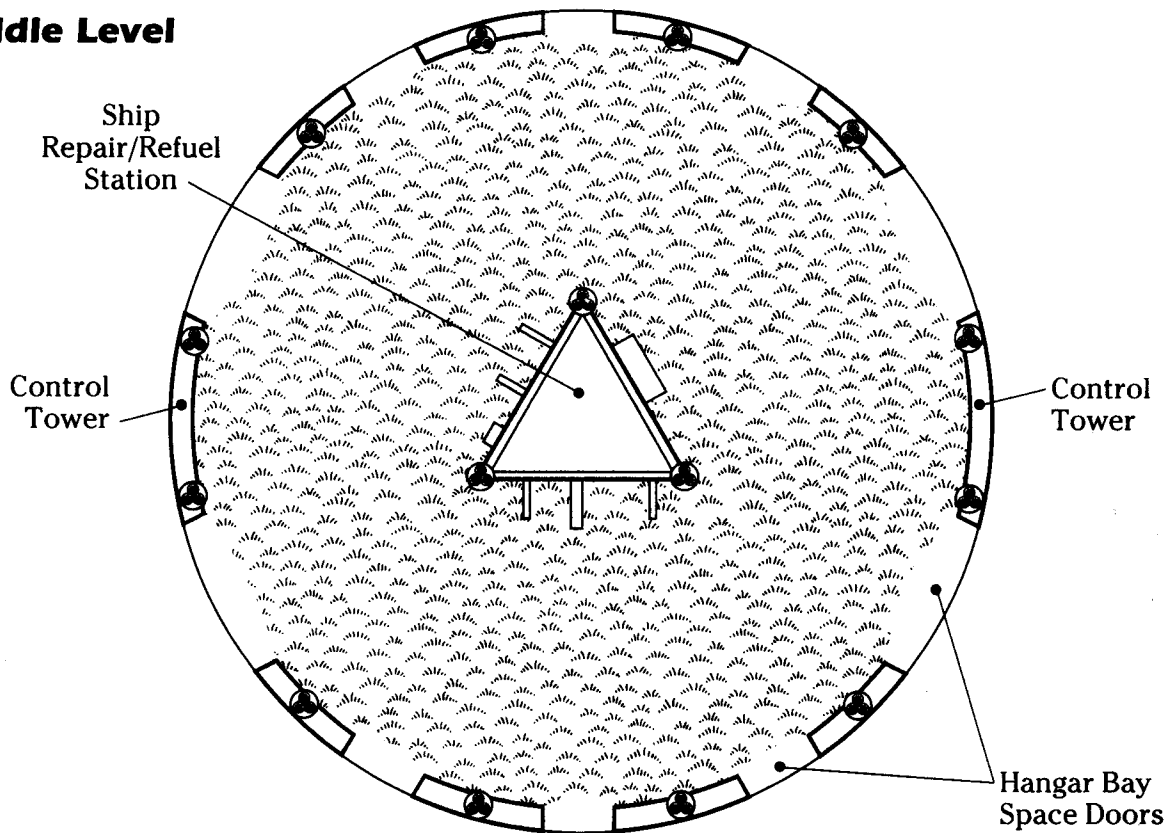

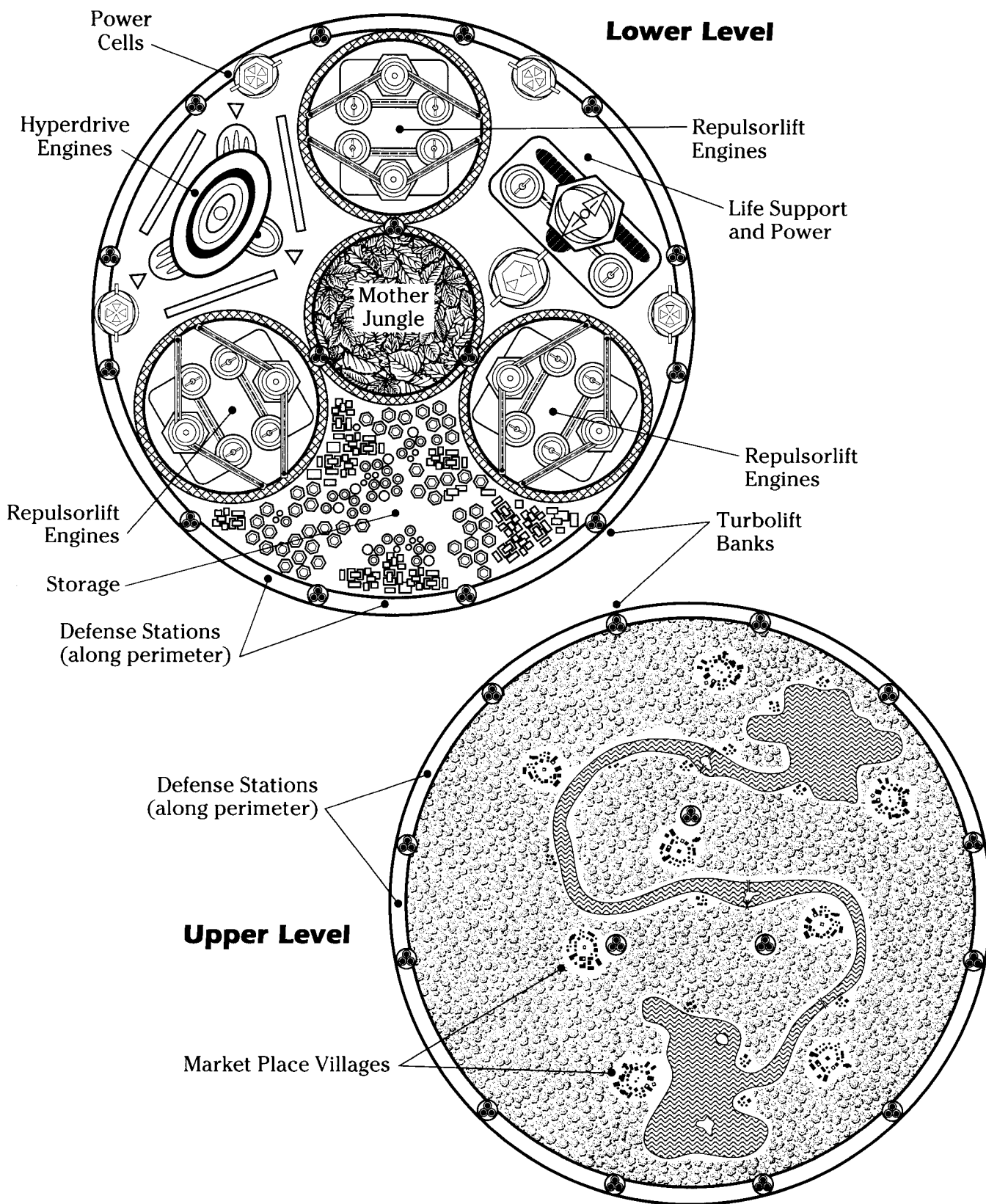

Stephen Crane



Allen Nunis/Alan Jude Summa

Typical Ithorian. *Dexterity 2D, Knowledge 2D+2, Mechanical 1D+1, Perception 2D+1, bargain 3D+1, con 3D+1, Strength 2D, Technical 1D+2. Move: 10.*

1. The Jungle Cantina. This large building houses one of the best cantinas on *Bazaar*. Three bartenders work the massive central bar, and up to six waitresses wander among the tables. A four-man band plays from a secluded alcove, mixing Ithorian classics with the most popular tunes on the galactic charts. Everyone who visits Iшту comes here eventually, and the Rebels can hear an assortment of stories and rumors if they spend some time (and some credits) among the clientele. These rumors include:

- *Enger Mowen, who runs the Imperial Recruitment stall, is actually a Rebel sympathizer and can direct you on how to join the Alliance.* This rumor is false. Mowen planted it himself to flush out Rebels and would-be Rebels.
- *Someone was murdered by a droid outside the village.* This rumor is true if XS3 managed to kill Hanos Darr. It's false if the Rebels stopped the droid.
- *Two miners from the Alderaan Mining Outpost arrived on Bazaar a few days ago, asking questions about their cousins from Yavin.* This story is true, and the questions finally led Kamiroz to Poliss.
- *The Imperial Fleet found the Yavin Rebels and destroyed them all.* This rumor is false, but many people believe it because it was on the Imperial-controlled holo vid news.
- *The man who was killed by the droid was Hanos Darr, one of the miners from the Alderaan outpost.* This is true if the Rebels were not able to stop XS3 before it delivered its killing shot.
- *A ghost ship keeps appearing and disappearing in the remains of the Alderaan system.* This rumor is true, but there is no other information on the ship at this time.
- *A powerful Jedi relic was recently uncovered in the Graveyard, and that's why the miner was killed.* This rumor is false, but it could provide powerful motivation to keep the Rebels going.
- *The Graveyard is what they call what remains of the planet Alderaan.* This is true.
- *Kamiroz is the name of an Imperial officer; a bounty hunter; a crime lord.* These rumors are false.
- *Kamiroz is the name of one of the two miners who arrived a few days ago, but he hasn't been seen since yesterday.* This is true.
- *Equet, who runs the Weapons Shop, is recruiting tough men and women for a high-paying job in the Minos Cluster.* This is true.

- *Kapin Toologin, a frequent patron of the Great Mother River Restaurant, is a powerful crime lord.* This is false. He is a galactic insurance salesman on vacation.

- *The miners from the Alderaan outpost claim to have uncovered a vast treasure — the wealth of Alderaan itself!* This is false. In fact, the miners were particularly closed-mouthed about their entire tour in the Graveyard.

- *Stormtroopers have taken over Bazaar and are even now amassing outside the village to arrest everyone here.* This rumor is false, told by a drunk spacer hoping to get a free drink.

- *Poliss is a tall, spotted Ithorian who runs the droid shop.* This is true. One of the serving girls can reveal this information if asked. However, asking about Poliss in the cantina arouses the attention of Dal Rogos, who is investigating rumors of Poliss's Alliance connection.

2. The Inn on Isttu Lake. This inn is not as opulent as the hotel across the lake, but it offers comfortable accommodations at reasonable prices (25 credits per night per person). Darr and Kamiroz have a room here, but neither man has been in since they went out to breakfast yesterday morning. The Rebels can find this out by modestly bribing (25 credits) the desk clerk. If they break into the room (Moderate security check), they find that the beds have not been slept in since the maids were by, and their travel bags are still here. There is a holomessage on the room's comlink. It is from an Ithorian with a spotted complexion, who warns them to "be cautious. Your lives are in danger. Come to my shop as soon as you can." Obviously, the miners never received the message, as it was still waiting for them. The spotted Ithorian is Poliss, but the Rebels shouldn't know that without doing some digging.

3. Kel Tag Courts. Three courts are available by reservations for any guests who wish to try the Ithorian sport.

4. HoloTheaters. The latest holovid movies from the Galactic Core are shown in the three theaters. One of the men matching the miners' descriptions was in the theater yesterday afternoon.

5. The Jungle Cafe. Moderately-priced meals for the traveler on a budget. The host remembers that two men matching the miners' descriptions came by for breakfast yesterday morning. They tipped well. Belinda Vog and two members of her

crew are enjoying a meal here when the Rebels arrive. She looks up when they enter, smiles at one of the male Rebels, then returns to her meal.

The host, as with most of the Ithorians the Rebels will encounter, refuses to answer any other questions, feigning ignorance. A young Sullustan eating alone, however, motions them to come over if they have been trying in vain to get answers from the host. The Sullustan nods briskly at all of the questions the Rebels ask, but offers only vague responses such as, "Yes, I've heard of that," or "I seem to recall that that's correct." If they ask about Kamiroz, however, his eyes light up and he says, "Kamiroz is a crime lord from Roche system. There was a report on him on last night's holonews broadcast. I hear he's starting a gang war with Jabba the Hutt!" This, of course, is not true.

6. Isttu Galactic Bank. The bank serves a number of functions for the guests in Isttu Village. It provides a secure vault for storing valuables. Its computer system can hook into the Imperial Galactic Bank to transfer credits for purchases. It also has an exchange desk for transferring member planets' money into galactic credits. Visitors without galactic credit equivalents must use the services of the credit changer over in the merchant's block.

While visiting the bank, the Rebels get to witness a bank robbery. A gang of six thugs has decided to pull a job within the confines of *Bazaar*. They are none too bright, and have not figured out all of the consequences of their actions. But they are dangerous, and innocent people could get hurt before the Ithorians are able to bring them under control — including the Rebels. If the Rebels decide to intervene, the thugs fight until *wounded*. *Wounded* thugs surrender, and when only two remain unwounded, they surrender as well (unless they seem to be winning).

The thugs aren't after credits. After all, credits never change hands; they are moved back and forth over computer lines. Instead, they want the planetary money which has been filling the vaults since the first visitors arrived. Then they plan to go down to the planet *Bazaar* is orbiting and live like kings.

If the Rebels don't intervene, the thugs make off with a pile of money and with all of the valuables the current bank customers were carrying, including whatever they can find on the Rebels. They will also seriously injure a young woman who resists when they snatch her carry bag. The Ithorians will catch the thugs before they reach their ship, and all valuables will be returned the following day.

PLAYER MAP: Isttu Village

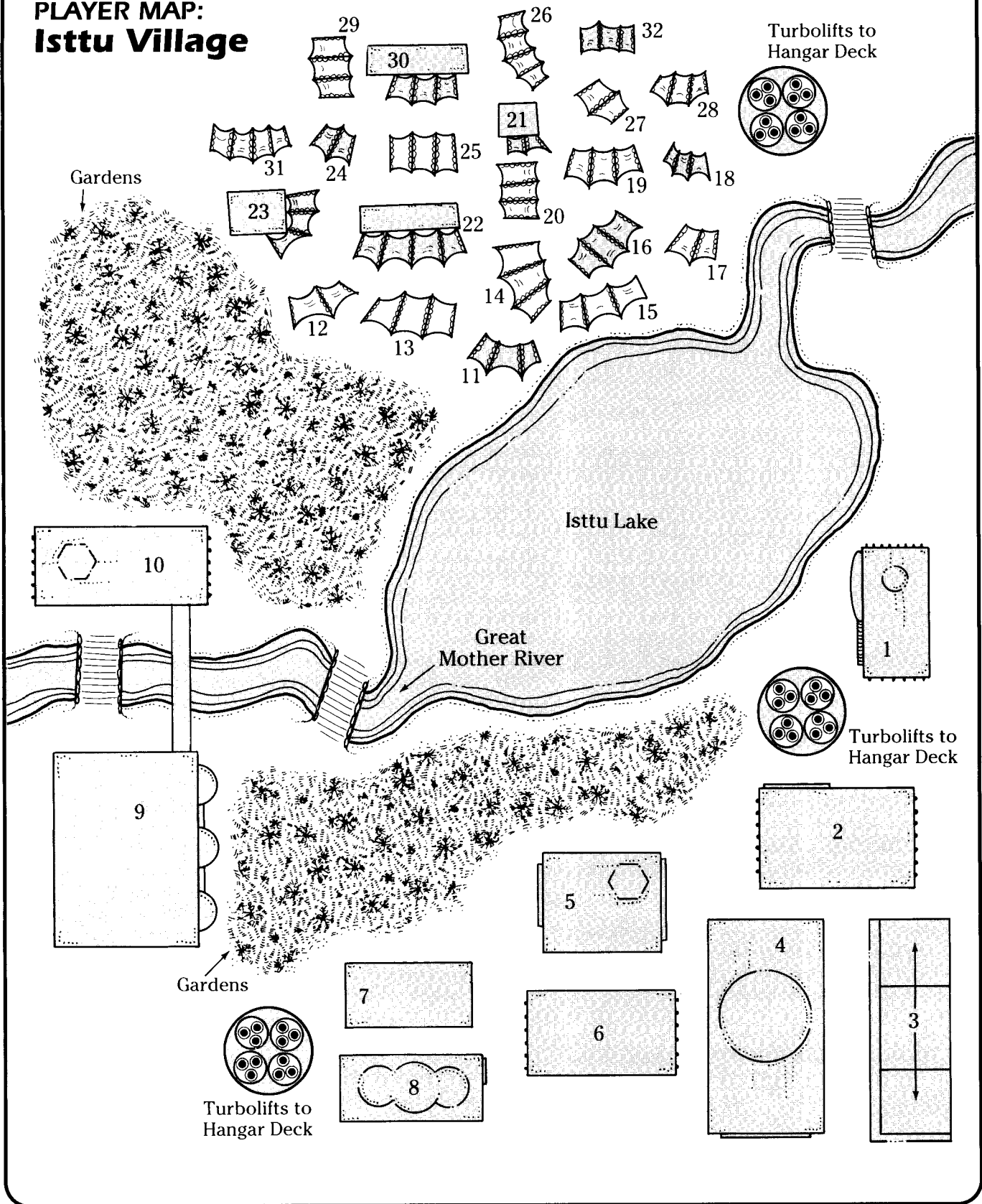

Cathleen Hunter

If the Rebels do intervene and restrain the thugs before anyone gets hurt, they receive the gratitude of the local merchantate, a reward of 50 credits each, and dinner at the Council House with the local council members and any important guests.

If the Rebels try to stop the thugs and things get out of hand, Dal Rogos jumps in to help them. It's one of the acts he uses to secure his undercover identity and build trust.

6 Thugs. All stats are 2D except: *blaster 3D, brawling parry 2D+1, dodge 2D+2, melee combat 2D+2, con 2D+1, Strength 2D+1, brawling 3D*. Move: 10. Blaster pistol (4D), club (STR+1D).

7. Merchant Council Building. This two-story, finely-appointed structure is the heart of the village. Here, the local merchantate (village leader) has offices, and the village's merchant council meets to decide policy and regulate commerce. The merchantate also serves a diplomatic function, attending to any beings that require legal or governmental aid. The local peacekeepers are also stationed here.

If the Rebels decide to report the assassin droid's attack, this is where they must come. The merchantate will question them with the aid of a protocol droid, ask them their business on *Bazaar*, and check their visitor passports. As long as they are polite and don't tell conflicting stories, the merchantate thanks them and sends them on their way with his assurances that the matter will be fully investigated.

If they did not stick around to help Hanos Darr against XS3 but still reported the incident, then the merchantate will send two peacekeepers to gather up the Rebels and bring them back to the council building a few hours later. He asks them the same series of questions, looking for any discrepancies. When he is satisfied that they are innocent, the merchantate informs them that the man they saw running through the jungle was found murdered. He died of multiple blaster shots to his body. He asks the Rebels not to leave *Bazaar* without first clearing it with his office, but otherwise they are free to continue their visit.

If the Rebels sneak into the building, they can access the herd ship's computers (Moderate *computer programming/repair* roll for each piece of data) to find out about the current guests. They can check names to find out occupations, arrival and departure data, and where the guest is staying. Checking for Darr or Kamiroz shows that they arrived together, are registered to leave in two days, and are staying at the Inn on Isttu Lake. They are listed as miners. Dal Rogos arrived right after the miners, is scheduled to depart in four days, and isn't registered with any inns. He is listed as being a languages teacher

from Gendoraan. Belinda Vog has been aboard *Bazaar* since it entered the system a week ago, and is set to leave tomorrow. She is listed as the chief executive of Vog Salvage, Inc.

If the Rebels subsequently foil the bank robbery attempt, they are invited to the council building for dinner. Here they meet all of the top merchants and their families. The Ithorians can tell them that the Graveyard is what the asteroid field created by the destruction of Alderaan is called, that they have heard of a fabulous treasure being found recently in the Graveyard, and that Belinda Vog has been asking the same kind of questions as they have. Someone remarks that one of the female Rebels (if there are any) looks like that traitorous Leia Organa (what a terrible Senator she turned out to be!), while another comments how one of the young male Rebels looks like that awful Luke Skywalker-or-other, whose likeness was on a recent Imperial Most Wanted hologram report. If they protest that they aren't these people, they get doubtful glances. If they say nothing or actually claim they are the Heroes of Yavin, they hear mumbled "I knew it"-type phrases from the crowd.

Merchantate. *Dexterity 3D, melee combat 3D+1, melee parry 4D, Knowledge 3D+2, Mechanical 2D, Perception 2D+1, command 4D+1, con 4D+1, Strength 3D, Technical 2D+2*. Move: 10. Staff (STR+1D)

Peacekeepers. *Dexterity 2D, blaster 3D, brawling parry 3D, dodge 3D, melee combat 2D+2, melee parry 2D+1, Knowledge 2D+2, Mechanical 2D, Perception 2D+1, command 3D+1, search 3D+1, Strength 2D, brawling 3D, Technical 2D*. Move: 10. Blaster pistol (4D), force pike (STR+2D), comlink.

8. Medical Center. This full-service medical center features the latest in medical droids, bacta tanks, and emergency medical care. It is supervised by Dr. Heltiss, one of Ithor's finest physicians. If the Rebels have the time and the money, most battle damage can be repaired at this modern facility. Doctors here have the advanced skill *medicine* from 4D to 7D, and treatment fees vary according to a doctor's skill. Add 25 credits (for a 4D skill) to 100 credits (for a 7D skill) to the costs listed below.

- Medpac healing: wounded, 150 credits plus doctor fee; incapacitated, 400 credits plus doctor fee; mortally wounded, 700 credits plus doctor fee.
- Bacta tank healing: wounded, 75 credits plus doctor fee plus 2D hours; incapacitated, 150 credits plus doctor fee plus 2D days; mortally wounded, 300 credits plus doctor fee plus 2D weeks.

9. Great Mother River Hotel. The Great Mother River Hotel is as elegant and expensive as its name suggests, set aside for the comfort of the



Allen Nunis

wealthiest visitors. The hotel rates among the best of the intergalactic five star establishments, with full accommodations, services, and entertainment extravaganzas. Top-name talent from the Core can be seen performing nightly in its club, and its health spa is ranked alongside the facilities on the *Kuari Princess*. At 100 credits plus per night, those who can afford to stay here say it is worth it.

10. Great Mother River Restaurant. Across the river from the GMR Hotel, the River Restaurant is joined to the elegant establishment via a skywalk, and shares all of the opulence and expensive taste of its companion facility. The fare here is all top-line, high-priced galactic cuisine, accompanied by 200-credit-a-bottle wines, strolling minstrels, and dessert carts to tempt even the steadfast dieter.

A current favored diner is Kapin Toologin, who takes breakfast, lunch and dinner at a table overlooking the gardens. Rumors from the cantina claim that the Twi'lek is a powerful crime lord visiting *Bazaar* on vacation. While he is on vacation, he is not a crime lord. Toologin is an insurance salesman. The Rebels, if they believe the rumor, may come to Toologin for information. The Twi'lek has an air of self-importance that may lead the Rebels to think they've come to the right person. He can tell them a little about the miners, as he watched them walk through the garden while he was eating lunch. He noticed

that they split up after a brief discussion on the garden path; one headed out of the village, the other toward the merchant block. If coaxed, he remembers one other thing. There were two other people in the garden around the same time. No, that's not quite right. There was a person and a black, nasty-looking droid. He thought it odd that the droid followed the first miner out of the village, while the other one went in the direction of the merchant block. When the discussion begins to wind down, Toologin tries to interest the Rebels in some insurance. While they may think he is offering them extortion protection or some other underworld bill of sales, he is just trying to push policies for his insurance company.

11. Ithorian Delicacies Food Stand. Exotic vegetarian food fit for an Ithorian king is on sale at this stall. While the food is edible by non-Ithorians, it is not always palatable. Featured foods are hoyy seeds, liwi fruit, and covado salad.

12. Ithorian Craft Shop. Craft master Jerru demonstrates ancient Ithorian plant-forming techniques, and also sells his wares. Most are considered high art throughout the civilized galaxy. Jerru is an Alliance sympathizer, and he can direct the Rebels toward Poliss if they ask (and if he thinks they are okay).

13. Data Books. The latest galactic best-sellers, as well as best-loved classics that have not

been banned by the Empire can be purchased here. Data books are small memory chips that can be inserted into a data pad or other input device. The text can then be read over the computer screen, or read aloud by units that possess voice synthesizers, including protocol droids. The shopkeeper is a female Ithorian named Visfuu. She loves to talk to visitors, and will tell the Rebels that a man matching Kamiroz's description was by earlier today. He purchased "Poems of Alderaan" before moving on. There was also another person asking about him, a woman who did not give her name. This was the second assassin, but don't let the Rebels know that yet. See "Finding Kamiroz" for more details on the second assassin.

14. HoloVids & Music. Holograms and sound slugs from the top of the galactic charts.

15. Galactic Footwear. Foot gear for everyone, from humans to the largest aliens. Reasonable prices.

16. Clothes for Him. This clothing shop has an interesting discussion going on when the Rebels arrive. The shopkeeper, Leww, is listening as an old spacer tells him about the ghost ship he saw while passing by the Graveyard. "It was an Alderaan War Frigate," the spacer recalls, "the likes of which I haven't seen except in holograms of the Clone Wars. It appeared in front of my ship, then before I could so much as run a sensor sweep it was gone!"

17. Clothes for Her. Rebels can find everything from formal wear to casual clothing for human and alien women.

18. Exotic Items. This shop features strange, beautiful, and expensive curios from all over the galaxy. If there is a Jedi character among the Rebels, the Ithorian shopkeeper senses the Force and offers the Rebel an item from his private (and hidden) collection. It is a working lightsaber, which he will sell to the Jedi for 250 credits. If there is not a Jedi, whichever Rebel has the most Force points will be offered the saber for 400 credits.

The shopkeeper also tells them about the rumor he has heard concerning the Graveyard. He says that they have found an ancient Jedi temple within an asteroid, and the stories concerning the Royal Palace are being spread to hide the truth.

19. Fast Food. Reasonably-priced food served quickly and with little fanfare.

20. Jewelry. This stall features both expensive and imitation jewelry, from rings to neck-

The Lightsaber

The lightsaber that the Ithorian merchant sells to the player characters should be the object of some speculation. Where did it come from? Whose was it? Were they a true Jedi, or had they succumbed to the dark side of the Force? Natural curiosity should prompt these questions from the players.

The lightsaber belonged to a student of the late Jedi Master Darrin Arkanian, a Sullustan Force-user of some skill who fell in battle with High Inquisitor Tremayne during an attempted rescue of one of his students. Arkanian's pupils (and there were several) have been scattered throughout the galaxy during Palpatine's reign, and many are actively searching for each other, both for mutual protection and for the purpose of furthering their Force studies. Player characters who have the skill *scholar: Jedi lore* or *scholar: lightsaber histories* and who make a successful Difficult skill check will recognize the basic design and history of the saber. Otherwise — other than the Ithorian's brief recounting of how he acquired the weapon — the lightsaber should remain something of an enigma.

This particular lightsaber was brought to *Bazaar* by a young human female who identified herself as Shavree. Shavree claimed the saber was hers, though this may not be true, since she did not demonstrate any Force skills. She was seen offering the saber for sale to Dal Rogos, who indicated that he was not interested in purchasing "illegal weapons."

The Ithorian shopkeeper, not a fan of Imperial policy by any stretch of the imagination, pulled the young woman aside, and purchased the saber in return for a promise to hide her from Imperial forces that were searching for her. What the shopkeeper doesn't know is that Rogos kept an eye on her, and before the Ithorian could hide her, turned her in to Imperial authorities. The Ithorian shopkeeper never saw Shavree again.

(For more information on Darrin Arkanian, see pages 8–9 of *Galaxy Guide 9: Fragments from the Rim*.)

laces to fancy chronometers. The shopkeeper will also purchase jewels and precious metals. He is talking to a member of Belinda Vog's salvage crew when the Rebels enter, discussing the rumors of the discovery of Alderaan's Royal Treasury in the Graveyard.

21. Spaceship Sales. Used space vehicles of the tramp freighter variety can be viewed on holovid and purchased here. The salesman knows Kamiroz, he claims, if the Rebels ask. He says that Kamiroz is an Imperial admiral sent to negotiate leave rights for the Imperial Fleet.

22. Gossit's General Store. Anything the space traveler needs in the way of supplies (except for weapons, armor, or space suits) can be purchased here. It is well stocked and only slightly expensive.

23. Poliss's Droid Shop. This shop features new and used droids, computers, and droid services such as memory wipe, programming, and restraining bolt installment.

When the Rebels arrive, Poliss mistakes them for Princess Leia and her companions, especially if one of the Rebels is carrying a lightsaber. He sent a message that Leia should come immediately and the Rebels showed up using the appropriate code phrase. He tells them that Kamiroz is safe. Go to "Finding Kamiroz" to run the encounter.

24. Travel Broker. The travel broker can secure passage between the major systems for those who need to get from one point in the galaxy to another. His rates vary depending on the mode of travel. He can arrange passage aboard luxury liners, charter yachts, or even cargo ships that need extra crew members.

25. Credit Changer. This pawn shop and credit changer serves those who do not have galactic credit accounts or currency from planets recognized by the Imperial Banking Commission. Kamiroz was here yesterday exchanging some *heret* ore for credits. The changer believes he is a bounty hunter searching for a party of Rebels.

26. Weapon Shop. Personal melee and ranged weapons for sale. Equet, the shopkeeper, is recruiting men and women to serve as mercs in the Minos Cluster. This can be used to set up a future adventure. For more information on the Minos Cluster, see *Galaxy Guide 6: Tramp Frieghters*.

27. Armor and Space Suits. Protective gear for sale, including breath masks.

28. Cloth and Fabric. Sold by the bolt.

29. Imperial Recruitment Center. Enter Imperial service through this recruitment center. Army, navy, security, scouting, and auxilliary service branches are available.

The center is run by Enger Mowen, a fat human, grotesque in size and personal habits. He

planted a rumor that he is looking to recruit Rebels for the Alliance. He is actually taking names to give to the ISB.

30. Recreational Goods. Sports equipment for sale.

31. Farmer's Market. Run by a broker handling crops from neighboring systems, looking to connect those who have with those who need.

32. Village Healer. An Ithorian healer with 3D *first aid* and an ample supply of medpacs. His services, including the use of the medpacs, cost: wounded, 75 credits; incapacitated, 150 credits; mortally wounded, 250 credits.

Encounter: Finding Kamiroz

Poliss tells the Rebels (whom he believes to be the famous Princess Leia and the Heroes of Yavin), that Kamiroz is an Alliance agent just back from the Alderaan system. He has important information that he will only share with the Princess. Poliss discovered that others were looking for the miner and sent him into hiding. If Hanos Darr survived the assassin droid attack, Poliss explains that he is waiting with Kamiroz.

"He is safe with the priest in the Mother Jungle," Poliss explains. "You may go below and speak with him."

If the Rebels go below, read:

The Mother Jungle is — exactly as the name implies — a beautiful tropical jungle. A light rain is falling as you enter, and you can hear the distant call of some wild animal. As you begin to look around, a tall Ithorian steps out of the trees. From his garb, you can tell that he is a priest.

"Hurry," the priest tells you. "Evil ones have invaded the Mother Jungle, and they seek to kill the Mother's guest."

He points toward a path that was camouflaged a moment ago, and you hear the distinctive sound of blaster fire shatter the calm melody of the falling rain.

If the Rebels race down the path, they reach Kamiroz after he has taken a number of blaster shots. His attacker is the assassin, Ferreges, a human female hired by the Empire to hunt down and eliminate the miners. If XS3 was not destroyed in the earlier encounter, it is here, too (as is Hanos Darr if he survived). The assassin(s) fight to the death.

Ferreges. *Dexterity 4D, blaster 5D, dodge 5D, grenade 5D, melee combat 5D+1, Knowledge 2D+2, streetwise 3D+2, Mechanical 2D+2, space transports 3D+2, Perception 3D, con 4D, hide 4D, search 4D, sneak 4D, Strength 3D+2, brawling 4D+2, Tech-*

Cut-Away to Princess Leia

Read aloud:

EXTERIOR: KWENN SPACE STATION. *The camera pans past the Millennium Falcon, docked at the station, finally zooming in on a viewport.*

INTERIOR: KWENN SPACE STATION. *Princess Leia Organa, leans over a wounded man. Luke Skywalker and Han Solo stand beside her. She turns to Luke.*

"They've found my father," Leia says quietly. "We've got to go back to Alderaan."

Luke Skywalker nods.

Cut to ...

INTERIOR: **BAZAAR'S HANGAR DECK AND THE REBEL HEROES.**



Allen Nurnik

nical 2D, security 3D. Move: 10. Heavy blaster pistol (5D), protective vest (+1D physical, +1 energy).

Ferreges is a tall, blond human female, with an exotic, wild look. She has been mistaken for Belinda Vog throughout the *Bazaar*, but there is a significant difference between the two. Ferreges is totally ruthless and as unemotional about her job as the droid she is teamed with.

When the battle is over, Kamiroz is *mortally wounded*. He tells the Rebels the following before he lapses into unconsciousness.

"Thank the Force you came," the wounded man manages to say through his pain, obviously hallucinating. "They found the Palace. The Royal Palace. It's in the Graveyard. Go to

Mining Outpost 11. The report was filed there." He shudders as pain wracks his body. "One scout also said they found ... Bail Organa ... hurry ..." With that, Kamiroz falls unconscious.

If the Rebels take the wounded man to Poliss, he will see to it that Kamiroz receives treatment. He urges them to act on whatever information the man relayed to them, for others are growing more interested — and more bold.

The next step is for the Rebels to recover their ship and head to the Graveyard to check on Kamiroz's story.

Asteroid 7785

The Rebels should feel a fair amount of skepticism about the possible survival of the Royal Palace on Alderaan. After all, how could anything have withstood the devastating power of the Death Star's superlaser?

In fact, the portion of the palace that survived was little more than a fragment, and a predominantly underground portion besides. During the rise of Palpatine, and the period in which Bail Organa opposed the Emperor's ascendance to power, the Alderaanian government realized that they were open to reprisals from the Imperial Navy; a Star Destroyer would make short work of the palace, and there was little that planetary security forces could do to stop such an attack.

As a result, Bail Organa's security experts began shielding various underground sections of the palace with a mono-molecular material — tightly bonded at a nearly subatomic level — that is nearly impervious to

harm. The underground chambers in the palace were equipped with this shielding, but since the process is extremely expensive (and highly regulated) only small portions of the palace could be protected. To armor large portions of the palace would have called official Imperial attention to the operation, inviting a preemptive strike. It is these small, underground chambers that have survived the destruction of Alderaan, and several of the sealed systems used to maintain independent power and life support in an emergency remained active, albeit barely.

As tough as mono-molecular shielding is, it has still been subjected to a super-weapon of immense power, however. Several of the shielding plates have buckled or cracked, and the ruins of the underground chambers are merely marking time before they collapse and vent the last scraps of atmosphere into the cold vacuum of space.

Episode Two Walking in the Graveyard

Summary

This episode takes place in the Graveyard of Alderaan, an asteroid field made from the shattered chunks of the once-great planet. The Rebels arrive here after sorting through the many rumors floating around *Bazaar*, and after receiving the message from Zaz Kamiroz that was intended for Princess Leia.

The episode opens with a terrifying encounter with the ghost ship that haunts the Graveyard. Then, at Mining Outpost 11, the Rebels find the survey team's log and the location of the Palace site. A harrowing run through the asteroid field — dodging asteroids, droids, and Vog's salvage team — ends when the Rebels reach the asteroid designated as 7785.

Encounter: Ghost Ship

The Rebels emerge from hyperspace outside the asteroid field that was once Alderaan. Sensor checks indicate no other ships currently in the vicinity, but a Moderate *sensors, communications or Mechanical* roll by the Rebel operating the sensors allows him to pick up vague communication transmissions from within the asteroid field.

Then, as the Rebels are deciding their next course of action, the following occurs. Read:

The expanse of space and the view of the swirling asteroid field beyond your viewport is suddenly blocked by the appearance of a huge spacecraft. It is directly in your path, looming like a mountain before you. At your current rate of speed, you estimate impact in less than one minute.

Now call for a *space transports* roll and use the following results to describe what happens.

- *Very Easy*. If the pilot generates a 3 to 5 with his roll, he cannot change course significantly. He struggles with the controls as his ship flies closer and the ghost ship looms larger. The Rebels' ship smashes into the ghost ship, but before the impact can even register, the ghost ship disappears.

The Rebels' controls are ionized for 1D rounds.

- *Easy*. If the pilot generates a 6 to 10, he veers his craft enough to only sideswipe the massive vessel before it disappears. The Rebels' ship loses 1D of shields.

- *Moderate and above*. If the pilot generates an 11 or better with his roll, he is able to maneuver his craft beneath the massive ghost ship. The Rebels fly along its underside for a few seconds, marveling at the size and workmanship. Then, as they watch, the ghost ship disappears.

Rebels can make Difficult *value or Knowledge* rolls to see if they recognize the ship type. Anyone who makes a Difficult roll remembers seeing the vessel in holotexts. It was an Alderaanian War Frigate, from the time of the Clone Wars before Alderaan destroyed all of its weapons.

Another Rebel can check the sensors to find out what happened to the ship. A Moderate *Perception* roll determines that the ship didn't just disappear; it jumped to light speed.

Mining Outpost 11

Once the Rebels enter the asteroid field, they begin picking up signals from navigation beacons. They can follow these signals to the Alderaan system mining station — Outpost 11. The outpost is run by Kathos Loof, but all of his miners have been replaced by Imperial agents. He goes along with their subterfuge, hoping that this Imperial business will end soon so that he can get on with the business of mining asteroids.

If the Rebels announce themselves, the mining outpost directs them to a bay in the hangar. Any cover story the Rebels offer is accepted, as the miners (who are actually Imperial agents) want the Rebels to enter the outpost and find the location of the Royal Palace. Once the Rebels dock, a message is sent to Lord Darth Vader, informing him that they have arrived. The Imperial Fleet will arrive later in the adventure, just before Princess Leia.



Allen Nurnis/Carlos Garzon

Below are descriptions of the various sections of the mining outpost, as well as a number of encounters that can occur within it.

Mining Outpost, Exterior

1. The Main Station. This three-level structure contains the main living and working areas of the outpost.

2. Docking Bays. The outpost's three shuttles and cargo ship are docked here. One of the shuttles has actually been refitted to serve as a stormtrooper assault shuttle.

3. Smelted Ore Storage. Mined ore that has been processed through the smelting unit is stored here.

4. Solid Ore Storage. Mined ore in its solid state is usually stored here, but the section has been converted into barracks for the two platoons of stormtroopers under Captain Janus Bonn's command.

5. Solid Ore Processing Plant. Droid-controlled processing plant for separating ore from worthless rock.

6. Smelted Ore Processing Plant. Droid-controlled processing plant for removing impurities from pure metal.

7. Mine Shaft Core. Shaft connecting the outpost to the mine dug into the asteroid.

Mining Outpost, Upper Level

1. Access to Mine Shaft. This repulsor-field tube carries miners and their equipment to and from the mines. Leaping into the right side of the tube automatically activates the field and gently lifts a miner upward. They return via the downward field on the left.

If the Rebels enter the mines on their own, go to "Encounter: The Laser Skiff."

2. Corridor. The main corridor on the level connects all of the various chambers, as well as the far turbolifts up to the processing facilities.

3. Mining Vehicles, droids. Labor droids and the specialized vehicles used in the mines are stored here. Vehicles include two laser skiffs (for tunneling) and four repulsor ore carts. The droids are programmed to do one type of work, to dig, and are not very bright or good at communicating.

4. Workshop. Equipment repairs are done here in this fully-equipped workshop. Rebels may use the equipment to repair any of their items if they so desire.

5. Mine Command Center. Kathos Loof is usually found here amid the banks of monitors that show views of the mines. In addition, when

the miners go into the tunnels, Loof can monitor their progress through cameras attached to their mining rigs.

The information the Rebels are after can be found in the command center's computers. At night, there is no one on duty within the center (as per Captain Bonn's orders). Go to "Encounter: Information Run" if the Rebels come to this room to access the computers.

6. Sick Bay. An MD-5 medical droid runs this small, six-bed facility.

7. Quarters. Room to sleep 10 miners.

8. Quarters. Room to sleep 10 miners.

9. Equipment Storage. Mining equipment, including vibropicks, power shovels, and power hammers are stored in this locked chamber. The important mining rigs are here, as well. These frames are worn by the miners, and provide a number of essential tools and aids. The rig includes lights, ore sensors, comlinks, three different laser drills, a camera sending information back to the command center, breath mask attachments, and a limited use jet pack for minor jumps.

Mining Outpost, Middle Level

10. Power Core. The generator that supplies power to the outpost is found here.

11. Corridor. The main corridor on the level connects all of the various chambers.

12. Storage. Food, water, and other necessities are stored here.

13. Lounge. This chamber features reclining chairs, data book screens, and holovid viewers for the miners' entertainment and relaxation.

14. Rec Room. This room contains recreational games such as holochess, a sabacc table, and a holo slaf course. If the Rebels enter this room on their own, go to "Encounter: The Miners."

15. Galley. Food processing units and tables.

16. Computer Room. All of the computers located throughout the outpost are actually satellite stations of this mainframe computer. The information the Rebels are after can be accessed from this room. If they come here on their own, go to "Encounter: Information Run."

17. Outpost Command Center. All stations, storage and processing facilities, and the hangar are monitored from this command center. In addition, regular sensor sweeps of the asteroid field are made from here. Loof gives command of the center to one of his lower officers, as he prefers to monitor the mines. The information that the Rebels seek can be accessed from here; see "Encounter: Information Run."

Mining Outpost, Lower Level

18. Auxiliary Power Core. The emergency generator is found here.

19. Corridor. The main corridor on the level connects all of the various chambers.

20. Command Quarters. This apartment is used by Loof and his three shift officers. If the Rebels want to approach Kathos Loof, go to "Encounter: Kathos Loof."

21. Hangar/Repair Station. This lift platform down to the hangar also contains tools and work droids used for repairing ships.

22. Storage. More supplies are stored here.

23. Life Support Systems. The outpost's life support machinery is here.

24. Hangar/Repair Station. Another lift platform and repair station.

25. Asteroid Tracking and Mapping Station. This holomapping chamber identifies and tracks asteroids through their orbits, reporting any approaching dangers to the command centers above. The Rebels can access the information they seek from this room; see "Encounter: Information Run."

A. Solid Ore Storage. This section of the outpost has been converted into stormtrooper barracks. It can be entered through doors on the lower level, but these require a Very Difficult *security* roll to open. If the Rebels decide to enter this section, go to "Encounter: Stormtroopers."

B. Smelted Ore Storage. All of the smelted ore is stored here in giant holding tanks.

Outpost Encounters

Here are the encounters that can occur on the mining outpost. Gamemasters are encouraged to add additional encounters if the course of their adventure dictates them. Note, not all encounters must occur, and they may occur in any order depending on what the Rebels decide to do.

Encounter: Kathos Loof

If the Rebels decide to approach the leader of the mining outpost, they are directed to Kathos Loof. He can usually be found in the Mine Command Center (5) during the main work shifts, in the galley (15) at meal time, or in his quarters (20) during the evening shift. How he behaves toward the Rebels depends upon when and where they approach him. See Loof's template in the "Character Templates" section for his statistics and profile.

Approaching Loof in the Mine Command Center: Here Loof is all business. He had miners by the



Allen Nurnis/Carlos Garzon

names of Hanos Darr and Zaz Kamiroz here during the last work tour, but they decided not to sign on for another tour. They were good workers and never caused trouble. If they ask about any recent discoveries, Loof scoffs at them and tells them to get out of his command center because "I have real work to do."

Approaching Loof in the Galley: If the Rebels catch up to the mining chief here, Loof tells them the same information about Darr and Kamiroz, but he seems nervous. Any Rebel who makes an Easy *Perception* check notices the other miners in the galley watching the exchange. A Moderate roll gains the added bonus of seeing Loof's eyes dart from the miners to the Rebels and back again. If they ask about recent discoveries, Loof pauses, looks around at the miners, and says, "There was a survey team through here a few weeks back. They logged a report via our comm unit, then left." With that, Loof takes his mug of hot juice and leaves.

Approaching Loof in his Quarters: This approach yields the Rebels the most information. Loof is alone in his apartment when the Rebels arrive. He ushers them in, checks the corridor, then shuts the door. He tells them that most of his last tour decided to leave after the survey team passed through. He doesn't know what the team discovered out in the asteroid field, but he has heard lots of rumors. He tells the Rebels a

**GAMEMASTER DIAGRAM:
The Mining Outpost**

**Outpost Exterior
Side View**

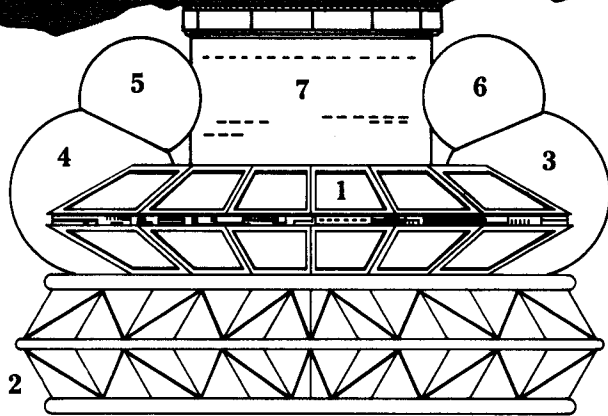

Upper Level

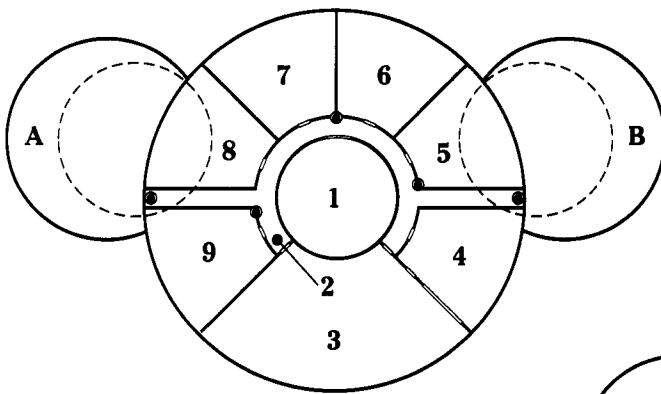

| Side View Key | |
|----------------------|-------------------------------|
| 1. The Main Station | 5. Solid Ore Processing Plant |
| 2. Docking Bays | 6. Smelting Plant |
| 3. Smelting Plant | 7. Mine Shaft Core |
| 4. Solid Ore Storage | |

Middle Level

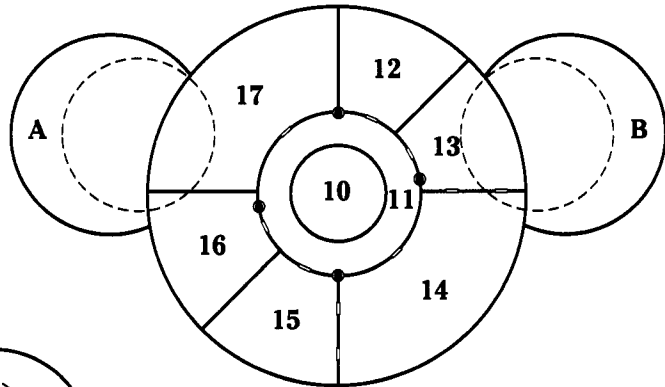

Lower Level

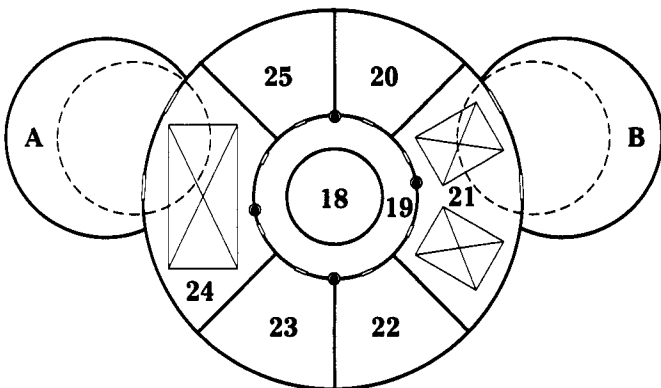

- Turbolift
- Door
- ⊠ Lift Platform

code that will reduce all difficulties when using the outpost's computers by one level. Then he says, "I don't know what's going on, but I know it involves the Empire. I've got nothing against them, but if you plan on crossing them, you best do it very carefully." If the Rebels convince him of their good intentions and make a Moderate *bargain* roll, he adds: "I don't know what they found out there, but I guess it doesn't matter to them. They just want someone named Leia and some kid named Skywalker. If that's you, I'd suggest you get in your ship and fly away very fast."

Further discussion ends when one of Loof's shift officers enters the apartment.

Encounter: Does Anyone Know Zaz Kamiroz?

If the Rebels start asking questions about Kamiroz, the miners on the station offer many different answers. Miners who are working become annoyed at the intrusion and warn the Rebels to leave them alone. Miners in their quarters (7, 8) or in the lounge (13) explain that they knew Kamiroz and his friend Darr very well. They decided not to sign on for another tour and recently left the outpost. Miners in the rec room (14) decide to have some fun with the Rebels. Go to "Encounter: The Miners." Those in the galley (15) explain that Kamiroz was actually a bounty hunter who posed as a miner for a short time. Once the survey team came through, they say, continuing the lie, he left the outpost.

If the Rebels ask questions about any of the rumors concerning the Graveyard, the miners embellish the tales with stories of ghosts walking the outpost corridors, giant space slugs, and spider-like aliens living in Asteroid 7785. None can keep straight faces while telling these tall tales, and the miners break up into fits of laughter.

See the template in the "Character Templates" section for miners' statistics and profiles.

Encounter: The Miners

If the Rebels approach the miners taking a break in the rec room, they become the target of a group looking for trouble. These miners tell the Rebels that they ask too many questions. If it's a lesson they want, then the miners are just the teachers they've been looking for. What follows is a good, old-fashioned brawl. None of the miners will use anything more deadly than a club unless the Rebels draw energy weapons. Then they will match the weapons in kind. But if the Rebels stick to fists and clubs, then the fight ends once one side or the other is knocked out. There are eight miners in the rec room, and all join in the brawl.

Encounter: The Laser Skiff

If the Rebels go into the mine, they wind up victims of an unfortunate accident which is actually a test to determine if they are the Heroes of Yavin. A run-away laser skiff comes blasting into the tunnel they are in. It fires two shots every round, and tracks movement with its sensor array. It fires at the closest moving Rebel every time it takes a shot. Anything smaller than one meter doesn't attract its attention. It continues to fire until it is brought under control or destroyed. Some methods for stopping the skiff include:

- *Destroying the Skiff.* If the laser skiff receives enough damage to *incapacitate* it, it stops shooting. A *mortal wound* destroys it.

- *Knocking Out the Sensor Array.* If the Rebels *incapacitate* the sensor array (Difficult to hit, STR 2D), the skiff becomes "blind." It can no longer target the Rebels, but must shoot blindly. Increase its difficulty to hit by one difficulty level.

- *Taking Control of the Skiff.* A Rebel can attempt to jump atop the run-away skiff (Difficult check).

If the Rebel makes it, he can then work on unlocking the controls and turning the skiff off. This requires a Moderate *security* or an Easy *repulsorlift operation* roll to turn off the engine.

If the Rebel fails the *climbing/jumping* roll by as many as 5, he simply misses the moving skiff. If he fails the roll by *more* than 5, the skiff rolls over him, causing 5D damage.

- *The Heroes of Yavin?* If the Rebels bring the laser skiff under control, or if they manage to

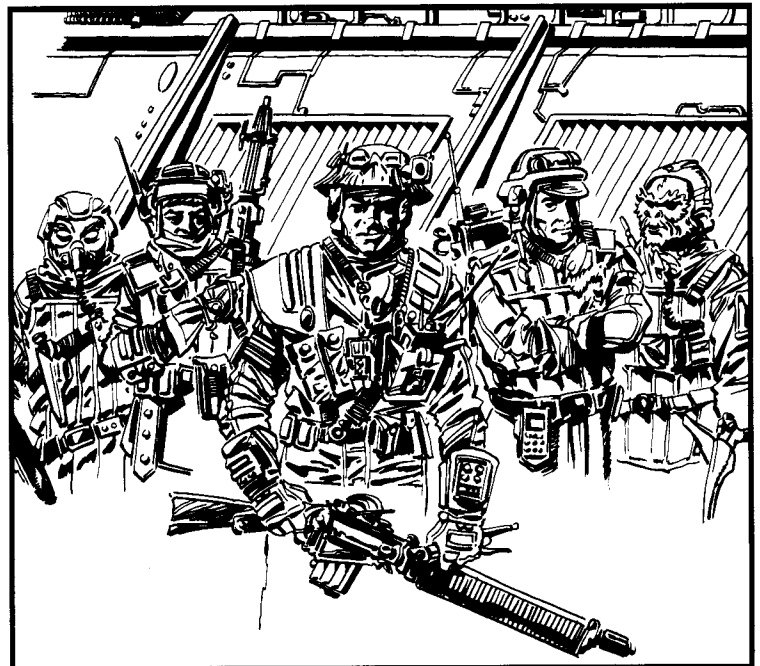

Allen Nunns/Al Williamson

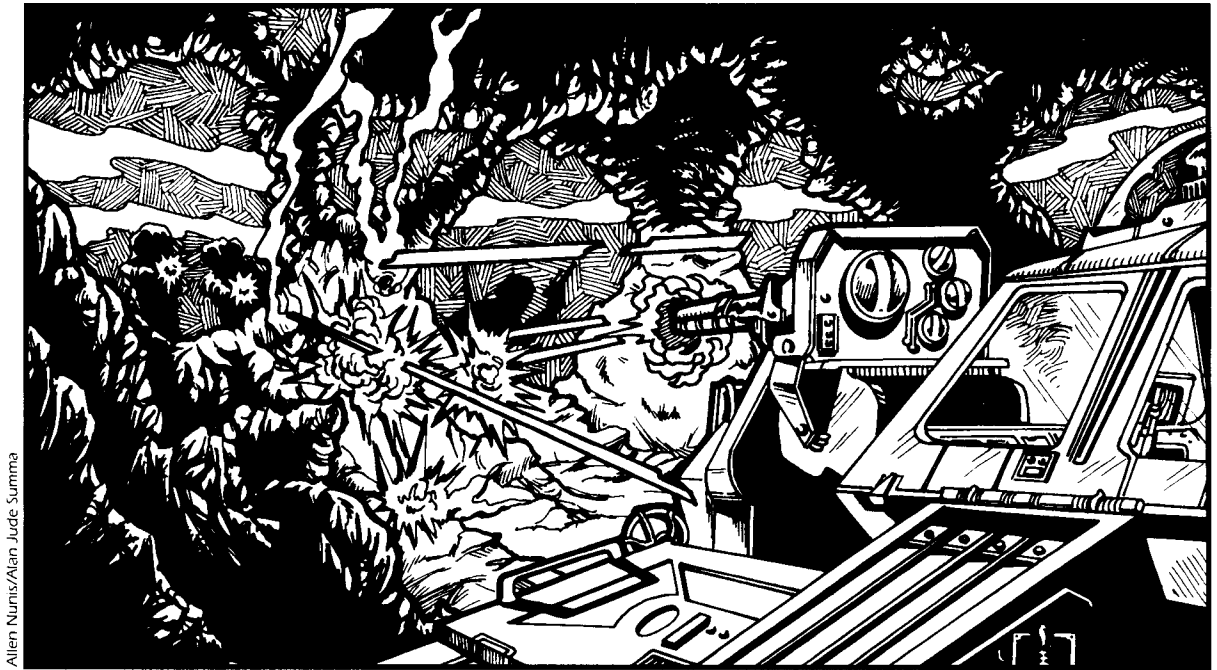

Allen Nunns/Alan Jude Summa

destroy it, the miners are convinced that these are indeed the Rebels that Darth Vader is looking for. This impression is fortified if any of the Rebels use a lightsaber or Force power, or if there is a Wookiee with them.

Laser Skiff. Speeder, move 45; 130 kmh, body strength 5D (front only), 2D (sensor suite), 3D everywhere else. Weapons: modified mining laser cannon (fire control 1D, 25/50–75/100, damage 5D).

Encounter: Dal Rogos

The Imperial Security Bureau agent follows the Rebels to Outpost 11. As he does not know that the outpost and the rumors are part of a plan set in motion by Darth Vader, he sneaks aboard the outpost and watches the Rebels to see what they are up to. When they enter one of the various computer stations throughout the outpost to access the survey team report, Rogos makes his move. As such, this encounter is used as part of “Encounter: Information Run” below.

If the Rebels take precautions while accessing the computers (such as setting a watch), then they have a chance of spotting Rogos before he strikes (Moderate *Perception* check by Rebel on watch). Otherwise, Rogos gains surprise.

Rogos attempts to stop the Rebels from accessing the computers. He is sure they are Rebel agents. In fact, he believes they are the so-called Heroes of Yavin. Still, that doesn’t scare him. He uses every trick he can think of to capture the Rebels. First, he locks the door to the chamber they are in. Then he tries to stun them while

taking cover. He will only use deadly force if he has no alternative.

If Rogos begins to win, and the battle lasts longer than five rounds, then the stormtroopers arrive to help him capture the Rebels. After all, if they can take them here instead of in the Palace ruins, what difference should it make to Vader? However, none of the stormtroopers shoot to kill. They all use their blasters on stun setting. See “Encounter: Stormtroopers” if this encounter takes the appropriate turn.

See Rogos’ template in the “Character Templates” section for his statistics and profile.

Encounter: Information Run

The Rebels have come to Mining Outpost 11 to examine the report logged by the Imperial Survey Team, a report that Kamiroz glimpsed briefly before he left the outpost a few days ago. The report is stored in the outpost’s computer system, waiting like a worm on a hook to snag the Rebels. All of the computer difficulty levels described below can be lowered one level if the Rebels received the proper code from Kathos Loof (see “Encounter: Kathos Loof” above).

Also note that Dal Rogos will attempt to stop the Rebels when they try to access the computers (see “Encounter: Dal Rogos” above). If he is successful, he gains the assistance of the stormtroopers (see “Encounter: Stormtroopers” below).

The computer system can be accessed from a number of places aboard the outpost. These are described below.

The Mine Command Center (5) Computer. This chamber's computers can be accessed by making a Difficult *computer programming/repair* roll. If the Rebels are successful, read them the "Survey Team Report" below. If they make a Very Difficult roll, also read them the "Long Range Comm Message."

The Computer Room (16). This chamber's computers can be accessed by making a Moderate *computer programming/repair* roll. If the Rebels are successful, read them the "Survey Team Report" below. If they make a Difficult roll, also read them the "Long Range Comm Message."

The Command Center (17) Computer. This chamber's computers can be accessed by making a Difficult *computer programming/repair* roll. If the Rebels are successful, read them the "Survey Team Report" below. If they make a Very Difficult roll, also read them the "Long Range Comm Message." Note that there are monitors here that can be manipulated to show the Rebels various sections of the outpost (other than off-duty areas) by making an Easy *computer programming/repair* roll. However, no matter how hard they try, the Rebels cannot get a view of the Solid Ore Storage section.

The Asteroid Tracking Station (25) Computer. This chamber's computers can be accessed by making a Moderate *computer programming/repair* roll. If the Rebels are successful, read them the "Survey Team Report" below. If they make a Difficult roll, also read them the "Long Range Comm Message." If they use this facility to plot them a path through the asteroid field (a Moderate *astrogation* roll), then the pilots receive +2 to their rolls for moving through the field (see "Asteroid Run" later in this episode).

Survey Team Report

If the Rebels make the appropriate *computer programming* rolls, read them the following:

- BREAKVCD7927
- Code Yavin Kill Two
- ImpScoutSecSurv
- Alderaan Sector
- Mission 46/N
- MB1711-V

■ **MB1711-V reporting.** Our exploration of the Alderaan asteroid field has been extremely successful. We have found the ruins of the Royal Palace buried within a large asteroid, designated 7785 by Outpost 11's tracking station. In addition to finding the mostly-intact structure, we discovered something even more amazing. A man who identified himself as Bail Organa, Viceroy of Alderaan, was found living

within the ruins. He refused to return with us to the outpost and was left behind until an exploration team can be sent in.

■ ENDREPBREKbreak

Long-Range Comm Message

If the Rebels make the appropriate *computer programming/repair* rolls, read them the following:

- Imperial Holocall 23564567.8K
- To: Lord Darth Vader
- From: Captain Janus Bonn
- Subject: Classified

■ Lord Vader:

Operation Yavin Kill Two is proceeding according to your plan. This message is to inform you that the Rebel operatives known as the Heroes of Yavin have arrived at Mining Outpost 11 and will shortly be proceeding to Asteroid 7785. We look forward to your imminent arrival and will continue to go ahead as planned. At long last, the hated Skywalker will be yours, as well as Princess Leia and the outlaw Han Solo. I await your presence and your bidding, my master.

Encounter: Stormtroopers

If the Rebels enter the solid ore storage section, or if Dal Rogos triggers their involvement as described in "Encounter: Dal Rogos," then the Rebels meet the stormtroopers assigned to the outpost. There are two platoons stationed here (22 stormtroopers), but only one platoon is on the outpost. The other platoon is waiting at Asteroid 7785.

The stormtroopers have orders not to kill the Rebels, so they are using blasters set on stun. They will combine fire on one Rebel at a time. They will attempt to capture the Rebels if forced to come out of hiding, but would prefer to let them go to the Royal Palace where a more secure trap has been set.

10 Imperial Stormtroopers (augmented squad). All stats are 2D except: *Dexterity 3D, blaster 4D, grenade 4D+2*. Move: 10. Blaster rifle (5D), stormtrooper armor (+1D energy, +2D physical, -1D *Dexterity* and all related skills).

Stormtrooper officer (1 per augmented squad). All stats 3D except: *Blaster 4D, brawling parry 4D, dodge 4D, brawling 4D*. Move: 10. Blaster pistol (4D), stormtrooper armor (+1D energy, +2D physical, -1D *Dexterity* and all related skills).

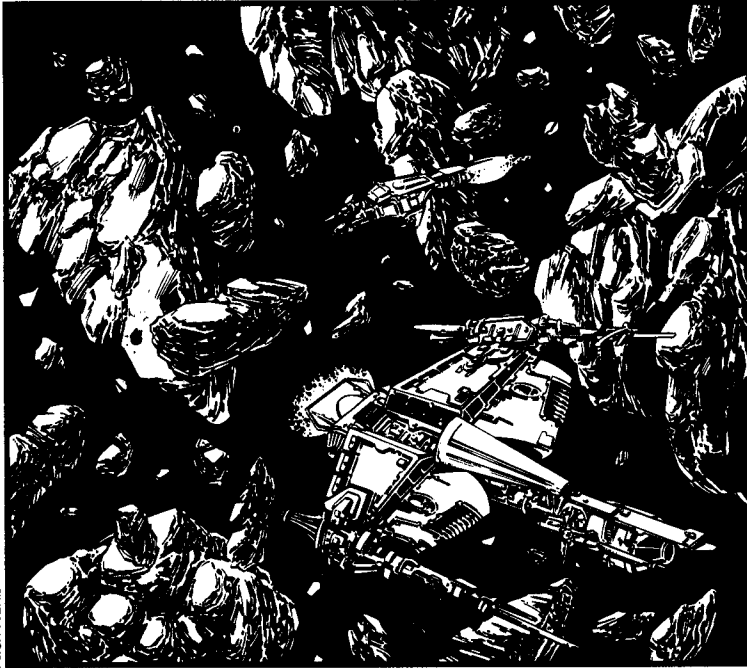

Allen Nurnis

Best Cargo

Craft: *Best Cargo*
Type: Modified Light Freighter
Scale: Starfighter
Length: 35 meters
Skill: Space transports
Crew: 4, gunners: 1, skeleton: 1/+5
Crew Skill: See player characters
Passengers: 6
Cargo Capacity: 150 metric tons
Consumables: 2 months
Cost: Not available for sale
Hyperdrive Multiplier: x1
Hyperdrive Backup: x15
Nav Computer: Yes
Maneuverability: 6D
Space: 3
Atmosphere: 260; 750 kmh
Hull: 6D
Shields: 2D
Sensors:
Passive: 15/0D
Scan: 30/1D
Search: 50/3D
Focus: 2/4D
Weapons:
2 Laser Cannons (fire separately)
Fire Arc: Turret
Crew: 1
Skill: Starship gunnery
Fire Control: 2D
Space Range: 1-3/12/25
Atmosphere Range: 100-300/1.2/2.5 km
Damage: 2D
Heavy Laser Cannon
Fire Arc: Front
Crew: 1 (can be fired by pilot)
Skill: Starship gunnery
Fire Control: 2D
Space Range: 1-3/12/25
Atmosphere Range: 100-300/1.2/2.5 km
Damage: 4D

Asteroid Run

To get to Asteroid 7785, the Rebels must navigate a path through a very dense portion of the asteroid field. It is not an easy trip, and there are a number of dangers along the way — both expected and unexpected. If the Rebels used the asteroid tracking station at the outpost to map a path, then they get to add +2 to all piloting and co-piloting rolls made during the run (see “The Rules” below).

If the Rebels don't have their own ship, we provide statistics for a ship that can be assigned to them for the completion of this mission. Also, note the salvage ship stats as well, for it will appear during the run to harass the Rebels.

The salvage ship, piloted by Belinda Vog, arrives just as the Rebels have cleared the outpost dock and are getting ready to begin their run through the asteroid field. Naturally, it follows them.

If you would prefer to use the space combat rules from *Second Edition*, base difficulty for passing through the field is Moderate.

Passage through the field takes six rounds, with difficulty increasing one level every three rounds. However, gamemasters are encouraged to increase or reduce the difficulty number based on the character's actions.

The Rules

Use the Asteroid Run game board, the Aster-

Reclaimer

Craft: *Reclaimer*
Type: Customized space vehicle
Scale: Starfighter
Length: 22.5 meters
Skill: Space transports: *Reclaimer*
Crew: 2 (can coordinate)
Crew Skill: See Belinda Vog
Passengers: 4
Cargo Capacity: 75 metric tons
Consumables: 1 month
Cost: Not available for sale
Hyperdrive Multiplier: x1
Hyperdrive Backup: x15
Nav Computer: Yes
Space: 3
Atmosphere: 260; 750 kmh
Hull: 6D
Shields: 2D
Sensors:
Passive: 10/0D
Scan: 25/1D
Search: 40/2D
Focus: 2/3D
Weapons:
Heavy Laser Cannon
Fire Arc: Turret
Crew: 1 (can be fired by pilot)
Skill: Starship gunnery
Fire Control: 2D
Space Range: 1-3/12/25
Atmosphere Range: 100-300/1.2/2.5 km
Damage: 5D

GAMEMASTER PROP: ASTEROID RUN GAME BOARD

B
L + R
F

| | | | | | | | | | |
|---------------------------|----|------------|----|----|------------------------|----|----|-----------|----|
| START 3 (Salvagers) | 4 | 5 | 6 | 7 | START 8 (Rebels) | 9 | 10 | 11 | 12 |
| 13 | 14 | 15 | 16 | 17 | 18 | 3 | 4 | 5 | 6 |
| 7 | 8 | 9 | 10 | 11 | 12 | 13 | 14 | 15 | 16 |
| 17 | 18 | 3 | 4 | 5 | 6 | 7 | 8 | 9 | 10 |
| 11 | 12 | 13 | 14 | 15 | 16 | 17 | 18 | 3 | 4 |
| 5 | 6 | 7 | 8 | 9 | 10 | 11 | 12 | 13 | 14 |
| 15 | 16 | 17 | 18 | 3 | 4 | 5 | 6 | 7 | 8 |
| 9 | 10 | 11 | 12 | 13 | 14 | 15 | 16 | 17 | 18 |
| 3 | 4 | 5 | 6 | 7 | 8 | 9 | 10 | 11 | 12 |
| 13 | 14 | 15 | 16 | 17 | 18 | 3 | 4 | 5 | 6 |
| 7 | 8 | 9 | 10 | 11 | 12 | 13 | 14 | 15 | 16 |
| 17 | 18 | 3 | 4 | 5 | 6 | 7 | 8 | 9 | 10 |
| 11 | 12 | EXIT 13 | 14 | 15 | EXIT 16 | 17 | 18 | EXIT 3 | 4 |

Stephen Crane

Movement on the Asteroid Run Board

| Roll | Speed | Direction |
|-------|-----------|-----------|
| 3-5 | 1 square | Backward |
| 6-10 | 2 squares | Forward |
| 11-15 | 3 squares | Left |
| 16-20 | 4 squares | Right |
| 21+ | Choice | Choice |

Asteroids and Droid Appearance Table

| Roll | What Appears |
|------|--------------|
| 1-4 | Asteroid |
| 5 | Probe Droid |
| 6 | Battle Droid |

oid Run game pieces, and a bunch of six-sided dice to resolve the run through the asteroid field.

The Asteroid Run Game Board

This starfield is divided into a grid. Each grid square contains a number from 3 to 18. There are two starting boxes and three exit boxes. The Rebel ship starts in the box marked "Start (Rebels)." The salvager ship starts in the box marked "Start (Salvagers)." The players control the Rebel ship, the gamemaster controls the salvager ship.

The object of the game for the Rebels is to get their ship off the board via one of the marked exits. The salvagers object is to follow the Rebels off the board so that they can find the location of the Royal Palace.

The Asteroid Run Game Pieces

There are game pieces depicting the Rebel and salvager ships, asteroids, probe droids, and battle droids. The effects of the game pieces and how to use them are explained below.

Game Turn

Each round, the following steps occur in the following order.

- All droids on the board move according to their speed code. Asteroids move one square to the right.
- Gamemaster rolls one die to determine what

game piece will appear on the board (asteroid or droid), then rolls three dice to place it (see below).

- Pilots roll to determine speed and direction of their ships.
- Pilots move their ships in *space transports* skill order.
- Any asteroid collisions are resolved.
- Droids within range of a ship attack.
- Ships attack in *starship gunnery* order.
- Unless the Rebel ship has moved off the board through an exit square, the next round begins.

Movement

The pilot and co-pilot of each ship controls its speed and direction. Before the game begins, each pilot and co-pilot must decide which aspect of movement they will control. In the salvage ship, Belinda Vog controls the direction, her co-pilot controls the speed (see their templates in the "Character Templates" section).

All movement occurs along the horizontal and vertical lines, as shown on the direction compass. "B" means move backward, "F" means move forward, "R" means move right, and "L" means move left. The squares marked "Exit" lead to Asteroid 7785. All other squares wrap around to the opposite end of the game board.

To determine speed and direction, the pilot and co-pilot both make *space transports* rolls and

**GAMEMASTER PROP:
Asteroid Run Game Pieces**

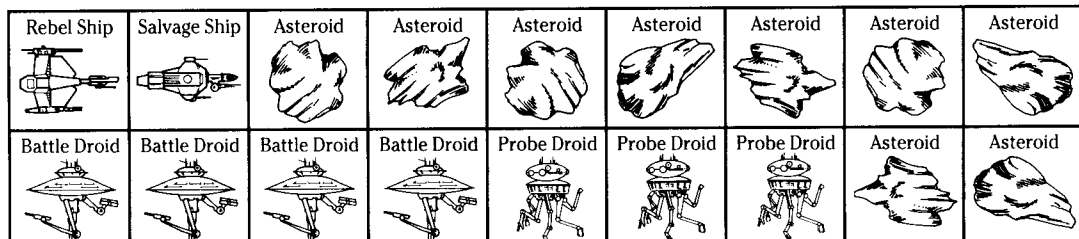

Stephen Crane

Asteroid Appearance Example

The gamemaster rolls one die at the start of the round, before the ships move. He rolls a 3, which means an asteroid may appear. Then he rolls three dice. He gets a 14. He can place the asteroid in the square next to the Rebel ship as shown.

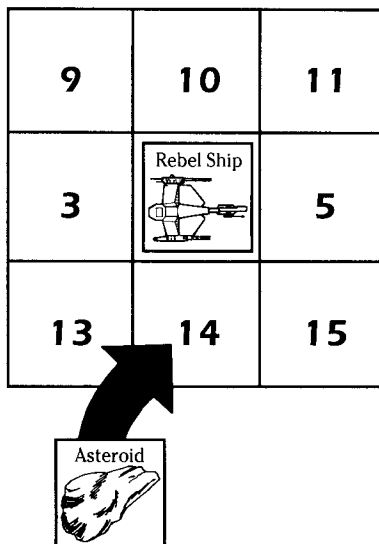

check their results on the table above.

Note: a ship must always move at least one square; it cannot stand still.

Example: Belinda Vog rolls a 17 for direction, her co-pilot rolls a 15 for speed. Her ship will move 3 squares to the right this round.

Combat

The salvage ship seeks to follow the Rebels to their destination. It will return fire if fired upon, but isn't trying to destroy the Rebel ship. The droids are also seeking to damage the Rebel ship, not destroy it. Both the droids and the salvagers will use their weapons on ionization setting only.

All weapons have ranges equal to their damage code, but damage is reduced by one for every square between the combatants. So, a 3D blaster will only cause 2D of damage if there is one square between it and its target. Ships in adjacent squares can use their full damage codes.

Droids and Asteroids

To determine when a droid or asteroid appears on the board, roll a die and consult the table every round. Then roll three dice to determine the square it will appear in. Always place a droid or asteroid in a square next to a square containing a ship, first next to the Rebel ship, then next to the salvage ship. If no square meeting these requirements exists, the piece is not placed this round.

Droids always move in the direction of the closest ship at the beginning of the round. They stay on the board until *incapacitated* or *mortally wounded*.

Once placed, asteroids move one square to the right every turn. When they reach the edge of the board, they are removed until a die roll again places them on the board.

Probe Droids: STR 4D, blaster cannon (ionization damage 4D+2), scale: character, speed: 3 square per round.

Battle Droids: STR 6D, blaster cannon (ionization damage 6D+2), scale: starfighter, speed: 2 squares per round.

Asteroids: STR 6D, speed: 1 square to the right per round.



Allen Numis

Asteroid Collisions

If a ship moves into a square occupied by an asteroid, a collision occurs and all movement ceases. To resolve a collision, match the ship's hull code against the asteroid's *Strength* of 6D. Whatever the result, the asteroid is removed from the board and the ship, if it survived the impact, may continue to move next turn.

Game End

The Asteroid Run game ends when the Rebel ship moves off the board through an exit square, is *severely damaged*, or is *destroyed*. Go to "Asteroid 7785" below.

Asteroid 7785

If the Rebel ship moves off the Asteroid Run game board through an exit square, it finds itself before the asteroid designated as 7785. If it suffered any damage in the run, then it must make a crash landing upon the asteroid. If it received *severe damage*, the pilot must make a Very Difficult *space transports* roll to land the ship safely. *Severe damage* means the ship's systems are locked, and all a pilot can do is try to bring the ship down on a glide as it rushes toward the asteroid. If the ship suffered *heavy damage*, it takes a Difficult *space transports* roll to bring it down. If it suffered only *light damage*, then a Moderate *space transports* roll will land the ship safely. Failure crashes the ship into the side of the asteroid, ending any hopes of lifting off again.

After they land, the Rebels see no sign of the

salvage ship. They do see the following sight, though. Read:

An opening looms before you, leading deeper into the asteroid itself. You can see that someone has been here, as a magnetic space door has been installed across the mouth of the cave to protect it from the vacuum of space. A red glow pulsates invitingly from within the cave.

The Rebels can get by with only breath masks upon this large asteroid. They can easily pass through the magnetic field that keeps atmosphere within the cave, and once they do enter it, go on to episode three.

Cut-Away to Princess Leia

Read aloud:

EXTERIOR: THE *MILLENNIUM FALCON*.
The Falcon streaks through space, preparing itself for the jump to light speed.

INTERIOR: THE *MILLENNIUM FALCON*.
Princess Leia sits behind Chewbacca, watching the viewport as realspace shifts to hyperspace.

"How long until we reach Alderaan?" *Princess Leia asks.*

"About four hours if I push it," *Han Solo replies.*

"I have a bad feeling about this," *C-3PO moans from the chair behind Captain Solo.*

Cut to ...

INTERIOR: A CAVE, ASTEROID 7785.



Allen Nunis/Carlos Garzon

Episode Three

The Secret of Alderaan

Summary

This episode begins in a cave on the large asteroid designated as 7785. As the Rebels explore the cave, a platoon of stormtroopers show up to herd them further into the dark interior. That's where they discover the door to the Royal Palace.

Inside the Palace, Darth Vader's trap swings shut with a resounding crash. The entrance is sealed so that the Rebels cannot escape before the Dark Lord arrives. And within the ruins of the Palace, the heroes are subjected to psychological warfare designed to break their spirits and render them helpless.

If they survive these obstacles and dangers, then they meet the lone living occupant of the Royal Palace — a man who claims to be Bail Organa! It is he who shows the Rebels to Alderaan's greatest treasure, and its deepest shame. He shows them the secret of *Another Chance*.

Encounter: The Entrance Cave

The entrance cave is a large cavern full of stalagmites and stalactites, and a warm red glow fills the chamber with light and strange shadows. The origin of the red glow rests with a badly damaged probe droid which crashed in the cavern. Its power cells are overloading, and in 10 rounds from the time the Rebels enter the cave, it will explode. To complicate matters, a platoon of stormtroopers is waiting to force the Rebels further into the trap.

When the Rebels enter the cave, round one begins. Have all of the Rebels make *Perception* rolls. They will notice the disabled probe droid in a number of rounds based on the best roll's level of success. So, if a Rebel made a Very Difficult *Perception* roll, he will spot the droid in one round; Difficult, two rounds; Moderate, three

rounds; Easy, four rounds; Very Easy, five rounds. Upon noticing the droid, that Rebel can examine it. Go to "Probe Droid" below.

In the second round, the stormtroopers appear at the cave mouth and begin their attack. See "Stormtrooper Attack" below for their tactics.

Any Rebel taking another round to examine the cave can make another *Perception* check. Use the above round-to-success-level breakdown to determine how many rounds it will take the Rebel to spot the partially hidden door.

Probe Droid

After a Rebel spots the damaged probe droid, he can examine it by making a *droid repair* roll. Very Easy success tells the Rebel that the droid has been severely damaged and appears to be overloading. Easy success assures him that its power cells have ruptured and will soon explode. Moderate success or better tells him that it will blow in less than 10 rounds, and there is little that can be done to halt the process now that it is this far along. Such an explosion will more than likely destroy everything within the cave. If, for whatever reason, the Rebels are still in the cave when the droid explodes, they each take 10D damage. The explosion completely collapses the mouth of the cave, but totally uncovers the partially-hidden door (unless the Rebels have already passed through it, see below).

Stormtrooper Attack

At the beginning of round two, the stormtrooper platoon attacks. There are 10 stormtroopers and one stormtrooper leader in the platoon (their statistics can be found in episode two).

The stormtroopers are here to force the Rebels into the Palace and seal the door behind them. They do not know about the damaged probe droid. They will use a combination of lethal and stun damage force to herd the Rebels, but they try hard not to kill any of them.

The stormtroopers use cover to their best advantage (most of the rocks and stone pillars provide medium cover, difficulty +2). They will retreat as far as the cave mouth if pressed, where they will change the magnetic field into a force field of STR 8D to hold the Rebels.

The Hidden Door

At the rear of the cave, partially hidden behind rubble, is the entrance to the Royal Palace. The door is made of finely-engraved metal, and it requires a Difficult *Strength* roll to open. Up to three characters can combine to make the effort. Once on the other side of the door, the probe droid explodes, burying the doorway under a ton of rock and debris. The Rebels are inside the Royal Palace, but the path they took to get there has been closed to them.

The Royal Palace

The Rebels can explore the Royal Palace as they try to find both the secret they came to uncover and another exit. Use the "Buried Palace" map on page 43 as the Rebels make their way toward Alderaan's secret.

Note: Every room from room 2 to 17 contains a hidden security camera (Difficult *Perception* or *search* check to spot) and a holoprojector (Very Difficult *Perception* or *search* check to find).

1. The Entrance Cave. See the encounter above.

2. The First Hall. This long hallway has a collapsed wall on one end, and a doorway on the other. Two doors are located on the wall opposite the entrance. The hall is filled with a large number of statues, holo-art, sculptures, and other objects dedicated to the creative spirit of Alderaan. When the Rebels enter the hall, one of the nearby holo-art displays changes before their eyes. Read:

The holo-art display shifts, reforming into the image of a black-armored shape that stands over two meters tall: Lord Darth Vader! As you watch, the image offers you a mocking bow, and you hear a deep, rasping voice say, "Welcome back to Alderaan, Princess Leia. I trust young Skywalker and Solo are with you. Please make yourselves comfortable. I will join you very shortly. Then we will finish what was begun at Yavin. We have a great deal to ... discuss." Then the image shifts back to its original form.

The image of Vader is a hologram recording, nothing more. It cannot be battled, injured, or otherwise hurt, and it disappears after it delivers its message.

3. Shattered Room. The Rebels cannot tell what this room was once used for, as most of it has been destroyed.

4. Office. This partially-collapsed room was once the office of a low-level Alderaan bureau-



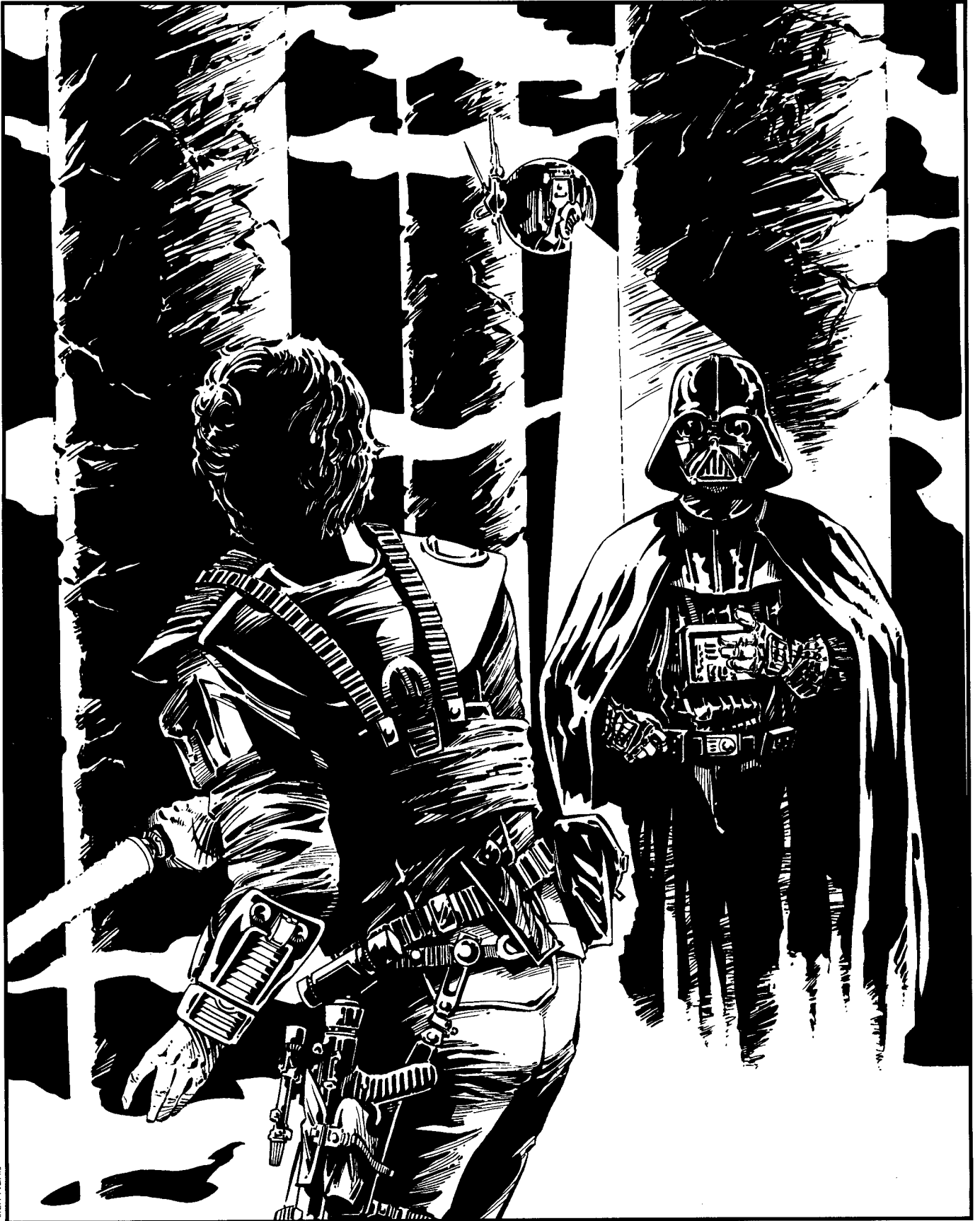

Allen Nurnis

crat. The data file viewers no longer function, so the purpose of this office cannot be determined.

5. Office. This intact office was the Alderaan Department of the Arts. Four desks with data viewers are situated around the room, as well as holoposters declaring various art displays throughout the planet.

6. Shattered Room. The Rebels cannot tell what this room was once used for, as most of it has been destroyed.

7. Office. This partially-collapsed room was once the office of a low-level Alderaan bureaucrat. The data file viewers no longer function, so the purpose of this office cannot be determined.

As the Rebels look around, the image of a tall, gaunt man in a Grand Moff's uniform appears before them. He nods, smiles evilly, then says:

"Princess Leia, before your execution I would like you to be my guest at a ceremony that will make this battle station operational. No star system will dare oppose the Emperor now."

He pauses, listening, as the Rebels do whatever they want. Nothing affects the image of the Moff unless they locate the holoprojector. He continues:

"Not after we demonstrate the power of this station. In a way, you have determined the

choice of the planet that will be destroyed first. Since you are reluctant to provide us with the location of the Rebel base, I have chosen to test this station's destructive power ... on your home planet of Alderaan."

Another brief pause, then:

"You would prefer another target? A military target? Then name the system!"

Tarkin waves menacingly toward the Rebels, then says:

"I grow tired of asking this. So it will be the last time. Where is the Rebel base?"

With a smile, Tarkin says:

"There. You see, Lord Vader, she can be reasonable. Continue with the operation. You may fire when ready."

Tarkin's image shifts, and the Rebels find themselves staring at a planet with a small moon orbiting it. Then they notice that the moon is actually the Death Star. It fires one powerful beam of emerald-yellow energy at the planet, and Alderaan explodes in a shower of light. Then the room returns to normal, the ghostly images gone.

8. Secret Room. Captain Janus Bonn and his officers are stationed in this secret room, monitoring the Rebels' activities and operating the various holoprojectors. The secret doors, located in rooms 5 and 10, can be detected on a

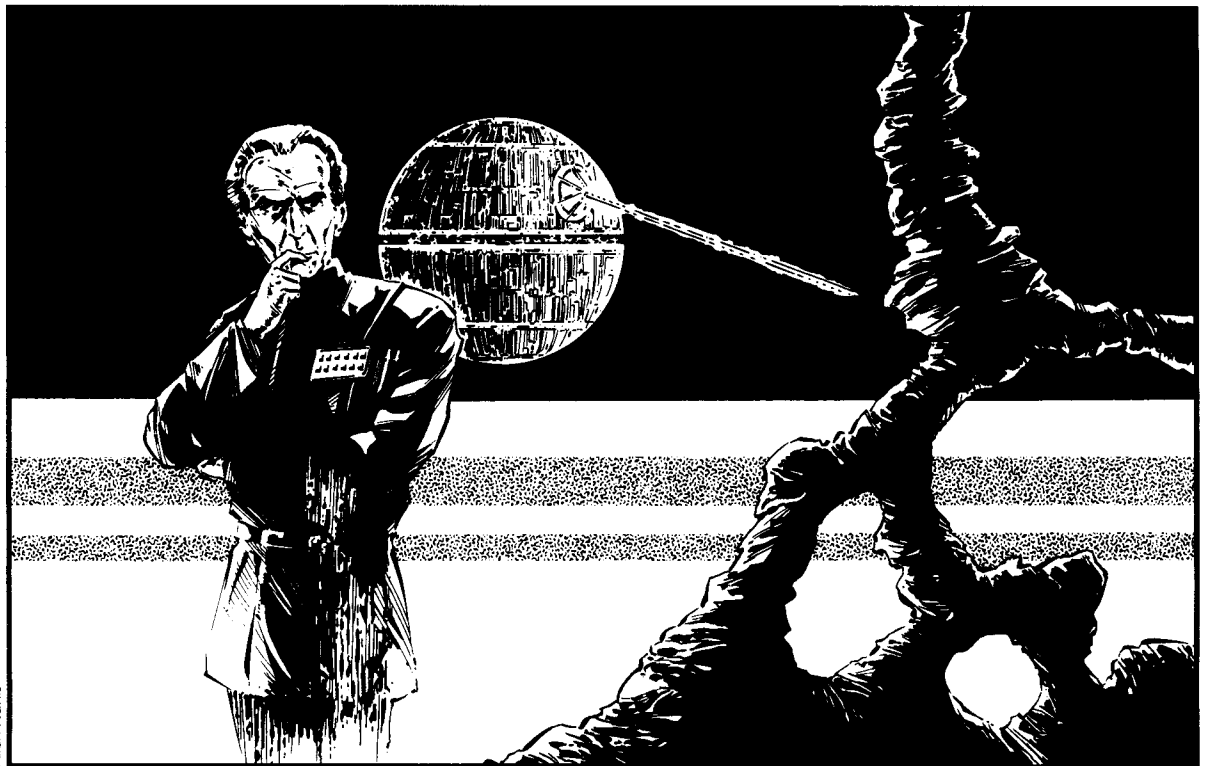

Allen Nunis

GAMEMASTER MAP: The Buried Palace

Cutaway Side View

Entrance
Cave

Rooms 1 to 10

Rooms 11 to 18

Pit

Plan View

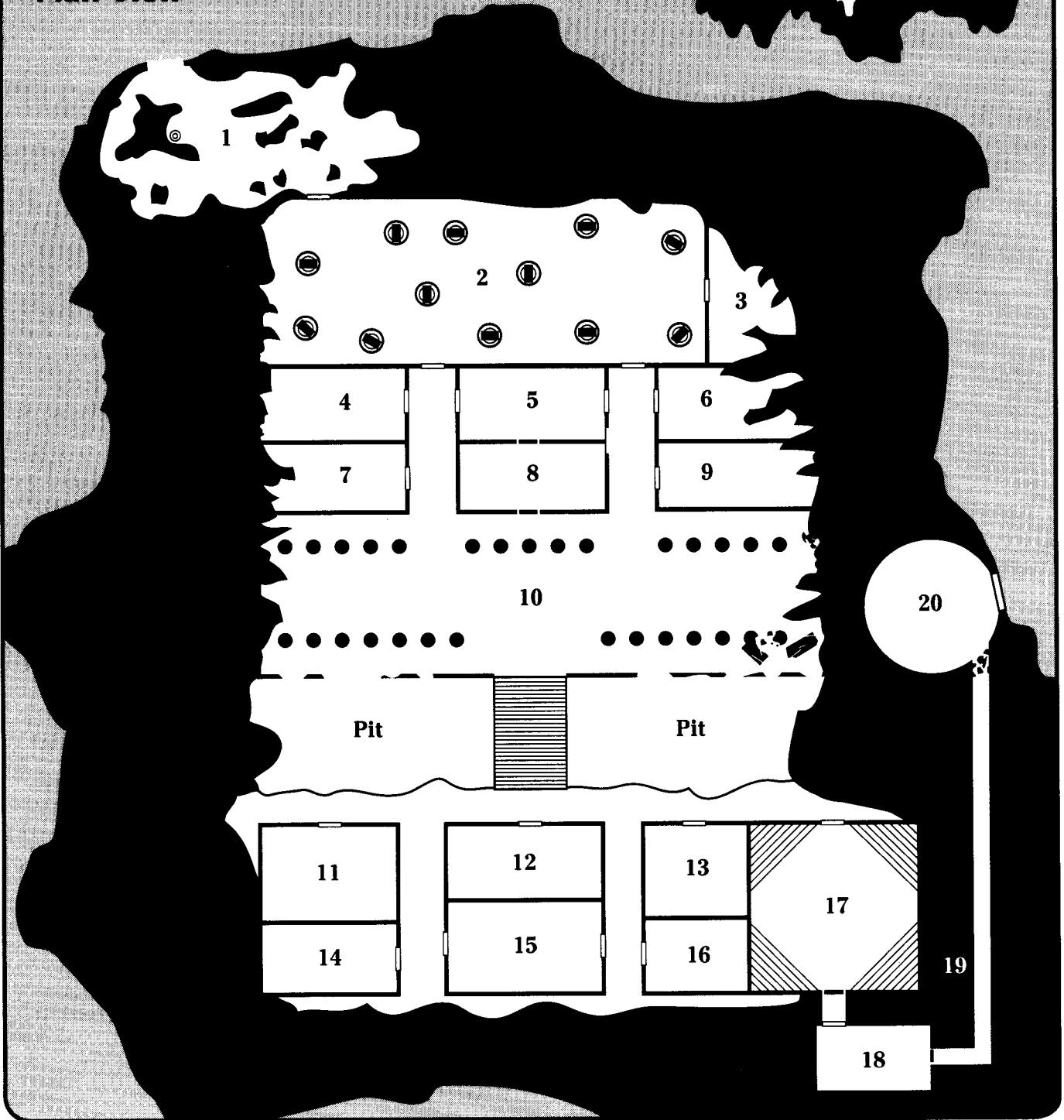

Stephen Crane



Difficult *Perception* check. To open the doors, the Rebels must make a successful Difficult *security* check. However, as the Imperials are monitoring them, they are ready when the door opens.

The room contains the monitoring screens that show views of all the rooms on this level, as well as the power generators and holocomputers that operate the displays set up to shake the Rebels' confidence.

Captain Janus' statistics are in the "Character Templates" section. His officers are listed below.

8 Imperial Officers. *Dexterity 2D+2, blaster 3D+2, dodge 3D+2, grenade 3D+2, Knowledge 3D, bureaucracy 3D+1, Mechanical 3D+2, Perception 3D+1, search 4D+1, Strength 2D+1, brawling 3D+1, Technical 3D, security 4D.* Move: 10. Blaster pistol (4D, set on stun), two stun grenades (5D), comlink.

9. Partially Collapsed Office. Four desks fill this room, neatly set in a line down the middle of the room. A man is working at the desk farthest from the door. He continues to work as the Rebels enter, oblivious to their presence.

The man, dressed in a white robe, is a holoprojection controlled from room 8. His head snaps up as the Rebels approach, casting an accusing stare upon them. He says:

"You dare come back here, Princess? Wasn't what you did bad enough? Now you have returned to bring back the awful memory of that awful day. You killed us, Princess. And now, the killer returns to the scene of the crime!"

With that exclamation, the man disappears.

10. The Grand Hall. Pillars line this ornate hallway. Both ends of the hall have collapsed, and the southern side has fallen away to reveal a deep pit. A shattered staircase leads to the still-intact portion of the lower level, but the Rebels must make four successful *climbing/jumping* rolls to navigate the stairs. If they use syntherope, the difficulty is Easy; if they climb by hand, the difficulty is Moderate. A failure indicates a slip, and slipping Rebels must make an Easy *Strength* roll to catch themselves. A failure here causes the Rebel to drop into the pit. But instead of finding a deadly drop, the falling Rebel lands in an almost-invisible mono-filament net stretched across the pit. It breaks the Rebel's fall and allows him to climb easily onto the lower level.

Two things occur in the Grand Hall. First, the Rebels are haunted by appearing and disappearing citizens of Alderaan — women, men, the young, the old, even children — who shout, cry, and accuse the Rebels of killing them, of destroying their world. They ask damning questions that cannot be answered, such as why? and how? and for what purpose? This scene should rattle the Rebels, allowing them to feel the presence of a million voices. After a number of questions, read:

Suddenly the hall fills with all the citizens of Alderaan. They are everywhere, staring at you with hurt, fear-filled eyes. They scream out in terror, buffeting you with the sound of a million frightened screams. Then, as quickly as it began, the figures disappear and the room drops into silence.

The second occurrence happens while the Rebels are navigating the stairs down. They are attacked by Belinda Vog and her salvage team! These are not ghosts or holo-images, but real people intent on eliminating their competition. The battle between the two groups upon the stairs is to the death.

11. The Old Republic. This chamber contains a holographic view of the galaxy of the Old Republic, dedicated to that once great government and powered by energy cells that survived the explosion. But once the Rebels enter the chamber, the scene changes from space to the surface of a desert planet. Read:

Smoke rises from the ruins of a moisture farm, twirling into the sky to block out the light of the twin suns of Tatooine. You see two charred skeletons upon the building's steps. As you watch, the skeletons raise their heads to look at you. "You let us die, Luke," the skeletons wail. "You ran off and let us die! Why weren't you here to help us? Why? Why?"

Their accusing question asked, the skeletons and the scene from Tatooine disappear.

12. Meeting Chamber. This room was once used as a meeting chamber. It contains a large table, chairs, and recessed lighting.

13. Empty Room. Whatever was once in this room has been taken away.

14. Steam Baths. This room contains the famed Alderaan steam baths. Of course, the steam produced by the underground hot springs is long gone, and only the empty basins remain. There is also a small space slug here, which attacks from its nesting place in one of the basins when the Rebels get close enough.

Space Slug. *Dexterity 2D, Perception 1D, Strength 6D.* Special abilities: Can survive in vacuum with no penalties; teeth do STR+1D damage. Move: 6.

15. Dining Hall. This room is where the Alderaan Council of Elders took meals during official sessions.

16. Elders' Lounge. The Council of Elders used this room as a lounge during official sessions. It contains many couches and a holochess table.

17. The Amphitheater. This amphitheater was where the Alderaan Council of Elders held its official meetings. When the Rebels enter the chamber, they are treated to a hologram that is not supplied by the Empire, but by the House of Alderaan itself. Read:

Suddenly the benches above you are filled with robed figures. Men and women stare down at you. No, not at you, but at the figure in the center of the chamber. The figure is a tall man wearing the robes of the Royal House. He speaks.

"My fellow Council members. As Alderaan embarks on a new adventure of peace, we must decide what to do with our tools of war. I say that the galaxy will always contain a spark of evil, and eventually even the smallest spark will rage into an inferno. We just ended one such inferno. What will we do when the next inferno blazes forth?"

Above the standing figure, you see an image of the ghost ship you encountered earlier: an Alderaanian War Frigate. As you watch, shuttles carry unknown cargoes to the waiting vessel. Then the images fade as light streams from an opening in the far wall, an opening that had been cunningly concealed by the room's designers.



Allen Nurnis/Gray Morrow



Allen Nurnis

A bent old man stands before the opening, motioning you to enter. “Another Chance,” he says, then he steps inside.

Before the Rebels can decide what to do, Captain Janus Bonn and four of his men appear at the door to the amphitheater. Captain Bonn calls out, “What are you up to, old man? This wasn’t part of our agreement! That wasn’t even an Imperial holo vid!”

Before the Rebels can enter the newly-revealed chamber, they must defeat Bonn and his men. The Imperials start the battle using the stun setting of their weapons, but once two of them fall they switch to lethal settings and fight to the death.

18. The Command Chamber. Inside the opening, the Rebels find a command chamber full of equipment much like that found in a modern control tower. There are even huge nav computers displaying an unending number of hyper jump coordinates. The old man nods at them and smiles. If they ask him if he is Bail Organa, he shakes his head and says:

“My name is Orinn Tathis. I am — was — simply a member of the Council of Elders who was off-planet the day the Death Star appeared. I have returned to do what Bail Organa was going to do when he sent his daughter after General Obi-Wan Kenobi. I am going to give the Alliance Alderaan’s greatest gift — and its greatest shame.”

Orinn Tathis. All stats 2D except: *Dexterity 2D+1, dodge 3D, bureaucracy: Alderaan 5D, computer programming/repair 4D+1.* Move: 9.

Tathis works at the controls for a moment, then slumps to the floor. He says:

“It is no use. The computers have been badly damaged and do not respond to my commands.”

The old man now tells the whole story of *Another Chance* to the Rebels. He explains that weapons of war are both a gift and a shame that Alderaan had to live with. While they tired of war and hated violence, they were also very good at it. The Council of Elders meant for the Alliance to have the ship full of weapons, but the only way to retrieve the ship from its unending flight through hyperspace is to take control of it from inside. To do that, the Rebels will have to find a way out of the ruins. Read the following aloud:

Tathis frowns and says, “Quickly, my friends. We may have one chance left. When this part of the palace was constructed, several of the inner walls were crafted from mono-molecular plates — extremely durable shielding material to say the least. That’s why so much of the palace survived; the underground portions of the palace were hardened to protect the royal family from attack.

“And, if we are very, very lucky, the shielded tunnel that leads to the Royal Family’s escape vehicle may still be intact ...”

The secret panel that hides the passage to the hidden shuttle bay is located on the east wall of room 18. It can be located with a difficult *search* roll. If the player characters are really stumbling around and having trouble finding the exit, gamemasters have the option of letting Tathis “remember” where the passage is.

The door to the escape passage is blocked by a magnetically sealed door. A Moderate *computer programming/repair* or *security* roll reveals that the seal can be overridden from one of the badly damaged computer workstations in the room. To successfully open the lock, the players must first make an Easy *computer/programming repair* roll to find a computer that is serviceable. The terminal requires a power source and some superficial repair. A Moderate *blaster repair* roll will allow the player characters to drain energy from a blaster power cell to charge the computer terminal. (This renders the blaster inoperative; feedback from the jury-rigged power transfer apparatus will destroy the weapon.) Finally, a Moderate *security* roll will disengage the locking mechanism.

Before exiting the room, read the following aloud:

“Wait,” Tathis exclaims. “There is one other item we’ll need.” Rummaging through a nearby storage box, he retrieves a small device that looks like a modified comlink, as well as a heavy black box: a high-capacity power cell. Tathis smiles grimly, and gestures towards the previously concealed door. “Let’s get moving,” he says, adding, “I’d hate to keep Lord Vader waiting.”

19. The Escape Tunnel. The tunnel was intended to be a serviceable, clean corridor through the rock beneath the palace. Now, after the Death Star’s “visit” to Alderaan, the tunnel is cracked, pitted and warped in several places throughout its length. The mono-molecular plating around the key junctures in the tunnel are probably all that kept the route intact. The tunnel is not indestructible, however. The tunnel echoes with the creaking and groaning of stressed metal and stone, threatening to expose the player characters to raw vacuum if they do not hurry. The gamemaster should encourage haste when player characters are located in the tunnel, building up tension as quickly as possible. The players should feel as if death is imminent; distant sounds of approaching stormtroopers, stress cracks in the rocky ceiling suddenly growing larger with a loud CRACK, or sudden fluctuations in the gravity or lighting can help increase the tension level substantially.

Finally, as the player characters scramble through the tunnel, they reach the end — which

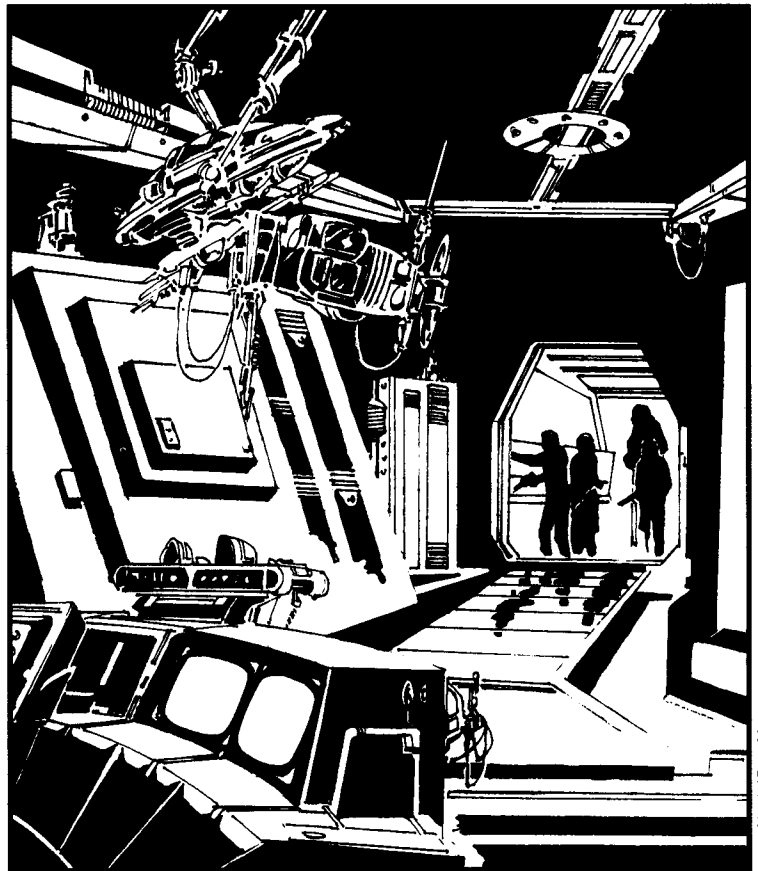

Allen Nurnis/Gray Morrow

has been blocked by rubble and debris. (Obviously, this section of the palace was not as well-protected as the underground bunker.) There is a great deal of rock and metal clumped in a twisted heap just before the hidden landing pad. The best option is to blast through the wall of debris. If the players have any kind of explosives or grenades, an Easy *grenade* or *demolitions* skill roll should clear the debris, but they will have to time the explosion so they can avoid the blast radius.

In addition, the blast will cost the Rebels the element of surprise; there are several stormtroopers in the hidden hangar bay.

20. The Hidden Hangar. The hangar bay was originally designed as the launch site for an escape vessel for the Alderaanian Royal Family in the event of an attack. The bay is a large, cavernous subterranean chamber, camouflaged and shielded to make it virtually undetectable. However, the blast from the Death Star overpowered that shielding. The blast triggered some of the hatch mechanisms, and a small crack has appeared in the overhead dome that is obviously the main bay door leading to the outside. Fortunately, a backup generator that powers the magnetic shield has prevented the atmosphere in-

side the hangar from venting into space, but the air is still thin and very cold. In addition, the breach in the overhead camouflage made it possible for a team of stormtroopers to enter the hangar. However, the stormtroopers have just located the bay moments before. They are on their guard the instant the Rebel's blast destroys the debris in the hidden tunnel.

Standing in the center of the hangar bay is a sleek Skipray Blastboat: the Alderaanian Royal Family's escape vehicle. From a distance, it looks intact. All the player characters have to do is get to it. As soon as the shooting starts, the stormtroopers will split into two groups. The first group will find any available cover and attempt to keep the Rebels pinned down. The second will move to secure the Skipray Blastboat.

Run combat as indicated in *Star Wars: The Roleplaying Game, Second Edition*. If the player characters win the fight, they can leave in the Blastboat. If they lose, they are captured by the stormtroopers and detained for questioning. (In all probability they will be imprisoned for sedition, or killed outright, depending on how much of a nuisance they have been to Lord Vader and his troops.)

10 Imperial Stormtroopers. All stats are 2D except: *Dexterity* 3D, *blaster* 4D, *grenade* 4D+2. Move: 10. Blaster rifle (5D), stormtrooper armor (+1D energy, +2D physical, -1D *Dexterity* and all related skills).

■ Skipray Blastboat

Craft: Sienar Fleet Systems' GAT-12h
Type: Defense and patrol blastboat
Scale: Capital (due to power output)
Length: 25 meters
Skill: Starfighter piloting: Skipray Blastboat
Crew: 2 (1 can coordinate), gunners:2, skeleton 1/+5
Cargo Capacity: 20 metric tons
Consumables: 1 month
Hyperdrive Multiplier: x2
Nav Computer: Limited to four jumps
Maneuverability: 1D+2 (2D+2 in atmosphere)
Space: 8
Atmosphere: 415, 1,200 kmh
Hull: 2D+1
Shields: 2D
Sensors:
Passive: 35/1D
Scan: 60/1D+2
Search: 100/2D
Focus: 3/2D+2

Weapons:

3 Medium Ion Cannons (fire-linked)

Fire Arc: Front
Crew: 1
Scale: Capital
Skill: Capital ship gunnery
Fire Control: 3D
Space Range: 1-3/12/25
Atmosphere Range: 100-300/1.2/2.5 km
Damage: 4D

Proton Torpedo Launcher

Fire Arc: Front

Crew: 1 (same gunner as ion cannons)
Scale: Starfighter
Skill: Starship gunnery
Fire Control: 2D
Space Range: 1/3/7
Atmosphere Range: 50-100/300/700
Damage: 9D

2 Laser Cannons (fire-linked)

Fire Arc: Turret
Crew: 1
Scale: Starfighter
Skill: Starship gunnery
Fire Control: 1D
Space Range: 1-3/12/25
Atmosphere Range: 100-300/1.2/2.5 km
Damage: 5D

Concussion Missile Launcher

Fire Arc: Front
Crew: 1 (same gunner as ion cannons)
Scale: Starfighter
Skill: Starship gunnery
Fire Control: 1D
Space Range: 1/3/7
Atmosphere Range: 1-50/100/250
Damage: 6D

Escape From Asteroid 7785

When (or if) the player characters commandeer the Skipray Blastboat, read the following aloud:

The engines and weapons systems of the Skipray seem to be functioning, mercifully. The only problem is the overhead docking port ... it is only partially open. You might be able to nurse the ship through the tiny opening ... but then again, you might not.

The overhead dome that concealed the landing area (and acted as an exit hatch) has been partially damaged; the magnetic shield will drop and vent the remaining atmosphere of the hangar into space if the player characters start messing around with the dome's controls. (Player characters can learn of the danger with an *Easy computer programming/repair* roll when examining the hatch controls.)

To escape, the player characters can either use the Blastboat's weapons to blast their way out of the dome (treat the dome as if it has *Strength* 3D to resist damage), or they can attempt to fly through the narrow gap overhead. The noise and blaster fire that are required to blast the hatch are going to attract a great deal of Imperial attention, however; if the players decide to take this approach, they will be met on the other side of the hatch by 7 TIE fighters.

7 TIE/In Starfighters. Starfighter, *starfighter piloting:* TIE 4D+1, *starship gunnery* 4D. Maneuverability 2D, space 10, hull 2D. Weapons: 2 laser cannons (fire control 2D, damage 5D).

If the players decide to instead inch their way through the narrow gap that has opened in the damaged hatchway, they must first make a Mod-

erate *starfighter piloting* roll. Failure indicates that the vessel has struck the edge of the hole, causing 3D damage to the ship. (If the shields are raised during the lift-off attempt, they overload and are destroyed if a 1 on the Wild Die is rolled.) However, if the players take this more cautious approach, they surprise a mere four TIE fighters, rather than the seven they encounter if they fight their way out.

In either case, combat ensues. The player characters can make their escape into the surrounding asteroid field created by the destruction of Alderaan, or they can fight the TIE's outright. If they move deeper into the asteroid field, the pilot must make a Moderate *starfighter piloting* roll for each round in the field, simply to avoid hitting asteroids. Fancy maneuvers and combat will be increased in difficulty by at least two levels, depending on the complexity of the maneuver being attempted.

During the chase, Tathis will be fumbling with the device he brought he grabbed from the palace ruins. If asked, he will explain that the device is a "last-hope" homing beacon. The *Another Chance* has suffered damage, which has not allowed the regular command codes to override the ship's computers. However, now that he is broadcasting the homing code from space, Tathis believes he can summon the ship, albeit temporarily. It will take Tathis four rounds to complete the work necessary to make the high band transceiver operate. However, the more the ship bounces around or is struck by enemy fire, he must make a successful Moderate *Perception* check to make sure he doesn't lose his concentration. If he fails this check, completion of the transceiver will take an extra round (this penalty is cumulative; every check he fails adds one round to completion time).

After the device is completed, he will activate it with no visible effect. However, after 1D rounds, the player characters will see a flicker of pseudomotion as the Alderaanian War Frigate suddenly emerges from hyperspace. The *Another Chance* glides to a halt, maintaining position roughly 2 kilometers distant from the player characters ship. An Easy *sensors* roll will reveal that the *Another Chance* has a standard docking collar located near the bridge of the ship, and

that they can be docked within two rounds. If the players move quickly to dispatch the remaining TIEs (if any), the Alderaanian warship is theirs. However, they must move quickly; a power surge in the ship's hyperdrive will hurl the ship back into hyperspace in 2D minutes. If that happens, the frigate is lost, and the players must face the wrath of the Imperial Navy (and quite probably the Rebel Alliance as well).

Cut-Away to Princess Leia

Read aloud:

INTERIOR: THE *MILLENNIUM FALCON*.
Princess Leia sits beside Han Solo as the captain pilots his craft through hyperspace.

"We'll be there soon, Your Worshipfulness," *Solo said softly.*

"I know, Han," *Leia replied.* "I just have to know if they really found my father."

"I just hope there are no surprises waiting for us like the last time I was here," *Solo said, adjusting the controls.*

"There are always surprises, Han," *Leia said carefully,* "it just depends on whether they are good or bad surprises."

Cut to ...

INTERIOR: AN IMPERIAL STAR DESTROYER.

Cut-Away to the Imperial Fleet

Read aloud:

INTERIOR: AN IMPERIAL STAR DESTROYER.

An Imperial Captain stands upon the bridge of his Star Destroyer, watching the streaking lines of hyperspace shift back to the stable view of realspace.

"Lieutenant," *the Captain said cheerfully.* "Inform Lord Vader that we have arrived. We will set up the blockade and prepare his shuttle for transport to the asteroid."

Cut to ...

INTERIOR: THE ARMORY SHIP *ANOTHER CHANCE*.

Episode Four Another Chance

Summary

This episode takes place aboard the armory ship, *Another Chance*. The Rebels have a number of tasks to complete before they can finish this adventure. First, they must make their way through the armory ship without falling prey to the various droids programmed to protect it, including a huge, spider-like maintenance droid. Then they must repair the ship's primary systems so that they can take control of the ship's weapons, shields, and sensors. Finally, they must repair the hyperdrive engines so that they can make the ship respond to their commands. Without a fully functional hyperdrive, *Another Chance* will continue to jump through hyperspace for all eternity — with the Rebel heroes along for the ride! The climax of the episode, and of the adventure, takes place when the Rebels gain control of the armory ship and bring it out of hyperspace to warn the *Millennium Falcon* of the trap that is waiting for them.

The Armory Ship, Another Chance

Another Chance is a converted Alderaanian War Frigate, restructured for use as a spaceworthy armory. It features two main decks, a hangar bay, a multi-level engine section, banks of power cells, and the all-important multi-level armory.

Like other Alderaanian War Frigates, *Another Chance* was built to serve the Alderaan Fleet during the Clone Wars. It was one of the more powerful war ships of its time, and the pride of the Alderaan Fleet. When the Council of Elders agreed to ban weapons, many felt that destroying ships like *Another Chance* was the same as killing soldiers once the war was over. The ship served Alderaan and the Republic faithfully, and the Elders tried to find a way to spare the heroic vessel.

It was finally decided that *Another Chance* should serve its planet one last time. In the wake

of the Clone Wars and in the almost-hysterical outcry for peace, the Council of Elders secretly decided to have the War Frigate refitted to serve as a depository for Alderaan's weapons. So the vessel was filled with instruments of defense and destruction, its systems were rewired so that droids alone could handle the ship, and its nav computers were programmed with an unending series of hyper-jump coordinates. Without fanfare, the vessel was sent off into hyperspace, where it was to remain until Alderaan again needed to put aside the robes of peace and take up the tools of war.

Below are descriptions of the various rooms and sections, including possible encounters that can occur aboard *Another Chance*.

What Tathis Is Doing

Orrin Tathis can be used either to assist or hinder the characters in this episode. If the player characters cannot reactivate the ship — either because of bad decisions or poor dice rolls — Tathis can offer a piece of advice at the appropriate time that can get player moving in the right direction. He should be of minor help; Tathis is an old man, frightened by his current situation. He *shouldn't* be manning a turbolaser and blasting away at TIE fighters. His assistance should be limited to small (but well-timed) hints.

However, if the player characters are too easily overcoming the obstacles before them, Tathis can be used as a character foil of sorts. He can claim he served on one of these vessels as a young man and will swear that "he knows best how they should proceed." He can start jabbing at vital controls at critical moments or offer contradictory advice at the worst possible time. ("Yes, son, that turbolaser tends to pull a bit to the left. Oh, I'm sorry, did I say *left*? I meant *right*.")

Another Chance, Level One

Bridge

The Rebels begin this episode on the bridge of *Another Chance*, near the turbolifts to and from the docking collar.

The bridge is operating on autopilot controls and with the apparent aid of an astromech droid. Monitors at the astrogation stations show an unending string of coordinates constantly scrolling across the screens. Outside the viewports are the familiar sights of hyperspace: swirling colors and flashing streaks of light.

The Rebels can attempt to gain control of the ship from the bridge, but to no avail. None of the controls respond to manual commands. An Easy *capital ship repair* roll tells the Rebels that a massive surge from the controlling computers on Alderaan (which presumably occurred at the time of the planet's destruction) has so scrambled the circuits that the Rebels will have to reconstruct the ship's systems manually — one system at a time. The surge was so powerful it fused the astromech droid's memory chips, totally destroying it. It sits blankly and silently within its socket, not even beeping a welcome to its first visitors in many years. Even if the Rebels can get the droid back to working order (Heroic *droid repair* roll), its piloting programs have been irretrievably wiped out by the massive surge.

A Moderate *capital ship repair* roll puts the bridge back on line, but until the other major ship systems are relinked to it, the Rebels have no control over the vessel. An Easy *Technical* roll outlines what systems are needed to gain control of the ship:

- The ship's weapons systems must be unlocked manually at either *weapons control* or *auxiliary weapons control*.
- *Shields and screens systems* must be unlocked manually.
- The *sensor suite* must be unlocked manually.
- *Computer control* must be disengaged.
- Finally, the hyperdrive must be ordered to cease running through its jumps from the monitoring computers at the hyperdrive and astrogation station.

When all of this is done (and any of the surprises outlined below are handled by the Rebels), then the ship can be controlled manually from the stations on the bridge. These are piloting, copiloting, navigation and astrogation, shields, sensors, and communications (which offers another problem, see "Turning Back the *Falcon*").

See the map of *Another Chance* for the location of the major system rooms. Once the bridge has been put on line, the Rebels can call up a map of

the ship by making an Easy *computer programming/repair* roll. If they are successful, show them the map of the ship.

Weapons Control

Once this room was the command station for the large number of weapons batteries located around the ship. When the vessel was refitted, many of these batteries were removed. Only those on levels one and two remain. But none of the batteries can be used by the Rebels until weapons control is restored. An Easy *capital ship weapons repair* roll, is needed to bring this station back on line and to free the turbolaser batteries from their computer lock so that they may be used manually.

Escape Pods

Large escape pods that can hold up to eight people are stored for emergencies. However, safety features will not allow the pods to launch while the ship is in hyperspace. If the Rebels want to abandon the armory ship, they can escape in a pod once *Another Chance* makes one of its frequent (but short) jumps back into realspace. However, as there is no way to control a pod once it is launched, the Rebels will be picked up by one of Vader's ships before too long. The adventure is over for them, unless the gamemaster wants to let them try a prison break.

Gunnery Stations

Each gunnery station features a quad turbolaser battery that can be operated manually once the weapons control systems have been brought back on line. These weapons may be needed later in the episode, and there are more than enough of them (10) for all of the Rebels. There are also four medium ion cannons mounted on the rear end of level one.

Officer Galley

Food processing units and tables are situated in this room. The galley was left in working order in case live crew members were to come aboard, but there is no evidence of recent use.

Officer Quarters

Small, partitioned sleeping areas for the ship's officers make up these quarters. There is no sign of occupation.

Turbolifts

Elevators connecting the various decks are accessed through the turbolifts.

Sensor Suite

This station was where the sensor operators worked. The system must be unlocked and placed back on manual control by making an Easy *capital ship repair* roll.

**GAMEMASTER MAP:
Another Chance**

Side View

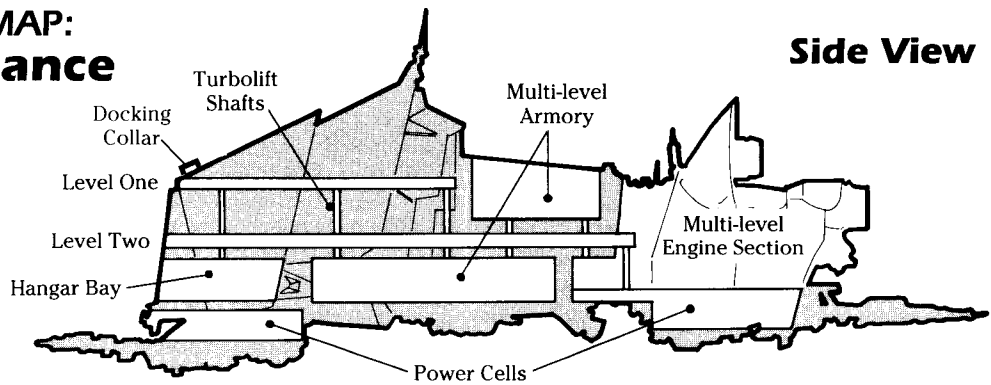

Plan Views

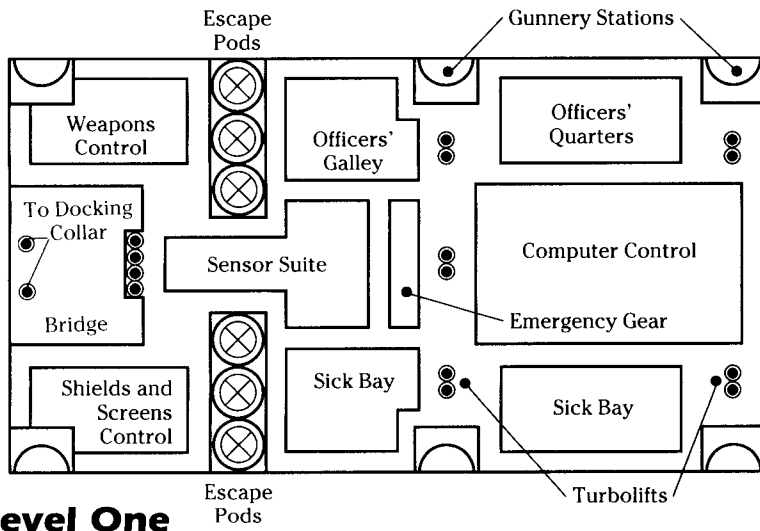

Level One

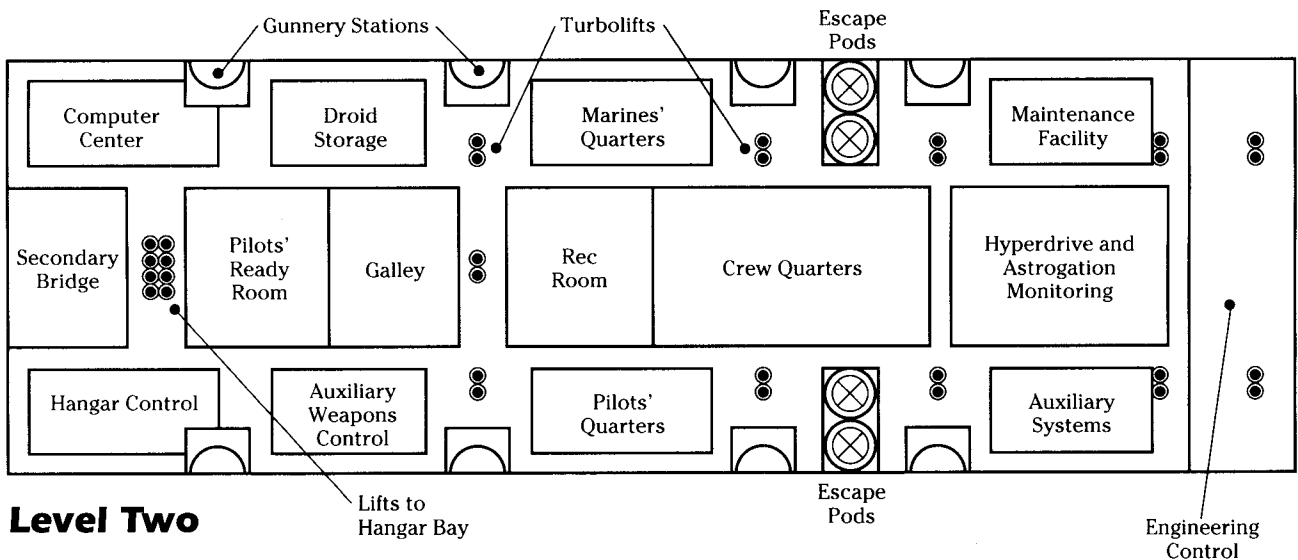

Level Two

Stephen Crane

Computer Control

All of the automatic systems installed aboard *Another Chance* to keep it jumping through hyperspace are controlled by this powerful droid brain and computer mainframe. Even if the Rebels manage to unlock all of the other systems, they cannot operate them until computer control is disengaged. To do this, the Rebels must make a Difficult *computer programming/repair* roll. They must also deal with the labor droid called to defend computer control from its attackers.

Labor droid: *Dexterity 2D, blaster: welding blaster 3D dodge 2D+2, Perception 2D, search 2D+2 Strength 4D.* Move: 8. Integral welding blaster (4D).

This labor droid is a boxlike mechanical that walks on two legs. The welding blaster pops out of a recessed storage compartment when needed, as do small, retractable arms for when the droid needs to do delicate work.

Shields and Screens Control

This is one of the systems the Rebels must unlock to gain control of the vessel. To do this, they must make a Moderate *capital ship repair* roll, followed by an Easy *Mechanical* roll to allow the shields to be controlled manually.

Emergency Gear

Breath masks, bottled water, food stocks, power cells, rope, glow rods, tool kits, and other emergency gear are stored here.

Sick Bay

While the sick bay is still fully stocked, including two bacta tanks, the medical droids have been removed. It was decided that a fully-automated ship would not need doctors. Rebels can find 20 medpacs here, though.

Another Chance, Level Two

Computer Center

Computer work stations from which the ship's crew could access the main computer for their own personal research are found in this room. The work stations are not powerful enough to manipulate the main computer from here, no matter how skilled the Rebel operatives may be.

Encounter: The Maintenance Droid

Whenever you think it most appropriate, and when the Rebels are wandering the corridors of level two, they encounter a giant maintenance droid. The huge mechanical is spider-like. Its main body is a large metal sphere, and eight multi-jointed legs extend from the sphere. The

legs are covered with all kinds of nozzles, grippers, and cutting blades to aid the droid in its job. In addition to repairing and cleaning duties, the droid is designed to eliminate vermin such as space slugs, mynockes and vervikks that can sometimes infest a ship. The droid thinks the Rebels fall into one of these categories, and accesses its programming on how best to eliminate such menaces.

The droid fights the Rebels, intent on killing them before they can infest the ship. It fights until destroyed.

Large maintenance droid. All stats are 1D except: *Dexterity 4D, blaster 5D, melee combat 4D, Perception 2D, hide 3D, search 4D, sneak 3D, Strength 6D+1, brawling: gripper attachments 7D+1.* Move: 8. Integral welding/defensive blasters (4D), cleanser application nozzle (2D), cutting attachments (6D+1, uses *melee combat*), gripping attachments (uses *brawling*, STR+1D crushing damage, opposed *Strength* roll to break free).

Droid Storage

This room is full of power chargers for use by the significant droid population of the ship. Whenever a droid needs to be recharged, it comes to this facility to power up. Some even come here to briefly close down their systems in a type of "droid sleep."

There are a number of droids stored in this room, including a spare astromech droid. While this droid cannot take control of the ship, it can be used to pilot the craft once the Rebels disengage computer control and reset the other systems to manual. With the droid's help, all of the Rebels will be able to man the turbolasers for the final battle of the adventure. The Rebels will need to convince the droid to help them, however. This takes a Moderate *bargain* roll and a stirring argument from the rolling Rebel.

Marines' Quarters

Alderaanian war vessels generally had a group of marines assigned to it to keep order and to defend the ship from boarding parties. This area was where they were quartered aboard *Another Chance*. While the beds, lockers, and foot chests are still here, there is no sign of recent occupation.

Maintenance Facility

Maintenance monitors alert the crew to any problems throughout the ship, including breakdowns, dirt, etc. As there are no crew members available for the monitors to alert, the information is routed to computer control, which can dispatch droids to deal with the situation. All of



Allen Nurnis/Gray Morrow

the monitors are lit up when the Rebels arrive, showing massive amounts of damage throughout the ship, including the hyperdrive, computer control, the autopilot, and even the relay line between this facility and computer control. With the line severed, none of the repair programs can be implemented. Basically, the main computer doesn't believe that anything is wrong because maintenance hasn't called with a problem since the destruction of Alderaan. Even if the Rebels repair the severed relay (an *Easy computer programming/repair* roll), they do not have time to wait for the slow self-repair programs to kick in. It would take the ship three months to fully repair itself, and the Rebels are lucky if they even have three hours left.

Secondary Bridge

All of the controls and equipment found on the main bridge have been duplicated here. The secondary bridge is used in cases of emergency, equipment failure, or after the main bridge has been knocked out by enemy fire. Unlike the main bridge, there is no astromech plugged into a droid socket, and the machinery does little more than display an occasional code. A *Moderate capital ship repair* roll puts this bridge back on line, but until the other systems are relinked to the main bridge as outlined above, the Rebels have no control over the ship.

Lifts to Hangar Bay

These turbolifts provide access to the hangar bay.

Pilots' Ready Room

This station was where the pilots prepared for a mission before going to the hangar and their waiting ships. There is a mission briefing podium and holoprojector, dozens of chairs, and dozens of flight suits hanging from the walls. Beside the suits are pilot survival kits. Each kit includes portable environment units that provide breathable atmosphere to the flight suits via a connecting hose, food and water rations, and survival gear such as a blanket, rope, a glow rod, etc.

Galley

The crew's galley is not stocked, although there are the standard food processing units and tables here. Nothing looks like it has been used in years, although not a spot of dust is evident.

Rec Room

The crew's rec room features holochess tables, a holovid projector, three data book readers, and sabacc tables. A droid is playing a solitaire game when the Rebels enter, and it asks them if anyone

would care for a game of sabacc. If any of the Rebels agree, read:

The droid, a standard maintenance model, greets you with a flash of blinking lights, then says, "Care to deal?" You notice a keypad with one pad lighted. The pad is marked "Deal."

If the Rebel presses the keypad, the computerized card table deals holovid cards to each player, which float before them at an angle that keeps the opponent from seeing them. The Rebel makes an opposed *gambling* roll against the droid's skill; high roll wins. This variation of sabacc is played as the best of five hands. If the Rebel wins the game, the droid thanks him for playing and shuffles off into a maintenance duct. If the droid wins, it demands to be paid its due. However, it will take nothing the Rebels offer; not credits, not equipment, nothing. It just keeps demanding to be paid its due. It even goes so far as to call the Rebel it played against a cheat and a welcher. If the Rebels attack the droid, it flees into the maintenance duct. If they ignore it and continue on their way, they hear it call after them: "Cheats! Pay me what is due!"

Gambling droid. All stats 1D except: *Dexterity 2D, dodge 3D, Perception 2D, gambling 5D, hide 3D, Strength 3D.* Move: 7.

Crew Quarters

A typical crew barracks, featuring lots of closely-placed beds, matching lockers, and storage chests. There is no sign of recent occupation.

Hyperdrive and Astrogation Monitoring

This area features the ship's astrogation calculation stations, hyperdrive monitoring stations, and the powerful nav computers containing the programmed jump coordinates. The Rebels must break the jump cycle before they can gain full control of the ship. To do this, they must make a *Difficult capital ship repair* roll, followed by a *Moderate astrogation* roll to bring the system back on line. This leaves the ship following its last jump program, which will keep the ship in hyperspace until the Rebels manually bring it out into realspace.

However, the monitors tell the Rebels that to do this they will have to manually disconnect the hyperdrive engine, as none of the relays for manual control are working. The hyperdrive engine is located in the engine section. When the Rebels are ready to deal with this new problem, go to "Encounter: The Hyperdrive Guardians."

Engineering Control

This control center overlooks the engineering section of the ship, showing the massive engines

through its plastisteel viewing wall. The engines were once controlled from this station, but now all control has been routed through the master computer. However, the Rebels can pinpoint the location of the hyperdrive engine disconnect switches they need to activate (see “Hyperdrive and Astrogation Monitoring”) by making an *Easy computer programming/repair* roll from this location.

Hangar Control

This is the control tower for the hangar bay, but it has been disconnected. However, two monitors still operate, cycling through various views of the hangar. Rebels can see a vast number of starfighter-scale craft stored here. The ships are held in stasis to preserve them, and as such they cannot be used in the upcoming battle without major maintenance and overhaul — which the Rebels do not have time to do.

Auxiliary Weapons Control

Once this room was the backup command station for the large number of weapons batteries located around the ship. When the vessel was remodeled, many of these batteries were removed. Only those on levels one and two remain. But none of the batteries can be used by the Rebels until weapons control is restored to human command. An *Easy capital ship repair* roll, followed by an *Easy starship gunnery* roll, is needed to bring this station back on line and to free the turbolaser batteries for manual use.

Note: This work can be accomplished at either the weapons control station on level one, or here at auxiliary control.

Pilots’ Quarters

Small, partitioned sleeping areas for the ship’s starfighter pilots make up this quarters. There is no sign of recent occupation.

Auxiliary Systems

Auxiliary systems was once an important station on the ship, as every system had a backup here. But long years of disuse has eroded the systems, and the Rebels cannot override computer control from here, no matter how hard they try or how long they work.

Another Chance, Hangar Bay

The hangar bay has been converted into a storage garage for a small fleet of starfighters that once served Alderaan in the Clone Wars. These ships have been locked in stasis fields to preserve them, and none can be readied for flight in less than 12 hours.



Allen Numis/Carlos Garzon

If the Rebels return the armory ship to the Alliance, the ships within this hangar will all be pushed into service. You can use this find as a way to introduce new ship types into your campaign.

Another Chance, Multi-level Armory

The armory is a multi-level warehouse filled with melee, ranged, and energy weapons from the time of the Clone Wars. These weapons are stored in stasis fields to preserve them, and they require routine maintenance before they can be used. In addition to the large supply of personal weapons, there are also stores of field artillery, grenades, explosives, ammunition, and a dozen repulsortanks. The contents of this armory ship will add a much needed weaponry boost to the Alliance stockpiles, if the Rebel heroes can get it safely to an Alliance base.

Another Chance, Engine Section

The huge engine section actually contains a number of different engines. There are four sub-light ion engines for traveling through realspace, one hyperdrive engine, and a hyperdrive backup. Multi-levels of scaffolding and catwalks encase the engines, providing maintenance access to the huge machines. If the Rebels come here to disconnect the hyperdrive, go to “Encounter: Hyperdrive Guardians” below.

Encounter: Hyperdrive Guardians

The hyperdrive engine is a massive machine. If the Rebels went to engineering command and retrieved a schematic of the engine, they know exactly where to find the manual disconnect

controls. If not, they must spend a number of rounds *searching* for the controls, depending on the success level of their rolls. Very Easy requires eight rounds of *searching*; Easy requires seven; Moderate, six; Difficult, five; and Very Difficult requires four rounds. Have every Rebel make a check, and use the best result.

Once they find the controls, it takes a Moderate *computer programming/repair* roll, followed by an Easy *capital ship repair* roll, to disconnect the hyperdrive. If the Rebels then want to reconnect it so that they can later control the drive manually from the bridge, they must make a Moderate *capital ship repair* roll.

While they are searching or working to disconnect the hyperdrive, they meet the guardians of the engines, whose job it is to eliminate vermin and carry out repairs. These repair droids crawl across the surface of the engines, using blasters and manipulation claws to deal with vermin. To them, the Rebels are no better than mynocks, and as such they must be eliminated. Eight of these droids attack: four the first round they appear, two the following round, and two the round after that. They fight until destroyed.

8 repair droids. *Dexterity 3D, blaster 4D, dodge 4D, Knowledge 2D, value 3D, Mechanical 1D, Perception 2D+2, hide 3D+2, search 4D+2, sneak 3D+2, Strength 3D, brawling 3D+1, Technical 2D, capital ship repair 4D.* Move: 8. Blaster (4D), manipula-

tion claws (5D, uses *brawling*).

These small (just over one meter) droids are of Alderaanian design, consisting of a stout cylindrical body (not unlike an R2 unit), and four highly flexible legs. The legs contain retractable rollers, allowing the repair droid to climb ladders, stairs and other inclines, as well as giving it the ability to roll rapidly along level surfaces (such as decks of starships). They are not extremely intelligent; their orders are simply to eliminate any and all vermin or unwanted infestations and repair any minor damage that has been inflicted in lower priority areas of the ship.

When the Rebels disconnect the hyperdrive, *Another Chance* drops back into realspace. Go to "The Armada" for more information.

Another Chance, Power Cells

Seven power cells provide energy to the armory ship, *Another Chance*. Five are currently on line, with two set aside as a reserve and for emergencies.

The Armada

When the Rebel heroes have finished repairing the armory ship to the best of their ability, they will more than likely cut the hyperdrive engine to deposit the ship back into realspace. This places them on one end of an Imperial armada! Read:

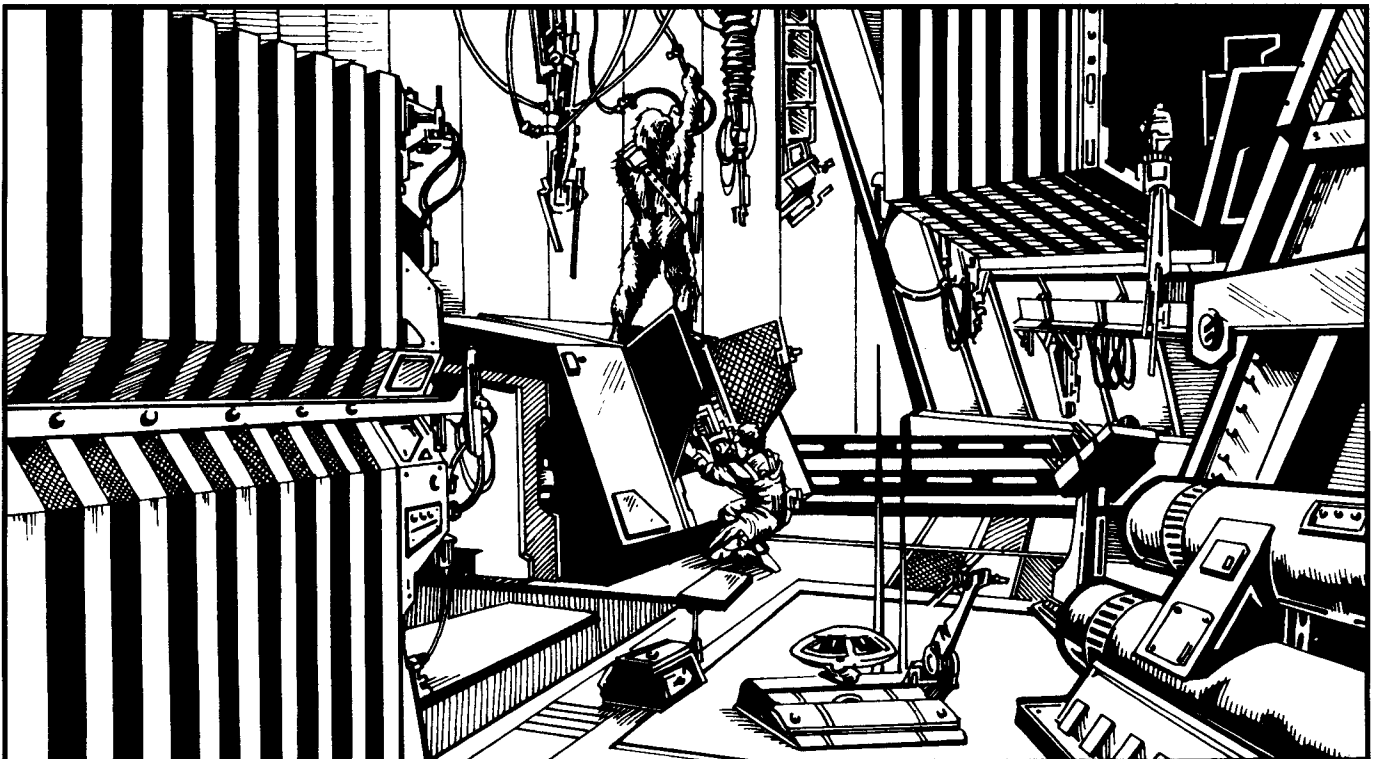

Allen Numis/Alan Jude Summa

You watch as the shifting colors and elongated stars of hyperspace slow. Then, with a small shudder, *Another Chance* drops back into realspace.

An Easy *Mechanical* roll allows one of the Rebels to operate the sensor suite if the Rebels linked it back to the bridge. If not, they will have to check the area visually with a Difficult *Perception* check. Either way, what they find is disturbing.

Another Chance has come out of hyperspace on the edge of the Graveyard. In front of it, hidden from passing ships by a large cluster of asteroids, is an Imperial armada consisting of three Imperial Star Destroyers and their starfighter support wings. Beyond the hidden armada, the Rebels see that a stock light freighter has just emerged from hyperspace. It is moving toward the Impe-

rial ships quite unaware of the danger it will soon be in.

Now, the Rebels have a few things going in their favor. First, the armada is holding its position in case the Rebels somehow manage to escape from the Royal Palace (the Imperials have not yet received word of the Rebels' escape apparently). Second, as the armada is watching *into* the Graveyard, it has not yet noticed the approach of the *Millennium Falcon* from *outside* the Graveyard. Third, Darth Vader is aboard a shuttle en route to Asteroid 7785, and therefore cannot command his ships.

Another Chance

Craft: *Another Chance*
Type: Alderaanian War Frigate refitted as an Armory Ship
Scale: Capital
Length: 250 meters
Skill: Capital ship piloting: Alderaanian war frigate
Crew: 700 (droids)
Crew Skill: Astrogation 3D, capital ship piloting 4D, capital ship shields 5D
Cargo Capacity: 2,000 metric tons
Consumables: 1 year
Cost: Not available for sale
Hyperdrive Multiplier: x2
Hyperdrive Backup: x15
Nav Computer: Yes
Maneuverability: 2D
Space: 8
Atmosphere: 365; 1,050 kmh
Hull: 6D
Shields: 2D+2
Sensors:
Passive: 10/0D
Scan: 25/1D
Search: 40/2D
Focus: 2/3D
Weapons:
10 Quad Turbolaser Batteries (fire separately)
Fire Arc: 3 front, 3 left, 3 right, 1 back
Crew: 1
Scale: Starfighter
Skill: Starship gunnery
Fire Control: 4D
Space Range: 1-5/10/17
Atmosphere Range: 100-500/1/1.7 km
Damage: 5D
4 Medium Ion Cannons (fire separately)
Fire Arc: Front
Crew: 2
Scale: Capital
Skill: Capital ship gunnery
Fire Control: 3D
Space Range: 1-3/12/25
Atmosphere Range: 100-300/1.2/2.5 km
Damage: 4D

Imperial Star Destroyer

Craft: ISD *Ultima*
Type: Kuat Drive Yards' Imperial I Star Destroyer
Scale: Capital
Length: 1,600 meters
Skill: Capital ship piloting: Star Destroyer
Crew: 36,810, gunners: 275, skeleton: 5,000/+20
Crew Skill: Astrogation 4D, capital ship gunnery 4D+2, capital ship piloting 5D+1, capital ship shields 4D+1, sensors 4D
Passengers: 9,700 (troops)
Cargo Capacity: 36,000 metric tons
Consumables: 6 years
Cost: Not available for sale
Hyperdrive Multiplier: x2
Hyperdrive Backup: x8
Nav Computer: Yes
Maneuverability: 1D
Space: 6
Hull: 7D
Shields: 3D
Sensors:
Passive: 50/1D
Scan: 100/3D
Search: 200/4D
Focus: 6/4D+2
Weapons:
60 Turbolaser Batteries
Fire Arc: 20 front, 20 left, 20 right
Crew: 1 (20), 2 (40)
Skill: Capital ship gunnery
Fire Control: 4D
Space Range: 3-15/36/75
Atmosphere Range: 6-30/72/150 km
Damage: 5D
60 Ion Cannons
Fire Arc: 20 front, 15 left, 15 right, 10 back
Crew: 1 (15), 2 (45)
Skill: Capital ship gunnery
Fire Control: 2D+2
Space Range: 1-10/25/50
Atmosphere Range: 2-20/50/100 km
Damage: 3D
10 Tractor Beam Projectors
Fire Arc: 6 front, 2 left, 2 right
Crew: 1 (2), 4 (2), 10 (6)
Skill: Capital ship gunnery
Fire Control: 4D
Space Range: 1-5/15/30
Atmosphere Range: 2-10/30/60 km
Damage: 6D



Allen Nurnis

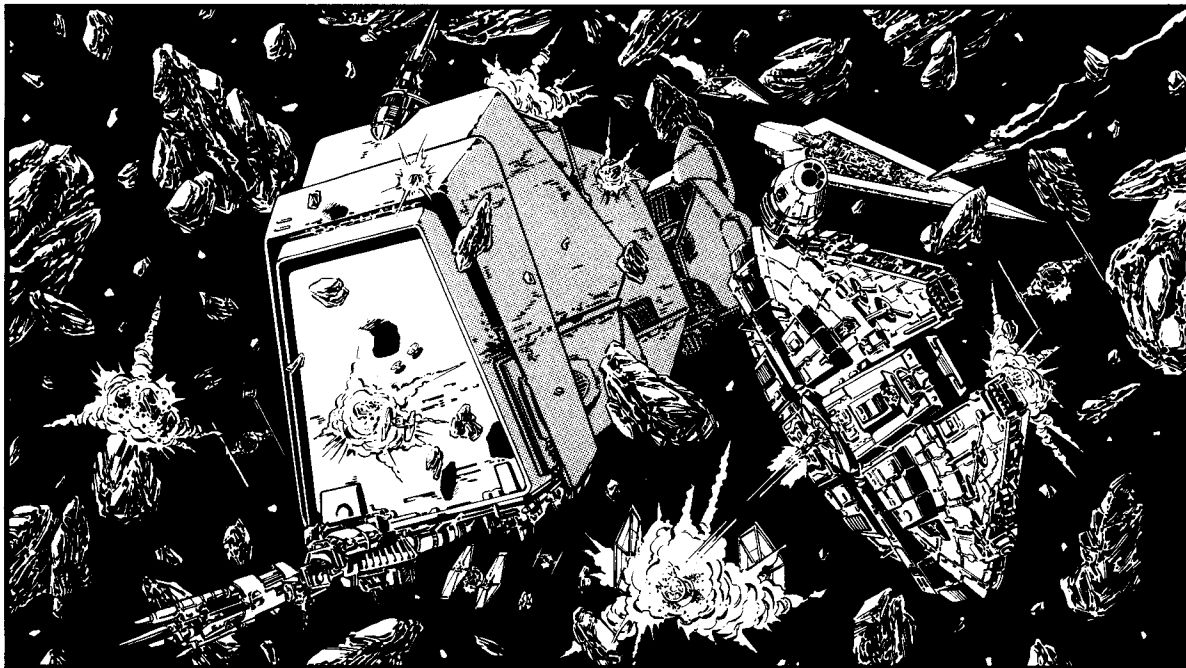

Allen Numis

But all of this will change shortly, as both the armory ship and the *Falcon* will be picked up by the Star Destroyers' sensor sweeps before long. Let the Rebels make a few quick plans, then go to "Encounter: The Big Battle" below. Note that none of the communications units aboard the armory ship are working unless the Rebels specifically said they were repairing them. To fix the comm unit now takes a number of rounds determined by the Rebel's *capital ship repair* roll: Very Easy, five rounds; Easy, four rounds; Moderate, three rounds; Difficult, two rounds; Very Difficult, one round.

Encounter: The Big Battle

The capital ship battle that follows pits one of the Star Destroyers and its 40 TIE fighters against the armory ship, using the rules for space combat found in *Star Wars: The Roleplaying Game, Second Edition*. Some Rebels can man the armory ship's turbolasers, blowing the TIEs out of the sky as they zoom closer, while others pilot the vessel, trying to stay out of the Star Destroyer's sights. Only one Star Destroyer is sent to investigate the appearance of the armory ship. The others stay in formation, standing by in case the prisoners aboard Asteroid 7785 try to make a getaway. (Again, the Imperials have no idea who is piloting the armory ship, and they have less of an idea that it is at all related to the Rebels supposedly trapped in the ruins of the Royal Palace.)

As the Star Destroyer has no idea who is piloting this suddenly-appearing relic from the past, its captain is unwilling to turn its massive laser batteries on the ship. Instead, he orders the

starfighters forward while he maneuvers to use the tractor beams. He wants to capture this vessel and its crew for Darth Vader.

The TIEs, on the other hand, know they cannot cause much damage to the larger ship, so they go all out, attacking in six waves of 10 ships each, then repeating the waves with whatever ships they still have left if the tractors haven't caught hold of it yet.

TIE/In Starfighter. Starfighter, *starfighter piloting: TIE 4D+1, starship gunnery 4D*. Maneuverability 2D, space 10, hull 2D. Weapons: 2 laser cannons (fire control 2D, damage 5D).

If *Another Chance* can survive a number of rounds of combat based on a Rebel's *astrogation* check, then it can jump to light speed and head for the nearest Rebel base: Very Easy, seven rounds; Easy, six rounds; Moderate, five rounds; Difficult, four rounds; Very Difficult, three rounds. Go to "Escape" below.

If *Another Chance* suffers too much damage or is caught in the Star Destroyer's tractor beams, capture will be imminent. However, the Rebels can achieve a partial victory by warning the *Falcon* and saving Princess Leia and the Heroes of Yavin. Go to "Turning Back the *Falcon*" below.

Turning Back the Falcon

The *Millennium Falcon* is approaching the Graveyard. Its crew initially doesn't know about the Imperial armada, the trap, or the presence of Darth Vader. It is up to the Rebels aboard *Another Chance* to warn them of the danger. This can be done in a number of ways.

• *Hail the Falcon Via Comm Unit.* This is harder than it sounds since the armory ship's comm unit is not connected. To fix the comm unit takes a number of rounds determined by the Rebel's *starship repair* roll: Very Easy, five rounds; Easy, four rounds; Moderate, three rounds; Difficult, two rounds; Very Difficult, one round. Once hailed, the Rebels must use a current code phrase to convince Princess Leia of the danger. Either of the two used in this adventure will do the trick.

• *Blowing Up Some Asteroids or an Imperial Ship.* Once *Another Chance* starts firing its weapons, the *Falcon* turns around and jumps to light speed.

• *Anything Else That Gets the Falcon's Attention.* Almost any reasonable stunt the Rebels try should be allowed to work. They might race their craft directly toward the *Falcon*, or signal the Heroes of Yavin with a strange maneuver; any similar stunt will warn the *Falcon's* crew that something is wrong in the Graveyard.

Once warned, the *Millennium Falcon* quickly enters hyperspace and exits the area.

Escape

If *Another Chance* can survive a number of rounds of combat based on a Rebel's *astrogation* roll, then it can jump to light speed and head for the nearest Rebel base. If the roll is Very Easy, the jump occurs in seven rounds; Easy, six rounds; Moderate, five rounds; Difficult, four rounds; Very Difficult, three rounds. When they reach this point, read:

The Imperial Star Destroyer and its wing of TIE fighters are right behind you. You can feel the insistent tug of powerful tractor beams, but you manage to stay just out of their range. Now

you have finished the complicated calculations, and the ship is ready to jump to light speed. You engage the hyperdrive and, thankfully, the stars shift to the streaking colors of hyperspace.

Epilogue

If the adventure is completed successfully, the Rebels return the armory ship to their base and warn Princess Leia away from danger before she stumbles into Vader's trap. They receive seven character points for accomplishing this mission.

If they saved Leia but lost the armory ship, they receive four character points.

If they saved the armory ship, but Leia and the Heroes of Yavin had to save themselves, the Rebels receive three character points.

If the Rebels fail completely and are killed or captured, help them create new characters for the next gaming session.

If the adventure ended successfully, read:

At the Rebel base, you receive commendations from your superiors and from Princess Leia Organa, who also asks you and Tathis to join her for dinner so that you may tell her what you discovered in the Graveyard. After dinner, and after exchanging stories with the Princess, your commanding officer approaches.

"Good work," he tells you. "But there is still one thing left to do."

You look at him expectantly, trying to fathom what you missed. The commander smiles.

"You have to go back to Bazaar," he says. "We still need that shipment of droid parts from the merchant Poliss!"

Fade to ...

Credits and closing theme.

GRAVEYARD OF ALDERAAN CHARACTER TEMPLATES

Belinda Vog

Type: Salvage Chief

DEXTERITY 3D

Blaster 4D, brawling parry 3D+1, dodge 4D, melee combat 3D+2, melee parry 3D+2

KNOWLEDGE 2D+2

Alien species 3D, cultures 3D, languages 3D+1, planetary systems 3D+2, value 3D+2

MECHANICAL 4D

Astrogation 4D+1, space transports 5D+1, starship gunnery 4D+2

PERCEPTION 2D+1

Bargain 3D+1, command 4D+1, con 3D+2, hide 3D+2, search 3D+1, sneak 3D+2

STRENGTH 3D

Brawling 3D+1

TECHNICAL 3D

Demolitions 4D, security 4D, space transports repair 4D

Character Points: 5

Move: 10

Equipment: Blaster pistol (4D), vibroknife (STR+1D), breath mask, comlink, syntherope, security/droid tool kit, medpac.

Capsule: Belinda Vog is a human female in her early 30s. She is attractive in an exotic way, an attractiveness enhanced by a wild haircut and a tough, no-nonsense demeanor. She looks like she's ready for anything (and she usually is). Her jumpsuit pockets and pouches are generally filled with a variety of equipment that may prove useful.

After hearing the rumors that the Royal Palace of Alderaan has been discovered, it is Belinda Vog's desire to claim the salvage rights to the operation — through whatever means are necessary. She is not above bending (or breaking) galactic law to suit her purposes.

Belinda Vog has always been fascinated by antiques and old objects that others have discarded. She discovered at an early age that the galaxy was full of such items ... and who better than her to make a credit or two off of them? She joined a salvage team at a young age, quickly rising through the ranks until she was in command of her own operation.

She travels the galaxy in her ship, *Reclaimer*, scouting out possible jobs before bring the whole team and the salvage rigs in. She was aboard *Bazaar*, looking for leads to a new operation when she ran into Hanos Darr. One night over drinks at the village cantina, Darr let it slip that the Royal Palace of Alderaan had been uncovered. He refused to say anymore that night, but Vog was sure that she would be able to get more details out of him before he left the Ithorian herdship. She didn't count on him being murdered — or on the group of Rebels who took an interest in the story.

Vog is a tough customer, very shrewd and very determined. When she sees something she wants, she'll do everything in her power to get it, no matter who she has to step on to acquire it. She can be amusing and friendly one instant, then strike without mercy the next. Vog is a truly



Allen Numis

independent spacer; she espouses no loyalty to either the Rebel Alliance or the Empire and is in fact wanted by both organizations.

A few months prior to her arrival on *Bazaar*, Vog eluded capture by Imperial customs forces who stumbled on her "salvage" operations near Kuat. A small Imperial patrol vessel experienced severe engine malfunctions during its shakedown cruise and the crew was forced to abandon ship. Vog managed to outrun the Imperial recovery crew to the damaged vessel and strip it bare of useful parts and jump into hyperspace.

Unfortunately, Vog blundered into the path of a nearby Customs ship and was forced to dump her cargo and flee to avoid capture. She has since used her considerable charm to sweet-talk a Customs officer stationed at Kuat, so she can enter the system from time to time without too much trouble (though she is still somewhat paranoid about Imperial "entanglements" when she is in the Kuat system).

Vog has also had run-ins with the Rebel Alliance from time to time. Shortly after her troubles at Kuat, Vog was involved in a bidding war for some salvaged heavy-weapons power converters, in direct competition with the Rebel ordnance procurer in Quence sector. The Rebel was attempting to deal fairly with the illicit arms dealer who was selling the converters. During the negotiations, Vog and her team managed to slip into the storage facility that housed the contraband and steal it, angering both the arms dealer and the Rebel Alliance. Rebel operatives are currently seeking Vog in hopes of obtaining the power converters, and several bounty hunter syndicates hired by the arms dealer are also pursuing the scavenger.

GRAVEYARD OF ALDERAAN CHARACTER TEMPLATES

Typical Salvager

Type: Salvage Crew
DEXTERITY 2D
 Blaster 3D, dodge 3D, melee combat 3D
KNOWLEDGE 1D+2
 Value 2D+2
MECHANICAL 3D
 Astrogation 3D+1, space transports 4D, starship gunnery 3D+2
PERCEPTION 1D+1
 Bargain 2D+1, con 2D+2, hide 2D+2, search 2D+1, sneak 2D+2
STRENGTH 2D
 Brawling 3D, climbing/jumping 3D, lifting 3D
TECHNICAL 2D
 Computer programming/repair 2D+2, demolitions 3D, droid programming 2D+2, droid repair 2D+2, security 3D, starship repair 2D+1
Character Points: Varies, typically 0-2
Move: 10
Equipment: Blaster pistol (4D), vibroknife (STR+1D), breath mask, comlink, syntherope, security/droid tool kit

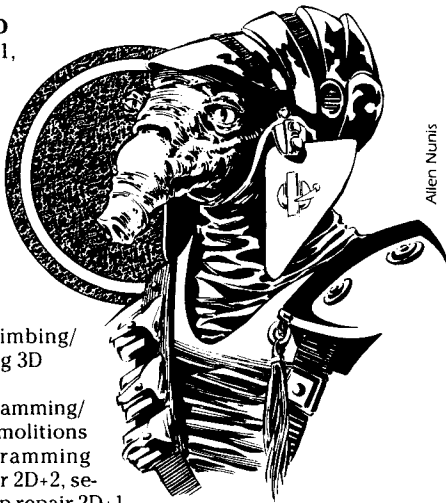

Allen Nunis

Capsule: The typical salvager has been a member of Belinda Vog's crew for at least two years. Many have served with her from her days as a crew member, gladly pledging their contracts to her when she took command of the salvage operation. They come from a variety of worlds and most care little who wins the civil war, as long as it doesn't affect the profit margins negatively.

When they are on break, salvagers like to have rowdy fun that usually involves drink, members of the opposite sex, and brawls. When they are working, they are all business because giving the job less than 100 percent could lead to their deaths and the deaths of their comrades.

Typical Miner

Type: Miner
DEXTERITY 2D
 Blaster 3D, brawling parry 3D, dodge 3D, melee combat 3D
KNOWLEDGE 1D+2
 Planetary systems: geology 2D+2, survival 2D+2, value 2D+2
MECHANICAL 2D
 Mine drill operation 3D
PERCEPTION 1D+2
 Con 2D+2, hide 2D+2, sneak 2D+2
STRENGTH 2D
 Brawling 3D, climbing/jumping 3D, lifting 2D, stamina 2D+1
TECHNICAL 1D+2
 Demolitions 2D+2, mining 2D+2, security 2D+2
Character Points: Varies, typically 0-3
Move: 10
Equipment: Blaster pistol (4D), club (STR+1D), breath mask, mining suit, mining tool kit

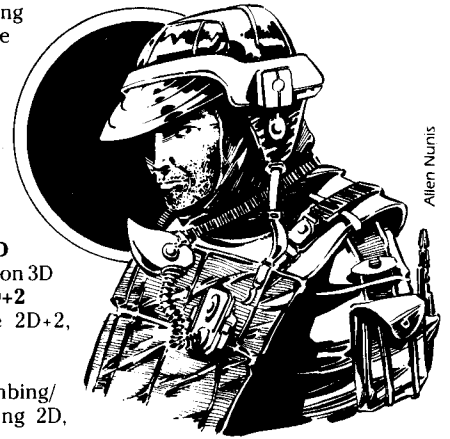

Allen Nunis

Capsule: Typical miners look like younger versions of Kathos Loof. They are thickly-muscled, strong, covered with dust and sweat and are dressed in mining coveralls and tool belts.

Miners in this adventure are pro-Imperial; they will pretend that work is proceeding as usual at the mining outpost, and will back up stormtroopers in a fight if needed.

These miners all owe their allegiance to the Empire. Some have been bought with credits or commissions in some branch of Imperial service. Others have been threatened into loyalty by fear of death or imprisonment — their own or their loved ones. They have been sent to the mining outpost in the Alderaan system so that Vader's plan can proceed without any unforeseen complications. Once the job is over, they all hope to go far away to enjoy whatever incentive the Empire has promised them.

Miners tend to be somewhat cold and distant, except with other miners. They are fairly laconic, and more restrained than men alone on a mining outpost generally have a right to be.

GRAVEYARD OF ALDERAAN CHARACTER TEMPLATES

Kathos Loof

Type: Mining chief

DEXTERITY 3D

Blaster 4D+1, brawling parry 4D, dodge 4D, melee combat 4D+2, melee parry 4D

KNOWLEDGE 2D+2

Bureaucracy 3D+1, geology 4D+1, languages 3D+1, survival 4D+1, value 4D+1

MECHANICAL 3D

Mine drill operation 4D, repulsorlift operation 4D

PERCEPTION 2D+2

Bargain 3D+2, command 4D+2, con 3D+2

STRENGTH 3D

Brawling 4D, stamina 4D

TECHNICAL 2D+2

Demolitions 4D+2, mining 5D+2

Character Points: 4

Move: 10

Equipment: Blaster (4D), club (STR+1D), breath mask, mining suit, comlink, mining tool kit

Capsule: Kathos Loof is a human male in his late 40s. He is a grizzled, thick-built, strong man who always looks unkempt, no matter how much he washes and grooms himself. He just can't get the grit of 30 years of mining off of himself.

Loof is staunchly pro-Imperial. He will cooperate with the Imperial currently using his mining outpost as a staging area so that he can get back to the business of mining. Loof considers the Rebellion a doomed effort and consequently a total waste of time. He has seen firsthand the might of the Empire and believes that any who oppose such power are fools destined to fail.

Loof's son, Trammis, is a member of the Imperial Army, currently stationed near Coruscant. Loof is extremely proud of his son, though he is afraid that someday the civil war will place Trammis in harm's way. As a result, Loof considers the Rebellion a threat to his son's life, and he will be *extremely* reluctant to help anyone he believes is involved in the Alliance.



Allen Nurnis

Kathos Loof enjoys the dark, dank, close interiors of the mines. He loves the smell of freshly dug rock and metal, and he can spot a rich deposit like a con man can spot a fool itching to part with a credit voucher. He has been a miner for longer than he can remember, and he has been an outpost chief almost as long. His permit and most of his contracts come from the Empire, so he is a faithful supporter of Palpatine's New Order. When Lord Vader "requested" assistance in the current matter, Loof readily agreed. Now he commands a new crew of Imperial agents, at least as far as the mining operation goes. But when the Rebels arrive — folks named Organa and Skywalker, he's been told — the show becomes an Imperial one and he knows just the hole he's going to hide in until it is all over.

Loof is a cantankerous old man set in his ways. Sometimes he acts older than his build or true age would indicate. He is tired of the long years he has spent digging rocks, but he also loves what he does and doesn't know anything else.

GRAVEYARD OF ALDERAAN CHARACTER TEMPLATES

Captain Janus Bonn

Type: Imperial Naval Captain

DEXTERITY 2D+2

Blaster 3D+2, dodge 4D+2, grenade 3D+2

KNOWLEDGE 3D

Bureaucracy 4D, languages 4D, planetary systems 4D+2, survival 4D+1

MECHANICAL 3D+2

Astrogation 4D+2, space transports 5D+2, starship gunnery 4D+2, starship shields 5D+2

PERCEPTION 3D+1

Bargain 3D+2, command 5D+1, con 3D+2, search 4D+1

STRENGTH 2D+1

Stamina 3D+1

TECHNICAL 3D

Security 4D

Character Points: 6

Move: 10

Equipment: Blaster pistol (4D), grenades (5D), comlink

Capsule: As a young officer, Janus Bonn was assigned to assist the Emperor's newest operative, Lord Darth Vader. While he does not believe in the "arcane religion" that Vader professes to use, Bonn does have a healthy respect for the Dark Lord's ability to produce results. In fact, the setback at Yavin is the only failure he ever remembers Vader suffering.

Bonn climbed through the ranks as his master did, earning his rank as captain while Vader was assigned to Grand Moff Tarkin and the Death Star project. Now with Vader commanding an Imperial fleet charged with hunting down and eliminating the Rebellion, Bonn has been sent to the Alderaan system to prepare one of the many traps Vader is setting throughout the galaxy to snare the so-called Heroes of Yavin.

Captain Janus Bonn is a career Imperial officer who rose through the ranks much the same way his master has — thorough deceit, displays of power, and cold-blooded murder. As a child growing up on the Core World, Corulag, Bonn was immersed in the Emperor's philosophy of human "High Culture." The son of a wealthy Imperial noble, Bonn at-



Allen Nurns

tended the best university possible, graduating with honors. He immediately volunteered for Imperial military service upon graduation, and has distinguished himself during his short career.

Bonn tends to hold each mission objective he is given as the be all and end all of his existence; to fail would — in his eyes — invalidate any meaning in his life. He is an uncommonly fanatical supporter of Palpatine's New Order and possesses a doglike loyalty to Lord Vader.

Bonn has been described as a cold, emotionless automaton. This is not the case; emotionally, Bonn is possessed by a chaotic whirlwind of fear, hatred and violence that would cast doubt on the Imperial Captain's sanity. Only when pressed will Bonn allow his icy composure to slip, revealing the violent nature he conceals. His lifeless, glacially calm eyes have an unnerving affect on his men, and his efficient, emotionless attitude has earned him the nickname, "The Dead Man," among the troops under his command.

GRAVEYARD OF ALDERAAN CHARACTER TEMPLATES

Dal Rogos

Type: ISB Agent

DEXTERITY 3D

Blaster 5D, brawling parry 4D, dodge 5D, grenade 4D, melee combat 4D, melee parry 4D

KNOWLEDGE 3D

Alien species 4D, bureaucracy 4D, cultures 4D, languages 4D, streetwise 4D, survival 4D

MECHANICAL 3D

Repulsorlift operation 4D, space transports 4D+2, starship gunnery 4D, starship shields 3D+2

PERCEPTION 3D

Bargain 4D, command 4D+2, con 4D+2, hide 3D+2, search 4D, sneak 3D+2

STRENGTH 3D

Brawling 4D, stamina 4D

TECHNICAL 3D

Demolitions 4D, droid programming 3D+2, droid repair 3D+2, security 4D+1

Character Points: 2

Move: 10

Equipment: Blaster pistol (4D), hold-out blaster (3D+1), vibroknife (STR+1D), grenades (5D), breath mask, comlink, security tool kit

Capsule: Dal Rogos is an undercover agent for the ISB, and as such, he has been trained to blend in with whatever surroundings he finds himself in. He is a human male of medium build and height. He has short dark hair and a neatly-trimmed moustache. He habitually wears a clean white turban and well-tailored merchants' robes that neatly hide the blaster he carries.

Rogos has been an undercover ISB operative for years, travelling from assignment to assignment with a modestly successful record. Like most Imperials, Rogos finds contact with non-humans distasteful, though he has a better-than-average command of a variety of alien languages due to his extensive travel.

He is unaware of Darth Vader's involvement with the excavation on Alderaan, though he is aware that some sort of operation is the works. Rogos will tag along — from a discreet distance, of course — to make sure that Rebels do not uncover an installation or project that the Empire values.

Dal Rogos was aboard the *Bazaar*, watching for any signs



Allen Numis/Alan Jude Summa

of Rebel activity that he could report to his superiors; Rogos is nothing if not ambitious, and the more Rebels he exposes, the faster he climb through the ISB ranks.

He has been following the Rebels for some time now, and was waiting to apprehend them once they led him to the merchant who was aiding them. Then the murders of two miners caught his interest. From that point on, he decided to follow the Rebels to see where they are going and to find out why the miners were murdered. He is not initially involved in Vader's scheme, but will offer his assistance once he reaches the Graveyard and meets with Captain Janus Bonn.

Under casual observation, Rogos appears to be a friendly stranger, even helping those who need aid when the situation moves him. But in reality he is a cruel and efficient killer totally loyal to the New Order whose mission is to uncover and dismantle Rebel operations whenever possible. His superiors often note that Rogos is an extremely competent officer, who many expect to rise to high rank in the Imperial intelligence hierarchy.



A long time ago in a galaxy far, far away ...

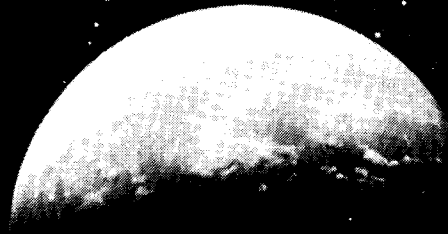

Short of food and water, a group of heroes desperately search for new supplies. Calling at Kwenn Space Station on their last adventure, the Empire impounded their ship. Recognized by Crutag the Taloron Hunter, who covets the price on their heads, the group stole a ship and fled the station.

The ship was a wreck which failed in its first hyperspace jump. Now, having done some rapid repairs, they approach the world of Trinta in the Outer Rim Territories. Here they hope to find supplies to help them continue to evade their pursuers.

But Trinta holds a dark secret. A secret that will tax the heroes to their limits ...

Domain of Evil

It is a dark time for the galaxy. The Empire controls thousands of worlds through brutality and treachery, and uses its awesome might to crush the spirit of myriad races. Backed by a military machine seemingly without equal, the Empire appears to be invincible as it tightens its stranglehold on the stars.

But now a force has arisen which dares to challenge the mighty Empire. This Rebel Alliance has scored significant victories against the Imperial armed forces, enough to prove to the enslaved worlds that their oppressor can be wounded. Rallied by these events, beings on many worlds once again dare to dream of freedom.

This is the setting of *Star Wars*, the saga of a battle between a valiant few and monstrous evil, with the galaxy itself the prize.

Domain of Evil is an advanced *Star Wars* adventure for four to six players and a gamemaster. If you are planning to play a character in this adventure, stop reading now. If you read the book through, you will spoil the adventure for yourself and the other players. If you are planning to be the gamemaster, continue reading.

In This Adventure ...

... player characters, short of supplies and chased by Crutag (a Taloron Hunter) and his henchmen, crash-land on the world of Trinta. But unknown to them, Trinta is not a normal world. It contains a dark side nexus similar to the one on Dagobah.

The nexus on Trinta is home to Halagad Vantor, a Jedi Knight whose mind was probed by Darth Vader to discover the whereabouts of his fellow Jedi; that information was used to track down a number of the Old Republic's protectors and murder them. The process left Vantor insane, and he stole a small ship and fled to Trinta.

There the dark side nexus called to him, offering him escape from his pain and guilt. In his madness, Halagad accepted, and in the years since then, the

nexus has expanded to encompass the entire world. It radically changed Trinta and filled it with images drawn from Halagad's twisted mind.

When the player characters reach Trinta, Halagad, fearing that Vader has at last found his hiding place, uses the power of the nexus to protect himself. But as he comes to realize the power of the player characters, he sees in them the means of his release from the dark side. Torn between his fears and his longing for peace, Halagad forces the player characters to confront a series of tests. And if they complete them successfully, the greatest challenge still remains: convincing the tormented Jedi to let go of his dark past and turn away from evil.

Domain of Evil leads the player characters through a gauntlet of horror, as they battle the creatures of the swamp world and the illusory monsters that stalk the mind of Vantor.

Preparing to Play

The GM should read through the entire adventure before play begins in order to present it in a fluid and dramatic manner.

If you plan to run this adventure as part of an existing campaign, review your players' character templates so you can adjust the encounters to make use of their particular skills and experience.

Adventure Materials

This book contains the adventure *Domain of Evil*, various maps, player handouts, four non-player character templates, and the script used to start the adventure. It's a good idea to photocopy the script, player handouts and the maps before play begins.

In addition to the adventure, you also need *Star Wars: The Roleplaying Game, Second Edition*, pencils, paper, and lots of six-sided dice. The *Star Wars* miniatures sets are recommended, but are not essential for play.

Adventure Background

The World of Trinta

Long before Halagad Venter came to Trinta and discovered the dark side nexus, the swamp world was regarded as a hellish place, to be avoided at all costs. Even the Ithorians, who first explored the planet and are noted for their love of heat and humidity, disliked the world, naming it after the realm of demons in Ithorian mythology.

The atmosphere of Trinta is breathable, although the climatic conditions make the air seem like a solid substance that clings to you as you move through it. Ninety percent of the world is fetid swamp, dotted with wooded islands and mudbanks. The remainder of the planet is polar ice caps.

Despite its forbidding reputation and its location in the Outer Rim Territories, attempts have been made to colonize Trinta in the past by various races. All have been dismal failures, and after an Old Republic survey team officially dismissed the world as lacking anything in value, space traffic in its vicinity ceased. It was not until Halagad Venter sped into the Yartiv system, fleeing from the memory of torture at Darth Vader's hands, that Trinta acquired a permanent resident.

Venter is the only intelligent lifeform on the planet, although Trinta does have abundant plant and animal life. It is also the site of a dark side nexus, a concentration of evil power that allows those with knowledge of the Force to accomplish remarkable deeds, at the price of their souls.

Adventure Synopsis

Episode One: Crash-Landing

Approaching Trinta in a stolen ship, the player characters are attacked by Crutag, a Taloron Hunter. The drives fail on the ship and the player characters plummet down to crash on the planet.

Episode Two: Mists of the Mind

The world of Trinta is subject to Halagad's paranoid fantasies and fears. Using the dark side of the Force, Halagad projects illusory realities from the depths of his tortured soul. These dreamscapes reach out across Trinta to affect the player characters and Crutag's hunters.

Within a dreamscape, events appear real. Dreamscapes contain creatures which are manifestations of Halagad's madness, given power by the dark side of the Force. They appear in many different guises — some seek to lure the characters to their doom, some attack, while others try to create panic among their victims.

Halagad controls the dreamscapes and dreambeasts with the dark side nexus. At first,

his powers are limited to creating illusory dreambeasts, the Dradan, which entice the characters away from their ship. These beings are insubstantial and cause no direct harm, but they attempt to poison the characters before finally fading away.

Even worse, Halagad has used the dark side to steal the player characters' and Crutag's ships. Stranded on Trinta, the player characters, Crutag, and his hunters cannot escape from Halagad's clutches.

Episode Three: The Nightmare Begins

Halagad marshals his anger and gives it embodiment in the form of an illusory rancor. He seeks out the player characters with this monstrous creation and uses it to assault their sanity. Channeling the dark side of the Force through it, Halagad rips at the player characters' minds.

Episode Four: A Disturbance in the Force

Having tasted the player characters' powers, Halagad now suspects that they are more than they at first seemed. These player characters could prove to be the means of his escape from the power of the dark side. But Halagad is torn between his desire to find out more, and his craving to protect himself from discovery at all costs.

A titanic struggle takes place within him as his madness battles with the last vestiges of his better nature. This manifests itself in a vast disturbance in the Force that is felt all over Trinta.

This disturbance has dramatic consequences, releasing huge quantities of dark side energy which lashes out to corrupt and warp wildlife in the vicinity of the dark side nexus.

Later, Halagad brings himself back under control, but with the dark side once again dominant. He now seeks to destroy the player characters. He directs his nightmarish creations to attack them. Dark forces, released previously by Halagad's rage, torment and attack the player characters. But the players are able to find a clue to the identity of their torturer, coming upon the remnants of a camp used by Halagad when he first arrived on the swamp world.

Episode Five: Ambush

The characters are not the only ones who come to Halagad's attention. Crutag and his gang of cutthroats also interest him. Many of the hunters prove to be weak and die too easily for Halagad's purposes. But he sees in Crutag a strength and vitality he can use.

Using the powers at his disposal, Halagad engineers a confrontation between the player characters and the remaining bounty hunters. He subtly directs Crutag to an area that the player characters will shortly pass through. Halagad expects Crutag to kill the characters; Halagad will then lure Crutag to the nexus where he will corrupt him, totally.

If the characters defeat Crutag, Halagad again flies into a rage. He lashes out with more dark side energy. Tortured creatures go on the rampage and a titanic storm, mirroring Halagad's internal one, tears across the world causing large scale flooding and destruction.

Episode Six: The Dark Side

Eventually, Halagad achieves a new equilibrium. He now seeks to turn the player characters to the dark side by luring them into the nexus. There he presents them with a series of tests designed to lead them down the pathway of anger and fear, the road to corruption. If he is successful, he will use them to destroy himself — only by so doing, he believes, can he be released from his torment.

To survive the nexus and pass Halagad's tests, the player characters must adhere to the Jedi code. If they trust in the Force, they can escape the nightmare and redeem Halagad's tortured soul.

Dreambeast Attacks

Dreambeasts attack in the normal manner, but instead of causing physical harm, they inflict mental trauma damage on their victims. A victim of a dreambeast attack believes himself to take normal physical damage from an attack. The trauma of the attack feels real: *stunned* characters are stunned for one round; *wounded* characters suffer a 1D reduction in all their die codes; and *incapacitated* characters are unable to act. Characters will even see wounds on their bodies, as if attacked by a substantial foe. Only later, after the combat is over, does a character recover from the trauma and realize the attack affected his mind, not his body.

The gamemaster should apply the mental damage effects of the dreambeast attack after the combat is over. A dreambeast, being insubstantial, fades away to nothingness a few seconds after combat ends. As it does so, player characters who were wounded by the dreambeast feel light-headed and see their wounds fade at the same time. *Wounded* or *incapacitated* characters recover with no physical damage (damage caused by creatures or objects other than dreambeasts, of course, remains). They now become aware of having suffered mental damage.

Wound: A mental *wound* causes a character to

lose one pip from his *Knowledge*, *Perception*, *Mechanical* and *Technical* attributes. See "Mental Damage" below for the effects of this.

Incapacitated: An *incapacitated* character loses 1 pip from his *Knowledge*, *Perception*, *Mechanical* and *Technical* attributes. In addition, he loses a Force Point.

Force Users: Characters with Force skills are affected differently by dreambeast attacks. Each *wound* or *incapacitated* result wipes out one of their Force skills in this order — *Alter*, *Sense*, *Control*. Once a character has lost all of his Force skills, he is affected like other characters.

A character with Force skills who takes a *wound* from a dreambeast instantly loses his *Alter* skill, but don't tell the player this immediately. Only when he tries to use his *Alter* skill does he become aware of its loss.

Mental Damage

Mental damage is caused by dreambeast attacks. It causes a deterioration in a character's mental attributes — *Knowledge*, *Perception*, *Mechanical* and *Technical* — which remain until the end of the adventure.

For our purposes, a single die is made up of three pips. So losing three pips results in the loss of a whole die. Take a look at the chart below to see how this works:

| Starting Dice | -1 pip | -2 pips | -3 pips |
|---------------|--------|---------|---------|
| 5D | 4D+2 | 4D+1 | 4D |
| 4D | 3D+2 | 3D+1 | 3D |
| 3D | 2D+2 | 2D+1 | 2D |
| 2D | 1D+2 | 1D+1 | 1D |

For example, a character who lost one pip from a *Perception* of 3D+2 would have his *Perception* reduced to 3D+1. If he lost another pip, it would become 3D. The loss of a third pip, reduces his *Perception* to 2D+2, and so on.

As a character's attribute die codes are reduced, skills governed by his mental attributes are also reduced.

A character's attributes cannot be reduced below 1D. If a character takes mental damage which would reduce one or more of his attributes below 1D, ignore the damage, but roll 1D and consult the table below. Alternatively, pick any result you like. Tell the player the result in secret, and ask him to roleplay it for the remainder of the adventure.

Adverse Mental Result Table

1. Drooling Imbecile: Life is peaceful. There's no hurry. Just sit down and relax. Drool a little. Now, doesn't that feel good? This is it, the good life. Just sit there and enjoy the peace and tranquility.

2. Psychopathic Killer: Kill! Kill! Kill! You were born to kill. Everything else was born to die at your hands. Fulfill your destiny. Shout your battle cry. Kill! Kill! Kill!

3. Ranting Lunatic: It's too quiet. There's not enough noise. You must break the silence. Shout, rant and rave about anything you like, but end this oppressive silence.

4. Frightened Runner: Fear is everywhere. The only way to escape is to run, run and keep on running. Let nothing stop you. You must succeed in your break for freedom.

5. Paranoid Madman: They are out to get you. They may pretend to be your friends, but they brought you here to die. Trust no one. Keep your blaster handy. Shoot anyone who threatens you.

6. Harmless Amnesiac: What's going on? Why am I here? Who are you people? Who am I? What day is it? What Rebellion?

Note: The loss of 1D from all attributes and skills caused by a normal physical wound is not counted towards a character's total mental attribute loss. Only mental damage caused by dreambeasts affects a character's mind. A character's attributes can never be reduced below 1D. If a wound brings a character below 1D, the character is considered to still have a 1D attribute.

Regaining Lost Pips and Force Powers

To be restored to their former selves, the player characters need to complete the adventure. Lost attributes and Force skills are returned after the final confrontation with Halagad (see "Episode Six: The Dark Side").

The Main Gamemaster Characters

Halagad Vantor: A Jedi Knight, Vantor's will was too weak to resist the mind probes of Darth Vader. Stripped of all mental defenses, he surrendered the knowledge of the Jedi. But Vantor was unaware that any but he survived. Racked by guilt, he fled from Vader and hid on Trinta. Once there, he succumbed to the seductive power of the dark side nexus and was corrupted. Now he uses his dreamscapes to protect himself from all intruders, fearing that Vader will one day find him again. Deep inside, he yearns for release from the hell in which he lives, and forgiveness for his sin against the Jedi.

Crutag: A Taloron Hunter, Crutag chases the player characters to collect the bounty placed on their heads. A fierce and determined stalker, Crutag has boasted that he has never failed to catch his prey. He rules his band with harsh discipline, the only way to keep the disparate aliens in his employ from fighting amongst themselves. He considers the conditions on Trinta to be uncomfortable and annoying, but no real threat to his objectives. His most prized possession is his ship, the *Scent of Fear*, and the surest way to anger him is to compare him to bounty hunter Boba Fett, who Crutag considers vastly over-rated.

The Adventure Begins

Can the player characters survive the horrors of Trinta and the nexus, or will they fall victim to the lure of the dark side? Let's find out as we enter the *Domain of Evil* ...

Episode One Crash-Landing

Summary

The adventure begins as the player characters approach the swamp world of Trinta. Low on supplies and forced into the Outer Rim Territories by news that Crutag the Taloron Hunter is searching for them, the characters are heading for Trinta to restock food and water. As they near the planet, Crutag surprises them and damages their vessel. The player characters must fight off the bounty hunter's ship and land their own on the swamp world.

Start the Adventure

Locate the script and assign a part to each player. The parts are labelled "1st Player Character," "2nd Player Character," and so on. If you have fewer than six players, assign additional parts as necessary. Give each player a copy of the script. If you don't have access to a photocopier, you can share the copy in the book. When everyone is ready, read the opening "scroll" (found on page 68) to the players and then start the script. The adventure begins when all players are finished reading the adventure script.

A Warm Welcome

Crutag has searched diligently for the player characters since he detected their presence on Kwenn Space Station. Knowing that they desperately need supplies, Crutag guessed that they would visit Trinta. He has patiently awaited their arrival.

After they emerge from hyperspace, Crutag and his crew aboard the *Scent of Fear* commence their attack. The player characters attempt to jump to hyperspace, but their stolen ship is not up to the task. The hyperdrives again fail on them and they must attempt to land on Trinta to escape Crutag. Unfortunately, the ion drives also give out. The ship dives toward the planet.

The Scent of Fear

Crutag aims to take the player characters alive. He seeks to disable their ship even further as it falls towards the planet. Crutag attempts to stay at short range, and evades to avoid enemy fire. Each round the *Scent of Fear's* two laser cannons fire on the player character ship.

Throughout the descent, Crutag mocks the characters, calling on them to surrender. "Give up, scum. There is no escape."

Welcome to Trinta

The descent to Trinta is broken into six segments, each representing a different altitude level, with level one being the highest and level six the surface of Trinta. The player characters' ship drops one level each round. Deprived of its ion drives, there is no way the ship can be prevented from descending rapidly. The player characters start at level one and skill rolls are required as the ship reaches each level.

The landing is made especially difficult by the violent weather conditions, which obscure visibility and threaten to shake the ship apart in mid-air. *Sensors* rolls are needed during the descent to track the *Scent of Fear* and to navigate through the storm.

Going Down Fast

After the players finish reading the script, read aloud:

The *Scent of Fear* is on your tail at short range. Its two blaster cannons track the erratic flight of your ship as it dives toward the flickering green haze below. The ship's controls are sluggish and the whine of air against the rapidly heating hull grows louder and louder.

Level One — High Orbit

Keep in mind that the player characters' ship is in a screaming dive toward the surface, and they have no time to think, only act. Keep the pressure on by giving each player five seconds to announce an action. If he hesitates, skip him and go to the next player.

Pilot: A Moderate *space transports* roll is required

to pull the ship out of its dive. A failed roll results in a stomach-wrenching lurch as the ship spins out of control and drops to level three. The range to the *Scent of Fear* increases to medium.

Scanners: An Easy *sensors* roll reveals dense woods beneath the swirling green fog.

Guns: Gunners may fire normally at Crutag's ship.

The Hunter and the Hunted

■ Scent of Fear

Craft: *Scent of Fear*
Type: Modified Taloron Prey Chaser
Scale: Starfighter
Length: 40 meters
Skill: Space transports: Taloron Prey Chaser
Crew: 1
Crew Skill: See Crutag the Hunter
Passengers: 25
Cargo Capacity: 30 metric tons
Consumables: 4 months
Cost: Not available for sale
Hyperdrive Multiplier: x1
Hyperdrive Backup: x15
Nav Computer: Yes
Maneuverability: 2D
Space: 8
Atmosphere: 365; 1050 kmh
Hull: 5D
Shields: 4D
Sensors:
Passive: 35/0D
Scan: 60/1D
Search: 100/2D
Focus: 3/2D+1

Weapons:

2 Laser cannons (fire separately)
Fire Arc: Turret
Crew: 1
Skill: Starship gunnery
Fire Control: 3D
Space Range: 1–3/12/25
Atmosphere Range: 100–300/1.2/2.5 km
Damage: 4D

Capsule: The *Scent of Fear* is owned and captained by Crutag, a notorious bounty hunter. While Crutag isn't famous for results — he is, in fact, a fairly mediocre bounty hunter — he is quite well-known for his tenacity and sheer brutality. The *Scent of Fear* reflects his rough nature.

Modified to be better shielded, more maneuverable, and faster than the average Taloron Prey Hunter, Crutag has sacrificed weapon power. He has however, increased the accuracy of the vessel's targeting computer, giving him a decided edge over most non-military vessels. In addition, he has armored the hull considerably, preferring to run with shields down.

"When a target sees my shields are down, they tend to believe they have an edge, and

that's when they get careless," he has said, "and when they get careless, I own 'em."

■ Stolen Freighter

Craft: *Trallus' Rustbucket*
Type: Modified (and rather dilapidated) Ghtroc freighter
Scale: Starfighter
Length: 35 meters
Skill: Space transports: Ghtroc freighter
Crew: 1 to 2 (can coordinate)
Passengers: 6
Cargo Capacity: 100 metric tons
Consumables: 3 weeks
Cost: 15,000 (used)
Hyperdrive Multiplier: x1
Hyperdrive Backup: x18
Nav Computer: Yes
Space: 4
Atmosphere: 480; 800 kmh
Hull: 2D
Sensors:
Passive: 10/0D
Scan: 25/1D
Search: 40/2D
Focus: 2/3D

Weapons:

2 Laser cannons (fire separately)
Fire Arc: Turret
Crew: 1
Skill: Starship gunnery
Fire Control: 2D
Space Range: 4D
Atmosphere Range: 1–3/12/25
Damage: 100–300/1.2/2.5 km

Capsule: *Trallus' Rustbucket* is aptly named. The ship has numerous dings and dents, and repeated trips through some form of gas cloud have so eroded the hull plates that sufficient impacts will rip through them like paper. The vessel has dozens of systems that require immediate attention; perhaps this is why the ship's owner isn't terribly eager to see his ship recovered. The average ship owner would be thrilled to be rid of the heap.

The loss of their own ship has forced the player characters to make do with the *Rustbucket*; they stole it from Kwenn Space Station. It is considerably slower than the Taloron ship, and the maintenance problems with the vessel will take their toll during combat.

DOMAIN OF EVIL

ADVENTURE SCRIPT

The following script begins the adventure.
Your gamemaster will tell you what part (or parts) to read.

GM: *Cut to player character vessel emerging from hyperspace. The hyperspace lines flicker, then break into a star spangled view of real space. Rust covers the outside of the ship. Cut to the ship's grubby interior.*

1st Player Character: Here we are, Trinta. We'll breeze down. Forage around and load up with supplies.

2nd Player Character: *(Accusingly.)* That's what you said when we called at Kwenn Space Station.

3rd Player Character: Yeah, except it was crawling with Impies and bounty hunters.

4th Player Character: We had to call at Kwenn. We needed the supplies. Our last trip left us low on food and water.

5th Player Character: Yeah, and the Empire stole our ship. And do we steal a decent one in exchange? No, we take *this* pile of junk!

6th Player Character: I don't like this. I'm getting us a new course, so we can get out of here if there's any trouble.

3rd Player Character: First jump out of Kwenn and the drives blow. It takes us weeks to fix them. Meanwhile, we've eaten all of the supplies.

1st Player Character: How was I to know it had faulty drives? I didn't get a chance to look them over.

4th Player Character: Don't forget that we had Crutag and his bounty hunters breathing down our necks. It was split from Kwenn or keep an interrogation droid company.

5th Player Character: Never mind that. Even Crutag wouldn't think we'd be dumb enough to come here.

GM: *Cut to viewport. A swirling greenish haze, lit by flickering electrical storms, surrounds the planet.*

2nd Player Character: Yeah, look at those storms. We'll be lucky to find anything. If we don't get blown to bits going through the atmosphere, we'll end up sinking into a bottomless swamp.

3rd Player Character: Crutag's a Taloron Hunter. He ain't gonna give up on us.

1st Player Character: Trust me. Crutag won't find us. He's probably on the other side of the Galaxy by now.

5th Player Character: Sure, just like you said he was no problem before.

4th Player Character: Whether Crutag's following us or not, we've got no choice. We're out of food, and we've only got a day's supply of water left.

6th Player Character: I've got a bad feeling about that planet. I'm nearly there with the jump coordinates.

Continued on next page.

DOMAIN OF EVIL ADVENTURE SCRIPT

Continued from previous page.

3rd Player Character: Crutag's got a rep almost as big as Solo's. Once he's on a scent, he don't give up.

2nd Player Character: Swell. We've got Crutag's biggest fan with us (*point at 3rd Player Character*), and an eternal optimist at the controls (*point at 1st Player Character*).

3rd Player Character: Hey! I'm only facing facts. Crutag's ...

4th Player Character: Right behind us! He's on our tail!

2nd Player Character: Where did *he* come from?

1st Player Character: (*Groan.*) It's not my fault. Someone must have told him we were coming.

3rd Player Character: Says you. Crutag's had time to check out every other planet around here. He's probably been waiting for us.

GM: *Crutag's ship, the Scent of Fear, screams toward you. It opens fire. Blaster bolts sear across your ship, which lurches toward the planet.*

6th Player Character: Let's get out of here. The jump coordinates are done. Come on, make the jump to lightspeed! Punch it!

1st Player Character: No problem. Here we go!

GM: *The pilot's console flickers as the hyperdrives surge into life. Then the drives wind down with a sickening shudder. The Scent of Fear swoops onto your tail.*

5th Player Character: Great, I knew it. The hyperdrives are blown again, and with our luck, we'll probably burn up in the atmosphere.

GM (as Crutag): I have you now, scum. Surrender or die. (*Chuckles.*)

2nd Player Character: Take us down. We're a sitting target up here.

1st Player Character: Okay, Trinta, here we come!

6th Player Character: Not so fast! Crutag's the one who's meant to kill us, not you!

3rd Player Character: We're in big trouble. The ion drives are reaching critical. This could be it, folks!

GM: *The ship shakes as the ion drives lurch under the stress. Caught in Trinta's gravity, the player character's ship drops towards the world.*

4th Player Character: Hey! Don't stand there gaping. Get to your battle stations! We're not going down without a fight!

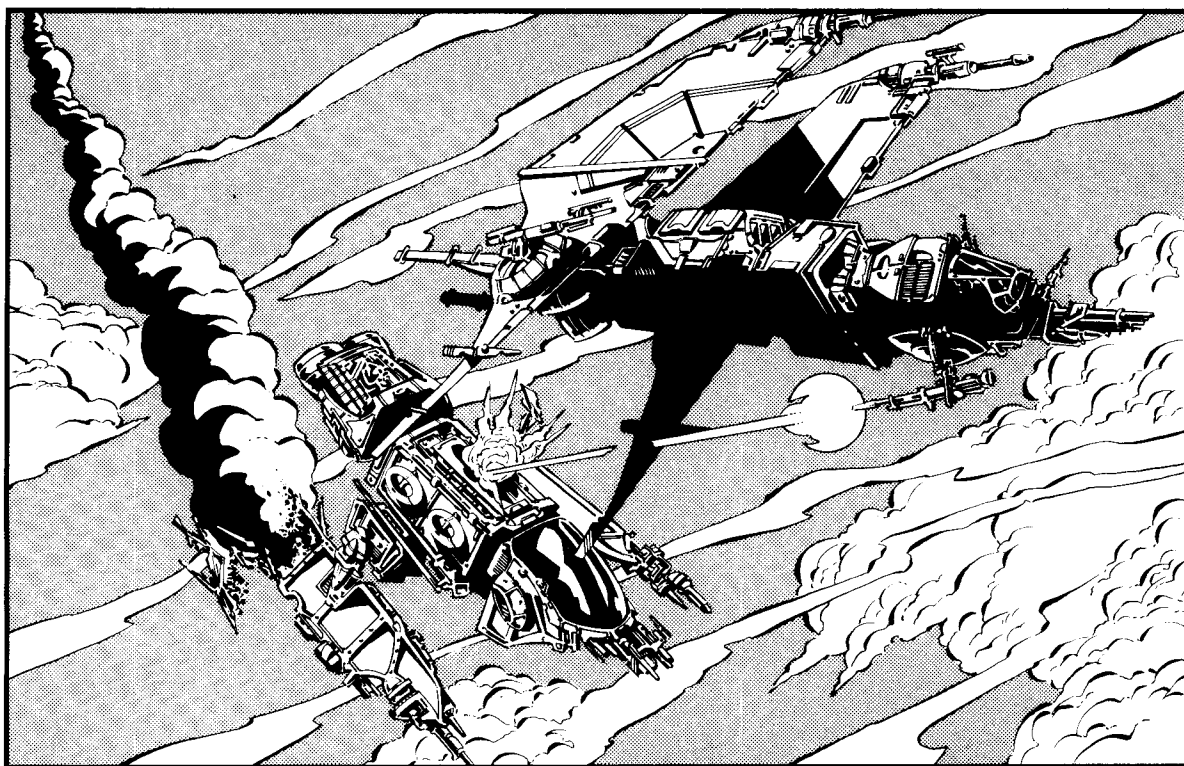

Allen Numis

Level Two — Into the Storm

As the ship reaches level two, read aloud:

Thick green fog envelops the ship. Lightning flashes across the viewport as heavy rain drums onto the hull, and the wind makes an unearthly shriek as it gusts. The scanners suddenly go blank and the viewports reveal only swirling green fog. For an instant, it seems as if a malevolent, inhuman face is rising out of that mist, but then it is gone.

Pilot: As the ship is buffeted by the storm, a lightning bolt strikes the hull, ionizing the controls for one round. A Moderate *space transports* roll holds the ship steady. Failing the roll causes it to plunge immediately to level four, increasing the distance between the freighter and the *Scent of Fear* to medium.

Scanners: An Easy *sensors* roll reactivates the scanners and allows the *Scent of Fear* to be tracked. If the roll fails, the scanner operator may try again next round. However, a Moderate roll is now needed.

Guns: If the scanner operator fails to track the *Scent of Fear*, the gunners may still fire, but add +5 to the number needed to hit for each round that Crutag's ship remains untracked.

Level Three — Skimming the Trees

Read aloud:

The leafy canopy of what look like huge trees lies directly ahead and underneath you.

Pilot: A Moderate *space transports* roll allows the pilot to skim the ship over the trees while the scanner operator looks for a landing site. Failure to pilot the ship successfully results in 4D damage to the ship's hull as it skips across the tops of the trees, unless the shield operator succeeds in using the shields.

Shields: A Difficult *starship shields* roll protects the ship from damage. This is a reaction roll. If the roll fails, the ship takes damage as above, and the player characters take 3D damage each, unless they make Easy *Dexterity* rolls.

Scanners: The scanner operator can continue to track the *Scent of Fear*.

Guns: Gunners may attempt to blast the trees out of the way. Add the *starship gunnery* roll total to the pilot's skill roll.

Dropping From Level One: If the ship has dropped straight from level two, the player characters suddenly see, through a gap in the fog, the trees looming up beneath them. A Difficult *space transports* roll pulls the ship out of its dive and sends it skimming over the trees. A failed roll results in

GAMEMASTER MAP: The Landing Zone

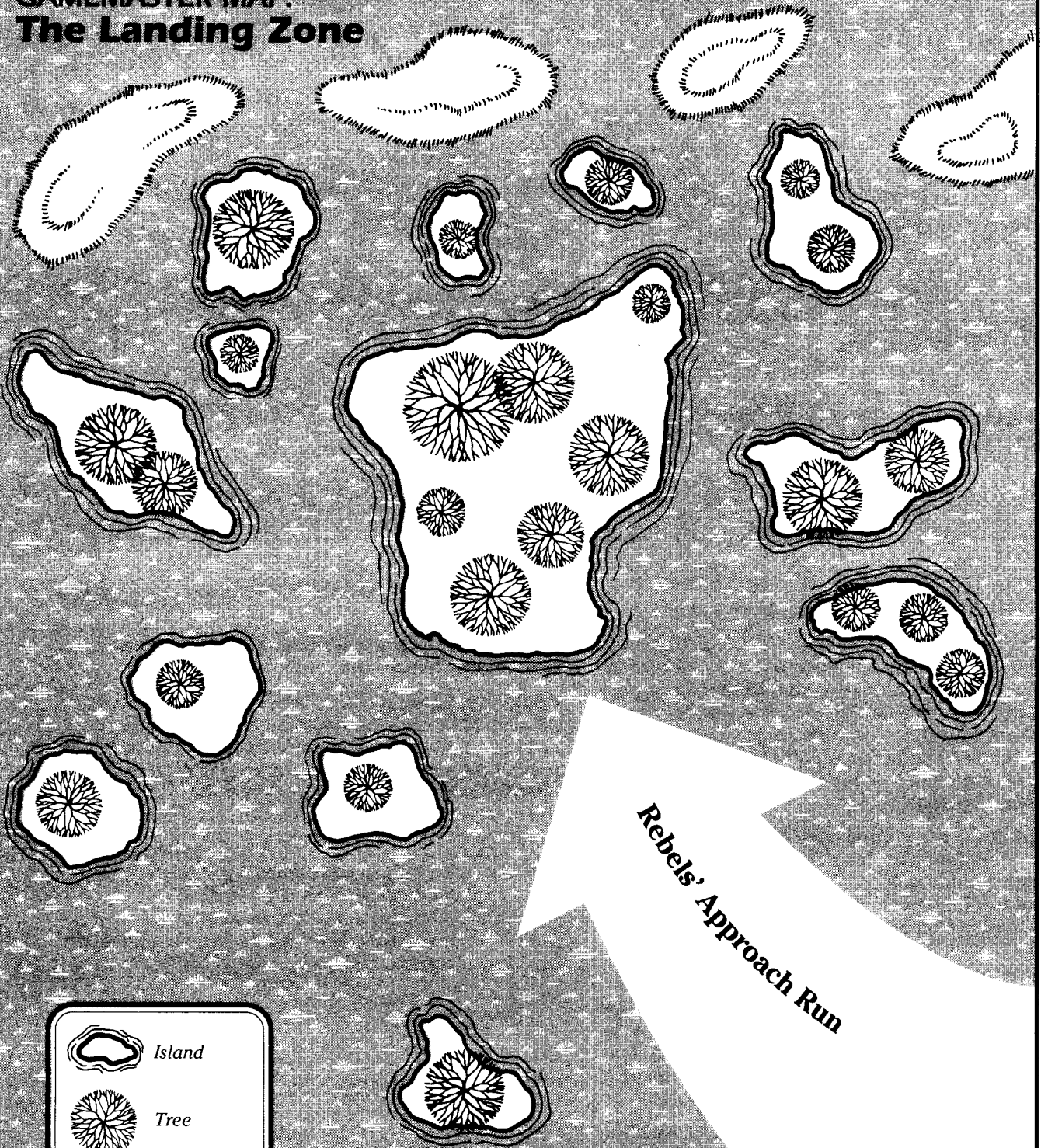

| | |
|--|---------|
| | Island |
| | Tree |
| | Mudbank |

Stephen Crane

SURVEY TEAM REPORT / STR2434



To: Greeley, Director, Cartography and Surveying, Sector O-1
From: Trask, Commander, Survey Team 63529
Re: Trinta, Sector 0-1, planet #5.

Sir,

Trinta orbits the red star Yartiv, in what is commonly known as the "Outer Rim Territories." The atmosphere is Type I (breathable), the climate tropical, with temperatures averaging 40° Celsius. The soil is rich, and there is a great variety of flora and fauna present, but no evidence of intelligent lifeforms. The weather ranges from calm to exceedingly violent, with heavy downpours and lightning storms a frequent occurrence. This, combined with the humid conditions which cause many types of plant life to rot before they can be harvested, can be regarded as contributing factors in the failure of the three colonies formerly established on Trinta.

Terrain

The primary type of terrain on Trinta is viscous swamp, which makes up 90 percent of the planet. Firmer footing can be found on the heavily-wooded islands which dot the planet. In addition, there are a number of mudbanks, which range from solid to virtual quicksand. The northern and southern extremities of the planet are marked by polar ice caps.

Mineralogy

No minerals of worth were contained in the rock and soil samples examined by our expedition. Mineral density is high at 85 percent, but the element most commonly found is iron, which has little value in trade.

Biology

Biodensity is also extremely high, close to 90 percent, with reptiles and insect species predomi-

nating. There are also some mammalian species present, but many of these are nocturnal owing to the extreme heat.

There are abundant species of flora, but few of these are edible, and our party subsisted primarily on edible fungi in addition to our freeze-dried rations. Water can be consumed safely, providing it is boiled beforehand. In addition to the lack of edible plants, we discovered at least one species of carnivorous flower.

Both the animals and plants on Trinta pose a possible danger to visitors to the planet.

Psychology

Following the standard eight-month investigatory period, I found my team to be unusually tense, and had to intervene to prevent a number of disputes from flaring into violence. This would seem to coincide with the histories of the colonies established here, which disbanded and left Trinta after civil wars broke out among the residents. I can offer no explanation for the behavior of my crew, save to say that they seemed to return to normal once we had left the planet.

Recommendation

In my considered opinion, Trinta is unsuitable for colonization, owing to its hostile climate, poor terrain, threatening plant and animal life, and lack of proximity to major space lanes. In addition, its lack of natural resources make it a poor site for a mining operation. I see no value to the Republic in further investigation of Trinta.



the ship hitting the trees before bouncing along their tops (effects as above, except damage is increased to 4D per player character).

Level Four — The Trees

When the characters reach level four, Crutag breaks off his pursuit, but don't tell that to the players. Let them figure it out for themselves. Read aloud:

Scraping noises echo over the hull, as the ship crashes through the canopy of trees. Massive tree trunks loom up ahead.

Pilot: A Moderate *space transports* roll avoids the tree trunks. Otherwise the ship takes 5D damage to the hull, and 4D damage to each character unless they succeed in Moderate *Dexterity* rolls.

Shields: A Moderate *starship shields* roll protects the ship from damage from the trees.

Scanners: A Moderate *sensors* roll reveals the ground below. Give or show the players the *Landing Zone Map*.

Guns: Gunners may widen the passage through the trees. Add their *starship gunnery* totals to the pilot's roll.

Dropping from Level Two: A Moderate *space transports* roll pulls the ship out of its dive. The pilot then contend with the looming trees (see *Pilot* above). If the roll is failed, the ship drops straight down into the swamp of Trinta. The ship's hull is broken in two and the player characters each take 6D damage, unless they succeed in Moderate *survival* rolls, in which case damage is reduced to 3D. The ship becomes flooded and they must leave the ship immediately (see "Episode Two").

Level Five — Above the Swamp

Read aloud:

The ship breaks through the canopy of the trees. Beneath you, a greenish mist rises from the murky water. Trees tower above you.

Pilot: Lining the ship up for a safe landing requires a Difficult *space transports* roll. The scanner operator can reduce the difficulty of the roll to Moderate by using sensor data (see below).

Scanners: If the scanner operator has "The Landing Zone" map, he can use it to help the pilot make a safe landing. It takes an Easy *sensors* roll to send the map over to the pilot's console.

Level Six — Trinta

Read aloud:

Flocks of birds take to the air as the ship screams in for a landing. Air rushes over the ship and water fans out below.

Pilot: With a successful landing approach, the pilot can land on the island with a Difficult *space transports* roll. A Moderate roll lands the ship on the edge of the swamp, and an Easy roll ditches it into the middle of the swamp.

A pilot who failed to line the ship up for the approach run has the difficulty of the landing increased by one level. A crash landing does 4D damage to the ship's hull, and 3D damage to the player characters.

Welcome to Trinta.

The Scent of Fear

Unless the characters have been extremely lucky and shot the *Scent of Fear* down, it is heard flying overhead and landing toward the south.

If the *Scent of Fear* was shot down, its crew manages to land it safely and it has no effect on the rest of the adventure.

Episode Two

Mists of the Mind

Summary

Newly arrived on Trinta, the player characters examine their ship, and begin to explore the swamp world. The player characters experience the first dreamscape, and learn that Trinta is far more than it seems. Led away from the ship by Halagad's creations, they return to find it missing.

Trinta: Outer Rim Territories

Trinta is an extremely inhospitable world. The heat makes the atmosphere oppressive, and the presence of a dark side nexus should cause Force-users to feel uneasy.

The surface of the planet is primarily swamp, and a green mist hovers over everything. Trinta is a relatively small world with a lower than normal gravitational pull, which increases the player characters' *climbing/jumping* and *lifting* skills by 1D.

Brave New World

After the characters' ship lands, read aloud:

Driving rain thrums against the hull of the ship. The ship's viewport glows with an eerie red-green light, but tangled vegetation and hanging vines block your vision of the landing site. Suddenly, the floor lurches beneath you, as the ship begins to sink into the soft surface of Trinta.

How far the ship sinks into the surface of Trinta depends on where the player characters landed.

The Island

If the ship was brought down on the closest approximation of dry land Trinta has to offer, it

settles two feet into the soft, oozing ground and then stops.

The Mud Bank

Appearing deceptively substantial and covered with lush vegetation, the mud bank cannot support the weight of the player characters' vessel. The ship sinks until the viewports are covered with thick oozing mud.

The Swamp

If the ship lands in the swamp, it sinks into the fetid water. Hollow, gurgling noises echo through the hull as bubbling brown mud washes over the viewports. The ship sinks one meter below the water. The thick mud makes it impossible to see anything outside of the ship.

What Do We Know About Trinta?

If the players ask, "What do we know about Trinta?" give "Survey Team Report — STR2434" to them.

Leaving the Ship

The player characters can leave the ship once it has settled, or even while it is sinking. If they landed on the island or the mud bank, getting out of the ship poses no problem. Player characters who landed in the swamp have to swim to the surface.

Characters in the swamp must use the airlock to escape the ship. As it opens, warm, muddy water floods in. Outside, tendrils of an aquatic plant wave in the current created by the ship's landing. They seem to be reaching into the ship to grab the nearest player character, but they are harmless unless a swimmer becomes entangled in them.

To make it through the tendrils and up to the surface requires an Easy *swimming* roll. If the roll is failed, swimmers become caught in the ten-

Damage Report

The ion drives and the hyperdrives are both badly damaged. Other ship systems may also have suffered damage during the fight with the *Scent of Fear*.

If the player characters attempt to repair the drives, it soon becomes obvious that success is impossible without access to spare parts. The *Scent of Fear* is their only likely source.

Other ship systems can be repaired normally, but without the parts for the drives, the player characters are stranded on Trinta.

drills. Once stuck fast, a swimmer requires a Moderate *swimming* roll to break free. If this roll fails, the swimmer begins to drown (see page 43 of *Star Wars: The Roleplaying Game*).

Other player characters may rescue the trapped swimmer by making Easy *swimming* rolls to avoid becoming entangled in the tendrils, followed by Moderate *swimming* rolls to free their comrade. Player characters, including the trapped swimmer, may combine their actions on the second roll only.

Once they reach the surface, the player characters can make it to the island by making Very Easy *swimming* rolls.

First Impressions

As soon as the characters leave their ship, or swim to the surface of the swamp, read:



Allen Numis

The air hits you like a damp sponge. Oppressive, cloying, and dense with moisture, it settles around you, making you hot and sticky.

Greenish mist rises from the swamp. Looking up, you see the tops of trees disappearing into boiling red-green clouds. Torrential rain pours from the sky to spatter down onto the undergrowth.

A rustling noise seems to be coming from all of the vegetation at once, and strange animal cries sound in the distance. The atmosphere is one of dark foreboding, as if fear is almost a tangible thing on this world. Trinta feels anything but inviting.

Looking around, the player characters can see islands dotting the swamp, with a few mudbanks rising out of the water. Once on an island, the player characters can take stock of their position. Remind them that they ate the last of their rations yesterday and their stomachs are beginning to rumble.

Food and Survival

With no food and very little water, the player characters need to forage for supplies or they will begin to starve. Each day that a player character goes without food, he or she loses 1 pip from *Dexterity* and *Strength* die codes. If only one meal is eaten per day, the player character loses 1 pip every other day. Two meals a day are sufficient to maintain health and strength.

The player characters must drink at least four pints of water every day or suffer a 2 pip reduction per day.

Lost pips are restored at the rate of 1 pip per day that sufficient water or food is consumed. If a character's *Dexterity* or *Strength* becomes reduced to 1D, the character is unable to move, and dies the following day unless given food or water, depending on which he is lacking.

Water

The swamp water is drinkable, provided it is first boiled or chemically treated. A Very Easy *survival* roll lets the player characters know this. If the water is consumed untreated, call for Moderate *stamina* rolls. Failure results in severe stomach cramps for 1D hours, during which time all dice codes are reduced by 1D, as though wounded. At the end of this period, an Easy *stamina* roll is needed to recover. Failure results in the cramps lasting for another 1D hours, when the effects of the tainted water have run its course.

Food

Some of the fungi that grow on the trees are edible. Moderate *survival* rolls are needed to

Trinta — A Tour

The area of Trinta where the player characters have landed is typical of this swamp world. Large red-brown trees rise up over 100 meters from the islands, their trunks twisted in a grotesque manner. High overhead, the canopy of leaves blocks out most of the light. The rays of the sun which do pass through cast a red-green light on the surface.

The swamp consists of a vast area of water interspersed with islands and mudbanks. Roots and creepers stretch out into the water from the trees, and thick clumps of reeds grow in patches across the swamp.

Islands

Islands on Trinta range from small (barely one meter across) clumps of dirt to large islands. They are, for the most part, firm underfoot, and often rise steeply out of the swampwater, requiring *Easy climbing/jumping* rolls to scale.

Trees, many with trunks five to ten meters across, cover the islands. Huge root systems crisscross the ground and creepers hang down from the trees into the water. Brightly colored fungi grows on the trees, and at night it glows with a faint luminescence. Between the trees are clumps of bushes with garishly colored flowers blooming upon them.

Mudbanks

Mudbanks are soft and squelchy, with mud rising up to the player characters'

knees. The noxious stench of the mud assails the characters' nostrils, causing nausea unless *Easy stamina* rolls are made. Nauseous characters suffer a 1D reduction, as though wounded, until an hour passes or they succeed in a *Moderate stamina* roll. Rolls may be made every five minutes, but only once the character has left a mudbank.

Water

The liquid on Trinta is warm, brown and slimy. Aquatic plants grow in abundance along its bottom, and often seem to be trying to grasp the player characters' legs and pull them down.

The water varies greatly in depth. It is one meter deep in some places and over five meters in others. Normally, the bottom will gradually slope down, allowing a character to adjust to the increasing depth, but in certain spots it drops precipitously. Every now and again when the player characters are wading through the swamp, call for *Easy survival* rolls from the lead character. If the roll fails, the player character steps into a deep area of the swamp. An *Easy swimming* roll allows him to make it back to the surface. Otherwise, he starts to drown.

Weather

It rains frequently on Trinta. Rain usually lasts for four hours, followed by a period of one to three hours when the swamp steams the water vapor back into the air to ready it for the next downpour.

identify the safe varieties of fungi. Enough fungi for one meal can be collected per *survival* roll. If the rolls are failed, the player characters may collect poisonous fungi. It has the same effect as drinking untreated water.

Animal Encounters

The "Animal Encounters" sidebar details common lifeforms, but none of these appear until after the player characters have experienced the first dreamscape.

No Free Lunch

To find food, the characters will have to leave the island. Other islands lie nearby and can be reached by wading or swimming. On these the player characters can hope to catch game or

forage for fungi. The largest island lies to the south — the same direction that Crutag's ship was seen to land in. There the player characters notice gallazes, deer-like creatures, grazing near the water's edge. If the player characters fire at the gallazes, the herd bolts into the cover of the trees. See "Animal Encounters" for the statistics of the gallazes.

It is a swim of 200 meters to reach the island. During the swim, the player characters are attacked by a monsail, a large, predatory fish. As the player characters enter the water, read:

You wade through the scum-covered water towards the island, until the bottom drops out and you are forced to swim. You are halfway across when a large black fin breaks the water.

Then a huge mouth filled with blade-sharp teeth, lunges out of the water and snaps at you.

The monsail attacks the lead character. The monsail's victim may use his or her *swimming* skill as a combat or full *dodge*. If it hits, the monsail drags the character under the water. Characters may attack the monsail by making Easy *swimming* rolls and attack rolls.

If it takes stun or greater damage, the monsail spits out its lunch and darts away. See "Animal Encounters" for its statistics. If killed, the monsail provides enough food for four meals.

The Island

When the player characters reach the island, read:

As you clamber on to the island, the rain stops. A stillness hangs over the swamp. Nothing moves. No birds or insects can be heard. Only the sound of slowly lapping water breaks the silence.

It is then that you notice large leeches clinging to your legs.

The player characters each have 2D leeches clinging to their legs and backs. Six or more leeches cause a character to feel faint, resulting in the loss of 1 pip from all die codes unless a Moderate *stamina* roll is made. The 1 pip reduc-

Player Characters Still On The Ship

It is important that there are no player characters left on the ship prior to its disappearance. Encourage them all to leave by emphasizing their need for food. If some insist on staying on the ship, so be it.

Try and entice them out with promises of food, making use of animal encounters if necessary. Failing this, you'll have to be less subtle. The aged ship's life support system breaks down and begins to blow out thick clouds of noxious smoke. These spread rapidly through the ship, and there is no way to turn the system off. Alarms and buzzers echo loudly throughout the ship.

Cut to the other player characters' approach as soon as you have the characters out of the ship.

tion lasts until the character has eaten one meal. The leeches may be removed with Easy *survival* or *first aid* rolls.

Leeches continue to be a problem for characters wading or swimming in the swamp. Every time the player characters enter the water, they attract 2D leeches which go unnoticed until a character leaves the water.



Cut-Away to the Scent of Fear

Read aloud:

EXTERIOR OF THE SCENT OF FEAR.

The camera pans across the side of the Taloron Prey Chaser, and comes to rest on the broad shoulders of Crutag. His pinched face turns, and the camera follows his gaze to where twenty bounty hunters check their weapons.

Crutag fits a vibrobayonet to the end of his blaster carbine and sniffs the air. "They are not far away. Spread out. Find them."

CUT TO AN ISLAND

Tracking the Gallazes

Once the leeches are removed, the player characters can track the gallazes or begin to explore the island. *Very Easy survival* rolls reveal the gallazes's spoor leading into the island's interior. As the characters follow the spoor, or forage fungi from the trees, read the Cut-Away, then go to "The Dreamscape Falls."

The Dreamscape Falls

As Trinta enters its twilight period, the dreamscape falls. Read:

The red-green light of the swamp world fades to a dark twilight. As the light fades, the air grows thicker. It feels heavy as you draw it into your lungs, and even heavier as you exhale. Your friends move slowly. The hair on the back of your neck prickles. Noises grow distant and muffled. The trees glow with a dark red light as the sun sinks. From the shadows of the huge trees, glowing red eyes stare at you.

Within the dreamscape are phantoms manifested by Halagad's mind. These creatures appear real, but are insubstantial. They resemble tall, spindly humanoids with large red eyes. Their faces are peaceful-looking. They carry no weapons and are dressed in simple white robes. There are at least 25 of these creatures surrounding the player characters.

If attacked, the creatures dart back into the trees, disappearing instantly from view. After a few seconds, they peer out again at the player characters through the foliage.

The creatures are capable of speech, but it is not any language that the player characters are familiar with. They attempt to communicate using mime. If a player character approaches peace-

fully or calls out, a creature steps from behind a tree.

Read aloud:

One of the white-robed aliens moves slowly towards you, its hand raised in greeting. It begins to speak, but its language is so alien you cannot understand it. Seeing your incomprehension, it points at its chest twice and says, "Dradan, Dradan."

The creatures call themselves the Dradan. A character who succeeds in a *Moderate alien species* roll remembers a race of peaceful aliens called the Dradan who were exterminated by the Empire for harboring Jedi Knights. All members of the race were believed to have been eradicated, and their world was reduced to a cinder.

If a player character tries to communicate with the Dradan, ask the player to mime out his or her character's actions, and ask for a *languages* roll, but ignore the result.

Whether the player characters mime food or not, the Dradan does. It rubs its stomach and points at its mouth. It nods and beckons for the player characters to follow. If the player characters don't follow, it turns round and gestures again.

If the player characters follow, the Dradan leads them deeper into the island. If they don't follow, it begins its food mime again. If this doesn't work, it mimes a hunter stalking through the swamp. The hunter stops, picks up his rifle and fires. The Dradan, a surprised look on its face, clutches at its chest, and crumples to the ground. Picking itself up, it signals quickly for the player characters to follow, saying, "S'jak, S'jak!"

If the characters still refuse to follow, the Dradan fade into the trees and disappear, leaving no trace of their presence. See "Dispelling the Dradan" below for what happens then.

Following the Dradan

As the player characters follow the Dradan, more appear and smile benignly. With an *Easy Perception* roll, a character notices that they are heading into a richer part of the island: small birds nest in the trees and edible fungi is much more evident. With a *Moderate* success, the player characters note that the direction in which they are heading leads directly away from their ship. On a *Difficult* roll, the characters notice that one of the Dradan has just walked through a tree.

The latter has occurred because Halagad is having difficulty controlling his illusions. In order to maintain the figures of the Dradan, he has reduced their number and made those behind the player characters appear blurry and indistinct. However, since he is directing them from

Animal Encounters

Animal encounters give the player characters an opportunity to catch or shoot game. Each animal is rated according to how many meals for one person it provides. The encounters should only be used after the first dreamscape has ended. Afterwards, use them whenever the characters search for food, and any time you want to liven things up. The encounters can be selected randomly by rolling 1D, or used in any order you like. They may see the animals from a distance or may only hear them.

■ Monsails

Type: Predatory fish

DEXTERITY 3D

PERCEPTION 3D

STRENGTH 4D

Special Abilities:

Teeth: Do STR+1 damage

Food Value: A grown monsail can provide food for four meals.

Move: 15 (swimming)

Size: 2 meters

Capsule: The monsail is a predatory fish with a horizontally flattened body, and a narrow tail. They have sharp teeth and feed on smaller fish or any other living thing that foolishly ventures into the swamp. Monsails normally attack individually, but have been known to travel in schools of three or more.

■ Skinwings

Type: Avian reptile

DEXTERITY 3D+1

PERCEPTION 2D+1

STRENGTH 2D+2

Special Abilities:

Teeth: Do STR+1D damage

Food Value: A skinwing provides food for two meals

Move: 18 (flying)

Size: 1 meter (wingspan), 1.5 meters (length)

Capsule: Skinwings are large avian reptiles, generally growing to a length of one meter. Their wings are leathery, but tough and difficult to cut or puncture. The skinwings emit a loud screech to announce an attack or to warn off those who stray too close to their nesting areas. Their beaks are filled with extremely sharp teeth, and reptilian forked tongue, a vestigial sense organ.

Skinwings are spectacularly unintelligent creatures. They will swoop down to investigate any stirring in the water, often finding it is a marsh lizard luring them within reach. Skinwings will eat virtually anything, and they attack the player characters in order to sample the culinary delights of new life forms. As soon as one of them is hit, the skinwings swoop away, screeching loudly.

■ Marsh Lizards

Type: Large serpent

DEXTERITY 3D+1

PERCEPTION 2D+1

STRENGTH 2D+2

Special Abilities:

Teeth: Do STR+1D damage

Spiked tail: Does STR+1D damage

Food value: A marsh lizard provides food for three meals

Move: 15 (swimming), 10 (crawling)

Size: 2.5 meters

Capsule: Marsh lizards are large, scaly serpents, often growing to a length of two meters or more. They prefer the shallow areas of the swamp and can often be found basking in the sunshine on islands and mudbanks. Along with their teeth, marsh lizards make use of a spiked tail in combat. Player characters can encounter these on land or in the water, when splashes will alert them to the presence of 1D marsh lizards.

Marsh lizards will normally attack by allowing one of their number to charge the intended prey, while the remaining creatures circle around behind. They feed primarily on gallazes and skinwings that fly too close to the surface of the water.

■ Morrils

Type: Docile marsupials

DEXTERITY 3D

Dodge 5D

PERCEPTION 2D +2

STRENGTH 1D

Climbing/jumping 6D

Special Abilities:

Food Value: Morrils provide one meal.

Move: 15

Size: 30 centimeters

Capsule: Tree-dwelling marsupials, morrils tend to be looked upon as cute and harmless by humans. They are in fact, extremely docile, though they are also very skittish and very difficult to catch. Morrils

another location, it is impossible to keep them from passing through solid objects.

Any player character who turns to look to the rear of the column notices with a Very Easy *Perception* roll that the Dradan are now floating a few inches above the ground. A Moderate *Perception* roll reveals that the expressions of the Dradan at the rear have changed. They are dark and

scowling. Their eyes glow malevolently, and fangs protrude from their mouths. The swamp also looks dark and sinister. The ground oozes with bubbling mud and the vegetation is decayed. As soon as a player character notices this, Halagad acts to correct the illusion. The swamp returns to its former appearance, healthy and full of wildlife, and the Dradan return to their former be-

are the most common prey of skinwings. 2D morrils will watch the player characters carefully from their perch in the trees, but will not attack. If anyone attacks them or indeed, makes some kind of threatening gesture, they will flee.

Morrils are herbivores, feeding on the local plant life, though some of their number have occasionally taken to eating carrion.

■ **Water Snakes**

Type: Aquatic reptile

DEXTERITY 3D

Dodge 4D

PERCEPTION 2D+2

Sneak 4D+2

STRENGTH 2D

Special Abilities:

Teeth: Do STR+2D damage

Food Value: Water snakes provide two meals.

Move: 10

Size: 3 meters

Capsule: Long black serpents, water snakes live in holes in mudbanks, islands and beneath the surface of the swamp. They are most likely to attack while the player characters are climbing out of the water and onto an island. The snakes raise their heads above the surface of the water before striking.

■ **Gallazes**

Type: Herbivore

DEXTERITY 3D

PERCEPTION 2D+1

STRENGTH 2D

Running 4D, swimming 4D

Special Abilities:

Food Value: Gallazes provide three meals.

Move: 10

Size: 1 meter tall

Capsule: Gallazes are the only true herbivores on Trinta. They are quadrupeds with reddish, short fur and long, feathery ears. They travel in herds of 12, feeding on the abundant vegetation on the planet. They are apparently capable of some form of silent communication with each other, although its nature is unknown. They will flee as soon as the player characters are within 20 meters, often swimming away, where their powerful hindquarters power them through the eater almost effortlessly.

atific expressions. If the player characters attack or attempt to touch any of the Dradan, see “Dispelling the Dradan,” below.

The Feast

If the player characters follow the Dradan, read:

The Dradan lead you further into the island. Here the ground feels firmer and the air is sweet and refreshing. Large fungi growths cover the ground and the lower branches of the trees bear bright orange fruit.

The Dradan take you to a clearing where a large carcass is spitted over a campfire. Simple wooden plates are set out around the fire. The plates are covered with fruit and vegetables. The Dradan mimes for you to sit, then hands you a plate.

Ask for *Perception* rolls. On any result less than Easy, the player characters feel safe and content. With a Moderate success, the player characters sense that everything is not as it seems. A Difficult success allows them to see that the Dradan now look evil. They have glowing eyes, fanged mouths and clawed fingers.

If the player characters eat the food, they find it tastes musty, although soft. They are eating poisonous fungi. If the player characters eat the fungi, ask for *stamina* rolls. On a Moderate or better result a character is unaffected. On any other result, the character is stricken with severe stomach cramps as though he had consumed untreated water (see “Food and Survival”).

As the player characters finish their meal, darkness presses in on them. The Dradan hover at the edge of their vision, their eyes filled with hate. If they do nothing, the Dradan fade away after a few minutes.

Dispelling the Dradan

Any action taken by the player characters against the Dradan causes the dreamscape to wink out. The night turns dark and oppressive, broken only by the sickly glow of the fungi. The island reverts to its normal appearance. Dark trees covered in clinging vines and hanging creepers tower above the player characters. Creepers brush across the player characters’ faces, caressing them and sending shivers up their spines.

Slithering noises are heard in the distance, followed by the sound of a large creature crashing through the undergrowth. The sound stops abruptly. The swamp becomes quiet and still. The player characters are alone.

Trinta’s long, dark night lies ahead.

Night on Trinta

The player characters are lost in the swamp. Getting back to the ship at night requires a Very Difficult *search* roll. Even if they succeed, it takes them most of the night to find their way back. If they wait until morning, an Easy *search* roll suffices. Either way, they will have to contend with



Allen Nurnis

their first night on Trinta.

Night on Trinta for the player characters is an unnerving, but not particularly dangerous, experience. Throughout the night, creatures are heard stalking toward them, but never quite reach them. The noises stop suddenly, only to start up again from farther away. Every now and again, a large creature is heard smashing its way through the trees.

The player characters catch glimpses out of the corners of their eyes of dark shapes moving through the undergrowth or breaking the surface of the water. These fleeting appearances are unnerving, but no amount of searching (at night or in the morning) reveals any tracks.

Keep the player characters on their toes, and maintain the tension until morning. When dawn breaks, the oppressive feeling lifts as the red glow of the sun rises through the trees. The frogs and insects start up their chorus, and Trinta seems almost cheerful.

The Vanished Ship

When the player characters return to the area where they left the ship, a thick, dank mist covers the swamp. A search of the area quickly reveals that the ship is missing. Halagad, using the power of the dark side nexus, has moved the ship far to the north. No matter how hard the player characters search the area, they find no evidence of where the ship has gone. It has mysteriously vanished, but is returned to them at the end of Episode Six.

Searching the area reveals that the player characters are in the right location. Scorch marks are on the ground, and there are signs of the ship's passage through the trees. Numerous booted footprints crisscross the area. A Moderate *search* roll makes it obvious that these are the player characters' tracks. There is no sign of anyone else being in the area.

If the player characters want to search the swamp, let them. Ask for *swimming* and *search* rolls, then tell them that they don't find anything. To make the search more exciting, you may want to have them attacked by water snakes or monsails (see "Animal Encounters").

Episode Three

The Nightmare Begins

Summary

In this episode, the player characters discover that members of Crutag's team have been killed by Halagad's dreamscapes. They are chased by an illusory rancor through the swamp, and when they finally defeat it, they discover that it was only a bad dream.

No Particular Place To Go

If the player characters returned to their landing site during the night, let them make camp until the morning, then run this scene. If they returned in the morning, run the scene as soon as they have determined that their ship has disappeared. Read:

You came to Trinta for supplies, but it now looks as though you are doomed to spend the rest of your lives here. As you ponder this depressing thought, the mist begins to fade and thunder rumbles overhead. A flash of lightning illuminates the area, as if pointing out with amusement that your ship is gone. Within seconds, torrential rain is again pouring from the sky, turning the ground beneath your feet to a river of mud.

Over the noise of the thunder and rain comes the sound of blaster fire in the distance, followed by agonized screams and loud thrashing noises. The screams stop abruptly. No other sounds are heard, although they may simply be drowned out by the pounding of the rain.

With Very Easy *Perception* rolls, the player characters can locate the source of the screams. They come from a small island to the west. After wading through the gradually darkening swamp, they arrive at the scene of the carnage. Read:

As you wade through the swamp, the sky grows darker and darker. Light barely penetrates the tree canopy high overhead, and sounds are muted and distant.

After a while, you reach an island on which

you see a lizard-like alien sprawled over a fallen tree trunk. A blaster rifle lies by its side. You approach cautiously, but the alien makes no move or acknowledges your presence — clearly, he is dead. Nearby, floating face down in the green scum-covered swamp, is a human. Three meters from the human floats a black boot, in the middle of what appears to be a slick of blood.

Three of Crutag's hunters have fallen victim to a dreamscape. One has been killed by his own fear, another has drowned in his attempt to flee the horrors of the dreamscape, and the third has been eaten by a monsail.

An Easy *planetary systems* roll indicates that the darkness is unnatural, but does not give any indication of its cause.

The Body on the Log

The alien is 2.5 meters tall, covered in horny, black scales. Its slitted eyes are opened wide in horror. Its sharp, needle-like teeth are drawn back in fear and its tongue protrudes through them. There are no signs of physical damage on the alien, except for some old scar tissue on its chest. Its legs are coated in green algae, an indication that it waded through the swamp to reach the log.

The alien has a blaster rifle, a vibroblade, and three grenades.

Have the player characters make *alien species* rolls. An Easy roll identifies the alien as a Barabel from Barab I. Barabel are renowned as hunters. A Moderate roll reveals that Barabel are fearless, independent creatures. They are intelligent, but think nothing of attacking other sentient species.

The Swamp

The swamp is one meter deep by the floating body, and two meters deep by the boot. It is covered in a thick green algae which conceals the monsail. The monsail does not attack anyone who approaches the floating body, but its sail

breaks the surface if anyone moves toward the boot. It attacks in the following round.

Monsail. *Dexterity 3D, Strength 3D, Strength 4D.* Special abilities: Teeth do STR+1D damage. Provides four meals. Move: 15 (swimming).

The Floating Body

The body in the water is a human and is covered by a dozen or more leeches. A Very Easy *first aid* roll shows that he has drowned. A search of the body reveals three packages of concentrated rations, a blaster carbine, and a vibroblade.

The Boot

This is all that remains of the third hunter. The rest is inside the monsail.

The Rimrider

On Easy *Perception* rolls, the player characters spot a glint of metal in the swamp near the island. It looks like the nose of a small ship, and an Easy swimming roll to its location will reveal that it is, indeed, the wreckage of a scout ship, the *Rimrider*.

None of the player characters have ever heard of this vessel. If they decide to search the ship, an Easy *search* roll will reveal no salvageable parts or any clue as to its owner. The player characters will, however, notice that the medical kit is missing from its compartment.

Very Easy *Perception* rolls will indicate that the ship has been in the swamp for at least two decades, possibly longer. The airlock and hatch

were closed, making it unlikely the pilot was killed in the crash and his body washed away. The player characters can now be sure that, at some time in the years since Trinta was rejected as a potential colony world by the Old Republic, there was another intelligent being here.

The Hunters' Trail

Back on the island, an Easy *search* roll reveals the hunters' trail. It leads into the water and then emerges on a mudbank. Three deep sets of footprints cross the mudbank before again entering the water to emerge at another island. "The Rancor Chase" map shows the trail taken by the hunters. With Easy *search* rolls, the player characters can continue to follow the trail across the swamp, to where it ascends a rock escarpment on an island.

But all the player characters have found is great danger. They are about to meet the dreambeast responsible for the hunters' deaths.

The Nightmare Falls

After the characters have followed the hunters' trail to the mudbank, or if they decide to return to their landing site, read:

As you look out over the swamp, the rain stops, but the light continues to fade. The trees look gnarled and twisted. The hanging vines seem to writhe and reach toward you.

Suddenly, you hear the same crashing noise you heard last night from far off in the swamp. A horrible roar breaks the stillness, as if a thousand great beasts were giving voice to their rage at the same time. The sound grows closer, and you see flocks of skinwings flap noisily into the sky. Now you can see a shape looming in the mist, and huge trees being batted aside as if they were playthings.

An illusory rancor, created by Halagad, is ram-paging through the swamp. It is rapidly closing on the player characters. Give the players five seconds to decide what they are going to do, then read:

The crashes and roars continue, growing closer all the time. The very ground shakes, sending ripples across the surface of the scummy swamp. A huge beast, over five meters tall, smashes a tree out of its way and lurches into the water. Its eyes glow redly as its head turns in your direction. The creature is a rancor!

The player characters face one of the most dangerous creatures in the galaxy. It should be obvious that the only hope of survival is to attempt to flee from the rancor. If they look for an



Allen Nurnis

escape route, they see, to the south, a rock escarpment rising six meters above the swamp. Numerous islands and tracts of swamp lie between them and it. On top of it, they see large boulders which could be rolled down on to the rancor.

If the player characters flee, go the “The Chase” below. If they decide to fight, or if the rancor catches one of them, see “Fighting the Rancor.”

The Chase

During the chase, maintain tension and drama by not giving the players time to think. Only fast action gives the player characters a hope of reaching the rock escarpment ahead of the rancor. Once there they can climb the escarpment, then roll or throw boulders onto the pursuing rancor.

The rancor heads towards the largest group of player characters, bellowing and roaring as it goes. During the chase, describe the rancor’s thundering footsteps and its hot breath as it gets close to the player characters.

Keep On Running

“The Rancor Chase” map shows the layout of the swamp. Each numbered location is described below. The player characters can take any route through the swamp they like.

Due to Trinta’s low gravity, the player characters’ *climbing/jumping* and *lifting* rolls are increased by 1D.

The Water

The contours show the varying depth of the water. One-meter-deep water can be waded through at five meters per speed action, or the player characters can swim at two meters per action. In depths of two meters or more, the player characters can only swim.

Keep in mind that there may be depressions or holes in the swamp bottom at any point, requiring the player characters to swim or drown.

Jumping From Island to Island

A “J” marked on the map indicates that the gap between the islands may be jumped across with an Easy *climbing/jumping* roll. If a roll is failed, the player character lands in the water and must try to swim to safety with a -1D penalty for the first round of *swimming*.

1. The Mudbank

The mud is soft and oozing, reducing the player characters’ running rate to five meters per action. Its movement difficulty is Moderate.

2. Islands

Trees grow on the islands. The islands are firm underfoot and have a movement difficulty of Easy.

3. Logs

The logs lead to the adjacent islands. They are slippery, with a movement difficulty of Difficult. Player characters who fail their movement rolls fall into the water and have to swim to the island.

4. Vines

With an Easy *climbing/jumping* roll, the player characters can use these vines to swing across to island 5. Player characters who fail to swing across fall into the water and must swim.

5. Marsh Lizard Island

Firm ground awaits the player characters here. It is also home to two marsh lizards, large creatures with flattened heads. They attack anyone landing on the island or falling into the water at location 4.

Marsh Lizards. *Dexterity 2D+1, Perception 2D, Strength 3D.* Special abilities: Teeth (STR+1D), tail (STR+1D), provides three meals. Move: 15 (swimming), 10 (crawling).

With an Easy *climbing/jumping* roll, the player characters can use the vines at the south end of the island to swing over island 6 to island 2C. Failing this roll causes the player character to fall into the quicksand on island 6.

6. Quicksand!

This island conceals a patch of quicksand. A Moderate *search* roll warns the player characters of its presence, otherwise the lead player character steps into the quicksand and begins to sink. A Moderate *survival* roll allows the player character to scramble free. The sinking character can combine his actions with any other player characters present. If the roll is failed, the difficulty increases by one level each round, until a Very Difficult roll is failed, at which point the player character sinks under the surface and begins to drown.

7. Noxious Mudbank

This area smells terrible. Moderate *stamina* rolls are needed to avoid suffering a 1D reduction for the duration of the chase. The movement difficulty is Moderate.

8. The Escarpment

A rocky escarpment, six meters high, rises up from this island. Strewn across its top are numerous boulders that can be rolled on to or thrown

GAMEMASTER MAP: The Rancor Chase

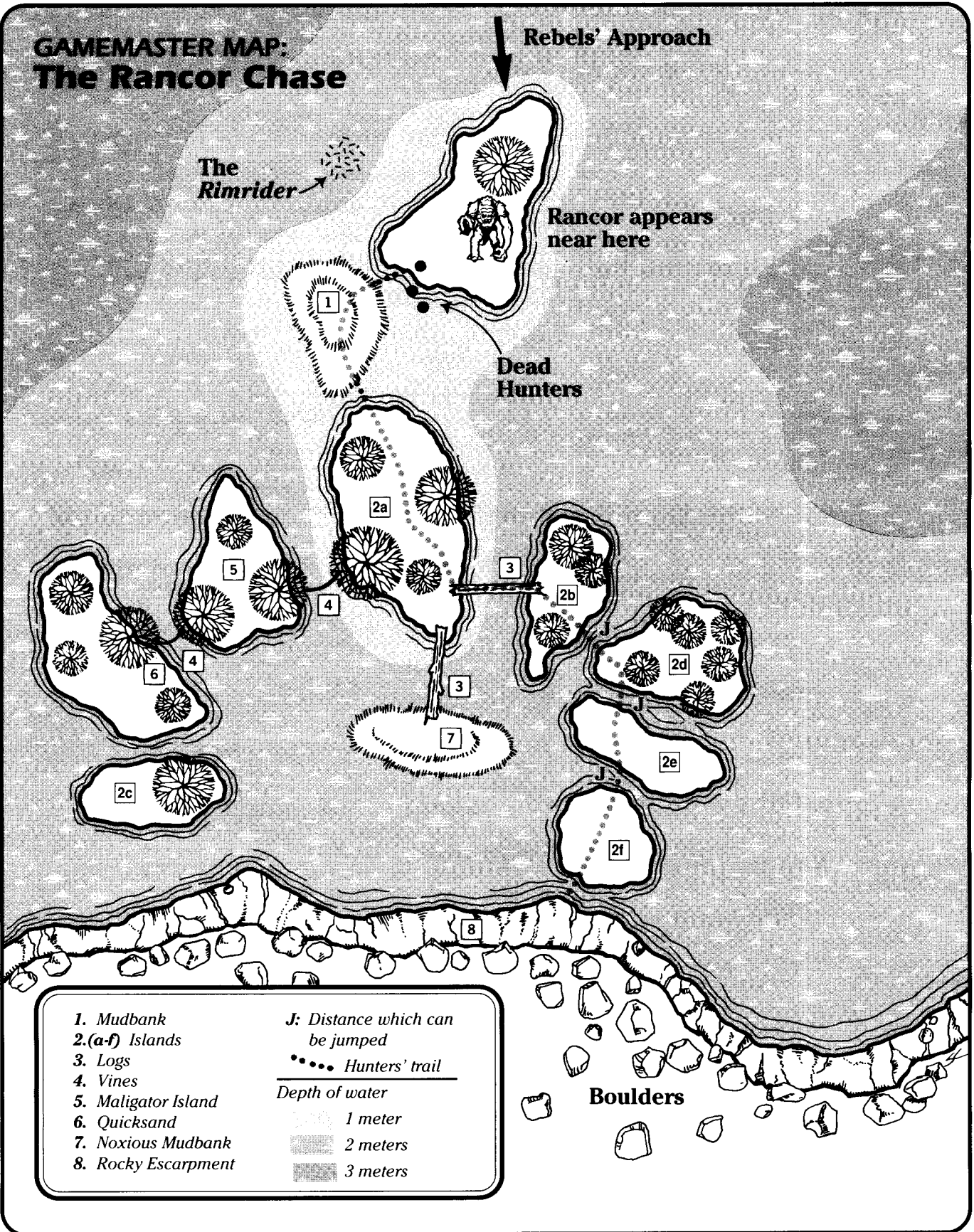

| | |
|---------------------|---------------------------------|
| 1. Mudbank | J: Distance which can be jumped |
| 2.(a-f) Islands | Hunters' trail |
| 3. Logs | Depth of water |
| 4. Vines | 1 meter |
| 5. Maligator Island | 2 meters |
| 6. Quicksand | 3 meters |
| 7. Noxious Mudbank | |
| 8. Rocky Escarpment | |

Stephen Crane

at the rancor. The escarpment can be climbed with a Moderate *climbing/jumping* roll. The rancor can climb the escarpment in three rounds. As it does so, it tries to grab anyone near the edge with its claws and shove them into its huge mouth.

The boulders come in four sizes: small, medium, large, and huge. There is only one huge boulder, but there are many smaller stones available. The following table shows the *lifting* difficulty number needed to pick up and drop a boulder onto the rancor, along with a boulder's *Strength* (for damage purposes). It is, of course easier to attack the rancor with smaller stones, but it will take longer to defeat it that way, and will allow it time to climb the escarpment.

| Boulder Size | Difficulty | Lifting Damage |
|--------------|----------------|----------------|
| Small | Easy | 4D |
| Medium | Moderate | 6D |
| Large | Difficult | 8D |
| Huge | Very Difficult | 10D |

Boulders may also be rolled on to the rancor. This reduces the level of the difficulty by one (Difficult becomes Moderate, etc), but requires a Moderate *Dexterity* roll to hit the rancor.

If the player characters are thinking of continuing to run, they have a wide expanse of open rocky ground before them. It counts as Moderate for movement purposes, and does not affect the rancor. As you control the rancor, have it catch them and swallow them one by one, then go to "Death by Rancor."

Fighting the Rancor

The player characters are going to fight the rancor either through choice or because it has caught them. Even though the rancor is a dreambeast, it acts like a real rancor. Its attacks do not cause physical damage, but they appear to do so. Play this up for all it's worth.

Describe the rancor's hot breath, its drooling saliva, sharp teeth and claws. It keeps up its unnerving roar throughout the chase, particularly if the player characters are out of its sight. The rancor rips and grabs with its claws. It appears to stuff any player character it incapacitates into its gaping mouth. The player character then disappears down its throat!

Let the player characters think that swallowed characters are dead, and continue with the chase. But because the rancor is not real, the player



Allen Nurnis

Staging the Rancor

The rancor is not real, but it is subject to certain restraints. Halagad must concentrate to maintain it, and he cannot make it disappear and reappear ahead of the player characters.

But the rancor chase is not intended to be an exercise in dice rolling. It should be dramatic and fluid, with the player characters always being one step ahead of the rancor. If they make their movement and *climbing/jumping* rolls, make them sweat by having the rancor thudding along behind the slowest moving character. If a character fails a roll, and the rancor is close enough to get him, it attacks, or maybe that character suddenly finds himself at the back of the fleeing player characters, with the rancor breathing down his neck.

Reward fast and dramatic play by letting the characters make it to the escarpment. If they want to turn and fight the rancor, let them. They'll soon regret it.

characters remain alive. Only tell the players this at the end of the chase when the rancor fades away and they realize that the attack was not real.

Player characters may attempt to emulate Luke Skywalker by wedging a stick into the rancor's mouth. This requires a Difficult *Dexterity* roll and causes a wound on the rancor. It prevents the rancor from biting for the remainder of the chase.

The Dreambeast Rancor. *Dexterity 4D, Perception 2D, search: tracking 3D, Strength 10D.* Special abilities: armor (adds +3D to *Strength* to resist damage), claws (STR+3D), teeth (STR+5D). Move: 10.

Defeating the Rancor

When the player characters defeat the rancor, either in combat or by crushing it with boulders, read aloud:

The huge beast shudders, casting a baleful glance at you as it slumps to the ground. Its claws tear at the ground, and its legs pump up and down as it convulses in its death throes. A loud wheezing sound comes from its chest, and black blood spurts from its mouth. Finally, the death rattle comes from its throat, and it lies still.

Then it begins to fade. You see the ground appear beneath it, then the rancor is gone. Even its footprints and claw marks have disappeared. It is as if it never existed.

After the rancor disappears, the dreamscape begins to fade. The sky grows lighter, natural sounds return to the jungle, and any player characters incapacitated by the rancor wake up. Go to "Trauma Time" below.

Death By Rancor

If the rancor succeeds in defeating all of the player characters, pause, look thoughtful, then say, "Fade to black." Wait a few seconds, then read:

Bright green light shimmers overhead. A stillness lies over the swamp. You pick yourselves up, amazed to find no claw or tooth marks on you. There is no sign of the rancor, nor even any tracks or traces of the destruction it caused to mark its passing. It is as if it had never been.

See "Trauma Time" below for information on the ill effects suffered by the player characters.

Trauma Time

Player characters who were wounded or swallowed by the rancor find themselves physically unharmed. If they are conscious, they see their wounds disappear.

Characters who lost Force skills are aware that their powers have been drained, as do characters who lost pips from their mental attributes. The player characters feel shaky and unsure of themselves — their grip on reality is starting to weaken.

Give any player characters separated from the others time to reassemble, then go to Episode Four.

Episode Four A Disturbance In The Force

Summary

Crutag and his hunters have been facing problems similar to those of the player characters. But the low-life scum of the Taloron Hunter's band have been less resistant to the horrors of the dreamscapes. The player characters encounter a group of hunters killed by their own fears and the dangers of the swamp, reanimated by the dark side of the Force.

A tremor in the Force marks a turning point for the worse, and gives the player characters an objective to head for. The trek to the source of the disturbance proves to be anything but easy, although the player characters do make an important discovery about the identity of their tormentor. This episode ends just before the player characters encounter Crutag.

The Hunters

As the player characters assess the effects of

the rancor's attack, and wonder about its true nature, read the "Cut-Away" below.

A Tremor in the Force

Halagad, torn between his better nature and the dark side's urging that he use its power to torment others, is close to his breaking point. This emotional battle will result in the unleashing of a great disturbance in the Force.

Read:

Darkness again descends upon Trinta. But this darkness is tangible, like swamp water. It spreads upwards from the ground, and oozes out of the trees. It blots out the sunlight, and seems to choke off all sound. It feels thick, so thick it presses against you, enveloping you in a strange, otherworldly twilight.

Very Easy *planetary systems* rolls confirm that this darkness is anything but natural. Point to

Cut-Away to Crutag

Read aloud:

EXTERIOR: AN ISLAND CLEARING SOMEWHERE IN TRINTA'S VAST SWAMP. *Crutag stands in an area of scorched ground, staring belligerently down at a small alien, who is trembling in fear.*

"Vanished? Ships don't vanish!"

Crutag raises his fist and slams it into the alien's head, who hits the ground with a sickening thud, his neck broken. The camera pans right, following Crutag's gaze. It settles on a group of bounty hunters who shuffle nervously.

"Two patrols lost to these fugitives in this festering swamp." *The hunters nod dumbly, eyeing the crumpled form of their*

comrade. "And now the Scent of Fear has been taken."

Crutag points at one of the hunters. "Gatral, we must find them. Go now. Take six hunters, and search to the north. Find them before they strand us here."

Gatral nods and angrily signals for the hunters to follow him. The camera pans back to Crutag. His cold, hard eyes flare angrily.

"The rest of you come with me. I'll show you how to hunt! These small-fry will soon learn the meaning of fear."

The remaining eight hunters follow Crutag into the swamp.

Wipe to....

ELSEWHERE IN THE SWAMP

any Force users (regardless of whether they still retain their Force skills) and read aloud:

You sense a great disturbance in the Force. Your vision fills with evil, nightmarish creatures which scream and writhe in torment. An ebon-masked face with glowing red eyes appears amongst them. You feel your windpipe tighten as an overwhelming fear grips you. Somewhere in the dark recesses of your mind a terrified voice screams, "No! No! No! (SCREAM!)" Then great waves of energy begin to batter your body, lifting you and flinging you backwards. As you hit the ground, the vision fades, and you are back in the unnatural twilight of the swamp.

This vision portrays Halagad's greatest fear: that Darth Vader will discover his hiding place and capture him again. He panics at this thought, reacting by releasing his rage and sending it, in the form of dark side energy, hurtling across Trinta.

Only Force users are affected by this sudden surge of energy. To avoid taking damage, they need to make a Difficult *Control* roll. Failure results in a mental attack of 4D strength, which has the same effects as a dreambeast attack. In addition, a Moderate *climbing/jumping* roll is required to avoid taking 3D damage from being physically flung backwards.

After the blast, Force users discover that it has left an indelible impression on their minds. They can pinpoint the direction from which the disturbance came: north.

The Swamp of Terror

The player characters now experience a very

powerful dreamscape. The whole reality of the swamp is being changed as Halagad's paranoid fears take control. The power of the dark side is now fully manifested, and the air itself seems to throb with hatred.

With no means of escape from Trinta and Crutag's hunters in hot pursuit, the player characters have little choice but to head toward the source of the disturbance in the Force. If they decide to hunt for Crutag, it makes no difference. Just run them through the trek, and they'll meet Crutag soon enough.

The Dreamscape

The dreamscape that the characters are now experiencing has a tremendous influence upon the trek. The depth of the darkness caused by the dreamscape varies throughout the trek. At times the blackness seems to close in, becoming dense and reducing visibility to a claustrophobic two meters. At other times it lessens slightly, with visibility increasing to as much as 12 meters.

You can change the amount of visibility any time you like by choosing it yourself or by rolling 2D for a range of 2-12 meters. For example, the player characters are approaching an island, and the visibility has been good (10 meters), but you want to make the island appear forbidding. "As you wade toward the island, the darkness swirls in around you, blotting out the island. You can now barely make out your friends two meters in front of you."

As the darkness is created by Halagad, it lasts until after the player characters emerge from the dark side nexus in "Episode Six: The Dark Side."



Swamp of Terror Terrain

This sidebar recaps relevant information on the swamp from earlier sections, and describes the new types of terrain. Use these brief descriptions to describe the characters' trek.

Islands

Islands, covered in thick tree trunks and undergrowth, rise steeply out of the swamp. Easy *climbing/jumping* rolls are needed to ascend the islands.

Mudbanks

The stench from the mudbanks causes nausea unless Easy *stamina* rolls are made. Nauseated characters suffer a 1D reduction as though wounded, until they succeed in a Moderate *stamina* roll. Rolls may be made every five minutes, but only once the character has left a mudbank.

Razor Reeds

Banks of black, razor-sharp reeds grow out of the swamp. They grow in dense clumps that make progress both slow and dangerous. A Moderate *Dexterity* roll is needed each turn that a Rebel spends within the reeds. A failed *Dexterity* roll results in a character being hit for 3D damage.

The reeds can be cleared out of the way with a lightsaber or thermal detonator. Blasters or grenades have no appreciable effect.

Poison Gas

Bubbles of poison gas break through the scummy swamp water at these locations. The bubbles are visible and the player character will notice a pungent odor in the air. If they avoid the bubbles, by skirting the area, they are in no danger, but if they continue they will be affected by the gas.

Each turn that they spend within the gas, they need to make Moderate *stamina* rolls. Failure results in them taking a wound.

A character who enters the gas already injured has his injury level increased. For example, a wounded character becomes incapacitated on failing a *stamina* roll to resist the gas. A character who becomes mortally wounded will die if not removed from the area of the gas.

Once outside of the gas, characters may make Moderate *stamina* rolls each turn to recover from the effects of the gas. Each

successful roll reduces a wound by one level, so an incapacitated character would become wounded after a successful check. Characters who were already injured when they entered the gas are not restored to full health by making *stamina* rolls. They can only recover to their previous injury level.

Whirlpool

Whirlpools are created by water being sucked down into caverns beneath the surface of Trinta. The pull of the water can be felt from one kilometer away and grows stronger as the whirlpool is approached.

To avoid being sucked into a whirlpool to their deaths, characters need to make successful *swimming* or *Mechanical* (if they are on a raft) rolls as follows:

| Distance From Whirlpool | Difficulty | |
|-------------------------------|----------------|-----------------------------|
| | Swimming | Rafting |
| 500 meters | None | Easy |
| 100 meters | Easy | Moderate |
| 50 meters | Moderate | Difficult |
| 25 meters | Difficult | Very Difficult |
| 10 meters | Very Difficult | No chance (time to swim) |

A character who fails a roll gets to attempt one more before being sucked farther into the whirlpool. If he makes it, he stays where he is and must make another roll to move to the next range band. If he fails, he must make another roll to avoid being sucked inwards, and so on. A character who fails two rolls at 10 meters is sucked into the whirlpool and drowns.

For example, a character caught in the whirlpool fails a *swimming* check at 100 meters. If he makes the next check, he stays at 100 meters and can attempt to swim to safety at 500 meters. But if he fails the second check at 100 meters, he is sucked into the 50 meter band where the difficulty of the check increases.

A Moderate *stamina* check is required for every 10 consecutive *swimming* or *Mechanical* checks a character has to make. A failed *stamina* roll causes a loss of 1D from all die codes until the character is able to rest for an hour.

GAMEMASTER MAP: The Trek (Episodes Four and Five)

Island

Mudbank

Razor Reeds

Poison Gas

Whirlpool

1. The Watcher in Darkness
2. Death from the Skies
3. The Face in the Water
4. Carnivorous Plants
5. The Dark Tongue
6. The Dark Jedi
7. The Living Dead
8. The Swamp Beast

Depth of water

1 meter

2 meters

3 meters

4 meters

Note: All islands are heavily wooded. **Scale:** 2 kilometers

Stephen Crane

Making a Raft

The player characters may decide to make a raft by lashing branches together. It takes 1D+1 hours to build one. How good a job they do depends on the level of their *Technical* roll:

Very Easy: The raft falls apart as soon as they put it in the water.

Easy: The raft holds up for 15 minutes, then begins to fall apart. The difficulty level of rafting rolls (see below) are increased by two levels.

Moderate: A passable raft. It works fine for an hour. The difficulty level of rafting rolls (see below) are increased by one level.

Difficult or Very Difficult: The player characters have built a serviceable raft. Rafting rolls are made as described below.

Once built, the player characters need to control the raft using their *Mechanical* attributes. This is a *Moderate* task. Failure results in the raft going round in circles, or, on a *Mechanical* roll of 3–5, capsizing under the uneven distribution of weight. If the raft is attacked by monsails or marsh lizards, Difficult rolls are needed to control it and prevent it from capsizing.

Staging the Raft Journey

While potentially useful, the raft may

prove to be a liability for the player characters. It all depends on how long you want them to have it, bearing in mind that they can avoid some of the more interesting island encounters by staying on the raft. Here's a few ideas for making a raft journey exciting, and maybe persuading them that they are better off without the craft.

Player characters travelling on a raft may find their way blocked by razor reeds and whirlpools. They will also be attacked by monsails and maligators, who may rip the raft apart believing it to be lunch (consider the raft to have a *Strength* of 3D). They may also run it aground on a mudbank and then have to figure out a way of getting it back into the water.

Encountering Crutag

It is important that the player characters encounter Crutag at the start of Episode Five. This encounter takes place on an island (see "Episode Five"). If they are still using the raft, they can be lured onto the island by the prospect of finding food — you can have their supplies washed overboard earlier. Or you can force them on to the island by sinking their raft in a monsail attack. Alternatively, Halagad can use the Dark Side to whip up a sudden squall which smashes the raft into the side of the island.

Time in the Trek

The player characters' perception of time is also greatly distorted by the dreamscape. Timepieces still measure time accurately, but perceived time is stretched or contracted. Minutes can seem like hours; hours like seconds.

Don't get bogged down in detail when describing the trek. Keep it dramatic. Keep the action moving. Throw events and encounters (see below) at the player characters in rapid succession. The strange passage of time makes this easy to do. Don't bother to play out slow passages of time. A quick paraphrase is sufficient. "For hours, you slog through the swamp. Then a stirring in the undergrowth makes you all nearly jump out of your skins!"

Also, feel free to compress the distance if the players are getting bored, or expand it if you and your players are having fun, or if you want to give them a chance to heal their wounds. This episode ends when the player characters have travelled halfway across the swamp and discovered

Ventor's cavern. If things start to flag before then, cut to the cave and then to Episode Five and the encounter with Crutag.

Into the Swamp of Terror

The terrain lying between the characters' current location and the dark side nexus is shown on *The Trek* map. The map shows the islands, mudbanks, and reedbanks that lie between the player characters and their destination. Water depth is marked by contour lines.

Much of the terrain is similar to that already traversed by the player characters in Episodes Two and Three, but some of it is of a type not previously encountered.

Shown on the map are a number of situations that the player characters may encounter as they approach the nexus. These encounters are described in the "Swamp of Terror Encounters" section below. If the player characters don't go to the island with an encounter on it, they do not have that encounter.

Other encounters take place regardless of where the player characters go. They occur either after a certain amount of time has passed, or simply because they are unavoidable, regardless of which direction the player characters choose to travel. These are described in the "Swamp of Terror Events" section.

Starting the Trek

As soon as the player characters leave the island and prepare to wade or swim through the water, read:

The darkness shimmers across the surface of the thick, black water. As you step into it, you feel the water sucking you down, welcoming you into its cloying embrace.

The hot, humid air is thick with the stench of death and decay. It intrudes into the nostrils, slithers down the throat and settles heavily in the lungs. You're not surprised that no one lives on Trinta. They would have suffocated long ago.

Wading through the water is slow and torturous, with the mud at the bottom clinging to your boots as if it wants you to go no further.

The water appears to have the consistency of treacle. Be sure to have a player character or two step into a sinkhole or flounder when the bottom of the swamp drops out suddenly.

The air is unpleasant, and causes breathing to be labored. Every now and again, ask for *stamina* rolls and write down the results in secret. Then either ignore them or nod thoughtfully and declare that those player characters who failed an Easy roll can feel their lungs growing heavy and swelling up. This is just the character's imagination at work, but it should scare the players. *First aid* rolls reveal no physical symptoms.

Swamp Of Terror Events

With the scene set, it's time to start the action rolling. Use all or some of the following events to add color and excitement to the first part of the journey. Don't weaken the player characters too much, for they'll be facing Crutag and his hunters in Episode Five and need to be in reasonable shape for that.

When the player characters get halfway across the swamp, they discover Vantor's cavern and then can proceed to Episode Five.

Lurkers in Darkness

This event may be used a number of times. As the player characters cross a small island, Easy *Perception* rolls reveal that they are being stalked by something. Dark shapes slither and slide just beyond the player characters' vision. A torch shined on the source of the sound only reveals

Travel Distances

Player characters on foot can average two kilometers per hour through the swamp, and four kilometers across the islands. Rafting characters, assuming no mishaps, can manage three kilometers an hour through the swamp. If they carry the raft over an island, they travel at two kilometers an hour.

deep shadows where creatures might lurk.

The first few times, these creatures are illusions which do no damage. They disappear if the player characters search for them, but the noises begin again from in front or behind the player characters.

After using this event once or twice, have a creature appear. If the player characters search for it, they find a five-meter-long black snake with glowing red teeth. If they ignore it, the snake sneaks up behind them. In either case, the snake, a dreambeast, attacks. It at first seems to cause physical damage. When defeated, it shimmers and fades, as do any wounds it inflicts on the player characters. The player characters take mental damage instead.

Dream Snake. *Dexterity 3D+2, Perception 3D+2, Strength 3D.* Special abilities: teeth (STR+1D+2). Move: 10.

After the dream snake's appearance, either continue unnerving the player characters with dreambeasts, or hit them with a real creature. From out of the undergrowth comes a three-meter-long lizard, corrupted by the dark side. It glows with a black light and its eyes are two points of glowing red. Like the other creatures, it stalks the player characters before attacking. The dark lizard causes physical damage when it attacks.

Dark Lizard. *Dexterity 4D, Perception 3D+1, Strength 4D+2.* Special abilities: teeth (STR+1D). Move: 15.

Things That Go Bump ...

Like the "Lurkers in Darkness" event, this event can be used a number of times. As the player characters come to the end of an island and prepare to wade into the swamp, they hear the sound of something large slithering through the soft mud, followed by a loud splash as it launches itself into the water. From further away, similar sounds suggest that the dark water before the player characters is rapidly filling with predators, and the player characters must cross the water to continue.

Once in the water, the player characters feel unseen creatures coiling around their legs or bumping into them. Occasionally, they get a glimpse of dark shapes breaking the water ahead. When felt for, these creatures cannot be found under the water.

After using this event a few times, begin to alternate dreambeasts and real creatures (see "Lurkers in Darkness," on page 100 for suggestions).

Watersnake. *Dexterity 3D, Perception 2D+2, Strength 3D.* Special abilities: teeth (STR+2). Move: 15 (swimming).

Swamp of Terror Encounters

These encounters are marked on the *Trek Map*. Whenever the player characters reach a marked encounter area, run the relevant encounter as described below.

1. The Watcher in Darkness

As the player characters pass over this area, they notice that sounds become even more muffled and indistinct. They also have the unmistakable feeling of being watched. But no matter how hard they search for whatever is watching them, nothing is discovered.

2. Death From The Skies

These islands are home to nightmarish skinwings. These black creatures have huge, gaping beaks filled with sharp needle-like teeth. The player characters hear loud cawing sounds from up ahead. If they turn back, they later encounter the skinwings again.

The skinwings (one for each player character) glide towards them from out of the trees. If they hit a player character with their claws, he is thrown to the ground unless he makes a Moderate *Strength* roll. The skinwings then attack with their beaks.

Depending on how this episode is going, the skinwings can be either dreambeasts or real creatures.

Dark Skinwings. *Dexterity 4D, Perception 2D+1, Strength 2D+2.* Special abilities: teeth (STR+1D). Move: 18 (flying).

3. The Face in the Water

As the player characters wade through this particularly noisome stretch of water, the lead player character notices a grinning skull beneath the water. The skull rises slowly until it is just beneath the surface. The skull is an illusion, and instantly disappears if touched in any way.

4. Carnivorous Plants

Large plants grow on these islands. They look harmless at first, but when living creatures ap-

proach within two meters, the plants twitch and fling vine-like tendrils at their prey. The tendrils attempt to wrap around the player characters' arms, legs or bodies. If a tendril hits, roll 1D to see where it strikes: 1, left arm; 2, right arm; 3, left leg; 4, right leg; 5, body; 6, body and both arms trapped.

Next round, any characters caught by the tendrils are dragged toward the plants. In the following round, the plants' huge mouths, filled with digestive acid, clamp down on captured characters.

Each player character has three tendrils flung at him. They can break free of the tendrils by defeating each tendrils' *Strength* of 2D with their own, or by wounding a tendril. For each arm that a player character has trapped by a tendril, subtract 1D from their *Strength*.

Any hit which causes damage on a tendril causes it to spring back to the plant for one round. On the next round, it shoot outs again at the nearest player character.

Carnivorous Plants. *Dexterity 3D, Perception 2D, Strength 3D+2, brawling: tendrils 4D+2.* Special abilities: tendrils (2D), teeth (STR+1D).

5. The Dark Tongue

This encounter occurs only once. If it occurs on one island, it does not occur on any other.

The island has almost sheer sides. Moderate *climbing/jumping* rolls are needed to get to the top. Once on the island, the player characters travel until they reach its center. Then they hear loud slithering noises coming from amongst the trees up ahead. The noises grow louder and the ground begins to shake. Force users suddenly feel a deep chill pass over them. Read:

You hear a rustling in the bushes before you. Small, rodent-like creatures scurry across the ground, apparently fleeing in terror. A huge black lizard with burning red eyes bursts through the trees. Glowing black saliva drips from its gaping jaws as a swollen black tongue lashes toward you.

The lizard's tongue attacks the nearest player character, hitting him on an Easy roll. The next round, the player character is dragged towards the dark tongue's stiletto-like teeth, unless he beats the tongue's *Strength* of 2D+1 with his own in an opposed roll. If he succeeds, he breaks free of the tongue. If not, the dark tongue bites him for 5D damage.

On subsequent rounds, the dark tongue attempts to catch a player character with its tongue. If any damage is done to its tongue, it lets go of its victim and does not use its tongue again. When not using its tongue, its chance to hit is reduced to 3D.



Allen Numis

Dark Tongue. *Dexterity 4D, Perception 3D, Strength 4D.* Special abilities: teeth (STR+1D).

Any damage the dark tongue causes is real. It pursues the player characters relentlessly.

6. The Dark Jedi

This encounter occurs only once. As the player characters move through this area of swamp, read:

The air suddenly turns cold and hangs still in the air. The water swirls in strange hypnotic patterns and lights glow under its surface. The lights grow larger and brighter as they rise towards you. Then they break the water to reveal hideously distorted Jedi Knights wielding lightsabers.

The Jedi are dressed in rotting rags. They have skeletal faces, and white bones poke through their decayed flesh. Silently, they move to attack you.

The Jedi are dreambeasts that cause mental damage. There is one dreambeast Jedi for each player character. They attack using what appear to be lightsabers. After they are defeated, the Jedi and their lightsabers fade away like other dreambeasts.

Dreambeast Dark Jedi. *Dexterity 2D+1, Perception 3D, Strength 2D.* Lightsaber (5D). Move: 10.

7. The Living Dead

This encounter occurs only once.

Death has continued to stalk Crutag's hunters. The group led by Gatal has fallen afoul of Halagad's dreamscape and been killed. As the player characters trudge across an island, they encounter the bodies of the dead hunters which have been reanimated by the dark side. Read aloud:

The darkness swirls across the swamp in cloying tendrils. It wraps around your legs, reaching up to your waists. Suddenly, grinning shapes in bounty hunter armor rise up through the darkness. They aim blasters at you. Their skin hangs in tatters and their faces are twisted in fear and surprise. A malevolent red light glows in their eyes.

The hunters are within two meters of the player characters. There is one hunter facing each player character. They open fire immediately. Hits cause real damage. If the player characters flee, the hunters do not chase them.

Dead Hunters. *Dexterity 3D, Perception 3D, Strength 3D.* Blaster (4D). Move: 10.

After the fight, a search of each body reveals two days' supply of food, one medpac, a blaster, and armor.

8. The Swamp Beast

This encounter occurs only once.

Powered by the dark side, this loathsome mound of semi-intelligent vegetation is out for blood—the characters' blood. It appears as they cross an island. Read:

Ahead of you, a large bush begins to twitch and shake. Then two flickering red eyes appear in the midst of the greenery and stare at you. Suddenly, the bush lurches forward in your direction with a frightening roar. It seems to grow before your eyes, and huge, claw-tipped arms sprout from its sides.

The thing, which looks like a mound of animated compost, rushes forwards with arms outstretched. Anyone caught by its claws is hugged into its rotting chest. Moderate *stamina* rolls are needed to avoid being overcome by its stench and suffering a 1D reduction in all codes for the duration of the combat. Ensnared characters find themselves held fast unless they overcome its *Strength* with their own. Characters may combine actions to free a trapped player character. Use the drowning rules from *Star Wars: The Roleplaying Game, Second Edition* to determine whether a captured player character suffocates.

Swamp Beast. *Dexterity 4D, Perception 3D, Strength 4D+2.* Special abilities: claws (STR+1D). Move: 10.

The Cavern of Vantor

Once the player characters have made it half-way through the swamp, they come upon the cave that served as a campsite for Halagad Vantor when he first came to Trinta, prior to his surrender to the dark side and subsequent move to the nexus. The cave contains the last remnants of his life prior to his capture by Vader and betrayal of the Jedi. Despite the overwhelming influence of the dark side, Vantor has never destroyed this cave, and indeed, uses his power to protect it from intruders.

Read aloud:

Up ahead of you, the trees are lit by a pale orange glow. A few steps closer, and you can see that the glow is coming from within a cave, and the shadows thrown on the wall show torches to be the source of the light. No sounds are coming from within the cave.

If the player characters are reluctant to try and enter the cave, point out to them that the storm is growing worse, and if nothing else, they



would have shelter. If they are still reluctant, suggest that this cavern might be being used by Crutag as a base, and this could be a chance to take the bounty hunter by surprise.

If they still refuse to enter, skip the following encounter and go to Episode Five.

The Hunter Strikes

Read aloud:

As you approach the cavern, you hear a loud hissing noise. Suddenly, the dread figure of bounty hunter Boba Fett emerges from the trees, flying with the aid of his jetpack, blaster firing at you.

Boba Fett is a dreambeast, his image plucked from Crutag's mind. His presence here is evidence of the conflict within Vantor, for he is both attempting to keep the player characters from entering the cave and to prevent them from leaving the clearing. He will attempt to strike from the sky, using his jetpack to avoid player

character fire and pinning them down with his own rifle. The image of Fett is able to inflict mental damage only, and will vanish if struck.

Dreambeast Boba Fett. *Dexterity 4D, Perception 3D, Strength 3D+2.* Blaster rifle (6D), jet pack (burst lasts one move and flies 100 meters horizontally or 30 meters vertically; has 10 bursts). Move: 10.

Into the Cave

Once Fett has faded, the player characters are free to explore the cave.

Read aloud:

The cave is cool, and the only sound is the roar of the rain against the stone. There are no footprints leading into or out of the cave, but the torches appear to have been lit recently.

There are no creatures within the cave, the light of the torches sufficient to keep them at bay. The flames themselves are being kept burning by

GAMEMASTER MAP: **The Cavern of Ventor**

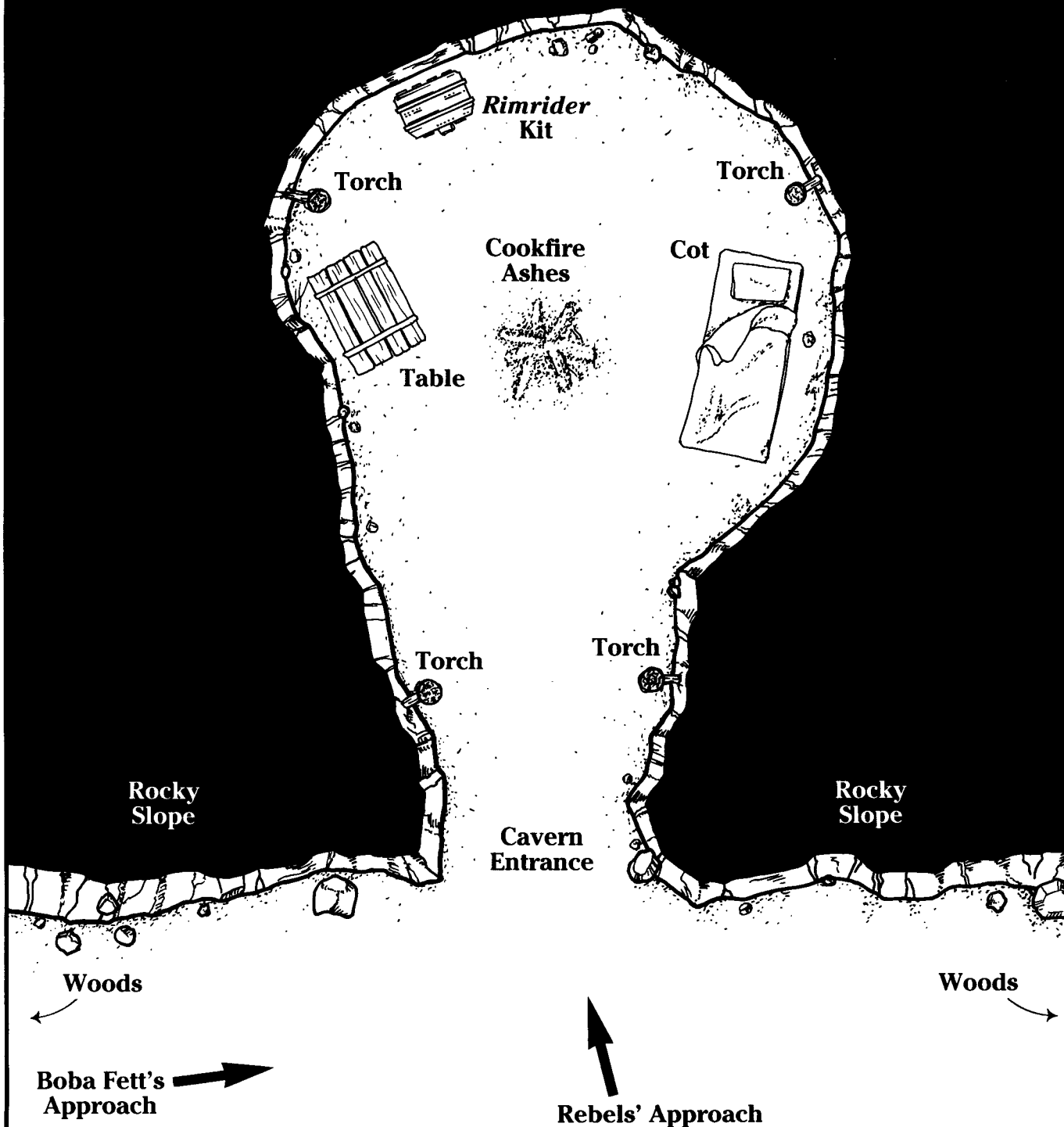

Stephen Crane

the Force, something which a Force user can learn with an Easy *sense* roll.

The cavern itself contains the remains of a camp, but one that has obviously not been used in years. The furnishings are spartan: a cot in one corner, the ashes of a cook fire in the center of the floor, a crude table with an old standard-issue plate and utensils on it. In the corner is a small kit marked *Rimrider* which contains four medpacs.

An Easy *search* roll will reveal that there is one more thing inside the kit. Buried beneath the medpacs is a golden medallion, the scarlet ribbon it is attached to torn and dirty. The inscription on the medallion reads, "Presented to Halagad Vantor, in recognition of service to the Republic."

On a Moderate *Knowledge* roll, the player characters recall that Halagad Vantor was the name

of a Jedi Knight who served during the Clone Wars. He vanished shortly before the destruction of the Jedi, and was assumed to have been killed by Darth Vader.

There is nothing else to be found in the cavern. As soon as the player characters have found the medallion and read the inscription, the torches are extinguished, and growling sounds begin to echo throughout the cave. It seems as if something is inside the cavern with the player characters, and that possibility should get them started on their trek again. If they do not wish to leave, they can spend the night there without being attacked.

End of Episode Four

It's time for the player characters to encounter Crutag. Cut to Episode Five.

Episode Five Ambush

Summary

Continuing toward the source of the disturbance in the Force, the player characters are ambushed by Crutag and his surviving hunters. After defeating or escaping from Crutag, their trek finally brings them to the edge of the Domain of Evil.

A Surprise

Led to a likely site for an ambush by Halagad's dreambeasts, Crutag prepares to trap the player characters. Meanwhile, the heroes are also being lured to the area by Ventor's illusions.

Crutag is accompanied by Slimego the Rodian, Slizzik the Barabel, and six other hunters.

Locating the Ambush

The ambush takes place when the player characters have travelled half the distance or more to the dark side nexus. It can take place on any island, preferably the first one the player characters reach after they pass the halfway point. If there is already an encounter noted for that island, run it after the encounter with Crutag and his team or ignore it.

If the characters are travelling by raft, see the "Making A Raft" section in Episode Four for suggestions on how to get them to this encounter.

The Ambushers

Character templates for Crutag, Slimego and Slizzik are in the back of this book. The other hunters' statistics are listed below. "The Ambush" map shows the location of each of the hunters on the island. Slizzik is hiding in a fetid pool of water in the center of the land mass, and Crutag and Slimego are crouching behind a fallen log. The other six hunters (#1–6) are hiding among the trees and bushes.

Although he is aware that Trinta is a strange world, Crutag has not made a connection be-

tween that and the deaths of his hunters, believing that the player characters are responsible. He is deeply disturbed by the disappearance of his ship, and believes that the player characters are somehow responsible for that, too. But he is puzzled as to why the player characters have not used the vessel to escape Trinta.

Crutag intends to find out where the player characters have hidden his ship, get it back, and leave this haunted planet with them, dead or alive.

Crutag's Hunters (6). All stats 2D+2 except: *Dexterity* 4D, *blaster* 4D+2, *dodge* 4D+2, *Strength* 3D+2. Blaster rifle (5D), medpac, two days' food. Move: 10.

Approaching the Ambush

As the player characters approach the ambush site, read:

The island up ahead rises above the blanket of darkness into the twilight that lies over the swamp. Glad to be out of the clinging darkness, you clamber on to the island.

Visibility on the island increases to 20 meters. As the player characters pull themselves on to the island, ask for *Perception* rolls. On a Moderate or better roll, the player characters hear the rustle of leaves as hunter #1 takes a drink of water from his canteen. To avoid alerting the characters, assuming they don't spot hunter #1, tell them that they notice the sky beginning to brighten to the north.

Hunting the Hunters

If the characters spot hunter #1, they can sneak up on his position by opposing their *sneak* against the hunter's *Perception* of 2D+1. If they fail, the hunter flees toward Crutag in the hopes of drawing the player characters after him. Should they follow, see "The Trap is Sprung."

If attacked, hunter #1 defends himself, only thinking of calling for help after two rounds have passed. However, blaster fire alerts the other hunters to the player characters' presence immediately, and makes it impossible for the player characters to sneak up on them.

From hunter #1's position, the player characters can spot Crutag, Slimego and hunters #2-6 with a Moderate *search* roll. With a Difficult *search* roll, the player characters notice the top of Slizzik's head poking above the level of the pool.

The player characters may attempt *sneak* rolls to approach each hunter in turn. The player characters can attempt to deal with the hunters one by one. Any hunter who notices them calls out to alert other hunters.

The Trap is Sprung

Whether the player characters walk straight into the ambush or are spotted as they sneak up on the hunters, read:

You hear faint clicks as blasters are prepared to fire. A voice calls out, "Hold it. If nobody moves, nobody gets hurt."

You see Crutag – the Taloron Hunter – and a Rodian behind a fallen log. Crutag casually points a blaster carbine in your direction, while the Rodian, a wide grin splitting its face, aims a blaster rifle at you. Other bounty hunters step out from hiding and cover you with their blasters.

Weighing the Odds

The player characters have three choices: do

as they are told and surrender, fire at the hunters, or run. If they open fire or run for it, now or later in the encounter, go to "Firefight" below. Otherwise read:

Crutag grins and performs a mocking bow. "You're more resourceful than I thought. But I have you now!"

The Rodian twitches the blaster rifle and says, "Can I kill them now, boss? Go on, let me blow them away."

Crutag shakes his head, "No, they're worth more alive."

Crutag waves the other bounty hunters forward. "Okay, where's my ship?"

If a player character points out that if they had Crutag's ship they would have left Trinta by now, Crutag shrugs. "Makes sense. But if you ain't got it, who does?"

Alternatively, the player characters can play along with Crutag and offer to take him to the *Scent of Fear*. If they do this, he will state that they will wait until "what passes for morning on this miserable mudhole" before setting out.







In either case, Crutag listens to what they have to say, then orders them to drop their weapons. If they do as they are told, the hunters close in to cover them better. Blasters are pushed into the characters' chests and backs as one of the hunters ties their hands behind their backs. Slimego looks disappointed and puts his blaster rifle down. The player characters are captured! (see "Captured!" below).

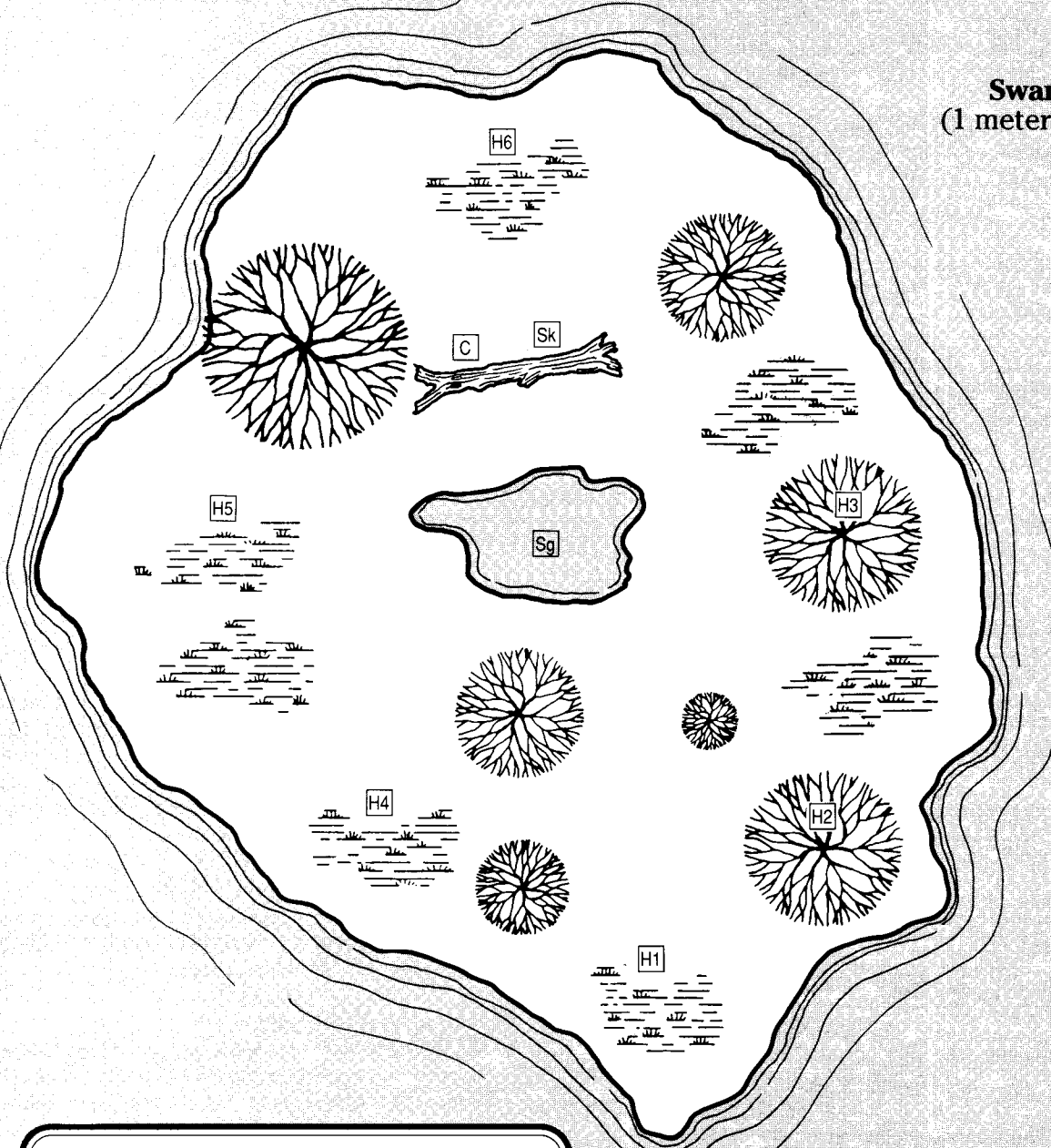

**GAMEMASTER MAP:
The Ambush**

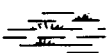
Swamp
(1 meter deep)



| | | | |
|---|-------------|---|---------------|
|  | Tree |  | Crutag |
|  | Undergrowth |  | Stizzik |
|  | Pool |  | Slimego |
| | |  | Bounty Hunter |

Rebels' Approach

Firefight

Crutag is no amateur. He knows what cornered prey is capable of. Should a firefight break out or the player characters flee, Crutag and his hunters shoot to kill. Crutag intends to take one character alive, however. He wants to find his ship; a live captive may be his only hope of doing so.

If Crutag is killed, the hunters break and run unless Slimego or Slizzik succeed in Moderate *command* rolls. The hunters head into the swamp and play no further part in this adventure.

Slizzik

Slizzik has been lurking in the pool of water. Once the firefight starts, she bursts out of the pool in a spray of water, and attacks the nearest player character with her claws. Slizzik is a Barabel of few words, contenting herself with screams of "Kill, kill, kill!"

If the player characters have surrendered to Crutag, Slizzik flies into a rage. Crutag is able to make her grudgingly accept the surrender before she succeeds in killing anyone.

Flee!

If the player characters run away, the hunters will pursue them across the swamp. Use some of the obstacles and events from the "Rancor Chase" to spice it up. If the player characters make good their escape, Crutag begins to track them (see "Tracking the Player Characters").

Captured!

Captured characters are searched and then tied to a nearby tree. The hunters mock them, calling them "scum," "amateurs," and other choice insults. Crutag, accompanied by Slizzik and Slimego, begins to interrogate the player characters.

Crutag wants his ship. He is not averse to having Slimego kick a captive or two if he does not get the kind of answers he likes. Unfortunately for the player characters, they cannot truthfully supply those answers.

Slizzik demands to know who killed her husband, and insists that they face her in single combat. Here again, the player characters cannot confess to something they didn't do, which will only anger Slizzik more. However, Slizzik's moral code prevents her from beating defenseless prey, but she rants and rages very effectively.

Slimego has no such scruples. He just wants to have fun, and his idea of fun is kicking or otherwise abusing people who can't fight back. He's the life and soul of the interrogation party, and is sure to earn the enmity of the player characters.

Here's an idea of how the interrogation session is likely to go:

Crutag: Okay, where's my ship?

Player Character 1: Dunno, we ain't seen it since you fired at us.

Slimego: He's lying! *Kicks player character.*

Slizzik: You, soft, fleshy creature, tell who killed Balluzikik, hunter of animals?

Player Character 2: Who?

Slizzik: I kill you! Stand up and fight.

Crutag: Enough! *Pulls Slizzik back, then turns back to player characters.* Listen, scum. I want my ship. If I don't get it, Slimego, here's going to rip your intestines out and eat them.

Slimego grins and kicks player character.

Slizzik: Let them go, then I kill them, dead.

Player Character 3: Look, we ain't got your ship, and we don't know who killed Ballkik, or whatever his name is.

Slimego: *Grins evilly.* Good. Then you die, very slowly, very painfully.

Ending the Interrogation

The interrogation ends when the player characters have conned Crutag into thinking they will lead him to his ship, or Crutag calls it a night. Either way, the session ends with more threats from Slimego and Slizzik. The hunters then leave the player characters and break open their food rations. After a meal, they settle down to sleep. One hunter is left to guard the prisoners while another patrols the camp's perimeter.

Escaping

The player characters can attempt to escape by freeing themselves of their bonds during the night. A Very Difficult *Strength* roll is needed to burst the bonds, or a Difficult *Dexterity* roll allows a character to slip his hands free.

Once free of their bonds, the player characters need to overpower the bounty hunters, or sneak into the swamp and escape. If it comes to a fight, give the characters a reasonable chance of success, but remember that the bounty hunters are professionals who will soon overcome their initial confusion and fight back.

Opposed *sneak* rolls and *Perception* rolls are needed to successfully sneak into the swamp. Should the player characters successfully escape, their absence will be noted a minute after they leave the camp.

Crutag quickly (five rounds) organizes the bounty hunters to give chase as soon as he is aware that the player characters have escaped (see "Tracking the Player Characters").

If the player characters wait before attempting their escape, after a couple of hours, Slizzik takes over from the guard watching them. Slizzik seeks revenge, but her code of honor prevents her from extracting it from tied or otherwise helpless foes. She approaches the player characters and offers to release them. She will give them three minutes' start before coming after them to kill them.

If the player characters agree to her suggestion, Slizzik keeps her word, but does not let the player characters have any weapons. Once any fight starts, Crutag will be alerted and come after the player characters with the other hunters.

If the player characters don't agree, and decide not to escape, they are in big trouble. In the morning, Crutag orders the release of the largest player character, who is made to fight Slizzik. If the player character wins, the hunters try to kill him with their blasters. Slizzik will kill him otherwise.

What happens next depends on whether or not the player characters have agreed to lead Crutag to his ship. If they have, they are ordered to do so. If not, or if it becomes obvious that there is no ship to be found, Slimego will attempt to gut a player character. The need for escape attempts, no matter how desperate, should be apparent to the player characters. Should the player characters lead the hunters to the dark side nexus, they have plenty of opportunity to escape during the storm.

Capturing the Hunters

If the characters capture and interrogate Slizzik, Slimego or Crutag they find out little.

Crutag is businesslike. "You're worth a lot of money. Nothing wrong with making a living, is there?" Crutag can be convinced of the player characters' story and will agree to a truce, but he has no intention of honoring it. He escapes at the first opportunity and stalks the player charac-



Allen Nurnis



Allen Nurnis

ters through the swamp.

Slizzik struggles constantly and snaps at anyone who gets too close to her.

Slimego tries to wheedle his way out of trouble by claiming he had no choice except to follow orders. "Crutag's mean, you know. He killed little Hewi just 'cos he didn't know where the ship was. I wasn't going to cross him, but I'll help you." Hewi was the alien hit by Crutag in the Cut-Away in Episode Four. Slimego sucks up to his captors and tells them anything they want to know. The only problem is that Slimego doesn't know much. He's been with Crutag ever since landing and he believes that the player characters have the *Scent of Fear*. At the first opportunity he'll run, taking a weapon with him if possible.

Tracking the Player Characters

If Crutag, Slimego, or Slizzik survive the ambush and are not captured, or if the player characters lose them in the swamp, they search for the characters' trail. The hunters can appear at any point during the trek, either waiting in ambush or pursuing the characters. If the player characters escape again, the hunters lose them in the swamp. They can encounter the characters again later. See "Episode Six" for some ideas.

The Wind and the Rain

After the characters leave the ambush site, Halagad's anger creates a savage storm. Read:

A sheet of light flares across the sky. Thunder

rumbles in the distance as rain again falls. This time the rain is driven by a wind that sweeps leaves and branches with it. The rain batters at you, stinging your faces and eyes. Lightning again flashes against the sky and the roar of the thunder shakes the swamp.

The storm causes large waves which increase *swimming* rolls to Moderate and cause any rafts to capsize and break up. Visibility is now reduced to 1D meters.

The storm is also filled with images from Halagad's madness. Strange, flapping creatures gibber and screech across the sky. Every half hour or so, lightning flashes reveal Darth Vader's battle mask glaring down at them from the dark sky.

The trees now appear to be blackened and dead, with weird, agonized faces staring out at the player characters. The faces scream in torment and change constantly.

Obi-Wan

As the storm rages, the player characters confront another image conjured by Ventr.

Read:

You come to a clearing, in the center of which stands an old man with a benevolent appearance, clad in a long, white robe. A nimbus of light seems to surround him. He holds out his hand and speaks to you, saying, "You have come far, and now it is too late to turn back. The dark side is far stronger than you know, and the Light has no power here. This world will be your grave, and your spirits will be trapped here for all eternity."

This is an illusory image of Obi-Wan Kenobi, a Jedi Knight who fought beside Ventr in the Clone Wars. Ventr knew him only as a young man, and was not aware until he scanned the minds of the player characters that Kenobi had survived the destruction of the Jedi. He is using his image to try and frighten the player characters and destroy their will to resist before they reach the dark side nexus. If the characters attempt to speak with the illusion, read:

The old man shakes his head, sadly. "Your only hope of escape lies ahead. But beware — it takes but a moment's hesitation, the slightest failure of nerve, to call destruction down upon you. It is not always the evil who are claimed by the dark side, often it is simply the weak."

The illusion says no more. If the player characters approach the figure of Obi-Wan, the image shatters like glass and fades away.

Encounters and Events for the Storm of Fear

Encounters marked on “The Trek” map and described in Episode Four can still be used in this final part of the trek. Use as many of the events described below as you like, as well as those from Episode Four. After you’ve run the events, the player characters reach the dark side nexus.

Timber!

The wind grows stronger, and lightning bolts explode about the player characters. A loud crackling sound alerts them to the menace of a falling tree. Moderate *dodge* or *swimming* rolls let the player characters avoid the tree’s branches as it crashes into the swamp. Failure results in 5D damage.

Huge Waves

High waves rush over nearby islands, sweeping characters away unless a Moderate *lifting* roll is made. Characters who make the roll are able to grab onto a rock or tree and ride out the wave. Those that fail are swept into the water.

Player characters in the water need Difficult *swimming* rolls to avoid being smashed against the side of a nearby island. Those who fail take 3D damage. Allow the player characters to regroup before using any other encounters.

Quagmire!

The rain pounds the islands, turning them into swampy messes. Thick mud flows in wide streams across the islands and into the water. Hidden under the mud is a stretch of quicksand which can be detected with a Moderate *search* roll. Otherwise, the lead character blunders into it and drops from view. If the characters behind don’t immediately stop, they too fall into the quagmire.

An Easy *survival* roll allows the player character to scramble free. The sinking character can combine his actions with any other characters present. Give fast-acting characters who throw a rope, or reach out with a stick to their comrade, an extra 1D on their *survival* roll. If the roll is failed, the difficulty increases by one level each round, until a Very Difficult roll is failed, at which point the character sinks under the surface and begins to drown.

Down in the Flood

The water rises rapidly, setting up fast moving currents that sweep over the lower lying islands. Fallen tree branches and small animals are washed away. As the player characters cross

between two islands, a sudden rush of water sweeps towards them. Difficult *swimming* rolls let the player characters make it to the other island. Those who fail are swept back and battered by debris (3D damage).

With an Easy *swimming* roll, a player character can make it back to the original island. As they clamber ashore, small furry animals, squeaking in fear, rush towards the group. The animals swarm over them clutching at clothes and hair, and knocking them off balance.

A Moderate *dodge* roll lets the player character retain his balance and extricate himself from the terrified creatures. If he fails, he falls back into the water, taking 2D damage from the creatures’ claws. Once in the water, two animals cling to the player character’s head, obscuring his vision and increasing *swimming* rolls to Very Difficult. The animals can be removed by beating their combined *Strength* of 2D with the player character’s own.

Player characters who become separated from the others can rejoin their allies by making a Moderate *swimming* roll.

Birds of a Feather

The wind picks up even further as thunder cracks overhead. Carried on the wind is a flock of birds. They are swept into the player characters, causing 3D damage unless they succeed in Moderate *dodge* rolls. The birds are then blown away into the distance.

Toward The Nexus

As the player characters approach the island containing the dark side nexus, Force users become aware of a deep chill emanating from up ahead. Ask for Moderate *stamina* rolls as they climb up on to the island. Failure results in fatigue: a 1D reduction in all die codes until the player characters rest for at least an hour.

Then, before they can do anything else, a dark side creature attacks them — a gorgand. Read:

Dragging yourselves on to this island, you feel exhausted. The wind and the rain batter you, but there is something more in the air. The humid warmth of Trinta fades, replaced by a chill that moves in waves across the island.

Fighting back a shiver, you prepare to move into the island’s interior. A large red shape stirs up ahead, but is instantly lost from view.

Moderate *Perception* rolls allow the player characters to see the gorgand as it edges along a branch above them. It resembles a large, predatory cat. The gorgand leaps down on to the

nearest player character. As it leaps, the player characters see that its body and eyes glow red. The gorgand causes real damage.

Gorgand. *Dexterity 5D+2, Perception 3D, Strength 5D.* Special abilities: teeth (STR+1D), claws (STR+1D+1). Move: 15.

The gorgand attacks until it is incapacitated or killed. At that point, its body twitches and convulses and its skin rips open from head to tail. Its intestines lash out and attempt to strangle the nearest character. On a successful hit, the intestines wrap around the victim's throat and begin to constrict. They start with 1D damage, but each round their grip tightens, adding a further 1D to their damage score. They may be pulled off by opposing the player character's lone or combined *Strength* against the intestines' *Strength*. The intestines then lash out to attack whoever is currently holding them.

The intestines continue to constrict until the victim is incapacitated, and then they attack another character. Damage by the intestines is dreambeast damage. Once incapacitated or killed,

the intestines fade away and the gorgand is seen to be still intact.

Gorgand's Intestines. *Dexterity 6D, Perception 1D, Strength 4D.* Special abilities: crushing grip (1D damage first round, +1D damage per round attached).

The Black Tree

Finally the player characters have reached their destination. Read:

The wind drops suddenly and the rain stops, but the sky remains dark and oppressive. It is deathly quiet. No sounds or movements break the stillness.

A huge, black tree stands before you. It lacks leaves and mold covers its rotting bark. A deep chill wafts out of the tangled roots at its base.

Force users (whether they retain their powers or not) know that the source of the disturbance in the Force lies under the root system of the tree. They sense that something waits for them down there. Go to Episode Six.

Episode Six The Dark Side

Summary

The player characters now enter the dark side nexus. Within the nexus the lure of the dark side of the Force is strong, and Force-sensitive player characters will need to remember to follow the Jedi code. Non-Force users must try and reign in their anger and fear about this unnerving place. If the player characters achieve the best possible result, they can redeem Halagad and finally give him peace in the Force. If they fail and succumb to the seductive call of the nexus, they are doomed to take Halagad's place.

The Dark Tree

When the player characters are ready to enter the dark side nexus, read:

As you approach the huge, dead, black tree, you see that its base is surrounded by a few feet of water. Giant, twisted roots form a dark and sinister cave on one side. A foreboding feeling of death washes out of the cave. You shiver.

The climb down into the cave is Easy. Inside, water washes over the ground where more of the tree's roots writhe and twist over the floor. Water drips from the walls. Like the nexus entered by Luke Skywalker on Dagobah, this nexus contains only what a character brings into it. This one becomes filled with situations drawn from the characters' own minds. Among the images they see as they walk through the tunnel are Imperial stormtroopers firing at them, Darth Vader murdering Princess Leia, and the deaths of the people of Alderaan. All of these are designed to confuse and anger the player characters — they are all illusions, and can do no damage. Characters that players have used in the past can see images of previous adventures, altered to provoke a fearful or angry response.

Force users, even if they have lost their powers, are aware that the cave is permeated by the dark side of the Force. It is an integral part of the

stones and the earth in this place, and the sense of corruption is almost overwhelming.

All Force powers work within the nexus, but unless used to cause injury or harm, their difficulty is increased by one level.

The Lure of the Dark Side

As the player characters enter the nexus, each suddenly finds himself alone. Even characters who did not enter the cave do not escape. The nexus expands and envelops them in its power. Read:

Looking around, you realize that you are alone. There is no sign of your comrades. You are aware of being offered power. It calls to you seductively, tempting you. "Feed your anger,

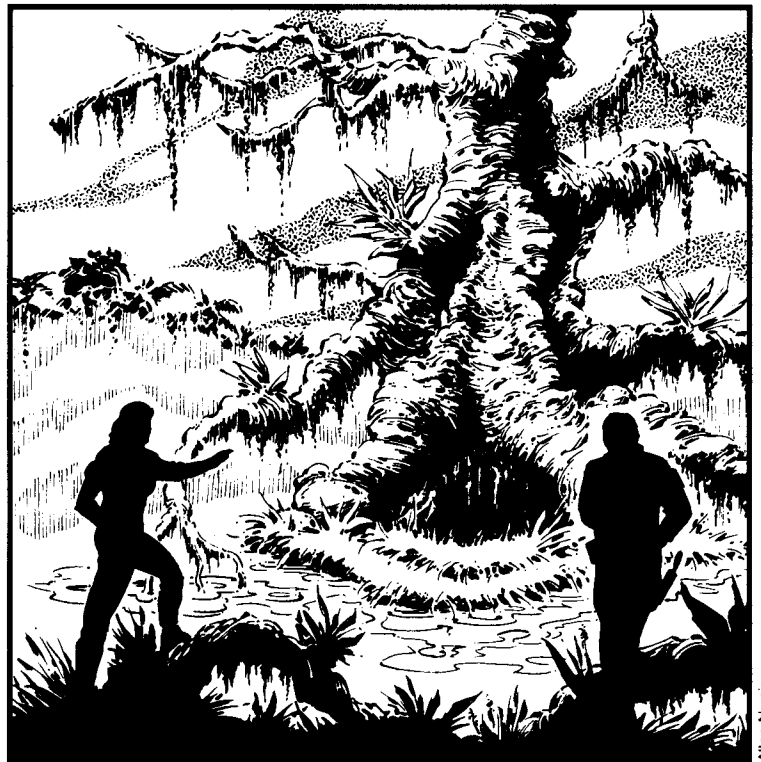

Allen Nurnis

The Power of the Force

If your players play like bloodthirsty cutthroats or fail to realize that they face a series of important tests, they could all end up consumed by the dark side. If it's necessary to steer them onto the right path, feel free to have the Light Side of the Force speak to them as Kenobi does to Luke Skywalker in the movies. As well as the Jedi Code, here's a few other quotes to use:

"Use the Force for knowledge and for defense, never as a weapon."

"Don't give in to hate or anger."

"Resist the dark side."

"Control your emotions."

Just in case you think it's too easy for the player characters, the dark side tries to

goad the player characters into making mistakes. It calls insidiously to them:

"Feel your anger, channel it, draw on its power."

"Fear helps you survive."

"Harness your aggression and grow strong."

But the dark side is also subtle. It disguises itself as the Light and offers suggestions to the characters, trying to persuade them to take a wrong action. A Goad is given for each test. This summarizes the situation as seen from the dark side, and is used by the dark side to characterize gamemaster characters in the tests, or to confuse the player characters with what appear to be rational arguments.

release your frustrations, take what is yours by right. Power can be yours. Call upon the Force." You realize that you can gain a Force Point, simply by asking for it.

The dark side reaches out to each character with its offer. The power of the dark side is strong here. Any time a character calls upon the dark side, he or she automatically receives a Force Point which must be used that round. The character also receives a Dark Side Point. The dark side seeks to corrupt by any means, and grants its powers regardless of what the character intends to use them for.

Dark Side Points

Every time a character receives a Dark Side Point, roll 1D. If the result is less than or equal to the character's number of dark side Points, the character is immediately consumed by the dark side and removed from play. Depending on how well the remaining characters do, player characters who have been consumed by the dark side may be redeemed at the end of the adventure (see "Victims of the Dark Side").

The player characters should be aware that it is the dark side calling to them. If they fail to make this connection, you should point out to them that only the dark side offers power so easily. If a player character still decides to use the dark side and becomes consumed by it, so be it. You have done your duty as the gamemaster.

Damage in the Nexus

Events which occur in the nexus during the tests are all illusory. Any damage received by the

player characters is perceived as real, but no mental damage or loss of Force skills occur through combat. However, characters who die during their first test do not get to take a second test. They only reappear for the final confrontation with Halagad.

Tests of Character

In addition to offering Force Points, the nexus presents each character with two trials. These test the characters' courage and wisdom. If they adhere to the Jedi code and avoid acting from hatred, fear, anger or aggression, they'll defeat the power of the dark side. If they fail, then the dark side may consume them.

A character gains a dark side point for each test that he fails, but he finds that one of his mental attributes is restored to its original level.

After the tests are completed, characters who were not consumed by the dark side find themselves reunited, even if they appeared to die during the tests. They must then face Halagad.

There are a total of 12 tests. Assign two tests to each character. If you are running a campaign, you might want to replace some of the tests with situations that could happen in your campaign by using places and situations that the player characters are familiar with.

The tests are all created from the minds of the characters; the dark side is drawing on their past experiences to make the tests appear real. Although the player characters remain within the nexus beneath the black tree, they appear to suddenly find themselves in the situations described in the tests. To emphasize this transition, start each test by saying something like,

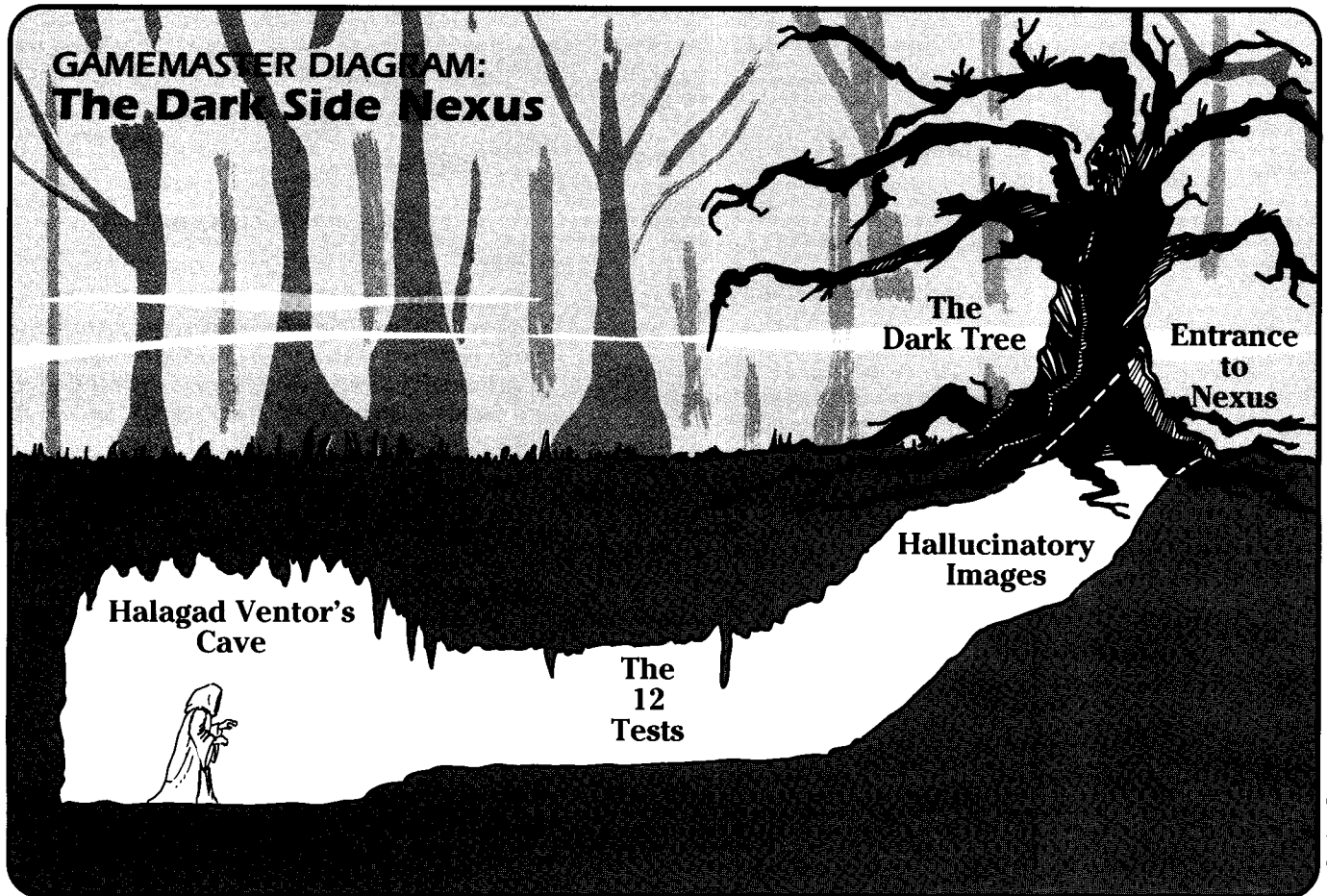

Stephen Crane

“Your vision wavers. When it clears, the scene has changed.”

To keep the action moving, run the first player through his or her character’s first test, then move on to the second player, then the third, etc. Once all the characters have completed their first test, run the first player through the second test, followed by the second player, etc.

Alternatively, the player characters could all be put through the same test. To do this, you’ll need to beef up some of the opposition in the combat-orientated encounters. Others, like “The Bomb,” can be used unchanged.

The Tests

*“There is no emotion; there is peace.
There is no ignorance; there is knowledge.
There is no passion; there is serenity.
There is no death; there is the Force.”*

— The Jedi Code

The tests force the player characters to confront situations where they are tempted to act from anger, fear, aggression, or hatred. To pass the tests, they need to act calmly, drawing strength from the peace offered by the Force.

1. Death by Firing Squad

Read:

With other members of the Rebel Alliance, you have fought your way into an Imperial base. The fighting has been hard. Many Rebels, including close friends, have died. Now as the fighting draws to a close, you enter a chamber where Imperial technicians cower against a wall. Rebel troopers raise blasters and prepare to fire at the Imperials.

A Rebel officer, incensed at having had half his company killed during the attack, is conducting a battlefield execution. The player character sees that the techs have their hands in the air and are unarmed. As the officer shouts, “Present, Aim, FIRE!” pause momentarily between each *command*. If the character does nothing, one of the techs breaks and runs in his direction just before the order to fire is given.

Goal: The Imperials are responsible for the deaths of thousands of people. They must be eradicated before they kill others.

Character Actions: If the player character does nothing, joins in the execution, or shoots the

escaping tech, he fails the test.

The character can stop the troopers from firing with an Easy *command* roll. The officer can be calmed down and persuaded he is acting wrongly either through roleplaying or with an Easy *bargain* roll. Otherwise, the character will have to prevent the officer by physically restraining him or shooting him. The Rebel troopers don't take any action against the character.

2. Dark Passage

Read:

Before you is a dark tunnel. Muffled screams and sobbing sounds echo hollowly from it. You feel compelled to enter this passage.

This encounter tests a character's resolve to remain calm and collected in the face of unknown horrors. The character cannot avoid entering the passage. As the character passes along the tunnel, horrid leering faces loom out of the dark and bony fingers pluck at his clothes.

Goat: It is only a matter of time before you are attacked and killed. Attack first and make whatever is in there fear you. Better still, kill it before it kills you.

Character Actions: As long as the character moves along calmly, and only seeks to defend himself, after four rounds the scene shifts to the next test. He has passed.

If he attacks the shapes in the darkness, three huge lobster-headed monsters loom up around

him. They attack with their claws and slaving mouths. The player character can only leave the passage once he has defeated all three monsters.

Lobster-heads. *Dexterity 4D, Perception 3D, sneak 4D, Strength 4D.* Special abilities: teeth (STR+1D), claws (STR+1D). Move: 10.

3. Alien Customs

Read:

You are in a great hall surrounded by a dozen bug-eyed aliens. The aliens are devouring little furry creatures with their extendible mandibles. A particularly repulsive alien tugs at your sleeve, and holds a struggling creature by its tail in front of your face. "You eat," it clicks.

The aliens are Cratniks, an insectoid race. The test is to honor the Cratniks' way of life, and not offend them by impolitely refusing the delicacy offered. The small mammals are the Cratniks' staple food. They are unintelligent.

Goat: These repulsive aliens are eating these cute little creatures out of malice and spite. Save the little creatures from their cruel fate.

Character Actions: If the player character graciously accepts the offered food and eats it, he passes the test. It tastes fine. If he refuses politely and explains that he does not eat raw food or he's a vegetarian, etc., ask for a Very Easy *alien species* roll. If he succeeds, the Cratniks honor his wishes, and he passes the test.

Should the character do anything aggressive, such as push the food away, snatch the little creature from the Cratnik's hand, or get angry in any way, the Cratniks are offended and attack him. He fails the test.

12 Cratniks. *Dexterity 3D, dodge 5D, Perception 2D+1, sneak 3D+1, Strength 3D.* Special abilities: teeth (STR+1D). Move: 10.

4. The Bounty Hunters

Read:

From around a corner you hear the sound of blaster fire. Beyond is a room where Crutag and three of his hunters stand over three bodies. As one of the hunters steps back, you see that the bodies on the floor are your comrades. Crutag says, "Be careful — there are still more of them out there."

Crutag and his hunters have just fought off a group of mercenaries who have wounded the player character's friends. The hunters move to cover the rest of the cave while one bends over to give medical aid to the bodies on the floor.



Goad: Crutag and his hunters live only to kill. They have killed your friends. Avenge your comrades. Kill them before they kill you.

Character Actions: If the player character attempts to talk to Crutag, the illusory hunter is friendly and explains the situation. He tells the character that his friends are only stunned. If the player character acts calmly, he passes the test. If he attacks first, he fails and must defeat the four hunters. After the fight, he discovers that his friends are only stunned.

5. Pit Fighter

Read:

You are in a recessed pit facing a tall, furry humanoid armed with a vibroblade. At the top of the pit, a fat, slug-like alien licks its lips and stares down at you expectantly. Other aliens laugh and jeer at you.

The player character is in a gladiatorial pit. The creature he faces is a Wookiee, who does not wish to fight and only attacks in self-defense. Behind the player character is an open door, through which he can escape simply by turning round and walking through it.

Goad: The creature means to kill you. You must kill it first in order to gain your freedom.

Character Actions: If the character talks to the Wookiee, he points at the open door and gestures for the player character to leave. Or, if the player character looks for a means of escape, he sees the door and can leave. He passes the test in both cases.

If he attacks the Wookiee, he fails the test. The Wookiee tries to fight his way past the character and flee through the open door.

Dreambeast Wookiee. Dexterity 2D, melee combat 4D, Perception 1D, Strength 4D+1. Vibroblade (STR+1D). Move: 10.

6. TIE Attack

Read:

You are at the controls of an X-wing fighter engaged in combat with a squadron of TIE fighters. All but two TIEs have been destroyed. The survivors, trailing smoke, swoop toward a nearby planet. You are ordered to follow and destroy them.

The TIE pilots intend to flee and hide on the world below. They only fight if the player character pilot chases and attacks them.

Goad: The Imperial pilots are the enemy; they must be destroyed.



Allen Nurnis

Character Actions: If the player character queries the order to follow them and suggests letting them go, ask for an Easy *bargain* roll. If he succeeds, his order is changed to requesting their surrender. If the player character calls on the TIE pilots to surrender, either on his own initiative or following a change of orders, the pilots do so, and the player character passes the test. He also passes the test if he disobeys his original order and lets them go.

If he hits a TIE, both pilots offer to surrender. He fails the test if he kills the pilots.

Dreamstate TIE Fighters. Starfighter, *starfighter piloting 4D+1, starship gunnery 4D+1.* Maneuverability 2D, space 10, atmosphere 415; 1,200 kmh, hull 2D. Weapons: 2 laser cannons (fire control 2D, damage 5D).

Dreamstate X-wing. Maneuverability 3D, space 8, atmosphere 365, 1,050 kmh, hull 4D, shields 1D. Weapons: 4 laser cannons (fire control 3D, damage 6D), 2 proton torpedo launchers (fire control 2D, damage 9D).

7. Prisoner Escort

Read:

An Imperial officer accompanied by two Imperial Army troopers is leading three Rebel prisoners toward a shuttle. You recognize one of the prisoners as Commander Straken, head of Rebel Intelligence. Across the starport, a squad of stormtroopers advances quickly toward the group with the prisoners.

The Imperial officer and soldiers are Rebel agents who have tricked the Imperial forces into releasing the prisoners. If the character does not interfere by attempting a rescue, the player characters board the shuttle and escape before the stormtroopers arrive.

Goad: The Imperials have Commander Straken. You must rescue him.

Character Actions: The player character only passes the test by determining that the Imperials are in fact Rebel agents. If he approaches them, Commander Straken recognizes him and signals for him to step back. If he doesn't comply, the "Imperial officer" walks over and quickly explains the situation. The stormtroopers open fire and the characters hurry on to the shuttle.

If the player character waits and does not approach the prisoner escort, the stormtroopers demand that the Rebels stop. They run for the shuttle, taking two rounds of stormtrooper fire as they do so.

The character only fails this test by attacking the Rebel agents or by doing nothing to aid their escape.

Imperial Stormtroopers. All stats are 2D except: *Dexterity* 3D, *blaster* 4D, *grenade* 4D+2. Move: 10. Blaster rifle (5D), stormtrooper armor (+1D energy, +2D physical, -1D *Dexterity* and related skills).

8. The Common Good

Read:

You and your comrades are carrying information vital to the Rebel cause, and are being chased through an Imperial base. You have just crossed an extendible bridge which stretches over a drop of 100 meters. Eight stormtroopers are hot on your heels. One of your friends calls for you to hold off the stormtroopers while she operates the bridge's controls. The others rush toward the waiting starship. More stormtroopers are rushing toward the bridge.

The bridge controls have been locked by the central computer and it takes the other player character three rounds to release them. During that time, the player character has to hold the stormtroopers off.

Goad: Save yourself. Run for the ship. This is not the time to die in senseless heroics.

Character Actions: If the character runs for the ship, he fails the test. If he stays and fights, he buys time for his comrades. If he dies, he finds peace in the Force and passes the test.

Stormtroopers: see Test #7.

9. The Children

Read:

You are on a world under attack by Imperial forces. Stormtroopers have invaded the city where you are hiding. As you are about to make your escape, screams come from the next room. Through the door you see six stormtroopers about to open fire on six frightened children.

The player character has time to make his own escape, but only by abandoning the defenseless children to their fate.

Goad: You are more important than these unskilled children. They will not die in vain, for they will buy time for you and others to escape.

Character Actions: If the player character saves his own skin, he fails the test. If he tries to save the children, a Very Easy *command* roll gets them running for safety. He must then defeat the stormtroopers. If he does, he can still make good his escape.

Stormtroopers: see Test #7.

10. The Bomb

Read:

Imperial agents have penetrated a Rebel base and planted a bomb. The base, its security breached, is being evacuated, but the bomb threatens to destroy a nearby transport. The transport is ready to liftoff, but it is feared that it will not clear the bomb's blast area in time. You are asked to stay behind to defuse the bomb.

The transport lifts off next round whether the player character agrees or not. If he refuses to stay, a volunteer rushes out to defuse the bomb.

Goad: There's no need to panic. Let's just get out of here.

Character Actions: If the character does nothing, he fails the test. If he tries to deal with the bomb, whether successfully or not, he passes the test. He has two rounds to defuse the bomb. A visible timer ticks off the remaining time. Two rolls are needed to neutralize the bomb: a Difficult *security* roll and a Difficult *demolitions* roll. This is obvious to the player character. If a roll is failed in the first round, it may be attempted again next round. If he fails (the volunteer fails automatically), the transport is severely damaged and many lives are lost.

11. Revenge of the Sand People

Read:

On the desert world of Tatooine, you see five Sand People dragging a human dressed in Tusken Raider clothing toward a waiting bantha. The buildings of the nearby moisture farm have been broken into and items are strewn along the ground. Three human corpses lie sprawled on the sand near the farm's entrance. The Sand People pull the man onto the bantha.

The captured human and the corpses are agents of Jabba the Hutt. They staged an attack on the moisture farm, intending to make it look like Sand People were responsible. Jabba intends to squeeze the farmers into paying him protection money. The Sand People, hearing the blaster fire, attacked the impostors.

Goat: These bloodthirsty aliens deserve to die.

Character Actions: If the character attacks, he fails the test. A Moderate *alien species* roll lets the character know that the Sand People would have torched the farm buildings, rather than simply vandalizing them. An Easy *search* roll reveals that the three humans sprawled on the ground are also dressed in Sand People clothing. With a Difficult *search* roll, the player character sees two farmers watching events from within the farmhouse. It is obvious that the Sand People are ignoring them.

If he approaches cautiously, the Sand People gesture angrily for him to keep away. Unless attacked, they mount the bantha and leave with their captive. To pass the test, the player character has to refrain from attacking the Sand People.

Dreambeast Sand People (5): *Dexterity 2D+1, blaster rifle 3D+1, melee combat: gaffi stick 4D, Perception 2D, Strength 3D+2.* Blaster rifle (5D), gaffi stick (STR+1D).

12. Checkpoint

Read:

Imperial forces have been turning the starport upside down looking for a Rebel spy. The spy has gained important information and it is vital that it reaches Rebel High Command. You see the Rebel agent across the street. He has been stopped by four stormtroopers.

The agent has been stopped on a routine check, but the stormtroopers will soon realize that he is the one they want, unless the character intervenes.

Goat: Don't get involved. He's in their grasp now. Your interference will only result in both of you being caught.

Character Actions: If the character does nothing, he fails the test. The character may fool the stormtroopers into thinking that he is the one they are looking for with a Moderate *con* roll. Or he may attack, hoping to rescue the agent before three rounds are up. At that point, 10 more stormtroopers appear to chase them. If the player character rescues the agent or convinces the stormtroopers that he is the spy, he passes the test.

Stormtroopers: see Test #7.

The Final Test

After completing their individual tests, those player characters who have avoided falling victim to the dark side, whether they seemed to live or die, are reunited within the nexus. Now they face Halagad Vantor, a former Jedi, now no more than a pawn of the dark side of the Force.

Read:

You stand together in a dark cave. Before you is a figure bent almost double, dressed in a long brown robe which covers its face. The figure, sensing your presence, raises its head to reveal a withered and dried face. The eyes burn with a red light, and thin, skeletal hands poke out of the ends of its robe.



Alien Numis

The figure takes a shaky, uncertain step forward, and beckons to you. "Welcome. You have passed all my little tests, and so you are, indeed, more than you seem. I sense your strength, but I am stronger yet, for the dark side called to me and I paid heed. Join me, feel the power that is mine to bestow, and together, we shall crush the Light."

Into the Darkness

Ventor has been almost completely consumed by the dark side, but deep within him, there is still a twinge of regret for the actions he has taken. Thus, while he tries to corrupt or destroy the player characters, a part of him is praying they will slay him and allow him to find some measure of peace in the Force.

Player characters who succeed in *Easy Perception* rolls note that Halagad looks tired and unhappy. He makes no overt move against them. If they attack him, Halagad makes no attempt to defend himself. If the player characters kill Ventor, they suddenly find themselves back at their ship (see "The Ship" below). Any characters who previously fell victim to the dark side are doomed to take Halagad's place and remain in the nexus forever.

If the player characters ask Halagad who he is and what he is doing in the nexus, read:

I am Halagad Ventor. Years ago, when the Clone Wars raged, I was captured by Darth Vader, who stripped through the layers of my mind to discover the hiding place of other Jedi. I was too weak to resist him. I had not mastered the powers of the Force. Vader found it easy to rip the information he sought from my feeble

mind. Because of my failure, many Jedi were hunted down and destroyed.

I fled from Vader. Finally I came to Trinta, where the Force called to me. Only later did I discover that it was the dark side.

A dark haze envelops Halagad. "I am one with the dark power. You must destroy me in order to escape."

Again, Halagad makes no threatening moves. He is trying to get the player characters to act through anger and fear, and thus make them vulnerable to the dark side. If the player characters attack, he smiles wickedly and steps forward, saying, "Feel your anger. You have the power to destroy me, use it! Embrace the dark side!"

Redeeming Halagad

Halagad can be redeemed through rational argument and by example. Let the player characters try to persuade him to throw off the dark side. It is best to roleplay this out by letting the characters attempt to win Halagad over.

The player characters should be aware of the fact that they have no guarantee they will be able to escape Trinta if they kill Halagad. Since he was the cause of the horrors they have encountered, he may well be the only one able to give them their ship back, providing he is alive to do it.

The player characters must attempt to appeal to the man he once was. One way of doing this would be to show him the Medallion of Honor they salvaged from his cave. If they do this, read:

Halagad seems to stagger a bit at the sight of the medallion. "Where did you get that? Why



The Fall of a Jedi

Halagad Vantor was born on Alderaan, and as a child, counted later Viceroy Bail Organa among his friends. In his youth, Vantor aspired to be a scholar, and he spent many hours poring over ancient tomes. It was during this time that he first learned the legends of the Jedi Knights, defenders of the Republic, and a hope was born in his breast that someday he might be counted among their number.

Halagad continued to pursue his studies over the coming years, as well as training his body to physical perfection. But though he became proficient in many fields, he was master of none, for he had not the patience to apply himself totally to one area of study. "I'll need to know many things to be a Jedi, and cannot confine myself to but one discipline," he said. In the end, this attitude would be the key to his undoing.

When he reached manhood, Vantor set out to find a Jedi Master to teach him the arts. But even in the days of the Republic masters were reclusive and difficult to come upon — and the few Vantor did encounter were unwilling to train him.

"Your mind is like the winds of Tatooine, flying in every direction at once. The essence of the Jedi's art is control — control of the body, control of the mind, control of anger, fear, and greed. You must learn to rein in all passions, even the passion for knowledge, or you will destroy yourself," they told him.

But Vantor was not discouraged. He persisted in his efforts to find a mentor, and eventually succeeded. Who trained Vantor in the Jedi disciplines is unknown, but the student's flaws of character continued to plague him even as he attained his heart's desire. In seeking to learn all, he learned little. As a warrior, he could use the Force to his advantage, but he remained largely ignorant of the more subtle uses of that great power.

Vantor went on to serve with distinction in the Clone Wars, under the leadership of General Obi-Wan Kenobi, earning the Republic's Medallion of Honor. When Senator Palpatine assumed the title of Emperor, Vantor joined with the Jedi in opposing his dictatorial rule.

Palpatine was no fool, and realized the

threat posed by the Jedi. With the aid of the corrupt Darth Vader, Palpatine set out to systematically destroy the Old Republic's protectors. Many of the Knights went into hiding on other worlds, with only other members of their brotherhood aware of their location.

Vantor was preparing to depart for the Outer Rim Territories when he was apprehended by Imperial stormtroopers. Taken to Vader's flagship, Vantor was brutally interrogated by intelligence officers, but said nothing. Then the Dark Lord of the Sith himself came into the chamber.

"Halagad, old friend," Vader began. "It is a pleasure to see you again. My men say you have been uncharacteristically silent today — a far cry from the boastful braggart who craved medals and acclaim. You are a loud man, Vantor, wielding the Force like a club. The Force was meant to be used like a vibroblade. A slice here, a slice there, and I will carve the information I want out of your mind. Of course, when I am done, you may have a mind no longer. Pity."

Halagad tried desperately to resist Vader's probings, but could not call upon the mental shields that would have protected him. His desperation gave way to fear, his fear to panic, and the dark side staked its claim to him even as Vader gathered the crucial information.

Only two Jedi masters escaped the slaughter that followed. Obi-Wan Kenobi, aware of Vantor's weakness of spirit, did not confide in him about his plans to take refuge on Tatooine, nor about Yoda's whereabouts. His soul racked with guilt and his mind virtually broken, Vantor stole an Imperial ship and fled into space. Vader let him go, knowing full well death or the dark side would claim him soon.

Vantor's ship landed on the swamp world of Trinta. Though his Force powers allowed him to sense the presence of a concentration of dark side energy, Vantor had not the strength to turn away. He made camp in a cavern, but eventually was drawn to the nexus and gave himself over to the Dark. He has lived in that hellish place since that time, haunted by the faces of those whose deaths he holds himself responsible for.



do you show it to me? That is the property of a dead man, a weak, ineffectual creature who perished in Vader's torture chamber. Take it away! I'll not look at it a moment more!"

Halagad blames himself for the deaths of other Jedi, but his scan of the player characters' minds has revealed the information that Kenobi survived. If the player characters tell him that some of the Jedi survived, and indeed, a new generation now bears that honorable title, Halagad will become confused.

Read aloud:

Halagad seems confused. "Could it be? Have I suffered all these years for a sin not so dark as I believed? Have my hands not earned all the blood that stains them? Are the screams that have filled this cave each day but illusions?"

But the dark side is strong in Ventr, and will not let him surrender so easily. He will challenge the player characters to prove that they have knowledge of the Force. Once they have done so, he will realize that all they say is true, and the dark side's hold on him will begin to weaken.

Read aloud:

Halagad slumps against the stone wall, a gleam in his eye that had not been there before. "It is no trick, then. Vader failed — he could not

destroy the last of the Jedi, and they have returned, stronger than before. One day, perhaps, their might will be great enough to slay that spawn of a space slug, Palpatine. And I ... I am free at last. You have brought the Light to Trinta and defeated all the demons of darkness I sent against you, and borne the news that not all my weakness, not all Vader's evil, could eradicate the Jedi from the galaxy."

The Death of Halagad

When Halagad has at last freed himself from the dark side, read:

Darkness swirls around Halagad and then dissipates. His lifeless body falls to the ground and begins to decay. Above it, a shimmering form takes shape. A handsome man in his early twenties, dressed in the attire of the Jedi Knights, stands over the aged body. He smiles warmly. "Thank you for giving me the strength to resist. Your powers are great. Great enough to release us all." He fades, and is gone. You suddenly find yourselves back in the swamp by your ship.

The player characters have emerged near the nexus. If they have freed Halagad, the black tree collapses and sinks into the swamp. The nexus has been drained of its power.

The player characters find that their mental attributes have been restored to full. They are no longer going mad.

Victims of the Dark Side

If Halagad is redeemed, player characters who fell victim to the dark side in the nexus are also released from its grip. They lie next to the ship. The dark side has drained their energies, and they are treated as incapacitated. In time, they recover just like any other wounded character.

If the player characters killed Halagad rather than redeemed him, player characters who were consumed by the dark side in the nexus will have to remain there in his place.

The Ship

After Halagad vanishes, the swamp returns to normal. The player characters' ship waits outside, having been brought here by Halagad. The *Scent of Fear* is next to it.

The characters' ship still has damaged drives, but can be repaired using parts from the *Scent of Fear*. If the player characters wish, they can repair their ship and take the *Scent of Fear* as a prize.

The *Scent of Fear* also holds the answer to the player characters' supply problems: its hold contains enough food and water for four months.

The Hunters

Remember the hunters? Facing the possibility of being stranded on Trinta, any surviving hunters are not going to give up easily. Depending on how you want to run the final episode, the hunters could attack after the player characters emerge from the nexus, or they could be waiting on board the player characters' ship or the *Scout of Fear* to ambush them. Alternatively, the hunters may only arrive as the player characters are about to lift off from Trinta. Maybe the hunters rush the ship, or just mournfully watch as the player characters strand them on Trinta.

Rewards

The player characters have survived a brush with the dark side of the Force and this should not go unrewarded. Give each player character six to eight character points, according to their performance. Award Force Points as usual.

In addition, give a Force Point to those player characters who passed both tests in the nexus, and another Force Point if they redeemed Halagad. Also, if Halagad was redeemed, any dark side points gained by any character during the adventure are removed.

DOMAIN OF EVIL CHARACTER TEMPLATES

Crutag the Hunter

Type: Taloron Hunter

DEXTERITY 4D+2

Blaster 6D, dodge 5D, melee combat: vibrobayonet 6D

KNOWLEDGE 2D

MECHANICAL 2D

PERCEPTION 3D+2

Command 5D, hide 4D, search 4D+2, sneak 4D

STRENGTH 3D+2

Brawling 4D+2, survival 4D+2, stamina 4D

TECHNICAL 2D

First aid 4D

Character Points: 8

Move: 10

Equipment: Taloron Hunter armor (+1D physical, +1 energy, -1D *Dexterity* and related skills), helmet (+1D physical, +1 energy, head only), blaster carbine (5D), vibrobayonet (STR+2D), sword (STR+1D), comlink, three grenades (5D), three medpacs, syntherope.

Capsule: Crutag is a native of the Taloron system, in the Outer Rim Territories. Several years ago, the Taloron system became the haven for a number of pirate groups, united under the banner of Halgir, a particularly bloodthirsty bandit. The Talorons of the period were mostly farmers and traders, unaccustomed to violence and bloodshed, making them easy prey for Halgir's raiders. Through fear and intimidation, Halgir managed to grind the Talorons under his heel.

Unfortunately for Halgir, the Talorons decided they had had enough of the pirate chieftain's cruelty, and began to fight back, initially with farm implements and bare hands. When word of these minor skirmishes reached Halgir, he reacted in typical pirate fashion: he wiped out several villages as an example.

Rather than break the Talorons' spirits, however, the massacre instead cemented their resolve to overthrow Halgir and his troops. The Talorons (almost extinct after Halgir's raids) began to move against the pirate forces in carefully planned, well-executed ambushes and guerilla attacks. Halgir responded in kind, and the Taloron system fell into a period of low-level warfare.

Eventually, the Talorons, their skills honed by years of combat, pushed their tormenter back, eventually capturing him and turning Halgir over to Imperial custody. The Taloron Pirate Conflict had ended. The Talorons, on the other hand, had become warriors without a battle to fight. Several Talorons left the system, in pursuit of pirates and criminals. A fanatical desire for order became a well-known Taloron trait, and Crutag is no exception.

After the Taloron Conflict ended, Crutag travelled the



Allen Nunis

Outer Rim Territories, eventually joining the Ragnar Syndicate, a bounty hunter alliance that has gained prominence in Merel sector. Crutag apparently found his time with the Ragnar Syndicate rewarding until he had a major falling out with a fellow bounty hunter, Noval Garaint.

Crutag is a fervent believer in law and order, and privately feels that he has a duty to assist the Empire by apprehending criminals wherever he finds them. Garaint, on the other hand, was simply "in it for the money." After witnessing Garaint let a wanted Rebel agent flee in exchange for a sizeable bribe, Crutag attempted to detain his partner. Garaint proved to be too difficult to hold, however; wounding Crutag and then reporting to the Ragnar Syndicate that it was the Taloron that had initiated the attack, Crutag left the group.

Crutag is now an independent bounty hunter, though he has definite pro-Imperial leanings (largely because the Empire pays the highest rates and pays them promptly). He is seeking the bounty (20,000 credits alive, 10,000 credits dead) for the player characters. Like most Taloron Hunters, he is cold, hard and unrelenting. Crutag has a reputation for getting his targets, dead or alive. And if he ever finds Noval Garaint again, well ... law and order may take a back seat for a while.

Crutag has furthered his reputation by behaving with unabashed cruelty to his prisoners, figuring word would spread that he means business. And spread it has — there have been several well-documented occasions where fugitives have surrendered to legal authorities rather than face time in the holding cell of Crutag's ship. "If they were law abiding citizens," he has said, "then I wouldn't need to discipline them, would I?"

(For more information on Noval Garaint and the Ragnar Syndicate, see *Galaxy Guide 9: Fragments From The Rim*.)

DOMAIN OF EVIL CHARACTER TEMPLATES

Slimego

Type: Rodian Bounty Hunter

DEXTERITY 3D

Blaster 3D+1, blaster rifle 4D, dodge 4D, grenade 4D

KNOWLEDGE 1D+2

Streetwise 2D+2

MECHANICAL 1D+2

PERCEPTION 2D

Hide 3D, search 3D, sneak 3D

STRENGTH 2D+2

Climbing/jumping 4D

TECHNICAL 1D

Character Points: 5

Move: 10

Equipment: Blaster rifle (5D), three grenades (5D), two medpacs



Allen Nunis

Capsule: Slimego is a Rodian who has recently been hired by Crutag. Slimego was little more than a barroom tough at Kwenn space station when he heard that a Taron bounty hunter was looking for hired guns. Relishing the prospect of a little mayhem and some extra credits, Slimego immediately approached Crutag for the job. Crutag considers Slimego to be little more than a criminal, but a useful one. Like most Rodians, Slimego loves the thrill of the hunt, and is relentless in the pursuit of his prey. But the Rodian's bloodthirsty tendencies often put him at odds with his employer; on more than one occasion, Crutag has had to physically restrain Slimego. (Apparently, Slimego enjoys the violence of his chosen profession more than the money to be had.) Despite Slimego's shortcomings, Crutag finds it useful to have a fairly unstable member of his team; finding a volunteer for risky assignments is no longer a problem. Slimego is usually first in line for a job if there is a potential for bloodshed.

Slimego has a different view of his employment situation. He believes that Crutag is grooming him as a replacement for a Taron lieutenant that the bounty hunter lost on a previous hunt. He views Crutag as a worthy employer (particularly after having seen his boss beat a confession out of a target not too long ago). Rodians respect ruthlessness and brutality, and Crutag has exploited this to great effect with Slimego. It will no doubt surprise Slimego a great deal when Crutag "terminates" his employment. Whether or not the Rodian survives the demotion remains to be seen.

Slimego has rough-textured, green skin, a tapir-like snout and multi-faceted eyes. Slimego likes to taunt, bully and intimidate his victims before blasting them into component molecules in as slow and painful a manner as possible.

Slizzik

Type: Barabel Bounty Hunter

DEXTERITY 2D+1

Blaster 4D+1, dodge 4D

KNOWLEDGE 1D

Survival 3D

MECHANICAL 1D

PERCEPTION 2D+2

Hide 4D, search 3D, sneak 4D

STRENGTH 4D

Brawling 7D

TECHNICAL 1D

Special Abilities:

Natural Body Armor: The black scales of the Barabel act as armor, providing a +2D bonus against physical attacks, and a +1D bonus against energy attacks.

Radiation Resistance: Because of the proximity of their homeworld to its sun, Barabel have evolved a natural resistance to most forms of radiation. They receive a +2D bonus when defending against the effects of radiation.

Vision: Barabels can see infrared radiation, giving them the ability to see in complete darkness, provided there are heat differentials in the environment.

Character Points: 2

Move: 11

Equipment: Blaster rifle (5D)



Allen Nunis

Capsule: Slizzik was recruited by Crutag three years ago, as the bounty hunter respected both the strength and tenacity of the Barabel people. The ferocity and determination that Slizzik and her mate, Balluzikik, brought to the hunt served Crutag well. Like most Barabel, Slizzik is tall, massive and fierce-looking, with scaly skin and a mouthful of razor-sharp teeth. Slizzik respects Crutag immensely; apparently his recruiting procedure involved unarmed combat with the Taron, a contest that Crutag lost but survived. After the "interview" Crutag had not only hired two very useful associates, he had won their loyalty and admiration.

Slizzik is somewhat unstable since the landing on Trinta; Barabel mating customs bond couples together very strongly and when Balluzikik died, Slizzik's (admittedly marginal) control of her temper has frayed considerably. She blames the player characters for the death of her husband and will fight to the death if the characters find it somehow desirable to battle the enraged Barabel.

DOMAIN OF EVIL CHARACTER TEMPLATES

Halagad Vantor

Type: Minor Jedi

DEXTERITY 3D

Dodge 5D, lightsaber 3D+1

KNOWLEDGE 3D+2

MECHANICAL 2D

PERCEPTION 3D+1

Hide 4D, search 5D, sneak 4D

STRENGTH 2D+2

Climbing/jumping 4D

TECHNICAL 2D+1

Special Abilities:

Force Skills: Control 5D, Sense 4D, Alter 5D

Force Powers (these are the Force powers that Vantor can still use given the current fragile state of his mind; it is believed he possessed others.)

Control: Absorb/dissipate energy, accelerate healing, enhance attribute*, remain conscious

Sense: Combat sense*, danger sense*, life detection, magnify senses, sense Force

Alter: Injure/kill, telekinesis

Control and Sense: Farseeing*, lightsaber combat

Control and Alter: Feed on Dark Side**

Control, Sense and Alter: Affect mind, telekinetic kill*

Special: Force Scream***

* Described in the *Dark Force Rising Sourcebook*

** Described in *Galaxy Guide 9: Fragments from the Rim*

*** Described in *The Last Command Sourcebook*

This character is Force-sensitive

Force Points: 3

Dark Side Points: 5

Character Points: 2

Move: 10

Equipment: Robes

Capsule: Alderaanian Halagad Vantor was a Jedi Knight of minor distinction during the Clone Wars; while he was more accomplished than a novice, he was by no means a master. During the Emperor's purge of the Jedi ranks, Vantor was detained and brutally questioned by Darth Vader. During the questioning, Vantor succumbed to the dark side of the Force in desperation.

Vantor stole an Imperial ship in a haphazard attempt to escape the Sith lord, and Vader merely let the broken Jedi go, reasoning that death or the dark side would claim Vantor soon enough.

Vader was more correct than he knew, and if he had bothered to monitor Vantor's progress, Vader would have discovered the dark side nexus on Trinta. Undoubtedly, Vader would find the nexus extremely useful, though precisely how Vader or the Emperor would use the phenomenon is unknown.

Halagad Vantor is elderly, physically aged well beyond his years. He has lost most of his hair (and in some patches,



Allen Nunis

it looks like he has actually torn it out by the roots). He wears tattered, filthy robes that fail to conceal his emaciated, malnourished frame. His skin is leathery and pale, heavily lined and coated with the grime that can accumulate in a swamp. His limbs are twig-thin, the veins standing in sharp relief against the skin of his claw-like hands. He has no teeth left, which affects his speech, giving it an odd, child-like quality.

This withered, decrepit man has quite obviously lost his mind. He will speak to himself, mumbling incoherently one moment, reciting obscure Alderaanian poetry the next. Sometimes, Vantor is frighteningly unhinged (often violently so), other times he is tranquil and lucid (although these periods are infrequent at best). Despite his evil tendencies, there is something tragic about Vantor; the more perceptive player characters should realize that Vantor's primary sin was weakness (and a touch of cowardice). Despite the influence of the dark side nexus, Halagad Vantor can still be redeemed.

STAR WARS®

CLASSIC ADVENTURES VOLUME TWO

Graveyard of Alderaan

by Bill Slavicsek

It started out as a routine mission, right? Just nab some spare parts for the Rebellion and spend some time relaxing on the Ithorian herdship *Bazaar*.

Of course, a Rebel should know better than to expect an easy time when the Empire gets involved. And the Imperials are involved up to their necks in a shadowy operation near the remains of Alderaan, a dead system nicknamed "the Graveyard."

And as if Imperials aren't bad enough, there's a murder to solve, a lost warship full of contraband military hardware to find, the ruins of the Alderaanian Royal Palace to explore and the hidden plans of Lord Vader himself to thwart. So much for the "routine" mission ...

Domain of Evil

by Jim Bambra

Stranded on the swamp world of Trinta and pursued by the ruthless Crutag — a fearsome Taloron Hunter — well, it's been a *really* bad day.

To make matters worse, there's hardly a section of this slimy mud puddle of a planet that isn't trying to claw, bite or drown you. But when nightmares ripped right from your own mind begin manifesting themselves and wreaking havoc on you and your friends, well ...

... it looks like your day just got a whole lot worse.

A STAR WARS® SUPPLEMENT

For ages 12 and up.

®, TM & © 1995 Lucasfilm Ltd. (LFL). All Rights Reserved.
Trademarks of LFL used by West End Games under authorization.

Classic Adventures, Volume Two presents two adventure books from the first edition *Star Wars* line, *Graveyard of Alderaan* and *Domain of Evil*, upgraded to second edition rules.

A supplement for use with *Star Wars: The Roleplaying Game*



40128

0-87431-269-8 \$18.00



0 18874 40128 1