

STAR WARS[®] MINIATURES BATTLES

ORIGINS
BEST
MINIATURES
RULES
1991
AWARD



STAR WARS[®] MINIATURES BATTLES

by Stephen Crane and Paul Murphy



A complete game presenting rules for playing tabletop battles
using *Star Wars* miniatures.

A long time ago, in a galaxy far, far away ...

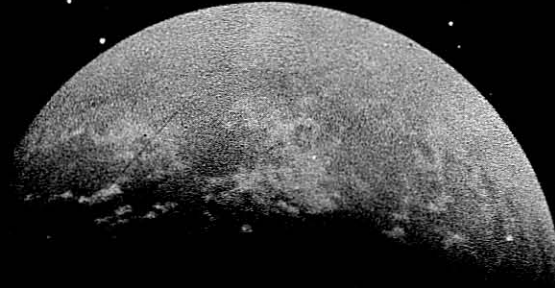

The bright flame of Rebellion burns across an oppressed galaxy. As the Emperor tightens his tyrannical grip on the planets of the Galactic Empire, courageous men and women turn to support that flame, the Rebel Alliance.

These valiant warriors, outgunned and badly outnumbered, must face the awesome might of a merciless Empire. They must battle the superb soldiers of the Imperial Army and Navy, who are ready to die for the greater glory of the New Order.

On a thousand-thousand worlds, the courageous freedom fighters of the Rebel Alliance come face to face with the fearless warriors of the Galactic Empire, fighting for the fate of an entire galaxy. It is these men and women who will decide whether the fire of the Old Republic is rekindled, or extinguished for all time.

STAR WARS[®] MINIATURES BATTLES

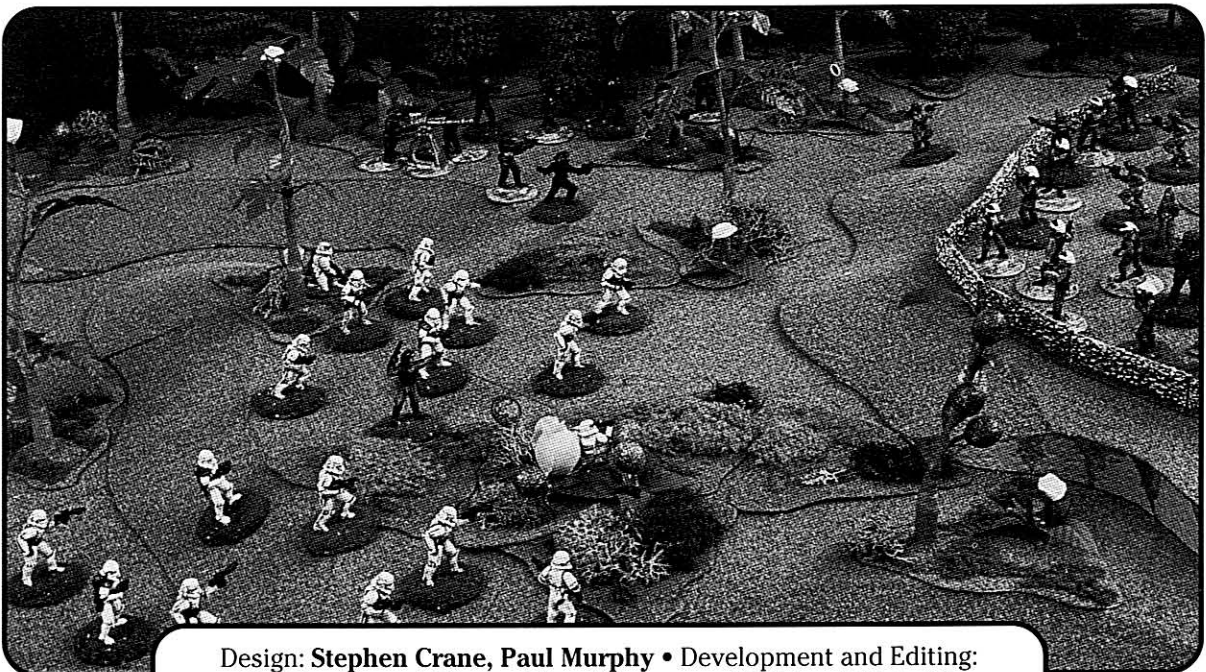

Design: **Stephen Crane, Paul Murphy** • Development and Editing:
Jim Bamba • Additional Development and Editing: **Bill Smith**
Graphics: **Stephen Crane, Richard Hawran, Allen Nunis, Tom O'Neill**
Cover and Interior Photographs: **Stephen Crane** • Terrain System and
Custom Scenery: **Geo-Hex** • Figure Painting: **T.G.W.P.**

Publisher: **Daniel Scott Palter** • Associate Publisher/Treasurer: **Denise Palter**
Associate Publisher: **Richard Hawran** • Senior Editor: **Greg Farshtey**
Editors: **Peter Schweighofer, Bill Smith, Ed Stark** • Art Director: **Stephen Crane**
Graphic Artists: **Nicole Black, Tom O'Neill, Brian Schomburg**
Sales Associate: **Bill Olmesdahl** • Licensing Manager: **Ron Seiden** • Warehouse Manager: **Ed Hill**
Accounting: **Karen Bayly, Wendy Lord, Kimberly Riccio** • Billing: **Amy Giacobbe**

Published by



RD3 Box 2345
Honesdale PA 18431

40090



T A B L E O F C O N T E N T S

Introduction	5
The Basic Game	
Chapter One: Soldiers and Squads	10
Chapter Two: Movement	14
Chapter Three: Fire Combat	16
Chapter Four: Close Assault Combat	27
Chapter Five: Morale	31
Chapter Six: Terrain	36
Chapter Seven: Introductory Scenario	39
Chapter Eight: Creating Squads	41
The Advanced Game	
Chapter Nine: Hidden Movement	46
Chapter Ten: The Gamemaster	48
Chapter Eleven: Advanced Weapons and Equipment	51
Chapter Twelve: Heroes	60
Chapter Thirteen: Creatures	67
Chapter Fourteen: Droids	72
Chapter Fifteen: Advanced Terrain	75
The Scenarios	81
Figures and Scenery	89
Troop Lists	97
Reference Sheets	103

Introduction

Blasters burn through the air as snowtroopers advance across the frozen tundra. A speeder, trailing thick, black smoke, plummets into the ice and explodes.

Across the blasted ice, a lone hero, armed only with a lightsaber, prepares to face the cloaked figure striding out of the darkness.

An exciting game of *Star Wars Miniatures Battles* is underway!

About This Revision

This revised version of *Star Wars Miniatures Battles* was brought about for a number of reasons. The appeal and popularity of *Star Wars Miniatures Battles* caused the original edition to sell through its entire print run. With demand still high for the game, and the release of *Star Wars* miniatures in blister packs (making it easier to assemble a unit of soldiers), it was decided the game should be reprinted.

In the same time frame, *Star Wars: The Roleplaying Game* had been revised to its second edition, expanding the scope of the roleplaying game and adding new, richer, levels of detail. Since one of the original intentions of the miniatures game was to be compatible with the roleplaying game — enabling players to make forays into mass combat as desired — the perfect opportunity had arisen to update these miniatures rules.

The last, but by no means the least important, reason was you, the players. As you became familiar with the game, and tried out the rules in different ways, several oversights and ambiguities were discovered. This book is also intended to rectify those points that have been brought to our attention.

What's New?

Those of you already familiar with *Star Wars Miniatures Battles* will find that this revised version of the game is still straightforward and easy to learn. However, a greater level of intricacy can now be experienced with the availability of the expanded skills of *Star Wars: The Roleplaying Game, Second Edition*.

The major changes that you will notice are that most troops now have a slightly greater Movement Rate than before, and that all combatants now cost a greater amount of Squad Generation Points (both due to the

introduction of the “Move” characteristic from the roleplaying game). However, these changes affect all figures, so the relative balance is still maintained.

The addition of the Move characteristic also provides greater flexibility in designing forces, especially if you use aliens and creatures from the roleplaying game. It adds a greater sense of “realism” to the game — those Ewoks will be hard-pressed to keep up with the rest of the troops now.

Additionally, the descriptions and procedures of some of the weapons and equipment have been clarified, and the charts, tables and record sheets have been revised to reflect all of the changes in this revised edition.

Those of you who are reading this game for the first time will still find an easy-to-learn game that can be played straight for quick and dirty battles, or elaborated on with extra layers of detail, as your imagination sees fit. So now, get comfortable, and prepare to experience the excitement and wonder of ...

A Galaxy Far, Far Away

On countless worlds groups of determined Rebels struggle to overthrow the tyranny of the Empire. Armed only with their trusty blasters, they battle the Empire's unstoppable stormtroopers. Now, with *Star Wars Miniatures Battles* you can fight out these thrilling conflicts using miniature figures upon a tabletop.

The game is played between two or more players who are split into two opposing sides: the Imperial forces and the Rebels. Unlike in *Star Wars: the Roleplaying Game*, a gamemaster is not required to adjudicate play, though one can be useful. Each player controls between six and sixty soldiers — Imperial stormtroopers, Rebel troopers, mercenaries, Wookiees, bounty hunters, or any of the other warriors from the *Star Wars* galaxy. The individual soldiers and heroes are represented by miniature figures. Players maneuver their model soldiers over a tabletop representing the battlefield — the forests of Endor, the deserts of Tatooine, or the frozen tundra of Hoth. During the game, soldiers fire at each other, engage in close assault combat, and perform many other thrilling actions.

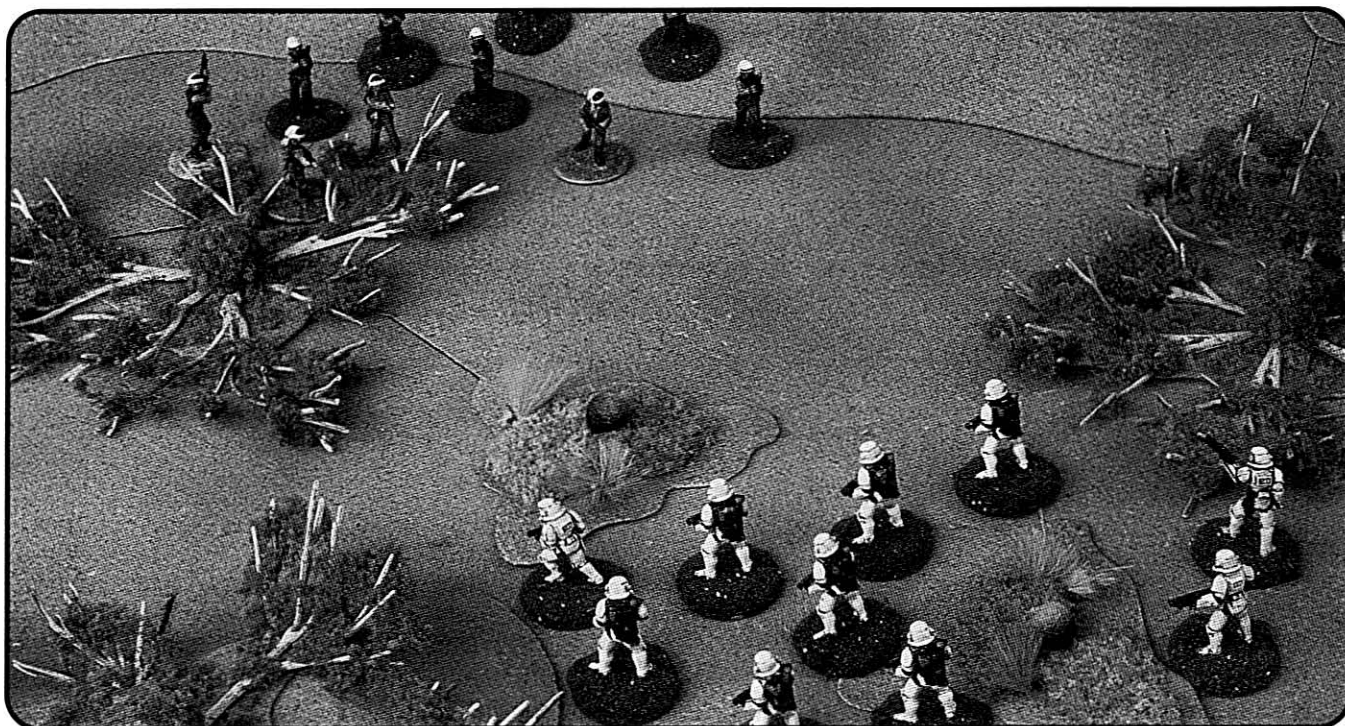

■ Soldiers in the Rebel Alliance may find themselves battling the oppressive tyranny of the evil Galactic Empire on many strange and exotic worlds.

The Basic Game contains all the information needed to begin play. It describes how squads are organized, fight and move, how soldiers react to the pressures of battle, and the order of events within a turn. An introductory scenario, "Like Rats in a Trap," is provided to get you into the action right away.

The Advanced Game adds rules for droids, creatures, heroes, the Force and shows you how to use exotic science fiction settings in your games. It discusses how a gamemaster can be added to create surprises and special situations for the players to deal with. More scenarios follow, along with information on how to design your own.

No miniatures game is complete without painted figures and model scenery. So, in "Figures and Scenery," we show you how easy and fun it is to paint your forces and build miniature terrain.

Using this Game with Star Wars: The Roleplaying Game

Star Wars Miniature Battles is compatible with *Star Wars: The Roleplaying Game, Second Edition*. Gamemasters can use these rules to easily resolve combat actions involving player characters and large numbers of gamemaster characters. To facilitate this, some of the standard roleplaying rules have been simplified or discarded and many other game mechanics changed.

As character attributes, skills and equipment are virtually unchanged from one system to another, it's

easy to translate characters from the roleplaying game to this one. *Star Wars Miniatures Battles* can also be played on its own. It is a complete stand-alone game; it is not necessary to own *Star Wars: The Roleplaying Game* to play and enjoy this one.

What You Need to Play

To play a game of *Star Wars Miniatures Battles*, you need the following:

Miniature Figures

A selection of 25mm miniature figures to represent your soldiers. Depending upon the size of your army, you will need between six and 60 figures. The figures should be mounted upon 1-inch bases and, for best effects, painted (see "Figures and Scenery"). Official *Star Wars Miniatures* accurately portray the common troop types and characters from the movies; we suggest that you use them in your games. *Star Wars Miniatures* are available at many fine book and game stores; if none are available in your area, see the end of this book to find out how to order them directly from West End Games.

Playing Area

You need a large table upon which to maneuver your figures. A 4' x 6' table is a good size; larger playing areas are even better, especially when using large numbers of soldiers on each side. Ultimately, the only limiting factor to table size is that you can reach easily into the center without risking life and limb.

Terrain

Once you have a table, you need to place miniature terrain on it to represent hills, rivers, woods, walls, and other battlefield features. Much of this can be scratch-built out of common materials available at hardware or hobby stores (see “Figures and Scenery”). Pre-built terrain for miniatures combat is available at many hobby stores. HO-scale railroad terrain is also useful; check your local model railroad hobby shop.

Other Materials

- Plenty of standard six-sided dice. The more the better; 10 is a good starting figure.
- Rulers or tape measures measuring in inches. One per player.
- Photocopies of the charts, tables, and Record Sheets in the back of the book. One copy of the charts and tables per player, and enough Record Sheets for the scenario being played. Permission is granted to copy these for your personal use.
- Pencils or pen and an eraser.
- Markers. You’ll find these in the back of the book. *Wound* markers are used to denote which soldiers have been injured in the combat. You may need more than we provided: you might consider photocopying them and mounting the copies on cardstock. As an alternative, you can use ring binder reinforcements — simply stick them to the base of the figure or place them over the figure’s arm or head.
Fire+1 and *No Fire* markers are a handy way of keeping track of a squad’s fire status and whether it has used opportunity fire.
- Templates. These are used, among other things, to show the burst areas of grenades and thermal detonators, and to show which areas of the battlefield are covered by smoke or fire. They can be found in the back of the book. For best results, the three sheets of templates should be photocopied (two or three times each) and the copies mounted on stiff cardstock. The originals should be kept in a safe place. That way, you can make as many copies of the templates as you need from the originals.

Game Scales

The ground scale used in *Star Wars Miniatures Battles* is one inch equals two meters: every inch measured on the tabletop equates to two meters of real distance. A blaster pistol with a long range of 120 meters can therefore shoot a maximum distance of 60” on the tabletop.

Where inches are mentioned in this book, they refer to tabletop distances. Meters are used only to describe real world distances, such as a two-meter-high wall.

Each miniature figure represents one soldier. In the Advanced Game, figures are used to represent the heroes, droids, and creatures of the *Star Wars* universe.

How To Play

This section provides a quick overview of the game. It does not give enough information here to play the game, but it does give a good idea of how the rules fit together. If you are confused by any of the ideas presented below, keep reading: they are explained in more detail later in the book.

Squads

Players maneuver their troops in groups of between three and 10 figures, called “squads.” Each squad contains a commander, one or more standard soldiers, and possibly one or two “specialists.” Squads move and fight together. Except for the commander and specialists, they all have the same abilities, combat skills, and weapons. As soldiers in the squads become casualties, the entire squad’s “morale” may suffer, and, if things get bad enough, the squad may break and flee from the field of battle.

Setting Up

At the start of the game, you and your opponent (or gamemaster) have to decide upon a battle scenario — the circumstances of the battle. That is, you have to decide where the battle takes place — inside the Death Star, in the streets and alleyways of Mos Eisley, in the jungles of Dagobah — and set up the tabletop appropriately.

You also have to create your squads and heroes. To do this, you need a number of Squad Record Sheets, a pencil, and perhaps some scratch paper. First, you and your opponent decide how many “Squad Generation Points” (SGPs) you each are to have. SGPs are spent to “purchase” your soldiers, their weaponry, and their training. Part of the fun of miniatures combat comes from spending your points efficiently to create an optimum army. Do you want a lot of troops who are not very well trained or armed, or do you want a smaller force made up of highly trained elite soldiers?

Each side does not have to begin with the same number of SGPs. Standard wisdom suggests that it takes three or more men to take out one man in a good defensive position. If both forces are meeting in the middle of a field, they should be equal; but if one side is inside Jabba’s palace and the other must advance across the open desert to dig them out, the attacking side needs to be given an advantage in the number of SGPs available.

For now, you don’t have to worry about designing your squads. The introductory scenario, “Like Rats in a Trap,” comes with ready-to-use squads. Once you’ve played this, you’ll be ready to design your own squads and fight larger battles.

Two battles are provided in the “Scenarios” section of this book. These describe the battlefield terrain and suggest the best types of squads for each side.

Sequence of Play

A game of *Star Wars Miniatures Battles* is played in turns. Each turn follows a strict “Sequence of Play” in which specific events occur. The sequence of play must be followed to the letter. A player who forgets to move a squad in the “Movement Phase,” cannot do so later in the “Fire Combat Phase”; he’s simply out of luck until the next turn. In friendly games — the kind we like to play — players can agree between themselves to cut each other a bit of slack on these things. However, until everybody is comfortable with the rules, we suggest that you follow the sequence of play exactly.

Terrain

Terrain is the ground over which troops move and fight. Various types of terrain may be encountered on the battlefield, including woods, swamps, hills, streams, rivers, and other features described in the “Terrain” section.

Terrain features can provide a focus for a battle as one side attempts to take a strategically placed hill from the defending forces. As well as acting as objectives, terrain influences the course of a battle by affecting movement, combat and visibility. Each of these effects are described in the relevant sections. So, rules on movement are covered in the “Movement” section, and rules which affect combat in the “Fire Combat” and “Close Assault Combat” sections.

1. The Initiative Phase

Players determine who has the “initiative” for the current turn. The players each roll a die and add the highest *command* skill on their side to the roll. The player who rolls the highest has the initiative for the turn. In the event of a tie, players re-roll.

2. The Movement Phase

The players move their squads across the battlefield. A player moves one of his squads, then the other player moves one of his. The players alternate moving until all squads have moved. The player with the initiative decides whether he will move first or second. In general, all soldiers in a squad stay together — usually within two to five inches of each other. Squad members who stray too far from the rest of their squad risk becoming “separated,” which has a number of adverse effects.

A squad does not have to move at all; it may stay right where it is. A squad which does not move may “opportunity fire” at squads which do move, providing it passes its *morale* test, or it can reserve its fire for the “Fire Combat Phase.”

A squad which wishes to “Close Assault” — engage in hand-to-hand combat with another squad — may declare a “Charge.” If the squad’s courage holds, that is,

it makes it through a morale test unscathed, it rushes toward the enemy. The enemy must then make its own morale test — if successful, it does not break in the face of the charge and gets to use “defensive fire” before the two squads fight each other with clubs, knives, or bare fists.

3. The Fire Combat Phase

The players’ squads fire at each other. Fire may be resolved in any order; all fire in this phase is assumed to be simultaneous. In general, an entire squad will shoot at the same target (typically, another squad); though squads can “split” their fire between two targets.

The firing player makes a “*blaster skill test*” for each squad member who can fire at the target; the difficulty of this test varies depending upon the terrain the target occupies, the distance between the firer and the target, and whether the firer moved during the turn.

For each successful hit, the firing player and target player make “opposed” rolls to determine the effect of the shot. The firing player rolls the “*Damage Strength*” of the weapon; the target player rolls the “*Strength*” of the target. Depending upon the result, the target soldier may be incapacitated, wounded, or take no damage from the shot.

As all fire is assumed to be simultaneous, a soldier who is wounded or incapacitated by enemy fire gets to fire back before he takes the effects of the damage.

4. Close Assault Combat Phase

Enemy soldiers in “base-to-base” contact with each other fight it out. The soldiers make “opposed skill tests,” using their “*melee combat*” skills, if armed with melee weapons; or their “*brawling*” skills if not. Winning soldiers may wound or incapacitate their opponents.

5. The Morale Phase

During this phase, you determine how well your soldiers are standing up to the pressures of battle. Some soldiers break and flee at their first casualty; others fight on until the last man. All squads which have had soldiers wounded or incapacitated in the current turn must make morale tests; in addition, some squads with reduced morale may attempt to “rally.”

Depending upon the outcome of the test, the squad’s morale level may decrease, stay the same, or even increase. If the result is particularly bad, the testing squad may be forced to “withdraw,” even if its morale still holds.

6. Special Actions Phase

In this phase, *Fire+1* and *No Fire* markers are removed from the table.

The Advanced Game expands this phase. Heroes can perform special actions — Force use, special skills, take command of squads, and so forth. A hero can make one special action during this phase. Certain special battlefield conditions as defined in the Advanced Game may be altered during this phase — weather may change, smoke may dissipate, fire may spread or go out, and so forth.



THE BASIC GAME

**"... we'd like to avoid any
Imperial entanglements"**

Chapter One Soldiers and Squads

Soldiers are grouped into squads which move and fire together. As a battle progresses and a squad's soldiers become casualties, the squad's morale may decline. If the squad's morale becomes low enough, the squad may become "broken" and all the soldiers in the squad will attempt to flee the battlefield.

Players use "Squad Generation Points" — or SGPs — to design their soldiers and squads (see the "Creating Squads" section). They record the details of their squads on Squad Record Sheets. A sample Record Sheet has been made out below; we suggest you refer to it frequently when reading this section.

Attributes, Training and Skills

A soldier's innate physical and mental quality is shown by his "Attributes" — *Dexterity* (DEX), *Knowledge* (KNO), *Mechanical* aptitude (MEC), *Perception* (PER), *Strength* (STR), and *Technical* aptitude (TEC). The higher the score, the higher the soldier's innate quality in that attribute. Each attribute controls a number of "skills," such as *blaster*, which is controlled by DEX. A soldier's "skill level" — how good he is at the skill — begins at the same level as the controlling attribute; when generating a squad, the player can use SGPs to purchase extra training in specific skills for his soldiers.

SQUAD NAME <u>BLUE RANGERS</u>	Walk Rate <u>8</u>	Run Rate <u>13</u>	Command Skill <u>4</u>	Number in squad <u>10</u>																														
TROOP TYPE <u>Hoth Troopers</u>	MOVEMENT RATES																																	
TROOP QUALITY <u>Elite</u> <u>20</u>	Skills point cost (from first column) : <u>51</u>																																	
Move: <u>10</u>	<table border="1"> <thead> <tr> <th>Weapon(s) Carried</th> <th>Dam.</th> <th>Short</th> <th>Med.</th> <th>Long</th> <th></th> </tr> </thead> <tbody> <tr> <td>Blaster Rifle</td> <td>5</td> <td>15</td> <td>50</td> <td>150</td> <td><u>15</u></td> </tr> <tr> <td>Vibroblade (STR+2)</td> <td>5</td> <td></td> <td></td> <td></td> <td><u>4</u></td> </tr> <tr> <td></td> <td></td> <td></td> <td></td> <td></td> <td></td> </tr> <tr> <td></td> <td></td> <td></td> <td></td> <td></td> <td></td> </tr> </tbody> </table>				Weapon(s) Carried	Dam.	Short	Med.	Long		Blaster Rifle	5	15	50	150	<u>15</u>	Vibroblade (STR+2)	5				<u>4</u>												
Weapon(s) Carried					Dam.	Short	Med.	Long																										
Blaster Rifle	5	15	50	150	<u>15</u>																													
Vibroblade (STR+2)	5				<u>4</u>																													
DEX: <u>3</u>	Armor: _____ STR/DEX mod.: _____ / _____																																	
Trng (3) Blaster <u>5</u> <u>2</u>	Star Wars Miniatures Battles SQUAD RECORD SHEET																																	
Spec (3) Blaster Artillery <u>3</u>					Point cost per soldier: <u>70</u> Number in squad: <u>x 10</u> BASE SQUAD COST: <u>700</u>																													
Grenade <u>3</u>	ID: _____ COMMANDER: <u>Command</u> <u>4</u> <u>1</u>																																	
Melee Combat <u>5</u> <u>2</u>	ID: _____ SPECIALIST: <u>Blaster</u> <u>6</u> <u>1</u>																																	
KNO: <u>2</u>	<table border="1"> <thead> <tr> <th>Weapon Carried</th> <th>Dam.</th> <th>Short</th> <th>Med.</th> <th>Long</th> <th></th> </tr> </thead> <tbody> <tr> <td>Repeat Blaster</td> <td>6</td> <td>25</td> <td>60</td> <td>150</td> <td><u>18</u></td> </tr> <tr> <td></td> <td></td> <td></td> <td></td> <td></td> <td></td> </tr> <tr> <td></td> <td></td> <td></td> <td></td> <td></td> <td></td> </tr> </tbody> </table>				Weapon Carried	Dam.	Short	Med.	Long		Repeat Blaster	6	25	60	150	<u>18</u>																		
Weapon Carried	Dam.	Short	Med.	Long																														
Repeat Blaster	6	25	60	150	<u>18</u>																													
Trng (3) Survival <u>2</u>	ID: _____ SPECIALIST: _____																																	
Spec (3) _____ <u>2</u>	<table border="1"> <thead> <tr> <th>Weapon Carried</th> <th>Dam.</th> <th>Short</th> <th>Med.</th> <th>Long</th> <th></th> </tr> </thead> <tbody> <tr> <td></td> <td></td> <td></td> <td></td> <td></td> <td></td> </tr> <tr> <td></td> <td></td> <td></td> <td></td> <td></td> <td></td> </tr> </tbody> </table>				Weapon Carried	Dam.	Short	Med.	Long																									
Weapon Carried	Dam.	Short	Med.	Long																														
MEC: <u>2</u>	Other costs: _____																																	
Trng (3) Beast Riding <u>2</u>	<table border="1"> <tr> <td>Morale Level</td> <td> <input type="checkbox"/> Steady <input type="checkbox"/> 7 <input type="checkbox"/> 6 <input type="checkbox"/> 5 <input type="checkbox"/> 4 <input type="checkbox"/> 3 <input type="checkbox"/> 2 <input type="checkbox"/> 1 <input type="checkbox"/> 0 </td> <td style="text-align: right;">720</td> </tr> <tr> <td></td> <td> E V A Shaken Dem. Broken </td> <td style="text-align: right;">SQUAD COST</td> </tr> </table>				Morale Level	<input type="checkbox"/> Steady <input type="checkbox"/> 7 <input type="checkbox"/> 6 <input type="checkbox"/> 5 <input type="checkbox"/> 4 <input type="checkbox"/> 3 <input type="checkbox"/> 2 <input type="checkbox"/> 1 <input type="checkbox"/> 0	720		E V A Shaken Dem. Broken	SQUAD COST																								
Morale Level					<input type="checkbox"/> Steady <input type="checkbox"/> 7 <input type="checkbox"/> 6 <input type="checkbox"/> 5 <input type="checkbox"/> 4 <input type="checkbox"/> 3 <input type="checkbox"/> 2 <input type="checkbox"/> 1 <input type="checkbox"/> 0	720																												
	E V A Shaken Dem. Broken	SQUAD COST																																
Spec (3) _____ <u>2</u>																																		
PER: <u>2</u>																																		
Trng (3) Command <u>3</u> <u>1</u>																																		
Spec (3) Search <u>2</u>																																		
Sneak <u>2</u>																																		
STR: <u>3</u>																																		
Trng (3) Brawling <u>5</u> <u>2</u>																																		
Spec (3) Swimming <u>3</u>																																		
TEC: <u>2</u>																																		
Trng (3) Demolition <u>2</u>																																		
Spec (3) First Aid <u>2</u>																																		
Skills point cost: <u>51</u>																																		

Most attributes and skills are only used in the Advanced Game. Because they are printed on the Squad Record Sheets, they are described here for completeness. Skill specializations are not listed here, but are discussed in Chapter Eight, "Creating Squads."

Attribute and Skill List

DEX: *Dexterity* is a measure of a soldier's coordination, balance, and physical finesse. It controls most combat skills. It is also a factor in how fast the soldier moves on the battlefield.

Blaster: Used to fire blasters and other light energy weapons.

Blaster Artillery: Used to fire artillery weapons.

Grenade: Used to throw grenades and thermal detonators.

Melee Combat: The soldier's skill with gaffi sticks, knives, spears, vibroblades, and so forth.

Specialized Skills: There are several other *specialized* skills, including *flamethrower* and *missile weapons*. They are for weapons that require special skills and knowledge to operate. They are only used occasionally in the game

KNO: *Knowledge* is a measure of a soldier's education and knowledge of facts and data. This attribute and the associated skills are generally used only in very special circumstances, as determined by the gamemaster (see the "Advanced Game").

Survival: A soldier's knowledge of hostile environments. It might be useful when the soldier encounters an unusual patch of woods, to determine if the plants are carnivorous before he walks into them (Advanced Game only).

MEC: *Mechanical* aptitude is a measure of the soldier's innate ability to control vehicles and riding beasts (Advanced Game only).

Beast Riding: Used to ride animals. See "Creatures" in the Advanced rules.

Ground Vehicle, Hover Vehicle and Repulsorlift Operation: Used to pilot mechanical vehicles of the respective type. These skills are not listed, but a space is provided under the *Mechanical* attribute so that one can be written in. Vehicles are not covered in this game but will be dealt with in a future supplement.

PER: *Perception* measures the soldier's sharpness of senses, his powers of observation, and his ability to remain alert and calm on the battlefield.

Command: This skill is one of the most important in the game. It determines the soldier's ability to remain in control and not panic during battle (see "Morale"). It also determines how close the soldier must remain to other soldiers in his squad to keep from becoming "separated" (see "Separation" on the next page).

Search: The soldier's ability to spot enemy soldiers who are *sneaking* (Advanced Game only).

Sneak: The soldier's ability to remain unseen on the

battlefield. Typically used in games with a gamemaster (Advanced Game only).

STR: *Strength* is a measure of a soldier's brawn and innate toughness. It determines how well he absorbs punishment, and is his base *Damage* when brawling or meleeing.

Brawling: The soldier's skill in unarmed combat.

Swimming: A soldier's ability to swim (Advanced Game only).

TEC: *Technical* is a measure of a soldier's "technical aptitude," his ability to use complicated technological devices (Advanced Game only).

Demolition: A soldier's skill in setting explosives, delayed charges, and so forth (Advanced Game only).

First Aid: A soldier's ability to heal battlefield injuries, if he has a medpac (Advanced Game only).

Squads

As described above, squads are the basic units of the game. The majority of the soldiers in the squad have the same attributes and skills and are armed with the same weaponry. One or two of the squad members may be "specialists," with different weapons, or training, or both. Squads are defined as "Average," "Veteran," or "Elite." This reflects their physical prowess, their training, the quality of their weaponry, and their morale. All members of the squad will be under the command of one man within the squad — the commander.

Squad Coherence

All of the soldiers in a squad must stay within "command distance" of another soldier in the squad. The squad's command distance is equal to the soldiers' *command* skill in inches. Command distance is measured

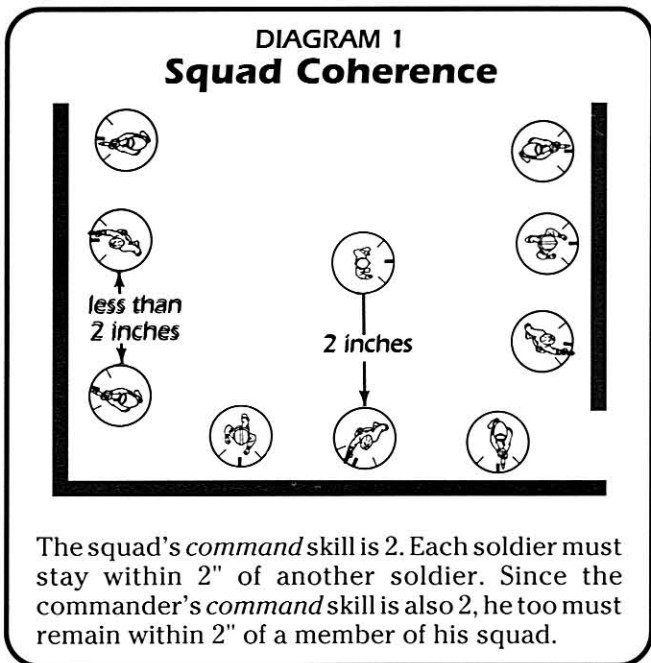

from the edge of a figure's base, not the figure. To provide his squad with the benefits of his, often higher, *command* skill, the commander of the squad must be within his command distance of one of the soldiers, who, in turn, must be within command distance of the other soldiers.

Separation

It is possible for soldiers to become separated from their comrades. For example, if while advancing across a field, a soldier is wounded, he falls down and then can only walk for the remainder of the battle. If his mates decide to run to reach cover, he may become separated from them.

If a squad becomes separated into groups of soldiers — say, for example, half the squad was across a bridge when it exploded — soldiers not with their commander are considered separated. If the commander is incapacitated, the player designates which soldiers are in the squad and which are separated from it.

Separated soldiers must attempt to rejoin their squad as quickly as possible. Until they do so, they suffer penalties to their combat skills. All fire combat difficulties are increased by 1, and they cannot initiate close assault. If the enemy engages them in close assault, separated soldiers have a -1 penalty to their *melee combat* or *brawling* rolls.

Separation penalties take effect as soon as a soldier becomes separated, and remain until he rejoins his squad.

Squad Fire

When firing, a squad shoots at an enemy squad. The squad may split its fire between two targets — two

different squads — but it may not fire at more than two targets. The range of the squad's shots is determined by measuring the average distance from the firing soldiers to the visible soldiers in the target squad; the difficulty of the shot is determined by the kind of cover the majority of the visible soldiers in the target squad occupy. This is discussed in more detail in "Fire Combat."

Skill Tests

Chance plays an important role in combat. When highly trained soldiers fire, sometimes they hit, sometimes they miss. A grenade may incapacitate one soldier, while the soldier right next to him is unharmed. A group of average soldiers may stand up to the rigors of battle, or they may break the first time they take a hit. In *Star Wars Miniatures Battles*, players roll standard, six-sided dice to simulate the effects of chance.

The two main types of dice-rolling players will engage in are called "skill tests" and "opposed rolls." In general, players make straight skill tests when a soldier is called upon to perform an action in which his skill is the only important factor in the success or failure of the action. For example, hitting a target with a blaster depends upon the soldier's skill with the blaster. Players make opposed rolls or tests when the action's success depends upon a comparison between two different factors — the amount of injury done by a successful blaster shot, for example, depends upon a comparison between the *Damage Strength* of the blaster and the target's *Strength*.



■ The Rebel Alliance has found many new allies among the alien species of the galaxy, a resource which the Empire has been too shortsighted to appreciate.

Note to Players of Star Wars: The Roleplaying Game

Star Wars Miniatures Battles uses much of the same terminology as that used in the roleplaying game, but the mechanics of dice-rolling are different. This is necessary because of the differences between the two systems in scale and number of combatants. You shouldn't have too much trouble picking up the new game system, however.

Straight Skill Tests

When making a straight skill test for a soldier, the player rolls a die and adds the soldier's skill level to the roll. This is compared to a "difficulty number" which has been determined for the test: if the roll is equal to or higher than the difficulty number, the soldier succeeds; if the roll is less than the number, he fails.

Example: A stormtrooper with a *blaster* skill of 3 fires at a Rebel squad in the open, within short range. The difficulty of the shot is 6. The Imperial player rolls a die and gets a 3. Three plus the stormtrooper's skill of 3 equals the difficulty number of 6, so the stormtrooper's shot hits.

Opposed Tests

When called upon to make an opposed test, each player rolls a die and adds the appropriate skill, attribute, or conditional modifier to the roll. The effects depend upon circumstances but, in general, the high roller is successful.

Example: Our stormtrooper from the last example hit his target, a Rebel trooper. Let's see how well his shot did. To determine the damage of a successful blaster shot, the firing and target players make opposed rolls. The firing player rolls a die and adds the blaster's *Damage Strength*; the Rebel trooper rolls a die and adds his *Strength* attribute.

In this case, the stormtrooper is carrying a blaster pistol with a *Damage Strength* of 4; the Rebel has a *Strength* of 3. The two players roll dice and add the appropriate numbers. The Imperial player rolls a 3; added to the blaster's *Damage Strength* of 4, gives him a final total of 7. The Rebel rolls a 2; added to the trooper's *Strength* of 3, gives him a 5; less than the Imperial player's roll. The Rebel is wounded. If, on the other hand, the Rebel's final score had been 7 or higher, the shot would have had no effect.

Bomb-Outs

Whenever a player rolls a 1 when making a roll, he bombs out. His score is 0, and no modifiers are applied to it.

Example: Assume that the Rebel from the previous example rolled a 1 when making the opposed roll against the Imperial player. The trooper's final score would not be 4 (the trooper's *Strength* plus the roll of 1), his final score would be 0. If the stormtrooper had also rolled a 1, his final score would also be 0—the two rolls would be tied.

Rollovers

Whenever a player rolls a 6 when attempting a skill test or opposed roll, he rolls the die again and adds the new roll to the previous one. If he rolls another 6, he continues to roll, adding it to his score. He only stops rolling when he rolls a number other than 6. Ones rolled during rollovers do not count as bomb-outs; they are added to the score as any other number (bomb-outs occur only on the first roll, never on rollovers).

Example: Assume that the much-abused Rebel from the previous examples rolled a 6 when making his *Strength* roll. He gets to roll again—and rolls another 6! He rolls once more, and gets a 1 this time. Since his last roll wasn't a 6, he stops rolling. His final score is 16—his *Strength* of 3, plus his rolls of 6, 6, and 1. He laughs at the stormtrooper's puny shot.

Chapter Two

Movement

During the Movement Phase, players alternate moving their squads, one at a time, across the battlefield. The player with initiative has the choice of moving one of his squads first or second. The distance a squad can move is governed by its "Movement Rates" — "Walk Rate" and "Run Rate" — and the terrain it is moving through. A squad does not have to move its full distance, or at all, unless it is "routing" (see "Morale").

Movement Rates

Each soldier has two Movement Rates — Walk Rate and Run Rate. These numbers represent the maximum distance the soldier can move in inches during the Movement Phase. There are penalties attached to certain forms of movement — a squad which walks has the difficulty of its Fire Combat roll increased by +1; a squad which runs cannot fire at all that turn. These penalties apply to the entire squad, even if only one soldier in the squad moved at that rate.

In general, a soldier's Movement Rate is equal to the distance he can move across clear, unobstructed terrain. Soldiers move more slowly across more difficult terrain. Each being in *Star Wars Miniatures Battles* and *Star Wars: The Roleplaying Game, Second Edition* has a Move value as part of its characteristics. A soldier's Movement Rates are determined by his Move and modified by his *Dexterity* attribute. Do not round off Move or Movement Rates.

Movement Rates

Walk = Move/2 + DEX

Run = Move + DEX

Example: A Rebel with a Move of 10 and a *Dexterity* of 3 has a Walk Rate of 8", and a Run Rate of 13".

Walk Rate

A soldier who is walking is moving slowly and carefully across the battlefield. A squad which walks can fire in the Fire Combat Phase with a +1 modifier to the difficulty level. After it has been moved the squad is marked with a *Fire +1* marker.

Run Rate

A soldier who is running is moving as quickly as possible. He is more concerned about reaching his

objective than anything else. If a squad runs, it cannot fire in the Fire Combat Phase. Wounded soldiers cannot run. A squad which runs is marked with a *No Fire* marker.

Facing

A soldier can only fire in a 90-degree arc from the front of his base. He cannot shoot at an enemy soldier that falls outside of this arc (see diagram 2). A walking soldier can have any facing desired. He can make any number of facing changes during his move. The facing of a stationary soldier may be changed during the Movement Phase, although any soldier who makes a facing change is considered to have moved at a walk this turn.

A running soldier may change his facing by a maximum of 90 degrees. This can be made as two 45-degree changes or one 90-degree turn. A running soldier ends his move facing the direction that he last ran in. If the soldier has not used all of his 90-degree turning allowance, it may be used at the end of his move to adjust his facing.

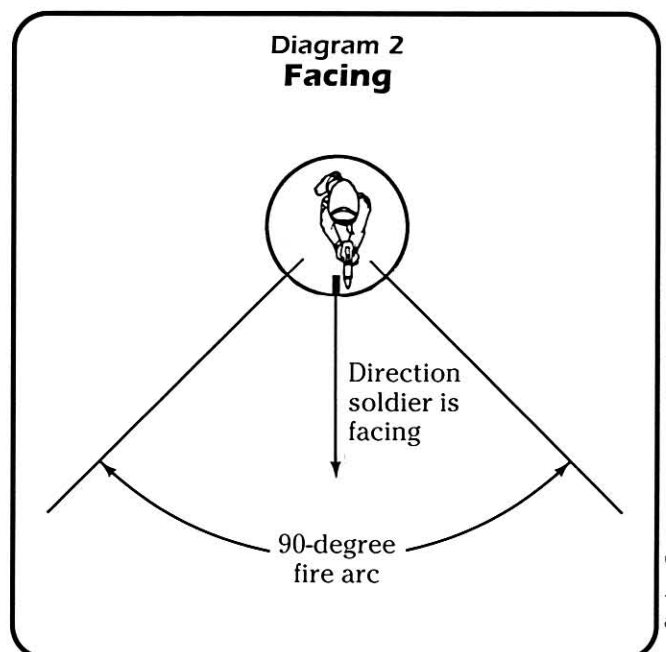

Example: A Rebel trooper is walking (Walk Rate 8") through Mos Eisley. He walks 5" straight ahead to an intersection, turns 90 degrees to the left, moves 3" down the alley, and then turns 90 degrees to cover a doorway. If he has a target, he can fire during the Fire Combat Phase. In a later turn, while attempting to outflank the Imperial heavy repeating blaster nest set up in the center of town, the Rebel runs (Run Rate 13"). He sprints 8" down the street, turns 45 degrees, runs across the two-inch-wide road, and turns another 45 degrees to face down the alleyway. He has run 10", used up all of his 90-degree turning allowance, and because he has run, he cannot fire during the Fire Combat Phase.

Prone Soldiers

Prone soldiers are lying on the ground, either because they have been knocked down by enemy fire, or because they have fallen down to avoid being hit by enemy fire. To show that a soldier is prone, simply turn the model on its side. A soldier may fall prone during the Movement Phase at no cost, but this ends his move immediately. A soldier who begins the Movement Phase prone can crawl up to 2" in any direction, or stand up at a cost of 2" (deducted from his Movement Rate), and move normally.

Example: The Rebel trooper from the example above, with a Walk Rate of 8" and a Run Rate of 13", begins the Movement Phase prone (he dove behind a wall last turn to avoid getting shot by the heavy repeating blaster situated on a nearby hillside). When his squad moves, he can crawl 2", get up and walk 6", or get up and run 11".

Terrain and Barriers

The type of terrain a soldier crosses affects how fast he can move. A soldier moving through underbrush can't move as fast as one crossing a flat plain, though both can move faster than a soldier slogging through a swamp. Certain "barriers" — walls, streams, ditches and so forth — also affect a soldier's movement. For purposes of describing its effects upon movement, terrain is classified into four types: clear, rough, very rough or impassable. Barriers are classified as moderate, difficult or impassable.

Clear Terrain: Clear terrain is relatively flat and unobstructed. It does not affect movement: soldiers move at their standard Movement Rates.

Rough Terrain: Rough terrain has a number of obstructions and/or is not quite level enough to allow unhindered movement. The following types of terrain are considered to be rough terrain: scrub, light woods, brush, and easy hills. Moving through rough terrain costs twice the normal movement cost.

Example: A stormtrooper with a Walk Rate of 6" crosses a two-inch-wide patch of scrub (rough terrain). The stormtrooper expends 4" of his Walk Rate to cross the scrub (each 1" of rough terrain counts as 2"), leaving 2" of his move left.

Very Rough Terrain: Very rough terrain contains a great number of obstacles and/or is steep enough to severely hinder movement. Examples of very rough terrain include heavy woods, swamp, and difficult hills. Moving across very rough terrain costs four times the normal movement cost. In addition, soldiers cannot run in very rough terrain.

Impassable Terrain: Terrain of this type cannot be moved through. It must be moved around. Examples of impassable terrain include force fields, cliffs, lava fields, and so on.

Barriers

Barriers — walls, ditches, hedges and so forth — reduce movement (it takes time to climb over or scramble under them). The cost for crossing a barrier is deducted from a soldier's Movement Rate. If a soldier cannot deduct the required amount (having already spent them to reach the barrier), he cannot cross it. He must wait until the next Movement Phase to cross. There are three types of barrier.

Moderate Barrier: Moderate barriers present only slight difficulties to cross. They include the following: doors, low fences, shallow trenches, narrow creeks. It costs 2" to cross a moderate barrier.

Difficult Barrier: Difficult barriers are substantially more difficult to cross. They include: windows, high fences, barbed wire, deep trenches, streams. Crossing a difficult barrier costs 4" of movement.

Impassable Barrier: As their name implies, these barriers cannot be moved through at all. Examples are: extremely high walls or rock formations, force fields, or lava streams.

The effects of terrain and barriers on combat are discussed in the "Fire Combat" and "Close Assault" sections.

Opportunity Fire

Opportunity fire takes place in the Movement Phase. Any squad which has not yet moved in the Movement Phase may attempt opportunity fire. The squad must pass a difficulty 4 morale test to fire, as described in the "Morale" section. A squad which successfully passes its test may opportunity fire, but cannot move or fire again in this turn, and is marked with a *No Fire* marker. A squad which fails its test may fire normally in the Fire Combat Phase, but cannot move during the current Movement Phase. See the "Fire Combat" section for how to resolve opportunity fire.

Chapter Three

Fire Combat

In fire combat, squads fire their ranged weapons — typically blasters, though some use esoteric weapons such as bowcasters — at enemy squads. A squad may shoot at any enemy squad in sight; it may split its fire between two enemy squads. Players in turn pick a squad, announce the squad's target(s) and resolve the fire combat. The player who does not have initiative picks first. However, all fire combat during this phase takes place simultaneously — that is, soldiers do not suffer the effects of combat until the Fire Combat Phase ends.

Fire Combat Summary

Fire Combat occurs in six steps:

- 1. Targeting:** Determine which soldiers in the firing squad have a "line of sight" (LOS) to soldiers in the target squad. Only soldiers with a LOS can fire at the target squad, and they may only fire at those soldiers which they can see (see "Line of Sight" below).
- 2. Range Determination:** Measure the average distance between the firing soldiers and the target soldiers. Compare this with the range of the weapon which

is being fired; the distance will be short, medium, or long. This determines the base difficulty of the firing soldiers' blaster test.

3. Final Difficulty of the Shot: The base difficulty of the shot may be modified by the terrain the targets occupy, whether the firing squad has moved, and other factors.

4. Make Blaster Tests for the Firing Soldiers: All successful tests indicate that the firing soldiers hit a soldier in the target squad.

5. Hit Determination: Determine randomly which target soldiers are hit.

6. Damage Determination: The firing player and target player make opposed rolls to determine the damage of each shot. Results are marked immediately, but not applied until the end of the Fire Combat Phase.

Fire Arcs

A soldier is limited to firing his weapon in a 90-degree arc centered on the front of the figure. If any part of the base of an enemy soldier is within the firing soldier's 90-degree arc, he can shoot at the soldier. Enemy soldiers who are outside of the arc cannot be fired at.

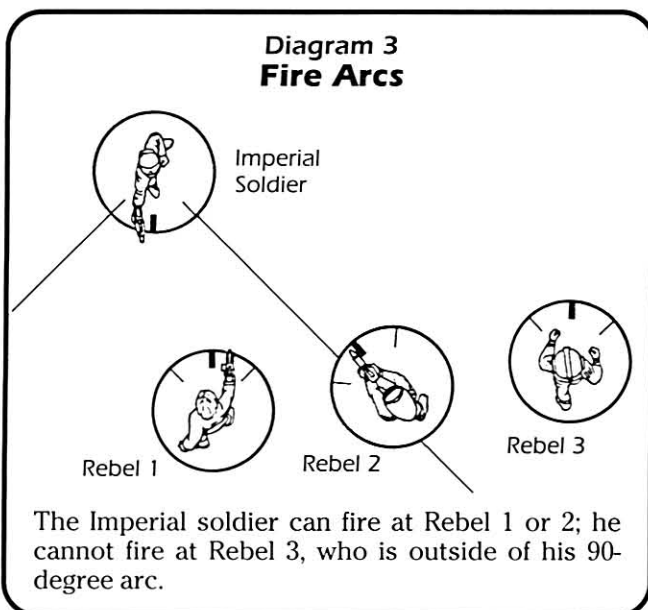

Line of Sight

In order for a squad to fire at an enemy squad, some of its soldiers must be able to see one or more of the enemy squad's soldiers — that is, they must have a Line of Sight (LOS) to the enemy. Generally, this is easy to determine — simply hunch down on the table and sight along from the model's head. If there is something blocking your sight of the enemy soldiers, the soldier cannot shoot at them. Alternatively, stretch a piece of string between the firer and the target, if it touches a building, woods or other object that blocks LOS, the target soldier cannot be fired at.

It is not necessary for the soldier to be able to see all the soldiers in the enemy squad — if a soldier can see even one he can fire.

Use common sense when determining LOS. LOS rules are notoriously difficult to craft, and there is always something to overlook. We do our best to cover every situation, but obviously, things crop up in games

**Diagram 4
Line of Sight**

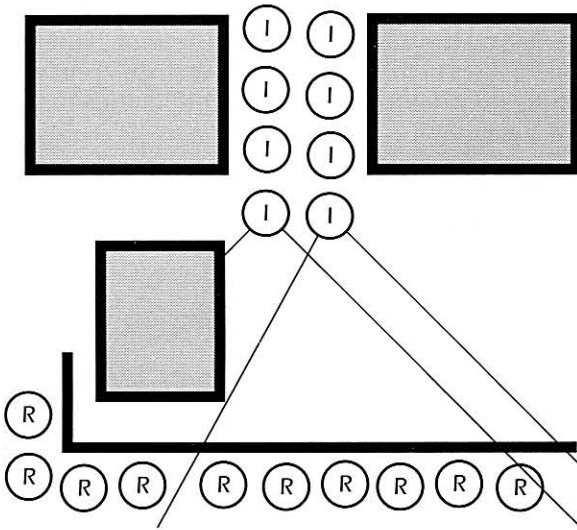

A squad of Imperial soldiers is advancing towards a Rebel squad behind a wall. The two squads fire at each other. Six of the Rebels can see the lead two Imperials, and the lead two Imperials can see the six Rebels. The four Rebels to the left have no LOS to the Imperials because the building is in the way; the six Imperials behind the leaders cannot see through their comrades.

Stephen Crane

which we cannot foresee. The general rule is: if you can't agree whether a soldier has a LOS to a target, roll a die: 1-3 the target can be fired at; 4-6 the target cannot be fired at. Of course, that means he is a legitimate target of whomever he is firing at, too ...

If you are playing with a gamemaster, he has the final say on LOS.

Blocking Terrain

Blocking terrain is battlefield features which block LOS. Blocking terrain may not be fired through, although, in certain cases, it may be fired over.

Soldiers

A soldier cannot trace a LOS through another soldier. If his only line of sight to the enemy passes over the base — not necessarily the figure — of another soldier, he cannot fire.

Soldiers can shoot past other soldiers if their fire would pass above the interposing soldier's head. For example, if the soldier and his target are sniping at each other from the rooftops, a soldier between them in the street below would not block LOS. Similarly, if the firing soldier is on top of a hill and the friendly soldier is at the base of the hill or on a lower level, he can fire over the friendly soldier's head.

**Diagram 5
Blocking Terrain**

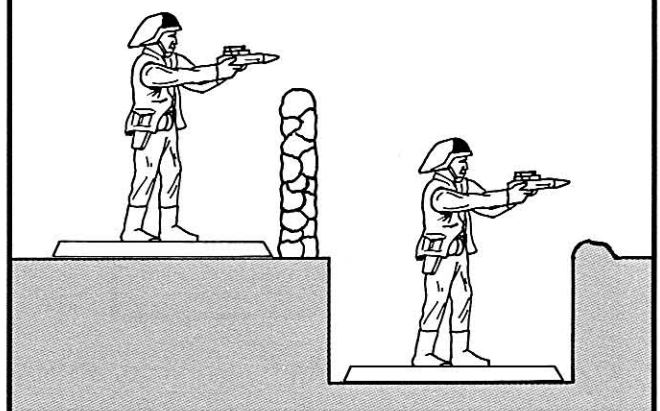

The soldiers shown are in excellent defensive positions. The front rank is protected by the trench; the soldiers behind them are protected by the wall and can fire over the front rank's head.

Stephen Crane

Walls

There are two standard types of walls in *Star Wars Miniatures Battles* — low walls and high walls.

Low Walls: A low wall does not block LOS unless the target is prone behind it; in that case, the soldier cannot be fired at unless the firer is directly on the other side of the wall.

High Walls: High walls block all LOS. Again, soldiers on top of hills or on a building may be able to trace LOS over high walls.

Buildings

Buildings block LOS, but may be fired out of or into through doors and windows. A soldier who is adjacent to a doorway or window can fire through it at anything on the other side (and can in turn be fired at). If firer and target are both more than 1" from the intervening door or window, they cannot see or fire at each other. A soldier who is prone cannot be fired at through a door or window unless the firer is directly adjacent to it. See Diagram 6 on the following page.

Woods

Woods are either light, medium or heavy. The distance a soldier can see through a wooded area depends upon the density of the woods.

Light Woods: A soldier can see up to 8" through light woods.

Medium Woods: A soldier can see up to 6" through medium woods.

Heavy Woods: A soldier can see up to 4" through heavy woods.

DIAGRAM 6
Buildings

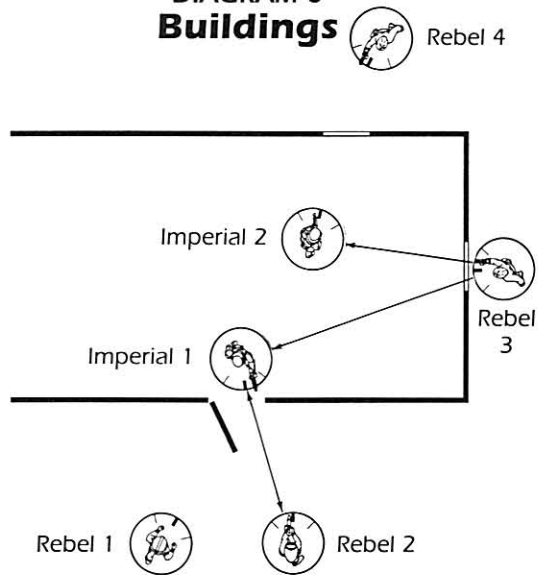

The Rebels are attacking an Imperial-infested dwelling.

- Rebel 1 can't see Imperial 1; the partially-closed door blocks his LOS.
- Rebel 2 can see Imperial 1, and *vice versa*.
- Rebel 3 is in an enviable position: he can see both Imperials, but they are facing in the wrong direction and cannot see him.
- Rebel 4 and Imperial 2 cannot see each other; they are both more than 1" from the window.

Stephen Crane

Range

The base difficulty of a shot is determined by the range of the shot — that is, the distance between the firing squad and the target squad. This is cross-referenced with the range of the weapon the firing soldier is using. Weapon ranges can be found in the “Charts and Tables” section. They show the maximum distance that a weapon’s range band extends. For example, a blaster pistol has a short range of 5", a medium range of 15", and a long range of 60". All shots up to 5" are at short range; shots between 5" and 15" are at medium range, and any shots between 15" and 60" are at long range. No shots may be attempted at greater than long range. *Before the game, weapon ranges should be written on the Squad Record Sheet for easy reference.*

Measuring Range

To determine the range of the fire, find the average distance between the firing soldiers and the targets. The easiest way to do this is to measure from the center of the firing squad’s “fire line” to the center of the visible soldiers in the target squad. The firing squad’s fire line is defined by the soldiers in the squad who are actually shooting at the enemy squad — soldiers who do not have LOS or who are firing at another squad are not counted.

Determining Base Difficulty

On the Squad Record Sheet find where the range you measured in the previous step falls within the firing weapon’s range, then look on the “Fire Combat Chart” below (and printed in the “Charts and Tables” section). This tells you the base difficulty of the shot. If there are any specialists in the squad armed with different weapons, they may have different base difficulties than the rest of the squad.

Fire Combat Chart

Range	Base Difficulty
Short	6
Medium	8
Long	10

Example: A squad of Rebel troopers, armed with blaster pistols, and containing a specialist with a medium repeating blaster, fires at an enemy squad 14" away. Fourteen inches is medium range for blaster pistols; short range for repeating blasters. Most of the squad’s base difficulty is 8; the specialist’s base difficulty is 6.

Determining Final Difficulty for the Shot

The base difficulty of the shot can be modified by cover, movement, and other factors, as listed on the “Fire Combat Modifiers Chart” below, and in the “Charts and Tables” section. All modifiers are cumulative.

Fire Combat Modifiers Chart

Target Condition	Difficulty Modifier
In Light Cover	+1
In Medium Cover	+2
In Heavy Cover	+3
Target Prone	+1
Firer Condition	Difficulty Modifier
Walking	+1
Opportunity Fire	+1
Defensive Fire	+1
Separated from squad	+1
Shaken	+1
Demoralized	+2
Following Fire (after 1st shot)	+2

Target Condition

All target condition modifiers are determined by the condition of the majority of the squad in sight of the firers — that is, if all 10 squad members are eligible targets and six are in light cover and four are in the open, the squad gains the benefits of light cover. If the squad is split exactly fifty-fifty, the squad gains the better benefit.

**Diagram 7
Range**

Example 1

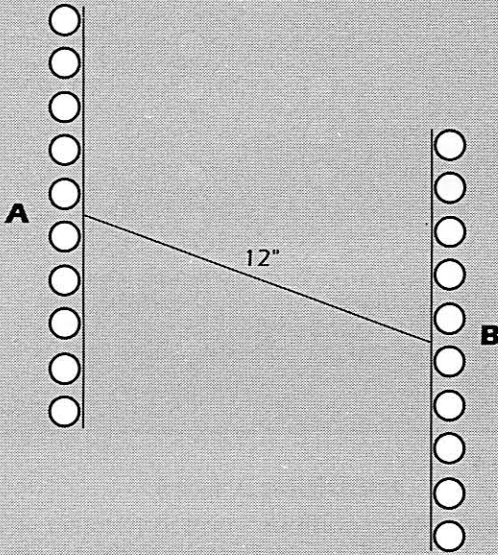

Example 2

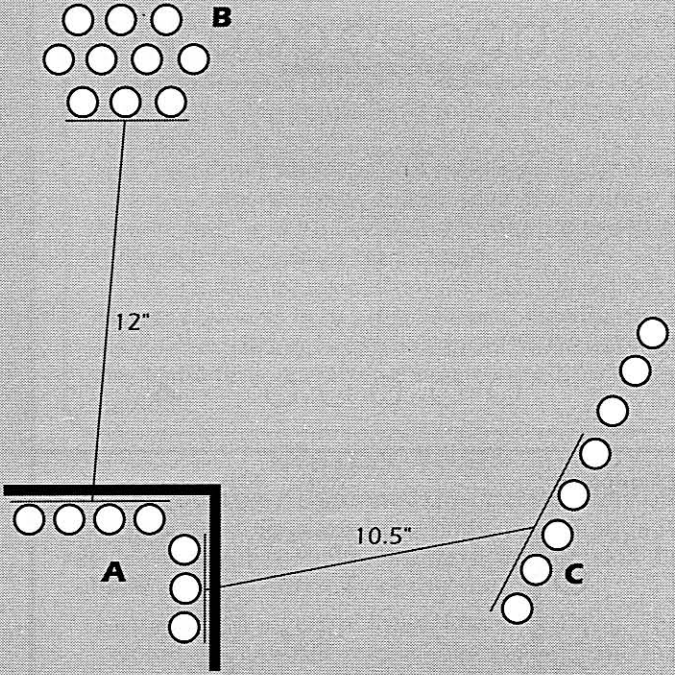

Example 3

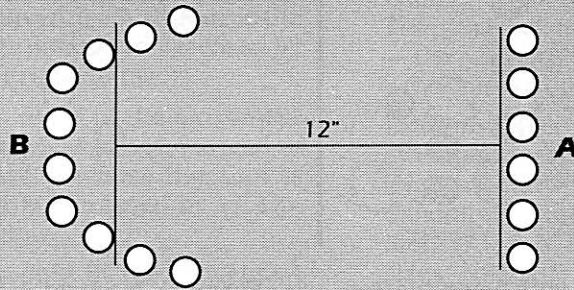

Example 1: All of Squad A is firing at Squad B. The range, measured from the center of each line, is 12".

Example 2: Squad A is splitting its fire between Squads B and C. Range for each fire is determined separately. Only the front rank of Squad B is visible to Squad A, so range is determined from the front rank. Similarly, the three rear soldiers in Squad C are out of sight (in the heavy woods); they do not affect the range.

Example 3: An odd situation: Squad B is in an unusual "U" formation. In cases like this, don't measure to the actual "center" of the line, instead, take your best guess at the average distance.

Game Note: As you can see from the above examples, in certain cases, some soldiers in the target squad are actually going to be much closer to the firers than the determined range, and some are

going to be much farther away. It could be argued that in "real life," the soldiers would concentrate their fire on the closer — and thus, easier — targets, and that therefore the range should be determined from the firers to the closest enemy soldier. We considered this, but decided to use the average distance instead, for two reasons:

First, because soldiers are not going to worry about precise measurements before they shoot — they are going to blaze away at the first target they see, not necessarily the closest.

Second, when moving our troops around on the table, we don't want to have to worry about precise alignment — we want to move them and see what happens. If range were determined by the closest target, we would have to take great care that our squads were always in line — any soldier a little out in front might drop the range, giving the enemy a much easier shot.

Diagram 8
Determining Final Difficulty for the Shot

Example 1

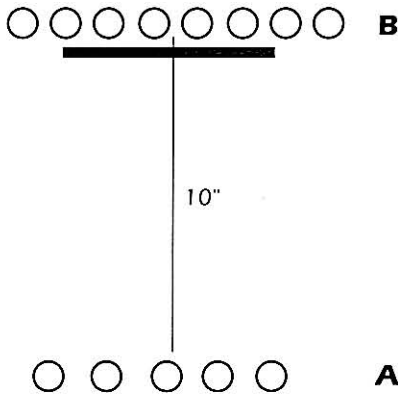

Example 2

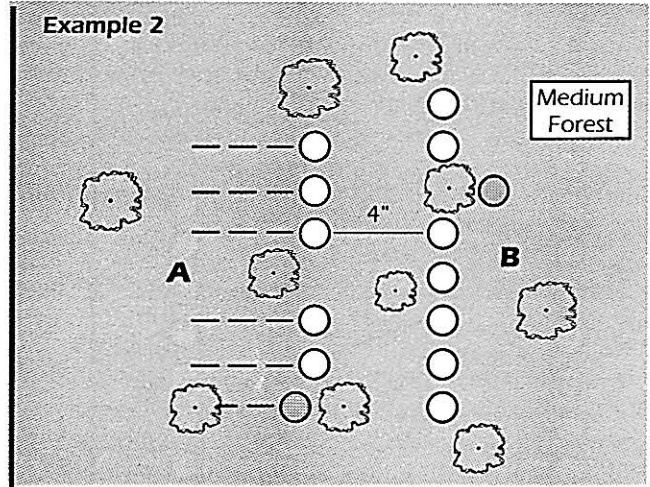

Example 3

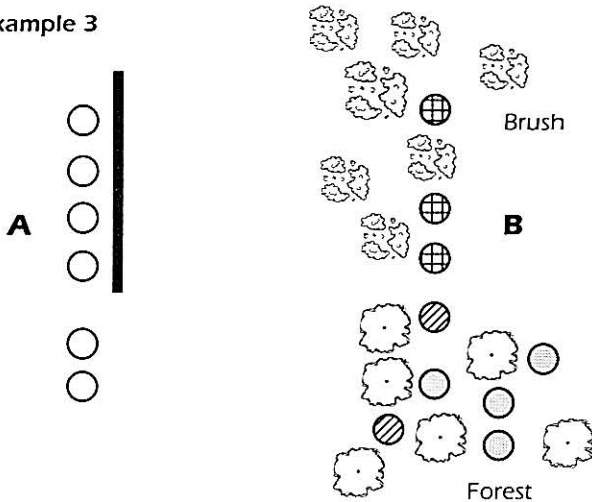

Example 4

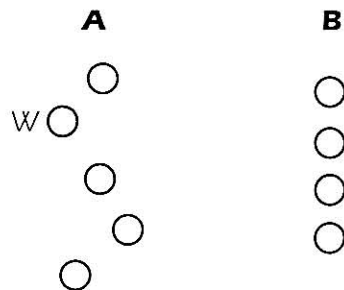

Example 1: Squad A, armed with heavy blaster pistols, is firing at Squad B. The two squads are 10" apart, medium range for heavy blaster pistols — the shot has a base difficulty of 8. Most of Squad B is taking cover behind a wall, gaining them medium cover — +2 to the difficulty. The final difficulty of the shot is 10.

Example 2: Squad A, armed with blaster carbines, walks forward to within 4" of Squad B and then opens fire. Four inches is short range for carbines — base difficulty 6. Because the fight is taking place in a medium forest, the defenders get the benefits of medium cover from the trees — +2. The attackers walked this turn, increasing the difficulty by an additional +1 for a final difficulty of 9. Note that the shaded soldiers do not take part in the battle — the shaded soldier in Squad A has no LOS to a target, and the shaded soldier in Squad B cannot be hit as no attacker has a LOS to him.

Example 3: Squad A is firing at Squad B. The range is medium — base difficulty of 8. Four members of Squad B, the shaded soldiers hiding behind trees, cannot be seen, so they do not modify the difficulty number. Of those who can be seen, two are on the edge of the woods (the soldiers with the diagonal lines through them) in medium cover from the trees, and three are in the brush (the cross-hatched soldiers) in light cover. Since more of the visible soldiers are in light cover than are in medium, the squad gets the benefit of light cover — +1. The final difficulty number for the shot is 9.

Example 4: What's left of Squad A is firing at the remnants of Squad B. The range is short — base difficulty 6. Squad A is shaken by the devastating losses it has taken in battle — +1 to the difficulty. The final difficulty is 7. One soldier is wounded so the final difficulty for him is increased by a further +1 to 8.

Cover Terrain: Shooting into or through cover terrain is harder than shooting across open ground, therefore the difficulty number of the shot is increased. Terrain which affects fire combat is called cover terrain. There are three types of cover terrain:

- Light cover is terrain which partially obscures the target but provides no substantial bulk to stop blaster shots. If a target is in light cover, the firer's difficulty number is increased by +1.
- Medium cover obscures at least half of the target figure and/or provides a good chance of absorbing or deflecting a blaster shot. A target in medium cover increases the firer's difficulty number by +2.
- Heavy cover hides most of the figure and is very difficult to penetrate. If a target is in heavy cover, the firer's difficulty number is increased by +3.

Prone: If the targets are lying down and still visible to the firers, the difficulty number is increased by +1. Prone targets who are behind cover cannot be fired on unless the firer is adjacent to the cover.

Firer Conditions

The majority of firer condition modifiers are determined according to the status of the whole squad — if one soldier walks, all are assumed to have walked. However, the modifier for soldiers separated from their squad is only applied to the separated soldiers, never the whole squad.

Walking: If any of the squad moved at a Walk Rate in the Movement Phase, the difficulty number is increased by +1. (Note that a squad cannot run and fire.)

Opportunity Fire: This takes place in the Movement Phase. The soldiers fire during that phase, instead of during the Fire Combat Phase. Because the shot is rushed, the difficulty number is increased by +1. Opportunity fire is discussed below.

Defensive Fire: This occurs only in the Movement Phase. When a squad is charged, the soldiers get a last shot before the two squads crash into each other. The firers' difficulty number is increased by +1 because their shot is hurried. See the "Close Assault Combat" section for details.

Separated From Squad: When a soldier becomes separated from his squad, he may still fire, but his difficulty number is increased by +1.

Firer Shaken or Demoralized: These are conditions of deteriorating morale which occur when a squad's confidence has been eroded, typically as result of taking casualties on the battlefield (see the "Morale" section for more information).

Following Fire: Some specialized weapons are capable of more than one shot a turn, providing the first shot hits. The difficulty number of each subsequent shot is increased by +2. Following fire weapons are described below.

Blaster Skill Test Summary

Skill tests are discussed in detail in "Soldiers and Squads," but to summarize: you roll a single die and add the soldier's *blaster* skill to the roll. If you roll a 1 — a "bomb-out" — the soldier scores an automatic 0 on the test. If you roll a 6 — a "rollover" — you roll again, adding the new roll to your score. You continue re-rolling as long as you roll sixes. The bombout applies only to the first roll; you don't bombout on rollovers. If the final score — the number rolled plus the soldier's *blaster* skill — is higher than or equal to the final difficulty, the soldier hit a target.

The suggested procedure for making a squad's *blaster* skill test is to grab as many dice as there are soldiers firing, bounce them all on the table at the same time and then check to see how many have hit.

Blaster Tests

After you have determined the final difficulty of the shot, you must discover how many of your squad hit. All firing soldiers make standard *blaster* skill tests against the final difficulty of the shot.

Example 1: A squad of five soldiers are firing. The soldiers all have the same *blaster* skill of 3 and are armed with the same weapons. The final difficulty number of the shot has been determined to be 8. The player rolls five dice: 1, 2, 3, 3, 5. The final scores — the rolls plus the soldiers' *blaster* skill of 3 — are 0 (because of the bomb-out), 5, 6, 6, and 8. One hit.

Example 2: Ten soldiers with *blaster* skills of 4 are attempting a very difficult shot. The targets are at long range and the firers moved this turn — a final difficulty number of 11. The firing player rolls 10 dice: 1, 1, 3, 3, 3, 4, 4, 5, 6, 6. He re-rolls the two sixes, rolling a 1 and another 6! He re-rolls the second 6, this time rolling a 2. His final scores are: 0, 0, 7, 7, 7, 8, 8, 9, 11, and 18. Two hits.

Example 3: A soldier with a *blaster* skill of 6 fires at a target at short range. The final difficulty number of the shot is 6 — a piece of cake. Unfortunately, the player rolls a 1 — a bomb-out — so the soldier's final score is 0, a miss.

Specialists and Wounded Soldiers

Specialists are likely to have better skills and often better weapons than the rest of the squad, and thus have lower final difficulties than their comrades. Therefore you must roll for their shots separately from the rest of the squad.

A wounded soldier's skills are all reduced by 1; this means that he has to roll one higher than the rest of the squad to hit. You must roll a wounded soldier's shot separately.

Alternatively, we recommend that you have on hand a bunch of differently colored and sized dice. Before you roll, indicate which dice are for the specialist and wounded soldiers, and then roll them all at once.

Example: “Okay. The range is 14”. That’s medium range for my five guys with blaster pistols, and short range for the specialist with the blaster rifle—final difficulties of 8 and 6. One of the soldiers with a blaster pistol is wounded. Everybody’s got *blaster* skills of 3.

“All right. Four red dice for the standard soldiers, a blue die for the wounded guy, and my lucky black die for the blaster rifle. This is where you get it, Imperial Scum!”

Clatter.

“Hmm! Not too promising. The red dice came up 1, 4, 4, and 5; swell — one whole hit. The wounded guy came up 5 ... no good. Well, isn’t that nice: the black die shows 6. No need to re-roll that one; I’ve scored high enough to hit you already. So, the final tally is: one hit with a blaster pistol, and one with the blaster rifle. Now let’s see who I hit.”

Assigning Hits

After seeing how many hits your squad caused against the enemy squad, you need to determine exactly which of the enemy soldiers were hit. All visible soldiers in the target squad have a chance of being hit; it is possible that your soldiers may hit the same soldier more than once, or each shot may hit a different soldier.

Hits are determined randomly. If there is only one visible target, he takes all the hits. If there is more than one visible target, you roll dice to see whom each of your shots hit. Each visible soldier has an equal chance of being hit by each shot.

Damage Determination

Now you must determine the effectiveness of the shots. For each hit, you and your opponent make opposed rolls; you roll a die and add the firing weapon’s *Damage Strength* and your opponent rolls a die and adds the target soldier’s *Strength*. To determine the damage the soldier takes, cross-reference the result on the “Damage Table.” Remember that any damage soldiers take is not applied until the end of the Fire Combat Phase. The “Damage Table” is printed below and in the “Charts and Tables” section.

Armor

Armor increases the wearer’s *Strength* for the purposes of resisting damage only. It has no effect on a soldier’s ability to cause damage. In the Basic Game only stormtroopers wear armor and its effects are already figured into their troop statistics. For more information on armor, see “Advanced Weapons and Equipment.”

Damage Table

Roll	Effect
DS < SR	No Effect
DS ≥ SR	Wound
DS ≥ SR+4	Incapacitated

DS = Weapon’s *Damage Strength* Roll

SR = Target’s *Strength* Roll

Examples: A Rebel armed with a heavy blaster pistol, *Damage Strength* of 5, has hit an Imperial soldier with a *Strength* of 3. The players make opposed rolls:

1. The Rebel player rolls a 1 and bombs out; his *Damage Strength* roll is 0. The Imperial player rolls a 4; his *Strength* roll is 7. The *Damage Strength* roll is less than the *Strength* roll: the shot has no effect.

2. The Rebel player rolls a 3; his *Damage Strength* roll is 8. The Imperial player rolls a 5; his *Strength* roll is 7. The *Damage Strength* roll is greater than the *Strength* roll: the target is wounded.

3. The Rebel player rolls a 4; his *Damage Strength* roll is 9. The Imperial player rolls a 2; his *Strength* roll is 5. The *Damage Strength* roll is greater than or equal to the *Strength* roll + 4: the Imperial soldier is incapacitated.

Effects of Damage

Damage results range from *no effect*, through *wounded*, to *incapacitated*. Hits are marked as soon as they occur, but as all fire takes place simultaneously, they do not take effect until the end of the Fire Combat Phase.

Wound: A wounded soldier is laid on his side, and marked with a *Wound* marker. In subsequent Movement Phases he can stand up at a cost of 2". Wounded soldiers suffer a -1 penalty to all their skills and attributes, and they cannot run.

A soldier who is wounded a second time is incapacitated.

Incapacitated: Incapacitated soldiers can take no further part in the battle, and are removed from the table at the end of the Fire Combat Phase.

Multiple Shots Against One Target

When one soldier has been hit by more than one shot, the firing player rolls a die for each shot. The target player makes a single *Strength* roll and compares it against each of the firing player’s rolls. The results of each shot are applied to the target soldier.

Example: Two Rebels with blaster pistols, *Damage Strength* 4, have hit an Imperial soldier, *Strength* 3. The Rebel player rolls two dice and adds 4 to each of them; the Imperial player rolls one die and adds three. The Rebel player rolls 4 and 1 for *Damage Strength* rolls of 9 and 0. The Imperial player rolls a 3, for a *Strength* roll of 6. The first shot wounds the soldier; the second has no effect.



■ A well-situated heavy weapons emplacement can be a major threat to advancing forces, but it also becomes a priority target in its own right.

Specialized Weapons

Some weapons are classified as “specialized weapons”: they require special rules for their use, and sometimes use very specialized skills for proper operation. Weapons with these specialized skills are marked on a case-by-case basis. All specialized conditions (except skill) are listed in the description.

Special Skills

Unless otherwise noted, weapons require the *blaster* skill (even the various repeating blasters). Some weapons, however, do require specialized skills, such as *missile weapons* (for the grenade launcher), *blaster artillery* (for artillery weapons) or other skills that are indicated under anti-infantry and anti-vehicle weapon write-ups.

Assembled Weapons

Assembled weapons use the following rules. Some weapons are much bigger and heavier than standard blasters. They are much too bulky to be carried by one soldier. Instead, the weapons are carried disassembled by two soldiers. The soldiers cannot move faster than a walk. They can fire other weapons and engage in close assault combat normally while carrying assembled weapons, but they cannot charge.

If one or both of the soldiers carrying a disassembled weapon is incapacitated, the weapon is destroyed.

It takes an entire Movement Phase to assemble a weapon. The two soldiers carrying the weapon must be within 1” of each other at the beginning of the Phase. Instead of moving, the soldiers spend the Movement

Phase assembling the weapon. At the end of the phase, it is ready to fire.

An assembled weapon is extremely difficult to move: it can be dragged only 1” per Movement Phase, and is treated as “walking” when determining fire combat difficulty numbers. If it is not moved during the Movement Phase, an assembled weapon can be turned to face in any direction without affecting its fire combat difficulty number.

An assembled weapon can be disassembled. Two soldiers from the same squad must begin their Movement Phase within 1” of the weapon; at the end of the Phase, the weapon is disassembled and may be carried and reassembled as described above.

Crewed Weapons

Some weapons require a crew of two or more. All crew members must be within 1” of the weapon. The firer aims the weapon while the crewman feeds it ammunition. The crewman cannot fire a different weapon in the same turn in which the crewed weapon fires. If only one soldier is manning the weapon, the weapon loses its “following fire” ability.

Following Fire

Weapons indicated *following fire* use the following rules.

When firing the weapon, the firing soldier makes a *blaster artillery* or appropriate weapon skill test. If successful, he has hit the target, and can attempt “following fire.” He makes another skill test with the difficulty number increased by +2. If that too hits, he makes

another test with the difficulty number increased by an additional +2. He can continue to fire for as long as he continues to pass the increasingly difficult tests.

Successful hits are distributed among the soldiers of the target squad as normal.

Example: The squad's specialist is armed with a medium repeating blaster, which is capable of *following fire* with a crewman; one of the other soldiers is crewing the weapon. The difficulty number of the shot is 8; the specialist's *blaster* skill is 4. The firing player rolls a 5; the shot hits. The specialist fires again; the new difficulty number is increased by +2 to 10. He passes this test and may fire again; the difficulty number of the next test is 12. He misses this shot, ending his following fire.

Repeating Blasters

Repeating blasters come in two configurations: standard and tripod-mounted. The tripod-mounted configuration costs more Squad Generation Points than the standard configuration (see "Creating Squads").

Standard Configuration: In its standard configuration, the repeating blaster is a normal blaster, fired by one soldier using his *blaster* skill. The soldier receives no penalties to movement when carrying a standard repeating blaster. Following fire is not possible.

Tripod-mounted Configuration: A repeating blaster in this configuration must be carried and fired by two soldiers; it must be assembled before it may be fired.

The firing soldier uses his *blaster* skill, but may perform *following fire*.

The firing soldier may discard the tripod mount during a Movement Phase. The weapon is then treated as a standard-configuration repeating blaster for the remainder of the game.

Grenades

Grenades are "area-effect weapons" which may damage more than one target. When throwing a grenade, the soldier makes a *grenade* test. If successful, the grenade lands where the soldier wanted it to. If the test fails, the grenade "deviates" to somewhere else on the battlefield.

In the back of this book is a "burst template" (the Grenade Burst Area of Effect Template) with a 2.5" radius, which represents the area of effect of an exploding grenade. When a grenade is thrown, the burst template is placed where the missile lands. Any models whose bases are beneath or touch the template may take damage from the explosion.

Grenades cannot be used in opportunity or defensive fire.

Throwing Grenades

Unlike blasters, which are targeted at entire squads, you announce the specific place on the table the soldier wants the grenade to land. The soldier *should* have a line of sight to the place he is throwing the grenade. It is not necessary, however, to throw a grenade directly at an enemy soldier — the soldier can chuck a grenade at an

Diagram 9
Grenade Deviation

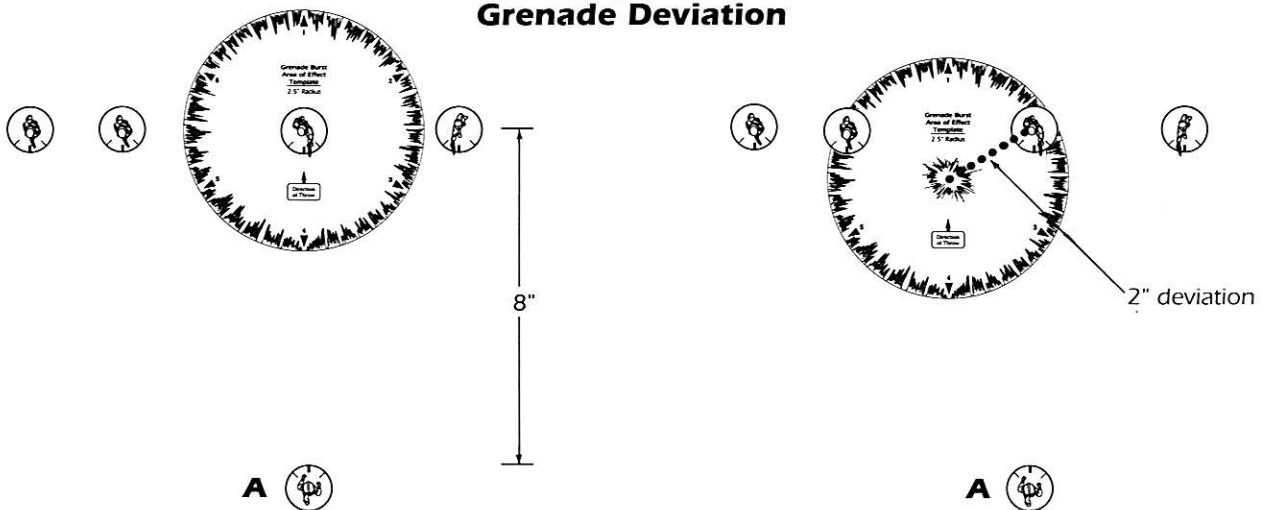

Example: Soldier A throws a grenade at the enemy lined up 8" away at medium range. The firing player places the burst template to show where the soldier is aiming. The soldier fails his *grenade* test, so the grenade has deviated.

The throwing player's first roll is a 5; the grenade has fallen short and to the left. The second roll is a 2; since 8" is medium range, the grenade deviates the roll in inches, or 2". The Burst Template is moved to the new position. It touches the bases of two soldiers, both of whom may be damaged by the blast.

empty spot to catch more enemies in the burst template, or in the hope that it will “deviate” onto soldiers he cannot see.

To throw a grenade, place the burst template on the target spot, with the template pointing in the direction of the throw. To find the range, measure from the center of the template to the throwing soldier. Apply normal fire combat modifiers to determine the final difficulty, and then make a *grenade* test. If the soldier passes the test, the grenade explodes where placed; otherwise, it has deviated.

Grenade Deviation

When a soldier fails a *grenade* test, the missile does not land exactly where he aimed it. It lands somewhere else — possibly doing more damage than the firer expected, possibly ending up near friendly soldiers.

To determine the point at which the grenade actually lands, roll a die and check the result on the Grenade Burst Template. For example, if you rolled a 4, the grenade would have deviated toward the soldier who threw it.

To see how far from the target point the grenade landed, roll another die. The effect of this die roll depends upon the range: at short range, the grenade deviates 1–3 inches (equal to half of the die roll; round fractions up); at medium range, the grenade deviates 1–6 inches (the die roll in inches); at long range, the explosive deviates 2–12 inches (twice the die roll in inches). This is summarized below.

Grenade Deviation Range Chart

Range	Distance Deviated
Short	1-3 inches (1D/2)
Medium	1-6 inches (1D)
Long	2-12 inches (1Dx2)

If the deviation rolls indicate that the grenade is going to land in a place where it could not reasonably go — through a high wall with no windows, for example — the grenade stops when it hits an obstruction and explodes.

Throwing Grenades Blindly

A soldier *can* throw a grenade at a target point to which he does not have line of sight — that is, blindly. However, he will not be very accurate.

**DIAGRAM 10
Grenade Damage**

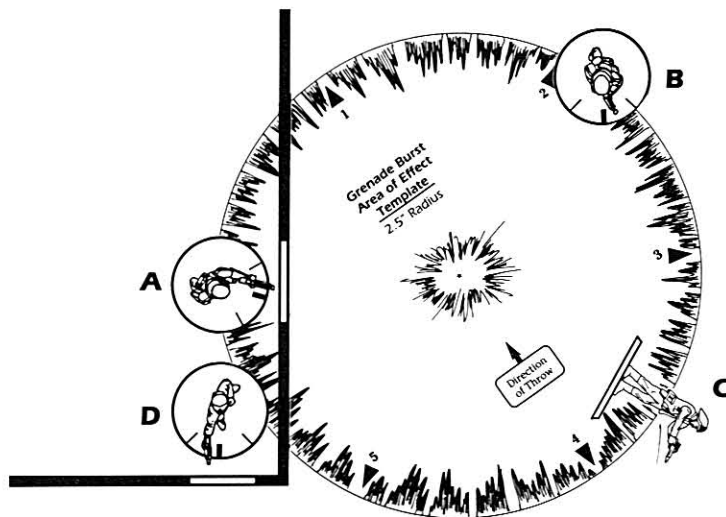

The bases of these four soldiers touch the burst template; all are potential victims of the explosion. Soldier A is separated by a high wall with a window in it; the *grenade's Damage Strength* is reduced by 1, to 3. Soldier B is standing upright with nothing protecting him from the blast; the *grenade's Damage Strength* is 4. Soldier C is prone; the *grenade's Damage Strength* is reduced to 3. Though soldier D's base touches the burst template, he is protected by a high wall, and there are no windows or doors on a direct line between him and the center of the template. He is unaffected by the explosion.

Stephen Crane

If the player picks a target location to which the figure cannot draw a LOS, the grenade automatically deviates before the *grenade* skill test is attempted. After rolling for deviation, the player makes the skill test, but the difficulty of the throw is increased by 3.

A successful roll indicates that the grenade has landed where the initial deviation roll had placed it. If the skill test is not successful, then roll for deviation again, from the point where the grenade previously “landed.” After determining the final location of the grenade, place the Grenade Burst Area of Effect Template at that point and resolve damage normally.

Grenade Damage

A grenade has a *Damage Strength* of 4. A soldier whose base touches the burst template must make an opposed *Strength* roll against the *grenade's Damage Strength*; the results are applied as described for fire combat, above.

If a soldier is separated from the center of the burst template by a high wall with a door or window between him and the explosion, the *Damage Strength* of the explosion is reduced by 1. If there are no doors or windows in a direct line between him and the center of the explosion, he is unaffected by the explosion. The *Damage Strength* of the grenade is reduced by 1 if the target is prone.

Thermal Detonators

Thermal detonators are high-explosive devices which, while not designed to be thrown, may be tossed if the soldier is desperate.

Thermal detonators are targeted in exactly the same way as grenades, though note that their ranges are much shorter than those of grenades. A 2.5" radius burst template is used for a thermal detonator. It should be noted that throwing a thermal detonator at short range is merely an interesting form of suicide — the throwing soldier will be well within the detonator's blast radius.

When throwing a thermal detonator, place the burst template as normal and then make a *grenade* test. If the soldier passes the test, the detonator explodes where he wishes it to. If he fails, it deviates as normal. A thermal detonator has a *Damage Strength* of 8.

Soldiers receive the same benefits of being prone or behind a high wall as they do when hit by grenades. However, a soldier who is separated by a high wall without windows or doors is still affected by the detonator. In such cases, the *Damage Strength* of the detonator is halved.

Thermal Detonators and Walls and Buildings

When a thermal detonator's blast template covers part of a low or high wall, or the side of a building, the force of the explosion makes a door-sized hole in the wall. (These rules are somewhat simplistic; the "Advanced Weapons and Equipment" rules provide more detailed rules for the effects of explosions on walls and those sheltering behind them.)

Archaic Weaponry

Throughout the galaxy, certain primitive soldiers use archaic weapons. These include bows, muskets, and Wookiee bowcasters. For simplicity, these weapons follow the standard rules for blasters, though their ranges and damage are often much lower.

Opportunity Fire

Opportunity fire occurs in the Movement Phase, as squads fire at enemy squads that are in or pass through their LOS. Squads which have moved in the current Movement Phase cannot opportunity fire. Once a squad opportunity fires, it cannot subsequently move during the same Movement Phase.

Any number of squads can use opportunity fire against a single enemy squad, or they may opportunity fire at different enemy squads.

Soldiers cannot throw grenades or thermal detonators during opportunity fire.

If the moving squad is charging into close assault combat, other squads can opportunity fire at it, while the charged squad performs "defensive fire." The charged squad cannot opportunity fire; all it gets is its defensive fire.



■ Archaic arms can still be effective weapons on the field of battle when employed by soldiers who are trained to use them well.

Announcing Opportunity Fire

A player announces that one of his squads is using opportunity fire against a squad which the other player is moving. The player may announce at any time during the squad's move. Once the squad has completed its move, it may no longer be the target of opportunity fire.

In order to be the target of opportunity fire, the moving squad must be within the firing squad's LOS. Also, the firing squad must be able to see at least 2" of the target squad's move (or the entire move, if the moving squad moves 2" or less). If, for example, the target squad ran behind a building and out of LOS of the firing squad, only those soldiers who moved 2" or more within the attacking squad's LOS could be shot at in opportunity fire.

Procedure

In order to conduct opportunity fire, the squad must successfully make a *command* roll as described in the "Morale" section.

Opportunity fire is assumed to take place exactly halfway through the moving squad's move. If this point is out of the firing squad's LOS, the fire takes place at the last point the firing squad could see the moving squad. Then resolve the opportunity fire as for regular fire combat. All normal combat modifiers apply; in addition, the difficulty of opportunity fire is increased by 1.

Casualties fall where the opportunity fire took place; the survivors of the moving squad complete their move. Any morale tests caused by opportunity fire do not occur until the Morale Phase. To act as a reminder that the squad has already fired, it is marked with a *No Fire* marker.

Chapter Four

Close Assault Combat

Close assault combat is a nasty, vicious business, where soldiers seek to come to physical grips with their opponents and overwhelm them with clubs, vibroblades, or simple brute strength. When two squads engage in close assault combat, the fight is almost always to the death; the combat usually ends with one squad broken, fleeing the field of battle.

Summary

To reach the enemy squad it wishes to engage in close assault, the attacking squad makes a “charge” morale test. If successful, the soldiers run toward their enemy. The enemy squad must make a “receiving a charge” morale test; if successful, it will face up to the attack. The charged squad gets to use defensive fire against the charging squad as it rushes their position.

The attacking soldiers cease to move when they come into “base-to-base contact” with the defenders. The soldiers are paired off as evenly as possible (soldiers who outnumber their opponents can “gang up”). Then each pair of soldiers make opposed *melee combat* or *brawling* rolls. The winner may then roll for damage upon the loser.

The side which suffered the least casualties may “force back” the opposing squad. The squads continue to engage in close assault combat in subsequent turns, until one squad “disengages” or becomes broken or destroyed.

Charging

A squad initiates close assault by charging an enemy squad. The player announces the charge at the beginning of the squad’s movement; demoralized or broken squads cannot initiate close assault.

A player cannot measure the distance to an enemy squad before announcing a charge.

“Charge” Morale Test

It takes great courage to charge into close combat with an enemy; only the steadiest squads will do it. Once the player announces the charge, the squad makes a morale test, against a “threat level” of 6 (see “Morale”). Apply the results immediately. If the squad becomes “demoralized” or “broken,” or receives a “withdraw” result, the charge is aborted. Otherwise, it continues.

“Receiving a Charge” Morale Test

If the charging squad passes its morale test, the defending squad must make its own morale test to see if it has the fortitude to stand up to the charge. The test has a “threat level” of 4; results are applied immediately.

If the squad becomes “broken” or receives a “withdraw” result, it is moved immediately, before the enemy comes into contact. The defending squad loses its chance to use defensive fire; it also may not fire in the upcoming Fire Combat Phase. The attacking squad must move to occupy the defenders’ position; if it has any movement remaining, it may continue moving or it may stop there.

If the defenders pass the morale test, they stay to face the attack.

Moving into Contact

Once the morale tests are completed, the charging squad moves at its Run Rate directly toward the defending squad. The charging squad must move directly toward the defenders. It cannot decide to halt its charge simply because the morale tests didn’t come out the way they wanted them to.

Halfway through the charging squad’s move, the defenders get to use defensive fire against the attackers (see below). Survivors continue moving until they are in base-to-base contact with a defender.

Soldiers coming into base-to-base contact stop moving immediately. The charge is considered to be successful if at least one soldier is able to make base-to-base contact with an enemy soldier.

If a squad’s Run Rate is insufficient to bring at least one soldier into contact with a soldier in the target squad, the charge is unsuccessful and the charging squad suffers a -1 reduction in its morale level (see “Morale”).

Defensive Fire

If a squad equipped with ranged weapons is charged from the front and succeeds in its morale test, the squad has the opportunity to use defensive fire against the charging squad.

Defensive fire takes place halfway through the charging squad’s move, or the first place where the charging squad is visible, whichever is closer to the defender. In addition

to the standard fire combat modifiers, there is a +1 modifier to the difficulty of the shot to reflect the hasty nature of the fire.

Incapacitated soldiers are removed immediately; wounded soldiers fall prone where the fire occurred. Survivors continue moving toward the attacking squad. The combat is resolved in the Close Assault Combat Phase.

The Fire Combat Phase

Soldiers in base-to-base contact with enemy soldiers cannot fire during the Fire Combat Phase. Soldiers who charged in the current turn may not fire, nor may soldiers who have used defensive fire in the current turn. Other soldiers may fire normally.

It is very risky to fire at squads engaged in close assault. The fire combat is resolved as normal, except that all visible soldiers of either side are eligible targets; hits are randomly allocated to both friendly and enemy soldiers.

Resolving Close Assault

Close assault combat is resolved in the Close Assault Combat Phase. Once the Fire Combat Phase is completed, any opposing soldiers in base-to-base contact engage in close assault combat.

Pairing Off

Pair off the opposing soldiers in base-to-base contact as evenly as possible. If there are more soldiers engaged on one side than the other, the player with the extra soldiers can have them fight any enemy he chooses, as long as they fight an enemy they are in base-to-base contact with. No more than three soldiers can be in base-to-base contact with a single soldier.

Close Assault Combat Skill Tests

Once the soldiers are paired off, each pairing is resolved separately. The soldiers make opposed skill tests

against each other. Soldiers using melee weapons — vibroblades, gaderffii sticks, clubs or the like — use their *melee combat* skill. Soldiers using bare fists use their *brawling* skill.

Each player rolls a die and adds the soldier's skill, as well as any modifiers which may apply (for example, -1 if the soldier is shaken, or -2 if the soldier is demoralized; see the "Close Assault Combat Modifiers Chart"). The high roller wins the combat and may inflict damage on the loser. There is no effect in the case of a tie.

If multiple soldiers are fighting a single soldier, the lone soldier chooses whom he wishes to attack, then all soldiers make their opposed rolls. If the single soldier beats the soldier he is attacking, he may damage him. If the single soldier beats the soldier(s) he is not attacking, he cannot damage that soldier, but he avoids being hit by that soldier. If any of the outnumbering soldiers' rolls beat the single soldier's roll, they hit him.

Close Assault Combat Modifiers Chart

Charging (1st turn only)	+1
Defending barrier	+1
Outnumbering opponent (per each additional soldier)	+1
Standard melee weapon	+1
Vibroaxe or -blade	+2
Lightsaber	+4
Attacked from side or rear	-2
Prone	-2
Separated from squad	-1
Shaken	-1
Demoralized	-2

Close Assault Modifiers

Charging: Soldiers who charge into combat gain a +1 bonus to their close assault rolls on the first turn of combat. If the combat continues, the bonus is lost.

DIAGRAM 11
Pairing Off

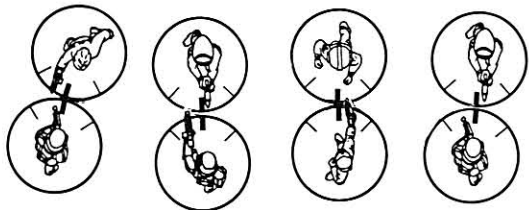

An equal number of opposing soldiers are paired off one on one.

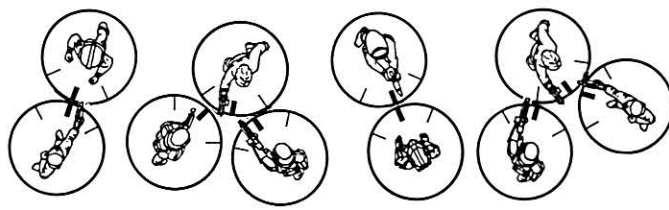

If there are more soldiers engaged on one side than the other, the player with the extra soldiers can have them fight any enemy he chooses, as long as they fight an enemy they are in base-to-base contact with.



■ On the desert world of Tatooine, a squad of Jabba the Hutt’s Gamorrean guards deals with a scouting party of Tusken Raiders who have wandered a little too close to the crimelord’s palatial summer estate.

Defending Barrier: Defending soldiers behind a barrier fight at +1.

Outnumbering Opponent: Soldiers gain a +1 bonus for each soldier they outnumber the enemy by. For example, if two soldiers are fighting one, the two soldiers both gain the +1 bonus. If three were fighting one, the three soldiers would each gain a +2 bonus. No more than three soldiers can fight a single soldier.

Standard Melee Weapon: Soldiers equipped with standard melee weapons — clubs, knives, swords, etc. — are better equipped to fight than soldiers without weapons and gain a +1 bonus.

Vibroaxe or blade: Powered weapons give their users a distinct advantage in close assault. Soldiers wielding vibroblades or axes gain a +2 bonus.

Lightsaber: The ultimate in close assault weapons, the lightsaber is a deadly weapon giving its user a +4 bonus.

Attacked From Side Or Rear: Soldiers attacked in the side or rear are at a great disadvantage: they fight at -2.

Prone: Prone soldiers fight at -2.

Separated From Unit: Soldiers separated from their squad cannot initiate close assault; if attacked they fight at -1.

Shaken or Demoralized: Adverse morale affects a squad’s ability to fight effectively.

Example: A single Rebel soldier fights off two Imperial stormtroopers. All are using bare fists; all have *brawling* skills of 3; the Imperials receive a bonus of +1 to their rolls because they outnumber their opponent by one.

The Rebel player decides that the Rebel soldier will fight the stormtrooper on the left. The single

Rebel rolls a 3, for a result of 6. The Imperial soldier on the left rolls a 2, adding the soldier’s *brawling* skill of 3 and the +1 bonus, giving a result of 6 also. This is a tie: neither soldier takes damage. The other stormtrooper rolls a 1, a bomb-out, for a final result of 0. The Rebel’s result of 6 beats him soundly, but as the Rebel was fighting the other stormtrooper, the Imperial takes no damage.

Damage

If one soldier beats the other’s roll, the soldiers make opposed rolls, comparing the *Damage Strength* of the winner against the loser’s *Strength*. The winner’s *Damage Strength* is the soldier’s *Strength*, plus his melee weapon’s *Damage Strength*; brawling soldiers just use their *Strength* attribute. Damage is determined in the same way as for fire combat: compare the rolls and consult the “Damage Table.”

Example: A Rebel and a pirate are engaged in close assault combat. The Rebel beats the pirate’s skill roll; the two players now check to see if the Rebel damaged his opponent. The Rebel has a *Strength* of 2 and is using a vibroaxe (*Damage Strength* 2). The pirate has a *Strength* of 3. The Rebel’s *Damage Strength* is 4 and the pirate’s *Strength* is 3. The Rebel rolls a 3, for a total of 7. The pirate rolls a 5, for a total of 8. Checking the “Damage Table,” we see that the *Damage Strength* roll is less than the *Strength* roll, so the pirate is not hurt by the attack.

If more than one soldier hits a single soldier, the lone soldier makes a single *Strength* roll and compares it to each of his opponents’ *Damage Strength* rolls individually.

Force Back and Advance After Combat

After the close assault combat has been resolved, compare the number of soldiers wounded and incapacitated on each side. The squad which has received the most casualties that turn has been forced back. If both squads have received the same number of casualties, neither is forced back.

A squad which is outnumbered (has less than half as many soldiers as the opposing squad) cannot force back the opposing squad, even if it inflicted more casualties than it received.

A squad which has been forced back retreats 4" directly away from the attacking squad while retaining the same facing. The opposing squad advances the same distance, remaining in base-to-base contact.

A squad cannot be forced back through certain barriers: doors, windows, walls and impassable terrain will halt the squad's backward movement.

A squad defending behind a barrier is not required to advance after combat. If a squad not behind a barrier does not wish to advance after combat, the commander must pass a difficulty 6 *command* test to stop his men from advancing in the heat of the battle.

The Morale Phase

During the Morale Phase, any squads which have taken casualties make morale tests. If a squad engaged in close assault combat becomes "Broken" or receives a "Withdraw" result, the other squad gets a "parting swing" at the squad as if they were disengaging (see "Disengaging," below).

The Movement Phase and Close Assault Combat

Soldiers in base-to-base contact with enemy soldiers cannot move except to change their facing. If a soldier in a squad involved in close assault combat is not in base-to-base contact with an enemy soldier, he can stay where he is and change his facing; if he moves, he must move directly toward an enemy soldier fighting his squad. Alternatively, the entire squad may attempt to "disengage" from the close assault combat.

Disengaging

Squads engaged in close assault combat normally keep on fighting each other until one side is eliminated or breaks. However, a squad may attempt to disengage from close assault.

The player attempting to disengage must make a difficulty 6 *command* test. If he succeeds, the squad turns 180 degrees and moves away from the enemy squad at its Run Rate.

While disengaging, the squad exposes itself to a parting swing. The enemy squad gets one free close assault attack at the disengaging squad. The attack is resolved immediately. The attacking squad receives a +2 modifier for attacking from the rear; if a disengaging soldier wins, he cannot hurt the enemy, he merely avoids taking damage himself. A squad which disengages has its morale reduced by 1 (see the "Morale" section).

Chapter Five

Morale

Morale is often the deciding factor in a battle. Morale affects how well a squad fights and its willingness to fight. It also determines whether soldiers perform actions such as opportunity fire or close assault. In the Morale Phase squads which have taken casualties make morale tests; other squads may attempt to improve their morale by rallying; and broken squads which fail to rally are moved. During the Movement Phase, squads who wish to charge, test to see if they do so, and those being charged test to see whether they stand up to the charge.

Morale Levels

When created, each squad is rated as average, veteran, or elite. In general, elite squads are better trained, equipped and led than veterans, who in turn are better than average squads. However, often the most important difference between them is their “morale level.” Elite squads begin with morale levels of 7, veteran squads with 6, and average squads with 5.

In addition to its morale level, a squad’s coolness under fire is determined by its commander’s *command* skill. An average squad led by a good commander is more likely to keep its head than one led by a poor commander.

As a squad takes casualties, its commander has to use his *command* skill to make morale tests to keep his squad in action. The more casualties, the more difficult the test. If the commander is unsuccessful, his squad’s morale declines, possibly to the point where it flees from the battle.

Squads begin the game with steady morale. If their morale level declines to the point where they are shaken, their combat skills begin to suffer. If they become demoralized, their combat skills will become even worse; in addition, they will not be able to advance towards the enemy. If the squad is broken, it flees from the battle altogether.

If a squad was not involved in close assault combat, or did not fire this turn, the commander may attempt to “rally” his squad to improve its morale level.

Keeping Track of a Squad’s Morale

You keep track of a squad’s morale level on the Morale Level Track on the Squad Record Sheet. At the beginning of the game, blacken in the boxes to the left of the squad’s

starting morale level. During play, cross off boxes as the squad’s morale declines; erase the crosses if the squad’s morale subsequently increases. A squad’s morale level cannot increase past its starting level.

Morale Statuses

As described above, a squad begins the game with steady morale. After a while in combat, it may become shaken, then demoralized, and finally broken.

Steady Morale: Morale Level 4 or Higher

This is the starting morale for each squad. Squads with steady morale are in good shape and fight without any morale level penalties.

Shaken: Morale Level 2–3

The difficulty of all *blaster*, *blaster artillery* and *grenade* skill tests for shaken squads is increased by 1. Soldiers engaged in close assault combat suffer a -1 modifier to their *melee combat* or *brawling* rolls.

In addition, the threat level of subsequent morale tests is increased by 1.

Demoralized: Morale Level 1

The difficulty of all *blaster*, *blaster artillery*, and *grenade* skill tests for a demoralized squad is increased by 2. Soldiers engaged in close assault combat suffer a -2 modifier to their *melee combat* or *brawling* rolls.

A demoralized squad cannot advance towards a visible enemy soldier, but it may move parallel to or away from enemy soldiers. It cannot attempt opportunity fire.

In addition, the threat level of subsequent morale tests is increased by 2.

Broken: Morale Level 0

Broken squads break and rout. When it first breaks, a broken squad immediately makes a full run move away from the enemy, heading, if possible, for the “rally point” (see “Rally Points”) or the nearest table edge. If there are enemy soldiers closer to its “rally point” or table edge than the routing squad is, the squad breaks for the closest unblocked table edge.

At the beginning of each Morale Phase, a rally test (see “Rally Test”) is made for the broken squad. If the test is



■ A squad of Anointed People advances into combat with invading stormtroopers for the greater glory of the Godking of Masterhome. (Assorted lizard man figures by Grenadier Models, Ral Partha and Martian Metals. Hut by Gallia Reproductions.)

successful, the squad halts and can be moved normally in subsequent Movement Phases. If the test is failed, the squad is moved at its Run Rate towards its “rally point” or the table edge.

Note: Broken squads are moved in the Morale Phase; not in the Movement Phase.

Once it has reached the “rally point” or a table edge, the squad stops moving. In the next Morale Phase, it has one last chance to “rally.” If the squad fails this rally test, it is immediately removed from play: all soldiers in the squad have scuttled, are in hiding, or have been captured.

During its flight, the squad abandons all assembled weapons. All skills, except the commander’s *command* skill, are reduced to 0. The squad cannot fire or initiate close assault combat.

Morale Tests

Three types of morale test are used: casualty morale tests, charge morale tests, and receiving a charge morale tests. Casualty morale tests are made in the Morale Phase by squads which suffered one or more casualties during the current turn. This is the most common type of morale test, and it is described below.

Charge and receiving a charge morale tests occur in the Movement Phase when one squad attempts to charge another. These two morale tests take additional factors into account, such as whether one side outnumbered the other, and whether the charge is against the enemy’s side or rear.

All three morale tests are made in a similar manner using opposed rolls. The player rolls a die and adds the commander’s *command* skill, or the squad’s *command* skill, if the commander has been incapacitated; the

opposing player rolls a die and adds the appropriate “threat level” listed below.

Morale Test Chart

Morale Test Type	Threat Level
Casualty	4
Charging	6
Receiving a Charge	4

Standard Threat Level Modifiers*

Shaken	+1
Demoralized	+2
Each casualty taken this turn	+1
Commander wounded or incapacitated this turn	+2
Squad is behind cover	-1
Squad wins turn of close assault	-1
Squad loses turn of close assault	+1

“Charge” Modifiers**

Attacking enemy’s flank or rear	-2
Attacking enemy behind barrier	+1

“Receiving a Charge” Modifiers***

Attacked in flank or rear	+2
Outnumbered 2:1	+2
Each following fire weapon in the squad	-1

*apply to all situations

** apply to charging squads only

*** apply to squads receiving a charge

Standard Threat Level Modifiers

The threat level is modified according to the following circumstances:

Shaken or Demoralized: As a squad's morale level declines it becomes harder for it to pass morale tests.

Each Casualty Taken This Turn: As well as triggering casualty morale checks, the number of casualties taken by a squad in the current turn increases the difficulty of the test. For each soldier wounded or incapacitated this turn, the threat level increases by +1.

Commander Wounded or Incapacitated This Turn: The wounding or loss of a squad's commander increases the threat level of the first morale test after the commander is hit by +2.

Squad is Behind Cover: A stationary squad within 1" of cover terrain between it and enemy squads has its threat level reduced by -1.

Squad Wins/Loses Turn of Close Assault: A squad which forces back its opponent in close assault has a -1 modifier to its threat level, if it needs to test morale in the following Morale Phase. Squads which have been forced back have their threat levels increased by +1.

"Charge" Modifiers

These are applied to squads which are attempting to charge. They are in addition to standard threat level modifiers.

Attacking Enemy's Flank or Rear: A flank or rear attack is one where the charging squad, because of the direction of its charge, avoids 50% or more of the enemy squad's fire arcs.

Attacking Enemy Behind Barrier: If the enemy squad is directly behind a barrier, and the attacking squad must attack across the barrier, the charging squad's threat level is increased by +1.

"Receiving a Charge" Modifiers

Attacked in Flank or Rear: A squad is less likely to pass its morale test if attacked in the side or rear. If less than 50% of the squad's members could fire on the charging squad, its threat level is increased by +2.

Outnumbered 2:1: If charged by a squad which has at least twice as many members as the defending squad, the threat level is increased by +2.

Each Following Fire Weapon in the Squad: Heavy weapons with their capability for following fire inspire confidence. For each following fire weapon that a squad has, its threat level for receiving a charge is decreased by -1.

Morale Test Results

Compare the two rolls on the table below to determine the results of the test. A result can never reduce a squad's morale to below 0; ignore any excess morale loss.

Morale Test Results

Roll	Result
TR+4 ≤ CR	Morale +1
TR ≤ CR	No Effect
TR > CR	Morale -1
TR ≥ CR+4	Morale -2; Withdraw

TR = Threat Roll; CR = *Command Roll*.

Explanation of Results

Morale +1: The squad's morale level actually increases by 1. A squad's morale level cannot increase beyond its starting value.

No Effect: The squad's morale is unchanged.

Morale -1: The squad's morale level decreases by 1, possibly causing it to become shaken, demoralized, or broken.

Morale -2; Withdraw: The squad's morale level decreases by 2, possibly causing it to become shaken, demoralized, or broken. In addition, the squad immediately withdraws 4" away from the closest enemy squad. Ignore terrain costs; simply move the squad 4". The squad's player may give the soldiers in the squad any facing he wishes. If this result causes the squad to become broken, ignore the "Withdraw" rules: the broken morale level takes precedence.

Example: An Average squad of 10 (starting morale level: 5) suffers its first casualty. During the next Morale Phase, it must make a morale test. Its commander's *command* skill is 3.



■ Charging into a hail of blaster fire requires courage, a characteristic which is not in short supply on either side of the conflict.

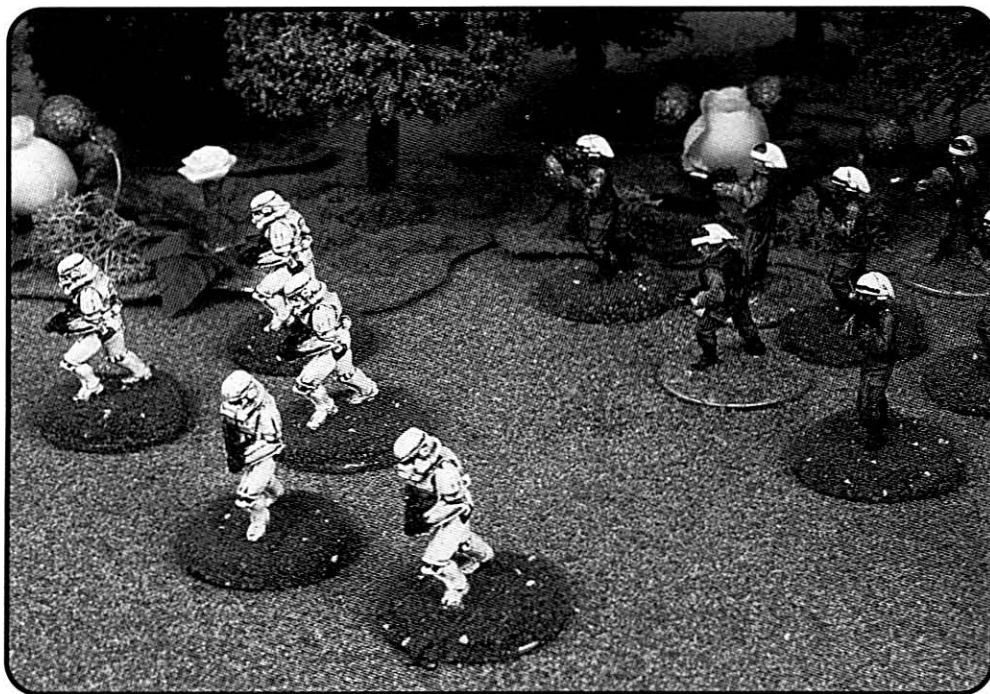

■ The best-laid plans of a field commander can collapse into ruins if a squad breaks and runs at an inopportune moment.

Receiving a Charge

When a squad is receiving a charge — that is, another squad is charging it, it must make a morale test with a threat level of 4. The morale test takes place after the charging squad's morale test, but before the defending squad's defensive fire.

The results of the morale test are applied immediately. If the squad becomes broken, it immediately routs away from the attackers; if it receives a "Morale -2; Withdraw" result, it withdraws 4" away. Otherwise, it stands.

If less than half its number are charging it, a squad does not have to make a morale test. If charged in the flank or rear, the squad must always make a test, regardless of how many soldiers are charging.

The squad's player must roll a die and add his *command* skill of 3. He rolls a 1 — uh oh, bomb-out — for a *command* roll of 0. The opposing player rolls a 3, plus 4 for the threat level, and plus 1 for the casualty, for a final threat roll of 7. The threat roll is greater than or equal to the *command* roll +4, so the squad's morale level is reduced by -2 and it must withdraw 4". The squad's new morale level is 3; the squad is shaken.

Casualty Morale Test

Casualty morale tests must be made in the Morale Phase by any squad which has suffered a casualty during the current turn. The threat level of the test is 4.

Charging

When a player announces that a squad is charging another squad (see "Close Assault Combat"), the squad must make a morale test before moving. The threat level of the test is 6.

The results of the morale test are applied immediately. If the squad becomes demoralized or broken, or if it receives a "-2 Morale; Withdraw" result, the charge is aborted.

If a squad contains at least twice as many soldiers as the enemy squad, it does not need to make a morale test, unless the enemy squad contains an assembled heavy weapon, in which case a normal morale test must be made.

Rallying

During the Morale Phase, squads with lower than starting value morale may attempt to rally. To be eligible to rally, soldiers in the squad must not have fired their weapons or engaged in close assault combat this turn. Also, there must be no enemy soldiers within 12" of the rallying squad.

To make a rally test, the player controlling the squad makes an opposed roll; the squad commander's *command* skill against the rally threat level. The base threat level of the test is 4.

Rally Test

Rally Threat Level: 4

Rally Test Threat Level Modifiers

Squad is behind cover	-1
Squad is Shaken	+1
Squad Demoralized or Broken	+2
Squad has taken 50% or more casualties	+2
Each casualty taken this turn	+1
Commander wounded or incapacitated this turn	+2

Rally Test Results

RR ≥ CR	No Effect
RR < CR	Morale +1
RR+4 < CR	Morale +2

RR = Rally Threat Level Roll; CR = *Command Roll*.

Example: A squad has been broken and is fleeing the field of battle. Last Morale Phase it reached the table edge and stopped; it must rally in the current Morale Phase or it will leave the table — and the game — for good. The commander of the squad has been incapacitated this turn; the acting commander (a standard squad member) has a *command* skill of 3. The rally difficulty is the base difficulty of 4, +2 because the squad is broken, +2 because the commander of the squad was incapacitated this turn — 8 altogether.

The squad's player rolls a die and adds 3; the opposing player rolls a die and adds 8. If the squad's player rolls higher (unlikely, but don't forget rollovers and bomb-outs), the squad's morale level increases to demoralized or shaken, and it does not run off the table.

Rally Points

When a squad routs, it heads for its rally point. Rally points are places on the battlefield where panicking soldiers feel safe enough to attempt to regroup. Normally, this is the spot where they entered the battle (the table edge they came on from); however, in certain situations, they may have different rally points.

For example, if a squad is defending a wall surrounding a city, its soldiers are not likely to break for a table edge. Instead, they will run to the safest part of the city, typically the center. These areas are designated "rally points." Both players must agree upon rally points before play begins, or the gamemaster may designate them.

If a rally point is on a table edge, and the squad fails its final "rally" attempt, it scoots right off the table. If the rally point is in the center of the table, the squad is assumed to disperse — into basements, ditches, the underbrush, a nearby bar, wherever — and are removed from play.

Opportunity Fire

The test to conduct opportunity fire is made in a manner similar to morale tests, but the squad does not suffer any reductions or increases in its morale level. The player makes an opposed *command* roll against a threat level of 4. Demoralized and broken squads cannot attempt opportunity fire.

Opportunity Fire Test

Opportunity Fire Test Threat Level: 4

Opportunity Fire Test Threat Level Modifiers

Squad is behind cover	-1
Squad is Shaken	+1
Squad has taken 50% or more casualties	+2

Opportunity Fire Test Results

OF ≥ CR	Cannot Fire
OF < CR	Can Fire

OF = Opportunity Fire Threat Level Roll;
CR = *Command* Roll.

Squads which fail their *command* roll cannot move, but may fire normally in the Fire Combat Phase.

Chapter Six Terrain

The effects of terrain on movement and combat have already been described in the “Movement,” “Fire Combat” and “Close Assault Combat” sections. This section describes specific terrain types and summarizes their effects in the “Terrain Effects Chart.” Several common terrain types are described below. More exotic terrain is covered in the Advanced Rules (see “Advanced Terrain”).

Terrain Types

Clear Terrain

Relatively level, unobstructed terrain, such as a grassy meadow or a rolling plain. Terrain of this sort does not interfere with movement and provides no cover. LOS is unobstructed by clear terrain.

Scrub or Brush

The ground is covered with shrubs, bushes, and small trees. Scrub or brush is represented on the tabletop by placing pieces of lichen on a piece of card or model terrain. Scrub or brush is considered rough terrain for movement purposes and light cover for combat effects. LOS is not affected by scrub or brush.

Woods

Woods are determined by scenario (or by mutual choice of the players before the game). They are represented by tree models scattered across a piece of card or model terrain which denotes the edges of the wood. The entire area is considered to be wooded; the models themselves represent particularly heavy clumps of trees. In addition, a soldier’s LOS may be blocked if it passes through the wooded area.

Light Woods: There are not many trees, and they tend to be scattered. This is rough terrain and light cover. LOS extends for 8”.

Medium Woods: Contains more trees than light woods. This is still rough terrain, but provides medium cover. LOS extends for 6”.

Heavy Woods: With many trees growing close together, this is very rough terrain and provides heavy cover. LOS extends for only 4”.

Swamp or Marsh

Wet, spongy land which is saturated, and in places covered, with water. This is considered very rough terrain. Tree growth can be the equivalent of light, medium or heavy woods, and therefore the cover provided and the effects on LOS vary as the corresponding woods designation. This is determined by the scenario or by mutual agreement. (A swamp like the one on Dagobah would be very rough terrain and provide heavy cover; LOS would extend for 4”.)

Hills

Hills are classified as either easy or difficult. Hills over two meters high block LOS; soldiers on the other side of hills cannot be seen.

Easy hills: When the horizontal distance between one-meter contour lines is greater than 1/2” the hill is easy (see Diagram 12). Easy hills are rough terrain. If a soldier is firing over the edge of the hill, it provides medium cover.

Difficult hills: If the distance between one-meter contours is 1/2” or less, the hill is difficult. Difficult hills are very rough terrain and provide medium cover as above.

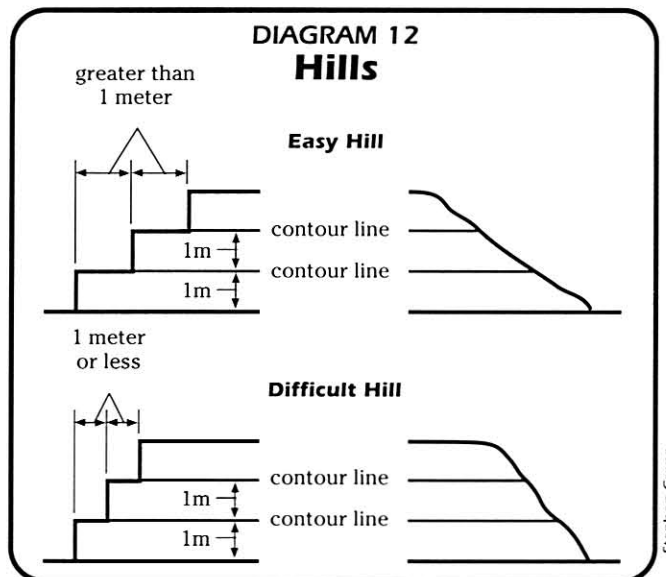

Woods and Visibility

Woods have many effects on combat. In addition to the terrain cost and cover listed under "Terrain Types," they also affect LOS. Because of the number of trees and their density in a given area, it is simply impossible to see anything too far away. The more trees there are, the less the distance a soldier can see. What a soldier can't see, he can't fire at.

If enemy squads meet in the woods, neither can fire at the other until they come within LOS. When they do, each squad will have the benefit of cover for being in the woods.

If one squad is in woods and an enemy squad is not, neither squad can see the other as long as the

squad in the woods is further from the edge of the woods than the LOS extends.

If the squad is within LOS of the edge of the woods, both sides can see and fire at each other. They will both still suffer a fire modifier for cover (cover is derived from having to shoot through the woods).

However, if a squad is in the woods, but within 1" of the edge, it can fire out of the woods with no fire modifier while still drawing the benefits of cover for itself.

The example below demonstrates the various effects of woods.

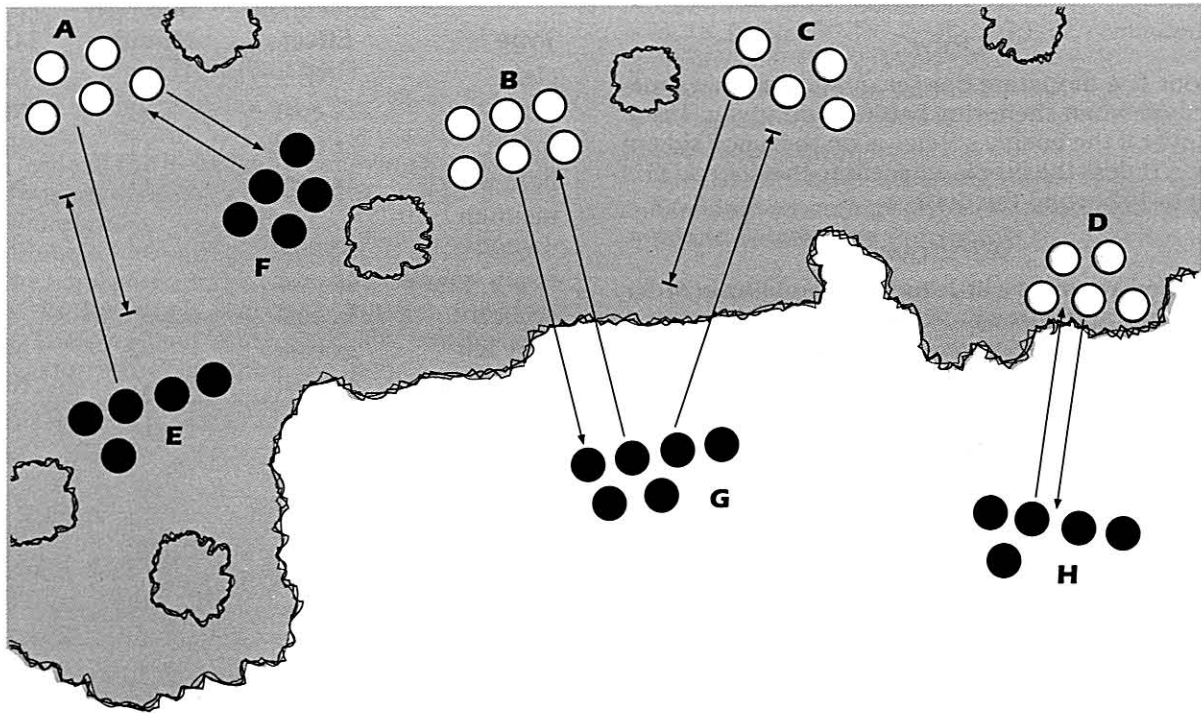

Example: A Rebel strike force, approaching through medium woods, has encountered an Imperial force in a clearing. Medium woods limit LOS to 6" and add a +2 modifier to fire combat for their covering effect.

Rebel squad A is approached by two Imperial squads in the woods. It cannot yet see Squad E, which is more than 6" away, and Squad E cannot see Squad A. Squads A and F are within 6" of each other and can see, and therefore fire at, each other. Their difficulty numbers are increased by +2 for firing through the woods.

Rebel squad B is 5" from the edge of the woods

and can therefore see beyond the edge to Imperial squad G. B and G can fire at each other but also at +2, since they must fire at each other through woods.

Rebel squad C has not yet made it to within 6" of the edge and cannot see squad G. Likewise, Imperial squad G cannot see far enough into the woods to see squad C.

Rebel squad D is within 1" of the edge of the woods, so it can see Imperial squad H, and H can see D. If squad H fires at squad D it must do so at +2 to the difficulty number. Squad D can fire at H with no modifier.

Creeks

Creeks are generally 3" across or less and count as rough terrain. They provide light cover for soldiers standing or moving in them and do not affect LOS.

Streams

Streams range from three to six inches across. They are very rough terrain and provide medium cover for soldiers in them. They do not affect LOS.

Barriers

Barriers are linear obstacles that present difficulties to movement and provide protection from fire. Barriers are cover terrain. Cover can be claimed only if a soldier is within 1" of the barrier. If an enemy soldier is also within 1" of the barrier, no cover can be claimed.

The more common types of barriers are described below.

Door

A door is a moderate barrier. A soldier draws medium cover when sheltering behind a doorway. There is no cover if the enemy soldier is on the same side of the door. Unless the firer is adjacent to the door, LOS is limited to 1" beyond the door.

Window

A window requires a little more scrambling in order to climb up and through. It is a difficult barrier. A window provides heavy cover to a soldier on the other side of it. Unless the firer is adjacent to the window, LOS extends for only 1" beyond it.

Walls

Walls are classified as being high or low.

Low walls: Freestanding walls and fences that are waist-high or lower are moderate barriers, and provide medium cover. LOS is not blocked by a low wall. However, prone soldiers behind a wall can only be fired at if the firer is directly on the other side of the wall.

High walls: High walls or fences are difficult barriers. Normally a soldier cannot be fired at if he is behind a high wall, but in cases where a shot is possible, high walls provide heavy cover. LOS is blocked by a high wall (except that soldiers with a height advantage can see over them; see "Blocking Terrain" in the "Fire Combat" section).

Barbed Wire

Barbed wire or the equivalent is a difficult barrier and provides no cover. LOS is not affected by barbed wire.

Trenches

Trenches, ditches or other depressions are either shallow or deep

Shallow trench: A trench which is as deep as half the height of a man, or less, is a moderate barrier. It provides medium cover to soldiers within the trench and does not affect LOS, except that there is no line of sight to a soldier who is prone within it, unless the firer is adjacent to the trench.

Deep trench: A trench which is deeper than a shallow trench counts as a difficult barrier and provides heavy cover when a shot is possible. LOS is affected as for shallow trenches.

Terrain Effects Chart

Type	Movement Effect	Fire Combat Difficulty Modifier	LOS
clear	NE	NE	NE
scrub	2x cost	+1	NE
brush	2x cost	+1	NE
light woods	2x cost	+1	8"
medium woods	2x cost	+2	6"
heavy woods	4x cost	+3	4"
swamp	4x cost	*	*
easy hill	2x cost	+2	NE
difficult hill	4x cost	+2	NE
creek	2x cost	+2	NE
stream	4x cost	+3	NE
Barrier Type			
door	2"	+2	1" beyond
window	4"	+3	1" beyond
low wall	2"	+2	NE
high wall	4"	+3	up to wall
barbed wire	2"	NE	NE
shallow trench	2"	+2	NE
deep trench	4"	+3	NE

NE = No Effect

*The effects of swamp on fire combat and LOS depend on whether the foliage is equivalent to light, medium or heavy woods.

Chapter Seven Introductory Scenario

Like Rats in a Trap

“Like Rats in a Trap” is an introductory scenario designed to quickly get you into a game of *Star Wars Miniatures Battles*.

The Situation

Imperial Intelligence has set a trap for Rebel forces operating on Vendrak V. They have planted information to mislead the Rebels into believing that a hangar at the starport contains weapons that would be useful to the Rebel cause.

The Rebels have obligingly taken the bait and entered the hangar under the cover of darkness with two squads. As the Rebels search the hangar, the trap is sprung. The overhead lights go on and two squads of Imperial stormtroopers enter the hangar.



■ Rebel soldiers are thankful for the large amounts of cargo strewn about the hangar, as they draw heavy cover from crates and bales in their desperate bid for freedom. Model railroad shops provide a good source of inexpensive props, such as the cargo containers shown here.

Rebel Forces

“Victor” squad:

- 7 Veteran Hoth Troopers.
- DEX 3, *blaster* 5; KNO 2; MEC 2; PER 2, *command* 4; STR 3, *brawling* 4; TEC 2; Move: 10.
- **Walk Rate:** 8"; **Run Rate:** 13".
- **Weapons:** blaster rifle.
- **Commander:** *command* 5.
- **Specialist:** *blaster: repeating blaster* 5.
Weapon: repeating blaster (standard configuration).
- **Squad Generation Points:** 399

“Bravo” Squad:

- 9 Average Standard Rebel Troopers.
- DEX 3, *blaster* 4, *melee combat* 5; KNO 2; MEC 2; PER 2, *command* 4; STR 2, *brawling* 4; TEC 2; Move: 10.
- **Walk Rate:** 8"; **Run Rate:** 13".
- **Weapons:** hunting blaster, vibroblade.
- **Commander:** *command* 4.
- **Specialist:** *blaster* 5.
Weapon: repeating blaster (standard configuration).
- **Squad Generation Points:** 442

Imperial Forces

Two Identical Squads

- 10 average Stormtroopers.
- DEX (1), *blaster* (3); KNO 2; MEC 2; PER 2; STR 2 (3), *brawling* 4; TEC 2; Move: 10.
- **Walk Rate:** 6"; **Run Rate:** 11".
- **Weapons:** blaster rifles.
- **Commander:** *command* 3.
- **Specialist:** *blaster: repeating blaster* (3).
Weapon: repeating blaster (tripod-mounted).
- **Squad Generation Points:** 436

The Battlefield

The battle takes place inside a large hangar and can easily be set up on a small table. The edges of the table represent the sides of the hangar. The walls of the hangar have been magnetically sealed, making them

DIAGRAM 13
"Like Rats In a Trap" Set-up Map

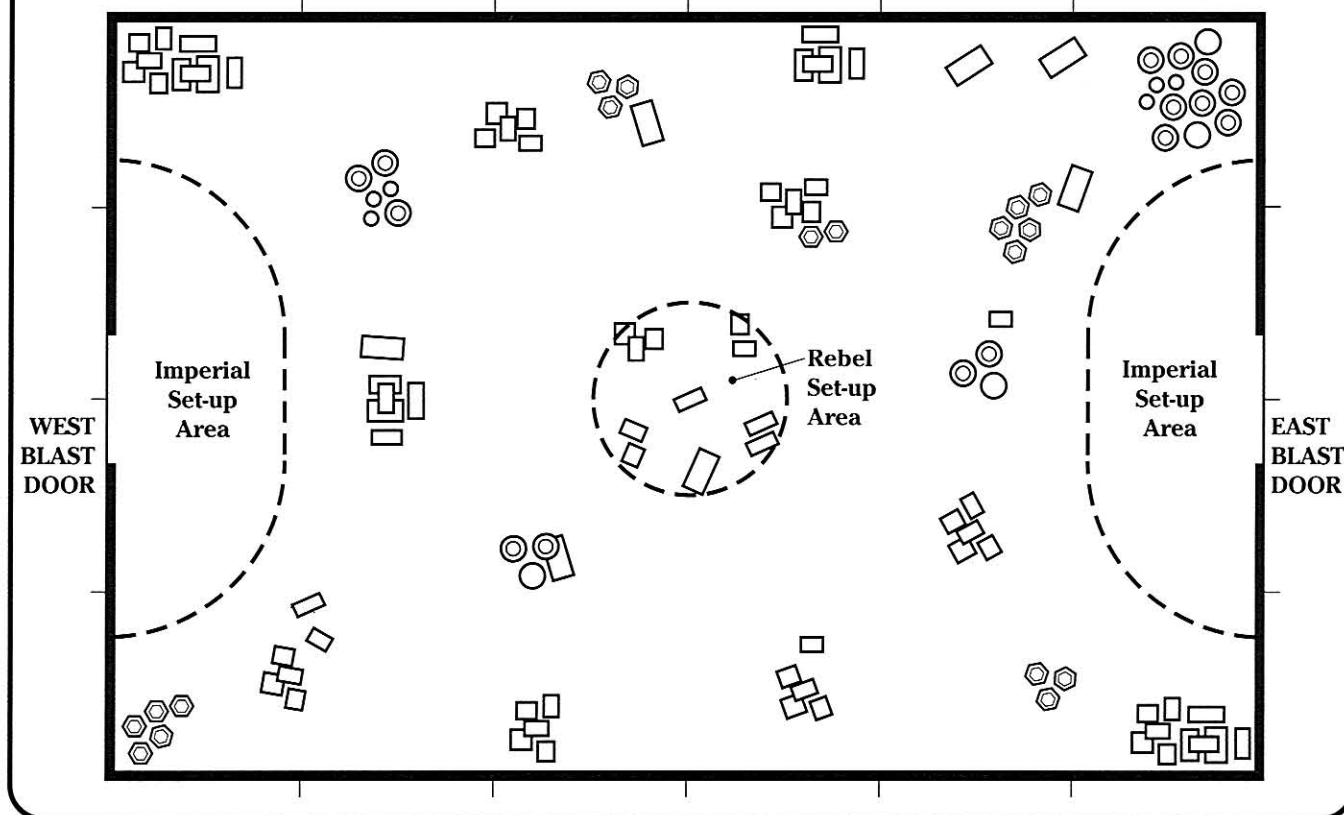

Stephen Crane

impervious to blaster fire. If any soldier fires directly at the wall, roll 1D; on a roll of 6 the shot bounces back to hit the character, otherwise it ricochets harmlessly.

The crates and boxes are one meter tall and provide medium cover. They contain only packaging. There are hundreds of overhead light panels which illuminate the hangar. It is obvious that there are too many lights for the Rebels to shoot them all out.

The blast doors to the east and the west are open and remain so throughout the battle.

The Set-up

The Rebels set up first in the center of the table. All Rebel forces must be within 6" of the crate in the middle of the room. They may have any facing.

One Imperial squad is set up within 11" of each blast door.

Objectives

The Rebels have to escape from the trap by getting at least one trooper from each squad through either or

both blast doors. The Imperials win if they prevent the Rebels from escaping.

Reinforcements

In the Special Action Phase of each turn the Imperial player rolls 1D. On a roll of 6, a squad of stormtrooper reinforcements become available. Reinforcements enter through one of the blast doors in the next Movement Phase. Roll 1D: on a roll of 1-3 they enter from the east; on a roll of 4-6, from the west.

The Rebels receive no reinforcements.

Suitable Models

The Rebels can be represented by any figures in the *Rebels* and *Rebel Troopers* blister packs (40405, 40406, 40413), as well as the *Rebel Commandos* packs (40414, 40417). *Stormtroopers* packs (40403, 40404, 40409, 40416) will, of course, provide stormtroopers.

Chapter Eight Creating Squads

Preparation

Before playing a game you need to select your army. The basic fighting unit is the soldier. As described in “Soldiers and Squads,” soldiers are grouped into squads. A squad contains a number of soldiers who are equal in abilities. It may also contain a commander and one or two specialists.

Squad Generation Points

A soldier’s abilities are what make him an effective fighter, along with the weapon or weapons he carries. In order to compare the relative values of different soldiers, these attributes and weapon values have been quantified into Squad Generation Points (SGPs).

SGPs are a measure of the soldier’s fighting trim, his training and the weapon(s) he carries; essentially, his fighting value. SGPs make it possible to compare how effective different soldiers are. When creating armies for a battle, SGPs allow you to determine a balanced force mix, or to see just how badly those Rebels are outclassed.

Squad Generation Points can be given as part of a scenario, determined by the gamemaster, or mutually agreed upon by two friendly players who want to slug it out. Our experience has been that 1000-2000 points per side makes for a good game.

Once the points are determined, it’s time to “buy” your armies.

Squad Generation

To begin, get a blank copy of a Squad Record Sheet. Next determine what type of soldier you’d like to have. We have provided a Troop List at the back of the book; this lists some basic troop types for both sides of the conflict, as well as some interested neutrals.

Your troops could also be based on player characters or gamemaster characters from *Star Wars: The Roleplaying Game*. The attributes and skills are the same. However, we suggest reserving your player characters for the Heroes (see “Heroes” in the “Advanced Game”) in your army. The basic soldier is a standard rank-and-file type of guy; to have a squad of hero-quality troops is highly unlikely (and would cost a lot of SGPs).

The Troop Lists

The troops listed are some of the standard troop types found on both sides of the Rebellion. Following is an explanation of the terms used in the lists.

DIAGRAM 14 Troop Listing

Hoth Trooper

Quality: Elite
Size: 3-10.
DEX: 3
KNO: 2
MEC: 2
PER: 2
STR: 3
TEC: 2
Move: 10
Skills: Level 3 — any.
Weapons: Any.
Armor: None.
Commanders: Level 3.
Specialists: Level 3 — any.

Stephen Crane

Quality: How effective this soldier is on the battlefield. Troops can be either average (basic training; little or no combat experience), veteran (experienced troops with better training) or elite (battle-hardened survivors). The higher the quality of a soldier, the stronger his morale, and the less likely he is to crack in battle.

Size: This is the number of soldiers in a typical squad.

DEX, KNO, MEC, PER, STR, TEC: These are the basic attributes of the soldier (explained in “Soldiers and Squads”). Troops who always wear armor have their DEX and STR already modified for armor. These adjusted values are shown in parentheses.

Move: This represents a soldier’s basic movement capability, and can vary by species. In *Star Wars Miniatures Battles*, a soldier’s Move is modified by his *Dexterity* to determine his Movement Rates.

Skills: Listed here is how much a given skill or skill specialization can be improved. The training level is the maximum amount a skill or specialization may be

increased by. Only listed skills or specializations, or those found under the listed attributes, can be increased.

Weapons: The soldier can be trained to use any of the weapons listed here.

Armor: This states what armor, if any, may be worn by the troops. It costs additional SGPs to equip troops with armor (see "Advanced Weapons and Equipment"). If an entry is listed as "free," these troops are automatically equipped with armor at no cost in SGPs.

Commanders: Commanders can increase their *command* skill up to the training level given here. "None" indicates that the commander has the same *command* skill as the rest of the squad.

Specialists: If the squad has any specialists, they can increase the listed skills or specializations by up to the training level indicated. "None" means that no specialists are available for this troop type.

Creating Your Forces

Let's assume you want to create a squad of somewhat better Rebel soldiers. Going to the "Troop List," you find the Hoth Troopers listing. These are elite Rebel soldiers. Write in the name of your squad (or save this until the end). Write in the troop type and the quality. On the Troop Quality line, fill in the SGP cost (in the U-shaped cost space) for the appropriate quality, as listed below:

Average	0
Veteran	10
Elite	20

Then enter the Move given in the troop listing, writing it below the "Troop Quality" cost (each point of Move costs one SGP).

Attributes and Skills

The next step is to transfer the attributes to the Squad Record Sheet. Write in the values, listing them in line under the quality cost. Each point of attribute code costs one SGP. Then fill in the Training (Trng) and Specialist (Spec) levels. These are the maximum training levels listed under "Skills" and "Specialists." This column is only used during squad generation, as a reminder of the maximum increases permitted for each skill.

Note that there is a blank line provided under each of the attributes. This is for soldiers who might have a special skill, such as the weapon skill *bowcaster* or *lightsaber* under *Dexterity*. These lines may also be used to enter skill specializations, if you are taking troops from *Star Wars: The Roleplaying Game, Second Edition*. Just write in the skill or specialization.

Skills can now be improved. All skills and specializations start at the level of the attribute they are listed under. You can add training levels to any skill up to the maximum number of levels (now listed in the "Trng" space). Each training level costs one SGP. Skill specializations are treated just like regular skills. They can be improved like skills at the same cost as regular skills.

Let's give these troops some training in the combat skills: *blaster*, *melee combat*, and *brawling*. Write in a "2" in the U-shaped cost space.

The troops should also be well-disciplined, so let's give them an additional level of *command*. Write in "1" for the cost.

The skill code is determined by adding the training level to the attribute code. Write in the appropriate codes to the left of the training levels you have added (giving you *blaster* 5, *melee combat* 5, *command* 3, *brawling* 5).

Total down the column, adding the troop quality cost, Move, attribute values, and the training levels. That gives us a total of 51 for the elite Rebel soldiers.

Filling in the Circles

At the top right of the record sheet are four circles. They are there for quick reference during the course of a game.

DIAGRAM 15
Creating Your Forces

SQUAD NAME BLUE RANGERS	
TROOP TYPE Hoth Troopers	
TROOP QUALITY Elite [20]	
Move: [10]	
DEX: [3]	
Trng (3)	Blaster [5] [2]
Spec (3)	Blaster Artillery [3] []
	Grenade [3] []
	Melee Combat [5] [2]
KNO: [2]	
Trng (3)	Survival [2] []
Spec (3)	[] []
MEC: [2]	
Trng (3)	Beast Riding [2] []
Spec (3)	[] []
PER: [2]	
Trng (3)	Command [3] [1]
Spec (3)	Search [2] []
	Sneak [2] []
STR: [3]	
Trng (3)	Brawling [5] [2]
Spec (3)	Swimming [3] []
TEC: [2]	
Trng (3)	Demolition [2] []
Spec (3)	First Aid [2] []
Skills point cost: [51]	

Stephen Crane

DIAGRAM 16
Filling in the Circles

WALKERS Operators [20] [10] [3] [2]	Walk Rate (8) (13) Run Rate	Command Skill (4) Number in squad (10)		Skills point cost (from first column) : [51]	
MOVEMENT RATES					
Weapon(s) Carried		Dam.	Short	Med.	Long

Stephen Crane

Now that we know the Move and *Dexterity* of the troops, we can determine their Movement Rates, as described in “Movement Rates” in the “Soldiers and Squads” section. Fill in 8” for the Walk Rate and 13” for the Run Rate.

If you don’t intend to give the commander a better skill, you can now fill in the *command* skill. Also fill in the number of soldiers in the squad. We want a full squad of ten soldiers, so we write in “10.”

Lastly, carry the skill points total from the skills column to the space above the weapons box.

Weapons and Armor

It’s time to arm our squad of Rebels. We want them to have a good range with a decent amount of damage, so let’s give them blaster rifles. Looking at the “Weapons Chart” in the back of the book, we can fill in the information we’ll need during the game. Transfer the damage and ranges to the record box. Write in the cost of the rifle (“15”) to the right of the weapon box, on the appropriate line.

In case the squad gets into close assault combat, we want to give them an advantage. So we’ll arm them with vibroblades. Damage is the *Strength* attribute plus 2, so fill in “5.” This is not a ranged weapon, so leave those boxes blank. Write in the cost (“4”).

To equip the troops with armor, write in the armor type and the modifiers to the soldier’s *Strength* and

Dexterity. Then write in the cost. We won’t bother with armor, so leave that line blank.

Total down the costs column to get the cost of each soldier in SGPs. Each of our elite Rebel soldiers, armed with a blaster rifle and a vibroblade, costs 70 Squad Generation Points.

Fill in the number of soldiers in the squad (“10” in this case) and multiply. So far our squad costs 700 SGPs.

Commanders and Specialists

For greater squad coherency, let’s give the commander a better *command* skill. We’ll give him an extra training level, for a *command* skill of 4. Write in the cost to the right of the line (“1”). Add the training level to the current *command* skill of the squad (3) and fill in the commander’s skill code (write in “4”). The ID space to the left of the commander is used to write in a reminder of which of your figures represents the commander. Likewise for the specialists.

To pack a little extra punch, let’s add a specialist with a repeating blaster. This is a good weapon to give the Imperials a little surprise, with better range bands and more damage than the squad’s standard weapon. Note that the heavy weapons specialist also carries a blaster rifle.

A repeating blaster is fired using the *blaster* skill, so let’s beef up the specialist’s skill. Write in the *blaster*

DIAGRAM 17
Weapons and Armor

[10] [3] [2] [5] [2] [3] [] [3] [] [5] [2] [] [] [2] [] [2] [] [2] [] [2] [] [2] [] [2] []	RATES		Skills point cost (from first column) : [51]		
Weapon(s) Carried		Dam.	Short	Med.	Long
Blaster Rifle		5	15	50	150
Vibroblade (STR+2)		5			
Armor:		STR/DEX mod.: /			
Star Wars Miniatures Battles SQUAD RECORD SHEET					Point cost per soldier: [70]
					Number in squad: x [10]
					BASE SQUAD COST: [700]

Stephen Crane

skill on the specialist's line. Giving him one more training level, we write a "1" in the costs column. Adding the training to the current skill code gives the specialist a skill of "6."

Write in the repeating blaster, its damage, ranges and cost. If you want another specialist, a space is provided. We'll stick with one, and total down the rest of the column. Adding the commander's cost and the specialist's cost to the Base Squad Cost, we find that our elite Rebel squad with a commander and a heavy weapons specialist costs us a grand total of 720 SGP.

To finish off the sheet, black out the morale levels to the left of the squad's level (since they're elite troops they begin with a morale level of 7). Write the commander's

command skill in the circle at the top of the sheet.

Our squad is now ready for action. Here's what the Squad Record Sheet looks like for the "Blue Rangers":

DIAGRAM 18
Commanders and Specialists

Star Wars Miniatures Battles
SQUAD RECORD SHEET

Number in squad: x 10 |

BASE SQUAD COST: 700 |

ID: _____ **COMMANDER:** Command 4 | 1 |

ID: _____ **SPECIALIST:** Blaster 6 | 1 |

Weapon Carried	Dam.	Short	Med.	Long	
Repeat Blaster	6	25	60	150	18

ID: _____ **SPECIALIST:** _____ | _____ |

Weapon Carried	Dam.	Short	Med.	Long	

Other costs: _____ | _____ |

Morale Level	<input type="checkbox"/> Steady	<input type="checkbox"/> 7	<input type="checkbox"/> 6	<input type="checkbox"/> 5	<input type="checkbox"/> 4	<input type="checkbox"/> 3	<input type="checkbox"/> 2	<input type="checkbox"/> 1	<input type="checkbox"/> 0	
		E	V	A		Shaken		Dem.	Broken	SQUAD COST

720

Stephen Crane

DIAGRAM 19
Completed Squad Record Sheet

SQUAD NAME BLUE RANGERS

TROOP TYPE Hoth Troopers

TROOP QUALITY Elite | 20 |

Move: _____ | 10 |

DEX: _____ | 3 |

Trng (3) Blaster _____ | 5 | 2 |

Spec (3) Blaster Arty. _____ | 3 | _____ |

Grenade _____ | 3 | _____ |

Melee Combat _____ | 5 | 2 |

_____ | _____ | _____ |

KNO: _____ | 2 |

Trng (3) Survival _____ | 2 | _____ |

Spec (3) _____ | 2 | _____ |

MEC: _____ | 2 |

Trng (3) Beast Riding _____ | 2 | _____ |

Spec (3) _____ | 2 | _____ |

PER: _____ | 2 |

Trng (3) Command _____ | 3 | 1 |

Spec (3) Search _____ | 2 | _____ |

Sneak _____ | 2 | _____ |

_____ | _____ | _____ |

STR: _____ | 3 |

Trng (3) Brawling _____ | 5 | 2 |

Spec (3) Swimming _____ | 3 | _____ |

_____ | _____ | _____ |

TEC: _____ | 2 |

Trng (3) Demolition _____ | 2 | _____ |

Spec (3) First Aid _____ | 2 | _____ |

_____ | _____ | _____ |

Skills point cost: | 51 |

Walk Rate (8) (13) Run Rate Command Skill (4) Number in squad (10)

MOVEMENT RATES

Weapon(s) Carried	Dam.	Short	Med.	Long	
Blaster Rifle	5	15	50	150	15
Vibroblade (STR+2)	5				4

Armor: _____ STR/DEX mod.: _____ / _____ | _____ |

Skills point cost (from first column): | 51 |

Point cost per soldier: | 70 |

Number in squad: x 10 |

BASE SQUAD COST: | 700 |

ID: _____ **COMMANDER:** Command 4 | 1 |

ID: _____ **SPECIALIST:** Blaster 6 | 1 |

Weapon Carried	Dam.	Short	Med.	Long	
Repeat Blaster	6	25	60	150	18

ID: _____ **SPECIALIST:** _____ | _____ |

Weapon Carried	Dam.	Short	Med.	Long	

Other costs: _____ | _____ |

Morale Level	<input type="checkbox"/> Steady	<input type="checkbox"/> 7	<input type="checkbox"/> 6	<input type="checkbox"/> 5	<input type="checkbox"/> 4	<input type="checkbox"/> 3	<input type="checkbox"/> 2	<input type="checkbox"/> 1	<input type="checkbox"/> 0	
		E	V	A		Shaken		Dem.	Broken	SQUAD COST

720

Stephen Crane

44

Star Wars Miniatures Battles



THE ADVANCED GAME

The Advanced Game introduces hidden movement and expands the Basic Game by adding rules for heroes and the Force, new weapons and equipment, droids, creatures and new terrain types. The Advanced Game also discusses the role of the gamemaster, showing how he can enhance a miniatures game. Finally, two scenarios are presented for use with the Advanced Rules.

"I have a bad feeling about this ..."

Chapter Nine

Hidden Movement

Hidden Movement

Commanders rarely have a bird's-eye view of the battlefield. Hills and trees not only block the LOS of his troops, they also conceal the positions of enemy troops. Even where blocking terrain does not completely conceal enemy soldiers, soldiers can attempt to hide using their *sneak* skills.

Handling Hidden Movement

There are a number of ways to handle hidden movement. The simplest is just to ignore it and get on with the game. The next simplest is to use counters which are placed on the table instead of the units.

Dummy Counters

Hidden models are not placed on the tabletop. Instead, dummy counters are used. To keep the other player guessing, the player receives three counters per squad or hero, creature, vehicle, etc. The counters



■ In a game with a gamemaster, these well-concealed stormtroopers could provide a distinctly unpleasant surprise to the first Rebel squad to come down the road.

should be numbered or otherwise labeled, and a written record kept of whether the counter represents an actual squad or model, or is a dummy.

Counters are moved as though they were an actual squad or model. As soon as a counter can be seen by one of the other player's soldiers, the owning player declares whether the marker represents a squad or hero, or is a dummy. Dummy counters are removed from the table. Other counters are replaced by the squad or hero.

If a squad or model moves so that it becomes hidden, it is replaced by counters at the start of the next Movement Phase.

Full Written Moves

This system requires a gamemaster to adjudicate when squads or models can see each other. The players, using maps showing the layout of the tabletop terrain, keep a written record of the positions and moves of their hidden squads or models. At the end of each Movement Phase the gamemaster examines both players' maps to see whether hidden units can see each other. If so, the units are placed on the table.

Partial Written Moves

This system is similar to full written moves, but can be used without a gamemaster. It works best when only one side has hidden forces. For example, the Rebels are holding the edges of a wood against an Imperial attack. Because the Rebels are hidden at the start of the game, the Rebel player notes the position of his troops on the map. Providing his troops stay hidden, he may move them on the map. But as soon as any troops are spotted by the enemy they are placed on the table.

Spotting Hidden Troops

When hidden troops step out into the open, they become spotted by enemy troops. But what if the troops are hiding in a building or at the edge of a woods? To handle situations like this, opposed rolls are made between the hiding troops' *sneak* skill and the spotting troops' *search* skill. The hiding troops' roll is modified according to terrain and weather conditions.

If the hidden troops' roll is higher, they remain hidden, otherwise they are spotted and placed on the tabletop.

Spotting Hidden Troops Chart

Condition	Modifier
Light Woods	+1
Medium Woods	+2
Heavy Woods	+3
In Building	+2
Behind Barrier	+1
Rain*	+1
Mist*	+2
Snow*	+2
Dark*	+4

*This modifier is negated if the enemy is able to see through it, e.g., has macrobinoculars, is of an alien species with night vision, or a Luma grenade is used.

Soldiers and models that fire are spotted automatically and are placed on the tabletop. It is not possible to fire and remain hidden.

In situations where more than one squad or model can spot hidden troops, only one check is made, but the highest skill level on that side is used.

A *sneak* roll is made for the whole squad. If the squad is spotted, all members of the squad are spotted. Heroes, even when attached to a squad, make separate *sneak* rolls, but only one *search* roll is made for the squad and hero. If the roll is high enough to beat the squad's and the hero's, they are both spotted.

In games with a gamemaster, he can oversee spotting checks as they are made. In a game without a gamemaster, the player with hidden troops must tell his opponent when spotting rolls are required.

Chapter Ten

The Gamemaster

Though not necessary, a gamemaster can significantly enhance a game of *Star Wars Miniatures Battles* by smoothing play, making rules judgments, and adding or changing rules to suit the players.

The gamemaster can also design interesting scenarios; since the scenario won't have come out of this book but out of his head, the players won't know what to expect. He can keep the players in the dark about the conditions of the upcoming battle or feed them erroneous information (a very enjoyable thing to do, and something which quite accurately reflects the "fog of war" that real military commanders must deal with).

The gamemaster can also add "special effects" to the game, including interesting or amusing situations that no rules set could hope to cover.

Finally, the gamemaster can be the villain in the game, running the Imperial forces against a number of players controlling the Rebels. This is the suggested manner to include *Star Wars Miniatures Battles* in games of *Star Wars: The Role playing Game*.

The Gamemaster as Referee

Star Wars Miniatures Battles is, by nature, a game of cooperation and competition. The players have both put a lot of effort into the game — buying the figures, painting them, purchasing or building the terrain, and so forth. In fact, miniatures games involve possibly the longest, most difficult preparations of any adventure games. Half (or more) of the fun is in getting the game together. When the time comes to actually push the pieces around on the tabletop, the players would be crazy to ruin the experience by bickering. But it does happen.

When the Imperial forces are in the midst of a magnificent flanking sweep of the Rebels' position, only to discover that the Rebels have treacherously set up a heavy blaster on a hilltop overlooking their approach, suddenly questions about line of sight become very important. Can the blaster sweep the Imperial column, or is it blocked by that light wood? If it is, the Rebels are in a good deal of trouble. If not, the lead Imperial squad is in for a bad few seconds.

Out come the rulers. The players begin crouching down and sighting along from the Rebel figures, point-

ing at the Imperial figures and gesticulating wildly. What was a fun game degenerates into chaos.

However, if a gamemaster is adjudicating, everything runs a lot smoother. He makes the call. After checking things over, he says, "Sorry. The Rebels can't see the squad. The woods definitely block LOS." Or, "The LOS skirts the edge of the woods. Take your shot." In either case, somebody is going to be disappointed, but the game proceeds.

Be Cruel but Fair

In miniatures combat, as in real life, war is hell. Somebody wins, somebody loses. As referee, your job is to ensure that both sides play by the rules — let the chips fall where they may. When judging situations, do not be influenced by partisan gamesmanship: apply the same standards to both sides, even if your decision will dramatically hurt or help one side over the other.

In football, when a referee must decide whether or not the receiver had both feet in-bounds when he made the catch, he isn't interested in whether or not one team is beating the other or what the league standings are; he judges the specific play. You must do the same.

First Thing We Do: Kill the Rules Lawyers

On the other hand, this is supposed to be fun. One of the things that a referee can do is allow the players to concentrate upon enjoying themselves and leave the rules to the gamemaster. Change or ignore the rules that you don't like. Add rules that you do. Most importantly: *Keep the game moving*.

"You Imperials are all down at this end; the Rebels are all here. Hmm. There's about four feet of forest between you — it'll take roughly forever for you to meet if we follow the rules. Okay. Everybody take double moves and ignore turning costs until you guys come into contact, then we'll go back to normal movement."

"All right. This is a skirmish game. Since nobody has more than ten figures on the table, we'll ignore the separation and morale rules altogether. You can split up or stay together as you like; your soldiers fire individually; and nobody breaks, everybody fights until the last man. Boy, is this gonna be a bloodbath!"

“Since your troops are all green, they can’t split fire at all. They have to fire at the same target. In fact, the commander of the squad tells them what to fire at: he has to have LOS to the target squad. What? Unfair? Well, maybe, but you do outnumber him three to one ...”

The Gamemaster as Scenario Designer

Designing scenarios can be a lot of fun. You can set up interesting situations and watch them unfold as the game progresses. The players experience the true uncertainty of battle: they don’t know what they are going to face.

The Basic Rules of Scenario Design

There aren’t any.

Well, that’s not exactly true. There is one: the scenario should be fun for the players. Other than that, you can do virtually anything you like. You can design the players’ force mix, or you can give the players points and let them do it. The forces can be even, or horribly unbalanced. You can position the forces on the battlefield or let the players do so. It doesn’t really matter. Once you and your players have played a few times, you will all be interested in experimenting. Go crazy.

Force Mixes: No One Said War Was Fair...

There are few times in history when absolutely equal forces have met on the battlefield. Typically, somebody is stronger than somebody else, or somebody has better weapons, or better-trained men. The stronger party is usually (but not always) the attacker, the weaker the defender.

Star Wars Miniatures Battles will provide an interesting game between unequal forces — in fact, you might say that this is the standard combat situation in which the inhabitants of the “galaxy far, far away” find themselves: the Rebels rarely have parity of numbers and weapons with the Imperials. But what they lack in these areas, they make up in the quality of their men, and the brilliance and courage of the heroes who accompany them. You can recreate these kind of situations by specifying how the players can spend their squad generation points. (When you do so, tell each player in private: it’s more fun when they don’t know what they are going to face.)

“Imperial player: you have 1500 points. You can spend up to 300 points on heroes; the rest on your squads. Your squads can be average or veteran; they can have whatever weaponry you want. Go to it.”

“Rebel players: you have 1500 points. You can spend up to 600 points on heroes; the rest on your squads. Your squads must be veteran or elite. You can have up to three specialized weapons, 30 grenades, no thermal detonators and no vehicles. Go to it.”

Is this fair? Uh, beats us. Try it and find out.

Player Briefings and Set-Up

In war it is rare for everybody to know what is going on. On a grand strategic level, you usually have a pretty good idea of what your enemy is up to. In World War Two, the German generals knew that the US and Britain’s objectives were to land on the continent and push into Germany, but they didn’t know *where* the landings would take place, forcing them to garrison the entire western coastline of Europe.

In the American Civil War, Lee was invading the North, completely unaware that the Union commander, McClellan, had obtained detailed copies of his army’s movements, allowing McClellan the opportunity to attack while Lee’s forces were spread over a distance of something like 50 miles.

It is hard to recreate that kind of uncertainty on the tabletop — the figures on the table are in plain sight of everybody — but it can be done. And it is certainly worth doing.

When you set up a game, decide what the situation is: who is the attacker; who is the defender; over what kind of battlefield is the battle going to take place? Think up a storyline for the battle, telling what has happened before. Are the Rebels on this planet beleaguered, or are they on the attack? Do the Imperials have good leadership, or incompetent generals? These all can affect the outcome of even the smallest skirmish.

After you’ve got that figured out, decide how much to tell the players. If their side has good intelligence and good leadership, the commanders even at the lower levels will know something of the overall situation. If not, they may be fighting in the dark. Even if the high command is good, everybody makes mistakes sometimes ...

We find that, when gamemastering, it’s fun to write out “Orders of the Day” for both sides. These include snippets of background, history, the commanders’ personalities, and also the objectives of the upcoming battle. Sometimes they are accurate, sometimes not so accurate. The players learn to take them with a healthy grain of salt — particularly the Imperials, who unfortunately, we judge to be saddled with a high command which doesn’t take proper care to ensure that their field officers are properly informed of all developments.

Special Effects

This covers any neat, unusual, or silly things you want to add to the game which are not covered by the rules. There is not enough room to cover the wide variety of tricks a resourceful gamemaster can add to a battle, but here are some of the things which have cropped up in games we have been a part of.

During one of our games, just when the Imperials were about to sweep the flank of the Rebel scum holding the outskirts of a mining colony on an asteroid, the gamemaster announced the imminent arrival of an

Sample Game

Orders of the Day: Imperial Commander 334.556/G7. Commander: you are hereby ordered to take and hold the village at coordinates 126/335.1 (known as Chakton). Your attack to commence at 0900 hours; you are to be in the possession of the village by 0930 hours. Insurgent forces in the area light; your attack will be supported by a diversionary attack to the north of your position by other Imperial forces. Mechanized squads 1134.7 and 1134.8 will be in reserve 10 kilometers behind your line. You may call for reinforcements as necessary. That is all.

You have 1500 points to spend on your forces. One 200-point hero, max. Any weapons. No vehicles. You set up within 8 inches of the road leading off the south end of the table.

Victory: Occupy the village by the tenth turn.

Orders of the Day: Alliance Commander Thickston Deke. 2-4 squads Imperials going to hit Chakton today from the west — probably ground troops. We want you to ambush them. Set up in the hills to the north and south of the village; let the Imps come in, and then paste 'em. Good luck.

You have 2000 points to spend on your forces, which must be evenly divided into two groups. You must have one 200-point hero with each group. Any weapons. No vehicles. Set up hidden (that is, tell me where you want your soldiers to be on the tabletop), one group to the north of the road, one to the south.

Victory: Destroy the Imperial forces. Do not allow them to retreat.

The Course of the Battle

The Imperials are running into an ambush. They are under the impression that the village is lightly-held, and that their attack is a surprise. Unfortunately, this is untrue. The Rebels, hidden in the hills, will wait until they have advanced well onto the table and then sweep down.

The Rebels seek to kill the Imperials, the Imperials to reach the village. Once the Rebels have sprung their ambush, however, the Imperials will be given new victory conditions: get off the table before they are wiped out. The Imperial reinforcements behind the lines become available after the eighth game turn, in all likelihood too late to do any good.

asteroid shower. The Imperial player damned the elements to do their worst and pressed the attack, while the Rebel player began to retreat into the mines. Sensing victory, the Imperials leapt from their positions and began to rush the Rebels — at which point the asteroid shower hit. The gamemaster chucked a handful of popcorn into the air over the table; several of these “asteroids” landed very near to the advancing Imperials, each doing the same damage as a grenade and virtually wiping out the main attacking force.

The Rebel forces advanced up to the edge of a strange-looking purple forest. The commander had never seen their like before. He attempted a difficulty 10 *survival* roll, and failed. Shrugging his shoulders, he ordered his men to move in. The trees were carnivorous; they attacked when the force was well inside.

The Rebels and Imperials were having a nice, orderly battle around an area filled with caves and hills. Unfortunately, no one knew that there was a very annoyed rancor in one of the caves ... it came out and attacked both sides, who hurriedly agreed to a truce until they could wipe the monster out.

The Rebels were holed up in a fuel-processing plant. The Imperials had orders to dig them out. The only problem was, it was extremely dangerous to fire any kind of weapons in there. Any time a soldier firing a weapon bombed out, he hit something volatile which exploded and burned quite impressively (the gamemaster had prepared dozens of fire markers before the game). By the game's end, the entire plant was about to go up, and both sides were fleeing from the imminent explosion.

See? We can't possibly write rules for all of this stuff. But you can.

The Gamemaster as Bad Guy

It can often be fun to have all of the players take command of a hero and a squad, and the gamemaster to take control of all of their opponents. This is the best way to play when including *Star Wars Miniatures Battles* in your *Star Wars: The Roleplaying Game* sessions; that way, you can have more control over the game's outcome than if you let somebody else control the Imperials.

In the spirit of the roleplaying game, as gamemaster you are less interested in winning than you are in giving the players a good time. You should be fair, and play the game honestly, but you must take care not to butcher the player characters gratuitously. The game is designed to make that extremely difficult, but if several Imperial squads decide to gang up on one hero, he's going to be in severe trouble.

However, there is nothing to say that an incapacitated hero is necessarily dead. Perhaps he's only knocked unconscious, to be picked up after the battle by the side that wins. Also, there's nothing to stop the Rebels from retreating if they get into trouble.

Chapter Eleven Advanced Weapons and Equipment

Blaster weapons and melee weapons are the primary weapons found on the *Star Wars* battlefield. In addition to these basic weapons, other weapons are designed to have greater combat potential, or to gain specific objectives.

There is also a variety of general equipment available to troops on the battlefield. This equipment serves to increase a soldier's fighting potential or survivability.

Listed below are a number of common and not-so-common weapons and items of equipment. Each entry contains the weapon's or item's cost in Squad Generation Points, the skill needed to use the weapon, its effect in game terms, a brief description and any relevant game rules.

Following the weapons and equipment are rules for artillery and a listing of some common artillery pieces.

Infantry Support Weapons

Flamethrower

Cost: 15 SGPs.

Skill: *Flamethrower*.

Damage: 4 (2).

Effect: Special.

Flamethrowers project a flammable liquid which is ignited as it leaves the nozzle of the weapon. This liquid is sticky and spreads out on impact. It has a 1" radius of effect. Flamethrowers have a *Damage Strength* of 4, and an incidental *Damage Strength* of 2. Their range bands are as follows:

Short:	3"
Medium:	4"
Long:	6"

When firing a flamethrower, designate a target and resolve fire as normal. If the target is hit, center a Flame Effect Template under the figure. The target makes an opposed *Strength* test against the full *Damage Strength* of the weapon. Any other figure whose base is wholly or partially within the effect template must make an opposed *Strength* roll against the incidental *Damage Strength*.

If the firer missed the target, determine deviation as for grenades, except that one unmodified die is used to determine the distance of deviation, no matter what the range. However, the flamethrower will never deviate by

more than half the distance to the target. If a target is within the area of effect, he is damaged at the flamethrower's incidental *Damage Strength*. The template should be left at the final position after resolving the damage. That area is now on fire (see "Advanced Terrain").

A flamethrower can be fired through a window or door subject to the same restrictions and modifiers applied to standard weapons. If the firing soldier hits his target, the template is centered over the target.

However, if the firer misses the target, the effect template is placed just on the firer's side of the aperture. If any part of a soldier (enemy or friendly) or its base is within the area of effect, conduct an opposed test against the incidental *Damage Strength*. The fire then spreads normally.

Grenade Launcher

Cost: 10 SGPs.

Skill: *Missile weapons*.

Damage: Varies depending on grenade used.

Effect: Increases grenade ranges.

Grenade launchers enable a soldier to hurl grenades much farther than by hand. But because a grenade is

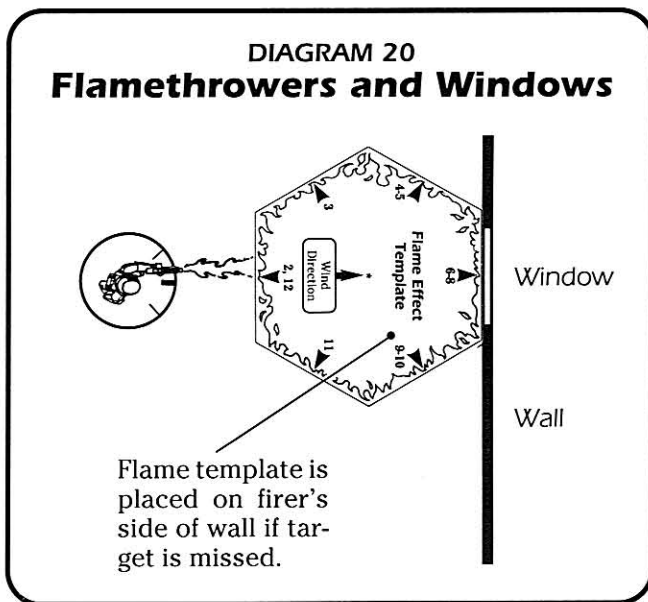

Stephen Crane

armed during the process of firing, there is a minimum range within which a grenade launcher cannot be used. A soldier cannot fire at a target closer than 3". Ranges are given below:

Short:	3" to 12"
Medium:	24"
Long:	40"

Grenades fired by a launcher also deviate farther than grenades thrown by hand. Use the following distances when determining launched grenade deviation:

Range	Distance of Deviation
Short	1–6 inches (1D)
Medium	2–12 inches (1Dx2)
Long	3–18 inches (1Dx3)

A grenade never deviates by more than half of the distance to the target. For example, a grenade launcher is used to fire a grenade at a soldier 14" away. This is medium range, so if the shot misses, the grenade scatters 1Dx2 inches, but it cannot deviate more than seven inches (half the distance to the target). Any rolls higher than 7 are counted as 7.

Thermal detonators cannot be fired from a grenade launcher.

Grenades

Cost: Varies by grenade type.

Skill: *Grenade* if thrown; *missile weapons* if a launcher is used.

Damage: Varies by grenade type.

Effect: Varies by grenade type.

In addition to the standard fragmentation grenade described in the basic rules, there are a variety of other types of grenades available:

Concussion

Cost: 8 SGPs per grenade.

Damage: 5.

Effect: Normal damage.

When standard (fragmentation) grenades explode, their shells burst into small fragments, and the force of the explosion sends the fragments outward at high velocity. Concussion grenades, on the other hand, use the concussive force of the explosion itself to inflict damage.

Use a 1.5" radius Area of Effect Template to determine which targets are hit.

Smoke

Cost: 5 SGPs per grenade.

Damage: None.

Effect: Increases difficulty of fire combat.

On detonation, smoke grenades dispense a thick, dark smoke which obscures vision. The radius of the smoke cloud is 2.5". Any shots taken through the Area of Effect Template incur a +2 increase to the difficulty. The effects are cumulative; if the LOS passes through more than one template, the difficulty is increased by +2 for each template it passes through. Smoke templates can

overlap; more than one may be laid down at the same position.

Smoke lasts for a maximum of five turns before dissipating. Each turn until the fifth, during the Special Actions Phase, roll a die for each patch of smoke and consult the "Cloud Dissipation Table" below. On the fifth turn, the template is removed automatically.

Cloud Dissipation Table

Die Roll	Effect
1–2	Cloud drifts.*
3–5	Cloud remains in position.
6	Cloud dissipates. Remove from table.

*1" in the direction the wind is blowing. Wind direction is determined by the gamemaster, or by using the Grenade Burst Area of Effect Template.

Note: Smoke and gas clouds in a confined area, such as a room, will not dissipate or drift.

Luma

Cost: 8 SGPs per grenade.

Damage: Special.

Effect: Negates the effects of darkness.

These grenades illuminate a 6" radius area for six turns. They are primarily used to increase visibility at night. All soldiers within the area of effect of a Luma grenade can be seen and targeted without the limitations and modifiers imposed by darkness (see "Advanced Terrain"). This is true from the instant of detonation.

Any soldier(s) within 1.5" of the point of impact when the grenade detonates must make a difficulty 6 *Perception* roll (to simulate their attempting to turn away in time) or be partially blinded. All future actions performed by the soldier(s) suffer a +2 modifier to the difficulty number. (The blindness is temporary, but sight will not return until after the game is over.)

Soldiers in battle armor are not affected by the blindness (their visors have flash guards which function automatically).

Stun

Cost: 10 SGPs per grenade.

Damage Strength: 4 (but see below).

Effect: Treat "wounded" as "-1 penalty for three turns"; "incapacitated" as "-1 penalty for five turns."

The stun grenade in general use is the Spore/B. The Spore/B delivers a cloud of Bothan stun spores, which induce disorientation.

Stun grenades have an area of effect 1.5" in radius and an initial *Damage Strength* of "4." The spore cloud lingers for four turns, although it slowly disperses over that time; each turn, its *Damage Strength* is reduced by one. In addition, roll for the cloud on the "Cloud Dissipation Table" each Special Actions Phase the cloud remains on the table.

Any soldier passing through the cloud (any part of the base crosses the template), must resolve an op-

posed *Strength* test against the current *Damage Strength* of the cloud. Soldiers who are “wounded” suffer a -1 penalty for three rounds; soldiers who are “incapacitated” suffer a -1 penalty for five rounds. If a soldier is already wounded, he suffers a -2 penalty to his skills and attributes, instead of just a -1.

If the soldier is wearing a breath mask, environment suit, space suit, or battle armor, he is unaffected by the stun grenade.

Gas Grenades

There are a variety of gases which can be delivered in a grenade. One common feature of gas grenades is that the cloud of gas released on detonation often lingers. Gas clouds may drift or dissipate. Each round a gas cloud is on the battlefield, roll on the “Cloud Dissipation Table” during the Special Actions Phase to determine what happens to the cloud.

Clouds which linger on the battlefield continue to have an effect (although sometimes this effect will change; see the specific rules below). Any soldier whose base passes partially or wholly into the area of effect of a cloud must resolve an opposed *Strength* test for damage. The test is resolved normally unless the description of the gas states otherwise. Standard gas types include:

T-238

Cost: 8 SGPs per grenade.

Damage: 1.

Effect: Treat “incapacitated” results as “wounds.”

T-238 is a chemical agent which attacks the digestive tract, causing severe, debilitating nausea. It is generally

not fatal, except in large or repeated doses. “Incapacitated” results are treated as “wound” results.

T-238 grenades have a burst radius of 2.5”. They last three turns; roll each turn on the “Cloud Dissipation Table” during the Special Actions Phase.

Breath masks, environment suits, space suits and battle armor protect against T-238.

CryoBan

Cost: 5 SGPs per grenade.

Damage: 2.

Effect: Creates area of intense cold.

CryoBan is a chemical which absorbs heat, thereby creating an area of intense cold. It then begins to break down rapidly, releasing the heat back to the environment.

The area of effect has a radius of 2.5” during the turn the grenade is detonated. The next turn the 2.5” radius template is replaced with a 1.5” radius template. The following turn the template is removed; the chemical has broken down fully.

Damage is resolved normally. CryoBan is not subject to drift and only dissipates as described above.

Breath masks, environment suits and the like do not protect against CryoBan.

Plank Gas

Cost: 15 SGPs per grenade.

Damage: 3.

Effect: “Wounds” give a -2 modifier to skills.

Plank gas is a corrosive chemical which eats away at the exposed skin of beings caught within it, and has a lasting, painful effect. Soldiers who are “wounded” by plank gas suffer a -2 penalty to all their attributes and skills.

Use the 1.5” radius Area of Effect Template for a plank gas grenade. Plank gas lasts only two turns, then dissipates entirely. Roll for the cloud on the “Cloud Dissipation Table” during the first turn it appears (Special Actions Phase).

Breath masks do not help against plank gas. Environment and space suits increase the target’s *Strength* by one for the damage roll, but the corrosion renders the suits useless immediately after the roll. Battle armor functions as normal: it increases the target’s *Strength* for the roll and is not destroyed.

Grenade Summary

Type	Cost	Dam.	Duration (turns)	Burst Radius	Effect
Fragmentation	5	4	1	2.5"	Normal damage
Concussion	8	5	1	1.5"	Normal damage
Smoke	5	–	5	2.5"	Block LOS (+2 to fire)
Luma	8	–	6 1	6" 1.5"	Negates dark Blinded; +2 difficulty
Stun	10	4*	4	1.5"	Wound = -1, 3 rounds Incap = -1, 5 rounds
T-238	8	1	3	2.5"	Incap = wound
CryoBan	5	2	2	2.5" **	Normal damage; cold; no drift
Plank gas	15	3	2	1.5"	Wound = -2 to skills; destroys space/ environ suits
Fex-M3	25	5	2	1.5"	Wound = incap

*reduce by 1 each turn.

**reduce to 1.5" on second turn.

Fex-M3 Nerve Gas

Cost: 25 SGPs per grenade.

Damage: 5.

Effect: Treat "wound" results as "incapacitated."

Fex-M3 is a particularly potent but volatile gas which attacks the autonomic nervous system and the brain stem of most species, shutting them down. "Wounded" results are treated as "incapacitated."

The area of effect has a 1.5" radius from the point of detonation. Duration of the cloud is two turns, but it is subject to a roll on the "Cloud Dissipation Table" during the Special Actions Phase of the first turn it appears.

The greatest effect is felt when Fex-M3 is inhaled, so breath masks afford some protection. Some of the chemical is absorbed through the skin, so the protection is not total: a soldier wearing a breath mask has his *Strength* increased by 2 when resolving damage. Environment suits, space suits and battle armor negate the effects of Fex-M3.

Lightsaber

Cost: 25 SGPs.

Skill: *Lightsaber*.

Damage: 5 or *control* + 5.

Effect: Special.

Lightsabers are the ancient and venerable weapons of the Jedi Knights. A controlled charge of pure energy is focused into a tight, parallel beam, which yields a "blade" of amazing strength.

As each Jedi made his own, they are exceedingly rare. Troops will generally not be armed with these weapons; only a hero would conceivably have one. Lightsabers are used differently than standard melee weapons. A hero uses his *lightsaber* skill when rolling to hit, instead of his *melee combat* skill. If the hero does not have the *lightsaber* skill, use his *Dexterity* attribute.

Combat and damage are resolved in the normal fashion, but a soldier with a lightsaber adds a +4 modifier to his close assault combat roll in addition to the lightsaber or *Dexterity* codes.

A lightsaber can be dangerous if its user is not sufficiently skilled. If the soldier using a lightsaber bombs out, he has injured himself and must roll for damage on himself.

A lightsaber has a *Damage Strength* of 5.

A soldier does not have to have any Force skills in order to use a lightsaber. However, this weapon becomes much more effective in the hands of a Force-using hero. If the character has the *lightsaber combat* Force power, his *control* skill level may be added to the *Damage Strength* (see "Force Skills" in the "Heroes" section). A Force-user can also use a lightsaber to parry and aim blaster bolts (see "Special Combat Abilities" in the "Heroes" section).

DEMP Gun

Cost: 10 SGPs.

Skill: *Blaster*.

Damage: 4.

Effect: Stuns droids.

DEMP guns — Anti-Droid Electro-Magnetic Pulse guns — are specifically designed to disable droids without permanently damaging them. This is useful primarily in covert missions, when the disabled droids are spirited away for questioning, but these weapons are also useful on the battlefield against war droids.

Ranges are as given below:

Short:	12"
Medium:	30"
Long:	125"

A "Systems Damage" result stuns a droid for 4 turns; a "Roll twice for Systems Damage" result stuns the droid for 6 turns. Stunned droids are treated as though they were wounded characters — their attributes and skills are reduced by 1. Successive stun results are cumulative.

Proton Torpedo Launcher

Cost: 10 SGPs for launcher; 10 SGPs per torpedo.

Skill: *Missile weapons*.

Damage: 6.

Effect: 1.5" by 10" area of effect.

Assembled weapon

Personal proton torpedo launchers fire a smaller version of the proton torpedoes used by starfighters for surface-attack missions. Proton torpedoes carry a proton-scattering energy warhead which affects any target within range during its flight.

Personal proton torpedoes have a limited firing range, as they tend to burn themselves out rapidly once the warhead is primed. A personal proton torpedo ignites after leaving the launcher, and affects everything in its path until it is expended, as represented by the Proton Torpedo Area of Effect Template.



■ In the hands of a skilled student of the Force, a lightsaber is formidable yet elegant weapon.

To fire a proton torpedo, make a skill roll against a difficulty of 8. If the test does not succeed, the torpedo has failed to arm and ignite, and is expended to no effect.

If the test is successful, place the proton torpedo template at the base of the firing soldier and point it in the direction of the target. Any soldiers whose bases (or any part of their bases) fall within the area of the template are affected by the torpedo and must make an opposed *Strength* test.

The torpedo continues in the direction it was fired until it reaches its maximum range or hits an obstruction. Walls and doors are hit at the *Strength* of the torpedo as well; if the obstacle is breached, the torpedo hits anything within range beyond the obstacle; if not, the obstacle blocks the torpedo.

A proton torpedo launcher comes with a standard load of six torpedoes, although a soldier may be equipped with less. They are difficult to come by, and are usually found built into spacetrooper armor. Disassembled proton torpedo launchers *can* be carried by only one soldier, but the soldier must take a full turn to assemble the weapon. A soldier can only drag an assembled proton torpedo launcher 1" per turn.

Tanglefoot Field

Cost: 5 SGPs per 1" square section of field.

Skill: Not applicable.

Damage: None.

Effect: Slows movement across field.

The tanglefoot field was conceived as a police weapon and is particularly useful against rioters. It is non-lethal, but slows their movement enough to make them easy targets for police with stun weapons.

The field is useful only in very flat terrain ("clear" terrain, that is, usually paved roads or squares), and requires time, special equipment and energy to set up; therefore, only defending soldiers with access to advanced police equipment may employ the tanglefoot. (This is, of course, entirely up to the gamemaster).

The tanglefoot field is set up before the game begins. The defending player notes the areas of clear terrain the tanglefoot covers on a piece of scrap paper (or describes it to the gamemaster). Movement within the field is at double cost.

Repulsorcraft ignore the effects of the tanglefoot field.

Thermal Detonator

Cost: 10 SGPs.

Skill: Grenade.

Damage: 8.

Effect: Blows up.

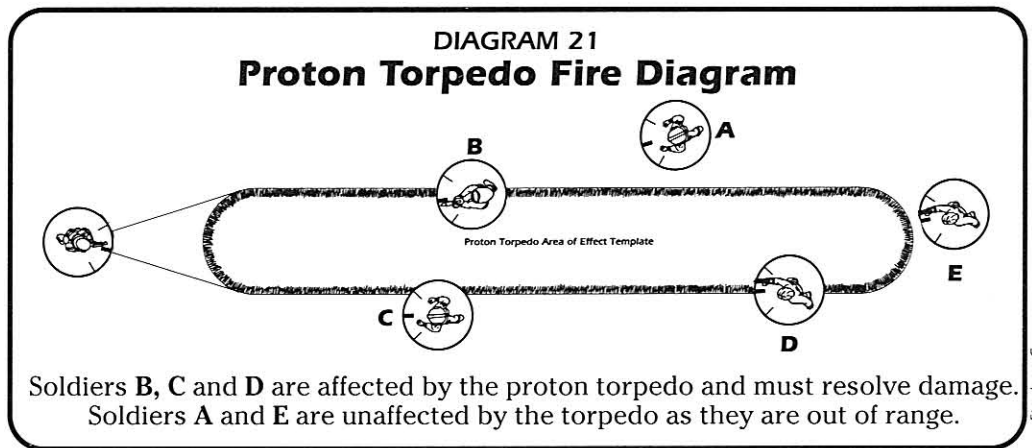

Stephen Crane

Thermal detonators used as grenades have already been described in the basic rules. But they can also be used as demolitions charges (see "Advanced Terrain").

Equipment

Armor

Cost: Varies by armor type (see "Armor Chart").

Effect: Increases *Strength* (varies by armor type) for determination of damage received.

Armor is used to reduce the amount of damage suffered when a soldier is hit. The use of armor is not very widespread in a galaxy of blaster weapons, with the major exception of the Empire. Stormtroopers wear a variety of armor types depending on their duties, ranging from lightweight scout armor up to the formidable spacetrooper armor. Note that stormtroopers must wear armor; there is no cost to equip stormtroopers with armor.

"Battle armor" is a generic term referring to a full or partial suit of armor that provides protection from weapons as well as from hostile environments. All of the armor types listed in the "Armor Chart" are classified as battle armor.

In addition to the types of armor that are available, there are protective helmets and vests. These can be of help in individual situations, but in the crossfire of coruscating energy that sweeps over the *Star Wars* battlefield, their effect is negligible.

Armor increases a soldier's *Strength* code for purposes of damage determination only. It does not affect any other use of *Strength*. The amount of increase depends on the armor type and is given in the "Armor Chart."

Example: A soldier with a *Strength* code of "2" wearing bounty hunter armor is hit by a blaster bolt. The soldier adds 3 (*Strength* of 2 plus 1 for the armor) to his opposed die roll for damage.

The disadvantage of armor is that it hampers free movement, thereby reducing a soldier's *Dexterity* code. This reduction applies to all *Dexterity*-based skills as well. The amount that *Dexterity* is reduced varies with armor type and is shown in the "Armor Chart."



■ The stark white armor of the elite corps of stormtroopers has come to symbolize the dread might of the evil Galactic Empire and the crushing fist of the Emperor himself.

Example: The soldier mentioned above has a *Dexterity* of “3” and a *blaster* skill of “4.” While wearing the bounty hunter armor his *Dexterity* is “2” and his *blaster* skill is “3.”

When filling out a “Squad Record Sheet” we recommend writing in the modified *Strength* and *Dexterity* values and marking them with parentheses or an asterisk as a reminder that they are modified values. Also, note that the attributes and skills given in the “Troop Lists” already reflect the armor modifiers for stormtroopers.

Armor Chart

Armor type	STR/DEX modifiers	Cost
Bounty Hunter	+1/-1	10 SGPs
Royal Guard	+1/0	25 SGPs
Sandtrooper	+1/-1	10 SGPs
Scout trooper	+1/0	25 SGPs
Snowtrooper	+1/-1	10 SGPs
Spacetrooper	+3/-1	50 SGPs
Stormtrooper	+1/-1	10 SGPs

Breath Mask

Cost: 10 SGPs.

Effect: Negates hostile atmosphere.

A breath mask provides a soldier with the atmosphere he requires to survive, as well as filtering out any harmful atmosphere.

It is by no means a substitute for a complete environment suit or space suit, but can provide that extra bit of protection needed when operating in a thin or mildly hostile atmosphere.

Breath masks can also provide protection against certain forms of gas weapons (see “Grenades”).

Camouflage Suit

Cost: 20 SGPs.

Effect: +2 difficulty modifier to firer targeting a camouflage suit and to spotting the wearer.

Photo-optic Replicators, more colloquially known as “camouflage suits,” are not actually suits. The standard OptiRep is a vest-like harness which serves as a mount for an active sensor package coupled with a small holo-projector.

The sensor takes constant readings of energy wavelengths in the visible spectrum in a complete 360-degree arc. It evaluates the readings (many hundreds of times per second) and causes the holo-projector to return a replicated image 180 degrees from the source.

The net effect is that a soldier wearing an active OptiRep appears to be part of the terrain he is in front of. The effect is not perfect (the faster the wearer moves, the more blurred the image), but in most circumstances provides a definite advantage to the wearer. Photo-optic Replicators are difficult to come by.

The effect of a camouflage suit on the tabletop is to make a hidden soldier harder to spot. The +2 is added to his *sneak* roll. Once spotted, a camouflage suit will not make a soldier “disappear,” but does make him more difficult to hit. The difficulty modifier is cumulative with terrain effects.

Example: A soldier firing at a target wearing a camouflage suit in medium cover has a total +4 modifier to his difficulty number.

Environment Suit

Cost: 10 SGPs.

Effect: Protects against gas and other environmental hazards.

Environment suits are designed to provide protection against hostile environments. Combining a breath mask with total body cover, they are somewhat cumbersome, making them less than ideal on the battlefield, but they do protect against certain hazards.

Environment suits negate or partially offset the effects of many forms of gas; see above. However, they also reduce their wearer's *Dexterity* and all DEX-based skills by -1, just as certain armor does (see "Armor").

Environment suits are not space suits; they do not protect against vacuum, as their seams burst almost immediately. Environment suits are not designed for combat; if a soldier wearing an environment suit suffers a wound, the suit is considered to have been breached and no longer offers any protection. However, it still reduces the soldier's *Dexterity* until he can remove the suit, which takes an entire turn. He cannot move in the Movement Phase or fire in the Fire Combat Phase of the turn that he removes the suit.

Space Suits

Cost: 15 SGPs.

Effect: Protects against vacuum and certain other hazards.

Like environment suits, space suits are not designed for the rigors of combat. They provide protection against certain hazards (see "Gas Grenades"), but at the cost of a -1 reduction to the wearer's *Dexterity* and all DEX-based skills.

Medpac

Cost: 10 SGPs.

Skill: *First aid*.

Effect: Removes wound status if successful *first aid* skill test is made.

The medpac is a compact first aid kit consisting of mini-diagnostic computer, drugs, syntheflesh, coagulants and antiseptics. It is used primarily to heal wounds.

A soldier with a medpac may attempt to heal a wounded soldier in the Special Actions Phase of any turn following the turn in which the soldier was wounded. The "healer" must be in base-to-base contact with the "patient," and must make a *first aid* skill test against a difficulty of 7.

Success means the patient is no longer wounded. Remove the *Wound* marker.

If the attempt failed, the soldier is still wounded. One other attempt may be made to heal the wounded soldier in a later turn. The second attempt is made against a difficulty number of 9. If that attempt also fails, the wound is too serious and cannot be healed during the course of the game.

A soldier may attempt to heal himself, but the difficulty number is increased by +1.

A medpac is depleted when used, whether the healing attempt was successful or not. One medpac must be used per attempt.

Macrobinoculars

Cost: 10 SGPs.

Effect: Improves soldier's vision.

Macrobinoculars (also known as "electrobinoculars") are light-enhancing video display binoculars allowing a soldier to see greater distances in difficult visibility. Since, in most games, a soldier can easily see from one end of the battlefield to the other unaided, their most important game function is to improve his sight in darkness or in other low-visibility situations.

Macrobinoculars negate the negative combat modifiers and limited visibility of fog, mist, rain, snow, and darkness (see "Advanced Terrain").

Combat Sensor

Cost: 10 SGPs.

Effect: +1 to a soldier's *search* skill test.

A combat sensor is a compact sensor package composed of a Full-Spectrum Transceiver linked to a Life Form Indicator. Due to its compact size, the FST/LFI configuration is not as sensitive as a shipborne package, but it does provide good general purpose assistance in detecting lifeforms or objects on the battlefield.

A soldier equipped with a combat sensor receives a +1 modifier to his die roll when taking a *search* skill test.

Targeting Computer

Cost: 10 SGPs.

Effect: -1 to a firer's difficulty number.

A targeting computer combines an macrobinocular sight with sophisticated electronic compensators and is linked to the soldier's weapon to provide better fire control.

A soldier equipped with a targeting computer reduces his fire difficulty number by one.

Comlinks

Cost: 10 SGPs.

Effect: Allows communication with off-board artillery.

All commanders on the battlefield are assumed to have some form of comlink through which they communicate with each other and headquarters; these communicators are tuned to a specific channel to allow the commander to "call in" bombardment against his opponents (see "Calling For Strikes").

Artillery

Artillery on the modern battlefield suffers from specific vulnerability problems, particularly from orbital bombardment and starfighter attack. Without expensive shielding and/or mobility provisions, its survivability rate is low. Due to this vulnerability, inclusion of artillery formations in the Imperial Order of Battle is on the decline.

In addition, skirmish battles of the type fought in *Star Wars Miniatures Battles* are rarely large enough to be supported by artillery. The optimum range for artillery also usually requires its placement well off the tabletop.

Because artillery is still in use in some isolated or remote sectors and Outer Rim worlds, rules are provided for the use of some of the more popular types.

There are two general types of artillery: on-board and off-board.

On-Board Artillery

On-board artillery refers to guns actually placed on the battlefield. These are expensive, and open to enemy fire, but provide a great deal of direct firepower.

On-board artillery is placed on the table as part of the initial set-up. As this artillery is immobile, only the soldiers on the defensive, in possession of the field at the beginning of the game, can employ on-board artillery.

The Crew

Soldiers use their *blaster artillery* skill to fire artillery. Most artillery pieces require three or more soldiers to crew them: a lead gunner and his crew. Fewer soldiers dramatically reduces the weapon's accuracy and rate of fire.

The artillery crew is considered to be a squad and follows all the rules for squads, including generation, morale, movement, and combat. When purchasing crew for an artillery piece, smart players generally buy a few more soldiers than necessary, both to replace injured crewmen and to provide a degree of small-arms protection to the gun and crew.

The crew must remain within 1" of the weapon to fire it; they may not fire other weapons in the same turn in which they crew the gun. Soldiers not actively crewing the gun may fire other weapons.

Firing the Gun

An on-board artillery piece fires in much the same way as any other weapon, but with important differences. It must have a LOS to the target, but as it is automatically equipped with the equivalent of macrobinoculars in its targeting systems, it is not affected by many battlefield conditions. All fire from on-board artillery is considered to be at short range.

When an artillery piece fires, the player places a burst template (determined by the type of artillery piece) at the target point and makes a *blaster artillery* test for the lead gunner. If successful, the artillery fire hits there. If the test fails, the shot "deviates" as if a grenade thrown at medium range. However, on a roll of 1-2 on the second deviation roll (the roll to determine range), the shot is considered to have "overshot" — been targeted so badly that it does not explode on the battlefield at all. When an overshot occurs, do not place a template; the shot has no effect.

Descriptions

Besides the standard statistics used for combat, there are a few additional items in the artillery descriptions.

They are explained here.

Crew: This is the number of soldiers needed to effectively fire the weapon. The Squad Generation Points of the crew are figured separately from the cost of the weapon; each crew can be considered a squad.

One of the crew members is designated the lead gunner. Use the lead gunner's *blaster artillery* skill when firing the gun. If the weapon is undermanned (any of the crew have been incapacitated), add +2 to the firing difficulty.

Body Strength: The battery's strength for resisting damage.

Body Points: When an artillery battery is hit, damage is figured using its *Body Strength*. Each wound result removes one of the battery's Body Points; each incapacitated result removes two. When all of the battery's body points are gone, the weapon is destroyed.

Fire Rate: The number of shots per turn the gun can fire. A Fire Rate of 1/2 means the gun can fire one time every two turns.

Fire Control: The battery's computer-assisted fire control systems make it more effective. A weapon's Fire Control is added to a gunner's *blaster artillery* skill when firing the weapon.

Light Anti-Vehicle Laser Cannon

The Atgar 1.4 FD P-Tower is a dish-shaped laser battery, standing about 4.3 meters high, which dates from the Clone Wars.

The crew positions are located around the weapon, without cover. Fire directed at the battery has a 50-50 chance of hitting a crew member instead of the weapon.

Skill: *Blaster artillery*

Crew: 4

Body Strength: 1

Body Points: 8

Minimum Range: 12"

Fire Rate: 1/2

Fire Control: 1

Blast Radius: 1.5" (use the Grenade Burst Template)

Damage: 8

Cost: 224 SGPs

Anti-Infantry Battery

The Golon Arms Twin DF .9/B Medium Anti-Infantry Battery is a turret sporting twin heavy repeating blasters mounted on a four-meter-high armored tower.

Note: this weapon does not get following fire benefits; its area of effect takes the place of that.

Skill: *Blaster artillery*

Crew: 2

Body Strength: 4

Body Points: 24

Minimum Range: 10"

Fire Rate: 1

Fire Control: 2

Blast Radius: 2.5"
Damage: 6
Cost: 388 SGPs

Off-Board Artillery

Off-board artillery represents both orbital bombardment and artillery placed well beyond the battlefield. As such, it is more powerful than on-board artillery, and less under the control of the commander of the battlefield. It is risky and expensive but, if it works properly, it can be devastating. Off-board artillery should only be used in games with a gamemaster.

Purchasing Strikes

When purchasing off-board artillery, you do not purchase the actual artillery pieces. Instead you purchase individual "strikes." Before the game, you expend SGPs to give you the opportunity to "call in" off-board strikes during the game. You are not assured of getting a strike exactly when you request it: the strike may be delayed or never show up at all (it may be under attack or responding to "more important" requests from other commanders).

There are two different types of off-board strikes available: "light" and "heavy." Rebels pay more for off-board strikes than do Imperials. The following chart shows the cost of artillery strikes.

Artillery Strike Cost Chart

	Light	Heavy
Rebel	30	50
Imperial	20	40

Calling For Strikes

A commander with a comlink may call for an artillery strike during the Special Actions Phase. He must have a LOS to the target point. A single commander may only call for one strike during a turn, though other commanders may request other strikes.

The player writes down the location of the strike and the turn in which he wishes it to arrive. He may ask for the strike to come in any of the next four Special Actions Phases. The player does not tell his opponent where or when the strike is coming.

Example: A commander is attacking a Rebel-held hill and has access to three heavy artillery strikes. On turn 2, he calls in one strike to hit the hill on turn 5. On turn 3, he calls in another to hit on turn 5. On turn 4, he calls in his third and final strike on the hill. With three heavy strikes coming in on them in turn 5, the Rebels on the hill are going to be in serious trouble.

Resolving Strikes

Off-board artillery strikes are resolved at the beginning of the Special Actions Phase, before any other actions take place. Each strike is resolved separately, one at a time.

The player with a strike due this turn makes a *command* roll on the following table for the commander who requested the strike. Use the commander's *command* skill even if the commander has been subsequently incapacitated; this judges his ability to communicate his orders at the time he called in the strike.

Artillery Strike Resolution Table

Command Roll	Result
1	No further bombardment available. This and all further off-board bombardment lost for the remainder of the game.
2-4	Strike cancelled.
5-6	Strike delayed 1 or 2 turns Roll a die: 1-3 = 1 turn; 5-6 = 2 turns.
7+	Strike occurs as requested.

Strike Location

Once a strike does occur, you must determine the location of the hit. Place a template at the target point, using a 2.5" radius template for a light strike; a 4" radius template for a heavy strike. (A 4" radius template has been included on one of the "Templates and Markers" cardstock sheets provided in the back of this book). Then, the opposing player orients the template so that the deviation directions face as he wishes.

Roll a die to determine the direction of deviation. Then roll to determine how far the strike deviates. On a roll of 1-2, it hits exactly where placed; on any other roll it deviates. Light bombardment deviates the number rolled in inches; heavy bombardment deviates the number rolled in inches times two. In addition, if you roll a 6, reroll and add the new roll to the first. Continue rolling and adding as long as you roll sixes.

Damage from Bombardment

Off-board bombardments hit with the following *Damage Strengths*:

Light Bombardment: Damage 8
Heavy Bombardment: Damage 12

Chapter Twelve

Heroes

Heroes are the essence of *Star Wars*.

Heroes — Luke Skywalker, Princess Leia Organa, Han Solo, Darth Vader and others like them — are extraordinary men, women and aliens with skill and courage far beyond those of normal beings. These heroes can appear upon the *Star Wars Miniatures Battles* battlefield with devastating effect.

Heroes are not immortal, and even Darth Vader can be injured by a lucky shot. However — whether they know it or not — heroes are in tune with the “Force,” making them incredibly difficult to damage. Usually it takes a hero to injure another hero.

Heroes are written up on Hero Record Sheets, one per hero (see “Creating Heroes”).

Lone Heroes

Heroes can move and fire upon the battlefield on their own. They are not subject to morale rules, nor do they have to stay within command distance of any other soldier. A lone hero moves, fires and is fired at as if he were a squad of one.

Heroes and Command

Heroes may be placed in command of a squad at the beginning of the game. In addition, the hero can assume command of a squad during any Special Actions Phase. The hero must be within his *command* rating in inches of the squad. The hero functions as the commander of the squad in all ways from then on, moving and firing with the squad, and subject to the same morale conditions as the squad. The hero can still use any special abilities he has.

The hero can relinquish command of the squad during a Special Actions Phase, either handing the squad over to a squad member or to another hero. To do so, the player simply states that his hero is relinquishing command, and tells the other player who the squad’s new commander is.

Targeting Heroes

If a hero is within his command distance of a squad, whether he is in command or not, he cannot be directly fired at by enemy soldiers. In effect, he becomes part of

the squad and the only way for soldiers to hit him is to aim at the squad and hope that their shot happens to be targeted upon him.

Special Skills

In addition to the standard skills available to all soldiers, heroes may be given any of the following skills:

Brawling Parry: The hero adds his *brawling parry* skill to his *brawling* or *melee combat* skill when engaged in hand-to-hand combat against an opponent who is *brawling*.

Dodge: The hero can attempt to dodge blaster and other weapon fire. After the hero has been targeted, he and the firer make opposed rolls, the firer using his weapon skill, the hero his *dodge* skill. There are no modifiers to this roll. If the hero ties or wins the roll, the fire combat has no effect; otherwise, the shot hits, as normal.

The hero can also dodge grenades. A hero in a grenade burst template makes a difficulty 6 *dodge* roll; if successful, he dives out of range, ending up prone adjacent to the burst template.

Heroes cannot dodge shots or grenades they don’t see coming. The hero can see in a 180-degree arc to his front; if shot at from the rear, he cannot dodge. Heroes cannot use this skill in close combat.

Melee Parry: The hero adds his *melee parry* skill to his *brawling* or *melee combat* roll when engaged in close combat against an opponent who is *meleeing*.

Climbing/Jumping: The hero can use this skill on the battlefield to climb impassable barriers, and to leap over other barriers.

The hero may attempt to climb normally impassable barriers, such as cliffs, walls, the sides of buildings, and so forth. Players should agree upon the difficulty of such barriers before play begins, but, as a general rule, most impassable barriers are difficulty 6-10.

A hero can climb up to 3 meters a turn; if the barrier is taller than that, the hero ends his move 3 meters up (or down); he must make additional rolls in the following Movement Phases to continue the climb.

A hero in the middle of a climb has all combat or skill rolls increased by a difficulty of 3. If engaged in close assault, he fights at -3. If fired at, a climbing hero is considered to be prone in clear terrain. A hero who is wounded while climbing immediately falls. A hero cannot *dodge* while in the middle of a climb.

A failed roll while attempting to cross an impassable barrier means the hero fell; place him prone at the base of the barrier. In addition, he may take damage from the fall. He makes an opposed *Strength* roll against the *Damage Strength* of the distance he fell. A 2-meter fall has a *Damage Strength* of 0; each additional meter adds +1 to the *Damage Strength*. The *Damage Strength* of the fall might be modified by other factors. If the hero falls into a pit of spikes, for example, the *Damage Strength* of the fall would be increased by +2.

A hero may cross difficult and moderate barriers at a cost of 1" by passing a *climbing/ jumping* test.

Heroes Jumping Barriers

Barrier Type	Difficulty Number	Cost
Moderate	4	1"
Difficult	6	1"

A failed roll means the hero must pay the normal cost to cross the barrier.

A hero can use his *climbing/ jumping* skill to cross pits, streams, trenches, and so forth.

Heroes Jumping Pits

Distance	Difficulty Number
1"	4
2"	6
3"	8

If the hero fails the roll, he only jumps half of the distance. A jump, regardless of the distance, costs a hero 1" of movement.

Special Combat Abilities

Heroes possess extraordinary abilities that make them a cut above other soldiers on the battlefield.

Multiple Targets

A hero can fire more than once at a squad or enemy hero. Each additional shot increases the difficulty of each shot by +2. The hero announces how many shots he is taking and then rolls the appropriate number of dice. Successful shots are targeted as normal.

Specific Targeting

A hero can target his shots at a specific soldier within a squad, or at a hero or droid drawing cover from the squad. The difficulty of the shot is increased by +4. If he is good enough, a hero can combine this with the multiple target ability to fire at the same soldier, hero, etc.



■ The extraordinary abilities and skills of heroes can help to keep them alive and active in situations that would spell doom for an ordinary individual.

Lightsaber

A hero with a lightsaber and the *lightsaber combat* Force power can use the lightsaber to parry blaster bolts, and “aim” them back at their firer. Instead of *dodging* an attack, a hero can decide to parry it. The attacker rolls his blaster attack as normal, and the hero makes an opposed roll using his *lightsaber* skill, which may be enhanced by his use of *lightsaber combat* (see below). If the hero wins, he successfully parries the blaster bolt and can “aim” it back at the firer. The hero makes a fire combat roll, taking into account modifiers for range, cover, etc. However, he uses his *control* skill rather than his *blaster* skill to direct the bolt. If he hits, the *Damage Strength* of the bolt is that of the weapon that fired it.

Heroes and the Force

Whether they are aware of it or not, some heroes are deeply in tune with the mystic power called “The Force.” Many heroes have “Force Points” which they can use during a scenario to avoid taking damage and to increase their chances of using skills successfully. In addition, some very special characters have training in the use of the Force; they have “Force skills.”

Force Points

Heroes gain Force Points when they are created (see “Creating Heroes”). Heroes spend their Force Points to roll extra dice when they fire weapons, fight in close assault combat, *dodge*, make *Strength* rolls to resist damage, use special abilities, and for most other dice rolls. Once a hero runs out of Force Points, he can no longer spend them, but he may still use any of his Force skills.

The hero **cannot** spend Force Points when making a *Damage Strength* roll to determine the damage he does against another soldier or hero unless he bombs out, in which case he can spend one Force Point on the roll. This rule applies to any *Damage Strength* roll, whether caused by fire combat, close assault combat, Force skill attacks, etc. He may, however, use Force Points to increase his *Strength* roll when he is the target of an attack.

Using Force Points: The hero chooses to spend Force Points after he rolls his normal die; if he is not happy with his roll, he pays one Force Point and rolls an additional die and adds the result to the first die roll. If the Force die roll is a “6,” the hero rolls over as normal.

If the hero is not satisfied with his new total, he may spend more Force Points. There is no limit to the number of Force Points that heroes can spend on any roll, except that heroes do not possess unlimited Force Points. In fact, when two heroes are engaged in opposed rolls against each other, an exciting bidding war may ensue, as each in turn spends Force Points to beat the other’s roll.

Force Skills

There are three Force skills: *control*, *sense*, and *alter*. Within each skill there are a number of powers which heroes trained in the Force can use. Certain Force powers are not available to Alliance heroes; some are

not available to Imperial heroes. These are listed in the Force skill descriptions.

Most Force powers are used in the Special Actions Phase, but some are used during the Movement, Fire, Combat, or Close Assault Combat Phases. A hero can use only one Force power per turn. When using a Force power, a hero cannot perform any other action that Phase.

Using Force Powers: To use a Force power the hero must possess its controlling skill. Some Force powers require a hero to have more than one Force skill in order to use them. Each skill power is used at the level of the controlling skill or, if two or three skills are used, at the level of the lowest skill. Skill rolls are straight or opposed depending on the skill and circumstances.

Certain Force powers require that the hero have one or more other Force powers in order to use them. These required powers are noted in the descriptions below.

Control Powers

This is the ability to control the hero’s own internal Force. It governs the following powers:

Absorb/Dissipate Energy: The hero can use this to avoid the effects of energy weapons such as blasters, lasers, etc. An *absorb/dissipate* attempt takes the place of the hero’s *dodge* attempt. After being targeted, the hero makes a difficulty 6 skill test; if successful, he absorbs the energy and need not make a *Strength* test. If he fails, he takes damage as normal. If hit by a heavy weapon, the difficulty is increased by +1.

When attempting to absorb multiple hits from the same firer (individual hero or squad), the hero makes one roll; the difficulty is increased by +1 for each shot he is attempting to absorb/dissipate. On a successful roll, he absorbs all damage.

The hero can only absorb/dissipate shots he sees coming — that is, if the firer is in the hero’s 180-degree front arc.

Control Pain: The ability to ignore the effects of a wound. A wounded hero who controls pain acts as if unwounded — he ignores negative skill modifiers, moves as normal, etc.

The hero makes a difficulty 6 *control* test in the Special Actions Phase; if successful, the hero acts as if unwounded. If the hero fails, he may make additional attempts in subsequent Special Actions Phases.

If he takes a second wound, a hero becomes incapacitated. He may attempt to *remain conscious*.

Remain Conscious: Requires *control pain*. The ability to stay conscious after taking tremendous damage. A hero with this power is not immediately removed from play after taking incapacitating damage — he may attempt to *remain conscious*.

Detoxify Poison: A hero with this power may attempt to detoxify or eject poisonous substances introduced into his body. The hero makes a difficulty 6 skill attempt after being hit with the poison; if he is successful, he ignores

the effects. If the hero is in contact with the poison for more than one round (say, by staying in an area filled with poisonous gas), he must make the attempt each round. If he fails, he suffers the effects as normal.

Even if the hero passes the roll, he may still suffer physical damage: if a hero is hit by a poison-covered spear, he can detoxify the poison, but will still be hurt by the spear itself.

In the Special Actions Phase of the turn in which he is incapacitated, the hero may make a difficulty 8 *remain conscious* attempt.

If he fails, he is removed from play, as normal. If he succeeds, he remains in play, but the difficulty of all of his skill tests are increased by +4, in close assault he fights at -4, and he may not run unless he uses *control pain* successfully.

To *control pain* after *remaining conscious* the hero needs to pass a difficulty 10 *control* test. He may attempt the roll each Special Actions Phase until successful.

Any further wounds automatically take a hero who has *remained conscious* out of play.

An incapacitated hero can be healed up to wounded status with a difficulty 6 *first aid* roll by a soldier with a medpac (see "Advanced Equipment").

Sense Powers

The ability to feel the web of connections that is the Force, and by tracing along the web, to read the feelings of others, and to heighten one's own senses.

Life Detection: The hero uses this power to spot hidden targets. In any Special Actions Phase, the hero may attempt to discover the location of characters/squads which are hidden. During the Special Actions Phase, the hero nominates a 6" by 6" section of the battlefield, and announces that he is using *life detection*.

The opposing player checks to see if anything is there, but does not immediately tell the other player. The two sides make opposed dice rolls, even if the opposing player knows that there is nothing to find. The opposing player keeps his roll hidden from the other player (his opponent will just have to trust him).

The sensing player's score is based upon his roll, plus his *sense* skill level. The opposing player's score depends upon what is there: if the area is empty, his score is simply his unmodified die roll. If a single squad or hero is there, his score is his die roll, plus the squad's or hero's *control* or *Perception* score, whichever is higher. If multiple squads/heroes are there, the opposing player's score is based upon the squad/hero with the highest *control* or *Perception* score.

If the sensing player wins, the opposing player must announce that the hero sensed something there, and tell him how many soldiers are in the squad he sensed, or that there is only one figure there, if a hero was sensed. If nothing was there, he tells the sensing player so. He need not reveal all of the squads/heroes in the area, just the one whose *Perception* or *control* score he based his roll on.

If the opposing player wins, he simply tells the sensing player that he sensed nothing there.

Receptive Telepathy: Requires *life detection*. The ability to read the thoughts and emotions of others through the Force. A hero using this power can learn about the skills and attributes of opposing squads/heroes within his line of sight. The skill is used in the Special Actions Phase.

The hero and the character he is using this power against make opposed rolls, with the hero using his *sense* level, and the defender using his *control* or *Perception*, whichever is higher. If the hero wins, he may examine the other squad's/hero's record sheet.

When successfully used against a squad, this power allows the hero to learn who the commander of the squad is. Some other Force Powers (*injure/kill* and *affect mind*) which attack the enemy squad's commander require that this power have been used on the squad in an earlier Special Actions Phase.

Control & Sense Powers

To use these, the hero must have both the *control* and the *sense* skills.

Lightsaber Combat: This power allows a hero to use a lightsaber more effectively. It is used in the Close Assault Combat Phase, just before the hero is involved in combat. The difficulty for the skill test is 6.

If the hero succeeds, he may add his *sense* skill level to his *lightsaber* skill rolls, and add his *control* level to the lightsaber's *Damage Strength*. These benefits last for the duration of the combat, or until the hero is wounded or incapacitated, whichever comes first.

If the hero does not succeed at the *lightsaber combat* test, he must use his unmodified *lightsaber* skill and the lightsaber's normal *Damage Strength*. He may not attempt to use *lightsaber combat* again for the duration of the combat.

A hero must have *lightsaber combat* in order to attempt to parry blaster bolts with his lightsaber. He may also try to use this power to enhance his parrying attempt. When a hero is fired upon, and decides to parry the blaster bolt, he may make a *lightsaber combat* skill test against a difficulty of 8. If he succeeds, he gains the enhancements outlined above for the duration of that Fire Combat Phase. The benefits cease if the hero is wounded.

Projective Telepathy: There are a number of uses for this power, both defensive and offensive. In both cases, this is used during the Special Actions Phase.

Defensively, the hero can use this power to attempt to remoralize squads on his own side, that is, increase their morale level. The attempt is difficulty 6 if the hero can see any of the soldiers in the squad, difficulty 8 if he cannot. If the roll is successful, the squad is immediately allowed to make a rally test at the hero's *command* skill, but modified by circumstances. Rally results are applied normally. This skill can be used on any squad with decreased morale, including broken squads.



■ Users of the Force can be a great asset to the side which fields them.

Offensively, the hero can use this power to attempt to demoralize enemy squads. The hero can use this power only on squads that he can see. The hero makes an opposed roll against the enemy commander's *command* skill; if the hero wins, the enemy squad must make an immediate morale test. The threat level of the test is the amount the hero's roll beat the commander's roll. All effects are immediately put into play — if the squad breaks, it immediately runs away, and if it beats the morale difficulty by 4 or more, it immediately gains a morale level, etc.

Alter Powers

These powers allow the hero to alter the physical universe through the Force.

Injure/Kill — Imperials only: Requires *life detection*. This power is used in the Special Actions Phase. The hero (or villain, in this case) makes an opposed roll against the victim's *control* or *Perception*, whichever is higher. If successful, the hero and victim make another set of opposed rolls, this time the victim uses his *Strength*, unmodified by armor. If the hero wins, the victim is wounded. If the hero wins by 4 or more, the victim is incapacitated.

This power has a range of 6" and the hero must have a LOS to his victim. When used against a squad, roll randomly among the visible squad members to determine the victim. If the hero previously used *receptive telepathy*, he may pick any of the visible soldiers to kill.

Telekinesis: The hero can use this power to hurl objects at opponents.

When attacking enemies, the hero uses this power in place of his fire combat attack. The hero must have a line of sight to his target. The difficulty of the attack is not modified by range or terrain; instead, it is determined by the size of the object he is hurling. A hero can use this power over any distance providing he can see his target.

If the hero sends something small at the opponent, the attack is difficulty 4, and, if it hits, it has a *Damage Strength* of 1.

If the hero sends something of moderate size at the opponent, the attack is difficulty 6, and it has a *Damage Strength* of 3.

If the hero sends something large at his opponent, the attack is difficulty 8, and has a *Damage Strength* of 5.

A hero can attempt to *dodge* the attack, following the normal rules for *dodging*.

Note that the object is assumed to be something lying nearby to the hero, rocks, crates, etc., not necessarily an item actually represented on the battlefield — a hero standing in the middle of a clear field with no terrain features could still find something to telekinese.

When used against an enemy squad, the shot is randomized among visible targets, unless the hero wishes to increase the difficulty of the shot by +4, in which case he can pick his victim.

A hero can also use this power to more accurately place grenades. This is a difficulty 4 shot; if the hero misses, the grenade deviates as if thrown from short range.

Control and Alter Powers

These powers are based upon the hero's *control* and *alter* scores, using whichever is lower.

Control Another's Pain — Rebels only: This works like the *control pain* power, except that the hero can use it on other heroes. To use this power, the hero must be in base-to-base contact with another hero during the Special Actions Phase.

Detoxify Poison in Another — Rebels only: This works like the *detoxify poison* power, except that the hero can use it on other heroes. The hero must be in base-to-base contact with another hero during the Special Actions Phase to use this power.

Control and Sense and Alter Powers

The skill of these powers is based upon the lowest Force skill level of the hero.

Affect Mind: The hero can use this power to affect the mind of his opponents. This power is used during the Special Actions Phase to confuse heroes or commanders of the opposing squads, causing them to fight poorly in the following turn.

If the target is the commander of an enemy squad, the hero must have employed *receptive telepathy* against that squad earlier in the game before he can affect the commander's mind.

The hero must be able to see his target. He can pick any enemy commander or hero he can see. The two make opposed rolls, the enemy using his *control* or *Perception*, whichever is higher. If the hero equals or beats the enemy's roll, he confuses him, causing the squad or hero to fight the following turn with a -2 penalty to all skill levels. A skill cannot be reduced to a negative number. The lowest it can become is zero.

If the hero beats the enemy hero's or commander's roll by four or more, he also causes him to immediately withdraw 4", following the normal rules for withdrawing (see "Close Assault Combat").

Hero Creation

Creating a hero is a process very similar to creating a squad. You can create a hero from scratch, or use one or more of your player characters from *Star Wars: The Roleplaying Game*. If you are using a pre-existing character from the roleplaying game, you can skip the next section and proceed directly to "Generating Heroes."

Creating a Hero From Scratch

You create a hero the same way you create a character for *Star Wars: The Roleplaying Game*. Choose one of the character templates and create your hero. Then transfer the attributes and skill codes to the Hero Record Sheet. Remember to round one pip down and two pips up. The same procedure can be used in *Star Wars Miniatures Battles* to create a hero on the Hero Record Sheet.

Here's a brief rundown of the process if you're not familiar with the roleplaying game. You begin with 18

points to distribute among the hero's attributes. No attribute can have more than four points or less than two points. Each Force skill costs one point of the initial 18 points. No Force skill begins with more than one point.

Now take seven more points and distribute them among the skills. Each skill starts at the level of the attribute it falls under. Additional points increase the skill they are applied to.

Example: A hero is created with a *Dexterity* of 3. Therefore all *Dexterity* skills begin at a level of 3. If a player allocates two of the additional seven points to the *blaster* skill, the hero has a *blaster* skill of 5.

These points can be used to increase Force skills. No skill can be increased by more than two points.

Generating Heroes

Once you've created your hero, or have your player character's character template ready, you can prepare the Hero Record Sheet. Enter the hero's Move. Fill in the attributes and skill codes. Under the attribute codes enter the amount by which the skill has been increased. Enter the actual skill total to the left of that.

As heroes can do more on the battlefield, and can utilize special skills, there are more skills listed on the Hero Record Sheet than on the Squad Record Sheet. This makes also heroes more valuable; each attribute and skill point costs **two** Squad Generation Points. There are blank lines provided under each of the attributes so you can record any additional skills or skill specializations. The specializations are treated as regular skills. Add up the Move, attribute codes and the skill increases. Multiply by two to find the "Skills Total."

Weapons and Armor

These are handled just as they are for squads. Enter the name, damage, ranges and cost of the weapons. Enter the type, modifiers and cost of any armor worn. Total down the column from the "Skills Total" to get the "Skills/Weapons/Armor" total.

Force Users

If your hero has Force abilities, use the section of the sheet to the right. The ability to use the Force costs 25 SGPs. Write "25" in the "Force Use" space. Force skill codes are entered below the "Force Use" line. Each point of Force skill costs 4 SGPs. Multiply the skill codes by four and enter the cost to the right.

Now choose the Force Powers your hero can utilize. Each Force power costs five points. Write in the name of the power on a line, then black out the boxes of the Force skill(s) which do not affect the power. These are provided as a handy reminder for use during the game. Enter the SGP cost for the power to the right of the boxes.

Example: A player chooses *receptive telepathy* for his hero. *Receptive telepathy* is based on the *Sense* skill, so the player fills in the "C" and "A" boxes.

Force Points

Force Points are available to any hero, not just those who can use the Force. They represent "trusting to the Force." How many Force Points a hero has available for a game is determined by rolling a die and consulting the "Force Points Table."

Force Points Table

Roll	Force Points
1-2	1
3-4	2
5	3
6	3 plus rollover

The player must declare how many rolls he will make before rolling the die. Each roll on the table costs 10 SGPs. If a "6" is rolled the player can roll again at no extra cost and add the new points obtained to his total. A player can reroll as many times as a "6" is rolled.

Add up the Force points obtained and enter them in the "Force Points" circle at the top of the Hero Record Sheet. Fill in the number of rolls taken at the bottom of the Force section of the sheet. Multiply by ten and record the SGP cost to the right. Total down the column from "Force Use" to the "Force Point Rolls" to get the "Force Total."

DIAGRAM 22 Force Powers Example

Control Pain	C	5
Remain Conscious	C	5
Life Detect.	S	5
Rec. Telepathy	S	5
Lightsaber Combat	CS	5
Proj. Telepathy	CS	5
Telekinesis	A	5

Stephen Crane

Completing the Hero

Add up (to the left) the "Force Total," the "Skills/Weapons/Armor" total and the "Base Cost" of the hero (a hero automatically costs 30 SGPs for being a hero). This the is total SGP cost of the hero.

Determine the "Movement Rates" as explained in the "Movement Rates" section and fill in the circles at the top of the sheet. Your hero is now ready for action.

DIAGRAM 23 Completed Hero Record Sheet

HERO NAME WUWUHUUL **Walk Rate** 7 **Run Rate** 12 **Force Points** 7

Template Type Alien Student of the Force

Height 6'2" **Weight** 120 **Sex** ? **Age** 7 seasons

Description Big, walking plant

Move: <u>10</u>	MEC: <u>2</u>	STR: <u>3</u>	Force Use <u>125</u>
DEX: <u>2</u>	Beast Riding <u>2</u> <input type="checkbox"/>	Brawling <u>3</u> <input type="checkbox"/>	Control <u>2</u> x 4 = <u>8</u>
Blaster <u>3</u> <input type="checkbox"/>	<u>2</u> <input type="checkbox"/>	Climb/Jump <u>3</u> <input type="checkbox"/>	Sense <u>2</u> x 4 = <u>8</u>
Blaster Arty. <u>2</u> <input type="checkbox"/>	<u>1</u> <input type="checkbox"/>	Swimming <u>3</u> <input type="checkbox"/>	Alter <u>2</u> x 4 = <u>8</u>
Brawl. Parry <u>2</u> <input type="checkbox"/>	PER: <u>2</u>	<u>1</u> <input type="checkbox"/>	Force Powers:
Dodge <u>2</u> <input type="checkbox"/>	Command <u>2</u> <input type="checkbox"/>	TEC: <u>2</u>	Control Pain <u>C</u> <input type="checkbox"/> 5
Grenade <u>2</u> <input type="checkbox"/>	Search <u>2</u> <input type="checkbox"/>	Demolition <u>2</u> <input type="checkbox"/>	Remain Conscious <u>C</u> <input type="checkbox"/> 5
Melee Parry <u>3</u> <input type="checkbox"/>	Sneak <u>2</u> <input type="checkbox"/>	First Aid <u>2</u> <input type="checkbox"/>	Life Detect. <u>S</u> <input type="checkbox"/> 5
Melee <u>2</u> <input type="checkbox"/>	<u>1</u> <input type="checkbox"/>	<u>1</u> <input type="checkbox"/>	Rec. Telepathy <u>S</u> <input type="checkbox"/> 5
KNO: <u>3</u>	Star Wars Miniatures Battles HERO RECORD SHEET		Lightsaber Combat <u>CS</u> <input type="checkbox"/> 5
Survival <u>3</u> <input type="checkbox"/>			Proj. Telepathy <u>CS</u> <input type="checkbox"/> 5
<u>1</u> <input type="checkbox"/>			Telekinesis <u>A</u> <input type="checkbox"/> 5
			<u>C</u> <input type="checkbox"/> <u>A</u> <input type="checkbox"/>
			<u>C</u> <input type="checkbox"/> <u>S</u> <input type="checkbox"/> <u>A</u> <input type="checkbox"/>
			<u>C</u> <input type="checkbox"/> <u>S</u> <input type="checkbox"/> <u>A</u> <input type="checkbox"/>
			<u>C</u> <input type="checkbox"/> <u>S</u> <input type="checkbox"/> <u>A</u> <input type="checkbox"/>
			<u>C</u> <input type="checkbox"/> <u>S</u> <input type="checkbox"/> <u>A</u> <input type="checkbox"/>
			Force Point Rolls: <u>3</u> x 10 = <u>30</u>

Weapon(s) Carried	Dam.	Short	Med.	Long	SKILLS TOTAL
Blaster Pistol	4	5	15	60	7
Lightsaber (dam. 5 + Control)	5(7)				25
					52
					52

Armor: STR/DEX mod.: / 1

HERO COST 228 = **BASE COST:** 30 + **SKILLS/WEAPONS/ARMOR:** 84 + **FORCE TOTAL** 114

Stephen Crane

Chapter Thirteen

Creatures

While the number of aliens inhabiting the worlds of the galaxy is vast, the number of creatures to be found on those worlds is even greater. Cataloguing even a fraction of their number would be a work far beyond the scope of this book. Fortunately, most creatures never appear on the field of battle.

Although relatively few of these creatures ever make it to the battlefield, the rules provided below will allow you to handle them when they do show up. Following the rules is a listing of the more common creatures likely to be found on a battlefield.

Using Creatures

Creatures are best used by the gamemaster. A creature makes a nifty surprise for the combatants when it pops up out of a cave in the middle of a battle, or is lurking in the corridors of a derelict hulk that a squad is searching. It could also be the objective that either or both sides need to retrieve from the battlefield. Perhaps the Rebels are aiding some planetary natives who use hunting packs or some outré cavalry in battle.

Each of these ideas could make for an interesting and fun scenario. The gamemaster will need to set up the conditions for the creatures' appearances, or the players can mutually agree on the use of creatures in a game.

Attributes

Creatures have less attributes than soldiers, and generally no skills. They are not subject to morale. The attributes they do possess are *Dexterity*, *Strength*, and *Perception*.

DEX: *Dexterity* affects movement.

STR: *Strength* is used to resist damage in an opposed skill test. It is also used for attacks when creatures do not have an attack skill.

PER: *Perception* is used to determine if a creature has noticed something.

Ratings

In addition to attributes, a creature has a Move and a Movement Rate, and may have an Orneriness Code and one or more Attack Forms.

Move: The creature's basic movement capability.

Movement Rate: This is the maximum distance in inches that the creature can move in a Movement Phase.

Orneriness Code: This rating is used when it becomes necessary to test whether the rider can retain control of the creature he is riding (see "Mounts" below).

Attack Forms: These are the methods whereby a creature can inflict damage, and includes the *Damage Strengths* of the attacks.

A creature's attributes and ratings can be found in the "Creature Chart."

Bases

Unless the creature is man-sized and man-shaped, it will most likely require a larger base than your typical soldier is mounted upon. A good rule of thumb is to use a base one inch wide by two inches long for a horse-sized creature. However, the size of the base will often be determined by the size of the miniature figure you are using; use a base big enough to support the figure.

The creature's front, back and sides are defined by the 90-degree arc extending from the corners of the base. If the creature is on a circular base, the arcs are figured from the center of the base, with the front arc centered on the direction the figure is facing. These directions are used in determining whether a creature can attack (see "Attack Forms" below).

Movement

Each creature has a Movement Rate. Like the Movement Rate for a soldier, this determines how far a creature may move in a given Movement Phase. Unlike a soldier, a creature has only one Movement Rate.

A creature's Movement Rate is determined like the Run Rate of a soldier — add the creature's *Dexterity* to its Move. This is the Movement Rate in inches.

The creature can move a number of inches up to and including its Movement Rate. A creature's movement is affected by the terrain it moves over, as though it were a soldier.

DIAGRAM 24
Creature Orientation

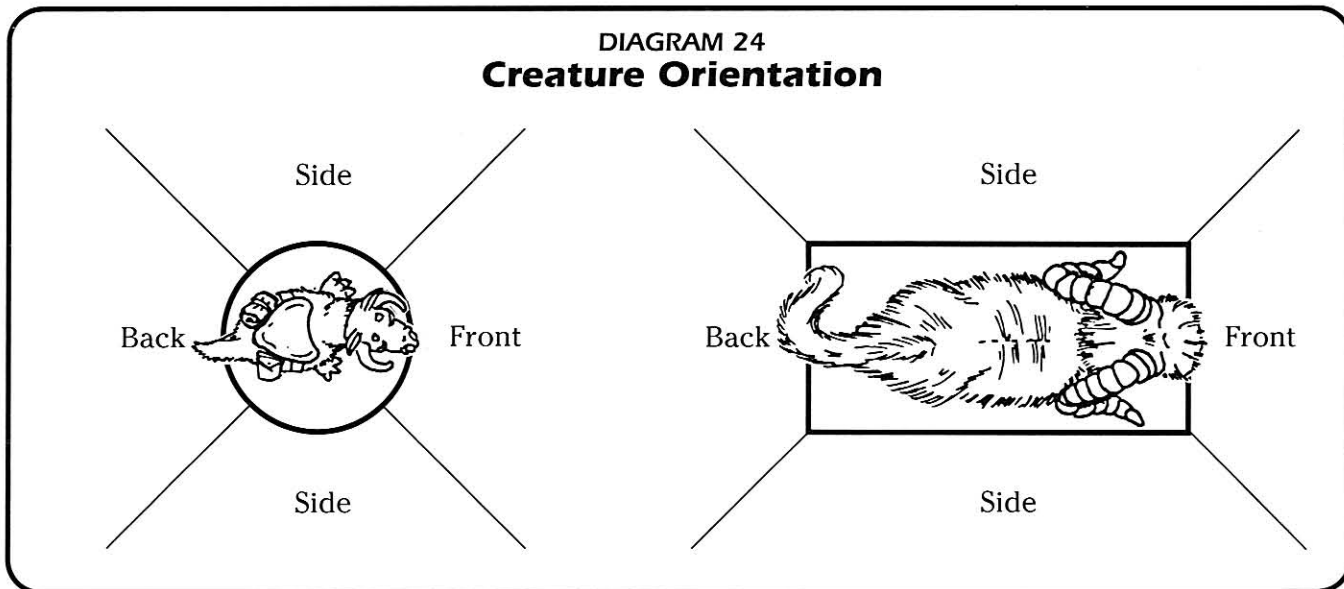

Stephen Crane

Combat

Creatures attack in close assault combat. Creatures charge into close assault, but they do not take a morale test in order to do so. Soldiers charged by creatures may use defensive fire.

Combat is resolved as for close assault combat. The *Damage Strength* of a creature's Attack Form is added to its die roll in an opposed skill test. If damage is inflicted, it is worked out normally. If the creature wins the combat, use the *Damage Strength* of the Attack Form. If the creature loses, use its *Strength* attribute.

Attack Forms

A creature may have one or more forms of attacking an opponent. Each Attack Form is listed for a creature in the "Creature Chart." Following the form is the *Damage Strength* of the attack, in parentheses. The various Attack Forms are described below.

Bite: The creature uses its long fangs to bite an opponent. A bite attack is made to the front.

Claw: The creature has formidable claws on its arms or forward appendages. A claw attack can be made to the front and sides.

Horn: Creatures with horns can make a butting attack. Horn attacks are made to the front.

Tail: The creature has a long tail with which it can lash out at opponents. Tail attacks can be made to the back and sides.

Trample: Some creatures are large enough to be able to step on and crush an opponent. Trample attacks can be made in any direction.

A creature with more than one Attack Form is able to make multiple attacks in the Close Assault Combat Phase. It gets one attack per Attack Form. A creature need not use all of its Attack Forms in the Phase. A

creature making multiple attacks suffers no penalty for doing so. A creature may also attack multiple targets, but does so at -2 to each attack roll for each target beyond the first. All targets must be in base-to-base contact.

Creature Costs

The cost of a creature in Squad Generation Points is determined in a manner similar to that for soldiers and squads. A Creature Record Sheet is provided in the back of this book.

The procedure for filling out the sheet is as follows. Write in the name of the creature at the top of the sheet. Fill in the *Dexterity*, *Strength*, and *Perception* attributes and the Move in the appropriate spaces. Enter the Movement Rate in the circle to the left. Below the attributes write in the Orneriness Code, if applicable. Then write in the creature's Attack Forms and the *Damage Strength* of each attack. Next to each Damage box write the same number; that is the point cost.

Total down the right-hand side and enter the number (note that the Orneriness Code is not added in). Multiply that number by the number of Attack Forms the creature has; the result is the cost of the creature in Squad Generation Points.

To the left of the cost we've provided a space to calculate the cost of a "pack" of the creatures. Simply multiply the creature's cost by the number of creatures. Below the cost is a space to keep track of any special features the creature might have.

In the "Creature Chart" we have provided the point costs of the creatures listed.

Mounts

Carrying riders into battle is the reason most creatures end up in the field. Although there is a wide variety of vehicles available throughout the galaxy, there are

worlds which are too primitive to have developed vehicles, and there are others where environmental conditions preclude the use of vehicles. Under those circumstances, creatures are often pressed into service.

Only creatures with an Orneriness Code may be ridden.

Movement

A creature used as a mount moves normally. A soldier can mount or dismount a creature during the Movement Phase. The creature cannot have moved this phase, but it may move afterwards (see below). It costs a soldier half of his Movement Rate to mount or dismount.

When mounting a creature, a soldier must make an opposed skill test, pitting his *beast riding* skill against the creature's Orneriness Code. If the soldier does not succeed in mounting the creature, he may not move further that phase. If he succeeds, he has mounted the creature and the creature may move up to half its Movement Rate.

A soldier may dismount freely. After a soldier dismounts, both he and the creature may move up to half their respective Movement Rates.

Fire Combat

During the Fire Combat Phase, a soldier may fire from the back of a creature he is riding. If the creature is standing still, the soldier may fire normally.

A soldier may fire from the back of a moving creature. A soldier doing so cannot fire at targets at long range, and has his difficulty number increased by +1 for firing from a moving surface.

Hitting Mounts and Riders

When a soldier riding a creature is targeted, there is a possibility that the mount will be hit. Roll a die; on a roll of 5 or 6 the creature being ridden is hit. If the creature is large (over 3 meters tall or long), it is hit on a roll of 4, 5 or 6. Resolve damage against the creature's *Strength*. For results of a hit, see the "Damage" section below.

Close Assault Combat

Combat involving mounts takes two forms. A soldier can fight from a creature's back, or the creature itself may fight. Sometimes both may do so.

In order for a creature to make an attack when it is used as a mount, the rider must make an opposed *beast riding* skill test against the creature's Orneriness Code during the Close Assault Combat Phase. If he succeeds, the creature may make an attack. If he fails, the creature may not attack.

It is also possible for a mounted rider to make a close assault attack. The opponent must be in one of the creature's side arcs and the rider must succeed in a difficulty 6 *beast riding* skill test. If he fails, the rider cannot attack this phase.

In order to make a close assault attack from the back of a large creature (one that is at least 3 meters tall), a soldier must be equipped with a suitably long weapon, such as a spear or force pike.

Damage

As a result of being hit, riders, mounts or other creatures may take damage. The results of this damage vary depending on which is hit and how badly.

Damage to Riders

A rider who becomes wounded during a combat phase must make an opposed skill test (*beast riding* skill versus Orneriness Code) to remain mounted. Remember to reduce the rider's skill by -1 if he is wounded. If the test is successful, the rider remains on the creature's back, otherwise he falls off his mount.

Use the Grenade Burst Template to determine in which direction the rider falls. Place the template over the mount and roll a die. Then place a figure, representing the rider, in base-to-base contact with the mount in the direction indicated by the die roll.

Finally, if the creature is horse-sized or less, remove the creature figure; it is assumed to have run off the battlefield. A larger creature is left in place and "runs amok" (see "Running Amok").

DIAGRAM 25
Sample Creature Record Sheet

Star Wars Miniatures Battles
CREATURE RECORD SHEET

CREATURE Rancor

24

MOVEMENT RATE

DEX:	4
STR:	7 (10)
PER:	1
Move:	20
Orneriness:	0

Attack Forms	Dam.	
claw (STR +3)	10	10
bite (STR +5)	12	12

Creature Cost:

Number of creatures:

Pack Cost:

Total:

Number of Attack Forms: 2

CREATURE COST

Special Features

Big, mean and ugly.

Armored skin: +3 to STR.

Stephen Crane

Creature Chart

Creature	DEX	STR	PER	Move	Move. Rate	Orn. Code	Attack Forms	SGPs
Bantha	2	8	2	5	7	2	horns (7) trample (8)*	24 (70)*
Cracian Thumper	3	3	4	12	15	1	claw (3) tail (5)	60
Dewback	3	4	2	35/7**	38/10**	3	bite (4)	48
Krayt Dragon	3	12	2	15	18	-	claw (8) bite (15)	110
Rancor	4	7(10)†	1	20	24	-	claw (10) bite (12)	114
Tauntaun	2	4	3	16	18	1	horns (5)	30
Vervikk (space rat)	3	3	2	6	9	-	bite (4)	18
Wampa	3	7	4	13	16	-	claw (7) bite (5)	78
Womp Rat	2	2	1	5	7	-	claw (3) bite (3)	32
Yavinian Runyip (grazer)	4	4	3	8	12	4	horns (4)	23

* Only trained war banthas may use this attack.

**The first value is during the day; the second is at night. Dewbacks become sluggish at night.

†Armored skin adds +3 to STR

If a soldier is incapacitated, rider and mount are removed from the tabletop, except for large creatures which run amok.

Damage to Creatures

Wounded creatures fall down. If the creature is not a mount, in the next Movement Phase it runs amok.

When a wounded mount falls down the rider must make a difficulty 6 *beast riding* test to avoid being trapped by it. If he succeeds, the rider is placed within 1" of the mount in a direction of the player's choosing.

If he fails, the creature has fallen on him. The rider is placed prone in either of the creature's side arcs and may not move until the creature stands up (lay the creature figure down over the soldier figure). The rider also takes damage; resolve an opposed *Strength* test against the creature's *Strength*.

A wounded creature can stand up in the next Movement Phase at a cost of 2". The rider may then attempt to mount the creature, as described above (see "Movement"). If he fails, the beast runs amok.

A creature which is incapacitated is handled like a

wounded creature, except that the figure is removed from play after all other effects are determined. If the creature has fallen on its rider, the figure should be left on the table. Each turn the pinned rider may attempt to pull himself free by opposing his *Strength* against the creature's *Strength*. If he succeeds in freeing himself from the weight of the creature, the rider may move normally, and the creature is removed from the table.

Large Creatures

When a large creature (over three meters tall or long) falls over, due to wounds or incapacitation, it may fall on adjoining troops (adjoining troops are those within 1.5" of the creature's base). Roll a die. If the result is 6 then the creature has indeed fallen on adjoining troops. If adjoining soldiers are in more than one of the creature's attack arcs, randomly determine which soldiers it falls on.

All soldiers fallen upon must make opposed *Strength* tests to avoid damage. They

are not trapped under the creature. Incapacitated large creatures are left on the table: they make good obstacles and provide light cover.

Running Amok

At times, a creature may become spooked by all the noise and activity on the battlefield. Wounded creatures tend to bolt. If a rider cannot maintain control of his mount under these circumstances, it runs amok. Unridden creatures always run amok when wounded.

A creature which is running amok runs at its full movement rate in a random direction. Place the Grenade Burst Template over the creature. Orient the template so that the "Direction of Throw" corresponds to the direction the creature is facing. Roll a die, but reroll if a 4 comes up. The creature moves its full movement rate in the direction indicated by the die roll.

If the creature's move brings it into base-to-base contact with any figure (soldier, hero, creature, droid, vehicle — friendly or not), it halts and attacks. The attack is resolved immediately. Figures involved in the



■ A creature which suddenly appears in the middle of a skirmish can be an unpleasant surprise for both sides.

attack may not move in the current Movement Phase unless they have already done so.

If the creature's move brings it up against a terrain feature it cannot cross, or one it would not (such as a chasm, cliff, barbed wire, etc.), it halts its move adjacent to the feature. If the creature is still running amok in the next Movement Phase, roll for direction until a logical direction is determined (the creature will not keep running toward the obstructing feature).

A creature which runs off the edge of the table is removed from play.

Regaining Control

At the beginning of each Movement Phase a die is rolled for each creature running amok. If the roll is greater than the creature's Orneriness Code, it stops running amok. The creature stays where it is. It may be mounted by any soldier or hero who beats its Orneriness Code with his *beast riding* skill. If the soldier or hero fails to mount, the creature runs amok again.

Point Costs for Mounts

A creature used as a mount costs the same number of Squad Generation Points as the unmounted creature. However, the squad pays a cost for using mounts. The cost per mount used by the squad is dependent on the Orneriness Code of the mount. Consult the following chart for the modifier to the cost of the mount, and add it to the base cost of 5 SGPs for a mount.

Mount Cost Modifier Chart

Orneriness Code	Modifier
1	6
2	5
3	4
4	3
5	2

Example: A tauntaun has an Orneriness Code of 1. Each tauntaun used as a mount costs a squad 11 SGPs.

When a squad is mounted, fill out a Creature Record Sheet for the number of creatures ridden, then add the cost of the creatures and the cost for mounts into the squad's total by writing it in on the "Other Costs" line of the Squad Record Sheet.

You can clip or staple the Creature Record Sheet to the Squad Record Sheet so that you have all the information in one place.

DIAGRAM 26
Mounted Squad Costs

		Weapon Carried					Dam.	Short	Med.	Long	
3	2	Repeat Blaster					6	25	60	150	18
5	2	ID: _____ SPECIALIST: _____									
3	2	Weapon Carried					Dam.	Short	Med.	Long	
2	2										
2	2	Other costs: 10 Tauntauns (260) + mount cost (110) =									370
2	2	Morale Level					<input checked="" type="checkbox"/> Steady <input type="checkbox"/> E <input type="checkbox"/> V <input type="checkbox"/> A <input type="checkbox"/> 7 <input type="checkbox"/> 6 <input type="checkbox"/> 5 <input type="checkbox"/> 4 <input type="checkbox"/> 3 <input type="checkbox"/> 2 <input type="checkbox"/> 1 <input type="checkbox"/> 0			1091	
Point cost:											SQUAD COST

Stephen Crane

Chapter Fourteen

Droids

Generally a rare sight on the battlefield, droids can be very effective fighting machines. However, most droids are programmed to avoid injuring Humans and other beings, even when expressly ordered to do so. Droids which are capable of doing so are assassin droids, probe droids, security droids, and war droids, but they are outlawed in most systems.

While these droids are technically illegal, the Empire has no qualms about using them, especially involving matters of internal security. In general, only Imperials have droids among their forces.

The Rebellion has access to droids of its own, and utilizes far more of them than the Imperial military does, but they are mostly non-combatant protocol and support droids. It may be possible for a combat droid to appear on the side of the Alliance. For instance, a bounty hunting droid might side with the Rebels for a battle as part of a gamemaster's scenario. It's possible, but rare.

Characteristics of Droids

Each droid counts as a squad in its own right. It cannot be part of a Human or alien squad. Droids have the same attributes and skills as regular soldiers, except that they cannot have the *command* skill. Droids are not subject to morale, and never have to make morale checks. A droid fights until it is destroyed.

Four droids are listed in the "Troop Lists" section. Droids may also be drawn from other *Star Wars* products.

A "Droid Record Sheet" is used to record a droid's characteristics. Fill in the droid's attributes and skill levels as shown in the "Droid Chart." Move, attributes and skills cost the same as for a normal soldier, so a DEX of 2 costs 2 SGPs. Unlike a normal soldier, a droid's skill levels cannot be improved higher than those it starts with.

Droid Cost: In addition to its attributes and skill costs, a droid costs an extra 10 SGPs; this is shown on the Droid Record Sheet as "Base Cost" and is figured into the droid cost given on the "Droid Chart."

Locomotive Systems: Droids with standard locomotive systems (tracks, legs, or rollers) move at a Walk Rate which is determined as for a regular soldier. At an additional cost of 10 SGPs a droid may be fitted with a repulsorlift unit. A repulsorlift unit doubles a droid's Walk Rate, and provides other movement advantages (see "Terrain Effects").

Weapons: A droid with the *blaster* skill may mount or carry any of the weapons from the "Blasters" or "Melee Weapons" section of the "Weapons Chart," and from the "Advanced Weapons" section. A droid with the *blaster artillery* skill may mount any heavy weapon.

A droid may mount or carry up to three weapons, any two of which it can fire in a Fire Combat Phase.

The cost for mounting a weapon on a droid is the normal cost of the weapon, plus 10 points.

Like a regular soldier, a droid may fire its weapons at targets within a 90-degree arc to its front. Depending on the miniatures you have available, a droid could have a turret-mounted weapon. A droid can only have one turret, and only one weapon can be mounted in it. A turret-mounted weapon has a fire arc of 360 degrees and costs an additional 15 SGPs.

Armor: A droid may have its *Strength* increased—for the purpose of resisting damage only—by fitting armor to it. *Strength* may be increased by +1 at a cost of 20 SGPs. Only one point of armor may be added, but it has no effect on a droid's DEX.

Equipment: Equipment from the "Advanced Weapons and Equipment" section may be added to a droid at the standard cost for the equipment.

Movement

Droids move in the Movement Phase of a turn.

Terrain Effects

Droids without repulsorlift systems cannot cross very rough terrain; treat it as impassable with respect to droids. It is also impossible for droids to cross difficult barriers. All other terrain is treated according to the standard rules for terrain.

Opportunity Fire

If it has not yet moved, a droid may fire one of its weapons as Opportunity Fire during the Movement Phase without needing to make a test. The droid cannot move after conducting opportunity fire, but it can fire one other weapon during the Fire Combat Phase.

Fire Combat and Droids

Fire Combat is handled just as for soldiers, except that a droid may fire two of its weapons in the Fire Combat Phase. It must fire the weapons when its turn to fire comes. It cannot fire once, let another soldier or squad fire, then fire again.

A droid may fire its weapons at two separate targets, but doing so increases the difficulty number of each attempt by +2.

Targeting Droids

Like heroes, droids can draw cover from a squad. A droid within 3" of a squad cannot be fired at directly. The only way to hit the droid is to fire at the squad, and hope that some of the fire is targeted on the droid.

Droids that are more than 3" from a friendly squad are fired at and targeted as a squad of one.

Damage

When a droid is hit, resolve damage in the usual manner with an opposed *Strength* test. Results of the *Strength* comparison vary from those of the standard "Damage Table" (use the "Droid Damage Table").

Droid Damage Table

Roll	Effect
DS < SR	No effect
DS ≥ SR	Roll for "System Damage"
DS > SR + 4	Roll twice for "System Damage"

DS = Weapon's *Damage Strength* Roll
 SR = Droid's *Strength* Roll

System Damage

If a droid sustains damage, it is treated differently from normal damage. Droids are stronger and more resilient than most beings; they also have redundant systems, allowing them to continue operating when damaged.

When a damage check calls for "System Damage," roll a die and consult the "System Damage Table."

DIAGRAM 27
Sample Droid Record Sheet

DROID NAME SC-4X (Essee Fourax)

DROID TYPE Security Droid

Move: 10

DEX: 3

Blaster 4 | 1

Blaster Artillery 3 |

Grenade 3 |

Melee Combat 3 |

KNO: 1

MEC: 1

PER: 2

Search 5 | 3

Sneak 2 |

STR: 3

Brawling 3 |

TEC: 1

Demolition 1 |

First Aid 1 |

Skills point cost: 25

MOVEMENT RATE 8

Skills point cost (from first column): 25

Weapon(s) Carried	Dam.	Short	Med.	Long	
Blaster Rifle	5	15	50	150	15

Number of weapons 1 x 10: 10

Turret (15): 15

Armor (20):

Repulsorlift (10):

Equipment Type	Effect

Special Features

Base Cost: 10

DROID COST 75

Star Wars Miniatures Battles
DROID RECORD SHEET

Stephen Crane

System Damage Table

Roll	Effect
1	Locomotive systems hit
2-3	Arm or weapon mount hit
4-5	Torso hit
6	Head hit

The damage effects for droids are explained below.

Locomotive Systems Hit: The droid's locomotive apparatus is damaged — one leg is mangled, a tread is thrown, or the repulsorlift drive is damaged. From this point on the droid moves at half its Movement Rate.

If this result comes up a second time, the droid can no longer move. Each Movement Phase, the droid may change its facing by 45 degrees. It can still fire if its weapon systems are intact, but any facing change is counted as "walking."

Arm or Weapon Mount Hit: One of the droid's manipulator appendages or weapon mounts is damaged, rendering a weapon inoperative. Randomly determine which weapon; that weapon may no longer be used. Successive results take out another random weapon until the droid has no more functioning weapons.

If a droid has no remaining weapons, it may still engage in close assault combat.

Torso Hit: The droid's data processors and power capacitors are damaged, resulting in reduced performance. Each time this result occurs reduce all of the droid's attributes and skills by one, and reduce its Movement Rate by 1".

When all of the droid's skills are reduced to zero, the droid explodes. Any soldiers within 3" of the droid are attacked (as by a grenade) with a *Damage Strength* of 5.



■ A droid on the battlefield is a formidable threat, and means a hard time ahead for the opposing forces.

Head Hit: The droid's optical sensors and microprocessors are damaged. The droid can no longer "see" clearly and goes out of control: it begins to move and fire randomly.

Use the Grenade Burst Template to determine movement. Place it over the droid and orient the Direction of Throw with the droid's front facing. Roll a die to determine the droid's new direction. It will move in that direction for its full Movement Rate.

If the droid encounters an obstruction it stops, but it moves again in the next Movement Phase. If the new direction moves it back into the obstruction it moves as far as possible and stops, until it randomly moves away in a later turn. If its Movement Rate allows, an out-of-control droid will move right into a hazard (i.e., off a cliff, into a fire, etc.) .

If the droid runs into a soldier or squad it stops its movement and engages in close assault combat with that squad (even if it is a friendly squad) during the following Close Assault Combat Phase. If still able to, it moves away again in the following Movement Phase.

During the Fire Combat Phase the droid fires two random weapons at the nearest target in its front arc, whether enemy or friendly. If there is more than one target available, randomly determine the actual target. An out-of-control droid has its fire difficulty number increased by +1.

Close Assault Combat and Droids

Close assault combat is handled normally, with the exception that a droid gets an additional +1 to its combat roll because of its tougher construction.

Example: An Imperial security droid with a *Strength* of 3 is engaged in close assault combat with a reluctant Rebel. The droid rolls a "4" for a combat roll of "8" (roll of 4 + STR 3 + 1 for being a droid).

If the droid wins, roll for damage normally. If the droid loses, use the "Droid Damage Table."

Self-Destruction

Droids can be programmed to self-destruct. Most assassin and probe droids have the programming built in, and many Imperial droids are equipped with programming which also allows them to be detonated by a remote comlink command.

At a cost of 10 Squad Generation Points, a droid can be equipped with self-destruct programming. Enter the programming in one of the weapon boxes.

A droid which has this programming may self-destruct at any time during any Fire Combat Phase. If it has not yet moved or used opportunity-fire, it may be detonated during the Movement Phase as a form of opportunity fire. A self-destructing droid explodes with a *Damage Strength* of 5, and affects all targets (as a grenade) within 3".

Chapter Fifteen

Advanced Terrain

Overview

This section describes additional types of terrain that can be used in *Star Wars Miniatures Battles* games. As these terrain types add extra complexity to the game, you may wish to wait until you are fully familiar with the Basic Game before using them, or only use them under the control of a gamemaster.

Note: All advanced terrain rules are optional; the special effects sections contain additional effects which are even *more* optional and should be used only if both players agree or under the control of a gamemaster.

Weather Effects

The effects of weather, or planetary environment, can have a great influence on the course of a battle. The following weather effects may be combined together to produce even more unusual conditions. For example, a battle could take place on a world subject to high winds which is currently experiencing a snow storm.

Where a range of effects are given for a weather effect, it can be determined by the mutual consent of the players, by the gamemaster, or randomly by rolling dice. For example, rain reduces visibility to between five and 20 tabletop inches. The gamemaster or players can set visibility as low as 5", as high as 20", or anywhere in between. Alternatively, 3D+2 could be rolled to determine visibility.

Fog/Mist

This reduces visibility — typically to 6", though especially heavy fog or mist may reduce it even further (gamemaster's choice). The fog/mist may be localized, covering only a portion of the battlefield, or it may cover the entire tabletop.

During the course of the game, the fog/mist may lift. At the end of the Special Actions Phase, one player rolls two dice and adds them together: if he rolls 10 or higher, the fog/mist begins to lift. Visibility increases by 1" each turn.

Macrobinoculars negate the effects of fog.

Special Effects: Fog/mist may be toxic, affecting soldiers each turn they remain within it. At the end of the Special Actions Phase, any soldier in poison fog has to

make an opposed *Strength* roll. Toxic fog has a *Strength* of 0 to 3, as determined by the gamemaster or players at the start of the game. Alternatively, roll 1D: 1 = 0; 2-3 = 1; 4-5 = 2; 6 = 3.

Environment suits, breath masks, and battle armor negate the effects of toxic fog.

Some fog/mist may be corrosive, possibly damaging metal weapons, vehicles and droids. At the end of the Special Actions Phase, any equipment in the corrosive fog must make an opposed *Strength* roll against the corrosive fog's *Strength* of 0 to 2 (choose or roll 1D: 1-2 = 0; 3-4 = 1; 5-6 = 2). Weapons have the same *Strength* as their *Damage Strength*. A wound result reduces the weapon's *Damage Strength* by one; incapacitated results destroy the weapon. Vehicles and droids follow the normal rules for damage.

Rain

Rain reduces visibility to from 5" to 20" (3D+2"). Macrobinoculars negate the effects of rain.

At the end of the Special Actions Phase, roll two dice to see if the rain continues: on a roll of 11 or higher, the rain ends. Otherwise, it continues. If the rain continues for 10 turns, the ground becomes muddy (see "Ground Effects").

Special Effects: On inhospitable planets, rain also may be toxic/corrosive, with the same effects as for fog/mist, above.

Heavy rain may cause rivers, creeks, lakes and other bodies of water to rise and flood. At the end of the Special Actions Phase, a gamemaster may increase the size of the area covered by the water by up to a tabletop inch per turn, thereby washing out bridges, roads, and buildings.

Snow

Reduces visibility range to from 5" to 20" (3D+2"). Macrobinoculars negate the effects of snow.

At the end of the Special Actions Phase, roll two dice; if the roll is 11 or higher, the snow stops. After it has snowed for 10 turns, the ground becomes "snow-covered" (see "Ground Effects"). A battlefield can always start snow-covered if desired by the players or the gamemaster.

Special Effects: Blizzard conditions may seriously disrupt a squad's ability to maintain coherency by cutting its command distance in half.

High Winds

High winds make it difficult to fire weapons with accuracy, increasing the difficulty of all shots from +1 to +3 (roll 1D: 1-2 = +1; 3-4 = +2; 5-6 = +3). Soldiers, heroes and droids with *Strength* attributes of 4 or higher are not affected.

At the end of the Special Actions Phase, roll two dice: On a roll 2 or 3, the wind decreases, reducing the increased difficulty of fire combat by -1 (to a minimum of 0, of course). On a roll of 11 or 12, the wind increases in velocity, increasing the difficulty of fire combat by a further +1. If this increases the wind difficulty to +4, figures with a *Strength* of 4 are affected by it; if it later increases to +5, figures with a *Strength* of 5 are affected, and so on.

Special Effects: Small-sized soldiers, particularly Ewoks, may be seriously hampered by high winds. Reduce their Movement Rates by half. In addition, when they attempt to move, each soldier or hero must make a *Strength* roll: if they roll 3 or less, they fall prone. A gamemaster may decide that they are instead blown off-course, and pushed up to 3" in the direction the wind is blowing.

Extreme Heat

Extreme heat can seriously weaken those not acclimated or wearing protective clothing, particularly during the rigors of combat. Every five rounds, during the Special Actions Phase, make a single *Strength* roll for each squad, hero, and creature. Depending upon the ferocity of the heat, the difficulty of the roll will be between 2 and 5 (roll 1D: 1 = 2; 2-3 = 3; 4-5 = 4; 6 = 5). If the figure passes the test, it is unaffected; if it fails, its *Strength* is reduced by one (to a minimum of one) for the remainder of the game.

Environment suits and battle armor reduce the difficulty of the roll by -2. Sandtroopers and standard stormtrooper armor reduces the difficulty by -1. Stormtrooper scout armor does not affect the difficulty. Spacetroopers in armor, creatures in vehicles, and natives to hot planets do not have to make the roll. Beings covered with fur (Ewoks, Wookiees, and so forth) have an increased difficulty of +1.

Special Effects: Specific areas on the battlefield may be even hotter than others. There may be a 3" band surrounding a lava stream or pool with a difficulty number as high as 6. During the Special Actions Phase, roll a single die for any explosives brought within that distance; on a roll of 1, the grenade or thermal detonator explodes.

Extreme Cold

Extreme cold has much the same effects as extreme heat, causing squads, heroes, and creatures to make *Strength* rolls against a difficulty number of 2 to 5 (roll

1D: 1 = 2; 2-3 = 3; 4-5 = 4; 6 = 5) every five turns to avoid becoming weakened. If the test is passed, no ill effects are suffered; if it is failed the figure's *Strength* is reduced by one (to a minimum of one) for the remainder of the game.

Environment suits, heavy clothing, fur-covered creatures and battle armor reduce the difficulty of the roll by -2. Snowtrooper armor and standard stormtrooper armor reduce the difficulty by -1. Stormtrooper scout armor does not affect the difficulty. Spacetroopers in armor, beings in vehicles and natives to cold-weather planets are not affected by the cold.

Special Effects: Water may freeze in very cold weather, converting streams, lakes, and so forth into clear terrain. Typically, this will not happen during the course of battle, but will be in effect from the start of the game. Of course, a stream may be frozen only on the surface, and there is only one way to find out if it will actually bear a soldier's weight. If there is a chance of the ice breaking, a *Strength* of 0-3 can be assigned and opposed to a figure's *Strength*. If the figure beats the *Strength* of the ice, the figure falls through and is immediately affected by the extreme cold of the water. Figures and creatures may have to *swim*, depending on the depth of the water.

Darkness

Darkness reduces visibility to 2-12" (2D) depending on the amount of light cast by stars, moons, or glowing rocks, fungi, lava pools, etc.

Increasing Visibility in the Dark

Various items of equipment can be used to increase illumination. A Luma grenade lights up a 6" radius area when it ignites. A glowrod (1 SGP cost) increases the holder's visibility to 4", but the holder becomes a very visible target to all within LOS. A Flame Template increases visibility to 10" (though, once again, those beyond that range will be able to see and shoot at anyone within that range).

Macrobinoculars negate the effects of darkness without making the user visible.

Ground Effects

The effects of weather can alter a battlefield's terrain dramatically.

Mud and Snow

Mud and snow convert clear terrain into rough terrain, doubling the cost of movement. They have no additional effect upon other types of terrain. Mud has no effect upon paved surfaces.

Special Effects: Mud has especially unpleasant effects upon heavily-traveled dirt roads or paths, making them into very rough terrain.

Snow may form huge drifts. These may be composed of soft snow, in which case they are impassable and merely block movement and fire combat; or the drift

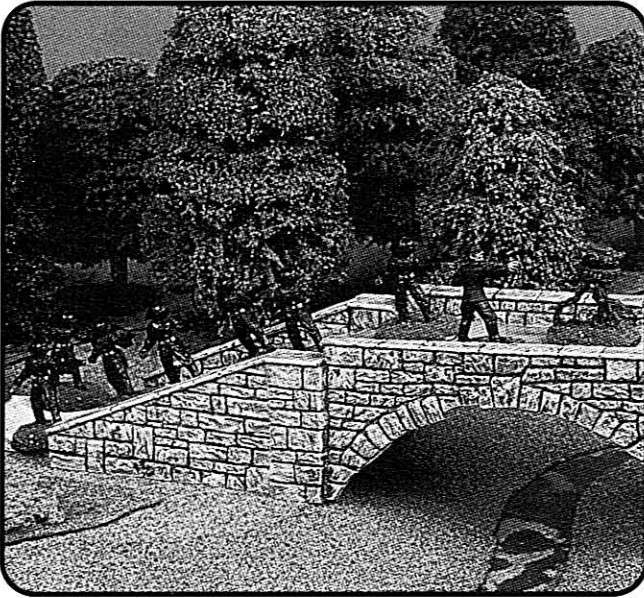

■ A squad of gunners marching forward to its new position stops to gather the reconnaissance reports of an advance scout probot. (Bridge by Gallia Reproductions.)

may be made of frozen snow, in which case they may be climbed with care, and for all purposes treated like difficult hills.

Fire

During the course of a battle, parts of the battlefield may catch on fire, particularly if the combatants are employing flamethrowers. For game purposes, flames cover 2" hexagonal areas, as represented by the Flame Effect Templates at the back of this book. If you are going to use fire in your game, you should make copies of the templates and paint them a suitable color (orange or red).

Starting Fires

A flamethrower automatically starts a fire. Thermal detonators start fires on a roll of 1 or 2 on one die. Heroes or soldiers may also start fires; a hero or soldier next to or in a building or other burnable area during the Special Actions Phase may attempt to set it on fire. Roll a die: a hero/soldier sets on fire a normal building, woods, or shrubs if he rolls a "1"; dry woods (as defined by the gamemaster or the players), and wooden buildings are set on fire on a roll of 1-2.

Spreading Flames

Though most fires begin as a single template, during the course of the battle a fire may spread. As the fire spreads, additional fire templates are placed adjacent to the existing ones. As the fire burns itself out, fire templates are removed. All adjacent fire templates are considered to be part of the same fire.

During the Special Actions Phase, roll a die for each fire (not each fire template) on the tabletop. On a roll of 1-2,

the fire burns down; remove the earliest-placed fire template. On a roll of 3-4, the fire stays the same. On a roll of 5-6, the fire spreads; place an additional template adjacent to the latest-placed template, according to the following rules.

Each template is numbered 2-12; when you place the first fire template, orient it so that the "Wind Direction" arrow points in the direction that the wind is blowing (determined at random or by the gamemaster). When adding a Flame Effect Template, roll two dice and place the new template next to that number on the previous template. Orient the new template so that the "Wind Direction" arrow on it, too, points in the direction that the wind is blowing. This ensures that the fire tends to burn down-wind.

Fires in especially flammable woods or wooden buildings may have an increased chance of spreading and a decreased chance of staying the same or going out.

Effects on Fire

Condition	Burns Down	Stays the Same	Fire Spreads
Normal	1-2	3-4	5-6
Dry woods	1	2-4	5-6
Wooden Building	1	2-3	4-6

High winds increase the likelihood of fires spreading; add +1 to each roll, except a roll of 1 which remains 1. Snow and rain increase the chance of a fire burning down; subtract -1 from each roll. In the event of rain and high wind together, the two cancel each other out.

Areas where fires have burned through may be filled with smoke for two or more rounds after the fire burns out (see "Smoke").

Impenetrable Barriers

Fire will not cross water, bare trenches or roads of more than 3" in width. It also will not spread into a metal building with a *Strength* of 4 or greater. If the spread roll for the fire indicates that it is to do so, the fire instead spreads from the earliest-placed fire template for that fire. From then on, all other templates will be placed from that template, until it, too, reaches an impassable barrier.

Effects of Fire

Any soldier in a Flame Effect Template must make a damage roll against the fire's *Strength* of 4 in the Special Actions Phase. Grenades or explosives within a Flame Effect Template explode on a roll of 1 or 2 on one die. If they do explode, treat the explosion as a normal attack by that weapon.

The difficulty of a fire combat shot is increased by +1 for each fire template that it passes through.

Fire will also damage buildings, attacking them with a *Strength* of 4. The fire will not spread into a closed building until the damage it inflicts equals the building's *Strength* rating (see "Buildings").

DIAGRAM 28
Placing Smoke Templates

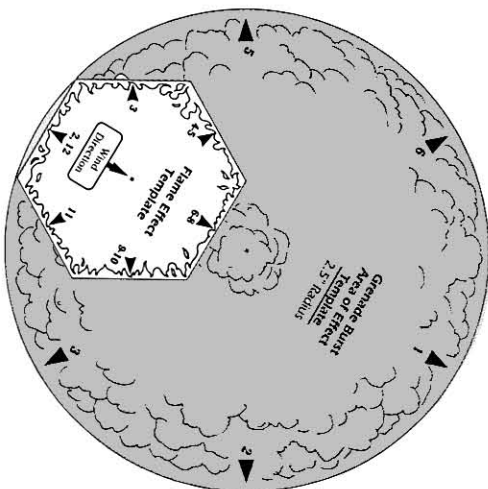

A smoke template is placed under the Flame Effect Template so that it extends in the direction the wind is blowing.

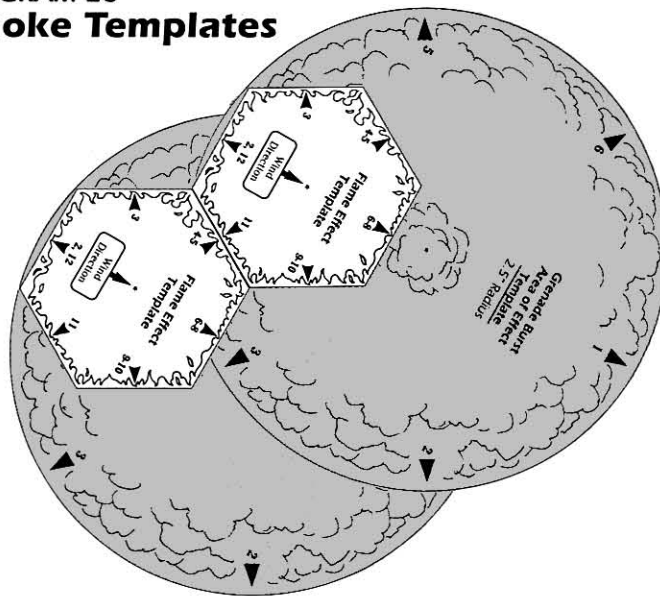

After determining that the fire has spread, a "4" is rolled and an additional Flame Effect Template is placed along the appropriate side of the original fire. A new smoke template is then placed under the newly-placed fire.

Stephen Crane

Special Effects: The direction of the wind may change, sending a fire back toward those who set it. This can be determined randomly by rolling a die each Special Actions Phase; on a roll of 6 the wind changes direction. Roll a die and consult a fire template to find the new direction. To ensure that the wind changes, treat a roll of 6, 7 or 8 as a 12.

Smoke

Some soldiers carry smoke grenades (see "Advanced Weapons"); occasionally, buildings or woods catch fire — particularly when a soldier is using a flamethrower. Smoke templates have a radius of 2.5" (use a 2.5" Grenade Burst Template). When a building or wood catches fire, place a smoke template so that it is half under the Flame Effect Template, but with its edge extending from the Flame Effect Template in the direction that the wind is blowing. If the fire spreads, additional smoke templates are added, but only to templates which have edges in the direction of the wind.

Smoke does not block LOS, but it increases the difficulty of fire combat by +2 for each smoke template the shot passes through. Note that smoke templates can overlap with each overlapping template adding to the difficulty of a fire combat shot. For example, a shot passing through an area where two smoke templates overlap would have its difficulty number increased by +4.

Gravity

The effects of gravity can vary from world to world. Most have standard gravity, but others have light or heavy gravity. Moving in heavy gravity doubles the normal movement cost. Moving in light gravity costs 1/2 the normal movement cost.

Example: On a planet with light gravity, a Rebel with a walking Movement Rate of 7" can cross 14" of clear terrain. Each inch he walks counts as only half an inch.

Special Effects: Variable gravity fields, where gravity switches between light, standard, and heavy without notice are possible. All figures crossing the edges of these fields, or who are within them when they change, must make *Dexterity* rolls to avoid falling prone.

Buildings

Though most of *Star Wars Miniatures Battles* takes place outdoors, there may be occasions when Rebels and Imperials battle indoors. The standard combat rules cover most situations, but some aspects of indoor combat need special rules.

Visibility

Most buildings are well-lit. Even if power is cut, emergency lighting will kick in, and visibility extends until it crosses blocking terrain. If, however, all the

lights are cut off, rooms and corridors without exterior doors or windows will become dark, reducing visibility to 2".

Walls and Doors

If a closed door is unlocked, it takes 1" of movement to open it. If it is locked, it must be kicked down, blown open, or unlocked. Walls, too, can be kicked down or blown open.

Walls and doors have "*Strength* ratings," determining how easy they are to break through; doors also have "*security* ratings," determining how difficult their locks are.

Obstructions Strength and Security Ratings Chart

Obstruction	Strength	Security Rating
Flimsy Partition	2	-
Primitive Exterior Wall	4	-
Reinforced Modern Wall	6	-
Security Wall	8	-
Starship-Grade Structural Wall	10	-
Flimsy Door	1	1
Primitive Exterior Door	3	2
Reinforced Modern Door	4	2
Security Door	6	6
Blast Door	8	4

Unlocking Locked Doors

All defenders within a building are assumed to be able to open, close and lock doors at all times, at a 1" movement cost. Intruders, however, must overcome the doors' *security* rating to do so. During the Special Actions Phase, the soldier must be adjacent to the door; he makes an opposed roll, his *Technical* attribute or appropriate skill against the door's *security* rating. If he beats the door's *security*, he unlocks it and may open it in the following Movement Phase.

Breaking Through Doors and Walls

Walls and doors have *Strength* ratings of from 2 to 10. Soldiers must overcome these *Strength* ratings to break through the obstructions.

Smashing Through

A soldier can attempt to kick open or push his way through an obstruction with a *Strength* rating of 4 or less. During the Close Assault Combat Phase, in place of his attack, he makes an opposed *Strength* roll, pitting his *Strength* against the obstruction's *Strength* rating. If he rolls 4 or more higher than the obstruction's roll, he has made a man-sized hole in the wall, or battered the door down.

One or two (but no more) adjacent soldiers can assist the soldier in his attempt; for each additional soldier helping him, the soldier adds +1 to his roll.

Shooting Through

A soldier can attempt to use blasters and other weapons to shoot a hole in an obstruction, though this is a difficult proposition at best. During the Fire Combat Phase, the soldier makes an opposed roll against the obstruction, rolling his weapon's *Damage Strength* -3 against the obstruction's *Strength* rating. Again, the soldier must roll 4 or more higher than the obstruction's roll to succeed.

Any number of soldiers (in the same squad and with a LOS to the wall) can assist the soldier, each soldier with a weapon of equal or greater *Damage Strength* adds +1 to the soldier's roll.

Blasting Through

A soldier can also try to use explosives to blow the obstruction down. If the soldier simply tosses a grenade or a thermal detonator at the obstruction, the soldier must make a *grenade* skill test.

If successful, the grenade lands where the soldier intended it to; otherwise it deviates as normal. If, once it has landed, the explosive's burst template intersects the obstruction, make an opposed roll, comparing the explosive's *Damage Strength* to the obstruction's *Strength* rating. If the explosive beats the obstruction's roll by 4, the obstruction is blown open.

Additional explosives thrown at the same target add their entire *Damage Strengths*, not just +1.

A soldier can use his *demolition* skill to carefully place explosives (grenades and/or detonators) next to an obstruction he wants to bring down, setting the explosive to detonate in one or two rounds, after he has time to get out of the blast radius.

The soldier makes a difficulty 6 *demolition* check when placing the explosive. If the soldier bombs out on this roll, the explosive detonates when he is setting it, causing normal damage to him and the obstruction. If



■ With the right weapon and good die rolls, no barrier is too difficult to cross. (Stone wall by Gallia Reproductions.)

he fails the roll, the explosive detonates at the appointed time, and with its normal *Damage Strength*. If he succeeds at the roll, the explosive detonates at the appointed time at twice its normal *Damage Strength*.

Multiple explosives can be set at the same place with one *demolition* roll; when they explode, their *Damage Strengths* are added together.

Special Effects: If, when an explosive detonates, it rolls twice as high as the obstruction, it may have caused extensive structural damage to the area, possibly causing a cave-in, electrical fire, massive concussion damage to anyone behind the obstruction, and so forth.

Floors, Stairs and Repulsorlifts

In games taking place inside buildings, more than one floor of the building can be the scene of fighting. Setting up the different floors of a building upon a tabletop is not as daunting as it may first appear, providing the individual floors are not too big.

For example, a two-story building could be set out so that each of its floors takes up half of the table. Three-story buildings would take a third of the table for each floor, and so on.

Obviously, large tower blocks are out of the question, but interesting games can be played by noting the positions and movements of troops on scale maps. The table is only set up and the figures placed on it when opposing soldiers meet. After fighting a battle on one floor, another floor can be set up on the table and the next battle fought.

When fighting battles involving multiple floors of a building, be sure to note where stairs, ladders and repulsorlifts enter and leave each floor, and to note the distances between floors.

Stairs: Stairs count as rough terrain. Soldiers can move on them as any other terrain.

Ladders: Ladders count as very rough terrain. When climbing a ladder, soldiers move vertically from one floor to another. So a soldier with a walking Movement Rate of 8" would climb 2" per turn (4 meters).

Repulsorlifts: Repulsorlifts move from floor to floor at a rate of two floors per Movement Phase. It takes half a soldier's Movement Rate to enter or exit a repulsorlift. So, a soldier could enter a repulsorlift and move up one floor in the same turn. On the following turn he could exit the repulsorlift and still have half his move.

Some repulsorlifts have *security* ratings just like doors; these must be overcome before the lift will operate.

Special Effects: It is possible for both sides to be attempting to control the same repulsorlift during the same Special Actions Phase, the attackers to access the lift, the defenders to deny access to the attackers. The soldiers make opposed *Technical* rolls, the building's original occupants adding the lift's *security* rating to his *Technical* attribute. The winner has control of the lift.

This may have nasty effects upon the loser, if, for example, the winner sends the loser's squad to a level

where half the defender's forces are waiting ... taking the stairs is usually a good idea when the enemy knows where you are.

Other Special Effects in Buildings

Security

When attacking a military installation, the attacker must contend not only with the defending soldiers, but also with the security devices in the building. Many buildings are equipped with hidden holo-cameras and motion and heat sensors, giving the defenders accurate knowledge of where the attackers are at all times.

In these circumstances, the attacker would have to place his soldiers on the table, while the defender would move facedown counters scraps of paper representing his forces (plus an equal number of blank "dummy" counters), revealing what they are only when the attacker gains LOS to the piece.

Remote Weapons

The defender might have remote-control weapons in strategic locations in his building. These would be equivalent to anything from a blaster pistol up to a heavy repeating blaster. They cost double the standard price of the weapon in SGPs. Remote weapons may be given *blaster* or *blaster artillery* skill levels up to a maximum of 4, at a cost of 3 SGPs per point.

Computer Stations

As we all know, all of the buildings in the *Star Wars* universe are equipped with numerous computer stations, where enterprising droids or soldiers can access the floorplans of the buildings, open or close security doors, and so forth. The usefulness of these stations is left firmly in the hands of the gamemaster. In general, it takes *Technical* rolls of difficulty 4-8 to operate a computer station; the more interesting the application, the higher the difficulty.

Spacecraft

Spacecraft are essentially buildings in space and they follow all of the normal rules for buildings. All exterior walls and airlocks have a *Strength* rating of eight or higher; internal walls and doors have lower *Strengths*.

The defender will have a good deal of control over the blast doors, repulsorlifts, oxygen circulation and gravity aboard the vessel, unless the attackers can reach the security and life-support stations.

Vacuum, of course, is the biggest danger in space. If soldiers are in a section of a vessel which suffers explosive decompression, they must make *Strength* rolls of 8 or higher to avoid being sucked out. Anyone not equipped with environment suits, space suits or full battle armor takes damage each turn until he reaches atmosphere. During the Special Actions Phase, the damage is at *Strength* 4; it increases by +2 each turn until he dies.



THE SCENARIOS

The following scenarios are provided to further your own Rebellion against a corrupt and evil Empire (or to allow you to quell the last flame of freedom in the Galaxy). The scenarios follow a standard format, the elements of which are explained below.

The Situation: This is the background of the battle; why it's happening, what each side is trying to achieve and what determines success.

The Forces: The squads and heroes involved. This lists the names, troop types, skills, weapons, commanders and specialists of each squad, as well as the point value. It also lists the pertinent information for any heroes involved in the battle.

The Battlefield: This describes the area over which the battle takes place, including the terrain conditions in force at the time of the battle. This is accompanied by a map which outlines the table layout.

The Set-up: The initial disposition of troops on the field, as well as entry conditions for reinforcements.

Gamemaster Notes: Special situations or conditions are covered here, as well as the conditions under which one side may be declared the winner. Also given in this section are figure suggestions; ideas as to which miniatures can be used for the characters involved.

Defending the Bridge

The Situation

During a fiercely-contested space battle in the Kwymar Sector, an Imperial assault shuttle suffered massive damage to its engines and control systems while acquiring its target. Being separated from its mothership, the crew was forced to put down on the nearest planet in the system, taking along a few spacetroopers who had returned to recharge their armor.

Realizing the value of this type of vessel should they be able to study it up close, Alliance High Command dispatched a contingent of ground troops to capture the shuttle and establish a defensive perimeter around it until an Alliance transport shuttle could arrive to cart it away.

When his sensors revealed the Rebel ship streaking to the planet's surface, the Imperial Fleet Commander ordered a contingent of stormtroopers planetward to defend the downed shuttle. Only one of the transports was able to make it through the barrage of fire taking place far above the newly interesting world.

The assault shuttle had landed in a thickly-grown forest on a low-technology world, far from any native settlements. Once on the ground the surviving stormtroopers quickly set up their own defensive perimeter, utilizing the terrain and what native architecture they could find. When Rebel forces were detected approaching through the woods, the call for assistance came crackling over the comlink channel.

Rebel Forces

"Rendor's Raiders" Squad:

- 10 Average Standard Troopers.
- DEX 3, *blaster* 4, *grenade* 4, *melee combat* 4; KNO 2; MEC 2; PER 2, *command* 3; STR 2, *brawling* 3; TEC 2; Move: 10.
- **Walk Rate:** 8"; **Run Rate:** 13".
- **Weapons:** blaster pistol, 2 grenades each.
- **Commander:** *command* 4.
- **Specialist:** *blaster* 5.
Weapon: repeating blaster (tripod-mounted).
- **Squad Generation Points:** 475

"Kwymar Six" squad:

- 10 Average Standard Troopers.
- DEX 3, *blaster* 4, *melee combat* 4; KNO 2; MEC 2; PER 2, *command* 3; STR 2, *brawling* 3; TEC 2; Move: 10.
- **Walk Rate:** 8"; **Run Rate:** 13".
- **Weapons:** blaster pistol.
- **Commander:** *command* 4.
- **Specialist:** *blaster* 5.
Weapon: repeating blaster (tripod-mounted).
- **Squad Generation Points:** 365

"Hitak Harriers" squad:

- 10 Veteran Hoth Troopers.
- DEX 3, *blaster* 5; KNO 2; MEC 2; PER 2, *command* 4; STR 3, *brawling* 4; TEC 2; Move: 10.
- **Walk Rate:** 8"; **Run Rate:** 13".
- **Weapons:** blaster rifle.
- **Commander:** *command* 5.
- **Specialists:**
1: *blaster* 6.
Weapon: repeating blaster (tripod-mounted).
2: *grenade* 6.
Weapon: 4 grenades.
- **Squad Generation Points:** 588

"Warhounds" squad:

- 10 Elite Mercenaries.
- DEX 3, *blaster* 6; KNO 2; MEC 3; PER 3; STR 3, *brawling* 4; TEC 2; Move: 10.
- **Walk Rate:** 8"; **Run Rate:** 13".
- **Weapons:** heavy blaster pistol.
- **Commander:** *command* 5
- **Specialist:** *blaster* 7.
Weapon: blaster rifle.
- **Squad Generation Points:** 598

Imperial Forces

"Able Company" squad:

- 10 Veteran Snowtroopers.
- DEX (2), *blaster* (4), *grenade* (4); KNO 2; MEC 2; PER 2; STR 3 (4), *brawling* 5; TEC 2; Move: 10.
- **Walk Rate:** 7"; **Run Rate:** 12".
- **Weapons:** blaster rifle.

- **Specialist:** *blaster* (5).
Weapon: repeating blaster (tripod-mounted).
- **Squad Generation Points:** 574

"Baker Company" squad:

- 10 Average Stormtroopers.
- DEX (1), *blaster* (3), *grenade* (2), *melee* (2); KNO 2; MEC 2; PER 2; STR 2 (3), *brawling* 4; TEC 2; Move:10.
- **Walk Rate:** 6"; **Run Rate:** 11".
- **Weapons:** blaster pistol, 2 grenades each.
- **Specialist:** *blaster* (4).
Weapon: repeating blaster (tripod-mounted).
- **Squad Generation Points:** 474

"Death from Above" squad:

- 5 Elite Spacetroopers.
- DEX (2), *blaster* (5); KNO 2; MEC 3; PER 2; STR 2 (5), *brawling* 6; TEC 3; Move: 10.
- **Walk Rate:** 6"; **Run Rate:** 10".
- **Weapons:** repeating blaster.
- **Specialist:** *blaster* (6).
Weapon: heavy repeating blaster.
- **Squad Generation Points:** 361

Home Brew

Create your own forces for this scenario using 1500 points to create the defending Imperial forces and 2100 points for the Rebels.

The Battlefield

The battle takes place in a local forest which is considered medium woods; rough terrain, medium cover, visibility 6". Place clumps of trees and brush around the table, being careful to clearly delineate the edge of the woods around the road and creek.

With the exception of the road and creek, the entire tabletop is wooded; therefore full movement is only possible on the road. Elsewhere, movement is at half-rate. The hill is easy, but is also wooded, so movement on the hill is at quarter-rate.

The hill ends in a cliff at the creek's edge. The cliff cannot be climbed from the creek.

The creek is 4" wide and flows from south to north. A soldier who falls prone in the creek due to a wound must make a *Strength* test against a difficulty number of 4 to avoid drowning. A soldier who voluntarily falls prone can test against his *swimming* skill level. A test must be made every turn the soldier remains prone. While prone in the creek, a soldier has medium cover.

A wall runs along the creek's edge from the cliff to the bridge and from the bridge to the north table edge. All walls on the table are low walls, providing medium cover and acting as moderate barriers.

The road permits movement at the normal rate and allows unlimited visibility along its length, but otherwise has no effect.

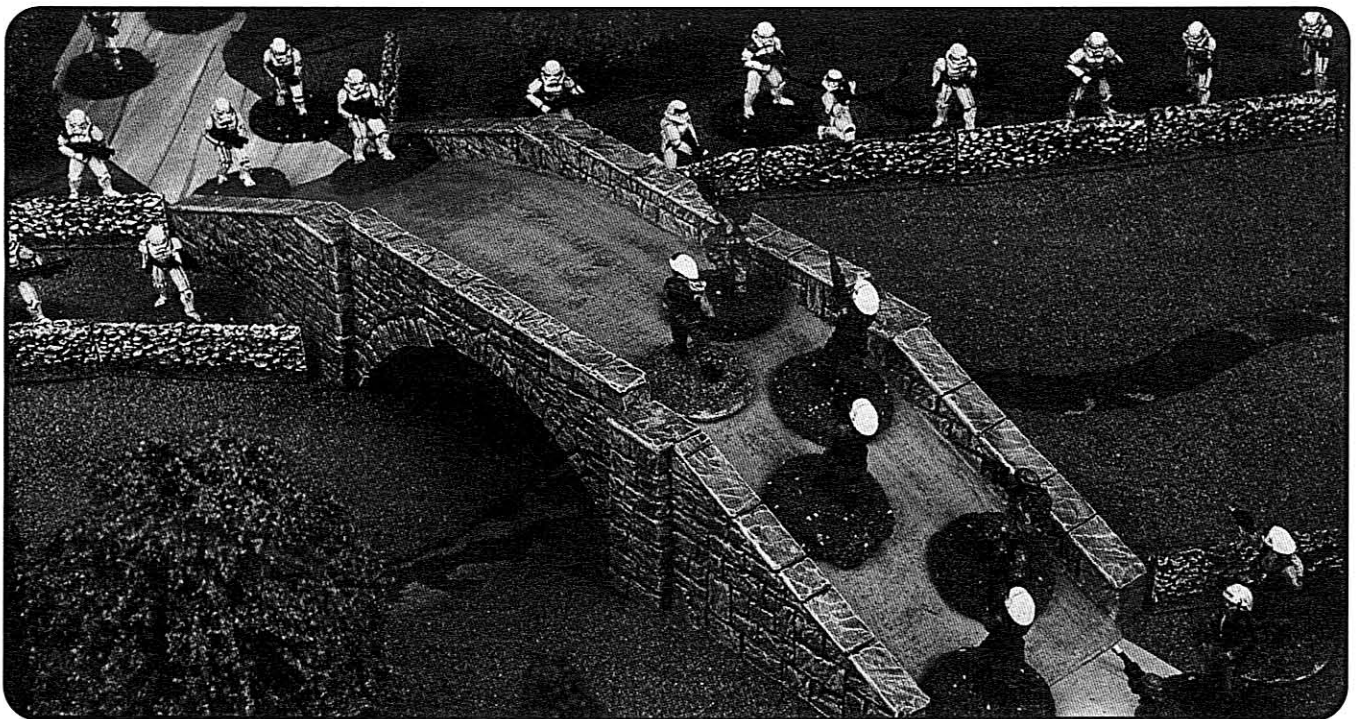

■ Rebels attempting a bold but futile dash across the Imperial-held bridge. (Bridge by Gallia Reproductions.)

DIAGRAM 29
"Defending the Bridge" Set-up Map

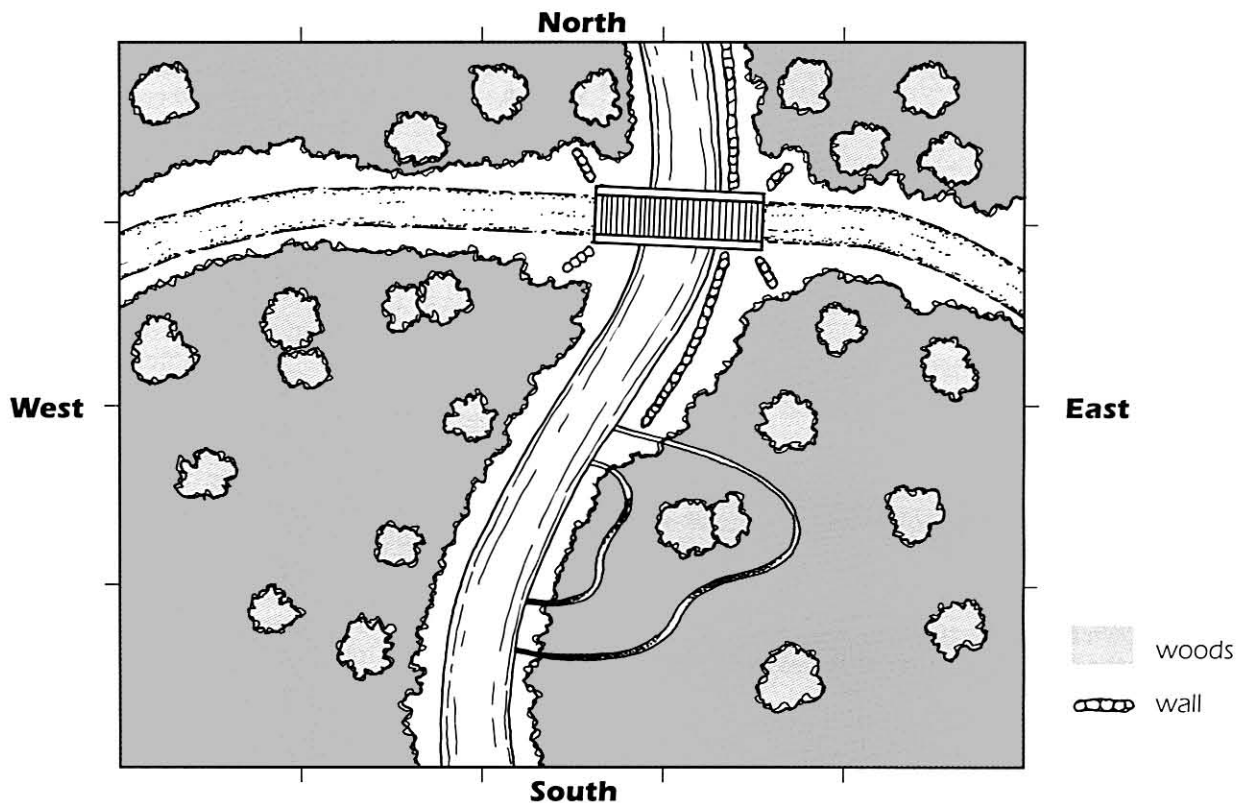

Stephen Crane

The Set-up

The Imperials set up a squad of stormtroopers anywhere east of the creek. Starting with turn two, roll one die for reinforcements at the beginning of the Movement Phase. If the roll is successful, reinforcements begin to arrive; bring on a squad from the east edge of the table. The remaining squad may enter on the following turn. The die roll needed on each turn is as follows:

Turn	Die roll for reinforcements
2	6
3	5,6
4	4,5,6
5	automatic entry

One Rebel squad may enter on the west edge of the table on Turn one. Thereafter, a new squad is brought on the west edge each turn.

When a squad is brought on to the table, the first rank of figures measures its move from the table edge. Therefore, other figures coming on behind them may not get their full Movement Rate.

Gamemaster Notes

To win the game, the Rebels must get at least one squad off the east edge of the table. The Imperials win by preventing this.

Suitable Models

The Rebels can be represented by any figures in the *Rebels* and *Rebel Troopers* (40405, 40406, 40413, 40421) or *Rebel Commandos* (40414, 40417) blister packs. *Bounty Hunters* packs (40420, 40422, 40426) are a good source for the mercenaries. Additional mercs can be recruited from any *Aliens of the Galaxy* packs (40429 and future releases).

Stormtroopers blister packs (40403, 40404, 40409, 40416) will provide stormtroopers. Spacetroopers are available in *Zero-G Assault Troopers* packs (forthcoming). Alternatively, they can be represented by regular stormtrooper figures; they will have to be marked so as to differentiate them from regular stormtroopers, or they can be built up with epoxy putty.

The Crystal Forest of Goratak

The Situation

Rebel Intelligence learned of a Plexus Droid Vessel carrying highly sensitive information about the Rebels' new starfighter manufacturing enterprise on Tar Morden. The PDV was intercepted *en route* to Imperial Intelligence Sector HQ. Hoping to throw the Rebels off the trail, it self-destructed to avoid capture, but also to cover the jettisoning of the I2-CG droid which contained the information.

Rebel sensors detected the droid, however, and tracked its descent to Goratak III, a barren world peculiar for its odd crystalline nature.

The droid crashed in an area marked by wild crystalline growth and was incapacitated, although the information remains intact within its memory core.

A Rebel strike force was immediately dispatched to retrieve the information. Always eager for a scrap with Imperials, an ex-pirate captain and Rebel sympathizer volunteered to assist the team. She was accompanied by her longtime companion, a Thuwisten (student of the Tyia — an alternate way of the Force) from the plant-like Revvien species found on the fringe of the galaxy. They must retrieve the droid or the Rebellion's war effort will suffer a major setback.

Imperial Intelligence gathered what forces it could on such short notice, hiring a squad of bounty hunters and augmenting it with two squads of snowtroopers, to retrieve the droid. They are working in tandem with a top-notch Mandalorian bounty hunter, Feskitt Bobb. The droid must be recovered in order to deal a crushing blow to the Rebellion in this Sector.

Rebel Forces

"Red Smoke" squad:

- 10 Veteran Hoth Troopers.
- DEX 3, *blaster* 5; KNO 2; MEC 2; PER 2, *command* 4; STR 3, *brawling* 4; TEC 2; Move: 10.
- **Walk Rate:** 8"; **Run Rate:** 13".
- **Weapons:** blaster rifle.
- **Commander:** *command* 5.
- **Specialists:**
1: *blaster* 6.
Weapon: repeating blaster.

2: *grenade* 6.

Weapon: 4 grenades.

- **Squad Generation Points:** 583

"Safari One" squad:

- 10 Average Standard Troopers.
- DEX 3, *blaster* 4, *melee combat* 5; KNO 2; MEC 2; PER 2, *command* 4; STR 2, *brawling* 4; TEC 2; Move: 10.
- **Walk Rate:** 7"; **Run Rate:** 11".
- **Weapons:** hunting blaster.
- **Commander:** *command* 5.
- **Specialist:** *blaster* 6.
Weapon: repeating blaster (tripod-mounted).
- **Squad Generation Points:** 461

"Buzz Boys" squad:

- 8 Elite Mercenaries.
- DEX 3, *blaster* 5, *melee combat* 5; KNO 2; MEC 3; PER 3; STR 3, *brawling* 4; TEC 2; Move: 10.
- **Walk Rate:** 8"; **Run Rate:** 13".
- **Weapons:** blaster rifle, vibroblade.
- **Commander:** *command* 5.
- **Specialist:** *blaster* 6.
Weapon: repeating blaster (tripod-mounted).
- **Squad Generation Points:** 573

Grindol Maal

- Pirate.
- DEX 4, *blaster* 5, *dodge* 6, *melee parry* 5, *melee combat* 5; KNO 2; MEC 4; PER 3; STR 3, *brawling* 4; TEC 3; Move: 10
- **Walk Rate:** 9"; **Run Rate:** 14".
- **Weapons:** blaster rifle, vibrocutlass.
- **Force Points:** 10 (3 rolls).
- **Squad Generation Points:** 148

Wuwuhuul

- Alien Student of the Force.
- DEX 2, *blaster* 3, *melee parry* 3; KNO 3; MEC 2; PER 2; STR 3; TEC 2; *control* 2, *sense* 2, *alter* 2; Move: 10.
- **Walk Rate:** 7"; **Run Rate:** 12".
- **Weapons:** blaster pistol, lightsaber (damage 5/7).
- **Force Powers:** Control Pain (C), Remain Conscious (C), Life Detection (S), Receptive Telepathy (S),

- Lightsaber Combat (CS), Projective Telepathy (CS), Telekinesis (A).
- **Force Points:** 7 (3 rolls).
- **Squad Generation Points:** 228

Imperial Forces

"Able Company" squad:

- 5 Veteran Snowtroopers.
- DEX (2), *blaster* (4), *grenade* (4); KNO 2; MEC 2; PER 2; STR 2 (3); TEC 2; Move: 10.
- **Walk Rate:** 7"; **Run Rate:** 12".
- **Weapons:** repeating blaster.
- **Commander:** *command* 5.
- **Specialist:** *blaster* (5).
- **Weapon:** heavy repeating blaster.
- **Squad Generation Points:** 312

"Baker Company" squad:

- 10 Veteran Snowtroopers.
- DEX (2), *blaster* (4), *grenade* (4); KNO 2; MEC 2; PER 2; STR 2 (3); TEC 2; Move: 10.
- **Walk Rate:** 6"; **Run Rate:** 10".
- **Weapons:** heavy blaster pistol, 2 grenades each.
- **Commander:** *command* 4.
- **Specialists:**
1: *blaster* (5).

- Weapon:** repeating blaster.
- 2: *blaster* (5).

- **Weapon:** repeating blaster.
- **Squad Generation Points:** 590

"Charlie Company" squad:

- 9 Elite Bounty Hunters.
- DEX 4, *blaster* 7, *grenade* 7, *melee combat* 4; KNO 2; MEC 2; PER 3, *command* 6; STR 3, *brawling* 6; TEC 2; Move: 10.
- **Walk Rate:** 9"; **Run Rate:** 14".
- **Weapons:** heavy blaster pistol, 2 grenades each.
- **Commander:** *command* 6.
- **Specialists:**
1: *blaster* 7.
Weapon: repeating blaster (tripod-mounted).
- 2: *blaster* 7.
Weapon: repeating blaster (tripod-mounted).
- **Squad Generation Points:** 730

Feskitt Bobb

- Bounty Hunter.
- DEX (3), *blaster* (8), *blaster artillery* (6), *brawling parry* (4), *dodge* (5), *grenade* (6), *melee parry* (5), *melee combat* (5); KNO 3, *survival* 6, *value* 6; MEC 3, *repulsorlift op.* 5; PER 3, *command* 5, *sneak* 6, *search* 9; STR 4 (5), *brawling* 6, *climb/jump* 4, *swimming* 5; TEC 2, *demo-*

DIAGRAM 30

"The Crystal Forest of Goratak" Set-up Map

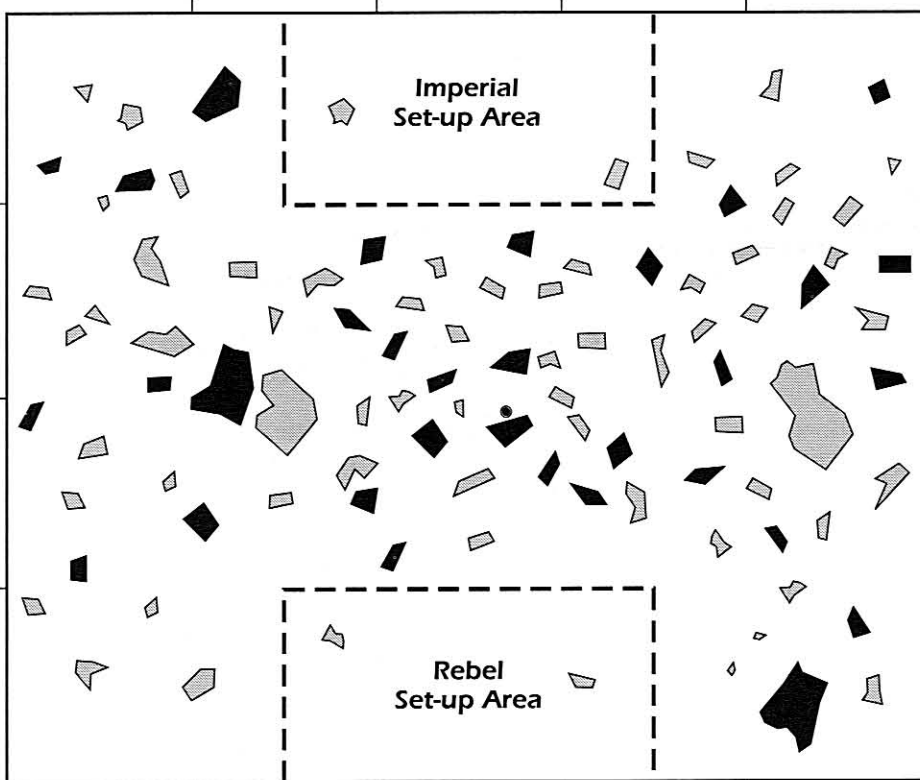

- ◆ High crystal growths
- ◐ Low crystal growths
- The objective: I2-CG

Stephen Crane



■ With the objective in sight, an intense Force battle ensues between the heroes of both sides.

lition 6; Move: 10.

- **Walk Rate:** 8"; **Run Rate:** 13".
- **Weapons:** blaster rifle, blaster pistol, grenade launcher.
- **Bounty Hunter armor:** STR +1; DEX -1.
- **Force Points:** 12 (4 rolls).
- **Squad Generation Points:** 258

Home Brew

Create your own forces for this scenario using 2000 points per side.

The Battlefield

The search takes place in a "forest" on Goratak, where strangely-shaped crystalline growths present a maze of obstructions. Other than the crystal growths, the terrain is clear.

Set up two types of growth as shown on the map; shaded "trees" represent waist-high crystals (medium cover) and black "trees" represent higher growths (impassable; block line of sight). A quick way to represent the crystal growths is to use chopped-up pieces of foam rubber.

The Set-up

The Rebels and the Imperials both set up in the center 24" of their respective sides of the table. They may set up anywhere within 12" of the edge.

Gamemaster Notes

The droid begins the game hidden in the center of the cluster of crystal growths. Do not place the droid figure on the table at the beginning of the game. When a squad or hero enters the cluster, begin having them make *search* skill tests of difficulty 6 (but don't tell them the difficulty). The test should occur in the Special Actions Phase.

If a soldier passed within 4" of the droid's location, had a line of sight to the droid during the course of his movement, and succeeded in his *search* test, he has spotted it. Place the droid figure on the table. Once the droid has been discovered, all forces know where it is.

The droid is too heavily damaged to be able to retrieve the information from it in the field. It must be carried to the proper facilities.

A soldier may pick up the droid if he is in base-to-base contact with it, no enemy soldier is in base-to-base contact with it, and he expends half his Movement Rate. If he has expended more than half his Movement Rate in order to get to the droid, he must wait until the next turn to pick it up.

A soldier carrying the droid may only move at half his Walk Rate. If he is wounded, he drops the droid. Use the Grenade Burst Template to determine where the droid lands: declare a direction of throw to orient the template, then roll for deviation. Place the droid along-

side the fallen soldier in the direction indicated.

Either side wins the game by carrying the droid off the table edge within the set-up area.

Suitable Models

You can use “R2-D2” from *Heroes 1* (40401) or “R5-D4” from *Droids 1* (40423) as the downed droid. “Boba Fett,” from *Bounty Hunters 1* (40420), is a good choice for the Mandalorian bounty hunter. From the *Rebel Operatives* pack (40434), the “Female Gambler” and from *Aliens of the Galaxy 1* (40429), the “Alien Student of the Force” will work nicely as the pirate and her companion.

An assortment of Rebels can be found in *Rebels* and *Rebel Troopers* packs (40405, 40406, 40413, 40421) and *Rebel Commandos* (40414, 40417). You can recruit a crew of bounty hunters from the *Bounty Hunters* packs (40420, 40422, 40426). *Stormtroopers* packs (40403, 40404, 40409, 40416) and *Snowtroopers* (40431) and *Sandtroopers* (40428) will provide a good selection of veteran stormtroopers.

FIGURES AND SCENERY

**"The Jundland Wastes are not
to be traveled lightly."**

Figures and Scenery

Now that you know how to play the game, you'll want to prepare both your forces and the battlefield. If you haven't done anything like this before, it may seem a bit daunting. But if you give it a try, you'll find yourself turning out some very respectable figures and scenery in no time. Painting figures and scenery can be a very enjoyable hobby in its own right.

There have been many books and magazine articles written about painting miniatures and building scenery (an especially good source for books and materials for scenery building is a model railroad shop). What we've provided below is a quick and dirty introduction to the art and hobby of miniatures painting. It is far from comprehensive, but it will help you get started.

As you progress, you'll no doubt move on to those sources mentioned above and expand your talents and pleasure greatly.

Figure Painting

Before beginning to turn out your armies, you need to gather some equipment. You'll need brushes, paints, water, thinner or turpentine, a hobby knife, sandpaper, files, toothpicks, epoxy, and some rags.

Brushes

The brushes you use should be good quality. This is an instance where you don't want to scrimp on quality. Buy sable brushes. Good sable brushes are expensive, but worth the investment; they will last a long time if properly taken care of. When buying brushes select only those that taper to a sharp point. A brush with a ragged end, or one that looks like a mop, is useless — you'll end up spattering paint all over your figures.

You'll need a #1 brush for general work. A #1 brush can be used for detail work, but as that takes some practice, you may want to have a #0 or #00 to start out.

Paints

The type of paint you use is mainly a matter of personal preference. There are a few types that are commonly used for painting figures.

Enamel paints are a popular choice. These are the paints that used primarily on plastic model kits, but they do an excellent job on miniatures. Enamels cover well, but require thinner or turpentine to clean.

Acrylics are also becoming very popular, especially now that many manufacturers are coming out with their own versions designed specifically for miniatures painting. Acrylics are thinned and cleaned with water, but dry to a waterproof finish.

Some figure painters like to use artists' oil paints. These paints are good when you want to do a lot of blending and special effects. A major drawback is that they take a long time to dry. Oils are better suited for painting collector figures than for mass producing armies.

Also used for collector figures are drawing inks. You can get some very nice finishes using successive washes of inks.

Knives, Sandpaper and Files

These are tools you'll use to clean and prepare your miniatures. Hobby knives with #11 and #16 blades are the most versatile. A few small needle files will let you get into narrow and tight places. A good sandpaper to use for miniatures is an emery board, one of those little sandpaper boards used to shape fingernails.

Epoxy

The best glue to use for assembling, repairing or converting miniatures is five-minute epoxy. It dries quickly and is good for filling gaps. A cyanoacrylate glue ("crazy glue") could also come in handy.

Preparing Your Figures

Before painting your figures, you'll need to prepare them. If you look closely at a figure, you may notice a fine raised line running up it on either side. This is a mold line, which results when the molten metal seeps into the seam between halves of the mold. Sometimes it spreads far enough to form a thin foil-like shape jutting from the figure. This is known as "flash." You may also see plugs of metal stuck to the miniature;

these are caused when the metal flows into a vent hole.

All of these features detract from the miniature's appearance and should be removed before painting. Plugs and flash should be cut off with a hobby knife. Exercise caution — these blades are extremely sharp. Mold lines and remnants of flash can be scraped off with the edge of the knife. Take care not to scrape off any of the details on the figure.

Mold lines can also be removed with fine sandpaper (or emery boards) or needle files. Again, be careful not to obliterate any detail on the figure. You may also want to even out the bottom of the base so that the miniature will stand without wobbling. You don't have to worry about that too much, though, as you will be attaching your figures to bases.

Bases can be made out of just about any material — wood, plastic, metal, cardboard — the main consideration is how easy is it to cut. You will want to avoid very smooth materials, like sheets of plastic, as figures on sloping terrain tend to slide to the bottom. A cardboard like 2-ply artist's illustration board or mat board (available in art supply stores) is a good base material. It is relatively sturdy and not too difficult to cut into small bases.

In *Star Wars Miniatures Battles* we like to use circular bases for the humanoid figures, because we think they look spiffy. A good source of circular bases is a hardware store; look for one-inch fender washers, or any other washer with an outside diameter of one inch. They're sturdy, and you don't have to cut them out.

Glue your figures to their bases with five-minute epoxy. The epoxy will harden in about five minutes, giving you time to mount a batch of miniatures. Give them about 24 hours to fully set. Epoxy is a good adhesive for basing miniatures because it is thick enough to fill gaps. If the bottom of a figure is not totally smooth, the glue will fill the space and your figure will now stand without falling over.

Crazy glues can also be used, but they are not good gap-fillers. They work best when you are adhering two flush-fitting surfaces.

Painting Your Figures

Once your miniatures are prepared and based, you're ready to begin painting. The first step is to apply a coat of primer.

The priming coat gives later layers of paint something to adhere to. It also helps your colors appear brighter. For that reason a white primer works better than a gray primer.

You can buy primers wherever you buy your paint. There are also spray primers available. These are useful for priming large amounts of figures. If you are brush priming, use an old brush. This kind of work will ruin your bristles quickly.

Coat the figure thoroughly, but be careful not to use too much paint. You don't want to fill in all the detail with too thick a layer of paint.

Once your figure is primed, it's time to begin painting. There are two methods that work well for painting miniatures for tabletop battles.



■ A family of moisture farmers faces off against a roving band of Sand People in yet another cross-cultural clash somewhere in the Jundland Wastes of Tatooine. (Building and vaporator by Stephen Crane.)

Wash and Drybrush

In this method, you start by painting in the colors you want to use on the figure, covering the figure's skin, clothing and equipment with the appropriate colors.

This gives you the basic color scheme, but the figure looks flat. A 25mm figure is too small and the surface detail too shallow to catch the light the way a real person does. Shadows and highlights need to be painted on in order to give the figure a more realistic look and allow it to stand out.

The next step is to mix up a wash of a darker version of the color you are painting. A wash is thinned-down mixture of paint and thinner (or paint and water if you are using acrylics). The wash should be thin enough to flow easily. A ratio of two parts thinner to one part paint works well.

Once the base coat is dry, brush the wash onto the area you are shading. The wash will flow into the crevices and low points, darkening them, but leaving the higher areas lighter. The wash will darken the overall color slightly, so use it sparingly.

When the wash is thoroughly dry, you can add the highlights. The shadows begin to give the figure a sense of depth, but the highlights will really make it pop. Highlights are applied by drybrushing.

Drybrushing is the procedure of lightly brushing on very dry paint. Mix up a lighter version of the base color. Dip your brush in the paint and blot it off on a rag or scrap board. Work it in until you have only some very dry paint left on the bristles (use an old brush for drybrushing; it will ruin a good brush).

Then lightly draw the brush across the surface of the figure. The dry pigment should adhere to the raised surfaces of the area you are painting. The result is that the lighter color rests only on the highest points of the base color, giving the effect of highlights.

With the darker color in the recesses as shadow and the lighter color as highlights, your figure will come to life as a visually appealing gaming piece.

Drybrushing can sometimes be difficult to master, but it is well worth the time learning to do it, as this technique really helps a figure's appearance. It is the main procedure used in the other method of painting your tabletop figures.

Successive Drybrushing

For this method, start by painting your figure with a darker version of the color you want it to be. When the base coat dries, mix up a lighter version of the first coat. Drybrush the figure with this color; but this time, apply the drybrush a bit more heavily, working it deeper into the recesses than you would for a highlight, but not as deep as the shadows.

After that coat dries (drybrushed layers dry fairly quickly), mix up an even lighter version and drybrush it on, but not as deeply as the last coat.

Mix up successively lighter colors, working up through the base color you'd like and up to a highlight

version of it. Each new coat of paint should be drybrushed even more lightly. Do this for each area of color and your figure is done.

Assembly-line Painting

Each of the above methods will give you a decent set of figures for gaming with. They may not be masterpieces, but don't feel daunted; you don't need a Mona Lisa to play the game with. Besides, if you spent all that time making art, it would take forever to get some squads into the field.

In order to get more figures done quickly, so you can get that Mon Cal unit onto the battlefield to surprise those Imperials, try assembly-line painting. Mount a row of similar figures on a scrap piece of wood. Use a white glue (like Elmer's) to temporarily hold them down.

When you're painting a particular color item, like the uniforms, or the equipment, work down the row of figures painting the area on each one before going onto the next. Then switch to the next color and do the same. You'll soon be turning out squads in no time.

As you progress, you may want to get more detailed in your painting. It may take more time, but there's nothing wrong with that if you're so inclined. There are many accomplished artists out there who can turn a 25mm figure into a work of art. You can take this as far as you want to go with it.

Finishing the Bases

To finish off your figure, you'll want to paint up the base. Our preferred method is with paint and scenic grass.

You can buy scenic grass in hobby shops and model railroad shops. It's a bag full of little green flakes that look like miniature grass.

Paint the base a green that matches the scenic grass (this ensures that the base doesn't show through the grass flakes). When that dries, spread white glue over the base and pour on scenic grass. Tamp it down a bit with your finger to set it in the glue, then pour off the excess grass. Let it dry.

You'll have a nice grassy base that makes the figure look like it's standing on real terrain. It will also make the base blend in with the terrain you're playing on, if you've chosen a matching groundwork. You can drybrush the grass with a light green or a yellow to give the figure extra pizzazz.

If you're using terrain that's not green and grassy, you can do the above, but then paint the grass some otherworldly color. Or use dirt, sand, or fine gravel instead of scenic grass to coat the base for a more "earthy" type of look (paint an appropriate color under the material you are gluing on).

To take the base one step further, you can add some accessories before painting and applying groundwork. We prefer spackling compound (a household filler), as it is ready-mixed and easy to use.

Spread it on the base up to the figure's feet, smoothing out the edges where the figure's base is glued down to the game base. While the spackle is drying, you can embed objects in it; objects like stones, skulls, discarded weapons, or whatever. Then proceed with painting and groundwork as outlined above, watching out for the embedded goodies. These little extras will add character to a figure.

If you don't mind a little bit of the game elements intruding into your figure painting, you can paint little marks along the edge of the base to aid in playing the game. Paint a mark at the front center of the base. Then there's no question as to which way the soldier's facing.

Measure 45 degrees in both directions from the front mark. Paint marks at those points. These marks represent the soldier's front arc for determining what he can fire at. They also help to regulate changing facing when the figure turns.

Protecting Your Figures

So, you've spent all this time painting your miniatures nicely. You'll want to protect all that painstaking work. The best thing to do is apply a clear fixative or varnish.

There are many brush-on varieties available. Most paint manufacturers make their own version. There are also spray cans available.

Fixatives generally come in three varieties: gloss, semi-gloss (sometimes called "satin") and matt (sometimes called "flat"). Gloss is a shiny finish, matt is a dull finish, and semi-gloss is somewhere in between.

The best protection is a gloss fixative. It dries to a hard shell. If you want your figure to have a dull finish, it's best to fix it with a gloss first, then apply a matt finish over the gloss.

Brush-on fixatives also allow you to detail your figures even more. You can change the look of a figure by selectively mixing finishes. Making a Rebel's skin and uniform matt, but applying a gloss finish to his gun and helmet give the figure an extra sparkle.

Scenery

You've got your figures and you're itching for a fight. Where are you going to duke it out? On the table, of course, but there are many ways you can go about getting the table ready for action.

Quick and Dirty

The quick way. First, get a big table. Four feet by eight feet is a good size, but three by six will do in a pinch.

Pile up a few books on the table. These will be your hills. Now cover the whole thing with a big green cloth (felt has a good texture). There you go — instant terrain.

Seriously, though, that's all you really need. Other features can be added with construction paper, or any other colored paper. Use blue for rivers, brown for rough terrain, white for snow, etc. This will provide you

with an interesting-looking arena in which to pit your forces against one another.

Further details can be provided with some pebbles (or aquarium gravel — it comes in a variety of colors and will give you a nice otherworldly look) and twigs for boulders and trees.

There you have it; simple, easy, satisfactory.

The Handyman's Way

Some people, however, yearn for more. Three-dimensional figures call out for three-dimensional terrain. With a few easily available materials and a good amount of time, you can turn out some really nice looking scenery and terrain.

The basic material is polystyrene. You can find this in plastics shops, sometimes already cut to size. You can also find it in home improvement and hardware stores, and in some lumber yards. It comes in large panels used for insulation.

It is easily cut down to size and will provide you with modular terrain system, allowing you a variety of battlefields from the same pieces.

Polystyrene is lightweight and easy to work with, but does leave quite a mess, so spread a lot of old newspapers around. It can be cut with a hobby knife, but make sure your blade is sharp, and keep replacing it to keep it sharp.

As polystyrene is fragile, you'll want to mount it to a stiff piece of cardboard or thin wood. This will protect the corners and edges and keep it rigid.

You'll also need some grass mat. This is a large roll of green paper with scenic grass glued onto it, and is available in model railroad shops. Using grass mat for the scenery and scenic grass for your bases will help your figures blend right in when used on your terrain.

Building Your Terrain System

Decide on the size panel you want to build your terrain around. Common sizes are one-foot square panels and two-foot square panels. One-foot panels will allow you more flexibility. Cut out a bunch of square panels, and a corresponding amount of the backing material you're using. Glue the styrene panels to the backing, apply pressure and let dry. White glue works best for polystyrene.

Clear Terrain

You are going to make a few different types of terrain, but you'll need more "clear terrain" panels than others. Cut the grass mat to the size of your panels and glue the pieces to the other side of the polystyrene panel.

You now have a bunch of clear terrain pieces you can butt up against each other on a tabletop to give you a battlefield. Few battlefields are flat as far as the eye can see, so you'll want to make some additional panels with extra scenic details on them. Your best bet is to make most of your additional items independent of the pan-

**DIAGRAM 31
Panel Construction**

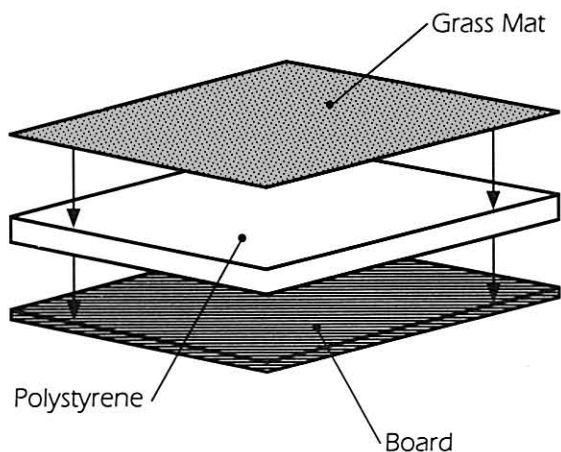

Stephen Crane

better to make these features independent of the panels so that they can be placed on the gaming surface in any orientation.

Hills are simply a stack of successively smaller irregularly-shaped curved forms cut from the polystyrene. You may want to strengthen the hill by gluing a piece of wood or board to the underside of the bottom piece, as you did for the panels. Glue a piece of grass mat (cut to the right shape) to the top of each piece, then glue the pieces together.

When the glue dries, spackle the exposed edges of each piece. When that's dry, paint the edges green. Later glue scenic grass over the painted edges, like you did for the bases of your figures. *Voilà!* A hill.

Polystyrene panels come in thicknesses of 1/2" or 3/4". Try to get the 1/2" thickness as that will give you convenient 1-meter-high contours on your hills. But if you have to use 3/4", just assume each level is one meter high.

Keep in mind the definition of easy and difficult hills when placing the levels together (see "Terrain").

Also keep in mind the size of your figures' bases. You don't want to place the edges of the levels so close to each other that you can't stand a figure on the hillside.

You now have your basic terrain pieces. Your layout can be spruced up with additional spot features like trees, bushes, walls, fences and buildings. These are covered in "Accessories" below.

els — things like hills, trees, woods, and patches of rough and very rough terrain — so that your system remains flexible.

Rivers and Roads

Where the panels come in really handy is for terrain features that go below the surface of the ground. You can make panels with rivers or creeks, ditches, and roads. Just carve out the polystyrene in the shape that you want your features, seal the surfaces and create details with spackle, then paint them up.

For rivers, paint the riverbed blue down the center and fade to green towards the sides. You can build up banks with the spackle; paint them earth-colored. Then pour white glue into the river (a thin layer should suffice, but you can always add more later). It will dry clear and give you a nice water effect. Or brush a gloss fixative on over the river color to give it that water sheen.

The reason you should coat the carved-out features with spackle or some other material is that certain paints, adhesives and fixatives react with the polystyrene, melting it. You need to have a non-reactive layer to protect your hard work.

Using spackle for these features will also give you the opportunity to model old, rutted dirt roads, or to detail the interiors of trenches.

When creating multi-panel features like rivers or roads, make sure that the feature begins and ends at the midpoint of a side of the panel. That way these features will always line up when you place panels side by side.

Hills

You will also need to build hills up from the surface. You can make hill panels, but as mentioned before, it is

**DIAGRAM 32
River and Road Placement**

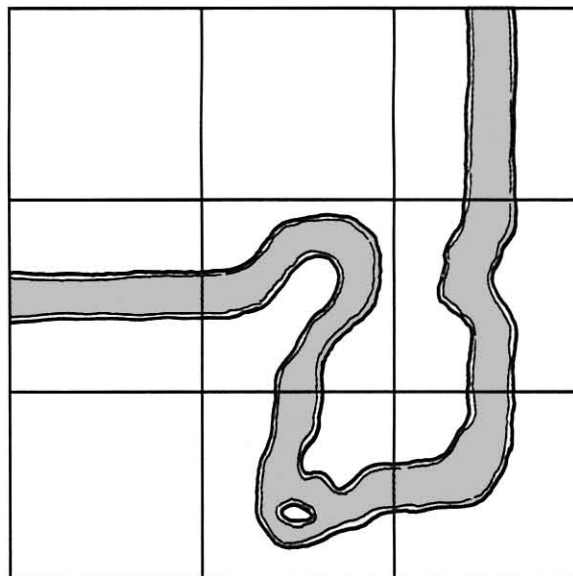

Make sure the river or road crosses the edges of the panels in their centers in order to extend the river or road to the length that you want.

Stephen Crane

**Diagram 33
Hill Construction**

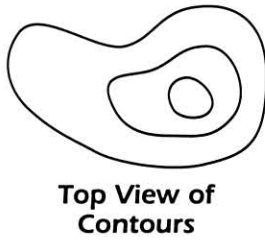

Hills are assembled from a series of successively smaller levels.

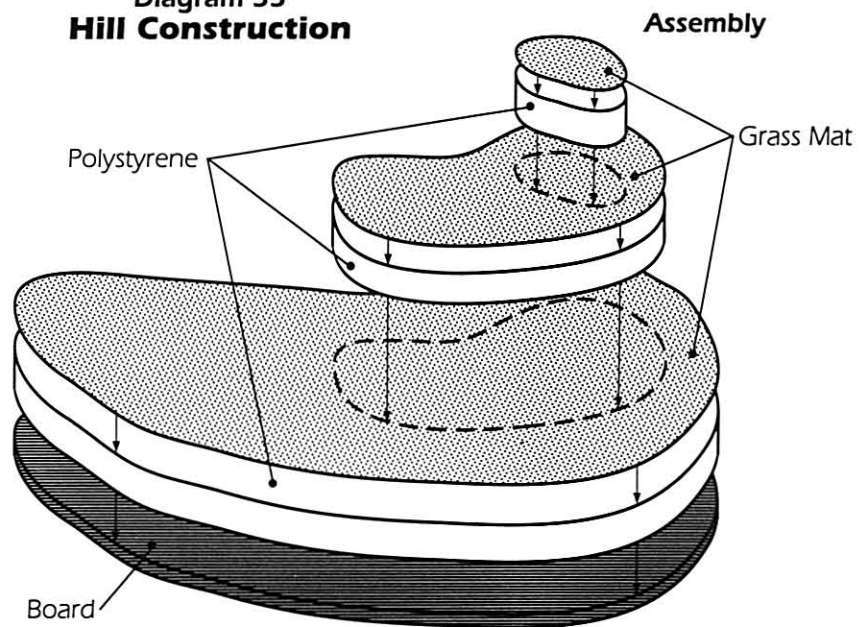

Stephen Crane

The Professional Way

If you don't have the time, facilities or inclination to make scenery and don't mind spending a few bucks, you can buy it. You can get some really good terrain and quality scenery really sets off the figures.

You can buy ready-made scenery, or have scenery custom-made (although this can get expensive). Check the ads in modelling magazines.

One of the more popular systems available is Gamescape, produced by Geo-Hex. Like a lot of systems sold or made to order, this is modular, giving you a wide variety of settings with just a basic selection. And the basics can be elaborated upon with expansion sets. Geo-Hex terrain is featured in the photographs in this book. For more information, write to:

Geo-Hex
Dept. SW2
2126 North Lewis
Portland, OR 97227

Accessories

Accessories like trees, bushes, walls and so forth should be mounted on their own individual stands so they can be placed anywhere on the layout. The bases can be made of illustration board, mat board, foam-core board or thin plywood. Foam-core is probably the best bet. It has a little bit of thickness which is good for holding things like tree trunks, but is not too thick to be obtrusive on the battlefield.

Bases should be cut out with irregular curved edges, so as to blend in better with the terrain. You should glue grass mat on the bases or paint them and glue on scenic grass.

To get an alien look to things, many of the standard accessories can be painted with exotic colors.

Another scenic material that you'll need when working on accessories is lichen. This a cleaned and dried moss-like plant that is sold in many hobby and model railroad shops. It is used for most types of vegetation in scale layouts.

Rough and Very Rough Terrain

Simply glue small, low clumps of lichen to a base, or glue on some coarse dirt or pebbles to represent terrain which is difficult to cross.

Walls and Fences

Use long thin bases for walls and fences. A good length is about three inches. Stone walls can be built up from little pebbles; aquarium gravel works well, also. Fences can be constructed from thin pieces of wood, either balsa wood strips from hobby stores or matchsticks, or the equivalent.

More modern or futuristic walls can be constructed of sheet styrene, which has a smooth surface. This is styrene plastic which is available in sheets of different thicknesses. You'll need regular modelling glue for styrene plastic.

Ready-made walls cast in resin or plaster are widely available from hobby stores. Once painted, they look excellent.

Trees

Trees are the easiest accessories to buy. Any HO scale trees (available in hobby stores) will work with 25mm figures, although you'll probably want to go for the biggest trees you can find.

You can mass-produce trees relatively simply. At an electrical supply store or in a lighting department, get some of that brown wire with three or four insulated strands running through it.

Cut away the outer brown insulation from the first 1/2" of one end and the last 1-1/2" at the other end. Spread out the strands at both ends and glue the shorter strands to a base (alternatively, don't strip the short end, just force it into a foam-core base).

Then glue a clump of lichen to the longer strands. Paint the strands brown. Your tree is now finished.

With a bit of extra work you can add further detail. Apply a clear glue over the lichen, or spray-paint it a corresponding green. While it's still wet, pour scenic grass over the lichen. The wet adhesive will cause the grass to stick to the lichen, giving the appearance of leaves. This technique works well for bushes also.

It adds a little variety to your tabletop to sometimes group two or three trees on a single stand. You can also add some rough terrain groundwork or some bushes under and around the trees.

Bushes

To create bushes, just glue some lichen to a base. Another material you can use — and this works especially well for hedges — is a sponge. Cut strips or clumps of sponge and glue them to a base. You can then add scenic grass as described under "Trees" above.

Buildings

Buildings present much more of a challenge. Your best bet is to find some commercially available buildings. Some buildings are available, cast in resin or in plaster. There are also printed cardboard buildings which you cut out and assemble. Unfortunately, there are very few buildings suitable for a science fiction setting.

One possibility is to start with available buildings and modify them until they look suitably alien. The other option is to build your own. Building your own structures opens limitless possibilities. Whatever you can think of and have the materials for can be built. You can use wood, styrene sheets, or cardboard.

One characteristic that instantly makes a structure look futuristic is curves. If a building has a lot of curves or domes it will fit right in. Keep your eyes peeled for possibilities in all sorts of household goods and discards.

Cardboard tubes, from the core of paper towels or tape, are good for towers and connecting walkways. Soda cans also make good towers. Margarine tubs can

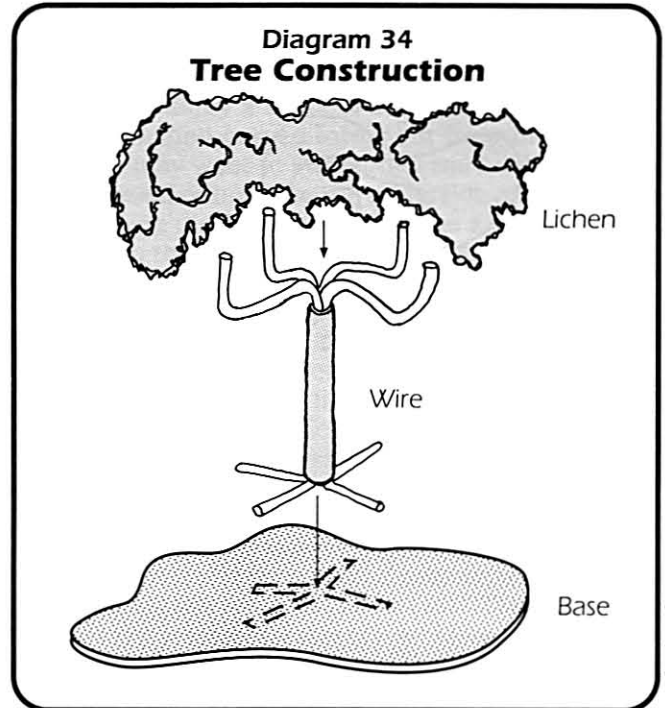

Stephen Crane

be modified to become domed buildings. Stack them mouth-to-mouth or base-to-base for different looks. The support in a box of disposable baby bottles can make a great bunker. Straws are good for pipes and rods.

Styrofoam balls used for making Christmas decorations are also good sources of domes, but be sure to spackle them before painting. Styrofoam packing material can be used to form the basic shape of buildings.

You'll want to start a "bits box" if you don't already have one. Keep those odd little bits you find around in the box. If you modify your miniatures you may find yourself with extra bits of equipment and weapons left over. Spare pieces from plastic model kits can go in the box. Soda bottle and water bottle caps are good for hatches. Keep some in the bits box.

When you need to add detail to a building, rummage through the bits box for ideas.

You may find yourself hoarding stuff, so try not to go overboard. But there are quite a few ordinary items that can make the perfect setting for your *Star Wars* adventure.

With the addition of a little imagination and enthusiasm, the sky's the limit. Have fun, and good gaming.



TROOP LISTS

"We're going to have company!"

Imperial Forces

Stormtrooper

Quality: Average.
Size: Any.
DEX: (1)*
KNO: 2
MEC: 2
PER: 2
STR: (3)*
TEC: 2
Move: 10
Skills: Level 2 — DEX, MEC, STR.
Weapons: Blaster pistol, blaster rifle, medium repeating blaster.
Armor: Stormtrooper — free.
Commanders: Level 2.
Specialists: Level 3 — *blaster artillery, repulsor op.*

Imperial Trooper

Quality: Average.
Size: 4.
DEX: 3
KNO: 2
MEC: 2
PER: 2
STR: 3
TEC: 2
Move: 10
Skills: Level 1 — DEX, STR.
Weapons: Blaster pistol, blaster carbine, blaster rifle, heavy weapons, grenade.
Armor: Any.
Commanders: Level 2.
Specialists: None.

Snowtrooper

Quality: Veteran.
Size: Any.
DEX: (2)*
KNO: 2
MEC: 2
PER: 2
STR: (3)*
TEC: 2
Move: 10
Skills: Level 3 — DEX, MEC, STR.
Weapons: Blaster pistol, blaster rifle, medium or heavy repeating blaster, grenade.
Armor: Snowtrooper — free.
Commanders: Level 3.
Specialists: Level 3 — *blaster artillery, repulsor op.*

Imperial Soldier

Quality: Veteran.
Size: 4.
DEX: 3
KNO: 2
MEC: 2
PER: 2
STR: 3
TEC: 2
Move: 10
Skills: Level 2 — DEX, STR.
Weapons: Blaster pistol, blaster carbine, blaster rifle, heavy weapons, grenade.
Armor: Any.
Commanders: Level 2.
Specialists: Level 2 — *blaster artillery.*

Spacetrooper

Quality: Elite.
Size: Any.
DEX: (2)*
KNO: 2
MEC: 3
PER: 2
STR: (5)*
TEC: 2
Move: 10
Skills: Level 4 — DEX, MEC, STR, TEC.
Weapons: Any.
Armor: Spacetrooper — free.
Commanders: Level 4.
Specialists: Level 4 — DEX, MEC, STR, TEC.

*Numbers in parentheses are the final values as modified by armor.

Neutral Forces

Mercenary

Quality: Average
Size: Any.
DEX: 3
KNO: 2
MEC: 3
PER: 2
STR: 2
TEC: 2
Move: 10
Skills: Level 1 — DEX, MEC, STR.
Weapons: Any.
Armor: Any.
Commanders: Level 2.
Specialists: Level 2 — DEX, MEC.

Bounty Hunter

Quality: Veteran.
Size: 2–10.
DEX: 4
KNO: 2
MEC: 2
PER: 3
STR: 3
TEC: 2
Move: 10
Skills: Level 2 — DEX, MEC, STR.
Weapons: Any blaster.
Armor: Bounty hunter.
Commanders: None.
Specialists: None.

Veteran Mercenary

Quality: Veteran.
Size: Any.
DEX: 3
KNO: 2
MEC: 3
PER: 3
STR: 2
TEC: 2
Move: 10
Skills: Level 2 — DEX, MEC, STR; Level 1 — any.
Weapons: Any.
Armor: Any.
Commanders: Level 3.
Specialists: Level 3 — DEX, MEC.

Elite Bounty Hunter

Quality: Elite.
Size: 2–10.
DEX: 4
KNO: 2
MEC: 2
PER: 3
STR: 3
TEC: 2
Move: 10
Skills: Level 3 — DEX, MEC, STR.
Weapons: Any blaster.
Armor: Bounty hunter.
Commanders: None.
Specialists: *blaster artillery* 4.

Elite Mercenary

Quality: Elite.
Size: Any.
DEX: 3
KNO: 2
MEC: 3
PER: 3
STR: 3
TEC: 2
Move: 10
Skills: Level 3 — DEX, MEC, STR; Level 2 — any.
Weapons: Any.
Armor: Any.
Commanders: Level 3.
Specialists: Level 4 — DEX, MEC.

Rebel Forces

Standard Rebel Trooper

Quality: Veteran
Size: 6–10.
DEX: 3
KNO: 2
MEC: 2
PER: 2
STR: 2
TEC: 2
Move: 10
Skills: Level 2 — any.
Weapons: Any.
Armor: None.
Commanders: Level 2.
Specialists: Level 2 — any.

Ewok

Quality: Veteran
Size: 4–6.
DEX: 2
KNO: 1
MEC: 1
PER: 3
STR: 2
TEC: 1
Move: 7
Skills: Level 2 — *melee combat, sneak*, STR.
Weapons: Spear.
Armor: None.
Commanders: Level 4.
Specialists: None.

Hoth Trooper

Quality: Elite
Size: 3–10.
DEX: 3
KNO: 2
MEC: 2
PER: 2
STR: 3
TEC: 2
Move: 10
Skills: Level 3 — any.
Weapons: Any.
Armor: None.
Commanders: Level 3.
Specialists: Level 3 — any.

Mon Calamari

Quality: Average
Size: 5–10.
DEX: 3
KNO: 3
MEC: 2
PER: 2
STR: 2
TEC: 3
Move: 9
Skills: Level 2 — any.
Weapons: Any.
Armor: Any.
Commanders: Level 2.
Specialists: Level 3 — any.

Wookiee

Quality: Veteran
Size: 3–4.
DEX: 2
KNO: 2
MEC: 3
PER: 2
STR: 4
TEC: 3
Move: 11
Skills: Level 2 — DEX, MEC, STR, TEC.
Weapons: Bowcaster, grenade, repeating blaster.
Armor: None.
Commanders: None.
Specialists: None.

Veteran Mon Calamari

Quality: Veteran
Size: 5–10.
DEX: 3
KNO: 3
MEC: 2
PER: 2
STR: 2
TEC: 3
Move: 11
Skills: Level 3 — any.
Weapons: Any.
Armor: Any.
Commanders: Level 3.
Specialists: Level 4 — any.

Elite Wookiee

Quality: Elite	PER: 2	Weapons: Bowcaster, grenade, repeating blaster. Armor: None. Commanders: None. Specialists: None.
Size: 3–4.	STR: 4	
DEX: 3	TEC: 3	
KNO: 2	Move: 15	
MEC: 3	Skills: Level 3 — DEX, MEC, STR, TEC.	

Advanced Game

Droids and Creatures

DROIDS

Assassin Droid

DEX: 4
 KNO: 1
 MEC: 1
 PER: 2
 STR: 5
 TEC: 1
 Move: 10
 Movement Rate: 9
 Skills: *blaster 5, search 5.*
 SGP: 36

Security Droid

DEX: 3
 KNO: 1
 MEC: 1
 PER: 2
 STR: 3
 TEC: 1
 Move: 10
 Movement Rate: 8
 Skills: *blaster 4, search 5*
 SGP: 35

Probe Droid

DEX: 3
 KNO: 2
 MEC: 1
 PER: 3
 STR: 4
 TEC: 1
 Move: 10
 Movement Rate: 9
 Skills: *blaster 4, search 4.*
 SGP: 46

War Droid

DEX: 3
 KNO: 1
 MEC: 1
 PER: 2
 STR: 6
 TEC: 1
 Move: 8
 Movement Rate: 7
 Skills: *blaster 5, blaster artillery 5.*
 SGP: 36

CREATURES

Bantha

DEX: 2
 STR: 8
 PER: 2
 Move: 5
 Movement Rate: 7
 Orneriness Code: 2
 Attack Forms: *Horns (7), trample (8)**
 SGP: 24 (70)*
 * Only trained war banthas may use the trample attack; they cost 70 SGPs each.

Dewback

DEX: 3
 STR: 4
 PER: 2
 Move: 35/7*
 Movement Rate: 38/10*
 Orneriness Code: 3
 Attack Forms: *bite (4)*
 SGP: 48
 * The first value reflects movement during the daytime; the second is at night. Dewbacks become sluggish at night.

Cracian Thumper

DEX: 3
 STR: 3
 PER: 4
 Move: 12
 Movement Rate: 15
 Orneriness Code: 1
 Attack Forms: *claw (3), tail (5)*
 SGP: 60
The thumper is a common Rebel mount much like a tauntaun (for more details see the Star Wars supplements, The Rebel Alliance Sourcebook and the Dark Force Rising Sourcebook).

Krayt Dragon

DEX: 3
 STR: 12
 PER: 2
 Move: 15
 Movement Rate: 18
 Orneriness Code: -
 Attack Forms: *claw (8), bite (15)*
 SGP: 110

Rancor

DEX: 4
STR: 7(10)*
PER: 1
Move: 20
Movement Rate: 24
Orneriness Code: –
Attack Forms: claw (10), bite (12)
SGPs: 114
 *The rancor's armored skin adds +3 to its STR for resisting damage.

Tauntaun

DEX: 2
STR: 4
PER: 3
Move: 16
Movement Rate: 18
Orneriness Code: 1
Attack Forms: horns (5)
SGPs: 30

Vervikk

DEX: 3
STR: 3
PER: 2
Move: 6
Movement Rate: 9
Orneriness Code: –
Attack Forms: bite (4)
SGPs: 18

The vervikk is a "space rat," a type of vermin commonly found haunting the infrastructure of many large starships (for more details see the Star Wars adventure, Riders of the Maelstrom).

Wampa

DEX: 3
STR: 7
PER: 4
Move: 13
Movement Rate: 16
Orneriness Code: –
Attack Forms: claw (7), bite (5)
SGPs: 78

Womp Rat

DEX: 2
STR: 2
PER: 1
Move: 5
Movement Rate: 7
Orn. Code: –
Attack Forms: claw (3), bite (3)
SGPs: 32

Yavinian Runyip

DEX: 4
STR: 4
PER: 3
Move: 8
Movement Rate: 12
Orneriness Code: 4
Attack Forms: horns (4)
SGPs: 23

The runyip is a grazing creature native to the fourth moon of Yavin (for more details see the Star Wars supplement, Galaxy Guide 2: Yavin and Bespin).

REFERENCE SHEETS

"Never tell me the odds."

Reference Sheets

SEQUENCE OF PLAY

- The Initiative Phase:** Roll for initiative.
- The Movement Phase:** Players alternate at moving squads, heroes, vehicles, creatures, etc. Non-moving squads can attempt opportunity fire.
Charges are declared and morale tests taken by attackers, and, if the attackers' morale holds, by defenders. Defenders whose morale holds use defensive fire.
- The Fire Combat Phase:** The players' squads fire at each other. Casualties take effect at the end of the phase.
- Close Assault Combat Phase:** Enemy soldiers in "base-to-base" contact with each other engage in close assault combat.
- The Morale Phase:** Broken squads are moved first. Then squads which have taken casualties take morale tests. Squads with lowered morale, which have not fired or fought this turn, and broken squads may attempt to rally.
- Special Actions Phase:** Remove *Fire+1* and *No Fire* markers from all units. Heroes perform special actions. Roll for any Advanced Terrain changes necessary.

MOVEMENT RATES

Walk = Move/2 + DEX

Run = Move + DEX

Movement	Fire	Facing
Walk	Fire +1	Any
Run	No Fire	90-degree turn
Prone		Move 2"/Stand up (2")

GRENADE SCATTER CHARTS

Thrown		Launched	
Range	Distance Deviated	Range	Distance Deviated*
Short	1-3 inches (1D/2)	Short	1-6 inches (1D)
Medium	1-6 inches (1D)	Medium	2-12 inches (1Dx2)
Long	2-12 inches (1Dx2)	Long	3-18 inches (1Dx3)

*No more than half the distance to the target

FIRE COMBAT SUMMARY

Fire Combat occurs in six steps:

- Targeting:** Determine which soldiers in the firing squad have a "line of sight" (LOS) to soldiers in the target squad. Only soldiers with a LOS can fire at the target squad, and they may only fire at those soldiers which they can see.
- Range Determination:** Measure the average distance between the firing soldiers and the target soldiers. Compare this with the range of the weapon which is being fired; the distance will be short, medium, or long. This determines the base difficulty of the firing soldiers' *blaster* test.
- Final Difficulty of the Shot:** The base difficulty of the shot may be modified by the terrain the targets occupy, whether the firing squad has moved, and other factors.
- Make Blaster Tests for the Firing Soldiers:** All successful tests indicate that the firing soldiers hit a soldier in the target squad.
- Hit Determination:** Determine randomly which target soldiers are hit.
- Damage Determination:** The firing player and target player make opposed rolls to determine the damage of each shot. Results are marked immediately, but not applied until the end of the Fire Combat Phase.

CLOSE ASSAULT COMBAT MODIFIERS CHART

[Advanced Game modifiers are shown in brackets]

Condition	Skill Modifier
Charging (1st turn only)	+1
Defending barrier	+1
Outnumbering Opponent (per each additional soldier)	+1
Standard melee weapon	+1
Vibroaxe or -blade	+2
Lightsaber	+4
Attacked from side or rear	-2
Prone	-2
Separated from squad	-1
Shaken	-1
Demoralized	-2
[Droid Attacking	+1]

FIRE COMBAT CHART

Range	Base Difficulty
Short	6
Medium	8
Long	10

Fire Combat Modifiers

[Advanced Game modifiers are shown in brackets]

Target Condition	Difficulty Modifier
In Light Cover	+1
In Medium Cover	+2
In Heavy Cover	+3
Target Prone	+1
[Multiple Targets — heroes only	+2]
[Specific Target — heroes only	+4]

Firer Condition	Difficulty Modifier
Walking	+1
Opportunity Fire	+1
Defensive Fire	+1
Separated from squad	+1
Shaken	+1
Demoralized	+2
Following Fire (after 1st shot)	+2
[Firing from moving surface	+1]

DAMAGE TABLE

Roll	Effect
DS < SR	No Effect
DS ≥ SR	Wound
DS ≥ SR + 4	Incapacitated

DS = Weapon's *Damage Strength* Roll
SR = Target's *Strength* Roll

Damage Effects

Wound: Falls down. Can stand up at a cost of 2". -1 penalty to all skills and attributes. Cannot run. Two wounds equal incapacitated.

Incapacitated: Removed from table.

WEAPON CHART

Blasters					
Weapon	Dam	Range in inches			SGPs
		Short	Med	Long	
Hold-Out Blaster	3	2	4	6	4
Sporting Blaster	3	5	15	60	6
Blaster Pistol	4	5	15	60	7
Heavy Blaster Pistol	5	4	12	25	8
Hunting Blaster	4	15	50	150	14
Blaster Rifle	5	15	50	150	15
Blaster Carbine	5	12	30	125	11
Repeating Blaster*	6	15	60	150	18

Heavy Blasters

Repeating Blaster**†	6	15	60	150	23
Medium Repeat Blaster†	7	30	75	200	27
Heavy Repeat Blaster †	8	38	100	250	33

* Standard Configuration † Following fire; Assembled; Crew
** Tripod-Mounted

Archaic Weapons

Crossbow	3	5	15	25	5
Longbow	3	5	15	50	5
Black Powder Pistol	3	2	4	6	3
Musket	3	5	15	50	6
Rifle	3	15	50	100	13
Submachinegun	4	5	25	50	9
Bowcaster	4	5	15	25	7

Grenades

Grenade	4	4	10	20	5
Thermal Detonator	8	2	4	6	10

Grenade Burst radius = 2.5"
Thermal Detonator Burst radius = 2.5"

Melee Weapons

Weapon	Damage	SGPs
Hands	STR	-
Club	STR+1	2
Gaderffii	STR+1	2
Spear	STR+1	2
Vibroaxe	STR+2	4
Vibroblade	STR+2	3
Lightsaber	5 (+control)	25

MORALE STATUS

Steady: No Problems

Shaken: *Blaster, blaster artillery and grenade* skill tests increased by +1. A -1 modifier to *melee combat* or *brawling* rolls. Threat level increased by +1.

Demoralized: Difficulty of all *blaster* and *grenade* skill tests increased by +2. *Melee combat* or *brawling* rolls at -2. Squad cannot advance towards a visible enemy soldier. No opportunity fire. Threat level increased by +2.

Broken: Squad routs.

MORALE TEST CHART

Morale Test Type	Threat Level
Casualty	4
Charging	6
Receiving a Charge	4

Standard Threat Level Modifiers*

Shaken	+1
Demoralized	+2
Each casualty taken this turn	+1
Commander incapacitated this turn	+2
Squad is behind cover	-1
Squad wins turn of close assault	-1
Squad loses turn of close assault	+1

"Charge" Modifiers**

Attacking enemy's flank or rear	-2
Attacking enemy behind barrier	+1

"Receiving a Charge" Modifiers***

Attacked in flank or rear	+2
Outnumbered 2:1	+2
Each heavy weapon in the squad	-1

*apply to all situations

** apply to charging squads only

*** apply to squads receiving a charge

MORALE TEST RESULTS

Roll	Result
$TR + 4 \leq CR$	Morale +1
$TR \leq CR$	No Effect
$TR > CR$	Morale -1
$TR \geq CR + 4$	Morale -2; Withdraw

TR = Threat Roll; CR = Command Roll.

RALLY TEST

Rally Threat Level: 4

Rally Test Threat Level Modifiers

Squad is behind cover	-1
Squad is shaken	+1
Squad demoralized or broken	+2
Squad has taken 50% or more casualties	+2
Each casualty taken this turn	+1
Commander incapacitated this turn	+2

RALLY TEST RESULTS

Roll	Result
$RR \geq CR$	No Effect
$RR < CR$	Morale +1
$RR + 4 < CR$	Morale +2

RR = Rally Threat Level Roll; CR = Command Roll

OPPORTUNITY FIRE TEST

Opportunity Fire Threat Level: 4

Opportunity Fire Test Threat Level Modifiers

Squad is behind cover	-1
Squad is Shaken	+1
Squad has taken 50% or more casualties	+2

OPPORTUNITY FIRE TEST RESULTS

Roll	Result
$OF \geq CR$	Cannot Fire
$OF < CR$	Can Fire

OF = Opportunity Fire Threat Level Roll

CR = Command Roll

GRENADE SUMMARY

Type	Cost	Dam.	Duration (turns)	Burst Radius	Effect
Fragmentation	5	4	1	2.5"	Normal damage
Concussion	8	5	1	1.5"	Normal damage
Smoke	5	-	5	2.5"	Block LOS (+2 to fire)
Luma	8	-	6	6"	Negates dark
			1	1.5"	Blinded; +2 difficulty
Stun	10	4*	4	1.5"	Wound = -1, 3 rounds Incap = -1, 5 rounds
T-238	8	1	3	2.5"	Incap = wound
CryoBan	5	2	2	2.5" **	Normal damage; cold; no drift
Plank gas	15	3	2	1.5"	Wound = -2 to skills; destroys space/ environ suits
Fex-M3	25	5	2	1.5"	Wound = incap

*reduce by 1 each turn.

**reduce to 1.5" on second turn.

TERRAIN EFFECTS CHART

Terrain Type	Movement Effect	Fire Combat Difficulty Modifier	LOS
clear	NE	NE	NE
scrub	2x cost	+1	NE
brush	2x cost	+1	NE
light woods	2x cost	+1	8"
medium woods	2x cost	+2	6"
heavy woods	4x cost	+3	4"
swamp	4x cost	*	*
easy hill	2x cost	+2	NE
difficult hill	4x cost	+2	NE
creek	2x cost	+2	NE
stream	4x cost	+3	NE

Barrier Type

Barrier Type	Movement Effect	Fire Combat Difficulty Modifier	LOS
door	2"	+2	1" beyond
window	4"	+3	1" beyond
low wall	2"	+2	NE
high wall	4"	+3	up to wall
barbed wire	2"	NE	NE
shallow trench	2"	+2	NE
deep trench	4"	+3	NE

NE = No effect.

*The effects of swamp on fire combat and LOS depend on whether the foliage is equivalent to light, medium or heavy woods.

CLOUD DISSIPATION TABLE

Die Roll	Effect
1-2	Cloud drifts 1" in wind direction.
3-5	Cloud remains in position.
6	Cloud dissipates. Remove from table.

ARMOR CHART

Armor type	STR/DEX mods	SGPs
Bounty Hunter	+1/-1	10
Royal Guard	+1/0	25
Sandtrooper	+1/-1	10
Scout trooper	+1/0	25
Snowtrooper	+1/-1	10
Spacetrooper	+3/-1	50
Stormtrooper	+1/-1	10

ARTILLERY STRIKE RESOLUTION TABLE

Command Roll	Result
1	No further bombardment available. This and all further off-board bombardment lost for the remainder of the game.
2-4	Strike cancelled.
5-6	Strike delayed 1 or 2 turns. Roll a die: 1-3 = 1 turn 5-6 = 2 turns.
7+	Strike occurs as requested.

Light Bombardment: Damage 8
Heavy Bombardment: Damage 12

JUMPING BARRIERS AND DISTANCE CHARTS

Barrier Type	Difficulty Number	Movement Cost
Moderate	4	1"
Difficult	6	1"

Distance Jumped	Difficulty Number
1"	4
2"	6
3"	8

DROID DAMAGE TABLE

Roll	Effect
DS < SR	No effect
DS ≥ SR	Roll for "System Damage"
DS > SR + 4	Roll twice for "System Damage"

DS = Weapon's *Damage Strength* Roll
SR = Droid's *Strength* Roll

SYSTEM DAMAGE TABLE (FOR DROIDS)

Roll	Effect
1	Locomotive systems hit
2-3	Arm or weapon mount hit
4-5	Torso hit
6	Head hit

OBSTRUCTIONS STRENGTH AND SECURITY RATINGS CHART

Obstruction	Strength Rating	Security Rating
Flimsy Partition	2	-
Primitive Exterior Wall	4	-
Reinforced Modern Wall	6	-
Security Wall	8	-
Starship-Grade Structural Wall	10	-
Flimsy Door	1	1
Primitive Exterior Door	3	2
Reinforced Modern Door	4	2
Security Door	6	6
Blast Door	8	4

SQUAD NAME _____
TROOP TYPE _____
TROOP QUALITY _____

Move: _____
DEX: _____
 Trng () Blaster _____
 Spec () Blaster Artillery _____
 Grenade _____
 Melee Combat _____

KNO: _____
 Trng () Survival _____
 Spec () _____

MEC: _____
 Trng () Beast Riding _____
 Spec () _____

PER: _____
 Trng () Command _____
 Spec () Search _____
 Sneak _____

STR: _____
 Trng () Brawling _____
 Spec () Swimming _____

TEC: _____
 Trng () Demolition _____
 Spec () First Aid _____

Skills point cost: _____

Walk Rate Run Rate Command Skill Number in squad

MOVEMENT RATES

Skills point cost (from first column): _____

Weapon(s) Carried	Dam.	Short	Med.	Long

Armor: _____ STR/DEX mod.: _____ / _____

Star Wars Miniatures Battles SQUAD RECORD SHEET
 Point cost per soldier: _____
 Number in squad: **x** _____
BASE SQUAD COST: _____

ID: _____ **COMMANDER:** Command _____

ID: _____ **SPECIALIST:** _____

Weapon Carried	Dam.	Short	Med.	Long

ID: _____ **SPECIALIST:** _____

Weapon Carried	Dam.	Short	Med.	Long

Other costs: _____

Morale Level	9	8	7	6	5	4	3	2	1	0	<input type="text"/>
	Steady	E	V	A		Shaken	Dem.	Broken			SQUAD COST



MINIATURES BATTLES Record Sheets

©, TM & © 1993 Lucasfilm Ltd. All Rights Reserved. Permission is granted to photocopy these sheets for personal use.

Star Wars Miniatures Battles CREATURE RECORD SHEET

CREATURE _____

MOVEMENT RATE
 DEX: _____
 STR: _____
 PER: _____
 Move: _____
 Orneriness: _____

Attack Forms	Dam.

Creature Cost: _____
 Number of creatures: **x** _____
 Pack Cost: _____
 Total: _____
 Number of Attack Forms: **x** _____
CREATURE COST _____

Special Features

HERO NAME _____
Template Type _____
 Height _____ Weight _____ Sex _____ Age _____
 Description _____

Walk Rate Run Rate
MOVEMENT RATES
Force Points

Move: _____
DEX: _____
 Blaster _____
 Blaster Artillery _____
 Brawl. Parry _____
 Dodge _____
 Grenade _____
 Melee Combat _____
 Melee Parry _____

KNO: _____
 Survival _____

MEC: _____
 Beast Riding _____

PER: _____
 Command _____
 Search _____
 Sneak _____

STR: _____
 Brawling _____
 Climb/Jump _____
 Swimming _____

TEC: _____
 Demolition _____
 First Aid _____

Force Use _____
 Control _____ x 4 = _____
 Sense _____ x 4 = _____
 Alter _____ x 4 = _____

Force Powers:
 _____ [C] [S] [A] _____
 _____ [C] [S] [A] _____
 _____ [C] [S] [A] _____
 _____ [C] [S] [A] _____
 _____ [C] [S] [A] _____
 _____ [C] [S] [A] _____
 _____ [C] [S] [A] _____
 _____ [C] [S] [A] _____
 _____ [C] [S] [A] _____
 _____ [C] [S] [A] _____
 _____ [C] [S] [A] _____

**Star Wars Miniatures Battles
HERO RECORD SHEET**

Skills:

 x 2

Weapon(s) Carried	Dam.	Short	Med.	Long

SKILLS TOTAL

Armor: _____ STR/DEX mod.: _____ / _____

Force Point Rolls: _____ x 10 = _____

HERO COST = **BASE COST:** **30** + **SKILLS/WEAPONS/ARMOR:** + **FORCE TOTAL**

DROID NAME _____
DROID TYPE _____

MOVEMENT RATE

Move: _____
DEX: _____
 Blaster _____
 Blaster Artillery _____
 Grenade _____
 Melee Combat _____

KNO: _____

MEC: _____

PER: _____
 Search _____
 Sneak _____

STR: _____
 Brawling _____

TEC: _____
 Demolition _____
 First Aid _____

Skills point cost: _____

Skills point cost (from first column): _____

Weapon(s) Carried	Dam.	Short	Med.	Long

Number of weapons _____ x 10: _____

**Star Wars Miniatures Battles
DROID RECORD SHEET**

Turret (15): _____

Armor (20): _____

Repulsorlift (10): _____

Equipment Type	Effect

Special Features

Base Cost: **10**

DROID COST

STAR WARS®

ADVENTURE JOURNAL

For use with Star Wars: The Roleplaying Game

A New
Short Story by
Timothy Zahn
in Issue #1

The *Star Wars Adventure Journal* has something for every *Star Wars* fan.
Be part of the *Star Wars* galaxy by subscribing now!



Each *Journal* will include original stories from the *Star Wars Universe* along with columns like ...

Wanted By Cracken, featuring new criminals in the *Star Wars* galaxy, from Imperial adversaries to bounty hunters.

Scout's Dispatch, new planets and locations for scouts to explore.

Rebel Field Guide, featuring equipment and advice on how to use it to the best advantage in the field.

Smuggler's Log, filled with adventure hooks and exciting locations for smuggler characters.

Objective Sighted, featuring *Star Wars Miniatures Battles* scenarios.

Letters to the Editor, with readers' comments about the *Journal*, *Star Wars* and *Star Wars* gaming.

New Horizons, spreading information about new *Star Wars* products such as novels, comics, toys and games.

Classified Ads, where people can seek and find information on *Star Wars* collectibles and communicate with other fans.

Please send me four issues of
The *Star Wars Adventure Journal*.

Name: _____

Address: _____

City: _____

State: _____ Zip: _____

Send check or money order for \$35 to *Star Wars Adventure Journal* Subscriptions, West End Games Ltd., RR 3 Box 2345, Honesdale, PA 18431-9560.

I'd like to write for the *Journal*! Please send me writers' guidelines. I have enclosed a self-addressed stamped envelope.

Star Wars Miniatures Battles

Templates and Markers

(Sheet 1 of 4)

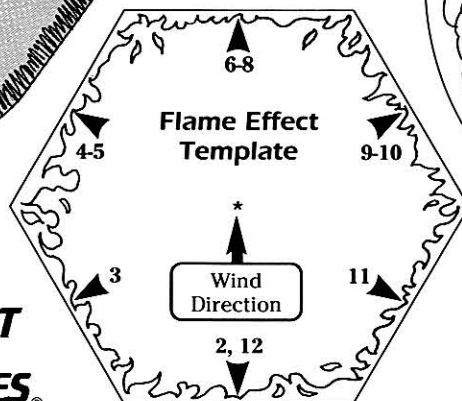
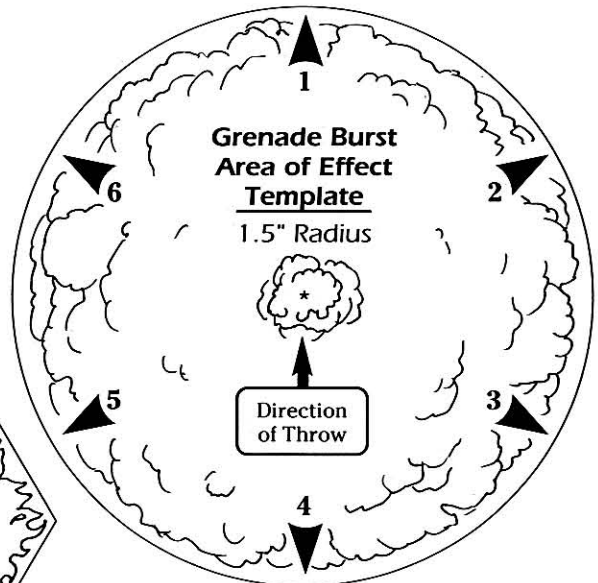
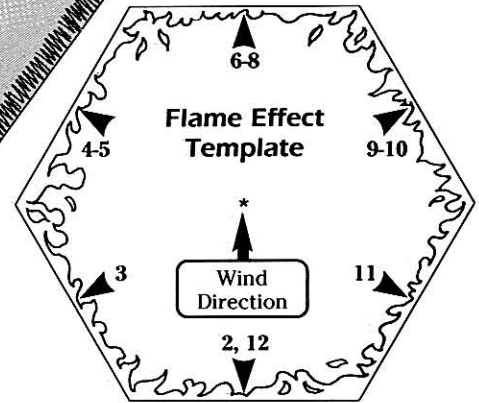
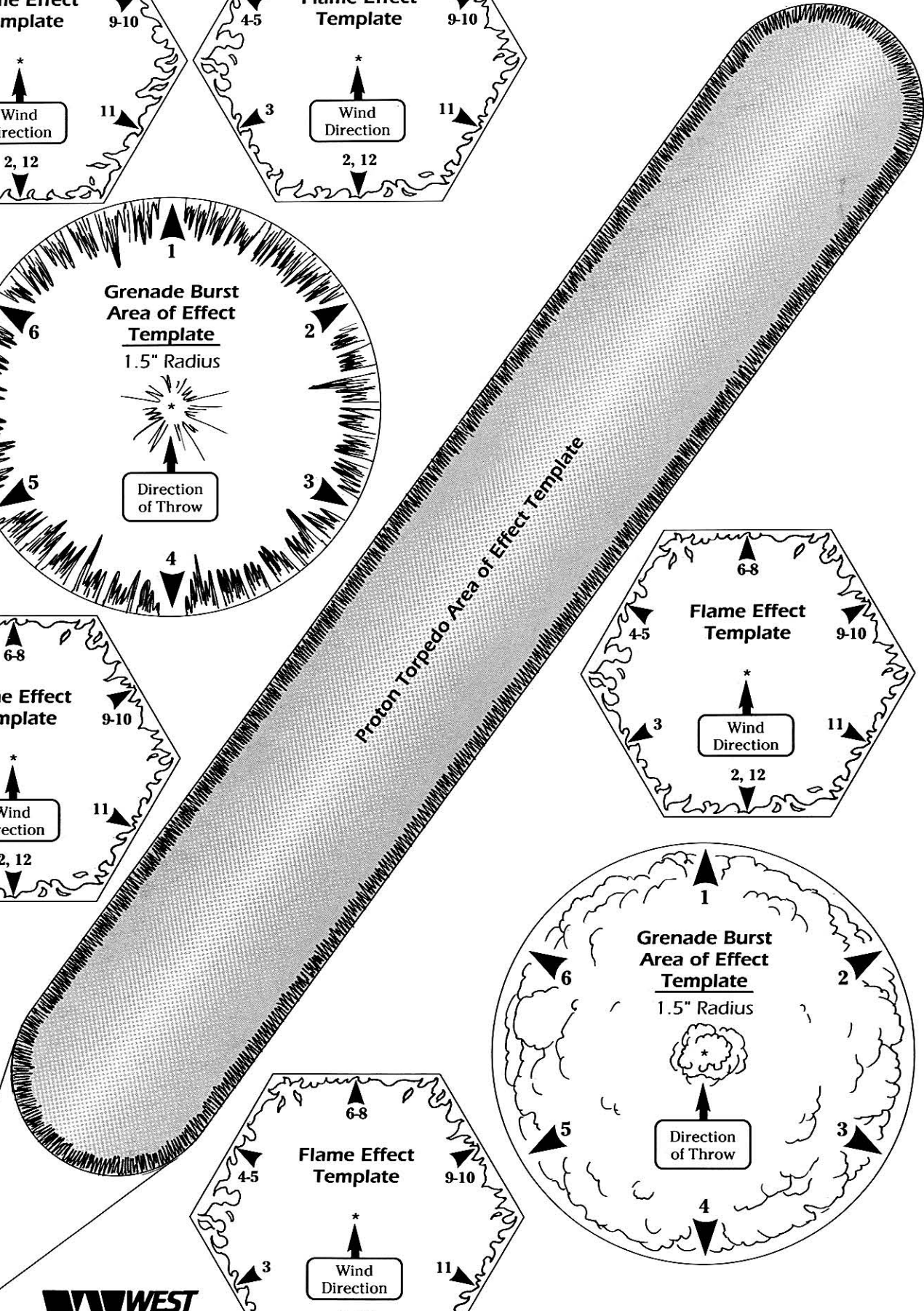
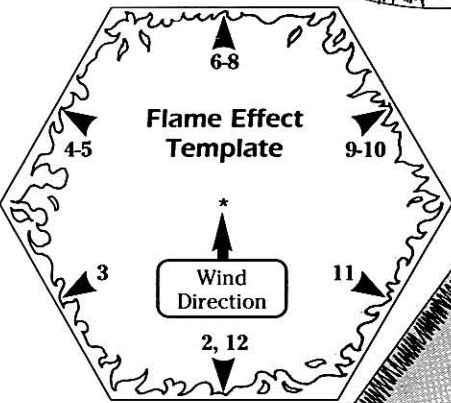
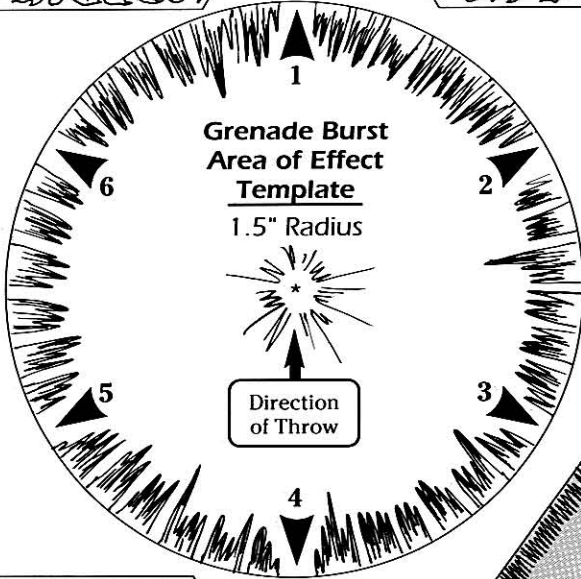
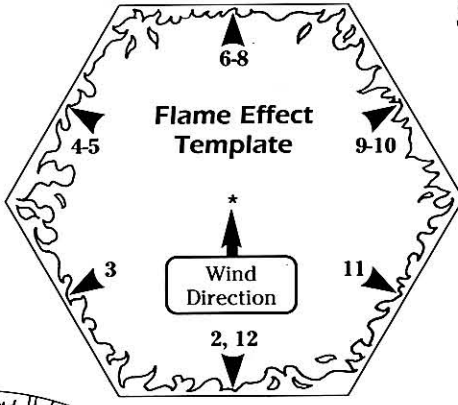
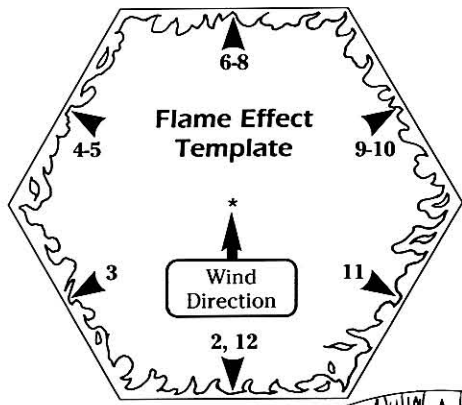

Star Wars Miniatures Battles

Templates and Markers

(Sheet 2 of 4)

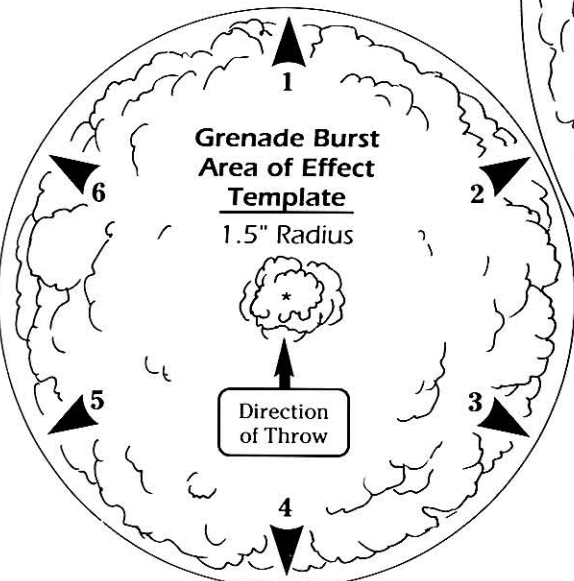
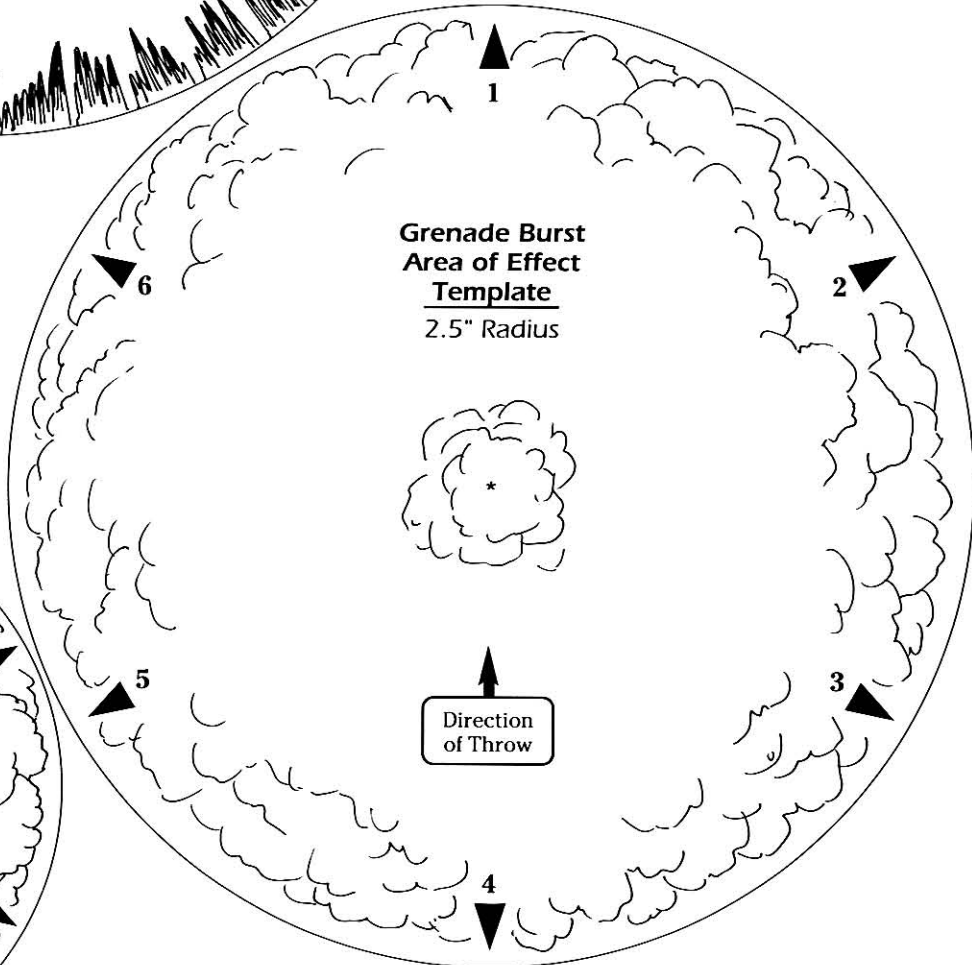
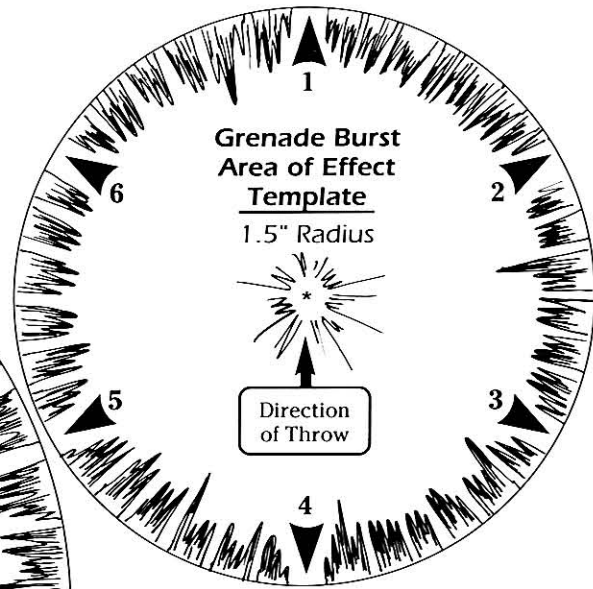
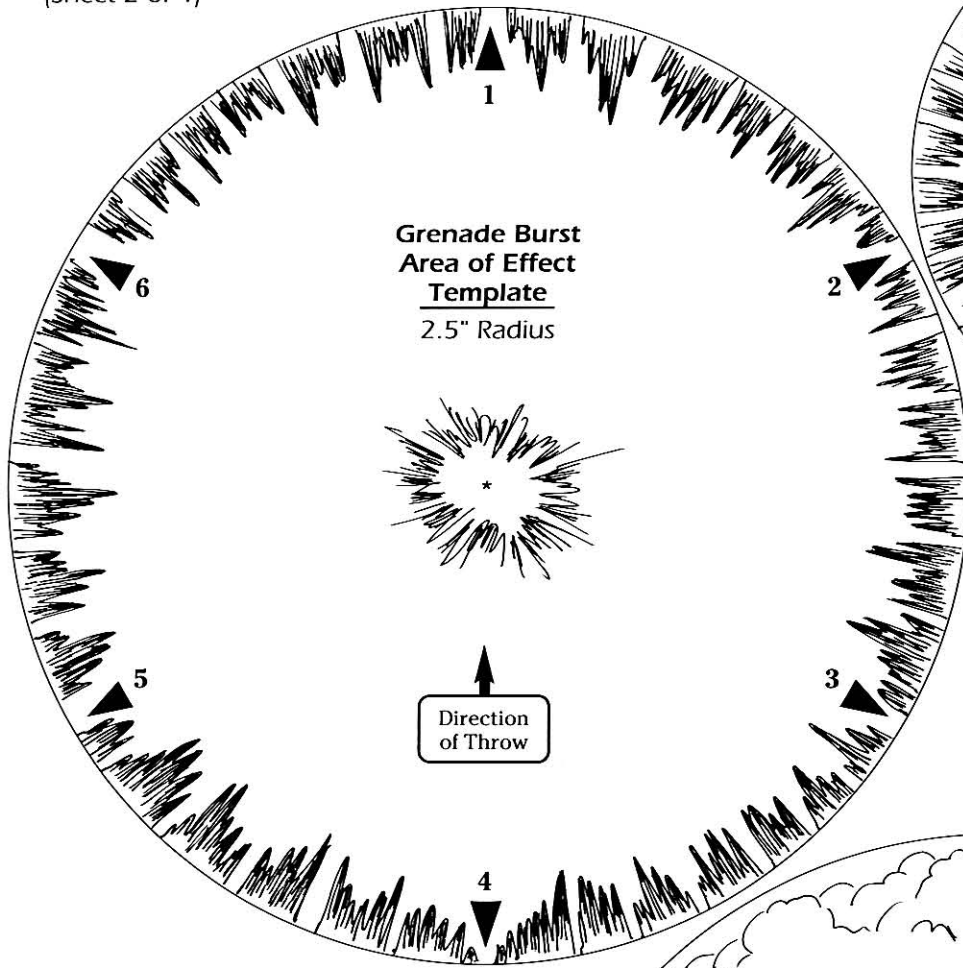

Star Wars Miniatures Battles

Templates and Markers

(Sheet 3 of 4)

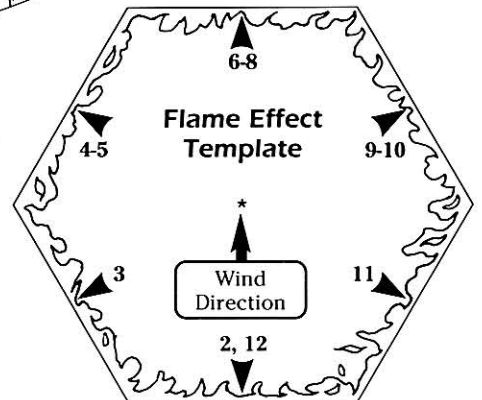
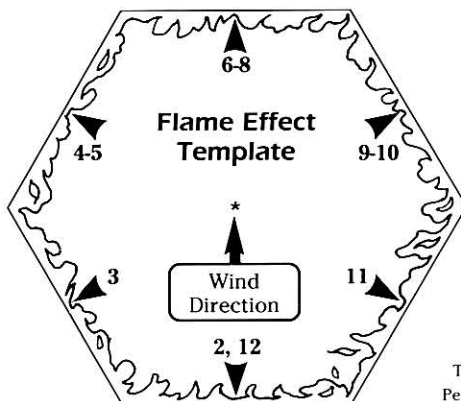
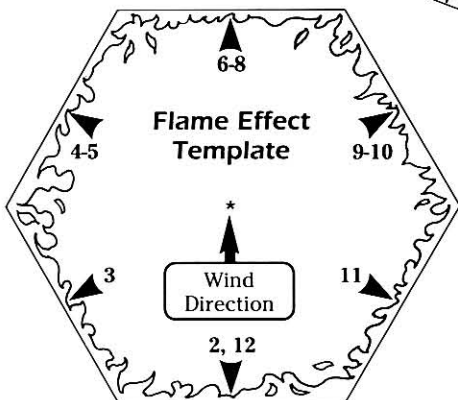
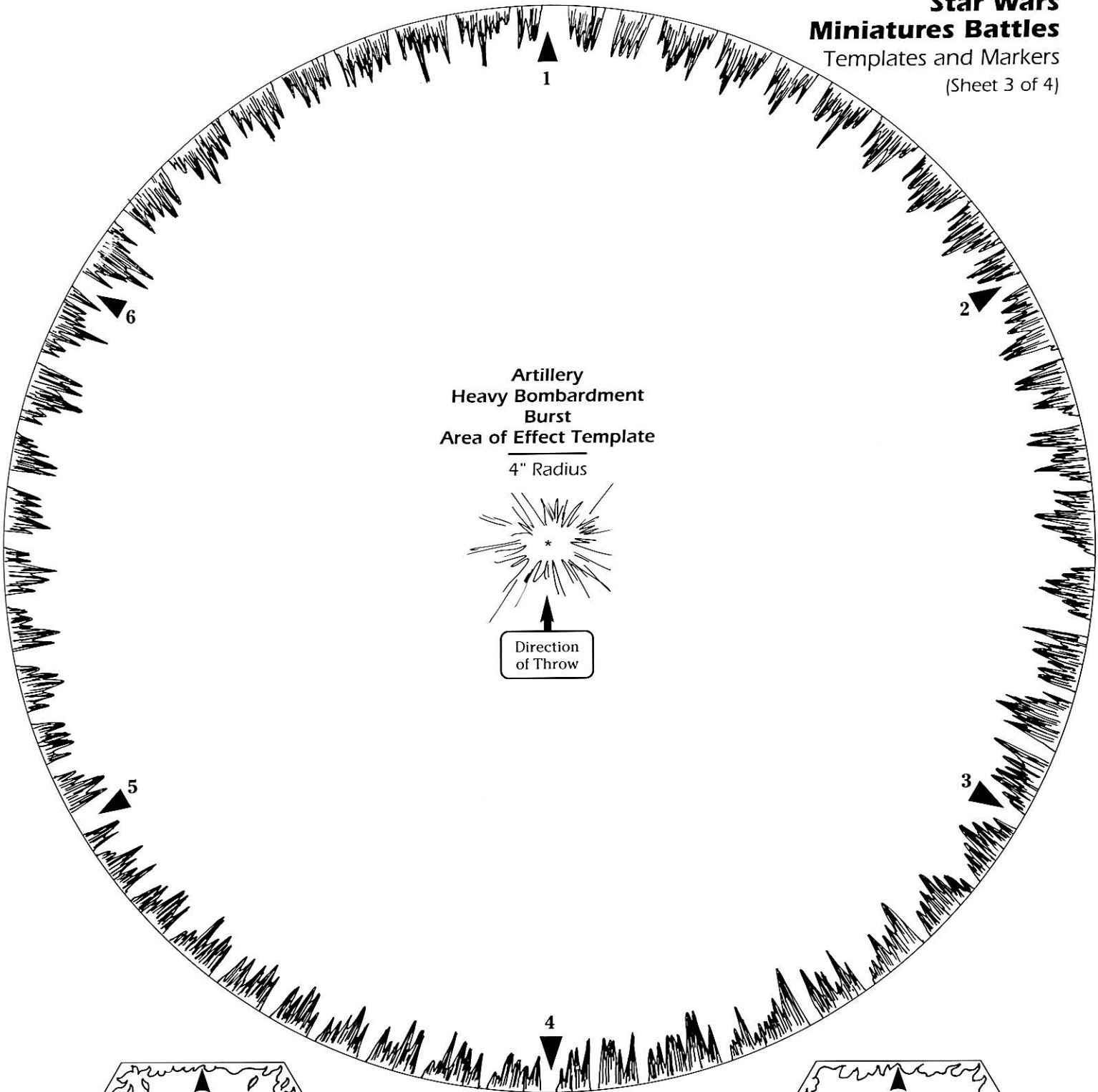



WOUND	WOUND	WOUND	WOUND	WOUND	WOUND	WOUND	WOUND	WOUND	WOUND	WOUND	WOUND	WOUND
WOUND	WOUND	WOUND	WOUND	WOUND	WOUND	WOUND	WOUND	WOUND	WOUND	WOUND	WOUND	WOUND
WOUND	WOUND	WOUND	WOUND	WOUND	WOUND	WOUND	WOUND	WOUND	WOUND	WOUND	WOUND	WOUND
WOUND	WOUND	WOUND	WOUND	WOUND	WOUND	WOUND	WOUND	WOUND	WOUND	WOUND	WOUND	WOUND
WOUND	WOUND	WOUND	WOUND	WOUND	WOUND	WOUND	WOUND	WOUND	WOUND	WOUND	WOUND	WOUND
WOUND	WOUND	WOUND	WOUND	WOUND	WOUND	WOUND	WOUND	WOUND	WOUND	WOUND	WOUND	WOUND
NO FIRE	NO FIRE	NO FIRE	NO FIRE	NO FIRE	NO FIRE	NO FIRE	NO FIRE	NO FIRE	NO FIRE	NO FIRE	NO FIRE	NO FIRE
NO FIRE	NO FIRE	NO FIRE	NO FIRE	NO FIRE	NO FIRE	NO FIRE	NO FIRE	NO FIRE	NO FIRE	NO FIRE	NO FIRE	NO FIRE
NO FIRE	NO FIRE	NO FIRE	NO FIRE	NO FIRE	NO FIRE	NO FIRE	NO FIRE	NO FIRE	NO FIRE	NO FIRE	NO FIRE	NO FIRE
NO FIRE	NO FIRE	NO FIRE	NO FIRE	NO FIRE	NO FIRE	NO FIRE	NO FIRE	NO FIRE	NO FIRE	NO FIRE	NO FIRE	NO FIRE
NO FIRE	NO FIRE	NO FIRE	NO FIRE	NO FIRE	NO FIRE	NO FIRE	NO FIRE	NO FIRE	NO FIRE	NO FIRE	NO FIRE	NO FIRE
FIRE +1	FIRE +1	FIRE +1	FIRE +1	FIRE +1	FIRE +1	FIRE +1	FIRE +1	FIRE +1	FIRE +1	FIRE +1	FIRE +1	FIRE +1
FIRE +1	FIRE +1	FIRE +1	FIRE +1	FIRE +1	FIRE +1	FIRE +1	FIRE +1	FIRE +1	FIRE +1	FIRE +1	FIRE +1	FIRE +1
FIRE +1	FIRE +1	FIRE +1	FIRE +1	FIRE +1	FIRE +1	FIRE +1	FIRE +1	FIRE +1	FIRE +1	FIRE +1	FIRE +1	FIRE +1
FIRE +1	FIRE +1	FIRE +1	FIRE +1	FIRE +1	FIRE +1	FIRE +1	FIRE +1	FIRE +1	FIRE +1	FIRE +1	FIRE +1	FIRE +1
FIRE +1	FIRE +1	FIRE +1	FIRE +1	FIRE +1	FIRE +1	FIRE +1	FIRE +1	FIRE +1	FIRE +1	FIRE +1	FIRE +1	FIRE +1
FIRE +1	FIRE +1	FIRE +1	FIRE +1	FIRE +1	FIRE +1	FIRE +1	FIRE +1	FIRE +1	FIRE +1	FIRE +1	FIRE +1	FIRE +1

STAR WARS® MINIATURES BATTLES

by Stephen Crane and Paul Murphy

Hoth, Protazk, Endor, Picutorion: trials of strength and fortitude. Outgunned and outnumbered, the valiant Rebel Alliance struggles against the forces of a merciless Galactic Empire. Do you have what it takes to lead your troops to victory and turn the tide of the Rebellion?

In *Star Wars Miniatures Battles*, you assemble your army of *Star Wars* miniatures and set forth across the tabletop to battle your foe. You pit your troops against the might of the Empire in order to rekindle the flame of the Old Republic. Or send in your stormtroopers to crush the traitorous Rebels for the greater glory of the New Order!

Now compatible with *Star Wars: The Roleplaying Game, Second Edition*.

You do not need the roleplaying game to play this game.

**A STAR WARS®
ADVENTURE GAME**

For ages 12 and up.

©, TM & © 1993 Lucasfilm, Ltd. (LFL). All Rights Reserved.
Trademarks of LFL used by West End Games under authorization.



40090

ISBN 0-87431-206-X



0 18874 40090 1