

STAR WARS®

MINIATURES BATTLES

IMPERIAL ENTANGLEMENTS



Scenarios for *Star Wars Miniatures Battles*

**WEST
END
GAMES®**

STAR WARS[®] IMPERIAL ENTANGLEMENTS

by Stephen Crane

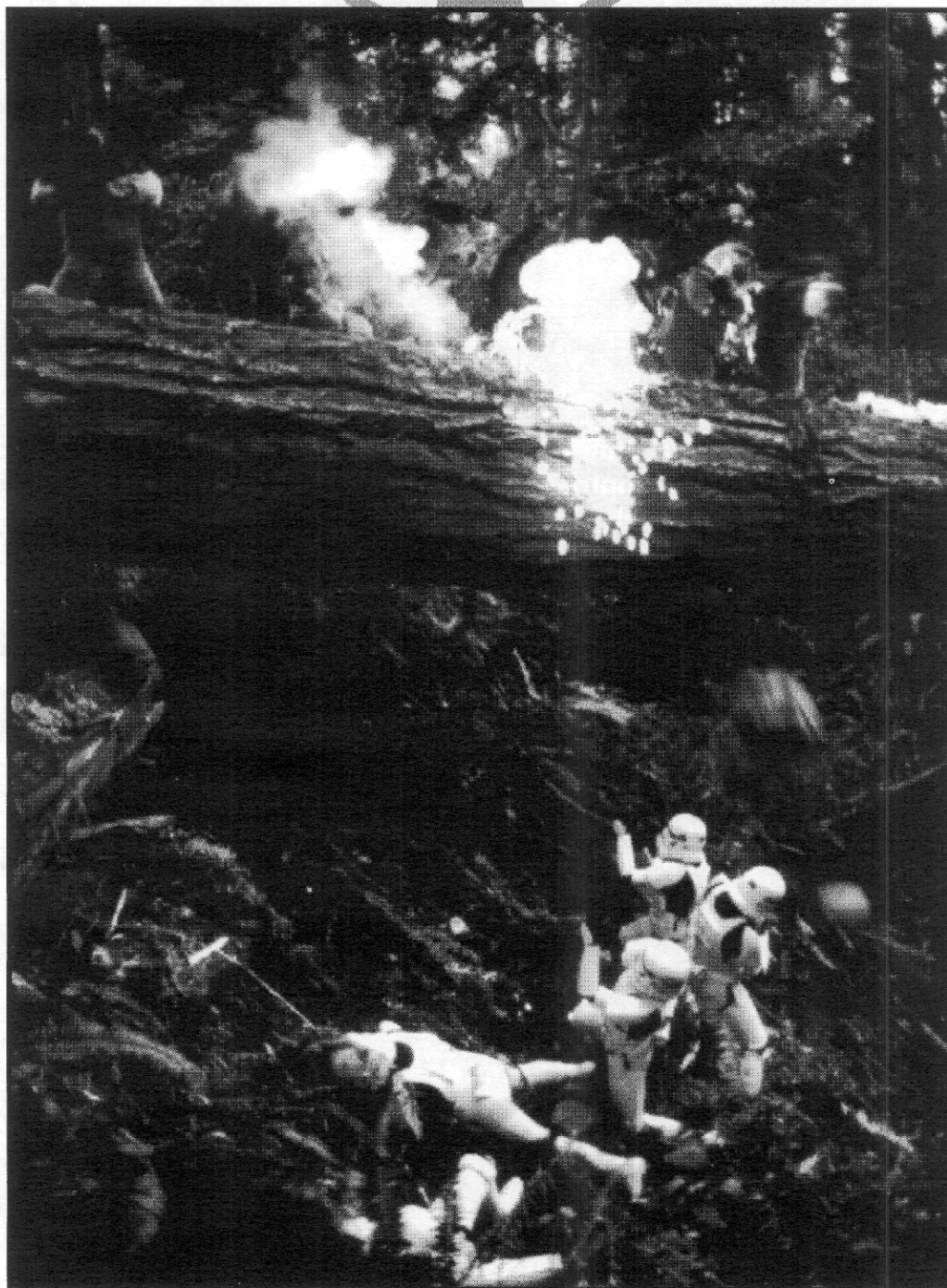

Scenarios for *Star Wars Miniatures Battles*

A long time ago in a galaxy far, far away ...

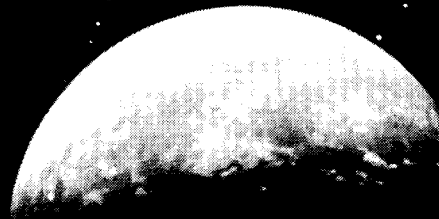

It is a time of turmoil. Even as the evil Galactic Empire seeks to crush the resistance of the Rebel Alliance, other battles rage on. Different factions pursue their own agendas, and their actions flare up into open conflict.

Against the backdrop of Empire versus Rebellion, pirates, scavengers, bounty hunters, gangs and criminals wage their own wars, seeking to gain the upper hand through force of arms.

Their ambitions know no bounds, often pitting their might against that of Imperial and Rebel adversaries. And as the balance of power shifts from Empire to New Republic, the strife continues, perhaps inflamed by the looming threat of renewed Civil War ...

STAR WARS®

IMPERIAL ENTANGLEMENTS

Scenarios for *Star Wars Miniatures Battles*

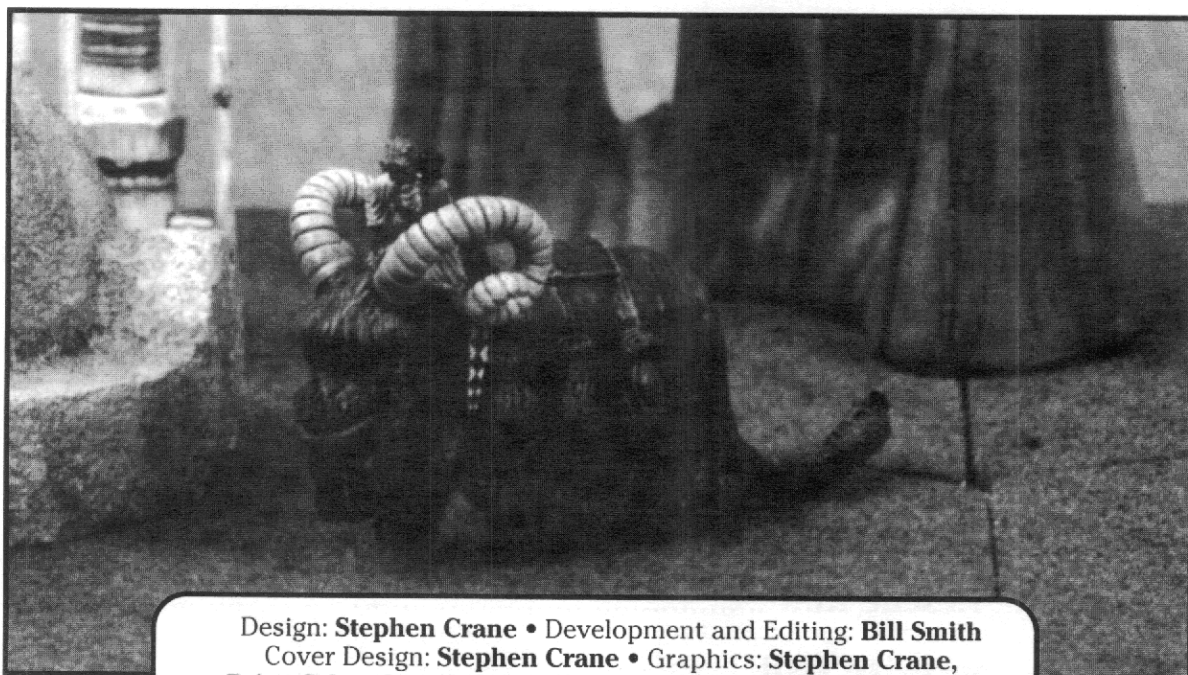

Design: **Stephen Crane** • Development and Editing: **Bill Smith**
Cover Design: **Stephen Crane** • Graphics: **Stephen Crane,**
Brian Schomburg • Cover Photograph: **Lucasfilm Ltd.** • Interior
Photographs: **Stephen Crane** • Terrain System and Custom
Scenery: **Geo-Hex** • Figure Painting: **Stephen Crane, Bill Refsland,**
Linda Robertello, Brian Schomburg, T.G.W.P., Jay Wirth

Publisher: **Daniel Scott Palter** • Associate Publisher/Treasurer: **Denise Palter**
Associate Publisher: **Richard Hawran** • Senior Editor: **Greg Farshtey**
Editors: **Peter Schweighofer, Bill Smith, George Strayton, Paul Sudlow, Eric S. Trautmann**
Art Director: **Stephen Crane** • Graphic Artists: **Tim Bobko, Tom O'Neill, Brian Schomburg**
Sales Manager: **Jeff Kent** • Licensing Manager: **Ron Seiden** • Warehouse Manager: **Ed Hill**
Accounting: **Karen Bayly, Wendy Lord** • Billing: **Amy Giacobbe**

Published by



RD3 Box 2345
Honesdale PA 18431

40127

C O N T E N T S

Introduction	5
Rules Clarifications and Upgrade	8
Scenario One: Big Game	12
Scenario Two: Terror in the Trees	26
Scenario Three: Hammer of Destiny	35
Scenario Four: A Bazaar Encounter	44
Scenario Five: To Hunt the Hutt	51
Scenario Six: Who Goes There?	58
Scenario Seven: Scavenger Hunt	66
Scenario Eight: Rescue Run	73
Scenario Nine: Surprise Visit	80
Troop Lists	85
Photo Credits	94

Introduction

This book is a collection of scenarios for use with the *Star Wars Miniatures Battles* rules system, which consists of the original *Star Wars Miniatures Battles* rulebook and the expansion volume, the *Star Wars Miniatures Battles Companion*.

Imperial Entanglements provides you with the chance to test your tactical prowess, and to give you a taste of the types of conflict that can arise in that galaxy far, far away, with a number of new scenarios dealing with various aspects of the Galactic Civil War, including disputes involving the soldiers of the New Republic.

Conflict is not reserved for just the Empire and the Alliance. The scenarios in this book cover a wide range of situations, and involve such diverse other groups as criminals, scavengers, bounty hunters and even native creatures. They also allow you to explore the tactical considerations of battles which occur in exotic environments, such as a forest canopy, a lava plain, or the floor of an impenetrable jungle.

For those of you who like to remain close to the heart of the *Star Wars* universe, many of the scenarios also involve familiar aliens, including Jawas, Hutts and Ewoks. And, of course, the Empire goes head-to-head with the Rebel Alliance in a number of disputes.

But *Imperial Entanglements* is not just scenarios. Also in this volume, you will find many snippets of new material. There are new rules for special occasions, new items of equipment, and new ideas for staging games and setting up science fiction battlefields. This information is scattered throughout the background material of each of the scenarios.

New equipment that is described in this book will include among its stats the item's Encumbrance Value. Encumbrance is an optional rule (described on pages 37–39 of the *Star Wars Miniatures Battles Companion*), but these values are included for those players who wish to incorporate it into their games.

Some new unit insignia and symbols are pre-

sented. Where they are described, they will also be shown in a color designation form using cross-hatched lines (presented on page 49 of the *Companion* and reprinted here), and in outline form so that they can be copied and colored. Permission is hereby granted to photocopy emblems, symbols, unit insignia, and game markers, as well as set-up maps, for personal use only.

Rules Upgrade

The section entitled “Rules Clarifications and Upgrade” explains and clarifies any rules ambiguities and oversights that have come to our

Color Designation

Quite naturally, most of the symbols and emblems in use are displayed in various colors. As it is impossible to show colors in a black-and-white book such as this, we have used the following system of cross-hatched lines to represent the different colors comprising the emblems provided in this book.

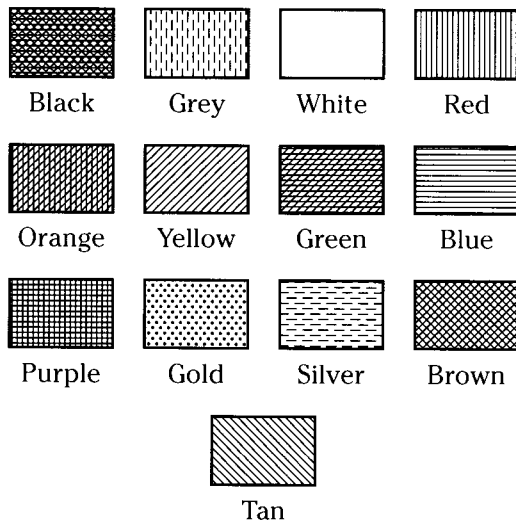



attention since the publication of the *Star Wars Miniatures Battles Companion*. Items discussed are presented in the order in which they appear in *Star Wars Miniatures Battles* and the *Star Wars Miniatures Battles Companion*.

The Scenarios

These are, of course, the bulk of the book. Each is a stand-alone scenario, some allowing you to test the mettle of valiant Rebels against the iron will of the Imperial juggernaut, and others dealing with the seamier side of the galaxy. There is also a solitaire scenario ("Big Game"), for those times when opponents are hard to come by.

Each of the scenarios in this book are presented in a standard format. The particulars of that format are:

The Situation: This explains the background leading up to the battle. It sets the stage for the coming conflict and explains what each side hopes to achieve.

The Forces: The squads, heroes, creatures, droids and/or vehicles which are involved in the battle. In most cases, specific squads are called for, and the name, troop type, skills, weapons, commander, specialists and the point value of those squads are listed. Otherwise the points available

to each side are listed, as well as any restrictions or special instructions as to what forces may or may not be used.

The Battlefield: A description of the terrain over which the battle will be waged. This is accompanied by a set-up map detailing the table layout and the entry positions of the forces involved.

The Set-up: The initial disposition and/or entry conditions for setting up the forces on the tabletop at the beginning of the game are described here. Also described in this section are instructions for any special conditions which may apply at the outset of the game, and the procedures for bringing reinforcements onto the table, if applicable.

Gamemaster Notes: This section covers special situations or conditions affecting the battle, and explains the victory conditions — how to determine the winner. This section may also contain suggestions for appropriate figures, or painting guides for some of the figures involved.

Most of the set-up maps show a 4'x5' table set-up. You should not feel limited by that size. You can use a bigger table, or a smaller one if space is a constraint. Generally it is only necessary to move some of the terrain elements around or change the relative positions of any objectives. Most battles will work quite well with a different-sized table.

The majority of the scenarios in this book detail the forces involved in the battle. Part of the squad's listing is the type of soldiers the squad consists of. Remember that the titles of the troop types are intended as a quick summary of the kind of soldier represented by the listing, not as an absolute description of the figure. For instance, Hoth Troopers (presented in the Troop Lists in *Star Wars Miniatures Battles*) refers not just to soldiers who were veterans of that posting, but also to soldiers who are of the quality of that type of trooper. So if the Troop Type on the Squad Record Sheet is described as "Hoth Troopers," you do not have to use the *Hoth Troopers* figures wearing the snow uniforms (which might look a bit odd if used in a jungle or a desert battle). You may use any type of Rebel figure — they just happen to be as good as the typical Hoth trooper.

There are also very few heroes provided in these scenarios. That is because the actions presented here revolve around the rank-and-file troops. Heroes are a part of the Galactic Civil War, but most line troops never get sight of one. However, if you like to play with heroes, or intend to incorporate one of these scenarios into your

roleplaying game so that your player characters may be involved, it is a simple matter to add them to the force mixes already furnished. Give each player an additional 200–250 Squad Generation Points to create a hero with, or use that amount to prepare some heroes before the game for the players.

After choosing a scenario to run, the gamemaster should prepare for the game by reading it thoroughly in order to become familiar with all of the details and special rules of the scenario. It will also be necessary to gather the figures needed and prepare the terrain for the game. Any special markers, counters or other props should also be readied before the game, so that when the players arrive, the game is set to begin.

Credits

The "Photo Credits" section provides information on the figures and terrain shown in the photographs in this book. It is hoped that this will generate new ideas for you and spark your creativity so that your hobby becomes even more engaging and enjoyable.

Rules Clarifications and Upgrade

All rules-intensive battle games, including *Star Wars Miniatures Battles*, have a few oversights and ambiguities. As in the past, we will attempt to correct or clarify any inaccuracies or omissions whenever possible. If you should come across any part of the rules that needs such attention, please write to West End Games and let us know the details.

Items discussed are presented in the order in which they appear in *Star Wars Miniatures Battles* and the *Star Wars Miniatures Battles Companion*.

Miniature Figures and Base Size

On page 6 of *Star Wars Miniatures Battles*, it is stated that the figures used in the game be mounted on 1-inch bases. This is the standard size for most soldiers and other beings, but as mentioned in the "Creatures" chapter, the base size for some figures may be larger or otherwise vary in size. Given the variety of species in the galaxy, there are also many smaller beings that may be involved in a game. A 1-inch base may be too large for those beings, and give them a much larger zone of control than their size would actually allow.

Therefore, the basic rule of thumb is that human-sized beings or creatures should be mounted on 1-inch diameter bases. However, beings or creatures that are half human-sized or smaller (such as Jawas, Ewoks, or Noghri) should be mounted on smaller, 3/4-inch-diameter bases. This will better simulate the fact that smaller beings can be grouped more closely, or may find it harder to prevent larger beings from passing through their ranks. And creatures or beings larger than human-sized should still be mounted on bases that are large enough to accommodate them, with horse-sized creatures being mounted on bases that are one inch by two inches.

A Note About Scale

In *Star Wars Miniatures Battles*, we use a ground scale of one inch represents two meters. This

rule is a simplification of the actual scale and is intended to make movement and other measurements simpler and easier to perform.

In terms of the miniatures, though, the scale for 25 mm figures (25 mm = 1") is generally assumed to be 1 inch = 6 feet, so that one inch really only represents 1.8 meters. This scale is actually 1/72, a common scale used for model kits of military vehicles. We recommend that when you are building accessories for your game, or just for your miniatures, that you use this scale. Even though the ground scale is slightly smaller, your buildings and vehicles will be seen in relation to your figures, and should be proportioned accordingly for the best effect.

To further complicate the issue, most 25 mm figures tend to be slightly larger than their scale would indicate (due to factors involved in producing and casting small models). This is why many figures look a touch too large when used with 1/72 scale model accessories. *Star Wars* miniatures are no exception. Many of these figures are a little larger than 25 mm. Based on our existing figures, we have determined that the average six-foot-tall being stands 27.6 mm from base of foot to top of head. This gives a ratio of 1 inch = 1.63 meters. Future *Star Wars* miniatures will adhere to this scale so as to be compatible with the wide range of figures that are already available.

Opportunity Fire and Fire Combat

Soldiers which are incapacitated during the Fire Combat Phase are not removed from the table until after all fire combat is resolved, as all fire is considered to take place simultaneously. Even though a figure is incapacitated, it has the chance to fire back.

A figure which is incapacitated due to opportunity fire, though, is removed from the table during its squad's movement, and does not get the chance to fire in the Fire Combat Phase.

Casualties

A casualty morale test must be made by a squad which has suffered casualties in the current turn. A casualty is a figure which has been wounded or incapacitated.

Already-wounded soldiers do not trigger casualty morale tests in later turns unless they receive a new "Wound" result.

Casualty Morale Test Modifiers

The threat level of a casualty morale test is increased by one for each soldier in a squad that is wounded or incapacitated in the current turn (as described on pages 32–33 of *Star Wars Miniatures Battles*). If the squad's commander is wounded or incapacitated in a turn, the threat level is increased by two. The +2 modifier for a wounded commander is not in addition to the basic modifier, but rather includes the standard +1 modifier for a casualty. So if the commander is wounded or incapacitated, the threat level is only modified by +2 due to the commander's injuries, *not* +3.

Difficulty Numbers

In the "Creating Alien Heroes" section on page 10 of *Star Wars Miniatures Battles Companion*, it was stated that the special abilities which some alien species might have could be adapted to *Star Wars Miniatures Battles* by converting the die codes to number values and considering an "Easy" difficulty in the roleplaying game to be difficulty 4 in *Miniatures Battles*, "Moderate" difficulty to be difficulty 6 and "Difficult" to be 8. These numbers were slightly off, however. The correct classifications are as summarized in the following chart.

Task Difficulty (Roleplaying Game)	Difficulty Number (Miniatures Game)
Very Easy	4
Easy	6
Moderate	8
Difficult	10
Very Difficult	12
Heroic	16

Note that this does *not* affect the base difficulties of fire combat. The difficulty numbers remain the same for short, medium and long range. It is just the classification of those numbers that has changed.

Wounded Drivers

Drivers in vehicles that provide less than total cover may be wounded by fire directed at the craft (see page 14 of *Star Wars Miniatures Battles Companion* for details). If the driver of a vehicle is wounded, he must make a difficulty 10 skill test against the appropriate vehicle operation skill (*repulsorlift operation, ground vehicle operation,*

or hover vehicle operation) to see if he retains control of the vehicle. If he fails the test, the vehicle goes out of control in the following Movement Phase. In successive Movement Phases the driver may attempt to regain control of the vehicle in the normal manner (page 26 of the *Companion*).

The Aurebesh

On page 50 of the *Star Wars Miniatures Battles Companion*, we presented an alphabet for the *Star Wars* galaxy. While there are many alphabets (as well as languages) in use in a galaxy-spanning civilization, some standards have developed to facilitate communication. One such alphabet is the Aurebesh, which is in common use by the military and various commercial concerns.

The Aurebesh has proven to be a popular feature of the *Star Wars* milieu, with many fans and players using it in various ways. However, as presented, the Aurebesh is limited in its application. While it works for unit designations and the names and logos of organizations, companies and other institutions, it is not complete enough to be used in a more widespread manner.

Therefore, we have extended the character set of the Aurebesh, in order to make it more versatile. In the accompanying diagram you will find the expanded Aurebesh, which now includes the more common punctuation marks, allowing you to employ this alphabet in a variety of different applications.

Vehicle Weapon Ranges

In the "Vehicle Weapon Chart" (page 87 of *Star Wars Miniatures Battles Companion*), the statistics for the various weapons are summarized. These stats correspond to those provided in the "Weapon Chart" for hand-held weapons, with the addition of the Fire Control value which is applicable to most vehicle-mounted weapons.

The major difference in the listed stats is that the short range for each of the weapons is presented as a range, with a low end and a high end. This was never explained, although those of you already familiar with *Star Wars: The Roleplaying Game* may have figured out what it was.

When the short range is listed as a spread, any range below the lower number is *point-blank* range. The base difficulty for a vehicle weapon firing at a target at point-blank range is 4.

Some vehicle weapons will have four ranges listed: point-blank, short, medium and long range. In this case, any range lower than point-blank range is so short as to make it extremely difficult for vehicle weapons to hit: the base difficulty for firing at less than point-blank range is 12. (There are no examples of these weapons in this supplement, but this rule is included for future reference.)

The Aurebesh



Aurek
(a)



Besh
(b)



Cresh
(c)



Dorn
(d)



Esk
(e)



Forn
(f)



Grek
(g)



Herf
(h)



Isk
(i)



Jenth
(j)

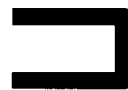

Krill
(k)



Leth
(l)



Mern
(m)



Nern
(n)



Osk
(o)



Peth
(p)



Qek
(q)



Resh
(r)



Senth
(s)



Trill
(t)



Usk
(u)



Vev
(v)



Wesk
(w)



Xesh
(x)



Yirt
(y)



Zerek
(z)



Cherek
(ch)



Enth
(ae)



Onith
(eo)



Krenth
(kh)



Nen
(ng)



Orenth
(oo)



Shen
(sh)



Thesh
(th)



(,)



(.)



(?)



(!)



(:)



(;)



(-)



(/)



(')



(')



(")



(")



((



)

Note: Horizontal lines are provided to show position of marks relative to top edge and baseline of letters.

Example: A Mk 1/S Heavy blaster cannon has listed ranges of 20–50/375/750 (in inches). Therefore any targets less than 20 inches away are at point-blank range and have a base difficulty of 4.

If a weapon's range listing had four ranges — for example 10–25/100/250/500 (in inches) — that would mean that point-blank range is 10–25 inches. Any targets 10–25 inches away have a base difficulty of 4. Any targets less than 10 inches away are at less than point-blank range and have a base difficulty of 12.

Many vehicle weapons, by design, are longer-range weapons. It is more difficult to aim at and accurately hit nearby targets with a large-scale weapon of this sort.

Landspeeder Windscreen

The metal miniature of the landspeeder (available in the *Landspeeder* pack, #40501) includes a windscreen, but, while accurate, the fact that it is cast in metal makes it look much heavier than it should be.

The following pattern is provided so that you can attach a more “realistic-looking” windscreen to the landspeeder if you like. You will need some clear acetate and the windscreen pattern (although a photocopy of the pattern would be better). You can purchase acetate sheets in an art supply store.

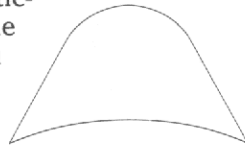

Hold the copy of the pattern in position on the clear sheet and transfer it to the acetate by sticking a pin through the pattern in various places along the edge. Using the series of pin holes as a guide, cut out the the acetate shape. You can now glue the thinner, clearer windscreen into place on your landspeeder.

Storm Skimmer

Around the time of the release of *Star Wars Miniatures Battles Companion* — and the rules for vehicles contained therein — West End Games came out with a number of 25mm metal vehicle miniatures. The Imperial Storm Skimmer was the only vehicle miniature not to have its statistics listed on the “Vehicle Chart.”

The stats for the skimmer could be ascertained by looking up the roleplaying stats in the *Dark Empire Sourcebook* and using the conversion information on pages 27–28 of the *Star Wars Miniatures Battles Companion*. But for those of you who do not have access to the *Dark Empire Sourcebook*, the miniatures game statistics of the Storm Skimmer patrol sled are presented here (for a more detailed description of the skimmer and its background, see page 118 of that *Sourcebook*).

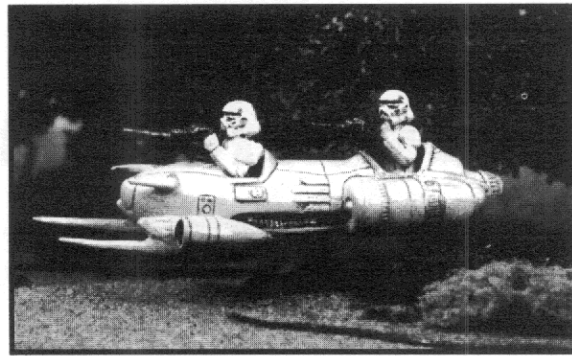

The miniature is in the *Storm Skimmer* pack, #40504, and comes with two stormtrooper crewers. While the storm skimmer is used primarily by the Empire, it would not be unlikely to see captured skimmers in use by Rebel forces. And even though the skimmer was first introduced in a New Republic–era product, it is an older vehicle that has been around for some time and so can be used in Classic-era battles.

■ Storm Skimmer

- **Drive System:** Repulsorlift.
- **Crew:** 2.
- **Passengers:** 0.
- **# Turns:** 2.
- **Turn Distance:** 3.
- **Move:** 150.
- **Cautious Speed:** 15.
- **Cruise Speed:** 45.
- **Top Speed:** 150.
- **Accel/Decel:** 15/15.
- **Flight Ceiling:** 15 km (Level 1500).
- **Body Strength:** 4.
- **Body Points:** 40.
- **Cover:** 5.
- **Weapons:**

Heavy Repeating Blaster (36 SGPs)

Fire Arc: F.
Skill: Vehicle blasters.
Fire Control: 1.
Range: 3–75/100/250.
Damage: 10.
Notes: Mounted in front; can be fired by driver; following fire.

Heavy Repeating Blaster (36 SGPs)

Fire Arc: LFR.
Crew: 1
Skill: Vehicle blasters.
Fire Control: 1.
Range: 3–75/100/250.
Damage: 10.
Notes: Mounted in back; fired by gunner; following fire.

- **Squad Generation Points:** 202.

Note that stormtroopers’ armor provides a sealed environment, and they can pilot the skimmer to its highest altitude. Rebels or others attempting to go that high would need to be equipped with some sort of pressure suit. This does not normally affect skimmers in a miniatures battle since Level 6 (60 meters) is generally the highest altitude permitted in the game.

Scenario One

Big Game

“Big Game” is a solitaire scenario for *Star Wars Miniatures Battles*, although it can also be played by two or more players. While it is designed for just one player, this scenario provides even more excitement if a gamemaster is available to run it for the player. That way many of the surprises will remain surprises until they are revealed, and thereby have a greater effect.

The Situation

Halor Dinnoral is a retired and extremely wealthy corporate exec with a penchant for hunting and collecting exotic wildlife. He maintains a vast network of contacts, through which he seeks information which will lead him to the next big thrill.

Dinnoral has recently received word about a promising situation. A free-trader known to one of his acquaintances was recently forced into an uncalculated hyperspace jump while trying to evade a rather large and nasty space slug. His jump brought him out near an uncharted system far from any established spacelanes. He has reported a world teeming with animal life in a wide variety of forms. Some of these life-forms proved to be quite large and of an extremely vicious disposition.

Having heard more than enough to pique his interest, Dinnoral has hired a team of adventurers to accompany him on his latest expedition. The hired muscle is there to do his dirty work (he is not quite the fearsome hunter he would have others believe), and to protect him from the dangers of the trip. Dinnoral’s objective is to capture as many new creatures as possible, so as to increase the uniqueness of his personal “zoo.”

The group’s shuttle drops them off on the fourth planet of the system and the hunt begins. Dinnoral is not quite sure what will be encountered, but he’s hoping for something impressive to display in his animal compound, or, failing that, on his wall.

The Forces

It is human against nature here. The player’s forces are the small hunting party assembled by Halor Dinnoral. Arrayed against them are the creatures of the planet (or at least of the area of the planet where the party chose to set down).

The Hunters

The player has 500 points to create a team of four or five adventurers. One of the adventurers may be a hero, but may not be worth more than 200 points. Each of the adventurers may be created with a different mix of attributes and skills; in effect, each is a 1-person squad.

In addition to the adventurers, the party contains Halor Dinnoral. Dinnoral’s vital statistics are given below.

■ Halor Dinnoral

- Veteran Corporate Exec.
- DEX 3, *blaster* 4, *missile weapons* 4; KNO 3, *survival* 4; MEC 2, *repulsorlift operation* 4; PER 4, *command* 5, *sneak* 5, *search* 6; STR 3, *bravling* 4; TEC 2, *first aid* 4; Move: 10.
- **Walk Rate:** 8"; **Run Rate:** 13".
- **Weapons:** Blaster rifle, heavy blaster pistol.
- **Squad Generation Points:** 72.

The Creatures

The opposing forces are the creatures of the planet. They are described in a general manner — according to their ecological niche — since the availability of figures varies widely. You may use whatever figures you might have to represent the creatures. Since this is an uncharted world populated by as yet unknown and unnamed creatures, you can’t be wrong.

The dearth of science fiction animal miniatures is a limiting factor, but with a little creativity that limit can be overcome. There *are* some creatures available. If you can find some or you already have something suitable, using the same miniatures, but with some of them painted in different color schemes, is one way to represent different kinds of creatures.

Another option is to look around for fantasy

creatures — there is no lack of monsters available. You will need to be judicious in your choices, as some fantasy monsters just don't have the right look for a science fiction game, but there are still quite a few fantasy creatures on the market that can double as science fiction creatures.

You can also look in toy stores for plastic or rubber toy animals. You may be able to find some science fiction or fantasy beasts on the shelves, or you can look for toys based on real animals and then modify them.

Also, be creative in the way you look at figures. A particular miniature or toy may not necessarily be designed as an animal, but looked at with a different viewpoint, and aided with a little modification or even just a different paint job, it can become some sort of creature. For instance, there are a number of organically-derived starfighter and spaceship miniatures available, which, while sculpted for a much smaller scale, can work as 25mm creatures.

The following creatures may be encountered in this game. See the "Gamemaster Notes" below for the method of determining which creatures show up. How the creatures behave and how they react to the hunters is also covered in the notes.

■ Grazing Herbivore

- **DEX:** 4.
- **STR:** 3.
- **PER:** 3.
- **Move:** 10.
- **Movement Rate:** 14.
- **Orneriness Code:** 4.
- **Attack Forms:** hoof* (STR+2).
- **Squad Generation Points:** 25.

* Equivalent to "claw" attack.

■ Grazing Omnivore

- **DEX:** 2.
- **STR:** 3.
- **PER:** 2.
- **Move:** 9.
- **Movement Rate:** 11.
- **Orneriness Code:** 5.
- **Attack Forms:** horn (STR+1), hoof* (STR+2).
- **Squad Generation Points:** 50.

* Equivalent to "claw" attack.

■ Pack-Hunting Predator

- **DEX:** 3.
- **STR:** 3.
- **PER:** 3.
- **Sneak:** 5.
- **Move:** 13.
- **Movement Rate:** 16.
- **Attack Forms:** bite (STR+2), claw (STR+1).
- **Squad Generation Points:** 66.

■ Avian Insectivore

- **DEX:** 3.
- **STR:** 2.
- **PER:** 2.
- **Move:** 21/4*.
- **Movement Rate:** 24/7*.
- **Attack Forms:** claw (STR+1).

- **Squad Generation Points:** 31.

* The first value is the creature's flying movement; the second is its walking movement.

■ Avian Predator

- **DEX:** 4.
- **STR:** 3.
- **PER:** 2.
- **Move:** 16/1*.
- **Movement Rate:** 20/5*.
- **Attack Forms:** bite (STR+2), tail (STR+2).
- **Squad Generation Points:** 70.

* The first value is the creature's flying movement; the second is its walking movement.

■ Arboreal Omnivore

- **DEX:** 4.
- **STR:** 2.
- **Brawling:** 3, *climbing/jumping* 4.
- **PER:** 2.
- **Move:** 12/6*.
- **Movement Rate:** 16/10*.
- **Attack Forms:** claw (STR+2).
- **Squad Generation Points:** 27.

* The first value is the creature's movement through the trees; the second is its movement on the ground.

■ Amphibious Predator

- **DEX:** 1.
- **STR:** 5.
- **Swimming:** 6.
- **PER:** 2.
- **Move:** 15/8*.
- **Movement Rate:** 16/9*.
- **Attack Forms:** bite (STR+2).
- **Squad Generation Points:** 31.

* The first value is the creature's movement in water; the second is its movement on land.

■ Carrion-Eating Insect Swarm

- **DEX:** 3.
- **STR:** 1.
- **PER:** 3.
- **Move:** 30.
- **Movement Rate:** 33.
- **Attack Forms:** bite (STR+5)*.
- **Squad Generation Points:** 43.

* The bite of an individual insect does *Damage* equal to its strength, but the swarm's cumulative effect is *Damage* 6.

The Battlefield

Dinnoral has chosen an area of the planet located in the temperate zone. This stretch of land has a lot of different features, and therefore the potential for a wide variety of life-forms. The clear areas on the map are grasslands. The native growth is short and regular, so the terrain is considered clear. To the south grows a taller species of grass, standing about waist-high. Movement through the tall grass costs double the Movement Rate — it is rough terrain.

Near the center of the table is a pond or small lake, which should be at least 12" in diameter and roughly circular. It is shallow near the shore but drops down precipitously near the center. Up to 3" from the shore the water is knee-high and counts as rough terrain. Any figure walking into the pond more than 3" from the shore suddenly

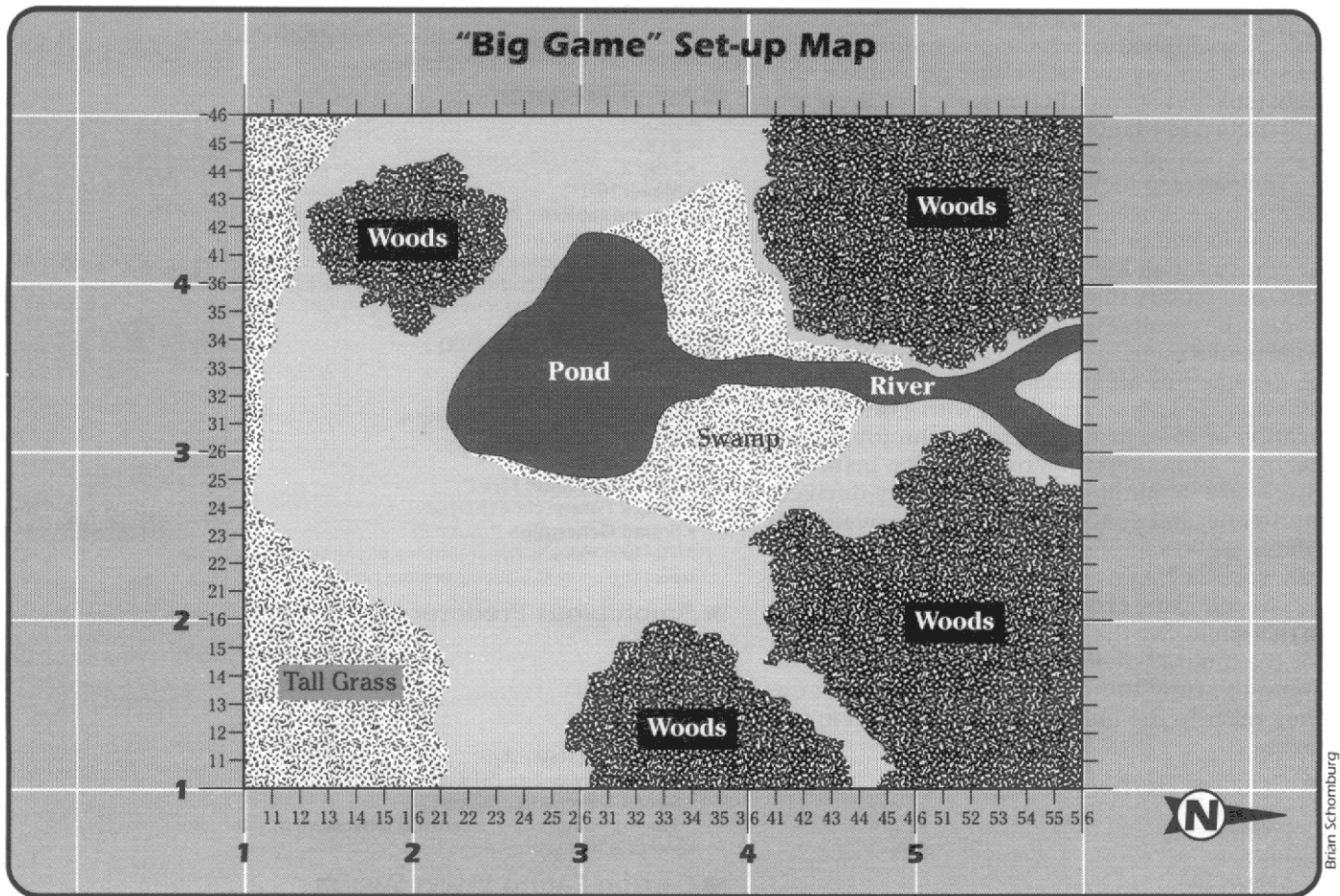

Brian Schomburg

drops down into the deeper water. The hunter must make a *swimming* or *Strength* test against a difficulty of 8 to swim back to the surface and get back to the shallow edge. If the hunter beats the difficulty number, then he is placed back in the 3" band of shallow water adjacent to the point where he fell in. However, unless he beats the difficulty number by four or more, he has lost his primary weapon (any other weapons are assumed to be holstered or sheathed and are retained). If he fails the test, the hunter drowns.

A stream runs from the north edge of the table to the pond. It is 4" wide and only knee-deep. It is rough terrain. The stream is easy-flowing and does not otherwise affect movement. A hunter who is wounded and falls prone in the stream must make a *Strength* test with a difficulty of 4 to avoid drowning. If a hunter voluntarily falls prone in the stream, he may test against his *swimming* skill if he has it. A test must be made every turn the hunter remains prone. While prone in the stream, a hunter receives medium cover against anything above the surface of the water.

The area borders on a light wood to the north. There are also a few free-standing coppices scattered about the area. All of the woods are light

woods; they are rough terrain, provide light cover and restrict line of sight to 8". You may wish to review the rules on woods and visibility on page 37 of *Star Wars Miniatures Battles*.

The north shore of the pond up to the woods is swampy. This is very rough terrain. There is no tree growth in the swampy land, so visibility is not affected, and no cover is available.

The Set-Up

The hunters come on the table as a group, at whatever point they choose. Squad coherence rules are not in effect for this game. After entering the table, the hunters may move independently in successive turns.

The creatures of the planet enter the table randomly starting with Turn Two. See the "Gamemaster Notes" for the mechanics of bringing creatures onto the table.

Gamemaster Notes

This scenario is designed for solitary play. As the hunting party wanders around, creatures will come on the table randomly and react in a particular manner. What kind of reaction depends

on the type of creature and the party's actions. Since each of the creatures is driven by its natural instincts, it is easier for the solitaire player to play them more objectively — they will follow a particular behavior pattern, regardless of whether it is good for the hunters or not.

If you intend to play this scenario solitaire, we recommend that you transfer the creatures' stats to Creature Record Sheets a few days before you start the game. That will give you time to forget the particulars of each creature. This scenario can also be played with a gamemaster and/or another player. If you do intend to play in either other manner, it is suggested that you read these "Gamemaster Notes" no further, so as not to spoil the awe and wonder of exploring an uncharted world.

Although this scenario is designed for solitaire play, it can be even more effective if a gamemaster is available to run the game for a player. This will serve to keep many of the creatures' actions and decisions a true surprise, and the hunters will not know what to expect, except through (possibly bitter) experience. And, in particular, "The Big Finale" (see below) will come as much more of a shock if the player does not expect it at all.

Finally, this scenario can be played with two players (with or without a gamemaster). In much the same way as having the gamemaster move creatures keeps their actions an unknown quantity, having another player move them will make the game even livelier. Creatures moved by another player will generally follow their natural instincts, but have a few more choices available to them, making them a bit more unpredictable than their solitaire counterparts.

Objective

Halor Dinnoral is looking for trophies — live trophies. He will gain a lot of prestige if he can display previously unknown animals in his zoo compound. To that end, he has instructed the hunters to shoot to stun. Once a creature is stunned, the hunters must "tag" it. A creature is tagged with a device that is a combination stun collar/homing com. The stun collar delivers a pulsed stun charge at regular intervals, which keeps most creatures stunned until it is removed. The homing com is a long-range comlink set to emit a recurrent signal, so that Dinnoral's ship can home in on the device in order to pick up the creature.

The player wins the game if, by Turn Twenty, he has on the table at least one live, tagged specimen of each type of creature that has entered into play — with the exception of the creature from "The Big Finale" (see below), which does not have to be alive — and no hunters have been killed.

Blaster Settings

In order to insure that he gets live trophies, Dinnoral has had the blasters rigged so that they cannot be set to kill. Any damage done with the hunters' blasters is stun damage only (see pages 39–41 of *Star Wars Miniatures Battles Companion* for the rules concerning stuns). Dinnoral's carbine is also stun-only, but his heavy blaster pistol has not been tampered with and is set to kill. Dinnoral will use it as a last resort, such as if he is attacked by a creature.

A modified blaster can be made to function properly again if a hunter works at it a bit. The player declares that a hunter (or hunters) is attempting to repair his blaster. The hunter cannot perform any other action in either the Movement Phase, Fire Combat Phase or Close Assault Combat Phase. During the Special Actions Phase the player rolls for a *blaster repair* test with a difficulty of 8. Lacking the skill, the hunter makes the attempt with his *Technical* attribute. If he succeeds, the blaster is now set to kill (it can be left on stun if the player wishes, but can then later be set to kill without further tests). If he fails the test, the weapon remains unchanged, but the hunter can try again on successive turns. If the hunter is attacked while attempting the repair then the repair attempt is interrupted and the hunter must try again in another turn.

If a hunter bombs out when attempting the repair roll, then the weapon is damaged beyond repair and can no longer be fired at all. A hero who bombs out may use a Force Point to roll the die again; in that case, the weapon is not damaged (unless he also bombs out on the extra roll).

Do not let the player know about the weapons or the possibility of repair until it becomes important. That way you can avoid having the hunters start with artificially high *blaster repair* skills. If you are playing the game solitaire without a gamemaster, no hunter may have a *Technical* attribute higher than 2, and the *blaster repair* skill may be increased by no more than 2.

Tagging Creatures

Not knowing what type of creatures he might encounter, Halor Dinnoral decided to have his acquisitions picked up directly by his shuttle, which has been modified to house a number of good-sized containment force fields. However, bringing down the shuttle every time he has a capture scares away any other creatures in the area. Yet leaving the capture behind risks losing it. Dinnoral's solution is to tag each capture with a homing comlink, so that after the hunt is complete, the shuttle can find all of the captures and pick them up.

Once the hunters have stunned a creature, they must tag it for future pick-up. A creature can

be tagged by one hunter. The figure must move into base-to-base contact with the prone creature. It takes half the figure's Movement Rate to affix the stun collar to the creature. If the hunter does not have enough of its Movement Rate remaining after moving up to the creature, he must wait until the next Movement Phase in order to attach the collar.

When a creature is tagged, you will need to mark it as such. A number of *Com* markers have been provided to use for tagging creatures. They represent the homing com/stun collar the creature is tagged with. Photocopy the markers, glue them to some thin cardboard, and cut them out.

Once the collar is fastened around the animal, it delivers a stun charge to the creature each turn. Normally this serves to keep the creature unconscious for the remainder of the hunt. But some creatures' metabolisms vary wildly, and it is possible that a creature may be able to shake off the effects of a stun, or it may be injured enough or frail enough that further stuns kill it.

Each turn a creature is tagged, make another opposed roll for the collar during the Special Actions Phase, comparing its *Damage Strength* of 5 to the creature's *Strength*. If the *Damage Strength* roll is four or more greater than the creature's *Strength* roll, then the creature has expired (become incapacitated).

If the *Damage Strength* roll is greater, but only by three or less, or if the results are equal, or even if the creature's *Strength* roll is greater by only three or less, it means that the creature remains stunned.

However, if the creature's *Strength* roll is four or more greater than the *Damage Strength* roll, then the creature has shaken off the stun. In the Movement Phase of the next turn, the creature stands up at a cost of 2", and then moves up to the remainder of half its Movement Rate. Rollovers and bomb-outs are handled normally.

Example: A creature with a *Strength* of 4 and a *Movement Rate* of 12 has been captured and tagged. During the Special Actions Phase of Turn Five, the player rolls for the collar's stun charge, getting a 1 — a bomb-out! — for a total of 0. Rolling for the creature's *Strength*, she gets a 5 for a total of 9. The creature has managed to resist the collar's

stun and has regained consciousness.

During the Movement Phase of Turn Six, therefore, the creature stands, expending 2" of its move. It then moves, according to its instructions, up to 4" more (one half its Movement Rate is 6", less the 2" for standing up).

Determining Creature Arrival

Different creatures will enter the table during the course of the game. The order of arrival will vary randomly, allowing you to replay the game if you wish. In some cases you may wish to vary the listed creatures, depending on the number of figures that you have to play with.

Roll to see what kind of creature(s) comes onto the table during the Special Actions Phase of each turn. The basic roll is two six-sided dice (rollovers and bomb-outs do not apply to this roll). This is modified by the location of the hunters on the table. Determine where the bulk of the hunters are located, and compare it to the set-up map. Reading across to the east edge, ascertain in which one-foot increment of the table they are (this is same number as the "tens" digit rolled up in the "percentile" roll — see "Bringing Creatures Onto the Tabletop," below). Add that number to the roll, then look up the result on the "Creature Arrival Table." The resultant creature or creatures enter the table during the Movement Phase of the following turn. Creatures entering the table have the initiative — they enter the table and move before the hunters (or any other creatures) move.

Example: During the Special Actions Phase of the third turn, the player rolls two dice and gets a "2" and a "3." He then checks to see where the hunters are located. He notes that most of them are in the swamp near the northeast shore of the pond. That puts them in the third one-foot increment along the eastern edge of the table (the area of the table between the "3" and the "4."). Adding "3" to his roll, he arrives at a final result of "8" (2+3+3). One or more grazing omnivores will enter the table during the Movement Phase of Turn Four.

If the hunting party is spread out more or less evenly across the tabletop, then take the average

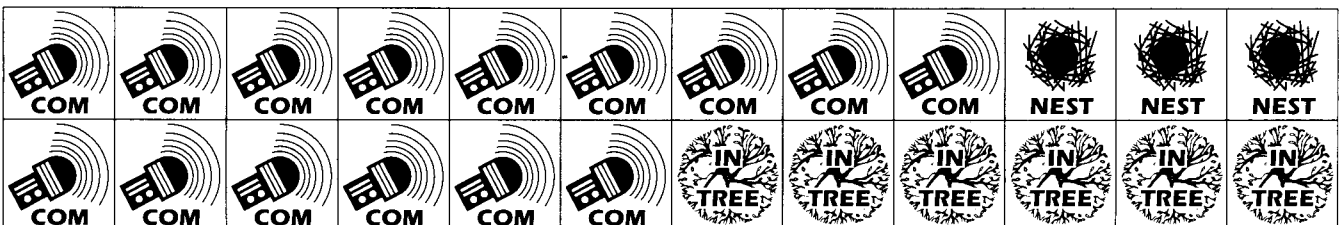

Permission is hereby granted to photocopy these markers for personal use.

Sequence of Play

Since this is a solitaire game, the movement and actions of the creatures encountered by the hunting party are determined by a fixed set of game mechanics. Because there are many creatures, there are, consequently, a lot of elements to keep track of. Therefore, this summary of when particular actions are performed during the course of a turn has been provided to aid you. The actions listed are those extra procedures required for this scenario; they are in addition to the actions normally performed during each of the phases. Not every action will need to be performed in any one phase. In addition to the action, there is a note as to what is involved in the action, as well as in which section the action is more fully described.

1. Initiative Phase

2. Movement Phase

- Determine what creature enters table (roll on "Creature Arrival Table"; "Determining Creature Arrival").
- Determine grazing herbivore's orientation (2 six-sided dice and Flame Effect Template; "Creature Behavior").
- Avian insectivore's initial attack occurs (normal combat; "Creature Behavior").
- Hunters can fire at "playing" arboreal omnivore (normal combat; "Creature Behavior").
- Amphibious predator's surprise attack occurs (4-6 die roll, difficulty 8 *Perception* test; "Creature Behavior").
- Test to break free of amphibious predator (opposed *Strength* roll; "Creature Behavior").
- Hunter can tag a creature (1/2 Movement Rate; "Tagging Creatures").
- If creature shakes off effects of stun collar, may get up and move (2" to rise, maximum

move of 1/2 Movement Rate; "Tagging Creatures").

3. Fire Combat Phase

- Arboreal omnivore throws fruit at hunters (normal combat; "Creature Behavior").

4. Close Assault Combat Phase

- Resolve avian predator's attack (normal combat; "Creature Behavior").
- Resolve amphibious predator's attack (normal combat; "Creature Behavior").

5. Morale Phase

6. Special Actions Phase

- Roll for creature type entering table (2 six-sided dice + location; "Determining Creature Arrival").
- Roll for arrival of the creature for "The Big Finale" (six-sided die + turn # >= 13; "The Big Finale").
- Attempt *blaster repair* (difficulty 8; "Blaster Settings").
- Test tagged creatures against stun collar (*Damage Strength* 5; "Tagging Creatures").
- Test if pack-hunting predators finish feeding (# of predators against 2x STR; "Creature Behavior").
- Reduce *Strength* of pack-hunting predators' kill ("Creature Behavior").
- Arboreal omnivore is removed from play if it entered woods and there are no hunters within 12" ("Creature Behavior").
- Determine arboreal omnivore's action (1: remove from play, 5-6: "plays"; "Creature Behavior").
- Place carrion-eating insect swarm, test for damage ("Creature Behavior").
- Remove carrion-eating insect swarm if carcass is devoured ("Creature Behavior").

Creature Arrival Table

Die Roll	Creature
3	None
4-6	Grazing Herbivore
7-8	Grazing Omnivore
9-11	Pack-Hunting Predators
12	Avian Insectivore
13-14	Avian Predator
15-17	Arboreal Omnivore

Special Arrivals

Creature	Arrival Condition
Amphibious Predator	Attacks hunter getting too close to water
Carrion-Eating Insects	Appear when creature is incapacitated

of their individual positions and add it to the creature arrival die roll.

In addition to this standard roll for determining creature arrival, there is another die roll to perform, which determines if the creature from “The Big Finale” comes onto the table. This additional die roll is explained in detail in “The Big Finale” section of the “Gamemaster Notes” below.

Bringing Creatures Onto the Tabletop

Some creatures have special conditions and/or procedures for entry onto the table; these are described below. Most creatures, though, will enter the table via one of the edges. To randomly determine where the creature(s) enter the table, first determine which table edge it uses. Roll a six-sided die and consult the following chart:

Die Roll	Table Edge
1	North
2–3	East
4–5	West
6	South

Now roll two six-sided dice to see where along that edge the creature enters. This roll is a “six-sided percentile” system — do not add the dice together; instead, read the first die as “tens” and the second as “ones” (it is a good idea to use two different-colored dice). Looking at the set-up map, you will see that the sides of the table are numbered, starting at the southeast corner of the table. Roll the two dice to determine where along the table edge the creature enters.

Note that each “tens” number represents the beginning of a one-foot increment along the table edge, and the “ones” digit is a two-inch increment. So a roll of “32” indicates a position 4” past the third foot mark.

If a roll is too high for the side of the table (for instance, the first die roll is a “5” or “6” on the east-west roll), then re-roll until an appropriate result is achieved.

Next, see the “Creature Behavior” section, which tells how many creatures enter the table, and explains how they react once they are on the tabletop.

Creature Behavior

Like many animals, each creature of the planet has a set of instinctive behaviors that govern its day-to-day actions. In a given situation, a creature will normally react in a fairly predictable way. Listed below are the various types of creatures that could be encountered during the hunt. Each listing describes the creature’s usual behavior, in terms of how to move the creature across the table, and how it will react to the

hunters and their actions. Also described is how many of each creature come onto the table.

- **Grazing Herbivore:** These are typical grazing creatures. They are generally docile, and spend most of the day foraging through the plant life for food. Being docile, they will first attempt to run away, but they will defend themselves if they are cornered.

When each group of herbivores first comes on the table, they will be grazing. After determining their point of entry, place the creatures (or creature) along the edge of the table, centered on the point of entry. They will move toward the clear terrain to the southeast of the pond (the area bounded by “2” and “3” from the south edge and “2” and “3” from the east edge). The herbivores move at 1/4 of their Movement Rate, as they are busily grazing the ground cover. While the herbivores in a patch of woods, they move at 1/2 their Movement Rate, since there is not as much ground cover to graze.

The herbivores will move generally in the direction of the clear grassland, as described above. However, depending on how savory the foliage along the ground is, they may wander off in a different direction. To simulate this, roll for the herbivore’s orientation at the beginning of each Movement Phase. Use a Flame Effect Template to determine in which direction the creature moves. Place the template over the creature, pointing the “Wind Direction” arrow in the direction the creature is currently moving. Roll two six-sided dice and compare the result to the numbers along the edge of the template. Move the creature 1/4 of its Movement Rate (or 1/2 in woods) in that direction. If an herbivore is moved off the table, the figure is removed from play. It may be used to represent another herbivore newly moved onto the table in a later turn.

If an herbivore is approached by hunters or other predators, it will scamper off a short distance. When it comes time for an herbivore to move, if a predator is within 5” of it, the herbivore will move its full Movement Rate away from the creature or hunter. The next turn it will return to grazing. However, if the predator were running toward the herbivore (i.e., moved its Run Rate or full Movement Rate), then the herbivore will continue to move away at its full Movement Rate. If one of the creatures is stunned or incapacitated by a blaster shot, all the herbivores within 5” will also begin to flee, in a random direction. Use the “Grenade Burst Area of Effect Template” to see in which direction they do so.

If the grazing herbivore is fleeing within 5” of another grazing herbivore, the other herbivore will begin to flee on its next move, in the same direction as the first one. Fleeing herbivores will attempt to run together if possible, trying to get



within 3" of each other and maintaining that distance. A single fleeing herbivore will not run toward other predators or into obstacles. It will run around those, trying to keep at least 5" from any predator or hunter.

Two or more fleeing herbivores will not go around creatures, however. They will keep running toward and past any creature or hunter in their path. Any creature or hunter caught in such a stampede (i.e., is in such a position that one or more herbivores run past within 1" of the figure) must make an opposed *Strength* roll against the creature's hoof attack in order to see if he takes damage from the stampede. Determine results normally using the "Damage Table." A figure must make a *Strength* roll for each stampeding creature that passes within 1" of it.

A grazing herbivore which flees off the table is out of play.

If one of these herbivores is cornered — it has no way to run except toward a hunter or other predator — it will attack the blocking figure with its hooves.

An herbivore will not graze to within 5" of a hunter or predatory creature. If the dice roll indicates such a movement, re-roll the dice until an acceptable direction is arrived at.

Number Appearing: The first time this result is rolled, three creatures come on the table. The second time herbivores are selected, two of them enter the table. On each successive result of

"grazing herbivore," one creature arrives on the table. If at any time this result is rolled and there are no other grazing herbivores on the table, then three of the creatures will enter again. This cycle is repeated each time there are no other grazing herbivores on the table.

- **Grazing Omnivore:** These are also grazing creatures, but their diet is not restricted to plants. They will eat whatever they can find or catch, vegetable or animal. When these creatures enter the table, they will gradually move to encircle the hunters with an eye to sampling a new taste treat.

When the omnivores first come on the table, they will also be grazing. After determining their point of entry, the creature(s) is placed on the edge of the table, centered on the point of entry. The omnivores move, while grazing, at 1/2 of their Movement Rate, as they are eating from the ground cover, but are on the lookout for large sources of protein.

The grazing omnivores will move toward the largest concentration of hunters, even if there are other creatures on the table (they have never seen "creatures" like the hunters, and are curious). If the hunters are evenly spread out, roll dice to randomly determine which hunter they will approach, just like assigning hits in fire combat.

Once the omnivores have moved within a full Movement Rate's distance of their target(s), they will move to attack. In the next Movement Phase,

they will move their full Movement Rate to engage the hunter or hunters in close assault combat, attacking with their horns and hooves. They will break off from the combat after they have taken 50% casualties (creatures wounded or incapacitated). At that point, they will turn and move at their full Movement Rate toward the center of the table edge on which they entered. If an omnivore runs off the table, it is removed from play.

Like the grazing herbivores, fleeing omnivores will run over any creature or hunter in their path. See the stampede description given above for grazing herbivores. In this case the victim of the stampede must make the *Strength* roll against the omnivore's *Strength* plus the attack bonuses of both of its attack forms. Since the omnivore has a horn attack of STR +1 and a hoof attack of STR +2, the creature's *Strength* for ascertaining stampede damage is 6 (*Strength* of 3, +1 for the horn attack, +2 for the hoof attack).

If one of the grazing omnivores is affected by blaster fire, any others within 3" of it will move 1/2 their Movement Rate away from it, but then continue on toward the hunters in successive turns.

If the grazing omnivores are pursued by predators, they will move at their full Movement Rate toward the nearest table edge opposite the predators. Again, an omnivore that runs off the table is removed from play.

Number Appearing: Four of these creatures come onto the board the first time this result is rolled. One will enter the table the next time this result comes up. After that, the number will vary, because there should be no more than five grazing omnivores on the table at any one time. If this result comes up when there are five on the table, treat it as a "None." Otherwise, bring on as many omnivores as necessary to bring the total on the table back up to five.

• **Pack-Hunting Predator:** The hunting pack is an evolutionary staple, and the pack predators of this planet are no exception. When they arrive on the table they are hungry and hunting for food. They don't care where it comes from; they will attack either grazing creatures or hunters, whichever they find.

When the predators enter the table, they will go after the first creatures they see. Place the pack on the table edge, centered on the point of entry. Then determine if the pack has a line of sight to any creatures or hunters. If there is a line of sight (LOS) to either, that is what the pack will hunt down. If there is a line of sight to more than one of each, then roll dice to determine which is the target. When determining targets, consider any hunters within command distance of each other to be one group. Likewise, any creatures of the same type within *Perception* distance of each other are a group.

Once a target is determined, move the predators toward the objective at their full Movement Rate. Once they reach the target, resolve the attack as close assault combat. If the pack manages to incapacitate its prey, they will begin to feed. The members of the pack are placed in base-to-base contact with the fallen figure and remain there until they are finished or until they are disturbed.

If the pack is left undisturbed, check to see if they have finished feeding starting in the Special Actions Phase of the following turn. Make an opposed roll for the pack, comparing the number of creatures in the pack to a number equal to twice the prey's *Strength*. If the pack succeeds in the test, than they are still feeding. If not, they have finished off the prey. Keep testing in each successive Special Actions Phase, but reduce the prey's value by one each additional turn.

One way to keep track of the current value is to use *Stun* markers, taking away one point each turn. Or you can make your own markers with just numbers on them. Another easy method is to place a die or dice next to the feeding pack, with the number of pips facing up equal to the current value of the prey. After each test, just turn the die so that one less pip is showing.

When the pack has finished their meal, they will seek another target and set off after it. Determine the next target in the same manner as described above for the pack's initial entry onto the table.

The feeding pack will be disturbed if they are fired upon, or if any hunter comes within 8" of a feeding predator. If the pack is disturbed, they will move to attack the figure or figures that disturbed them, following the procedure described above. Likewise, if at any time the pack is fired on while pursuing prey, they will turn their attention to the hunter — or group of hunters — that fired on them.

If the pack is fired on by the hunters they are pursuing, they will veer away from the target for one turn, but then turn back toward the target and continue advancing. Once involved in close assault combat, the pack is tenacious. They will continue attacking until they have suffered 60% casualties (predators wounded or incapacitated), at which point the remaining creatures will set off to find easier prey. The remaining pack members will run toward the nearest table edge. After one turn of running, they will turn to pursue another target they can draw a line of sight to (except the hunters who bested them). If there is no such target, they will continue on to the table edge, checking in each successive turn for other prey. If the predators do not find another target before they run off the edge of the table, they are taken out of play.

Number Appearing: When this result first comes up, bring on a pack of five creatures. As long as there are still members of the pack on the table, ignore any further “pack-hunting predators” results. If there are no longer any predators on the table, then the next time this result comes up, bring on another pack of five.

• **Avian Insectivore:** The avian insectivore is not a direct threat to the hunters, as it does not prey on mammals. However, it is very territorial, and if it perceives a threat to its nest, it will attack creatures many times larger than itself and attempt to drive them off.

If this creature is rolled up on the “Creature Arrival Table,” find the hunter figure which is closest to a woods. Then extend a ruler or tape measure from the hunter to the woods. Measure out 12” from the hunter and into the woods. Place a *Nest* marker at that point in the woods (these markers have been provided with this scenario; see the instructions in “Tagging Creatures,” above, for preparing them). If the hunter is further than 12” from the woods, place the counter at the edge of the woods at the point nearest to the hunter.

This avian is currently nesting at this place and has become aware of the hunters. If the hunter is within 12” of the nest, the avian will immediately attack him. Place the avian figure adjacent to the hunter during the Movement Phase and resolve the attack right away. After the attack has been concluded, the avian may move half its Movement Rate; it is assumed to be completing its move. From that point on the avian is moved normally. It will continue to attack any hunters until they move more than 12” from the nest. The avian attacks whichever hunter is currently closest to the nest. Once all of the hunters have moved away, it returns to its nest.

If the hunter is further than 12” from the nest when this encounter is rolled up, then the avian does nothing at this time. However, if anyone gets within 12” of the nest, the avian will fly forth to attack.

If you are playing this game as a gamemaster, it becomes even more frustrating for the player if you do not place the *Nest* marker on the table, but mark its location on the map. The hunters will have to work at discovering where the nest is.

The avian insectivore’s nest is located in a tree in the woods. The trees block Level 1, so any flight through the woods must be done at Low Level. The avian may also fly over the woods, from Level 2 to Level 6. When it leaves the nest to attack, it may do so either up through Level 2, or down through Low Level. If you are playing without a gamemaster, roll a die to determine which: 1–4, Low Level; 5–6, Level 2.

Blaster fire will not deter the avian insecti-

vore, unless it hits the creature. It ignores misses. Remember to keep in mind the restrictions on line of sight and cover when firing at the avian flying at Low Level in the woods. If the avian is at a higher Level, fire is handled normally. You will still have to check for line of sight if the hunter is near the border of the woods — the edge of the trees may block his view up to the avian. If the hunter is in the woods and the avian is above the woods, the hunter cannot see or fire at the avian.

Number Appearing: One avian appears each time this result is achieved, until there are three active on the table. After that, treat this result as “None.”

• **Avian Predator:** This particular avian is looking for its next meal, and the hunters look particularly interesting to it as it flies by.

When the avian predator comes on the table, roll normally for table edge and position. The avian comes flying in at that point, moving at its Minimum Flight Rate. It enters moving perpendicularly to the table edge. If the entry point is in the woods, the avian predator can enter either at Low Level or at Level 2, as for the avian insectivore described above. If there is no gamemaster, roll for its entry Level: 1–2, Low Level; 3–6, Level 2.

Once on the table, the avian will turn toward the nearest hunter that it has a line of sight to. It will charge the hunter and attack in close assault combat (it does not require a morale test to do so). This type of avian predator dives on its target, attempting to drive the prey to the ground where the avian can rend it with its beak and claws. Therefore, when the avian moves into base-to-base contact with its target, combat is not resolved immediately. If the hunter has not yet moved in this Movement Phase, he can no longer do so.

The attack is resolved in the Close Assault Combat Phase. The close assault combat is then handled normally. The hunter can try to disengage, which will give the avian a parting attack as described in “Disengaging” on page 30 of *Star Wars Miniatures Battles*. Once disengaged, the avian will take to the air again and go after the nearest hunter.

The avian predator will not normally attempt to disengage, but will do so if it receives a wound. The hunter then gets a parting swing at the avian. A wounded avian predator will return to the point at which it entered the table in order to fly off the table. It is then out of play and will not return.

If the creature manages to incapacitate a hunter, it will begin to feed on him. It can be driven off by blaster fire — a hunter firing a blaster at it, even if he misses, will cause the avian to take to the air, forsaking its meal. How-



ever, it will still be hungry and will then go after the nearest hunter it can see. If the avian remains undisturbed, it feeds as described above for the pack-hunting predators. Once it has finished, it will take off and fly back to the point at which entered the table and then leave the table.

Number Appearing: One avian predator appears each time this result is rolled.

- **Arboreal Omnivore:** The arboreal omnivore is a creature with a varied diet. While it does consume other creatures, it does not hunt large prey, preferring to grab an occasional tree-dwelling lizard or such. It does not pose much of a threat to the hunters, but is a playful creature when it is satiated, making it a little harder to capture. It could also be a distraction if it becomes playful at the wrong time.

The arboreal omnivore prefers to stay within the canopy of the forest, venturing to the ground only occasionally, such as when it is seeking food or just playing. And while it does favor the forest, it will make sporadic forays into the plains looking for food (it is particularly fond of certain large burrowing insects that frequent the high grasses).

If this result comes up on the "Creature Arrival Table," roll as normal for the creature's entry position. If the arboreal omnivore enters the table at a point not located in any of the woods, then it will begin its movement by heading toward its territory in the woods. Roll one six-sided die. On a result of 1–2, the creature will head for the northwest woods. If the die roll is 3–4, then it will head for the northeast woods. And if the roll is 5–6, the omnivore will be returning to the

woods on the east side of the table.

The creature moves to its own territory at its full Movement Rate. If the copse of woods to the southwest is in its way, it will pass through it rather than going around it. Since this is an arboreal creature, evolved to live in the forest, it suffers no movement penalty when moving through the woods. It moves at the normal movement cost, not at the double cost that is usual for rough terrain.

If the omnivore should pass within 12" of a hunter or hunters that is in a woods while it is returning to its home, it will turn to head toward the hunters, its curiosity piqued. If the creature is fired upon while crossing clear terrain, it will turn toward the wooded area closest to it, but away from the direction the fire originated in.

On the turn that the arboreal omnivore enters its home woods, it will complete its full movement, going as deep into the woods as its movement allows. In the Special Actions Phase of that turn, the creature will take to the trees and be removed from play, unless there is a hunter or group of hunters within 12" of it, in which case it will turn and head toward the hunter(s) next turn. The 12" range can span gaps in the woods. For instance, if an arboreal omnivore has returned to its home in the east woods, but a group of hunters is in the northeast woods within 12" of the omnivore, it will detect that they are there and proceed to investigate the disturbance. The creature does not need a line of sight to the hunters; it can hear their commotion in the woods and zero in on them.

The arboreal omnivore approaches the hunters by traveling through the forest's canopy. Therefore, it draws additional cover above and beyond that of being in the forest. The difficulty of a shot aimed at an arboreal omnivore in the forest's canopy is increased by 2. You will need to indicate which creatures are up in the trees, so we have provided a few *In Tree* markers for you to photocopy, mount and use. Place the marker next to any creature which is up in the trees, and remove it when the creature drops to the ground. The omnivore will move to a distance of 3" from the hunters (or the majority of hunters, if the party has split up). If the hunters are all separated, roll a die to randomly determine which hunter the omnivore decides to follow.

The creature follows the hunter or hunters around for a while, until it becomes bored or loses interest. Occasionally the omnivore may become frisky and want to "play." Roll a die at the beginning of the Movement Phase each turn; a result of "1" means the creature has gotten bored and will leave, while a roll of "5" or "6" means it decides to play. If the creature becomes bored, remove the figure from play immediately. If the

creature remains on the table, it will move as the hunters move, keeping the same distance, until they leave the woods. At that point the omnivore will return to other more interesting things and is removed from play.

While it is following the hunters, the omnivore may occasionally “play” a little by swinging down and swiping at one of the hunters. If the die roll indicates that this happens, use the following procedure.

The creature moves first. Determine which hunter the creature will “play” with. If the creature is following a particular hunter, he will be the target. If the omnivore is following a group, roll a die to randomly determine the target. Then place the creature figure on the opposite side of the target figure, the same distance it currently is from the target. As an example, if the omnivore is located 3” to the northwest of the target figure, it should be moved to 3” southeast of the figure. This represents the creature swinging down from the trees, past the target, and back up into the trees. While swinging by, it takes a swipe at the target figure. Treat the swipe as close assault combat, making an opposed roll of the creature’s *Strength* against the target’s *brawling parry* (if the target is a hero), *brawling skill* or *Strength*.

Next determine if any damage was inflicted — use the standard rules for determining damage, described on page 29 of *Star Wars Miniatures Battles*. If the hunter sustains damage, follow the normal procedures. If the arboreal omnivore is wounded or incapacitated it is still placed in the position opposite its starting position, but it is placed lying prone. It has fallen to the ground — remove the *In Tree* marker. The hunter who was swiped at may not fire in the Fire Combat Phase of that turn.

The hunter receiving the swipe may attempt defensive fire, if the creature approached the hunter through the hunter’s 90° front fire arc. Any attempt is at +1 to the difficulty, due to the creature’s swinging. However, the omnivore does not receive the +2 cover modifier as it has left the cover of the canopy. Other hunters may attempt to shoot at the swinging omnivore, also at +1 to the difficulty, but must randomly determine who was hit by any successful fire — the creature or the other hunter. Any hunter who fires at the swinging omnivore may not fire again in the Fire Combat Phase.

While the arboreal omnivore is following the hunters, any of the hunters with a line of sight to the creature may attempt to fire at it up in the trees. The canopy does not obstruct line of sight, but does provide cover as described above. If the creature is wounded, it falls to the surface. Place the figure on its side, prone, and remove the *In Tree* marker. You must also check to see if the

creature sustained any damage from the fall. Use the rules on page 61 of *Star Wars Miniatures Battles* for determining falling damage. Damage from the fall is cumulative with damage from the weapon fire.

If the omnivore is fired upon, but not wounded or incapacitated, it will become angry and “return fire.” It begins to hurl hard-shelled fruits at the hunter or group of hunters from its vantage point in the trees. The attack is resolved in the Fire Combat Phase. Determine the target as for the swipe, and then resolve the fire combat. The arboreal omnivore must beat a difficulty number of 8 to hit its target. The hurled fruit has a *Damage Strength* of 2.

The creature continues to sling a fruit at the group each successive Fire Combat Phase. Once it has begun to fire on the hunters, it will no longer “play”; ignore results of “5” or “6” on the die roll made in the Movement Phase. Continue to roll the die each Movement Phase, though — if a “1” is rolled, the omnivore will still become bored and leave.

Number Appearing: Roll a die. If the result is 1–3, one arboreal omnivore comes onto the table. On a roll of 4–6, there are two creatures. Additional arboreal omnivores can enter the table even though previous ones may already be in play.

• **Amphibious Predator:** This predator lives primarily in the water, although it does venture onto land from time to time. In addition to lying in wait for prey that can be found in the water, the amphibious predator will also lunge forward from the water to catch land-based prey that strays too close to the shore.

Any time that one or more of the hunters comes within 3” of the edge of the pond or stream, there is a chance that an amphibious predator has noticed them and will try to make them its next meal. As soon as a hunter approaches the water within 3”, roll a six-sided die; on a roll of 4–6 an amphibious predator comes hurtling out of the water after her.

Resolve the attack as soon as it occurs (it interrupts the hunter’s normal movement). First, the hunter has a chance of avoiding the lunging creature. Have the player make a *Perception* roll for the hunter. The difficulty number for dodging the surprise attack is 8. If the hunter succeeds, she may be moved 2” back from the point at which she was attacked (moving directly away from the body of water). She may then continue her movement, up to the limit of her Movement Rate less the 2”.

If the hunter fails the test, the creature has surprised her and may attack. The attack occurs too swiftly for the hunter to try defensive fire, and the hunter may no longer move in this phase.

During the Close Assault Combat Phase, resolve the attack as normal close assault combat.

If the amphibious predator is wounded, it will retreat directly to the water in the next phase it is able to move. If the hunter is wounded, she falls to the ground as normal, and the creature will then try to drag the body into the water, where it can devour it at leisure. If the hunter gains initiative in the next turn, she can stand up and move away in the Movement Phase, in which case the predator will pursue her once again. If the predator gains the initiative, it will seize the wounded hunter in its jaws and drag her toward the water. The predator moves at half its normal Movement Rate while dragging a body. The hunter can try to break free by making an opposed *Strength* roll against the predator's *Strength* when the creature begins to drag her. If she succeeds, then she can stand up and move away. Remember that standing up costs 2" of movement.

The other hunters can shoot at the amphibious predator, but run the risk of hitting the creature's victim. To determine who gets hit by a successful fire attempt, roll a die. A result of 4-6 means that the creature was hit, and a 1-3 means that the hunter was hit. If the hunter was incapacitated by the predator's attack, the creature will nevertheless drag the body into the water. The other hunters may still fire at it in an attempt to get a new capture for Dinnoral. Determine the recipient of a successful hit as described above. If the victim is hit, that just means that the creature was missed and can continue moving.

If a hunter avoids the attack by making the *Perception* roll, the amphibious predator will pursue the hunter up to 6" from the water. It will not venture further than that, and will instead return to the water.

Number Appearing: Roll a six-sided die. On a 1-2, one creature lurches out of the water; 3-4, there are two creatures; 5-6, three creatures.

- **Carrion-Eating Insects:** Like the Enarcian thrifly, these carnivorous scavengers are attracted to the scene when a creature is incapacitated, where they swarm around the carcass and swiftly devour it. While they normally just feed on carrion, when they are in a feeding frenzy they will attempt to feed on almost anything that comes in contact with the swarm.

If a creature (or hunter) becomes incapacitated, a swarm of the carrion-eating insects will begin to form around the body. On a die roll of 1-3, the swarm will gather by the Special Actions Phase of the current turn. If the result is 4-6, it forms by the Special Actions Phase of the following turn. During the appropriate Special Actions Phase, center a 1.5"-radius Grenade Burst Area of Effect Template over the body. If the body is not completely covered, place additional templates over

the body, ranging them along its length.

If any other figure's base is wholly or partially covered by a template, the player must test its *Strength* against the swarm's *Damage Strength* of 6. The damage test is resolved as soon as the templates are placed.

The swarm of insects remains over the body for a number of turns equal to the body's prior *Strength*. At that point the insects have devoured the entire body and disperse. The templates and the figure they are covering are removed from the table during the Special Actions Phase of the swarm's last turn. You can keep track of the number of turns remaining with dice or markers as described above in the section dealing with the pack-hunting predators.

There are some exceptions to the arrival and effect of these insects, as some of the other indigenous life forms have developed evolutionary responses to the carrion swarm. The pack-hunting predators, for instance, exude a scent that repels the insects, so the swarm does not gather around the kill a pack is feasting on. If the pack moves on before the kill is fully devoured, such as if it is driven off, then the swarm will gather around the remaining carcass. But if the pack has finished off the prey, there is not enough left after they are done to attract the insects.

The amphibious predator is also unaffected by the swarm, due to its thick hide. The swarm will gather normally, but the amphibious predator will continue to drag the body into the water in spite of them. Move the template(s) along with the figure, maintaining their relative positions. Once the body is dragged into the water, the swarm disperses. Otherwise, it remains over the body for as long as described above.

The Big Finale

Unknown to the hunting party, there is a creature that is a lot more deadly than any they have so far encountered. It is a roving territorial carnivore which makes a circuit of its wide-spread territory every few days. It was passing near the pond area, and the commotion has caused it to come see what is transpiring.

The big surprise works best if you, as a gamemaster, run this for another person. That way when the creature appears, it will really come as a shock.

During the Special Actions Phase, a die is rolled to determine if this special creature enters the game. Roll a single six-sided die, then add the current turn number. If the total is equal to or greater than 13, then the creature has arrived. In the next Movement Phase, follow the normal procedure for determining where along the table edge the carnivore enters, and move the creature into the table. Note that, for practical purposes,

you do not have to start rolling for this creature's entry until Turn Seven, as any earlier roll will not yield a high enough total to trigger its entry.

When the creature is first placed on the table, roll another six-sided die. This number is the carnivore's Hunger Rating. The Hunger Rating is the number of creatures or hunters the carnivore will eat before it leaves the table. Keep track of the current Hunger Rating with dice or markers as described above in the entry for pack-hunting predators.

Once the creature enters the table, it will move toward the nearest hunter figure to which it has a line of sight. Note that due to the creature's size and the density of trees, the creature treats any of the woods as very rough terrain. If it cannot see any of the hunters, it will move toward the nearest creature that it can see on the table.

If the carnivore has no LOS to any other figure on the table, it will instead move randomly, as it searches the area for the disturbance that attracted it. To move the creature randomly, roll two six-sided dice and use a Flame Effect Template as described above for the grazing herbivores (although this creature will not randomly move off the table; reroll any results that would indicate such a movement).

While the roving carnivore is randomly searching it moves at 1/2 of its Movement Rate, except in the woods, where it will move its full Movement Rate (which is actually reduced to 1/4 due to the very rough terrain).

If the creature is fired upon while it is moving randomly, it will turn and move toward the figure which fired at it.

Once the creature achieves a LOS to another figure, it will move toward the figure at its full Movement Rate, seeking to come into base-to-base contact with the figure. It will continue to pursue the hunter if it does not reach him in the current turn. When the roving carnivore comes into base-to-base contact with a hunter (or other creature), conduct combat as normal in the following Close Assault Combat Phase. If the carnivore inflicts "Incapacitated" damage on its opponent, it has grabbed the hapless victim and gobbled it up. Other results are treated normally.

When the roving carnivore has consumed a number of hunters or creatures equal to its Hunger Rating, it is satiated and will leave the table. Use a Grenade Burst Area of Effect Template to determine a random direction. The creature will then move in that direction (skirting any obstacles if necessary) until it leaves the table.

■ Big Finale (Giant Roving Carnivore)

DEX: 4.

STR: 8 (11).

PER: 1.

Move: 20.

Movement Rate: 24.

Orneriness Code: 0.

Attack Forms: claw (STR+3 = 11), bite (STR+5 = 13).

Special Features: armored skin (+3 to STR).

Squad Generation Points: 120.

Figure Notes

The hunters can be drawn from any of the *Rebel Commandos* packs (40414, 40417), *Bounty Hunters* packs (40420, 40422, 40426), *Aliens of the Galaxy* packs (40429, 40443), or the *Pirates* pack (40448).

Halor Dinnoral is best represented by the Old Senatorial, which is the older, bald man with the goatee and long-vested outfit in the pack of *Rebel Operatives* (40434).

The creatures of the planet will have to be represented by whatever figures you can manage to find, as discussed above in the section about "The Creatures." Remember to be flexible in how you approach the types of creatures you will need. For instance, the avian animals could be bird-like and feathered, reptilian or mammalian with bat-like wings, or even wingless creatures that float along through the use of internal gas sacs. The amphibious predator can be represented by a frog-like creature, an alligator- or lizard-like creature, or even a snake-like or worm-like creature.

Depending on the figure you end up with, you might have to modify the creature's attacks a bit, as a snake-like creature may not have a claw attack. Or you could justify the attack in the creature's description: perhaps the snake-like creature has small clawed appendages that it normally uses to drag itself around, but are also used when the creature attacks.

The "big finale" creature can be represented by a dinosaur figure, although you'll probably want to modify it a bit to give it that otherworldly feel. With the current popularity of dinosaurs it is not hard to find a variety of dinosaur types, and many of them are fairly well detailed and inexpensive. Check out your local toy store or a discount toy store in the mall. The author was able to find a plastic *Tyrannosaurus Rex* toy very close to 25mm scale for only a dollar and a half. In a pinch, you can use the *rancor* figure. Again, it could be modified if you want to give it a different feel.

Scenario Two

Terror In the Trees

The Situation

In the days following the defeat of Imperial forces on the forest moon of Endor, isolated elements of those forces could still be found in the vicinity of the Imperial shield generator base. With the base and landing platform in Rebel hands, and the Imperial fleet dispersed to unknown systems, these units found their contingency orders — to rendezvous with their command elements for regrouping and redeployment — impossible to carry out. Considering that the likelihood of retrieval was practically nonexistent, many of these units determined to inflict the retribution of the Empire on as much of the enemy as possible while they were still able.

The remnants of a stormtrooper platoon and a scout trooper squad have combined forces to punish the insurrectionist furballs who aided the Rebel Alliance in this heinous act against the New Order. They have been scouring the forest for a number of days now, hunting native game to survive and still seeking a shuttle or other ship — doing their best to try to return and further serve the Empire. In the process, they are also eliminating any enemy presence they come across.

As yet another day drags on, word comes back from the vanguard of scout troopers that they have discovered the entrance to an enemy encampment. They have in fact come across one of the Ewoks' hidden approaches to a small village located up above in the forest's canopy. This access is a large hollow tree, which has had a crude staircase built into it. The stairway winds its way around the inner side of the trunk and branches and eventually lets out onto one of the Ewoks' village platforms.

However, unknown to the Imperial forces, this village is hosting some Rebels, who have come to assist the Ewoks in repairing their village and settling down into their normal routine.

As the white-clad harbingers of Imperial doom pour out into the village in the trees, the battle is joined.

Rebel Forces

The Rebel player has one squad of Rebel commandos, who have been assigned to help out an Ewok village. The balance of his forces are the Ewoks themselves and their traps (see "Ewok Tricks and Traps" in the "Gamemaster Notes" for details).

■ Vine Runners

- 6 Veteran Ewoks.
- DEX 2, *melee combat* 4, *thrown weapons* 4; KNO 3; MEC 1; PER 3; STR 3, *climbing/jumping* 5; TEC 1; Move: 7.
- **Walk Rate:** 5-1/2"; **Run Rate:** 9".
- **Weapons:** 2 spears, knife.
- **Commander:** *command* 4.
- **Specialist:** *blaster* 3.
- Weapon:** blaster pistol.
- **Squad Generation Points:** 261.

■ High Hunters

■ Trailblazers

- (2 identical squads)
- 6 Veteran Ewoks.
 - DEX 2, *melee combat* 4, *thrown weapons* 4; KNO 3; MEC 1; PER 3; STR 3, *climbing/jumping* 5; TEC 1; Move: 7.
 - **Walk Rate:** 5-1/2"; **Run Rate:** 9".
 - **Weapons:** 2 spears, knife.
 - **Commander:** *command* 4.
 - **Squad Generation Points:** 253.

■ Recon-A

- 10 Average Rebel Troopers.
- DEX 3, *blaster* 4; KNO 2; MEC 2; PER 2, *command* 3; STR 2, *brawling* 4; TEC 2; Move: 10.
- **Walk Rate:** 8"; **Run Rate:** 13".
- **Weapons:** blaster carbine.
- **Commander:** *command* 4.
- **Specialists:**
- 1: *blaster* 5.
- Weapon:** repeating blaster (standard configuration).
- 2: *blaster* 5.
- Weapon:** blaster rifle.
- **Squad Generation Points:** 416.

Imperial Forces

The remnants of a stormtrooper platoon that was decimated have regrouped and reorganized themselves into two full squads. In the course of their wanderings they have come across a squad

of scout troopers. The scouts were on perimeter duty when they became involved in the original battle with the Ewoks, and so do not have any vehicles. Now they are working in conjunction with the newly-formed stormtrooper squads.

■ **Explorer Squad Esk-23**

- 10 Veteran Scout Troopers.
- DEX 2, *blaster* 4; KNO 2; MEC 3, *repulsorlift operation* 4; PER 2, *command* 3; STR 2; TEC 2; Move: 10.
- **Walk Rate:** 7"; **Run Rate:** 12".
- **Weapons:** blaster rifle.
- **Commander:** *command* 4.
- **Squad Generation Points:** 452.

■ **Stormtrooper Squad Aurek**

■ **Stormtrooper Squad Besh**

(2 identical squads)

- 10 Veteran Stormtroopers.
- DEX (1)*, *blaster* (3)*; KNO 2; MEC 2; PER 2; STR 2 (3)*, *brawling* 4; TEC 2; Move: 10.
- **Walk Rate:** 6"; **Run Rate:** 11".
- **Weapons:** blaster pistol.
- **Commander:** *command* 4.
- **Squad Generation Points:** 432.

*Numbers in parentheses are the final values as modified by armor.

The Battlefield

When the stormtroopers finish their ascent through the hollow tree, they find themselves high above the forest floor in a typical Ewok village. Two-thirds of the way up, the tree containing the stairs splits up into a number of branches, two of which are large enough to continue the stairs through. The result is that this entrance to the village has two accessways. The stormtroopers can arrive through either one, or both. Leaving the stairs, the stormtroopers will step out onto wooden platforms built around the tree's branches. These platforms are connected by means of suspended wooden walkways with a series of other platforms and walkways.

The area represented on the tabletop is the outskirts of the village. The hollow-tree approach that the stormtroopers are utilizing is one of many "back doors" to the village. It is an easy way into the village for hunting and foraging parties approaching from the east, and also serves as a quick means of escape if there is a threat in the center of the village. The wide walkway running off the table to the northwest is the "main road" into the heart of the community. Access to the main walkway from the stairs is by means of the series of narrower walkways leading from the tree passage. Various platforms are located along the walkways. Most of the platforms are supported by huge tree trunks and branches. Some of those trees have been hollowed out to make storehouses for the village. The trunks of others serve as the inner wall of huts built against the trees. The walkways and platforms are well-se-

Grenade Damage Effects

There are no grenades available in this scenario, but if you should choose to play a variation allowing their use, the walkways and platforms have a *Strength* of 4. If the Grenade Burst Area of Effect Template overlaps part of a walkway or platform, make an opposed roll comparing the grenade's *Damage Strength* to the walkway's *Strength*. If the grenade's roll beats the walkway's roll by four or more, then the walkway has been blasted through. Place a 1.5"-radius template over the point at which the grenade exploded. This area is now a hole opening onto the forest below. Soldiers may fall through this hole (see "Falling Over the Edge" in the "Gamemaster Notes" below).

If the grenade did not explode on a walkway or platform, but the template overlapped it at some point, center the 1.5"-radius template over the area of walkway which was affected.

It is possible for a walkway to be totally cut in half by an exploding grenade. Since the walkways are secured to many trees and branches for stability, a walkway so severed will not collapse and can still be used, but will now be impassable at the break (although a hero could attempt to jump the gap — see the jumping rules on page 61 of *Star Wars Miniatures Battles*).

cured, and are considered clear terrain.

The walkways and platforms have railings to prevent anyone accidentally going over the edge, but these have been built for Ewoks. Therefore they are too low to effectively prevent a human-sized being from toppling over if he or she is not careful. The rules governing falling soldiers are detailed below in the "Gamemaster Notes."

The walkways are 3" wide; wide enough to accommodate three figures walking side by side. The platforms are at least twice as wide as the walkways. The "main road" is 10" wide.

The two hollow trunks to the east (1 and 2 on the set-up map) are the branches providing entry to the platform system from the ground. The hollow tree in the center of the south edge (3) of the table is a weapons storehouse for the village. It contains primarily spears, and some knives, which in normal times are used for hunting. Now, in this time of recent conflict, there are many more spears stored here. This is a small room — no more than five Ewoks may occupy it at any one time, and no human-sized figures can enter it.

"Terror In The Trees" Set-up Map

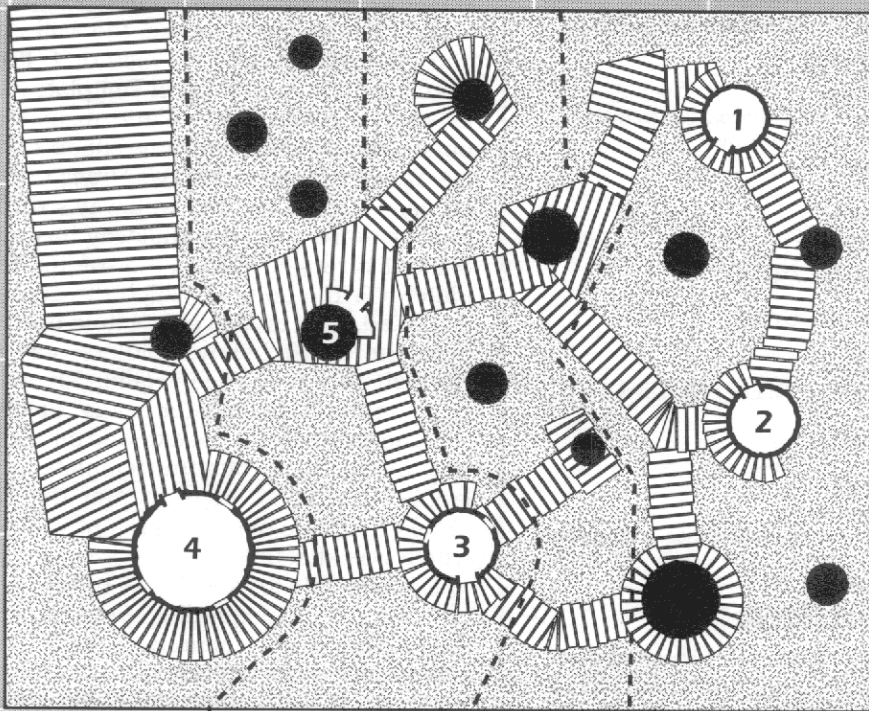

Brian Schomburg

KEY

● Tree (blocks line of sight)

The following symbols should be used by the Rebel player to indicate the position of the Ewok traps (they are to scale with the map):

⊠ Log pincers

→ Log Sweep

⊠ Pitfall

Rebel Set-up Line

Ewok Set-up Line

Trap Set-up Line

The large hollow tree at the southwest corner (4) is also a storehouse, which is normally used for dry goods and foodstuffs. However, due to the recent battle this storehouse has also been filled with spears. This is a much larger room, and can accommodate up to 10 figures, including human-sized soldiers.

The hut built against the tree near the center of the table (5) is a sentry post. The hut is small and provides basic cover

for a lookout. Up to two Ewoks may occupy the hut.

The hut and the two storehouses have a single door each, as well as some windows. Soldiers can fire from the windows, gaining heavy cover when so situated. A soldier firing from a doorway has medium cover. The windows and doors are also large enough for Ewoks to throw spears from. Two soldiers at a time can pass through the doors of each of the trees. The hut's door only allows one figure at a time.

While the canopy of the forest is thinner at the level of the Ewok village, there are still numerous branches and vines suspended in the field of view. Visibility in these woods is limited to 16". The very thick trees shown on the set-up map, as well as the storehouses and entry branches, actually block line of sight (LOS).

The Set-Up

Prior to placing any figures on the table, the Imperial player notes which access tree (1 or 2) each of his squads will enter through. After the Imperial has determined his entry points, the Rebel player deploys his figures. The Rebel may place his Ewok figures on any walkway or platform west of the Ewok Set-up Line. No more than one-third of the Ewoks may start around trees 3 and 5. The balance of the Ewok force must be located near tree 4 and its connecting platform, or on the main walkway which heads northwest. Ewoks may be placed inside the storehouses or hut. Any Ewoks inside trees or huts are deployed hidden — indicate their positions on a copy of the set-up map or a piece of scratch paper. An Ewok figure is not revealed unless it moves out of the building it is in, fires, or an Imperial gains LOS

to it. If revealed, place the figure on the table. It remains revealed for the remainder of the game.

Rebel soldiers may be placed on any walkway or platform west of the Rebel Set-up Line. No Rebels may start inside the storehouse.

In addition to the soldiers available for this battle, the Rebel player has three Ewok traps which can be located in the village. Their locations should be noted on a copy of the set-up map before the Imperial player deploys his troops. See the "Ewok Tricks and Traps" section in the "Gamemaster Notes" for how the traps work and where they can be situated.

After the Rebel forces have been deployed, the Imperial begins the game with the first Movement Phase, bringing his squads out of the entry branches he previously determined and onto the platforms surrounding them. The first figures out of the branches measure their move from the doorway in the branch. Figures following them out may not be able to use their full Movement Rate. Play then continues as normal.

The Imperial player may withhold one of his squads for up to four turns. If he has not brought the squad out earlier, it must be moved onto the table during Turn Five.

Gamemaster Notes

The Imperials are seeking to destroy all resistance. Their objective is to wipe out the Ewoks and Rebels and obliterate the village. The Imperial player wins the game if he manages to get any eight soldiers off the table via the main road to the northwest.

The Rebel player wins if he prevents the Imperial player from achieving his victory condition.

Imperial Morale

Because they are stranded with almost no hope of recovery, the Imperial troops are very firm in their resolve. Therefore, whenever testing for Imperial morale, reduce the threat level of the test by 2. All standard modifiers still apply. The Imperials' rally point is the entry tree through which they entered the table. Imperials who rout to that point do not leave the table, though. They remain by the tree, out of sight as much as possible. They may attempt to rally in each successive Morale Phase, until they finally succeed.

The Rebel rally point is the northwest corner where the main road exits the table. Rebels or Ewoks routing off the table are out of the game.

Falling Over the Edge

The Ewok walkways are fairly sturdy — and steady — constructions. Soldiers can run on the walkways and platforms with no modifiers to movement. However, human-sized soldiers who lose their balance near the edge run the risk of

falling over, as the railings have been built with the Ewoks in mind.

Two situations can lead to a soldier falling out of the village: being wounded, or being forced back after close assault combat. A soldier who is wounded, and whose base is within 1/2" of the edge of a walkway or platform, runs the risk of falling over the edge. When the soldier is wounded, determine in which direction he falls. Center a Grenade Burst Area of Effect Template over the soldier, orienting the "1" and "4" arrows along the edge of the platform or walkway. Roll a six-sided die and check the result on the template. If the result is either of the two arrows pointing off the side of the walkway that is within 1/2" of the soldier, he falls over the edge and is removed from play. On any other roll, the soldier is laid on its side, as per the normal procedure for a wounded soldier.

An Ewok who is wounded near the edge must also determine if he falls over the edge. If the result is a fall, the Ewok may make a difficulty 4 *Strength* roll to catch himself. If successful, he does not fall and follows the normal procedure for wounds.

A soldier which is forced back after close assault combat may be forced over the edge of a

Determining Direction of Fall

The stormtrooper on the walkway is hit by blaster fire and wounded. Since he is within 1/2" of the edge of the walkway, he might fall over the edge. Center the template over the figure and orient arrows "1" and "4" with the edge of the walkway, then roll the die. In this case, if the Imperial player rolls a 2 or 3, the stormtrooper has fallen over the edge and is removed from play.

If a 1, 4, 5 or 6 were rolled, then the stormtrooper would be laid on its side, following the normal procedure for wounds.

Brian Schomburg

platform or walkway. If the force-back would cause the soldier to back over the edge, then the soldier can make an opposed *Strength* roll, pitting his *Strength* against the opposing soldier's *Strength*. If he beats the opponent's roll, he is not forced back. If he loses, he is pushed over the edge. The opposing soldier still advances on a forced-back soldier, but stops at the edge of the platform. He is not required to advance the full 4" in this case (see "Force Back and Advance After Combat" on page 30 of *Star Wars Miniatures Battles*).

Note that a soldier falling out of the village is not necessarily dead. He may have fallen into a cluster of foliage, or grabbed a vine on his way down. For the purposes of this scenario, the soldier is no longer part of the game. In the case of an ongoing campaign, or if the soldier is a roleplaying game character involved in the miniatures battle, the gamemaster can determine the circumstances of the soldier's return and what damage he may have suffered.

Ewok Tricks and Traps

The Ewoks have a special trick they can resort to during the game. Due to the abundance of vegetation, and vines in particular, an Ewok can attempt to swing across the open areas to another platform or walkway. In addition, there are a number of traps that can be set up before the start of the game.

In order to have an Ewok attempt to swing on a vine, the Rebel player chooses a target point and makes a *climbing/jumping* or *Strength* test. The difficulty of the test depends on how far the Ewok swings; it is equal to the distance traveled by swinging, rounded up to next whole number. The maximum distance an Ewok may swing is 8". The distance to the target point cannot be pre-measured. If the declared target point is more than 8" from the Ewok, then the attempt to cross the gap failed and the Ewok swings back to the starting position.

If the Ewok is successful in the *climbing/jumping* test, she swings to the designated point. If not, use the Vektored-Effect Weapon Deviation Template to determine the direction that the Ewok actually swung. Place the point of the template at the starting point of the swing, and align the "Direction of Shot" with the target point. Roll a six-sided die to see in which direction the Ewok travels. If the new swing does not reach a walkway or platform, then the Ewok swings back to its starting position.

Swinging on a vine costs half the difficulty number in inches from the Movement Rate. Note that in the case of a failed swing in which the Ewok returns to the starting point, the Ewok has traveled the distance twice, and the movement

cost is doubled. If the final movement cost exceeds the Ewok's Movement Rate, then the Ewok falls prone when it returns to its starting position.

Example: *An Ewok with a Walk Rate of 5-1/2", wishing to swing over to a nearby platform, walks 1" to the edge of the platform he is on. He declares where he wishes to swing to — it is a point 5-3/8" from where he is (the distance is measured after the destination is declared). The Ewok makes a climbing/jumping test against a difficulty of 6 (5-3/8 rounded up). Succeeding in his roll, the Ewok swings to the target point, using up an additional 3" (half of the difficulty number of 6). The Ewok may still walk another 1-1/2" after arriving on the destination platform.*

If the Ewok had failed the skill test, it would instead return to its starting point, expending 6" of its Movement Rate in the process. Since the total movement cost of 7" (walking 1" plus the swinging cost of 6") is greater than the Ewok's Movement Rate, the Ewok falls prone upon returning to the starting point.

Rebels and Imperials may also attempt to swing on a vine, but the difficulty number for these soldiers is increased by 2 (due to their lack of experience with this form of locomotion). If a human bombs out while attempting the skill roll, she falls off the vine and into the forest below — the figure is removed from the game.

Due to the recent battle with the "white-shells," there are still a number of traps located around the village. In addition to the traps that were laid on the forest floor to combat the Imperials, these traps were placed in the village as a defensive measure. There are three remaining traps which have not yet been dismantled. Before the game begins, the Rebel player should note the location of each of these traps, preferably on a copy of the set-up map. All of the traps must be located west of the Trap Set-up Line indicated on the set-up map

There are three types of trap. The "log pincers" trap consists of two logs suspended in the trees in such a way that they will crash together end to end when the trap is sprung, crushing whatever stands between them. (A "log pincer" trap was used to crush an AT-ST in *Return of the Jedi*.) The area of effect for the log pincers is 1" wide x 6" long. Any soldier caught in this trap must test his *Strength* against a *Damage Strength* of 8.

The second trap — the "log sweep" — is a log suspended by two vines that will swing across the designated area when released, sweeping along whomever was standing there at the time. The log is 3" wide and sweeps an area 4" long.

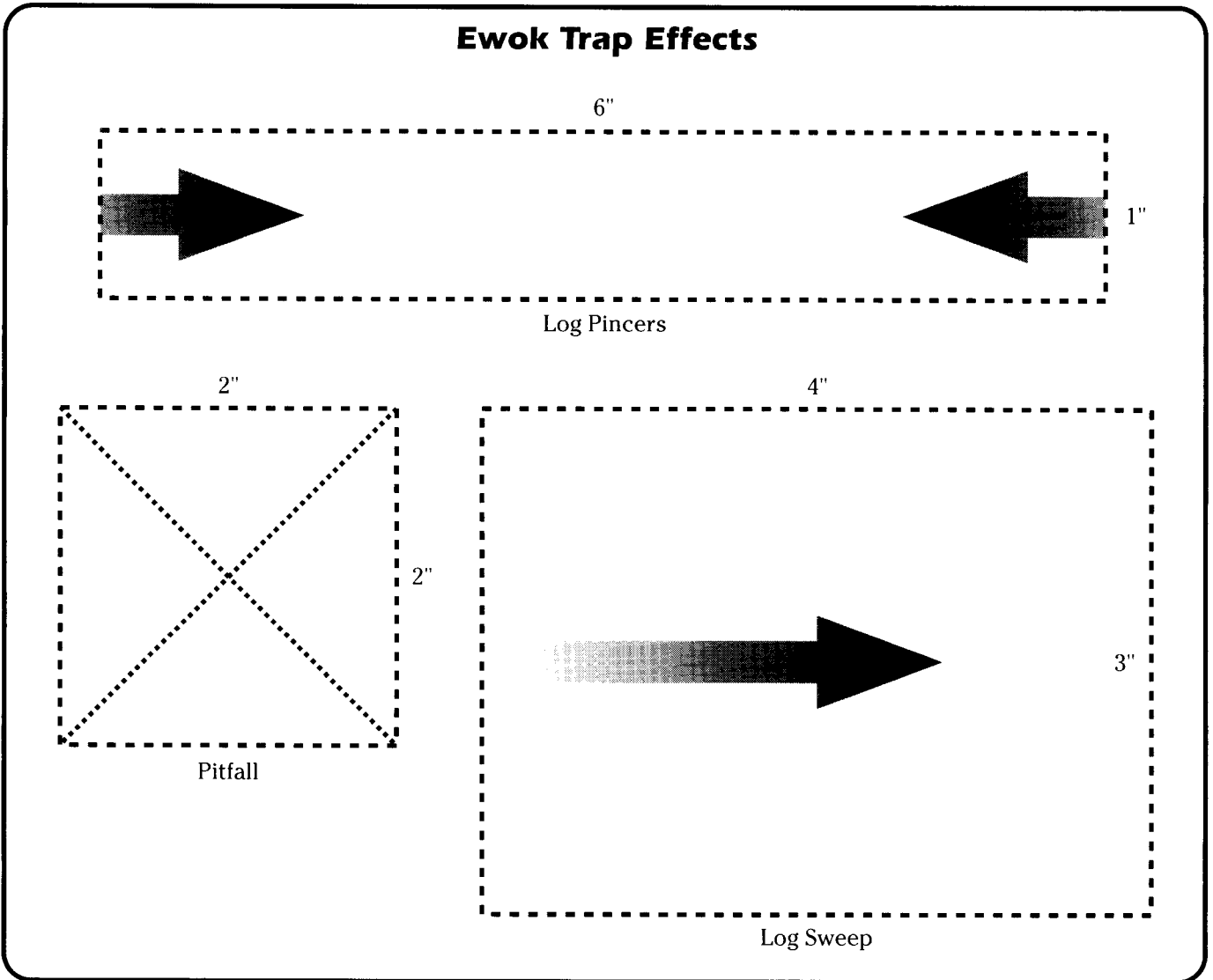

Brian Schomburg

When the Rebel player notes this trap on the set-up map, she should indicate in which direction the log will swing. Anyone hit by the log tests for damage against a *Damage Strength* of 6. All soldiers caught by the trap are placed on their sides at the far end of the sweep, whether they were damaged or not. If this trap is placed in such a position that it ends its sweep at the edge of a walkway or platform, any soldier caught by the log is swept off the edge and falls into the forest (and is therefore removed from the game).

The last trap — the “pitfall” — consists of loose flooring on a walkway or platform, so that the slats will fall away when stepped on, dropping the victim into the forest below. The trap covers a 2" x 2" area. When activated, any soldier with at least half its base within the area of the trap falls through to the forest below and is removed from the game. Once the trap has been activated, place a 2" x 2" marker on the location

of the trap; this is now open to the forest below (color the marker green or black to represent the opening). Any soldier walking over the marker falls through, and soldier wounded within 1/2" of its edge must check to see if he falls over the edge. If this trap is placed on a walkway so that less than 1" remains between the edge of the trap's opening and the edge of the walkway, then the walkway will be rendered impassable once the trap is sprung (of course, that may be what the Rebel wants to happen).

It is assumed that once the battle begins, some non-combatant Ewoks have moved into position to man the traps, so they can be sprung at the best possible time. In other words, the Rebel player may choose when during the Movement Phase to spring a trap, waiting to catch as many Imperials as he can. However, if the Rebel forgets to spring a trap before the victims move out of range, he'll just have to wait for another opportunity.



It is possible for victims to avoid a trap. When the trap is sprung, each soldier subject to its effects may make a *Perception* test against a difficulty of 8. If successful, the figure is moved adjacent to the area of effect and placed on its side (with the exception of the log sweep — in that case the figure is laid down right where it was standing). The soldier is now prone, but safe. If the test is failed, the victim suffers the full effects of the trap.

Ewok Weapons and Supply

Each Ewok is armed with two spears and a knife at the start of the scenario. These weapons can both be used in close assault combat using the *melee combat* skill. The spears can also be used as ranged weapons, using the *thrown weapons* skill. Spears are thrown in the Fire Combat Phase. Note that spears cannot be thrown from a prone position.

Each Ewok can carry two spears. Only one can be thrown per turn. The ranges for a thrown spear are as follows — short: 1.5"; medium: 2.5"; long: 5".

Once an Ewok has thrown both spears, she can no longer act in the Fire Combat Phase. The Ewok can then only fight in close assault combat, either using *brawling* or *melee combat* (using its knife) against an opponent. If an Ewok goes to a storehouse, though, she can come out with two new spears. The Ewok must enter the storehouse

in order to pick up the spears. It costs half the Movement Rate to find and pick up two suitable spears. If an Ewok does not have enough movement remaining to do so, it must wait until the next Movement Phase to enter the storehouse. If an Ewok has a sufficient Movement Rate, it may enter the storehouse, pick up its spears and leave again in the same turn.

Any Ewoks remaining in a storehouse have an unlimited supply of spears, which they can throw from the windows and door.

One of the Ewoks also has a blaster pistol, which he found after the Battle for Endor. He managed to practice firing it without killing himself, and has become somewhat proficient with it. This is the specialist in the Vine Runners squad. If he is incapacitated, then the blaster is lost (it skitters across the platform and falls into the forest far below).

Setting Up the Terrain

Creating the village in the trees is not as difficult as it might at first seem. You don't really need to build or buy a vast amount of model trees. You will, however, need a few bags of lichen. You may already have some, otherwise you can purchase them in a hobby shop or a model railroad store. A piece of green fabric large enough to cover your table would be good, also, but is not absolutely required. The fabric can be felt, or some other type of material.

First, spread the fabric over the table. Then cover it with a thin layer of lichen. The fabric is optional, as stated above — its primary purpose is to keep the color of the tabletop from showing through the gaps in the lichen covering.

The tree trunks can be made from different sizes of cardboard tubes. Smaller trees can be made from paper towel cores; these can be scattered throughout the layout. It is also possible to use actual pieces of real branches to represent the large trees: ask a friend who has a fireplace or wood-burning stove.

The big trunks, particularly the storehouses, can be made from round oatmeal packages. Cut out the windows and doors in the appropriate positions. It may be necessary to put in a floor that is high enough to clear the layer of lichen. Out of cardboard, cut a circle with a diameter slightly less than that of the container used for the tree. Leave three or four tabs evenly spaced around the edge of the circle. The tabs should be as long as the layer of lichen is high. Fold the tabs

down and insert the circle into the container — a quick and simple floor.

The walkways and platforms can be made out of strips of cardboard. Cut out a series of 3" wide strips to use for the connecting walkways. The walkways surrounding trees can be made by piecing together short lengths of straight walkway, or by cutting circles out of cardboard that are 6" larger in diameter than the tubes they are surrounding. Then cut out the center of the circle so that it can be slipped over the trees. Platforms can be cut to shape from the same cardboard. You may also want to draw a light line or a dotted line 1/2" in from the edges of the walkways and platforms as a quick guide to which soldiers would need to check for falling from the village if wounded.

Since this is an Ewok village, everything should look rough-hewn, so you do not have to worry about the edges of the strips and circles. The wooden slats making up the walkways can be drawn right onto the cardboard. Then place the



Contingency Orders Imperial Commander 347.609/D5 (or replacement)

Commander: If you are reading these orders, things have not gone well. You are hereby ordered to make all efforts to locate and link up with any elements of our forces and report back to Assault HQ with all haste and by whatever means necessary for new orders and redeployment.

Should this prove impossible, you are to harry the enemy at all opportunities, eliminating all threats and destroying the enemy's support and logistics capabilities, wherever you may find them, and for as long as you are able.

Having regrouped with additional elements, you have been carrying out the second part of your orders. Now, your scout elements have reported finding the way into a village of the vile furballs who have caused you so much trouble. It's time to make them pay. Besides, you're tired of eating lizards and bugs; maybe the furry little vermin will taste good roasted.

You enter the village from either or both of the large hollow trees on the east side of the map (trees 1 and 2). Indicate which entry point each squad will use before the game begins. After the Rebel player has set up, you get the first move. Bring on your squads in any order, subject to your Movement Rate. You may hold back one squad for four turns; in Turn Five it must begin to enter the table.

Victory: Get at least eight soldiers off the table via the wide walkway to the northwest, so that they can wreak havoc in the village.



Orders of the Day Alliance Commander Bren Harvist

Commander: You've got mop-up duty, Bren. You have been assigned to the Ewok village in Sector 5-7 to help the natives get things back in order. Do what you can to help them. The situation has pretty much settled down, and we have a lot of other pressing concerns, so you'll be on your own. We don't anticipate any problems.

If there is trouble, keep the safety of our diminutive allies in mind, but remember, they are effective fighters in their own right, so don't feel obliged to coddle them.

The Ewoks have three traps already in position in the village. See me about how they work. Mark their positions on a copy of the set-up map before the game begins.

You set up after the Imperial player has chosen his starting positions. Your Rebel squad may be placed on any walkway or platform west of the Rebel Set-Up Line, but not inside the storehouse. The Ewoks may be set up on any walkway or platform west of the Ewok Set-Up Line. No more than one-third of the Ewoks may start around trees 3 and 5; the rest must be located near tree 4 or on the main walkway heading northwest. Ewoks may be placed inside the storehouses or hut; they are deployed hidden — indicate their positions on a copy of the set-up map.

Victory: Protect the village: don't allow any Imperials to get off the table to the northwest.



walkways and platforms directly on top of the layer of lichen in the appropriate positions. You can affix them to the trees so they are a bit more secure, and there you have a nice basic Ewok village.

Of course, you can get more elaborate if you wish. The walkways can be made more realistic-looking if you glue down strips of wood across

them, instead of just drawing the boards in. You can chop up flat wood toothpicks or coffee stirrers to use for boards. Popsicle sticks could work also, but may be a little too thick and large, even when cut down. The trees themselves can be textured with putty or spackle and then painted. You could also attach smaller branches to the "trunks" and perhaps glue on some clumps of lichen. Of course, there's also nothing to stop you from constructing an even more detailed Ewok village suspended a foot or so above the table, if you really want to go for an impressive effect. However, that sort of thing may be a bit too involved for the average player, especially for a one-time game.

Figure Notes

Rebel troopers can be used from any of the *Rebels* or *Rebel Troopers* packs (40405, 40406, 40413, 40421), but the most appropriate-looking figures for a battle on Endor are found in *Rebel Commandos 1* (40414) and *Rebel Commandos 2* (40417), as well as *Rebel Troopers 4* (40421).

Ewoks are available in the *Ewoks* pack (40438). You may also choose to use Ewoks from the Galoob *Micro Machines Ewoks* figure set, although these figures are out of scale with the other figures.

Any of the *Stormtroopers* packs (40403, 40404, 40409, 40416) or the *Sandtroopers* pack (40428) are good for the stormtroopers, and the scout trooper squad comes from *Scout Troopers* (40433).

Scenario Three Hammer of Destiny

The Situation

Sweeping across the lava plains of Turak IV, two repulsortank battalions of the Hell's Hammers regiment have succeeded in taking the forward positions of the Rebel forces. Consolidating their position, they await infantry support to hold their objective. Unfortunately, the ineptitude of General Maltaz leaves the Hammers vulnerable as Rebel forces counterattack from their bases hidden in the Hitak Mountains, resulting in the loss of almost every tank.

However, not every tank was destroyed in the final assault. Bringing up the right flank during the initial advance, Hammer 4:3 sustained damage to its repulsorlift units, careening into a cluster of lava columns. While the remaining tanks of squad four continued to race forward, the crew of 4:3 debarked to take cover away from the enticing target of an immobile repulsortank.

Advancing Rebel forces did indeed take note of the downed repulsortank, but more as a valuable acquisition than as a target. Coming back its position, they continued their advance on the exposed regiment. The local Alliance Operations HQ has mobilized several reserve squads to reconnoiter the situation and retrieve the vehicle if possible.

At the same time, the Hammers' Regimental Command has dispatched its own retrieval team. The team is to neutralize and secure the area so that the unit's engineers can bring in a repulsorlift barge and effect recovery of the vehicle. Not only is this standard procedure, but it is a matter of regimental pride. Their mission is to make sure that the repulsortank stays in the hands of the Hammers.

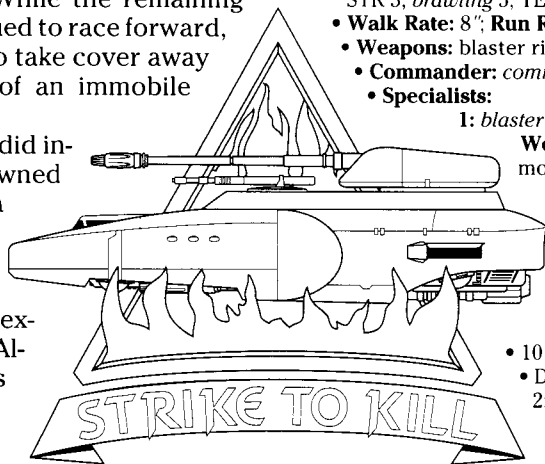

Imperial Forces

The retrieval force consists of two squads of Imperial army troopers, cross-attached from Battlegroup Turak, and operating in conjunction with the Hammers' support arm. Their job is to clear the area around the repulsortank by eliminating any enemy presence.

In addition to the retrieval force, the tank's crew is available to the Imperial player. They have holed up in a cavern in the lava formation to the northeast of the tank and become available after the main force arrives.

■ Squad 5-Aurek

- 10 Veteran Imperial Army Troopers.
- DEX 3, *blaster* 5, *melee combat* 4; KNO 1; MEC 1; PER 2; STR 3, *brawling* 5; TEC 1; Move: 10.
- **Walk Rate:** 8"; **Run Rate:** 13".
- **Weapons:** blaster rifle, vibroblade.
- **Commander:** *command* 4.
- **Specialists:**

1: *blaster* 6.

Weapon: repeating blaster (tripod-mounted).

2: *grenade* 5.

Weapon: 3 fragmentation grenades.

• **Squad Generation Points:** 583.

■ Squad 5-Cresh

- 10 Average Imperial Army Troopers.
- DEX 3, *blaster* 4; KNO 1; MEC 1; PER 2; STR 3, *brawling* 4; TEC 1; Move: 10.
- **Walk Rate:** 8"; **Run Rate:** 13".
- **Weapons:** blaster rifle, vibroblade.
- **Commander:** *command* 3.

• **Specialist:** *blaster* 5.

Weapon: repeating blaster (standard configuration).

• **Squad Generation Points:** 430.

■ Hammer 4:3 Crew

- 5 Elite Imperial Army Assault Troopers.
- DEX 3, *blaster* 4, *vehicle blasters* 4; KNO 1; MEC 4, *repulsorlift operation* 6; PER 2; STR 1, *brawling* 3; TEC 1; Move: 10.
- **Walk Rate:** 8"; **Run Rate:** 13".
- **Weapons:** blaster carbine, blaster pistol.
- **Commander:** *command* 5.
- **Specialist:** *vehicle blasters* 6.
- **Specialist:** *vehicle blasters* 5.
- **Squad Generation Points:** 336.

Rebel Forces

The reconnaissance and acquisition team dispatched by Alliance Operations consists of two reserve squads from the Hitak Harriers — as the Rebel forces based in the Hitak Mountains call themselves — and a team of Rebel techs who are to examine the tank to determine if it is salvageable and worth recovering.

■ Hitak Harriers, Red Squad

- 10 Veteran Hoth Troopers.
- DEX 3, *blaster* 5, *vehicle blasters* 4; KNO 2; MEC 2, *repulsorlift operation* 4; PER 2, *command* 4; STR 3, *brawling* 4; TEC 2; Move: 10.
- **Walk Rate:** 8"; **Run Rate:** 13".
- **Weapons:** blaster rifle.
- **Commander:** *command* 5.

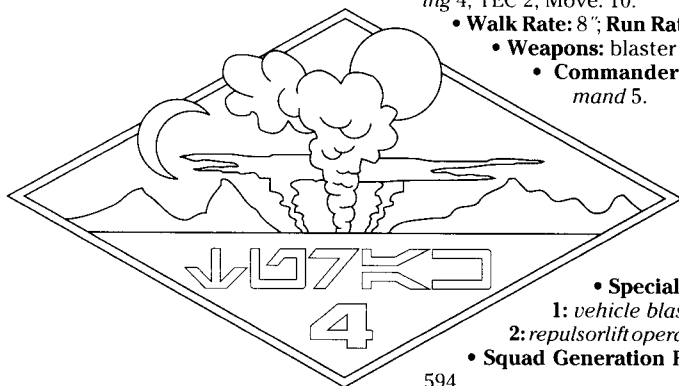

- **Specialists:**
1: *vehicle blasters* 6.
2: *repulsorlift operation* 5.
- **Squad Generation Points:** 594.

■ Hitak Harriers, Green Squad

- 10 Veteran Hoth Troopers.
- DEX 3, *blaster* 4; KNO 2; MEC 2, *repulsorlift operation* 3; PER 2, *command* 4; STR 3, *brawling* 4; TEC 2; Move: 10.
- **Walk Rate:** 8"; **Run Rate:** 13".
- **Weapons:** blaster rifle.
- **Commander:** *command* 5.
- **Specialists:**
1: *blaster* 5.
Weapon: repeating blaster (tripod-mounted).
2: *repulsorlift operation* 6.
- **Squad Generation Points:** 588.

■ Hitak Harriers, Tech Team

- 6 Veteran Hoth Troopers.
- DEX 3, *blaster* 4, *vehicle blasters* 5; KNO 2; MEC 2, *repulsorlift operation* 5; PER 2, *command* 4; STR 3; TEC 3, *repulsorlift repair* 5; Move: 10.
- **Walk Rate:** 8"; **Run Rate:** 13".
- **Weapons:** blaster pistol.
- **Commander:** *command* 5.
- **Specialists:**
1: *repulsorlift operation* 6.
2: *repulsorlift repair* 6.
- **Squad Generation Points:** 315.

The Battlefield

The mission takes place on one of the many lava plains that cover this region of Turak IV. The plains are created by the near-constant lava flow from the adjoining mountains. Lava flows down and spreads across the plains, eventually cooling and creating a hard, level surface. Additional formations are caused as lava pockets seep up onto the plains from below. Occasionally a steady stream of molten rock oozes through, forming lava pools.

There are also rough spots on the plains, caused when the substructure of the plains shifts, cracking the surface and shattering large patches of the cooled rock, which form large irregular piles of rubble. It is in one of these mounds that the repulsortank's crew has taken shelter.

The tank has come to rest on a portion of the plain near a large hill of rubble. The terrain is predominantly clear, but is dotted with patches of rubble that are rough terrain. There are also a number of lava columns scattered across the plain. The columns are about 1/2" in diameter and stand from 2"–6" high; they are impassable and block line of sight (LOS). Some of the columns have fallen or been knocked down. They provide medium cover to soldiers standing behind them, and are moderate barriers to movement. Fallen lava columns do not block LOS.

There are also a few ridges on the battlefield. They are 1/2" high. Crossing the edge of a ridge costs 2" of movement (either moving on or off). The ridges are flat on top, so movement on top of a ridge incurs no additional movement cost.

The hill of rubble is located at the northeast corner of the table. This is an irregular hill of broken rock sloping up to 2" high at the corner. It is possible to scramble across its surface, but it is very rough terrain. There is a cave located in the face of the hill. It is 3" across and situated at the end of a short trail that leads up from the plain. The trail is rough terrain. This is the cave that the tank's crew begins the game inside. The inside is little more than a hollow spot in the pile of rubble. It is a rough circle about 4" in diameter, leaving little room for movement or combat.

Up to three soldiers may fire from the cave at one time. Soldiers firing from the cave are subject to being fired upon; they can be seen by their targets. Soldiers further back in the cave cannot be seen or fired on.

The tank itself is lodged in a cluster of lava columns near the middle of the table. It is described below in the "Gamemaster Notes" section. The tank blocks LOS. Soldiers standing on the far side of the vehicle from enemy soldiers cannot be seen or fired at. Soldiers on top of the vehicle can be targeted, or can fire at soldiers alongside the tank on the ground. It requires 3" of movement to clamber onto the tank or to jump down from it, and the surface of the repulsortank counts as rough terrain. The main turret provides medium cover to soldiers on top of the tank, if the enemy has to fire across it to hit the soldiers.

The geology of the plain has recently become unstable, leading to some dangerous developments. See the "The Obstacles" section in the "Gamemaster Notes" for the details.

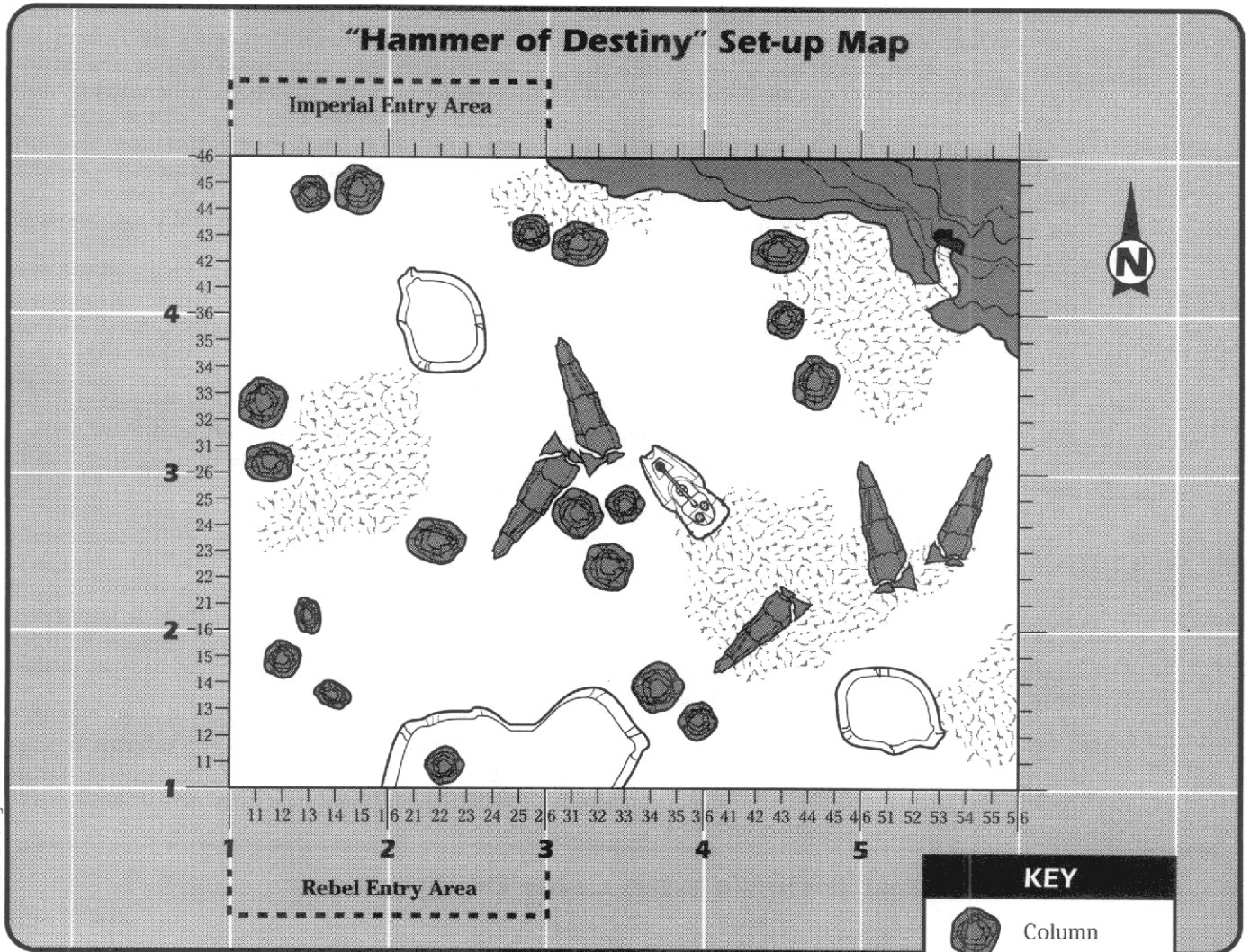

The Set-Up

The Rebel recon-and-acquire squads, and the tech team, set up along the west 24" of the south table edge, no more than 6" from the edge.

The Imperial retrieval squads set up along the west 24" of the north table edge, no more than 6" from the edge. The tank's crew begins the game hidden, inside the cave located in the pile of rubble to the northeast. They will remain inside the cave until they draw a line of sight to one of the other Imperial squads. At that point, they are free to leave the cave at the Imperial player's discretion.

The Rebel and Imperial player should set up simultaneously. Roll for initiative normally to determine who gets to move first. The side which gains initiative may move first or allow the other side to move first.

Gamemaster Notes

The objective for both sides is relatively simple. The Imperials are trying to clear the table — they must eliminate all the Rebels or force them off the





table. This will secure the retrieval zone so that the Hammers' recovery barge can come in and pick up the tank.

The Rebels are trying to do a little more. They need to determine if the tank is salvageable (it is), and then attempt to recover it. They can do that in one of two ways. They can try to repair it under fire and drive it away, or they can eliminate all Imperial troops in the area so that a better-equipped team can come in and grab the vehicle. It is a Rebel victory if they can get the tank off the south edge of the table, or if they eliminate or drive off all Imperial troops.

The Rebels' rally point is on the west side of the ridge along the south edge, behind the lava columns. The Imperial rally point is the north-west corner of the table.

The Objective

The reason for all of this activity is the downed tank: Hammer 4:3. Unit 3 of the 4th Squadron

KEY	
	Column
	Cave entrance
	Rough terrain
	Ridge (1/2" high)

(Armor Troop Zerek) is an S-1 FireHawke, a heavy repulsortank developed and manufactured by Gorm•Talquist, a heavy industries conglomerate, and in common use throughout the Imperial Army.

After taking a direct hit during its advance, the tank's repulsortank units were damaged and it crashed to the ground, skidding along and smashing through the terrain until it came to rest in a cluster of lava columns. The crew withdrew from the vehicle rather than be sitting ducks. With the exception of its repulsortanks, the tank is still functional. Its main and secondary guns still work. They can be traversed and fired (to do so requires the *vehicle blasters* skill).

The Imperial objective does not require that any soldiers enter the tank, although they may wish to do so in order to use the weapons, or to deny access to the Rebels.

The Rebels must enter the tank, however. They need to get at least one member of the tech team into the tank to check out its condition (follow the boarding rules on pages 20–21 of the *Star Wars Miniatures Battles Companion*). If the tech remains in the tank for one turn, without doing anything else, he can determine that the tank is still functional. He will also discover that the repulsors can be repaired.

To do a thorough job on the lift units requires the proper facilities, but the repulsors can be jury-rigged to raise the vehicle and give it limited

propulsion. The field repair will require at least three turns of dedicated work by two of the technicians, one working inside the vehicle and the other outside. The tech on the outside must be adjacent to the back edge of the tank. The techs can do nothing else in the turns they are working on the tank, and if they are disturbed in any way (being wounded or involved in close assault combat, for instance) they cannot make their repair attempt.

During the Special Actions Phase of the first repair turn, each technician must make a *repulsortank repair* test with a difficulty of 10. During the next Special Actions Phase, they must each make another *repulsortank repair* test, again with a difficulty of 10. In the Special Actions Phase of the third turn, each tech must make a *repulsortank repair* test, this time against a difficulty of 6.

If either tech fails a roll, he may attempt it again in each following turn, until he succeeds. He may then continue with the additional rolls in successive turns. The failure of one tech does not affect the progress of the other. It is entirely possible for one technician to be done with his repair rolls while the other one has yet to succeed on his first attempt.

Additional techs may assist with the repairs. Technicians assisting with the interior repairs must, of course, be inside the vehicle. Techs assisting on the exterior must also be adjacent to

Unit Insignia with Color Designation

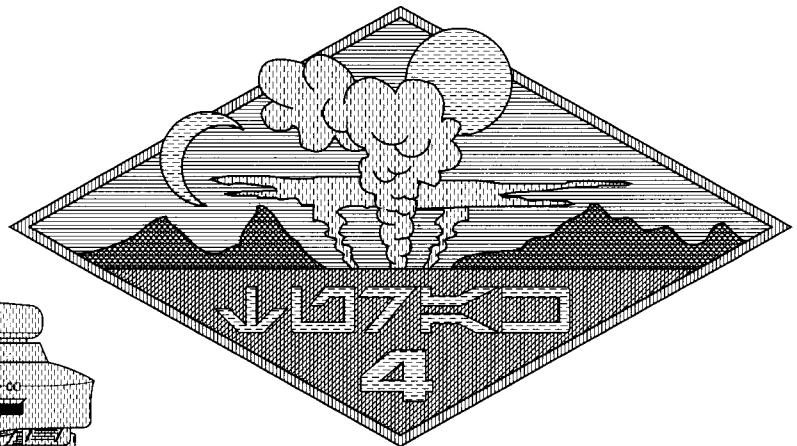
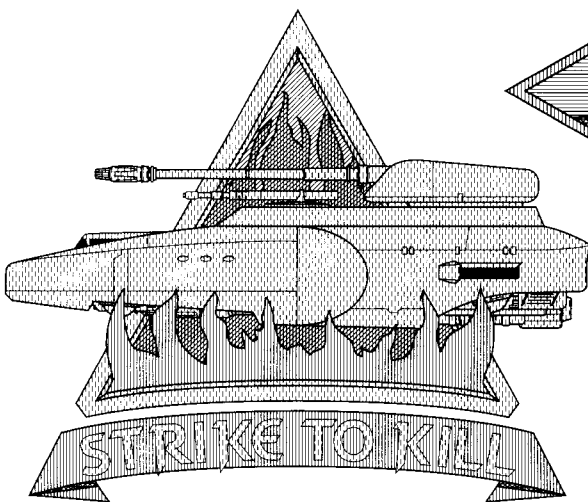

the back of the tank, and in base-to-base contact with one of the other techs performing the repairs. No more than three technicians may work on either the interior or exterior repairs at one time. When additional techs are assisting, each of them may make the same skill roll in that turn, if necessary. So, if three techs are working together at the back of the tank, and the first one misses his roll, there are still two more opportunities for this step of the repair to be completed in this turn, as each of the additional techs may attempt the roll, also. Multiple successes by two or more techs do not speed up the repair process; it still requires one successful roll per turn.

When both series of repair rolls have been completed, the tank's drive system is functional — to a limited extent — and the tank may be moved. Use the statistics presented below in brackets when moving the jury-rigged repulsortank. Any technician or other soldier may drive the tank if he has the *repulsorlift operation* skill, and movement is performed normally.

A soldier without the skill may attempt to drive the tank, also, but at a penalty. The driver must make a skill roll (using his *Mechanical* attribute) for *any* maneuver performed, even for normally free turns or for driving in a straight line. The difficulty number for those actions is 4. Note that the Flight Ceiling for the jury-rigged tank is only 1 meter. This means that the tank will not be able to cross fallen lava columns, but must instead go around them.

As stated above, the repulsortank's weapons are still functional (even if the unit's repulsorlift drives are not repaired). However, the vehicle's fire control systems were damaged when it crashed, so any fire attempts must be made with the gunner's unmodified skill. Any soldiers entering the vehicle may assume the gunners' positions and fire the weapons once they are warmed up. It will take one turn, once inside the tank, to power up the weapons. The fire control systems cannot be repaired in the field.

Remember to keep track of how many soldiers are in the repulsortank at any one time. There are positions for five crewers, as well as space for one passenger. Soldiers can board the tank to assume the gunners' positions and the driver's position, but there may also be technicians inside the vehicle performing repairs. Repairs are performed from the additional crewers' positions or the passenger's position.

We have provided a template in the shape of the tank with the six interior positions indicated on it. Keep the template alongside the table. Then, when a soldier or tech enters the tank, you can place that figure on the corresponding space on the template. That way there will be no question as to where a particular soldier is.

Using the FireHawke in the Roleplaying Game

You may wish to use the S-1 FireHawke in a roleplaying adventure, either as an objective, or as a means to one. Given below are the roleplaying game stats for the tank.

■ S-1 FireHawke Heavy Repulsortank

Craft: Gorm•Talquist S-1 FireHawke
Type: Heavy repulsortank
Scale: Speeder
Length: 10.1 meters
Skill: Repulsorlift operation: S-1 FireHawke
Crew: 3, gunners: 2
Crew Skill: Repulsorlift operation 4D+2, vehicle blasters 5D
Passengers: 1
Cargo Capacity: 50 kilograms
Cover: Full
Altitude Range: Ground level–2 meters
Cost: Not available for sale
Maneuverability: 1D+2
Move: 140; 400 kmh
Body Strength: 4D+2

Weapons:

Heavy Laser Cannon

Fire Arc: Turret
Crew: 1
Scale: Speeder
Skill: Vehicle blasters
Fire Control: 2D+2
Range: 200–1/3/5 km
Damage: 6D

Medium Blaster Cannon

Fire Arc: Left/front/right
Crew: 1
Scale: Speeder
Skill: Vehicle blasters.
Fire Control: 1D+1
Range: 50–200/500/1 km
Damage: 3D+2

■ Gorm•Talquist S-1 FireHawke Heavy Repulsortank

Note: Numbers in [brackets] are the values for the tank in its partially repaired state.

- **Drive System:** Repulsorlift.
- **Crew:** 5.
- **Passengers:** 1.
- **# Turns:** 2 [1].
- **Turn Distance:** 3 [4].
- **Move:** 140 [10].
- **Cautious Speed:** 14 [1].
- **Cruise Speed:** 42 [3].
- **Top Speed:** 140 [10].
- **Accel/Decel:** 14/14 [1/1].
- **Flight Ceiling:** 2m [1m] (Low Level).
- **Body Strength:** 10.
- **Body Points:** 100.
- **Cover:** F.
- **Weapons:**

Heavy Laser Cannon (315 SGPs)

Fire Arc: T.
Crew: 1
Skill: Vehicle blasters.
Fire Control: 3 [0].
Range: 100–500/1,500/2,500.

Gorm Talquist S-1 FireHawke Heavy Repulsortank

Top View

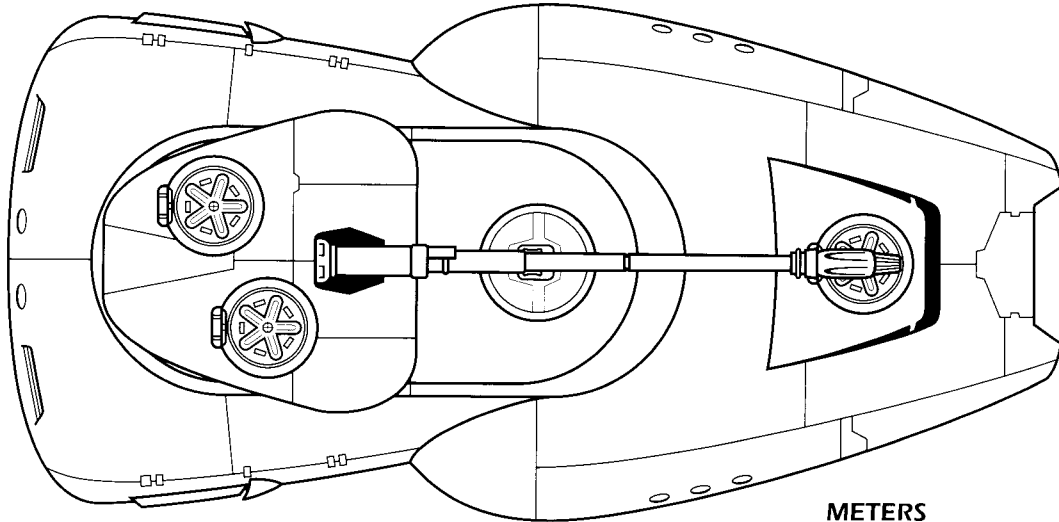

METERS



Side View

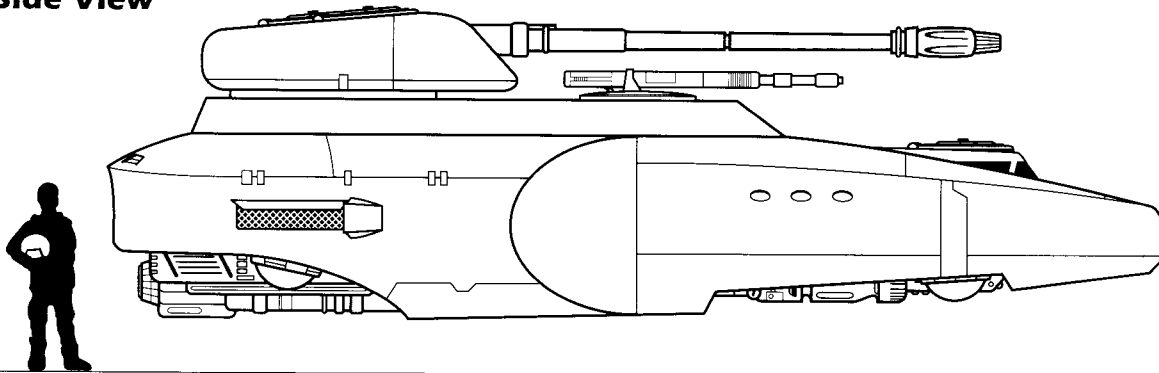

Damage: 12.

Notes: Not capable of following fire.

Medium Blaster Cannon (64 SGPs)

Fire Arc: LFR.

Crew: 1

Skill: Vehicle blasters.

Fire Control: 1 [0].

Range: 25-100/250/500.

Damage: 8.

Notes: Following fire.

• **Squad Generation Points:** 542.

Representing the Tank

West End Games does not currently have a repulsortank in its vehicle miniatures line. There are, however, a number of options.

The first is to buy another commercially available tank miniature. Ground Zero Games makes

an excellent line of 25mm resin science fiction vehicles, including some grav-tanks. GZG is located in the U.K., but their lines are available in the U.S. from Capricorn Space, a division of Geo-Hex. See their address on page 96 of this book.

Alternatively, you could represent the tank with a plastic toy, perhaps modifying it a bit by cutting off parts or gluing on others, or giving it a different paint job. A simpler method would be to build a simple box out of cardboard at the appropriate size (the tank would be about 5" long, 3" wide and 1-3/4" high). You can then draw the various views of the tank onto the different sides of the box.

Lastly, you can use a cardboard template representing the shape of the tank. We have pro-

Repulsortank Templates

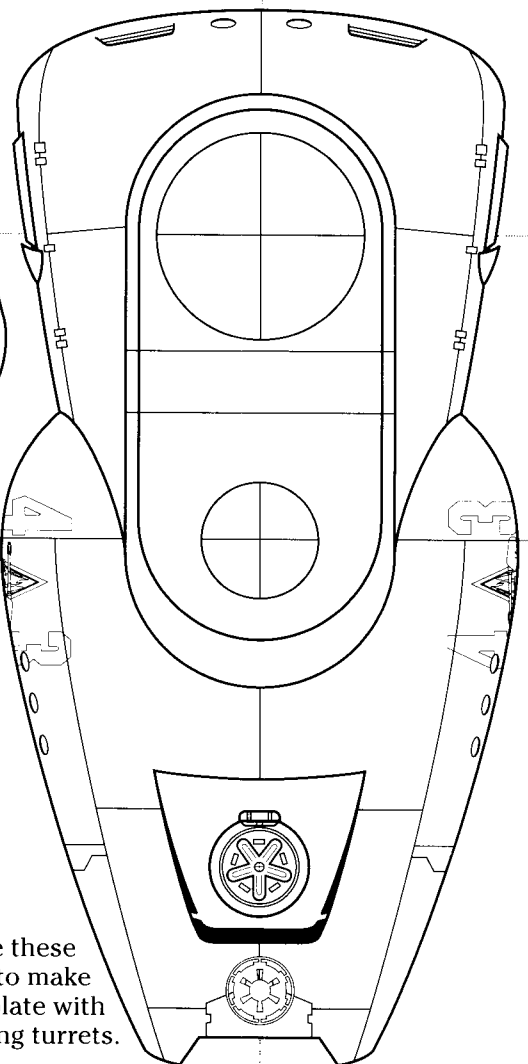
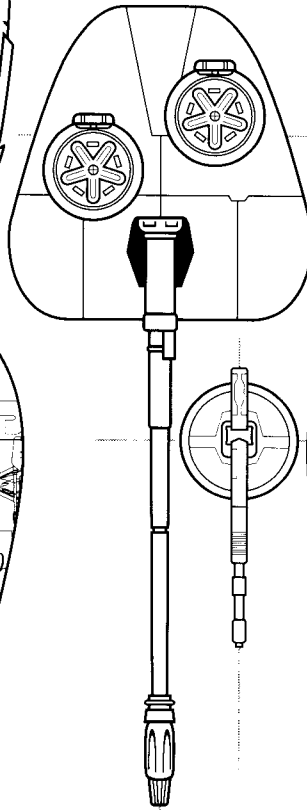
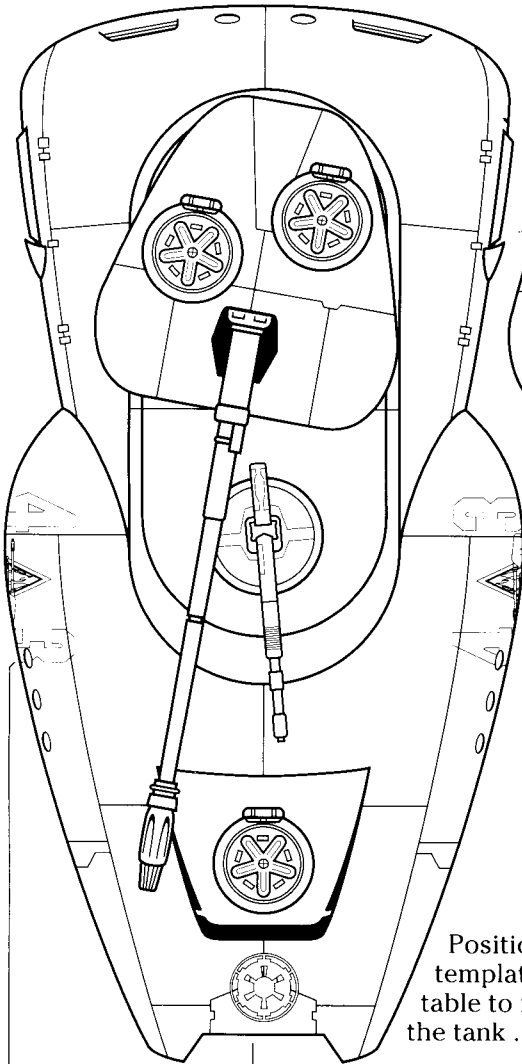

Position this template on the table to represent the tank ...

... Or use these pieces to make a template with rotating turrets.

- Unit numbers are painted red.
- The Imperial symbol is navy blue.

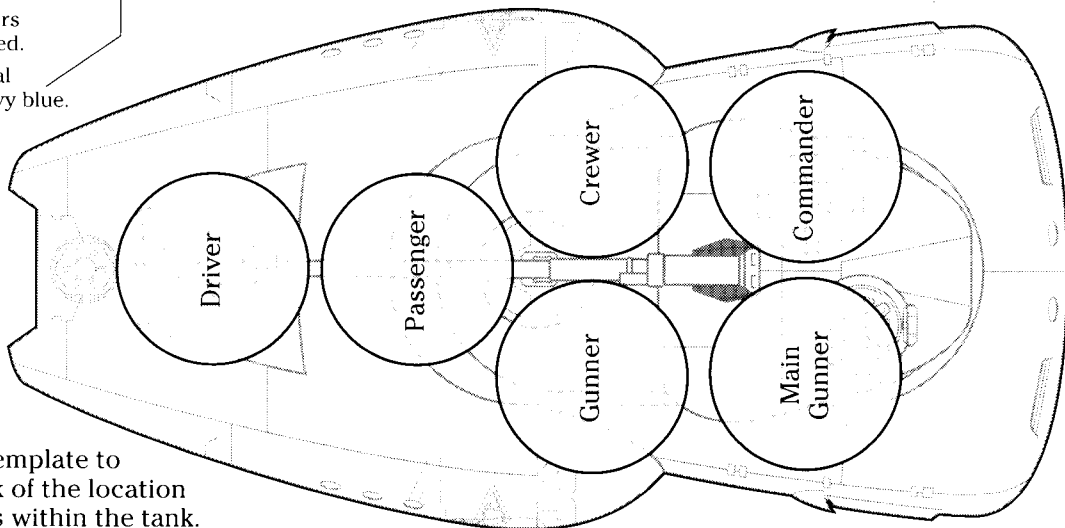

Use this template to keep track of the location of soldiers within the tank.

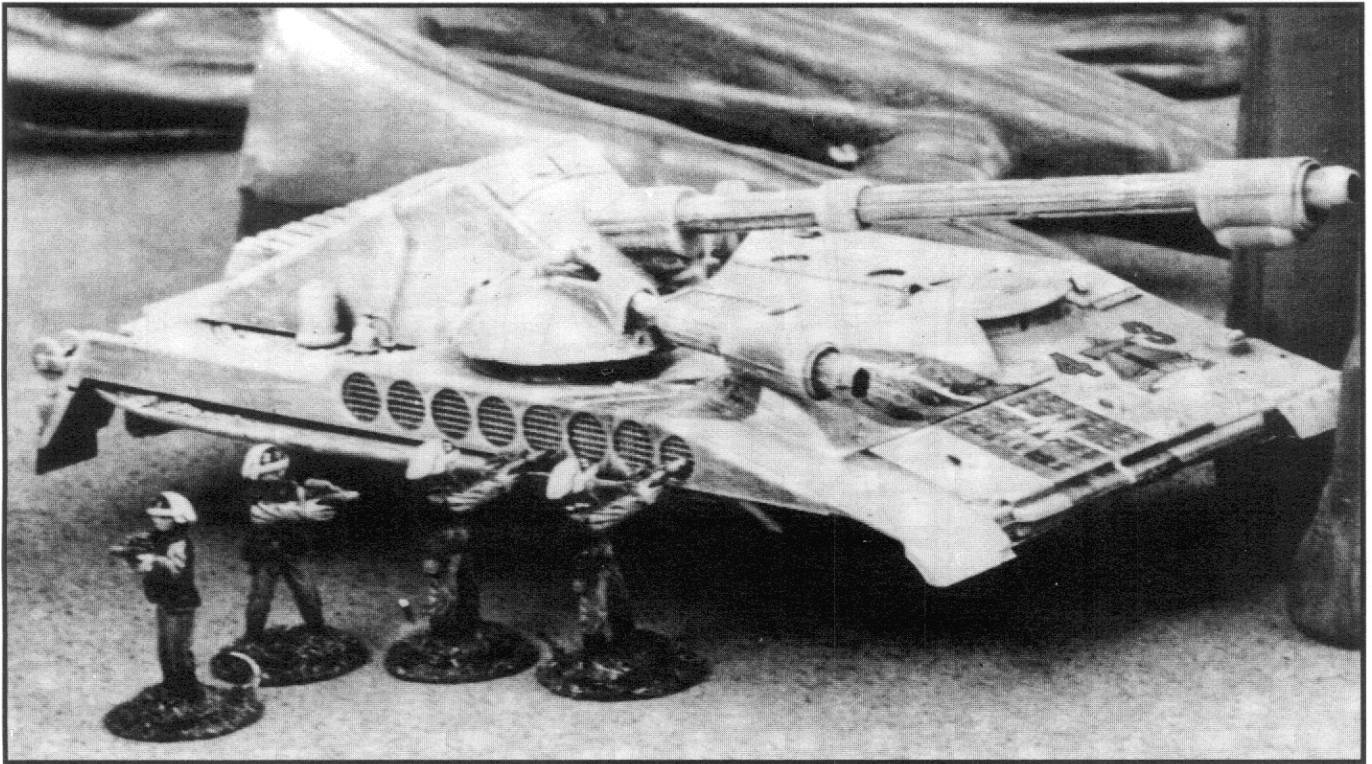

vided a top view of the S-1 FireHawke, drawn in scale with the miniatures. Photocopy the page, then glue it to some heavy cardboard and cut it out. You can then place the template on the tabletop to represent the repulsortank on the battlefield.

Hammer 4:3 is an Imperial Army vehicle, and so is painted in traditional Imperial gray. However, it also bears the markings of the Hell's Hammers unit. The Hammers is one of those rare regiments that can get away with decorating its vehicles. Because of the proud tradition of the Hammers and its value to the Imperial military, it retains a certain independence of action, and Imperial Command is willing to tolerate some idiosyncrasies in light of the regiment's performance.

In addition to the symbol of the Hammers, the tank's unit designation is displayed on its sides. The vehicle also bears the emblem of the Galactic Empire (see page 56 of *Star Wars Miniatures Battles Companion*).

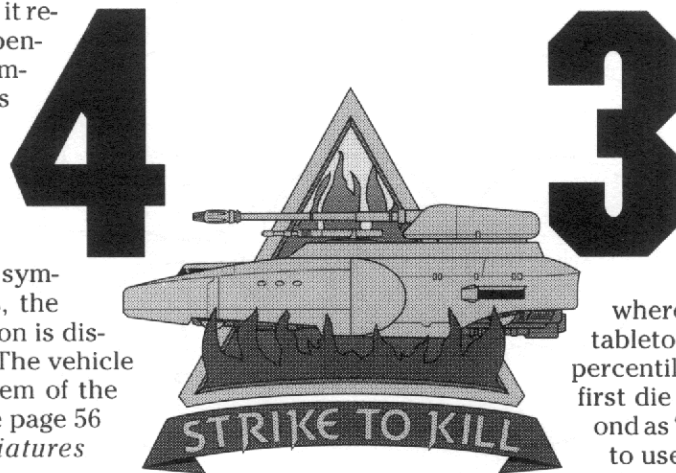

■ Unit designation numbers are painted on a vehicle in red.

The Obstacles

Aside from the fixed physical obstacles, there is another geological obstacle to the success of both sides' missions. The heavy volcanic activity in the region has rendered the planetary crust beneath the plains unstable. The magma which normally seeps up from below the plains is now being repeatedly ejected quite vigorously through the unstable crust, resulting in frequent lava geysers. These geysers are extremely hot and forceful, and pose a major hazard to any soldier caught near one.

Roll for geysers each Special Actions Phase. Roll a six-sided die and halve the result (rounding up) — that many geysers burst forth from the ground.

Then roll two six-sided dice to randomly determine where they appear on the tabletop. This is a "six-sided percentile" system — read the first die as "tens" and the second as "ones" (it is a good idea to use two different-colored dice). Do not add the dice

together. Looking at the set-up map, you will see that the sides of the table are numbered, starting at the southwest corner of the table. Roll the two dice to determine the east-west position of the geyser, then roll them again to find the north-south position. Measure out into the table to find the intersection of the two rolls — that is where the geyser appears.

Note that each “tens” number represents the beginning of a one-foot increment along the table edge, and the “ones” digit is a two-inch increment. So a roll of “32” indicates a position 4” past the third foot mark.

If a roll is too high for the side of the table (for instance, the first die roll is a “5” or “6” on the north-south roll), then that geyser does not appear this turn.

After the positions have been determined, center a 2.5” Grenade Burst Area of Effect Template on the location of each geyser. Any figure partially or totally touching the template must roll against the lava’s *Damage Strength* of 8.

After ascertaining any damage results, remove the grenade template and center a Flame Effect Template on the location. The template remains in that position for the rest of the game. The fire will not spread. The normal rules for fire (see page 77 of *Star Wars Miniatures Battles*) apply to any figures entering the area of the flame template.

Figure Notes

For the Rebel troopers, you can use figures from any of the *Rebel Troopers* packs (40405, 40406, 40413, 40421), or *Rebel Commandos* (40414, 40417). The techs can also be represented by any of these figures.

The Imperial figures should come from the *Imperial Army Troopers* packs (40411, 40418), as the retrieval force and the tank crew are all Imperial Army. The tank crew’s uniforms can be decorated with the symbol of the Hammers.



Orders of the Day Imperial Commander 343.245/H5

Commander: Hammer 4:3 is down. The support unit is ready to pick it up, but the retrieval zone is too hot — enemy units are crawling all over it. Go clear out the RZ. Eliminate all traces of enemy interference so that the transport barge can pick up 4:3 and get it back for repairs. Reports also indicate that the crew made it out safely. Find them and bring them back.

You have two squads. Set them up along the west 24” of the north table edge, no more than 6” from the edge. You also have the tank’s crew, who begin the game hidden inside the cave located in the rubble hill to the northeast. They can leave the cave as soon as they have a line of sight to one of your other squads.

The tank’s guns still work, and can be used if a soldier enters the vehicle. Each gun requires a separate gunner. Roll for initiative to determine who goes first.

Victory: Clear the table of all Rebels.



Orders of the Day Alliance Commander Torv Keist

Commander: Our lead elements report that one of the Imps’ tanks went down in Sector 5-7, but is still in good condition. It may just be its drives. Take two squads and a tech unit out and see if it’s worth recovering. If it is, try to get it back here. If you can’t move it, see if you can’t convince the Imps to leave it there for us.

You have two squads and a tech team. Set them up along the west 24” of the south table edge, no more than 6” from the edge. You must get one of the techs into the tank to determine if it is worth recovering. If it is, you’ll need the techs to make it travel-worthy. I will fill you in on the details as they become necessary.

Roll for initiative to determine who goes first.

Victory: Get the tank off the south edge of the table. Failing that, eliminate the Imperial presence on the table.

Scenario Four

A Bazaar Encounter

The Situation

War is hell. So they say, and if you're engaged in one of the many battles being fought for the freedom of the galaxy, so it is. You're trying to survive amid all the carnage and destruction, you don't know if you'll ever get back home, and the next blaster bolt may be the one with your name coded into it.

However, there are some good things about being in the army. You meet many different beings, and form some lasting friendships, and you get to see a lot of exotic places.

But between the good and the bad lies the vast middle ground: boredom. Most of the time you find yourself involved in drills, or maintenance, or just waiting around to be moved to your next assignment.

No one knows this more than your average dirtsider stationed in the Outer Rim Territories. One of the reasons the Alliance has chosen to station many of its troops out on the Rim is that the Imperial presence is not as pronounced, and that the areas involved are vast, making it harder for those Imperial ships located there to find the Alliance forces.

That means that many of the Rebel forces on the Rim don't often see much action. Garrison troops and reserves are supposed to wait around until they're needed.

One such group of Rebel soldiers finds itself in just that sort of predicament. They are currently in transit, on their way to augment a garrison force in an adjoining sector. The shortage of transport ships has left them cooling their heels at an Alliance transfer point on the planet Tatooine, facing a five-day layover.

Halfway through the wait, the Rebel commander realized the troops needed a diversion. As luck would have it, a group of Jawas had recently set up a trading camp east of the settlement of Anchorhead, just off the Circle Route leading to Mos Eisley. The commander has authorized a contingent of Alliance troopers to

leave the waystation for some R & R at the Jawa camp. Piling into a transport speeder, the troops set off into the sands.

Meanwhile, in Anchorhead, a local swoop gang — the Krayt Draggers — has also discovered that the Jawas have set up camp. The Draggers are a group of bored farm youth, who have nothing to occupy themselves with between harvests except for their swoops and whatever ruckus they can raise. They dislike Jawas intensely, and take every opportunity they can to hassle the diminutive traders. Determined to have some fun tormenting the little pests, they rev up their engines and set off into the sands.

The Forces

There are three distinct forces taking part in "A Bazaar Encounter." The swoop gang is trying to stir things up, but then finds itself engaged in defending itself. The Rebels become unwilling participants in the battle as they attempt to fend off the Krayt Draggers. And the Jawas will be doing their best to stay out of the line of fire.

Rebel Forces

The Rebels have come to the camp expecting to pass some time, and maybe find a good deal on equipment or some mementos to send to the folks at home. The Rebels are not in uniform (since they don't want to call attention to themselves), and have not come looking for trouble, so they are not heavily armed.

Rebel Troopers

- 10 Veteran Hoth Troopers.
- DEX 3, *blaster* 5; KNO 2; MEC 2; PER 2, *command* 4; STR 3, *brawling* 4; TEC 2; Move: 10.
- **Walk Rate:** 8"; **Run Rate:** 13".
- **Weapons:** blaster pistol.
- **Commander:** *command* 5.
- **Specialists:**
 - 1: *blaster* 6.
 - Weapon:** No additional weapon carried at this time.
 - 2: *repulsorlift operation* 5.
 - Weapon:** No additional weapon carried at this time.
- **Squad Generation Points:** 465

The Rebels have access to the speeder that brought them to the camp — an old-model landspeeder that has had a blaster mounted on its hood by Rebel techs.

■ **Landspeeder**

- **Drive System:** Repulsorlift.
- **Crew:** 1.
- **Passengers:** 1 (may fire from vehicle).
- **# Turns:** 2.
- **Turn Distance:** 3.
- **Move:** 115.
- **Cautious Speed:** 11.
- **Cruise Speed:** 33.
- **Top Speed:** 115.
- **Accel/Decel:** 11/11.
- **Flight Ceiling:** 2m (Low Level).
- **Body Strength:** 2.
- **Body Points:** 20.
- **Cover:** 5.
- **Weapons:**
 - **Mk 2e/S Laser Cannon**
 - *Fire Arc:* F.
 - *Skill:* Vehicle blasters.
 - *Fire Control:* 2.
 - *Range:* 1.5–25/50/100.
 - *Damage:* 6.
 - *Notes:* May be fired by driver; following fire.
- **Squad Generation Points:** 127.

The Swoop Gang

The Krayt Draggers are a mixed bag of hoodlums and thrill-seekers. Most of them are merely seeking some camaraderie in their boredom. But they are easily swayed toward violent and vicious behavior by the more forceful, malicious members of the gang, particularly the gang’s leader, Kav Lepkin.

The group is not totally a “swoop” gang — the best many of the gangers could manage is a speeder bike. Still, it gives them a much-valued mobility and the illusion of being able to escape from the dreariness of their lives.

While the Krayt Draggers number about 15, only five of them were around when the news of the Jawas came in. Three of the Draggers are riding swoops, while the other two are on speeder bikes.

■ **Krayt Draggers**

- 5 Average Gang Members.
- **DEX** 3, *blaster* 4, *vehicle blasters* 4; **KNO** 2; **MEC** 3, *repulsorlift operation* 5; **PER** 2, *command* 3; **STR** 2, *brawling* 4; **TEC** 2; **Move:** 10.
- **Walk Rate:** 8”; **Run Rate:** 13”.
- **Weapons:** blaster pistol.
- **Commander:** *command* 4.
- **Specialist:** *vehicle blasters* 5.
- **Weapon:** Swoop-mounted laser cannon.
- **Squad Generation Points:** 192

■ **Krayt Draggers Swoop (3)**

- **Drive System:** Repulsorlift.
- **Crew:** 1.
- **Passengers:** 0.
- **# Turns:** 4.
- **Turn Distance:** 1.
- **Move:** 210.
- **Cautious Speed:** 21.
- **Cruise Speed:** 63.
- **Top Speed:** 210.
- **Accel/Decel:** 21/21.
- **Flight Ceiling:** 350m (Level 35).
- **Body Strength:** 2.
- **Body Points:** 20.
- **Cover:** 4.
- **Squad Generation Points:** 143.

■ **Krayt Draggers Speeder Bike (2)**

- **Drive System:** Repulsorlift.
- **Crew:** 1.
- **Passengers:** 0.
- **# Turns:** 4.
- **Turn Distance:** 1.
- **Move:** 185.
- **Cautious Speed:** 18.
- **Cruise Speed:** 54.
- **Top Speed:** 185.
- **Accel/Decel:** 18/18.
- **Flight Ceiling:** 20m (Level 2).
- **Body Strength:** 4.
- **Body Points:** 40.
- **Cover:** 4.
- **Squad Generation Points:** 154.

Each of the gang’s swoops and bikes is armed with a light laser cannon having the following characteristics:

■ **Laser Cannon**

- **Fire Arc:** F
- **Skill:** Vehicle blasters.
- **Fire Control:** 1.
- **Range:** 1.5–25/50/100.
- **Damage:** 4.
- **Notes:** May be fired by driver; following fire.
- **Squad Generation Points:** 20.

Instead of a laser cannon, the swoop of Kav Lepkin, the gang’s leader, is outfitted with a heavier blaster:

■ **Mk 2e/S Medium Blaster Cannon**

- **Fire Arc:** F.
- **Skill:** Vehicle blasters.
- **Fire Control:** 2.
- **Range:** 25–50/125/250.
- **Damage:** 6.
- **Squad Generation Points:** 38.
- **Notes:** May be fired by driver; following fire.

Jawas

These are typical Jawas; they are scavengers and traders, not fighters. They will defend themselves if necessary, but prefer to scurry away and hide out until the trouble passes. These Jawas carry their own cobbled-together blasters, which



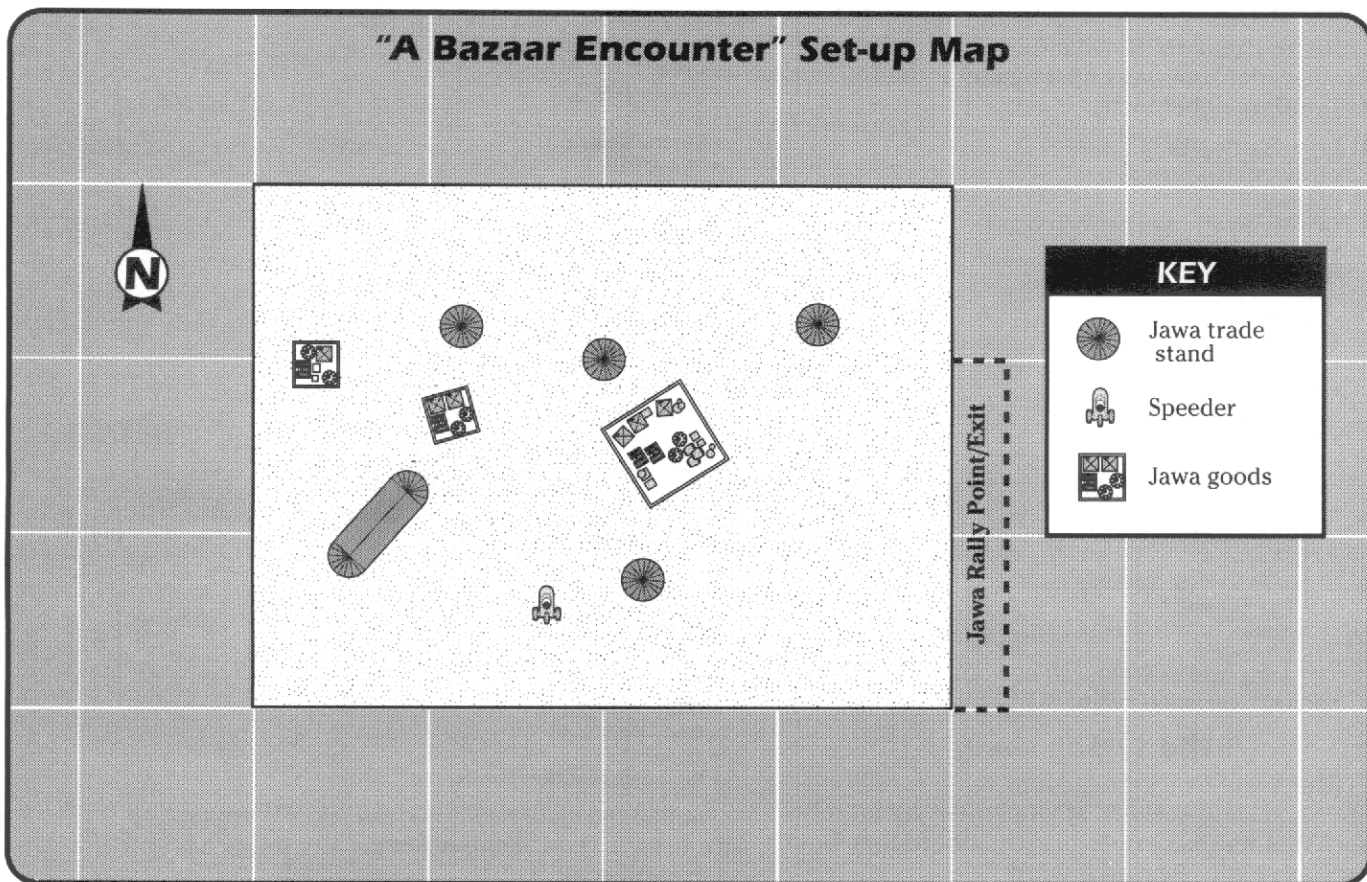

are significantly more dangerous than the ionization guns normally favored by Jawas. The Jawas are run by the Rebel player, subject to the rules outlined below in the "Gamemaster Notes" section.

■ Jawa Traders

- 15 Average Jawas.
- DEX 2, *blaster* 3; KNO 2; MEC 3; PER 1, *command* 2; STR 1, *brawling* 2; TEC 3; Move: 8.
- **Walk Rate:** 6"; **Run Rate:** 10".
- **Weapons:** Jawa blaster.
- **Squad Generation Points:** 435.

■ Jawa Blaster

- **Skill:** Blaster.
- **Range:** 4/12/40.
- **Damage:** 4.
- **Encumbrance Value:** 4.
- **Squad Generation Points:** 6.

The Battlefield

The altercation takes place within the grounds of the Jawa trade camp. The camp consists of a number of trade stands scattered around the base of a sandcrawler. There are also scattered piles of goods displayed on pallets and deactivated repulsorsleds. The sandcrawler itself is not represented on the table, but is assumed to be standing alongside the south 24" of the east

edge of the table.

Most of the trade stands are circular counters within which the Jawa traders hawk their wares. The stands are surmounted by conical canopies, which serve to shade them from the blistering suns. The circular stands are about 3" in diameter, and the coverings come to a point about 3" above the tabletop. The long stand is 3" wide and 9" long, and as high as the smaller stands.

Each stand can accommodate four beings inside it (except the long stand, which can hold up to 12 beings). The stands are designed for Jawas, so due to the low height of the canopy, it takes a human-sized being its entire Movement Rate to clamber under the canopy and over the counter to get inside. Jawas need only expend half their Movement Rate. Once inside, the stand provides heavy cover. Due to the height of the canopies above the stands, no vehicles traveling at Low Level or Level 1 can pass over them.

The piled trade goods consist of open pallets, stacked crates and cargo containers, and assorted junk. It is possible to clamber through them, although they are treated as very rough terrain. A being within one of the stacks also draws medium cover from the various items surrounding her. The stacked goods block any vehicle flying at Low Level.

The area on which the trade camp is situated is packed sand, and so is considered clear terrain.

Parked near the south edge of the table is the Rebels' landspeeder. The transport that brought the bulk of the Rebels to the camp dropped them off and returned to the base, so as not draw unwanted attention. The landspeeder is the vehicle used by the Rebel commander and his driver, which appeared innocuous enough to remain at the camp.

The Set-Up

The Rebels begin the game scattered throughout the trade camp. Any individual figure may be located within 2" of any trade stand or display of goods. Figures not within that distance must be grouped two or three together, within command distance of each other (they are standing around chatting). With the exception of this initial set-up of freestanding groups, squad coherence does not apply for this game. Figures may move and fight independently without separation penalties.

Jawa figures should be set up around the camp also. Start by placing at least one Jawa in each trade stand — three of them should be placed in the long stand — and one near each display of trade goods. Then place the remaining Jawas anywhere in the camp, except that no Jawa can be placed in the area between trade stands 3 and 5 and the "sandcrawler."

The Krayt Draggers swoop gang enters the board in the first turn, and takes the first move. The Draggers' point of entry is random, depending upon the shifting sands in and around the camp. To determine on which side of the table they enter, roll a six-sided die. The side of entry is determined from the following table.

Die Roll	Entry Side
1-3	Enter along the north edge
4-5	Enter along the west edge
6	Enter along the south edge

Gamemaster Notes

This is basically a shoot-'em-up. It begins with a surprise attack, and how it develops depends on how quickly the Rebels can gather their wits and set up a defense. The Jawas can be a little help, but mostly they serve as yet another impediment, complicating the battle for both sides (see "Jawa Reactions," below, for details).

The Rebels and the swoop gangers ignore the morale rules for this game. The Jawas are a different story, however.

Jawa Reactions

When the shooting starts, the Jawas begin to hightail it back to their sandcrawler. Their main

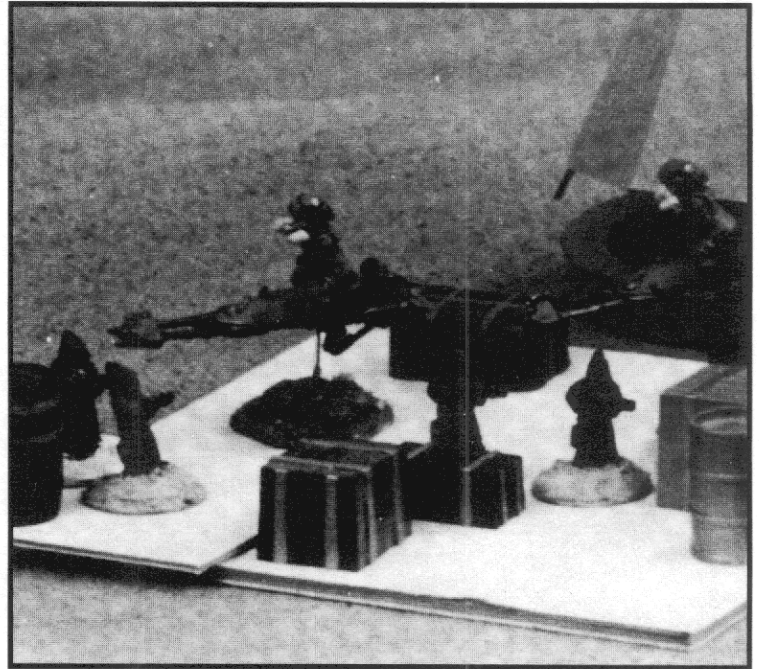

interest is to make it to the protection of their mobile fortress, where they can sit out the battle until it is safe to go back out and pick up the pieces. The only problem some of the Jawas have is that the goods they are leaving undefended are their own, and they'd hate to have anything happen to them.

Torn as they are between survival and greed, it is difficult to predict just how any individual Jawa will react. At the beginning of the Rebel player's Movement Phase in Turn One, make a morale test for each Jawa or group of Jawas on the tabletop who are have a line of sight to a swoop or speeder bike. All Jawas who are within command distance of at least one other Jawa are considered to be in a group with those other Jawas. Only one test is made for a group, and the results are applied to the entire group.

The test is taken as if it were a "receiving a charge" morale test, but the only modifiers that are applied are those for casualties incurred in the current turn, or for a squad behind cover. Any Jawas in the open who fail their morale test are considered to be routing. Jawas who are in cover will remain where they are if they receive a "Morale -1" result on the "Morale Test Results" table, but *will* rout if they receive a "Morale -2; Withdraw" result, immediately clambering out of the trade stand and running toward the sandcrawler.

The Jawas do not have a rally point *per se*. Routing Jawas begin to run immediately toward the entrance ramp of the sandcrawler (the southern 24" of the eastern table edge) with the full intent of entering the sandcrawler (i.e., leaving

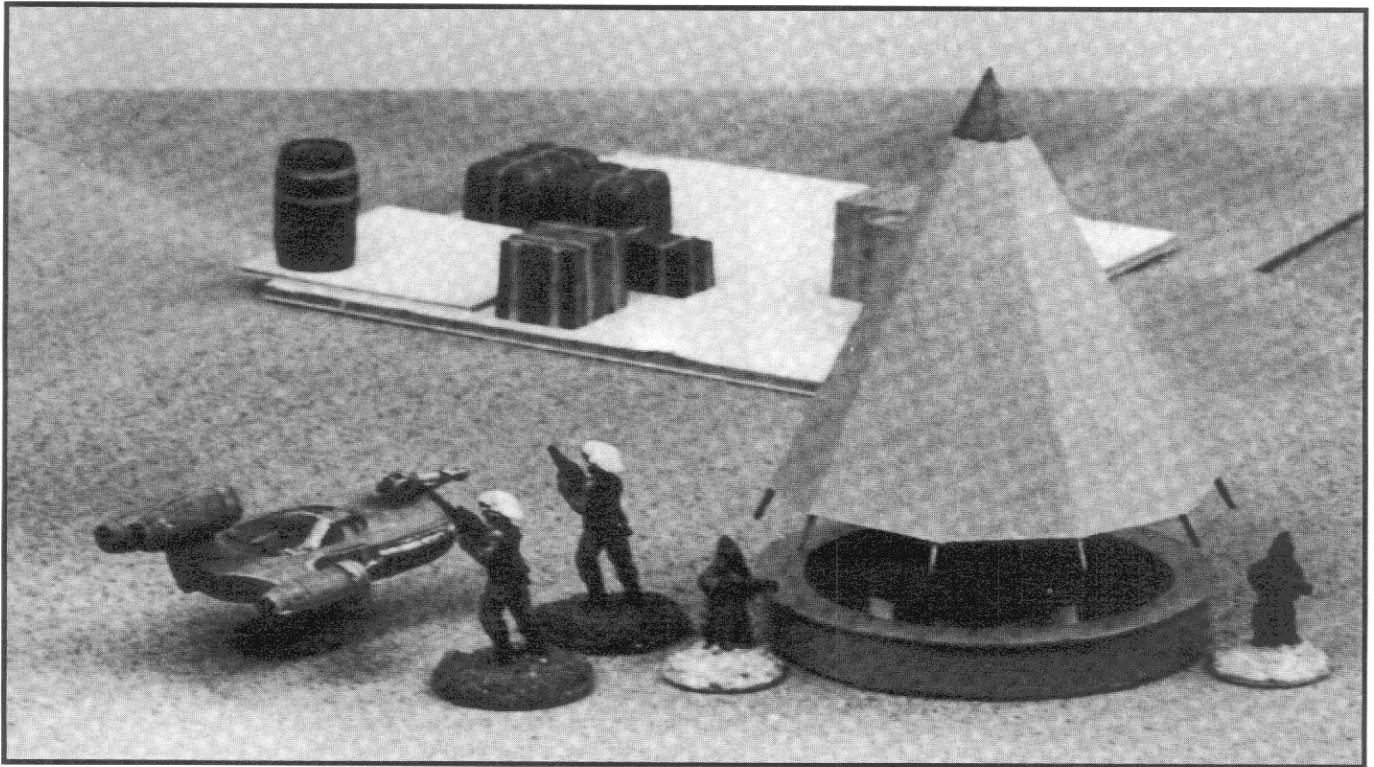

the table). Routing Jawas cannot be rallied, and will continue to head toward the sandcrawler by the most direct route possible.

Jawas who pass the test may fire weapons at the invading swoop gangers, or choose to move elsewhere on the table, each during the relevant phase.

The morale test must be repeated in each successive Morale Phase for each Jawa remaining on the table who has a line of sight to a gang member.

Finding Weapons

A Jawa trade camp harbors a wealth of interesting and useful items ... assuming you can find them among all the junk. During the course of the battle, it may be possible for some of the Rebels to come across additional weapons, which would give them more of an edge against the swoop-riding gang.

During the Special Actions Phase, any Rebel trooper can attempt to *search* for a weapon if he is inside a trade stand, or within one of the displays of goods. The difficulty of finding a weapon is 6 in a trade stand, and 8 in a pile of wares. If the trooper is successful, determine what he found by rolling a six-sided die and consulting the following tables.

Each of the items in the tables are standard examples of their types, as listed in the "Weapon Chart." As each item is discovered, cross it off the list. If a crossed-off number is rolled at a later attempt, reroll the die until a result that is still available is achieved.

The proton torpedo launcher is heavily damaged and cannot be repaired in the course of the game. Besides, there are no torpedoes to launch.

Trade Stand		Pile of Goods	
Die Roll	Item Found	Die Roll	Item Found
1	heavy blaster pistol	1	gaderffii
2-3	blaster rifle	2-4	repeating blaster (without tripod)
4-5	smoke grenade	5	one stun grenade, two frag grenades
6	blaster carbine	6	proton torpedo launcher (non-functional)

The Landspeeder

The commander's transportation remained at the camp due to its everyday appearance (the mounted blaster is low to the hood and hard to discern at a distance). When the game begins it is parked near the south edge of the table. Any Rebel trooper(s) can move to the speeder, get in and begin driving it — provided it has not already been destroyed — which will help to even the odds a bit. Follow the normal rules for boarding vehicles (see pages 20–21 of the *Star Wars Miniatures Battles Companion*). The vehicle and its weapon are both fully charged.

A second Rebel may enter the vehicle in addition to the driver. The passenger may fire the vehicle's weapon (using his *Dexterity* if he does not have the *vehicle blasters* skill), or may fire his personal weapon out of the vehicle, leaving the vehicle's weapon to be fired by the driver. See "Vehicle Fire Combat" on pages 22–24 of the *Star Wars Miniatures Battles Companion* for the pertinent rules.

Simplifying the Game

If you feel that the morale tests required for the Jawas tend to bog down the game, you can simplify their reaction. In this variation, if any Jawa has a LOS to a swoop ganger at the beginning of a Movement Phase, then the Jawa automatically routs and begins running to the safety of the sandcrawler. This eliminates some of the die-rolling, but leaves the Jawas in as an obstacle.

You may wish to simplify things even further, so that the swoop gang and the Rebels can mix it up in the maze of the trade camp without any distractions. In that case, assume that the Jawas "go to ground" when they are threatened. That is, once a Jawa spots a ganger, he immediately ducks under the nearest piece of cargo or hunkers down in the trade stand he is in. In game terms, remove the Jawa from the board. In this case, you may wish to add a few more Rebel troopers to balance the forces.

Complicating the Game

If you would like even more options during the course of the game, give each player an extra 225 SGPs and let them create a hero for each side. The logical choices would be the Rebel commander and the gang's leader, but feel free to be creative (who knows, a Force-using Jawa might make an interesting tactical study).

Figure Notes

Rebel troopers can be recruited from any of the *Rebels* or *Rebel Troopers* packs (40405, 40406, 40413, 40421), or *Rebel Commandos* (40414, 40417), but the figures should be painted a vari-

ety of colors to represent civilian clothing. Another option would be to use any already-painted Rebel figures that you might have — the Rebel colors will help to differentiate the forces, and you can just pretend that the Rebels are really in civilian clothing. The landspeeder is from the *Landspeeder* pack (40501).

The swoop gang can be represented by *Rebel Speeder Bikes* (40503). Paint the riders in the colors of the Krayt Draggers to differentiate them from Rebels. The Draggers' colors are orange and dark green. The symbol they often paint on the backs of their jackets is that of the overlapping twin suns in orange, with the dark green silhouette of a krayt dragon's head superimposed over the larger of the suns. You will also have to indicate some difference between the three swoops and the two speeder bikes. You can do this with two different variations on the Draggers' color scheme, or you could actually do a little conversion work on some of the speeders. A simple method is to add something to the bases of the speeder bikes to set them off from the others. You will also need to indicate the gang leader's swoop, as it carries a different weapon.

The Jawas are perhaps the hardest figures to acquire. A single Jawa is included in *Denizens of Tatooine* (40427), but getting 15 of them means quite a few extra figures and no little expense. An option is the *Galoob Micro Machines Jawas* figure pack, although these figures are smaller than a scale Jawa would be.

Another way to deal with this is to substitute other figures for the Jawas. For instance, the *Noghri* are short, wear hooded robes, and come three to the pack (40439). You could use a collection of plastic pawns to represent the Jawas, perhaps painting them brown and putting two white dots on the "head" to represent their eyes.

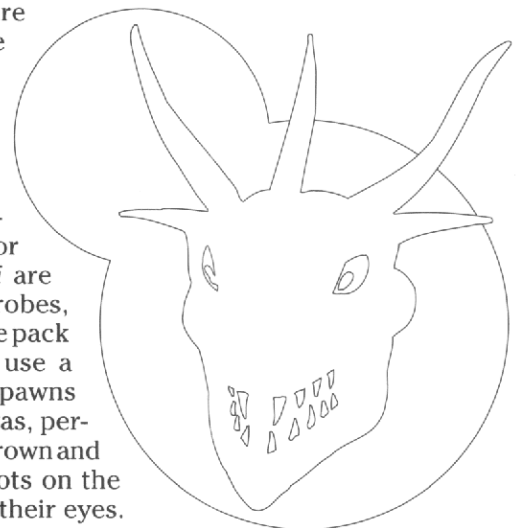
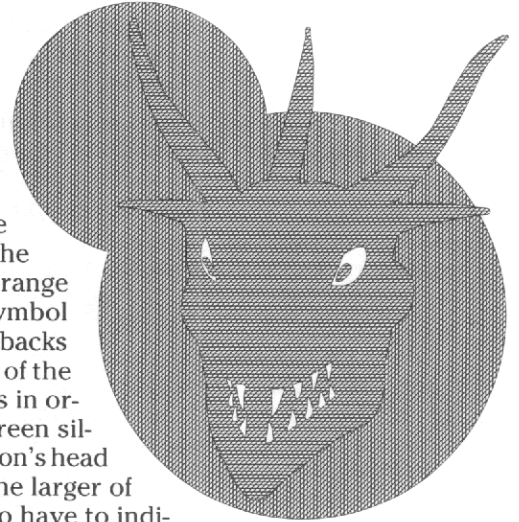



So What Are We Gonna Do? Kav Lepkin, Krayt Draggers Gang Leader

Hey, chums, there's some o' them stinkin' glow-eyes outside o' town. I can smell 'em from here and I say it's up ta us to keep our town smellin' clean. So let's go have some fun and shoot up some brownies. Last one there's a vermin-lover.

You're heading out to have some fun shooting up a Jawa trade camp. As far as you're concerned, it's just some good old fun — who cares if a few Jawas get shot up? There always seem to be more than enough of them anyway. Even so, the local constabulary looks down on it. So if there are any witnesses, well, they'll just have to disappear as well.

Because the sands between here and the Jawa camp are shifting and treacherous, you're not sure of the best approach to the camp until you're practically there. Roll a six-sided die. On a 1, 2 or 3, you can enter anywhere along the north edge of the table. On a 4 or 5 you can enter along the west edge. If the result is a 6, you come on the table along the south edge.

Victory: Get away without any witnesses (other than the Jawas — who listens to them, anyway?).



Orders of the Day Alliance Commander Harrin Tarn

Commander: We are still awaiting the arrival of the transports which will carry us off this forsaken dustball. The current ETA puts them here in two days. Since we don't want our soldiers going stir crazy, you are hereby authorized to take your troops out for a little R & R. But nothing high-profile, mind you. A Jawa bazaar has been set up near the Circle Route out of Anchorhead; that should be remote enough to risk a visit.

Remember, this is a casual visit. Make sure your boys aren't carrying any heavy armaments. We don't want to call attention to ourselves, and besides, we don't want to risk losing any of our important equipment to those grabby little pests. You've got four hours. Enjoy yourself.

If there's any trouble, you may of course defend yourselves, but try to lay low until we can get there to pick you up.

Victory: Survive to get back to base.

Scenario Five

To Hunt the Hutt

The Situation

An Imperial bounty has been posted for Mennac the Hutt, a middle-level gangster in the criminal organization of the Vanderijar clan. In response to the posting, a team of bounty hunters has determined to capture the Hutt. They have been tracking “her” now for almost a week, and, on the backwater world of Trendivar they finally get a break. The hunters found someone who saw Mennac and was willing to discuss it — after suitable monetary persuasion.

They learn that the Hutt is about to leave Trendivar to return to her fortress/palace on Nal Hutta. They need to act now, and quickly. They know that Mennac’s ship is currently at Docking Bay 73 of the local starport, and head there posthaste to prepare a little surprise for their quarry.

Meanwhile, having completed her business on Trendivar, Mennac is preparing to head back to her ship when she is alerted to the fact that

someone is looking for her. She hastens her preparations and rushes back to the ship, expecting some kind of trouble.

As the Hutt’s party enters the docking bay, the hunters get ready to effect their acquisition.

The Hutt’s Forces

Mennac’s party consists of the Hutt herself and her consort, Jobwah, her personal Gamorrean guards, and some of her enforcers. Both of the Hutts are riding on Hutt floaters, light repulsor platforms that grant them a much greater mobility than their bulk would normally allow. In addition to her retinue, Mennac has a “pet” with her on her floater. It is a vicious little creature that can be easily goaded into a frenzy, so that it will attack whomever it is directed at.

Note: Characters with Force Points have listed in (parentheses) how many rolls were made to determine the number of Force Points, since the number of rolls affects the SGP cost of a given hero.

Hutt Special Abilities

Hutts have an innate resistance to the Force. This makes it much harder for a hero to use the Force against a member of that species. If any Force skill is used against a Hutt, the Hutt adds *double* its *Perception* to the die roll when making an opposed roll with its *Perception* against the Force skill use.

This resistance also means that Hutts may not normally use the Force, i.e., Hutts are not believed to be able to have Force skills or Force powers.

Force Points are a different matter, however. Even though a hero who uses Force Points is considered to be “trusting to the Force,” this actually means that the hero is not actively tapping the Force, but has benefitted from the generally positive influence of that all-encompassing energy. In that

respect, Force Points are more a representation of “luck” than of actual Force use (actual Force use is what Force skills are for). By the same token, while a being with a resistance to the Force cannot benefit from its influence, this very lack of Force-sensitivity develops in the being a certain strength of will that sustains him in times of crisis. In this sort of case, “Force Points” represent that internal strength and the external results it can engender.

The upshot of these metaphysics is that Hutts, while resistant to the Force, may still choose to roll for Force Points when creating a “hero,” following the normal procedure outlined on page 66 of *Star Wars Miniatures Battles*. The use of Force Points is described on page 62 of that book.

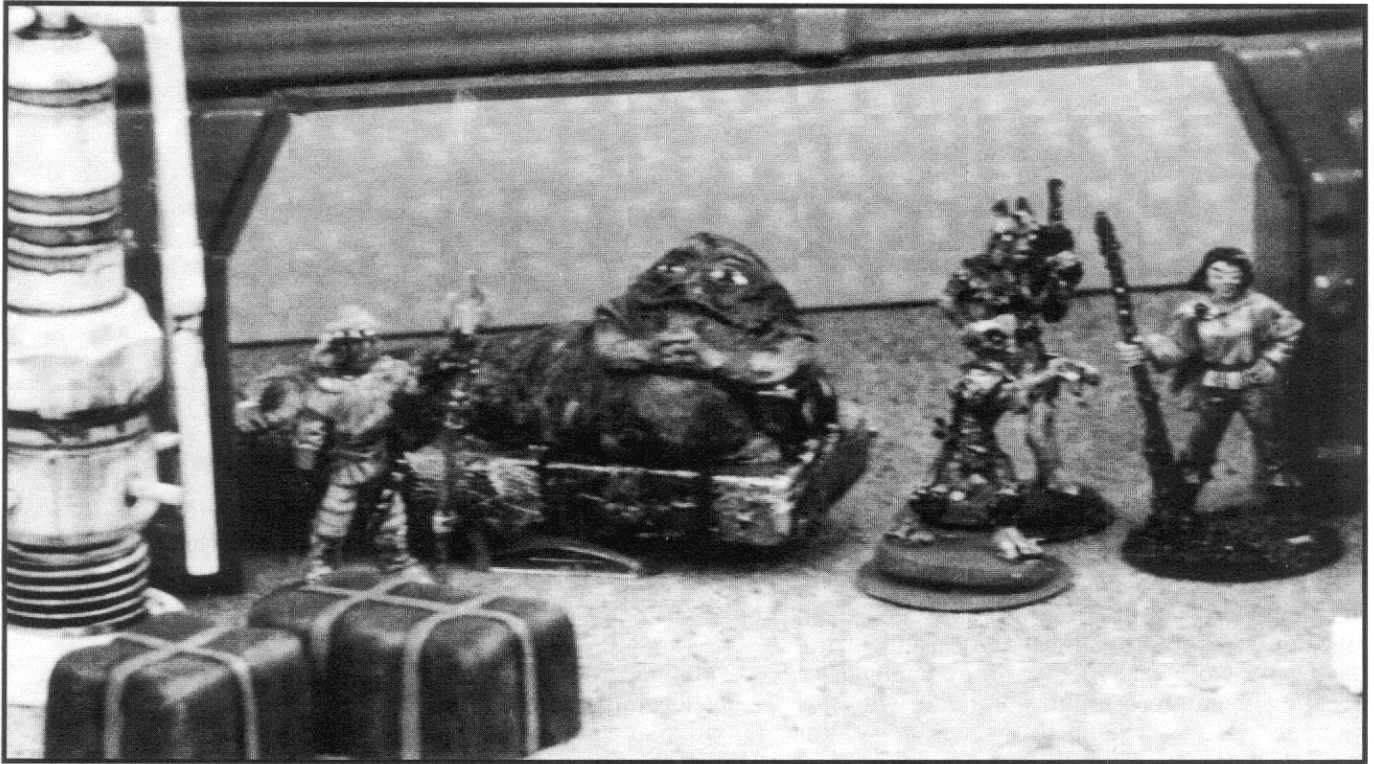

■ Mennac the Hutt

- Hutt Gangster.
- DEX 2, *vehicle blasters* 3; KNO 4; MEC 2, *repulsorlift operation: Hutt floater* 4; PER 4, *command* 6; STR 2; TEC 3; Move: 2.
- **Walk Rate:** 3"; **Run Rate:** 4".
- **Weapons:** No personal weapons; laser cannon built into floater (see below).
- **Force Points:** 5 (2 rolls).
- **Squad Generation Points:** 98.

■ Mennac's Personal Guard

- 5 Average Gamorrean Guards.
- DEX 3, *melee combat* 5; KNO 1; MEC 1; PER 2; STR 4, *brawling* 6; TEC 1; Move: 8.
- **Walk Rate:** 7"; **Run Rate:** 11".
- **Weapons:** vibro-ax.
- **Commander:** *command* 3.
- **Specialists:**
 - 1: *blaster* 4.
 - Weapon:** blaster rifle.
 - 2: *blaster* 4.
 - Weapon:** blaster pistol.
- **Squad Generation Points:** 161.

■ Mennac's Enforcers

- 5 Average Enforcers.
- DEX 2, *blaster* 3; KNO 2; MEC 2; PER 2; STR 4, *brawling* 5; TEC 1; Move: 10.
- **Walk Rate:** 7"; **Run Rate:** 12".
- **Weapons:** heavy blaster pistol, vibroblade.
- **Commander:** *command* 4.
- **Specialist:** *grenade* 5.
- Weapon:** 2 smoke grenades.
- **Squad Generation Points:** 205.

■ Jobwah the Hutt

- Hutt Gangster.
- DEX 2, *blaster* 3; KNO 3; MEC 1, *repulsorlift operation: Hutt*

floater 3; PER 4, *command* 5; STR 3; TEC 4; Move: 1.

- **Walk Rate:** 2.5"; **Run Rate:** 3".
- **Weapons:** hold-out blaster.
- **Force Points:** 2 (1 roll).
- **Squad Generation Points:** 88.

■ Kentril (Mennac's Vicious Pet)

- DEX: 2.
- STR: 3.
- *Brawling* 4
- PER: 2.
- Move: 8.
- **Movement Rate:** 10.
- **Attack Forms:** bite (5); claw (4).
- **Squad Generation Points:** 50.

■ Hutt Floater

- **Drive System:** Repulsorlift.
- **Crew:** 1.
- **Passengers:** 0 (3 if driver and passengers are Human-sized).
- **# Turns:** 2.
- **Turn Distance:** 3.
- **Move:** 25.
- **Cautious Speed:** 2.5.
- **Cruise Speed:** 7.5.
- **Top Speed:** 25.
- **Accel/Decel:** 2.5/2.5.
- **Flight Ceiling:** 30m (Level 3).
- **Body Strength:** 2.
- **Body Points:** 20.
- **Cover:** 4.
- **Squad Generation Points:** 71.

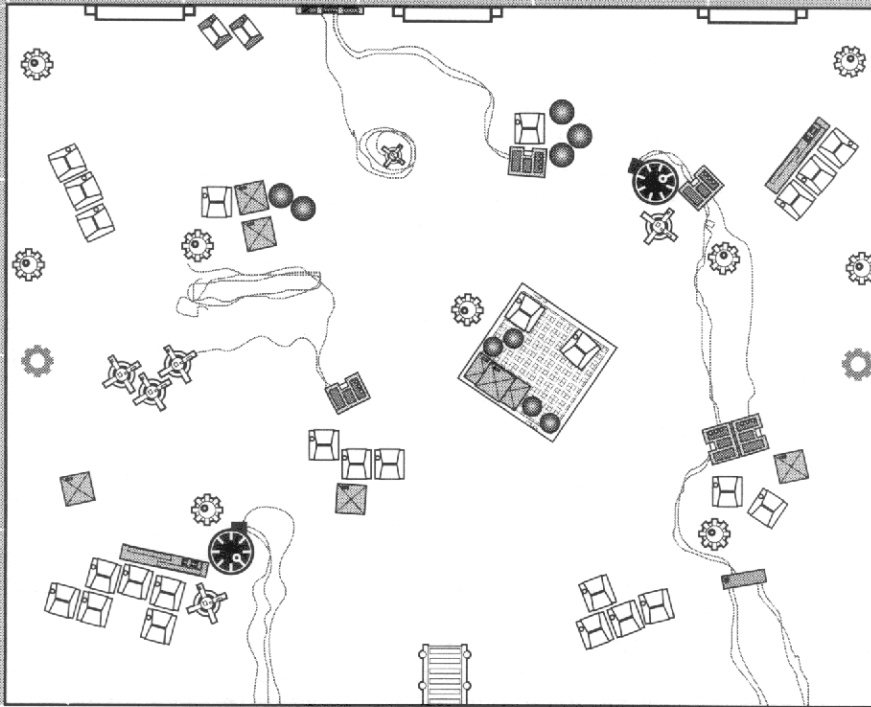

Mennac, being a typical Hutt, does not trust anyone, and so has a hidden blaster mounted in her floater.

"To Hunt the Hutt" Set-up Map



Brian Schomburg

KEY

-  Landing Light
-  Probot Entry Point

■ **Mk 2/S Laser Cannon**

- **Fire Arc:** F.
- **Skill:** *vehicle blasters.*
- **Fire Control:** 1.
- **Range:** 1.5–25/50/100.
- **Damage:** 6.
- **Notes:** Following fire; may be fired by driver.
- **Squad Generation Points:** 20.

Bounty Hunters

The team of bounty hunters is called Grim Destiny, and consists of eight experienced hunters. The eight are commanded by the bounty hunter Garm Trodask, who is a hero.

■ **Grim Destiny**

- 8 Veteran Bounty Hunters.
- **DEX** (3)*, **blaster** (5)*; **KNO** 2; **MEC** 2; **PER** 3, **command** 4; **STR** (4)*, **brawling** 5; **TEC** 2; **Move:** 10.
- **Walk Rate:** 8"; **Run Rate:** 13".
- **Weapons:** heavy blaster pistol.
- **Armor:** bounty hunter.
- **Commander:** *command* 5.
- **Specialists:**
 - 1: *blaster* (6)*.
Weapon: blaster rifle.
 - 2: *grenade* (5)*.
Weapon: 2 stun grenades.
- **Squad Generation Points:** 536.
- *Numbers in parentheses are the final values as modified by armor.

■ **Garm Trodask**

- Bounty Hunter.
- **DEX** (3)*, **blaster** (5)*, **brawling parry** (4)*, **dodge** (5)*, **melee combat** (5)*, **melee parry** (4)*; **KNO** 2; **MEC** 3; **PER** 3, **command** 5; **STR** (5)*, **brawling** 5; **TEC** 2; **Move:** 10.
- **Walk Rate:** 8"; **Run Rate:** 13".
- **Weapons:** heavy blaster pistol, vibroblade.
- **Armor:** bounty hunter.
- **Force Points:** 10 (4 rolls).
- **Squad Generation Points:** 169.
- *Numbers in parentheses are the final values as modified by armor.

The Battlefield

Docking Bay 73 is a typical small-time docking bay. It is essentially a glorified pit dug into the surface of the planet, large enough to hold a small ship. The sides of the bay are sheer, smooth-surfaced plascrete, broken only by three 6"-wide access arches in the north wall. The landing area is open to the sky. Mennac's ship is located in the south end of the landing bay, off the table. The side of the ship runs along the south edge of the table. Descending from the ship, in the center of the south edge, is the ship's access ramp. It is 2" wide.

Strewn about the floor in various locations around the floor are stacks of cargo containers, deposited there by an earlier ship and still awaiting pick-up. There is also some support equipment — such as maintenance carts and power feed transformers — in the bay. These items are about waist-high, so figures standing behind them draw medium cover. It is possible for figures to clamber over these stacks. But though they are low, they are also wide, and so count as difficult barriers. Some of the cargo containers are taller (shown on the map shaded gray); these block line of sight and are impassable barriers. They also block flight at Low Level.

Landing lights and directional beacons set in the floor, as well as cables snaking around the floor, make those areas difficult to cross — they are counted as rough terrain. The rest of the landing bay floor is clear terrain.

The Set-Up

The bounty hunters set up first, and may set up hidden. Any or all of the hunters may be hidden at the start of the game. In order to be hidden, a figure must be placed behind a stack of cargo or a piece of maintenance equipment, with no line of sight to any of the doors. Figures may be set up hidden behind low items during the initial deployment; they are assumed to be crouching down behind them. Squad coherence is not in effect for this scenario, so they may be as spread out as the player wishes. The bounty hunter player should indicate on a copy of the set-up map where all of her hunters will start, even the ones which are not hidden.

After the bounty hunter player has determined her initial set-up, the Hutt player should do the same, deciding which figures will enter by which doors. Each Hutt may be moved independently, as if it were its own squad. As stated above, the squad coherence rules are not in effect, so the enforcers and the bodyguard may move independently of each other. But they must be set up initially as if those rules applied, and move together for the first Movement Phase. After the first move, they may separate if so desired.

Once the Hutt player has decided on his initial deployment, the bounty hunter player should place any non-hidden figures on the table.

At this point, the game begins. The Hutt player gets the first move, and brings his forces onto the table through the appropriate doors.

As usual, hidden figures are placed on the table if they fire or fall within an enemy's line of sight. In addition, the bounty hunter player may declare that a figure hidden behind a low obstacle is standing up, and place the figure on the table.

Gamemaster Notes

This is basically an ambush. The bounty hunters have managed to get between the Hutt and her ship. However, they must fight through the Hutt's guards to get to her. Complicating the situation further is the bounty hunters' discovery that there are two Hutts — Mennac, the target, and her consort, Jobwah — and they don't know which is which.

The bounty hunters win this scenario if they manage to capture Mennac the Hutt and get her off the table. In order to do so they will have to take Mennac prisoner. See pages 41–42 of *Star Wars Miniatures Battles Companion* for the rules on capturing prisoners. It is suggested that you also use the stun rules (pages 39–41) in this scenario. If a capture attempt against Mennac is successful, she is considered to have been knocked off her floater. The bounty hunters can then take her prisoner. One or more of them can also board the floater during their next Movement Phase, if they wish. Otherwise it continues to float just above the ground at that location, becoming a moderate barrier, but providing no cover.

Once Mennac is captured, the hunters must get her off the table. They may do this either by exiting through any of the doors to the north, or leaving the table to the south by means of the entry ramp into her ship. They will then deliver her to the proper authorities (using her own ship, if they exited via the ramp).

If Mennac is captured, Jobwah will flee through the nearest door. Mennac's guards will attempt to rescue her, though. It will probably be necessary to eliminate or drive off her lackeys, but if the hunters can succeed in shepherding the slow-moving Hutt off the table in the face of the entourage's resistance, good for them.

The Hutt player wins by getting Mennac off the board via the ship's entry ramp at the center of the south edge of the table. No other figures count, as Mennac is concerned only with her own safety. She does not care if Jobwah or any of her retinue make it into the ship — she considers them expendable. She will take off by herself once she boards the ship.

Although getting Jobwah off the table is not part of the Hutt player's objective, he should try to play the Hutt in character. Jobwah will be trying his best to get up the ship's ramp, and any moves and attacks he makes should serve to further that goal. This will also serve to keep the bounty hunters in the dark as to which Hutt is Mennac.

Due to the position of the access ramp under the main body of the ship, it can only be entered by a floater if it is flying at Low Level. Therefore it is possible for one or more bounty hunters to

attempt to block the ramp. It is also possible for either of the Hutts to try to ram any figures in the way. If they do, follow the normal collision rules given on pages 26–27 of *Star Wars Miniatures Battles Companion*.

Mennac's Vicious Pet

Some time ago, Mennac acquired a kentril, a vicious carnivorous rodent, which she now keeps as a pet. The kentril has been domesticated as little as necessary, so that it retains its savage streak, making it an excellent watchbeast and attack beast. When Mennac is travelling, it generally lies curled up peacefully on her floater in front of her great bloated belly, where she can occasionally reach down and stroke its nasty little head.

When the creature is roused, however, it is swift and vicious in its attack, which is why Mennac likes it so much. The kentril has been trained to go off on Mennac's command, at which

point it will attack whomever Mennac indicates.

During the Hutt player's Movement Phase, the player may declare that the kentril is attacking and indicate a target being. The kentril will move at its full Movement Rate toward the target and attempt to engage in close assault combat with it. If it has insufficient move to reach the targeted figure in the current Phase, it will continue to pursue its target in the next and subsequent turns until it does finally reach its goal. It will then commence its attack in the Close Assault Combat Phase of that turn. The beast is tenacious and will continue to attack in successive turns. However, if it is wounded, make a casualty morale test for the kentril (during the Morale Phase), testing against the creature's *Perception*. If it succeeds at the morale test, then it continues to attack in the next turn. If it fails the morale test (the Threat Roll is greater than the *Perception* Roll), the creature routs, heading for the entry ramp of the ship to exit the table. It will try to run around soldiers

Communique Bounty Hunter Garm Trodash

Garm: We've got a lead on your Hutt target, Mennac Vanderijar. She's there on Trendivar with you. Word has it that her business is complete and she's hightailing it out of there, so you'd better move fast. Her ship's at Docking Bay 73 in the spaceport. Your best bet is to stake out the landing bay and wait for her to show up.

Appended to this file you find the Notice of Imperial Remandation for one Mennac Vanderijar, the posting from IOCI's *Imperial Enforcement DataCore*, your Target Permit and all applicable regional permits. Everything's been cleared. Happy hunting!

You have a team of bounty hunters led by a hero bounty hunter. You are hunting Mennac the Hutt. You know where her ship is and she's got to come back to it.

Set up your hunters anywhere on the table (squad coherence does not apply in this scenario). Your target will be entering through one of the three doors in the north wall. Your hunters may be set up hidden. To hide, they must be placed behind any of the obstructions on the table, such as cargo containers, maintenance carts, etc. Even low items (moderate barriers) can be used to hide behind for the initial set-up.

Victory: Capture the Hutt and bring her off the table by means of the ship's ramp to the south or the one of the doors in the north wall.

Itinerary Mennac the Hutt

Great One: Now that your business is completed, it would be a good idea to get back to the ship. We are not yet sure if you can trust your new ally, and we expect some kind of trouble if we linger too long.

In addition to Mennac, you have Jobwah (another Hutt), a squad of henchmen, a squad of Gamorrean Guards, and a kentril, a nasty little pet. The Hutts are on floaters. See me about the details of the floaters and the pet. Your ship is located at Docking Bay 73 (along the south edge of the table). You may enter by any of the three doors in the north wall.

Choose one of the Hutts to carry the kentril — it starts out on that Hutt's floater. Then determine which of your forces will enter the table by which doors. Each squad must observe the squad coherence rules. However, if anything should happen, your forces can begin to move independently, and the squad coherence rules can be ignored.

After the other player has finished his set-up, you get the first move: bring your forces onto the table via the doors you selected.

Victory: You must get Mennac the Hutt off the table via the ramp in the center of the south table edge.



Orders of the Day Imperial Recon Unit 42B8/ S327

Droid dd54639//322T: You are hereby ordered to find and terminate Mennac Vanderijar, a Hutt. Proceed with all haste to Trendivar to intercept target at Docking Bay 73.

Avoid getting involved with third parties in the search. However, you may return fire if you are attacked.

You have two Imperial probe droids, whose mission is to kill Mennac the Hutt. The probots enter the table during the Special Actions Phase of Turn Two. Place one each at the midpoint of the east and west sides of the table. They begin moving in the Movement Phase of Turn Three.

You may not initiate combat with any bounty hunters unless they have attacked you first.

Victory: Kill Mennac the Hutt.

blocking its way, but if it cannot do so, it will attack them. It will even attack Mennac's soldiers if they get in the way (they usually know better).

If the kentril should defeat the soldier it is attacking, it will return to Mennac's floater (even if it started on Jobwah's; see below), following it around if it is currently in motion, and hopping on board if it stops or is stopped. Mennac can sic

the beast on another figure once it returns to her.

Both Jobwah and the kentril have been associated with Mennac's court for a long enough time that the kentril has become familiar with Jobwah — familiar enough to ride on Jobwah's floater if Mennac so desires. Mennac does this as a matter of course, so that the location of the kentril does not give Mennac away. Therefore, as part of the initial set-up, the Hutt player should decide on which floater the kentril is located and indicate that on the Hero Record Sheet of the appropriate Hutt.

Complicating the Game

This option can be used if you would like to complicate the game, or make it more interesting, or allow a third player to be involved. In this variation, two probots show up during the skirmish. Apparently, the Empire would rather not have to pay bounty hunters, so they sent out some probe droids to eliminate Mennac. These two have tracked down the Hutt. They want to eliminate her, not capture her. Since they also cannot distinguish between the two Hutts, they will attack both of them. The probe droids will ignore the bounty hunters. The droids will, however, attack the bounty hunters if the hunters attack them. The gamemaster can play the droids, or a third player can do so.

The probots enter the table during the Special Actions Phase of Turn Two. They come in at the midpoint of each side, dropping down from the landing bay's rim above. Just place them on the table at the indicated positions. They begin moving in the Movement Phase of Turn Three.

The stats for probe droids are given in the "Troop Lists" on page 101 of *Star Wars Miniatures Battles*. The probots' objective is to kill Mennac the Hutt.

Figure Notes

The Hutts can of course be represented by *Jabba the Hutt* packs (40444). The platform on which Jabba rests can be decorated or otherwise modified to represent the Hutt floater. Alternatively, and if you are feeling ambitious, the platform could be carved away from the Jabba figure so that you have a stand-alone Hutt figure. The Hutt figure can be placed on your own scratch-built version of a Hutt floater, and it also allows you to have the Hutts squirming across the docking bay if they should somehow be knocked off their floaters.

The enforcers in the Hutt's entourage can be represented by any figures in *Bounty Hunters 2* (40422) or *Bounty Hunters 3* (40426), as well as *Aliens of the Galaxy 1* (40429), *Aliens of the Galaxy 2* (40443), *Jabba's Servants* (40445) and *Pirates* (40448). Even though the members of the "squad" all have the same statistics, they can be repre-

sented by a mix of seedy-looking lowlifes. If you need justification, consider that the Hutt hires minions based on the skills she needs in lackeys, so the members of her guard will tend to have the same abilities and not necessarily reflect the standard characteristics of their species. Recommended miniatures to include in the entourage are Greedo the Rodian and Barada the Klatooinan, both from *Bounty Hunters 3*. It might also look rather interesting if the Hutt has her own personal borg; use Lobot (from 40424, *Cloud City*). The Gamorreans can be found in 40450, *Gamorrean Guards*.

The kentril poses a problem, as there currently are no creature miniatures in the *Star Wars* line. It has purposely not been described, so that you can use whatever figure you can find that

seems suitable. See the “Big Game” scenario in this book for more ideas for creature miniatures.

The bounty hunters are best chosen from the *Bounty Hunters* packs (40420, 40422, 40426), particularly from *Bounty Hunters 1* (40420). They can also come from the *Aliens of the Galaxy* packs (40429, 40443), or from *Pirates* (40448), but be sure to paint them differently from any similar aliens working for the Hutt. You might also wish to give each of the bounty hunters’ outfits some common element or symbol so that they look like a team (see *Galaxy Guide 10: Bounty Hunters* for some ideas on bounty hunter guilds and their emblems).

If you choose to include the probe droids, the figure can be found in pack 40442, *Encounter on Hoth*.

Scenario Six

Who Goes There?

This scenario presents a somewhat unorthodox approach to table layout and movement, but in so doing it provides a unique way to experience the “fog of war” and the disorienting effects of jungle warfare. All of the standard rules for movement apply. The only difference is in how movement is interpreted on the tabletop. You should get used to it quickly, and we feel that you will find it an interesting experience.

The Situation

The Alliance to Restore the Republic has maintained a small but effective strike force on the heavily-jungled world of Mentanar Vosk for a few months now. Strike Force Altagak’s mission has been to harry the Imperial garrison at every opportunity, in order to keep the Imperials off-balance and to distract them from detecting other Alliance activity in the area. Altagak (which draws its name from a reptilian predator native to Altora, which is known for its abilities to stalk silently and attack quickly) has been particularly successful in its mission, which has led the Imperials to devote most of their energies to extirpating this annoyance.

Continuing their raids from their hidden staging area located in an ancient ruined temple — a relic of a once-proud but now-extinct species — the Alliance strike force harasses the Empire, leaving them scant time to effectively respond.

Until now, the Imperial forces have been simply reacting, and have been unable to make any headway against their seemingly invisible foe.

But recent intelligence work has uncovered Strike Force Altagak’s secret staging area. A force of stormtroopers has been dispatched to secure the base and neutralize any transportation that would allow the Rebels to get off-world, stranding them to be hunted down.

However, Alliance Intelligence is just as effective, and Altagak has been warned of the Imperial raid. The strike force is currently *en route* to its base with the utmost haste, hoping to arrive there before the Imperials and make use of the escape shuttle stashed within the hoary confines of the archaic temple.

The Forces

Strike Force Altagak consists of two squads of elite Alliance troopers. Normally, one squad at a time is dispatched on a mission, but in this instance two separate targets were attacked simultaneously. Having received the word that the Imperials were onto them, the squads have regrouped and are headed back to their headquarters.

The Imperial garrison commander, underestimating the size of the Rebel resistance, has sent out two squads of elite stormtroopers to eliminate the strike force and its base.

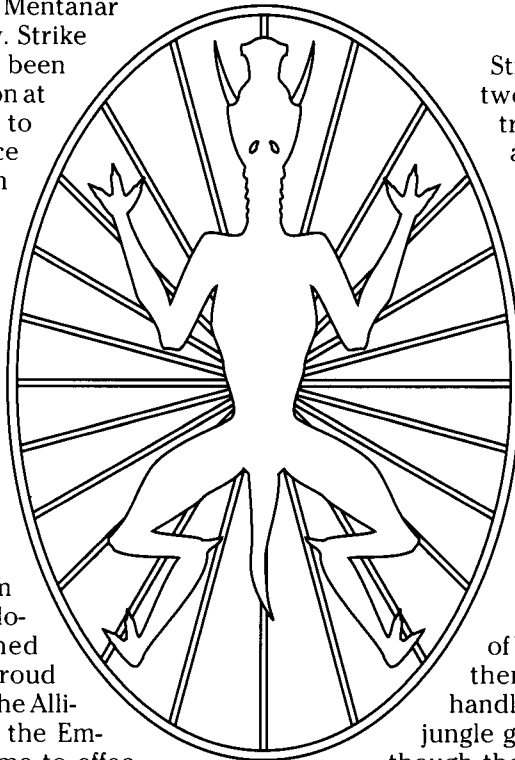

While both groups consist of battle-hardened veterans, neither force has quite gotten a handle on dealing with the thick jungle growth of Mentanar Vosk. Although the jungle has the expected effects on the movement and visibility, its homogeneous nature makes getting about confusing, and it is the rare squad that can stay a course in the midst of the planet’s luxuriant foliage. The

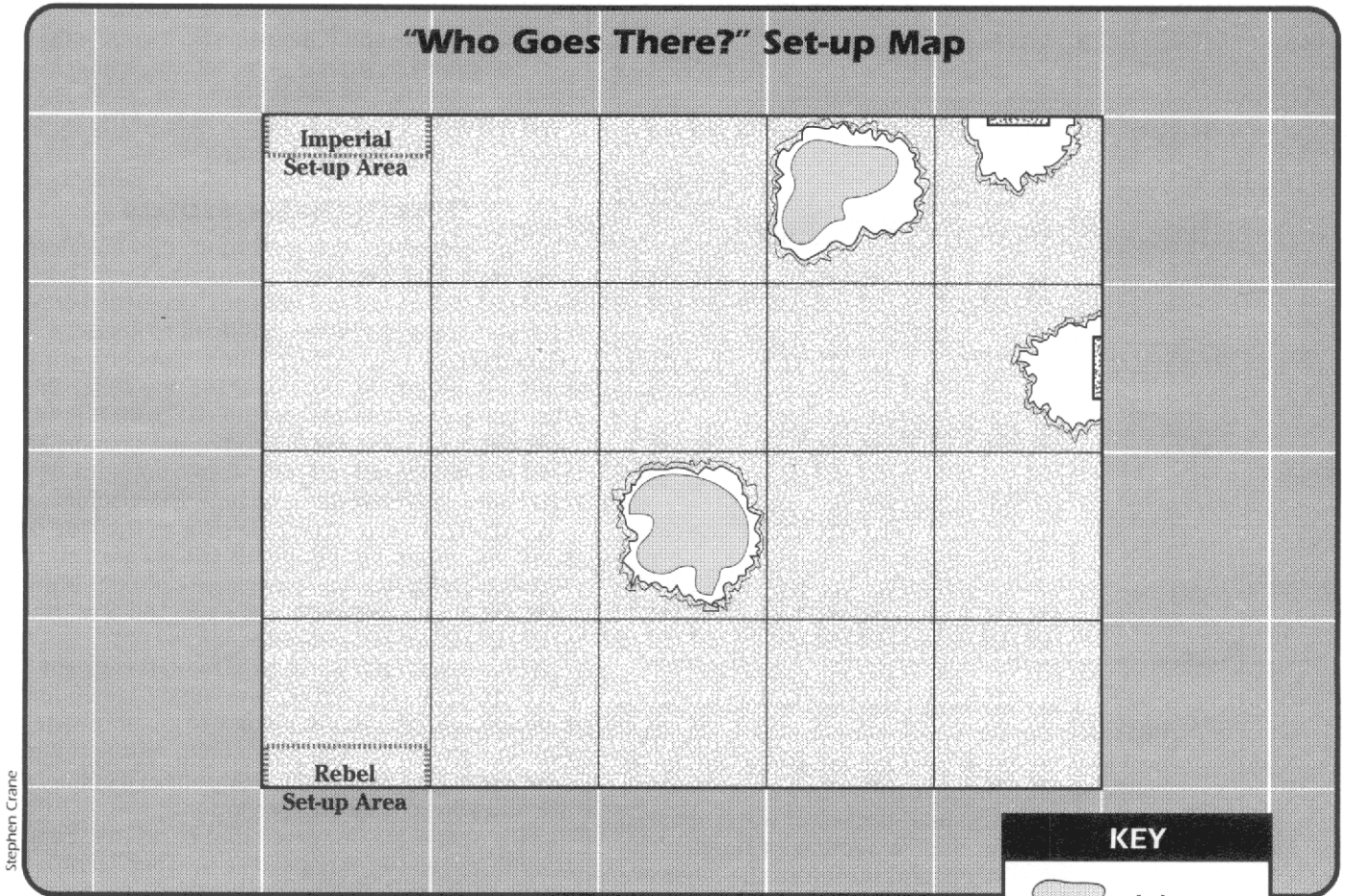

"Who Goes There?" Set-up Map



Stephen Crane

KEY	
	Lake
	Woods
	Temple entrance

forces stationed on the planet have managed to complete their missions in spite of the jungle's nature, but it remains a constant hindrance.

Rebel Forces

■ **Altagak's Fangs**

- 10 Elite Rebel Troopers.
- DEX 3, *blaster* 5; KNO 2; MEC 2; PER 2, *command* 4; STR 2, *brawling* 4; TEC 2; Move: 10.
- **Walk Rate:** 8"; **Run Rate:** 13".
- **Weapons:** blaster carbine.
- **Commander:** *command* 5.
- **Specialist:** *blaster* 5.
Weapon: repeating blaster (standard configuration).
- **Squad Generation Points:** 619.

■ **Altagak's Tusks**

- 10 Elite Rebel Troopers.
- DEX 3, *blaster* 5, *melee combat* 4; KNO 2; MEC 2; PER 2, *command* 3; STR 2, *brawling* 3; TEC 2; Move: 10.
- **Walk Rate:** 8"; **Run Rate:** 13".
- **Weapons:** blaster rifle, vibroblade.
- **Commander:** *command* 4.
- **Specialist:** *blaster* 5.
Weapon: repeating blaster (tripod-mounted).
- **Squad Generation Points:** 684.

Imperial Forces

■ **Stormtrooper Squad Dorn-2/323**

■ **Stormtrooper Squad Dorn-7/325**

- (2 identical squads)
- 10 Veteran Snowtroopers.
 - DEX (2)*, *blaster* (4)*; KNO 2; MEC 2; PER 2; STR (3)*, *brawling* 5; TEC 2; Move: 10.
 - **Walk Rate:** 7"; **Run Rate:** 12".
 - **Weapons:** blaster rifle.
 - **Commander:** *command* 5.
 - **Specialists:**
 - 1: *blaster* (5)*.
Weapon: repeating blaster (standard configuration).
 - 2: *blaster* (5)*.
Weapon: repeating blaster (standard configuration).
 - **Squad Generation Points:** 601.

*Numbers in parentheses are the final values as modified by armor.

The Battlefield

The setting for this mission is a section of the dense jungle that covers much of Mentanar Vosk. The specific area is the jungle leading to the front face of the long-abandoned temple. With the exception of the lakes and the area immediately surrounding them, and the cleared approaches to the temple entrances, the entire table is covered in medium jungle (which is the same as medium woods).

The Actual Layout

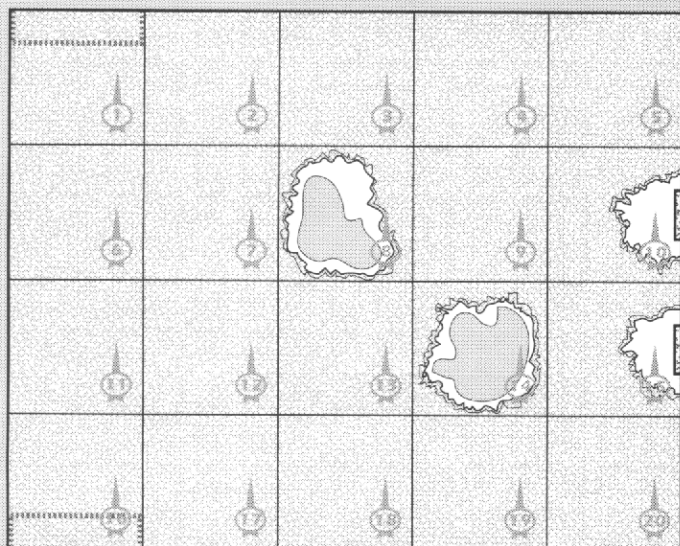

Stephen Crane

As such, the terrain is rough terrain, costing two times the normal movement cost. The jungle provides medium cover to soldiers within its confines, and limits visibility to 6”.

There are two small bodies of water located near the middle of this section of jungle. The water is waist-deep, and therefore the lakes are very rough terrain. The bottom of each lake drops off quickly, so any soldier entering one is immediately up to his waist in water. A soldier who is wounded and falls prone in the lake must make a *Strength* test with a difficulty of 4 to avoid drowning. If a soldier voluntarily falls prone in the lake, he may test against his *swimming* skill (if he has the skill). A test must be made every turn the soldier remains prone. While prone in the lake, a soldier receives medium cover against anything above the surface of the water.

The area around the lakes is clear terrain. The cleared areas in front of the temple entrances are also clear terrain. The temple entrances themselves are 6” wide and are merely open arches. A squad succeeds in entering the temple by simply passing through an archway, thereby leaving the table.

The Set-Up

The Rebel forces are set up along the “south” edge of the table. They

can be placed anywhere within 12” of the “west” side of the table and 6” in from the “south” edge.

The Imperial squads are set up along the “north” edge of the table. They can start anywhere within 12” of the “west” side of the table and 6” in from the “north” edge.

Gamemaster Notes

In any conflict on the ground, commanders make their plans and set their men to their tasks, and then hope that all works out. Once the battle is joined, though, it is very difficult to keep track of everything that is happening. Concentration on the objective at hand, fear for one’s life, and the limited view of the battlefield from a point approximately 1.7 meters above the ground all combine to prevent participants from getting a clear and coherent idea of how the conflict is developing. This is what is known as the “fog of war.” The commander and his troops are acting within a cloud of uncertainty. He can only hope that the enemy is where it is expected and that nothing untoward or unforeseen occurs.

But such is not the case in a miniatures game. Each commander has an unrealistic viewpoint analogous to the vantage point of an airspeeder flitting high above the battlefield, and can see where all of his own and his opponent’s soldiers are and where they are moving.

This scenario eliminates that certainty. Even though all of the troops can be seen, neither commander truly knows where they are in relation to each other, or where they are actually heading. This serves to make the game more representative of actual fact — the commander

Key to the Table Layout

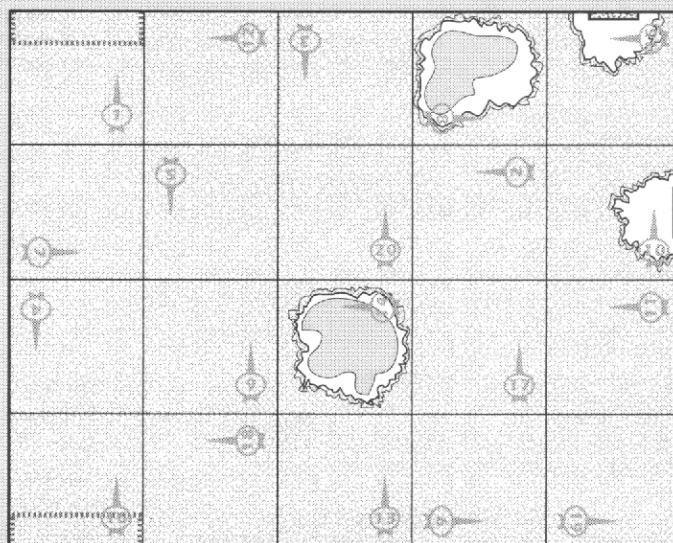

Stephen Crane

knows the enemy is out there, but can't be sure when or where his men will encounter them.

The Table Layout and Movement

What is on the table is in reality a fragmented view of the actual jungle. All of the elements of the battlefield are represented, but have been jumbled around.

The set-up map shows all of the terrain as it should appear on the table. However, the real position of all the terrain elements is shown in the diagram entitled "The Actual Layout." As you can see from the maps, the table is divided into

12"-square sections. In the actual layout the squares are numbered sequentially from west to east and from north to south. Each square is also been marked with a directional arrow pointing north.

The "Key to the Table Layout" shows the relationship between the terrain elements as placed on the table and in their actual positions. The sections making up the actual layout have been shuffled around, and some of them have been rotated, yielding the table layout shown in the set-up map and detailed in the key.

As gamemaster, you will use the two diagrams,

Example of Movement

Note: In this example, top and bottom refer to the edges of sections that are nearest the top and bottom edges of the page, respectively. North and south refer to the actual north and south edges of a section as shown in "The Actual Layout," no matter what its orientation in the table layout. Therefore, the north edge of section 11 in the "Key to the Table Layout" is the left edge, and the top edge in the key is actually the east edge of section 11.

A Rebel squad has decided to make a run for their objective, intending to run to the middle of the table and then down its length to the far edge. The squad's Run Rate is 13". The jungle is medium woods, so the squad can move 6-1/2" at a run each turn.

On Turn One, the squad enters the table and moves straight ahead. On Turn Two, they continue moving ahead, and cross the north edge of section 16. Checking the actual layout, we see that section 11 is north of section 16, so the squad has moved into section 11 across its south edge. Checking the "Key to the Table Layout," we find out where section 11 is located on the table and that the south edge of the section is to the right. Therefore, the squad enters section 11 on the table from the right edge.

The Rebels move into section 11 and turn right to head across the top edge. Then, during Turn Four, they cross over the top edge of the section (which is the east edge of section 11, since it is oriented with north to the left). Consulting the actual layout again, we find that section 12 is to the east of section 11. The squad enters section 12 through its west edge. Looking back at the "Key to the Table Layout," we locate section 12 and note that the west edge of the section is its bottom edge in the table layout. The Rebel squad enters section 12 from the bottom edge.

Deciding to stay their course, the Rebels move straight ahead, and two turns later cross the top edge of section 12. Looking at the key, we see that the top edge of 12 is its east edge and then checking the "Actual Layout" diagram we see that section 13 is the next section to the east. The Rebels have entered section 13 by its west edge. The "Key to the Table Layout" shows us where section 13 is and also that its west edge is to the left. So the squad enters section 13 from the left.

As the squad continues to advance and change direction, it is a simple matter to check its location on the "Key to the Table Layout" and then relate it to the "Actual Layout" in order to determine where on the tabletop they are really moving.

Example of Movement

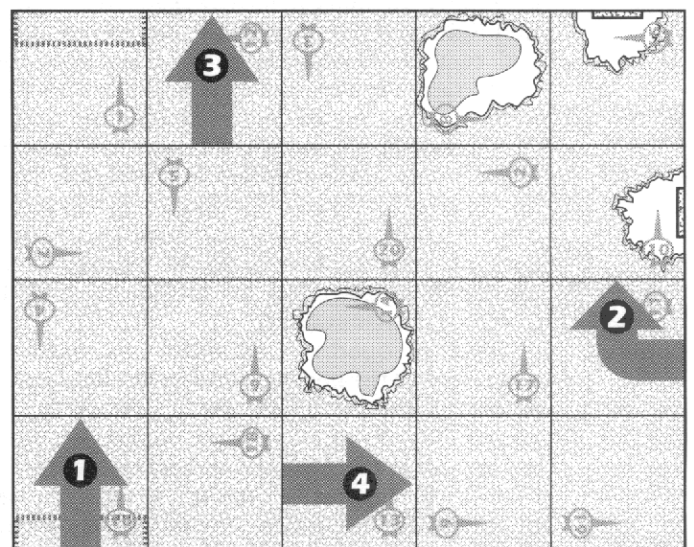

Stephen Crane

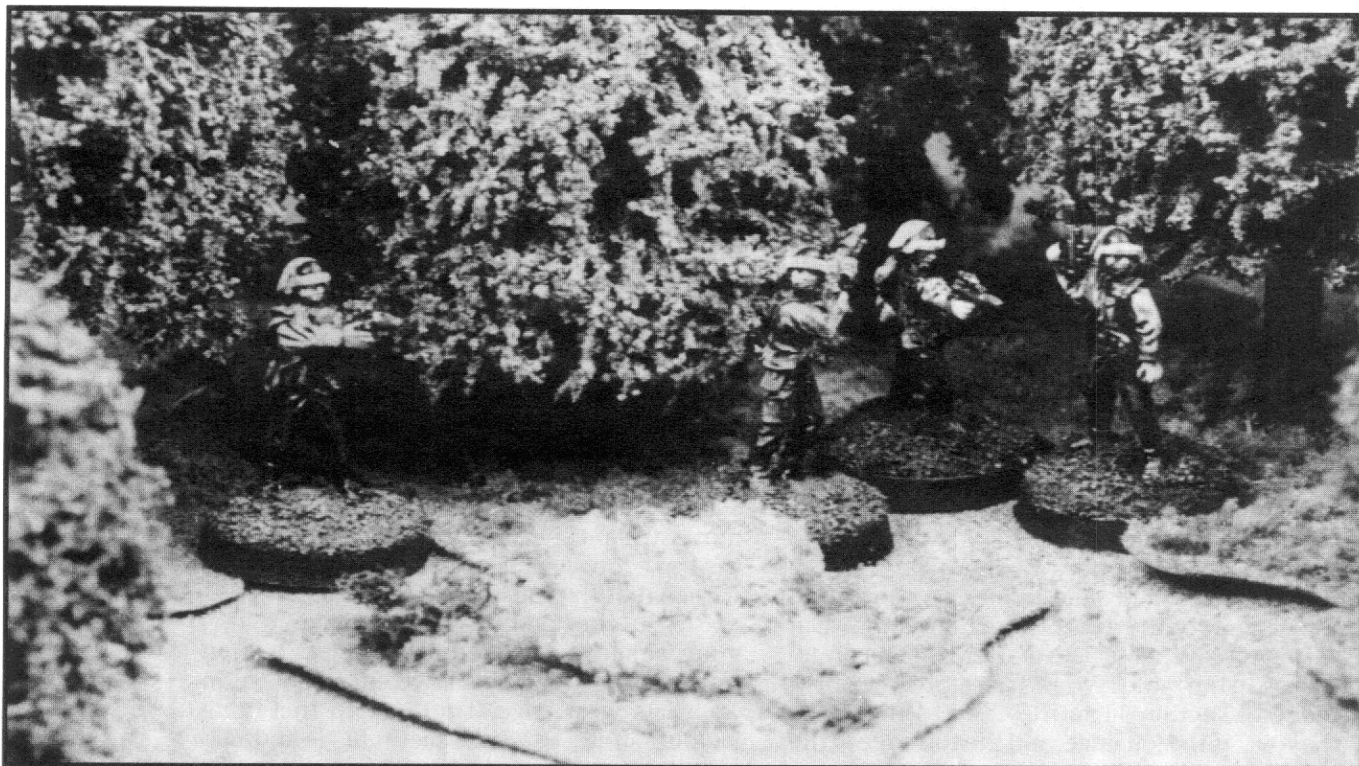

“The Actual Layout” and the “Key to the Table Layout,” to keep track of the squads’ movement. The “Key to the Table Layout” shows how each section is actually oriented, in other words, which way is north in each square. “The Actual Layout” shows you which sections adjoin any particular square, so that you can determine what section a squad is entering when it crosses the edge of an adjoining section.

Movement is performed as normal for the most part. Squads can move at their Walk Rate or Run Rate as desired, with the normal modifiers and results. Movement varies from the norm only when a squad wishes to cross from square section into another. A squad wishing to cross the edge of a section must do so in one complete move. If any of the soldiers in the squad do not have enough movement remaining to cross the edge in a turn, then the squad must wait until the next Movement Phase to do so. A squad cannot move out of a section or into one though the corner of either section.

When a squad is committed to crossing an edge and has the necessary Movement Rate available to it, then you will need to check the diagrams. Find the number of the section the squad is currently occupying by checking on the “Key to the Table Layout.” You will also need to check the section’s orientation — which way is north in that particular section, and which edge is the squad about to cross?

Once you know that information, look for the

same section on “The Actual Layout” map. Knowing which edge of the section the squad is crossing, you can determine which section they are entering, and across which edge of the destination section they are moving.

Going back to the “Key to the Table Layout,” find the destination section and determine its orientation. Now you know in which section and on which edge of that section the player will place her squad. The player then moves the squad its remaining Movement Rate into the destination square, performing any turns or other moves she desires as she completes the move.

Objectives

The objective for both sides is fairly straightforward. Either side must enter the base by one of the entry arches at the edge of the table at least one full turn before the other side can do so.

If the Rebels succeed in doing so, they manage to erase any information the base contains and get away in the shuttle they keep there for getting off-world, giving them the victory. If the Imperials arrive first, they will be able to gather the information in the base and disable the shuttle, preventing the escape of the Rebels; this is an Imperial victory.

If the two sides arrive at the entrance within a turn of each other, then the game is a draw.

The Imperial rally point is the Imperial Set-up Area. The Rebels’ rally point is the temple. If a routing squad’s path toward the temple is

blocked, they will attempt to head back to the Rebel Set-up Area.

Making Your Own Layout

Of course, you are not limited to just this one layout. Once the real layout is mapped out as in "The Actual Layout," you can mix up the sections in any order you wish. A blank layout map has been provided for you to use in setting up your own games. Once you have drawn your layout onto a copy of the map (permission is hereby granted to photocopy this map for personal use), you just cut it apart and rearrange the section in whatever manner you wish, randomly or planned. It is not necessary to use the table proportions given, either. It is an easy enough matter to draw up your own grid for 3' x 6' table, or some other size.

Each of the sections is 12" square as presented here. That is because it is a logical choice, as it is the most usual increment of measurement for a miniatures table. Also, many terrain systems are made up out of 12" panels, making it easy to keep track of the sections.

You can use differently sized sections if you wish. Sections which are too large, though, will

present enough confusion to the players. Smaller squares are also a possibility, which increases the confusion factor, but that makes it harder to keep track of what is going on. In addition, if the squares are too small then a squad can move across more than one in a turn, eliminating some of the confusion factor.

When laying out your terrain on the actual layout, make sure each terrain feature fits within one square. Features that straddle section edges are more difficult to lay out and make it easier for the players to figure out the relationship of the squares.

This type of set-up is not restricted to just forest or jungle battles. It could also work for fog-enshrouded battlefields or night battles, or as the result of some other type of alien weather or terrain effect.

Otherworldly Terrain

Although this scenario was set in a jungle, it could as easily have been a forest, and in fact, whether you use a "forest" or "jungle" really just depends on what type of mood you wish to evoke. Each environment has its own feel that helps to establish the setting of the scenario. At

Blank Layout

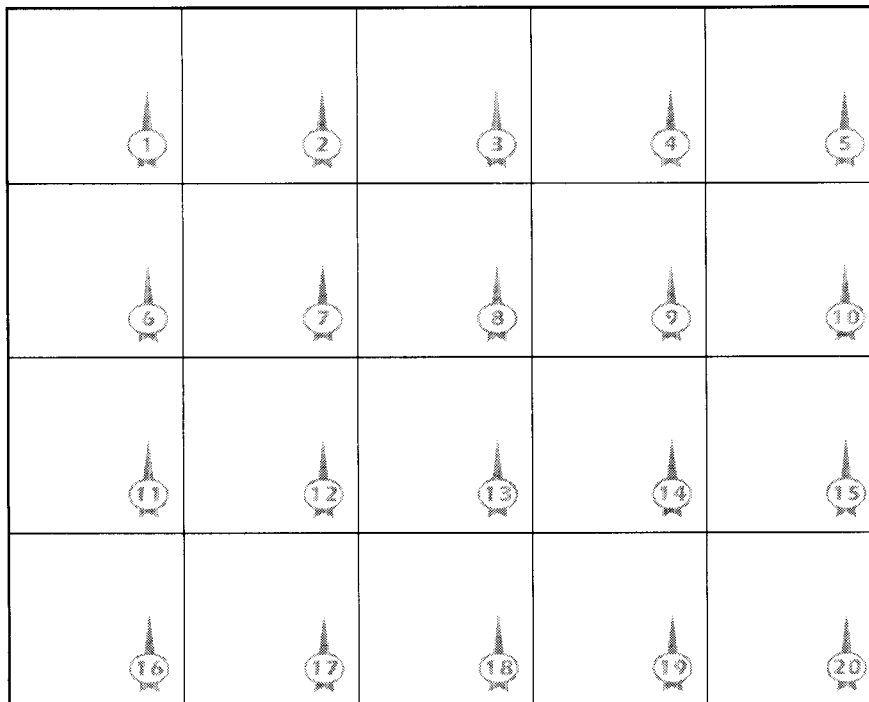

Stephen Crane



other times, the choice of setting may just boil down to what type of trees and foliage you have to set up the table with.

In either case, though, the odds are your foliage is green and brown, with maybe a few autumn colors mixed in. This works just fine for most games, and of course is pretty much all that's available from commercial sources. But *Star Wars* is a science fiction game, and one of the appeals of any science fiction setting is the really alien encounter.

In order to give your games that otherworldly feel, you should consider breaking away from the norm. Try to look at things from a different perspective. Sometimes all it takes are a few slight variations to give a very different feeling to something familiar.

One of the easier places to begin in *Star Wars Miniatures Battles* is with the terrain you use. If your encounter is taking place on another planet, make it *look* like another planet. And one of the easier changes to make is color. Don't stick to conventional green and brown for trees and shrubs. Try different color combinations. Maybe this particular planet has light blue grass and foliage, and the tree trunks are white. Perhaps another world is carpeted with red grass, and the trees have black trunks topped with purple and/or red foliage.

This may seem like a major undertaking, but it is relatively simple to get a nice effect without too much work. Changing the color of the grass gives you a major visual difference, since it covers most of the tabletop. And changing the color of the grass could be as simple as laying a large piece of felt over the table as the basic ground cover. Just one yard of 72"-wide felt covers a 3' x 6' table. If you prefer a more textured look to your groundwork, you could use traditional green grass mat (a green paper roll with scenic grass glued to one side), and lightly spray paint a different color over it. Varying the speed and pressure as you spray over the mat can also give you some interesting textural effects.

If you are using a commercially available terrain system, you can also paint it, but you should think this over first, though. Once you change the color you'll be stuck with it, and it may be expensive to replace them with green again (you could paint them again, but too many coats of paint may adversely affect the look of the surface).

The flora of the world can be made by painting over existing trees. Spray the foliage whatever color you have chosen. When that is dry, paint the trunks and branches of the trees. You can also make your own trees (the procedure was described in detail on pages 95–96 of *Star Wars Miniatures Battles*). To get that alien look, all you have to do is change the color of the materials you are working with. Spray paint a batch of lichen before you start assembling the trees. Paint the wire after you have cut it down to length and formed the branches and roots. It may even be possible to get wire with insulation in the color you have chosen for the planet's trees, saving you that part of the paint job.

If you are following the suggestion on page 96 of *Star Wars Miniatures Battles* and going that extra step for a more detailed look by attaching scenic grass to the lichen, you can vary the colors there as well to get an even stranger effect. Color the static grass (or get some chopped foam) in a color that is different from the lichen used in the tree. This will give you an interesting combination of colors in the same piece of foliage.



Orders of the Day Imperial Commander 205.104/G3

Commander: You are hereby ordered to proceed with all haste to coordinates 235.4/491, where you will find the base of the insurgents that have been operating in the area. Squad 1045.2 has recently reported contact with the Rebels; you are to arrive at their base while they are still engaged. Once there, destroy all equipment, recover any datafiles and neutralize any transportation the Rebels may have, so that we may track them down for capture and interrogation.

Victory: Enter the base by one of the entry arches at the edge of the table at least one full turn before the Rebels can do so.

Besides color, another way to make your terrain look different is to change the shape of common elements to something less familiar. Some of the major components on a gaming table are the trees and bushes. If you change them from their conventional appearance, it can give your terrain an exotic look. This may involve more work than just picking up trees from the hobby store, but will be well worth it.

One of the easiest ways to get different kinds of plants is to visit a pet shop. There are many types of plastic aquarium plants that can be used as is or cut up into smaller plants to give you some very different-looking trees. Any kind of plastic plant can serve to provide a number of otherworldly trees. You can find many plastic and fabric plants in craft shops or in the craft departments of some department stores.

Using these sources, you can either modify existing model trees or make your own. Look at the photos on pages 6, 9 and 33 of *Star Wars Miniatures Battles* and page 26 of the *Star Wars Miniatures Battles Companion*. The alien flora used in those and other photos was built from scratch.

One other easy change is to use unconventional types of rocks. Decorate your tabletop with alien rock formations. Aquarium gravel is a good source for differently colored rocks. You can buy it in bags of individual colors, or mixed together. Try using crystalline or clear stones instead of opaque ones. They will also look suitably alien.



Orders of the Day Alliance Commander Stav Kren, Strike Force Altagak

Commander: Break off your current mission and return to base immediately. The Imperials have discovered the location of your staging area and are sending a force to take it. You must get there before them and evacuate from the planet. A transport will be waiting in low polar orbit to pick up your shuttle. Leave behind all equipment and wipe all datafiles. You must get to your ship; otherwise we will be unable to pick you up from the surface due to the heavy jungle.

Victory: Enter the base by one of the entry arches at the edge of the table at least one full turn before the Imperials can do so.

Figure Notes

You can use Rebel troopers from any of the *Rebels* or *Rebel Troopers* packs (40405, 40406, 40413, 40421), but commando figures might be better, given the mission profile of Strike Force Altagak. Commando figures can be found, appropriately enough, in *Rebel Commandos 1* (40414) and *Rebel Commandos 2* (40417), as well as *Rebel Troopers 4* (40421). If you opt to try the alien-terrain look described above, you should paint the commandos' fatigues and ponchos in an appropriately-colored pattern.

Stormtroopers can be recruited from any of the *Stormtroopers* packs (40403, 40404, 40409, 40416) or the *Sandtroopers* pack (40428).

Scenario Seven Scavenger Hunt

The Situation

New Republic troops have been engaged in a massive mopping-up operation on the world-city of Coruscant. Various factions of the Empire have managed to put aside their differences and suspend their internecine struggles in order to unite against a common foe — the fledgling New Republic. Determined to deny the enemy that which they themselves cannot possess, the Imperial forces have combined arms to lay waste to the former Imperial capital and current seat of New Republic government. After many fierce battles, New Republic ground forces have been dropped by transport to particularly contested areas of the planet in order to curtail Imperial advances.

Yet while this struggle for the fate of a galaxy rages on around them, certain groups go about their own business — a business that feeds on the misery and loss of those who struggle for their ideals. These groups are the war scavengers. The scavengers — or “scavs” as they are often called — avoid the areas of major conflict, preferring instead to loot those sections of the city where the fighting has passed. But sometimes an item of booty so enticing presents itself that the scavs risk entering a hot zone in order to acquire it.

In just such a case, scavenger crews have discovered a New Republic transport that has disembarked its troops to pursue a renegade Imperial force. Attempting to abscond with the entire ship, the scavs have discovered that it is buttoned up tight, and they are unable to gain access to it. Deciding that even a little gain is better than none, the determined scav crews have set to work to strip the transport of whatever spoils they can detach and carry off.

However, they have not gone unnoticed, and a detachment of the New Republic forces assigned to the transport have been ordered to return to the ship to drive off the scavengers before they can irreparably damage it, thereby stranding the

New Republic troops in the midst of hostile forces. As the New Republic approaches, the scavs are hard at work ...

New Republic Forces

New Republic Planetary Operations Tactical Command (TacComm) has dispatched three squads from platoons involved in the current assault and charged them with clearing away the scavs and securing the transport. The three squads of New Republic soldiers are all that can be spared at this point.

■ Red Squad, Third Platoon

- 10 Veteran New Republic Troopers.
- DEX 3, *blaster* 5; KNO 2; MEC 3; PER 2, *command* 3; STR 2, *brawling* 3; TEC 2; Move: 10.
- **Walk Rate:** 8"; **Run Rate:** 13".
- **Weapons:** blaster rifle.
- **Commander:** *command* 4.
- **Specialist:** *blaster* 6.
- **Weapon:** repeating blaster (standard configuration).
- **Squad Generation Points:** 550.

■ Gold Squad, Second Platoon

- 8 Veteran New Republic Troopers.
- DEX 3, *blaster* 5; KNO 2; MEC 3; PER 2, *command* 3; STR 2, *brawling* 3; TEC 2; Move: 10.
- **Walk Rate:** 8"; **Run Rate:** 13".
- **Weapons:** blaster pistol.
- **Commander:** *command* 4.
- **Squad Generation Points:** 361.

■ Green Squad, Second Platoon

- 10 Veteran New Republic Troopers.
- DEX 3, *blaster* 5; KNO 2; MEC 3; PER 2, *command* 3; STR 2, *brawling* 3; TEC 2; Move: 10.
- **Walk Rate:** 8"; **Run Rate:** 13".
- **Weapons:** blaster rifle.
- **Commander:** *command* 4.
- **Specialist:** *grenade* 5.
- **Weapon:** 2 concussion grenades.
- **Squad Generation Points:** 549.

Scavengers

The scavengers have two work crews currently at work on stripping the transport. All of the scavengers are armed and will fight if necessary. In order to keep that from happening, the

scavs have brought along some weapons for defense — a hunting pack of six neks and a refurbished war droid. The neks are controlled by a beast handler, the crew's specialist.

Each crew has a beast handler specialist, and each one has a concom for controlling the pack. If one beast handler is incapacitated, the other may attempt to take over control of the pack by passing a *beast handling* test with a difficulty number of 8. If he fails, the neks run amok (following the rules on pages 70–71 of *Star Wars Miniatures Battles*). The handler may attempt to take control of the neks in successive turns, each time testing against a difficulty of 10. Full details on using neks in a game can be found on pages 47–48 of the *Star Wars Miniatures Battles Companion*.

The droid is programmed to defend the scavengers, but it is free to choose its own course of action in doing so.

■ **Scav Crew 1**

- 12 Average Scavengers.
- DEX 2, *blaster* 4; KNO 2; MEC 3, *repulsorlift operation* 4; PER 2, *sneak* 3; STR 2; TEC 3, *droid repair* 5, *space transports repair* 5; Move: 10.
- **Walk Rate:** 7"; **Run Rate:** 12".
- **Weapons:** heavy blaster pistol.
- **Commander:** *command* 3.
- **Specialists:**
 - 1: *beast handling* 6.
 - Weapon:** concom (nek controller).
 - 2: *grenade* 4.
 - Weapon:** 2 fragmentation grenades, 2 smoke grenades.
- **Squad Generation Points:** 540.

■ **Scav Crew 2**

- 10 Average Scavengers.
- DEX 2, *blaster* 4; KNO 2; MEC 3, *repulsorlift operation* 4; PER 2, *sneak* 3; STR 2; TEC 3, *droid repair* 5, *space transports repair* 5; Move: 10.
- **Walk Rate:** 7"; **Run Rate:** 12".
- **Weapons:** blaster pistol.
- **Commander:** *command* 3.
- **Specialists:**
 - 1: *beast handling* 6.
 - Weapon:** concom (nek controller).
 - 2: *blaster* 5.
 - Weapon:** blaster carbine.
- **Squad Generation Points:** 448.

■ **Nek (Cyborrean Battle Dog)**

- **DEX:** 2.
 - **STR:** 3 (5)*.
 - **PER:** 3.
 - **Move:** 12.
 - **Movement Rate:** 14.
 - **Attack Forms:** bite (5), claw (6).
 - **Squad Generation Points:** 62 (per nek).
 - **Squad Generation Points:** 372 (for entire pack).
- *The nek's integral cybernetic body armor adds 2 to its *Strength* for resisting damage.

■ **XL-5 (Exell-Five)**

- War droid.
- DEX 3, *blaster* 5, *blaster artillery* 5; KNO 1; MEC 1; PER 2; STR 6; TEC 1; Move: 8.
- **Movement Rate:** 7".
- **Weapons:** blaster rifle, repeating blaster.
- **Notes:** Repeating blaster cannot perform following fire.
- **Squad Generation Points:** 94.

Beast Handling Difficulty Numbers

Summarized below are the difficulty numbers for the various *beast handling* tests that may be required in this scenario.

Action	Difficulty Number
Send neks into battle*	6
Restrain neks that see combat within 12"	8
Regain control of neks running amok	10
Prevent wounded neks from running amok	8
Direct neks to disengage from combat	8

Additional tests that may be required are described below.

Action	Difficulty Number
If neks pass within 12" of close assault combat, distance to make <i>Perception</i> test to see if they notice combat	
Each four soldiers involved in the nearby combat	-1

* If the test to send neks into combat fails, roll one die; if the result is less than the number of neks in the pack, they run amok.

The Battlefield

The site for this altercation is a bombed-out and blasted section of the world-spanning city of Coruscant. The major terrain features at this battle are craters and piles of debris — the remains of buildings long ago blasted by Imperial ordnance. While almost the entire battlefield is covered with debris of some sort, most of it is lightly scattered, and so is clear terrain.

There are a number of large concentrations of debris, though, and these do affect movement and provide cover. These piles of rubble are composed of the shattered remains of the structures that once stood in this part of the city. Most of the rubble piles are loose debris carpeting the ground, making movement difficult — they are rough terrain (costing twice the normal Movement Rate to cross) and provide light cover to soldiers within or behind them. Some of the debris is piled higher and composed of larger structural elements. These areas are very rough terrain, costing four times the normal Movement Rate. The dense rubble provides medium cover.

The craters dotting the landscape are a result of the fallout from heavy orbital bombardment of the adjoining blocks, compounded by artillery barrages. The craters are not very deep, but the edges of the craters are the equivalent of low walls: moderate barriers which cost 2" to cross and provide medium cover (see pages 15, 17, 28–29, 30 and 38 of *Star Wars Miniatures Battles* for

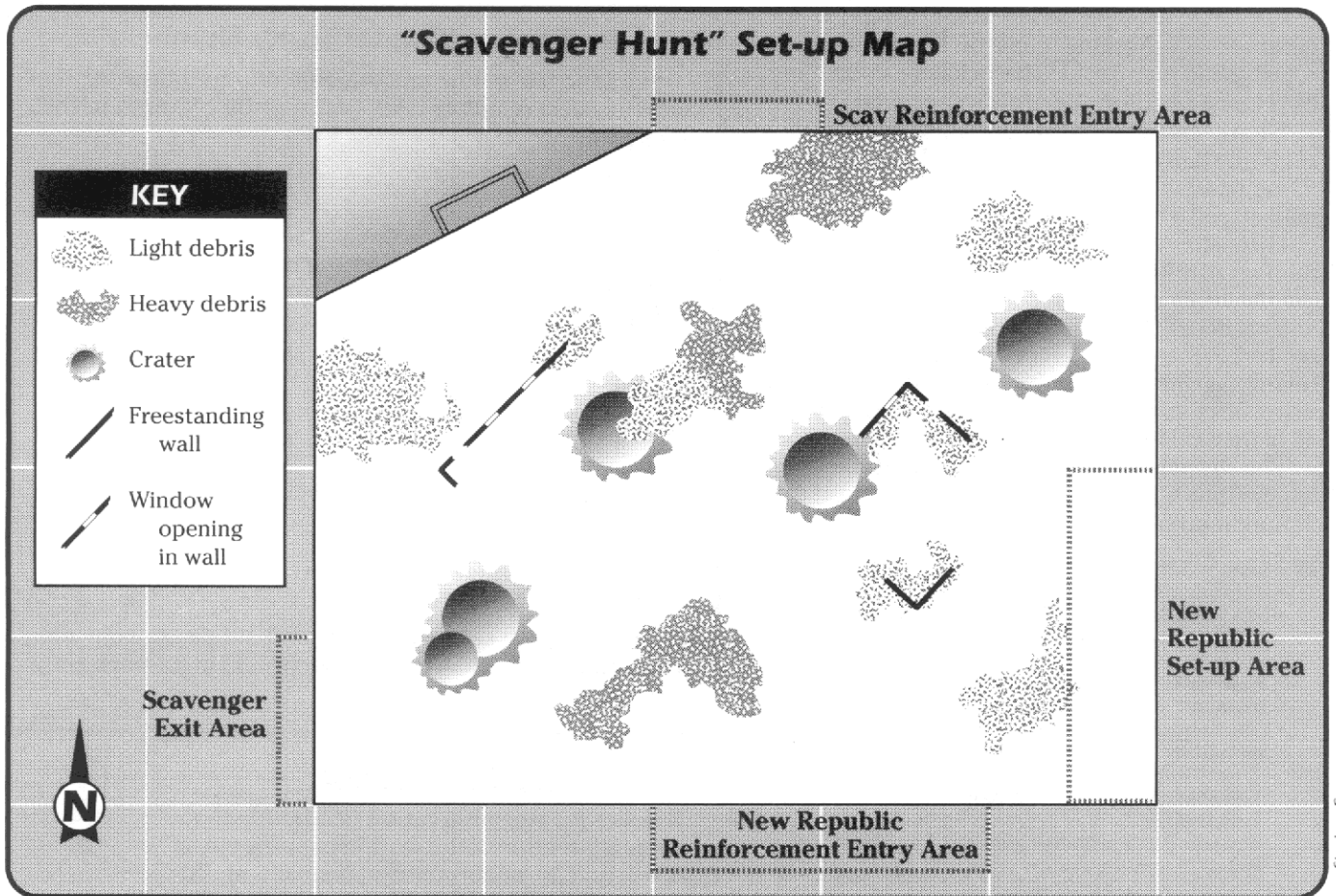

the details of movement and combat involving barriers).

In addition to the craters and rubble, there are a few freestanding walls which managed to survive the bombardment without falling. They are high walls which block line of sight. There are window openings in two of the walls (the windows have long since been destroyed) and gaps have been blasted in some of the walls. The gaps in the walls are treated as doors and the window openings follow the normal rules for windows (see pages 17, 18 and 38 of *Star Wars Miniatures Battles* for the effect of buildings on line of sight and fire combat).

To the northwest is the edge of the New Republic transport. This is impassable, as it sits too low to the ground to allow movement under it. It runs off the table to the north and to the west. Midway along the portion of the transport which is on the table is the troop embarkation/debarkation ramp, which is currently closed and secured. It is 6" wide.

The Set-Up

The scavenger player sets up first. Scavenger figures must be set up within 3" of the edge of the

transport. They should be placed on the table facing the ship (they are busy trying to dismantle as much of the ship as possible in their limited time). The scavenger player may designate one figure from each squad as a guard. That figure may be placed anywhere within 5" of the ship, but also within command distance of another member of its squad. The neks and the droid are not placed on the table at the beginning of the game.

Once the scavenger player has set up his squads, the New Republic player may place his figures on the table. The New Republic soldiers are set up anywhere within 6" of the eastern edge of the table and within 24" of the southern edge of the table. The New Republic player sets up only two of his squads in this initial set-up (Gold Squad and one other squad of the player's choice). The reason is that TacComm has selected squads from different elements of the ongoing operation so as not to unduly weaken either flank of the assaulting force. The squads' orders are to rendezvous at the transport. Due to some enemy resistance along the way, though, they do not arrive at the same time.

Once the New Republic player has set up his squads, the game begins with the New Republic

moving first. Until their forces are spotted by the scavengers, the New Republic will have the initiative each turn.

During the second Movement Phase, when it is the New Republic's turn to move, the player should roll a six-sided die. If the result is a 1, 2 or 3, then he can bring the third New Republic squad onto the table along the edge marked as the "New Republic Reinforcement Entry Area" (the 24"-wide entry area along the southern edge of the table). The figures enter the table along the entry area edge and are moved onto the table as far their Movement Rate allows (this means that some soldiers behind the first rank may not get their entire movement in their entry turn). If the result of the die roll is a 4, 5 or 6, the other New Republic squad enters the table in the next Movement Phase (during the third turn).

The New Republic force is considered to be spotted if either of the scavengers' guards can draw an unobstructed line of sight to any New Republic soldier at any point during the Movement Phase. The war droid and the hunting pack may be brought onto the table during any Movement Phase after the scavengers have spotted the New Republic forces. Only one of the two can be brought on in a given Movement Phase. The droid or neks enter the table through the "Scav Reinforcement Entry Area" (the center 12" of the north table edge).

When the nek hunting pack is brought onto the table, the neks are moved to one of the two scavengers holding a concom. They must move to within 3" of the handler before they can be sent to attack. When the war droid enters the table it may move freely.

Gamemaster Notes

The scavengers' objective is to seize enough booty to make this operation worthwhile, and then to retreat back to their own ship with their spoils. The New Republic's objective is to prevent the scavengers from succeeding in their mission. If the scavengers plunder too much of the ship's systems, then it will not function when the troops need to lift off.

How effective the scavengers have been is determined in the Special Actions Phase of each turn, and is measured in Plunder Points. During the Special Actions Phase, the scavenger player makes a *space transports repair* test with a difficulty number of 8. Rollovers and bomb-outs are treated normally. Failure to make the roll means that the scavengers did not retrieve anything valuable this turn (or are still working at detaching some part or other from the ship). If the skill test was successful, then some useful plunder was acquired.

Take the number by which the die roll ex-

ceeded the difficulty number and multiply it by the number of scavengers who were working on the ship during the turn. That is the number of Plunder Points gained for the turn. Scavenger figures are considered to be working on the transport if their base is in contact with the ship, the ship is in their fire arc, they have taken no other action during the turn, and they have not been wounded during the turn. Note that while a skill roll total of 8 indicates success, no useful salvage is obtained, as the skill total exceeds the difficulty number by 0.

Example: Seven scavengers begin the turn in contact with and facing the transport. They do not move in the Movement Phase, and do not fire in the Fire Combat Phase. However, one of the scavengers is wounded by blaster fire in that phase. None of the scavengers engages in close assault combat. Because one of the scavengers was wounded during the turn, only six scavengers have worked on the transport for the entire turn.

During the Special Actions Phase, the scavenger player attempts the space transports repair test. Rolling a "5," the player adds the skill level of 5 for a result of 10. That exceeds the difficulty number of 8 by two points. Multiplying the two points by the number of scavengers working on the transport (2 x 6) yields a result of 12 Plunder Points.

Keep track of the total number of Plunder Points, adding each turn's result to the previous ones. When the scavengers have acquired 60 Plunder Points, they have obtained what they came for and can head back to their own ship to make good their escape. The scavengers are supplied with the equipment necessary to carry off their booty — various pouches, harnesses and repulsorgrips allow them to haul away the scavenged parts without being unduly encumbered, so their Movement Rates are unaffected. The scavenger player must proceed to reform his squads if they are split up, and can then begin to move them toward their exit area.

In this scenario, scav squads can be split, leaving some of the scavengers to work on the transport, while the others fend off the New Republic soldiers. Once combat is joined, the scavenger player (during the Movement Phase) may turn as many figures away from the transport as he wishes, moving them normally. Figures working on the ship or moving off to combat do not suffer any separation penalties for being out of command distance with each other. Any further divisions do, however, affect whichever part of the squad is subsequently separated.

Example: Scav Crew 1, consisting of 12 scavengers, is stripping the New Republic

transport. When the New Republic forces are spotted approaching, seven of the scavs, including the commander, are moved away from the ship in order to hold them off. Even if the seven scavs move more than 3" away

Orders of the Day Crew Chief Soskar Renn

Chief: Our sensors have detected a large ship at rest near your work zone. It looks like there'll be some good pickin's on this baby. Nobody's near the ship, so it should be an easy job. Take a crew and some defenses and see what you can salvage. Try to get the whole ship if possible, otherwise just go for parts. Remember, we're looking for power circuitry and modules in particular, but don't let anything else that looks good slip by. Strip that ship and get the stuff back to our shuttle.

You have a work crew divided into two squads, as well as some neks and a war droid for "defense." Set up the work crews in contact with and facing the edge of the transport, which spans the northwest corner of the table. You may designate one guard from each squad. The guards face into the table, and may be placed anywhere within 5" of the ship, but must also be within command distance of another member of their respective squads. Do not place the droid or neks on the table; they are your defensive reserves.

Once one of your guards spots any of the approaching forces, you can break off a part of each squad to defend against the threat. There are no separation penalties as long as one part of the squad is still working on the ship. Once the enemy has been spotted, you may bring the nek pack or droid onto the table through the "Scav Reinforcement Entry Area," but only one of them in a single Movement Phase. The neks must rendezvous with their handler before being able to attack.

Your success in scavenging parts, and how much you have appropriated, will be determined by a skill roll each turn; I will fill you in on the details as it becomes necessary. Once you have gathered enough booty, you must exit from the table along the southwest edge.

Victory: Acquire 60 Plunder Points worth of parts and then get at least half your starting force off the table along the "Scav Exit Area" on the southwest edge.

from the rest of the work crew, neither group will suffer any separation penalties.

Later, three of the scavs move out of command distance from the other four members of the squad (which include the commander). Separation penalties now apply to the three scavengers, who have become separated from their squad, and must now attempt to rejoin the squad.

The effects of separation from a squad are explained on page 12 of *Star Wars Miniatures Battles*.

Once the scavengers have achieved their required Plunder Points, any scavengers next to the transport must move to rejoin the other members of their work crew. Then the entire crew can move toward the exit area. Once the retreat is underway, scav work crews can no longer be split up or they will experience the normal effects of separation.

The scavengers' exit area is marked on the set-up map. The scavenger player must exit at least half of his figures from the table along the southern 12" of the western edge — after gaining the 60 Plunder Points — in order to claim victory.

The New Republic player attains victory by preventing the scavs from damaging the ship and escaping with their booty. If the scavengers manage to obtain more than 45 Plunder Points, they will have pilfered enough components to adversely affect the transport, and its engines will be inoperable. The New Republic must prevent as many scavs as possible from working on the ship, and drive them off the table before they can reach 45 Plunder Points, thereby doing too much harm to the transport.

There are various levels of victory in this scenario, depending on how well each side performs. They are graded as follows:

- **Decisive New Republic Victory:** The New Republic troops incapacitate the scavengers or drive them off the field before they can acquire 45 Plunder Points.
- **Marginal New Republic Victory:** The New Republic manages to eliminate or drive off the scavengers, but the scavs have obtained 45 or more Plunder Points.
- **Marginal Scavenger Victory:** The scavengers acquire 60 or more Plunder Points, but do not manage to get more than half of their troops off the table via the exit area.
- **Decisive Scavenger Victory:** The scavengers acquire 60 or more Plunder Points and succeed in getting half or more of their men off the table via the exit area.



Variations

If you feel that this scenario is too easy or too hard for the scavenger player, you can vary the Plunder Point total needed by the scavs in order to adjust the difficulty of the scenario.

For a game with a different feel, add a hero Force-user to the New Republic side. Using 250 Squad Generation Points, create a Force-using hero. If you are using the hero option, you must also reduce either Green Squad or Red Squad to half strength (i.e., five soldiers).

Figure Notes

New Republic troopers can be recruited from any of the *Rebels* or *Rebel Troopers* packs (40405, 40406, 40413, 40421), as the uniforms and their colors did not really change much after the rise of the New Republic. Figures from the *Rebel Commandos* packs (40414, 40417) could also be used, but they would work best for Gold Squad.

The scavs are a motley lot. They can be represented by any non-standard or assorted figures, which can be culled from the *Bounty Hunters* packs (40420, 40422, 40426), the *Aliens of the Galaxy* packs (40429, 40443), *Jabba's Servants* (40445), *Pirates* (40448), and *Mos Eisley* (40449); or even *Rebel Operatives* (40434) and the *DarkStryder Crew* (40446, 40447, 40452).

It is also possible to use figures wearing a more regular uniform, like the *Pilots and Gunners* (40408) or the soldiers from the *Rebel Commandos* packs

 **Mission Brief:**
New Republic Commander Darreen Spens

Commander: We have reports of a pack of those lousy scavs heading toward your transport. The unit's going to have to move out fast if things turn ugly out there, so we can't afford to have anyone messing with the ship. Take three squads and get back to the transport to make sure that everything is secure. If the scavengers show their faces, give them a good reason to ply their "trade" over by the Imperial lines.

You have two full squads and a scout squad (Gold Squad) with which to defend the transport. Set up Gold Squad and one of the others in the "New Republic Set-up Area." You have initiative until the scavs spot you, then roll for initiative normally each turn. You can bring your remaining squad onto the table in Turn Two if you roll a 1, 2 or 3 on a six-sided die. Otherwise, it comes on in Turn Three. The third squad enters the table through the "New Republic Reinforcement Entry Area."

Victory: Drive off or otherwise eliminate the scavengers before they can damage the transport beyond repair (that is, before they garner 45 or more Plunder Points).

(40414, 40417). The key with these figures is in the paint job. Vary the colors from the usual uniform colors that a figure of that type would normally wear. Paint the figures a variety of

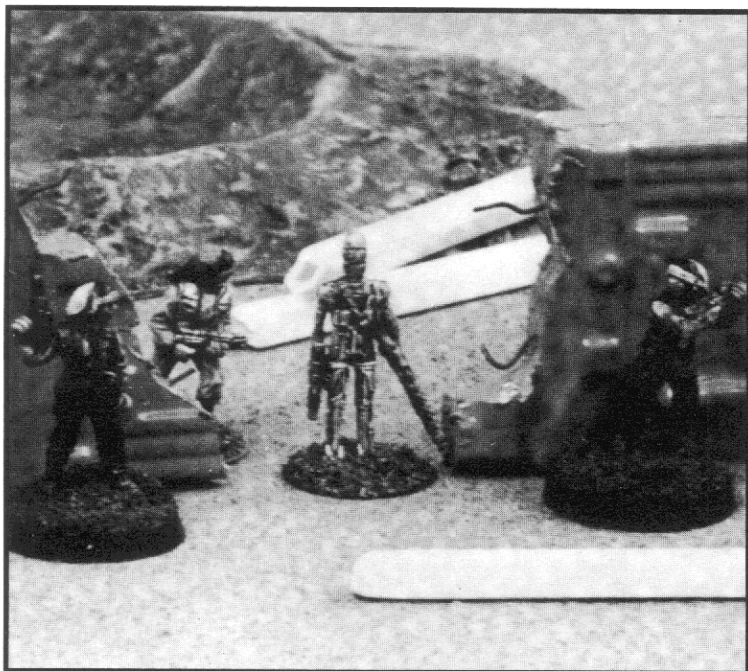

different colors, and try to give them a worn and haphazard feel.

As described in Scenario Five, "To Hunt the Hutt," you can justify using an assortment of aliens to represent a work crew having all the same attributes and skills. Basically, the workers are assigned or selected based on their abilities, so that even though the figures are quite disparate, they all tend to be equally skilled.

The war droid is best represented by the assassin droid, IG-88, which is found in pack 40420, *Bounty Hunters 1*, although you could also use the probot from *Encounter on Hoth* (40442) or the Imperial droid from *Droids 1* (40423).

The neks will require the most creativity, as there are currently no figures for these creatures. Finding or making appropriate figures is discussed in Scenario One, "Big Game." If you cannot find a small alien animal figure (or even an Earth creature, which can be modified with a few dabs of putty), a robotic creature figure would also work. An illustration showing neks can be found on page 58 of the *Dark Empire Sourcebook*; this is a good reference if you wish to convert an existing figure.

Scenario Eight Rescue Run

The Situation

While on Koovis observing the recent activities of the Imperial planetary garrison force on maneuvers, an important Rebel operative by the name of Klev Natasken has been apprehended by Imperial forces. Having successfully resisted a number of field interrogations, Natasken is being held for transfer to an Imperial Security Bureau (ISB) interrogation facility. Not only does Natasken have important information on the Imperial armed forces and the Imperial intelligence network in the system, but he also knows quite a bit about the Rebellion's operations in the sector.

In light of this, Alliance Sector Command has determined that it is imperative that he be removed from Imperial hands, not only for his own sake, but also to safeguard their own operations and to gain some valuable information on the Empire's plans. A strike force of SpecForces Infiltrators was immediately mobilized to rescue Klev Natasken.

Natasken is currently being held in an Imperial field camp, awaiting transport off-world. He is being held in small satellite camp with a minimal guard (the Imperial commander has assigned a force that he feels is large enough to maintain security, but not so big that it would attract undue attention to itself). Once the ISB transport arrives at the main camp, an armored speeder will be dispatched to the field camp to pick up Natasken and bring him to the ship. The ISB ship is scheduled to arrive at dawn. Should there be trouble, the guard force can call on any of the squads that are patrolling the perimeter of the main camp.

The Infiltrators have been covertly transported to Koovis in a small sensor-shielded drop-ship and, under cover of the planet's night, have been paradropped a short distance from the camp. Their mission is to free Klev Natasken before the transport arrives and bring him back to the pick-up point for retrieval by their drop-ship.

Rebel Forces

Two squads of Infiltrators have been assigned to the rescue mission. They have been paradropped in two different locations so as to give each squad a better chance of achieving its objective should one of the squads be discovered. After they have landed, the squads may move independently of each other, or may choose to rendezvous and work together, at the Rebel player's discretion.

■ "Nighthawks" Squad

- 8 Elite Infiltrators.
- DEX 3, *blaster* 5; KNO 2; MEC 2; PER 2, *command* 4; STR 2, *brawling* 3; TEC 2, *security* 3; Move: 10.
- **Walk Rate:** 8"; **Run Rate:** 13".
- **Weapons:** blaster carbine.
- **Commander:** *command* 5.
- **Specialists:**
 - 1: *blaster* 6.
Weapon: repeating blaster (standard configuration).
 - 2: *grenade* 5.
Weapon: 3 Luma grenades; 3 Spore/B stun grenades.
- **Squad Generation Points:** 556.

■ "Nightcrawlers" Squad

- 10 Elite Infiltrators.
- DEX 3, *blaster* 5; KNO 2; MEC 2; PER 2, *command* 4; STR 2, *brawling* 3; TEC 2, *security* 3; Move: 10.
- **Walk Rate:** 8"; **Run Rate:** 13".
- **Weapons:** heavy blaster pistol.
- **Commander:** *command* 5.
- **Specialists:**
 - 1: *blaster* 6.
Weapon: blaster rifle.
 - 2: *security* 5.
- **Squad Generation Points:** 589.

Imperial Forces

The Imperial force commander has assigned one squad of Army troopers to stand guard over the captured Rebel traitor. As the prisoner is locked securely in a field habitation, the commander feels that one squad is sufficient to guard him, and can handle a small rescue force. If a large force were to attempt the rescue, they would be detected early enough for him to mobilize a defensive force. In addition to the guard

force, there are a number of squads patrolling the area between the main camp and the satellite camps, and one or more of them should be close enough to lend support if required.

In fact, at the time of the Rebel assault, there is only one squad close enough to arrive in time for the battle. Once the Rebels are spotted by the Imperial camp and the call for assistance goes out, the additional squad will head for the camp to reinforce the guard.

■ Squad 7-Senth

- 10 Average Imperial Army Troopers.
- DEX 3, *blaster* 4; KNO 1; MEC 1; PER 2; STR 3, *brawling* 4; TEC 1; Move: 10.
- **Walk Rate:** 8"; **Run Rate:** 13".
- **Weapons:** blaster rifle, vibroblade.
- **Commander:** *command* 3.
- **Specialists:**
 - 1: *blaster* 6.
 - Weapon:** repeating blaster (standard configuration).
 - 2: *blaster* 6.
 - Weapon:** repeating blaster (tripod-mounted).
- **Squad Generation Points:** 456.

■ Patrol Squad 34/258

- 12 Veteran Snowtroopers.
- DEX (2)*, *blaster* (4)*; KNO 2; MEC 2; PER 2; STR (3)*, *brawling* 5; TEC 2; Move: 10.
- **Walk Rate:** 7"; **Run Rate:** 12".
- **Weapons:** blaster rifle.
- **Commander:** *command* 5.
- **Specialists:**
 - 1: *blaster* 5.
 - Weapon:** repeating blaster (standard configuration).
 - 2: *blaster* 5.
 - Weapon:** repeating blaster (tripod-mounted).
- **Squad Generation Points:** 682.

*Numbers in parentheses are the final values as modified by armor.

The Battlefield

The Imperial garrison is on maneuvers in a lightly forested region located in the southern temperate zone of Koovis. The satellite camp where Klev Natasken is being held actually occupies the site of an abandoned supply dump.

It is surrounded by wooded stretches which have begun to encroach on the grounds and structures of the camp. Because the maneuvers were just an exercise for a long-entrenched and somewhat bored garrison, security was a bit lax, and with all the excitement and tumult engendered by the discovery and apprehension of the Rebel spy, the site has not been fully cleared.

The table layout represents the edge of the camp where Natasken is being held, and the wooded ground surrounding the camp.

The interior of the camp is clear terrain. The area around the camp is lightly wooded, consisting of clear ground with scattered small copses of trees. Those wooded areas are made up of light woods; therefore, movement through a wooded area is across rough terrain. The trees provide

light cover and limit line of sight to 8". You may wish to review the rules concerning woods and visibility on pages 36 and 37 of *Star Wars Miniatures Battles*. Visibility in the wooded copses is further reduced due to the darkness of night. See the special rules for darkness and visibility in the "Gamemaster Notes" below.

Stretching across the table from north to south are the remains of the power fence that was arrayed around the supply dump when it was operational. The power fence is totally inoperable. What remains are sections of the fence's base, which house the projectors that generated the fence. These base sections are considered low walls, and will provide medium cover. It costs 2" of a soldier's Movement Rate to clamber over one of the walls.

There is also a large fallen tree on the eastern side of the table. It is considered to be a high wall. The fallen tree blocks line of sight, but can be fired over by soldiers adjacent to the trunk. Soldiers standing behind the tree have the benefits of heavy cover. The tree can be climbed over; doing so requires 4" of a figure's Movement Rate.

The north and south drop sites, located just beyond the northwest and southwest corners of the table, are rocky clearings in the woods which extend into the table corners. Bordering the clearings are a number of large rocks. These boulders act as high walls, providing heavy cover to soldiers sheltering behind them. The boulders block line of sight, except for soldiers who are in base-to-base contact with the rocks. They cannot be climbed over.

The structures that appear on the table are small storage sheds that have been converted into temporary habitation modules. Each of the structures has walls with a *Strength* of 6. There are no windows in any of the buildings. The doors of the sheds face into the camp (to the east). Each door has a *Strength* of 4. The door of the shed in which Klev Natasken is being held has a *security* rating of 3 (the locking mechanism has been enhanced in light of the contents). The doors of the other two sheds have a normal *security* rating of 2.

The Set-Up

The Infiltrator squads have been paradropped in two different locations to increase the chances that at least one of the squads will make it to their objective. To begin the set-up for this scenario, the Rebel player should decide which of his squads will enter from the north drop site and which will arrive from the south drop site. The Rebel player makes a note of his choices, then the Imperial player may set up his forces.

Prior to his set-up, the Imperial player should

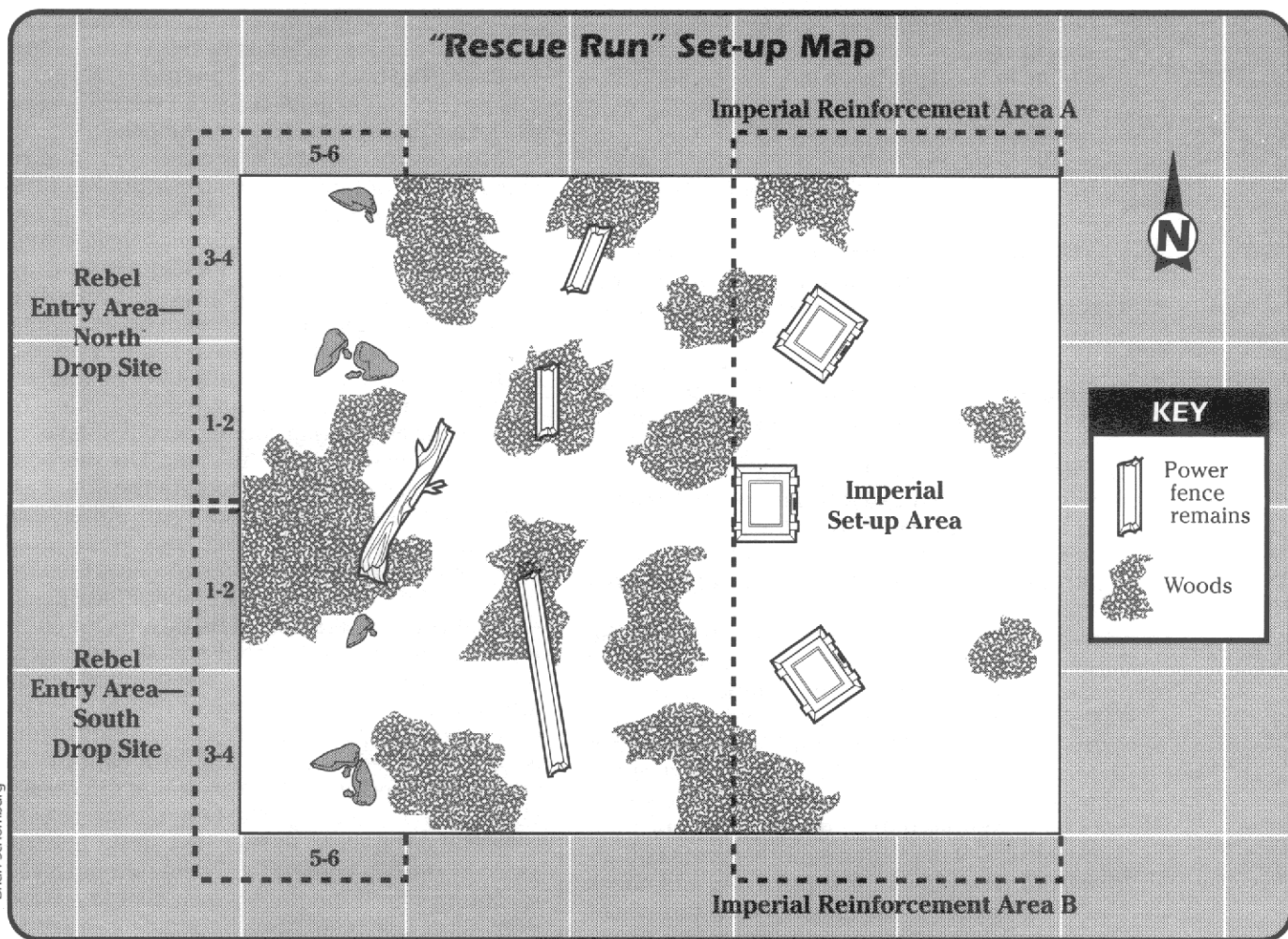

not be aware of what the Rebel player's starting options are. To start with, the Imperial player must decide in which habitation module — or shed — Klev Natasken is being held. He should make a note of it, or inform the gamemaster, but the Rebel player should not know the location. Remember that the door of the module in which the prisoner is locked up has an enhanced *security* rating (see "The Battlefield," above).

After that, the Imperial Army troopers may be set up anywhere within 24" of the eastern edge of the table. Squad coherence does not apply during set-up, and the troopers can initially be placed any distance from other troopers in the camp. Once the troopers are fired upon, or any Rebels are spotted, squad coherence takes effect and the soldiers must attempt to move within command distance of each other before they can move to attack the Rebels. Any members of the squad not within command distance of the main group suffer the normal separation penalties when involved in combat.

During set-up, at least one soldier must be placed within 2" of the door of the habitation

module in which the Rebel spy is being held. This soldier is Natasken's guard (see "Guarding Prisoners" in the "Gamemaster Notes" section below for more information on how to handle the guard). He may later move away from the shed if the door is locked when he does so.

When the Imperial player has placed his figures on the table, the Rebel player begins the first turn by taking his move. Paratropping is a good method for delivering troops to clandestine operations, but it is subject to many unforeseen circumstances, and troops may not land precisely where they intended to. The Rebel player rolls a single six-sided die for each of the Infiltrator squads to determine at which section along each entry edge they actually enter the table, comparing the die roll to the numbers along the entry edges previously picked for each squad. The 12" edge matching the die roll is the edge that squad enters the table across.

Example: The Rebel player has decided that the Nightcrawlers squad will enter the table via the north drop site. At the beginning

of Turn One, he rolls a die to determine where exactly the squad enters the table. Rolling a "4," he looks at the set-up map to see that the Nightcrawlers enter the table along the northernmost 12" of the western edge.

The same procedure would be used for the Nighthawks entering through the south drop site.

The Infiltrators enter the table and move as far as their Movement Rate allows. Note that figures entering behind other figures may not get to move their entire Movement Rate.

The stormtroopers are one of the squads patrolling the outskirts of the main camp, and the only squad close enough to respond in time to the call for reinforcements that goes out when the Rebels are sighted. The call for assistance goes out over a dedicated comm channel as soon as a Rebel figure is spotted (i.e., any Imperial figure which can draw a line of sight to any Rebel Infiltrator), or a Rebel soldier fires at any Imperial figures.

When the reinforcements are activated, the Imperial player rolls one six-sided die and adds 2 to the result. The total is the number of turns it takes the reinforcements to arrive. The squad arrives during the Movement Phase of the turn determined, and enters the table as part of the Imperial player's normal move. Since the squad was on a random patrol, the Imperial does not know exactly where the reinforcements will arrive from. The player must roll a die, and check the result against the Imperial Reinforcement Entry Areas shown on the set-up map. The squad enters through the edge matching the die roll.

Example: During the Movement Phase of Turn Four, Imperial troopers spot advancing Infiltrators. The Imperial player rolls a die to determine when the reinforcements arrive, and rolls a "2." Adding 2 to that gives a final result of 4. The reinforcements will arrive four turns later, during the Movement Phase of Turn Eight.

When the Movement Phase of Turn Eight arrives, the Imperial player rolls a die to see where the reinforcements are coming from. He rolls a "3," indicating that the stormtroopers arrive through Imperial Reinforcement Entry Area A, along the north edge of the table.

Gamemaster Notes

The Rebels have a tough job ahead of them. They have to sneak into the camp, find the Alliance operative and spirit him away; all the while under fire from the Imperial Army. In order to successfully complete their mission, the Rebels must retrieve Klev Natasken from the Imperials and get him to one of the drop sites, where they

can summon a ship to escape off-world. The Imperials must prevent this from happening. These are the basic victory conditions, although it is possible to achieve a partial victory — see the levels of victory described below.

In order to retrieve Klev Natasken, one or more Infiltrators must move to within 3" of the operative, as if they were changing the guard (see page 41 of *Star Wars Miniatures Battles Companion*). If there are more Rebels within 3" of Natasken than there are Imperials, he is then considered to be in the possession of the Rebels. If there are more Imperials, he is in Imperial custody. If there are equal numbers of soldiers around the agent, make an opposed *command* or *Perception* test, pitting the highest skill level in one group against that of the other. The side with the higher result gains custody of the spy. Custody of Natasken does not prevent either side from attacking the other while they are in proximity of each other (in either the Fire Combat Phase or the Close Assault Combat Phase).

If Natasken enters Rebel custody, he is henceforth considered part of that squad, and moves with it like a standard soldier. He will also then be armed with the basic weapon of the squad. The only way the Imperials can regain custody of him is by successfully seizing him in a capture attempt (see page 41 of *Star Wars Miniatures Battles Companion* for details). The Imperial intent is to keep Natasken alive so that he can be interrogated by the ISB, consequently they should try to recapture him if the Rebels gain custody. However, as a last resort the Imperials can try to incapacitate the spy so that the information he carries concerning the Empire does not fall into Rebel hands. Whether Klev Natasken is alive or dead at the end of the scenario affects the level of victory (see the victory conditions listed below for details).

If the operative is ever free of Imperial custody (is more than 3" away from any Imperial figure), but not near Rebel soldiers, he can be moved as a separate squad by the Rebel player. However, he must be moved toward the nearest Rebel soldiers in an attempt to join their squad.

After Klev Natasken has joined a Rebel squad, the squad should begin to move toward either of the Rebel Entry Areas. Upon arriving within 12" of either the northwest or southwest corner of the table, the Rebel player can declare that he is activating a homing beacon, summoning the dropship to pick them up. He does not have to do so as soon as the squad(s) enters the pick-up zone, but can wait until a later turn to do so.

The ship will arrive three turns after the beacon is activated, during the Special Actions Phase. When it does arrive, it will automatically pick up whatever Rebel troops are in that corner area,

while driving away any Imperial forces with heavy fire from its blaster cannons. If the ship picks up the Rebels while Natasken is part of their squad, they have won the game.

If the Imperials can prevent the Rebels from making good their escape with the operative, then they have won the game.

There can actually be various levels of victory in this scenario, which are determined by how well each side performs. The victory conditions are as follows:

- **Decisive Rebel Victory:** If the Rebel troops manage to get Klev Natasken to a pick-up zone and onto a ship, it is a decisive victory for the Rebel Alliance.
- **Marginal Rebel Victory:** The Rebels manage to reach the pick-up zone and escape from the planet, but Natasken has been incapacitated.
- **Marginal Imperial Victory:** If the Imperials are able to eliminate the Rebel strike force, but Natasken is incapacitated, it is a marginal victory for the Empire.
- **Decisive Imperial Victory:** The Imperials have eliminated the Rebel Infiltrator teams, and Natasken is still alive and a prisoner of the Imperials.

There are two Rebels rally points, one for each squad. A routing squad heads for the corner of the table where it entered the game. The Infiltrators are disciplined enough that they will not go running off into the woods, however. Once a squad reaches the rally point, it remains there, and attempts to rally in each successive Morale Phase. Neither of the Infiltrator squads will rout off the table.

The Imperials have two rally points, also. A routing squad will run to the nearest of the northeast or southeast corners of the table, following the normal rout rules. They will exit the table if they fail their final rally test.

Darkness and Visibility

The rescue mission takes place at night, so visibility is limited. However, both of the planet's moons are full, so the darkness is offset somewhat. Soldiers are able to see up to 12". Because it is dark, the visibility within the wooded areas, which is normally 8", is reduced to 7".

Unfortunately, there is one further complication: there are scattered clouds that are moving

quickly. When the cloud cover is heavier, visibility is reduced even further.

Note: This can be considered an optional rule, and can be ignored if you feel it will slow down your game too much.

When the game begins, visibility is the best it can be, given that it is nighttime; line of sight extends 12", but only 7" in the woods. During each Special Actions Phase, make a die roll to see how visibility is affected by the shifting clouds. Read the result given below:

Die Roll	Table Edge
1-2	Cloud cover becomes heavier, visibility is reduced
3-4	No change in cloud cover and visibility
5-6	Cloud cover lightens, visibility increases

Each time visibility is reduced, it is reduced by 1", so the starting visibility would become 11" in the clear and 6" in the woods. Likewise, if the visibility increases, it does so by 1". In order to keep track of the current visibility range, we have provided a series of *Visibility Markers*. Photocopy the markers, mount them on cardboard and cut them out. Place the marker displaying the current visibility in a prominent place on the tabletop, so that both players can see what it is. As the cloud cover varies, change the marker to reflect the current situation.

If the visibility is currently the best it can be (12"/7") and the die roll determines that the cloud cover lightens, treat the result as "No change." In the same manner, if the visibility is as poor as it can be (7"/2"), and the roll reveals that the visibility is reduced further, then treat that result as "No change."

Guarding Prisoners

Klev Natasken, the Rebel spy, starts the game in one of the habitation modules, with a guard outside the door. This is an exception to the normal rules for prisoners, which state that the prisoner must be kept within 3" of the soldier guarding him. In cases where the prisoner or prisoners are kept within some form of enclosure, a guard can be placed outside at each entrance or exit and remain there. As long as the only possible ways out are guarded, a prisoner does not have to remain within the normal 3"

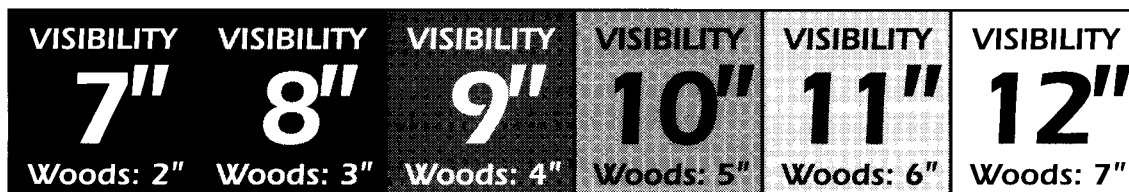

Permission is hereby granted to photocopy these markers for personal use.

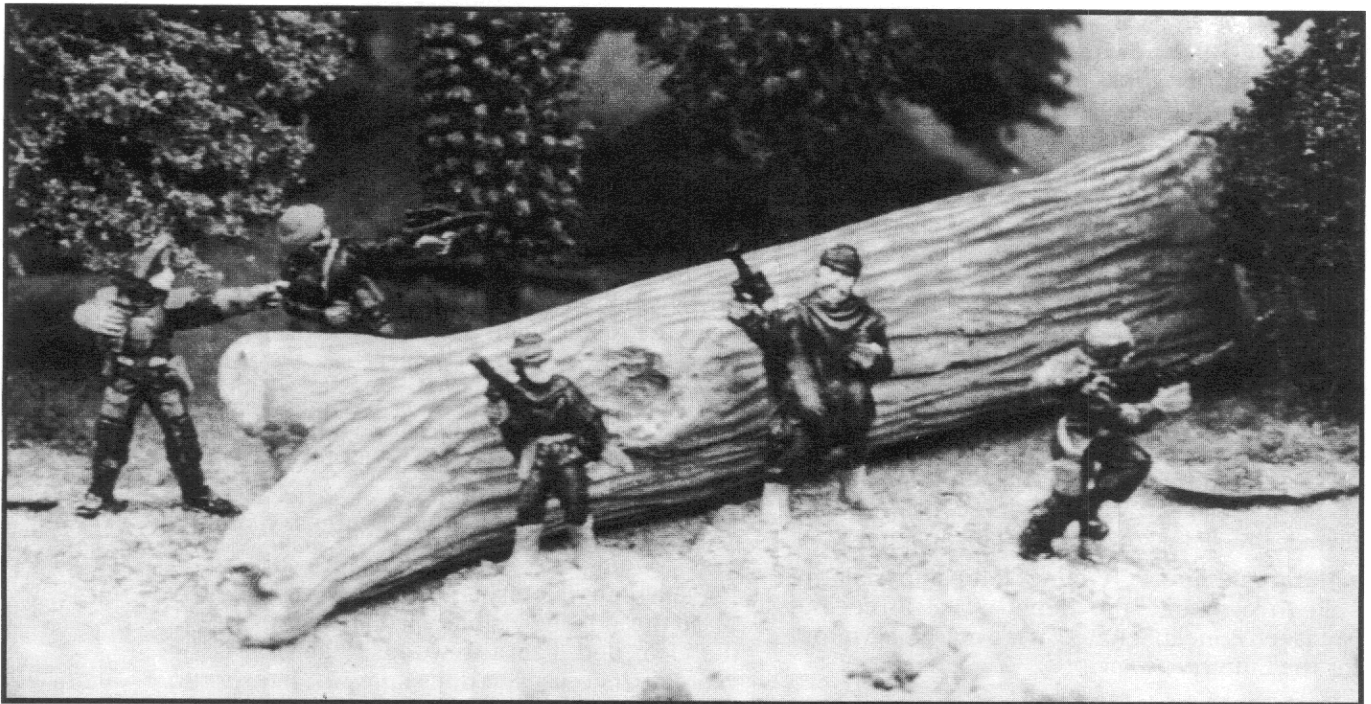

distance from the guard.

When prisoners are contained in this manner, the normal guard-to-prisoner ratio can also be ignored. A single soldier can guard more than five prisoners if they are all within a confined area with only one exit, and the guard is stationed at that exit. If the exit is a door or some other obstruction that can be locked or otherwise prevent movement, then even the one guard is not required once the prisoners are inside and the door is locked or blocked.

Spies Everywhere

The Rebels are not the only ones to have undercover spies in their enemy's camp. Unknown to Rebel Command, Imperial operatives have infiltrated the Rebel organization at different levels. As soon as word of the discovery and capture of Klev Natasken was received, and a rescue operation was planned, an Imperial agent in the ranks of the local Sector Command caught wind of it. The agent, knowing the importance of the information that the Rebel carried, volunteered to be part of the commando force that was assigned to the rescue. In this way, he figured, he would be in a position to act early if the Rebels should indeed succeed at the rescue attempt.

Since the Imperial operative is deep undercover, the Imperial military has no knowledge of his existence, and consequently no idea that they have an ally inside the enemy forces. Therefore, the Imperial player also should not know at first that one of the Rebel soldiers is an Imperial spy. Once the agent reveals himself, the Imperial player

determines which figure is actually the agent by a random dice roll.

The Imperial agent is activated if the Rebels have custody of Klev Natasken and they have initiated the homing beacon. The Imperial player rolls a die to discover in which squad the agent is located; on a 1–3, he is in the Nighthawks, and on a 4–6, he is with the Nightcrawlers. Then determine which figure in the squad is the agent by a die roll, the same way that you assign hits after fire combat. Klev Natasken is, of course, not included in the figures that are being diced for.

Once the Imperial player knows who his agent is, he takes over control of that figure. The agent moves as soon as he is revealed. If the agent had previously moved in the Movement Phase as part of a Rebel squad, then he may still move when revealed, but only up to half his Movement Rate.

Ideally, the Imperial agent will attempt to capture Natasken and return him to an Imperial squad, but failing that, he will try to incapacitate the Alliance operative so that the Imperial information does not fall into Rebel hands.

Figure Notes

The SpecForces Infiltrators can be gathered from *Rebel Commandos 1* (40414) and *Rebel Commandos 2* (40417), as well as *Rebel Troopers 4* (40421), although you can also use any regular Rebel troops from the *Rebels* or *Rebel Troopers* packs (40405, 40406, 40413, 40421) if you wish. If you are using Rebel commandos, stay away from the figures with ponchos, as that sort of uniform does not fit the mission profile. The Infiltrators



Orders of the Day Imperial Commander 792.203/S60

Commander: You are hereby ordered to detain the captured Rebel spy. You will hold the spy until an armored speeder arrives at your camp to transfer him to an ISB transport for further interrogation. Your force is small so as not to attract undue attention, but should you need assistance, you may call on any of the patrols that are securing the perimeter of base camp. We don't know if the Rebels will try to rescue the spy, but be prepared.

You have a small Army force with which to watch the Rebel spy. Choose which structure the prisoner will be kept in, and note that information. At least one of your soldiers must remain within 2" of the door of the structure the spy is being held in. Set up the rest of your soldiers within 24" of the eastern edge of the table. Squad coherence does not apply during set-up. However, if you encounter hostile forces, you must bring your own forces together before they can fight.

If you gain a line of sight to any Rebels or are fired upon by any soldiers, you may summon stormtrooper reinforcements. Roll a die and add 2. The reinforcements arrive in that many turns. When the reinforcements arrive, roll another die to determine through which entry area they come on the table.

It is dark, so visibility is limited to 12" (7" in the woods). This may vary as the cloud cover changes. I will keep you informed as the situation changes.

Victory: Drive off or eliminate all Rebels while keeping custody of the Rebel operative. Failing that, make sure that the Rebels do not take him with them.



Orders of the Day Alliance Commander Meenan Atraxas

Commander: Klev Natasken, our operative on Koovis, has been captured. He knows far too much to be allowed to undergo interrogation. Gather together two squads of Infiltrators and get ready for a planetary paradrop. You must get to the Imperial camp, find our operative and get him back to the drop-off point for pick-up.

You have two squads, which will be dropped at two different sites. Choose which squad will go north and which will go south. After the Imperial player sets up, roll to see where within each drop zone your squads came down. You must find the operative and drive off his guards so that he can join your squad. Once you have rescued the operative, get back to one of your entry areas. Your arrival there will set off a homing beacon. If you can survive there for three turns, the drop-ship will arrive to carry you away.

It is dark, so visibility is limited to 12" (7" in the woods). This may vary as the cloud cover changes. I will keep you informed as the situation changes.

Victory: Recover the operative, and get back to one of your entry areas with him. Then hold out for three more turns, when the ship comes down to lift you off.

should be painted with black uniforms, or you could use a black and dark gray color scheme.

Klev Natasken can be represented by just about any Rebel or neutral figure, depending on how you approach the situation. The Rebel uniform is in keeping with Natasken's affiliation, but he could be in civilian clothes as part of his cover story. To really confuse the issue, you could even use an Imperial figure for Klev Natasken — perhaps he was in an Imperial uniform to cover his spying activities, or he took a guard's uniform to facilitate his escape.

The Imperial guard force should come from the *Imperial Army Troopers* packs (40411, 40418).

The Imperial reinforcements can come from any of the *Stormtroopers* packs (40403, 40404, 40409, 40416) or the *Sandtroopers* pack (40428).

Scenario Nine

Surprise Visit

Note: The following scenario originally appeared as the “Objective Sighted” scenario in the *Star Wars Adventure Journal* (Vol. 1, #4 — November, 1994).

The Situation

Alliance Intelligence has determined that Santhe/Sienar Technologies has come one step closer to developing a viable cloaking shield for the Imperial Navy. At a secret lab on Dennaskar, a breakthrough has been achieved in the channeling capacity of the polarity-charging flux refractor, one of the major subsystems of the cloak’s energy directional scrambler.

Imperial scientists are now eager to put the improved flux refractor to the test, so Santhe/Sienar has prepared a prototype for Imperial review. The prototype is being transported to the nearest landing field by Santhe Security for Imperial Navy pickup.

Dennaskar is a lightly populated world, and the lab is situated in a remote area for secrecy’s sake. Therefore, the trip to the landing field is rather long and passes through some relatively wild terrain. The Rebel Alliance sees a perfect opportunity to hijack the prototype and a strike team is dispatched to secure the refractor for the Rebellion.

As the Rebel strike team sets up an ambush near a wooded stretch of the road, fortune shines on them. As the convoy nears the ambush site, the escort speeder blows its turb thrust converter coil, forcing the escort to travel on foot. The Rebels look forward to an easy assault.

The Forces

The Rebel player has 2,000 SGP’s with which to assemble two or three squads. Up to 600 points may be used for a vehicle or one or two heroes.

The Imperial player has 1,800 points to assemble his forces. He should set up two squads of Santhe Security troopers as escorts, and a reduced squad of stormtroopers — the speeder truck’s surprise cargo. The stormtrooper squad

must consist of five to eight stormtroopers and a heavy repeating blaster. A Troop Listing for Santhe Security Troopers is provided in the Troop Lists at the end of this book.

In addition to his troops, the Imperial player is supplied with a speeder truck, which has the following statistics:

■ Speeder Truck

- **Drive System:** Repulsorlift.
- **Crew:** 1.
- **Passengers:** 10.
- **# Turns:** 2.
- **Turn Distance:** 3.
- **Move:** 55.
- **Cautious Speed:** 5.
- **Cruise Speed:** 15.
- **Top Speed:** 55.
- **Accel/Decel:** 5/5.
- **Flight Ceiling:** 3m.
- **Body Strength:** 6.
- **Body Points:** 60.
- **Cover:** F.
- **SGPs:** 155.

It is also equipped with a repeating blaster mounted on the top of the cab. The blaster is capable of following fire, and has these statistics:

■ Repeating Blaster

- **Fire Arc:** F.
- **Skill:** *Vehicle blasters.*
- **Fire Control:** —
- **Range:** 15/60/150.
- **Damage:** 6.
- **Notes:** Following fire; may be fired by driver.
- **SGPs:** 23.

The Battlefield

The ambush occurs at a point where the woods encroach on the road. There are two low hills and a small hillock flanking the road. All the hills are easy terrain, reducing movement to half-rate. The woods are medium terrain, providing medium cover and also reducing movement to half-rate. Where the woods cover the hills, movement is reduced to quarter-rate.

Movement along the road and in the clear terrain is unaffected.

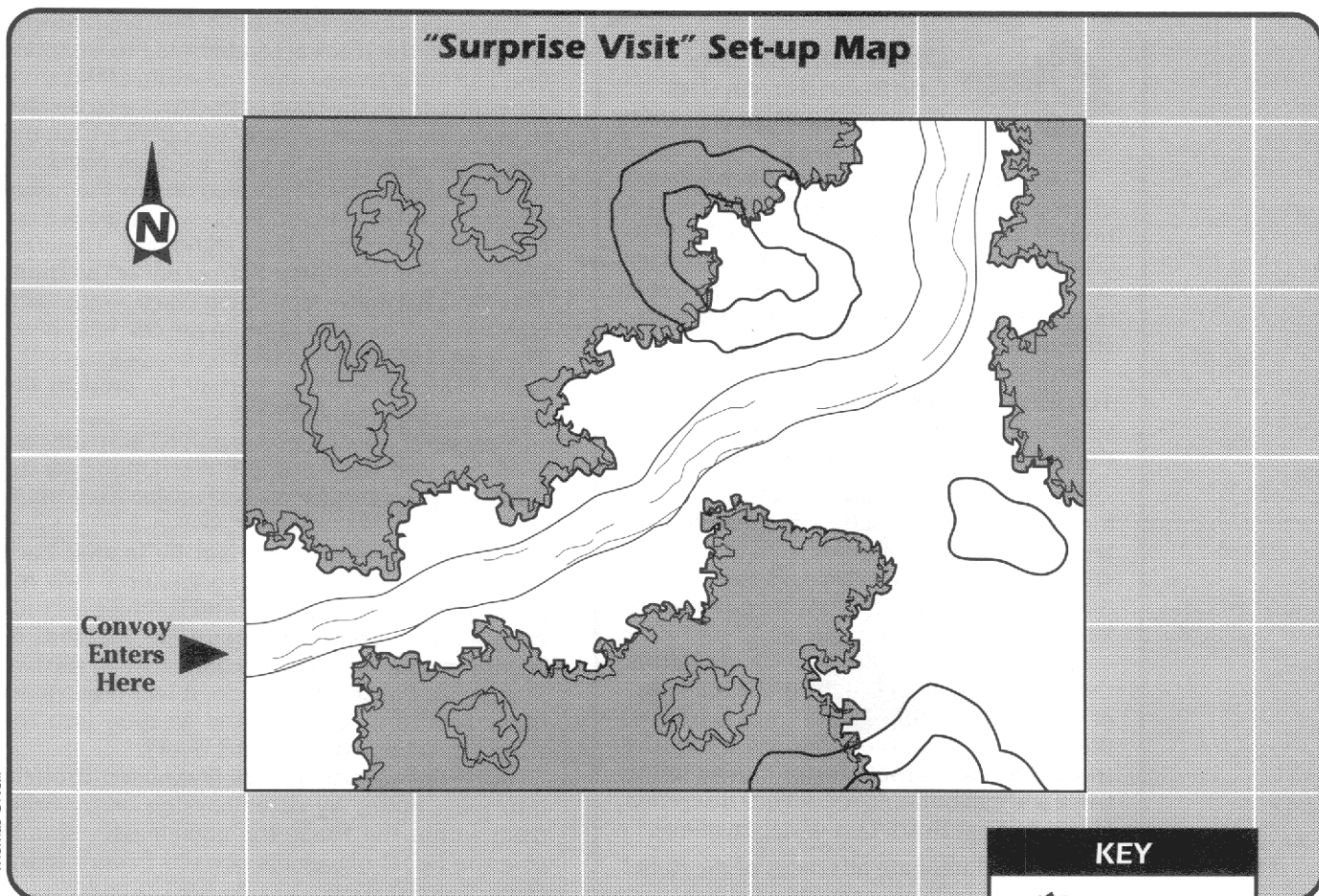

Thomas O'Neill

The Set-Up

The Rebels forces are deployed secretly, on either side of the road. The Rebel player should mark his initial deployment on a copy of the set-up map. Soldiers who begin the game in the woods and more than 1" from the edge of the woods are hidden, as are any soldiers behind a hill.

The gamemaster adjudicates movement of hidden troops. If there is no gamemaster, the honor system must suffice. Troops are revealed and placed on the table when they move into line of sight of any enemy forces, or if they fire weapons.

The Imperial troops come onto the table along the road from the west. The speeder truck must enter the table on the road. The Santhe Security escort troops may enter anywhere within 4" of the road. The stormtrooper squad begins the game in the back of the truck, so it is not visible. The stormtrooper figures should be kept out of sight so that they are a surprise when finally revealed.

It is possible not all the Imperial troops will make it onto the table in the first turn. Any troops

which did not enter the table on the first turn enter on the second turn. The Imperial player may delay the entry of one of the squads until the second turn if she so desires.

KEY	
	Woods
	Contour Line (1/2")

Gamemaster Notes

The Rebels are in the unenviable position of having been second-guessed. The Imperial forces have discovered the ambush plan and have prepared their own ambush in return.

The speeder truck does not contain the flux refractor. It was removed and a squad of stormtroopers was placed in the back of the truck with a heavy repeating blaster. They are to emerge from the truck when the Rebel forces are fully committed to the assault, and eliminate them.

The stormtrooper squad begins the game in the back of the speeder truck, out of sight. The Imperial commander may deploy them when he deems it appropriate. The stormtroopers disembark from the back of the truck, following the normal rules for disembarking, which are pre-

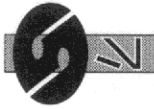

Orders of the Day Commander of the Guard, Santhe Security

Commander: Rebel forces have learned of the planned shipment of our confidential project for the Empire. You are ordered to eliminate them. You will have a stormtrooper squad assigned to your force. They will occupy the transport vehicle in place of the shipment.

Set up two squads to serve escort duty. You will approach on foot after abandoning your "broken-down" escort vehicle to lure the Rebels into the trap. Allow no survivors.

You have 1,800 points to assemble your forces. Set up two squads of Santhe Security troopers as escorts, and a squad of stormtroopers. The stormtrooper squad must consist of five to eight stormtroopers and a heavy repeating blaster.

You will enter the table on the road from the west, no more than 4" from the road. One of your security squads will enter in front of the speeder truck, the other will follow the truck. The stormtroopers are hidden in the truck and can be deployed at your discretion (see me about the details of deployment).

Victory: Eliminate all traces of the Rebel scum.

sented in Chapter One of the *Star Wars Miniatures Battles Companion*.

The stormtrooper squad is equipped with a heavy repeating blaster, which is a crewed *assembled* weapon capable of following fire. The blaster is already assembled within the back of the truck. The doors of the truck are rigged with explosive bolts; the Imperial player may choose to blow off the rear doors and fire the blaster from within the truck.

Blowing the bolts requires a *Mechanical* test by a stormtrooper against a difficulty of 4. This occurs during the Fire Combat Phase. Failure means that the bolts did not detonate and the door remains in place; the blaster cannot be fired that turn. The attempt may be repeated in each successive turn.

Once the doors are blown off, the heavy blaster may be fired out the back of the speeder truck. From the orientation of the truck, the blaster has a Fire Arc of R. In addition, any three stormtroopers not crewing the weapon may fire their own weapons out the back of the truck at any targets they can draw a LOS to.

Once the doors have been removed, stormtroopers in the truck are vulnerable to weapons fire. The firing troops must be within a 90-degree arc centered on the back of the truck and be able to draw a LOS to the doors. Troopers within the truck are considered to have medium cover.

The stormtroopers may also deploy the heavy blaster outside the truck. To do so, the truck must begin the Movement Phase stationary. The crew may then manhandle the blaster out of the truck. This takes the entire Movement Phase — the crew and the truck may not move in the current phase. The assembled heavy blaster is then placed on the table behind the truck. It may be fired in the following Fire Combat Phase.

Thereafter, the weapon is moved normally, according to all the rules and restrictions for assembled weapons (see page 23 of *Star Wars Miniatures Battles*).

The assembled blaster can be loaded back into the truck, but to do so requires two full Movement Phases, during which time the truck cannot move. The crew cannot fire weapons or engage in close assault combat between the two Movement Phases. If they do, it will require another two turns to hoist the weapon into the truck (they have had to start over).

Once the stormtroopers have been brought into play, either by disembarking or by firing from within the truck, the gamemaster should give the Rebel player his revised Orders of the Day.

Commandeering The Truck

Rebel troops may attempt to take control of the truck. The truck must be moving at a Rate of no more than 8". If a soldier moves next to the door on the driver's side of the cab he may declare that he is jumping onto the truck and is attempting to wrest control of the vehicle from the driver. A soldier engaged in this attempt is exempt from the effects of being separated from his squad.

The soldier must expend 2" of his Movement Rate and make a difficulty 6 *Dexterity* test. If he succeeds, he has managed to cling to the side of the truck. In the following Close Assault Combat Phase he may close assault the driver. If he fails, he loses an additional 3" of his Movement Rate, but may attempt to jump on the truck again if he has sufficient Movement Rate remaining.

Should the trooper succeed in clinging to the truck, he may attack the driver in the following Close Assault Combat Phase. The combat is resolved normally, except that the attacking soldier's die roll is reduced by 2 as a result of his precarious position. Along with the normal results of the attack, the loser of the combat is thrown from the speeder truck and ends up

Orders of the Day Alliance Commander Pash Deven

Commander: Santhe Security is transporting an improved component for the Empire's cloaking project. We want it. They'll be shipping it out by speeder truck along a relatively isolated road. Assemble two or three squads and ambush 'em. Capture the component and bring it back. If that's not possible, destroy it — we don't want the Imps to have it if we can't.

You have 2,000 points to spend on your forces. Up to 500 points may be used for a vehicle or one or two heroes. Set up hidden, on both sides of the road — mark your set-up on a copy of the map.

Victory: Capture the component and carry it off the northeast corner of the table. Or, for a marginal victory, destroy the component.

Orders of the Day Alliance Commander Pash Deven

It's an ambush — get the information and get out of there!

Victory: Have one of your men get a look in the truck to confirm or deny the shipment of the component — then get him and at least five others off the table though the northeast corner (anywhere from the hill down through the northeast woods).

prone on the ground. Place the figure on its side alongside the truck next to the driver's door. In the case of a tie, the attacking soldier remains hanging onto the truck and may attempt close assault combat in the following turn.

The attacking soldier may also try to clamber into the speeder truck from the passenger side. Follow the procedure described above; if the soldier is successful, he has climbed into the cab. He may then close assault the driver in the following Phase, but with no reduction in his die roll. The loser of the close assault combat is still thrown from the truck through the driver's door. While a soldier is hanging onto the truck with the intention of commandeering it, the driver must make a *repulsorlift operation* test for every move or maneuver he makes (including straight ahead

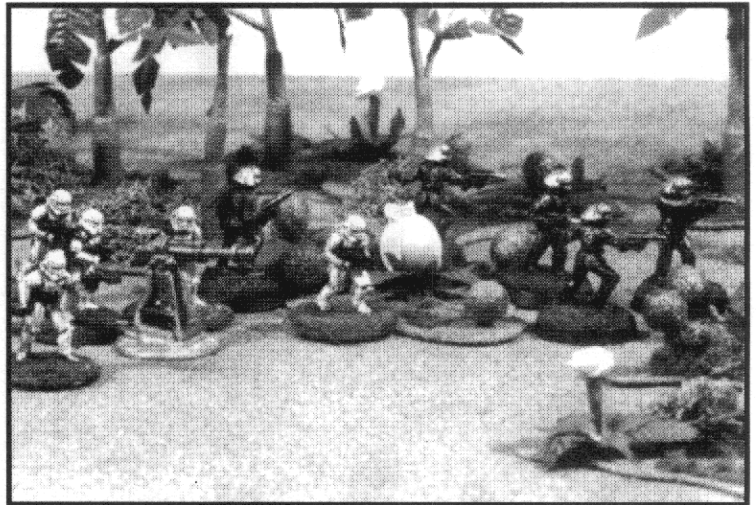

and turns). The difficulty of each *repulsorlift operation* test is increased by 2 while the driver is being attacked.

Rally Points

The rally point for Rebel soldiers north of the road is the area between the road and the hill at the north edge of the table. For Rebels south of the road, it is the southeast corner of the table.

The Imperial rally point is the southwest corner of the table.

Victory Conditions

The Rebels achieve victory by surviving to get information back to the Alliance. Six or more soldiers must retreat off the table, and at least one must have had a line of sight into the truck during the game. Retreating soldiers must leave the table through the woods along the east side of the table, or along the north edge of the table between the hill and the northeast corner.

The Imperial player is victorious if he eliminates all the Rebels.

Using An Optional Rule

The Imperials achieve a decisive victory if they can capture one of the Rebels and escort him off the table via the west end of the road. The optional rules for taking prisoners are presented in Chapter Three of the *Star Wars Miniatures Battles Companion*.

Painting Note

Santhe Security troopers can be represented by any figures from *Star Wars* miniatures packs 40412 (*Imperial Naval Troopers 1*) or 40419 (*Imperial Naval Troopers 2*).

The basic uniform of Santhe Security forces is similar to the uniform of Imperial naval troopers. Again, because of Santhe Corp's close ties to the

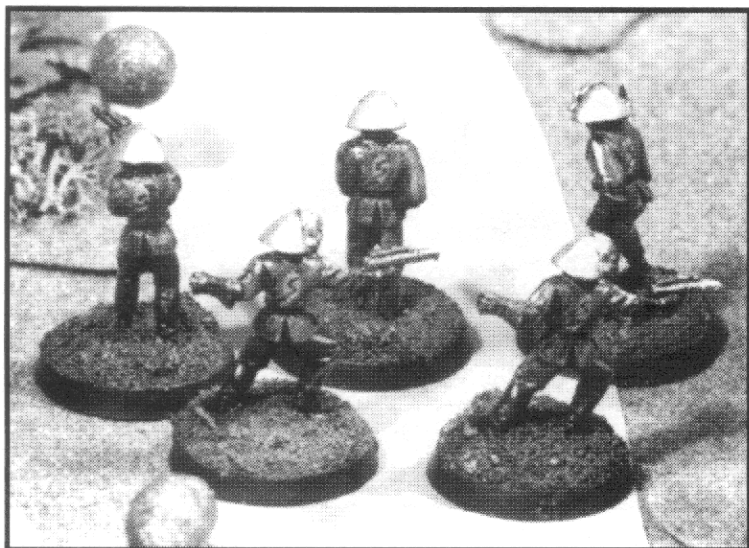

Empire, its forces are permitted to wear similar uniforms.

Santhe Security uniforms are black — like Imperial naval trooper uniforms — but have silver piping running down the outside of the shoulders, arms and legs. The boots are black, and the helmets are silver. The simplified Santhe corporate logo or the Santhe Security logo (depending on the squad's mission) is generally emblazoned on the back, so that Santhe soldiers are readily visible to one another. This also helps insure that they are not mistaken for Imperial troops. When set against black, as on the security uniforms, the oval portion of the Santhe logo is displayed in silver for better visibility.

Troop Lists

The following section provides a selection of new troop types for use in generating squads for your *Star Wars* miniatures games. These listings expand on the available types of soldiers originally provided on pages 98–102 of *Star Wars Miniatures Battles*. Each listing is presented as described in Chapter Eight of that book, “Creating Squads” (pages 41–42).

In addition to the listing of each soldier’s basic characteristics, there is a brief description of each troop type. This is followed by some suggestions for what type of miniature can be used to represent the soldiers, as well as color tips for

painting the figures.

Note: The titles given each type of soldier are intended as a quick summary of the kind of soldier represented by the listing, not as an absolute description of the figure.

For instance, the Hoth Trooper listing in *Star Wars Miniatures Battles* refers not just to soldiers who were veterans of that posting, but also to soldiers who are of the quality of that type of trooper. You may use any type of Rebel figure — they just happen to be as good as the typical Hoth trooper.

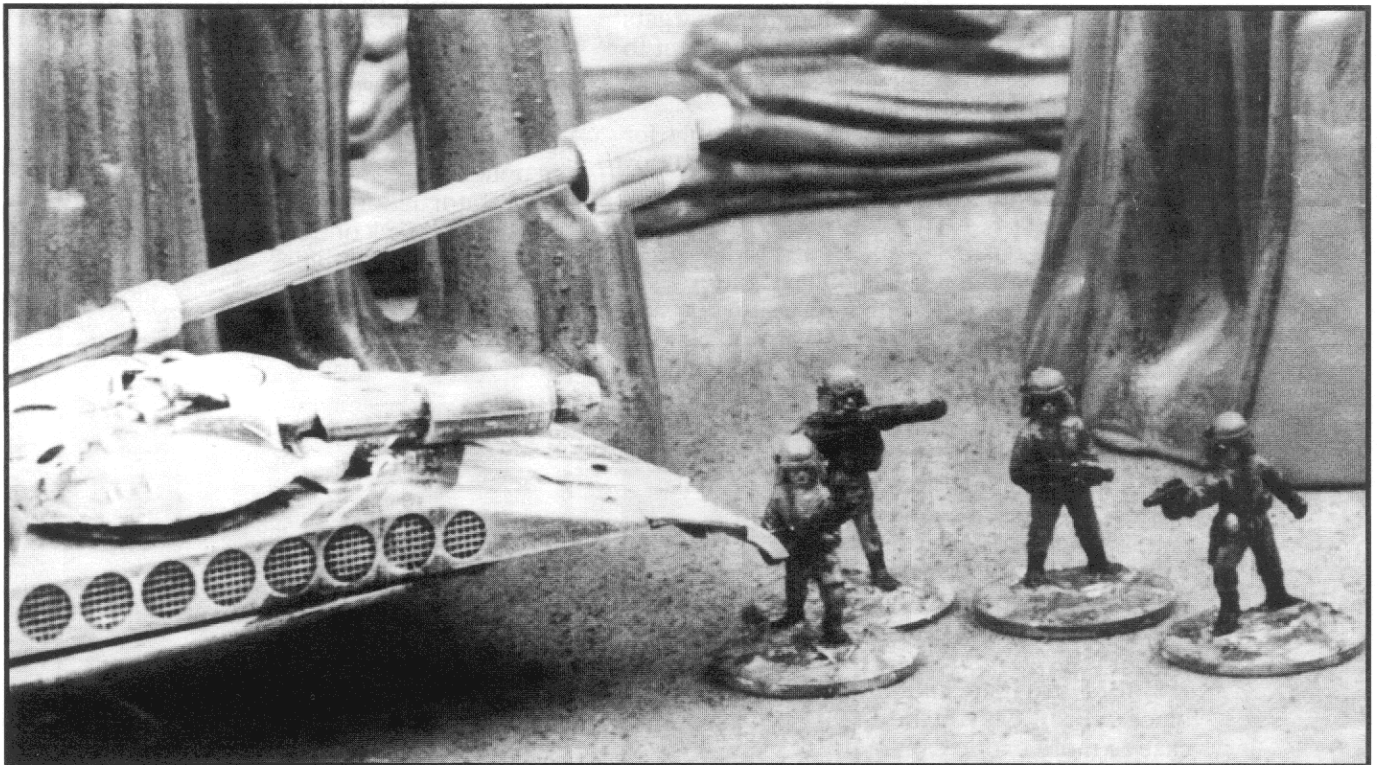

Rebel/New Republic Forces

■ Commando

Quality: Elite.

Size: 3–5.

DEX: 4.

KNO: 2.

MEC: 1.

PER: 4.

STR: 4.

TEC: 2.

Move: 10.

Skills: Level 2 — DEX, MEC; Level 1 — TEC, PER.

Weapons: Blaster pistol, blaster rifle, repeating blaster, medium repeating blaster, heavy repeating blaster, grenade.

Armor: Any.

Commanders: Level 3.

Specialists: Level 3 — *blaster, blaster artillery, survival, sneak.*

Commandos are the special missions forces of the Alliance and the New Republic, which are sent in to perform covert operations as needed. They are highly-trained soldiers, who are prepared for any type of mission, including securing forward objectives, eliminating obstacles — either real or potential — and softening up targets for an attack to follow. The Rebel troops sent to shut down the shield generator on Endor in *Return of the Jedi* were commandos.

Figure/Painting Notes: Figures suitable for use as commandos are those in the *Rebel Commandos* packs (40414, 40417), and the figures in *Rebel Troopers 4* (40421).

The shirt and pants — and a poncho, if worn — are generally issued in a camouflage pattern. For the more familiar jungle or forest situation, the pattern is the standard green and brown, but that can vary widely depending on the predominant terrain of an alien world. For instance, tans and browns would be used for desert terrains, white for snowy terrains, and reds and oranges for volcanic worlds. Even more exotic patterns can also be used, such as pale blues and white for a world with white-trunked trees bearing blue foliage.

Boots are generally black or brown, but in the case of more exotic camouflage, boots can be issued in a corresponding color. The helmet is usually the same color as the dominant color of the camouflage pattern.



■ Infiltrator

Quality: Elite.

Size: 3–10.

DEX: 3.

KNO: 2.

MEC: 2.

PER: 2.

STR: 2.

TEC: 2.

Move: 10.

Skills: Level 3 — DEX; Level 2 — PER; Level 1 — any.

Weapons: Blaster pistol, blaster rifle, vibroblade, garotte.

Armor: Any.

Commanders: Level 3.

Specialists: Level 3 — MEC, TEC.

Infiltrators are a specialized breed of commando, whose specific mission is to penetrate enemy lines and sow confusion and fear in areas the opposition thought secure.

Figure/Painting Notes: Figures appropriate for infiltrators are essentially the same as those in the *Rebel Commandos* packs (40414, 40417), and the figures in *Rebel Troopers 4* (40421), with the exception of those figures wearing ponchos.

Infiltrator uniforms and helmets are black or dark gray, or some combination of the two colors. Their boots are black.



Rebel/New Republic Forces

■ Rebel Tech

Quality: Veteran.
Size: 5–10.
DEX: 3.
KNO: 2.
MEC: 2.
PER: 2.
STR: 2.
TEC: 3.
Move: 10.
Skills: Level 3 — TEC; Level 2 — DEX; Level 1 — any.
Weapons: Blaster pistol.
Armor: None.
Commanders: Level 3.
Specialists: Level 3 — DEX, MEC.

Technicians — or techs, as they are more commonly referred to — are those soldiers trained to operate and repair any equipment the Alliance or New Republic utilizes. They are also field engineers, able to build or assemble whatever might be needed to achieve an objective or bolster the defense of a location.

Though their duties are specific, they are members of the regular army, and so wear the predominant uniform of the Alliance, as worn by the soldiers defending Princess Leia's blockade runner in *Star Wars: A New Hope*. (Technicians who don't serve in the field — such as those maintaining the Alliance's fighters at Yavin Base — wear a simple white work uniform.)

Figure/Painting Notes: Techs wear the standard uniform of the Alliance and New Republic, and so any figures from the following packs are usable as techs: 40405, *Rebel Troopers 1*; 40406, *Rebel Troopers 2*; 40413, *Rebel Troopers 3*.

The uniform consists of a medium blue shirt and dark gray pants. The vest worn over the shirt is black. The boots are black, and the blast helmet is white with a black visor. For an example of a standard Alliance/New Republic uniform, see the photo on the cover of *Star Wars Miniatures Battles*.



■ Standard New Republic Trooper

Quality: Veteran.
Size: 5–10.
DEX: 4.
KNO: 2.
MEC: 3.
PER: 2.
STR: 3.
TEC: 2.
Move: 10.
Skills: Level 2 — any.
Weapons: Any.
Armor: None.
Commanders: Level 3.
Specialists: Level 3 — any.

These are the standard line troops of the New Republic, and for the most part they are the same troops who served and fought for the Alliance to Restore the Republic. They generally wear the uniform that was the standard for Alliance soldiers, such as those defending the blockade runner in *Star Wars: A New Hope*.

Figure/Painting Notes: Standard New Republic troopers can be found in the following packs: 40405, *Rebel Troopers 1*; 40406, *Rebel Troopers 2*; 40413, *Rebel Troopers 3*.

The uniform consists of a medium blue shirt and dark gray pants. The vest worn over the shirt is black. The boots are black, and the blast helmet is white with a black visor. For an example of a standard Alliance/New Republic uniform, see the photo on the cover of *Star Wars Miniatures Battles*.



Neutral Forces

■ Enforcer

Quality: Average.

Size: 3–5.

DEX: 2.

KNO: 2.

MEC: 2.

PER: 2.

STR: 4.

TEC: 1.

Move: 10.

Skills: Level 2 — DEX.

Weapons: Blaster pistol, blaster rifle, vibroblade, club.

Armor: None.

Commanders: Level 2.

Specialists: Level 3 — DEX; Level 2 — *brawling*.

Enforcers are the “muscle” and strong-arms of the many gangsters and crime lords of the galactic underworld. Their main purpose is to instill fear in and keep in line those who deal with their boss. These brutes are generally from a variety of species, including humans, but they are almost invariably all rough-and-tumble types of individuals.

Figure/Painting Notes: Crime gangs rarely wear uniforms, and enforcers are most often found in ordinary civilian dress. Appropriate figures for enforcers would be in *Aliens of the Galaxy 1 and 2* (40429, 40443) and *Jabba’s Servants* (40445) — with the exception of the dancing girl. For human enforcers you could use the female gambler from pack number 40434, *Rebel Operatives*, and some of the figures from the *Rebel Commandos* packs (40414, 40417). When using commandos, just paint each figure in different colors than the others, so that they don’t appear to be wearing uniforms. You can also use figures from the *Bounty Hunters* packs (40420, 40422, 40426), although enforcers would not normally be armored. The best bounty hunter figures to use are those in *Bounty Hunters 3* (40426), with those in *Bounty Hunters 2* (40422) running a close second.

Painting enforcer figures leaves you a lot of leeway. They can be just about any color you want to make them. As mentioned above, there are usually no uniforms, and the enforcer wears everyday clothing.



■ Gang Member

Quality: Average.

Size: 3–20.

DEX: 3.

KNO: 2.

MEC: 3.

PER: 2.

STR: 2.

TEC: 2.

Move: 10.

Skills: Level 2 — DEX, STR.

Weapons: Blaster pistol, vibroblade, club.

Armor: None.

Commanders: Level 2.

Specialists: Level 3 — *blaster, melee combat, brawling*.

Gangers are those individuals who band together in groups in order to protect themselves, impress their will on others, or to bolster their own self-esteem. They are generally ordinary beings in ordinary clothes, although they do tend to adopt gang “colors,” which are added to the clothing in order to display the allegiance of the ganger wearing them.

Figure/Painting Notes: The figure suggestions provided above for enforcers also apply to gang members. Particularly appropriate packs are *Bounty Hunters 3* (40426) and *Aliens of the Galaxy 2* (40443). The *Rebel Commandos* packs (40414, 40417) are also useful. The painting notes for enforcers apply, too, with the exception that gangers will generally have some symbol or particular colors adorning their clothing, so as to show which gang they are loyal to.



Neutral Forces

■ Ruffian

Quality: Average.

Size: 3–10.

DEX: 2.

KNO: 2.

MEC: 2.

PER: 2.

STR: 3.

TEC: 2.

Move: 10.

Skills: Level 2 — DEX.

Weapons: Blaster pistol, blaster rifle.

Armor: None.

Commanders: Level 2.

Specialists: Level 3 — *melee combat, brawling.*

Ruffians are like gang members, except they are even less organized. They are basically bullies who get their pleasure intimidating other beings and making themselves feel as if they are important and tough.

Figure/Painting Notes:

The figure suggestions provided above for enforcers and gang members also apply to ruffians. Once again, particularly appropriate packs are *Bounty Hunters 3* (40426), *Aliens of the Galaxy 2* (40443) and *Rebel Commandos* (40414, 40417). The painting notes given for the enforcers apply, too — ruffians will usually be found in ordinary clothing of just about any color or pattern.



■ Santhe Security Trooper

Quality: Veteran.

Size: 5–10.

DEX: 3.

KNO: 3.

MEC: 1.

PER: 3.

STR: 3.

TEC: 2.

Move: 10.

Skills: Level 2 — DEX, STR, MEC, TEC.

Weapons: Blaster pistol, heavy blaster pistol, blaster rifle.

Armor: Bounty hunter.

Commanders: Level 3.

Specialists: Level 3 — *brawling, melee combat, repulsorlift operation, vehicle blasters.*

Santhe Security troopers are the private security forces of Santhe Corporation and its many subsidiaries. In addition to providing security for its own holdings, Santhe's troopers are often leased out to provide security for other corporations or even planets. For more details on these troopers, see pages 63–64 of the *Star Wars Miniatures Battles Companion*.

Figure/Painting Notes: Santhe Security uniforms are modeled on the uniforms of Imperial Navy troopers. Therefore, Santhe troopers can be found in packs 40412, *Imperial Naval Troopers 1*, and 40419, *Imperial Naval Troopers 2*.

The basic uniform consists of black pants and a black shirt. A strip of silver piping runs down the outside of the shoulders, arms and legs. The boots are black. Santhe Security helmets are silver. The Santhe Security logo or the simplified Santhe corporate logo is displayed on the back of the shirt in silver. See page 64 of the *Star Wars Miniatures Battles Companion* for details of the Santhe logos.



Neutral Forces

■ Scavenger

Quality: Average.

Size: 3–12.

DEX: 2.

KNO: 2.

MEC: 3.

PER: 2.

STR: 2.

TEC: 3.

Move: 10.

Skills: Level 2 — DEX, MEC, TEC; Level 1 — any.

Weapons: Any.

Armor: None.

Commanders: Level 2.

Specialists: Level 3 — DEX, *beast handling*, *droid repair*; Level 2 — STR.

Scavengers are those beings who swarm over the sites of recent battles in order to salvage whatever they can for sale to interested parties. They are mostly a motley assortment of humans and aliens, with various articles of clothing and equipment thrown together haphazardly.

Figure/Painting Notes: Generic humans and aliens are once again the best figures to use for these individuals. See the figure notes above for

enforcers and gang members. In the case of scavengers, though, figures with more armor and heavier weapons are acceptable — perhaps even preferable. Good scavenger figures can be found in *Bounty Hunters 2* and *3* (40422, 40426), *Aliens of the Galaxy 2* (40443) and *Rebel Commandos* (40414, 40417).

Like the other neutral troop types previously described, the color scheme for scavengers can vary from figure to figure. Scavenger units will try to maintain a consistency of clothing, but even in cases where the color of the clothes is the same, detail bits like armor, helmets or gloves will probably vary in color due to the scavenged nature of the equipment that the scavs use.



Imperial Forces

■ Imperial Army Trooper

Quality: Average.

Size: 4–10.

DEX: 3.

KNO: 1.

MEC: 1.

PER: 2.

STR: 3.

TEC: 1.

Move: 10.

Skills: Level 2 — DEX, STR.

Weapons: Blaster pistol, blaster carbine, blaster rifle, repeating blaster, medium repeating blaster, heavy repeating blaster, grenade.

Armor: Any.

Commanders: Level 2.

Specialists: Level 3 — *blaster, blaster artillery, grenade.*

These are the standard line troops of the Imperial ground forces. If the Imperial Army is involved in a conflict, they are the troopers that will be on the battlefield. These soldiers were seen at the battle of Endor in *Return of the Jedi*.

Figure/Painting Notes: These soldiers are available in pack 40411, *Imperial Army Troopers 1*, and pack 40418, *Imperial Army Troopers 2*.

The Imperial Army uniform consists of a medium-gray coverall. The troopers wear black boots, belt and gauntlets. The helmet is also gray, and the goggles on the helmet are black. The lenses can be black, or a very dark red or green to represent the different kinds of tinted and vision-enhancing goggles in use by the army. The Imperial symbol is usually worn on both arms at the shoulders.



■ Imperial Army Assault Trooper

Quality: Average.

Size: 1–6.

DEX: 3.

KNO: 1.

MEC: 4.

PER: 2.

STR: 1.

TEC: 1.

Move: 10.

Skills: Level 2 — DEX, STR.

Weapons: Blaster pistol, blaster rifle, grenade.

Armor: Any.

Commanders: Level 3.

Specialists: Level 3 — *STR, blaster, blaster artillery, vehicle blasters, ground vehicle repair, hover vehicle repair, repulsorlift repair*; Level 2 — *ground vehicle operation, hover vehicle operation, repulsorlift operation.*

Imperial assault troopers are like the regular soldiers of the Army, but with specialized training for working in tandem with ground assault vehicles. They serve as carried troops — with particular attention to balancing the advantages and limitations of mechanized combat vehicles — but can also serve as drivers, gunners and commanders for vehicles.

Figure/Painting Notes: These soldiers are available in pack 40411, *Imperial Army Troopers 1*, and pack 40418, *Imperial Army Troopers 2*.

The Imperial Army uniform consists of a medium-gray coverall. The troopers wear black boots, belt and gauntlets. The helmet is also gray, and the goggles on the helmet are black. The lenses can be black, or a very dark red or green to represent the different kinds of tinted and vision-enhancing goggles in use by the army. The Imperial symbol is usually worn on both arms at the shoulders.



Imperial Forces

■ Imperial Naval Trooper

Quality: Veteran.
Size: 4–10.
DEX: 2.
KNO: 1.
MEC: 2.
PER: 3.
STR: 3.
TEC: 1.
Move: 10.
Skills: Level 2 — DEX, STR.
Weapons: Blaster pistol, blaster carbine, blaster rifle.
Armor: Any.
Commanders: Level 2.
Specialists: Level 3 — DEX.

Naval troopers are the corps of soldiers maintained by the Navy to serve aboard its capital ships. In addition to serving as shipboard combat troops, they also provide security, handle hangar traffic control and monitor sensor arrays, and perform other duties as required. Naval troopers are the soldiers seen aboard the Death Star in *Star Wars: A New Hope*, as well as aboard the Super Star Destroyer *Executor* in *The Empire Strikes Back*.

Figure/Painting Notes: Soldiers of the Imperial Navy are available in miniatures packs 40412, *Imperial Naval Troopers 1*, and 40419, *Imperial Naval Troopers 2*.

The basic uniform consists of black pants and a black shirt. The boots, gloves and helmet are also black. The buckle and other attachments on the belt are silver.



■ Imperial Royal Guard

Quality: Elite.
Size: 2–5.
DEX: 5.
KNO: 2.
MEC: 3.
PER: 3.
STR: 3.
TEC: 2.
Move: 10.
Skills: Level 2 — DEX, PER, STR.
Weapons: Heavy blaster pistol, force pike*.
Armor: Royal Guard.
Commanders: Level 3.
Specialists: Level 3 — *melee combat: force pike*, STR, TEC.
 * Force pikes do STR+3 damage.

These soldiers are the Emperor's elite personal guard. They wear elaborate red, robed armor that sets them apart from ordinary Imperial troopers. These are the guards seen in the Emperor's throne room in the second Death Star during *Return of the Jedi*.

Figure/Painting Notes: Royal guardsmen are available in pack 40425, *The Emperor*.

The Imperial Royal Guard wear red battle armor covered with a flowing red robe. The helmet is also red. The eyeslit should be painted a darker red to make it stand out on the helmet. The force pike is black with details in silver.



Imperial Forces

■ Scout Trooper

Quality: Veteran.

Size: 5–10.

DEX: 2.

KNO: 2.

MEC: 3.

PER: 2.

STR: 2.

TEC: 2.

Move: 10.

Skills: Level 2 — DEX; level 1 — MEC, PER.

Weapons: Blaster pistol.

Armor: Scout trooper.

Commanders: Level 3.

Specialists: Level 2 — MEC, TEC.

Scout troopers are stormtroopers trained for reconnaissance and patrol duties. They have light armor. Scout troopers are the biker scouts seen on Endor in *Return of the Jedi*.

Figure/Painting Notes: Scouts are provided in

Scout Troopers, pack number 40433.

Scout trooper armor is white. However, as they are more lightly armored, more of the black body glove under the armor shows through. The torso armor, shoulder armor and elbow armor are white, while the rest of the arm and the gloves are black. The legs are also black, with white knee pads and boots over the leg covering. The helmet is white with a black viewplate over the eyes. There are black belt straps holding equipment onto the torso armor.

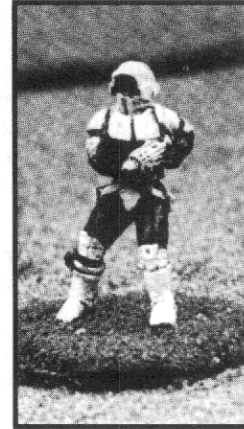

Photo Credits

Page 1: Scene from *Return of the Jedi*, courtesy of Lucasfilm Ltd.

Page 3: Figures from 40507, *Bantha with Rider*, customized and painted by Bob Lippman; terrain system: Geo-Hex; homestead and vaporator scratch-built and painted by Stephen Crane.

Page 6: Figures from 40505, *AT-PT*, 40408, *Pilots and Gunners*, 40415, *Imperial Officers*, 40442, *Encounter on Hoth*; gray walker painted by Stephen Crane, camouflaged walker painted by Bill Refsland, soldiers and probot painted by T.G.W.P.; terrain system: Geo-Hex; rock formations: repainted aquarium decorations; rubble: crumbled cork.

Page 11: Figures from 40504, *Storm Skimmer*, painted by Bob Lippman; terrain system: Geo-Hex.

Page 19: Figures from 40412, *Rebel Commandos 2*, 40406, *Rebel Troopers 2*, painted by Bill Refsland/Linda Robertello; terrain system: Geo-Hex; alien trees and plants custom-built by Geo-Hex.

Page 22: Figures from 40412, *Rebel Commandos 2*, 40406, *Rebel Troopers 2*, painted by Bill Refsland/Linda Robertello; rancor from 40311, *The Rancor Pit* (boxed set — out of production), painted by unknown; terrain system: Geo-Hex; alien trees and plants custom-built by Geo-Hex.

Page 32: Figures from 40403, *Stormtroopers 1*, 40428, *Sandtroopers*, painted by T.G.W.P.; customized stormtrooper converted and painted by Stephen Crane; walkway scratch-built by Stephen Crane (flat toothpicks glued to cardboard strip).

Page 34: Figures from 40438, *Ewoks*, painted by T.G.W.P.; customized Ewok converted and painted by Stephen Crane; walkway scratch-built by Stephen Crane (flat toothpicks glued to cardboard strip).

Page 42: Figures from 40413, *Rebel Troopers 3*, painted by Bill Refsland/Linda Robertello; repulsortank scratch-built and painted by Bill Refsland; terrain system: Geo-Hex; rock formations: repainted aquarium decorations.

Page 47: Figures from 40427, *Denizens of Tatooine*, painted by Brian Schomburg, and 40503, *Rebel Speeder Bikes*, painted by Bill Refsland/Linda Robertello; terrain system: Geo-Hex; Jawa trade stand scratch-built and painted by Stephen Crane; cargo: model railroad accessories, painted by Stephen Crane.

Page 48: Figures from 40406, *Rebel Troopers 2*, painted by T.G.W.P., 40427, *Denizens of Tatooine*,

painted by Brian Schomburg, and 40501, *Landspeeder*, painted by Bill Refsland/Linda Robertello; terrain system: Geo-Hex; Jawa trade stand scratch-built and painted by Stephen Crane; cargo: model railroad accessories, painted by Stephen Crane.

Page 52: Figures from 40422, *Bounty Hunters 2*, 40443, *Aliens of the Galaxy 2*, 40444, *Jabba the Hutt*, 40448, *Pirates*, painted by Bill Refsland/Linda Robertello; terrain system: Geo-Hex; wall and archway assembled from Wild Walls system, foamcore and illustration board; vaporator scratch-built and painted by Stephen Crane; docking bay equipment assembled from plastic household scraps (shoe spacers, can lids, bottle caps, etc.).

Page 56: Figures from 40450, *Gamorrean Guards*, painted by T.G.W.P., 40408, *Pilots and Gunners*, 40417, *Rebel Commandos 2*, painted by Bill Refsland/Linda Robertello; terrain system: Geo-Hex; docking bay equipment assembled from plastic household scraps (cellophane tape cores, pizza box spacers, shoe spacers, detergent nozzles, can lids, bottle caps, etc.).

Page 62: Figures from 40405, *Rebel Troopers 1*, 40413, *Rebel Troopers 3*, painted by Jay Wirth; terrain system: Geo-Hex.

Page 64: Figures from 40403, *Stormtroopers 1*, 40428, *Sandtroopers*, painted by T.G.W.P.; terrain system: Geo-Hex.

Page 71: Figures from 40405, *Rebel Troopers 1*, 40406, *Rebel Troopers 2*, 40413, *Rebel Troopers 3*, scavs painted by Bill Refsland/Linda Robertello, Rebels painted by Jay Wirth; terrain system: Geo-Hex; craters by Citadel Miniatures, customized and painted by Stephen Crane (the Citadel craters are out of production, but Sci-Fi Supply currently makes an assortment of craters).

Page 72: Figures from 40405, *Rebel Troopers 1*, painted by Jay Wirth, 40406, *Rebel Troopers 2*, 40420, *Bounty Hunters 1*, painted by Bill Refsland/Linda Robertello; terrain system: Geo-Hex; walls assembled from Wild Walls system and foamcore board; craters by Citadel Miniatures, customized and painted by Stephen Crane (the Citadel craters are out of production, but Sci-Fi Supply currently makes an assortment of craters).

Page 78: Figures from 40417, *Rebel Commandos 2*, 40421, *Rebel Troopers 4*, painted by Brian Schomburg; terrain system: Geo-Hex; fallen tree by Otherworld Artifacts, painted by Stephen Crane.

Page 85: Figures from 40411, *Imperial Army Troopers 1*, 40418, *Imperial Army Troopers 2*, painted by Stephen Crane; repulsortank scratch-built and painted by Bill Refsland; terrain system: Geo-Hex; rock formations: repainted aquarium decorations.

Page 86, left: Figure from 40421, *Rebel Troopers 4*, painted by T.G.W.P.; terrain system: Geo-Hex.

Page 86, right: Figure from 40417, *Rebel Commandos 2*, painted by Brian Schomburg; terrain system: Geo-Hex.

Page 87, left: Figure from 40413, *Rebel Troopers 3*, painted by Bill Refsland/Linda Robertello; terrain system: Geo-Hex.

Page 87, right: Figure from 40406, *Rebel Troopers 2*, painted by T.G.W.P.; terrain system: Geo-Hex.

Page 88, left: Figure from 40448 *Pirates*, painted by Bill Refsland/Linda Robertello; terrain system: Geo-Hex.

Page 88, right: Figure from 40405, *Rebel Troopers 1*, painted by Bill Refsland/Linda Robertello; terrain system: Geo-Hex.

Page 89, left: Figure from 40417, *Rebel Commandos 2*, painted by Bill Refsland/Linda Robertello; terrain system: Geo-Hex.

Page 89, right: Figure from 40412, *Imperial Naval Troopers 1*, painted by Jay Wirth; terrain system: Geo-Hex.

Page 90: Figure from 40405, *Rebel Troopers 1*, painted by Bill Refsland/Linda Robertello; terrain system: Geo-Hex.

Page 91, left: Figure from 40411, *Imperial Army Troopers 1*, painted by Stephen Crane; terrain system: Geo-Hex.

Page 91, right: Figure from 40418, *Imperial Army Troopers 2*, painted by Stephen Crane; terrain system: Geo-Hex.

Page 92, left: Figure from 40412, *Imperial Naval Troopers 1*, painted by T.G.W.P.; terrain system: Geo-Hex.

Page 92, right: Figure from 40425, *The Emperor*, painted by Bill Refsland/Linda Robertello; terrain system: Geo-Hex.

Page 93: Figure from 40433, *Scout Troopers*, painted by T.G.W.P.; terrain system: Geo-Hex.

Note: Five-digit numbers and italicized titles refer to *Star Wars* miniatures blister packs available from West End Games.

■ ■ ■

The following companies have provided invaluable assistance in the preparation of scenery and figures for this book:

Geo-Hex has an extensive and continually expanding terrain system, and can also provide custom-built terrain. They can be contacted at:

Geo-Hex
2126 North Lewis
Portland, OR 97227

Ground Zero Games produces an excellent range of resin 25mm science fiction vehicles, as well as battlefield architecture and other science-fiction figures. Ground Zero Games' vehicles and architecture are available in the United States from Capricorn Space, A Division of Geo-Hex, at the address given above.

Their products are available in the U.K., Europe and the rest of the world from:

Ground Zero Games
"Fizno"
Barking Tye
Needham Market
Suffolk IP6 8JB
U.K.

Sci-Fi Supply produces a high-quality line of vacuum-formed terrain accessories in their Wild Walls and Battlezone lines for fantasy and science fiction gaming. They can be contacted at:

Sci-Fi Supply
1541 Jason Street
Kissimmee, FL 34744
Fax: 407-846-8416

The MASTERBOOK System

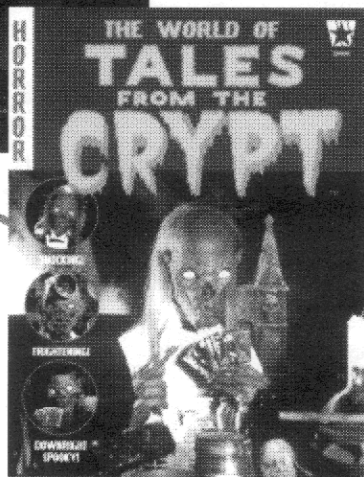
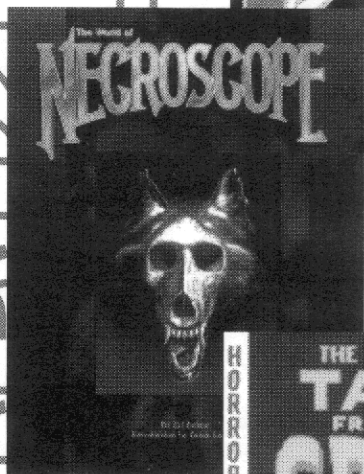
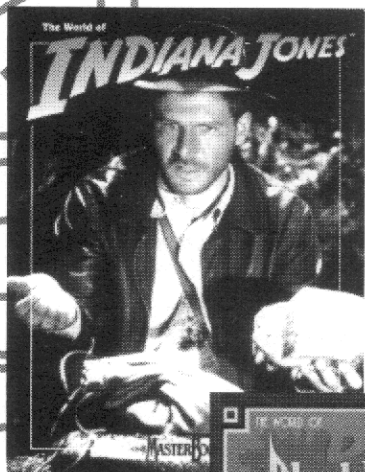

MasterBook is a universal roleplaying game rules system — this means it is flexible enough to be used with virtually *any* game setting you can imagine! You might be a scout ship pilot exploring the outer reaches of space; a two-fisted adventurer battling angry natives to recover a lost treasure; a psychic battling demons from another dimension; or any one of a thousand other roles! You need the *MasterBook* to adventure in *The World of Necroscope*, as well as these other worlds, also available from West End:

The World of Aden
The World of Bloodshadows
The World of Indiana Jones
The World of Shatterzone
The World of Species
The World of Tales From The Crypt
The World of Tank Girl
and many more to come!

To order the *MasterBook*, send a check or money order for \$20, plus \$3 shipping and handling, to the address listed below.

The MasterDeck

In this book, you will see references to the *MasterDeck*, cards that can be used to enhance your gameplay with this system. These are **optional**, and are not required for you to use the *MasterBook* system.

The *MasterDeck* is sold separately by West End Games. To order, send a check or money order for \$10 to:

West End Games
RR3, Box 2345
Honesdale, PA 18431

Indiana Jones TM & © 1996 Lucasfilm Ltd (LFL). All Rights Reserved.
Trademarks of LFL used by West End Games under authorization.

Necroscope © 1996 Brian Lumley

Tank Girl © 1996 UA Pictures Inc. All Rights Reserved. Licensed by MGM/UA L&M.
Bloodshadows and Shatterzone TM & © 1996 West End Games Ltd.

Species © 1996 MGM Pictures, Inc. Licensed by MGM/UA L&M. All Rights Reserved.

Tales From The Crypt TM & © 1996 Tales From The Crypt Holdings

The World of Aden TM Strategic Simulations, Inc.

MasterBook is a trademark of West End Games Ltd.

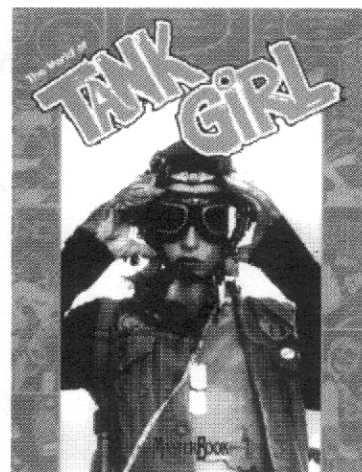
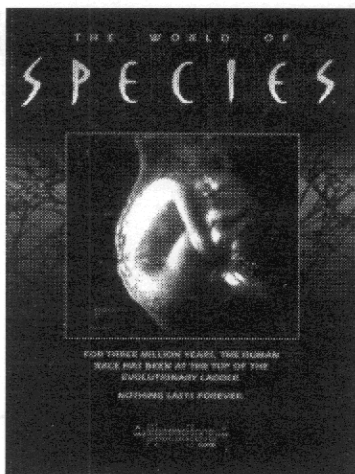

MASTERBOOK
INDIANA JONES
NECROSCOPE
TANK GIRL
TALES FROM THE CRYPT
SPECIES
BLOODSHADOWS
SHATTERZONE
ADEN

STAR WARS®

MINIATURES BATTLES

IMPERIAL ENTANGLEMENTS

by Stephen Crane



Emblem of the "Hammers"
elite Imperial repulsortank unit



Unit patch of Rebel
Strike Force Altagak

The Galactic Civil War rages on, as the dreaded Imperial war machine continues its campaign to eradicate the Rebel menace, only to find itself on the defensive as the New Republic rises from the ashes of the Old.

As the struggle grows in intensity, it draws other factions into an ever-widening vortex of conflict — and gangsters, scavengers, bounty hunters and aliens all find their fortunes and destinies inextricably bound up in the clash of the two mighty forces.



Emblem of the
Krayt Draggers swoop gang



Unit patch of the
Hitak Harriers Rebel unit

This supplement to the award-winning *Star Wars Miniatures Battles* game provides a number of engaging scenarios set in a galaxy far, far away. Within these pages you will find exotic environments, familiar aliens and tactical challenges, all with suggestions for staging the scenarios and rules for any special conditions that may apply, as your troops battle their way across a forest canopy, a lava plain, the floor of an impenetrable jungle and other strange locales.

These are some Imperial entanglements you won't want to avoid.

A supplement for use with *Star Wars Miniatures Battles*. Also compatible with the *Star Wars* roleplaying game.



40127

A STAR WARS
SUPPLEMENT

For two or more players, ages 12 and up.

0-87431-271-X \$15.00

