

STAR WARS

D 6 CONVERSION THE UNKNOWN REGIONS

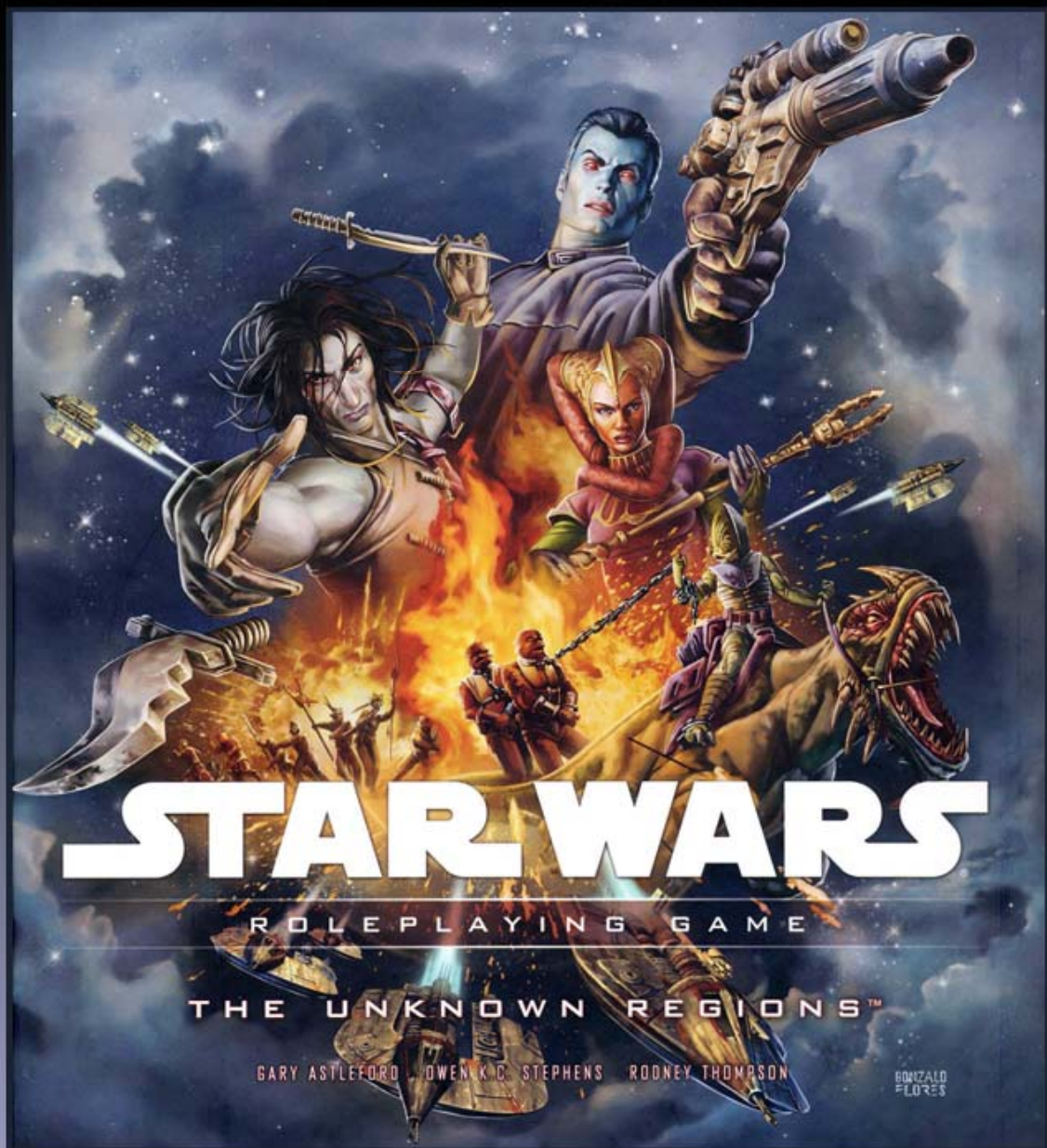

Inspired by



Alien Species

Anzat



Home Planet: Anzat

Attribute Dice: 12D

DEXTERITY 2D/4D

KNOWLEDGE 2D/4D+1

MECHANICAL 2D/4D

PERCEPTION 1D/3D

STRENGTH 3D/4D+2

TECHNICAL 2D/4D

Special Abilities:

Presence Sense: The Anzati's acute senses enable them to sense a person's Luck. When rolling *search: tracking* to find a living creature, an Anzat gains a bonus equal to 1D per Force Point plus 1 pip per Character Point the quarry possesses. If the target is Force Sensitive, this bonus is increased by +1 pip per full die of Force Skills the quarry possesses.

Mesmerize: As a standard action, an Anzat can make a *persuasion* roll against the *willpower* of a target within 10 meters. If the mind attack is successful, the target can take no actions in the next round. If the attack fails, the target is immune to this effect for 24 hours.

Soup Drinking: A successful *brawling* attack against a grappled, stunned or helpless creature allows the Anzat to insert his proboscises into the creature's brain and drain its "soup". The proboscises do STR stun damage, and once the victim is stunned it remains helpless until the Anzat stops feeding or dies. Each round of feeding subtracts 1 pip from all of the victim's attributes. If its *Strength* is reduced to zero, the victim dies. By draining 2D from a victim, the Anzat can recover one Wound Level. If the target survives the feeding attempt, he will regain his full *Strength* and *Dexterity* attributes after resting for 8 hours,

however, the other attributes are permanently reduced.

Stealthy: Because they must secretly hunt sentient beings, Anzati have grown adept at maintaining their stealth and secrecy. This is reflected in a +1D bonus to their *hide* and *sneak* skills.

Low-Light Vision: Poor lighting penalties are reduced by 2D.

Long-Lived: Anzati are practically immortal, and can live for eons as long as they feed regularly.

Move: 10/12

Size: 1.6-1.8 meters tall

Source: Ultimate Alien Anthology (pages 13-14), The Unknown Regions (pages 10-11)

Chadra-Fan



Home Planet: Chad

Attribute Dice: 12D

DEXTERITY 2D/4D

KNOWLEDGE 1D/3D

MECHANICAL 2D+1/4D+1

PERCEPTION 2D/5D

STRENGTH 1D/2D+1

TECHNICAL 2D/4D

Special Abilities:

Sight: The Chadra-Fan have the ability to see in the infrared and ultraviolet ranges, allowing them to see in all conditions short of absolute darkness.

Smell: The Chadra-Fan have extremely sensitive smelling which gives them a +2D bonus to their *search* skill.

Story Factors:

Tinkerers: Any mechanical device left within reach of a Chadra-Fan has the potential to be disassembled and then reconstructed. However, it is not likely that the reconstructed device will have

the same function as the original. Most droids will develop a pathological fear of Chadra-Fan.

Move: 5/7

Size: 1 meter tall

Source: Ultimate Alien Anthology (pages 31-32), Alien Anthology (page 62), Galaxy Guide 4: Alien Races (pages 27-28), Legacy Era Campaign Guide (page 211), The Unknown Regions (pages 11-12)

Ishi Tib

Home Planet: Tibrin

Attribute Dice: 12D

DEXTERITY

1D+1/3D+1

KNOWLEDGE 2D/4D

MECHANICAL 1D/3D

PERCEPTION 1D+2/4D

STRENGTH 2D/4D

TECHNICAL 2D/4D+2

Special Abilities:

Beak: The beak of the Ishi Tib does Strength +2D damage.

Planners: The Ishi Tib are natural planners and organizers. At the time of character creation only, they may receive 2D for every 1D of beginning skill dice placed in bureaucracy, business, law enforcement, scholar or tactics skills (Ishi Tib still have the limit of being able to place only 2D of beginning skill dice in a skill). **Immersion:** The Ishi Tib must fully immerse themselves (for 10 rounds) in a brine solution similar to the oceans of Tibrin after spending 30 hours out of the water. If they fail to do this, they suffer 1D damage (cumulative) for every hour over 30 that they stay out of the water (roll for damage once per hour, starting at hour 31).

Move: 9/11

Size: 1.7-1.9 meters

Source: Ultimate Alien Anthology (pages 77-78), Galaxy Guide 4: Alien Races (pages 54-55), The Unknown Regions (page 12)

Krevaaki

Home Planet: Krevas

Attribute Dice: 12D

DEXTERITY 2D/4D

KNOWLEDGE 1D/4D+1

MECHANICAL 1D/4D

PERCEPTION 1D/3D+2

STRENGTH 2D/4D

TECHNICAL 1D/4D



Special Abilities:

Natural Armor: Krevaaki possess an exoskeleton which provides a +1 pip bonus to any *Strength* rolls made to resist damage.

Stoic: The face of a Krevaaki is composed of a series of shifting, chitinous plates with a limited range of expression. During face-to-face communication, it is difficult (if not impossible) for anyone who is not a Krevaaki to read their facial expressions. Krevaaki gain a +2 pip bonus when attempting to make *con*, *intimidation*, or *persuasion* skill rolls against non-Krevaaki.

Tentacles: Krevaaki use their tentacles in the same way as bipeds use their arms and legs. Krevaaki receive a +2 pip bonus on all *climbing/jumping* skill checks that involve climbing, and a further +2 pip bonus to *brawling* skill checks made when grappling an opponent. On the flip side, the tips of their tentacles lack the dexterity of a humanoid finger, and Krevaaki suffer a -1D penalty on rolls made to perform intricate work or manipulate small objects.

Story Factors:

Xenophobic: Because Krevaaki are considered a bizarre species by most bipeds, they prefer to conceal their tentacled lower bodies.

Move: 10/12

Size: 2 meters

Source: Ultimate Alien Anthology (pages 91-92), Power of the Jedi Sourcebook (page 68), Jedi Academy Training Manual (page 111), The Unknown Regions (pages 12-13)

Nikto



■ Four of the Nikto races: an Esral'sa Nikto, a Kadas'sa Nikto, a Kajain'sa Nikto and a M'shent'o'su Nikto.

Home Planet: Kintan

Attribute Dice: 12D

DEXTERITY 2D/4D+2

KNOWLEDGE 2D/3D

MECHANICAL 1D/3D

PERCEPTION 1D/3D+2

STRENGTH 2D/4D+1

TECHNICAL 2D/3D

Special Abilities:

Esral'sa'Nikto Fins: These Nikto can withstand great extremes in temperature for long periods. Their advanced hearing gives them a +1 bonus to search and Perception rolls relating to hearing.

Kadas'sa'Nikto Claws: Their claws add +1D to climbing and do STR+2 damage.

Kajain'sa'Nikto Stamina: These Nikto have great stamina in desert environments. They receive a +1D bonus to both survival: desert and stamina rolls.

Vision: Nikto have a natural eye-shielding of a transparent keratin-like substance. They suffer no adverse effects from sandstorms or similar conditions, nor does their vision blur underwater.

Move: 10/12

Size: 1.6-1.9 meters

Source: Galaxy Guide 12 – Aliens: Enemies and Allies (pages 60-63), Ultimate Alien Anthology (pages 108-111), Gamer Magazine Issue 6 (pages 88-91), The Unknown Regions (pages 13-14)

Shistavanen



Home Planet: Uvena Prime

Attribute Dice: 12D

DEXTERITY 1D/5D

KNOWLEDGE 1D/4D

MECHANICAL 1D/4D

PERCEPTION 1D/5D

STRENGTH 1D/4D

TECHNICAL 1D/3D

Special Abilities:

Claws: Do STR+2 damage.

Night Vision: Shistavanens have excellent night vision and can see in darkness with no penalty.

Move: 10/13

Size: 1.3-1.9 meters

Source: Alien Encounters (page 141), Ultimate Alien Anthology (page 141), Alien Anthology (pages 97-98), The Unknown Regions (page 14)

Sluissi

Home Planet: Sluis Van

Attribute Dice: 13D

DEXTERITY 1D/2D

KNOWLEDGE 1D/3D+1

MECHANICAL 2D/3D

PERCEPTION 1D+1/3D+2

STRENGTH 1D+2/3D+2

TECHNICAL 2D/5D



Special Abilities:

Technical Aptitude: Sluissi receive an extra 4D beginning skill dice, all of which must be placed in Technical. They may place up to 4D in beginning Technical skills. Unfortunately, whenever a Sluissi uses a Technical skill, the action always takes twice as long as for other species.

Story Factors:

Relaxed: Sluissi, in general, are a very calm bunch. Nothing excites them. Their patience and seemingly inability to get genuinely upset or excited sometimes infuriates other species.

Move: 8/10

Size: 1.5-1.8 meters

Source: Ultimate Alien Anthology (pages 146-147), Alien Anthology (page 99), The Thrawn Trilogy Sourcebook (page 149), Dark Force Rising Sourcebook (pages 96-97), The Unknown Regions (pages 14-15)

Squib

Home Planet: Squab

Attribute Dice: 12D

DEXTERITY 2D+2/4D+2

KNOWLEDGE 1D/3D

MECHANICAL 2D/4D

PERCEPTION 2D/4D

STRENGTH 1D/3D

TECHNICAL 1D/3D



Story Factors:

Haggling: Squibs are born to haggle, and, once they get started, there is no stopping them. They get a +2D bonus to *bargain* rolls. The surest way to lure a Squib into a trap is to give it the chance to make a deal.

Move: 8/10

Size: 1 meter tall

Source: Ultimate Alien Anthology (pages 150-151), Alien Anthology (pages 103-104), Galaxy Guide 4: Alien Races (pages 83-84), The Unknown Regions (pages 15-16)

Verpine

Home Planet: Roche
Asteroid Field

Attribute Dice: 12D

DEXTERITY 1D+1/3D

KNOWLEDGE 1D+1/3D

MECHANICAL 1D+2/3D+2

PERCEPTION 1D+1/4D

STRENGTH 1D+1/3D

TECHNICAL 2D/5D

Special Abilities:

Microscopic Sight: +1D to search for small objects

Body Armor: The Verpine's natural chitinous plate armor gives them a +1D bonus against physical attacks.

Organic Telecommunication: Because Verpine can send and receive radio waves through their antenna, they have the ability to communicate with other members of their species with specially-tuned comlinks. The range is very limited when they are activating individually (1 km) but greatly increases when in the hive.

Technical Bonus: All Verpine receive a +2D bonus when using their *Technical* skills.

Move: 10/13

Size: 1.9 meters

Source: Ultimate Alien Anthology (pages 176-177), Alien Anthology (pages 111-112), Galaxy Guide 4: Alien Races (pages 91-93), The Thrawn Trilogy Sourcebook (pages 151-152), Dark Force Rising Sourcebook (pages 97-98), The Unknown Regions (page 16)

Chiss

Home Planet: Csilla

Attribute Dice: 12D

DEXTERITY 2D/4D

KNOWLEDGE 2D/4D

MECHANICAL 2D/4D

PERCEPTION 2D/4D

STRENGTH 2D/4D

TECHNICAL 2D/4D

Special Abilities:

Low-Light Vision: Low-lighting penalties are reduced by 2D.



Skill Bonuses: At the time of character creation only, Chiss characters gain 2D for every one die they assign to the *tactics*, *command*, and *scholar: art* skills.

Tactics: Chiss characters receive a permanent +1D bonus to all *tactics* skill rolls.

Move: 10/12

Size: 1.6 to 2.1 meters tall.

Source: Ultimate Alien Anthology (pages 36-38), Alien Anthology (pages 64-65), The Force Unleashed Campaign Guide (page 192), Legacy Era Campaign Guide (pages 11-12), The Unknown Regions (pages 124-126)

Ebruchi



Home Planet: Unknown

Attribute Dice: 12D

DEXTERITY 1D+2/3D+2

KNOWLEDGE 1D+2/3D+2

MECHANICAL 2D/4D+2

PERCEPTION 1D+2/3D

STRENGTH 3D/5D

TECHNICAL 2D/4D+2

Special Abilities:

Headstrong: Ebruchi are headstrong and stubborn. As such, they receive a +1D bonus to all *willpower* skill checks.

Unsettling: Most species find Ebruchi physical traits and habits unsettling. Once per encounter, when an Ebruchi makes a successful *intimidation* roll against a target, this opponent suffers a -1 penalty to all actions until the end of the encounter. This is a mind-affecting effect.

Story Factors:

Agoraphobic: Having spent generations in space, all Ebruchi suffer from a mild case of agoraphobia, or fear of wide-open spaces on planetary surfaces.

Nomadic: Having no homeworld of their own, the Ebruchi have become a race of nomadic, bullying pirates.

Move: 10/12

Size: 1.6 to 2.2 meters

Source: The Unknown Regions (pages 127-129)

Killik

Home Planet:

Alderaan (formerly)

Attribute Dice: 12D

DEXTERITY 2D/4D

KNOWLEDGE 1D+2/3D+2

MECHANICAL 1D+2/3D+2

PERCEPTION 2D/4D+1

STRENGTH 2D+2/4D+1

TECHNICAL 1D+1/3D+1

Special Abilities:

Joiners: A Killik can turn a helpless unconscious target into a Joiner. The process takes 1 minute and exposes the target to mind-altering pheromones. Once the target becomes a Joiner, its attitude shifts to friendly to the Killik and its allies, and the target gains a +10 bonus to *willpower* rolls against attempts to use *persuasion* to alter its perceptions of its new Killik friends. A target transformed into a Joiner can attempt a Very Difficult *willpower* roll once per day to remove the effect and return to its original attitude. This is a mind-affecting effect.

Low-Light Vision: Low-lighting penalties are reduced by 2D.

Hive Mind: Killiks share a hive mind and use their antennae to communicate by telepathy with other members of their species. A Killik within 1 kilometer of another Killik can communicate with it via telepathy.



Multiple Limbs: A Killik has four limbs that can be used as arms and hands, allowing two manual *Dexterity* actions before applying multiple action penalties.

Natural Armor: The Killik's chitinous exoskeleton provides +2 to resist damage from physical attacks only. It gives no bonus to energy attacks.

Claws: The Killik's limbs end in three-fingered claws that do STR+1D damage.

Hives: The attributes above are considered to be average for a Killik. However, different hives have vastly different characteristics. Below are a few examples, with stats modifications:

Aebea - **DEXTERITY** 3D/5D, **STRENGTH** 1D/3D, +1D to *dodge* rolls while flying, **Move:** 12/15 (flying), **Size:** 1 meter

Gorog - **DEXTERITY** 4D/6D, **STRENGTH** 0D/1D, Bluish in color, Poisonous bite: Inflicts STR damage and can inject acidic brown poison that can inflict an additional +2D damage, Poisonous spit: Can spit globs of acidic brown poison that can inflict 2D damage upon successful contact with skin.

Jooj - If two dozen can latch onto a target, they can crawl under armor and pierce the skin with hooked mandibles, draining blood every second, each round they're latched on, they inflict 1D damage. For every additional two dozen latched onto a target, the damage increases by +1D. **Move:** 12/14, **Size:** 3 centimeters

Kolosolak - **Scale:** Walker, **DEXTERITY** 1D/3D, **STRENGTH** 2D/10D (depends on size, larger = higher Die), Body armor protection increases up to +5D depending on size, **Move:** 6/8, **Size:** 50 meters long, 10 meters tall

Mollom - +2D bonus to all *burrowing* rolls.

Qeeq - **DEXTERITY** 4D/6D, **STRENGTH** 0D/2D, +2D to *dodge* rolls while flying, **Move:** 15/20 (flying), **Size:** less than 1 meter,

Rekker - +2D bonus to *climbing/jumping* rolls when jumping only, **Size:** 3 meters

Taat - **TECHNICAL** 3D/5D, Receive +1D to all *first aid* rolls.

Wuluw - Can greatly increase range of hive mind telepathy.

Move: 10/12

Size: 1.6 to 2.2 meters

Source: The Unknown Regions (pages 130-133)

Lugubraa

Home Planet: Stratos Distribution

Attribute Dice: 10D

DEXTERITY 1D+1/3D+1

KNOWLEDGE 1D/2D

MECHANICAL 1D/2D+1

PERCEPTION 1D/2D+1

STRENGTH 3D/4D+2

TECHNICAL 1D/1D+1

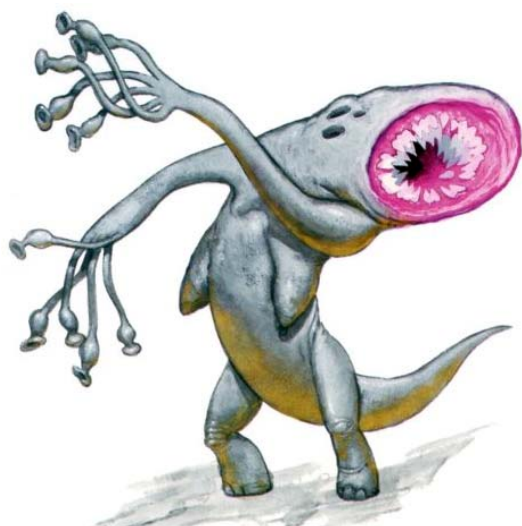

Special Abilities:

Barbed Tentacles: Do STR+1D damage and provide a +1D *climbing* bonus.

Teeth: Do STR+2 damage.

Darkvision: Although Lugubraa have no eyes, their echolocation and heat detection abilities grant them the equivalent of normal monochromatic sight, ignoring penalties due to poor lighting or smoke concealment.

Lockbite: The combination of tiny suction cups on the end of the Lugubraa's limbs and their teeth-ringed mouths give the Lugubraa a +1D bonus to all *brawling* rolls when attempting to grapple an opponent. If the roll is successful, the Lugubraa automatically latches onto the target with its teeth, increasing the *Strength* difficulty required to break the grapple and pry the Lugubraa loose by one level.

Lugubraa Learning: Those rare Lugubraa who survive past 50 years of age undergo a second cognitive kick-start, gaining an extra 1D to their *Knowledge*, *Mechanical*, *Perception* and *Technical* attributes.

Airless Survival: Lugubraas are capable of surviving near-indefinitely in vacuum or in thin and toxic atmospheres.

Story Factors:

Potential Parasites: Appetite drives the Lugubraa. Without proper countermeasures, a small group of Lugubraa could grow into a ravenous plague capable of consuming all organic matter off the surface of a planet before starving while trying to draw nutrients from minerals – a slow and inefficient process.

Move: 10/12

Size: 1.5 meters

Source: The Unknown Regions (pages 134-136)

Rakata



Home Planet: Rakata Prime

Attribute Dice: 12D

DEXTERITY 2D/4D

KNOWLEDGE 2D/4D

MECHANICAL 2D/4D+1

PERCEPTION 1D+1/3D+2

STRENGTH 1D+2/3D+2

TECHNICAL 2D+1/4D+2

Special Abilities:

Force Blind: For reasons unknown, they have lost their connection to the Force. Rakata characters can't be Force Sensitive, though they can still gain Dark Side Points and be affected by Force Powers.

Rage: Once per day, a Rakata can fly into a rage, gaining a +1D bonus to melee attacks and damage, but cannot use skills that require patience and concentration. A fit of rage lasts for a number of rounds equal to 5+ the character's number of full *Strength* dice. At the end of its rage, the character is tired, suffering a -1 penalty to all actions until he rests for at least 10 minutes.

Move: 10/12

Size: 2 meters tall on average

Source: Knights of the Old Republic Campaign Guide (pages 17-18), The Unknown Regions (pages 140-142)

Rhandite

Home Planet: Nihil Retreat

Attribute Dice: 12D

DEXTERITY 1D/3D

KNOWLEDGE 3D/5D

MECHANICAL 2D+1/4D

PERCEPTION 2D+2/4D+2

STRENGTH 1D/3D

TECHNICAL 3D/5D+1



Special Abilities:

Force Sensitive: All Sorcerers of Rhand are Force-sensitive.

Twisted: Each Sorcerer gains from one to three special abilities unique to his or her relationship with the Dark. Create these abilities, or select one or more from existing creatures.

Story Factors:

Repulsive Appearance: The Rhandites' repulsive physical appearances allow them to reroll

intimidation checks and take the better result. They also gain a +2D bonus to resist other people's *persuasion* attempts.

Move: 10/12

Size: 1.8 meters

Source: The Unknown Regions (pages 143-145)

Ssi-ruu



Home Planet: Lwhekk

Attribute Dice: 12D

DEXTERITY 2D/5D

KNOWLEDGE 1D+1/4D

MECHANICAL 1D/3D+2

PERCEPTION 1D/3D+1

STRENGTH 3D/5D

TECHNICAL 1D+2/3D+2

Special Abilities:

Tail: Does STR+1D damage.

Claws: Do STR+2D damage.

Enhanced Senses (Smell): Ssi-ruuk have a highly developed olfactory senses, they receive +1D to *search* rolls if the search attempt is scent-based (maximum range of 20 meters). In addition Ssi-ruuk can tell by scent if a human is lying: if the Ssi-ruu makes a moderate *alien species: human* roll (the Ssi-ruu must have the specialization), increase the interrogation subject's *willpower* difficulties by one difficulty level if the Ssi-ruu is actively seeking duplicity.

Poor Vision: Ssi-ruuk have poor vision compared to humans. They suffer a -1D penalty for actions involving vision at a range of greater than 50 meters. (This penalty does not apply for starship or vehicle weapons which have a fire control modifier and similar cases where computers or sensors negate the limitations of their vision.)

Natural Body Armor: The thick hide and scales of the Ssi-ruuk provides +2D against physical and +1D against energy attacks.

Force Blindness: The Ssi-ruuk are incapable of sensing or using the Force. Ssi-ruuk may not be Force-sensitive, although they may earn, possess and use Force Point and Character Points.

Story Factors:

Ssi-ruuvi Religion: Ssi-ruuvi religion states that if a Ssi-ruu dies away from a properly consecrated world, that Ssi-ruu's spirit is doomed to wander the galaxy without rest. Consequently, Ssi-ruuk tend to avoid open conflict away from their own planets, preferring to have droids and P'w'ecks do their fighting for them, while they monitor the battle from a distance. If confronted on an unconsecrated world, they are very likely to flee from battle.

Move: 11/14

Size: 1.9-2.2 meters

Source: Alien Encounters (pages 145-146), The Truce at Bakura Sourcebook (pages 83-84), Ultimate Alien Anthology (pages 151-153), Alien Anthology (pages 104-105), The Unknown Regions (pages 146-148)

Tof

Home Planet: Tof

Attribute Dice: 12D

DEXTERITY 1D+1/3D+1

KNOWLEDGE 1D+2/3D+2

MECHANICAL 1D+2/3D+2

PERCEPTION 2D/4D+1

STRENGTH 2D+1/4D+2

TECHNICAL 2D/4D

Special Abilities:



Aggressive Combatants: Tofs are aggressive and wild combatants. During character creation, Tof characters get an extra 1D to a single attack skills (i.e. *blaster*, *melee combat*, *brawling*).

Fearless: Tofs are fearless on the battlefield. They receive a +2D bonus to *willpower* rolls to resist fear, *intimidation* or *affect mind* attempts.

Heavy Drinkers: Alcoholic beverages have a peculiar effect on Tofs. A drunken Tof receives a +1D bonus to his *Knowledge*, *Perception*, and *Strength* attributes while suffering a -1D penalty to their *Dexterity* attribute and a reduction in their Move by 2. All associated skills are similarly affected.

Move: 10/12

Size: 2.0 to 2.5 meters

Source: The Unknown Regions (pages 149-151)

Vagaari

Home Planet: Vagar Praxut

Attribute Dice: 12D

DEXTERITY 2D/4D

KNOWLEDGE 2D/3D+2

MECHANICAL 2D/4D

PERCEPTION 2D/3D+2

STRENGTH 2D+2/4D+1

TECHNICAL 2D/4D

Special Abilities:

Deceivers: Vagaari are accomplished actors and deceivers, gaining a +1D to all *con* rolls.

Frightening Visage: Vagaari characters start with a free 1D in *intimidation*. When wearing traditional masks and garments, they can



reroll a failed *intimidation* attempt and take the better result.

Bioknowledge: Because of the numerous species they have invaded and conquered, Vagaari receive a +1D bonus to the following skills: *first aid*, (A) *medicine*, *scholar: biology* and *alien species*.

Story Factors:

Nomads: The Vagaari are a nomadic race of ruthless conquerors.

Move: 10/12

Size: 1.6-1.7 meters

Source: The Unknown Regions (pages 152-154)

Altiri

Home Planet: Altiria/Anarris

Attribute Dice: 12D

DEXTERITY 2D/4D

KNOWLEDGE 3D/4D

MECHANICAL 2D/4D

PERCEPTION 2D/4D

STRENGTH 2D/4D

TECHNICAL 2D/4D

Special Abilities:

Visually Striking: Altiri have a visually surprising or stunning appearance. They receive a +1D bonus to all *persuasion* rolls made against Humans or other near-Humans.

Versatile: Altiri are versatile and accomplished at many tasks. During character creation, they get an extra 1D to spend on skills.

Story Factors:

Anarrian hatred: The Altiri have a long-standing grudge against the Anarrians as a result of numerous wars that have occurred throughout the millennia.

Move: 10/12

Size: 1.7 meters

Source: The Unknown Regions (page 163)

Anarrian

Home Planet: Altiria/Anarris

Attribute Dice: 12D

DEXTERITY 2D/4D

KNOWLEDGE 2D/4D

MECHANICAL 2D/4D

PERCEPTION 2D/4D

STRENGTH 3D/4D

TECHNICAL 2D/4D

Special Abilities:

Strength Surge: Once per encounter, an Anarrian can briefly enhance their strength, adding +1D to any *Strength*-based skill or to a melee or brawling damage.

Story Factors:

Altiri hatred: The Anarrians have a long-standing grudge against the Altiri as a result of numerous wars that have occurred throughout the millennia.

Move: 10/12

Size: 1.8 meters

Source: The Unknown Regions (page 163)

O'reenian

Home Planet: O'reen

Attribute Dice: 12D

DEXTERITY 2D/4D

KNOWLEDGE 2D/4D

MECHANICAL 2D/4D

PERCEPTION 3D/4D+1

STRENGTH 2D/4D

TECHNICAL 2D/4D

Special Abilities:

Persistent: O'reenians are tireless and get a +2D bonus to *stamina* rolls.

Story Factors:

Military Society: O'reenians have a militaristic outlook to their society similar to that of the Chiss. As such, all O'reenians have at least one military-based skill.

Move: 10/12

Size: 1.6 to 1.8 meters

Source: The Unknown Regions (page 163)

Weapons

Blastsword

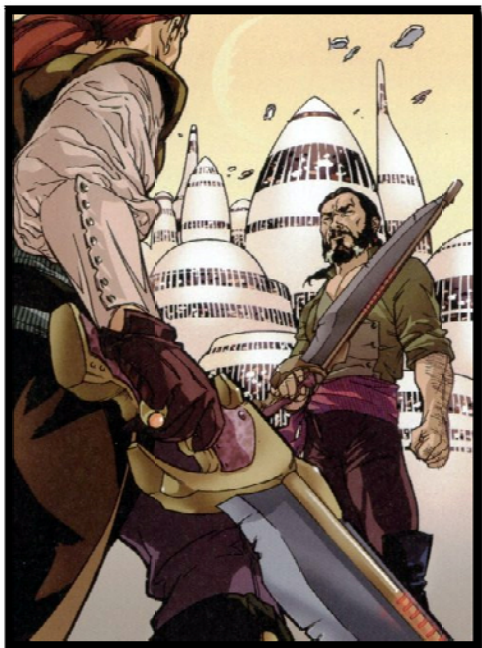

Model: Adumari Blastersword

Type: Blaster blade

Scale: Character

Skill: Melee combat: blastersword

Cost: 600

Availability: 3, R

Difficulty: Moderate

Damage: STR+2D (max: 4D+1), plus 4D energy

Game Notes: Upon contact with a target, the blade discharges a standard blaster bolt, dealing extra damage.

Source: Hero's Guide (page 122), The Unknown Regions (page 36)

Hand-Held Contact Stunner

Model: SoroSuub CS-12 Stun Master

Type: Contact stunner

Scale: Character

Skill: Melee combat: contact stunner

Ammo: 5

Cost: 575 (power cells: 15)

Availability: 2, R

Difficulty: Very Easy

Damage: 4D+2 stun

Game Notes: Small 15 cm long, 5 cm wide cylinder with a flat disc with 13 contact studs protruding from the forward end. Easy difficulty to *hide* (+2D to *hide* against weapon detectors, +1D against physical searches).

Source: Gundark's Fantastic Technology (page 10), Operation: Elrood (page 86), Arms and Equipment Guide (page 31), The Unknown Regions (page 36)

Electropole



Model: Otoh Gunga Defense League Electropole

Type: Melee weapon

Scale: Character

Cost: 1,500

Availability: 3, R

Difficulty: Moderate

Damage: STR+1D+1 (stun or killing)

Game Notes: This staff can deliver both bludgeoning (lethal) and electrical (stun) damage at the wielder's whim. Before damage is rolled, the wielder must decide what percentage of stun and real damage he will inflict on the target.

Source: Secrets of Naboo (page 49), The Unknown Regions (page 36)

Survival Knife

Model: Explorer's knife

Type: Melee weapon

Scale: Character

Skill: Melee combat: knife

Cost: 100

Availability: 1

Difficulty: Very Easy

Damage: STR+1D (maximum: 6D)

Game Notes: With a built-in digital compass, the handle is hollowed out to allow storage of very small items, such as a fire rod, a short length of binding wire, or an energy cell.

Source: The Unknown Regions (page 36)

Vibro-Saw

Model: Greel Wood Logging Corporation TreeFelling Vibroblade

Type: Vibro-saw

Scale: Character

Skill: Melee combat

Cost: 400

Availability: 1, R
Difficulty: 15
Damage: STR+2D+1
Source: Gundark's Fantastic Technology (pages 14-15), The Unknown Regions (page 36)

Yctor Arms Black Powder Pistol

Model: Yctor Arms Black Powder Pistol
Type: Black powder pistol
Skill: Archaic guns: black powder pistol
Ammo: 1
Cost: 200
Availability: 4
Range: 3-10/25
Damage: 3D
Source: Gundark's Fantastic Technology (page 20), Arms and Equipment Guide (page 23), The Unknown Regions (page 37)

W-90 Concussion Rifle



Model: BlasTech W-90 Concussion Rifle
Type: Blaster rifle
Scale: Character
Skill: Concussion weapons: rifle
Ammo: 25
Cost: 1,000
Availability: 2, X
Fire Rate: 1
Range: 3-50/150/450
Damage: 5D
Game Notes: A successful attack knocks the target prone, whether it deals damage or not.
Source: Gamer Magazine 6 (page 34), The Unknown Regions (page 37)

Tasari Crossbow

Model: Tasari Crossbow
Type: Custom made projectile weapon
Scale: Character
Skill: Projectile weapons: crossbow
Ammo: 1
Cost: 300, 20 per 10 bolts
Availability: 3
Fire Rate: 1
Range: 10/20/40
Damage: 3D
Game Notes: Crossbows do only 1D damage to targets wearing Space Age body armor (such as stormtrooper armor or blast vests). It takes 10 rounds (one minute) to reload a crossbow.

Crossbows will not set off weapons detectors, and can be fired silently.

Source: Adventure Journal 15 (page 191), The Unknown Regions (page 37)

Heavy Slugthrower Pistol

Model: Heavy Slugthrower Pistol
Type: Heavy slug-thrower
Scale: Character
Skill: Firearms: pistol
Ammo: 8
Cost: 400 (ammo 15)
Availability: 2, R
Range: 1-5/15/30
Damage: 4D+2
Game Notes: When firing more than one shot per round, each extra shot suffers a cumulative -1D attack penalty.
Source: The Unknown Regions (page 38)

Magna Caster

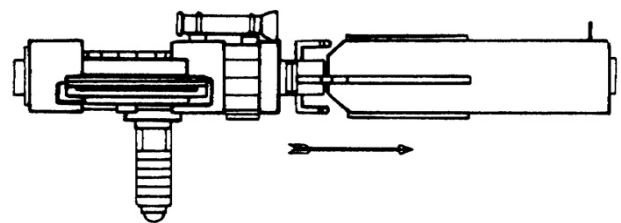

Model: Frohad's Galactic Firearms Magna Caster-100
Type: Magnetically-enhanced missile weapon
Scale: Character
Skill: Missile weapons: magna caster
Ammo: 10
Cost: 2,000, 150 (quarrel clip)
Availability: 3, F
Body: 2D
Fire Rate: 2
Range: 5-50/75/100
Damage: 6D/5D/4D
Source: Galladinium's Fantastic Technology (pages 75-76), Rules of Engagement – The Rebel SpecForce Handbook (page 63), Arms and Equipment Guide (page 26), The Unknown Regions (page 38)

Squib Tensor Rifle

Model: Amberlandrax Armaments Squib Tensor Rifle
Type: Tractor beam weapon
Scale: Character
Skill: Tensor rifle
Ammo: 15, 50 with replaceable power generator
Cost: 15,000
Availability: 4, F, R or X

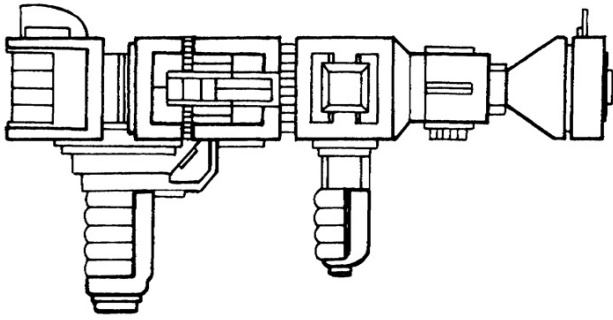

Range: 25-75/150/250

Damage: 4D

Game Notes: The tensor rifle does 3D damage for the first hit; subsequent hits to the same target within 30 seconds cause increasing damage: 4D for the second hit, 5D for the third, etc. Due to the great difficulty of targeting and handling this rather bizarre weapon, double the normal penalty for multiple actions in a round (two actions would be a -2D penalty; three actions would be a -4D penalty, four actions would be a -6D penalty, etc.)

Source: Galladinium's Fantastic Technology (pages 89-90), Arms and Equipment Guide (pages 37-38), The Unknown Regions (page 39)

Targeting Blaster Rifle

Type: Sporting blaster rifle

Scale: Character

Skill: Blaster: blaster rifle

Ammo: 50

Cost: 1,000

Availability: 2, F

Range: 3-30/100/300

Damage: 4D+1 (5D+1 if aiming for a full round)

Game Notes: Targeting blaster rifles can be easily disassembled for carrying and storage. Disassembling or reassembling the rifle requires an entire round during which no other actions can be taken.

Source: The Unknown Regions (page 39)

Verpine Shatter Gun

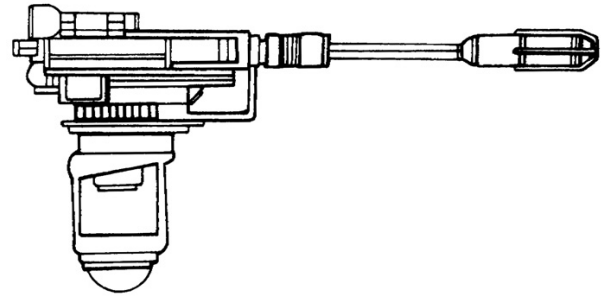

Model: Verpine Shatter Gun

Type: Magnetic accelerator weapon

Scale: Character

Skill: Firearms: Verpine shatter gun

Ammo: 100

Cost: 30,000, 1,000 (ammo)

Availability: 4, F, R or X

Body: 1D

Range: 50-400/900/1.5 km

Damage: 6D

Game Notes: If the shatter gun is jarred, dropped or otherwise banged in any significant manner, roll damage against the weapon's body.

Source: Galladinium's Fantastic Technology (pages 91-92), Arms and Equipment Guide (page 38), The Unknown Regions (page 39)

Equipment

Antidote Synthesizer

Type: Portable antidote manufacturing device

Cost: 2,500

Availability: 2

Game Notes: Antidote synthesizers may be used when more advanced medical attention is not available. When given a sample of a toxin, the antidote synthesizer will analyze the sample and produce 3 doses of an antidote within 1D rounds. The antidotes grant a +1D bonus to any *first aid* roll made to treat the venom or poison.

Source: The Unknown Regions (page 40)

Climbing Harness

Type: Mountaineering safety device

Cost: 45

Availability: 1

Game Notes: When properly using a climbing harness and synthrope, a character will fall only when failing a *climbing/jumping* roll by 10 or more.

Source: The Unknown Regions (page 40)

Givin Emergency Vacuum Seal

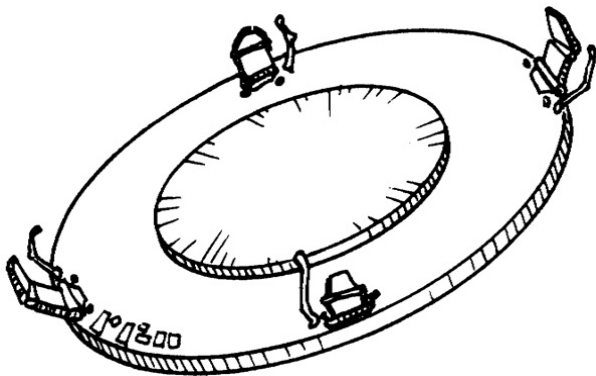

Model: Galvtronos Givin Interchanges, Limited EVS BBS-909

Type: Emergency vacuum seal

Cost: 750 (up to 50 centimeters in diameter); 1,000 (51-100 centimeters in diameter)

Availability: 3

Game Notes: Normal application requires a Moderate *Strength* total (to fight the pull of the atmosphere rushing out into space) and a Moderate *Dexterity* total (to reach and hit the controls while the character is fighting not to get pulled out into space). Seals come in different sizes ranging from 10 centimeters to 1 meter in diameter.

Source: Galladinium's Fantastic Technology (page 66), The Unknown Regions (page 40)

Fire Paste

Type: Fire starting fuel

Cost: 15

Availability: 1

Game Notes: Fire paste is highly flammable, igniting with a single spark and burning for 2D minutes. The paste will ignite on any surface including ice or wet wood. If applied to a living creature and ignited it deals 2D damage as long as it burns. A single tube contains five applications.

Source: The Unknown Regions (page 40)

Fire Rod

Type: Fire starting fuel

Cost: 25

Availability: 1

Game Notes: A fire rod is a plastic tube containing two separate chambers. When the chambers are broken, the chemicals contained within mix and begin a chemical reaction which will immediately combust, burning for 3D minutes. Adding additional fuel, such as wood, will allow the fire to burn longer.

Source: The Unknown Regions (page 40)

Hypoinjector Wristband

Type: Drug injection device

Cost: 350

Availability: 2

Game Notes: A hypoinjector wristband helps a character from succumbing to the effects of poisons or other harmful chemicals. The wristband contains a small monitoring device which scans for the presence of harmful chemicals, and stores up to 8 doses of vaccines, antidotes, or other medications. Once the presence of a harmful chemical or pathogen is detected, the hypoinjector automatically administers the necessary medication (if it is already pre-loaded into the wristband). The character gets +2D to all *Strength* or *stamina* rolls to resist the effects. The power cells must be replaced after 5 days of continuous use. Replacing the vials of medications or antidotes requires 1 round for a single vial, or 4 rounds for the entire set.

Source: The Unknown Regions (pages 40-41)

Microlab

Type: Automatic analysis portable laboratory

Cost: 1,800

Availability: 2

Game Notes: A microlab is a handheld portable laboratory for analyzing substances. A sample of the substance is placed in a small tube that is then

slid into the microlab. A Moderate *Knowledge* roll (or relevant sciences skill) is necessary to complete the examination, and the results are then displayed on the device's small screen.

Source: The Unknown Regions (page 41)

Personal Multitool

Type: Multipurpose tool

Cost: 100

Availability: 1

Game Notes: Multitools vary, but a standard multitool carries a 5-cm vibroblade, a low-power hydrospanner, a small hydrogrip, a toothpick, and a miniature set of eating utensils. These tools are stored within the 6-cm handle and each fold out on a hinge. The multitool may grant a +1 to +1D bonus to various tasks as determined by the gamemaster. The vibroblade can be used as an impromptu weapon, dealing STR+2 damage.

Source: The Unknown Regions (page 41)

Personal Translator

Type: Portable translating unit

Cost: 2,000

Availability: 2

Game Notes: The translator unit is small enough that it can be worn around the neck or carried in a pocket. The translator can be programmed with the language of the owner as well as three other languages, and has a *languages* skill of 4D. The translator can translate only spoken language, and does not interpret body language or sign language.

Source: The Unknown Regions (page 41)

Plastent

Type: Temporary inflatable shelter unit

Cost: 300

Availability: 1

Game Notes: The inflation unit can set up the plastent within a few minutes. The lightweight shelter stands 2 meters tall, and can accommodate 4 humanoids. In addition to protecting against harsh weather conditions, the plastent can have small pieces of equipment, such as a sensor array, mounted onto it.

Source: The Unknown Regions (page 41)

Portable Beacon

Type: Broad range landing beacon

Cost: 1,500

Availability: 2

Game Notes: Broadcasts a signal easily detectable by sensors within 10,000 km. The beacon has a spike that may be driven into the ground, and a

tripod which can be set on a flat surface. The signal can be altered to broadcast a warning or distress signal with a Moderate *communications* roll.

Source: The Unknown Regions (page 41)

Repulsor Boots

Type: Repulsorlift outfitted footwear

Cost: 200

Availability: 2

Game Notes: When activated, a pair of repulsor boots allow a character to hover up to 0.5 meters above the ground, but limiting his speed to a maximum Move of 3. The boots also grant a +3D bonus to all *climbing/ jumping* rolls.

Source: The Unknown Regions (page 41)

Repulsor Hitch

Type: Repulsorlift lifting device

Cost: 100

Availability: 1

Game Notes: A repulsor hitch may be attached to a heavy load, making it easier to transport. The repulsor can lift items up to 200kg. Anything over 200kg is not affected by the hitch.

Source: The Unknown Regions (page 41)

Riding Saddle

Type: Beast riding accessory

Cost: 125

Availability: 1

Game Notes: A riding saddle is a support for the comfort of the rider of an animal for which the saddle is specifically designed. The cost of most saddles is included with the purchase of a domesticated animal intended to be ridden. Use of a riding saddle grants a +1 *beast riding* bonus.

Source: The Unknown Regions (page 41)

War Saddle

Type: Beast riding accessory

Cost: 250

Availability: 1

Game Notes: The war saddle provides a sturdier platform for riding a creature. War saddles grant a +1D bonus to *beast riding* rolls. They also allow a rider to direct an animal with his or her knees and stay in the saddle.

Source: The Unknown Regions (page 42)

Shipsuit

Model: Ayelic/Krongbing Textiles Shipsuit

Type: General purpose shipsuit

Cost: 200

Availability: 1

Game Notes: Multi-pocketed coverall, fireproof and electrically nonconductive.

Source: Gundark's Fantastic Technology (page 76), Pirates & Privateers (page 47), The Unknown Regions (page 42)



Signal Wand

Type: Tight-beam transmission device

Cost: 300

Availability: 2

Game Notes: The wand is a .25 meter long stick capable of orbital-range broadband comlink communications. However, it can also transmit a tight-beam communication beyond an orbital gravity well. If the wand is connected to a more powerful energy source, it can reach interstellar distances, however, given the precise focus of a tightbeam transmission, the user must know exactly where to direct the signal wand (*Difficult communications* roll). The wand also features an external red light for transmission of simple visual codes.

Source: The Unknown Regions (page 42)

Sonar Mapper

Type: Echolocation mapping sensor

Cost: 400

Availability: 1

Game Notes: Though not as accurate as a typical scanner, a sonar mapper is occasionally used as a backup sensor device in situations where a sensor pack would not work. By using echolocation, it is able to map an area through frequent pulses that are detected by a specialized sensor system. The pulses are only accurate to a range of 100 meters. The mapper also records up to 12 hours of readings, making a good backup map if the user becomes lost.

Source: The Unknown Regions (page 42)

Subsonic Field Emitter

Type: Field pest repellent

Cost: 120

Availability: 1

Game Notes: This device is primarily for the comfort of a character not wishing to be disturbed by vermin or insects while outdoors. The emitter broadcasts a pulse attuned to the nervous system of very small nonsentient creatures. Insects and other such pests are unable to come within six meters of the emitter.

Source: The Unknown Regions (page 42)

Water Extractor

Type: Water collection and purification device

Cost: 400

Availability: 2

Game Notes: A water extractor is essentially a canteen with a water-condensing and purifying cone at the orifice. The condensers will collect water from the air and purify it, providing drinkable water to a character. Atmospheres on various planets provide different results, though a user on Tatooine will collect enough water to sustain a human being for a full day within 16 hours.

Source: The Unknown Regions (page 42)

Droids

AS23 Aerial Survey Droid

Type: Arakyd Industries AS23 Aerial Survey Droid

DEXTERITY 4D+2

Flying 6D+1

KNOWLEDGE 3D

Survival 6D

MECHANICAL 1D

PERCEPTION 2D+1

Search 5D

STRENGTH 1D+1

TECHNICAL 2D

Equipped With:

- Flying locomotion
- Automap
- Infrared sensors (ignores low-visibility penalties)
- Improved sensor package (+2D to *search*)
- Internal comlink

Spotter: When in flight, the AS23 can use its observation skills to locate enemy targets and relay their locations back to its master to assist in targeting for long-range and artillery weapons. Any such attacks against spotted targets ignore all concealment and gain a +2D attack bonus.

Move: 15 (flying)

Size: Small

Cost: 23,500 credits

Source: The Unknown Regions (page 43)

DSH-3 Probe Droid

Type: Arakyd Industries DSH-3 Probe Droid

DEXTERITY 4D+1

Dodge 5D

KNOWLEDGE 2D+1

Survival 6D

MECHANICAL 1D

Sensors 3D

PERCEPTION 2D+2

Search 7D+1, sneak 8D

STRENGTH 1D

TECHNICAL 1D

Equipped With:

- Internal comlink
- Recording holo-unit (can record and play back up to 5 minutes of footage)
- Repulsorlift unit
- Improved sensor package (+1D bonus to all *search* rolls)
- Infrared vision (the droid can see in the dark up to 30 meters)
- Low-light vision (low-lighting penalties are reduced by 2D)

• Motion sensors (+2 bonus to *search* checks against moving targets)

• Telescopic vision (the droid's visual sensors include a long-range capability)

Move: 16

Size: 0.3 meters

Cost: 13,000 credits

Source: The Unknown Regions (pages 43-44)

F1 Exploration Droid

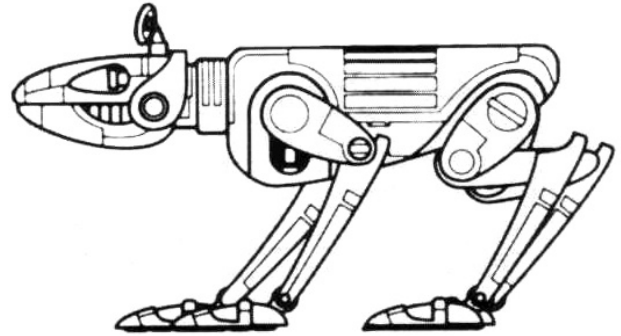

Type: Cybot Galactica F1 Exploration Droid

DEXTERITY 2D

KNOWLEDGE 1D

Survival 4D

MECHANICAL 2D

Communications 2D, sensors 5D

PERCEPTION 1D

Hide 2D, sneak 2D, search 3D

STRENGTH 1D

Lifting 2D

TECHNICAL 1D

Security 2D

Equipped With:

- Four legs
- Heavy grasper jaw designed for holding targets without crushing damage
- Two photoreceptors (human range)
- Auditory sensors (human range)
- Olfactory sensors
- Motion sensor array (+1D to *search* for detecting movement, range 50 meters)
- Communications link to a base-ship computer extending from the rear of the body
- Binary vocoder

Move: 10

Size: 1 meter

Cost: 2,750 credits

Source: Cynabar's Fantastic Technology – Droids, Galaxy Guide 8 – Scouts (page 44), The Unknown Regions (page 44)

MULE Droid

Type: Mechanical Universal Labor
Eliminating Droid, PackTack 41LT-R

DEXTERITY 1D

KNOWLEDGE 1D

MECHANICAL 3D

Repulsorlift
operation 4D+1

PERCEPTION 3D

Search 3D+2

STRENGTH 6D

Lifting 7D

TECHNICAL 2D

Droid programming
4D, droid repair 5D

Equipped With:

- Heavy lifting claw
- Large storage bay (2 cubic meters) protected by +1D armor
- Repulsorlift, max altitude one meter

Special Skills:

Repair Advice: Although the Mule cannot repair itself, it can advise anyone attempting to fix it, using the combined actions rules.

Move: 7

Size: 1.5 meters

Cost: 7,500 credits

Equipment: Often slung with additional storage pods.

Source: Galaxy Guide 8 – Scouts (page 45), Rules of Engagement – The Rebel SpecForce Handbook (page 56), The Unknown Regions (page 45)

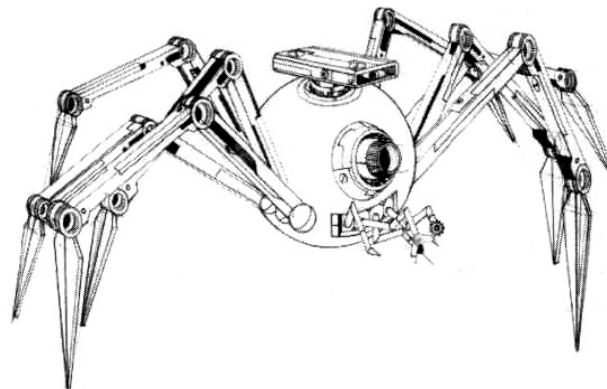
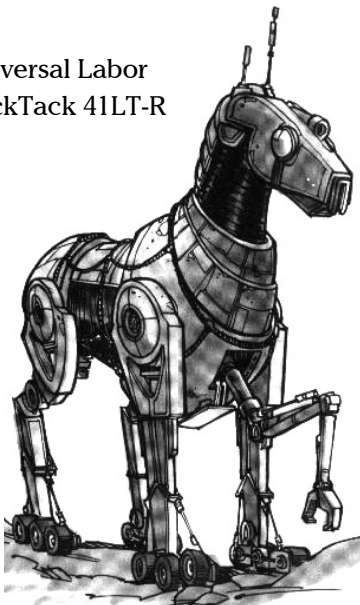

- Photoreceptor eye
- Stun blaster (5D damage, 3-20/35/50)
- Medical probe module
- Three fine manipulators
- Sensor pack

Move: 12

Size: 1-meter diameter, 2 meters tall

Cost: 17,000 (new), 8,000 (used)

Source: Cynabar's Fantastic Technology – Droids, Adventure Journal 2 (pages 213-214), The Unknown Regions (page 46)

WED 20 Treadwell Droid

Type: Cybot Galactica WED 20 Treadwell Droid

DEXTERITY 2D

KNOWLEDGE 2D+2

Alien species 4D+2, planetary systems 5D, survival 4D

MECHANICAL 1D

Communications 2D, sensors 3D

PERCEPTION 3D+2

Search 6D

STRENGTH 1D+1

TECHNICAL 3D

Equipped With:

- Video recorder
- Dual-tread locomotion
- 2 manipulator arms
- 5 field research tool appendages
- Vocabulator
- Internal comlink
- Internal microlab

Move: 8

Size: 1.6 meters

Cost: 8,300 credits

Source: The Unknown Regions (page 47)

Scout Survey Droid

Type: SoroSuub Wanderer Scout Survey Droid

DEXTERITY 3D

Blaster: stun blaster 5D

KNOWLEDGE 0D

MECHANICAL 3D

PERCEPTION 1D

Search 5D

STRENGTH 2D

Climbing/jumping 4D

TECHNICAL 1D

Medical dissection 6D

Equipped With:

- Eight mechanical legs

Vehicles

48 Roller Wheelbike

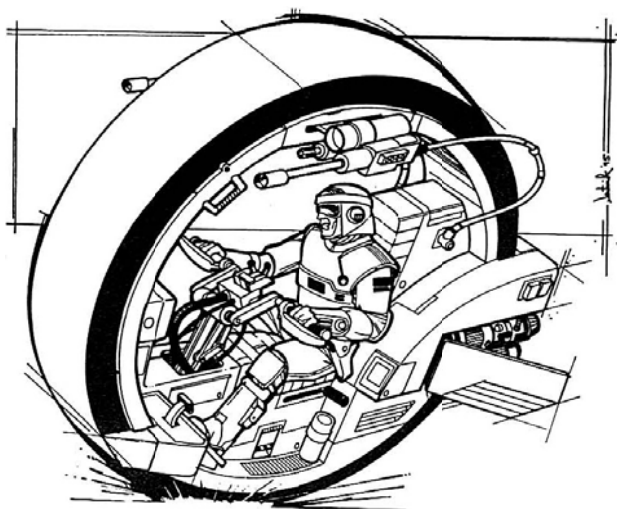

Craft: Gallis-Tech 48 Roller Wheelbike
Type: Surface scout vehicle
Scale: Speeder
Length: 2 meters
Skill: Ground vehicle operation: wheelbike
Crew: 1
Crew Skill: Vehicle blasters 4D, ground vehicle operation 3D
Cargo Capacity: 20 kilograms
Cover: 1/4
Cost: 8,000 (new), 1,500 (used) (civilian version)
Maneuverability: 1D
Move: 35; 10 kmh
Body Strength: 1D+2
Weapons:
Repeating Blaster (military version)
Fire Arc: Front
Scale: Character
Skill: Vehicle blasters
Fire Control: 1D
Range: 3-50/120/300
Damage: 6D
Source: Classic Adventures – Volume Four (page 143), Adventure Journal 6 (page 208), The Unknown Regions (pages 47-48)

Aerosled

Craft: Tangan Industries Aerosled Mark III
Type: Airspeeder
Scale: Speeder
Length: 4.1 meters
Skill: Repulsorlift operation: Aerosled
Crew: 1
Cargo Capacity: 24 kilograms
Cover: Full
Altitude Range: Ground level-500 meters
Cost: 22,000 (new), 12,000 (used)

Maneuverability: 3D
Move: 270; 780 kmh
Body Strength: 1D+2
Laser Cannon
Fire Arc: Front
Skill: Vehicle blasters
Fire Control: 2D+1
Range: 20-100/150/250
Damage: 4D
Source: The Unknown Regions (page 48)

All-Terrain Roller

Craft: All-Terrain Roller
Type: Off-road quad bike
Scale: Speeder
Length: 4 meters
Skill: Ground vehicle operation
Crew: 1
Passengers: 1
Cargo Capacity: None
Cover: 1/4
Cost: 3,500 (new), 500 (used)
Move: 45; 120 kmh
Body Strength: 1D
Source: Galaxy at War (page 179)

Compact Assault Vehicle

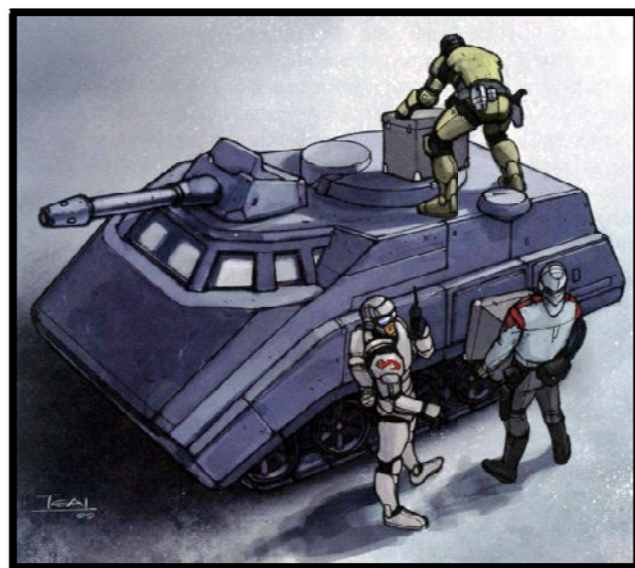

Craft: Nen-Carvon CAVw PX-10
Type: Compact assault vehicle
Scale: Speeder
Length: 5.1 meters
Skill: Ground vehicle operation: CAVw PX-10
Crew: 1
Crew Skill: Ground vehicle operation 4D+2, vehicle blasters 4D+1
Cargo Capacity: 100 kilograms
Cover: Full

Cost: Not available for sale (25,000 on the black market)

Maneuverability: 1D

Move: 90; 260 kmh

Body Strength: 3D+2

Weapons:

Medium Blaster Cannon

Fire Arc: Turret

Skill: Vehicle blasters

Fire Control: 2D

Range: 50-250/750/1.5 Km

Damage: 5D

Source: Imperial Sourcebook (pages 70-71), The Unknown Regions (pages 48-49)

Groundcar

Craft: Typical Groundcar

Type: Wheeled automobile

Scale: Speeder

Length: 5 meters

Skill: Ground vehicle operation

Crew: 1

Passengers: 4

Cargo Capacity: 300 kilograms

Cover: Full

Cost: 4,000 (new), 1,000 (used)

Maneuverability: 1D

Move: 55; 160 kmh

Body Strength: 2D+1

Source: The Unknown Regions (page 49)

Land Crawler

Craft: Land Crawler

Type: Treaded land vehicle

Scale: Speeder

Length: 6.5 meters

Skill: Ground vehicle: Landcrawler

Crew: 1

Passengers: 6

Cargo Capacity: 5 metric tons

Cover: Full

Cost: 7,500 (new), 3,000 (used)

Maneuverability: 0D

Move: 30; 95 kmh

Body Strength: 3D+1

Source: The Unknown Regions (page 49)

Landmaster

Craft: Jaffryes Universal Automotive ARK-II Series Landmaster

Type: All-terrain amphibious wheeled vehicle

Scale: Speeder

Length: 8.5 meters

Skill: Ground vehicle operation: ARK-II

Crew: 2, gunners: 1, skeleton: 1/+5

Passengers: 10

Cargo Capacity: 800 kilograms

Cover: Full

Cost: 120,000 (new), 30,000 (used)

Maneuverability: 1D

Move: 80; 240 kmh

Body Strength: 7D

Weapons:

Medium Blaster Cannon

Fire Arc: Turret

Crew: 1

Skill: Vehicle blasters

Fire Control: 2D

Range: 50-250/750/1.5 Km

Damage: 5D

Source: The Unknown Regions (page 50)

Mobile Recon/Research Vehicle

Craft: Hyrotii Corporation Mobile Recon/Research Vehicle

Type: Mobile research center

Scale: Walker

Length: 20 meters

Skill: Repulsorlift operation: MR/RV

Crew: 5, gunners: 1

Crew Skill: Repulsorlift operation 4D, vehicle blasters 3D+2

Passengers: 4

Cargo Capacity: 2 metric tons

Cover: Full

Altitude Range: Ground level-3 meters

Cost: 220,000 (new), 90,000 (used)

Maneuverability: 1D

Move: 70; 200 kmh

Body Strength: 4D

Weapons:

Light Quad Blaster Cannon

Fire Arc: Turret

Crew: 1

Scale: Speeder

Skill: Vehicle blasters

Fire Control: 3D

Range: 30-200/500/1 Km

Damage: 5D

Carried Craft: 2 speeder bikes

Source: The Unknown Regions (page 50)

Ikas-Adno Nightfalcon

Craft: Ikas-Adno 22-B Nightfalcon

Type: Speeder bike

Scale: Speeder

Length: 4.87 meters

Skill: Repulsorlift operation: speeder bike



Crew: 1
Passengers: 1
Cargo Capacity: 4 kilograms
Cover: 1/4
Altitude Range: Ground level-10 meters
Cost: 6,250 (new), 1,000 (used)
Maneuverability: 3D+1
Move: 160; 400 kmh
Body Strength: 1D+2
Weapons:
Laser Cannon
Fire Arc: Front
Skill: Vehicle blasters
Fire Control: 2D
Range: 30-50/100/200
Damage: 4D
Source: Rulebook (page 243), Wretched Hives of Scum and Villainy (page 74), d20 Core Rulebook (page 200), Adventure Journal 2 (page 196), The Unknown Regions (page 50)

New Republic SRV-1

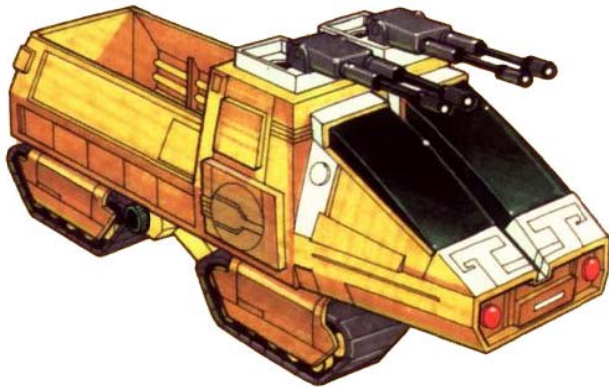

Craft: Aratech SRV-1
Type: Tracked scouting and retrieval vehicle
Scale: Speeder
Skill: Ground vehicle operation: SRV-1
Crew: 2, gunners: 2, skeleton: 1/+5
Crew Skill: Varies
Passengers: 8 (troops)
Cargo Capacity: 3 metric tons (only if no passengers are carried)
Cover: Full (command cabin), 1/2 (all other areas)
Cost: 7,500 (new), 3,000 (used)
Maneuverability: 0D
Move: 35; 100 kmh
Body Strength: 3D+1

Weapons:

2 Medium Laser Cannons

Fire Arc: 1 front/left/back, 1 front/right/back
Crew: 1
Skill: Vehicle blasters
Fire Control: 1D+2
Range: 50-200/500/1 Km
Damage: 3D+2

Source: The DarkStyder Campaign (pages 75-76), The Unknown Regions (page 51)

Landing Sphere

Craft: Loronar Landing Sphere
Type: Surface to starship transport
Scale: Speeder
Length: 6 meters
Skill: Repulsorlift operation: SkyBlind landing sphere

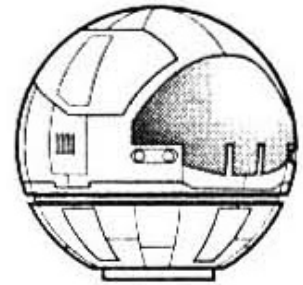

Crew: 1
Passengers: 7
Cover: Full
Cargo Capacity: 5 metric tons; 2 cubic meters
Consumables: 1 week
Cost: 178,600 (new), 89,300 (used)
Move: 225; 650 kmh
Maneuverability: 0D
Body Strength: 5D
Shields: 1D (shields apply only against sensors)
Sensors:
Passive: 5/0D
Scan: 10/1D
Search: 15/2D
Focus: 1/2D
Source: Galaxy Guide 8 – Scouts (page 38), The Unknown Regions (page 58)

Wind Skiff

Craft: Converted Wind Skiff
Type: Wheeled wind-powered craft
Scale: Speeder
Length: 9 meters
Skill: Ground vehicle operation: Wind Skiff
Crew: 1
Passengers: 4
Cargo Capacity: 900 kilograms
Cover: None
Cost: 13,000 (new), 3,500 (used)
Maneuverability: 2D
Move: 105; 300 kmh
Body Strength: 2D
Weapons:
Debris Clearing Laser Cannon
Fire Arc: Front

Skill: Vehicle blasters

Fire Control: 0D

Range: 30-50/100/200

Damage: 3D

Source: The Unknown Regions (pages 188-189)

Eeok Patrol Speeder

Craft: Eeok Protector VI Patrol Speeder

Type: Security aircrasher

Scale: Speeder

Length: 12 meters

Skill: Repulsorlift operation: Patrol Speeder

Crew: 1

Passengers: 6

Cargo Capacity: 500 kilograms

Cover: Full

Altitude Range: Ground level-5 kilometers

Cost: 50,000 (new), 40,000 (used)

Maneuverability: 2D+2

Move: 280; 800 kmh

Body Strength: 3D

Light Laser Cannon

Fire Arc: Front

Skill: Vehicle blasters

Fire Control: 2D

Range: 50-200/500/1 Km

Damage: 4D

Rocket Launcher

Fire Arc: Front

Skill: Vehicle blasters

Fire Control: 2D

Range: 50-250/750/1.5 Km

Damage: 6D

Source: The Unknown Regions (page 214)

Starships

Deep-X Explorer

Craft: Uulshos DPx Yacht

Affiliation: General

Era: Rebellion

Type: Modified space yacht

Scale: Starfighter

Length: 12 meters

Skill: Space transports: DPx

Crew: 1, gunners: 2

Passengers: 5 (including two to operate blaster cannon)

Cargo Capacity: 50 metric tons; 20 cubic meters

Consumables: 6 months

Cost: 135,000 (new), 55,000 (used)

Hyperdrive Multiplier: x1

Hyperdrive Backup: x8

Nav Computer: Yes

Maneuverability: 2D

Space: 7

Atmosphere: 350; 1,000 kmh

Hull: 2D

Sensors:

Passive: 20/0D

Scan: 30/1D

Search: 50/2D

Focus: 3/3D

Weapons:

2 Blaster Cannons (fire separately)

Fire Arc: Front

Crew: 1 per gun

Skill: Starship gunnery

Fire Control: 0D

Space Range: 1-2/8/15

Atmosphere Range: 100-200/800/1.5 km

Damage: 1D

Source: Galaxy Guide 8 – Scouts (page 36), The Unknown Regions (page 51)

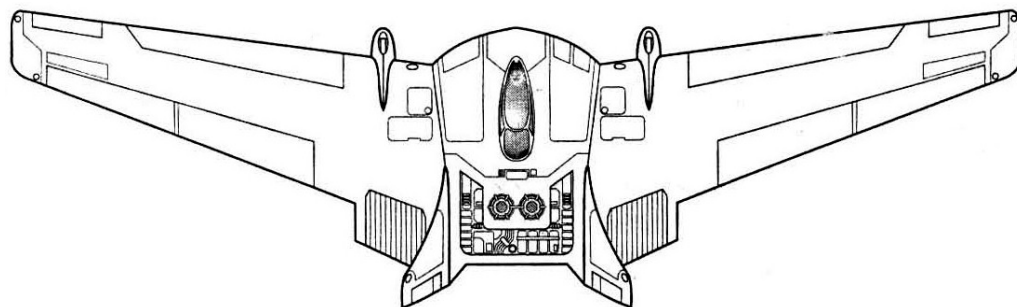

Drexl Starfighter



Craft: Sorosuub *Drexl*-class “Planetary Defender”

Affiliation: General

Era: Rebellion

Type: Planetary defender

Scale: Starfighter

Length: 21 meters

Skill: Starfighter piloting: Drexl

Crew: 2 plus astromech droid, skeleton: 1/+5

Crew Skill: Astrogation 4D, starfighter piloting 4D+1, starship gunnery 4D+2, starship shields 4D

Cargo Capacity: 70 kilograms (plus 50 kilograms with no co-pilot)

Consumables: 2 days

Cost: 165,000 (new), 100,000 (used)

Hyperdrive Multiplier: x3

Nav Computer: No (uses astromech droid programmed with 10 jumps)

Maneuverability: 2D+2

Space: 8

Atmosphere: 365; 1,050 kmh

Hull: 5D

Shields: +2

Sensors:

Passive: 20/0D

Scan: 40/1D

Search: 60/2D

Focus: 3/3D

Weapons:

Dual Laser Cannons

Fire Arc: Front

Skill: Starship gunnery

Fire Control: 2D

Space Range: 1-3/12/25

Atmosphere Range: 100-300/1.2/2.5 km

Damage: 5D

2 Concussion Missile Launchers (12 missiles)

Fire Arc: Front

Skill: Starship gunnery

Space Range: 1/3/7

Atmosphere Range: 50-100/300/700

Damage: 8D

Source: The Unknown Regions (page 52)

JumpMaster 5000



Craft: Corellian Engineering JumpMaster 5000

Affiliation: General

Era: Old Republic

Type: Scout Ship

Scale: Starfighter

Length: 20.1 meters

Skill: Space transports: JM-5K

Crew: 1

Crew Skill: Space transports 4D, starship gunnery 4D+1, starship shields 4D, sensors 4D+2

Passengers: 1

Cargo Capacity: 50 metric tons

Consumables: 4 months

Cost: 110,000 (new), 40,000 (used)

Hyperdrive Multiplier: x3

Hyperdrive Backup: x15

Nav Computer: Yes

Maneuverability: 1D+2

Space: 10

Atmosphere: 415; 1,200 kmh

Hull: 4D

Shields: 1D

Sensors:

Passive: 20/0D

Scan: 40/1D

Search: 60/2D

Focus: 3/4D

Weapons:

Laser Cannons

Fire Arc: Turret

Skill: Starship gunnery

Fire Control: 2D

Space Range: 1-3/12/25

Atmosphere Range: 100-300/1.2/2.5 km

Damage: 4D

Source: The Unknown Regions (page 52)

MRX-BR Pacifier

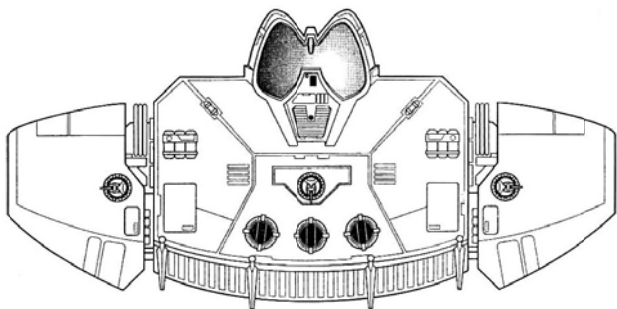

Craft: Sydon Vehicle Works MRX-BR Pacifier
Combat/Contact Vessel

Affiliation: Empire / General

Era: Rise of the Empire

Type: Exploration fighter

Scale: Starfighter

Length: 25 meters

Skill: Space transports

Crew: 1

Passengers: 3

Cargo Capacity: 25 metric tons; 10 cubic meters

Consumables: 1 year

Cost: 170,000 (new), 100,000 (used)

Hyperdrive Multiplier: x1

Hyperdrive Backup: x8

Nav Computer: Yes

Maneuverability: 1D

Space: 7

Atmosphere: 600; 1,200 kmh

Hull: 2D

Shields: 2D

Sensors:

Passive: 30/1D

Scan: 60/2D

Search: 120/3D

Focus: 10/3D+2

Weapons:

3 Laser Cannons

Fire Arc: 1 rear, 1 left, 1 right

Crew: 1 each (can be fired remotely from cockpit)

Fire Control: 3D

Space Range: 1-3/12/25

Atmosphere Range: 100-300/1.2/2.5 km

Damage: 3D

2 Proton Torpedo Launchers

Fire Arc: Front

Crew: 1

Skill: Starship gunnery

Fire Control: 2D

Space Range: 1/3/7

Atmosphere Range: 50-100/300/700

Damage: 9D

Source: Galaxy Guide 8 – Scouts (page 42), Lord of the Expanse: Gamemaster Guide (page 42), The Unknown Regions (pages 54-55)

Mu-2 Shuttle

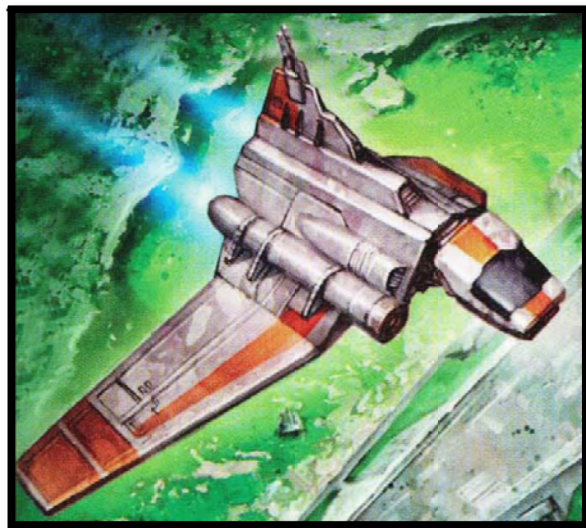

Craft: Sienar Fleet Systems Mu-2 Long Range Shuttle

Affiliation: Empire / New Republic

Era: Rebellion

Type: Scout shuttle

Scale: Starfighter

Length: 20 meters

Skill: Space transports: Mu-2

Crew: 2

Passengers: 14

Cargo Capacity: 100 metric tons; 40 cubic meters

Consumables: 6 months

Cost: 160,000 (new), 110,000 (used)

Hyperdrive Multiplier: x2

Hyperdrive Backup: x20

Nav Computer: Yes

Maneuverability: 1D

Space: 5

Atmosphere: 295; 850 kmh

Hull: 4D

Shields: 1D+2

Sensors:

Passive: 25/1D

Scan: 50/2D

Search: 60/2D

Focus: 3/3D

Weapons:

2 Laser Cannons (fire-linked)

Fire Arc: Front

Crew: 1 (co-pilot)

Skill: Starship gunnery

Fire Control: 2D

Space Range: 1-2/12/25

Atmosphere Range: 100-300/1.2/2.5 km

Damage: 4D+1

Source: Galaxy Guide 8 – Scouts (page 37), The Unknown Regions (page 55)

Preybird Fighter



Craft: Sorosuub *Preybird*-class Starfighter
Affiliation: General / New Republic
Era: Rebellion
Type: Heavy assault starfighter
Scale: Starfighter
Length: 21 meters
Skill: Starfighter piloting: Preybird
Crew: 1, gunners: 1
Crew Skill: Astrogation 4D, starfighter piloting 4D+2, starship gunnery 5D, starship shields 4D
Cargo Capacity: 15 kilograms
Consumables: 4 days
Cost: 84,000 (new), 50,000 (used)
Hyperdrive Multiplier: x3
Nav Computer: Limited to five jumps
Maneuverability: 3D
Space: 9
Atmosphere: 400; 1,150 kmh
Hull: 2D+2
Shields: 1D+1
Sensors:
Passive: 20/0D
Scan: 40/1D
Search: 60/2D
Focus: 3/3D
Weapons:
2 Heavy Laser Cannons (fire-linked)
Fire Arc: Front
Skill: Starship gunnery
Fire Control: 2D+1
Space Range: 1-3/12/25
Atmosphere Range: 100-300/1.2/2.5 km
Damage: 5D
2 Concussion Missile Launchers (10 missiles)
Fire Arc: 1 front, 1 rear
Skill: Starship gunnery
Space Range: 1/3/7
Atmosphere Range: 50-100/300/700
Damage: 8D
Source: The Last Command Sourcebook (pages 132-133), The Thrawn Trilogy Sourcebook (pages 225-226), The Unknown Regions (page 56)

SCT Scout Craft



Craft: Mesens Corporation SCT Scout Craft
Affiliation: General
Era: Rebellion
Type: Long-range exploration vessel
Scale: Capital
Length: 75 meters
Skill: Space transports: SCT Scout
Crew: 2, gunners: 3
Crew Skill: Astrogation 3D+3, space transports 2D+2, starship gunnery 3D, starship shields 2D+2, sensors 3D+1
Passengers: 8
Cargo Capacity: 275 metric tons
Consumables: 3 months
Cost: 1.2 million (new), 720,000 (used)
Hyperdrive Multiplier: x3
Hyperdrive Backup: x12
Nav Computer: Yes
Space: 4
Atmosphere: 280; 820 kmh
Hull: 2D
Shields: 1D
Sensors:
Passive: 40/1D
Scan: 80/2D+2
Search: 130/4D
Focus: 5/4D+2
Weapons:
Dual Turbolaser Turret
Fire Arc: Turret
Crew: 1
Skill: Capital ship gunnery
Fire Control: 2D+1
Space Range: 3-15/35/75
Atmosphere Range: 300-1.5/3.5/7.5 km
Damage: 6D
2 Dual Laser Cannons (fire separately)
Fire Arc: Turret
Crew: 1
Scale: Starfighter
Skill: Starship gunnery
Fire Control: 3D+1
Space Range: 1-3/12/25
Atmosphere: 100-300/1.2/2.5 km
Damage: 5D
Source: The Unknown Regions (pages 56-57)

SkyBlind Recon Ship

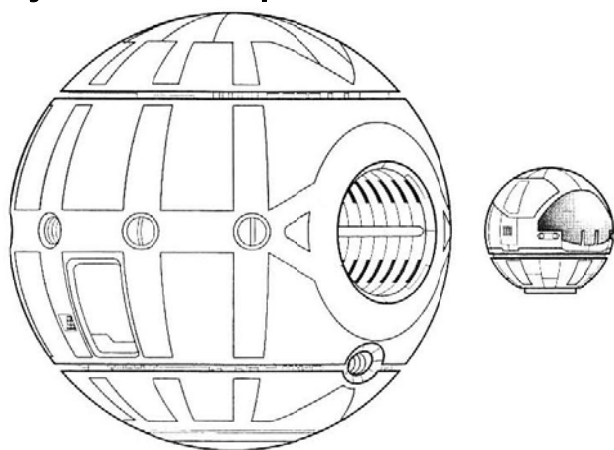

Craft: Loronar SkyBlind Recon Ship
Alignment: General
Era: Rise of the Empire
Type: Reconnaissance scoutship
Scale: Starfighter
Length: 21 meters
Skill: Space transports: SkyBlind
Crew: 1
Passengers: 7
Cargo Capacity: 50 metric tons; 20 cubic meters
Consumables: 6 months
Cost: 1,120,000 (new), 560,000 (used)
Hyperdrive Multiplier: x3
Hyperdrive Backup: x20
Nav Computer: Yes
Maneuverability: 0D
Space: 2
Atmosphere: 225; 650 kmh
Hull: 6D
Shields: 3D (shields apply to defense against sensors as well)
Sensors:
Passive: 50/2D
Scan: 30/1D
Search: 50/2D
Focus: 3/3D
Weapons:
Proton Torpedo Launcher
Fire Arc: All
Skill: Starship gunnery
Fire control: 0D
Space range: 1/3/7
Atmosphere Range: 50-100/300/700
Damage: 7D
Carried Craft: 1 Landing Sphere (see Vehicles section)
Source: Galaxy Guide 8 – Scouts (page 38), The Unknown Regions (page 57)

Star Seeder

Craft: Kuat Drive Yards *Star Seeder*-class Ship
Affiliation: General
Era: Rebellion
Type: Colony ship
Scale: Capital
Length: 250 meters
Skill: Capital ship piloting: KDY Seedship
Crew: 550, skeleton: 143, with *command* 4D+2
Crew Skill: Capital ship piloting 3D+2, starship shields 3D, sensors 3D+2, scanning planets 4D+1, astrogation 4D, capital ship gunnery 3D, survival 4D, medicine 4D+2
Passengers: 800
Cargo Capacity: 7,500 metric tons; 3,000 cubic meters
Consumables: 5 years
Cost: 3 million (new), 1 million (used)
Hyperdrive Multiplier: x3
Hyperdrive Backup: x15
Nav Computer: Yes
Maneuverability: 1D
Space: 4
Atmosphere: 280; 800 kmh

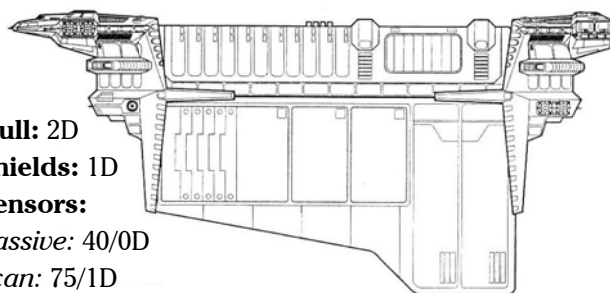

Hull: 2D
Shields: 1D
Sensors:
Passive: 40/0D
Scan: 75/1D
Search: 250/4D
Focus: 5/5D
Weapons:
6 Turbolaser Batteries
Fire Arc: 2 front, 2 back, 1 left, 1 right
Crew: 1
Skill: Capital ship gunnery
Fire Control: 0D
Space Range: 3-15/35/75
Atmosphere Range: 6-30/70/150 km
Damage: 3D
Tractor Beam Projector
Fire Arc: Front/down
Crew: 2
Scale: Starfighter
Skill: Starship gunnery
Fire Control: 1D
Space Range: 1-5/15/30
Atmosphere Range: 2-10/30/60 km
Damage: 4D
Source: Galaxy Guide 8 – Scouts (page 39), The Unknown Regions (page 58)

Vaya Scout Ship



Craft: Hoersch-Kessel Vaya-class Scout Ship

Affiliation: Old Republic / General

Era: Old Republic

Type: Scout ship

Scale: Starfighter

Length: 30 meters

Skill: Space Transports

Crew: 1, gunners: 2

Passengers: 4

Cargo Capacity: 60 metric tons

Consumables: 1 month

Cost: 45,000(new), 15,000 (used)

Hyperdrive Multiplier: x8

Hyperdrive Backup: x15

Maneuverability: 3D+1

Space: 2

Atmosphere: 450; 700 kmh

Hull: 3D

Shields: 3D; 2D

Sensors:

Passive: 6/0D

Scan: 15/1D

Weapons:

Laser Cannon

Fire Arc: Front

Crew: 1

Skill: Starship gunnery

Fire Control: 2D

Space Range: 1-2/8/18

Atmosphere Range: 50-100/350/650

Damage: 3D

Concussion Projectile Launcher

Fire Arc: Front

Crew: 1

Skill: Starship gunnery

Fire Control: 3D

Space Range: 1/2/5

Atmosphere Range: 24-60/90/120

Damage: 5D

Source: Tales of the Jedi Companion (page 115),
The Unknown Regions (pages 58-59)

Dartship

Craft: Killik Dartship

Affiliation: Killik Colony

Era: New Jedi Order

Type: Attack fighter

Scale: Starfighter

Length: 12 meters

Skill: Starfighter piloting: Dartship

Crew: 1

Crew Skill: All skills 4D

Cargo Capacity: 70 kilograms

Consumables: 2 days

Cost: Not available for sale

Maneuverability: 2D+2

Space: 10

Atmosphere: 415; 1,200 kmh

Hull: 3D+1

Sensors:

Passive: 20/0D

Scan: 40/1D

Search: 60/1D+2

Focus: 3/2D+2

Weapons:

Laser Cannons

Fire Arc: Front

Skill: Starship gunnery

Fire Control: 2D

Space Range: 1-3/12/25

Atmosphere Range: 100-300/1.2/2.5 km

Damage: 4D

Dartship Ram - Due to its shape and construction, a dartship deals an extra 1D damage when successfully ramming an enemy ship (see R&E Rulebook, pages 109-110). Also, if more than one dartship rams a target in a single round, each dartship that collides deals +1D damage to the target.

Source: The Unknown Regions (page 133)

Royal Fortune Light Clipper

Craft: Royal Fortune-class Light Clipper

Affiliation: Tof armada

Era: Rise of the Empire

Type: Attack frigate

Scale: Capital

Length: 290 meters

Skill: Capital ship piloting: Royal Fortune

Crew: 430, gunners: 50

Crew Skill: All skills 4D

Passengers: 200

Cargo Capacity: 8,000 metric tons

Consumables: 1 year
Cost: Not available for sale
Hyperdrive Multiplier: x2
Hyperdrive Backup: x12
Nav Computer: Yes
Maneuverability: 1D
Space: 6
Atmosphere: 330; 950 kmh
Hull: 2D+1
Shields: 1D+2
Sensors:
Passive: 20/0D
Scan: 48/1D
Search: 70/2D
Focus: 3/3D
Weapons:
38 Laser Cannons
Fire Arc: 19 left, 19 right
Crew: 1
Scale: Starfighter
Skill: Starship gunnery
Fire Control: 1D+2
Space Range: 1-3/12/25
Atmosphere Range: 100-300/1.2/2.5 km
Damage: 4D
10 Quad Laser Cannons
Fire Arc: 5 front, 5 back
Crew: 1
Scale: Starfighter
Skill: Starship gunnery
Fire Control: 1D
Space Range: 1-3/12/25
Atmosphere Range: 100-300/1.2/2.5 km
Damage: 5D
Fotia's Fire Cannon
Fire Arc: Front
Crew: 2
Scale: Starfighter
Skill: Starship gunnery
Fire Control: 1D
Space Range: 3-15/35/75
Atmosphere Range: 300-1.5/3.5/7.5 km
Damage: 7D (2D for the following two rounds)
Carried Craft: 15 starfighters, 4 longboat shuttles
Source: The Unknown Regions (page 151)

Surfeik Cruiser

Craft: Arized Surfeik Cruiser
Affiliation: Vagaari Empire
Era: Rise of the Empire
Type: Assault cruiser
Scale: Capital
Length: 550 meters

Skill: Capital ship piloting: Surfeik cruiser
Crew: 500, gunners: XX
Crew Skill: All skills 4D
Passengers: 1,500 (slaves)
Cargo Capacity: 10,000 metric tons
Consumables: 1 year
Cost: Not available for sale
Hyperdrive Multiplier: x2
Hyperdrive Backup: x15
Nav Computer: Yes
Maneuverability: 1D
Space: 4
Atmosphere: 280; 800 kmh
Hull: 4D+1
Shields: 2D
Sensors:
Passive: 30/1D
Scan: 70/1D+2
Search: 120/2D+2
Focus: 6/3D+2
Weapons:
33 Laser Cannons
Fire Arc: 12 left, 12 right, 5 front, 4 back
Crew: 1
Scale: Starfighter
Skill: Starship gunnery
Fire Control: 2D
Space Range: 1-3/12/25
Atmosphere Range: 100-300/1.2/2.5 km
Damage: 5D
7 Projectile Launchers
Fire Arc: 1 front, 3 left, 3 right
Crew: 1
Skill: Capital ship gunnery
Fire Control: 2D
Space Range: 2-12/30/60
Atmosphere Range: 200-1.2/3/6 km
Damage: 8D, plus 4D in a 100-meter radius.
Pseudograv Projector
Fire Arc: Turret
Crew: 1
Skill: Capital ship gunnery
Fire Control: 2D
Space Range: 3-15/35/75
Damage: Blocks hyperspace travel
Living Shield Blisters: Vagaari use prisoners as living shields, displayed in transparent bubbles on the ship's hull. An attacking ship attempting to avoid hitting a blister takes a -3D penalty to its attack roll. Battery fire and missile weapons cannot attempt to avoid the blisters.
Carried Craft: 18 starfighters, 2 shuttles
Source: The Unknown Regions (page 154)

Creatures

Aiwha



Type: Colossal cloned aquatic herd animal

Planet of Origin: Kamino

DEXTERITY 1D+1

PERCEPTION 2D+1

STRENGTH 6D

Swimming 8D

Special Abilities:

Slamming: Aiwhas can slam against an opponent, doing STR+2D damage.

Move: 20 (swimming or flying)

Size: 20-30 meters wingspan

Orneriness: 1D

Source: Geonosis and the Outer Rim Worlds (page 78), The Unknown Regions (page 69)

Bantha



Type: Herd animal

Planet of Origin: Unknown

DEXTERITY 2D

PERCEPTION 2D

STRENGTH 8D

Special Abilities:

Horns: STR-1D damage

Trample: STR damage

Move: 5

Size: 2-3 meters at the shoulder

Orneriness: 2D

Source: Core Rulebook (page 222), The Star Wars Sourcebook (pages 86-87), Galaxy Guide 1: A New Hope (page 22), Galaxy Guide 7: Mos Eisley (page 78), Rules of Engagement: The Rebel Specforce Handbook (page 53), Alien Anthology (page 22), The Unknown Regions (page 70)

Bergruutfa

Type: Domestic riding beast

DEXTERITY 1D

PERCEPTION 1D+2

Search 3D+1

STRENGTH 6D

Brawling: head butt 7D, lifting 9D

Special Abilities:

Armored Head: +2D to resist energy and physical damage.

Armored Body: +1D to resist energy and physical damage.

Head Butt: STR+1D damage: for every 2 result points the target is thrown one meter.

Drool: Any being who steps in bergruutfa drool must make a Dexterity roll to avoid slipping.

Move: 15; 42 km/h

Size: Up to 7 meters (at shoulder)

Orneriness: 1D

Source: Rules of Engagement: The Rebel Specforce Handbook (page 53), Creatures of the Galaxy (pages 14-15), The Unknown Regions (page 70)



Eopie

Type: Domestic riding beast

DEXTERITY 1D+2

PERCEPTION 1D+1

Search 3D

STRENGTH 4D+1

Brawling 5D, lifting 5D+2, stamina 7D

Special Abilities:

Bite: Does STR+2 damage.

Move: 7

Size: 1.75 meters tall

Orneriness: 1D

Source: Gamer Magazine Issue 4 (pages 34-35), Secrets of Tatooine (pages 13-14), The Unknown Regions (page 60)

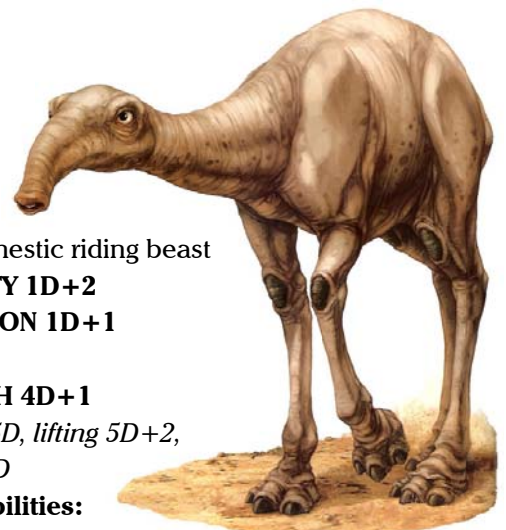

Fenwolf

Type: Transport beast

Planet of Origin: Unknown

DEXTERITY 3D+1

PERCEPTION 2D

Search 2D+2

STRENGTH 4D+2

Special Abilities:

Bite: Does STR+2D damage

Senses: Fenwolves have a keen sense of smell and take no concealment penalties from visibility when making searching for a target within 20 meters.

Move: 14

Orneriness: 2D

Source: The Unknown Regions (page 61)

Kaadu

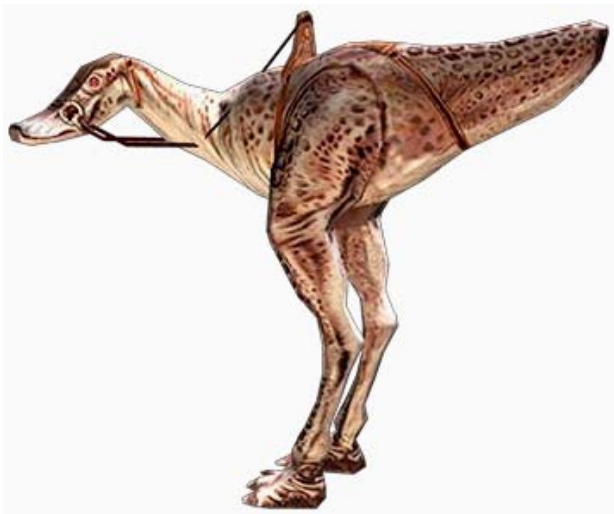

Type: Amphibious riding animal

Planet of Origin: Naboo

DEXTERITY 2D+2

PERCEPTION 1D+2

Search 3D

STRENGTH 3D+2

Climbing/jumping 4D, swimming 5D+1

Special Abilities:

Kick: Does STR+1D damage.

Low-Light Vision: Poor-lighting penalties are reduced by 2D.

Move: 20

Size: 2.5-3 meters

Orneriness: 1D

Source: Secrets of Naboo (page 58), The Unknown Regions (pages 61-62)

Kalak

Type: Large herd animal

Planet of Origin: Roon

DEXTERITY 1D+2

PERCEPTION 1D+1

Search 3D

STRENGTH 4D+2

Special Abilities:

Bite: Does STR+1D+1 damage.

Move: 18

Size: Large

Orneriness: 2D

Source: Geonosis and the Outer Rim Worlds (page 118), The Unknown Regions (page 62)

Maru



Type: Reptilian riding beast

Planet of Origin: Alaris Prime

DEXTERITY 4D

PERCEPTION 1D+2

Search 3D+1

STRENGTH 3D+1

Special Abilities:

Tail Slam: Does STR+1D damage.

Move: 15

Size: Large

Orneriness: 2D

Source: The Unknown Regions (page 62)

Orray

Type: Riding mount

Planet of Origin: Geonosis

DEXTERITY 2D+2

PERCEPTION 1D+1

Search 2D

STRENGTH 4D

Special Abilities:

Bite: Does STR+2D damage.

Sting Tail: Orrays have tail stingers for defense, but domesticated orrrays have these weapons amputated, which makes them more docile. If the orrray succeeds in a *Dexterity* attack, the target has been stung and suffers the effects of the stinger's



poison. The affected character must make a Difficult *stamina* roll or be rendered immobile for 1D minutes.

Move: 12

Size: 1.5 meters tall, 3 meters long

Orneriness: 5D (reduced to 3D when sting tail is removed)

Source: The Unknown Regions (page 62)

Rakazzak Beast

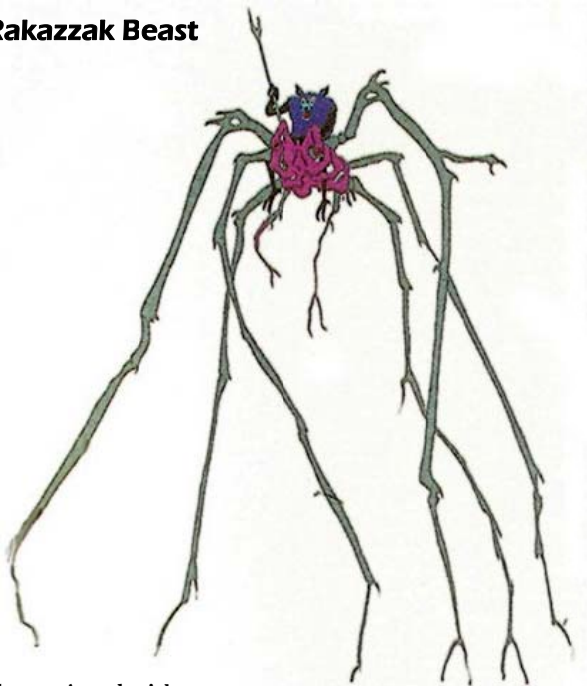

Type: Arachnid mount

Planet of Origin: Endor

DEXTERITY 5D+1

PERCEPTION 3D

Search 4D

STRENGTH 3D+1

Brawling 5D+1

Special Abilities:

Claws: Do STR+2D damage

Move: 16

Size: 3 meters tall

Orneriness: 2D+2

Source: Unknown Regions (page 62)

Rockhopper



Type: Transport beast

Planet of Origin: Roon

DEXTERITY 3D+2

Running 4D+2

PERCEPTION 2D

Search 4D

STRENGTH 3D

Stamina 5D+2

Special Abilities:

Bite: Does STR+1D+2 damage

Tail Slam: Does STR+1D damage

Move: 13

Size: 1-1.8 meters at the shoulder

Orneriness: 1D

Source: The Unknown Regions (page 62)

Ukian Torbull



Type: Pack animal

Planet of Origin: Ukio

DEXTERITY 2D

Dodge: 3D

PERCEPTION 2D

STRENGTH 2D

Special Abilities:

Tough Hide: +1D protection against physical attacks.

Appetite: The torbull must be fed and watered at least four times a day. A minimum of 20 liters of

water and 10 kilograms of grain (or similar food sources) are required to sustain the Torbull. Constant grazing is usually effective, though when operating in desert conditions ample food must be carried. The Orneriness of a torbull that has missed a feeding increases by 3D. A torbull that misses more than two consecutive feedings dies of hunger.

Tame: The Torbull does not have an aggressive nature; when ridden, the rider receives +1D to *beast riding*.

Move: 10 (walking) 15 (swimming)

Size: 2 meters at the shoulder, 5 meters long

Orneriness: 1D

Source: Coree Rulebook (pages 222-223), The Unknown Regions (page 63)

Ycaqt

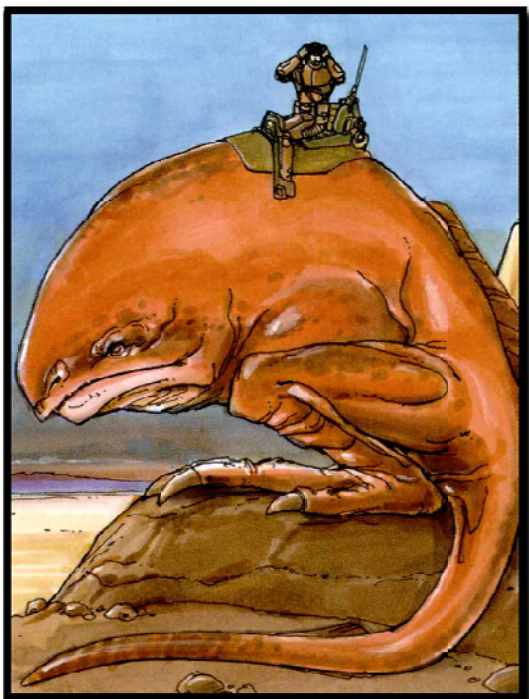

Type: Transport beast

Planet of Origin: Velmor

DEXTERITY 2D+2

Running 3D+1

PERCEPTION 2D

Search 2D+2

STRENGTH 4D+2

Climbing/jumping 6D+2

Special Abilities:

Tail Slam: Does STR+2 damage.

Trample: Does STR+1D damage.

Move: 18

Size: 3 meters tall

Orneriness: 2D

Source: Alien Anthology (page 51), The Unknown Regions (pages 63-64)

Dark Wolf



Type: Desert predator

Planet of Origin: Sriluur

DEXTERITY 4D+2

PERCEPTION 3D+2

Hide 6D, search 5D+1, tracking 6D, sneak 6D

STRENGTH 4D+2

Brawling 6D, climbing/jumping 7D+1

Special Abilities:

Stinger Tail: Does STR damage. If it deals damage, target must make a Moderate *stamina* roll or take a temporary -1D penalty to *Strength*.

Claws: Do STR+2 damage. If it deals damage, target must make a Moderate *stamina* roll or be paralyzed for 1D hours.

Bite: Does STR+1 damage.

Night Hunter: Dark wolves gain a +1D bonus to *tracking* at night.

Darkvision: Can see up to 20 meters in total darkness.

Move: 16

Size: Medium-size

Source: Geonosis and the Outer Rim Worlds (page 131), The Unknown Regions (pages 64-65)

Saber Cat

Type: Feline predator

Planet of Origin: Monastery

DEXTERITY 4D+2

PERCEPTION 2D+2

Search 5D+2, sneak 6D+2

STRENGTH 3D+1

Brawling 4D, climbing/jumping 6D+2

Special Abilities:

Bite: Does STR+1D damage.

Claws: Do STR+2 damage.

Gore: Does STR+1D+2 damage.

Pounce: When pouncing on a target, the saber cat's *jumping* and *brawling* are considered a single action, taking no MAPs and happening simultaneously.

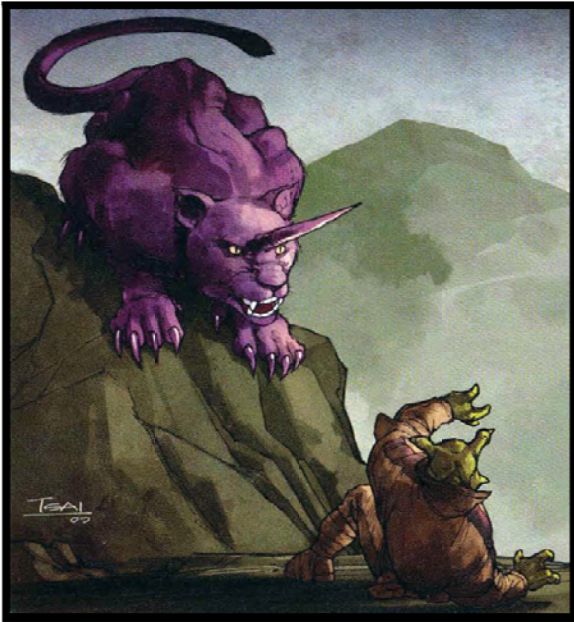

Move: 13

Size: Medium

Source: The Unknown Regions (page 65)

Strill

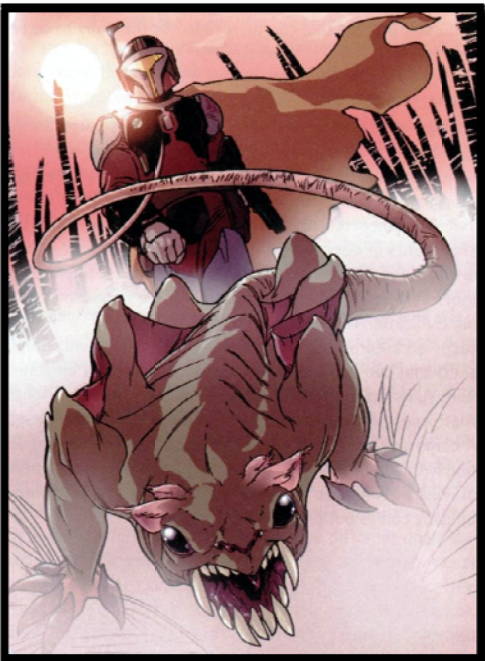

Type: Hunting beast

Planet of Origin: Mandalore

DEXTERITY 3D+1

PERCEPTION 2D+2

Search 6D+2

STRENGTH 4D+2

Gliding 5D, *lifting* 6D+1

Special Abilities:

Bite: Does STR+2 damage.

Gliding: Strills are covered with loose flaps of skin which they can use to glide over short distances.

Move: 7

Size: 1 meter long

Source: The Unknown Regions (page 65)

Mnggal-Mnggal

Type: Amorphous creature

Planet of Origin: Unknown

DEXTERITY 3D+2

Thrown weapons 4D+2

PERCEPTION 3D+1

Search 7D

STRENGTH 2D+2

Brawling 3D+2

Special Abilities:

Darkvision: Mnggal-Mnggal ignore low-visibility penalties.

Amorphous: Raw quantities of Mnggal-Mnggal have no defined shape and can alter their forms at will within the limitations of their current sizes. Such alterations can include the creation of pseudopods for combat or tendrils for grasping and tripping targets. Mnggal-Mnggal is not a natural mimic and cannot imitate or copy other creatures or alter its natural color. Additionally, it can divide into two smaller forms, or two forms can merge into a larger one.

Flying Fragment: Mnggal-Mnggal can separate fragments from a larger form that fly through the air as a ranged attack that deals STR+2 damage. These flying fragments can remain airborne for the duration of an encounter before becoming reabsorbed by the larger form.

Mnggal-Mnggal Seed: If the Mnggal-Mnggal manages to invade a creature through a facial orifice, it proceeds to consume it from the inside, and eventually replaces all of its innards, manipulating the creature like a puppet. After swallowing a Mnggal-Mnggal seed, the victim must make a *Strength* roll every 4 hours, the difficulty starts at Easy and increases by +2 each time. If the roll is successful, the seed continues to attack until physically removed from the creature's body. If the victim fails a roll, each hour it takes 3D damage and suffers a cumulative -1 *Strength* penalty. Once the target's *Strength* reaches 0, it is effectively consumed and becomes a Mnggal-Mnggal zombie (see below).

Force-Sensitive: This creature is Force-sensitive.

Immune: The raw ooze of Mnggal-Mnggal is immune to edged and impact weapons, and blaster fire causes only minor damage (damage is halved). Killing a pool of Mnggal-Mnggal is best accomplished by wide-spray application of fire, acid, poison, or noxious chemicals.

Move: 10

Size: From a cupful to a large deep lake.

Source: The Unknown Regions (pages 137-139)

Mnggal-Mnggal Zombie

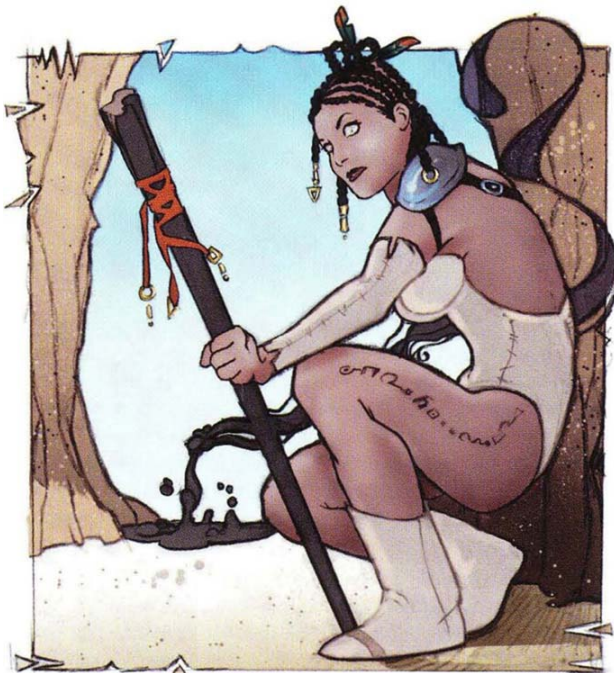

Type: Zombified creature

Planet of Origin: Unknown

DEXTERITY 1D+1

Thrown weapons 3D

KNOWLEDGE 2D+2

MECHANICAL 1D+2

PERCEPTION 2D

Search 5D

STRENGTH 2D+2

Brawling 3D+2

TECHNICAL 2D

Special Abilities:

Host's Abilities: Mnggal-Mnggal zombies retain any physical Special Abilities the original host possessed.

Decay: Since the zombie is effectively dead, it gradually rots away normally.

Darkvision: Mnggal-Mnggal zombies ignore low-visibility penalties.

Force-Sensitive: This creature is Force-sensitive.

Move: 10

Size: Original host's size

Source: The Unknown Regions (pages 137-139)

Brintak

Type: Huge beast

Planet of Origin: Giaca

DEXTERITY 3D

Dodge 3D+2

PERCEPTION 2D

Search 6D, sneak 1D

STRENGTH 7D

Special Abilities:

Bite: Does STR+2D damage.

Claws: Do STR+1D damage.

Mouth Tentacles: If the attack deals any damage, the target must make a Moderate *stamina* roll or be paralyzed for 1D rounds.

Low-Light Vision: Poor lighting penalties are reduced by 2D.

Pounce: When pouncing on a target, the brintak's *jumping* and *brawling* are considered a single action, taking no MAPs and happening simultaneously.

Roar: A brintak can produce a terrifying, rumbling roar and make an *intimidation* roll against any enemies within 10 meters. If the roll succeeds, the target must move away from the brintak and suffers a -1 penalty to all actions for 1D minutes. This is a mind-affecting effect.

Move: 10

Size: Huge

Source: The Unknown Regions (page 173)

Reiko

Type: Chitinous beast of burden

Planet of Origin: Volik

DEXTERITY 2D

PERCEPTION 3D+1

Search 4D+1

STRENGTH 6D+1

Lifting 7D, stamina 8D

Special Abilities:

Gore: Does STR+1D+2 damage.

Battering Rush: Whenever a reiko makes a charge attack against a large vehicle, the attack, if it hits, deals STR+3D damage and the vehicle is pushed away.

Chitinous Skin: The reiko's rock-like skin provides it +1D to resist physical damage and increases the difficulty to spot it on rocky terrain by +2D.

Move: 10

Size: 2-3 meters at the shoulder

Source: The Unknown Regions (page 188)

Vindinax

Type: Insectoid predator

Planet of Origin: Unknown Regions

DEXTERITY 3D+2

PERCEPTION 3D+1

Search 6D, sneak 7D+1

STRENGTH 4D+1

Brawling 5D

Special Abilities:

Claws: Do STR+1 damage.

Bite: Does STR+1D damage.

Rend: If a vindinax succeeds in making two claw attacks to a target in the same round, the second attack deals STR+2D damage.

Move: 10

Size: Medium

Source: The Unknown Regions (page 198)

Avka Young

Type: Aerial predator

Planet of Origin: Durace

DEXTERITY 2D+2

PERCEPTION 3D

Search 4D

STRENGTH 3D+1

Brawling 3D+2

Special Abilities:

Claws: Do STR+1 damage.

Blind: Avka young are still blind, but can sense tremors. They will attack whatever movement they can sense, but are easily distracted by new movements.

Move: 6 (walking), 10 (flying)

Size: 2 meters tall

Source: The Unknown Regions (page 218)

Avka Mother

Type: Aerial predator

Planet of Origin: Durace

DEXTERITY 1D+1

PERCEPTION 3D

Search 5D

STRENGTH 6D+2

Special Abilities:

Claws: Do STR+3D damage.

Scale: Speeder

Move: 6 (walking), 14 (flying)

Size: Huge

Source: The Unknown Regions (page 218)