

STAR WARS

D 6 C O N V E R S I O N

THE CLONE WARS CAMPAIGN GUIDE

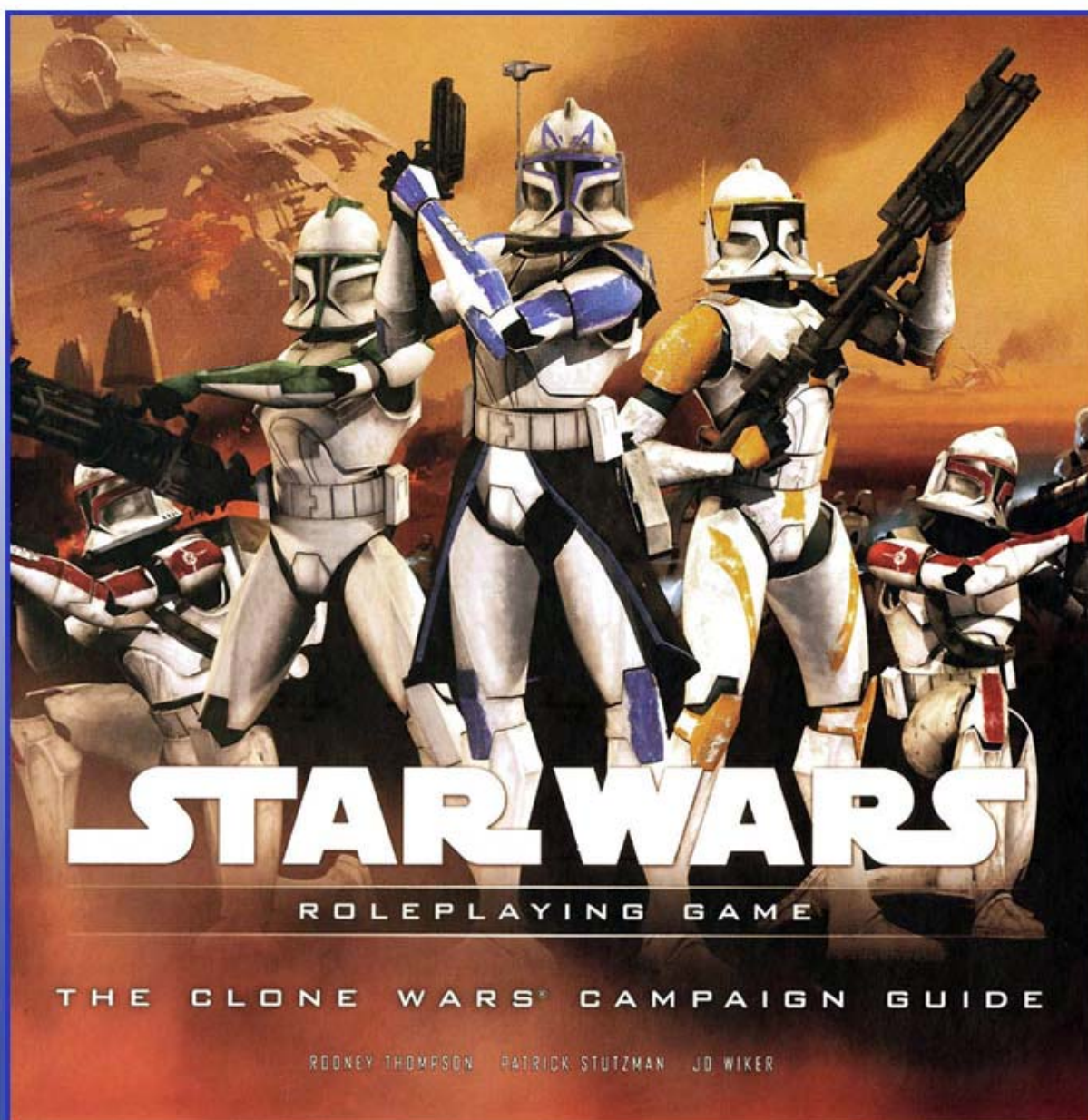

Inspired by



Alien Species

Chagrian



Home Planet: Champala

Attribute Dice: 12D

DEXTERITY 1D+1/3D+1

KNOWLEDGE 1D+1/4D

MECHANICAL 1D+1/4D

PERCEPTION 1D+1/4D

STRENGTH 2D/4D+1

TECHNICAL 1D+1/4D

Special Abilities:

Amphibious: Chagrians can survive both on land and in water.

Low-Light Vision: Poor lighting penalties are reduced by 2D.

Radiation Resistance: Chagrians gain a +2D bonus when resisting damage caused by radiation.

Story Factors:

Weak Sense of Taste: Chagrians lose their sense of taste, and as such, they do not relish food the way most other species do. Many feel that eating is a waste of time.

Move: 10/12

Size: 1.7 to 2.2 meters tall.

Source: Ultimate Alien Anthology (pages 32-33), Alien Anthology (pages 62-63), The Clone Wars Campaign Guide (page 159)

Dug

Home Planet: Malastare

Attribute Dice: 12D

DEXTERITY 2D/4D+2

KNOWLEDGE 1D/3D+2

MECHANICAL 1D+2/4D+1

PERCEPTION 1D/3D+2

STRENGTH 1D+1/4D

TECHNICAL 1D/3D+2

Special Abilities:

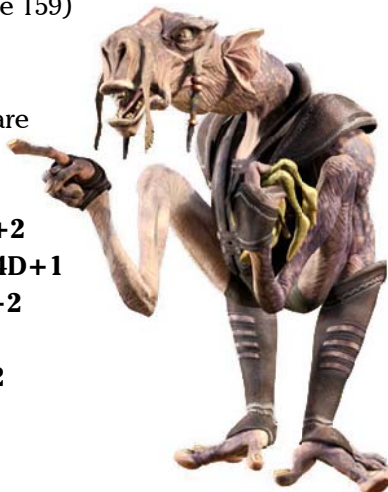

Nimble: Due to their physiology, Dugs gain a permanent +1D bonus to their *climbing/jumping* skill.

Shout: Dugs can issue forth a deep bellow which can be heard up to 3 kilometers away.

Story Factors:

Reputation: Dugs are known as bullies and thugs by most other sentient species, and are almost universally disliked by non-Dugs. Many crimelords, however, employ them as assassins and henchmen.

Move: 7/9

Size: 1 meter tall

Source: Ultimate Alien Anthology (page 50), The Clone Wars Campaign Guide (pages 10-11)

Gen'Dai

Home Planet: Unknown

Attribute Dice: 12D

DEXTERITY 2D/4D

KNOWLEDGE 1D+1/3D+2

MECHANICAL 2D/4D

PERCEPTION 1D/3D

STRENGTH 3D/5D

TECHNICAL 1D+2/4D

Special Abilities:

Indicisive: Because of their extraordinarily long life spans, Gen'Dai are slow in their decision-making processes, taking a -1D penalty to Initiative rolls.

Mental Instability: As they age, Gen'Dai begin to lose touch with reality, losing 1 pip in both *Knowledge* and *Perception* every thousand years.

Hibernation: A Gen'Dai can enter a state similar to *hibernation trance* with a Moderate *Perception* roll. He can remain in hibernation indefinitely, ceasing to age and needing no food, water or air until it emerges from the trance.

Surge: When a Gen'Dai is injured, he recovers one wound level every 1D rounds.

Regeneration: A Gen'Dai can regrow lost body parts, including significant portions of its physical structure and individual limbs, in 2D minutes. At the end of that time, all persistent penalties associated with the loss of one or more limbs are removed.

Resilient Physiology: Because of their unique physiology, the Gen'Dai can shrug off the effect of wounds that would be fatal to any other species. Double the numbers of the Damage Chart when calculating a Gen'Dai's wound, thus: Stunned is



0-6, Wounded 7-16, Incapacitated 17-24, Mortally Wounded 25-30 and Killed 31+.

Move: 12/14

Size: 2.5 meters tall

Source: The Clone Wars Campaign Guide (page 11)

Geonosian



Worker

Home Planet: Geonosis

Attribute Dice: 11D

DEXTERITY 1D+1/4D

KNOWLEDGE 1D/3D+2

MECHANICAL 1D/3D+2

PERCEPTION 1D/3D+2

STRENGTH 2D/4D+1

TECHNICAL 1D/4D

Move: 10/12

Size: 1.6 meters tall

Aristocrat

Home Planet: Geonosis

Attribute Dice: 12D

DEXTERITY 2D/4D+2

KNOWLEDGE 1D/4D

MECHANICAL 1D/3D+2

PERCEPTION 1D+2/4D+1

STRENGTH 1D/3D+1

TECHNICAL 1D+1/4D

Special Abilities:

Flight: Geonosian aristocrats and some workers have wings, and are able to fly.

Natural Armor: Due to their thick chitinous shells, Geonosian aristocrats gain a +2 pip bonus to *Strength* rolls made to resist any form of damage.

Radiation Resistance: Geonosians gain a +2 pip bonus to *Strength* rolls made to resist the effects of harmful radiation.

Story Factors:

Caste-Driven Society: Geonosians are born into a caste-dominated society. Any Geonosian worker who wishes to leave the toils of his caste may do so by participating in gladiatorial combat, but at the very real risk of death. Geonosian aristocrats hold the power within their society, while the workers are considered more or less expendable.

Move: 10/12 (walk), 16 (flight)

Size: 1.7 meters tall

Source: Ultimate Alien Anthology (pages 64-65), The Clone Wars Campaign Guide (page 181)

Iktotchi



Home Planet: Iktotchon

Attribute Dice: 12D

DEXTERITY 1D/3D+2

KNOWLEDGE 1D+1/4D

MECHANICAL 1D+2/4D+1

PERCEPTION 1D+1/3D+2

STRENGTH 1D+2/4D+1

TECHNICAL 1D+1/4D

Special Abilities:

Tough Skin: Grants +1 pip against physical damage.

Expert Pilots: Iktotchi get a permanent +2 pip bonus to all *piloting* skill rolls.

Story Factors:

Precognition: All Iktotchi have a limited form of precognition. Most Iktotchi are unable to control when these visions manifest, and generally receive them as vivid dreams or daydreams. Force sensitive Iktotchi who possess the Farseeing force power gain a +2D bonus on both *control* and *sense* rolls when using that power.

Move: 10/12

Size: 1.6 to 2 meters tall.

Source: Ultimate Alien Anthology (pages 75-76), Alien Anthology (pages 80-81), The Clone Wars Campaign Guide (page 12)

Kaleesh

Home Planet: Kalee

Attribute Dice: 12D

DEXTERITY 2D/3D+2

KNOWLEDGE 1D+1/3D+2

MECHANICAL 2D/4D

PERCEPTION 2D/4D+1

STRENGTH 2D+1/4D+1

TECHNICAL 1D+2/3D+2

Special Abilities:

Nomads: Kaleesh are a nomadic people who have learned to live off the land. At character creation only, they get 2D for every 1D placed in the *survival* skill.

Darkvision: Because of the thermoreceptor glands next to their eyes, Kaleesh suffer no penalties from darkness at up to 20 meters, though they cannot distinguish colors in such situations.

Driven: Kaleesh are focused individuals who maintain sight of their goals even under adverse conditions. Because of this single-minded drive, they gain a +2D bonus to *willpower* rolls.

Persistent: A Kaleesh can reroll any *stamina* check, but the result of the reroll must be accepted, even if worse.

Move: 10/12

Size: 1.6-1.8 meters

Source: The Clone Wars Campaign Guide (pages 12-13)



placed in *first aid*, *medicine* and directly related skills.

Resistant: Scientific refinements to their genetic code makes Kaminoans resistant to poisons, disease, radiation and other and other hazards that target their physiology. They gain a +1D bonus to *stamina* to resist such threats.

Story Factors:

Cloners: Kaminoans are known as clone technicians. Kaminoans turned to cloning early in their history, to better assist in the survival of their species.

Move: 10/12

Size: 2.1-2.7 meters

Source: Ultimate Alien Anthology (page 82), The Clone Wars Campaign Guide (pages 13-14)

Kerkoiden



Home Planet: Kerkoidia

Attribute Dice: 12D

DEXTERITY 2D/4D

KNOWLEDGE 1D+1/3D+2

MECHANICAL 2D/4D

PERCEPTION 3D/4D+2

STRENGTH 1D+2/3D+2

TECHNICAL 1D+2/3D+2

Special Abilities:

Predator's Heritage: Despite their stature, Kerkoidens are descended from predatory beings, with sharp teeth and claws. Their attacks deal STR+2 damage.

Social Cunning: Kerkoidens get a +1D bonus to both *con* and *persuasion* rolls.

Move: 10/12

Size: 1.4-1.8 meters

Source: The Clone Wars Campaign Guide (pages 14-15)

Kaminoan

Home Planet: Kamino

Attribute Dice: 12D

DEXTERITY 1D/3D+2

KNOWLEDGE 2D+1/4D+2

MECHANICAL 1D/4D

PERCEPTION 1D/3D+1

STRENGTH 1D+2/4D

TECHNICAL 2D/4D+1

Special Abilities:

Physiologists: Kaminoans are expert cloners and possess remarkable knowledge about the physiologies of species across the galaxy. At character creation they get 2D for every 1D



Nautolan



Home Planet: Glee Anselm

Attribute Dice: 11D

DEXTERITY 1D+1/4D

KNOWLEDGE 1D/3D+1

MECHANICAL 1D/3D+2

PERCEPTION 1D/3D+2

STRENGTH 2D/4D+1

TECHNICAL 1D/3D+1

Special Abilities:

Breathe Underwater: As amphibious creatures, Nautolans can breathe in both air and water.

Expert Swimmers: Nautolans gain a permanent +1D bonus to all *swimming* skill rolls.

Low-light Vision: Poor lighting penalties are reduced by 2D.

Pheromone Detection: Nautolans possess tendrils which act as their major sensory organs, and they barely function outside of water. The tendrils are so sensitive that they can sense odors and pheromones, which can allow an observant Nautolan some idea of a target's emotional state. Because of this, Nautolans gain a +1D bonus to all skills rolls involving interpersonal relations (ie, *bargain*, *command*, *con*, *intimidation*, *investigation*, or *persuasion*) when in water. When outside of water, this bonus is reduced to a mere +1 pip.

Story Factors:

Language: The Nautolan language is only fully pronounceable when the speaker is under water.

Move: 10/12 (walking), 8/10 (swimming)

Size: 1.8-2 meters

Source: Ultimate Alien Anthology (pages 104-105), Power of the Jedi Sourcebook (pages 71-72), The Clone Wars Campaign Guide (page 15)

Nelvaanian

Home Planet: Nelvaan

Attribute Dice: 12D

DEXTERITY 2D/4D

KNOWLEDGE 1D/3D+1

MECHANICAL 2D/3D+2

PERCEPTION 2D+2/4D+2

STRENGTH 2D/4D

TECHNICAL 1D/3D

Special Abilities:

Low-light Vision:

Poor lighting penalties are reduced by 2D.

Primitive:

Nelvaanians suffer a -1 pip

penalty when using

technological weapons and other machinery.

Scent: Nelvaanians have a keen sense of smell, gaining a +3D bonus to *search* for targets within 20 meters and ignoring visibility penalties when tracking.

Move: 10/12

Size: 1.5-2 meters

Source: The Clone Wars Campaign Guide (page 16)



Polis Massan (Kallidahin)



Home Planet: Unknown

Attribute Dice: 12D

DEXTERITY 1D+2/3D+1

KNOWLEDGE 3D/5D

MECHANICAL 2D/4D

PERCEPTION 2D/4D+1

STRENGTH 1D/2D+2

TECHNICAL 2D/4D+2

Special Abilities:

Skilled Physicians: Polis Massans treat the Medicine advanced skill like a regular skill for advancement cost purposes.

Darkvision: Polis Massans are able to see in complete darkness, suffering no penalties. However, they cannot perceive colors in total darkness.

Mute: Polis Massans have no vocal cords, and must rely on a combination of sign language, computers, and telepathy in order to communicate with others. When they learn new languages, they can understand but not speak them.

Limited Telepathy: Polis Massans are able to employ a weak form of telepathy that allows them to convey simple feelings and thoughts to any willing recipient. This is a free action for targets within 20 meters, beyond that it requires a *Perception* roll of Moderate difficulty, modified by proximity like a Force Power.

Move: 10/12

Size: 1.4-1.6 meters

Source: Wizards Website

Republic Clone



Home Planet: Kamino

Attribute Dice: Add 2D to the stats below, without adding more than 2 pips to any single attribute.

DEXTERITY 3D

KNOWLEDGE 2D+1

MECHANICAL 2D+2

PERCEPTION 2D+1

STRENGTH 3D

TECHNICAL 2D+2

Special Abilities:

Military Training: All clones go through intensive military training throughout their formative years.

At character creation only, clone characters get an extra 2D to spend on military-related skills.

Story Factors:

Obedient: Clones are conditioned to obey their superiors' orders without question, loyally following the chain of command.

Accelerated Growth: Clones age twice as fast as normal humans.

Move: 10/12

Size: 1.83 meters tall

Note: This set of stats is for use by PC clones. For clone NPCs refer to the specific clone rank/specialization.

Source: The Clone Wars Campaign Guide (page 91)

Umbaran

Home Planet: Umbara

Attribute Dice: 12D

DEXTERITY 2D/4D

KNOWLEDGE 2D/4D+1

MECHANICAL 2D/4D

PERCEPTION

2D+2/4D+2

STRENGTH 1D+1/3D+1

TECHNICAL 2D/4D

Special Abilities:

Darkvision: Umbarans can see in the dark up to 20 meters. Darkvision is black and white only but otherwise functions as normal light.

Low-Light Vision: Umbarans gain 2D in low-light conditions, and retain the ability to distinguish color and detail under these conditions.

Light Sensitivity: Abrupt exposure to bright light (such as sunlight) blinds Umbarans for 1 round. In addition, they suffer a -1 penalty while operating in bright light without protective eyewear.

Perceptive: Umbarans gain a +2 bonus to *Perception* against *con* and *bargain* rolls.

Story Factors:

Influence: In situations where a character's reputation can be a factor, Umbarans gain a +2 bonus to *con*, *bargain*, *persuasion*, *investigation* and *intimidation* rolls.

Move: 10/12

Size: 1.7-2 meters (male), 1.5-1.8 meters (female)

Source: Ultimate Alien Anthology (pages 175-176), The Clone Wars Campaign Guide (page 160)



Vurk

Home Planet: Sembla

Attribute Dice: 12D

DEXTERITY 1D+2/3D+1

KNOWLEDGE 2D/4D

MECHANICAL 1D/3D

PERCEPTION 2D+1/4D+2

STRENGTH 2D+2/4D+2

TECHNICAL 1D+2/4D

Special Abilities:

Breathe Underwater: As amphibious beings, Vurks cannot drown underwater.

Expert Swimmers: Vurks get a permanent 2D bonus to *swimming*.

Story Factors:

Placid: Vurks are renowned for their ability to remain calm and collected, even in the face of danger. They get a 2D *willpower* bonus to resist fear and losing his temper.

Nomads: As nomads, Vurks are accustomed to moving around, even through dangerous places. They get a 1D bonus to *survival* rolls.



Move: 10 (6 swimming)

Size: 1.7-2.0 meters

Source: The Clone Wars Campaign Guide (page 17)

Starships

Dagger Starfighter



Craft: Republic Sienar Systems *Dagger*-class Starfighter

Affiliation: General

Era: Old Republic

Source: The Clone Wars Campaign Guide (page 81)

Type: Space superiority fighter

Scale: Starfighter

Length: 14.8 meters

Skill: Starfighter piloting: Dagger

Crew: 1

Cargo Capacity: 55 kilograms

Consumables: 1 week

Cost: 35,000 (new), 8,000 (used)

Hyperdrive Multiplier: x2

Nav Computer: 3 pre-programmed jumps

Maneuverability: 2D

Space: 7

Atmosphere: 350; 1,000 kmh

Hull: 2D

Sensors:

Passive: 15/1D

Scan: 35/2D

Search: 65/2D+2

Focus: 3/3D+2

Weapons:

3 Laser Cannons (fire-linked)

Fire Arc: Front

Skill: Starship gunnery

Fire Control: 1D

Space Range: 1-3/12/25

Atmosphere Range: 100-300/1.2/2.5 km

Damage: 6D

Dianoga Assault Starfighter

Craft: Koensayr *Dianoga*-class Assault Starfighter

Affiliation: General

Era: Old Republic

Source: The Clone Wars Campaign Guide (page 82)

Type: Assault starfighter

Scale: Starfighter

Length: 16.1 meters

Skill: Starfighter piloting: Dianoga

Crew: 1

Cargo Capacity: 90 kilograms

Consumables: 3 days

Cost: 45,000 (new), 12,000 (used)

Hyperdrive Multiplier: x2

Nav Computer: Programmed with 5 jumps

Maneuverability: 1D

Space: 6

Atmosphere: 330; 950 kmh

Hull: 2D+2

Shields: 1D

Sensors:

Passive: 20/1D

Scan: 40/2D

Search: 70/2D+2

Focus: 3/3D+2

Weapons:

4 Laser Cannons (fire-linked)

Fire Arc: Front

Skill: Starship gunnery

Fire Control: 1D+1

Space Range: 1-3/12/25

Atmosphere Range: 100-300/1.2/2.5 km

Damage: 6D

Heavy Ion Cannon

Fire Arc: Front

Skill: Starship gunnery

Fire Control: 1D

Space Range: 1-3/10/20

Atmosphere Range: 100-300/1/2 km

Damage: 5D

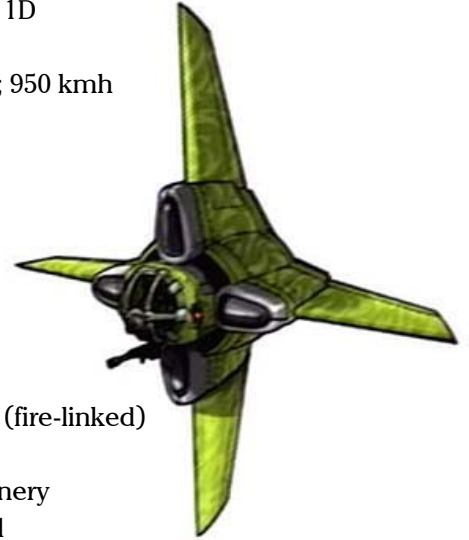

Sabaoth Starfighter

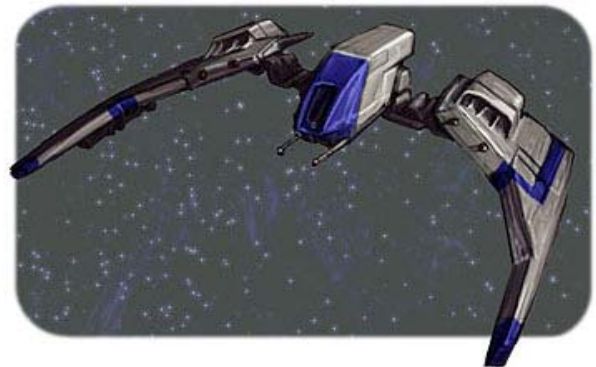

Craft: Sabaoth Starfighter

Affiliation: Sabaoth Mercenaries / General

Era: Old Republic

Source: The Clone Wars Campaign Guide (pages 220-221)

Type: Light interceptor

Scale: Starfighter
Length: 13 meters
Skill: Starfighter piloting: Sabaoth fighter
Crew: 1
Crew Skill: All skills 5D
Cargo Capacity: 50 kilograms
Consumables: 1 week
Cost: 170,000 (new), 72,000 (used)
Maneuverability: 3D
Space: 9
Atmosphere: 385; 1,110 kmh
Hull: 2D+1
Sensors:
Passive: 20/0D
Scan: 40/1D
Search: 70/2D
Focus: 3/2D+2
Weapons:
4 Laser Cannons (fire-linked)
Fire Arc: Front
Skill: Starship gunnery
Fire Control: 3D
Space Range: 1-3/12/25
Atmosphere Range: 100-300/1.2/2.5 km
Damage: 4D

MorningStar Assault Starfighter



Craft: MorningStar-A Assault Starfighter
Affiliation: General / Mercs
Era: Old Republic
Source: The Clone Wars Campaign Guide (page 83)
Type: Space superiority fighter
Scale: Starfighter
Length: 14.4 meters
Skill: Starfighter piloting: MorningStar
Crew: 1
Cargo Capacity: 75 kilograms
Consumables: 3 days
Cost: 43,000 (new), 10,000 (used)

Hyperdrive Multiplier: x2
Nav Computer: 5 pre-programmed jumps
Maneuverability: 1D
Space: 6
Atmosphere: 330; 950 kmh
Hull: 2D+1
Shields: 1D+1
Sensors:
Passive: 15/1D
Scan: 30/2D
Search: 65/2D+1
Focus: 3/3D
Weapons (MorningStar-A):
3 Light Laser Cannons (fire-linked)
Fire Arc: Front
Skill: Starship gunnery
Fire Control: 1D
Space Range: 1-3/12/25
Atmosphere Range: 100-300/1.2/2.5 km
Damage: 5D
Concussion Missile Launcher (4 missiles)
Fire Arc: Front
Skill: Starship gunnery
Fire Control: 1D+1
Space Range: 1/3/7
Atmosphere Range: 50-100/300/700
Damage: 8D
Weapons (MorningStar-B):
3 Light Laser Cannons (fire-linked)
Fire Arc: Front
Skill: Starship gunnery
Fire Control: 1D
Space Range: 1-3/12/25
Atmosphere Range: 100-300/1.2/2.5 km
Damage: 5D
3 Heavy Laser Cannons (fire-linked)
Fire Arc: Front
Skill: Starship gunnery
Fire Control: 1D
Space Range: 1-3/12/25
Atmosphere Range: 100-300/1.2/2.5 km
Damage: 7D
Weapons (MorningStar-C):
3 Heavy Laser Cannons (fire-linked)
Fire Arc: Front
Skill: Starship gunnery
Fire Control: 1D
Space Range: 1-3/12/25
Atmosphere Range: 100-300/1.2/2.5 km
Damage: 7D
3 Concussion Missile Launcher (10 missiles each)
Fire Arc: Front

Skill: Starship gunnery
Fire Control: 1D+1
Space Range: 1/3/7
Atmosphere Range: 50-100/300/700
Damage: 8D

Phoenix Hawk Light Pinnacle

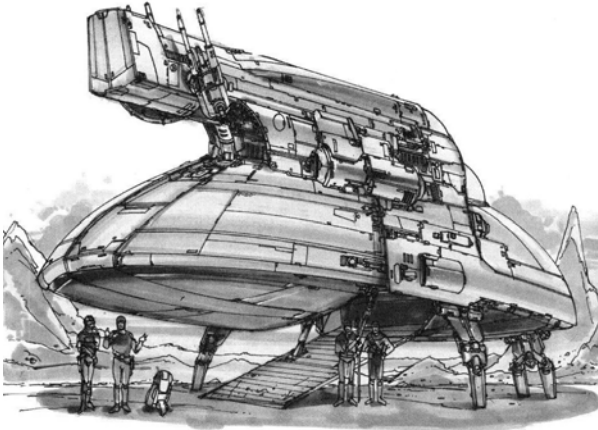

Craft: Kuat Systems Engineering S40K Phoenix Hawk Light Pinnacle
Affiliation: General
Era: Old Republic
Source: Starships of the Galaxy (page 72), The Clone Wars Campaign Guide (page 84)
Type: Starfighter/transport
Scale: Starfighter
Length: 19.2 meters
Skill: Starfighter piloting: Phoenix Hawk
Crew: 1 or 2
Passengers: 4
Cargo Capacity: 20 metric tons
Consumables: 2 months
Cost: 112,000 (new), 22,500 (used)
Hyperdrive Multiplier: x2
Nav Computer: Limited to 2 jumps
Maneuverability: 1D
Space: 5
Atmosphere: 295; 850 kmh
Hull: 5D
Shields: 2D
Sensors:
Passive: 15/0D
Scan: 30/1D
Search: 50/3D
Focus: 2/4D
Weapons:
2 Heavy Blaster Cannons (fire-linked)
Fire Arc: Turret
Skill: Starship gunnery
Fire Control: 1D
Space Range: 1-5/10/17
Atmosphere Range: 100-500/1/1.7 km

Damage: 6D
2 Light Ion Cannons (fire-linked)
Fire Arc: Rear
Skill: Starship gunnery
Fire Control: 1D
Space Range: 1-3/7/36
Atmosphere Range: 100-300/700/3.6 km
Damage: 3D

Scurrg H-6 Prototype Bomber



Craft: Nubian Design Collective Scurrg H-6 Prototype Bomber
Affiliation: General
Era: Old Republic
Source: The Clone Wars Campaign Guide (page 85)
Type: Heavy assault starfighter
Scale: Starfighter
Length: 22 meters
Skill: Starfighter piloting: Scurrg H-6
Crew: 2, gunners: 1, skeleton: 1/+5
Passengers: 3
Cargo Capacity: 10 metric tons
Consumables: 2 weeks
Cost: 150,000 (new only)
Hyperdrive Multiplier: x2
Hyperdrive Backup: x10
Nav Computer: Limited to 5 jumps
Maneuverability: 1D+2
Space: 7
Atmosphere: 350; 1,000 kmh
Hull: 4D+2
Shields: 1D+2
Sensors:
Passive: 25/1D
Scan: 40/1D+2
Search: 70/2D+1
Focus: 4/3D
Weapons:
6 Laser Cannons (fire-linked)
Fire Arc: Front
Skill: Starship gunnery
Fire Control: 2D
Space Range: 1-3/12/25
Atmosphere Range: 1-300/1.2/2.5 km
Damage: 8D

Twin Laser Cannon

Fire Arc: Turret

Crew: 1

Skill: Starship gunnery

Fire Control: 3D*

Space Range: 1-3/12/25

Atmosphere Range: 1-300/1.2/2.5 km

Damage: 6D

Energy Bomb Launcher (10 bombs)

Fire Arc: Ventral

Skill: Starship gunnery

Fire Control: 2D+1

Space Range: 1/3/5

Atmosphere Range: 50-100/300/500

Damage: 13D

Note: Bomblet Generator generates a new bomb every 10 rounds, but only 10 can be stored at one time.

*Can be set on auto-fire using only fire control to hit.

Jedi Starfighter



Craft: Kuat Systems Engineering Delta-7 Aethersprite-class Starfighter

Affiliation: Jedi Order

Era: Rise of the Empire

Source: d20 Rulebook (page 229), Starships of the Galaxy – Saga Ed. (page 60), The Clone Wars Campaign Guide (page 137)

Type: Light interceptor

Scale: Starfighter

Length: 8 meters

Skill: Starfighter piloting: Delta-7

Crew: 1 plus hardwired astromech droid (can coordinate)

Crew Skill: All skills typically at 4D

Cargo Capacity: None

Consumables: None (1 week with booster ring)

Cost: 180,000 (new), 145,000 (used), (high-maneuver variant: 210,000/160,000), high-speed variant: 385,000/290,000)

Hyperdrive Multiplier: x1 (with booster ring, see below)

Nav Computer: Uses a modified astromech droid programmed with 10 jumps

Maneuverability: 3D (high maneuver variant: 4D)

Space: 9 (high-speed variant: 11)

Atmosphere: 400; 1,150 kmh (high-speed variant: 435; 1,260 kmh)

Hull: 2D

Shields: 1D

Sensors:

Passive: 25/1D

Scan: 45/2D

Search: 65/2D+2

Focus: 3/3D+1

Weapons:

2 Dual Lasers (fire-linked)

Fire Arc: Front

Skill: Starship gunnery

Fire Control: 2D

Space Range: 1-3/12/25

Atmosphere Range: 100-300/1.2/2.5 km

Damage: 6D

Notes: The Delta-7 requires a separate hyperdrive module in the form of a booster ring (the TransGalMeg Industries Syluire-31 hyperdrive booster ring). Docking with the ring takes 3 rounds to accomplish, and requires a *Difficult starfighter piloting* skill check (the fighter's maneuverability counts for this roll). Additionally, the Delta-7 incorporates a specially-designed astromech droid (R4-P series), which is hardwired into the starfighter. Without the proper droid, the pilot suffers a -1D penalty to his *astrogation* skill checks. The droid suffers the same penalty to both its *astrogation* and *starfighter repair* skill checks.

Azure Angel



Craft: Modified Kuat Systems Engineering Delta-7 Aethersprite-class Starfighter

Affiliation: Anakin Skywalker

Era: Rise of the Empire

Source: The Clone Wars Campaign Guide (page 138)

Type: Modified interceptor

Scale: Starfighter

Length: 8 meters

Skill: Starfighter piloting: Delta-7

Crew: 1 plus hardwired astromech droid (can coordinate)

Cargo Capacity: None

Consumables: 1 week

Cost: Not available for sale

Hyperdrive Multiplier: x1

Nav Computer: Uses a modified astromech droid programmed with 10 jumps

Maneuverability: 3D+2

Space: 11

Atmosphere: 435; 1,260 kmh

Hull: 2D+1

Shields: 1D

Sensors:

Passive: 25/1D

Scan: 45/2D

Search: 65/3D

Focus: 3/4D

Weapons:

4 Laser Cannons (fire-linked)

Fire Arc: Front

Skill: Starship gunnery

Fire Control: 2D

Space Range: 1-3/12/25

Atmosphere Range: 100-300/1.2/2.5 km

Damage: 7D

Proton Torpedo Launcher (16 torpedoes)

Fire Arc: Front

Skill: Starship gunnery

Fire Control: 2D

Space Range: 1/3/7

Atmosphere Range: 50-100/300/700

Damage: 9D

Jedi Interceptor

Craft: Kuat Systems Engineering Eta-2 *Actis*-class Interceptor

Affiliation: Jedi Order

Era: Rise of the Empire

Source: Wizards Website, Starships of the Galaxy - Saga Ed. (page 82), Saga Edition Core Rulebook (page 180), The Clone Wars Campaign Guide (page 139)

Type: Interceptor

Scale: Starfighter

Length: 5.47 meters

Skill: Starfighter piloting: Eta-2



Crew: 1 and astromech droid (can coordinate)

Cargo Capacity: 60 kilograms

Consumables: 2 days (1 week with booster ring)

Cost: 290,000 (new), 140,000 (used), (high-maneuver variant: 320,000/240,000), (high-defense variant: 310,000/230,000)

Hyperdrive Multiplier: x1 (with booster ring, see below)

Nav Computer: Uses astromech droid programmed with 10 jumps

Maneuverability: 4D (high-maneuver variant: 5D)

Space: 13

Atmosphere: 515; 1,500 kmh

Hull: 2D+1 (high-defense variant: 2D+2)

Sensors:

Passive: 10/0D

Scan: 15/1D

Search: 20/2D

Focus: 2/2D+1

Weapons:

2 Laser Cannons (fire-linked)

Fire Arc: Front

Skill: Starship gunnery

Fire Control: 3D

Space Range: 1-3/12/25

Atmosphere Range: 100-300/1.2/2.5 km

Damage: 5D

2 Light Ion Cannons (fire-linked)

Fire Arc: Front

Skill: Starship gunnery

Fire Control: 3D

Space Range: 1-3/10/20

Atmosphere Range: 100-300/1/2 km

Damage: 4D

Notes: The Eta-7 requires a separate hyperdrive module in the form of a booster ring. Docking with the ring takes 3 rounds to accomplish, and requires a Difficult *starfighter piloting* skill check (the fighter's maneuverability counts for this roll).

BTL-B Y-Wing



Craft: Koensayr BTL-B Y-wing (BTL-S1)
Affiliation: Old Republic
Era: Rise of the Empire
Source: The Clone Wars Campaign Guide (page 173)
Type: Attack starfighter
Scale: Starfighter
Length: 16 meters
Skill: Starfighter piloting: Y-wing
Crew: 1, gunners: 1, 1 astromech droid (can coordinate)
Cargo Capacity: 130 kilograms
Consumables: 1 week
Cost: 127,000 (new), 63,000 (used)
Hyperdrive Multiplier: x2
Nav Computer: No (uses astromech droid programmed with 10 jumps)
Maneuverability: 1D+2
Space: 6
Atmosphere: 330; 950 kmh
Hull: 4D+1
Shields: 1D+2
Sensors:
Passive: 20/0D
Scan: 35/1D
Search: 40/2D
Focus: 2/3D
Weapons:
2 Laser Cannons (fire linked)
Fire Arc: Front
Skill: Starship gunnery
Fire Control: 2D
Space Range: 1-3/12/25
Atmosphere Range: 100-300/1.2/2.5 km
Damage: 5D
2 Light Ion Cannons (fire linked)
Fire Arc: Turret
Crew: 1
Skill: Starship gunnery
Fire Control: 3D
Space Range: 1-3/7/36
Atmosphere Range: 100-300/700/3.6 km
Damage: 4D

Proton Torpedo Launcher (10 torpedoes)

Fire Arc: Front
Skill: Starship gunnery
Fire Control: 2D
Space Range: 1/3/7
Atmosphere Range: 50-100/300/700
Damage: 9D

Hyena Bomber



Craft: Baktoid Armor Workshop *Hyena*-class Bomber
Affiliation: Separatists
Era: Rise of the Empire
Source: The Clone Wars Campaign Guide (page 208)
Type: Droid bomber
Scale: Starfighter
Length: 3.5 meters
Skill: Starfighter piloting
Crew: 0 (droid brain)
Crew Skill: Starfighter piloting 4D+1, starship gunnery 4D+1
Cargo Capacity: None
Consumables: 2 days
Cost: 23,000
Maneuverability: 1D
Space: 9
Atmosphere: 400; 1,150 kmh
Hull: 2D+1
Sensors:
Passive: 20/0D
Scan: 40/1D
Search: 60/2D
Focus: 3/3D
Weapons:
2 Light Laser Cannons (fire-linked)
Fire Arc: Front
Skill: Starship gunnery
Fire Control: 2D
Space Range: 1-5/10/17
Atmosphere Range: 100-500/1/1.7 km
Damage: 3D
Proton Torpedo Launcher (6 torpedoes)
Fire Arc: Front

Fire Control: 2D+1

Skill: Starship gunnery

Space Range: 1/3/7

Atmosphere Range: 30-100/300/700

Damage: 9D

Light Concussion Missile Launcher (6 missiles each)

Fire Arc: Front

Fire Control: 2D+1

Skill: Starship gunnery

Space Range: 1/3/7

Atmosphere Range: 30-100/300/700

Damage: 7D

Belbullab Heavy Starfighter



Craft: Feethan Ottraw Scalable Assemblies
Belbullab-22 Starfighter

Affiliation: Separatists

Era: Rise of the Empire

Source: The Clone Wars Campaign Guide (p204)

Type: Heavy fighter

Scale: Starfighter

Length: 6.71 meters

Skill: Starfighter piloting: Belbullab

Crew: 1

Cargo Capacity: 140 kilograms

Consumables: 1 week

Cost: 168,000 (new), 125,000 (used)

Maneuverability: 1D

Space: 8

Atmosphere: 380; 1,100 kmh

Hull: 5D+1

Shields: 1D+2

Sensors:

Passive: 15/0D

Scan: 25/1D

Search: 40/2D

Focus: 3/2D+2

Weapons:

2 Triple Laser Cannons (fire-linked)

Fire Arc: Front

Skill: Starship gunnery

Fire Control: 2D

Space Range: 1-3/12/25

Atmosphere Range: 100-300/1.2/2.5 km

Damage: 5D

Belbullab Heavy Assault Craft

Identical stats as the Belbullab Heavy Starfighter except for:

Craft: Feethan Ottraw Scalable Assemblies
Belbullab-23 Starfighter

Weapons:

2 Triple Laser Cannons (fire-linked)

Fire Arc: Front

Skill: Starship gunnery

Fire Control: 2D

Space Range: 1-3/12/25

Atmosphere Range: 100-300/1.2/2.5 km

Damage: 6D

Belbullab Heavy Bomber

Identical stats as the Belbullab Heavy Starfighter except for:

Craft: Feethan Ottraw Scalable Assemblies
Belbullab-24 Starfighter

Weapons:

2 Triple Laser Cannons (fire-linked)

Fire Arc: Front

Skill: Starship gunnery

Fire Control: 2D

Space Range: 1-3/12/25

Atmosphere Range: 100-300/1.2/2.5 km

Damage: 6D

2 Concussion Missile Launchers (6 missiles each)

Fire Arc: Front

Skill: Starship gunnery

Fire Control: 1D+2

Space Range: 1/3/7

Atmosphere Range: 30-100/300/700

Damage: 9D

Soulless One

Craft: Modified Feethan Ottraw Scalable Assemblies
Belbullab-22 Starfighter

Affiliation: General Grievous

Era: Rise of the Empire

Source: The Clone Wars Campaign Guide (page 204)

Type: Modified heavy fighter

Scale: Starfighter

Length: 6.71 meters

Skill: Starfighter piloting: Belbullab

Crew: 1

Crew Skill: Astrogation 4D, starfighter piloting 6D+1, starship gunnery 6D, starship shields 5D

Cargo Capacity: 160 kilograms

Consumables: None

Cost: Not available for sale

Maneuverability: 2D+1

Space: 8

Atmosphere: 380; 1,100 kmh

Hull: 5D+1

Shields: 1D+2

Sensors:

Passive: 20/1D

Scan: 30/1D+2

Search: 50/2D+1

Focus: 5/3D+2

Weapons:

2 Triple Laser Cannons (fire-linked)

Fire Arc: Front

Skill: Starship gunnery

Fire Control: 2D+1

Space Range: 1-3/12/25

Atmosphere Range: 100-300/1.2/2.5 km

Damage: 6D

CIS-Advanced Starfighter



Craft: CIS-Advanced Starfighter Prototype

Affiliation: Separatists / Old Republic

Era: Rise of the Empire

Source: The Clone Wars Campaign Guide (pages 205-206)

Type: Space superiority fighter

Scale: Starfighter

Length: 8 meters

Skill: Starfighter piloting: CIS-Advanced Fighter

Crew: 1

Cargo Capacity: 190 kilograms

Consumables: 2 days

Cost: Not available for sale

Maneuverability: 1D+1

Space: 11

Atmosphere: 450; 1,300 kmh

Hull: 3D

Shields: 1D+2

Sensors:

Passive: 15/1D

Scan: 25/2D

Search: 40/3D

Focus: 3/4D

Weapons:

2 Heavy Blaster Cannons (fire-linked)

Fire Arc: Front

Skill: Starship gunnery

Fire Control: 3D

Space Range: 1-3/12/25

Atmosphere Range: 100-300/1.2/2.5 km

Damage: 6D

Proton Torpedo Launchers (24 torpedoes)

Fire Arc: Front

Skill: Starship gunnery

Fire Control: 2D+2

Space Range: 1/3/7

Atmosphere Range: 30-100/300/700

Damage: 9D

Freefall Bomber



Craft: Nubian Design Collective *Freefall*-class Bomber

Affiliation: Naboo

Era: Rise of the Empire

Source: Gamer Magazine Issue 5, The Clone Wars Campaign Guide (page 82)

Type: Bomber fighter

Scale: Starfighter

Length: 30 meters

Skill: Starfighter piloting: Freefall

Crew: 2, gunners: 2, skeleton: 1/+5

Crew Skill: Starfighter piloting 4D+1, starship gunnery 4D+1, starship shields 4D+1

Cargo Capacity: 20 metric tons

Passengers: 10

Consumables: 4 weeks

Cost: 70,000 (new), 18,000 (used)

Hyperdrive Multiplier: x2

Hyperdrive Backup: x10

Nav Computer: Yes

Maneuverability: 1D+2

Space: 7

Atmosphere: 350; 1,000 kmh

Hull: 4D

Shields: 1D+1

Sensors:

Passive: 20/0D

Scan: 35/1D

Search: 40/2D

Focus: 2/3D

Weapons:**4 Laser Cannons** (fire-linked)*Fire Arc:* Front*Crew:* 1*Skill:* Starship gunnery*Fire Control:* 1D*Space Range:* 1-3/12/25*Atmosphere Range:* 100-300/1.2/2.5 km*Damage:* 6D**Bomb Chute** (20 bombs)*Fire Arc:* Ventral*Crew:* 1*Skill:* Starship gunnery*Fire Control:* 1D*Space Range:* 1/3/7*Atmosphere Range:* 50-100/300/700*Damage:* 13D**Pursuer Enforcement Ship****Craft:** MandalMotors *Pursuer*-class Enforcement Ship**Affiliation:** General**Era:** Rise of the Empire**Source:** Pirates & Privateers (page 75), The Far Orbit Project (page 83), The Clone Wars Campaign Guide (pages 79-80)**Type:** System patrol vehicle**Scale:** Starfighter**Length:** 30.1 m**Skill:** Starfighter piloting: Pursuer**Crew:** 1**Crew Skill:** Varies**Passengers:** 2, 5 (prison cells)**Cargo Capacity:** 35 metric tons**Consumables:** 5 weeks**Cost:** 200,000 (new), 80,000 (used)**Hyperdrive Multiplier:** x1**Hyperdrive Backup:** x16**Nav Computer:** Yes**Maneuverability:** 1D**Space:** 7**Atmosphere:** 350; 1,000 kmh**Hull:** 4D**Shields:** 1D**Sensors:***Passive:* 35/1D+1*Scan:* 55/2D+1*Search:* 80/3D+1*Focus:* 3/4D+1**Weapons:****Twin Blaster Cannon** (fire-linked)*Fire Arc:* Front*Skill:* Starship gunnery*Fire Control:* 2D*Space Range:* 1-5/10/17*Atmosphere Range:* 100-500/1/1.7 km*Damage:* 5D**2 Ion Cannons** (fire-linked)*Fire Arc:* Turret*Skill:* Starship gunnery*Fire Control:* 2D*Space Range:* 1-3/7/36*Atmosphere Range:* 100-300/700/3.6 km*Damage:* 4D**Punworcca 116 Sloop****Craft:** Huppla Pasa Tisc Shipwrights Collective's *Punworcca 116*-class Interstellar Sloop**Affiliation:** General**Era:** Rise of the Empire**Source:** The Clone Wars Campaign Guide (page 210)**Type:** Interplanetary yacht**Scale:** Starfighter**Length:** 15.2 meters**Skill:** Space transports: Punworcca 116**Crew:** 2, skeleton: 1/+5**Passengers:** 11**Cargo Capacity:** 240 kilograms**Consumables:** 1 week**Cost:** 35,700**Hyperdrive Multiplier:** x1.5**Nav Computer:** Yes**Maneuverability:** 2D**Space:** 8**Move:** 550, 1,600 kmh

Hull: 2D
Shields: 1D+1
Sensors:
Passive: 20/1D
Scan: 45/2D
Search: 80/3D
Focus: 2/3D+2

Weapons:

Tractor/Repulsor Beam Array

Fire Arc: 14 left, 14 right, 14 top, 14 bottom, 14 front, 14 back

Skill: Tractor beam operation

Fire Control: 2D

Space Range: 1-3/12/25

Atmosphere Range: 100-300/1.3/2.5 km

Damage: 4D

Barloz Medium Freighter



Craft: Corellian Engineering Corporation *Barloz*-class Freighter

Affiliation: General

Era: Old Republic

Source: Stock Ships (pages 53-55), Pirates & Privateers (page 65), Starships of the Galaxy (page 78), The Clone Wars Campaign Guide (pages 75-76)

Type: Medium freighter

Scale: Starfighter

Length: 41 meters

Skill: Space transports: Barloz freighter

Crew: 2, skeleton: 1/+5

Crew Skill: Varies widely

Passengers: 4

Cargo Capacity: 120 metric tons

Consumables: 2 months

Cost: 120,000 (new), 17,500 (used)

Hyperdrive Multiplier: x2

Hyperdrive Backup: x12

Nav Computer: Yes

Maneuverability: 1D

Space: 5

Atmosphere: 295; 850 kmh

Hull: 4D
Shields: 1D
Sensors:
Passive: 10/0D
Scan: 25/1D
Search: 40/2D
Focus: 2/2D

Weapons:

Laser Cannon

Fire Arc: Turret

Skill: Starship gunnery

Fire Control: 1D

Space Range: 1-3/12/25

Atmosphere Range: 100-300/1.2/2.5 km

Damage: 3D

G9 Rigger



Craft: Corellian Engineering Corporation
G9 Rigger Transport

Affiliation: General

Era: Old Republic

Source: The Clone Wars Campaign Guide (page 76)

Type: Light freighter

Scale: Starfighter

Length: 34.1 meters

Skill: Space transports: G9 Rigger

Crew: 2, skeleton: 1/+5

Passengers: 6

Cargo Capacity: 70 metric tons

Consumables: 1 month

Cost: 85,000 (new), 45,000 (used)

Hyperdrive Multiplier: x3

Nav Computer: Yes

Space: 3

Atmosphere: 240; 700 kmh

Hull: 3D+1

Sensors:

Passive: 10/0D

Scan: 20/1D

Search: 35/1D+2

Focus: 2/2D

Weapons:

Double Light Laser Cannon

Fire Arc: Front

Skill: Starship gunnery

Fire Control: 1D

Space Range: 1-3/12/25

Atmosphere Range: 100-300/1.2/2.5 km

Damage: 4D

Light Laser Cannon

Fire Arc: Front or rear

Crew: Co-pilot

Skill: Starship gunnery

Fire Control: 2D

Space Range: 1-3/12/25

Atmosphere Range: 100-300/1.2/2.5 km

Damage: 3D

GS-100 Salvage Ship

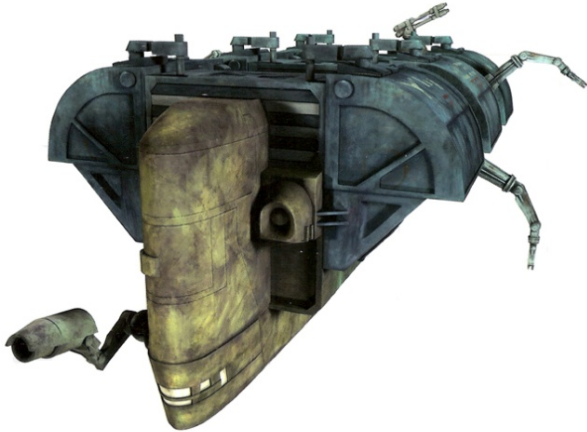

Craft: Gallofree Yards GS-100 Salvage Ship

Affiliation: General

Era: Rise of the Empire

Source: The Clone Wars Campaign Guide (page 78)

Type: Medium freighter

Scale: Starfighter

Length: 50 meters

Skill: Space transports: GS-100

Crew: 2, skeleton: 1/+5, gunners: 1

Passengers: 20 (droids)

Cargo Capacity: 140 metric tons

Consumables: 1 month

Cost: 190,000 (new), 95,000 (used)

Hyperdrive Multiplier: x3

Nav Computer: Yes

Space: 1

Atmosphere: 140; 400 kmh

Hull: 6D+1

Sensors:

Passive: 15/0D

Scan: 30/1D

Search: 80/2D

Focus: 4/3D

Weapons:

2 Medium Laser Cannons (fire-linked)

Fire Arc: Turret

Crew: 1

Skill: Starship gunnery

Fire Control: 1D+2

Space Range: 1-3/12/25

Atmosphere Range: 100-300/1.2/2.5 km

Damage: 4D

KR-TB Doomtrader



Craft: Corellian Engineering Corporation KR-TB "Doomtrader"

Affiliation: General

Era: Old Republic

Source: The Clone Wars Campaign Guide (pages 78-79)

Type: Medium transport

Scale: Starfighter

Length: 50 meters

Skill: Space transports: KR-TB Doomtrader

Crew: 2, plus astromech, skeleton: 1/+5

Passengers: 6

Cargo Capacity: 350 metric tons

Consumables: 1 month

Cost: 350,000 (new), 70,000 (used)

Hyperdrive Multiplier: x2

Hyperdrive Backup: x15

Nav Computer: Yes

Maneuverability: 1D

Space: 6

Atmosphere: 310; 900 kmh

Hull: 6D

Shields: 2D

Sensors:

Passive: 30/1D

Scan: 60/1D

Search: 90/2D

Focus: 4/3D

Weapons:

Dual Laser Cannons

Fire Arc: Front

Skill: Starship gunnery

Fire Control: 2D

Space Range: 1-3/10/20

Atmosphere Range: 100-300/1/2 km

Damage: 6D



Banking Clan Transport

Craft: Techno Union BC-714 Luxury Transport
Affiliation: Intergalactic Banking Clan
Era: Rise of the Empire
Source: The Clone Wars Campaign Guide (page 203)
Type: Space cruiser
Scale: Starfighter
Length: 55.2 meters
Skill: Space transports: BC-714 Transport
Crew: 17
Passengers: 30
Cargo Capacity: 80 metric tons
Consumables: 6 months
Cost: 1.7 million (new), 980,000 (used)
Hyperdrive Multiplier: x1
Hyperdrive Backup: x6
Nav Computer: Yes
Space: 4
Atmosphere: 600; 1,800 kmh
Hull: 4D+2
Shields: 3D
Sensors
Passive: 40/1D
Scan: 70/2D
Search: 100/3D
Focus: 4/3D+2

Seltiss-2 Caravel

Craft: Ubrikkian Industries Seltiss-2 Caravel
Affiliation: Hutts
Era: Rise of the Empire
Source: The Clone Wars Campaign Guide (p. 80)
Type: Luxurious subspace shuttle
Scale: Starfighter
Length: 30 meters
Skill: Space transports: Seltiss-2 Caravel
Crew: 2, gunners: 2
Passengers: 12
Cargo Capacity: 50 metric tons

Consumables: 1 month
Cost: 800,000 (new), 160,000 (used)
Space: 5
Atmosphere: 295; 850 kmh
Hull: 6D+2
Shields: 2D

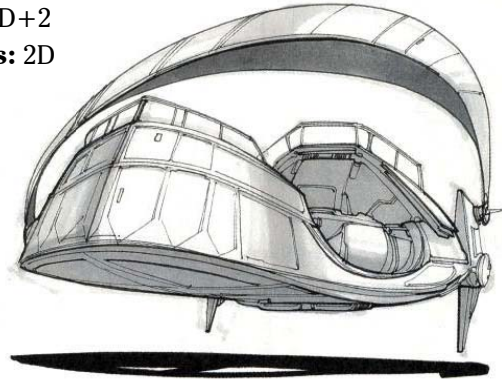

Sensors:
Passive: 15/0D
Scan: 30/1D
Search: 75/2D
Focus: 4/3D
Weapons:
Laser Cannon Battery
Fire Arc: Turret
Crew: 2
Skill: Starship gunnery
Fire Control: 1D+2
Space Range: 1-3/12/25
Atmosphere Range: 100-300/1.2/2.5 km
Damage: 4D

Seltiss-2 Caravel Cabin

Craft: Ubrikkian Industries Seltiss-2 Caravel cabin
Affiliation: Hutts
Era: Rise of the Empire
Source: The Clone Wars Campaign Guide (pages 80-81)
Type: Detached cabin
Scale: Starfighter
Length: 9 meters
Skill: Space transports: Seltiss-2 Caravel
Crew: 1
Passengers: 6
Cargo Capacity: 5 metric tons
Consumables: 2 weeks
Cost: 400,000 (new), 80,000 (used)
Space: 3
Atmosphere: 240; 700 kmh
Hull: 1D+2
Shields: +2
Sensors:
Passive: 7/0D
Scan: 20/1D
Search: 10/1D+1
Focus: 2/2D

CR20 Troop Carrier



Craft: Corellian Engineering Corporation CR20 Troop Carrier

Affiliation: General / Old Republic

Era: Rise of the Empire

Source: The Clone Wars Campaign Guide (page 166)

Type: Troop carrier

Scale: Capital

Length: 60 meters

Skill: Space transports: CR20 Troop Carrier

Crew: 6, skeleton: 2/+7

Passengers: 40 (troops)

Cargo Capacity: 15 metric tons

Consumables: 2 weeks

Cost: 680,000 (new), 265,000 (used)

Hyperdrive Multiplier: x3

Hyperdrive Backup: x12

Nav Computer: Yes

Maneuverability: 0D+2

Space: 5

Atmosphere: 295; 850 kmh

Hull: 1D

Shields: +1

Sensors:

Passive: 25/1D+1

Scan: 50/2D

Search: 75/2D+2

Focus: 3/3D

Weapons:

2 Double Turbolaser Cannons (fire separately)

Fire Arc: Turret (left and right)

Skill: Capital Ship Gunnery

Fire Control: 1D+1

Space Range: 1-8/17/60

Atmosphere Range: 100-800/1.7/6 km

Damage: 6D

Carried Vehicles: 12 speeder bikes

Droch Boarding Ship



Craft: Colicoid Creation Nest *Droch*-class Boarding Ship

Affiliation: Separatists

Era: Rise of the Empire

Source: The Clone Wars Campaign Guide (p207)

Type: Boarding shuttle

Scale: Starfighter

Length: 20 meters

Skill: Space transports: Droch Boarding Craft

Crew: 1

Passengers: 6 (droid troops)

Cargo Capacity: 30 kilograms

Consumables: 1 day

Cost: 43,000

Maneuverability: +2

Space: 5

Atmosphere: 295; 850 kmh

Hull: 2D

Sensors:

Passive: 15/0D

Scan: 30/1D

Search: 60/2D

Focus: 3/2D+1

Weapons:

Light Laser Cannon

Fire Arc: Turret

Skill: Starship gunnery

Fire Control: 2D

Space Range: 1-3/12/25

Atmosphere Range: 100-300/1.2/2.5 km

Damage: 3D

Boarding Drill

Fire Arc: Front

Skill: Starship gunnery

Range: Contact

Damage: 8D

Note: The boarding drill pincers pierce the target's hull upon direct contact. Roll the target ship's hull -2D; if the boarding drill roll scores a "lightly damaged" result, it has breached the hull. Once the hull is breached, the pincers require 5 rounds to open the access to the interior of the target ship.

Sheathipede Shuttle



Craft: Trade Federation *Sheathipede*-class Lapiz Cutter Shuttle

Affiliation: Neimoidians

Era: Old Republic

Source: Secrets of Naboo (page 18), The Clone Wars Campaign Guide (page 210)

Type: Transport shuttle

Scale: Starfighter

Length: 15 meters

Skill: Space transports: Sheathipede shuttle

Crew: 2 pilot droids

Crew Skill: As pilot droid

Passengers: 5

Cargo Capacity: 500 kilograms

Consumables: 5 days

Cost: 22,000 (new), 9,000 (used)

Space: 5

Atmosphere: 295; 850 kmh

Hull: 4D

Shields: 2D+1

Sensors:

Passive: 15/0D

Scan: 25/1D

Search: 40/2D

Focus: 1/2D

Kappa Troop Shuttle

Craft: Republic Sienar Systems *Kappa*-class Shuttle

Affiliation: Old Republic/ Empire/ Rebel Alliance/ General

Era: Old Republic

Source: Rules of Engagement: The Rebel SpecForce Handbook (pages 46-47), The Clone Wars Campaign Guide (page 171)

Type: Troop Shuttle

Scale: Starfighter

Length: 35 meters

Skill: Space transports: Kappa shuttle

Crew: 2, gunners: 2

Crew Skill: Space transports 4D, starship gunnery 4D, starship shields 3D

Passengers: 40

Cargo Capacity: 50 metric tons (rarely + 2 AT-PTs)

Consumables: 1 month

Cost: Not generally for sale

Hyperdrive Multiplier: x1

Hyperdrive Backup: x10

Nav Computer: Yes

Maneuverability: 1D

Space: 5

Atmosphere: 295; 850 kmh

Hull: 4D

Shields: 1D

Sensors:

Passive: 20/0D

Scan: 40/1D

Search: 80/2D

Focus: 4/2D+2

Weapons:

2 Double Blaster Cannons

Fire Arc: Turret

Skill: Starship gunnery

Fire Control: 2D

Space Range: 1-3/12/25

Atmosphere Range: 100-300/1.2/2.5 km

Damage: 4D

2 Repeating Blaster Cannons (fire-linked)

Fire Arc: Front

Scale: Speeder

Skill: Starship gunnery

Fire Control: 2D

Atmosphere Range: 1-50/100/250

Damage: 3D+2

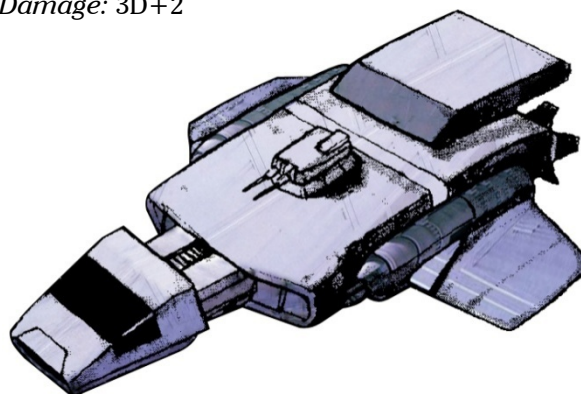

Nu Attack Shuttle

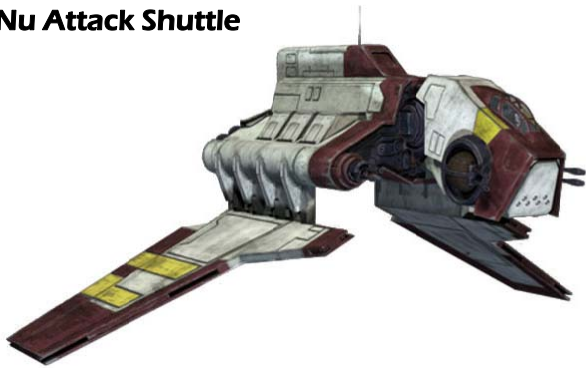

Craft: Cygnus Spaceworks *Nu*-class Attack Shuttle

Affiliation: Old Republic

Era: Rise of the Empire

Source: The Clone Wars Campaign Guide (page 172)

Type: Military orbital shuttle

Scale: Starfighter

Length: 19 meters

Skill: Space transports: *Nu* Shuttle

Crew: 2, skeleton: 1/+10

Passengers: 30

Cargo capacity: 2 metric tons

Consumables: 2 days

Cost: 85,000 (new), 50,000 (used)

Hyperdrive Multiplier: x1

Nav Computer: Yes

Maneuverability: 2D

Space: 5

Atmosphere: 295; 850 kmh

Hull: 3D+2

Shields: 2D

Sensors:

Passive: 20/0D

Scan: 35/1D

Search: 75/2D

Focus: 3/2D+2

Weapons:

2 Medium Laser Cannons (fire-linked)

Fire arc: Front

Skill: Starship gunnery

Fire control: 2D

Space range: 1-4/12/25

Atmosphere range: 100-400/1.2/2.5 km

Damage: 4D

2 Double Light Laser Cannons (fire-linked)

Fire arc: Front turrets

Crew: Co-pilot

Skill: Starship gunnery

Fire control: 2D+1

Space range: 1-3/1/2

Atmosphere range: 100-300/1/2 km

Damage: 4D

Techno Union Starship



Craft: Techno Union *Hardcell*-class Starship

Affiliation: Techno Union

Era: Rise of the Empire

Source: The Clone Wars Campaign Guide (page 207)

Type: Armed transport

Scale: Capital

Length: 220 meters

Skill: Capital ship piloting: Hardcell Starship

Crew: 166, gunners: 24

Crew Skill: Astrogation 3D, capital ship gunnery

3D+2, capital ship piloting 3D, capital ship shields

3D, capital ship repair 3D, sensors 3D+1

Passengers: 1,017

Cargo Capacity: 12,400 metric tons

Consumables: 6 months

Cost: Not available for sale

Hyperdrive Multiplier: x1

Hyperdrive Backup: x8

Nav Computer: Yes

Space: 2

Atmosphere: 330; 950 kmh

Hull: 2D+2

Shields: 2D

Sensors:

Passive: 20/1D

Scan: 60/2D

Search: 80/3D

Focus: 4/3D+2

Weapons:

8 Laser Cannons

Fire Arc: Sides

Crew: 3

Scale: Starfighter

Skill: Starship gunnery

Fire Control: 4D

Space Range: 2-10/20/40

Atmosphere Range: 0.2-1/2/4 km

Damage: 4D

C-9979 Landing Craft



Craft: Haor Chall Engineering C-9979
Affiliation: Trade Federation
Era: Old Republic
Source: Secrets of Naboo (page 8), The Clone Wars Campaign Guide (page 205)
Type: Heavy transport
Scale: Capital
Length: 370 meters
Skill: Capital ship piloting: C-9979
Crew: 88 droids or 140 sapients
Crew Skill: All appropriate skills at 3D
Passengers: 30 repair droids, 40 commander battle droids, 39 pilot battle droids, 15 security droids,
Cargo Capacity: 1,800 metric tons
Consumables: 1 day
Cost: 200,000 (new), 75,000 (used)
Maneuverability: 1D+1
Space: 5
Atmosphere: 295; 850 kmh
Hull: 2D
Shields: 1D
Sensors:
Passive: 15/0D
Carried Craft: 28 Trade Federation troop carriers, 114 AATs, 11 MTTs

Commerce Guild Starship

Craft: Commerce Guild *Diamond*-class Cruiser
Affiliation: Separatists
Era: Rise of the Empire
Source: The Clone Wars Campaign Guide (page 206)
Type: Transport cruiser
Scale: Capital
Length: 522 meters
Skill: Capital ship piloting
Crew: 100, gunners: 48
Cargo Capacity: 1,380 metric tons
Consumables: 3 months
Cost: 5 million (new), 2,125,000 (used)

Hyperdrive Multiplier: x0.75

Hyperdrive Backup: x4

Nav Computer: Yes

Maneuverability: 1D

Space: 2

Atmosphere: 500; 1,450 kmh

Hull: 3D

Shields: 1D

Sensors:

Passive: 15/1D

Scan: 30/2D

Search: 60/3D

Focus: 3/4D

Weapons:

8 Laser Cannons

Fire Arc: 4 front, 2 left, 2 right

Crew: 6

Skill: Capital ship gunnery

Space Range: 1-5/15/30

Atmosphere Range: 2-10/30/60 km

Damage: 3D

Carried Craft: 600 Homing Spider Droid, 2,400 Dwarf Spider Droids

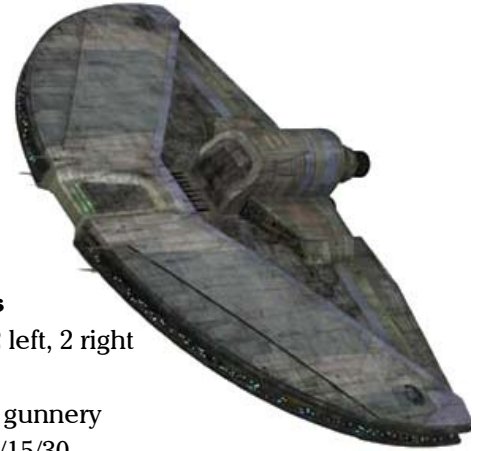

Consular Cruiser Charger c70



Craft: Corellian Engineering Corporation *Consular*-class Cruiser Charger c70 Retrofit
Affiliation: Old Republic
Era: Rise of the Empire
Source: The Clone Wars Campaign Guide (page 170)
Type: Retrofitted diplomatic transport
Scale: Capital
Length: 115 meters
Skill: Capital ship piloting: Consular Cruiser
Crew: 3, gunners: 5, skeleton: 2/+5
Passengers: 20 (troops)
Cargo Capacity: 6,000 metric tons
Consumables: 6 months
Cost: 1.65 million (new), 700,000 (used)
Hyperdrive Multiplier: x1.5
Nav Computer: Yes
Maneuverability: +2
Space: 6

Atmosphere: 330; 950 kmh

Hull: 4D+2

Shields: 2D+2

Sensors:

Passive: 40/1D

Scan: 80/2D

Search: 100/3D

Focus: 5/4D

Weapons:

4 Light Turbolasers

Fire Arc: Turret (2 left, 2 right)

Crew: 1

Skill: Capital Ship Gunnery

Fire Control: 2D

Space Range: 3-15/35/75

Atmosphere Range: 500-1/3/8 km

Damage: 3D

2 Medium Laser Cannons (fire-linked)

Fire Arc: Front

Scale: Starfighter

Crew: 1

Skill: Starship gunnery

Fire Control: 2D

Space Range: 1-3/12/25

Atmosphere Range: 100-300/1.2/2.5 km

Damage: 4D

MedStar Frigate

Craft: Kuat Drive Yards *MedStar*-class Frigate

Affiliation: Old Republic

Era: Rise of the Empire

Source: The Clone Wars Campaign Guide (page 171)

Type: Medical frigate

Scale: Capital

Length: 250 meters

Skill: Capital ship piloting: MedStar Frigate

Crew: 390, gunners: 50

Passengers: 655

Cargo Capacity: 4,800 metric tons

Consumables: 3 years

Cost: 4,875,000 (new), 2,550,000 (used)

Hyperdrive Multiplier: x1

Hyperdrive Backup: x10

Nav Computer: Yes

Maneuverability: +2

Space: 3

Hull: 2D+1

Shields: 2D

Sensors:

Passive: 30/1D

Scan: 50/2D

Search: 90/3D

Focus: 3/4D

Weapons:

4 Turbolasers

Fire Arc: 2 left, 2 right

Crew: 5

Skill: Capital Ship Gunnery

Fire Control: 2D+2

Space Range: 3-15/35/75

Atmosphere Range: 2-6/24/50 km

Damage: 4D

6 Laser Cannons

Fire Arc: 1 front, 2 right, 2 left, 1 back

Scale: Starfighter

Crew: 5

Skill: Starship gunnery

Fire Control: 3D

Space Range: 1-3/12/25

Atmosphere Range: 100-300/1.2/2.5 km

Damage: 4D

Tractor Beam Projector

Fire Arc: Front

Skill: Capital ship gunnery

Fire Control: 3D

Space Range: 1-5/15/30

Atmosphere Range: 1-5/15/30 km

Damage: 4D

Pelta Medical Frigate



Craft: Kuat Drive Yards *Pelta*-class Frigate

Affiliation: Old Republic

Era: Rise of the Empire

Source: The Clone Wars Campaign Guide (pages 172-173)

Type: Multi-purpose frigate

Scale: Capital

Length: 200 meters

Skill: Capital ship piloting: Pelta Frigate

Crew: 900

Passengers: 300

Cargo Capacity: 275 metric tons

Consumables: 1 month

Cost: Not available for sale

Hyperdrive Multiplier: x2

Hyperdrive Backup: x16

Nav Computer: Yes

Maneuverability: 1D

Space: 5

Hull: 2D+2

Shields: 2D

Sensors:

Passive: 35/1D

Scan: 70/2D

Search: 90/3D

Focus: 4/4D

Weapons:

6 Light Turbolaser Cannons

Fire Arc: 3 front, 1 left, 1 right, 1 back

Crew: 6

Skill: Capital ship gunnery

Fire Control: 3D+2

Space Range: 3-15/35/75

Atmosphere Range: 6-30/70/150 km

Damage: 3D

9 Light Laser Cannons

Fire Arc: 1 front, 3 right, 3 left, 2 back

Scale: Starfighter

Crew: 6

Skill: Starship gunnery

Fire Control: 4D

Space Range: 1-3/12/25

Atmosphere Range: 100-300/1.2/2.5 km

Damage: 4D

Tractor Beam Projector

Fire Arc: Front

Crew: 3

Skill: Capital ship gunnery

Fire Control: 4D+2

Space Range: 1-5/15/30

Atmosphere Range: 1-5/15/30 km

Damage: 4D+2

Sabaoth Destroyer

Craft: Ubrikkian Custom Destroyer

Affiliation: Sabaoth Mercenaries / General

Era: Old Republic

Source: The Clone Wars Campaign Guide (page 220)

Type: Warship

Scale: Capital

Length: 675 meters

Skill: Capital ship piloting: Sabaoth Destroyer

Crew: 250, gunners: 114

Crew Skill: Astrogation 3D, capital ship gunnery 3D+2, capital ship piloting 3D, capital ship shields 3D+1, capital ship repair 2D, sensors 3D+2

Passengers: 3,000

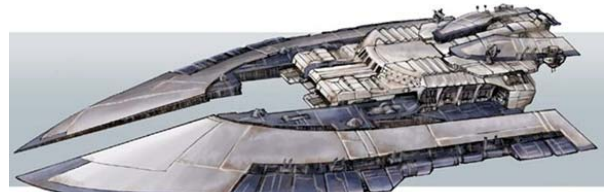

Cargo Capacity: 3,000 metric tons

Consumables: 1 year

Cost: 3.5 million (new), 1.5 million (used)

Hyperdrive Multiplier: x3

Hyperdrive Backup: x18

Nav Computer: Yes

Space: 4

Maneuverability: 1D

Hull: 3D

Shields: 2D+2

Sensors:

Passive: 30/1D+1

Scan: 60/2D+1

Search: 90/3D+2

Focus: 6/4D+2

Weapons:

24 Heavy Laser Cannons

Fire Arc: 4 front, 10 left, 10 right

Crew: 3

Scale: Starfighter

Skill: Starship gunnery

Fire Control: 2D

Space Range: 1-3/10/20

Damage: 6D

14 Light Turbolaser Cannons

Fire Arc: 7 left, 7 right

Crew: 3

Skill: Capital ship gunnery

Fire Control: 2D

Space Range: 4-20/50/110

Damage: 2D+2

Carried Craft: 12 starfighters

Trade Federation Cruiser



Craft: Free Dac Volunteers/Pammant Docks Providence-class carrier/destroyer

Affiliation: Trade Federation

Era: Rise of the Empire

Source: Wizards Website, The Clone Wars Campaign Guide (pages 208-209)

Type: Carrier/destroyer

Scale: Capital
Length: 1,088 meters
Skill: Capital ship piloting
Crew: 21,992, gunners: 358, skeleton: 8,000/+15
Crew Skill: Astrogation 4D, capital ship piloting 4D+1, capital ship gunnery 4D+1
Passengers: 48,247 plus 1.5 million deactivated battle droids (no more than 6,000 can be activated on-board at once)
Cargo Capacity: 29,000 metric tons, 160 MTTs and 280 assorted droid armored vehicles
Consumables: 1 year
Cost: Not available for sale (valued at 125 millions)
Hyperdrive Multiplier: x1.5
Hyperdrive Backup: x15
Nav Computer: Yes
Maneuverability: 1D+1
Space: 8
Atmosphere: 365; 1,050 kmh
Hull: 6D
Shields: 3D+2
Sensors:
Passive: 30/1D+1
Scan: 60/2D+1
Search: 90/3D+2
Focus: 6/4D+2
Weapons:
14 Quad Turbolasers
Fire Arc: 4 front, 5 left, 5 right
Crew: 4
Skill: Capital ship gunnery
Fire Control: 4D
Space Range: 3-15/35/75
Atmosphere Range: 6-30/70/150 km
Damage: 6D
34 Dual Laser Cannons
Fire Arc: 6 batteries turret, 2 batteries front, 4 batteries left, 4 batteries right, 1 battery rear
Crew: 2
Scale: Starfighter
Skill: Starship gunnery
Fire Control: 4D
Space Range: 1-5/10/20
Atmosphere Range: 100-500/1/2 km
Damage: 5D
2 Heavy Ion Cannons (fire-linked)
Fire Arc: Front
Crew: 3
Skill: Capital ship gunnery
Fire Control: 4D
Space Range: 3-15/35/75
Atmosphere Range: 6-30/70/150 km

Damage: 4D
12 Point-Defense Ion Cannons
Fire Arc: 2 batteries left, 2 batteries right
Crew: 2
Scale: Starfighter
Skill: Starship gunnery
Fire Control: 4D
Space Range: 1-5/10/20
Atmosphere Range: 100-500/1/2 km
Damage: 3D
102 Proton Torpedo Tubes (16 torpedoes each)
Fire Arc: Turret
Crew: 2
Scale: Starfighter
Skill: Starship gunnery
Fire Control: 2D
Space Range: 5-20/50/110
Atmosphere Range: 5-50/100/300 km
Damage: 9D
Starfighter Complement: 120 Tri-fighters, 120 "Vulture" droid starfighters, 8 landing craft

Invisible Hand

Craft: Modified Free Dac Volunteers/Pammant Docks *Providence*-class carrier/destroyer
Affiliation: General Grievous
Era: Rise of the Empire
Source: Wizards Website, The Clone Wars Campaign Guide (pages 208-209)
Type: Carrier/destroyer
Scale: Capital
Length: 1,088 meters
Skill: Capital ship piloting
Crew: 600, gunners: 358, skeleton: 200/+15
Crew Skill: Astrogation 5D+2, capital ship piloting 6D, capital ship gunnery 5D+2
Passengers: 125,000 plus 1.5 million deactivated battle droids (no more than 6,000 can be activated on-board at once)
Cargo Capacity: 29,000 metric tons, 160 MTTs and 280 assorted droid armored vehicles
Consumables: 1 year
Cost: Not available for sale
Hyperdrive Multiplier: x1
Hyperdrive Backup: x15
Nav Computer: Yes
Maneuverability: 1D+1
Space: 8
Atmosphere: 365; 1,050 kmh
Hull: 6D
Shields: 3D+2
Sensors:
Passive: 30/1D+1

Scan: 60/2D+1

Search: 90/3D+2

Focus: 6/4D+2

Weapons:

14 Quad Turbolasers

Fire Arc: 4 front, 5 left, 5 right

Crew: 4

Skill: Capital ship gunnery

Fire Control: 4D

Space Range: 3-15/35/75

Atmosphere Range: 6-30/70/150 km

Damage: 6D

34 Dual Laser Cannons

Fire Arc: 6 batteries turret, 2 batteries front, 4 batteries left, 4 batteries right, 1 battery rear

Crew: 2

Scale: Starfighter

Skill: Starship gunnery

Fire Control: 4D

Space Range: 1-5/10/20

Atmosphere Range: 100-500/1/2 km

Damage: 5D

2 Heavy Ion Cannons (fire-linked)

Fire Arc: Front

Crew: 3

Skill: Capital ship gunnery

Fire Control: 4D

Space Range: 3-15/35/75

Atmosphere Range: 6-30/70/150 km

Damage: 4D

12 Point-Defense Ion Cannons

Fire Arc: 2 batteries left, 2 batteries right

Crew: 2

Scale: Starfighter

Skill: Starship gunnery

Fire Control: 4D

Space Range: 1-5/10/20

Atmosphere Range: 100-500/1/2 km

Damage: 3D

102 Proton Torpedo Tubes (16 torpedoes each)

Fire Arc: Turret

Crew: 2

Scale: Starfighter

Skill: Starship gunnery

Fire Control: 2D

Space Range: 5-20/50/110

Atmosphere Range: 5-50/100/300 km

Damage: 9D

Starfighter Complement: 120 Tri-fighters, 120

"Vulture" droid starfighters, 16 landing craft

Subjugator Heavy Cruiser

Craft: Free Dac Volunteers Engineering Corps
Subjugator-class heavy cruiser

Affiliation: Separatists

Era: Rise of the Empire

Source: The Clone Wars Campaign Guide (pages 210-211)

Type: Heavy cruiser

Scale: Capital

Length: 7,892 meters

Skill: Capital ship piloting

Crew: 22,350, gunners: 830, skeleton: 8,000/+15

Crew Skill: All skills 4D

Passengers: 60,000 (battle droids)

Cargo Capacity: 13,000 metric tons

Consumables: 2 year

Cost: Not available for sale

Hyperdrive Multiplier: x2

Hyperdrive Backup: x12

Nav Computer: Yes

Maneuverability: 1D+1

Space: 3

Hull: 6D

Shields: 2D+2

Sensors:

Passive: 30/1D+1

Scan: 60/2D+1

Search: 90/3D+2

Focus: 6/4D+2

Weapons:

70 Heavy Turbolasers

Fire Arc: 30 front, 20 left, 20 right

Crew: 5

Skill: Capital ship gunnery

Fire Control: 4D

Space Range: 3-15/35/75

Atmosphere Range: 6-30/70/150 km

Damage: 6D

22 Medium Turbolasers

Fire Arc: 7 front, 5 left, 5 batteries right, 5 rear

Crew: 5

Skill: Capital ship gunnery

Fire Control: 3D+2

Space Range: 3-15/35/75

Atmosphere Range: 6-30/70/150 km

Damage: 5D

60 Point-Defense Light Laser Cannons

Fire Arc: 30 left, 30 right

Crew: 5

Scale: Starfighter

Skill: Starship gunnery



Fire Control: 3D+1

Space Range: 1-5/10/20

Atmosphere Range: 100-500/1/2 km

Damage: 3D

10 Tractor Beam Projectors

Fire Arc: 3 front, 3 left, 3 right, 1 rear

Crew: 3

Skill: Capital ship gunnery

Fire Control: 3D

Space Range: 1-5/15/30

Atmosphere Range: 2-10/30/60 km

Damage: 4D

2 Ion Pulse Cannons

Fire Arc: 1 left, 1 right

Fire Rate: 1/4

Crew: 20

Skill: Capital ship gunnery

Body: 4D

Fire Control: 3D

Space Range: 5-20/50/110

Atmosphere Range: 5-50/100/300 km

Damage: 11D

Game Notes: When the Ion Pulse Cannon fires, it generates an energy disc with a diameter of 10 space units that targets all starships on its fire arc, friend and foe alike. Ships may attempt a *piloting* roll to evade the pulse, but they suffer penalties due to the size of the pulse. Targets at Point-blank range cannot dodge, at Short range suffer a -15 penalty, at Medium -10 and at Long range -5. Due to their nimbleness, Starfighter-scale ships get to add their Space score to their dodge roll.

If the Ion Pulse Cannon is Heavily Damaged while powering up for a shot, it automatically overloads and is destroyed.

Starfighter Complement: 114 "Vulture" droid starfighters, 48 Hyena Bombers, various support craft

Vehicles

AT-AP



Craft: Rothana Heavy Engineering All Terrain attack Pod (AT-AP)

Type: Tripod walker

Scale: Walker

Length: 10.97 meters tall

Skill: Walker operation: AT-AP

Crew: 2, gunners: 1

Cargo Capacity: 200 kilograms

Cover: Full, 1/2 to top blaster gunner

Cost: Not available for sale (valued at 150,000 new)

Maneuverability: 1D

Move: 21; 60 kmh

Body Strength: 4D

Weapons:

Heavy Projectile Launcher (50 shells carried)

Fire Arc: Front

Skill: Vehicle blasters

Fire Control: 1D

Range: 200-800/1.8/3.5 Km

Damage: 6D

Note: If fired in the same round the AT-AP moves, driver must make a Very Difficult *walker operation* check to avoid hazard and double the difficulty to gunner's attack roll. To avoid this, the walker must be stationary and extend its third leg. Extending and retracting the third leg are free actions that take one round.

Heavy Blaster Cannon

Fire Arc: Turret

Scale: Speeder

Crew: 1 (can be fired from cockpit at 0D fire control and front arc only)

Skill: Vehicle blasters

Fire Control: 2D

Range: 50-300/500/1 Km

Damage: 5D

Medium Laser Cannon

Fire Arc: Front/left/right turret

Skill: Vehicle blasters

Fire Control: 1D+2

Range: 75-400/750/1.5 Km

Damage: 3D

Source: The Clone Wars Campaign Guide (page 163), Wizards Website

AT-Xt

Craft: Rothana Engineering All-Terrain Experimental Transport

Type: Light walker

Scale: Walker

Length: 6.2 meters tall

Skill: Walker operation: AT-Xt

Crew: 1

Cargo Capacity: 12 kilograms

Cover: Full

Maneuverability: 0D+2

Move: 8; 25 kmh

Body Strength: 2D

Shields: +2

Weapons:

Heavy Laser Cannon

Fire Arc: Front

Skill: Vehicle blasters

Fire Control: 1D

Range: 50-30/500/1 Km

Damage: 4D

Twin Proton Grenade

Launcher (18 grenades)

Fire Arc: Front

Skill: Missile weapons

Fire Control: 1D+1

Range: 10-50/80/150

Damage: 5D (2 grenades)

Source: The Clone Wars Campaign Guide (page 163)



AT-RT

Craft: Kuat Drive Yards

All Terrain Recon Transport

Type: Recon walker

Scale: Walker

Length: 3.2 meters tall

Skill: Walker operation: AT-RT

Crew: 1

Cargo Capacity: 20 kilograms

Cover: 1/4

Cost: 40,000 (new),
24,000 (used)

Maneuverability: 2D

Move: 25; 70 kmh

Body Strength: 1D+2

Weapons:



Laser Cannon

Fire Arc: Front

Skill: Vehicle blasters

Fire Control: 1D

Range: 50-300/500/1 Km

Damage: 3D

Source: The Clone Wars Campaign Guide (page 164), Wizards Website

AT-TE



Craft: Rothana Heavy Engineering All-Terrain Tactical Enforcer

Type: Walker

Scale: Walker

Length: 12.4 meters long

Skill: Walker operation: AT-TE

Crew: 1, gunners 6

Crew Skill: All skills typically at 5D

Passengers: 38 (troops)

Cargo Capacity: 10 tons

Cover: Full

Cost: Not available for sale

Maneuverability: +1

Move: 21; 60 kmh

Body Strength: 5D+1

Weapons:

Heavy Projectile Cannon

Fire Arc: Front

Skill: Vehicle blasters

Fire Control: 2D

Range: 50-300/1/3 Km

Damage: 5D

6 Light Blaster Cannons (fire separately)

Fire Arc: 4 front, 2 rear

Scale: Speeder

Crew: 1

Skill: Vehicle blasters

Fire Control: 2D

Range: 10-250/500/1 Km

Damage: 4D

Source: d20 Core Rulebook (page 197), The Clone Wars Campaign Guide (pages 164-165)

SPHA-T



Craft: Rothana Engineering Self Propelled Heavy Artillery-Turbolaser

Type: Heavy artillery walker

Scale: Walker

Length: 34 meters

Skill: Walker operation: SPHA-T

Crew: 15, gunners: 10

Passengers: 30 (troops)

Cargo Capacity: 500 kilograms

Cover: Full

Cost: Not available for sale

Maneuverability: 0D

Move: 12; 35 kmh

Body Strength: 7D+1

Weapons:

12 Blaster Cannons (fire separately)

Fire Arc: 2 front, 2 rear, 5 right, 5 left

Scale: Character

Crew: 1

Skill: Vehicle blasters

Fire Control: 1D

Range: 10-50/250/500

Damage: 6D

Heavy Turbolaser Cannon (SPHA-T)

Fire Arc: Front

Scale: Starfighter

Crew: 10

Skill: Vehicle weapons

Fire Control: 2D

Range: 100-400/2/4 Km

Damage: 7D

Heavy Ion Cannon (SPHA-I)

Fire Arc: Front

Scale: Starfighter

Crew: 10

Skill: Vehicle weapons

Fire Control: 2D+1

Range: 100-500/2.5/5 Km

Damage: 4D

Heavy Laser Cannon (SPHA-V)

Fire Arc: Front

Crew: 10

Skill: Vehicle weapons

Fire Control: 2D

Range: 100-300/1/2 Km

Damage: 5D+2

Heavy Missile Launcher (SPHA-C)

Fire Arc: Front

Crew: 10

Skill: Vehicle weapons

Fire Control: 2D+2

Range: 200-1/3/6 Km

Damage: 8D

Heavy Mass-Driver Cannon (SPHA-M)

Fire Arc: Front

Crew: 10

Skill: Vehicle weapons

Fire Control: 1D+2

Range: 10-250/500/1 Km

Damage: 6D

Source: The Clone Wars Campaign Guide (pages 168-169), Wizards Website

Homing Spider Droid



Craft: Baktoid Armor Workshop OG-9 Homing Spider Droid

Type: Droid walker

Crew: Droid brain

Crew Skill: 4D in all appropriate skills

Scale: Speeder

Length: 7.6 meters wide, 6.2 meters tall

Skill: Walker operation: droid walker

Cargo Capacity: None

Cost: 70,000 (new), 42,000 (used)

Maneuverability: 1D

Move: 17; 48 kmh

Body Strength: 3D+1

Weapons:

Homing Laser Cannon

Fire Arc: Turret

Skill: Vehicle blasters

Fire Control: 2D

Range: 50-400/900/2 Km

Damage: 5D

Light Blaster Cannon

Fire Arc: Turret

Skill: Vehicle blasters

Fire Control: 2D

Range: 5-300/600/1 Km

Damage: 3D

Source: Ultimate Adversaries (pages 149-150), The Clone Wars Campaign Guide (pages 200-201)

Tri-Droid



Craft: Techno Union Tri-Droid

Type: Droid walker

Scale: Walker

Length: 14 meters tall

Skill: Walker operation: droid walker

Crew: Droid brain

Crew Skill: 4D in all appropriate skills

Cargo Capacity: None

Cost: 100,000

Maneuverability: 0D

Move: 18; 50 kmh

Body Strength: 3D

Weapons:

3 Ordnance Launchers (48 shells)

Fire Arc: Turret

Skill: Vehicle blasters

Fire Control: 2D

Range: 50-400/900/2 Km

Damage: 5D

Source: The Clone Wars Campaign Guide (page 202)

Wookiee Flying Catamaran



Craft: Appazanna Engineering Works *Oevvaor* Jet Catamaran

Type: Exotic flying watercraft

Scale: Speeder

Length: 15.1 meters

Skill: Repulsorlift operation

Crew: 2

Passengers: 2

Cargo Capacity: 50 kilograms

Cover: 1/2

Altitude Range: Water level-1,000 meters

Cost: 12,125 (new), 2,700 (used)

Maneuverability: 2D

Move: 125; 370 kmh (water), 150; 430 kmh (air)

Body Strength: 2D+2

Source: Wizards Website, The Clone Wars Campaign Guide (page 219)

Wookiee Ornithopter



Craft: Appazanna Engineering Works Raddaugh Gnasp Fluttercraft

Type: Patrol ornithopter

Scale: Speeder

Length: 7 meters

Skill: Rotor vehicle operation: ornithopter

Crew: 1, gunners: 1

Cargo Capacity: 3 kilograms

Cover: 1/4

Altitude Range: Ground level-1,000 meters

Cost: 14,750 (new), 3,200 (used)

Maneuverability: 3D+2

Move: 110; 310 kmh

Body Strength: 1D+2

Weapons:

Laser Cannon

Fire Arc: Rear

Crew: 1

Skill: Vehicle blasters

Fire Control: 1D

Range: 10-50/200/500

Damage: 4D

Source: Wizards Website, The Clone Wars Campaign Guide (page 219)

DC0052 "Intergalactic" Speeder



Craft: Daystar Craft DC0052 Airspeeder

Type: Airspeeder

Scale: Speeder

Length: 2 meters

Skill: Repulsorlift operation: airspeeder

Crew: 1

Cargo Capacity: 3 kilograms

Cover: Full

Altitude Range: Ground level-170 kilometers

Cost: 10,000 (new), 2,000 (used)

Maneuverability: 3D+1

Move: 280; 800 kmh

Body Strength: 2D

Source: The Clone Wars Campaign Guide (page 138)

STAP

Craft: Baktoid Armor Workshop Single Trooper Aerial Platform (STAP-1)

Type: Single trooper aerial platform

Scale: Speeder

Length: 1.9 meters

Skill: Repulsorlift operation: STAP

Crew: 1

Crew Skill: Repulsorlift operation 4D; vehicle blasters 4D

Passengers: None

Cargo Capacity: None

Cover: 1/4

Altitude Range: Ground level-500 meters

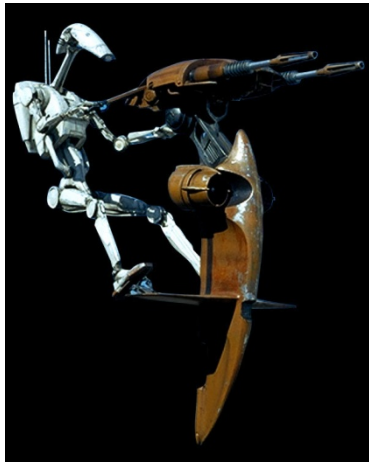

Cost: 2,500

Maneuverability: 3D

Move: 105; 300 kmh

Body Strength: 1D

Weapons:

2 Blaster Cannons (fire-linked)

Fire Arc: Front

Skill: Vehicle blasters

Fire Control: +2

Range: 50-400/900/3 Km

Damage: 4D

Source: d20 Core Rulebook (page 237), Secrets of Naboo (page 10), The Clone Wars Campaign Guide (page 202)

Trade Federation Troop Carrier

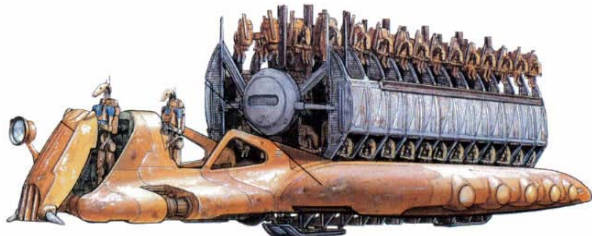

Craft: Baktoid Armor Workshop's Troop Carrier

Type: Troop transport

Scale: Speeder

Length: 26 meters

Skill: Repulsorlift operation: repulsorlift sled

Crew: 2 (droids); skeleton: 1/+5

Crew Skill: Repulsorlift operation 4D, vehicle blasters 4D

Passengers: 112 (battle droids)

Cargo Capacity: 4 tons

Cover: 1/2

Altitude Range: Ground level-2 meters

Cost: 37,000

Maneuverability: 1D

Move: 18; 50 kmh

Body Strength: 3D+2

Source: The Clone Wars Campaign Guide (page 202)

BARC Speeder



Craft: Aratech Biker Advanced Recon Commando (BARC) Speeder

Type: Speeder bike

Scale: Speeder

Length: 4.57 meters

Skill: Repulsorlift operation: speeder bike

Crew: 1

Cargo Capacity: 5 kilograms

Cover: 1/4

Altitude Range: Ground level-150 meters

Cost: 8,300 (new), 1,550 (used)

Maneuverability: 2D

Move: 180; 520 kmh

Body Strength: 2D+1

Weapons:

4 Blaster Cannons (fire-linked)

Fire Arc: Front

Skill: Vehicle blasters

Fire Control: 1D

Range: 30-50/100/200

Damage: 4D+2

Source: The Clone Wars Campaign Guide (page 165)

Swamp Speeder

Craft: Uulshos Manufacturing Infantry Support Platform (ISP)

Type: Light attack vehicle

Scale: Speeder

Length: 5 meters

Skill: Repulsorlift operation: swamp speeder

Crew: 2

Cargo Capacity: 55 kilograms

Cover: 1/2

Altitude Range: Ground level-1.3 meters

Cost: 11,600 (new), 2,880 (used)

Maneuverability: 1D+2

Move: 35; 100 kmh

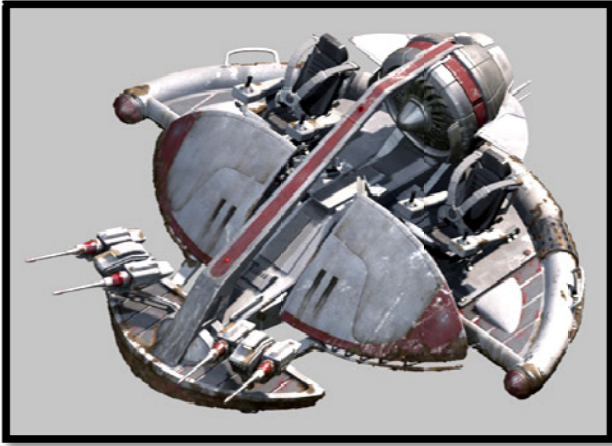

Body Strength: 2D+1

Weapons:

2 Twin Blaster Cannons

Fire Arc: 1 front/right turret, 1 front/left turret

Skill: Vehicle blasters

Fire Control: 1D+1

Range: 10-100/500/800

Damage: 4D

Source: The Clone Wars Campaign Guide (page 166), Wizards Website

Carrier Gunship



Craft: Rothana Heavy Engineering LAAT/c Cargo Gunship

Type: Airspeeder

Scale: Speeder

Length: 17.4 meters

Skill: Repulsorlift operation: LAAT/c Cargo Gunship

Crew: 1

Crew Skill: All skills typically at 5D

Passengers: None

Cargo Capacity: 40 tons (1 AT-TE, 4 AT-XTs, 1 Republic troop transport, 1 TX-130 *Saber* tank, or 1 forward command center)

Cover: Full

Altitude Range: Up to 1,000 meters

Cost: 58,000 (new), 42,000 (used)

Maneuverability: 1D (+1 when loaded)

Move: 216; 620 kmh

Body Strength: 4D+1

Weapons:

2 Composite Beam Pinpoint Laser Turrets (fire separately)

Fire Arc: Turret

Skill: Vehicle blasters

Fire Control: 2D+1

Range: 10-75/150/300

Damage: 3D

Source: The Clone Wars Campaign Guide (pages 166-167)

Medlifter

Craft: Ubrikkian Industries Model 300 Medlifter Troop Transport

Type: Medical troop transport

Scale: Speeder

Length: 9 meters

Skill: Repulsorlift operation: airspeeders

Crew: 2

Passengers: 4

Cargo Capacity: 1 metric ton

Cover: Full

Altitude Range: Ground level-100 meters

Cost: 24,000 (new), 5,100 (used)

Maneuverability: 1D

Move: 280; 800 kmh

Body Strength: 2D+1

Source: The Clone Wars Campaign Guide (page 167)

Republic Troop Transport



Craft: Rothana Heavy Engineering Republic Troop Transport (RTT)

Type: Landspeeder

Scale: Speeder

Length: 18 meters

Skill: Repulsorlift operation: RTT

Crew: 1, gunners: 1

Passengers: 12 (troops)

Cargo Capacity: 3 tons

Cover: Full

Altitude Range: Up to 5 meters

Cost: 42,000 (new), 10,200 (used)

Maneuverability: 1D+1

Move: 200; 580 kmh

Body Strength: 4D

Weapons:

Laser Cannons

Fire Arc: Front

Skill: Vehicle blasters

Fire Control: 2D+2

Range: 3-50/200/400

Damage: 5D

Missile Launchers (12 missiles)

Fire Arc: Front

Crew: 1

Skill: Missile weapons

Fire Control: 3D

Range: 30-200/700/2 Km

Damage: 4D+2

Source: The Clone Wars Campaign Guide (pages 167-168)

TX-130 Fighter Tank



Craft: Rothana Heavy Engineering TX-130 *Saber*-class Fighter Tank

Type: Assault tank

Scale: Speeder

Length: 8.2 meters

Skill: Repulsorlift operation: Saber Tank

Crew: 2 + optional astromech droid, gunners: 1

Passengers: 2

Cargo Capacity: 750 kilograms

Cover: Full to pilot and co-pilot, 1/2 to gunner

Altitude Range: Ground level-2 meters

Cost: Not available for sale

Maneuverability: 2D

Move: 110; 320 kmh

Body Strength: 4D

Shields: 1D

Weapons:

2 Heavy Laser Cannons (fire-linked)

Fire Arc: Front

Skill: Vehicle blasters

Fire Control: 2D

Range: 50-500/1/2 Km

Damage: 7D

Medium Twin-Laser Turret

Fire Arc: Turret (front/left/right arcs only)

Crew: Co-pilot

Skill: Vehicle blasters

Fire Control: 1D+2

Range: 5-50/200/500

Damage: 5D

Concussion Missile Launchers (8 missiles)

Fire Arc: Front

Crew: 1 or co-pilot

Skill: Vehicle blasters

Fire Control: 2D

Range: 50-500/1/2 Km

Damage: 6D

Medium Twin-Laser Turret

Fire Arc: Turret

Crew: 1

Skill: Vehicle blasters

Fire Control: 1D+2

Range: 5-50/200/500

Damage: 6D

Source: Wizards Website, The Clone Wars Campaign Guide (page 169)

UT-AT



Craft: Kuat Drive Yards/Mekuun Unstable Terrain Artillery Transport

Type: Armored repulsorlift transport

Scale: Walker

Length: 23.8 meters

Skill: Repulsorlift operation: UT-AT

Crew: 1, gunners: 5

Passengers: 20 (troops)

Cargo Capacity: 26 metric tons

Cover: Full

Altitude Range: Ground level-2 meters

Cost: Not available for sale

Maneuverability: 0D

Move: 16; 45 kmh

Body Strength: 4D

Weapons:**Heavy Laser Cannon***Fire Arc:* Front*Crew:* 1 (cockpit gunner)*Skill:* Vehicle blasters*Fire Control:* 1D+2*Range:* 200-1/3/5 Km*Damage:* 5D+2**2 Medium Laser Cannons***Fire Arc:* Front*Crew:* 1 (cockpit gunner)*Scale:* Speeder*Skill:* Vehicle blasters*Fire Control:* 1D*Range:* 50-200/500/1 Km*Damage:* 5D+2**4 Anti-Infantry Laser Turrets***Fire Arc:* Turret*Crew:* 1*Scale:* Character*Skill:* Vehicle blasters*Fire Control:* 1D*Range:* 5-20/200/400*Damage:* 8D**Ion Bomblet Generator***Fire Arc:* Front*Scale:* Speeder*Skill:* Vehicle blasters*Fire Control:* 1D*Range:* 20-100/200/300 Km*Damage:* 4D

Note: The UT-AT must come to a complete stop for one full round before engaging the bomblet generator.

Source: The Clone Wars Campaign Guide (page 170)

Ground Armored Tank

Craft: Baktoid Armor Workshop Ground Armored Tank (GAT)

Type: Assault tank

Scale: Speeder

Length: 7 meters

Skill: Repulsorlift operation: GAT

Crew: Droid brain

Crew Skill: All skills 5D

Cargo Capacity: None

Altitude Range: Ground level-1 meters

Cost: 17,500 (new), 11,000 (used)

Maneuverability: 2D

Move: 45; 130 kmh

Body Strength: 5D+1

Weapons:

2 Medium Laser Cannons (fire-linked)

Fire Arc: Front*Skill:* Vehicle blasters*Fire Control:* 2D*Range:* 50-500/1/2 Km*Damage:* 4D+1

2 Concussion Missile Launchers (24 missiles)

Fire Arc: Front*Skill:* Vehicle blasters*Fire Control:* 2D*Range:* 50-500/1/2 Km*Damage:* 6D

Source: The Clone Wars Campaign Guide (page 198)

MTT

Craft: Baktoid Armor Workshop Multi Troop Transport

Type: Heavy armored troop transport

Scale: Walker

Length: 31 meters

Skill: Repulsorlift operation: MTT

Crew: 1 pilot droid, 1 gunner droid

Crew Skill: 4D in all applicable skills

Passengers: 100 Infantry Battle Droids, 10 Security Battle Droids, 2 Commander Battle Droids

Cargo Capacity: 10 metric tons

Cover: Full

Altitude Range: Ground level-4 meters

Cost: 138,000 (new), 80,000 (used)

Maneuverability: 0D

Move: 12; 35 kmh

Body Strength: 4D

Weapons:**2 Dual Blaster Cannons** (fire-linked)*Fire Arc:* Front*Skill:* Vehicle blasters*Fire Control:* 2D*Range:* 50-400/900/3 Km*Damage:* 4D+1

Game Notes: If attacked from the rear, the MTT only has an effective Body Strength of 1D due to the thinness of the rear armor (to allow for ventilation of the power plant). If the MTT suffers a damage result of Heavy or higher from a rear attack, the power plant will explode within 2D turns. This explosion will destroy any droids and/or characters on board and completely gut the MTT.

Source: d20 Core Rulebook (page 201), Secrets of Naboo (page 9), The Clone Wars Campaign Guide (page 200)

Tsmeu-6 Wheel Bike

Craft: Z-Gomor Tembuell Guppatt Corp. Tsmeu-6 Personal Wheel Bike

Type: Personal wheel bike

Scale: Speeder

Length: 3.5 meters long

Skill: Ground vehicle operation/walker operation

Crew: 1

Passengers: 0 (Civilian version: 1)

Cargo Capacity: 5 kilograms (Civilian version: 10kg)

Cover: 1/4

Cost: Not available for sale (weaponless Civilian version: 15,000 new)

Maneuverability: 1D+2

Move: 115; 330 kmh (wheeled), 3; 10 kmh (walker)

Body Strength: 2D

Weapons:**Double Blaster Cannon***Fire Arc:* Front*Skill:* Vehicle blasters*Fire Control:* 2D*Range:* 50-100/200/400*Damage:* 5D

Note: The claws built into the wheel rim inflict +1D ramming damage.

Source: Wizards Website, The Clone Wars Campaign Guide (page 203)

Hailfire Droid

Craft: InterGalactic Banking Clan IG-227 Hailfire-class Droid Tank

Type: Wheeled droid tank

Scale: Speeder

Length: 5.5 meters tall, 6 meters long

Skill: Ground vehicle operation

Crew: Droid brain

Crew Skill: All skills 4D

Cargo Capacity: None

Cost: 60,000 (new), 36,000 (used)

Maneuverability: 2D

Move: 40; 120 kmh

Body Strength: 3D

Weapons:**2 Hailfire Missiles Launcher** (15 missiles each)*Fire Arc:* Front*Skill:* Missile weapons*Fire Control:* 2D*Range:* 50-250/1/3 Km*Damage:* 6D**Laser Cannon***Fire Arc:* Front*Skill:* Vehicle blasters*Fire Control:* 1D*Range:* 50-500/1/2 Km*Damage:* 4D

Source: Ultimate Adversaries (page 151), The Clone Wars Campaign Guide (page 199)

Persuader Tank Droid

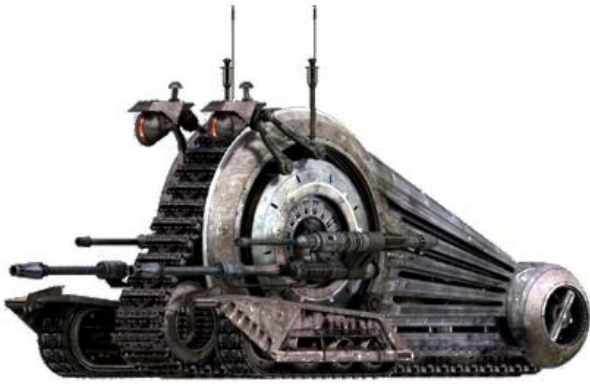

Craft: Corporate Alliance NR-N99 *Persuader*-class Droid Enforcer

Type: Tank droid

Scale: Speeder

Length: 6 meters long, 4 meters tall

Skill: Ground vehicle operation

Crew: Droid brain

Crew Skill: All skills 4D

Cargo Capacity: None

Cost: 100,000 (new), 60,000 (used)

Maneuverability: 1D

Move: 35; 96 kmh

Body Strength: 5D

Weapons:

2 Ion Cannons (fire-linked)

Fire Arc: Front

Scale: Walker

Skill: Vehicle blasters

Fire Control: 1D

Range: 5-300/600/1 Km

Damage: 4D+1

2 Heavy Repeating Blasters

Fire Arc: 1 front/left, 1 front/right

Skill: Vehicle blasters

Fire Control: 1D

Range: 50-400/900/2 Km

Damage: 4D+1

2 Missile Launchers

Fire Arc: Front

Skill: Missile weapons

Fire Control: 2D

Range: 10-30/150/300 (thermal detonator), 50-250/1/2 km (missiles and torpedoes)

Damage: 8D (thermal detonators), 9D (concussion missiles), 8D (homing missiles), 10D (dumbfire torpedoes)

Source: Ultimate Adversaries (page 150), The Clone Wars Campaign Guide (page 201)

Manta Droid Subfighter



Craft: Haor Chall Engineering Manta Droid Subfighter

Type: Underwater attack vessel

Scale: Speeder

Length: 5 meters

Skill: Watercraft operation: Manta

Crew: Droid brain

Crew Skill: All skills 3D

Cargo Capacity: None

Depth Range: Water level-20 kilometers

Cost: 22,000

Maneuverability: 2D

Move: 55; 160 kmh

Body Strength: 2D+2

Weapons:

2 Laser Cannons (fire-linked)

Fire Arc: Front

Skill: Vehicle blasters

Fire Control: 1D+1

Range: 10-100/500/800

Damage: 4D+1

2 Torpedo Launchers (12 torpedoes)

Fire Arc: Front

Skill: Vehicle blasters

Fire Control: 1D

Range: 30-300/800/1.5 km

Damage: 6D

Source: The Clone Wars Campaign Guide (pages 199-200)

Droids

Galactic Chopper Medical Assistant Droid

Type: Ubrikkian Model DD-13 Cybernetic Surgical Droid

DEXTERITY 1D

KNOWLEDGE 2D

Alien Species 4D+1

MECHANICAL 1D

PERCEPTION 2D

(A) Injury/ailment diagnostics 4D, search 4D

STRENGTH 1D

TECHNICAL 2D

Computer programming/repair 3D, first aid 4D, (A) medicine: cyborging 4D+2

Equipped With:

- Medical computer scomp link: interface to adequate medical computer or surgeon droid adds +1D to all medical skills.
- Medical diagnostic computer and sensor
- Vocabulator
- Two manipulator arms
- Various surgical attachments
- Hypodermic injectors (4D stun damage)
- Amputation vibroblade (STR+3D)
- Internal storage (10kg)
- Three legs

Move: 8

Size: 1.83 meters tall

Cost: 4,150

Source: The Clone Wars Campaign Guide (page 66)

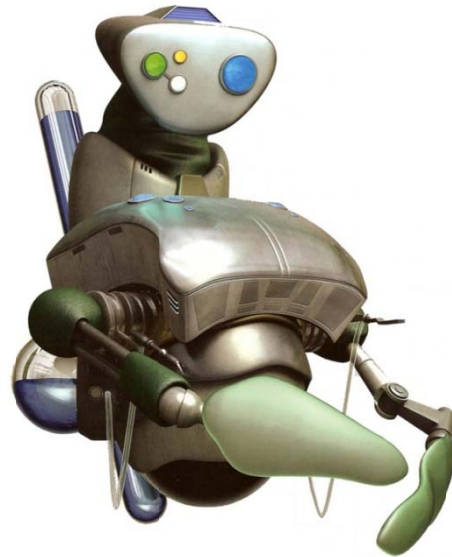
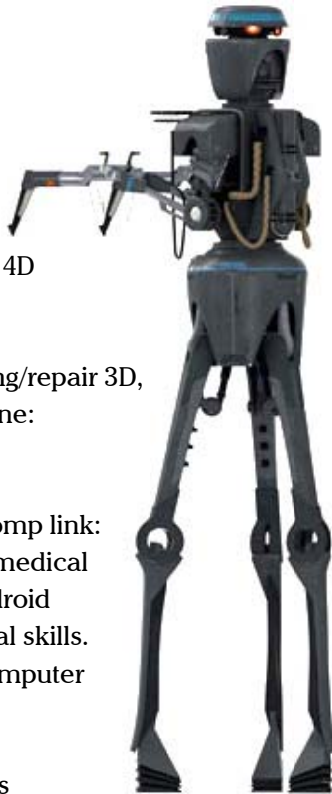

-Two manipulator arms with cradling paddles

-Vocabulator

Move: 10

Size: 1.16 meters

Cost: 5,870

Source: The Clone Wars Campaign Guide (page 67)

IM-6 Medical Droid



Type: Cybot-Galactica IM-6 battlefield medical droid

DEXTERITY 2D+2

KNOWLEDGE 2D

Alien species 5D+1

MECHANICAL 1D

(A) Bacta tank operation 3D

PERCEPTION 2D

(A) Injury/ailment diagnosis 4D+2, search 3D+2

STRENGTH 2D

Lifting 3D+1

TECHNICAL 3D

Computer programming/repair 4D+2, first Aid 5D, (A) medicine 5D

EW-3 Midwife Droid

Type: Chroon-Tan B-Machine

DEXTERITY 2D

KNOWLEDGE 2D

Alien species 5D

MECHANICAL 1D

PERCEPTION 2D

Persuasion: calming 4D

STRENGTH 2D

Lifting 3D

TECHNICAL 2D

First aid 5D, (A) medicine: infant delivery 7D

Equipped With:

- Repulsorlift unit
- Multi-spectrum photoreceptors
- Warming cushion

Equipped With:

- Repulsorlift unit
- Internal comlink
- Two manipulator arms
- Vocabulator
- Improved sensor package (+2D to *search*)
- Medpac reservoir (5 medpacs)
- Surgery kit

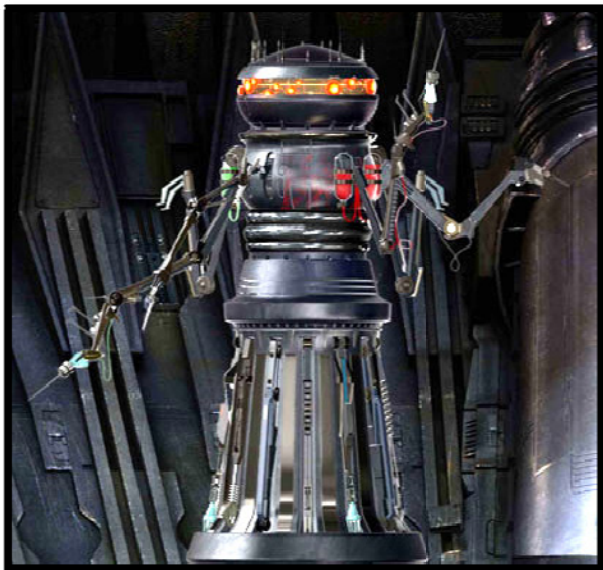
Move: 12**Size:** 1 meter tall**Cost:** 11,800**Source:** The Clone Wars Campaign Guide (page 67)**FX-6 Medical Droid****Type:** Medtech Industries FX-series Medical Assistant Droid**DEXTERITY 1D****KNOWLEDGE 1D**

Alien Species 3D

MECHANICAL 1D

(A) Bacta tank operation 3D+1

PERCEPTION 2D

(A) Injury/ailment diagnostics 3D+2

STRENGTH 1D**TECHNICAL 2D**

First aid 3D+2, (A) medicine 4D

Equipped With:

- Medical computer scomp link: interface to adequate medical computer or surgeon droid adds +1D to all medical skills.
- Readout screen
- Medical diagnostic computer and sensor
- Infrared sensors
- Analytical computer and sensors
- 14 light manipulator arms
- 6 main manipulator arms

-Various surgical attachments

-Hypodermic injectors (4D stun damage)

-Medicine dispensers

-Mobility caster trio

Move: 4**Size:** 1.83 meters tall**Cost:** 4,300 credits**Source:** The Force Unleashed Campaign Guide (page 103), The Clone Wars Campaign Guide (pages 160-161)**SP-4 Analysis Droid****Type:** Cybot Galactica SP-4 Analysis Droid**DEXTERITY 2D****KNOWLEDGE 3D+1**

Bureaucracy 6D, planetary systems 7D, scholar: electronics 7D, scholar: science 7D, scholar: starships 7D, scholar: weapons 7D

MECHANICAL 2D+2

Sensors 5D

PERCEPTION 3D

Investigation 5D+2, search 5D

STRENGTH 1D+1**TECHNICAL 2D**

Computer programming/repair 6D

Equipped With:

- Comlink
- Improved sensor package with infrared vision
- Two manipulator arms
- Two legs
- Vocabulator
- Wireless computer interface.

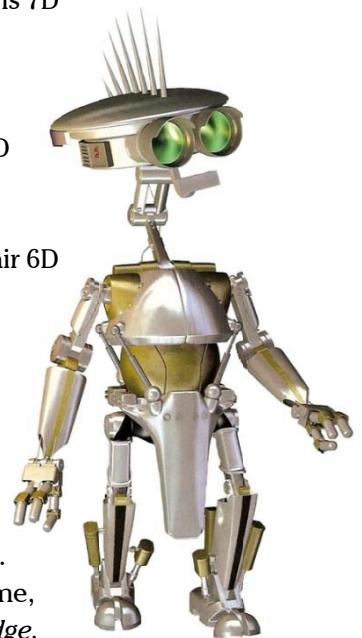
When connected to mainframe, adds +1D to +3D to *Knowledge*, depending on mainframe's size)**Move:** 7**Size:** 1.46 meters**Cost:** 3,100 credits**Source:** The Clone Wars Campaign Guide (page 68)**LE Repair Droid****Type:** Cybot Galactica LE-series repair droid**DEXTERITY 1D****KNOWLEDGE 2D****MECHANICAL 2D**

Astrogation 2D+1, communications 3D, sensors 3D

PERCEPTION 1D**STRENGTH 2D****TECHNICAL 2D**

Capital ship repair 4D,
computer programming/repair
5D, space transports repair 3D

Equipped With:

- Humanoid body (two arms, two legs, head)
- Visual/audial sensors (human range)
- Vocabulator speech/sound system

Move: 7

Size: 1.7 meters tall

Cost: 12,800 (new), 6,500 (used)

Source: Cynabar's Fantastic Technology – Droids (page 65), Platt's Smugglers Guide (pages 60), Arms and Equipment Guide (pages 50-51), The Clone Wars Campaign Guide (pages 68-69)



MECHANICAL 3D

Astrogation 4D, space transports 4D+2, starship shields 3D+2

PERCEPTION 1D

Search 2D

STRENGTH 1D

TECHNICAL 2D

Computer programming/repair 4D, space transports repair 3D

Equipped With:

- Audio and visual receptors (equipped with nightvision)
- Two manipulator arms
- Tread locomotion system (magnetic)
- Astrogation buffer (stores 10 hyperjumps)
- Vocabulator

Move: 7

Size: 1.6 meters

Cost: 4,200 credits

Source: The Clone Wars Campaign Guide (page 161)

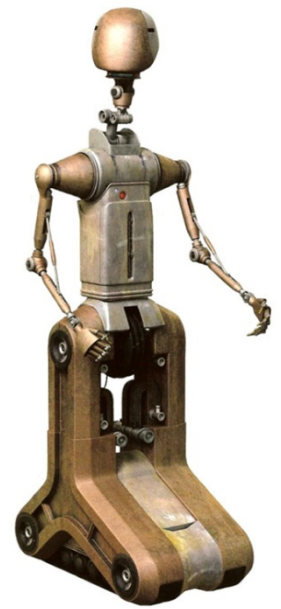

P2 Astromech Prototype

Type: Industrial Automaton
Astromech Droid Prototype

DEXTERITY 1D

KNOWLEDGE 1D

MECHANICAL 1D

Space transports 2D

PERCEPTION 1D

Search 2D

STRENGTH 2D

TECHNICAL 2D

Space transports repair 5D

Equipped With:

- Three wheeled legs (one retractable)
- Heavy grasper arm
- Three medium arms (retractable)
- Laser welder (5D damage, 0.5 meter range)
- Video display screen
- Buzsaw (5D damage)
- Armored hull (+1D to *Strength* when resisting damage)

Move: 4

Size: 2.2 meters

Cost: 2,500-4,200 (used)

Source: Cynabar's Fantastic Technology – Droids, Arms and Equipment Guide (page 46), The Clone Wars Campaign Guide (page 69)



Pit Droid

Type: Serv-O-Droid DUM Series Pit Droid

DEXTERITY 2D

KNOWLEDGE 1D

MECHANICAL 1D

Ground vehicle operation 2D+2, repulsorlift operation 2D+2

PERCEPTION 1D

STRENGTH 2D

Lifting 4D+1

TECHNICAL 2D

Computer programming/repair 3D, ground vehicle repair 4D, repulsorlift repair 4D

Equipped With:

- Foldable humanoid body (two arms, two legs, head)
- Receiver/transmitter with antenna (range .25 km)

Move: 6

Size: 1.19 meter tall

Cost: 1,300

Source: The Clone Wars Campaign Guide (page 70)

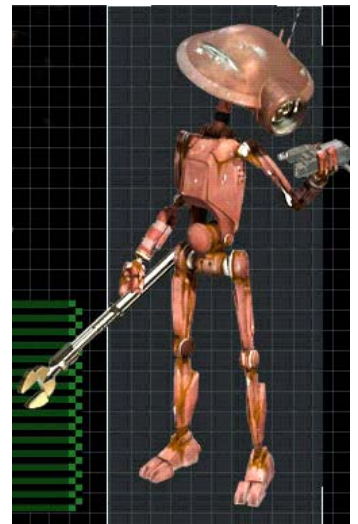

FA-4 Pilot Droid

Type: SoroSuub FA-4 Pilot Droid

DEXTERITY 2D

KNOWLEDGE 2D

Planetary systems 4D+1

5YQ Protocol Droid

Type: Cybot Galactica 5YQ-series Protocol Droid

DEXTERITY 1D

KNOWLEDGE 2D+1

Cultures 4D, languages 6D

MECHANICAL 1D

PERCEPTION 1D

STRENGTH 1D

TECHNICAL 1D

Equipped With:

-Humanoid body (two arms, two legs, head)

-Two visual and audial sensors – human range

-Vocabulator

-Internal storage (5kg)

Move: 8

Size: 1.7 meters tall

Cost: 1,460

Source: The Clone Wars Campaign Guide (page 70)



PERCEPTION 1D+2

Search 3D

STRENGTH 3D

Brawling 4D, stamina 4D

TECHNICAL 1D

Equipped With:

-Humanoid body (two arms, two legs, head)

-Improved sensor package (+2D in low-light conditions)

-Vocabulator

-Quadanium battle armor with cortosis bonding (+1D+2 to *Strength* against physical damage, +2D against energy damage, +2D+2 against lightsaber damage).

Move: 10

Size: 1.9 meters tall

Cost: 5,860

Equipment: Blaster carbine (5D)

Source: The Clone Wars Campaign Guide (page 71)

Marksman-H Training Remote

Type: Industrial Automaton Marksman-H Hovering Remote

DEXTERITY 3D

Blaster array 5D, dodge 4D

KNOWLEDGE 1D

MECHANICAL 1D

PERCEPTION 1D

Search 4D

STRENGTH 1D

TECHNICAL 1D

Equipped With:

-Blaster array (can do 1 pip, 2 pip, 1D, or 1D+1 of damage, fire rate: 6, range: 2-3/5/10)

-Motion sensors (+2 to *search* rolls against moving targets)

Move: 15

Size: 10 centimeters in diameter

Cost: 350 credits

Source: Power of the Jedi (pages 57-58), Hero's Guide (page 154), The Clone Wars Campaign Guide (page 162)



IG-86 Sentinel Droid

Type: Holowan

Mechanicals IG-86 sentinel droid

DEXTERITY 4D

Blaster 4D+2, dodge 5D+2

KNOWLEDGE 2D

MECHANICAL 1D

PERCEPTION 2D

Search 4D

STRENGTH 3D+1

Brawling 4D, climbing/jumping 6D

TECHNICAL 1D

Computer programming/repair 2D+2

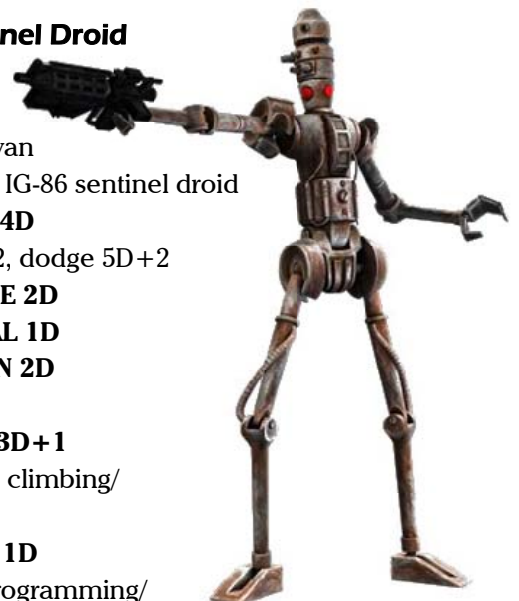

BCA-11/X Training Droid

Type: Baktoid Combat Automata BCA-11/X lightsaber practice droid

DEXTERITY 3D

Blaster: blaster carbine 5D, dodge 3D+2

KNOWLEDGE 1D

MECHANICAL 1D

Equipped With:

- Humanoid body (two arms, two legs, head)
- Durasteel shell (+1D to *Strength* against physical damage, +1 against energy damage)
- Vocabulator

Move: 10**Size:** 2 meters tall**Cost:** 19,000**Equipment:** Blaster rifle (5D)**Source:** The Clone Wars Campaign Guide (page 71)**Advanced Dwarf Spider Droid****Type:** Commerce Guild Advanced Dwarf Spider Droid (A-DSD)**DEXTERITY 2D+1**

Blaster artillery: blaster cannon 3D+2, missile weapons 4D+1

KNOWLEDGE 1D**MECHANICAL 1D****PERCEPTION 1D+1****STRENGTH 4D+1**

Climbing 5D+1

TECHNICAL 1D**Equipped With:**

- Blaster cannon (9D)
- Fire-linked missile launchers (9D/7D/5D, blast radius: 2/4/6, 36 frag missiles carried)
- Quadanium armor (+1D to *Strength* to resist damage)
- Comlink
- Digging claws
- Locked access (the droid's shut-down switch is secured or internally located)
- Magnetic feet
- Restraining bolt
- Improved sensor package (+2 to all *search* skill rolls)
- Infrared vision (can see in the dark up to 30 meters)
- Self-destruct system (8D damage)

Move: 12, 4 (burrowing)**Size:** 1.6 meters tall**Cost:** 25,000**Game Notes:** As an action, the Advanced Dwarf Spider Droid can pull its armored legs in close, gaining +1D+2 to resist damage, but being unable to move.**Source:** The Clone Wars Campaign Guide (pages 188-189)**A-Series Assassin Droid****Type:** Pollux Poi A-series assassin droid**DEXTERITY 3D+1**

Blaster: wrist blasters 6D+2,

melee combat 6D+1,

melee parry 6D

KNOWLEDGE 2D**MECHANICAL 1D****PERCEPTION 2D+1**

Search 6D, sneak 3D+1

STRENGTH 3D+1**TECHNICAL 1D****Equipped With:**

- Vocabulator
- 2 wrist blasters (5D)
- Finger blades (STR+2)
- Humanoid body (2 arms, 2 legs, head)
- Improved sensors (+1D to all *search* rolls, infrared vision)
- Quadanium battle armor (+1D physical, +1 energy)
- Locked access (The droid's shut-down switch is secured or internally located)

Move: 11**Size:** 3 meters tall**Cost:** 14,000**Source:** The Clone Wars Campaign Guide (page 189)**B1-A Air Battle Droid****Type:** Baktoid Combat Automata B1-A Series Air Battle Droid**DEXTERITY 2D**

Blaster 3D, dodge 2D+2, melee combat 3D

KNOWLEDGE 1D**MECHANICAL 1D+2**

Jet pack operation 3D

PERCEPTION 1D

Search 2D

STRENGTH 2D**TECHNICAL 1D****Equipped With:**



- Integrated multichannel comlink
- Remote receiver (5,000 km range)
- Vocabulator
- 2 wrist blades (STR+2 damage)
- 2 wrist blasters (4D)
- Jet pack (10 charges)
- Move:** 10 (walking or flying)
- Size:** 1.91 meters tall
- Cost:** 2,100
- Source:** The Clone Wars Campaign Guide (pages 189-190)

Battle Droid Assassin

Type: Baktoid Combat Automata B1 Series Assassin Battle Droid

DEXTERITY 2D

Blaster 2D+2, blaster: blaster rifle 3D+2, grenades 2D+2

KNOWLEDGE 1D

MECHANICAL 1D

PERCEPTION 1D

Search 1D+2

STRENGTH 2D

Brawling 3D

TECHNICAL 1D

Equipped With:

- Integrated multi-channel comlink
- Improved sensor package (+2D to *search*)
- Remote receiver (5,000 km range)
- Vocabulator (the droid can replicate organic speech)
- Equipment:** Heavy blaster rifle (5D+2, range: 3-50/150/430, when using targeting scope, reduce all Long Range or precision shot difficulty levels

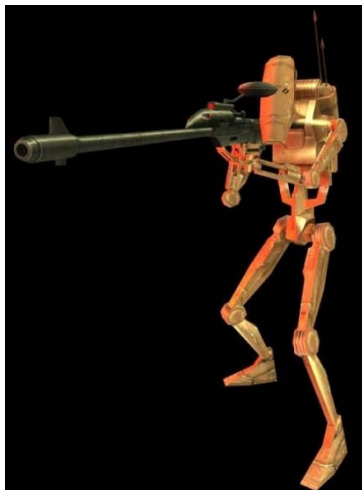

to Moderate), Hold-out blaster pistol (3D), 2 frag grenades (5D).

Move: 10

Size: 1.91 meters tall

Cost: 6,460 credits

Source: The Clone Wars Campaign Guide (page 190)

Snow Droid



Type: Baktoid Combat Automata B2 Series Cold Assault Battle Droid

DEXTERITY 1D+1

Blaster 2D+1, dodge 2D

KNOWLEDGE 1D

Intimidation 2D+1

MECHANICAL 1D

PERCEPTION 1D

Search 2D

STRENGTH 4D

Brawling 4D+2, climbing/jumping 4D+2

TECHNICAL 1D

Equipped With:

- Remote receiver (5,000 km range, with local back-up processor)
- Integrated comlink
- Plasteel shell (+2 to *Strength* to resist damage)
- Vocabulator

Move: 8

Size: 1.93 meters tall

Cost: 5,500 credits

Equipment: Heavy blaster rifle (5D+2)

Source: The Clone Wars Campaign Guide (pages 190-191)

Cortosis Battle Droid

Type: Baktoid Combat Automata B2 Series Battle Droid

DEXTERITY 2D

Blaster 3D+2, dodge 3D

KNOWLEDGE 1D

Intimidation 2D+1

MECHANICAL 1D

PERCEPTION 1D

Search 2D+1

STRENGTH 3D

Brawling 4D+1, climbing/
jumping 3D+2

TECHNICAL 1D

Equipped With:

- 2 wrist blasters (6D)
- Remote receiver (5,000 km range, with local back-up processor)
- Integrated comlink
- Cortosis-durasteel battle armor (+2D to resist damage, +3D against lightsabers)
- Vocabulator

Move: 10

Size: 1.93 meters tall

Cost: 25,000 credits

Source: The Clone Wars Campaign Guide (pages 191-192)



Droid Commando

Type: Baktoid Combat Automata BX-Series Droid Commando

DEXTERITY 4D

Blaster 6D, brawling parry 4D+2, dodge 4D+2, grenade 4D+2, melee combat 4D+2

KNOWLEDGE 3D

Tactics 5D+2

MECHANICAL 2D

PERCEPTION 2D+2

Con 3D, search 6D, sneak 6D

STRENGTH 2D

Brawling 5D

TECHNICAL 2D

Equipped With:

- Humanoid body (2 legs, 2 arms, head)
- Low-light vision (poor lighting penalties are reduced by 2D)
- Internal comlink
- Vocabulator
- Armor (+1D against energy attacks)

Move: 10



Size: 1.8 meters tall

Cost: 17,900 credits

Equipment: Blaster rifle (5D), electrobinoculars

Source: The Clone Wars Campaign Guide (page 192)

IG Lancer Droid

Type: Phlut Design Systems

IG-series Lancer Combat Droid

DEXTERITY 3D

Blaster 4D, dodge 4D, melee combat 5D

KNOWLEDGE 1D

MECHANICAL 2D

Repulsorlift operation 5D

PERCEPTION 2D

STRENGTH 3D

TECHNICAL 1D

Equipped With:

- Humanoid body (two arms, two legs, head)
- Internal comlink
- Vocabulator
- Remote processor

Move: 11

Size: 1.96 meters tall

Cost: 2,700

Equipment: Energy lance (STR+4D damage)

Source: Threats of the Galaxy (page 141), The Clone Wars Campaign Guide (pages 192-193)



IG-110 Lightsaber Droid

Type: Holowan Mechanicals IG-series lightsaber droid

DEXTERITY 4D

Dodge 4D+2,

lightsaber 7D+2

KNOWLEDGE 2D

MECHANICAL 1D

PERCEPTION 2D

Search 5D

STRENGTH 3D+2

Brawling 4D

TECHNICAL 1D

Equipped With:

- Humanoid body (two arms, two legs, head)
- Magnetic feet
- Improved sensor package (+2D to *search*)
- Low-light vision (poor lighting penalties are reduced by 2D)
- Secondary battery
- Vocabulator
- Quadanium armor (+1D to *Strength* to resist damage)



Move: 10

Size: 1.95 meters tall

Cost: 27,000

Equipment: 2 lightsabers (5D)

Source: The Clone Wars Campaign Guide (page 193)

JK-13 Security Droid

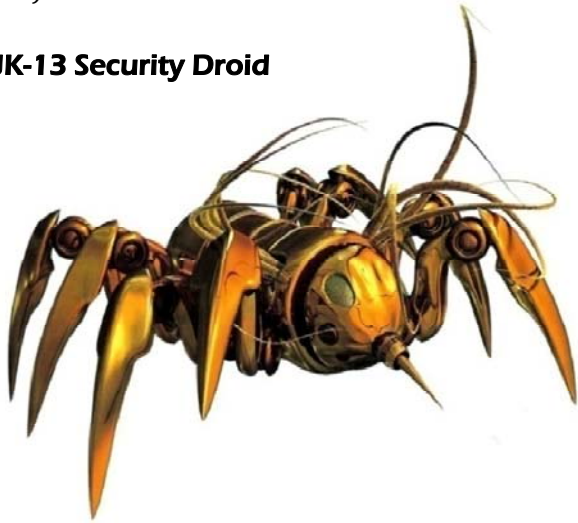

Type: Cestus Cybernetics JK-13 Security Droid

DEXTERITY 3D+1

Dodge 5D+2, melee combat: stun tentacles 7D, melee parry 6D, running 5D

KNOWLEDGE 2D

MECHANICAL 1D

PERCEPTION 2D

Sneak 3D+2, search 3D

STRENGTH 4D+1

Brawling 5D, climbing/jumping 5D, stamina 5D+2

TECHNICAL 1D

Equipped With:

- Eight legs
- Climbing claws (+3D to *climbing*)
- 10 stun tentacles (STR+2 stun damage)
- Improved sensor package (+2D to *search*)
- Shield generator (+3D against energy attacks)
- Organic Force-sensitive processor

Special Abilities:

Force Skills: Sense 3D+1

Force Powers:

Sense: Combat sense, danger sense, life detection

Move: 14 (walking), 8 (climbing)

Size: 1.5 meters

Cost: 50,000

Game Notes: *Killing Rage:* If a JK-13 security droid inflicts a Mortally Wounded or Killed result on a target, the droid flies into a berserk fury, gaining a +1D rage bonus on melee attack rolls and melee damage rolls, but losing the ability to use Force Skills, until the end of the encounter.

While raging, the droid attacks the nearest target (friend or foe) until the droid is destroyed.

Source: The Clone Wars Campaign Guide (pages 193-194)

Assault Crab Droid



Type: Confederacy of Independent Systems LM-432 "Muckraker" Crab Droid

DEXTERITY 2D

Blasters 4D+2, dodge 4D, melee combat: claws 6D, missile weapons: jet system 4D+2

KNOWLEDGE 1D

MECHANICAL 1D

PERCEPTION 2D

Search 5D+1

STRENGTH 4D+2

Climbing/jumping 6D

TECHNICAL 1D

Equipped With:

- Blaster cannon (4D+2 damage)
- Water/mud jet sprayer with vacuum pump (4D stun blinding damage, 100-liter water tank)
- Duranium heavy armor (+2D to resist damage)
- Six claws (STR+1 damage, 2 tipped with heavy duranium stabilizers, granting +2D to *climbing*)

Note: Opponents adjacent to or on top of the droid may attack weak points between the armor plating on the droid's body, this increases the difficulty of the shot by +1D, but a successful attack ignores the droid's armor. The droid further suffers a -2D *Dexterity* penalty to opponents standing on top of the droid.

Move: 10 (walking), 5 (climbing)

Size: 6 meters tall

Scale: Speeder

Cost: 40,000

Source: The Clone Wars Campaign Guide (page 194)

LR-57 Combat Droid

Type: Retail Caucus LR-57 Combat Droid

DEXTERITY 2D+2

Blasters 4D

KNOWLEDGE 1D
MECHANICAL 1D
PERCEPTION 2D

Search 6D,
hide 5D+1

STRENGTH 5D+1
TECHNICAL 1D

Equipped With:

- Internal comlink
- Vocabulator
- Remote receiver
- 2 double heavy blasters (6D damage)
- Durasteel plating (+1D against physical damage)
- Improved sensor package (+2D to *search*)
- Low-light vision (poor lighting penalties are reduced by 2D)

Move: 13

Size: 6 meters tall

Cost: 16,000

Source: The Clone Wars Campaign Guide (page 195)

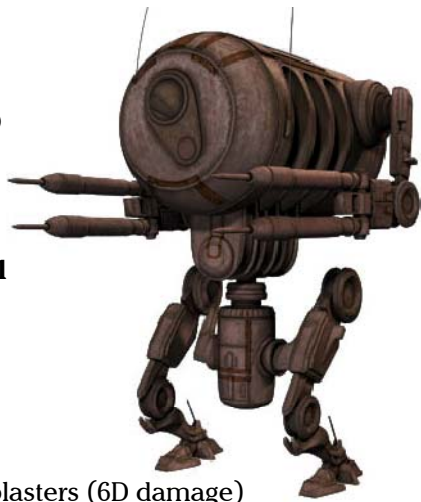

Moderate *stamina* roll every hour or suffer 4D damage until treated – Difficult *first aid* roll).

Move: 10 (walking), 5 (climbing)

Size: 3.6 meters tall (at full height)

Cost: 2,500

Source: The Clone Wars Campaign Guide (page 196)

Battle Droid Commander

Type: Baktoid Combat Automata OOM-series Command Battle Droid

DEXTERITY 2D

Blaster 3D

KNOWLEDGE 2D

Tactics 3D+2

MECHANICAL 1D

PERCEPTION 1D+1

Command 2D, search 3D

STRENGTH 2D

Brawling 3D

TECHNICAL 1D

Equipped With:

- Integrated multichannel comlink
- Remote receiver (5,000 km range)
- Vocabulator

Equipment: Blaster carbine (5D, range: 3-20/60/210), macrobinoculars, personal holoprojector

Move: 10

Size: 1.91 meters tall

Cost: 1,200 credits

Source: Secrets of Naboo (page 11), Invasion of Theed (page 24), Arms and Equipment Guide (pages 56-57), The Clone Wars Campaign Guide (page 196)

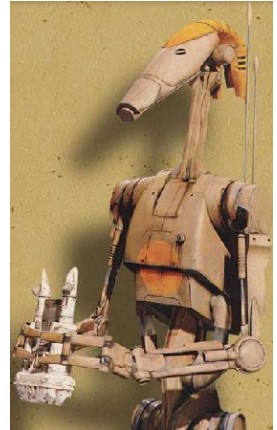

Octuptarra Combat Tri-Droid



Type: Techno Union Octuptarra Droid

DEXTERITY 3D

Laser cannon 4D+1

KNOWLEDGE 1D

MECHANICAL 1D

PERCEPTION 1D+2

STRENGTH 3D+1

Climbing 5D

TECHNICAL 1D

Equipped With:

- 3 magnetic feet
- 3 laser turrets (5D)
- Internal comlink
- Improved sensor package (+2D to *search*)
- Low-light vision (poor lighting penalties are reduced by 2D)
- Self destruct system: explosives (7D+2 on a 4-meter radius), or virus (target must make a

Battle Droid Pilot

Type: Baktoid Combat Automata OOM-series Pilot Battle Droid

DEXTERITY 2D

Blaster 3D, missile weapons 3D, vehicle blasters 3D

KNOWLEDGE 1D

MECHANICAL 3D

Astrogation 4D, capital ship piloting 3D+2, repulsorlift operation 4D

PERCEPTION 1D

STRENGTH 2D

Brawling 2D+2

TECHNICAL 1D

Computer prog/repair 1D+2, repulsorlift repair 1D+1



Equipped With:

- Integrated multichannel comlink
- Remote receiver (5,000 km range)
- Vocabulator (the droid can replicate organic speech)

Equipment: Blaster carbine (5D, range: 3-20/60/210)

Move: 10

Size: 1.91 meters tall

Cost: 1,000 credits

Source: Secrets of Naboo (page 13), Invasion of Theed (page 25), The Clone Wars Campaign Guide (page 196)

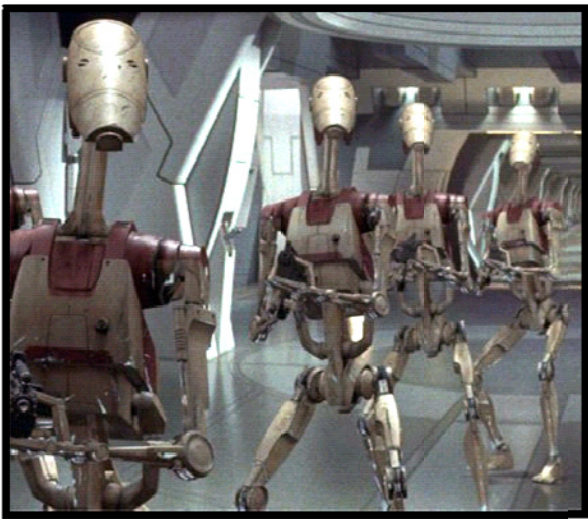
Battle Droid Security

Type: Baktoid Combat Automata OOM-series Security Battle Droid

DEXTERITY 1D+1

Blaster 2D

KNOWLEDGE 1D+2

MECHANICAL 1D

PERCEPTION 1D+1

Search 2D+1

STRENGTH 2D

Brawling 3D

TECHNICAL 1D

Computer programming/repair 1D+2

Equipped With:

- Integrated multichannel comlink
- Remote receiver (5,000 km range)
- Vocabulator (the droid can replicate organic speech)

Equipment: Blaster carbine (5D, range: 3-20/60/210)

Move: 10

Size: 1.91 meters tall

Cost: 900 credits

Source: Secrets of Naboo (page 13), Invasion of Theed (page 25), The Clone Wars Campaign Guide (page 196)

Chameleon Droid

Type: Arakyd Industries/Techno Union Modified Spelunker Probe Droid

DEXTERITY 3D

Blaster 3D+1

KNOWLEDGE 1D

MECHANICAL 1D

PERCEPTION 2D

Hide 4D, search 4D, sneak 4D

STRENGTH 3D

Brawling 4D

TECHNICAL 2D+2

Demolitions 4D+2

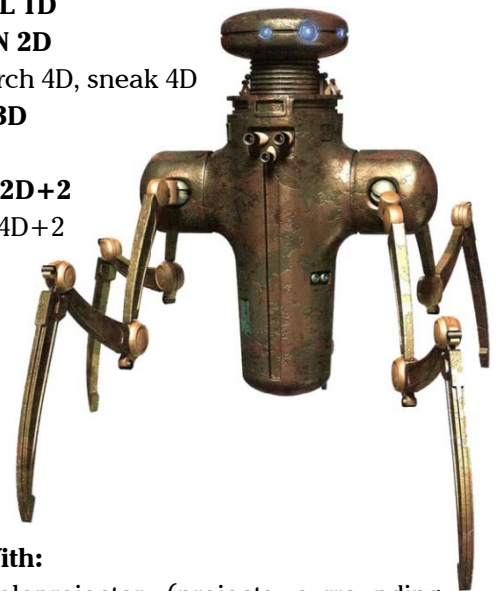
**Equipped With:**

- Cloaking holoprojector (projects surrounding imagery in the droid's place, adding +4D to *hide* and +3D to *sneak*)
- Sensor array (+2D to *search*)

-Small repulsorlift unit (+3D to *running* and *climbing/jumping*)

-Four articulated legs with traction-field generators (+3D to *climbing*)

-Triple Laser cannon (6D+2 damage)

-Minelayer (24 frag mines, remote detonator)

Move: 10 (walking), 5 (climbing)

Size: 2 meters tall

Cost: 15,750

Source: The Clone Wars Campaign Guide (p197)

Ultra Droideka

Type: Droideka Series Ultra Destroyer Droid

DEXTERITY 3D

Blaster: heavy repeating blaster 5D

KNOWLEDGE 1D

MECHANICAL 1D

PERCEPTION 1D

Search 3D+2

STRENGTH 5D+2

TECHNICAL 1D

Equipped With:



- Two mounted heavy repeating blasters (8D)
- Durasteel plating (+1D physical)
- Defensive shields (+5D to *Strength* to resist energy damage, can't be deployed in "wheel mode")

-Remote receiver (5,000 km range)

-Integrated comlink

Move: 5 walking, 25 in "wheel mode"

Size: 3.9 meters tall

Cost: 29,000 credits

Note: After the shields have been active for 5 rounds, they start draining energy from the droid's blaster, reducing its damage by 1D every round until drained. At this point the shield is deactivated and the blaster returns to normal operation. The shield can only be activated again after 5 rounds.

Source: The Clone Wars Campaign Guide (pages 197-198)

CLL-6 Binary Load Lifter



Type: Cybot Galactica CLL-6 Binary Load Lifter Worker Droid

DEXTERITY 1D

KNOWLEDGE 1D

MECHANICAL 1D

PERCEPTION 1D

STRENGTH 6D

Lifting 8D

TECHNICAL 1D

Equipped With:

-Walking locomotion

-2 cargo trays

Move: 7

Size: 3 meters tall

Cost: 4,200 (used)

Source: Platt's Smugglers Guide (page 60), The Clone Wars Campaign Guide (page 72)

FA-5 Valet Droid

Type: SoroSuub FA-5 Valet Droid

DEXTERITY 2D

KNOWLEDGE 1D

MECHANICAL 2D

Repulsorlift operation 3D

PERCEPTION 1D

Search 2D

STRENGTH 2D

Lifting 3D+2, stamina 3D

TECHNICAL 1D

Computer programming/repair 2D

Equipped With:

-Audio and visual receptors

-Humanoid body

(two arms, two legs, head)

-Voculator

Move: 9

Size: 2.1 meters

Cost: 1,100

Source: The Clone Wars Campaign Guide (page 72)

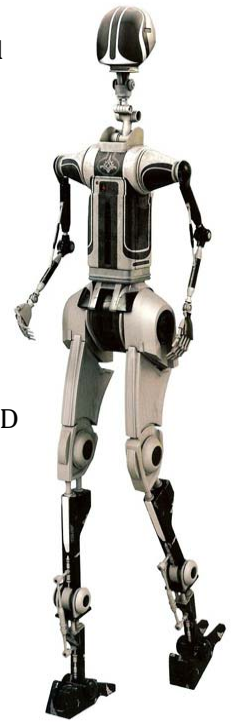

Salvager

Type: Industrial Automaton IW-37 Pincer Loader Droid

DEXTERITY 2D+1

KNOWLEDGE 1D

MECHANICAL 1D

PERCEPTION 1D

Search 3D

STRENGTH 5D+2

Lifting 7D+1

TECHNICAL 1D

Equipped With:

-Two articulated legs

-Durasteel plating (+1D+1

to *Strength* against physical

damage, +1 against

energy damage)

-Two auto-balance repulsor generators

-Heavy-duty precision pincer-arm

Move: 9

Size: 2.5 meters tall

Cost: 8,000

Source: The Clone Wars Campaign Guide (page 73)

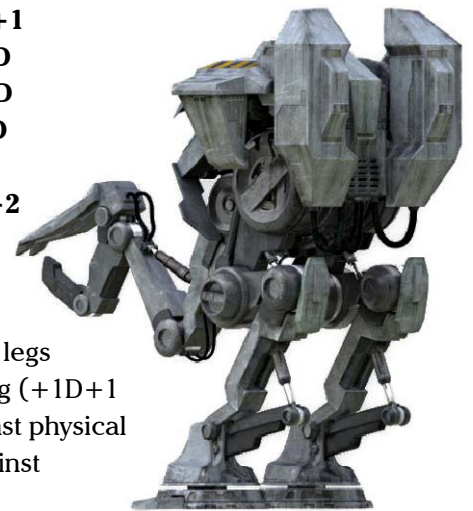

Creatures

Akk Dog



Type: Reptomammal beast

Planet of Origin: Haruun Kal

DEXTERITY 2D+1

PERCEPTION 2D

STRENGTH 5D

Special Abilities:

Natural Armor: Grants +2D to resist damage.

Teeth: Do STR+2D damage.

Move: 10

Size: 5-6 meters long

Source: Clone Wars Campaign Guide (page 57)

Dactillion



Type: Winged raptavian

Planet of Origin: Utapau

DEXTERITY 3D+2

PERCEPTION 2D+2

Search 4D

STRENGTH 6D

Climbing 7D

Special Abilities:

Claws: Do STR+2 damage and grant a +1D bonus to *climbing*.

Beak: Does STR+1D damage.

Move: 14 (flying), 6 (ground)

Size: 6 meters tall, 24-meter wingspan

Orneriness: 3D

Source: Clone Wars Campaign Guide (page 221)

Horax



Type: Giant reptillian

Planet of Origin: Nelvaan

DEXTERITY 1D+1

PERCEPTION 1D

Search 2D+2

STRENGTH 6D

Special Abilities:

Gore: Does STR+2D damage.

Tail Slap: Does STR+1D damage and knocks target prone.

Move: 12

Size: 15 meters tall

Scale: Speeder

Source: The Clone Wars Campaign Guide (page 221)

Kybuck

Type: Praries dasher

Planet of Origin: Kashyyyk

DEXTERITY 4D

PERCEPTION 3D

STRENGTH 2D

Jumping 6D, lifting 4D

Special Abilities:

Charge Attack: Using horns to charge deals STR+2 damage.

Move: 30

Size: 1.5 meters at the shoulders

Orneriness: 1D

Source: Dawn of Defiance – Traitor's Gambit (page 16), The Clone Wars Campaign Guide (page 129)



Weapons

Garrote

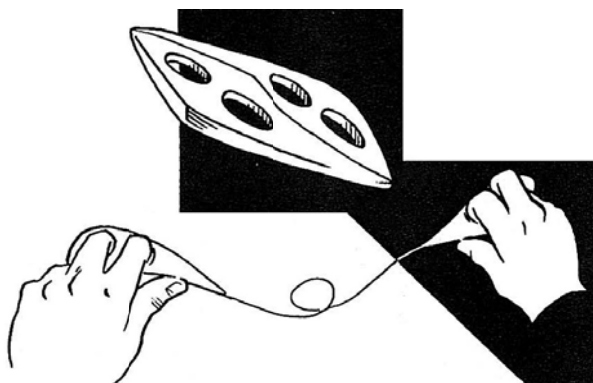

Model: Standard-issue Garrote

Type: Single cord strangling weapon

Scale: Character

Skill: Melee combat: garrote

Cost: 50 credits

Availability: 1

Difficulty: Moderate (from behind)

Damage: STR+1D

Game Notes: Target may attempt a *brawling parry* to resist with a +10 difficulty modifier.

Source: Rules of Engagement – The Rebel SpecForce Handbook (pages 44-45), Arms and Equipment Guide (page 28), The Clone Wars Campaign Guide (pages 59-60)

Snap Baton

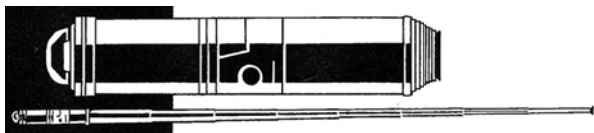

Model: Merr-Sonn Snap Baton

Type: Modified personal defense baton

Scale: Character

Skill: Melee combat: baton

Cost: 200

Availability: 2

Difficulty: Moderate

Damage: STR+1D

Source: Rules of Engagement – The Rebel SpecForce Handbook (page 60), Arms and Equipment Guide (page 29), The Clone Wars Campaign Guide (pages 59-60)

Stun Gauntlets

Model: Palandrix Personal Protection Gear Stun Gauntlets

Type: Hand-to-hand stun gauntlets

Skill: Brawling

Ammo: 10 charges



Cost: 200

Availability: 2

Difficulty: Easy

Damage: STR+2D stun

Source: Gundark's Fantastic Technology (pages 12-13), Pirates & Privateers (page 43), Arms and Equipment Guide (page 31), Knights of the Old Republic Campaign Guide (page 202), The Clone Wars Campaign Guide (page 60)

Vibroknuckler

Model: Czerka Vibroknuckler

Type: Melee weapon

Scale: Character

Skill: Melee combat: vibroknuckler

Cost: 200

Availability: 2, R

Difficulty: Very Easy

Damage: STR+1D+1 (STR+1 if unpowered)

Source: Arms and Equipment Guide (page 30), The Clone Wars Campaign Guide (page 60)

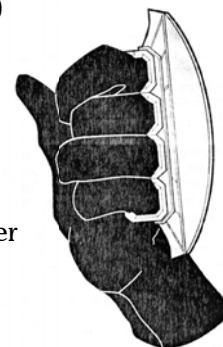

Duelist Vibrorapier

Model: LaserHone Duelist Vibrorapier

Type: Personal combat vibroblade

Skill: Melee combat

Cost: 300

Availability: 2, R

Difficulty: Moderate

Damage: STR+3D
(maximum: 7D)

Source: Gundark's Fantastic Technology (page 14), Pirates & Privateers (page 42), Arms and Equipment Guide (page 30), The Clone Wars Campaign Guide (page 60)



Espo Riot Gun



Model: BlasTech 500 Riot Gun

Type: Riot Gun

Scale: Character

Skill: Blaster: blaster rifle

Ammo: 300

Cost: 1,500

Availability: 2, R

Range: 3-30/100/300

Damage: 5D+1

Game Notes: On constant-fire mode, each “shot” fires five blasts; holding the trigger down will fire six “shots” per round. In game terms, once a shot hits in a round, all following shots at the same or immediately adjacent target (within one meter) are one difficulty level lower. With this type of firing mode, it is much easier to shoot down a row of stormtroopers or other targets.

Source: Gundark’s Fantastic Technology (page 32), Han Solo and the Corporate Sector Sourcebook (page 117), Arms and Equipment Guide (page 15), The Clone Wars Campaign Guide (page 61)

BlasTech DH-23 “Outback”

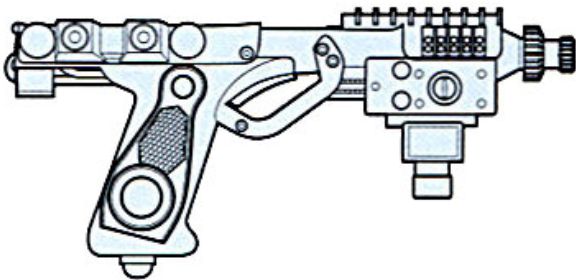

Model: BlasTech DH-23 Blaster Pistol

Type: Blaster pistol

Scale: Character

Skill: Blaster: blaster pistol

Ammo: 100

Cost: 500

Availability: 2, R

Body: 2D

Range: 3-10/20/80

Damage: 4D+1

Source: Arms and Equipment Guide (pages 7-8), The Clone Wars Campaign Guide (page 61)

BlasTech DLT-20A

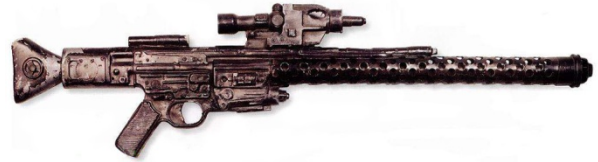

Model: BlasTech DLT-20A Blaster Rifle

Type: Blaster rifle

Scale: Character

Skill: Blaster: blaster rifle

Ammo: 100

Cost: 1,300

Availability: 1, R

Range: 4-35/110/280

Damage: 5D+1

Source: Arms and Equipment Guide (pages 15-16), The Clone Wars Campaign Guide (pages 61-62)

BlasTech DT-12

Model: BlasTech DT-12 Heavy Blaster Pistol

Type: Heavy blaster pistol

Scale: Character

Skill: Blaster:
heavy blaster pistol

Ammo: 25

Cost: 900

Availability: 1, R

Range: 2-5/20/35

Damage: 5D+1

Game Notes: Its large trigger makes it a preferred choice for those who lack hands like those of a human.

Source: Arms and Equipment Guide (page 10), The Clone Wars Campaign Guide (pages 61-62)

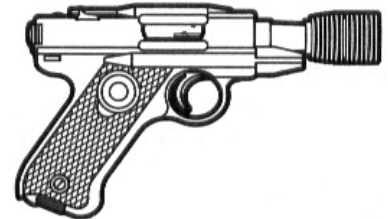

Czerka Adjudicator

Model: Czerka Adjudicator

Type: Slug throwing hold-out pistol

Scale: Character

Skill: Firearms

Ammo: 4

Cost: 300, 50 (wrist
clamp magnetic holstering
lock), 10 (ammo)

Availability: 2, F or R

Fire Rate: 2

Range: 1-5/10/25

Damage: 3D+1

Game Notes: If optional spring clamp is employed, user gains +1D to the character’s *firearms* skill to quickdraw against an opponent

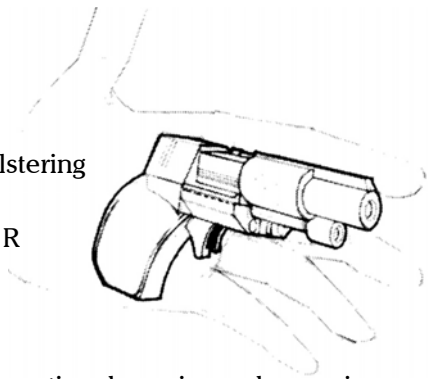

(for quickdraw rules, see *Han Solo and the Corporate Sector Sourcebook*, page 122)

Source: Galladinium's Fantastic Technology (page 73), Arms and Equipment Guide (page 22), The Clone Wars campaign Guide (pages 61-62)

Czerka Adventurer



Model: Czerka Adventurer

Type: Slugthrower rifle

Scale: Character

Skill: Firearms

Ammo: 15

Cost: 360 (ammo clip: 6)

Availability: 1, F

Range: 3-30/100/300

Damage: 4D

Source: Arms and Equipment Guide (page 23), Saga Edition Core Rulebook (page 130), The Clone Wars Campaign Guide (pages 61-62)

EMP Grenade

Type: Ion grenade "droid popper"

Scale: Character

Skill: Grenade

Cost: 500

Availability: 2, R

Range: 3-5/15/30

Blast Radius: 0-2/4/6

Damage: 6D/5D/4D

ionization

Source: The Clone Wars Campaign Guide (pages 61-62)



Micro Blaster

Model: Gee-Tech 12 Defender MicroBlaster

Type: Micro blaster

Scale: Character

Skill: Blaster: hold-out blaster

Ammo: 2

Cost: 400 (power pack: 10)

Availability: 2, R or X

Fire Rate: 1

Range: 1-5/no effect at further ranges



Damage: 2D+2

Game Notes: Very Difficult *search* skill roll required for characters and weapon detectors to find micro blaster. Weapon cannot be reloaded

Source: Gundark's Fantastic Technology (page 25), Arms and Equipment Guide (page 13), The Clone Wars Campaign Guide (pages 61-62)

Merr-Sonn Model 434 DeathHammer

Model: Merr-Sonn Model 434 "DeathHammer" Blaster Pistol

Type: Blaster pistol

Scale: Character

Skill: Blaster:

blaster pistol

Ammo: 100

Cost: 850

Availability: 1, F or R

Range: 2-8/20/80

Damage: 5D+1

Source: Galaxy Guide 9: Fragments from the Rim (page 11), Arms and Equipment Guide (page 9), The Clone Wars Campaign Guide (pages 61/63)

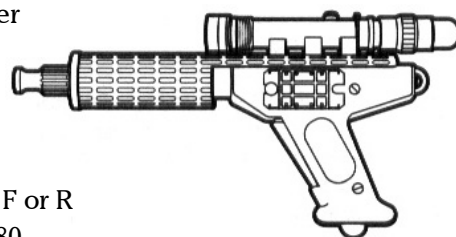

SoroSuub "Firelance"



Model: SoroSuub "Firelance" Blaster Rifle

Type: Blaster rifle

Scale: Character

Skill: Blaster: blaster rifle

Ammo: 100

Cost: 1,200 (power packs: 25)

Availability: 2, R or X

Fire Rate: 1

Range: 3-30/100/300

Damage: 5D

Source: Gundark's Fantastic Technology (pages 33-34), Arms and Equipment Guide (page 18), The Clone Wars Campaign Guide (pages 61/63)

MM9 Wrist Rocket System

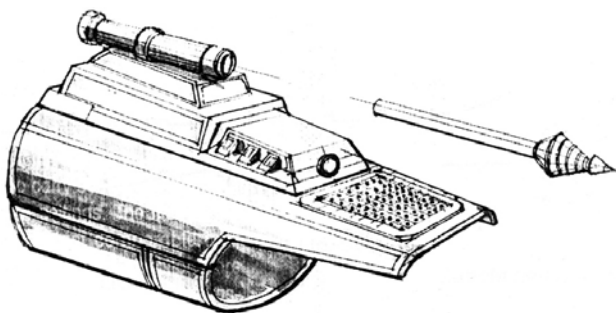

Model: Kalvarek Consolidated Arms MM9 Rocket System

Type: Wrist-mounted rocket launcher

Scale: Character

Skill: Missile weapons: wrist weapons

Ammo: 1

Cost: 2,500

Availability: 2, R

Range: 2-6/20/80 (unless otherwise noted)

Damage: Varies with rocket type (see below)

Game Notes:

Locris Syndicated Securities Type-12A Explosive Antipersonnel Rocket

Blast Radius: 0-1/2/3/4

Damage: 5D/4D/3D/2D

Cost: 400

Availability: 2, X

Merr-Sonn K26 Explosive Antivehicle Rocket

Scale: Speeder

Range: 3-10/30/120

Blast Radius: 0-1/2

Damage: 5D/4D

Cost: 500

Availability: 2, X

Locris Syndicated Securities Type-12B Hollow-Tip Rocket with FGA-583 Nerve Toxin

Damage: 3D on impact; if the weapon does damage, target must make a Difficult *stamina* roll or suffer a -2D *Strength* penalty.

Cost: 600

Availability: 4, X

Locris Syndicated Securities Type-12B Hollow-Tip Rocket with Accudrop Stun Gas

Damage: 3D stun damage; the weapon fills the target area with a 2-meter-radius cloud of gas. The gas is as inhaled poison, victim must make a Difficult *stamina* roll or suffer a -1D *Dexterity* penalty.

Cost: 400

Availability: 2, R

Locris Syndicated Securities Type-12B Hollow-Tip Empty Rocket

Damage: 3D

Cost: 200

Availability: 2

Merr-Sonn DEMP Ionization Blast Rocket

Blast Radius: 2 meters

Damage: 4D ionization

Cost: 400

Availability: 2, R

BlasTech Lumablast Rocket

Range: 3-10/30/120

Blast Radius: 4 meters

Damage: Every creature within the blast radius must make a Difficult *stamina* roll or be blinded for 1D rounds.

Cost: 400

Availability: 2, R

Kelvarek "Dumb" Energy Quarrel

Damage: 3D

Cost: 450

Availability: 1, R

Source: Arms and Equipment Guide (pages 27-28), The Clone Wars Campaign Guide (page 63)

Sonic Cannon



Model: Gordarl Weaponsmiths LR1K Sonic Antipersonnel Cannon

Type: Sonic artillery

Scale: Character

Skill: Blaster artillery: sonic turret

Crew: 2, skeleton: 1/+5

Ammo: Unlimited

Cost: Not available for sale

Availability: 4, R

Body: 4D

Fire Rate: 1

Fire Control: +2

Range: 20-400/1/3 km

Damage: 6D

Source: The Clone Wars Campaign Guide (page 103)

AV-7 Antivehicle Cannon

Model: Taim & Bak AV-7 Antivehicle Cannon

Type: Mobile anti-vehicle artillery

Scale: Speeder

Skill: Missile weapons: anti-vehicle; repulsorlift operation: artillery

Crew: 1

Cover: 1/4

Ammo: 30

Cost: 14,000 (new), 8,000 (used)

Availability: 3, X

Body: 3D

Altitude Range: Ground level-2 meters

Move: 8; 25 kmh

Fire Rate: 1

Fire Control: 3D

Fire Arc: Front turret



Range: 20-600/3/16 km

Blast Radius: 3 meters

Damage: 5D+1

Game Notes: Must be stationary with legs deployed to fire.

Source: The Clone Wars Campaign Guide (page 103)

Equipment

Camo Armor

Model: Creshaldyne Industries Scout Armor

Type: Light scout armor

Cost: 1,500

Availability: 2

Game Effects:

Basic Suit: +1D physical, +2 energy for torso, arms and legs.

Camo Field: +1D to difficulty of *search* or *Perception* rolls for those trying to spot the wearer if the wearer remains motionless.

Source: Galaxy Guide 10: Bounty Hunters (page 87), Gundark's Fantastic Technology (pages 49-50), Rules of Engagement – The Rebel SpecForce Handbook (page 34), Arms and Equipment Guide (page 43), The Clone Wars Campaign Guide (page 64)

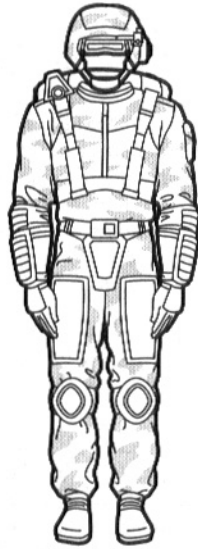

Shadowsuit

Model: Ayellixe/Krongbing Textiles Shadowsuit

Type: Anti-sensor suit

Cost: 600

Availability: 3

Game Notes: Adds +2D to *sneak*.

Source: Rules of Engagement – The Rebel SpecForce Handbook (page 34), Arms and Equipment Guide (page 40), The Clone Wars Campaign Guide (page 64)

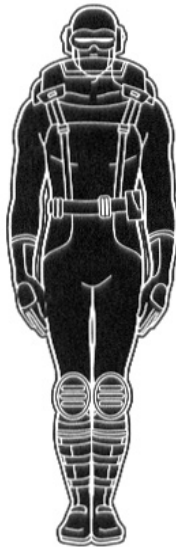

Thinsuit



Model: Karflo Corporation Thinsuit

Type: Insulation armor

Cost: 900

Availability: 2

Game Notes: +1 against physical attacks. Provides up to 18 hours of limited protection against chemical exposure in most known atmosphere types and temperature extremes from -30 to 100 degrees. Breath mask with extended filter (lasts up to 6 hours), storage room for up to 5 more filters. Can be worn in space, providing heat and protection for nearly one hour,

however it does not contain air supply.

Source: Galaxy Guide 8: Scouts (page 45), Rules of Engagement – The Rebel SpecForce Handbook (page 33), Arms and Equipment Guide (page 42), The Clone Wars Campaign Guide (page 64)

Tracker Utility Vest

Model: Ayellixe/Krongbing textiles Tracker Utility Vest

Type: Utility vest

Scale: Character

Cost: 300

Availability: 2

Game Notes: Provides +1 to resist physical damage. The vest can carry up to 28 objects of 1 kilogram or less, each in one of a series of pockets, pouches and straps.

Source: Arms and Equipment Guide (page 41), The Clone Wars Campaign Guide (page 64)



EVA Vacuum Pod

Model: Regallis Engineering EVA Vacuum Pod

Type: Droid-monitored space pod

Skill: Powersuit operation:

repair pod

Crew: 1

Cover: Full

Cost: 15,000

Maneuverability: 1D

Move: 55; 160 kmh

Body Strength: 4D

Game Notes: Life support system capable of functioning for 2 hours. Has full comlink system and a number of attachments

for the two forward arms, plus an exterior “storage pouch” of additional attachments. An annual maintenance overhaul of each pod (Easy *powersuit repair* total) is required.

Source: Galladinium's Fantastic Technology (page 54), Arms and Equipment Guide (page 45), The Clone Wars Campaign Guide (pages 64-65)

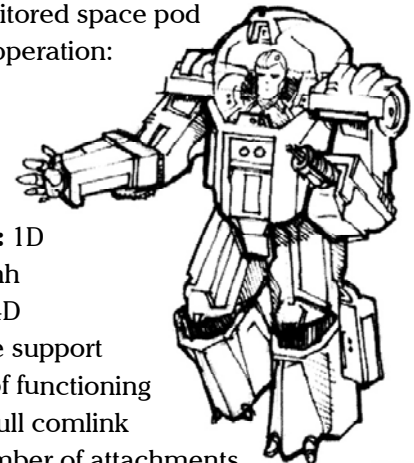

Bioscanner

Model: Cryoncorp Mediscan 21

Type: Medscanner

Cost: 3,000

Availability: 2

Game Notes: The difficulty level for using this scanner is the same as that for using a medpac – Easy for Wounded, Moderate for Incapacitated and Difficult for Mortally Wounded characters.

Successful use of a medscanner adds 1D to *first aid* rolls.

Source: Gundark's Fantastic Technology (pages 103-104), The Clone Wars Campaign Guide (page 65)

Bracer Computer

Model: Standard Bracer Computer

Type: Computer

Skill: Computer programming/repair

Cost: 1,300

Availability: 2

Game Notes: Has all the abilities of a standard datapad, including datacard reading. It features a holographic screen that displays information as a two-dimensional image about 3cm above the device. Plus, the keyboard accommodates one-hand typing.

Source: The Clone Wars Campaign Guide (page 65)

Camo-Netting

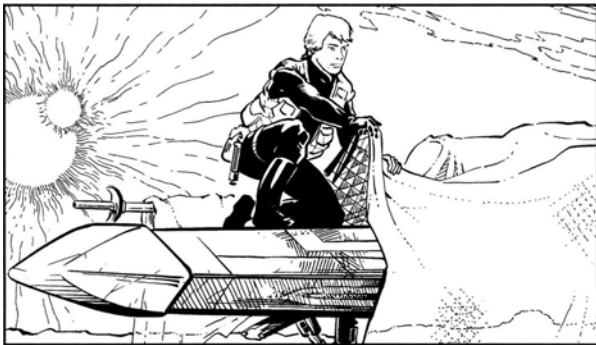

Model: Fabritech CN-15 Camouflage Netting

Type: Camo-netting

Skill: Hide

Cost: 3,500

Availability: 2, R

Game Notes: Camo-netting adds +2D to the difficulty to detect the camouflaged object with sensor-scanning equipment at ranges greater than 250 meters. Camo-netting offers no bonus at a range of less than 250 meters. If more than three camo-nets are used in tandem, the sensor-scanning equipment gains a +1D to detect the nets because of the interference the nets cause.

Source: Gundark's Fantastic Technology (page 106-107), Rules of Engagement – The Rebel SpecForce Handbook (page 44), Shadows of the Empire Sourcebook (pages 110-112), Arms and Equipment Guide (page 92), The Clone Wars Campaign Guide (page 65)

Halo Lamp

Type: Glow device

Cost: 30

Availability: 2

Range: 5-meter radius

Game Notes: A pocket-sized disc that fits in the palm of a human hand and can be attached as a weapon accessory.

Source: The Clone Wars Campaign Guide (page 66)

Visual Wrist Com

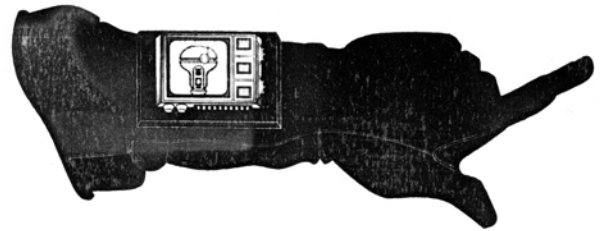

Model: Fabritech PAC20

Type: Visual wrist comlink

Skill: Communications

Cost: 1,500

Availability: 2

Range: 75 kilometers over land and up to low orbit

Game Notes: Can send and receive two-dimensional images as well as standard audio signals. Energy cell lasts 10 days of operation. Device also functions as a very basic datapad.

Source: Arms and Equipment Guide (page 87), The Clone Wars Campaign Guide (page 66)

Force Powers

Pall of the Dark Side

Control Difficulty: Difficult

Required Powers: *Concentration*

Effect: This power allows a character with Dark Side points to conceal her Force sensitivity from other characters. In game terms, any time a Jedi rolls their Sense Force potential power to detect the player's Force sensitivity, the player may immediately roll *control* to activate Pall of the Dark Side. This roll does not incur a multiple action penalty. If the roll is successful, then she may add half of her Dark Side score to her *control* roll to resist detection (were normally, a character would only roll her *control* roll to resist being detected).

Example: Jedi Master Ambelled Daru suspects that Darth Arius may be a Sith Lord. Ambelled Daru rolls a 28 on his *sense* roll to Sense Force Potential. Darth Arius immediately activates pall of the Dark Side. He rolls a 23 on his *control* roll, successfully activating the power. He then adds half of the number of Dark Side points to his roll (in this case half of 12 is 6) for a total of 29. His new score exceeds Ambelled Daru's roll, and thus Ambelled Daru's attempt to Sense Force Potential fails.

Source: Clone Wars Campaign Guide (page 31)

Cloak

Sense Difficulty: Easy

Alter Difficulty: Special

Required Powers: *Absorb/dissipate energy, concentration, telekinesis.*

This power may be kept up.

Effect: This power allows the Jedi to bend light around himself making him more difficult to see. In game terms, this power adds a bonus to the Jedi's *sneak* roll. The amount of the bonus depends on the Jedi's *alter* roll. For a Difficult roll, the Jedi may add +2D to his sneak roll; for a Very Difficult, he may add +2D+2, and for a Heroic roll, he may add +3D+1.

Source: Clone Wars Campaign Guide (page 50)

Malacia

Sense Difficulty: Moderate.

Alter Difficulty: Target's *control* or *Strength* roll.

Required Powers: *Enhance another's attribute, enhance attribute, control pain, control another's pain, transfer force.*

Effect: This power causes extreme dizziness and nausea in a single target within the user's line of sight. A target affected by this power is considered to be stunned for 2D rounds, and cannot take any actions during that time.

Source: Power of the Jedi Sourcebook (pg 13), The Clone Wars Campaign Guide (page 51)

Morichro

Control Difficulty: Moderate, modified by proximity.

Alter Difficulty: *Perception* or *control* roll of the target.

Required Powers: *Accelerate another's healing, control another's pain, control pain, hibernation trance, injure/kill, life detection, life sense, place another in hibernation trance.*

Note: A character with more than two Dark Side Points cannot utilize the power.

Warning: If the target of this power dies for any reason while being under its influence, the Force-user who initiated the power gains a Dark Side Point.

Effect: This power is an offensive variation of *place another in hibernation trance*. It allows a Force-user to put someone into a trance-like state. If the target fails his *Perception* or *control* roll to resist this power, in addition to rolling a "1" on the Wild Die, the target immediately dies and the user of the power gains one Dark Side Point. The target can spend a Force Point in order to escape immediate death. When used against a living being, *morichro* has a maximum range of 10 meters. The effects are otherwise identical to the *place another in hibernation trance* power.

Source: Power of the Jedi Sourcebook (pg 16), The Clone Wars Campaign Guide (page 51)

Phase

No. Just... no.

Rend

Control Difficulty: Easy (or opposed *control* roll), modified by proximity

Sense Difficulty: Easy, modified by proximity

Alter Difficulty: Target's *Strength* roll

Required Powers: *Control pain, inflict pain, injure/kill, life sense, telekinetic kill*

Warning: A character who uses this power automatically receives a Dark Side Point.

Effect: This power allows a Force user to telekinetically grab hold of a person or object and pull in two directions at once, inflicting incredible pain or even death. The target takes damage determined by the Force user's *alter* roll. If the target is killed, then he is torn in two. If the target is Force sensitive, then the target may make a *control* roll opposed to the attacker's *control* roll.

Source: Clone Wars Campaign Guide (page 51)

Shatterpoint Sense

Sense Difficulty: Very Difficult for present events, Very Difficult for future events (adding an additional +10 for events that are not in the immediate future).

Required Powers: *Emptiness, hibernation trance, sense path, postcognition, sense force, farseeing, life sense*

Time to use: One minute.

Effect: This power allows the Jedi to reach out through the Force and view the events and people around him in such a way that reveals their interconnectedness. The power extends through the Force to see the ever-changing sea of events in terms of their probability and causality; however, it only allows the Jedi to understand connections between people and events. When viewing these events and connection, the power creates an vision in the Jedi's mind allowing them to view reality as though it were a crystal or gem. It allows them to view multiple facets, as well as viewing faults and veins as they run through the gem (the faults being the connections of causality and destiny that bind people together). Many of the interconnections create shatterpoints, important linchpins in destiny. Having this understanding of these shatterpoints allows the Jedi to potential to strike the gem in hopes to shape events to the greater good.

However, the power has several limitations. Shatterpoint sense will not reveal much additional factual information about the universe. If a Jedi were to have reached out to Chancellor Palpatine through Shatterpoint Sense, they would discover a strong (and growing) connection between Palpatine and Anakin Skywalker. It would not reveal that Palpatine was a Sith Lord, nor would it reveal Anakin's destiny to become a Sith Lord. However, in order to get a vision of Anakin's shatterpoints, the Jedi would separately have to focus on Anakin, where he would see a strong connection to both Palpatine and Padmé

Amidala. Further, the power would not allow them to understand the nature of Anakin's connection to Padmé, or understand that they were secretly married.

In game terms, this power functions very well as a plot device. It can add a direction or richness to the intrigue of a campaign. Visions through Shatterpoint Sense are always imperfect, and thus gamemasters are discouraged from revealing too much information. The player must choose to focus on one character, and if he makes the difficult, the gamemaster may reveal that there is a strong connection between that character and others. If the player exceeds the difficulty by 5, then the GM may reveal the strength of those connections, or whether or not they are growing or waning in strength. If the player exceeds the difficulty by 10, then the gamemaster may reveal whether or not there is a taint of the Dark Side in those connections.

Shatterpoint Strike

Sense Difficulty: Very Difficult

Required Powers: *Emptiness, hibernation trance, sense path, farseeing, life sense, shatterpoint sense*

Effect: Shatterpoint is a very rare power that allows a Jedi to see faults and fissures within objects, much like faults of a gem. These faults may exist because of previous interactions with the Force (such as prior healings that may be undone), or natural fissures which occasionally occur. Such fissures may only exist for the briefest moment, and can disappear with very little provocation, such as a slight movement of the person or object. These faults will generally make the object or person much more vulnerable to attack. Just as striking on the fault of a gem may cause it to shatter, striking a shatterpoint will easily destroy a person or object. In game terms, if the gamemaster determines that a shatterpoint exists within a person or object, the Force user may make his rolls to sense it. The Force user must then, as a separate action, make an attack that same round to strike the shatterpoint. When the target rolls to resist damage, the damage resistance total is reduced by half. For every +10 that the Force user exceeds the difficulty, the resistance total is reduced by another -5.

Source: Clone Wars Campaign Guide (page 51)

Technometry

Control Difficulty: Easy

Sense Difficulty: Moderate

Alter Difficulty: Moderate (or opposed *Perception* roll for droids)

Required Powers: *Absorb/dissipate energy, affect mind*

Effect: This power allows the Force user to reach out through the Force to gain a greater sense of a computer or droid, and in some cases exercise control over it. If the Jedi is attempting to gain access to a computer or modify a droid, she may choose to extend herself through the Force to feel and understand that system. She then gains a +2D to her *computer programming/repair, droid programming, or droid repair* rolls. This effect lasts for three rounds.

Alternatively, the Jedi may reach out through the Force to jam a droid's senses for three rounds. During that time, the droid will take a -2D to all *Perception* rolls to detect the presence of the Jedi (assuming the Jedi is attempting to sneak by or avoid detection), also the droid takes a -2D to all offensive and defensive rolls. In some cases, the jamming may confuse the droid and cause it to flee, until the effects have dissipated.