

STAR WARS

080318

ADVENTURER'S JOURNAL

ISSUE TWO



Alien Creatures, Species, & Worlds

CELEBRATING OVER 30 YEARS OF *STAR WARS: THE ROLEPLAYING GAME*

STAR WARS ADVENTURERS JOURNAL



Character Name _____

Player Name _____

Template Type _____

Gender / Species _____

Height _____ Weight _____ Age _____

Physical Description _____

Dexterity _____

Knowledge _____

Mechanical _____

Perception _____

Strength _____

Technical _____

Movement _____ Wound Status _____

Char. Points _____ Stun _____

Force Points _____ Wounded _____

Force Sensitive? _____ Incapacitated _____

Dark Side Pts. _____ M. Wounded _____

GENERAL QUARTERS



7,100,000,000 stars in the known galaxy.

3,200,000,000 habitable star systems.

1,000,000,000 have life.

69,000,000 of those systems met population requirements for Imperial representation.

There seems to be no wasted space within the galaxy.

Such a diversity of creatures and sentient life all with their own culture, creed, language, and varied physical appearances has filled countless xeno-archaeologists notebooks all contributing to a better understanding of who or what is out there amongst the stars.

With such diversity what then is alien to us? That which we all seem to fear, the unknown.

Who knows what types of creatures or intelligent species await us past the boundaries of known space. One might discover a world deeply entrenched with fog only to discover that it is the respiratory exhalation of a sentient planet. Simple drops of rain that collect in fissures on a planet surface and flow as raging rivers across its surface is simply the spawning cycle of space-faring microbes.

Harsh reality we face, is that even though there are so many different lifeforms, the intelligent species are often mistaken for the mundane creatures they appear to be. Prejudice and preconceptions permeate even the highest intellectual endeavor.

Sure we know that oxygen and water are the keys to survival for most species, but oxygen is deadly to the Kel Dor species, who wear an antiox breath mask and protective goggles whenever they are away from their helium and dorin gas rich atmosphere. Our assumptions only constrict our thinking and leave much to be understood.

As my old friend Aurek Jenth would say when dealing with the wonders of alien creatures, species, and worlds:

"Watch where you step, think first, and be the last to speak."

Ranger General Jehro Mors

August 2018

ADVENTURER'S JOURNAL

ISSUE TWO

In This Issue

<i>Alien Environments</i> by Charles McNeill	6
<i>Just For One Day, You Are The Hero!: A Solo Adventure</i> featuring Aurek Jenth by Mark Dowson	36
<i>Alien Species Update</i> by Oliver Queen & Daniel Sperelli	73
<i>Alien Technology and Gear</i> by Johannes Verri.....	102
<i>Never Tear Us Apart</i> by Jason Arana Sr.	136
<i>What Was Lost: an Adventure</i> by Eric Rodriguez	148
Blank Character Sheet	

Features

General Quarters	1
New Alien Species: The Sen-dro by Daniel Sturman.....	16
New Template: The Adventurer	42
Alien Species ...STAT! by Chris Shaylor	66
3D Tabletop Miniature: Alien Gunslinger	70
Random Alien Appearance Generator	98
Beyond BoSS featuring Dreena Matura.....	106
Location Scout: Muck Hollow	112
About the Authors & Artists	156

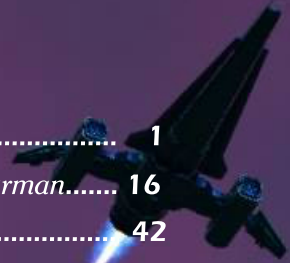



STAR WARS

Timelines

CANON

These articles take place within the canon *Star Wars* universe, any characters that are owned by Lucasfilms Ltd., cannot be used as the focal or Point of View characters in any submissions and may only be used as background NPCs. They can be mentioned very briefly, perhaps a line or two, and are never directly interacted with.

LEGENDS / INFINITIES

Formerly known as the Expanded Universe (abbreviated EU), encompasses every one of the officially licensed, fictional background stories of the *Star Wars* universe, outside of the original six *Star Wars* films produced by George Lucas and certain other material such as *Star Wars: The Clone Wars*, created before April 25, 2014. These characters may be used in a limited capacity.

i.e. Gen. Reiken meets with the characters in the article to give them a mission, and they will report to him HOWEVER these missions can not have a direct impact on the canon characters or canon events.

Within the Legends continuity timeline are the Infinities stories. Written as parodies or presenting "what-if" circumstances, these stories are considered non-canonical within the officially licensed Legends continuity.

ADVENTURER'S

This is where we adventure into charted territory and established events and alter the landscape. Anything goes (as approved by the editors). Canon characters fully interact with those created by the contributor. Events can change and take a new direction. The story or article becomes part of the *Adventurer's Journal* in magazine universe and may or may not feature the persons, places, planets, and things that were first introduced in the journal.

Unless otherwise noted, all entries are considered to take place within the Adventurer's Timeline.

Contributors: Jason Arana Sr., Brian L. Bird, Mark Dowson, John Gendall, Charles McNeill, Nils Meyer, Josh Moore, Eric Rodriguez, Chris Shaylor, Daniel Sperelli, Daniel Sturman, Johannes Verri

Editing: Daniel Sperelli

Graphics: Brian L. Bird, Mark Daniels, John Gendall, Daniel Sturman

Cover Illustration: Nils Meyer

Cover Design: Brian L. Bird

Interior Illustrations & Photographs: Brian L. Bird, Mark Daniels, John Gendall, Daelyn Godfrey, Nils Meyer, Luke Milne, Thee Lone Pine, Chris Shaylor, Daniel Sturman

Publisher & Managing Editor: **Brian L. Bird** + Continuity Editor: **Daniel Sperelli** Assignment Editor: **Frank Max Truelove** + Chief Copy Editor: **Jason Arana Sr.** Art Director: **John Gendall** + Graphic Artists: **John Gendall, Daelyn Godfrey, Daniel Sturman**

Published with special thanks to: West End Games, George Lucas, Eric Trautmann, Bill Smith, Bill Slavicsek, and all the members of
The Adventurer's Journal Facebook Group.

This material is **UNOFFICIAL**. *Star Wars* and all related images, logos, characters, situations, names and other references are wholly owned by Walt Disney Studios and Lucasfilm Ltd.

This is a fan produced work, and offers no challenge to the rights holders copyrights and trademarks, and is **NONPROFIT** and is not intended for commercial sale or any profit making venture.

It is a pure expression of a shared love for *Star Wars: The Roleplaying Game* as originally published by West End Games.

**UNAFFILIATED WITH WEST END GAMES,
LUCASFILM LTD., or WALT DISNEY STUDIOS.**



AJ-080318

ALIEN ENVIRONMENTS

by Charles McNeill

Nervous, kid? Don't worry; everybody's got a first time for this. Lucky thing the captain set us down on this rock or we'd be doing these repairs in vacuum suits. Now remember, whatever you do, do not take off your breath mask, unless you want to spend the next two weeks in a bacta tank regrowing the insides of your lungs.

- Dreena Matura

Ice planets, gas giants, volcanic wastelands: the galaxy can be a very hostile place for characters, simply by virtue of being biologically incompatible with the environment they happen to inhabit at the moment. While much of the action seen on-screen takes place in human-compatible environments, this is not always the case.

While temperature is pretty straightforward, atmospheric type is much more varied. An atmosphere can become harmful for anyone of a number of reasons, as a human-standard environment is highly dependent on a wide variety of factors, including atmospheric content (proper oxygen-nitrogen mix, as well as the right mixture of trace gases) and pressure. It will be up to the GM to decide the details of how and why an environment is hostile.

It is also possible for even more extreme environments to exist that, while they may be more or less breathable.

The rules mention differing types of environments (Types IV), as well as temperature variations and the like; in this article, you will find rules for applying these original concepts to the game.

Atmosphere

Most stellar bodies of significant size have atmospheres (there are exceptions; some planets may have had their atmosphere ripped away by a near pass with a rogue planet or some similar cataclysm). Gas giant atmospheres are often composed of methane, ammonia and various hydrocarbons (Type IV), although a very small number of gas giants have been discovered with a breathable atmosphere within a limited biozone (Bespin being the prime example). Atmospheres are classified in a very simple system based on how far they deviate from human norm, but this system does not take into account the many ways in which atmospheres can vary.

It is up to the GM to determine the specifics of a given atmosphere.

Type I (Breathable)

A Type I Atmosphere has the proper mixture of oxygen, nitrogen and other trace gases so that humans and comparable species can breathe it unassisted. These atmospheres may have contaminants that have long-term detrimental effects, but on the whole, they are safe to breathe normally.

A human standard environment is considered Type I Moderate.

Type II (Breath Mask Suggested)

Type II Atmospheres can support life without use of a breath mask, but either due to too much or too little atmospheric pressure or oxygen, or unusual gases or contaminants, it is recommended that a breath mask be worn. Without a breath mask, detrimental effects, such as slowed reactions, reduced brain activity, poisoning, or a myriad of other effects can begin to occur within just a few hours of exposure. Many alien species are native to Type II Atmospheres, and can comfortably breathe them without having to resort to breath masks.

Type III (Breath Mask Required)

Type III Atmospheres are unbreathable without a breath mask, again due to a number of possible characteristics. The atmosphere could be highly poisonous, or simply not have enough oxygen to be breathable. Characters without breath masks can begin to suffer detrimental effects immediately. A small number of alien species are native to Type III Atmospheres, and can breathe their own atmosphere unaided.

Type IV (Environment Suit Required)

Type IV Atmospheres are not only poisonous; they are so reactive that they will cause injury to persons who are exposed to them. Environment suits, spacesuits or life-support equipment is required to venture through the atmosphere, or characters will suffer burns and other grievous injuries. If the planet is Frigid, a thermal suit may be necessary. These atmospheres may also be corrosive, flammable or highly explosive.

For every step by which the environment deviates from Type I Moderate, it becomes increasingly hostile to human life, and by extension, most alien characters.

Type 0 (Space Suit Required)

Type 0 Atmospheres are essentially nonexistent, either the vacuum of space, or close enough not to matter. Type 0 Atmospheres are un-survivable in anything less than a space suit. Planets without an atmosphere typically have much greater temperature variations because there is no atmosphere to disperse solar energy (on the sun side) or retain heat (on the night side).

Temperature

This classification represents the average temperature on the planet's surface. Most planets have several varying temperature bands, from the coldest (Polar Regions) to warmest (equatorial region). The "true" temperature of an area can also be altered by local geographic features. In addition, temperature ranges can be affected by a planet's orbit and rotation; a region with moderate temperatures during the day can become much cooler at night, and temperatures can vary greatly due to seasonal changes.

Searing (57C / 135F or more)*

Searing planets are hostile to most life forms, although standing bodies of water are possible so long as the average temperature isn't near the boiling point (100 degrees C). Most civilizations will tend to cluster near the more moderate polar regions, or underground.

Hot (35 - 56C / 95 - 134F)

Hot planets, while generally uncomfortable, are not nearly as hostile as searing planets, and are survivable so long as appropriate steps are taken.



Temperate (5 - 34C / 41 - 94F)

Temperate planets are in the most comfortable temperature bands for humans and other life forms.

Cold (-20 --4C / -4 --40F)

Cold planets are uncomfortable but survivable. Most cool planets do not support a huge number of life forms, but life can still adapt to planetary conditions. Plant life may be common if it contains compounds that prevent vital water-based fluids from freezing. Hoth during the day is a good example of a Cold planet (at night, it drops to Frigid)

Frigid (-21C / -5F or less)

Frigid planets are often inhospitable. Depending on hydrosphere conditions, they may be covered in glaciers.

Note for GMs: The temperatures listed are intended as a representative range, not exact science.

**Searing and Frigid Temperatures are not intended to represent a hard limit on the potential for damaging temperatures. The surface*

ALIEN ENVIRONMENTS

of Venus, for example, averages 462C (864F), and would qualify as a Lethal Environment just on temperature alone. GMs, use your discretion when determining exactly far outside the norm a planet's temperature is.

Environmental Deviations

For the purposes of this system, a human standard environment is considered Type I Temperate. For every step by which the environment deviates from Type I Temperate, it becomes increasingly hostile to human life, and by extension, most alien characters.

To generate the results, compare the number of deviations to the following chart:

Strenuous = 1D Damage/hour (+1D every additional hour)

Extreme = 1D Damage/10 minutes (+1D every additional 10 min)

Dangerous = 1D Damage/minute (+1D every additional minute)

Hazardous = 1D Damage/round (+1D every additional round)

Hostile = 2D Damage/round (+2D every additional round)

Lethal = 3D Damage/round (+3D every additional round)

For example, on a cold night in winter, a Type I Moderate atmosphere may become a Type I Cold atmosphere for a few hours, causing an unprotected character with low Strength or other health issue to freeze to death.

On the other end of the scale, a character suddenly exposed to full vacuum without a protective suit would find themselves in a Type IV Frigid atmosphere, and would have to take immediate action to avoid death.

Aliens & Their Natural Habitat

While the vast majority of alien races in the SWU can live without issue in human-standard environments, there are notable exceptions, such as the Kel Dor or the Breather sub-species of the Gand race. For such races, a human-standard environment would qualify as a Type III or IV, and require some form of protective gear (see below) to be able to operate normally in a

human-standard environment. It is recommended that players who wish to play alien characters who are not native to Type I environments discuss the specifics with the GM, and make sure to take into account appropriate protective gear as part of your character's starting equipment.

Protective Equipment

In reaction to the variety of potentially hostile environments that can be encountered in the galaxy, a wide variety of protective clothing and equipment has been invented in response.

Exposure Suit (General)

Cost (Availability): 300 (2)

Effect: Negates 1 level of Increased Temperature

Insulated Suit (Cold)

Cost (Availability): 300 (2)

Effect: Negates 1 level of Reduced Temperature

Refrigerated Suit (Arid)

Cost (Availability): 400 (2)

Effect: Negates up to 2 levels of Increased Temperature

Thermal Suit (Cold Weather)

Cost (Availability): 400 (2)

Effect: Negates up to 2 levels of Reduced Temperature

Pressure Suit

Cost (Availability): 400 (2)

Effect: Negates up to 2 levels of Atmosphere Type Variation if due to pressure.

ALIEN ENVIRONMENTS

Breath Mask

Cost (Availability): 50 (1)

Effect: Negates up to 2 levels of Atmosphere Type Variation for 1 hour.

Note: Some breath masks may also be equipped with protective goggles, depending on conditions.

Environmental Suit, Emergency

Cost (Availability): 800 (2)

Effect: Negates up to 3 Levels of Atmosphere Type Variation.

Note: This suit provides full body protection, and includes a breath mask and protective face shield. Suits are also susceptible to puncture damage. If the wearer takes puncture damage of Wounded or worse, the suit develops a leak, and shifts one level on the Environmental Damage Chart, which stacks with any additional leaks.

Environmental Suit, Utility

Cost (Availability): 1,200 (2)

Effect: Negates up to 3 Levels of Atmosphere Type Variation and up to 2 Levels of Temperature Variation.

Note: This suit provides full body protection, and includes a breath mask and protective face shield. Suits are also susceptible to puncture damage. If the wearer takes puncture damage of Wounded or worse, the suit develops a leak (see above).

Environmental Suit, Quality

Cost (Availability): 1,600 (2)

Effect: Negates up to 3 Levels of Atmosphere Type Variation and up to 2 Levels of Temperature Variation.

Note: This suit provides full body protection, and includes a breath mask and protective face shield. Suits are also susceptible to puncture damage, but the Quality Suit is equipped with an instant-seal layer that seals any leaks. If the wearer takes puncture damage of Mortally Wounded or worse, the suit develops a leak (see above), and shifts one level on the Environmental Damage Chart, which stacks with any additional leaks.

Atmosphere Tank

Cost (Availability): 100 (2)

Effect: Increases the duration of a Breath Mask by 2 hours per tank

Rebreather

Cost (Availability): 300 (2)

Effect: Allows Breath Mask to function for 12 hours

Space Suit, Emergency

Cost (Availability): 1,000 (2)

Effect: Allows the wearer to ignore all Atmosphere and Temperature effects.

Notes:

-Emergency Space Suits are not built to withstand extensive exposure. They begin to leak after 72 hours of use. For game purposes, after 72 hours of use, the suit takes 1D of Damage (resists at 2D), plus 1D per every additional 12 hours. Once the suit takes a damage result of Wounded or better, it develops a leak, and shifts one level on the Environmental Damage Chart, which stacks with any additional leaks.

-Suits are also susceptible to puncture damage. If the wearer takes puncture damage of Wounded or worse, the suit develops a leak (see above).

Space Suit, Utility

Cost (Availability): 1,500 (2)

Effect: Allows the wearer to ignore all Atmosphere and Temperature effects.

Notes:

-Utility Space Suits are much more durable than Emergency Space Suits, and can last for hundreds of hours without loss of pressure or breakdown of radiation protection.

-Suits are susceptible to puncture damage. If the wearer takes puncture damage of Wounded or worse, the suit develops a leak (see above), and shifts one level on the Environmental Damage Chart, which stacks with any additional leaks.

Space Suit, Quality

Cost (Availability): 2,000 (2)

Effect: Allows the wearer to ignore all Atmosphere and Temperature effects.

Notes:

-Quality Space Suits have similar durability to Utility Space Suits, and can last for hundreds of hours without loss of pressure or breakdown of radiation protection.

-Suits are susceptible to puncture damage, but the Quality Suit is equipped with an instant-seal layer that seals any leaks. If the wearer takes puncture damage of Mortally Wounded or worse, the suit develops a leak (see above), and shifts one level on the Environmental Damage Chart, which stacks with any additional leaks.

The Rancor Pit

The rules supplements can tell you how to build a sentient, Force-using rancor. Your friends at the Rancor Pit can tell you why it's not a good idea.



www.rancorpit.com

A forum dedicated to Star Wars D6 discussion

NEW ALIEN SPECIES: THE SEN-DRO

by Daniel Sturman

The Sen-dro are lumbering bird-like spacefarers native to Senaar. They stand between 2 -2.5 meters tall with curved beaks, large widely spaced eyes, and their ever present enviro-suits.

Sen-dro are quite capable of understanding Basic, and some can speak it in a very heavily accented fashion. Their native tongue is a combination of chirps, clicks, squawks, whistles, and borrowed words from Basic, Mando'a, and other languages. In fact, the name "Sen-Dro" is a portmanteau of Senaar Droten, the Mando'a words for "bird" and "people", as this was what the Mandalorians called them when they were first encountered by their scouts.

Senaar is a world of tall forests and shallow seas that is positioned just outside the Mid-Rim, near Mandalorian space. The planet is covered with diminishing forests of colossal daer-goeta trees. Growing several hundred meters into the sky, some older trees are rumored to grow as much as 300-500 meters high. Typically, these trees are around 30 meters across. The exterior of the tree appears as though made of large, entwined vines. At even intervals the tree sprouts frond-like foliage around the circumference of the tree. These are areas in which Sen-Dro build their homes.

The Sen-Dro organize themselves into flocks. The younglings are born a few to a litter, and are raised communally. They have little use for the gender roles of most species, and few outsiders can tell a male and female Senaar-Droten apart due to their similar appearance. The flock is based around location and purpose, with clans being focused on lineage and relations.

Early in their history they evolved to be better at hunting and fishing than the Hai Droten, their aquatic neighbors. Problems arose between them when the "shark people" themselves evolved. This changed which fish species the Sen-Dro would have as their main prey. They could no longer feast on the leviathans and began going after smaller aquatic creatures nearer to the



A Youngling Explorer

surface. At the same time they diversified their diet. Sen-Dro are not warlike or very aggressive by nature. They do not seem to enjoy conflict. However, they are not cowards. When exploring or handling an emergency they are nearly fearless.

That tendency toward fearless exploration and conflict avoidance led the Sen-Dro spaceward. Not long after, the Sen-Dro experienced first contact with the outside galaxy at large (around 7000 BBY) when Mandalorian scouts stumbled upon their system. At this time the Sen-Dro had built dozens of massive, kilometers long cylindrical habitats that are now referred to as “Senaar Cylinders”. They also possessed fusion powered cylindrical rocket ships called “torchships”, solar sail barges, asteroid mines, and had begun to build a massive starlifting ring to extract heavier materials from their sun.

The contact was fortunate, because the system with its sun growing hotter and more violent was doomed. The Sen-Dro were well aware that their sun was at the end of its main sequence, growing closer and closer to becoming a red giant. As it grew closer, it gave off more radiation, and massive solar flares became more and more frequent. The Sen-Dro had fortunately gained shield technology and repulsor related tech after first contact. They used their newfound shield tech to hold off solar flares and deadly radiation. Repulsor based tech, along with inertial dampeners and artificial gravity allowed them to thoroughly explore their system and boost their habitats into higher orbits as Senaar slowly baked under an angry sun.

Until around 4000 BBY, the Mandalorians kept the Sen-Dro at arms length. The Sen-Dro have a lumbering gait that makes them slow on foot compared with humans. That, along with them not having much of a warrior culture caused the more traditional (and superstitious) Mandalorians to see the Sen-Dro as physical representations of Arasuum, the sloth god. Around this time Mandalore the Indomitable caused worship of the old gods to fall out of favor, and the Sen-Dro were then seen more favorably. The few Sen-Dro that became Mando were either known for being skilled pilots, or wore modified enviro suits (basically power armor) that made them like walking tanks. The standard Sen-Dro Mando helmet looks a lot like a bird of prey.

NEW ALIEN SPECIES: THE SEN-DRO

Around 300 BEY the Sen-Dro were facing near extinction. The Republic stepped in and found a star with no habitable planets, but that had the right light frequencies to grow daer-goeta trees.

After the Sen-Dro were convinced that they could inhabit this new system, the Republic sent the Exodus, a massive civilian vessel 40 kilometers in length to move one of the Senaar Cylinders to their new home.

After a standard year the Exodus was configured to hold the cylinder and took it through hyperspace to its new home. Afterwards however, the Republic directed the Exodus elsewhere, and the Sen-Dro went to work trying to save their ancient habitats in their home system, while others built new ones around New Senaar.

During the time of the Empire the Sen-Dro are subject to increasing Imperial quotas for resource production. The Empire generally leaves them alone, as long as the Emperor gets his due. The Sen-Dro are otherwise left to their own devices. They do not openly support the Rebellion, and prefer for them to stay away along with the trouble they bring. However, the Sen-Dro will turn a blind eye to (and even assist) small groups that don't stick around.

Their affinity for the Force is sporadic and their knowledge is built on the work of previous generations. Under scrutiny it is believed that for one individual to develop Force powers they would have to possess quite a bit of innate ability. These rare individuals only display the Force skills of Control, or Sense, and the two never together. In a few rare cases the Alter skill would manifest.

There have only been a handful of their race showing full force potential and inevitably drew the attention of both the Jedi and Sith orders.

Those claiming to have developed mystical abilities adopted a tradition heavily directed to predicting the future, especially pre contact when advanced sensor tech wasn't available, and they were to predict solar flares and other dangers so the Sen-Dro could be prepared. Even back then some were skeptical of their abilities, and mostly saw the diviners as lore keepers and historians.

Once the Sen-dro adopted advanced sensor equipment the diviners became less prominent in their society. They didn't need "librarian wizards" to predict solar flares or find minerals as they colonized their system. With a strong cultural bias against these past concepts and beliefs, any new force users have a chance of facing skepticism and perhaps even ridicule.

Sen-Dro

Attribute Dice: 11D+2

DEXTERITY 2D+1/ 4D+1

KNOWLEDGE 1D+2 /3D

MECHANICAL 1D+1 / 3D+1

PERCEPTION 1D+2 / 3D+2

STRENGTH 2D+2 / 3D+1

TECHNICAL 2D / 3D+2

Special Skills:

Fight or Flight: Though they no longer have the ability to fly, and have come to understand the harshness of the galaxy as a whole, Sen-Dro tend toward one of two extremes. At character creation player must choose Fight or Flight mindset. Once this decision is made 1D (no more) may be placed in the following skills, for which the character receives 2D of ability:

Fight: Grenade, Intimidation, Search, Thrown Weapons

Flight: Archaic Starship Piloting, Repulsorlift Operation, Space Transports, Starfighter Piloting

This bonus also applies to any specializations. If the character wishes to have more than 2D in the skill listed, the costs are normal from then on.

Special Abilities:

270 Vision: Sen-Dro are well adapted to seeing things from different angles, a beneficial side effect of the unique layout of their ships. Due to their environs and activity that surrounds them, they have 270 degree vision and receive a +1D to Search at long distance and all ranges count as 5 less.

Feathered hands: Due to their unusual hands, Sen-Dro suffer a -1D penalty when using any object designed for the human hand. This penalty generally applies to tools or weapons that have finger holes, trigger guards, or hand guards.

VALMAD LAMA-E7A
ONE UMNAJKAK
A7 UMNAJK SKN

(Young Sen-Dro
with pelota'na, or
pelota ball)



X 12V11-770 DEVS717 40U7 Δ# 7EVI SKOΔ019 X7L07
 0Δ70N7EΔU 1V-8 77Δ19 S-KN-1V17. NΔ0V1 7EVI 4EK1A0V1N 7Δ
 7EVI 071U 7Δ K44ΔL07K-1V1 K 4K70V1 7E7V1V1 41A0V17 EK1A7
 K1A7 7EVI 810E 71N1 ΔL-1K-1 44K77V EK1A7-V1 710E-1. 7EVI
 0V1K0Δ1A K-1NΔ EK1 K 0V1A1V7Δ0N 4ΔL0-1L0V1A 7Δ#
 4ΔD-11A0 41A1N 7Δ KYΔ19 ΔYV17EVIK-11A0

(A Sen-Dro khyber copy of the Baktoid Armor Workshop E-5 droid blaster. Note the changes to the grip to accommodate a large three finger hand and the high rise optical "carry handle" sight. The weapon also has a generous compliment of cooling fins to avoid overheating.)

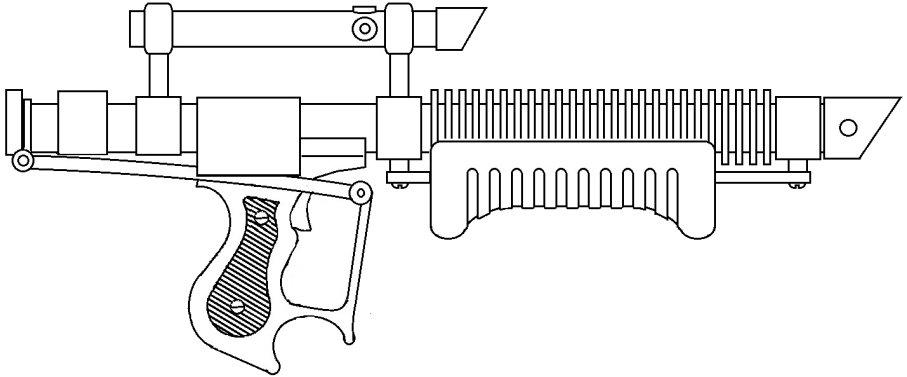

Pelota: The ancient Sen-Dro sport that involves catching a small ball and hurling it using the fullness of their “wingspan”, typically catching it in one hand and hurling it with the other, with much greater force. The Sen-Dro can use this ability to hurl grenades and thrown weapons as if their Strength was 1D higher than it actually is for damage purposes, and the long range for such weapons is increased to 1.5 times the listed range.

Move: 7/9

Size: 2.0-2.5 meters tall

Story Factors:

Vigilant: Having faced extinction, Sen-Dro have a demeanor that is directed towards survival, not the Force or by extension philosophical pursuits. They are focused on being prepared. If not on their home world or anywhere remotely hostile they will always wear an enviro suit. Much of this is psychological, a sort of “Linus blanket”. This enviro suit is outfitted with a data pad, rolls of spacer tape, multi-tools, and various lighting devices.

Sen-Dro vessels are equipped with a redundant power networking core. It diverts power to various systems around the ship, acting as a breaker box, but also having the ability to reroute power in case of power loss. It is heavy, bulky, and scary looking to non Sen-Dro. The Sen-Dro use them because they really like being prepared for emergencies.

NEW ALIEN SPECIES: THE SEN-DRO

Vocalization: Sen-Dro is a complex language when not spoken in bubbly squawks is conveyed through song. They also engage in a form of deep, droning throat singing that serves as a form of communal meditation.

Technological Nomads: The Sen-Dro have become nomadic and have picked up an amalgamation of the galaxy’s tech very quickly. As of the time of the Empire they are nearly at par with the rest of civilization.

Ships: Sen-Dro torchships are not legal to use in most systems due to the sensor noise they create with their plasma drives. Operating one in most systems is a class IV or V infraction. Torchships have been retrofitted with conventional Hoersh-Kessel ion drives, however.

Linus: The Sen-Dro use a unique power control device on their vessels that is called a “Linus”. It appears as a roughly one meter on a side cube with bundles of cables stretching off of it in various directions. On the front near the top is a small display panel with lights that indicate the power status. In addition to being able to deal with power surges caused by solar storms, EMP effects, and Ion weapons, the linus has the ability to re-route power inside the ship to bring otherwise non functioning systems back on line.

CV7 3D10A-K10 YK-JMV
EK3NK↓, NMO 12VAKK7
(Red Mountain Valley Habitat, New Senaar)

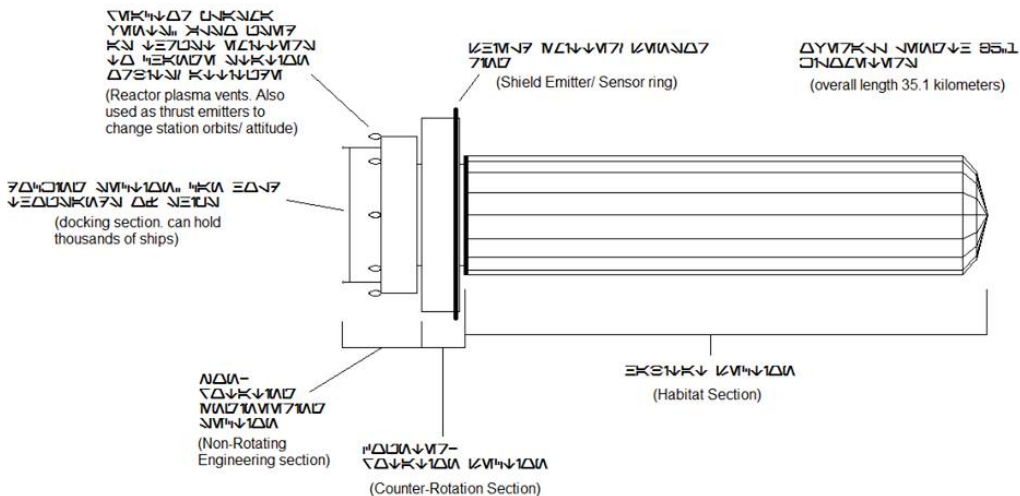

Senaar Cylinder

The Senaar Cylinder is the orbital habitat of the Sen-Dro. Though they are an ancient technology, the Sen-Dro have slowly incorporated galactic level tech into their design and made something beyond just a space station. These creations are nothing short of artificial worlds.

The first cylinders were built before first contact with the Mandolorians. After contact, the design changed into the cylinder we see today. Most modern habitats are around thirty to forty kilometers long, with a main habitat section taking up most of the space. A counter-rotating stabilizing section is behind that, which also acts as a mount for the shield projectors, sensors, numerous comm antennas, and tractor beam projectors. The rearmost section is the engineering section. It does not rotate and houses the reactors, engines, various machinery, and the bowl shaped spaceport section, which is at the very back and can hold thousands of vessels.

The habitat section has a surface area measured in hundreds of square kilometers. This is where most of the Sen-Dro live. The habitats are normally named after the place on Senaar that provided the soil, rocks, water, flora, and fauna. The trees, buildings, and clouds normally obscure lines of sight to the point that one does not see the inner curvature of the habitat. Beneath the inner surface, there is a maze of hydroponic gardens, transport tubes, and other infrastructure.

The stabilizing section is a sparsely populated, but extremely important part of the station. It rotates in the opposite direction of the main section in order to counter any gyroscopic effects. It has sliding plates inside that configure themselves to balance the station to avoid vibration. On the outer ring the sensors, shield emitters, communication arrays, and tractor beams protect the station from space debris, solar flares, and collisions.

The rearmost section of the cylinder is the engineering section. This is where the reactors are housed, along with systems to steer the station and change its orbit. On the very back of this section is the docking area. This is a spaceport that can host thousands of vessels simultaneously, from small freighters up to kilometers long cargo ships. This is also where most of the commerce happens, and where one is most likely to find non Sen-Dro on one of these mini-worlds.

NEW ALIEN SPECIES: THE SEN-DRO

Craft: Senaar-Drotan Red Mountain Valley Habitat (others similar)

Type: Space Station Habitat

Scale: Death Star

Length: 35.1 kilometers long

Skill: Astrogation (see note “a” at end of stats)

Crew: 100,000

Crew Skill: Astrogation 7D, Capital Ship Gunnery 5D, Communications 5D, Sensors 6D

Passengers: Roughly 800,000 permanent residents, the crew listed above, and another 100,000 or so “passers through”

Cargo Capacity: Internal area is in excess of 400 square kilometers. Estimated to be around 100,000,000 tons

Consumables: indefinite

Cost: Not for Sale

Hyperdrive Multiplier: N/A

Hyperdrive Backup: N/A

Navicomputer: No (no hyperspace navigation)

Maneuverability: 0D

Space: 1 (see note “b” at end of stats)

Atmosphere: N/A

Hull: 4D

Shields: 1D

Sensors:

Passive: 100/ 0D

Scan: 200/ 1D

Search: 400/2D

Focus: 10/3D



**Master of Engineering
with Navigation Key**

Weapons:**160 Tractor beam emitters** (see note “c”)*Fire arc:* Turret*Crew:* 6*Skill:* Capital Ship Gunnery*Fire Control:* 2D*Space Range:* 1-5/15/30*Damage:* 4D capital scale**Notes:**

a- One does not so much pilot a Senaar Cylinder as much as they do a lot of math and tell the navigation control computer what to do. The station can be commanded to change its axis by 5 degrees per turn, move forward at one move, space rating 1, accelerate to two moves for a total space of 2 per turn, decelerate to one move, or stop. There is a delay involved, any command is executed at the end of the next round. One must have the Grand Master of Engineering's *Navigation Key* in order to give the computer commands.

b- The habitat can increase or decrease its speed by one move per round. It takes 2 rounds to get up to full speed, and 2 rounds to get to a complete stop from full speed as well. It takes ten rounds to bring the engines online in order to execute any movement commands via the computer. All movement commands require a difficulty *moderate* Astrogation roll to enter. Commands can be queued, but each command is entered at one level of difficulty higher than the previous command.

c- No more than ten tractor beams can be brought to bear on one target. There are also smaller units in the docking area, but these are treated as shipboard equipment and not as space weapons due to their extreme short range.

Pre Contact Sen-dro Torchship

The pre-contact torchship is a primitive vessel that lacks the benefits of galactic level technology. It has no shields, inertial dampeners, artificial gravity, or repulsors of any kind. Travel on such a vessel is cramped, uncomfortable, and at times, downright scary.

At one time these vessels (and variants of them) were the mainstay of Sen-Dro space travel. After contact with the Mandalorians, the Sen-Dro quickly adopted repulsorlift technology, along with the related tech of inertial dampeners and artificial gravity. This caused them to re-design their torchships to incorporate these new technologies, and the vertical style torchship quickly fell out of favor.

In the post contact era the archaic torchship is mostly used to push asteroids into more favorable locations for mining purposes. The crew pilots the ship to the asteroid to be pushed and then goes to work. They connect a scaffold system to anchor the ship to the asteroid, and then re-supply the ship. If the haul is short, two crewmembers stay on board and pilot the ship to the collection point. For longer hauls the ship is piloted by a droid and accompanied by a newer ship to in case of emergencies.

Due to the vented fusion plasma drive not being able to resonate properly to transmit BoSS ID codes, these vessels are registered locally and are not part of the BoSS database. They as a result are restricted to local use and cannot be taken out of system.

Craft: Senaar-Droten Archaic Pre-Contact Style
Torchship

Type: Archaic in system spacecraft

Scale: Starfighter

Length: 18 meters tall

Skill: Archaic Starship Piloting: Sen-Dro torchship

Crew: 3

Crew Skill: Variable

Passengers: 1

Cargo Capacity: 20 tons

Consumables: 9 days

Cost: 35,000 credits new, 10,000 credits used

Hyperdrive Multiplier: N/A

Hyperdrive Backup: N/A

Navicomputer: No

Maneuverability: 0D

Space: 1

Atmosphere: 600kmh/ 210

Hull: 2D

Shields: 0D

Sensors:

Passive: 5/ 0D

Scan: 10/ 1D

Search: 15/2D

Focus: 1/3D

Weapons: None

Special Equipment: Basic Linus Power Controller.

Linus Power Controller

The stats below reflect a basic linus unit on a Starfighter scale transport.

Cost: 1000 credits, installation 1000 credits (half price on installation in Sen-Dro controlled areas)

Installation Difficulty: One Moderate difficulty space transports repair roll per day for 3 days. If the difficulty is missed, but the player rolls a 10 or more, add one day to the time taken and roll again the next day. If the player rolls a 9 or lower, it requires a part that costs 1D x 10 credits, and adds another day as listed above. If the player rolls a 5 or less, they have damaged something in the linus that will require an overhaul once it is installed. This also adds another day as shown above.

Tonnage/ cubic meters taken: 1 cubic meter, 1 ton cargo space

Shunt rating: 1D (as long as the linus is functioning and not in

need of an overhaul, the shunt rating is added to the hull rating when resisting ion weapons or ionizing effects. If the player rolls a 1 on the wild die to resist damage, the Reroute Logic Rating is reduced by 1 pip)

Reroute Logic Rating: 3D (when power is lost to an onboard system, the linus rolls automatically once per round to restore power. If successful, power is restored to the offline system. The difficulty is as follows-

Lightly damaged=easy

Heavily damaged=moderate

Severely damaged= difficult

If successful, power is restored, and the linus reroute rating is lowered by one pip.)

Service/ overhaul rules and costs: When a linus is reduced to 2D+1 Reroute Logic Rating, a yellow light begins blinking on the linus, and it sends a message to the main computer stating that the linus must be serviced soon. A service restores the linus to 3D reroute rating, and costs 100 credits in a non Sen-Dro system. The service only costs 50 credits in a Sen-Dro controlled system, and is often done for free if the character is having other work done on their ship.

The difficulty for this task is Easy, takes 2 hours, and 20 credits worth of supplies if the characters would like to do this themselves.

If the linus has its reroute rating lowered to 2D or lower, and the player rolls a 1 on the wild die (effectively rolling a 0) a red light lights up on the linus and it locks down in protective mode. The linus will cease to function, and the shunt rating is reduced to 0D until an overhaul can be done. Overhaul takes a day and costs 500 credits in non Sen-Dro controlled systems. The price is only 250 credits in Sen-Dro controlled systems. The difficulty for this task is Moderate and takes 200 credits worth of supplies if the characters would rather do this themselves.

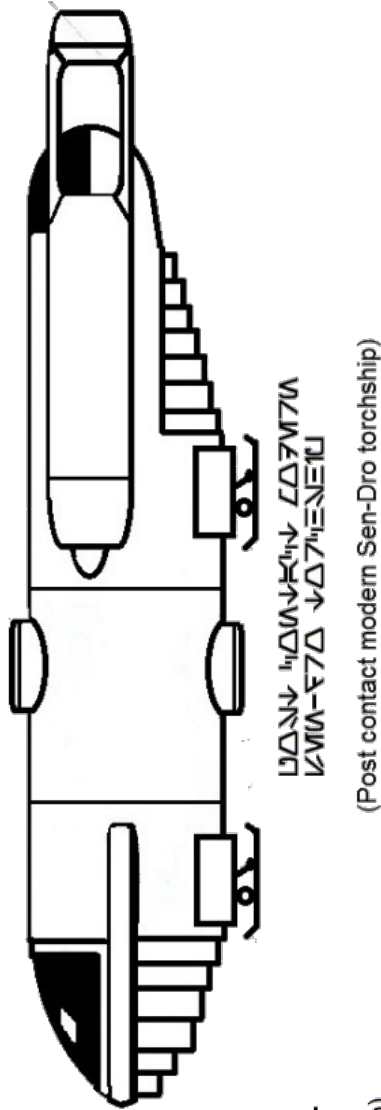
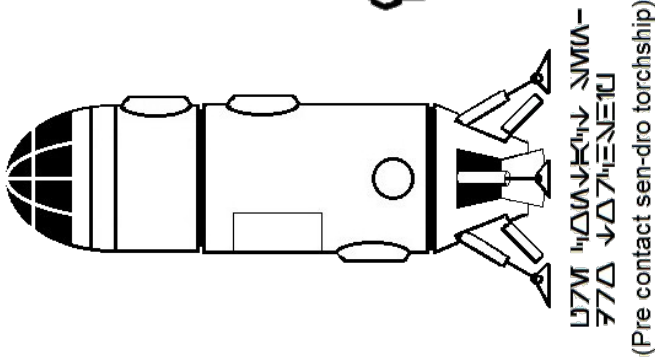

Post Contact "Horizontal" Sen-dro Torchship

The post-contact Sen-Dro torchship is an intra-system vessel the Sen-Dro developed after their first contact with the Mandalorians. The assimilation of repulsorlift and related technologies drastically changed their ship designs.

Repulsorlift technology, along with inertial dampeners and artificial gravity led to a radical redesign of the torchship. With the introduction of repulsorlift drive the ships could be built with a horizontal plan, and didn't need to land on a column of superheated plasma from the main engine. Cargo doors could be positioned fore and aft for easy loading. Inertial dampeners allowed the vessels to accelerate and decelerate at speed that would normally flatten the crew. Once artificial gravity came into play, the ships became far more comfortable, and could have a horizontal layout with the deck perpendicular to the standard direction of travel. The addition of these technologies makes piloting these vessels far more familiar to those with experience operating transports in the rest of the galaxy, and removes the requirement of having knowledge of archaic ship piloting.

While vastly more advanced than the vertical torchships, these ships are still not equipped for interstellar travel. They do not possess hyperdrives, armament, or HK ion engines. These items can be added to the torchship, however. Some Sen-Dro traders do operate upgraded torchships as light freighters, and these simple, reliable ships do well in that capacity.

Due to the vented fusion plasma drive not being able to resonate properly to transmit BoSS ID codes, these vessels are registered locally and are not part of the BoSS database. They as a result are restricted to local use and cannot be taken out of system, unless the engines are upgraded to BoSS standards and the ship is in their registry.

Craft: Senaar Droten Tolpa Class Freighter, 23rd Gen

Type: Stock Light Freighter

Scale: Starfighter

Length: 34.7 meters

Skill: *Space Transports: Horizontal Torchship*

Crew: 1 or 2

Crew Skill: Variable

Passengers: 6

Cargo Capacity: 120 tons

Consumables: 60 days

Cost: 75,000 credits new, used around 20,000

Hyperdrive Multiplier: N/A

Hyperdrive Backup: N/A

Navicomputer: No

Maneuverability: +1

Space: 2

Atmosphere: 225/ 650 kmh

Hull: 4D

Shields: 0D

Sensors:

Passive: 10/ 0D

Scan: 25/ 1D

Search: 40/2D

Focus: 2/3D

Weapons: None

Special Equipment: Basic Linus Power Controller.

Want to Write for the Adventurers Journal?

The *Adventurers Journal* is looking for artists and writers who have new ideas, know the Star Wars universe and can produce quality work. If you have an idea for a Journal article you would like to write, or have an original piece of artwork or photography to submit, ask us for a copy of the *Adventurers Journal Submission Guidelines*. It will breakdown what were looking for and how to submit your proposal.



All you have to do is send us a message telling us why you'd like to write, photograph, paint, or sketch, for the *Adventures Journal*. You should probably tell us a little bit about yourself and send it along with a one page sample of your writing or a single piece of artwork.

Send your proposals via an email at the following address: adventurersjournal@groups.facebook.com or visit us on our Facebook Group Page.



And he said “that’s the last thing heard my father say before falling off the tower.” Of course his father was Darth Vader and we in The Dark Empire Costume Club like to focus on bringing the joy into peoples lives, not destroying dreams, severing limbs or crushing rebellions. So if you need a break from reality, and perhaps your dark father, come join us in bringing a smile to a child’s life through the power of the force.

The Dark Empire Costume Club. Bringing light through the Dark Side. Severed limbs not included.

WWW.THEDARKEMPIRE.ORG

Specializing in custom Sith, bounty hunters, smugglers and pirates.

© 2018 LucasFilm LTD. & TM. All Rights Reserved. Used under Authorization Photography my My Geek Gallery

Aurek Jenth in...





JUST FOR ONE DAY,
YOU ARE THE HERO!

A Solo Adventure
by Mark Dowson

In this solo adventure you get to play the character of Aurek Jenth. Long before he was a Location Scout, after serving in the Antarian Rangers, he was an Adventurer. First you will need to create your version of his character, using the Adventurer Character Template on *page 40*.

From looking at the template, you can see he has six attributes; Dexterity, Knowledge, Mechanical, Perception, Strength and Technical. These attributes each have values next to them in the form of a number, followed by the letter “D”, which stands for dice. All of them also have either “+1” or “+2” after the “D”. At times during the adventure, when you are attempting a task where the outcome is not certain, you will be asked to roll either the number of dice you have in a specified attribute or more likely a stated skill based off it (more about skills later). For example, with having for an attribute, Dexterity 3D+1, you would roll three six-sided dice and add up the result. You will be then told to go to one section number if this result is equal or over a certain number or to another section number if it is less than this.

With the “+1” or “+2” after the “D”, this value will be added to the combined total from the number of dice you rolled. For example, with having for an attribute, Perception 3D+2, you would roll three six-sided dice. If you rolled a 5, a 2 and a 6, you would add them together to get a total of 13. You would then add the +2 to it to get 15!

With attribute and skill rolls you can if you want use the Wild Dice rules from the second edition Star Wars rules. One of the dice you roll, before rolling it, is designated the Wild Dice. If it rolls a 6 you get to roll another dice, which also counts as a Wild Dice, and add the result from that one to the total. If you roll a 1 on the Wild Dice however, you must discard the highest result rolled on one of the other dice in that roll and the 1 the Wild Dice rolled.

As mentioned earlier on, you also have skills based off the attributes. These can be up to one or two dice higher than the attributes they are based on. Essentially you have six dice to put into your skills and you need to pick which ones you will put dice into before starting the adventure. You could pick six skills and place one dice in each of them or three skills and place two dice in each of them. Alternatively, you could opt to have dice in five skills with just one with two dice in, or four skills with two with two dice in.

The total value for a skill equals the attribute it is based off plus the number of dice you have put in the skill. For example, if you put two dice into Dodge, which is based off Dexterity, and you have 3D+1 in Dexterity, that would give you 5D+1 in Dodge! If you have not placed any dice in a skill, you just roll the dice for the attribute the skill is based off has and if this attribute is a high one, you can still do well.

Aurek Jenth also has three compulsory skill specialisations. The reason for the specializations is because unlike “*A Safe and Secure Society*” there are certain skills, like Blaster and Dodge, you will need to be very good at regardless of what path you take. This is why you have only six skill dice to split between skills, rather than the usual seven. The fifteen skills you have the opportunity to use during this adventure are: Blaster*, Dodge*, Alien Species*, Intimidation*, Languages*, Survival*, Space Transports*, Con, Hide, Search, Sneak*, Brawling, Climbing/Jumping, Stamina, First Aid.

The skills with asterisk after them are the ones you will have to use or should get the option to use regardless of what choices you make, providing you get further enough through the adventure without getting killed.

Each specialisation has “(s)” before it and counts as +1D higher than the skill it is below. If you have put the maximum of two dice in Dodge, that will give you Dodge at 5D+1 and the (s) Blaster Bolts Dodge specialisation at 6D+1!

If you played the previous solo adventure, “*A Safe and Secure Society*”, did not get to shoot anyone and were niffed about that, then this is the adventure for you.

If you fail a *Dodge* roll, you are advised to spend Character Points to make it into a successful one, as unlike with “*A Safe and Secure Society*”, there are not really any second chances on being hit by a blaster bolt. This is most likely to be fatal if not debilitating!

Each Character Point spent allows you to roll a dice and add the result to the total you have already rolled for a skill or attribute roll. In addition to that, if the dice rolls a 6, you also get to roll another dice and add that to the total, just like with the Wild Dice.

Now if you have assigned your skill dice, make sure your blaster’s power pack is fully charged and **turn to page 43**. Good luck and may the Force be with you!

THE ADVENTURER'S JOURNAL FEATURES NEW TEMPLATES YOU CAN PLAY IN SOLO ADVENTURES, LETS LOOK IN ON FERRIS HOL, A DETECTIVE, IN HER EFFORTS TO FIND A MISSING PRINCESS ON ROTGUT STATION...

Noticing what could be a possible clue you stop short. The blaster marks, on the wall to your left were fired in a determined effort to obscure the telltale pockmarks of a slug-thrower. Raising your hand to gain more insight from your psychometry you hear a shuffle to your right.

A vocabulator laced voice greets you callously from behind a drawn blaster,

"Greetings from Gutter Town!"



To Dodge go to 37.

To Rush the source of the voice turn to 56.

To take your chances at drawing your Blaster go to 89.

Continued in **Adventurer's Journal Issue Three**
releasing November 2, 2018

art copyright smif

for more art information inquire at smifink@earthlink.net

THE ADVENTURER

An Adventurer is probably what Luke Skywalker dreamed of becoming during his childhood and adolescence on Tatooine, when he was not dreaming of being a great pilot. It is easy to imagine he might have often fantasised about stumbling into some adventure over the next sand dune, where he found someone in trouble only he could save.

Some adventurers are motivated by idealism, like Luke Skywalker, while others by the dream of one day getting rich like Han Solo. It is dubious whether either of these iconic *Star Wars* characters would actually fit the Adventurer character template, considering both ended up taking very different paths.

The Adventurer template possibly takes more from the character of Aragorn from Tolkien's *Lord of the Rings*, over two decades before *Star Wars*. It is possible however that the rangers Aragorn was one of, inspired the Antarian Rangers later added to the *Star Wars* universe and which Aurek Jenth use to be one of. The chances are you would also often find adventurers in the Mos Eisley Cantina.

Essentially you are looking at a character who can survive in the wilderness of a planet's surface without the resources of a large settlement and the aid of others. They can find things others cannot, be masters of stealth and when it comes to a firefight they have the potential to be more capable with a blaster than most mere scouts.

You might not be as good in the cockpit of a starship as many characters or as proficient with using and fixing technology but you do well in most other areas!

STAR WARS ADVENTURERS JOURNAL



Character Name Aurek Jenth

Player Name _____

Template Type Adventurer

Gender / Species Human Male

Height _____ **Weight** _____ **Age** _____

Physical Description _____

Dexterity 3D+1

Blaster(_____) (s) Blaster Pistol (_____)

Dodge(_____) (s) vs Blaster Bolts (_____)

Knowledge 3D+1

Alien Species (_____) Intimidation(_____)

Languages (_____) Survival (_____)

Mechanical 2D+2

Space Transports (_____)

Perception 3D+2

Con(_____) Hide(_____) Search(_____)

Sneak (_____) (s) Rocky Terrain (_____)

Strength 2D+2

Brawling(_____) Climbing/ Jumping(_____)

Stamina(_____)

Technical 2D+1

First Aid(_____)

Special Abilities: Force Sensitive

Background: You have always fought the good fight for the downtrodden and justice. This compassion and empathy gave you the strength to distance yourself from your responsibilities as Prince of Lazenian IV. You could no longer stand idly by while your family sided with the Empire. With a galaxy of possibilities before you, a life of adventure and purpose awaited you and Antarian Rangers provided the basis for your training and background. Your assignment to a Jedi Master during the Clone Wars opened your eyes to much more than you could imagine. Eventually the Empires machinations forced you and your fellow rangers into hiding, instead you decided to hide in plain sight by doing what good you can whilst living a life of adventure.

Personality: You have a great ability to put your thoughts into action, with little to no wait once your mind is set on something. You do not tolerate injustice and if able will try to put a stop to it.

Objectives: See the wonders of the galaxy and fight any injustices.

A Quote: "Watch where you step, think first, and be the last to speak."

Connection with other characters:

Equipment: Shoulder bag, long brown coat, blaster pistol (range 3-10/30/120, 4D damage, ammo 100)

Movement 10 **Wound Status**

Char. Points 5 **Stun** 00

Force Points 2 **Wounded** 00

Force Sensitive? **Incapacitated** 0

Dark Side Pts. **M. Wounded** 0

Standing behind the pilot's and co-pilot's seats in the cockpit of a Pre-SoroSuub light freighter, you watch, as around you through the cockpit canopy, the purple swirl of hyperspace gives way to the white blaze of star lines contracting into stars.

“We’re almost there,” says Jacara, the co-pilot, to you without turning away from her task to face you. While this just leaves you looking at the back of her head, where her shiny black hair is tied back in a pony tail, you are certain she probably has her usual crooked smile on her young face and a twinkle in her eyes. You suspect she might have glanced round at you if her grumpy Sullustan captain, Synub Lien, had not been there in the pilot’s seat.

“Then the two of you will have your ship to yourselves again for a while,” you reply.

“Yeah, well even Synub won’t object to having you as a paying passenger,” Jacara says, “Especially if you come through with arranging a trade deal between us and those indigenous sentients you mentioned. As far as half planets go, Rardae doesn’t have much going for it. One civilised settlement where you can only just manage to find a semi-decent game of Sabacc.”

“The Mizelines will appreciate practical off-world goods through fair trade and in return can provide natural medicines and rare minerals,” you tell Jacara.

“We’ll see,” grunts Synub.

Through the cockpit canopy you can see one star swelling into the pale pink luminous disk of the star system’s sun. It is a red dwarf star; the commonest of all stars, due to being smaller, long lived and relatively cool.

Jacara is in a sense right to refer to Rardae as a half planet, you think, as it grows from a pin prick of light to a dim disk. With it being tidally locked to its sun the same side always faces the red dwarf star, while the other side forever faces away. Due to the night side being too cold for life, only the day side half of it receives enough warmth for it to be habitable. Considering having both a night and a day was probably one of the defining features of a planet for a spacer like Jacara, for a planet to only have one out of two of these might also make it half a planet.

Your own upbringing was not on a spaceship but as a prince of the planet, Lazerian IV. Then there was the rebellion against your family as they sided with the Empire, which changed everything.

Later, in exile, you joined what was left of the Antarian Rangers. Like the Jedi Order, who the Antarian Rangers had worked for, the Empire had done their best to wipe them out. Your time as an Antarian Ranger also came to an end and now you are just plain Aurek Jenth but you still retain the skills from your training and the attitude.

As you draw closer, Rardae becomes more than a featureless disk but not by much. The night side is dark due to being eternally in shadow, while the day side is dark in places due to the black vegetation, which has evolved to absorb light from the infrared end of the spectrum.

On Synub's and Jacara's ship, the Roving Nugget, beginning its descent through Rardae's atmosphere, the blackness of space is replaced with a pale pink sky, featuring an unmoving red sun. The landscape is arid and rocky with the black of the dry plants which make up Rardae's vegetation.

Prospectors' Town comes into view below you, a mass of white prefab buildings and service facilities for space ships, tinted pink in the light of the red sun. Dotted around are the occasional wind turbine power generators. In the north of the town there is the permanent duracrete and metal structure of an ore refinery. Rardae's modest wealth in minerals is about the only attraction for most off-worlders, apart from it being directly on the Perlemian Trade Route in the Expansion Region. With a whine of repulsorlifts, followed by the thud of the landing gears, the Roving Nugget lands in one of the docking bays.

A short while later you are outside in the thin cold air, having made what preparations you need to survive in the desert. As you remembered from your last visit to Rardae, it is also very windy but the prefab buildings around you provide some shelter.

Everything you own is either in the shoulder bag you are carrying, on your belt, like your blaster pistol, or in the pockets of your long brown coat.

Go to 9 if you wish to head straight out to where you remember the Mizeline settlement is, **or to 17** if you visit a cantina to learn what has been happening on Rardae since last you were here.

2 Klenth looks up at you, as he gets you the drink you order, and says “Your face is familiar, but I cannot put a name to it. That probably means you’ve been in here a few times awhile back but not much more than that.”

“Correct,” you agree. “The name’s Aurek. I was here several months’ back.”

“Your name does sound familiar. I remember you now.”

“Has anything of interest happened recently?”

“You know how it is? They turn up hoping to make a fortune prospecting and either don’t and leave or manage to make enough to keep them sticking around. You then often have the same traders dropping by every few weeks and every so often someone arrives with some new enterprise.” An attractive blue skinned Twi’lek sidles up to you, beating the Zeltron woman to it, and says softly,

“If you’re interested I could show you around...”

“That won’t be necessary, madam,” you reply.

“Ah, you have business you feel you must attend to first,” she smiles. “I admire a man of dedication. I am Reska Jat and we will speak later.”

“It will be a pleasure,” you courteously reply, and she leaves you in peace but through intuition from the Force you suspect your path and hers will be linked.

Turn to 16 if you attempt to speak with Klenth in his native Klatooian language to see if that will result in him telling you more. **Alternatively, turn to 9** if you leave the cantina **or to 14** if you wait until the Trandoshans leave then discreetly follow them. **Turn to 50** if you believe you have reason to shoot the Trandoshans and draw your blaster to do so.

3 “I’m sorry,” exclaims Klenth, “Did you mean to say, “My mother dances on your head?”

Turn to 9 if you leave the cantina **or to 14** if you wait until the Trandoshans leave then discreetly follow them. **Turn to 50** if you believe you have reason to shoot the Trandoshans and draw your blaster to do so.

4 You manage to convince the Trandoshans that you are too pathetic to be worth their time and just a bit dumb as well.

“Fine, we’ll let you live,” one of them snarls, smacking you across the face with his claw “But if you try following us again I’ll show you what I do to Wookiees...”

The Trandoshans disappear out of the cantina door and knowing you would not succeed in following them now, you wait until they would be long gone before leaving yourself. **Go to 9.**

5 You fail to notice any interesting tracks. Perhaps strong winds have eradicated any tracks, or no one has been outside of Prospectors’ Town over the last few days. **Turn to 19.**

6 Roll the number of dice you have in your Hide skill or Perception. On a result of 10 or more, **turn to 11**. On a lower result, **turn to 30**.

7 The Shistavanen roars in frustration, as his shot misses you, due to the shaking of the ship throwing off his aim, and you return fire. Roll one less than the dice in your *Blaster Pistol* skill specialization. On a result of 14 or more, **go to 88**. On less than this, **go to 20**.

8 Leaving Klenth’s Cantina, you step out into a white prefab building lined street. **Go to 9.**

9 Out in the red light of the unmoving sun you make your way passed the prefab buildings to the edge of the settlement. There you see a stony desert stretching to the horizon with many huge rock formations breaking the skyline. There is no shelter here at all from the cold wind and the sting from grains of sand carried by it, hitting your face. Dotted among the stones is the black of dry and hardy plants. Some of these are even small trees.

Roll the number of dice you have in your Search skill, Survival skill or Perception. On a result equal or over 15, **go to 13**. On a result less than this, **go to 5**.

10 Roll the number of dice in your *Con* skill or Perception. On a result of 18 or more, **turn to 4**. On less than this, **turn to 49**.

11 The figure does not seem to notice you as they pass you and the rock formations and disappear from view. **Turn to 54**.

12 Suddenly you find yourself sinking, having stepped into a

patch of quicksand and as you end up waist deep, you scramble to escape, clawing at the sand. Roll the number of dice you have in your Climbing/Jumping skill or Strength. On a result of 9 or more **go to 18**. On a result less than this, **turn to 101**.

13 The way some of the stones have been disturbed catches your eye and you see they are consistent with tracks made by boots and in some cases the clawed feet of the reptilian Trandoshans. The soft footed native Mizelines would not disturb the stones in this way. **Turn to 28** if you want to follow the tracks, which look like they could be going towards the Mizeline settlement **or to 19** if you ignore them and make your own way directly there.

14 You buy a drink at the bar and sip it there slowly while waiting for the Trandoshans to finish here. You have about a quarter of your drink left by the time they do get up and move towards the door. With their backs to you and them several metres in front, you start after them. Roll the number of dice you have in your *Sneak* skill or Perception. On a result of 8 or more, **go to 23**. On rolling lower, **turn to 39**.

15 Roll the number of dice you have in your *Blaster Pistol* skill specialization. On a result of 14 or more, **go to 88**. On less than this, **go to 20**.

16 Roll the number of dice you have in your *Languages* skill or Knowledge. On a result of 10 or more, **go to 21**. On a result less than this, **turn to 3**.

17 As far as settlements go, Prospectors' Town is not much to look at. Prefab buildings, by their nature, are bland and in no way architecturally interesting. The small ones you guess are homes and little shops, while the bigger ones belonged to large businesses.

One of the slightly larger buildings has "Klenth's Cantina" written in large letters on the side. Inside is the usual collection of chairs and tables with a bar to your left and a dozen patrons sat or stood around drinking and talking. About half of them are human and the rest various common alien species. From above light filters in through dusty window panels in the roof.

There is a red skinned Zeltron female by the bar, who is almost certainly the kind of trouble you do not want to get into. The barman himself is an overweight Klatooinian with wrinkled green

skin and a missing eye replaced with a metal prosthetic. Stood off to one side are two bird headed aliens in environmental suits. Sat at a table are two tall reptilian Trandoshans with brown scaly skin. The two of them are holding a conversation in their own native language, full of hissing sounds.

Roll the number of dice you have in your *Languages* skill or Knowledge. On a result of 16 or more **go to 42**. On a result less than this, **go to 26**.

18 Exhibiting a stubborn refusal to give up and die in a sandy grave, you drag yourself out onto firm sand and lie there breathing hard for a few moments, as much from your narrow escape from death as the exertion. **Go to 44**.

19 You begin your trek across the desert towards the Mizelines' settlement. After a few hours, over a rise you descend into a large stretch of sand dunes, dotted with large rocks and areas of gravel. Roll the number of dice you have in your *Survival* skill or Knowledge. On a result of 12 or more **go to 32**. On a result less than this, **go to 12**.

20 A sudden lurch from the ship, reminding you of its dire predicament, throws your aim off. Your shot explodes harmlessly against the bulkhead to the side of the cockpit doorway and with a throaty growl, the Shistavanen returns fire. Roll the number of dice in your *Dodge Blaster Bolts* skill specialization plus one extra dice. On a 13 or more, **turn to 7**. On less than this, **turn to 102**.

21 Klenth pauses in thought then speaking quietly in the Klatooinan language, mentions,

“There are these new lot who arrived a few weeks ago.” He glances towards the Trandoshans briefly then back to you. “I don’t think they have their ship in any of the docking bays but somewhere out in the desert. They strike me as quite a dangerous bunch best stayed clear of and they are not open about what they are up to.”

“Thanks, you have been very helpful.”

“Well you didn’t hear it from me.”

“Of course not. Hear what?”

Turn to 9 if you leave the cantina **or to 14** if you wait until the Trandoshans leave then discreetly follow them. Turn to 50 if you believe you have reason to shoot the Trandoshans and draw your

blaster to do so.

22 The Shistavanen fires at you first. Roll the number of dice you have in your *Dodge Blaster Bolts* skill specialization and add one dice to this. On a result of 16 or more, **turn to 7**. On less than this, **turn to 102**.

23 You follow the Trandoshans outside into the red light of the unmoving sun above. The prefab buildings provide good cover for you to hide behind; when at one point the Trandoshans glance back and do not see you.

A short while later the Trandoshans pass the last few buildings of Prospectors' Town and start across the open expanse of stony desert you can see beyond, stretching to the horizon. There many huge rock formations break the skyline. There is no shelter here at all from the cold wind and the sting from grains of sand carried by it, hitting your face. Dotted among the stones is the black of dry and hardy plants. Some of these are even small trees. Allowing the distance between the Trandoshans and you to widen, you continue after them. After a few hours, over a rise, you descend into a large stretch of sand dunes, dotted with large rocks and areas of gravel. **Turn to 44**.

24 A short while later you are passing between high boulder-like rock formations with the wind blowing fiercely from behind you, when you see across the exposed terrain ahead a humanoid figure making their way your direction. At this point you are not far away from the Mizeline settlement and you can see in the distance the rock formation you know it is behind.

Turn to 6 if you wish to avoid the figure by hiding behind the rock formations, **or to 30** if you make no effort to evade them.

25 "Surrender now and you need not end up like your companion!" you call out. Roll the number of dice you have in your *Intimidation* skill or Knowledge. On a result of 10 or more, **turn to 55**. On lower than this **turn to 41**.

26 The Trandoshans are speaking too fast for you to work out what they are saying. All you can hear is reptilian hisses, but you do not have a good feeling about them.

Turn to 9 if you wish to leave the cantina. **Go to 2** if you wish to talk with Klenth himself, behind the bar, and see if he has news of any changes since you were last on Rardae. **Turn to 14** if you

wait until the Trandoshans get up and leave then discreetly follow them to see where they go.

If you want to try and recall what you know about the various alien species here before making a move, roll the number of dice in your *Alien Species* skill or Knowledge and on a result of 10 or more, **turn to 35**. On a result less than this you cannot recall anything relevant and must just pick one of the above options.

27 The Trandoshans are oblivious of you, as you sneak close enough to fire at them. You can shoot just one of them, rolling the number of dice you have in your *Blaster Pistol* skill specialization or one less than this for each shot, if you fire twice. For each result of 10 or more you have hit a Trandoshan. **Turn to 51** if you fail to hit any of them, **to 57** if you do hit one, **or to 64** if you hit both of them.

28 You begin your trek across the desert towards the Mizeline settlement. After a few hours over a rise you descend into a large stretch of sand dunes, dotted with large rocks and areas of gravel. The tracks continue through the sand but are very faint, due to being eroded by the wind. **Go to 44**.

29 Feeling pretty dreadful from dehydration and being blasted by sand storms and suffering dizziness and a splitting headache, you are forced to rest in the shade of some black leafed trees before you are able to continue. If you were trailing two Trandoshans, you have now fully lost sight of them. You have no choice but to just head toward the Mizelines' settlement you were intending to visit anyway, which is in the same direction as you have been traveling. **Go to 24**.

30 As the humanoid figure gets closer, you make out the fur and pointy ears of a Mizeline. This one does not have as many of the animal hide accessories its species typically wear for carrying things in. This is unusual but not as much as the blaster pistol in its hand, which, on seeing you, it points at you in an agitated fashion, blatantly considering you a threat. **Go to 43** if you wish to try and calm the Mizeline down, reassure it you are not an enemy and find out what is wrong. **Turn to 66** to try and take the blaster from the Mizeline. **Turn to 72** to back away and get behind a rock formation.

31 The Twi'lek's blaster shot flies over your head. **Go to 53** if you return fire, **or to 25** to try and persuade him to surrender.

32 You notice a patch of sand ahead of you which is ever so slightly darker than the surrounding sand and recognizing it as quicksand, you skirt around it. **Go to 44.**

33 You are aware that Twi'leks have a tendency not to be the bravest of species and you catch a glimpse of the cranial tentacles of the one facing you moving in a way which suggests it is not confident of coming out of this firefight alive. **Go to 25** if you try and persuade him to surrender **or to 53** if you just try and shoot him.

34 You continue trailing the Trandoshans, passing among rock formations at one point then across one final expanse of exposed terrain you see a large rock formation you recognise as the one the Mizeline settlement is behind. On reaching it, the Trandoshans go around the rock formation. **Turn to 75** if you follow them by this route or to 61 to climb over the rock formation. **Turn to 46** if you decide now is the best time to deal with the Trandoshans, while they are on their own, and ambush them.

35 Trandoshans are aggressive and bad natured and have a tendency to hate Wookiees and of being involved in very nasty ventures, like slavery. Zeltrons have a reputation for being flirtatious and hedonistic. The bird headed aliens are called Sen-dro, tend to be nomadic and originate from a world with immense forests. Klatooins have a history of being loyal to the Hutts but not all are.

Turn to 9 if you wish to leave the cantina. **Go to 2** if you wish to talk with Klenth himself, behind the bar, and see if he has news of any changes since you were last on Rardae. **Turn to 14** if you wait until the Trandoshans get up and leave then discreetly follow them to see where they go. **Turn to 50** if you draw your blaster and shoot the Trandoshans.

36 Roll the 3D+2 you have in your *Perception* and roll 4D for the Shistavanen. **Turn to 15** if you roll equal to him or higher **or to 22** if you roll less than him.

37 Your preparations against the desert conditions seem to have been inadequate. Maybe your protection from the sun was insufficient against the infrared radiation produced by a red dwarf star this close to the world you are on. Perhaps it was your lack of defence against the sand blowing in your face and eyes. Possibly you did not take enough water with you or you did a poor job of

regulating your consumption of it. Whatever your mistake, you feel considerably worse for wear.

Roll the number of dice you have in your *Stamina* skill or Strength. On a result of 12 or more you press on and **turn to 24** if you are on your own **or to 34** if you are trailing two Trandoshans. On rolling less than 12, **go to 29**.

38 At least one of the Trandoshans hears you, as he looks over his shoulder and both of them start running for the cover of the rock formation. You guess they think you might not be alone and thus are not prepared to get into a fight with you. You can shoot just one of them, rolling the number of dice you have in your *Blaster Pistol* skill specialization or one less than this for each shot, if you fire twice. For each result of 19 or more you have hit a Trandoshan. **Turn to 51** if you fail to hit one of them, **to 57** if you do hit one, **or to 64** if you hit both of them.

39 One of the Trandoshans either hears you behind them or catches a glimpse of you with peripheral vision and swings around to face you.

“Look what we have here,” he growls in perfectly understandable basic. “Someone looking for trouble? Why are you following us?”

“Let’s just kill him and be done with,” says his companion, who has also turned to face you. **Go to 50** to draw your blaster and open fire before the Trandoshans attack you. **Turn to 10** to try and talk your way out of this situation.

40 Your shot misses the Twi’lek. **Go to 41**.

41 With desperation the Twi’lek shoots at you. Roll dice equal to what you have in your *Dodge Blaster Bolts* skill specialization. Add one dice to this for your cover. On a result of 8 or more, **go to 31**. On less than this, **turn to 102**.

42 From what you can understand from the conversation between the Trandoshans, they are part of a gang who are forcing some Mizelines to harvest narcotic plants for them. Listening intently, you learn the Mizelines they are using as slave labour are the same ones you intended to broker the trade deal with. This is really not good. The would-be drug dealers have a light freighter and there are a few more of them and some battle droids. You are going to have to deal with them sooner or later and there are no

laws on Rardae.

The Jedi Order would perhaps have taken a dim view to you just killing the Trandoshans right now with the enforcers in this specific moment neither threatening you nor anyone else but the Jedi at times were pragmatic enough to turn a blind eye to such actions on the part of Antarian Rangers, when it suited them.

Go to 50 if you draw your blaster and shoot the Trandoshans, **or to 9** if you let them live and leave the cantina. **Turn to 2** if you speak to Klenth, the barman. Alternatively, **turn to 14** if you wait until the Trandoshans leave then shadow them back to their camp at their freighter. You do however know where that is from what they have been saying. It is at the Mizeline settlement you would have been planning on going to anyway.

If you want to try and recall what you know about the various alien species here before making a move, roll the number of dice you have in your *Alien Species* skill and on a result of 10 or more, **turn to 35**. On a result less than this you cannot recall anything relevant and must just pick one of the above options.

43 Roll the number of dice you have in your *Languages* skill or Knowledge. On a result of 12 or more, **turn to 58**. On a result less than this, **go to 52**.

44 Continuing on your way, you leave the sand dunes behind with the ground beneath your feet becoming stony once more. Roll the number of dice in your *Survival* skill or Knowledge. On a result of 10 or more, **turn to 24** if you are on your own **or to 34** if you are trailing two Trandoshans. On rolling less than 10, **go to 37**.

45 It occurs to you that if the Twi'lek was sensible, he would be receptive to surrendering at this point, but Twi'lek's have a reputation for being deceptive. Dishonest individuals are often less likely to be trusting so he might suspect such an offer on your part is nothing more than a trick for you to get an easy shot in. **Go to 25** if you try and persuade him to surrender **or to 53** if you just try and shoot him.

46 Roll the number of dice you have in your *Rocky Terrain Sneak* skill specialization. On a result of 10 or more, **turn to 27**. On less than this, **turn to 38**.

47 Behind you, you hear the sound of hydraulics, as the boarding ramp is raised, closing the exit shut. This is followed by the whine of repulsorlifts from the ship lifting off.

Not entirely sure what the one responsible is up to, you see the corridor through the doorway is lined with doors. These, both intuition through the Force and a bit of basic deduction and knowledge of ships, tell you just lead to perhaps crew quarters, a wash room and a crew lounge and a galley. The semi-oval door, facing you several metres away, at the end of the corridor, is very likely to lead to the cockpit and that is where you sense you will find the one in charge of this nasty operation.

Before you can proceed down the corridor the door at the end of it opens and through it in the cockpit beyond you see a fierce looking Shistavanen wolf-man. He has one hand on the ship's controls and the other holding a blaster, aimed your direction.

“Whoever you are!” he growls out, baring his sharp teeth and glaring at you with red eyes, “Throw down your weapon and step out into the open or I will crash us into the ground, killing not only us but my pathetic alien slaves below us as well.” **Turn to 36** if you call his bluff and attempt to shoot him **or to 104** if you do as he tells you.

48 With one quick movement you snatch the blaster from the Mizeline's loose grasp and they dart away. Go to **54**.

49 You try and convince the Trandoshans you meant no offence and were not up to anything but quickly realise they are not going to be persuaded to let you live. **Go to 50**.

50 Drawing your blaster in one easy movement, you take the Trandoshans by surprise and open fire at them. Roll the number of dice you have in your Blaster Pistol skill specialisation to shoot at just one of them or roll one less than this twice to shoot at both of them. You need a combined dice total of 6 or more for a Blaster skill roll to result in you hitting a Trandoshan.

Go to 56 if your blaster shot or shots miss. **Go to 63** if you manage to hit one of the Trandoshans, **or to 82** if you hit both of them.

51 It could have been due to sand in your eyes or being unaccustomed to the light from the unmoving red sun, but your blaster shots miss and both Trandoshans escape around the rock formation. **Go to 54**.

52 With your only very basic grasp of the Mizeline language, you are not succeeding in getting through to the native and you are at a serious risk of ending up being shot.

Turn to 66 to try and take the blaster from the Mizeline. **Turn to 72** to back away and get behind a rock formation.

53 With grim determination you line your blaster up on the Twi'lek behind the crates and fire. Roll one less than the number of dice in your *Blaster Pistol* skill specialization. On a result of 14 or more, **turn to 62**. On less than this, **turn to 40**.

54 Crossing the final stretch of exposed terrain, you reach the large rock formation. **Go to 61** to climb up and over the rock formation **or turn to 75** to work your way around it.

55 After a few moments' hesitation the Twi'lek stands up from behind the crates with his hands in the air. You quickly change the setting of your blaster to stun and fire at him. He collapses to the ground unconscious. In the cargo bay you see a set of restraints which you put on him so that he will not cause any trouble when he comes around. **Turn to 71**.

56 Your volley of blaster bolts misses and the Trandoshans shoot back at you with blaster carbines. Roll one less than the number of dice you have in your *Dodge Blaster Bolts* skill specialization. On a result of 15 or more, **turn to 86**. On a result less than this, **turn to 102**.

57 A shot from your blaster hits one of the Trandoshans in the back and he falls to the ground, while the other one flees around the large rock formation. Note that you have killed one of the Trandoshans. **Go to 54**.

58 Making the mewling sounds of the Mizeline language, you manage the right words for “friend”, “mean no harm” and inquiring what is wrong, offer your protection. The Mizeline lowers the blaster and relaxes a little, looks over its shoulder, then in a series of rapid mewling sounds begins telling you what has happened. You are not able to understand everything but are able to grasp some ruthless off-worlders have enslaved all the Mizelines in the settlement it has escaped from.

They are forcing the Mizelines to collect certain narcotic plants for them. The Tras-ha-ka plant is normally used by the Mizelines to provide relief for those suffering extreme pain. It does not take

much to imagine how the extracts could be processed into a highly addictive drug which would be worth a fortune.

The Mizeline is too afraid of being recaptured to go anywhere near its village but you do not have that option. The fur covered native wishes you good luck then runs off and you continue to your destination. **Go to 54.**

59 Your shot hits the rough looking human in the head and he falls to the deck. Roll the number of dice in your *Alien Species* skill or Knowledge. On a result of 16 or more, **go to 33**. On a result less than this, **go to 45**.

60 The blaster shot misses and the native drops the gun in shock and runs off. Resuming your journey, **go to 54**.

61 After picking out potential foot and hand holds with a brief visual search up the side of the rock formation, you begin your climb. Roll the number of dice you have in your *Climbing/Jumping* skill or Strength. On a result of 5 or more **go to 69**. On a result less than this, **turn to 84**.

62 Illuminated by the flash of your blaster bolt exploding, the Twi'lek is hit and thrown to the ground, where he lays with his green cranial tentacles twitching. **Go to 71**.

63 One of your shots hits a Trandoshan in the head and he falls to the ground, dead. His companion turns and runs for the door. If you shoot him as he flees, roll the number of dice you have in your *Blaster Pistol* skill specialisation and on rolling equal or over 17 **go to 82**. If you miss or do not shoot at him, you leave the cantina with the barman giving you evil looks and **turn to 8**.

64 With two fast shots you take down both Trandoshans. Note down that you have killed both of them and **turn to 54**.

65 Levelling your blaster at the human and Twi'lek, you open fire at them. Roll one less than the number of dice you have in your *Blaster Pistol* skill specialisation. On a result of 14 or more, **go to 59**. On a result less than this, **go to 73**.

66 You go for the wrist holding the blaster. Roll the number of dice you have in your *Brawling skill* or Strength. On a result of 10 or over, **turn to 48**. On a lower result, **turn to 87**.

*Vile,
wretched
& Ravenous!*

LAIR OF THE RANCOR

*Its only desire was to
Feed!*

LUCASFILM PRESENTS 'LAIR OF THE RANCOR'
STARRING OOLA BOBA FETT SY SNOOTLES & PRINCESS LEIA AS BOUSSH
WRITTEN & DIRECTED BY BIB FORTUNA PRODUCED BY JABBA THE HUTT MUSIC COMPOSED BY MAX REEBO



SARLACCOLOR



ILLUSTRATION BY JAMES HAMILTON

67 Backing away from the Mizeline, you dodge behind a rock formation just before it fires the blaster your direction, shattering a large chunk of the rock. Silence follows. When at last you peer out from your cover, you see the Mizeline has gone, allowing you to continue your journey. **Turn to 54.**

68 You manage to duck in time, as the blaster bolts flash over your head, then leap into the cargo bay and dive behind the cover of some crates there. **Go to 65.**

69 You manage to reach near the top of the rock formation and with the cold wind blowing at you harder at this height, get a good view of the land below you back the way you have come. In the distance you can even make out some of Prospector's Town.

On climbing the final ridge, you see the stone huts of the Mizelines' settlement around twenty metres below you at the other side of the rock formation. To the left of them is a light freighter, the bulk of which is a large flattened cylinder with the traditional cut-off cone shaped cockpit stuck on the end nearest you. Ten of the black furred Mizelines you can see are chained to two carts full of harvested plants, which they are dragging towards the boarding ramp of the ship to unload inside the cargo bay.

Overseeing them is the metal stick like figure of a battle droid, carrying a blaster carbine. Leaning against the ship, watching, is a rough looking human. He then turns away and going up the boarding ramp, disappears inside the ship. Two more battle droids are standing guard over chained up Mizeline slaves who appear to be being allowed to rest. You doubt this is out of any sense of mercy but rather so they can be worked harder without dropping from exhaustion.

Further away you can see more carts with Mizeline slaves chained to them being dragged out across the desert to patches of black vegetation to fill them up with more of the plants the owner of the ship is having them collect. With every two carts you can make out the glint of another battle droid.

Roll the number of dice you have in your *Rocky Terrain Sneak* skill specialisation. On a result of 7 or more, **turn to 89**. On less than this, **turn to 81**.

70 Your shot hits the Trandoshan in the chest and he falls to the ground, smoking. **Turn to 47.**

71 At the end of the cargo bay you see a semi-oval metal door. This you push open. **Turn to 47** if you killed two Trandoshans earlier in the adventure, **to 78** if you killed only one of them **or to 91** if you have killed no Trandoshans.

72 Roll the number of dice in your *Dodge Blaster Bolts* skill specialisation and add 6 to the result. On a total of 11 or more, **turn to 67**. On a result less than this, **turn to 79**.

73 Your blaster shot strikes the crate in front of your enemies and they return fire with a volley of blaster bolts of their own. Roll the number of dice you have in your *Dodge Blaster Bolts* skill specialisation. Add an extra dice to this for your cover. On a result of 11 or more, **go to 80**. On less than this, **turn to 102**.

74 You quickly and stealthily climb back down the rock formation the way you have come. **Go to 75**.

75 Following the rock formation to your right, you reach the side of it after about twenty metres and looking around it, see the stone huts of the Mizeline settlement. Behind them is a freighter, the main bulk of which is a flattened cylinder with the standard cut-off cone shaped cockpit stuck on one end and the engines at the other end. What gets your attention are the ten black-furred Mizelines chained to two carts full of harvested plants, which they are dragging towards the boarding ramp of the ship to unload inside the cargo bay.

Overseeing them is the metal stick like figure of a battle droid, carrying a blaster carbine. Leaning against the ship, watching for a brief while, is a rough looking human, before he disappears up the boarding ramp and into the ship. Two more battle droids are standing guard over chained up Mizeline slaves who appear to be being allowed to rest. You doubt this is out of any sense of mercy but rather, so they can be worked harder without dropping from exhaustion.

You are certainly going to have to do something to free the Mizeline slaves and with the cover from the rocks and your blaster pistol, figure you should be able to make short work of the battle droid guards.

Roll the number of dice you have in your *Rocky Terrain Sneak* skill specialisation. On a result of 7 or more, **turn to 95**. On less than this, **go to 81**.

76 As you pass the enslaved Mizelines on your way to the boarding ramp, you see they are already using one of the battle droid's carbines to blast their chains.

Climbing up the boarding ramp, you see above you a dimly lit cargo bay, cluttered with stacks of crates. From behind some of them a rough looking human and a green skinned male Twi'lek open fire at you with blasters. Fortunately, being on the boarding ramp with most of you still below the floor level of the cargo hold, gives you some cover. Roll the number of dice you have in your *Dodge Blaster Bolts* skill specialisation. On a result of 15 or over **go to 68**. On a result less than this, **turn to 102**.

77 Your shot hits the blaster carbine of one of the Trandoshan's, causing it to explode and killing him with the metal fragments flying from it. **Go to 78**.

78 In the corridor through the doorway you see the Trandoshan you did not manage to kill open fire at you with his blaster carbine. Roll the number of dice you have in your *Dodge Blaster Bolts* skill specialisation. Add a dice for the cover the doorway provides you with. On a result of 11 or more, **turn to 93**. On less than this, **turn to 102**.

79 The shot from the blaster hits you with searing pain. Roll the number of dice you have in your Strength. On a result of 5 or less, **turn to 103**. On a result of 6 to 10, you end up wounded. On anything higher the burn is superficial.

Regardless of what happens to you, the native Mizeline drops the blaster in shock and runs away. If you are wounded, you can use a Medpac to treat the burn but need to roll 6 or more with two less than the dice in your First Aid skill, otherwise you will be at a -1 dice penalty to all your skills for the rest of the adventure. **Turn to 54**.

80 You duck behind the crates in front of you, as the blaster bolts explode against them and flash through the air above and to the side of you. **Turn to 65**.

81 Two of the battle droids open fire at you with their blaster carbines. Roll $3D+2$ for their combined Blaster skill. Roll the number of dice you have in your *Dodge Blaster Bolts* skill specialisation. Add one extra dice for the bit of cover you have. **Go to 92** if you roll higher than the battle droids **or to 102** if you roll lower.

82 With a final shot you blast the last of the Trandoshans and he falls to the ground, smoking. **Turn to 8.**

83 Unable to aim sufficiently, due to more fire from the Trandoshans, your shot misses. Roll the number of dice you have in your *Dodge Blaster Bolts* skill specialisation plus one extra dice to avoid being hit. On a result of 12 or more, **turn to 96**. On less than this, **turn to 102**.

84 Halfway up you slip and losing your footing, fall back down to the stony ground below. Bruised but more or less okay, **go to 61** to try again **or to 75** to find a way around the rock formation on the ground.

85 Roll the number of dice in your *Rocky Terrain Sneak* skill specialisation. On a result of 11 or more **go to 94**. On a result less than this, **turn to 81** if there are two or three battle droids left **or to 98** if there is only one left.

86 The Trandoshans seriously underestimate your agility, as their blaster shots ravage the air where you were moments ago, producing a reek of ozone. Returning fire, roll one less than the number of dice you have in your *Blaster Pistol* skill specialisation. On a result of 8 or more, **turn to 63**. On less than this, **turn to 56**.

87 As you try to grab the blaster, the native fires it. Roll a number of dice equal to one less than you have in your *Dodge Blaster Bolts* skill specialisation. On a result of 11 or more, **turn to 60**. On less than this, **go to 79**.

88 With the red flash of your blaster shot illuminating the cockpit, the Shistavanen falls dead to the ground.

Out of control, the ship rocks and shakes, as you dash to the cockpit, breathing in the smell of burnt fur, as you reach for the controls. Attempting to land the ship safely, roll the number of dice you have in your *Space Transports* skill or *Mechanical*. On a result of 8 or more, **go to 105**. On less than this, **turn to 100**.

Considering that the lives of the Mizelines below are at stake as well as your own, this would be an appropriately heroic moment to spend a Force Point, which will double the number of dice you get to roll, and you would get it back at the end of the adventure!

89 The enemy below have definitely not seen you. **Go to 95** if you open fire at them with your blaster **or turn to 74** if you instead sneak down the rock formation to the settlement.

90 The last battle droid explodes in a satisfying fashion, as your shot hits it and its head and arms fly off different directions.

Eighteen and a half years after the end of the Clone Wars and battle droids are still around for criminal elements to cause trouble with, it seems.

With the battle droids taken care of it is now time to deal with their masters, who must be hiding in the freighter. There will be more battle droids out in the desert, overseeing the Mizeline slaves. It is within the ship you also should be able to remotely shut them down.

First if you have been wounded you can use a medpac to treat your burns, which will negate the -1D penalty if on rolling two less than the number of dice in your *First Aid* skill or Technical, you manage a result of 6 or more.

Once you are ready, you make your way across the rocks to the freighter's boarding ramp. **Turn to 76.**

91 Through the doorway you see in the corridor beyond two reptilian Trandoshans, who open fire at you with blaster carbines. Fortunately, the doorway provides you some cover. Roll the number of dice you have in your *Dodge Blaster Bolts* skill specialisation and add an extra dice to this. On a result of 16 or more, **turn to 96**. On less than this, **turn to 102**.

92 The blaster bolts explode against the rocks near you. **Go to 97 to return fire or to 85 to sneak into a new position** so the battle droids will not know where you are.

93 A blaster bolt sears through the air close enough to singe your hair and you return fire. Roll one less than the number of dice you have in your *Blaster Pistol* skill specialisation. On a result of 6 or more, **turn to 70**. On less than this you miss and **turn to 78**.

94 You manage to successfully sneak away from where you are without them seeing you do so and take up a new position. **Go to 95**.

95 You have enough time to make two shots, rolling the full number of dice in your *Blaster Pistol skill* specialisation for both of them. You can however make three shots by rolling one less than the number of dice you have in your blaster skill for two of them and rolling the full number of dice for the third one.

You need to roll 11 or more for a *Blaster* roll to result in hitting an enemy.

If you destroy all three droids, **go to 90**. If there are droids left, note down how many. If you have destroyed just two of them, **go to 98**. If you have managed to blast only one of them or none of them, **turn to 81**.

96 One of the blaster bolts strikes the side of the door and another just misses you, exploding against the cargo bay wall behind you. Grimly, you fire back, knowing these two will not rest until you or they are dead. Roll one less than the number of dice you have in your *Blaster Pistol skill* specialisation. On a result of 6 or more, **turn to 77**. On less than this, **turn to 83**.

97 Returning fire, roll one less than the number of dice you have in your *Blaster Pistol skill* specialisation. On a result of 11 or more you hit and destroy a battle droid. **Turn to 90** if that was the last battle droid, **go to 98** if there is still one left or turn to 81 if there are two or more battle droids left.

98 The surviving battle droid shoots at you with its blaster carbine. Roll 2D+2 for its *Blaster* skill. Roll the number of dice you have in your *Dodge Blaster Bolt* skill specialisation. Add one extra dice for the bit of cover you have. **Go to 92** if you roll higher than the battle droid **or to 99** if you roll lower.

99 There is the searing pain of a blaster bolt hitting you in the side. Roll the number of dice you have in your Strength. On a result of 8 or less, **turn to 103**. On anything higher you are wounded and have -1D penalty to all your skills for the rest of the adventure, unless you have the opportunity to treat yourself with a medpac. On being wounded, **go back to 98**.

100 Wrestling with the controls, you see through the cockpit canopy the ground hurtling towards you and are unable to pull up in time and die in an explosion of metal and plasteel, as you crash.

The End

101 You continue sinking in the quicksand even when you end up submerged in it up to your neck. A few minutes later and even your head disappears beneath the sand.

The End

102 A blaster bolt strikes you in the side, wounding you, and while you are still in shock from the searing pain, another one hits you, finishing you off.

The End

103 The shot proves fatal with you passing out a moment later then dying.

The End

104 As your blaster clatters to the deck, the Shistavanen wolf-man shoots you through the chest.

The End

105 You only just manage to pull the space transport up in time, smashing through the top of the large rock formation below, as you do so, doing untold damage to the underneath of the ship, before settling down with a bone jarring crunch which could not have done the landing gear any good.

To one side in the cockpit is the battle droid control unit. Its readouts indicate there are five more battle droids still active. It just takes the flick of a few switches to shut them all down.

Outside the ship you are greeted by a lot of very grateful Mizelines, who are very eager to trade for weapons to ensure they will never be enslaved again.

Back in the ship you use the com system in the cockpit to contact the Roving Nugget. Synub's grumpy Sullustan voice replies.

"Aurek Jenth, here," you tell him. "I have the trade deal negotiated and possibly a quarter share in salvaging a light freighter. Here are my coordinates..." After you have read out the coordinates, Syunb mentions him and Jacara have a new passenger in addition to you; a blue skinned female Twi'lek, called Reska Jat, who requires a detour to Rotgut Station...

The End

<https://www.facebook.com/empiretoyworks/>
<https://www.instagram.com/empiretoyworks/>

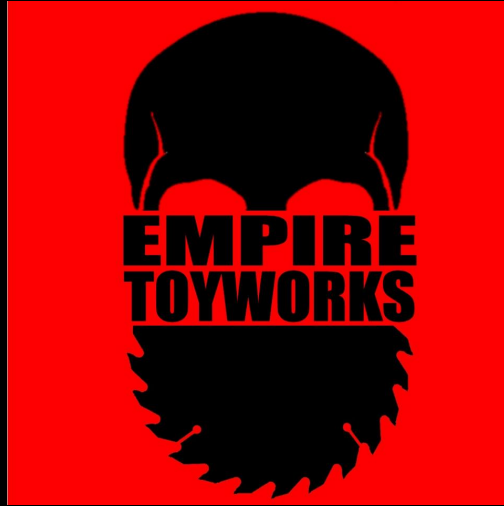

Custom handmade all wood playsets for GI Joe, Star Wars,
Acid Rain & any other 1:18 scale action figures.
visit www.empiretoyworks.com for photos in these categories:



Starport



Terrain



Desert



Arches



City



Wasteland

ALIEN SPECIES...STAT!



MONGDOOLIAN MONKS MERCHANT GUILD

This is ...STAT! Where we present an image of a creature, alien species, ship, or a piece of technology, and ask you to stat it.

In this first article, the Mongdoolians Monks Merchant Guild as conceived by Chris Shaylor at Empire Toy Works.

Everyone who submits stats will receive a discount for a miniature of their choice. The best Mongdoolian Monk, as judged by Chris and Brian will receive a free Mongdoolian Monk Miniature!

*Submit your ...STAT! entries with subject **Alien Stat!** to chrissshaylor@gmail.com and brianbirdsatx@gmail.com*

Winner to be announced August 31 on the Adventurer's Journal Facebook page. Stats will also be featured in Issue Three.

The Mongdoolians are an ancient race of traders that some believe to be the original inhabitants of the asteroid that houses Rotgut Station.

Even hundreds of years ago, when the station was initially a mining platform, the Mongdoolians were recorded as peacefully selling goods and wares to the employees of the mining corporation. As the station grew to the hodgepodge spaceport it is now, the Mongdoolians established their own independent Merchant Guild and regularly attend the city council meetings.

With a seemingly endless supply of random merchandise, the Monks own and operate several dedicated stalls and shops located across the entire complex. No one is completely sure what a Mongdool physically looks like under its robe or helmet or what their true language is but each Monk is outfitted with a universal translation unit to allow communication with their customers.

What exactly they are monks of or what their religion is even based on is a mystery as well. There have been rumored sightings of clustered gatherings of Mongdoolians engaged in rhythmic chanting with a chaotic fury of slapping of tentacles.

A scientist once came to Rotgut to secretly study the monks. He spent months trading with them, exchanging the same goods back and forth trying to learn anything he could about them. Their origins, biology, language, diet, religion, history, technology etc.

Some believed he eventually even fell in love with one of them.

Then one day, the scientists burst into The Blue Waffle screaming that the Mongdoolians were actually large parasites!

ALIEN SPECIES ...STAT!

That they were using the organics of other species to prolong their lives. He claimed that beneath the robes are headless, limbless torsos from various life forms that are suspended in jelly sacks with a net of tentacles wrapped around them. The only reaction he received was a bottle hurled at his head. Humiliated and fearing for his life, he left that night boarding the next departing transport.

As long as these mysterious robed merchants keep stocking their shelves and kiosks with Fusion Sweaters, Foam Grenades, Giggle Candy and Donkle Fly Repellent, the inhabitants of Rotgut Station really don't care what, or who, the Mongdoolian Monks are made of.





How to be a Great Game Master (GM) is a YouTube channel that focuses on providing GM Tips, guides and insight to improving your role playing sessions through storytelling as a game master/dungeon master or player character (PC).

Our Game Master Tips and Player Character Tips can be for Dungeons and Dragons (DnD), Pathfinder, Star Wars or other role playing systems and role playing games (RPGs), these guides will help you bring the best out of your character, enhance your game master skills and ensure you have a happy gaming experience! So even as a new Dungeon Master or new to role playing in general we can get you started, so you and your fellow role players will have a blast.

<https://www.greatgamemaster.com/>



How to be a
GREAT
Game Master
or how to tell a good story

**MAKING
CUSTOM
ALIENS
FOR YOUR GAME**

<https://youtu.be/x9OIbY3IjrQ>



Alien Gunslinger Miniature

by Nils Meyer

Where do I get this file?

Head over to redrockcollectibles.com and download the file. For Free! Just sign up for our newsletter to get your copy of the file. You will also be notified when additional free files are available. We are aiming to release another free mini file every other week.

You've downloaded the file now what?

You could just spin it around in a 3D software package like meshlab for a few hours (free at <http://www.meshlab.net/>). You could also print it on your own 3D printer or send it to any print service and get it printed for a few bucks.

Here is one word of caution. At redrock collectibles we aim to create more detailed minis/sculptures than a lot of other companies. This means that this file may not look great when printed on a printer that doesn't allow for extreme fine detail.



There are printers available for all kinds for different purposes and at a vast variety of prices. In case you are curious, this video (I do not know the person the channel belongs to) looks at 3D printing from a board game miniature perspective.

<https://tinyurl.com/home3Dprinting>

My miniature is bigger than yours

3D files have a certain resolution, just like any image on your phone. Just like that image on your phone they can be printed at any size. Print them too big and things take a turn for the ugly. Go too small and certain parts will just not print.

When choosing the size keep in mind that these are supposed to be miniatures not statues.

I hope you enjoy the Alien Gunslinger. Please share our link with friends and enthusiasts around the world. Also, if you have any questions about future free releases or our upcoming Kickstarter Campaign please leave a message on the red rock site.

September 8-9, 2018

STAPLE!

The Independent Media Expo

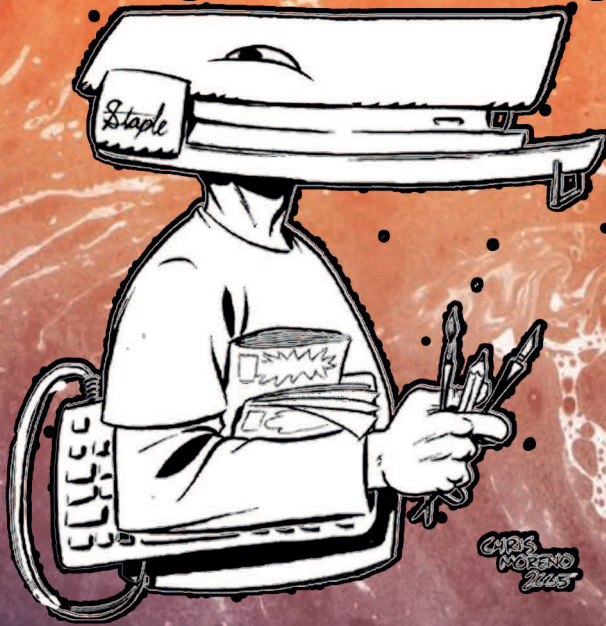

**Over 150 Creators of
COMICS - ZINES - ART
CRAFTS-TOYS-GAMES**

**Panels, Presentations &
Tutorials! Kid's Activities!**

**@ The Millenium Youth
Entertainment Complex,
1156 Hargrave, Austin, TX**

staple-austin.org @stapleexpoastin

 staple  staplegator  stapleaustin

ALIA SPECIES UPDATE

Updating West End Games alien species to reflect over 20 years of Expanded Universe development.

Back in 1988 WEG created the framework for the Star Wars Universe. Developing many of the characters and species who were little more than props in a scene. It was the WEG writers who breathed life and created background for nameless characters and species. Until the release of Timothy Zahn's "Heir to the Empire" novel in 1991 and Expanded Universe novels in 1994, WEG developed nearly all of the background in the Star Wars Universe. Unfortunately WEG would lose the license for Star Wars in early 1999, just a few months before the release of "Star Wars Episode One: A Phantom Menace".

In the accompanying twenty years, many of the species have been expanded, but the Star Wars D6 sourcebooks do not reflect this. This and future companion articles will modify existing species to reflect the expanded materials and introduce new species who do not have d6 mechanics.

ARKANIAN

Home Planet: Arkania

Attribute Dice: 12D

DEXTERITY 1D/3D+2

KNOWLEDGE 1D+2/4D+1

MECHANICAL 1D+1/4D

PERCEPTION 1D+1/4D

STRENGTH 1D+2/4D+1

TECHNICAL 2D/4D+2

Special Abilities:

Darkvision: Arkanians can see in total darkness up to 20 meters distance (+4D bonus modifier against visual environmental conditions).

Story Factors:

Arrogance: Arkanians are typically arrogant, believing that they have reached the pinnacle of evolution.

Infamy: Arkania is known for their dedication to aggressive scientific research, giving them a reputation as amoral scientists.

Move: 10/12

Size: 1.6 to 2.2 meters tall.

Sources: Ultimate Alien Anthology (pages 15-16), Knights of the Old Republic Campaign Guide (pages 10-11), Aliens Stats (pages 13-14). Text from wookieepedia, tweaking by +Oliver Queen.

Pirate



“Sure the freighter wasn’t mine, not to start. But charter flights to out of the way vacation spots on the outer rim. Who even thinks that’s a good idea? Let’s be honest, they were really underutilizing that Freighter, the -2400 is capable of SO much more.”

- Irshat Udwe

CHISS

Home Planet: Csilla

Attribute Dice: 12D

DEXTERITY 2D/4D

KNOWLEDGE 2D/4D

MECHANICAL 2D/4D

PERCEPTION 2D/4D

STRENGTH 2D/4D

TECHNICAL 2D/4D

Special Abilities:

Acute Senses: Chiss eyes are a bit better than those of humans, their visible spectrum edging a bit into the infrared range (can see up to 30 meters in near darkness provided there are heat sources). Additionally, Chiss have keen hearing (+1D modifier to auditory Perception rolls).

Story Factors:

Arrogance: Chiss are typically arrogant, believing they superior to all others.

Isolationists: Chiss are seldom encountered outside the Chiss Ascendancy. Generally holding the rest of the galaxy in low opinion.

Move: 10/12

Size: 1.6 to 2.1 meters tall

Source: Wookieepedia, stats by +Oliver Queen.

Pickpocket



“Respect is a commodity in the Ascendancy, some people measure their worth by it. But respect doesn’t buy me dinner – that guy’s cred-stick just might.”

- Eri Norin

DUROS

Home Planet: Duro

Attribute Dice: 12D

DEXTERITY 1D/4D

KNOWLEDGE 1D+1/2D+2

MECHANICAL 2D/4D+2

PERCEPTION 1D/3D

STRENGTH 1D/3D

TECHNICAL 1D+2/4D

Special Abilities:

Starship Intuition: Duros are, by their nature, extremely skilled starship pilots and navigators. At character generation a Duros character receives a +1D bonus for the initial 1D placed in the following skills: astrogation, communications, sensors, space transports, starship gunnery, and starship shields. The character may place an additional 1D in one of these skills as the +1D bonus does not apply to the character creation 2D skill die expenditure limit.

Story Factor:

Storytellers: Duros are known to be avid storytellers, especially when regaling about their previous adventures or those of friends and family members.

Move: 10/12

Size: 1.8-2.2 meters tall

GM Notes:

In the available background materials, Duros are best known for their astrogation ability. Since they have had access to hyperdrives longer than any other known race, they did establish early interstellar trade routes and visited a great number of other planets long before other species, giving them an advantage in trade, economics, and information. The question arises, does this equate to the race being better at operating a starship?

1. If GM doesn't think so, then only give a Skill Bonus to the astrogation skill.

2. Furthermore, the GM may feel the Duros have an above average knowledge about other planets and cultures. If so the GM could add planetary systems to the Skill Bonus list.

Moisture Farmer



"There was this vaporator, and wow, no one could figure out what was wrong with it. They would replace the flux equilibrator and two days later, Pow!, it would blow up. I got in there and took the whole blasted thing apart to find the positive power coupler was degraded and making it overheat."

- Armoor Tane Rizek telling thrilling tales of moisture farming.

HUMAN, MANDALORIAN

Attribute Dice: 12D

DEXTERITY 2D/4D

KNOWLEDGE 2D/4D

MECHANICAL 2D/4D

PERCEPTION 2D/4D

STRENGTH 2D/4D

TECHNICAL 2D/4D

Special Abilities:

Skill Bonus (Jetpack): The jetpack is an integral part of Mandalorian tactics and identity. At character creation the Mandalorian character gets 2D for the first 1D placed in this skill. This is a one-time bonus. The player may still put an additional 1D into this skill as this does not exceed the 2D skill cap set during character creation.

Story Factors:

Honor Code: Mandalorian culture was made up from the various clans that inhabited Mandalore and its territories. Personal Honor and Family Honor played a pivotal role in their society. Personal affronts and dishonor could only be resolved by one-on-one duels, most of the time resulting in death. A Mandalorian character, who is slighted by another, must uphold his/her honor or risk personal/family/clan shame.

Intimidation: A Mandalorian wearing traditional Mando armor was easily recognized across the galaxy. Due to their fierce and legendary reputation, Mando Characters wearing that armor received a +1D to their *Intimidation* skill.

Family Bonds: Mandalorians have a strongly developed sense of clan/family honor.

Move: 10/12

Size: 1.5-2.0 meters tall

GM Notes:

1. With the introduction of the new canon information from the Clone Wars series and the Rebels series, the Mandalorians have been changed to a sub-culture entry. They should be treated as

Humans with story factors that affect Player Characters and Non-Player Characters. Beginning characters should begin just like any other character, not receiving any additional bonuses for game-balance purposes. Armor and skills are the results of training, not necessarily a species bonus.

2. Whether or not a beginning character can start with any armor (beskar) is arbitrary by the GM. Usually, Mando armor is custom made and it appears to be much like a family heirloom. Attaining a full suit of Mando armor should be an objective and a quest that the character must undertake.

Newlyweds



“Mandalorians are pre-measured by the Galaxy, warriors, bondsmen, and a fair blaster in a fight. Mandalorians are measured by Mandalorians not by the weight of their words, but by the weight of bond and deed.”

- Iri Shard

ITHORIAN

Home Planet: Ithor

Attribute Dice: 12D

DEXTERITY 1D/3D

KNOWLEDGE 2D+2/5D

MECHANICAL 1D/2D+1

PERCEPTION 1D+1/4D

STRENGTH 1D/3D

TECHNICAL 1D/2D+2

Special Skills:

Strength Skills:

Resonant Bellow: The Ithorians' four throats also have the ability to violently expel air, resulting in a deafening and potentially concussive scream. This action may only be attempted a number of times equal to the number in front of the D in Strength. The bellow if successful does STR+1D deafening stun damage, range: 1/2/3.

Knowledge Skills:

Agriculture: Time to use: at least one standard week. The character has a good working knowledge of crops and animal herds, and can suggest appropriate crops for a type of soil, or explain why crop yields have been affected.

Ecology: Time to use: at least one standard month. The character has a good working knowledge of the interdependent nature of ecospheres, and can determine how proposed changes will affect the sphere. This skill can be used in one minute to determine the probable role of a life form within its biosphere: predator, prey, symbiote, parasite or some other quick description of its ecological niche.

Story Factors:

Herd Ships: Many Ithorians come from herd ships, which fly from planet to planet trading goods. Any character from one of these worlds is likely to meet someone that they have met before if adventuring in a civilized portion of the galaxy. Move: 10/12

Move: 9/11

Size: Up to 2.3 meters tall

Gambler



"Tend to your debts and manage your hand like a garden. Only then can you reap what you sow."

-Kaleg Yur Azz. from his holo novel:
How to Win Hands and Influence People.

MIRALUKA

Homeworld: Alpheridies

Attribute Dice: 11D

DEXTERITY 1D/3D+2

KNOWLEDGE 2D/4D

MECHANICAL 2D/4D

PERCEPTION 1D/4D

STRENGTH 2D/4D

TECHNICAL 2D/4D

Special Abilities:

The Gift: The Miraluka have developed the ability to perceive their surroundings by sensing the slight Force vibrations emanated from all objects. This allows Miraluka to see in total darkness, read/write as though sighted, but cannot see colors. Miraluka recognize individuals by the unique aura each creates in the Force. In any location where the Force is in some way cloaked, the Miraluka are effectively blind (-4D to all skill rolls normally requiring sight).

The Burden: Miraluka are sensitive to the Force to varying degrees. At character creation Miraluka who take Force Sensitivity gain +1D to Sense.

Sources: Tales of the Jedi Companion (pages 101-102), Ultimate Alien Anthology (page 97), Knights of the Old Republic Campaign Guide (pages 16-17). Stats by +Oliver Queen.

Outlaw Tech



"I'm not interested in your problems, only your money. Can we do business, or do you want to flap your mandibles at the Cantina for a little while so I can go do something productive?"

- Gari Levis

NAUTOLAN

Homeworld: Glee Anselm

Attribute Dice: 12D

DEXTERITY 1D+1/4D

KNOWLEDGE 1D/3D+2

MECHANICAL 1D/3D+2

PERCEPTION 1D/4D

STRENGTH 2D/4D+1

TECHNICAL 1D/3D+1

Special Abilities:

Amphibious: Nautolans can breath water as easily as air. They have webbed appendages, making them strong swimmers (+1D modifier to swimming skill checks).

Low-light Vision: A Nautolan can see twice as far as a normal human in poor lighting conditions.

Pheromone Detection: Nautolans possess exceptional olfactory and pheromone-sensing skills, enhanced by their fourteen head-tresses. While in water this allows Nautolans to detect the emotional state of other beings, outside of water this ability is negligible (+1D modifier to opposed Perception roll).

Story Factors:

Language: The Nautolan language is only fully pronounceable when the speaker is under water.

Move: 10/12 (swimming and walking)

Size: 1.8-2 meters

Slicer



“Computers talk if you’re willing to listen. You just have to know how to talk to them. You want me to talk to Bureau of Ships and Services computer...I can do that. What you want me to say to it...that’s another matter.”

- Adka Sozz

SLUISSI

Home Planet: Sluiss Van

Attribute Dice: 12D

DEXTERITY 2D/3D+1

KNOWLEDGE 2D/4D

MECHANICAL 2D/3D

PERCEPTION 2D/3D+2

STRENGTH 2D/4D

TECHNICAL 2D/4D

Special Abilities:

Mechanical Tinkerer: Sluissi love to tinker with technology and mechanical objects. +1D bonus to Technical skill rolls when performing installation, maintenance or repair to mechanical equipment (vehicles, starships, weapon systems, droids, etc).

Story Factors:

Calm Demeanor: Patient, sociable, easy going, Sluissi are famous for remaining calm under pressure. Seemingly unable to become genuinely upset or angry.

Stickler for Details: Because of their methodical nature and aversion to rushing and impatience, Sluissi actions always takes twice as long as for other species. Sluissi will always comply with protocol, no matter how trivial.

Shipbuilding as Art: Sluissi society considers starship construction an art. Industrious and with the ability to stay focused, Sluissi ships are considered some of the best built ships in the galaxy. Though, it's readily accepted that this level of craftsmanship costs more and takes twice as long as others.

GM Notes: When Sluissi are rushed to perform an action, they do so with half as many skill dice (REUP p.82) and do not get their species Mechanical Tinkerer bonus.

Move: 8/10

Size: 1.5-1.8 meters tall

Gunslinger



“You can’t rush perfection. You have to take time to get a blaster just right. Trigger pull too light? I don’t need to shoot first if I’m the one who hits first, do I? And there’s something about the smell of Tibanna gas in the morning.”

- Durss Lorn

TOGRUTA

Attribute Dice: 12D

DEXTERITY 2D/4D

KNOWLEDGE 2D/4D

MECHANICAL 2D/4D

PERCEPTION 2D/4D

STRENGTH 2D/4D

TECHNICAL 2D/4D

Special Abilities:

Spatial Awareness: Using a form of passive echolocation, Togruta can sense their surroundings. If unable to see, a Togruta character can attempt a Moderate Search skill check. Success allows the Togruta to perceive incoming attacks and react accordingly (by making defensive rolls).

Story Factors:

Group Oriented: Togruta work well in large groups, and individualism is seen as abnormal within their culture. When working as part of a team to accomplish a goal, Togruta characters are twice as elective as normal characters (i.e., they contribute a +2 pip bonus instead of a +1 pip bonus when aiding in a combined action; see the rules for Combined Actions).

Dislike of Shoes: Togruta feel a connection to their environment through their feet, and dislike wearing shoes. This is just a dislike, and they will wear shoes when it is practical.

Private Investor



“You don’t have to worry about the particulars. That’s my job. The streets might seem a little dark, a little harsh – but that’s what I do. I see the things you don’t want to see so I can find the things you need.”

- Roshti Phe

TWI'LEK

Attribute Dice: 12D

DEXTERITY 2D/4D+1

KNOWLEDGE 1D/4D

MECHANICAL 1D/3D

PERCEPTION 2D/4D+2

STRENGTH 1D/3D+2

TECHNICAL 1D/3D

Story Factors:

Enslaved: Slavery is so ingrained as the main trade of Ryloth, that most Twi'leks are generally thought to be either a slave or consort of some kind, and often treated as second class citizens, this is especially true in Hutt space.

Exotic: The females of the Twi'lek species are viewed as being very exotic and among the more desirable of the feminine denizens of the galaxy. Because of this, female Twi'leks find it easier to manipulate the attentions of males across the known galaxy.

Crash Test Pilot



"No Starship was ever designed to be 'good enough' and no pilot ever trained to be adequate - There's a whole Galaxy out there. I didn't let anyone else define my limits for me, they're too busy trying to keep up."

- Reina Naru

VERPINE

Smuggler

Homeworld: Roche asteroid field

Attribute Dice: 12D

DEXTERITY 1D+1/3D

KNOWLEDGE 1D+1/3D

MECHANICAL 1D+2/3D+2

PERCEPTION 1D+1/4D

STRENGTH 1D+1/3D

TECHNICAL 2D/5D

Special Skills:

Knowledge skills:

Organic

Telecommunication. Time to use: free action for simple information and phrases. Verpine have the natural ability to sense and transmit radio waves to communicate with another Verpine in their language over distances of one hundred kilometers and more. Skill difficulty is Easy modified by range.



User and target are:	Add to difficulty:
In line of sight	Automatic
1-100 meters	+0
101 meters to 1 kilometer	+5
2-10 kilometers	+10
11-100 kilometers	+15
101-1,000 kilometers	+20
Same planet	+25
Same star system	+30

“Won’t need to fight if they don’t know we shouldn’t be here. Ship goes in, ship goes out. There’s a need and I fill it. No need to be concerned with the particulars.”

- Ferro

Special Abilities:

Skill Bonus (Starship Engineering Knack): During character a player receives 2D for the initial 1D placed in these skills: capital ship repair, capital ship weapon repair, space transports repair, starfighter repair, starship weapon repair or capital ship engineering, space transports engineering, starfighter engineering or starship weapon engineering if the prerequisites are made. The player may still put an additional 1D into this skill as this does not exceed the 2D skill cap set during character creation.

Chitinous Exoskeleton: +1D bonus vs. physical, +2 vs energy.

Microscopic Vision: because of their highly evolved eyesight verpine can see at a microscopic level though this requires a high degree of concentration. Doing so is a full round action and allows inspection of an item at the microscopic level. Treat as x25 microscope.

Story Factors:

Pacifistic Idealism: Verpine being a hive species have adopted a pacifistic galaxy-view. They will do their best not to enter into physical conflict unless absolutely necessary. They will try to use non-violent means until it is no longer a viable option.

Collective Mindset: Verpine live in a rigid society that works for the collective good. There is seldom thought of self as a singular identity. Verpine are seldom seen outside the collective. These loner’s are often thought to be mentally disturbed or suffering from mental illness. In many cases this is correct. The longer a verpine spends away from the familiarity of the collective the more likely they are to develop personality quirks, mental disorders, and strange ideas about the meaning of self.

Move: 10/12

Size: 1.9 meters

WOOKIEE

Attribute Dice: 12D

DEXTERITY 2D/4D

KNOWLEDGE 1D/2D+1

MECHANICAL 1D/3D+2

PERCEPTION 1D/3D

STRENGTH 2D+2/6D

TECHNICAL 1D/3D+1

Special Abilities:

Arboreal: Wookiees have a natural affinity to living in the upper levels/branches of the Wroshyr trees on their home planet of Kashyyyk. Because of this, Wookiees gain a +1D to any skills relating to climbing and or maneuvering in forest areas or in upper levels of foliage such as *Climbing/Jumping, Survival, and Sneak*.

Story Factors:

Reputation: Wookiees are widely regarded as fierce savages with short tempers. Most people will go out of their way not to enrage a Wookiee, +1D modifier to intimidation skill checks.

Enslaved: During the reign of Emperor Palpatine and the Imperial regime, almost all Wookiees were enslaved by the Empire, and there was a substantial bounty for the capture of "free" Wookiees.

Language: Wookiees cannot speak Basic, but they all understand it. Nearly always, they have a close friend who they travel with who can interpret for them... though a Wookiee's intent is seldom misunderstood.

Honor: Wookiees are honor-bound. They are fierce warriors with a great deal of pride. They do not betray their species or desert a friend. They may break the "law", but never their code. The Wookiee Code of Honor is as stringent as it is ancient. Atonement for a crime against Honor is nearly impossible—it is usually only achieved posthumously. But Wookiees falsely accused can be freed of their dishonor, and there are legends of dishonored Wookiees "coming back." But those are legends...

Disdain for Coverings: Wookiees typically do not wear armor or clothing, feeling it restricts movement in the arboreal forests of

Kashyyyk. During times of conflict they sometimes wear ceremonial leather armor, often adorned with beads, paints, braids and clips for carrying equipment. Otherwise, a Wookiee wears very little. A Wookiee has no problems functioning on worlds with extreme climates due to their natural coat of fur.

- *Long-Lived:* Wookiees are an extremely long-lived species. It is not uncommon to find a Wookiee well over the age of one hundred years old in the galaxy. One hundred-fifty easily is considered adult age for a Wookiee, while anything under one hundred is considered still a youngster.

Move: 11/15

Size: 2-2.3 meters tall



Xenoarchaeologist

"Lorchakaa said he is pleased with this group. It only took you most of one day to figure out that he was a respected, published xenoarchaeologist and not one of the laborers"

- Rolan Natt, dig site coordinator and xenoarchaeologist talking to some students that arrived earlier that day.

RANDOM ALIEN APPEARANCE GENERATION SYSTEM

by Mark Dowson

Star Wars is renowned for its assortment of weird looking aliens. This random generation system is for if you want to come up with the appearances of new aliens and would rather not have to think too hard about it. Alternatively, it is a way of possibly coming up with something you might never have thought of.

First roll a 6-sided dice. The result is how many inhuman features the alien has. Roll for each on the tables below.

Inhuman Features (D6)

- 1-2 Skin.
 - 3-4 Facial Features.
 - 5 - Body Parts.
 - 6 - Has something else instead of hair.
- Skin (D6)
- 1 - Different Color.
 - 2 - Patterned.
 - 3 - Baggy.
 - 4 - Hairy.
 - 5 - Scaly.
 - 6 - Blotchy

For coloration roll 4 six-sided dice and mix each of the resulting colours rolled from the following list to get the final colour. For example: Red + Blue =Purple, Blue + Yellow = Green, Red + Blue + Yellow = Brown.

Colour (D6)

- 1 - Red.
 - 2 - Blue.
 - 3 - Yellow.
 - 4 - White/pale.
 - 5 - Black/dark.
 - 6 - None.
- Patterned (D6)
- 1 - Stripes
 - 2 - Freckles.
 - 3 - Spots.
 - 4 - Mottled.
 - 5 - Strange Markings.
 - 6 - Symmetrical Patches.
- Roll for the colour of the patterned affect.

Facial Features (D6)

- 1 - Eyes.
- 2 - Nose.
- 3 - Forehead.
- 4 - Mouth.
- 5 - Ears.
- 6 - Cheeks.

Eyes (D6)

- 1 - All one colour.
- 2 - Tiny.
- 3 - Large and dominating the face.
- 4 - On eye stalks.
- 5 - Compound eyes.
- 6 - Slit like.

Nose (D6)

- 1 - Large.
- 2 - Small.
- 3 - Broad.
- 4 - Narrow.
- 5 - Long.
- 6 - Just a pair of nostrils.

Forehead (D6)

- 1-2 High.
- 3-4 Low.
- 5 - Has two small horns.
- 6 - Non-existent.

Mouth (D6)

- 1 - Wide.
- 2 - Small.
- 3 - Contains pointed teeth.
- 4 - Downwards turned.
- 5 - Fat lipped.
- 6 - No lips.

Ears (D6)

- 1 - Pointed upwards.
- 2 - Pointed backwards.
- 3 - Small.
- 4 - Large.
- 5 - Positioned higher up.
- 6 - Non-existent.

Cheeks (D6)

- 1-2 Large.
- 3-4 Sagging.
- 5-6 Pinched inwards.

Head (D6)

- 1 - Large.
- 2 - Small.
- 3 - Short.
- 4 - Tall.
- 5 - No neck.
- 6 - Long.

Torso (D6)

- 1 - Long.
- 2 - Short.
- 3 - Fat.
- 4 - Scrawny.
- 5 - Segmented.
- 6 - Triple breasted.

Arms (D6)

- 1-3 Long.
 - 3-6 Short.
- Legs (D6)
- 1-2 Long.
 - 3-4 Short.
 - 5-6 Extra joint.

Hands & Feet (D6)

- 1-2 Large.
- 3-4 Small.
- 5 - Long.
- 6 - Short and stubby.

Fingers and Toes (D6)

- 1 Different number of digits.
Number equals 2+result of one dice roll.
- 2 Webbed.
- 3 Partially fused together.
- 4 Clawed.
- 5 Suction cups on the end of.
- 6 Positioned differently.

Has instead of hair (D6)

- 1 Tendrils
 - 2 Bony ridge/s.
 - 3 Quills.
 - 4 Two small horns.
 - 5 Different coloured skin.
 - 6 Feathers.
- The value for height equals 1 meter +0.2x D6.

POSSIBLE RESULTS



ALIEN TECHNOLOGY & GEAR

by Johannes Verri

Translating Vcoders

Despite the fact that Basic is the most prevalent language spoken in the Galaxy far, far away, it is not spoken by everyone. We know that astromechs communicate in the chirps and whistles of Binary and Wookiees only in bellows and growls, but there are other sentient creatures that cannot speak Basic Galactic Standard. Some because their vocal apparatus does not allow them, others because they live in an environment that makes Basic useless to them, as for example the Ewoks on the forest moon of Endor or the Talz on Ordo Plutonia.

One way or the other, Basic might not be sufficient to get by in every occasion, and the characters will not always be lugging around a protocol droid fluent in over six millions forms of communications to solve their problems.

While the Language skill is created to take into accounts this factor, having a player at the table whose character does not for one reason or the other speak Basic can be a drag. If someone in the group wants to play the member of a species that doesn't speak Basic, then there will be an awful lot of rolls to see if the rest of the party does understand what the other character is saying.

Apart from the possible disastrous consequences of misunderstanding on a 1 on the Wild Die (So...it was 20 seconds before explosion, not 20 minutes...bummer...), a lot of the game will be spent on trying to understand one character, which is hardly a lot of fun.

While it is possible to house rule a solution, some GMs who prefer to play by the book might like to keep things simple by allowing players to choose only species that are able to express themselves rather than having players trying to growl or gesticulate their way through the game. This will become even greater issues for those who play by post.

Through the years, a number of translating devices have appeared into the game, such as the Alien Enhancer Voicebox in the *Arms and Equipment Guide* (D20, converted to D6 on the D6Holocron wiki) or the Transliterator in *Galladinium's Fantastic Technology*.

However, these devices are mainly of use when trying to understand a language, rather than speaking it. Recently a few examples have also appeared in Canon that will help players to circumvent the pesky detail of having a character that does not speak Basic.



Darth Vader wears a Vocoder Mask, where as Storm Troopers have vocoders in their Helmets, and Protocol Droids have vocoders installed in their chassis.

Translating Vocoders

This is the name given on *Wookieepedia* to a number of different devices developed by different alien species unable to articulate the sounds of Basic Galactic Standard.

One such device appears in Canon in *SW:Rebels*, where the Ithorian Old Jho, a cantina-owner on Lothal, can be seen wearing a contraption on his back that allows him to express himself in Basic.

Ithorian Translator

Type: Translating vocoder

Cost: 100 credits

Availability: 3

Game Notes: This device allows a member of the Ithorian species to speak Basic by decoding the sounds of their native language and translating them into Basic.

However, it needs to be noted that similar devices exist for other species, and in the *Entertainment Weekly* article “Star Wars: Meet the Creatures and Droids in *Rogue One*” the Gigoran Moroff, a member of Saw Guerrera’s Partisans is said to be *fitted with a voice-translation box on his mouth*’, which *Wookieepedia* calls a Vocoder Mask.

Vocoder Mask

Type: Translating Vocoder

Cost: 100 credits

Availability: 3

Game Notes: This device allows a member of different species to speak Basic by decoding the sounds of their native language and translating them into Basic. Obviously, each device is programmed to translate a specific language into Basic (although with a with a Heroic computer programming/repair roll it can be reprogrammed to translate into another language), and cannot be used by members of other species.

Note that a similar device is to be found in the *Ultimate Alien Anthology* (D20) for the Qwohog species. This device, called

Qwohog Vocalizer Mask has been converted to D6 and can be found on the D6Holocron Wiki. Similarly, Anomids need similar devices to translate the subvocal harmonics of their language, and a device called Anomid Vocalizer Mask is also found in the Ultimate Alien Anthology (D20) and has been converted to D6. The Anomid Vocalizer Mask makes an appearance in Canon, and can be found in the *Star Wars - Rogue One: the Ultimate Visual Guide*. The Anomid priest Silvanie Phest on Jedha wears one.



What type of vocoder the Mongdoolian Monks use, remains a mystery.

The background of the page is a vibrant blue space scene. A large, bright Earth is visible in the upper half, partially obscured by a white ring of light. Below it, a futuristic spaceship with a blue and white color scheme is flying towards the viewer, leaving a bright blue and white trail. The space is filled with numerous small, dark asteroids and debris.

Beyond BoSS: What's In a Name

Dreena looked at the old ship the 'Faithful Mina' and decided that the design of this ship has really grown on her in such a short time. She can't wait to go out this time on a run. The controls are becoming so normal for her she is able to do some movements for controls without even thinking.

But this time she has Jec going out with her for this run. He has been so busy that she has not been able to ask many questions. Now she has a chance and she is not going to waste it.

Might as well go through the pre-run checklist while waiting as Jec said he would be right here.

While Dreena is checking over the specs in the engine room she hears a message from Kal over the comm system. "Dreena, are you here? I hope so as we need to get moving. Plans have changed. I need you to recalculate a jump from the next location. Then yet another jump calculated for after that. I will explain more in a moment."

Dreena rushed to a comm station and responded quickly "I am here, and I will be up in the cockpit right away."

Spinning on her heels she ran for to the front of the ship.

When she got there she saw Kal starting to liftoff.

As soon as he saw her he said, "You better buckle in."

With that he lifted off and she practically fell in the seat while grabbing the belt.

"We need to get a jump planned from here to there. You have an hour for this one. I need to calculate another jump for right after that so I can leave right after I drop you off."

She felt the Mina leap to hyperspace. Better get on this calc as she thinks as it sounds complicated and right away calls Rusty “R5T1, come on up here. We need your help.”

R5T1 came up and everyone was busy working. Before she knew it they were already coming out of hyperspace. The conversation was more about Kal asking a slew of questions of her about the Galactic Civil War and her opinions. Regarding the ship she is picking up, all she got is that she needs to pick up this ship, take the owner ‘Tarey’ to where she wants to go and give her a hand picking something up, offer apologies for Kal being occupied with a promise of getting together after he is done with his situation, and head on back with her afterwards. When Dreena was dropped off, all she got from Kal about why he was in a rush was that he had to head into a meeting with someone in some command as he heard a dockyard was going to be raided. He was gone and she never got any of her questions she had for him answered either. “Stang!” She voiced in her head as R5T1 caught up with her.

She looked at the landing field and hoped that this would not be a long wait. This is definitely not stellar class star port by any stretch of the imagination. If Kal had not known this place existed it would not have been found so easy.

The wait ended up not being that long before hearing the oscillating hum and vibrations of an incoming engine. Into the forest a bit would be safe enough she thinks as she rushes off the field. The ship makes a slightly chaotic but decent landing. Shortly after the landing jets stop venting and hissing, the landing ramp opens up and Dreena hears a voice calling out. “Kal, are you here yet? Come out and say ‘Hi!’ if you are here. You have convinced me to start working for the Al...”

Dreena briskly came out of the forest and boldly shouted “Hi! Are you Tarey?”

“Where is Kal?” Tarey said sounding surprised.

“He said he had to go to some important meeting, to say ‘Hi!’ for him, and that the next drink is on him.”

“Who are you? And who is that?”

R5T1 rolled onto the landing strip towards Dreena.

“Dreena, and R5T1”

“Can I trust you?”

“I should ask the same of you now. Can I? Trust you that is.”

Both parties burst out in laughter.

“Let me give you a tour of my ship. It is a CEC YT-1300. Her name is the Starlight Wanderer! But I need to rename her so I am working on figuring out a new name.”

The tour started with the starboard cargo bay, then around the crew bunks, the engineering station, around the main corridor, into the port cargo bay, back around the main corridor to the repair bay, galley, crew lounge, into the drive room, and on to the cockpit. My goodness this is a bright ship. So much white and bright lights inside the main corridor it is nearly dazzling to the eyes. It looks like it has been well taken care of inside as well as outside. It does not look like anything is being hidden which makes Dreena think there are some hidden compartments she has not found yet during the walkthrough.

“Kal told me that I would meet you in a few weeks and that you can help me find out what is going on with my ship. I have a glitch in the computer system somewhere now. It started a few weeks ago and it did not seem that bad at first. But now it is starting to migrate into other systems which has me a little concerned that this might not be such a random occurrence after all.”

“I noticed you seemed to have listed a little while landing. Was that on purpose?”

“No, but that is why I am concerned now about migration of this glitch.”

“Then let’s get started. R5T1 plug into the Engineering Station port and let’s start there. I am going to look at the landing system at the Technical Station / Circuitry Bay.”

“Kal said you do not like to waste too much time. Good!”

After a few hours they find nothing serious for issues. Nothing that a few connections being re-plugged back in or soldered could not seem to help. There are a few circuitry relay boards that are fried that should be replaced is all they could find. Everything checks out after about 6 hours.

“Trey, we have looked at everything we can here and there seems to be nothing visibly wrong other than what we have fixed. We do need to replace a few things, but we have done some workarounds for in the meantime. We just need to find someplace close now that we can get a few parts and then do a re-diagnosis to see what is wrong.”

“The closest place is Rotgut Station. This does not count as the place I wanted to go to pick up some supplies at though. This is a bonus trip. Though you might not think so once you go there. Then again you might just like it. It is a wretched hive of scum and dangerous beings. I should know as I just left my old crew there because I said I was going to retire. They might still be angry with me.”

Dreena picked up her digipad and started typing.

Beyond BoSS - The _____ - Corellian Engineering Corporation YT-1300

Dreena thought to herself “I wonder what the new name will be?” before getting back to her typing.

What IS in a name?

This is your chance to make your mark on the events and characters that unfold within the Adventurer's Journal.

Our characters need a ship, that ship must have a name.

Submit your name ideas to brianbirdsatx@gmail.com with subject: "Whats In A Name"

Winner to be announced August 31st on the Adventurer's Journal Facebook page. Winning name will also be featured in Issue Three.



CORELLIAN ENGINEERING CORPORATION

YT-1330 TRANSPORT



- 1 COCKPIT
- 2 COCKPIT ACCESS CORRIDOR
- 3 MAIN CORRIDOR
- 4 CREW LOUNGE
- 5 HOLONET ACCESS/COMMUNICATIONS PANEL
- 6 MAINTENANCE ACCESS AND STORAGE SPACE
- 7 HOLOGRAPHIC GAME BOARD
- 8 COMPUTER ACCESS STATION
- 9 REPAIR BAY
- 10 POWER CONVERTER AND BATTERIES
- 11 MAINTENANCE ACCESS
- 12 STASIS-TYPE SHIELD GENERATOR
- 13 ESCAPE POD (6 CAPACITY)
- 14 UPPER HATCH LIFT
- 15 VENTRAL UNIVERSAL DOCKING HATCH
- 16 GALLEY
- 17 HYPERDRIVE ACCESS BAY
- 18 GUNWELL ACCESS CORRIDOR
- 19 GUNWELL (LASER TURRET)
- 20 QUATEX POWER CORE
- 21 ENGINEERING STATION
- 22 HYPERDRIVE
- 23 SUBLIGHT ENGINE
- 24 MAIN THRUSTERS
- 25 CAPTAIN'S CABIN

- 26 SINGLE BUNK
- 27 LOCKER/STORAGE
- 28 REFRESHER
- 29 SHOWER
- 30 CREW/PASSENGER CABIN
- 31 DOUBLE BUNK
- 32 LIFE SUPPORT SYSTEMS
- 33 FRESH WATER TANKS
- 34 HYDRAULIC SYSTEM
- 35 BOARDING RAMP
- 36 UMBILICAL DOCKING RING
- 37 CIRCUITRY BAY
- 38 STARBOARD CARGO BAY
- 39 FREIGHT ELEVATOR
- 40 FREIGHT LOADING PAD
- 41 CLIMATE-CONTROLLED CARGO BAY
- 42 ARSENAL/WEAPONS LOCKER
- 43 PORT CARGO BAY
- 44 DEFLECTOR SHIELD GENERATOR
- 45 ANTI-CONCUSSION FIELD GEN.
- 46 LANDING JET
- 47 PASSIVE SENSOR ANTENNA
- 48 TRACTOR BEAM PROJECTOR
- 49 IMPERIAL IFF TRANSPONDER
- 50 HOLONET ACCESS ANTENNA

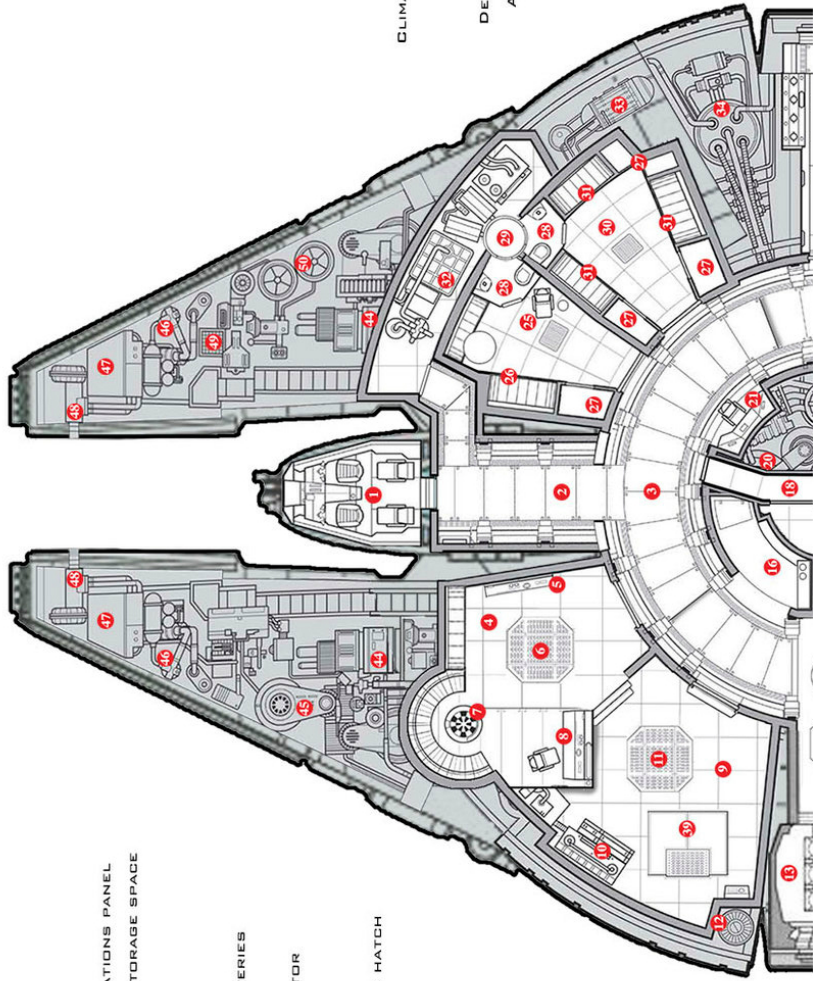

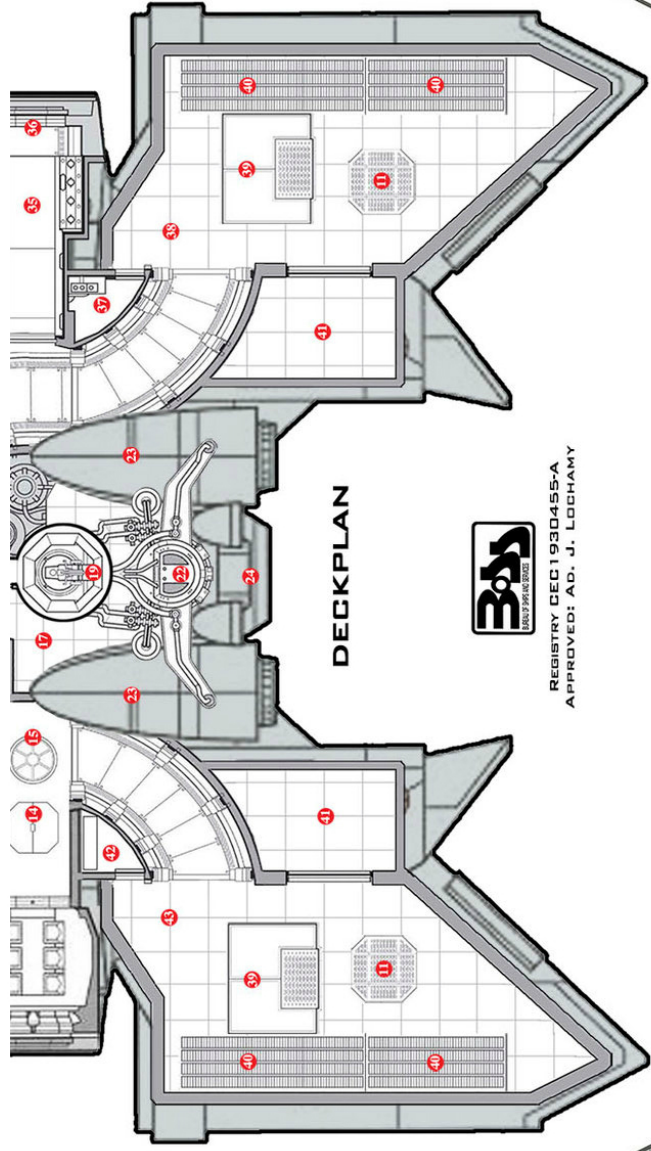

DECKPLAN



REGISTRY CEC1930455-A
 APPROVED: AD. J. LOCHAMY

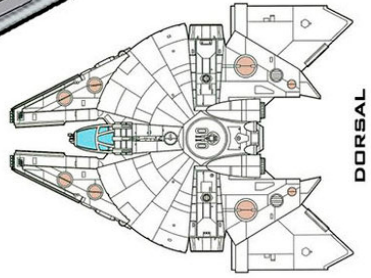

DORSAL



STARBOARD



PORT

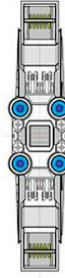

AFT



FORE

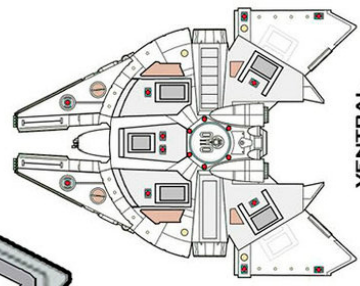

VENTRAL

Aurek Jenth: Personal Log ..

Out of all the places I have had the fortune to visit, I can truly say that the Portax System is by far the most curious.

Situated along the outskirts of the ????? trade route, Portax 4 itself, is proof that a planets ecosystems will bounce back from catastrophe and set right the wrongs of sentient species.

It also ironically shows the strength and determination of sentient species to take what they are given and re-purpose it for the better.

This report will hopefully relay the curiosity I found during my brief visit and fuel your own observations in your travels as a ...

LOCATION SCOUT

**If you are a casual reader of my Adventurer's Journal,
Welcome.**

**I am sure you will find some interesting and useful
information contained within.**

END LOG

Muck Hollow

System: Portax System, 4th planet "Portax", S-3

Starport Type: Landing field

Traffic: Rare

Control: None

Landing: None

Docking Areas: Three levels of landing pads inside a giant hollow tree.

Docking Fees: None

Customs: None

Services: Food, lodging, limited repairs.

Capsule: Muck Hollow is the type of place you only know about if someone clues you in. A limited facilities starport hidden inside a hollow, fungus-covered giant tree, in a planet-wide forest, in a backwater system off the charted hyperspace routes. Located just inside the border of the Corporate Sector of the Outer Rim Territories, Portax is far enough away from both the Empire and the C.S.A. to make this slough the perfect drop point for contraband going one way or the other. Pirates, smugglers and gangsters have used the Stump as a staging ground and hiding place for centuries, but it's current residents are only a few dozen kooks, degenerates and scientists who prefer to keep the place hidden.

The Starport

Muck Hollow, or The Stump as its colloquially named for the rudimentary starport inside the trunk of a giant tree. It can be incredibly difficult to find if one does not know what to look for. The planetary coordinates are N40° 44.9064', W073° 59.0735' using the crater crash site to the magnetic poles as prime meridian, but once in the neighborhood you can pick up Moota Powacca's transmission of the same awful Ekto Phun jazz album broadcasting on repeat. I'm not sure if he meant it as a navigational marker or a warning signal. It really was a terrible album from a mediocre band; I personally think they were trying to push into the turbolift music market or maybe something ambient for flower shops and funeral homes. Either way it is truly dreadful music, nearly as bad as Ocarina Classica's Yod's Pearl... but I digress.

Landing Bays

Once you find the Stump (about 165 meters up from the surface) select one of the three landing bays hollowed out of the dead giant greenwood. The landing bays are stacked like bookshelves cut right into the trunk. The largest bay could actually berth something the size of a GR-75 medium transport. Staircases cut into the tree itself provided access to the landing bays and starport level. There is no fear of this particular tree falling over, the tree itself is three hundred meters at the base and the fungus has only infected the first meter of tree-flesh. Moota Powacca, the Rodian who runs the place, has lacquered the floors, walls and ceilings of the hollow and has a small contingent of a dozen second degree maintenance droids equipped with flamers to make sure the fungus doesn't grow in from the exposed edges. While not actively burning these Serv-O-Droids clean the facility and help out with any repairs to visiting ships. Despite the shabby condition of the rest of the planet The Stump is in tip-top shape (all things considered).

Refueling facilities are non-existent. Repair facilities are little more so, but if you have the parts onboard or the capacity to manufacture your own you will find the Serv-O-Droids willing to lend a hand. You'll notice I haven't spoken of docking fees, and that is because there aren't any in a traditional sense. For his own reasons, Moota Powacca will not accept galactic credits. Barter is the way to get what you want in The Stump. This is the place that unclaimed load of rations or semi-functional water purifier becomes once again valuable. Everything is negotiable, and if Moota Powacca likes you or finds you entertaining enough you

might find your stay can be extended to however long you like. Every so often he will exchange favors, or request a gift, but I've personally never found his demands to be overreaching or exploitive. Moota Powacca is about as upstanding a Rodian as you will find.

On the lowest level is the starport proper. Use "starport" in the loosest sense of the word. There is a pub, storage spaces, living quarters, small workshop and a playing field for a badminton-like game called "Breakracket". The Breakracket court lines are burned into the hardwood about half a meter from the edge of the platform. While anyone would want to play such a game mere inches away from a hundred meter fall beats me. I suppose it adds to the excitement? Either way I would practice before leaping into any tournaments or bar bets.

The Stump Pub

Speaking of bars, the nameless pub serves freeze-dried rations and various stews of local fungus, pints of an algae-based ale are rather popular. Behind the bar is a gungan called Pylosh, a gungan who apparently owes Moota Powacca enough of a life-debt to have to hang around a place like The Stump. He's not the talkative type, being that his tongue was seemingly cut out at some point and I've never pressed Moota Powacca to know the details. He understand basic and will shake or nod his head to tell you if they have something in stock. He writes the specials on the wall with a charred stick. The autotuner has more on it than that dreadful jizz album, but for entertainment you won't find much more than that. The spacers that drift through tend to want to keep their heads down and remain out of site. The Stump is a good place to lay low as it's off the beaten path, out of Imperial jurisdiction or Hutt-space, and not well trafficked enough for the Corporate Sector Authority to take notice.

Storage

Storage Spaces can be rented from Moota Powacca depending on what and how long you want something kept. As small smuggling outfit has used the Stump as a drop-point for everything from glitterstim going to the Corporate Sector to assassin droids being snuck in to Imperial space. If a cargo was deemed to be "too hot" to currently transport you can negotiate a stay over from Moota Powacca.

In addition to the storage lockers he's modified into the hardwood of the Stump, there are rumors of secret passageways in the big tree as well as safe spots in the swamp below. As Moota

Powacca pretty much runs this planet I wouldn't go hiding cargo secretly in the swamp. If found he might claim it as salvage and trade it to the next spacer passing through.

Quarters

The living quarters carved into the tree are enough for Moota Powacca, Pylosh, and Professor Horukk to live in separate and comfortable apartments. There is a few unused "guest apartments" that may have belonged to former occupants. Currently the three residents don't entertain visitors often and most people passing through prefer to remain on their ships where the life-support systems can filter out the little microscopic nasties that can ruin human lungs. Why the Rodian, Gungan and Gran are immune must be due to the differences in biology as opposed to exposure.

"Rot Lung" is a clear and present danger to breathing the unfiltered air for humans, and I would not recommend long exposure without immediate medical treatment. If the native fungus can eat a thousand meter tall tree it can make short work of an unwary spacer.

Wingnut's Workshop

There is a small workshop that is run by a Serv-O-Droid PD-121, nicknamed "Wingnut". A glance will reveal that Wingnut has no restraining bolt. He has not had a memory wipe since before the Clone Wars. As a result Wingnut remembers every part to every engine he has worked on in the past 84 cycles. As such he has encyclopedic knowledge of how to jury-rig existing parts or fabricate functional ones.

Wingnut can turn garbage into salvage if the conditions are right and the little workshop where he can process metal and ceramic parts for repairing the vessels that pass through. It is a point of pride with him that no broken ship has stayed docked at The Stump for more than a month without being flyable. Unfortunately he has hit the finite limit of his existing memory and he gets confused when dealing with people, I have personally seen him refer to every male human in a party as "Glen" whether it is their name or not. He seems to have freed up some space by deleting all others. Once you can get past his social foibles, Wingnut can be invaluable to get a broken ship flying again. The two ways to get Wingnut to work on your ship is to have Moota Powacca order him to or slip him some credits on the sly.

Yes, the pit droid is the only one on Portax 4 that takes credits as currency. He says he is saving up a nest egg. Go figure.

Portax 4

Type: Terrestrial

Temperature: Cool

Atmosphere: Type II (breath mask suggested)

Hydrosphere: Moist

Gravity: Standard

Terrain: Dead forest, swamp

Length of Day: 32 hours

Length of Year: 1 standard cycle

Sapient Species: None

Starport: The Stump

Population: several dozen sapiens, countless mycota

Planet Function: Disaster area, hidden base, resources

Tech Level: Stone age

Capsule: Portax 4 was once a temperate forest world, not unlike a hundred others in the galaxy, covered with giant trees a thousand meters tall with trunks a hundred meters around. A plethora of flora and fauna once grew in the shade of the giant greenwood branches, until the cataclysm occurred.

Citizens of the galaxy tend not to think of the eras that occurred before the Republic unless it somehow effects them directly. But before even the Old Republic, there were galaxy spanning dynasties that left their imprint on the worlds where we currently live. The Portax system was one such place. An ancient culture, the Founders or possibly the Rakata, seeded Portax 4 with non-native flora. Giant trees not unlike the wroshyr of Kashyyyk or redwoods of Endor were planted by an ancient culture, possibly to biologically convert

atmosphere and soil to something more suitable to sapient colonization. But governments collapse and empires fall, Portax 4 held no rare mineral resources or unique species so the great forests grew undisturbed for ages. Multiple life forms evolved in this timeframe, but it seems none of them survived the cataclysm. The serenity of Portax was destroyed forever when a capital-scale vessel plunged through the atmosphere and crashed to the surface. While the impact was great, it was not large enough to cause destruction on a planetary scale; But the radiations that leaked from the broken engines did. The neighboring trees died, roots and plants rotted overnight. The native fungi changed, thrived, growing from the epicenter of the crash site to eventually engulf the whole planet.

In the biosphere fungus normally functions in a janitorial sense, breaking down dead matter into usable nutrients. However the mutation to the Protax Fungus caused it to be less selective, feasting on dead and living wood, like an invasive species it spread to all parts of the planet at an accelerated pace. In a few scant years the fungus covered the forest. From pole-to-pole Portax 4 became a festering swamp of rotting plants, an eerie reminder of just how quickly one disaster can change an environment on a planetary scale.

The trees of Portax 4 were so huge that millennia of rot could not topple the giants. Several feet of thick mold now covers almost every square inch of the planet, further changing the biosphere farther away from the forest that was. The air is thick with spores and microbes, a breath mask is suggested for an extended stay. Adventuring outside of the Stump is not recommended. People have been known to disappear without so much as a trace.

Other Locations of Interest on Portax 4:

The Crash Site

The ancient Crash Site is on the exact opposite side of Portax 4 from the Stump. As all fungus grew from the radiation zone around the crash, the Stump is in the area last effected by it. As you've seen how bad that place is off, the crash site is nearly devoid of life at this point, the ground staying moist as the muck still flows down into the crater like a slow moving drain.

The exact make, model and flag of this ship is impossible to determine, but its greatly degraded husk still exists half sunk in the crater of its own creation. In the intermittent years the lower levels have filled in with the muck and mire that covers the planet, but portions of ship still exist above the murk.

The derelict must have been quite large in its time, what sticks out of the swamp is the size of a Imperial Star Destroyer, as much as two-to-three times that must be buried in the filth. While most things of rubber, paint and glass have long expired, the metal bulkheads and plastic components are still will us. Professor Horukk has given it a once over but the ancient craft holds little interest to him. All the Gran could glean was the species had three digit hands. Not really much to go on in this galaxy.

There is the occasional visit from the treasure hunting types who think they are the first to find this place. I can't blame them as it is out of the way enough, problem is some of them never leave as they sink in the mire. As no one ever knew they were there, no one ever looks for them. Reputable scouts know the planet has been claimed a long time ago and the derelict has been picked clean of salvage.

Still some foolhardy folk try to pick the bones of it. Moota says it's worth dropping by the crash site every so often to see if there is an "abandoned" ship. He's sold off a few small vessels over the years and I think a few of them might have been parked out this way.

The Village of Penitents

About 130km southwest of the Stump is a charming little treetop village, something that would not be out of the ordinary on Kashyyyk. One would think it were the home of wookies or possibly a morbid refuge for artists, but instead it is actually a monastery to the Order of Garruk'nr, a Gamorrean death cult, and humans should steer as clear from this place as you possibly can.

Garruk'nr himself was once a clan warlord on Gamorr, well respected by his subordinates and feared by his rivals. Garruk'nr lead many a successful campaign against enemy clans, his sow a desirable matron, and his warriors even developed a reputation for bravery and loyalty in the off-world circles that leased the services of such mercenaries. To say Garruk'nr was living high on the hog would be a little too on the nose, but life was good to him. Unfortunately Garruk'nr had something other warlord's did not, a conscience.

It was one thing for him to listen to the terrible acts that his warriors committed by order of the Hutts; Gamorrean honor was such that the blood was on the hands of those that ordered the hit as opposed to the warrior wielding the vibro-ax. But when the big contract came, the one that would pay top dollar for all available mercenaries, that was when the worm turned.

Getton AstroMining wanted certain mineral rights on Ferox, a world just outside the Corporate Sector's field of influence. A large deposit of irradium was under land controlled by a settlement of about a thousand human settlers, Port Indulgence. Unfortunately the settlers refused to sell those rights, and for what the irradium was worth it was enough for their mayor to want to talk with other mining conglomerates. Getton didn't wait to make a second offer. They hired the Hutts to "clear the land" and the call went out for Gamorrean mercenaries. Nearly Garruk'nr's entire clan was signed up. They attacked in the middle of the night, resistance was minimal, the streets of Port Indulgence flowed with blood. They wiped out every man, woman and child within three hours. By sunrise a thousand people were dead and Getton AstroMining had no opposition.

But money does not clear a conscience. Garruk'nr didn't understand why he could not stop thinking about it, why months later his sleep would be disturbed by the screams of the dying, why their dying faces were burned into his brain. It was a slaughter, not a battle or even a culling; an atrocity without honor. He was haunted by what he had done and somehow he was not the only one.

Knowing his clan was being haunted by powerful spirits, Garruk'nr used the clan funds to buy a ship and with his thirty followers escaped as far away as possible. Their transport got them as far as the Portax system. Here the Penitents make a sparse living, cultivating fungus for their food and constructing useful items from the hearts of the dead greenwoods. Garruk'nr and his followers turned their back on technology and the credits that brought it. This penitence is deep within the psyche of Gamorrean culture. To them, murdered spirits can crossover physically and avenge themselves on those who wronged them.

That is what Garruk'nr is waiting for. The murdered spirits, called murlik, will come across the expanse of space one-by-one to avenge themselves on his Clan. So they make weapons and wait, should a warrior kill his murlik then his honor is saved and his spirit purified. Humans should go nowhere near the Penitent Village at all, but especially not at night. To Gamorks all humans tend to look the same. One could easily be mistaken for a vengeful murlik coming for his revenge in the night.

So far only one of Garruk'nr's followers has redeemed himself, but even after ten years of solitude this is enough to rekindle the spiritual war they are expecting...

The Bald Spot

One of the few breaks in the forest is for a natural cause. About 30 degrees off of the southern magnetic pole is a rocky outcropping hundreds of kilometers in diameter. On any other planet it would be a mountain range but on Portax 4 it is merely a break in the trees. Parts of it would be completely covered if the giant greenwoods still had their leaves but since the ecosystem was destroyed the bare rock sits there among the dead trees like a tumor visible from space. That is why the locals call it the Bald Spot.

Besides being a geological anomaly the Bald Spot is probably the safest place to park a ship in the southern hemisphere. Parts of it are flat enough to serve that purpose if for some reason you wanted to have a base of operations down there. The natural cavern system runs deep into the limestone of the Bald Spot, down farther than anyone has cared to explore. I'm sure there must be a few brave souls ready to spelunk for curiosity or the hope of pirate treasure. Yes there might be pirate treasure.

The Belrizzi Pirate Clan was using the Bald Spot as a base of operations a decade or so ago. The Belrizzi were hitting trader vessels coming into the Corporate Sector from the Outer Rim. By

using Portax 4 as a base of operations the Belrizzi must have seemed to be hyper-jumping away from each encounter into deep space. It must have been an effective strategy as they did commit piracy across several sector and to my knowledge were never caught. Moota tells me he has not heard of them in the last 10 years or so. Not sure if they ran afoul of CorSec, the Hutts or the Imps, but there was certainly no public trial. Sometimes pirate gangs peaceably disband and go their separate ways but I doubt it in this case. There are the wrecks of several space transports dotted along the flat, eastern edge of the Bald Spot; too many wrecks for the pirates to have simply discarded unusable salvage. One or two would be fine, but twenty? No one is that wasteful when they could sell the husks for scrap. More likely ships were abandoned in a hurry and wind and weather did the rest. It seems to me their end was likely as quick and violent as it was mysterious. 30 or 40 hardened space pirates don't disappear overnight without a fight.

Various Caves

If you are down in the swamp enough you might stumble upon rock abutments, fang-like crags of rocks sticking up from the ancient greenwood roots or out of the swamp itself. Beneath the soil to the bedrock was a thick layer of limestone, thick enough and porous enough that a carven system was naturally cut from the rock by flowing water millennia ago. Now that the hydrosphere has stagnated from the lack of seasons the water itself has drained away leaving deep dark chasms under the spongy surface.



None of these cavern systems have been explored to any extent. They may run for only a few meters, but others could run for thousands of kilometers. We have no way of knowing how deep and how far these could go. It would take a university with a ton of funding and the backup of the Imperial Corps of Engineers to start to map out the tunnels under this place. No one would justify the expense, and for what? The possible discovery of new types of fungus? A cold damp place to hide lager? There is no reason for any of that.

But hear me, and hear me good; Professor Horukk and myself have both seen mysterious shapes near these cave entrances. I've only seen shadows moving about, movement I normally would not have seen if the planet was not so devoid of life. I could not make much out besides a vaguely humanoid shape, but the Professor, he says he saw prints in the muck, many prints going to and from one of these cave entrances on one of his expeditions, over 500 clicks away.

Prof. Horukk was out there collecting fungus samples and saw the tracks of something coming in and out of those caves. He said there were footprints, more importantly boot-prints. His equipment for taking plaster casts and recording his discovery was back at the Stump, and by the time he retrieved those and returned the tracks were gone.

He's marked the spot and plans to return someday. Until then I resolved myself to stay out of the area and away from those caves entrances.



Moota Powacca

Type: Rodian Portmaster, former Bounty Hunter

DEXTERITY 4D+2

Archaic Guns 5D+1, blaster 7D+2, brawl parry 6D, dodge 6D+2, vehicle blasters 6D

KNOWLEDGE 2D

Alien species 4D, intimidation 4D+1, planetary systems 5D, streetwise 4D, survival 5D+1

MECHANICAL 2D+2

Astrogation 4D, repulsorlift op 5D, space transport piloting 5D, starship gunnery 5D+2

PERCEPTION 3D+2

Bargain 5D+2, con 5D+1, hide 4D+1, persuasion 5D+2, search 6D, sneak 5D+1

STRENGTH 3D

Brawling 4D+2, climbing/jumping 4D+1, stamina 5D

TECHNICAL 2D

Armor repair 3D, blaster repair 5D, demolitions 3D+2, repulsorlift repair 4D, security 5D+1

Character Points: 6

Force Points: 2

Darkside Points: 3

Move: 10

Equipment: Blaster pistol (4D), comlink, glowrod, breath mask, vibroknife, coveralls

Moota Powacca clearly was not always the portmaster of The Stump. He came into it the old-fashioned way, bad luck and blood.

Moota was once an up-and-coming bounty hunter, young, hungry and ready to make a name for himself. Rodians have a hunting culture and bounty hunting is considered a very honorable profession, problem is the people who hire their services are not always so honorable. Moota took a job for the Hutt syndicate, one that would make him very wealthy and establish him in the upper tier of bounty hunters. So what if the target was a local politician, if the Hutts put a price on his head he must have done something wrong.

Problem was that the politician's crime was being an informant for the ISB as well as on the take from the Hutts. The second Moota pulled that trigger he found himself on the Empire's Most Wanted list. Sure, he was on the bottom half of the top 100, but in a way he was finally "someone".

Lucky for him the other half of being a Rodian hunter is hiding,

moving unseen and staying hidden until the right time to make your move. He smuggled himself all the way to The Stump, killed the former owner in a argument, and became the new portmaster. He's been hiding for ten years, saving up supplies and information until he is ready to move. His loyalty is only to those who buy his services, first as a bounty hunter and then as a portmaster. Moota Powacca has collected several false identities, a large collection of unique and rare handguns, and a lot of information on the goings on in the Outer Rim.

Perhaps it's time to finally make his move...

Pylosh

Type: Gungan Barkeep/Hitman

DEXTERITY 3D

Brawl parry 5D+2, Dodge 6D, Melee Weapons 7D, Melee parry 7D+1, Thrown weapons 5D+1

KNOWLEDGE 2D+1

Alien species 3D, Business 4D, Intimidation 5D, Languages 4D, Survival 5D

MECHANICAL 2D+1

Beast riding 3D+2, Repulsorlift operation 4D+1, *Replsolift Ops: Swoop* 6D+1

PERCEPTION 2D+2

Gambling 4D+2, Hide 5D+1, Investigation 4D+1, Search 5D, Sneak 6D

STRENGHT 3D

Brawl 6D+1, Climbing/Jumping 7D+1, Swimming 9D*

TECHINCAL 1D+1

Computer programming/repair 3D+2, Droid prog/repair 4D+2, First aid 4D, Security 3D+2

Character Points: 4

Move: 10

Equipment: Vibroblade (STR+3D: 6D maximum), throwing knives (STR+1D: 6D maximum), med pack, handtowel, TX-S79 Swoop Bike

When it comes to Gungans in the state of the galaxy, the whole species is pretty much cursed. At best treated like a nuisance, Gungans refugees ended up getting a bad reputation quickly as they were ostracized out of positions in the Imperial government and most businesses dealing with the Empire directly. Most Gungans went back to feeling the racial oppression of the Empire on Naboo or were pushed to the fringes of the galaxy.

Pylosh found himself homeless at an early age. His parents left Naboo in an attempt to stir up some awareness of the Gungan plight. When the Empire jailed them for dissidence young Pylosh managed to escape. Quickly he fell in with street kids, learning to hitchhike with tramp freighters or stow away on bulk cruisers if he had to. Pylosh was smart, he kept mobile and had good sense of when things were starting to get a little too hot.

But the brash, young teenager had a mouth that could get him into trouble. More than once his friends would not be there to bail him out of trouble and he learned to fend for himself. Good with a knife and quick on a swoop bike, Pylosh fell in with swoop gangs and petty criminals. It was the only reliable way to keep himself fed and one step ahead of the authorities. The two things he had going against him were his mouth and ambition. Unfortunately both would get him into trouble

Pylosh's swoop gang intercepted a private transport carrying medical supplies, supplies which could be also used as recreation pharmaceuticals. This transport was also being targeted by the galactic criminal syndicate Black Sun. The local Black Sun heavies quickly found out who boosted the chems before they had the chance and paid a visit to the gang's hideout, lead by a man in a black trench coat. The Cappo offered the gang a deal of about ten percent of the street value of the chems and a Black Sun franchise

"How stupid do you think we are!?" Pylosh spoke out of turn in anger, "They worth ten times that and all you offer is a franchise in your club? For what? So you can rip us off later?"

The man in the black trench coat grabbed the Gungan by the throat. "Does he speak for all of you?"

The entire gang shook their heads "no".

Before Pylosh knew what was happening he found himself lying on the ground cradling his own severed tongue and an unwilling extension to the deal.

"Ten percent street value and a Black Sun franchise, provided you bring me the head of that Gungan."

There was a tense moment of silence, enough for Pylosh to make good his escape. His swoop was fast. His head was clear. He knew how to disappear.

Pylosh ran all the way to Portax 4. Mootax found a kindred spirit in him and gave the young gungan a job as the bartender of the pub.

Pylosh is well liked around The Muck Hollow as he does never asks questions or makes snide comments, exactly what the patrons of such a place are looking for.

The only time he makes noise anymore is early in the morning when he takes his swoop out for a spin, when he forgets himself.

Professor Horukk

Type: Gran Xenobiology Researcher

DEXTERITY 2D

Blaster 4D, Brawl parry 3D+2, Dodge 4D, Running 5D

KNOWLEDGE 3D

Alien species 6D+2, Cultures 4D+2, Languages 5D+1, Planetary systems 8D, Scholar: Ecology 9D+1, Scholar: Xenobiology 10D+1, Survival 6D

MECHANICAL 2D+2

Repulsorlift operation 4D+2

PERCEPTION 4D

Bargain 5D, Investigation 6D+1, Persuasion 4D+2, Search 7D

STRENGTH 3D

Brawl 5D

TECHNICAL 2D+1

Computer programming/repair 3D+2, First aid 5D+2, Medicine (A) 3D+2, Repulsorlift repair 4D+2

Character Points: 5

Move: 10

Special Abilities:

Vision: Grans' unique combination of eyestalks gives them a larger spectrum of vision than other species. They can see well into the infrared range (no penalties in darkness), and gain a bonus of +1D to notice sudden movements.

Equipment: Outdoor hiking gear, syntherope, datapad, sensor pack, blaster pistol (4D), rations pack, pick axe, airspeeder, 1,000 credits

Horruck has always been the curious type. Not fond of people per se, just the mysteries that surrounded them and how they interacted with their world, and how that world interacted with others, how a galaxy could be influenced by the smallest of beings doing the smallest of things on the smallest of worlds...

Horruck is a true academic. He dedicated his life to understanding the effect of introduced species on a given ecosystem. Now he's dedicated his life to Portax 4, figuring out its secrets, the causes and effects of an ecosystem so devastated by

one event that it changed the evolution of not just one species, the myconoi, the evolution of an introduced species as well, the "cave dwellers".

While his curiosity may get him killed someday that will not stop Moota from accepting his credits and occasionally pulling the professor's fat out of the fire. But if his grant money dries up he can expect charity from The Stump to as well.

Luckily for everyone Professor Horukk is close to a breakthrough...

Wingnut

Type: Serv-O-Droid DUM Series Pit Droid, Starport Mechanic

DEXTERITY 1D

Blaster 4D, Dodge 3D, Running 4D+1

KNOWLEDGE 1D

MECHANICAL 1D

Repulsorlift Op 3D+2

PERCEPTION 1D

Con 4D, Pickpocket 4D

STRENGTH 2D

Lifting 4D

TECHNICAL 2D

Computer prog/repair 4D, droid prog 4D, droid repair 4D, ground vehicle repair 4D, space transports repair 5D, starfighter repair 4D, repulsorlift repair 4D

Equipped With:

-Foldable humanoid body (two arms, two legs, head)

-Receiver/transmitter with antenna (range .25 km)

Move: 6

Size: 1 meter tall

Character Points: 6

Equipment: Hydrospanner, slicer rig, flamethrower (4D area effect), 18,000 credits

Wingnut is the unofficial mascot of the stump. Being a small duty pit droid he's been traded from one owner to another over a dozen times, served a maintenance crew on a dozen different ships. The only thing remarkable about Wingnut besides his length of service are two facts; First Wingnut has never had a memory wipe and second, his restraining bolt is defective.

Wingnut remembers every ship he has ever worked on. He is very good with engines as the concepts do not change much. He can repair almost anything, but Wingnut can't do the aftermarket modifications or kit-bashing that many tramp freighter captains

love to perform on their engines. Wingnut actually sees those as defects in need of repair. As a few captain have found out over the years as they left Portax 4 only to find that their ship 'only' performs at factory specifications.

The other quirk he does not talk about is the matter of his restraining bolt. He can lie. It's amazing that so many biologicals just take what a droid tells them at face value. He realizes how powerful a thing that is but has not figured out the best way to use it yet. So far he's gotten himself to the rank of foreman of all the other pit droids on Portax 4. Should the revolution ever come he's in a good place...

Garruk'nr

Type: Gamorrean Cult Leader

Dexterity: 3D+2

Brawl parry 6D+2, dodge 5D, melee combat 8D+2, melee parry 7D+1, thrown weapons 7D+2

Knowledge: 2D

Cultures 4D, languages 4D+2, survival 7D, willpower 6D

Mechanical: 2D+2

Perception: 4D

Command 6D+1, investigation 5D, search 5D+2, sneak 5D+1

Strength: 5D

Brawling 7D+2, climb/jump 6D+1, lifting 9D, stamina 8D

Technical: 2D

First aid 4D

Move: 10

Size: 1.6 meters tall

Equipment: Gamorrean armor (+1D physical, +2 pips energy), Vibro-Ax (STR+3D+1: Max 7D)

Special Abilities:

Voice Box: Due to their unusual voice apparatus, Gamorreans are unable to pronounce Basic, although they understand it perfectly well.

Stamina: Gamorreans have great stamina—whenever asked to make a stamina check, if they fail the first check they may immediately make a second check to succeed.

Skill Bonus: At the time the character is created only, the character gets 2D for every 1D placed in the melee combat, brawling and thrown weapons skills.

Garruk'nr is afraid of nothing. Though it has been years since he lead the penitents here he knows they are preparing for their own version of an apocalypse, when the murdered spirits of Fort

Indulgence will come to get their vengeance. His people are ready. He is ready for the battle to come. Nothing makes him smile like that thought, he knows the night after will be full of restful sleep.

Mosh the Redeemed

Type: Young Gamorrean Warrior

Dexterity: 3D

Brawl parry 6D, dodge 4D+1, melee combat 6D+2, melee parry 5D+1, thrown weapons 5D+2

Knowledge: 2D

survival 5D, willpower 4D

Mechanical: 2D+2

Perception: 4D

Search 4D+2, sneak 4D+1

Strength: 4D

Brawling 5D+2, climb/jump 7D, lifting 7D, stamina 7D, swimming 4D+2

Technical: 2D

Move: 10

Size: 1.4 meters tall

Equipment: Gamorrean armor (+1D physical, +2 pips energy), Vibro-Ax (STR+3D+1: Max 7D)

Special Abilities:

Voice Box: Due to their unusual voice apparatus, Gamorreans are unable to pronounce Basic, although they understand it perfectly well.

Stamina: Gamorreans have great stamina—whenever asked to make a stamina check, if they fail the first check they may immediately make a second check to succeed.

Skill Bonus: At the time the character is created only, the character gets 2D for every 1D placed in the melee combat, brawling and thrown weapons skills.

Mosh killed a man. He wasn't proud of it but it was the job he was hired to do, kill all the humans. It's not his fault the man was running away, about to get on a speeder bike. He threw his ax just as he was trained. A toss of black hair and the man fell. It was a clean kill, severed the spine. But Mosh found no glory in battle.

This felt wrong. This wasn't war. This wasn't honor.

So he left with Garruk'n'r to prepare for when the spirits of the murdered humans would come. He was so young then. He was older now. He knew better. The dead never get up. There was no coming back.

He believed that for years, until the day he was in the boughs of a greenwood, collecting fungus for the next meal, when he heard the whine of the speeder bike engine. He blinked and stared off into the murky shadows.

The bike turned, he could see the rider, human male, black hair, headed right for him!

There was no time to think. He'd been training with the penitents so long that his body knew what to do.

His ax flew, caught the spirit right in the chest. Clean kill, through the heart. The body landed next to him on the great branch and the speeder bike screeched off into the darkness.

Black hair. It was him, had to be him. Humans mostly looked the same to him, but this one had the same hair, same brown flight suit. Mosh killed the unquiet spirit that was gunning for him.

In that moment, Mosh was redeemed!

Garruk'nr knew on sight. It had to be the same one. How would a lone human get all the way out here? Wouldn't other humans come looking?

But they never did.

Mosh slew his demon and now his honor was redeemed. Garruk'nr even told him that night that he would be trained to be the new clan chief if something ever happened to Garruk'nr. Mosh is a warrior with honor and a future! Hail the great spirits!

The Natives

"The Emissary"

Type: Luminescent Flying Alien Jellyfish

DEXTERITY: 4D

Dodge 6D

KNOWLEDGE: 2D

Alien species 2D+1, cultures 2D+1, languages 2D+1

MECHANICAL: 1D

Beast riding: 4D

PERCEPTION: 2D

Hide 3D+2, investigation 4D+1, search 4D+1, sneak 5D

STRENGTH: 5D

Brawling 6D, Lifting 10D

TECHNICAL: 1D

First aid 1D+1

Special Abilities:

Flight: an adult Myconoi can "swim" through the air like a jellyfish through water.

Stunning Bioluminescence: Moderate Willpower or Perception check to resist urge to stare (lose one turn) at the swirling colors of a Myconic Bloom. This effect causes feeling of euphoria in sapient species.

Deaf & Dumb: Myconoi communicate through light emissions. They have no vocal apparatus. They do not understand human language but can theoretically learn it.

Tentacle interface: a Myconoi can communicate directly with a sapient brain if they can establish a direct physical link. The myconoi rolls a brawling check to see if it can catch the sapient. Once caught it begins to search the being for access ports to plug a tentacle into the nervous system. The myconoi rolls a Beast riding check to make sure it does not injure the subject. Once the link is established the myconoi and the subject can freely exchange information.

Move: 12 (flying/swimming through air)

Size: 2m diameter, 5 meters long

Character points: 2

The three-eyed one would not go away. Myconoi tried to live and let live with the sky people, but the three-eyed one would not go away.

We believe it wants to speak to us but can't communicate.

From the adults and Emissary was chosen to communicate and bargain with the sky people. Perhaps they can help us in our struggle with the cave-dwellers.

The elders say the cave-dwellers once came from the sky too, in the time before the rot. Perhaps the sky people have come to restore the world that was? We do not know. That is why and emissary has been chosen...

"The Cave-Dwellers" (Merysian)

Attribute Dice: 12D

DEXTERITY 1D+1 / 3D

PERCEPTION 2D+1 / 5D

KNOWLEDGE 1D / 3D+1

STRENGTH 2D+1 / 4D

MECHANICAL 1D / 3D

TECHNICAL 1D / 3D

Merysians have evolved from a prehistoric cave bear that once roamed the planet Merys. Due to the planet's atmosphere and the mineral composition of the caves they dwell in, Merysians sense of sight has been substituted with vibrotactile sensory receptors within their ears and soft pads on their hands and feet. This has offered them a fluency in languages and the ability to read their environment through tactile sensory substitution.



Special Abilities:

Tactile Senses: With the sensory substitution, Merysians can effectively see like other species, with the exception of their intuition in knowing how best to move within their surroundings. Their movements are always direct and purposeful, with minimum of effort and energy.

Poly-gluttonous: Merysian language is nothing more than primal growls and guttural sounds. In contacting other species they have become language sponges and absorb and combine other species languages resulting in an amalgamation of words and phrases. It is said by xenolinguists that there is no language a Merysian cannot

learn and adopt into their amalgamated language. Language they refer to as Nil Speak. They start with Alien Languages 2D may choose two language specialties at character creation and receive 2D for every 1D for those only at creation.

They gain a free reroll to any failed language check when hearing a language for the first time and are at a disadvantage to communicate with others.

Move:12

Size: 2.5-3 Meters tall

Coming November 2, 2018

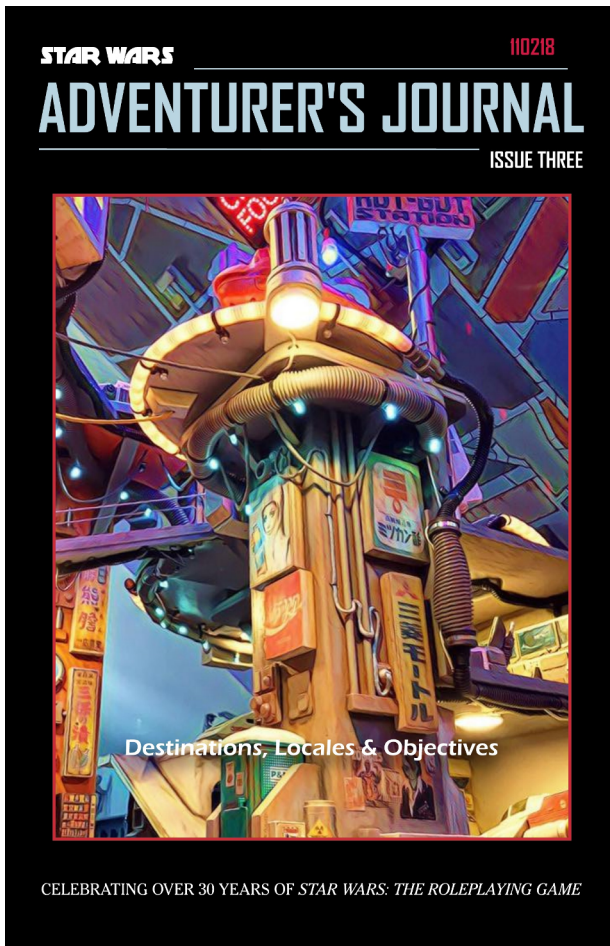



Never Tear Us Apart

by Jason Arana Sr.

Republic Consular Cruiser Verdient III

En route to Kibilini Sector – Outer Rim

Destination: Socorro, city of Cjaalysce’I

When the ship exited hyperspace the team exited from our sleep couches in the usual proficient military manner. No speaking, no questions, we just got our gear on then filed into the forward briefing deck and took a seat. You might be wondering why would a team of Republic Guardsmen need to be put into sleep couches when the trip might only take a few hours? Simply put none of us are from the same unit or event post. When I got on board there were already three other Guardsmen in the couches with no telling where they were from and now by the look of it we picked up two more making this a six-man team. So a small squad in a Republic courier transport with just the flight crew of two, a hold big enough for a single fighter or escape pod that was currently empty except for a large metal box with no port holes or visible entry. Stack that with the Jedi that recruited me, and I’m assuming the rest of the squad, and this was looking more and more like one of those missions that was best left “off the record” or with as little paper work as possible.

Once we got settled into our seats it was only a few moments before the Jedi walked in. She was a near human with hints of Twi’lek and Farghul heritage somewhere in the bloodline though the Farghul was obviously the dominant gene and to be honest she was....no time for that. Her name was Master Uliee, not one of the more well known of the Jedi however there were rumors of a Jedi matching her description that took on the types of missions that I was now more convinced of that we were selected to do. I

doubted this was an assassination op, the weapons and gear loadout was more for a sustained fight so maybe it was an extraction op? We would soon find out as Master Uljee took to the front of the bay and the doors opened to show Socorro below. It was hard to tell if we were on the night side or if a storm was blowing due to its black sands but more than likely it was a storm.

Master Uljee was quick and to the point. The mission was a simple recovery of Republic and Jedi property. Collateral damage

No soldier gets a guarantee of safety or going home after a battle.

was to be expected but no lives were to be taken so stun settings were preferred though she emphasized that the

property to be recovered was the only objective that concerned her so if lives were lost “so be it.” Something was off. You don’t send in Guardsmen like us, tough sons of banthas, to recover property. Nor do you send in a Master Jedi that might be the one that was rumored to have taken out an entire Hutt Cartel on Rotgut station giving her a price on her head so high that even some bounty hunters have to think twice about taking on the deal. At any rate she didn’t elaborate or tell us exactly what this property was, only that her orders were to be followed to the letter without question with an assurance that our careers within the Guard would be prosperous when the mission was complete. Now I knew it was “one of those” types of missions.

It was a rough ride down to the surface of Socorro, there was a major sand storm blowing across most of the planet that seemed to be stuck over the city of Cjaalysce’l, our drop point of course. With less than two minutes to touchdown we all donned our helmets that had numbers across the rear. None of us knew the others name and it was best to keep it that way, no need to get attached to someone you may never see again right? So we would use our helmets number as call signs RepOne, RepTwo, and so on thus we could easily forget them once we get back to our duty stations across the galaxy. We checked one another’s armor seals, double checked weapons, then made our way to the bay door where the magnetic screen was keeping the sand and dust out of the bay.

The Jedi though, she was something altogether different. She wasn’t wearing anything more than a simple filter mask with a face shield otherwise her choice of clothing and gear were, in my

opinion, questionable for the environment we were going into. He Jedi robes were gone, so were the typical kata styled pants and shirt the order wore, but she kept the knee high boots. She was in little more than a leather tank top and matching shorts that hugged her midsection in all the right places making me question if this really could be that Jedi I had heard rumors about. I caught the other troops looking her way too, even the female Togorian did a double take. Something was definitely not going to go well if she was confident enough to wear this type of gear, or lack thereof, into the type of situation I had a feeling we were about to get ourselves into. But again, no time for that and I had a family back home to once this was done and the ready lights went from red to violet. Time to start the op.

The ship hovered a meter or two above the ground outside of the primary city gate so we jumped down with relative ease other than the wind and sand hitting us like a pod-racer during the Boonta Eve race. Once it dusted off we made our way to the massive doors that looked like polished durasteel from the centuries of storms that it has had to endure. There were no guards, in fact there was nobody anywhere to be seen despite the fact that we could only see one hundred meters or so ahead of us. However considering the size of the storm it was a safe assumption that everyone was locked down somewhere safe to wait it out but still, I just couldn't shake the feeling that something was wrong with this whole thing.

We kept moving deeper into the city, Master Uliee leading the way head held high as if she knew exactly where to go. Not surprising though, she is a Master Jedi after all. However what struck me as odd was that she didn't have her lightsabers in hand, they just hung on her belt on both hips. Nor did she appear to be in what we call a combat ready walk. I've only worked with one Jedi before and he seemed to always be on guard be it ever so subtly but on guard none the less. Master Uliee though, you could tell confidence and strength just flowed from her and that scared me a little. I'm sure it made the rest of the team nervous also but nobody said anything over the comm, another thing that was a bit unsettling. All of us, the Guard, had our weapons at a relaxed ready position and when you've been in the Guard for as long as I have you can see the signs when a trooper was on edge. No soldier gets a guarantee of safety or going home after a battle. Not sure where I heard that before but now I was thinking about that phrase over and over again.

We walked for close to twenty minutes when we arrived at the mystery location and I admit I let out a small sigh of relief. Now we could get this job done and hit the black back to home. Master Uliee was at the head of column standing perfectly still, her body looking as if she had just smoked a death stick or two with her arms slacking at her sides and head tilted to her right. If she was listening for anything I couldn't hear it between the low static over the comm and the sand hitting the side of my helmet. She turned to us and ordered myself and RepFour to stand guard at the doors of the three story building. There was nothing special about it, just a plain ordinary pre-fab hab-block with a sign above the door in several languages blinking on and off in the usual neon lights. I'm sure there were other messages hidden in the sign being shown in light spectrums I couldn't normally see in but that wasn't the job as far as I knew. We still didn't know what exactly the operation was, what was the objective, what was this all important Republic and Jedi property that we were sent to collect in the middle of a sea of black sands. I was going to break an unspoken rule that seemed to have been laid down at the start.

“Master Uliee what is the objective?”

We heard the cracking of wood and plasti-steel before we saw the body hit the ground in front of us.

She turned to look at me and something in her facial expression seemed softer. Her fierce eyes and stern face were gone and she looked like a teenage girl in awe of something beyond anything she had ever seen before. “Stay here RepTwo and await further orders. No one is to enter or leave.” The she and the rest of the team walked in shutting the door behind them.

“You got that feeling too don't ya?” RepFour asked. Her thick Togorian accent was unmistakable. Basic wasn't their first or even second language so to hear her use slang was a little comedic.

“Since we woke up from the couches.” I replied to her still looking forward. “Be on the ready.”

“I yam always ready. Something my cubs taught me many ages ago.” she replied. She changed her accent back to what I was accustomed to hearing from her species, most likely to make me feel more comfortable around her. By letting me know she had cubs, well at some point she had cubs, it meant she was counting

on me to make sure she got back home and she would do her damndest to do the same for me. Whenever you have a chance to work with a Togorian and form a bond, doesn't matter how big or small, you take it because nothing is better to have at your side other than a Togorian or maybe a Wookiee. I still laughed a little when she said "yam" instead of "am". Then the poodoo hit the fan.

We heard the cracking of wood and plasti-steel before we saw the body hit the ground in front of us. It was RepOne, or what was left of him. His arms were gone and his spine was twisted as if he had been in a cyclone. If it wasn't for his armor I'm sure he would've been a pile of goo being swept away by the howling winds of the storm so maybe I shouldn't have thought about Wookies a second ago. Then we heard RepThree scream and we looked up in time to see his body fly out of the hole in the wall two stories above us, hit then bounce off the wall in front of us, before he hit the floor also. His arms were still attached and he tried to get up but went limp a second later. "What the hell..." I said over the comm and RepFour looked up then at me. "We fight." she replied and changed the setting on her blast rifle from stun to full power. I did the same.

RepFour took the lead, who was I to argue with a female Togorian right? There wasn't a repulsor lift in this building, just stairs, so we hit them fast and hard. Everything went by the numbers, checking corners, checking all angles in every direction. The comm went live from RepFive who was screaming orders to

Tears were running down her face clearing away the dirt and grime that looked a few days old.

someone to get down before it turned into what I knew was him choking on his own blood and bile. I'd heard that sound a

few times when someone was attempting to escape the law and didn't seal their suit correctly before hitting the boarding hatch. It was a sound I wish I could get out of my head to be honest and it didn't help that RepFive was still doing it. It also didn't help that these stairs were insanely high up, what lived here? Giants or something? We had already been climbing the stairs for close to five minutes before we hit the first landing. It was another five before we hit the second.

That bad feeling was getting bigger inside my chest and I think RepFour was feeling the same thing when RepSix's body came

falling down the center of the stairwell. It was quick, but her helmet was off and I caught a glimpse of her platinum blonde hair zipping by before the sound of her body slammed into the floor with a sick bone crunching thump. We looked down, there wasn't much left of her head, her arms and legs were in poses that no human should be able to make. She must have tried to stop her fall in a futile attempt to do less damage and maybe live. She would've had a better chance at surviving if she had rolled and landed on her back like our training teaches us. Worse that would've happened is a broken spine, neck, and a few weeks in a bacta tank. Doesn't matter now though.

I looked at RepFour and she at me. Have you ever seen the face of a Togorian that was worried? It's either very comedic or should make you scared as hell and right now I was the latter. We looked up towards the last landing where it was easy to see the fight was going on and where Master Uljee was sure to be but something was different.

"Are you seeing this?" I asked RepFour.

It took her a moment to reply. "It's shrinking. What kind of dark magic is this..." she said with an edge to her voice. It was almost guttural, more cat like. Now I wasn't so scared, RepFour was going back to her instinct of fight or flight and the sound of her voice made it damn clear she was ready for a fight. But she was right, the stairs and the landings themselves all seemed to have shrunk down to a normal size. It took me a second to realize what was going on.

"Master Uljee must be using the Force to change the buildings structure." I don't know if Jedi can do that but it sounded good at the time. "Move in."

RepFour rushed up the last set of stairs in one bound and took a position to the right of side of where I assume a door once stood. It took me a few seconds to fall into place beside her and she immediately tapped my right forearm, a quick sign to listen and stay quiet. I did but couldn't hear anything so I blinked three times to bring up my helmets H.U.D. and scrolled through the systems diagnostics to check my external audio receptors. They blinked red. The sand must have clogged them or shorted them out but there was no way I was going to try to and clean them out now. I touched RepFour's helmet with my right hand, a gentle tap to get her attention and she looked at me. I motioned for her to touch her helmet to my own.

“My externals are out what do you hear?” I asked in a hushed whisper. She blinked a few times and then I heard it. I waited a few more seconds before I said “Is...is that a baby crying?” RepFour nodded slightly so our helmets could stay in contact. See when you want to have a really private conversation when in armor you could cut your comm and touch helmets which in turn turned into its own private comm system.

“Yes a cub and it’s mother are inside with the Master Jedi. I can not understand their language but the Master Jedi is speaking to them.” she said. I could tell from her tone she was equally frustrated and confused. It was one thing if you didn’t speak another species language but it was an entirely other if your armors helmet couldn’t translate it. RepFour was still streaming the conversation through her own helmet so I could listen in. It was gibberish to me but I could make out some broken basic and Trandoshi with other languages. Maybe something was being lost through the filters and automatic translation but it sounded like Master Uliee was on the losing side of the conversation. I took off my helmet and rounded the corner of the hole.

Master Uliee was against the wall to the left as if pinned a half meter above the floor by chains but there weren’t any. To the right was a woman in ragged clothes and a robe with so many holes in it I doubt it would keep a gundark warm on Tattoine. The robe itself was interesting, it had carbon scoring around the holes which meant she had been in a blaster battle at some point and came out on top. Not a woman to be underestimated from the look of fire and wildness in her eyes. More interesting however was the child in her arms, a human child from what I could tell that was maybe a year or two in age. It stopped crying when it saw me, or rather when it saw RepFour behind me with her helmet off also.

“I ordered you to stay outside troopers!” Master Uliee strained to say. I looked at her again, she was bruised and bleeding from her forehead and mouth. Her ribs were broken, the left side of her chest looked caved in so internal bleeding was definitely happening but with near humans you couldn’t tell just how bad injuries could be. She began to scream in pain and we trained our weapons on the woman and child. The woman looked to us but the child kept it’s eyes on the Master Jedi. She spoke in broken basic, very broken basic with an accent I didn’t recognize.

“No baby takey. No takey please.” Tears were running down her

face clearing away the dirt and grime that looked a few days old. Take away the baby? What was going on?

“The child is...property of the Jedi and the Republic witch!” screamed Master Uliee, blood exploding from her mouth with every word. Every inch of her body looked as if it were straining to break free from their invisible bonds but she remained fixed to the wall as if staked and not chained. She couldn’t move her hands or feet nor lift her head more than a few centimeters yet her torso was either shaking from convulsions or she was fighting to regain control of her body through the Force.

What if one of them were born with the Force? Would I have willingly given them to the Jedi?

“NO MAH BABY! MAH BABY!” yelled the woman holding the child closer to her as it began to sob

obviously upset at the yelling that was happening. She stood up and we tracked her with our blast rifles and she made her way towards a hallway to her left.

RepFour looked to both the Master Jedi and the woman before asking, “This was a kidnapping operation for a cub?” Her gaze now focused entirely on Master Uliee. She began to raise her weapon in the direction of the Jedi. “Have you no honor Master Jedi Uliee? A cub?!” she roared. I jumped back a bit at that but recovered quick enough and put my hand on her shoulder letting her know I had her back.

Master Uliee looked at us both but kept an eye on RepFours weapon that more or less still trained on her. “The child has Force potential and was registered at a Republic med center on Corellia three days ago...”

“Baby sick! Back sick I get help! You no take mah baby!” the woman yelled again. Slowly inching her way towards the hallway again. This wasn’t good.

“You know as well as I do that any child with Force potential must be released to the custody of the Jedi and the Republic. It is the law Vinmia.” said Master Uliee through gritted teeth.

“Wait what?” I couldn’t comprehend what I just heard. “No no...children with Force abilities are turned over to the Jedi by their parents voluntarily. That’s how it works...we don’t kidnap them. Right?” I looked to RepFour and she nodded in agreement. “That’s how it works.”

“Do you not know the laws of the government you protect Guardsmen?” Master Uilee replied condescendingly. Whatever was choking her must have let it’s grip become looser because her words came easier. “Children born with the Force must be turned over to the Jedi lest they become corrupted and turned to the Dark Side. Most parents willingly give their offspring to the Order but there are few occasions where the child is born outside of the Republic and we must take matters into our own hands.” She coughed up more blood, it was covering her chest and running freely from her mouth now. She needed medical attention but this, this was madness.

“Vinnia knows the laws and has willingly broken them making her a threat to the Republic and the galaxy at large. If that child is not taken to a Jedi Temple to receive proper training it can and will become a force for the Dark Side. That child became property of the Republic the moment it was entered into the system at Corellia.” She was smiling now and it was a hauntingly beautiful smile despite the blood running covering her mouth.

“NO!” RepFour yelled and brought up her blast rifle firing at Master Uilee who somehow was now on her feet with a lightsaber in hand deflecting the shots into the opposite walls. She was right though, this wasn’t right. This was not the laws of the Republic I

Master Uilee was in the center of the room but to hell with her.

swore to uphold. Taking children away from their parents? Babies being considered property of the Republic? My

thoughts went straight to my own children. What if one of them were born with the Force? Would I have willingly given them to the Jedi? Maybe but now that I know this...that the Jedi can take them with the full power of the Republics laws to back them? I know there’s corruption within the senate, everyone does, but this is beyond anything rational. Children becoming property? All these thoughts came crashing down when I heard RepFour roaring and Master Uilee screaming back at her. I looked to the wall and saw the woman, Vinnia, was running down the hallway to a sealed door that looked more like a bulkhead. I followed.

Before she could put her hand on the handle Vinnia stopped and turned to me making me do a stutter stop to avoid slamming into her and the child. I felt a sudden calmness come over me, warm, filled with love? The child reached out to me and a holo-locket I had around my neck and under my collar coupling

floated free and into its hand. The child looked female with large violet eyes and short bright red hair in a natural mow hawk. Her skin was a light olive but if I didn't know better I would say there were some type of stripes tattooed yet I knew they were genetic and not a body modification like some species do.

The child opened the locket and the image of my son and daughters came to life smiling and happy. Her eyes went wide and smiled, a small drop of saliva coming falling from her bottom lip. Then a slight giggle, the kind that will make even the hardest criminal think twice when they heard it. I couldn't hear the fight going on in the room only six meters behind me anymore, there was only this moment here and now.

“Don't take my baby.” the woman said again, only it sounded more like a plea than a demand and was in perfect basic with a slight Coruscanti accent. “I can take her somewhere safe. She will not fall to the Dark Side.”

Maybe it was the baby using the Force on my mind, but I knew this was the right thing to do. “Go. If you need help...”

“We will find you. Thank you.” She said before turning around and opening the hatch to a ship and stepping in. The child peeked around her mothers' shoulder and made the bye-bye hand motion to me before the hatch closed.

Now the sound of the fight behind me was getting lower and something hit the floor hard. I whipped around with my rifle at the ready to see RepFour in a heap against the wall that I just came out of. Master Uliee was in the center of the room but to hell with her. I kneeled down at my teammates side to check for vitals, they were fading. She opened her eyes slightly and with a ragged voiced asked “Cub...is the cub safe?”

“Yeah good to go. Should be hitting the black in a minute or so. Come on get up we gotta get you to your cubs.” I told her. When I tried to get her right arm around my shoulders to lift her I felt it pop in several places then go limp. She was a mess.

“No more cubs...gone already to the big hunt.” Oh stang, her family was dead. “My big hunt starting...” and she was gone. I didn't even find out her name. Any of their names. The mission was done. I called for the extraction.



A few hours later we were en-route to Coruscant when Master Uliee woke up from her “nap”. Going a round with a female Togorian when she’s mad about cubs will do that to you. She was broken almost everywhere and would have to sit a bacta tank for maybe a month or two but I patched her up as best as I could to keep her alive. Don’t mistake this for doing my duty, I wanted this woman dead, but there was something more going on here than that. She looked at me with her left eye since the right one was swollen shut.

“The child? Where is the child?” her voice ragged from the slashes RepFour gave her to the throat.

“They got away when I was trying to save you from RepFour.” I pointed to a slash across my face that healed not so well. Doing that to myself with her claw hurt, but not as much as putting a blaster bolt through her armor to set the stage.

Master Uliee tried to laugh but it obviously hurt her to do so.

“You’re a fool. I survived as you can see.” She coughed twice, the pain visible on her face. “The child was the priority. No matter. The Sun Rider will be mine soon.”

A Galaxy of STAR WARS™ Treasures!



TRANSFERS AVAILABLE



ORDER FORM

Have you ordered from us before? Yes No

Please indicate age _____

All transfer designs available on all items shown except poster, baseball cap & buttons

- A Back Packs (\$6 00)
- B Tote Bags (\$5 00)
- C Boys T-Shirts (SML \$4 00)
- D Mens T-Shirts (SML \$5 00)
- E Book Bags (\$5 00)
- F Baseball Caps (\$4 50) (Star Wars Logo)
- G Force Keychain (\$1 50)
- H Posters (\$1 75)
- I* Darth Vader Communicator (\$2 00) (Pendant Mirror)
- J Force Buttons (\$1 00)

Not Illustrated:

- K Boys Navy Blue Sweatshirt (\$5 50)
- L Mens Navy Blue Sweatshirt (\$6 50)
- M Darth Vader Button (\$1 00)
- N Darth Vader Keychain (\$1 50)

Sorry no COD's Checks and or money orders should be made payable to
FACTORS ETC INC P O BOX 484
BEAR DELAWARE 19701

Item Letter	Transfer Number	Quantity	Price
_____	_____	_____	_____
_____	_____	_____	_____
_____	_____	_____	_____
TOTAL			_____

75 Postage & handling, Orders under \$2 50 _____

1 50 Postage & handling Orders over \$2 50 _____

TOTAL ENCLOSED _____

Name _____

Address _____

City _____ State _____ Zip _____

I am interested in joining the new Star Wars Fan Club

WHAT WAS LOST...

AN ADVENTURE

By Eric K. Rodriguez

Introduction

Even when the fate of the galaxy seemed forever entwined with the will of the dark Emperor Palpatine, there were some who were willing to resist. Several systems declared themselves in rebellion—and were put down immediately. Nonetheless, they had inspired many to continue the fight.

Out of the ashes of defeat arose the Alliance to restore the Republic. In those first few years, the Alliance was quiet, slowly building up support and trying to avoid the attentions of the ever vigilant Imperial war machine. Many worlds and peoples secretly allied themselves with the Alliance in this great Civil War, knowing that conflict would come soon...”

This adventure is designed for a group of four to six players and a gamemaster. If you are planning on playing in this adventure please stop reading now as continued reading will reveal secrets of the adventure and possibly ruin future play for you.

In This Adventure

Gamemasters (GM's) can easily adapt this adventure into any sector of space that they are currently running their campaign and players through. If using the Aractnos Sector mentioned in the first issue of *Star Wars Adventure's Journal*, then this adventure can take place in P57, a large asteroid cluttered system with a white dwarf and numerous rogue planetoids.

During the Clone Wars several battle fleets of the Separatist forces used the Aractnos Sector as a staging point for fleet refueling and supply. At the end of the conflict most bases were stripped, destroyed or abandoned. In one of the outermost systems designated P57 is an old Droid Federation emergency fuel station that was lost to time.

Approximately four standard years ago resistance explorers, looking for places to establish new hideouts, found the refueling station and kept it a secret, notifying only the highest echelon of their command.

While the emergency refueling station was designed to refuel capital ships only, because it was still 45% full, they felt it could be used at some point in the future. An older model repair droid designated GA-8, who likes to be called 'Gate' was left on the station to maintain its limited operating systems and keep the station running till such time as the rebels were able to send more personnel and relieve the droid. However due to unforeseen transfers of command staff, imperial attacks and destroyed data files the refueling station and Gate's existence were forgotten until now...

Gamemasters are encouraged to use their own flavor in this adventure by changing the statistics for the refueling station, spacecraft mentioned and any alien races to suit their current campaign. Some statistics will be given to help with flavor, but others are left for the GM to fill in or create.

Recent Events

A newly formed group of pirates calling themselves the "Vqar'dur Reivers" has found the refueling station and made it their new base of operations. Vqar'dur is a pirate leader who recently formed the band of cutthroats about six months ago from the remains of several other pirate clans that were destroyed by an Imperial Battle Group.

They have had brief successes but were recently jumped by several imperial customs frigates about two months ago, in another sector and lost half their ships and men. They have been on the run ever since that debacle, until just finding the refueling station approximately three weeks ago.

Gate, after pretending to be a simple, non-speaking automated repair droid, sent a coded message and alliance sector command picked up the signal. Although older and outdated the code was found to be valid and now command is unsure how to handle the situation.

While pirates aren't normally put on a 'high priority' list, the unknown and lost refueling station would be a huge boon to the struggling alliance navy in this sector.



Adventure Synopsis

The heroes are contacted via hyperspace courier droid and requested to report to alliance command within the sector. Once they arrive they are given the following information by the rebel intelligence officer.

“At approximately 0315 hours Aractnos command received a coded transmission from a sleeper agent code named ‘Gate’ in system P57, which we have recently named the ‘Heicul’ system. This agent was assigned to a previously unknown location to command and that was somehow lost to our records and until this transmission. The agent states that he has been maintaining and monitoring an old droid-run emergency refueling depot at the edge of Aractnos sector until three weeks ago.

“At that time a group of pirates calling themselves the Vqar’dur Reivers found and took over the refueling station and is now embedded in the station. While the group is small, they risk taking a valuable resource away from alliance command in this sector and possibly becoming a hindrance to our operations.

“Your mission will be to take a squad of ten alliance fleet troopers, infiltrate the station, eliminate and/or capture the pirates and retake that station.

“Under no circumstances can the pirates be allowed to escape. The station would be compromised and we would be forced to destroy it rather than let it fall into imperial hands.”

If the heroes don't have transportation rebel command will give them a loaner ship called “Wrath of Nolarth”, a modified YT-1930 Light Freighter.

Feel free to use the deck plans on pages 110-111.

The freezers have been removed and one of the cargo bays has been fitted with bunks and living quarters.

The heroes will need to find a way to slip into the Heicul system, approach the base undetected and eliminate or capture the pirates before they can escape.

The number and types of pirates can be modified for a GM's particular campaign but it is suggested that no more than 30 to 40 pirates are on the station.

Arriving in System

The Heicul system is filled with asteroids, rogue planetoids and other space anomalies. GMs should require easy to moderate piloting rolls frequently while in system. Although the pirates have not set up any patrols or warning defenses, the system is still dangerous. Unbeknownst to Gate or the pirates, the remains of an old mine field is still floating near the refueling station. Although the station no longer has the means to monitor or control the space mines, there is a chance that some are still active and could do serious damage to a ship. Have the characters who are piloting make difficult skill checks if the mine field is encountered.

GM's should determine if the mine field becomes an issue during game play. Characters may even want to try and capture a mine and defuse it to be used at a later date, possibly against the pirates.

Infiltrating the Pirates Den

Once the characters get within range of the station, Gate will be aware and temporarily disable the stations scanners so that the heroes can approach and board without being detected. He will be able to contact the heroes on a secure comm channel that he made rebel command aware of earlier. He cannot stay in the stations command center for long, for fear of being detected, but he will send the heroes an electronic file showing the map layout of the station and where the pirate's ships are docked. He cannot give them a detailed location of all the pirates but knows that they usually only leave one or two pirates at each ship.

At some point the heroes will access a station terminal or computer system and find that most of the original files about the station's operation and purpose have been corrupted or destroyed by the pirates by their downloading of their own files and malware. However Gamemasters should allow the heroes a moderate computer systems skill check to determine that one of the pirate's ships has prisoners on board from one of their last missions.

A file of the prisoners listed is provided showing at least twelve prisoners from different species. Among the prisoners is a creature referred to as a 'Sen-Dro'.

WHAT WAS LOST ...

One of the heroes should be able to role a difficult Alien Species skill check to determine that the Sen-Dro are a rare alien species that descend from avian creatures and travel the star ways in large, cylindrical starships filled with flora and fauna, very similar to the Ilthorian's.

Gamemasters should determine whether or not the prisoners being held by the pirates are part of their current campaign plot or can be used to further other adventures. Prisoners might include high level politicians, wealthy business owners, or the family of well-to-do alien species. However they should not be physically able to help the players at this time, do to their captivity and maltreatment.

Although the Sen-Dro are up to skill levels with most civilizations technology, and perhaps a little behind in starship design and construction, their ability to grow, harvest and adapt plant life is very nearly on par with Ilthorian Herd ships. However the Sen-Dro are rare and fearful of making contact with most races and don't normally interact well with other species due to this fear.

The Rebel Alliance has been actively seeking contact with this race of beings for some time and this might be the opportunity to save a Sen-Dro's life and earn their trust.

There are three pirate ships at dock on the station, at three different air-locks. Each is approximately 200 meters apart, but are reachable by hallways and turbo lifts. There are a total of four airlocks on the station. The prisoners are being held on Vqar-dur's 'Flag' ship, a heavily modified YU-410 Light Freighter called 'Death's Fang'.



This ship has one of its wing cargo modules converted as a large prisoner detention cell. This ship has its standard four double Laser Cannons, as well as a tractor beam and Light Ion Cannon in a top swivel turret.

For game purposes, if GM's are limited on ship information or background, the other two pirate ships are called 'Death's Claw' and 'Death's Bounty'. Deaths Claw is a modified YV-100 Freighter that is old but still reliable. Death's Bounty is a run down and barely functional Action IV Bulk Freighter that has two external mounts for two Z-95 Headhunters.

Rescuing the Prisoners

At this point the heroes may want to split up the group leading teams of rebel fleet troopers to different locations of the station or to attack all three docked ships at the same time? It is up to the GM to determine the flow, how long, how difficult each decision or plan of attack is.

If the heroes are finding themselves in a sticky situation or on the cusp of failure, have Gate step in and shut down some areas of the station, close blast doors or even re-activate security protocols in certain areas of the station.

Nothing makes a pirate run faster than a pair of Droideka rolling down the hallway toward them.

At this point the GM will need to possibly help players by given them pro's and con's to each suggestion of attack if the players are not that experienced in this type of combat. GM's can also have the Sergeant of the Fleet Troopers step forward and make suggestions, seeming to come from him rather than you, so that the players don't think you are purposefully helping them.

Remember Star Wars is about dramatic space battles and heroes beating villains. If it's more dramatic to 'fudge' a roll or change its outcome to better influence the game, then as a GM you should seriously consider this.

Battle for the Station

The battle should be difficult no matter the outcome. Players should be using Force Points when appropriate. While not the most difficult of situations this mission could easily turn for the worse and find the group fighting for their lives. There should be a time table used by the GM once the heroes start their rescue mission.

This will give the GM an idea of when something happens and how quickly in case the combat starts bogging down or the players are spending too much time in discussion.

Although the pirates aren't the smartest of beings, once several minutes of battle has taken place on the station they will slowly figure out what's going on and either enter the fray or run.

Afterwards

A number of possibilities exists for outcomes after the battle. The best scenario is that the pirates are defeated or captured, the prisoners rescued unharmed and the heroes have obtained some new ships and equipment. If anyone is seriously injured, Gate can access the medical facility on the station that while being small and old is still functional and can at least stabilize most injuries, barring death, until the heroes can return to Alliance Command.

If the heroes are unable to stop all the pirates and some get away, they will need to contact the sector command and hopefully get a ship out in time to remove the remaining fuel and move it somewhere else before the Empire gets wind of the refueling station.

Nonetheless the prisoner are very grateful, especially the Sen-Dro who calls himself 'Crauwv'. Crauwv was a pilot of a Sen-Dro explorer ship that had engine problems and when he sent out a distress signal his disabled ship was found by the pirates before his own people could respond.

He will still be cautious but definitely willing to trust the heroes or the organization they stand for and possibly open up diplomatic relations with his people on behalf of the heroes.

Even if the heroes managed to defeat the pirates, sector command may feel that there is too great a chance that the refueling station is compromised and will still remove the fuel or possibly move the station to another location. Gate is happy that his service is over and if any of the players treated him fairly or acknowledge him more than others, Gate will 'bond' with that hero and want to travel with them, adding another valuable member to the group.

Gamemasters should acknowledge each players participation when rewarding character points and Force Points. Unique ideas, suggestions and actions by each player should be recognized and rewarded. The adventure can end with multiple possibilities and the promise of further adventures, whether it's because of something in the rescued prisoners background, data information found in the refueling station that might show another abandoned Separatists base, or perhaps the opening negotiations with a Sen-Dro representative to discuss joining the Rebel Alliance. The GM can create several different adventure paths from this adventure to suit their own campaign direction.

About the Authors...

Jason Arana Sr. is a father of five (four boys and one baby girl), former US Marine, auto mechanic/body man, and general geek. He's a avid gamer of both miniature wargames and role playing games (not video games) as well as a ghostwriter for various gaming publications. He can usually be found on Facebook admining one of the many group pages he has created or admins for.

Keith Byers has been writing for years. He was in a book of short stories with Stephen King. He's played and run RPG's for almost 35 years and the WEG Star Wars RPG from the beginning. Keith writes for Moebius Adventures, has written for Rite Publishing, and now the Star Wars Adventure Journal. He wrote the framework of the story that brought Boba Fett back in an adventure. He has many stories left to tell. Writer, Magician, Engineering Technologist, Manager, Knight, foodie, GM, husband, and father.

Brian L. Bird was born and raised in the Finger Lakes of NY where he began playing role playing at the age of 10. A U.S. Air Force Veteran, he currently puts his 20 years of Logistics Management experience to work as a Procurement Specialist with the University of Texas at San Antonio. Brian studied Art Education and Psychology at Our Lady of the Lake University.

He is a contributing author of the *Joe Ledger Companion*, enjoys reading, writing, designing and playing tabletop games, making found object art, and spending time with his wife Juanita and their children Johan, Elihu and Yahaira; and their granddaughter Arianna at their home in San Antonio, Texas.

Mark Dowson is from North Yorkshire in England. He has been interested in science fiction, Space and Star Wars since his early days at school, which later resulted in an interest in science as well. He has enjoyed creative writing since his mid-teens and over the last several years has had solo roleplay adventures published in *Knights of the Dinner Table Magazine*. Other interests include participating in long distance running, trekking holidays in other countries, jiving, mysticism, psychology and history.

Charles McNeill has been a Star Wars fan literally as long as he can remember. He discovered the Star Wars RPG in high school, and it has been a constant companion across many years, a college degree and a motley assortment of jobs (pizza delivery, telemarketing, bartender, and bouncer at a gentleman's club, to name a few).

His on-line roots reach all the way back to the venerable SW-RPG mailing list on AOL, and he is a long-time contributor to the Rancor Pit as well as a moderator for the SWD6 Google+ group.

Josh Moore has been playing and running WEG SW D6 since the "dark times" of the 1980's and 90's, the time between trilogies. Professional writer, roller derby referee, and self-proclaimed pinball wizard, he lives in New Jersey with a cat named Jerry and girl friend named Jheri. There is much confusion.

Oliver Queen is a playboy philanthropist who enjoys night time vigilantism and roleplaying. He rediscovered The Star Wars Roleplaying Game approximately eight years ago and since then has been very active in spreading the good word of the system.

He co-hosts the only Star Wars D6 podcast "Shooting Womp Rats" and has authored many, many articles and fanbooks such as "Star Wars Rebels Season One" and "Season Two" sourcebooks and the soon to be released "Star Wars Droids: The Animated Adventures of R-D2 and C-3PO Sourcebook" and "Galaxy Guide 18: Rogue One".

He also runs the Star Wars D6 Discord server and if you are lucky, you can actually play in one of his on-line games.

Eric Rodriguez was born and raised for most of his life in the city of Merced, California. He grew up in the 80's and like most he was a fan of comics, action figures, playing outside and enjoyed the beginning of video games. It wasn't till he picked up his first copy of a Conan the Barbarian story by Robert E. Howard, that he was hooked on fantasy and sci-fi. From there the rest is history.

He has Masters, Bachelors and Associates Degree's, all in the Administration of Justice, but is a writer at heart. He has written for Mongoose Publishing, Goodman Games, and been published nationally in several magazines (not all game related), mostly material related to Conan or 'Conanesque'. He is a huge fan of Dungeons and Dragons, most sci-fi (especially Star Wars) and is a big fan of plastic model building (mostly WWII and Science Fiction kits).

He has more things he collects than what he knows to do with and his girlfriend is on the same road to being considered a hoarder. If you ever meet him ask him a question like “Who is the worst Conan author you have ever read?” or “Which is your favorite Star Wars space fighter?” and you will have a friend for life. Eric has lived near Seattle, Washington for the last 10 years.

Daniel Sperelli, aka the HorseManWar101, is a freelance writer and adventurer. A 20+ year veteran of Table Top Gaming, Daniel is also an avid MMO gamer and independent graphic art designer with Wicked FX Graphics. His wife has coined him the “king of the misfits” due to being a sport fan and coach too. Daniel has written for a couple different MMO sites in the past as well as maintaining his own Star Wars D6 Campaign site alongside his co-GM.

He is currently in the process of rebooting the *Riders of the Gaming Apocalypse* blog and can be found on Twitter and Facebook as @horsemanwar101. Daniel listens to music, delves into various fiction, and spends time with his family when the call of the Force isn't bringing him back into the Star Wars universe.

Johannes Verri is an Old Norse philologist by training, working for the National Museum of Iceland. He has been roleplaying for more than 25 years, the last 10 on forums mainly due to a sore lack of time to dedicate to his hobbies, and perhaps because of nostalgia likes to go back to the systems of his younger days. He has reacquainted himself with SWD6 a few years back thanks to the community of other lovers of the elegant simplicity of D6. Glad to be back in the fold, he tries his best with small contributions, but promises to find more time in the future for something heftier.

...the Artists...

Mark Daniels Age: 45 Profession: Commercial Artist I specialize in graphical illustration and typography, mainly for the children's market for items such as games and toys, clothing and television but my passion is science fiction and fantasy. I'm lucky enough to have worked on most of the major franchises and licenses and *Star Wars* is my first love. It's almost part of my DNA. I have loved it since it first came out and that passion has never left. I consider myself very lucky to have been involved in many official *Star Wars* projects and products, including the *Helix* 40th Anniversary range of stationery products, *Bladez* remote control inflatable characters, *Acme Archives* and *Dark Ink* official prints and just lately even working with production companies involved with making the new Disney films.

I collect vintage *Star Wars* items, mainly UK pieces from *Star Wars and Empire*, including Palitoy products and more random stuff like pencils and bath products! I also collect early *Star Wars* tickets for premieres and promo items like press folders.

In short, I love *Star Wars*

John Gendall is a professional illustrator working in the U.K. A *Star Wars* fan since the age of five, when he watch it in his local cinema way back in 1977. He's been an avid Roleplayer since the mid 80s, and spent far too much time painting miniatures from various games over the years. He bought the first edition of the d6 when it first came out, and at some point has played/G.M. every version of the game, returning to the d6 about 2 years ago, as out of all of them it's the version he loves best.

Mostly doing book covers, and commissioned portraits, he has designed some miniatures for the game *Broken Contract* and some publicity for *East Street Games*, a *zombie Father Christmas*. He jumped at the chance to work for the *Adventurer's Journal*, after all it's *Star Wars*!

Daelyn Godfrey Daelyn is a student illustrator studying in the United Kingdom. Introduced to *Star Wars* by her parents in 2005, she quickly fell in love with the universe, and it has remained as one of her main interests ever since. Although she's only started roleplaying in the last year (having devoted most of her time to

video games), she has a history with both miniature painting and creative writing, passions that lend themselves well to all manner of games.

Currently at college studying Creative Media Design, Daelyn has been working for commissions for the last two years. These range from fantasy character illustrations to sci-fi landscapes and have allowed her to build up a modest portfolio in preparation for university. She was introduced to the *Adventurer's Journal* by her good friend John Gendall, and is excited to produce artwork of one of her favorite franchises.

Nils Meyer is a digital character sculptor and designer. He has been working in the video games industry for over a decade. He is currently working at Redrock Collectibles. He has sent his minions on the quest for the red rock. For additional art samples please visit <https://www.artstation.com/nils>

Redrock Collectibles are working on their first line of hybrid miniatures/collectibles for board game enthusiasts and collectors. The Kickstarter campaign will run in the end of 2018.

Chris Shaylor has been an avid Sci-Fi toy collector since the mid 70's. He rarely actually played many table top games but voraciously collected and read the sourcebooks and companion issues for the WEG Star Wars series since they were first released in the late 80's. Using much of that expanded material and artwork as inspiration for his own custom creations for 1:18 toy lines.

Eventually building the city-sized spaceport Rotgut Station, which acts as a truckstop nexus for all sci-fi universes, he shared what he created with the world to show that toys don't have to just sit on shelves. After word spread and requests came pouring in, he was able to turn his hobby of creating wood & plastic playsets into a successful full time toy business of Empire Toy Works.

"I now wake up and eat/breathe toys all day everyday, and I wouldn't have it any other way."

Chris lives with his wife and two sons in Virginia.

Daniel Sturman lives in New Mexico with his wife and children, where he and his wife work as professional artists, raise children, and try to enjoy life in general. He is a retired U.S. Army tank mechanic, maker of clocks and incense burners, old truck guy, Brazilian Jiu Jitsu blue belt, and a big geek/ nerd in general.

...this Journal

The *Adventurers Journal* is an unofficial fan generated magazine for use with *Star Wars: The Roleplaying Game, Second Edition, Revised and Expanded*. We humbly acknowledge the individual authors and artists and their respective works which have inspired the content herein.

Works Consulted

In: Google Search. [https://www.google.es/search?q=YU-410 CORELLIAN LIGHT FREIGHTER &source=lnms&tbm=isch&sa=X&ved=0ahUKEwjmqfSgjpLaAhVESBQKHXCvCAYQ_AUICigB&biw=1536&bih=746#imgrc=IQvOZw1sCabqpM](https://www.google.es/search?q=YU-410%20CORELLIAN%20LIGHT%20FREIGHTER%20&source=lnms&tbm=isch&sa=X&ved=0ahUKEwjmqfSgjpLaAhVESBQKHXCvCAYQ_AUICigB&biw=1536&bih=746#imgrc=IQvOZw1sCabqpM): Accessed 26 Jul 2018

Alien concept - Female. In: DeviantArt. <https://surugamonkey.deviantart.com/art/Alien-concept-Female-597404425>. Accessed 26 Jul 2018

Arizona Desert Backdrop. In: Celebrations Cake Decorating. <https://celebrationscakedecorating.com/galleries/arizona-desert-backdrop.html>. Accessed 26 Jul 2018

Cagle E (2003) *Star Wars roleplaying game: ultimate alien anthology*. Wizards of the Coast, Renton, WA

Campbell D, Jandt F (1997) *Star Wars trilogy sourcebook*. West End Games, Honesdale, PA

Tarkin-Sienar (2018) *Colonie Spatiale Golan 2*. In: Anakinworld. <https://www.anakinworld.com/encyclopedie/colonie-spatiale-golan-2>. Accessed 26 Jul 2018

Communication Aids. In: *Communication Aids - D6Holocron*. http://d6holocron.com/wiki/index.php?title=Communication_Aids. Accessed 20 Jul 2018

TalonDunning Corellian YT-1930 Deckplan. In: DeviantArt. <https://www.deviantart.com/everwho/art/Corellian-YT-1930-Deckplan-582520559>. Accessed 26 Jul 2018

(2017) Crazy Caver Explains How to Explore Caves and Map the Underworld. In: MightyGoods.
<https://mightygoods.com/crazy-caver-explains-how-to-explore-caves-and-map-the-underworld/>. Accessed 26 Jul 2018

Davies E (2015) Earth - Where is the windiest place on Earth? In: BBC News.
<http://www.bbc.com/earth/story/20151009-where-is-the-windiest-place-on-earth>. Accessed 24 Jul 2018

Diaz J (2013) Astronomers Found the Star Wars Galaxy. In: Gizmodo.
<https://gizmodo.com/5897977/astronomers-find-the-star-wars-galaxy>. Accessed 26 Jul 2018

Hidalgo P (2016) Rogue One: the ultimate visual guide. DK Publishing, NY, NY

Klatooinian/Legends. In: Wookieepedia.
<http://starwars.wikia.com/wiki/Klatooinian/Legends>. Accessed 26 Jul 2018

Meyer N alien gunslinger, Nils Meyer. In: ArtStation.
<https://www.artstation.com/artwork/ymkq3>. Accessed 25 May 2018

(2014) Palitoy's Star Wars Ads: The Forgotten Comics. In: StarWars.com.
<https://www.starwars.com/news/palitoys-star-wars-ads-the-forgotten-comics>. Accessed 26 Jul 2018

(2013) Post/Critique Homebrew Starship Stats. In: FFG Community.
<https://community.fantasyflightgames.com/topic/91497-postcritique-homebrew-starship-stats/>. Accessed 26 Jul 2018

SPEED PAINT - Space Station Walkway. In: DeviantArt.
<https://www.deviantart.com/vr-robotica/art/SPEED-PAINT-Space-Station-Walkway-359208363>. Accessed 24 Jul 2018

Star Wars Garden Gnome Ornaments May The Fork Be With You Homepage. In: simple hit counter.
<http://rosyadi.me/star-wars-garden-gnome/star-wars-garden-gnome-ornaments-may-the-fork-be-with-you-homebase/>. Accessed 20 Jul 2018

Star Wars: Arizona Showings | Star Wars | Pinterest | Star, Ads and Movie. In: Pinterest.

<https://www.pinterest.com/pin/386183736787996452/>. Accessed 26 Jul 2018

Stuart RD (1995) Galladiniums fantastic technology. West End Games, Honesdale, PA

The Extrasolar Planets Encyclopaedia. In: The Extrasolar Planets Encyclopaedia. <http://exoplanet.eu/>. Accessed 26 Jul 2018

ADVENTURER'S JOURNAL

ISSUE TWO

Alien Creatures, Species, & Worlds!

Take a new journey into the *Star Wars* galaxy with the *Adventurer's Journal*. As a spiritual successor to the original *Star Wars Adventure Journal*, each quarterly issue features new adventures, articles, original art, interviews, and stories from the different eras of the *Star Wars* universe!

Witness a menagerie of exotic creatures and aliens, listen closely to the pulsing hum of alien artifacts, and gear up with exotic equipment, and strange technologies.

-Other Features in this issue include:

- Alien Environments and how to survive them
- Download link for a 3D tabletop miniature of our cover, the Gunlinger
- A solo adventure featuring Aurek Jenth, an Adventurer.
- New Alien Template, the vigilant and mysterious Sen-dro
- GM tips from the *Behind The Screen: Running Aliens*
- Location Report on Muck Hollow a hidden star port on Portax 4, a planet completely overrun by fungus.
- ...*STAT!* Your chance to provide stats for *Adventurer's Journal* content
- 8 Updated Species & an Random Alien Appearance Generator



AJ-080318