

SPECIAL ISSUE

\$1.50

REVISED THIRD EDITION

THE
STAR FLEET
HANDBOOK

THE ALIENS OF *STAR TREK*

- VULCANS
- KLINGONS
- ROMULANS



STAR FLEET HANDBOOK

CONTENTS

PAGE

Vulcan/Vulcan History	1
Vulcans	2
Vulcan Glossary	3
Surak's Construct: An Introduction to Vulcan Philosophy	4
Klingon Empire/Klingon History	5
Klingon Field Items	6
Klingon Battle Cruiser	7
Klingon Battle Cruiser (Diagram)	8
Klingon Small Craft/Alphabet/Traditional Numerals	9
Romulan Star Empire/Romulan History	10
Romulan "Bird of Prey"	11
Romulan "Bird of Prey" (Diagram)	12
Photographs (Vulcans)	13
Photographs (Klingons/Romulans)	14

Copyright © 1976 by Interstellar Associates ▲

THE STAR FLEET HANDBOOK - edited and published (approximately bimonthly) by
Geoffrey Mandel, 201 W. 16th St. (Apt. 20A), New York, NY 10011

subscriptions: 8/\$3.50 postpaid
sample copies: 50¢ + 15¢ postage each

Contributions (especially articles and artwork on STAR TREK's characters, aliens and technology) are welcome. Contributors receive a free copy of the issue in which their submission appears.

ACKNOWLEDGEMENTS

THE STAR TREK CONCORDANCE and the 3RD SEASON SUPPLEMENT to the CONCORDANCE (Mathom House Publications, P.O. Box 74866, Los Angeles, CA 90025) was a source for much of the information on Romulans, Klingons and Vulcans.

KRAITH CREATOR'S MANUAL (Carol Lynn, 11524 Nashville, Detroit, MI 48205) for information and glossary of the Kraith universe.

PASTAKLAN VESLA #2 and Jacqueline Lichtenberg for the original Surak's Construct.

Various artwork throughout is credited to Joy A. Fenton, Matt Jeffries (from THE MAKING OF STAR TREK) and Greg Jein.

Comments on this publication may be sent to Geoffrey Mandel, 201 W. 16th St. (Apt. 20A), New York, NY 10011

VULCAN

Vulcan is the Terran name given to a Class M world in the trinary 40 Eridani system, 15.9 light years from Earth. Vulcan's sun, 40 Eridani A, is an orange star about one-third as bright as Sol; it appears 50% larger than Sol does from Earth. The other stars in the system are a white and red dwarf. Vulcan is about 45 million miles from its sun, and its year is about 132 Earth days.

The natives (Vulcanians, or simply Vulcans) call their planet *Tsaichrani*. The planet appears a deep violet-red from space. A great part of the surface is desert, sand and shale glittering with flecks of mica, and occasional weathered stone formations (typical is the *Sas-a-shar*, commonly called "Vulcan's forge"). There are also cooler forested regions in the south, several mountain ranges such as the *Arlanga*, and seas (with little salt content). The air is thin, hot and dry during the day, although there is a temperature drop at night. Surface gravity is somewhat higher than Earth normal. The sky varies from a cloudless deep red to a yellow-ocher with mottled cloud formations (during the month of *Tasmeen*, the damp season). Although Vulcan has no moon, it orbits a common center with a cratered Mars-like "sister planet" in a Trojan relationship.

history

Vulcan pre-history contains several accounts of possible extra-Vulcanian contact, including space travelers from the now-dead planet *Arret* half a million years ago. Vulcan was once conquered in its remembered history, but it was so long ago Vulcans can no longer conceive of this state. Five thousand years ago, Vulcans were warlike and wildly emotional, committed to irrationally opposing views. They were aggressive, militaristic, and violent, and as a result came very close to destroying themselves. It is commonly believed that the *Preservers*, an ancient super-race, removed the military influence from Vulcan several millenia ago, during the last of its great devastating wars. These militarists were "seeded" on the distant world of *Romulus*, and eventually evolved into the present-day *Romulans*. During Vulcan's suffering, one of the sides found emissaries to go to the other side and mediate for peace. Foremost among these was *Surak*, who is considered the father of logical Vulcan thought. Ultimately, logic did prevail, largely because of *Surak's* efforts and philosophies. During the *Reforms*, and their reaction away from emotionalism, the Vulcans based their culture on logic, reason, and emotional control; but in this transition, they reasoned that it was necessary to maintain the old tests of strength and courage, such as the *Kahs-wan* ordeal and the *Koon-ut-kali-fi*. Since the *Reforms*, Vulcans have developed rigorous mental control. Although they once ate meat, they are now vegetarians and are revolted at the idea of digesting animal carcasses. Vulcans are non-violent, and do not believe in killing in any form - they are not, however, incapable of doing so given a sufficiently logical reason (normally only in self-defense). In addition to the advanced technique of *tal saya*, they possess a nerve pinch which produces instant unconsciousness in all humanoid species. Non-emotion and logic has prevailed for almost 9000 Vulcan years - children are taught from birth that to show emotion is not only improper but disgraceful.

Vulcan today is one of the major worlds in the United Federation of Planets - it supports a relatively small population, well-dispersed in small, logically-planned and self-sufficient cities such as *ShiKahr* and *Dycoon*. Vulcan Space Central operates a large military and merchant space fleet (Vulcan traders are not uncommon), and several Starships in the UFP Star Fleet are primarily Vulcan-manned. Surface transportation on Vulcan is largely by desert skimmer. Among the higher institutions located on this world is the renowned Vulcan Academy of Sciences.



SEHLAT

Vulcans

Vulcans are humanoid - specifically, they constitute the main body of the Vulcanoid species. They are, for the most part, tall and slender with straight, dark hair and a pale yellow complexion. Vulcans have somewhat enlarged, pointed ears, which result from the need to "cup" the tenuous sound waves more efficiently in the thin atmosphere. Also noticeable are their upswept eyebrows and high cheekbones. Vulcan blood is green, because of traces of copper and nickel (human blood is iron-based). Vulcan arteries have a larger average diameter and are thus more efficient - their faster, lower-pressured heart results in about the same volume delivered as with that of a human. The heart is located in the lower right area of the chest. The normal pulse rate for a Vulcan is 242 beats per minute - they have practically no blood pressure by human standards. Vulcan sensory organs are slightly better developed than those of Terrans. They can withstand higher temperatures (they prefer a level of around 50°C, especially when at an advanced age), go for longer periods of time without food, water and sleep, and can tolerate a higher level of pain. Vulcans normally sleep with their eyes open - they close their eyes only when ill or in a coma. Vulcan eyes have a nictitating membrane to protect against the unshielded rays from Vulcan's sun. Vulcans have a great physical strength, necessary against the higher gravity, and are extremely formidable when aroused. The Vulcan body is dependent to a high degree on the brain for life-support, and can not survive for long when deprived of normal brain functions.

Vulcans possess a limited but effective telepathic ability, which enables them to perform the Vulcan mind meld, a technique in which the Vulcan merges his mind with that of another sentient being. Through this, he can read its thoughts or hold it under a limited telepathic control. The physical and emotional costs are quite high, and Vulcans consider it embarrassing. The extreme form of the mind meld is the Vulcan mind fusion, which requires a great deal of concentration. A Vulcan faces the risk of losing his separate identity when attempting a mind fusion, so it is therefore used only in extreme cases. Vulcans also practise a mind touch, which can be used to put a suggestion in or excise a memory from another's mind. These telepathic abilities usually require direct physical contact. It is not uncommon for Vulcans to enter contemplative moods, becoming close and difficult to deal with - to a Vulcan, meditation is a private, personal experience not to be discussed with others.

Traditionally, Vulcans are married by rite in childhood; less than a marriage but more than a betrothal, the two participants' minds are locked together at age seven. At the proper time in adulthood they enter the *pon far*, and the mating drive outweighs all other motivations. They are drawn to their ancient ceremonial grounds for *Koon-ut-kali-fi*, the marriage. If the woman offers a challenge, she must choose a champion; the two males will then fight to the death, since the biological forces controlling a Vulcan during *pon far* are out of his power to suppress, and he will go into *plak tow*. The woman becomes the property of the victor. Thereafter, Vulcans enter *pon far* every seven years - this cycle is inherent in all Vulcans, and during this time they will die unless they can consummate the marriage.

The Vulcans are an extremely ancient and highly civilized race. They are as a rule proud, dedicated, loyal, and have a strong sense of honor. They never bluff, seldom speculate, and are almost incapable of outright betrayal or lying.

LE-MATYA



Vulcan glossary

- AHN WOON Oldest of Vulcan weapons; a leather band with handles at the ends, about six feet long. It can be used as a bola, a sling, or a garrote.
- D'MALLU A carnivorous plant that dwells in the desert. It uses its several long tentacles to capture and digest small desert animals. Its color is vermilion red.
- IDIC (From the Terran acronym "Infinite Diversity in Infinite Combination") a concept in Vulcan philosophy.
- KAH-IF-FAR Vulcan term that signifies the beginning of a ceremony.
- KAHS-WAN The test of manhood; to survive for ten days in the Vulcan desert without food, water or weapons.
- KALI-FI Vulcan term meaning "(act of) challenge"; specifically to single combat for a woman.
- KARI-FAR (Literally "fulfill the point-in-the-cycle") the opening phrase in the Vulcan marriage ceremony.
- KEVAS An exotic Vulcan fruit, producing a purple juice; a trade item.
- KOON-UT-KALI-FI Honorific term for "challenge or marriage"; ceremonies which are viewed in about the same light.
- KRAITH The vessel used in the Ceremony of the Affirmation; a priceless artifact.
- KROYKAH The extreme form of "cease and desist". Used only in emergency situations by one with ultimate authority, it is never ignored.
- LE-MATYA A predatory animal, more reptilian than mammalian. A mountain-dweller, it hunts only at night, killing its prey with poisonous claws. Its coloring is light green and yellow in a diamond pattern.
- LIRPA A traditional Vulcan weapon, about four feet long; at one end, a semi-circular razor-edged blade, at the other a massive metal cudgel. It may be used as a machete, a bludgeon, or a quarterstaff.
- NI VAR An art form in which two (or more) subjects are contrasted and compared. It may take the form of a poem, song, drawing, etc.
- NOME (Literally "all") a concept in Vulcan philosophy.
- PLAK TOW (Literally "blood fever") Vulcan term meaning "frenzy" during pon far.
- PLOMIK A thick orange Vulcan soup.
- PON FAR "Mating time"; the point in the physical cycle of a Vulcan male when he must return to his home and take a wife.
- SEHLAT A Vulcan bear-like mammal, originally found in the cooler forested regions. Often domesticated, it is intensely loyal and makes an excellent pet.
- TAL SAYA (Literally "merciful execution") a means of snapping the neck quickly and cleanly.
- TSAICHRANI The Vulcan term for modern Vulcan society.

VULCAN PROPER NAMES (TYPICAL)

MALE: Spock, Sarek, Surak, Sikar, Satak, Stonn, Selek, Stark, Sofek, Seppek, Sessek, Sauk, Saptiir

FEMALE: T'Pau, T'Pring, T'Pal, T'Ruel, T'Aniyeh, T'Yuzeti, T'Uriamne, T'Vret, T'Zorel

LINEAL: xtmpsrzntwlf d



LIRPA

SURAK'S CONSTRUCT

an introduction to Vulcan philosophy



All of Vulcan philosophy rests in the five main concepts embodied in the Vulcan hand salute.

The SMALL FINGER represents the philosophy of the Idic (infinite diversity in infinite combination), which is: the greatest joy in all creation is in the infinite ways that infinitely diverse things can join together to create meaning and beauty. The Vulcan pendant that symbolizes the Idic concept is a

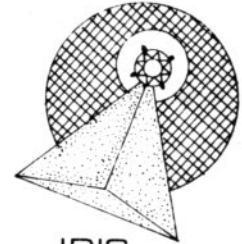

IDIC

gold circle (representing infinity, nature, woman, etc.) and a silver triangle (which can represent the finite, art, man) uniting to produce a gemstone.

The RING FINGER represents the philosophy of Nome (meaning "all"), which may be stated thus: an infinite variety of things combine to make existence worthwhile, and delight in one's own nature does not mean denigration of those who are different. This is more than the Idic, and it includes the Idic concept. The interdependence of the two is illustrated by the close pairing of the two representative fingers.

The MIDDLE FINGER represents the Doctrine of the Domination of Logic over Emotion. Surak's Construct asserts that for the sake of survival, logic must be of greater influence than emotion. Hence, logic, represented by the longest finger, is separated from Nome-Idic (which includes within itself both logic and emotion).

The INDEX FINGER represents the Vulcan Reverence-for-Life. Paired with the Doctrine of the Domination of Logic, it indicates that continued existence demands that logic rule over emotion.

The THUMB stands alone, representing the high regard placed on individual privacy. Surak made Privacy one of the cornerstones of his Construct, as he believed that under no circumstances is it justifiable to infringe the dignity of another living being (this attitude is perhaps the key to the Vulcan lack of a human "sense of humor").

To use this salute, together with the phrase "Live long and prosper...", is to grant to another the absolutely inviolable right to privacy of mind, the right to be different from the speaker even to the extent of being opposite, and to invite combination of differences to the advantage of both with assurance that rigorous logic will protect all rights to continued worthwhile existence.

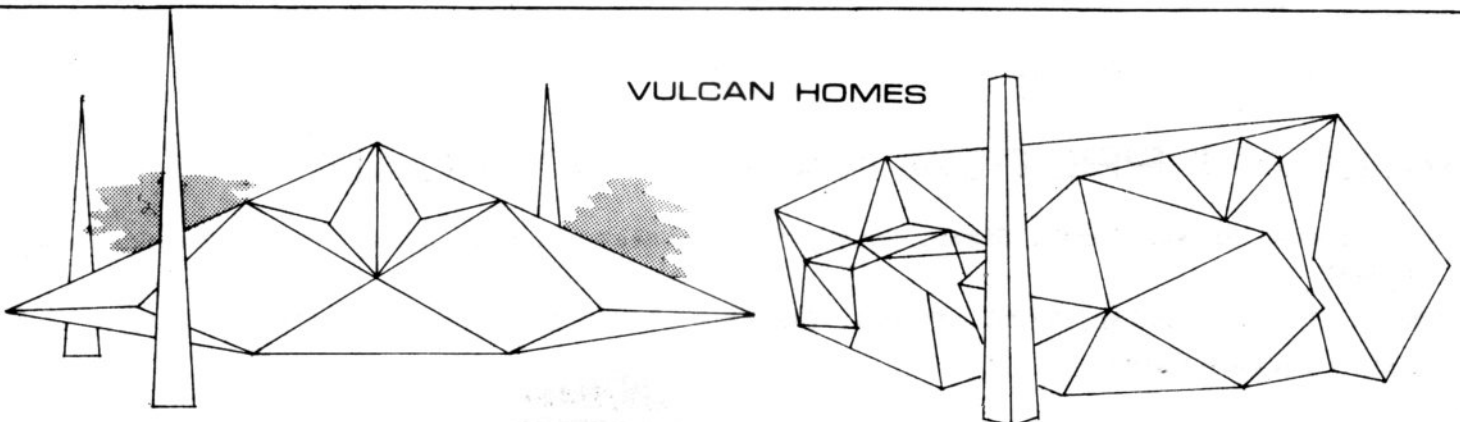

VULCAN HOMES

KLINGON EMPIRE

Physically, Klingons are very similar to humans. Aside from some internal differences, they have a satanic expression and heavy bifurcate or angular eyebrows. As with humans, the skin coloring of various Klingon subspecies differs from light (almost Caucasoid) to a darker reddish-brown.

The Klingon home planets are poor in resources - Klingons have always fought to survive, and feel they always must. Under the doctrines of Kahless the Unforgettable (the tyrant who set the pattern for his planet's ruthless ways), the Empire evolved as a military dictatorship with war as a way of life. Present Emperor of the Klingon worlds is Karhummur the Fortieth.

The Klingon Empire has been the primary enemy of the Federation for many years, and although there is an established boundary between the two, it is often violated. The Empire is ruled through shrewdness, deceit and absolute power. Cruelty is something admirable to the Klingons - they regard humans as soft and weak, and will go out of their way to provoke an incident with the Federation. Their society is controlled by the cleverest, strongest or most treacherous - advancement is often by assassination. Their methods of colonization are brutal, but efficient, seizing a planet and annihilating those that refuse to comply.

Notable officers of the Imperial Klingon Fleet include: Kor (Commander, Battle Cruiser Klothos), Kaas (First Officer, Klothos), Kanff (Engineer, Klothos), Kali (Lieutenant, Klothos), Koloth (Captain, Battle Cruiser Devisor), Korax (First Officer, Devisor), Kang (Commander, Battle Cruiser Carnage), Mara (Science Officer, Carnage), Kuri (Commander, Battle Cruiser Thanatos), Kumara (Commander, Battle Cruiser Klathas), Kritt (Helmsman, Klathas), Kanndad (Engineer, Klathas), Korreg (Scanner-Control Officer, Klathas), Kattrun dek Prenn (Surgeon-in-Battle, Klathas), Krell (Agent, Klingon Empire), and Kras (Agent, Klingon Empire).

history

The Federation has fought two long and bloody wars with the Klingons, ending 25 solar years ago with the battle of Donatu V. A war between the two was nearly fought some three years ago (Stardates 3198-3201) - the space fleets of both were mobilized and prepared to fight in orbit of Organia (a Class M planet in the disputed territory). Intervention by the Organian super-beings prevented what surely would have been almost total destruction of both sides; as it stands now, they are kept at peace with each other by the Organian Peace Treaty which calls for a cease in hostilities between the two.

Under the terms of the Treaty, the Klingons and the Federation have not been involved in any major disputes. To this date, the minor skirmishes that have occurred include incidents where the Klingons attempted to gain control of Capella IV (Stardate 3497), the planet Neural (4211), the Tellun Star System (4372), and Sherman's Planet (4523) - all of these were ultimately awarded to the Federation; also, combat prompted by a hate-seeking entity aboard the Starship Enterprise involving a group of Klingons under Commander Kang; the preliminary testing of the stasis field on the Enterprise by the Battle Cruiser Devisor (Stardate 5392); and the Delta Triangle incident (5267) where Commander Kor of the Klothos attempted to destroy the Enterprise through sabotage of its engines.

IMPERIAL EMBLEM

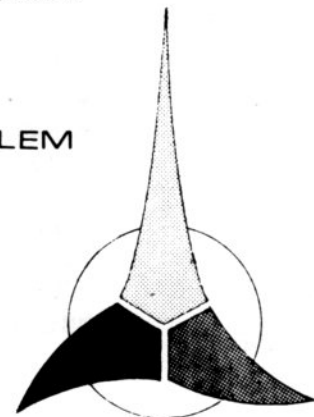

COMMUNICATIONS DEVICE

Klingon FIELD ITEMS

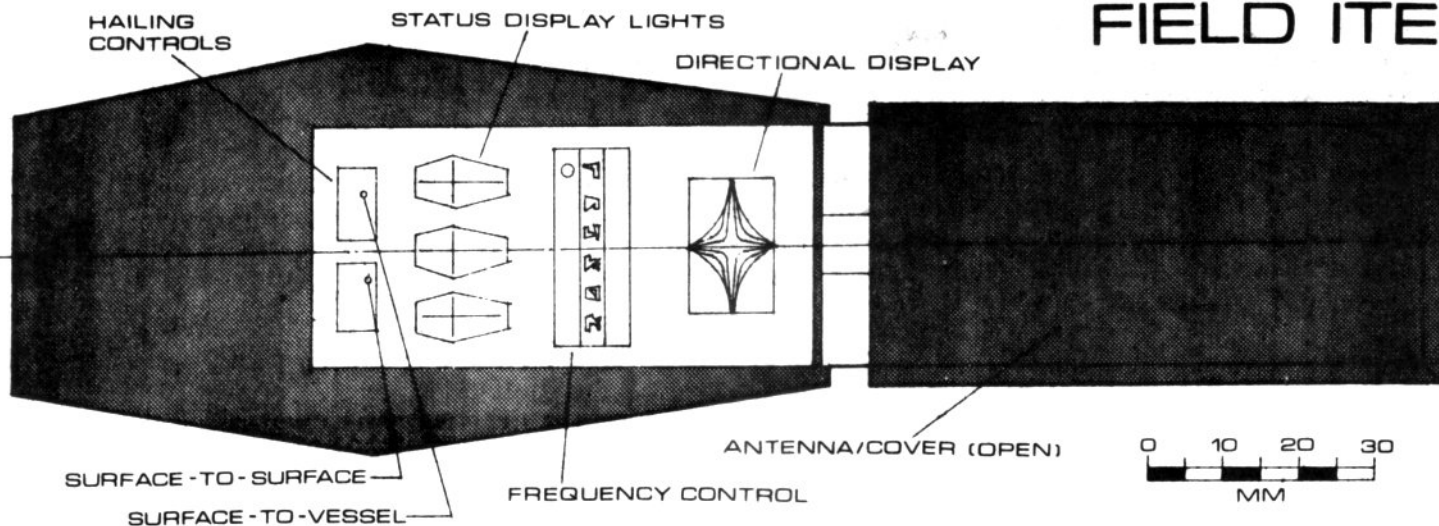

The Klingon COMMUNICATIONS DEVICE is of the type presently in use by units of the Imperial Fleet. Similar in nature and operation to the equivalent Star Fleet device, it has a somewhat less effective range. Its low-power energy sensor provides (through the DIRECTIONAL DISPLAY) approximate range and direction of energy-radiating objects and other communicators. It is activated by flipping open the ANTENNA/COVER, then operated by depressing either the SURFACE-TO-SURFACE or SURFACE-TO-VESSEL HAILING CONTROL. The STATUS DISPLAY LIGHTS (3) provide operational status, and the FREQUENCY CONTROL is used for fine adjustment and among multi-member landing groups.

SONIC DISRUPTOR PISTOL

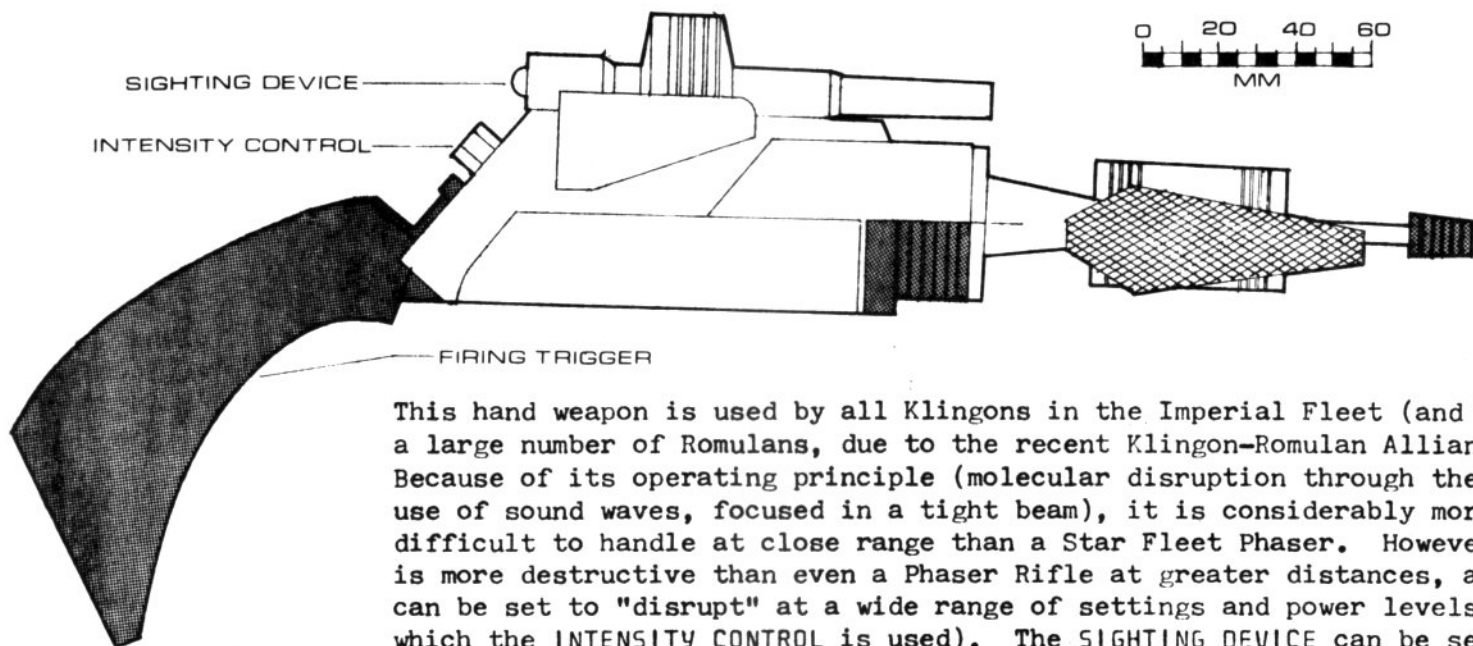

This hand weapon is used by all Klingons in the Imperial Fleet (and by a large number of Romulans, due to the recent Klingon-Romulan Alliance). Because of its operating principle (molecular disruption through the use of sound waves, focused in a tight beam), it is considerably more difficult to handle at close range than a Star Fleet Phaser. However, it is more destructive than even a Phaser Rifle at greater distances, and it can be set to "disrupt" at a wide range of settings and power levels (for which the INTENSITY CONTROL is used). The SIGHTING DEVICE can be set for visual, audio or energy magnification, enabling it to detect and aim accurately at almost any type of target over great distances.

COLORS:



Other weapons in use by the Klingon Empire include a SONIC DISRUPTOR FIELD (based on the same principles as the pistol); a deadly nerve gas, THERAGEN; and the MIND SCANNER (known variously as the "Mind-sifter" or "Mind-ripper", depending on the intensity used), a psychic probe.

KLOLODE CLASS D-7 CLASS STARSHIP

Klingon BATTLE CRUISER

PARTICULARS:

Gross Weight:	110,000 Metric Tons
Crew Complement:	454
Cruising Speed:	Warp 6
Battle Maximum:	Warp 7
Propulsion:	Warp Drive Ion-Impulse

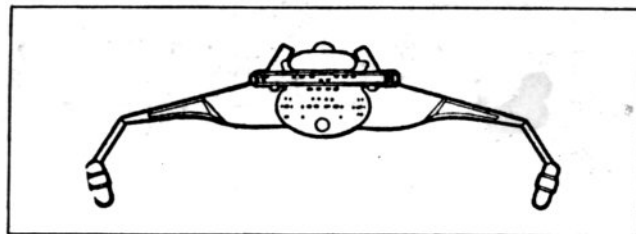

The Klingon Battle Cruiser (comparable to the Federation Heavy Cruiser Class Starship in military capability) is designed for efficiency, and in appearance the calculated use of terror. Space on board a Battle Cruiser is reduced to a minimum - as a result, it is considerably smaller than a Starship, but more dangerous than its size would indicate. It supports a crew of over 400, less than 20 of which are women (usually considered as inferiors in Klingon society). Luxuries do not exist aboard a Battle Cruiser, and every function is geared towards effective attack and battle capabilities.

With a cruising speed of Warp 6 (and a battle maximum of Warp 7), the D-7 Class Battle Cruiser is the most formidable space vessel in the Klingon fleet. Superior in weaponry and maneuverability, it lacks only the speed and tremendous power of a Starship. In addition to its dual S-Two Graph units (the equivalent of a Starship Warp Drive), it is equipped with Impulse Engines and a Hangar Deck for Impulse-powered small craft.

Prototype to the D-7 is the D-6 Class Battle Cruiser - almost identical in appearance, it lacks the power and versatile weaponry of the D-7. Due to the recent Klingon-Romulan Alliance, Romulans are now equipped with Klingon-built ships of the D-6 model, and many Klingon vessels now employ the Romulan Cloaking Device.

Battle Cruisers in the Klingon Imperial Fleet:

Annihilation	Executioner	Klothos
Atropos	Furious	Lachesis
Carnage	Invincible	Ruthless
Conqueror	Kahless	Thanatos
Destruction	Klathas	Vengeance
Devisor	Klolode*	

*class vessel

ARMAMENT:

PHASER BANKS (9)

The Battle Cruiser's phaser banks are comparable to the Star Fleet equivalent. They can be fired in bursts, or in a steady beam. 3 banks are located under the Primary Hull; 4 are located on the top of the Secondary Hull, and 2 are below.

DISRUPTOR BATTERIES (2)

The disruptor batteries, drawing power directly from the Warp Engines, can be set to fire bolts or a steady beam of disruptive force.

STASIS FIELD GENERATOR

Projects a stasis beam that neutralizes all higher-order energy fields (Warp Drive units, Deflectors, weaponry). However, due to the severe power demand on the Warp Engines, its military use is limited.

DIAGRAM

Klingon BATTLE CRUISER

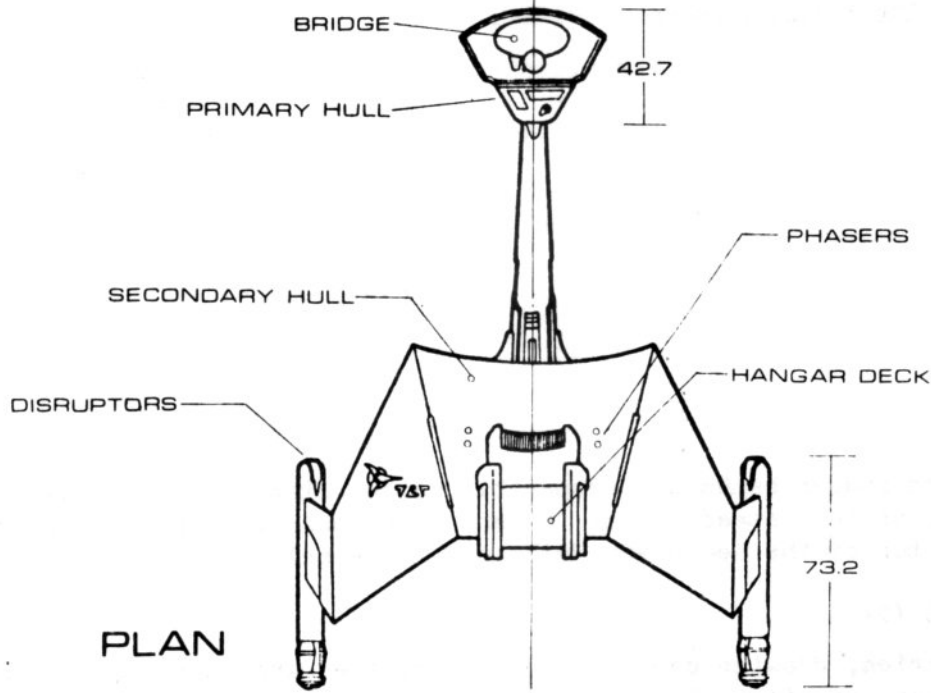
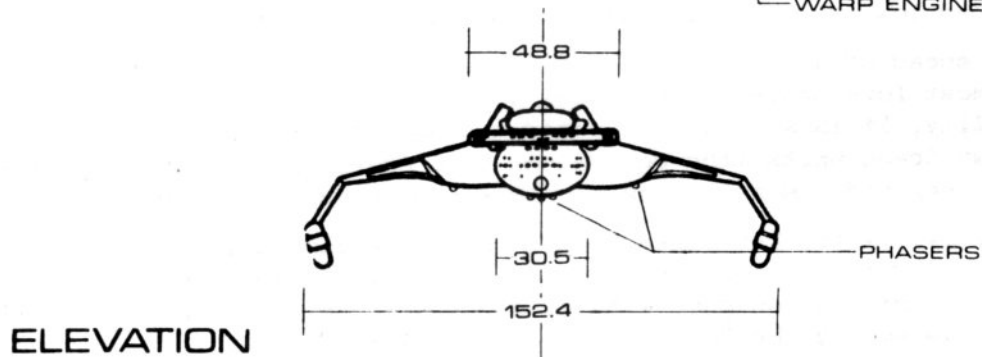
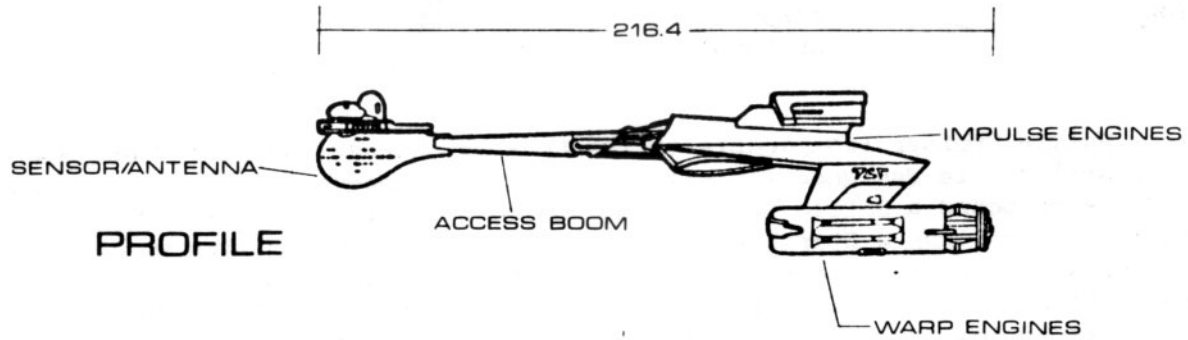

COLOR:
[] LIGHT GRAY

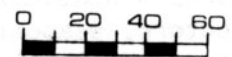
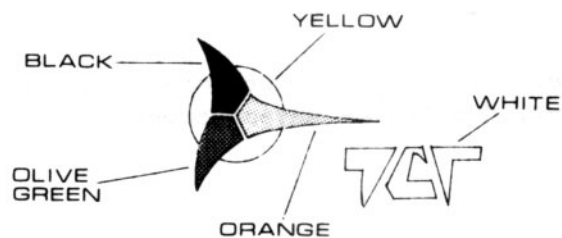

ALL DIMENSIONS ARE IN METERS

Klingon

SMALL CRAFT

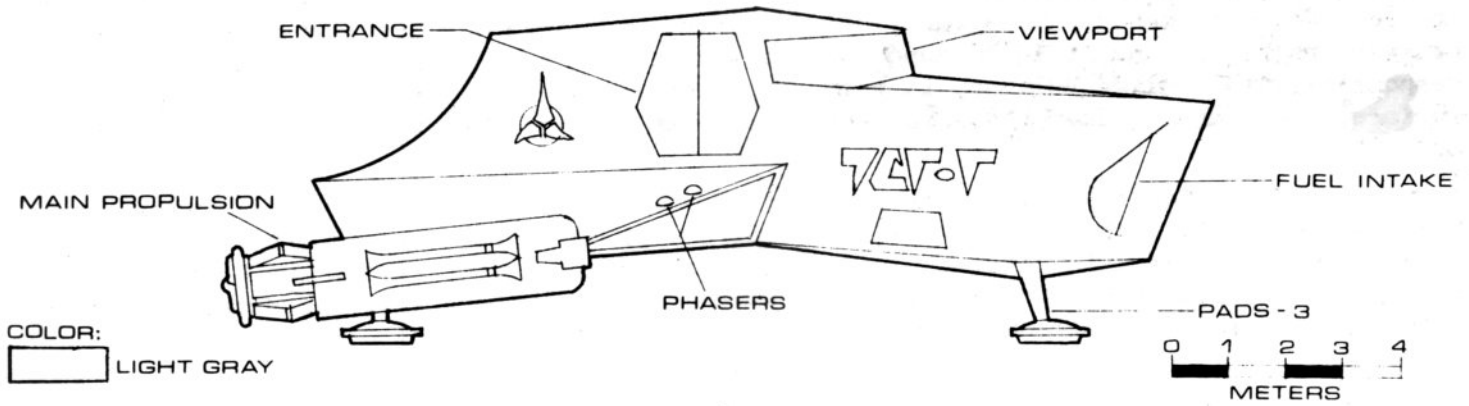

ALPHABET

L
 F
 B
 D
 G
 H
 J
 Y
 A
 E

M
 N
 TH
 P
 R
 S
 T
 K
 V
 Ē, I, Ī

Z
 Ō, Ô
 W
 X
 ŌŌ
 U, ʘ
 N̄

TRADITIONAL NUMERALS

1
 2
 3
 4
 5
 6
 7
 8
 9
 10

ROMULAN STAR EMPIRE

The Romulans are Vulcanoid, offshoots of the Vulcan race, evolved in a strikingly different manner than that of their forebearers. They are physically almost identical to Vulcans - the men, however, tend to have curly hair and narrow features. They have complete equality between the sexes, and it is not uncommon to see a woman in a position of great responsibility. Unlike Vulcans, they are an aggressive and militaristic race - brutal in warfare, they rarely take prisoners, yet have a remarkably advanced culture of philosophy and art.

The Romulan Star Empire encompasses a number of solar systems, including the binary stars of Romulus and Romii. Circling Romulus (the Empire's primary sun, a white dwarf) in a trojan relationship are the twin Romulan homeworlds, Romulus and Remus. Among the comets present in a near this system are Icarus-Four, and an unidentified rogue which produced a strange aging disease in colonists on Gamma Hydra IV (an Earth outpost that borders the Neutral Zone).

A Commander (commanding an entire fleet) or Subcommander (piloting a single vessel) may be identified by a red sash worn over the shoulder; a Centurion (commanding a military unit of 100 men) wears a blue sash. Lesser officers have no sash, but usually wear metal helmets.

The Empire is governed by the Romulan High Council, under the jurisdiction of the Imperial Praetor (more correctly a Consul, in the rank of ancient Rome).

history

Little is known of early Romulan history - one current theory states that an ancient super-race, known as the Preservers, passed through the Galaxy millenia ago, rescuing primitive cultures threatened by extinction and "seeding" them where they would have the chance to develop. Vulcan at that time was undergoing a period of wide-spread war and disorder - the Preservers, endeavoring to save the Vulcans from destruction, removed many of Vulcan's military leaders to the hostile planet Romulus light-years away. With the military influence removed, the Vulcans denounced violence and emotion by following the ways of Surak. The Romulans, warlike in nature but realizing that cooperation was necessary for survival, evolved instead as a military state with a structure and philosophy similar to Earth's ancient Roman Empire.

The Romulan War, fought over a century ago, occurred when Romulan warships (primitive by modern standards) emerged from the Star Empire and waged combat with the Federation. The war continued for years, until finally the superior Earth technology won out over the Romulan determination, and a treaty was established. A Neutral Zone between the two was decided upon, entry into which by either side constitutes an act of war. 8 Earth outposts were built in asteroids on the Federation side of the Zone. However, Outposts 1, 3, 4 and 8 were destroyed by a Romulan Warship (Stardate 1709) during preliminary testing of the Cloaking Device. This was the first Federation-Romulan contact in over a century, and it resulted in the destruction of the Warship. Since then, four Federation violations of the Neutral Zone have been made: the first due to the inexperience of Commodore Stocker, newly-appointed to Star Base 10 (Stardate 3478); the second a successful attempt by the Starship Enterprise to capture the improved Cloaking Device now being installed aboard Klingon Battle Cruisers (5027); another due to the disruption caused aboard the Enterprise by a Vendorian, a Romulan spy (5148); and the fourth occurred when followers of Dr. Sevrin seized command of the Enterprise for transportation to the planet Eden in Romulan space (5832). Romulan units were involved in a recent attempt to ambush and capture the Enterprise, which managed to escape through an energy field (later causing a strange malfunction in the ship's computers - Stardate 3183).

COMMAND
INSIGNIA

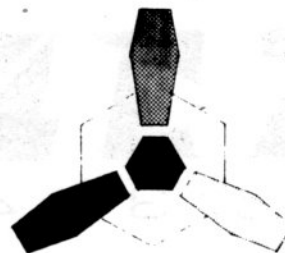

EMPIRE CLASS CRUISER TYPE

Romulan 'BIRD OF PREY'

PARTICULARS:

Gross Weight: 60,000 Metric Tons
Crew Complement: 225
Battle Speed: Warp 5
Propulsion: Warp Drive
 Ion-Impulse
Armament: Energy Plasma Weapon
 Cloaking Device

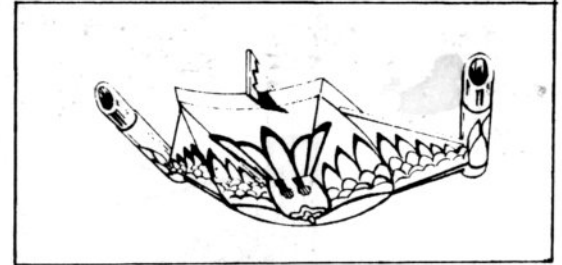

The Romulan "Bird of Prey" (Cruiser Class) is a small and highly maneuverable spacecraft, built for planetary destruction and effective battle capabilities. Its simple and clean lines are accented by a stylized bird of prey (the Romulan fah-nyak) design which covers the underside of the Main Hull. It is a remarkable example of Romulan engineering, considering its small size and limited power.

The "Bird of Prey" is equipped with three main functions: a Star Drive, similar to a Federation Starship's Warp Engines; an Energy Plasma Weapon (generating an energy bolt that envelops the target, causing it to implode - it is capable of disintegrating a Rodinium shield); and a Cloaking Device which renders the Romulan ship "invisible" to alien sensing devices. Initially, motion sensors were the only method known to indicate the presence of a Romulan vessel using the Cloaking Device, but in its improved form (now being installed aboard Romulan Battle Cruisers) it is completely transparent to all forms of sensor probes. The "Bird of Prey" can channel the energy available from its Star Drive to only one other function at a time - to use the weaponry and Cloaking Device simultaneously with the engines would cause a dangerous power overload. Clearly, the Cruiser can not be entirely effective in battle.

A Flagship (a Cruiser that commands an entire fleet) is identified by a pink wave-pattern repeated on the aft end of the Main Hull and Antenna Fin, and on the trailing edge of the Engineering Struts.

The Romulans are now equipped with Klingon Battle Cruisers (D-6 Class) due to the recent Klingon-Romulan Alliance. They appear as normal Klingon spacecraft, except for the exterior markings which again include a bird of prey design. The interiors of these Romulan Battle Cruisers are more luxurious than those of the equivalent Klingon craft, and they include the improved Cloaking Device as a defensive weapon.

Starships in the Romulan Space Fleet include:

Cruiser Class

Centurion
Combatant
Empire*
Gladiator
Magistrate
Praetorian
Predator
Warrior

Battle Cruiser Class

Formidable
Illustrious
Lares*
Manes
Penates
Victorious

*class vessel

DIAGRAM

Romulan 'BIRD OF PREY'

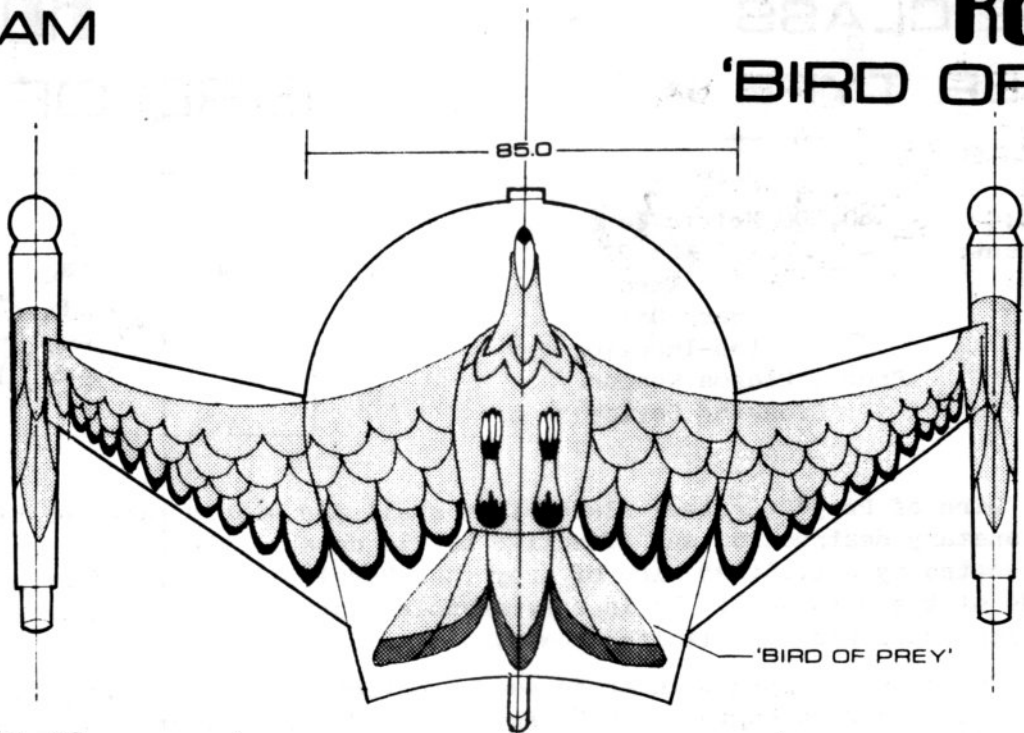

BOTTOM PLAN

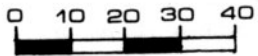

ALL DIMENSIONS ARE IN METERS

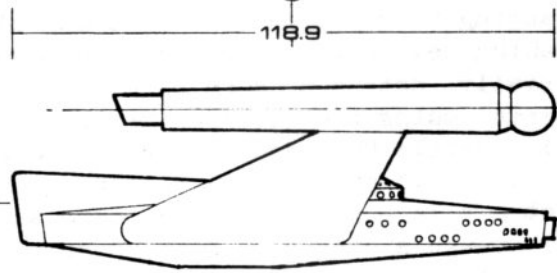

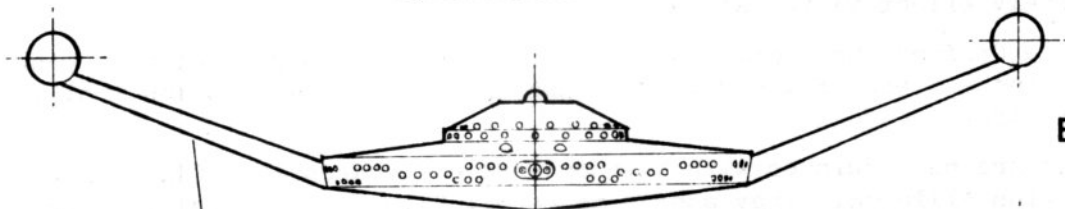

PROFILE

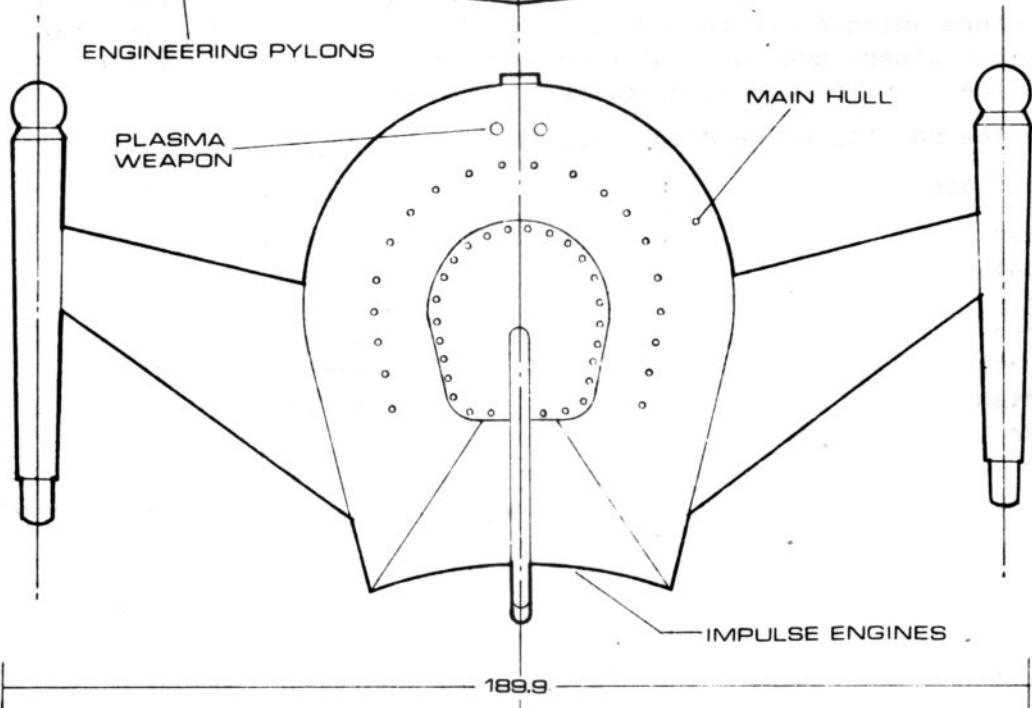

ELEVATION

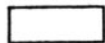

TOP PLAN

- COLORS:
-  LIGHT GRAY
 -  SAND
 -  RED



SPOCK



SAREK



T'POL



LYRETTE



T'POL & STONN



SURAK



VULCAN



KOR



KANG



MARA

KLINGONS



COMMANDER & CREW



DECURION



FLEET COMMANDER

ROMULANS