

Starlog Presents

THE OFFICIAL MAGAZINE

STAR TREK

THE NEXT GENERATION

TM
K49128
U.K. £3.95

TECHNICAL JOURNAL

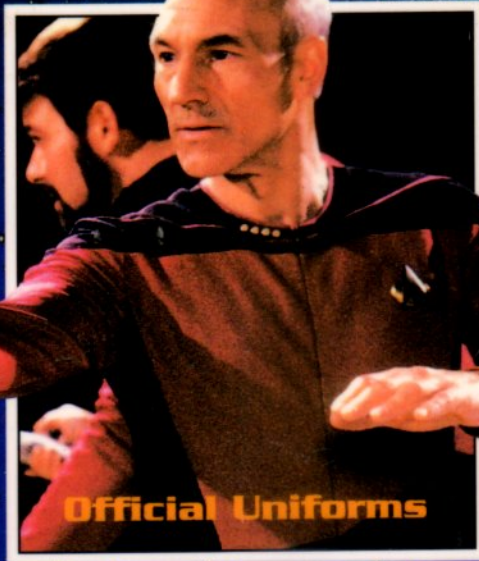

Official Uniforms



Spaceships—
Detailed Blueprints
Enterprise Floorplans

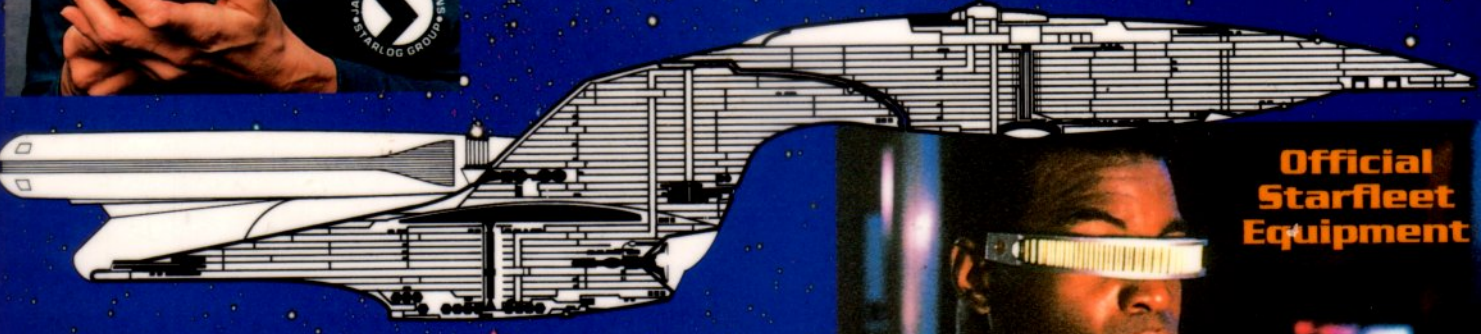

Official
Starfleet
Equipment

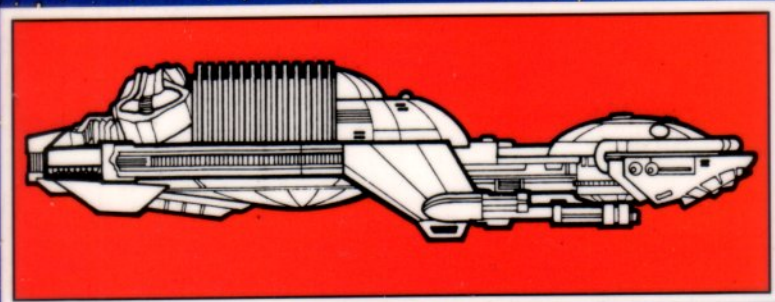
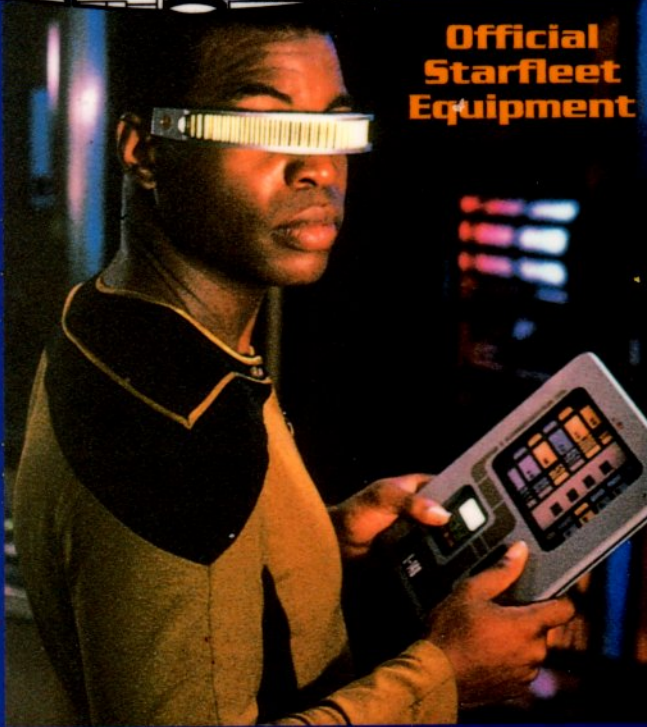

Weapons—
Ship-Mounted and
Handheld
24th Century
Technology Revealed

\$6.95 U.S./\$8.95 CANADA



04

Starlog Presents
The Official Magazine

Star Trek®: The Next Generation™

Technical Journal

By **SHANE JOHNSON**



- 6 Author's Dedication**
- 7 Introduction**
- 8 United Federation of Planets**
- 10 Starfleet**
- 12 Enterprise Layout**
- 28 Starfleet Uniforms**
- 40 Medical**
- 46 Personal Equipment**
- 54 Galaxy Class Starships**
- 68 Defensive Arms**
- 73 Principle Cultures**

President/Publisher
NORMAN JACOBS

Executive V.P.
RITA EISENSTEIN

Associate Publisher
MILBURN SMITH

V.P./Circulation Director
ART SCHULKIN

Creative Director
W.R. MOHALLEY

Editor
DAVID HUTCHISON

Managing Editor
MICHAEL BENSON

Contributing Editors
MICHAEL McAVENNIE
ANTHONY TIMPONE
MICHAEL GINGOLD

Consultants
LIA PELOSI
KERRY O'QUINN

Art Director
CALVIN LEE

Art Staff
JIM McLERNON
YVONNE JANG
JOHN KELLY

Production Staff
STEVE JACOBS
PAUL HALLASY

The Official STAR TREK: THE NEXT GENERATION Technical Journal is Copyright ©1992 Paramount Pictures and published by Starlog Communications International, Inc. under exclusive license from Paramount Pictures. All Rights Reserved. Reprinting in whole or in part without Paramount's written permission is strictly forbidden. STAR TREK and STAR TREK: THE NEXT GENERATION are Registered Trademarks of Paramount Pictures. All STAR TREK: THE NEXT GENERATION photos & graphics are Copyright ©1987, 1988, 1989, 1990, 1991 1992 Paramount Pictures. Additional copies of this magazine are available on a limited basis from the editorial address: Starlog Communications International, Inc., 475 Park Avenue South, NY, NY 10016 for \$6.95 + \$2.05 postage & handling per copy. Checks payable to Starlog Press. Printed in U.S.A.

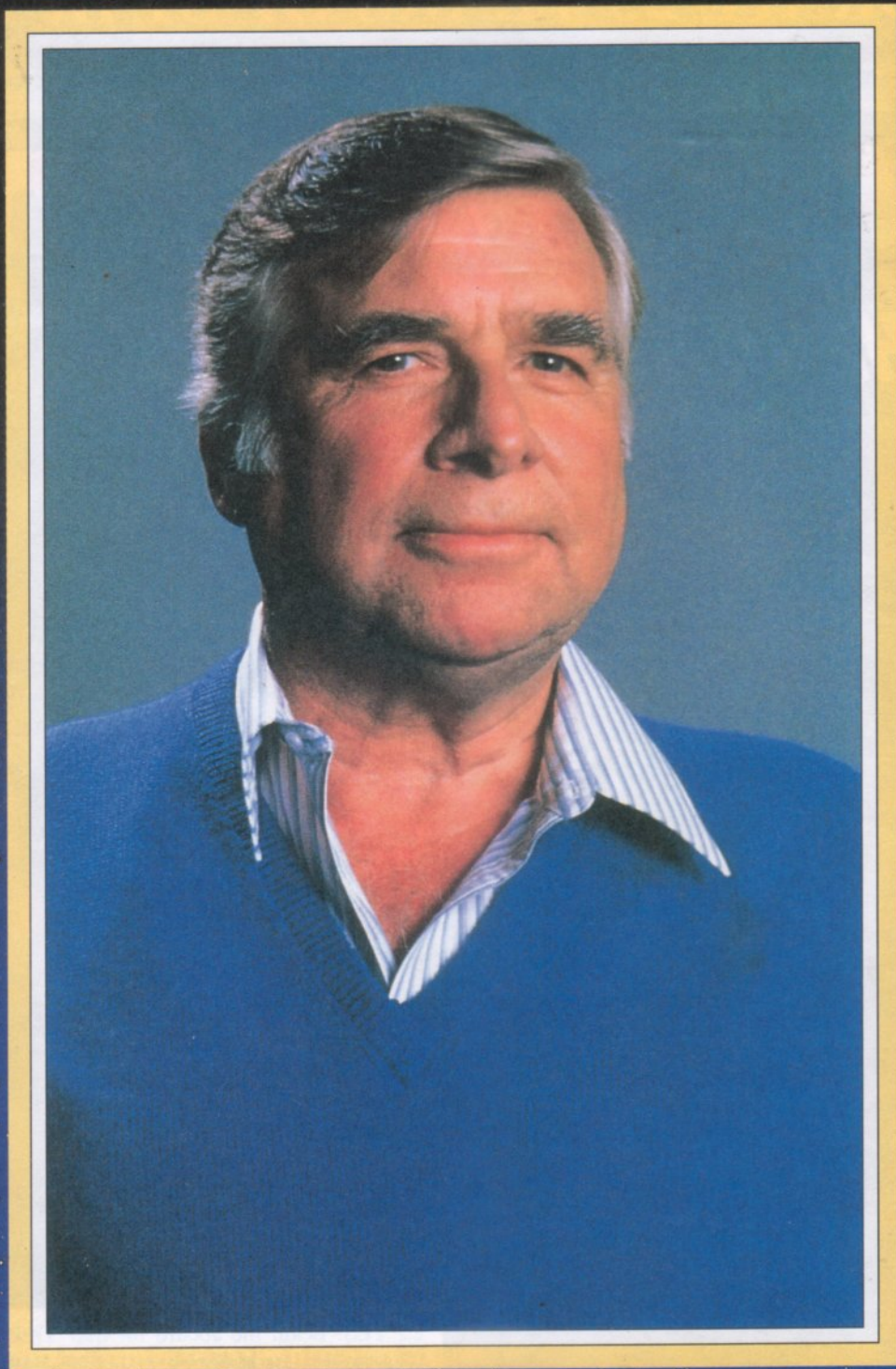

**Dedicated with all appreciation to
Gene Roddenberry.
You made a difference in my life;
and you will be missed.
Thank you for Star Trek.**

**NOTICE: ALL ADVERTISING CONTENT
AND SPURIOUS PHOTOGRAPHS HAVE
BEEN OMITTED FROM THIS DOCUMENT**

Introduction

This JOURNAL presents a visual overview of the technical universe of *Star Trek: The Next Generation*. Here, using blueprints, full-color photographs and descriptive text, you, the reader will enjoy a guided tour of the scientific 'reality' presented each week on your television screen. This technical backdrop has been maintained with incredible continuity from one episode to the next.

As was done by many publications in the early to mid-seventies (then dealing with the original *Star Trek* television series), this JOURNAL will (I hope) present you with a fun, very user-friendly and visually exciting look at this rebirth of the *Star Trek* universe. It is my intention not to be comprehensive, but to touch upon and give a general look at the new Starship *Enterprise*, her support technologies and the scientific achievements of Starfleet's foes and allies.

It is my hope that the JOURNAL you now hold serves as a welcome, pictorial addition to the *Star Trek* universe and that I have contributed to the technical continuity that has helped the saga of *Star Trek*, in all of its incarnations, to stand head-and-shoulders above the rest.

—Shane Johnson, November 1991

Author's Acknowledgements

Much has gone into the development and execution of this publication, but it would not have been possible were it not for the efforts of the following people:

David Hutchison, my editor, who saw to it that my every research need was filled to the letter and who provided much encouragement as this JOURNAL became a reality.

My wife, Kathy, who was always there with her invaluable eye for what would and would not work.

Jamie Murray and the guys at KTXA-21, who went the extra mile and spent a lot of weekend hour satisfying my unreasonable need for obscure data.

Steve and Melanie McClellan, who didn't get mad when I accidentally threw away the phaser.

Alan and Lyrae Beckner, for keeping me in line.

Mike Kott, who was thoughtful enough to suggest to Starlog that I might be the one to do this project.

Publisher Norman Jacobs, who agreed and approached me with it.

Mark Vinson, who took me in from the cold for the day and let me work out this text on his word processor.

The officers and crew of the U.S.S. Joshua, NCC-3700, who gave their support and have become cherished friends.

The guys at Laser Copy.

April Gorman and the crew of the Equulus.

Jim Pearson and the crew of Deinonychus.

Professor Julius Sumner Miller.

Shaun Johnson, my brother, who is currently stationed in Guam, where mildew is the official plant and waders are a fashion statement.

—Shane Johnson

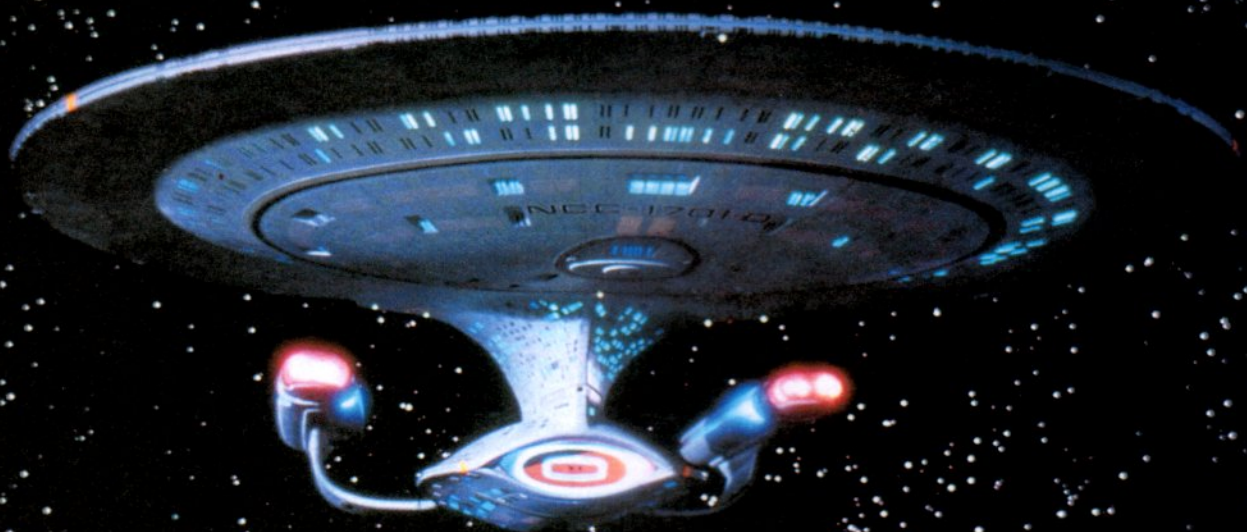

AN OVERVIEW: The United Federation of Planets Today

Starfleet, like its 20th-century naval counterpart, undergoes a continual process of introducing ever-more-incredible technologies into the vessels and instruments that insure the security of Federation space. Much has changed since the first Constitution Class starships pushed back the boundaries of known space and brought humanity into direct contact with its interstellar neighbors.

The vastness of space looms prohibitively wide, humbling us as it has since the days of the first Apollo lunar missions. Even today, with the advent of the new, more efficient warp propulsion systems, only 19 percent of our Milky Way galaxy has been charted, let alone explored. More than three-quarters of the stars within reach still hold their distant secrets—and are home to millions of civilizations we will never know in their present states.

Still, much has been done in the past 80 years to widen our knowledge of the universe around us. Many cherished allies have been befriended as we have extended a hand of good will. Periods of misunderstanding

sometimes threatened our friendship, while methods of communication and understanding were forged. Enemies have been made, despite all efforts to the contrary, as races have been encountered whose only desire is the forceful overtaking of worlds and sectors not their own.

In addition to the space claimed by the United Federation of Planets and its allies, hundreds of thousands of cubic parsecs have been mapped by sensors from a distance and are only now being entered by the vessels of Starfleet. Improved subspace radio systems and relay beacons have expanded communications capabilities far beyond the limitations once accepted as insurmountable.

Perhaps the most monumental change in the complexion of relations between the Federation and its neighbors in space has been the alliance with a longtime enemy, the Klingon Empire. No longer a feared adversary, the Klingons have engaged in an open exchange of technology and have repeatedly proven an honorable desire to forge an even stronger alliance.

The Romulans, however, are an-

other story. Gone for more than 60 years, leaving their side of the Neutral Zone virtually abandoned, this powerful culture has re-emerged with an impressively improved level of technology that easily equals that of the Federation. Encounters with the militant Romulan Empire have dramatically increased in number, many verging on the brink of warfare with Federation and Klingon forces. The Romulans are ever more uncomfortable with the UFP/Klingon alliance, which borders two-fifths of their galactic territory.

Beyond Romulan space lie the Borg—a race of humanoid/machine fusions which exists only to absorb those civilizations they encounter. Following a devastating battle loss at Wolf 359—during which Federation forces unsuccessfully attempted to use sheer force to stop a single Borg vessel—the Borg were finally defeated in Earth orbit using data gathered by the *U.S.S. Enterprise* in its initial encounter with the intruder. It is not known how many Borg vessels, if any, remain in deep space.

Other races, such as the Ferengi and the Cardassians, have become known through encounters with their respective vessels far from their home worlds, which remain virtually unknown to Federation science. □

GALACTIC CORE

EARTH

APPROXIMATE LIMIT OF EXPLORED SPACE

UNITED FEDERATION OF PLANETS

ROMULAN SPACE

KLINGON SPACE

KNOWN BOUNDARY OF BORG SPACE

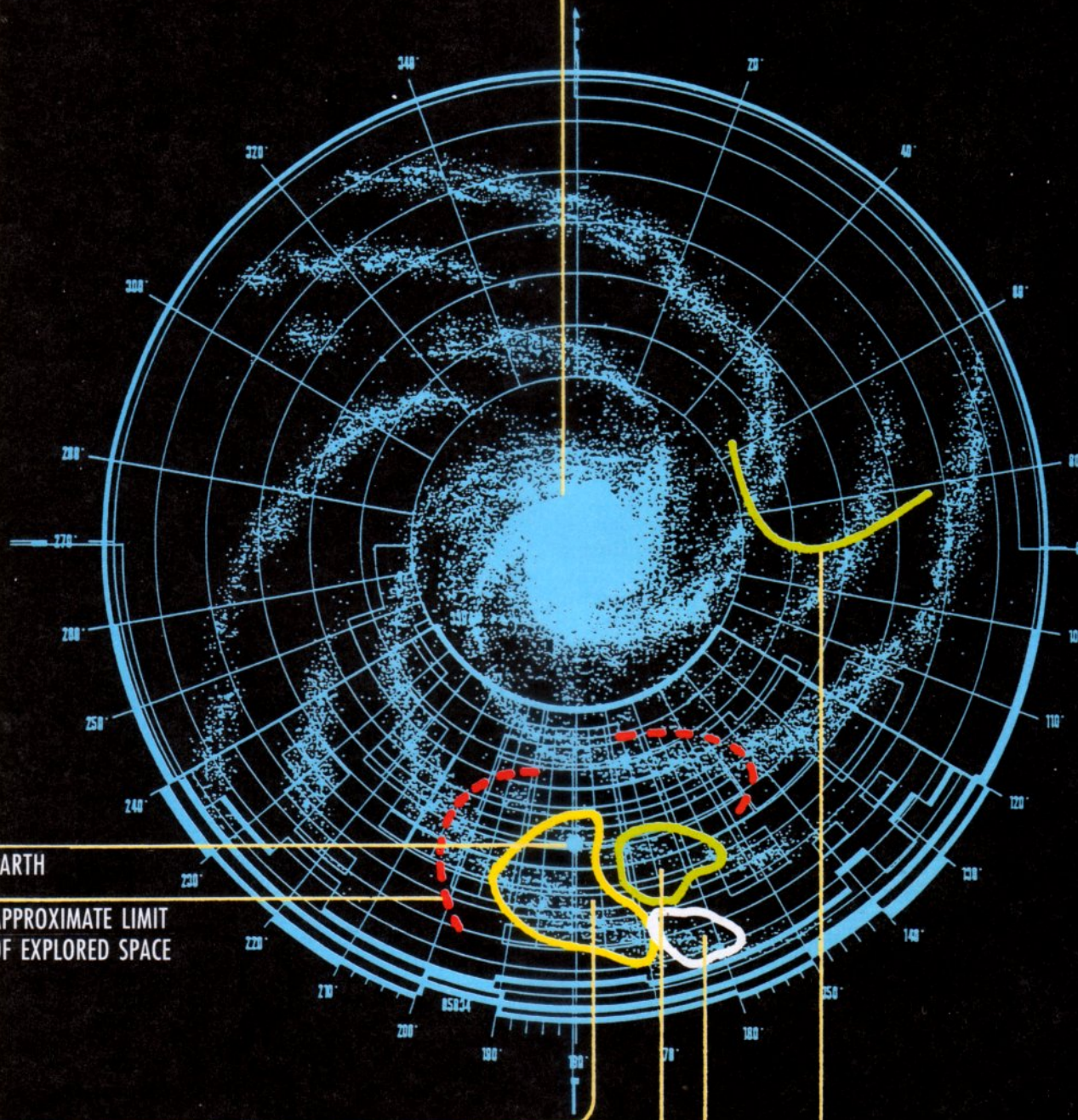

The exploratory capability of today's Starfleet vessels has surpassed the expectations of Federation science, providing answers to questions held for decades. New warp capabilities, undreamed of not so long ago, have not only taken us farther into the stars but have also opened the door for a wide array of spin-off technologies that have vastly improved virtually every facet of Federation life.

Computer memory systems, medical technology, deflector and defense arrays, phaser systems, transporter and fabricator capabilities, and terraforming and colonization techniques have taken great leaps in only the past few decades. Information retrieval is now possible at speeds beyond that of light—gone is the once familiar computer statement "Working..." as databank after databank was searched for information. Near instantaneous responses are now commonplace throughout Starfleet's vast computer network.

The sarium krellide power system, now in use in all Starfleet hand-held equipment and weapons systems, has replaced the dilithium/translator technologies of days past. Greater reliability and duration between power charging periods have improved the flexibility and field time of devices so equipped and has often proven to be the difference in the success of colonization and landing expeditions.

The standard Starfleet communicator is no longer the familiar, hand-held flip-open device still in use in some of the more distant reaches of Federation space. A simplified unit, worn as an insignia on the uniform breast and activated by a gentle tapping, now provides personnel with greater communications range and continual transporter lock capability.

The Federation transporter, the mainstay of planetary exploration, has enjoyed many refinements over the past several years and is now able to serve in capacities unknown not long ago. Range has been increased somewhat, as has the system's ability to beam personnel and objects through greater thicknesses of solid matter (such as rock, if transporting to underground colonies). However, perhaps the greatest advancement has been the

addition of a proven biofilter system which prevents known unwanted, dangerous disease organisms from being inadvertently brought aboard ship following landing party exploration.

The standard Federation tricorder has enjoyed recent refinement into a truly invaluable tool, both for landing party/away team and shipboard use. With more than seven times the internal memory and wider data access than the previous unit, it has become a renaissance device. Detachable mission module peripherals, added to the head of the basic tricorder unit, instantly specialize the device into one of several possible computer/sensor arrays. With a simple module addition, the unit can become a geological laboratory, a stellar analysis reader, a medical diagnostic unit programmed for up to 14 humanoid/carbon-based life forms, a meteorological weather center, or any one of several other optional data-gathering devices. A hand-held remote sensor unit, carried in a recess in the tricorder's forward most section, adds even greater flexibility and allows specific sensor analysis to the molecular level.

The Personal Access Display Device (PADD) serves as a portable computer terminal and is generally used only aboard ship or within Starfleet facilities. Tied into the main shipboard computer system, the PADD provides immediate access to visual display data and serves as a channel for both storage and retrieval of databank information. Datafeed control is accomplished through combined vocal commands and manual manipulation of a series of touchstrips on the PADD's upper surface.

Personal phaser technology has led to the development of new units, which function at a higher efficiency rate yet remain cooler during operation. This is due in part to the advanced sarium krellide power sources now commonly used, which generate only 41 percent of the waste heat common to dilithium/translator systems.

The new phaser science has led Starfleet away from the combination units of earlier days, wherein a low-powered Phaser I unit snapped into a larger power pack unit creating a high output Phaser III rifle unit. Today,

Phasers I, II, and III are wholly self-contained and provide a wide range of defensive and tool-use options.

Sixteen power levels are available to the more powerful Phaser III units, ranging from light neural stun to an explosive disintegration option. Phaser II can be set up to level 16, but with a 33-percent smaller power reserve. Phaser I can be programmed for power levels one through eight, ranging from light neural stun to the vaporization of humanoid life forms of Terran size and mass.

Phaser I is smaller than its earlier silver and black counterpart, the initial design introduced following the original advent of phaser technology. It delivers beam energy intensity roughly equivalent to that once found in the original Phaser II.

Two versions of Phaser II have been utilized in recent years, both being approximately the same size and configuration. The newer of the two holds an edge in power efficiency, although both styles are still in use by Federation colonies and Starfleet vessels.

Phaser III is a long-range rifle with an increased power reserve capacity. It features a flip-up sight for long-distance targeting and has proven useful as a tool for emergency geological excavation.

Ship-mounted phaser systems have also taken a dramatic turn in configuration and capability. No longer are phaser banks limited to paired, rotating beam emitters placed along the fore/aft and port/starboard axes of vessel primary and secondary hulls. In use for the first time on Starfleet's new Galaxy Class vessels are linear phaser array clusters, aligned in emission strips which traverse varied sections of the ship's outer hull. These Type X (Ten) phased array emitter units offer a far more efficient and variable beam weapon defense than previous designs could possibly have provided, and make possible a more rapid adjustment and a much broader range of beam frequency harmonics. These linear phaser clusters, because of their minimal hardpoint requirements and direct sensor ranging, can be placed at almost any point on a starship's hull and allow full-hemisphere firing arc targeting. □

PRIVACY LOUNGE

UP

RAMP TO
MAIN BRIDGE

CONFERENCE TABLE

EQUIPMENT BAY

VIEWPORT OVER

DISPLAY SCREEN

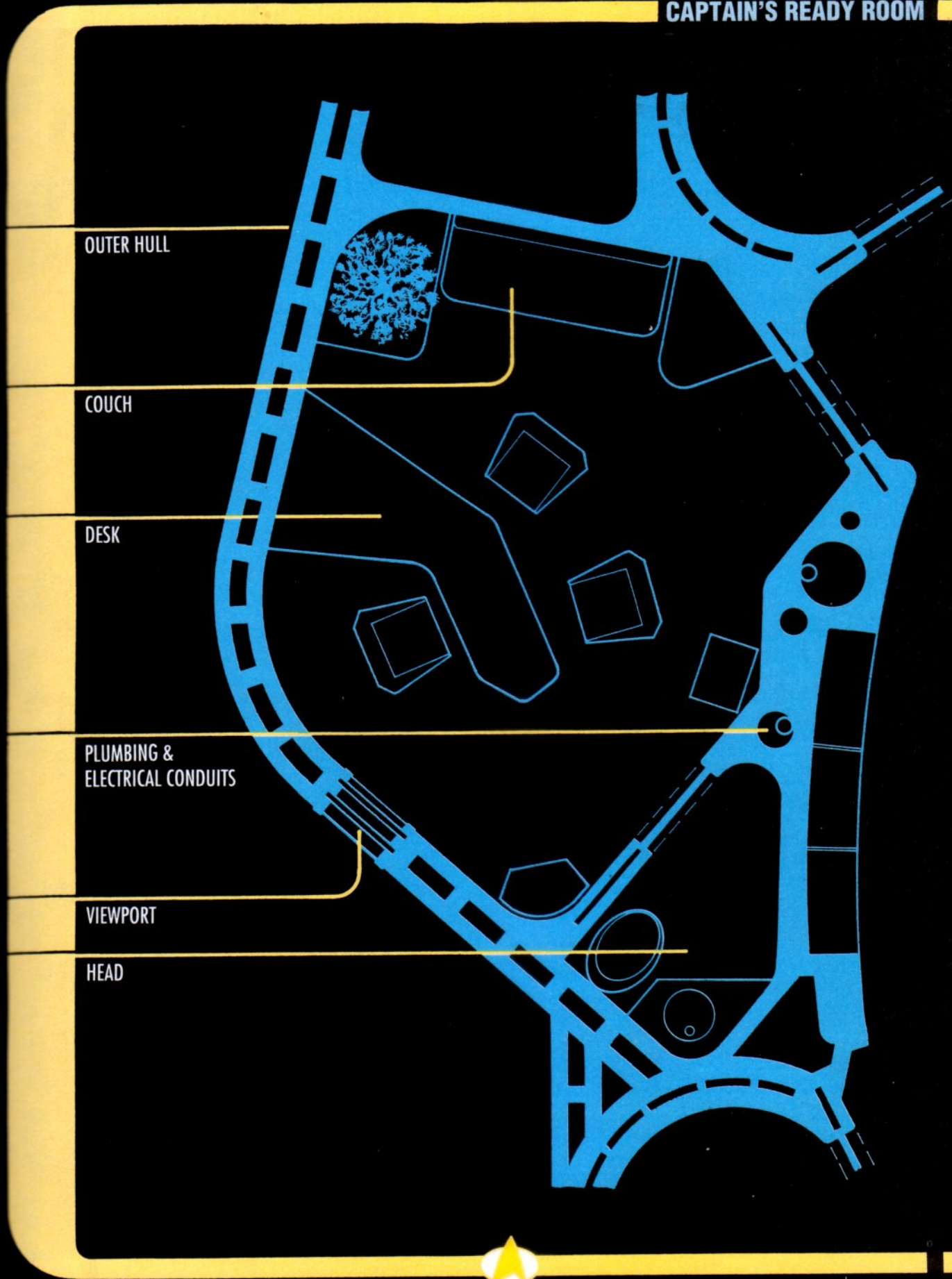

GALAXY CLASS 2401

PERSONNEL TRANSPORTER

CORRIDOR

WEAPONS ROOM (VOICEPRINT ACCESS)

OPERATOR'S CONSOLE

SERVICE CORRIDOR

SERVICE LOCKER

TRANSPORT CHAMBER

TRANSPORTER CONTROLLER

CIRCUIT BREAKER ROOM

STATIC SHIELDING COILS

UP

LAB

CMO'S LAVATORY

NURSERY

CMO'S OFFICE

RECEPTION

MEDICAL EQUIPMENT STORAGE

PRIMARY ICU

PRIMARY BIOBED

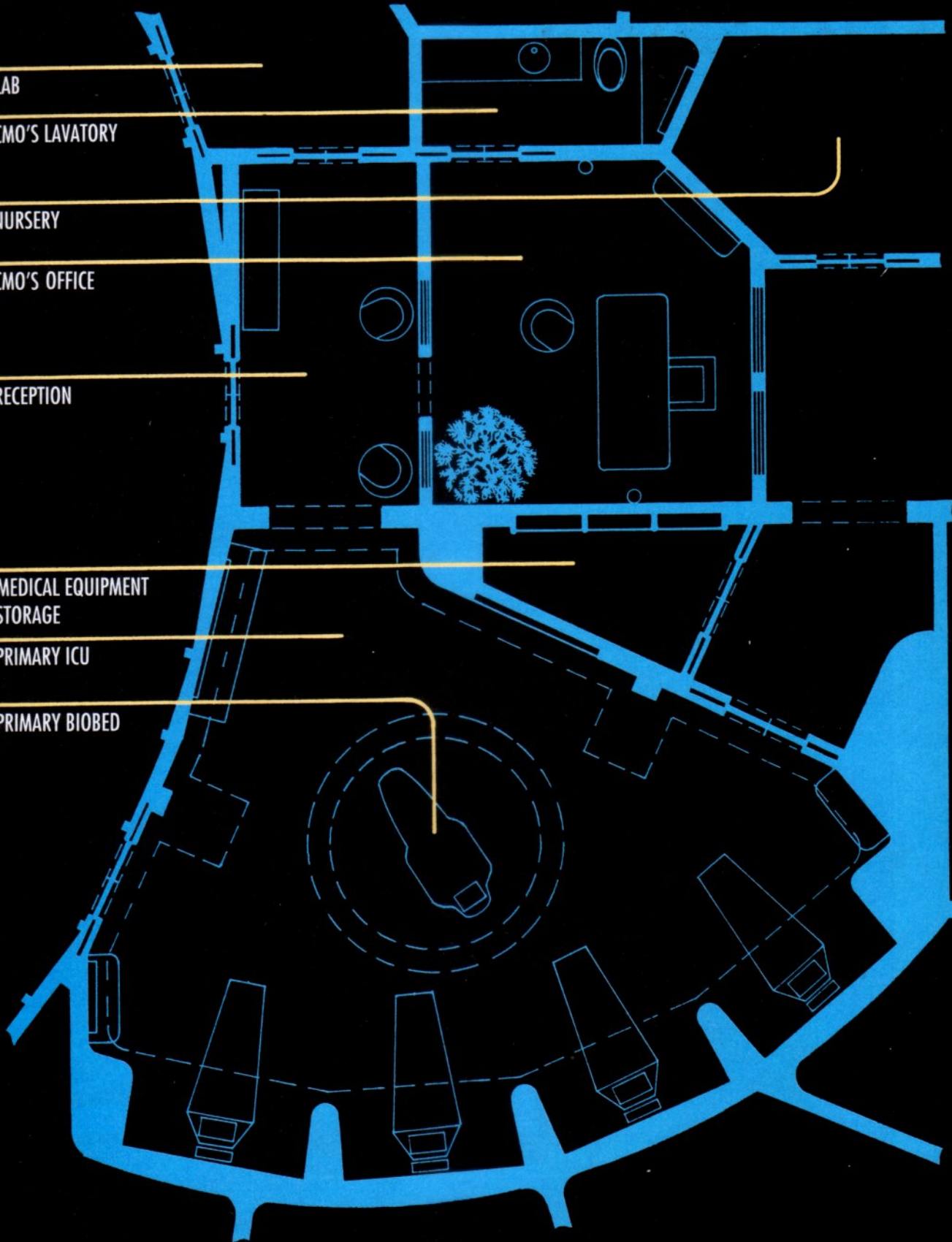

VIEWPORTS

MAIN ENTRANCE

BAR

UP

UP

UP

TABLES W/CHAIRS



MAIN TURBOLIFT

EQUIPMENT BAY

COMMAND SEATING

RAMP TO CONFERENCE LOUNGE

AFT STATIONS

TACTICAL STATION

HEAD

LIFE SUPPORT SYSTEM

EMERGENCY TURBOLIFT TO BATTLE BRIDGE

HOLOGRAPHIC IMAGING SYSTEM

CONN/OPS STATIONS

STANDBY TURBOLIFT CAR

SECONDARY MATTER FEED

POWER TRANSFER CONDUIT

TURBO ELEVATOR

MATTER/ANTIMATTER
REACTOR

DUTY ENGINEER'S
CONSOLE

CHIEF ENGINEER'S OFFICE

EQUIPMENT ROOM

MASTER SYSTEMS DISPLAY

MASTER SITUATION MONITOR

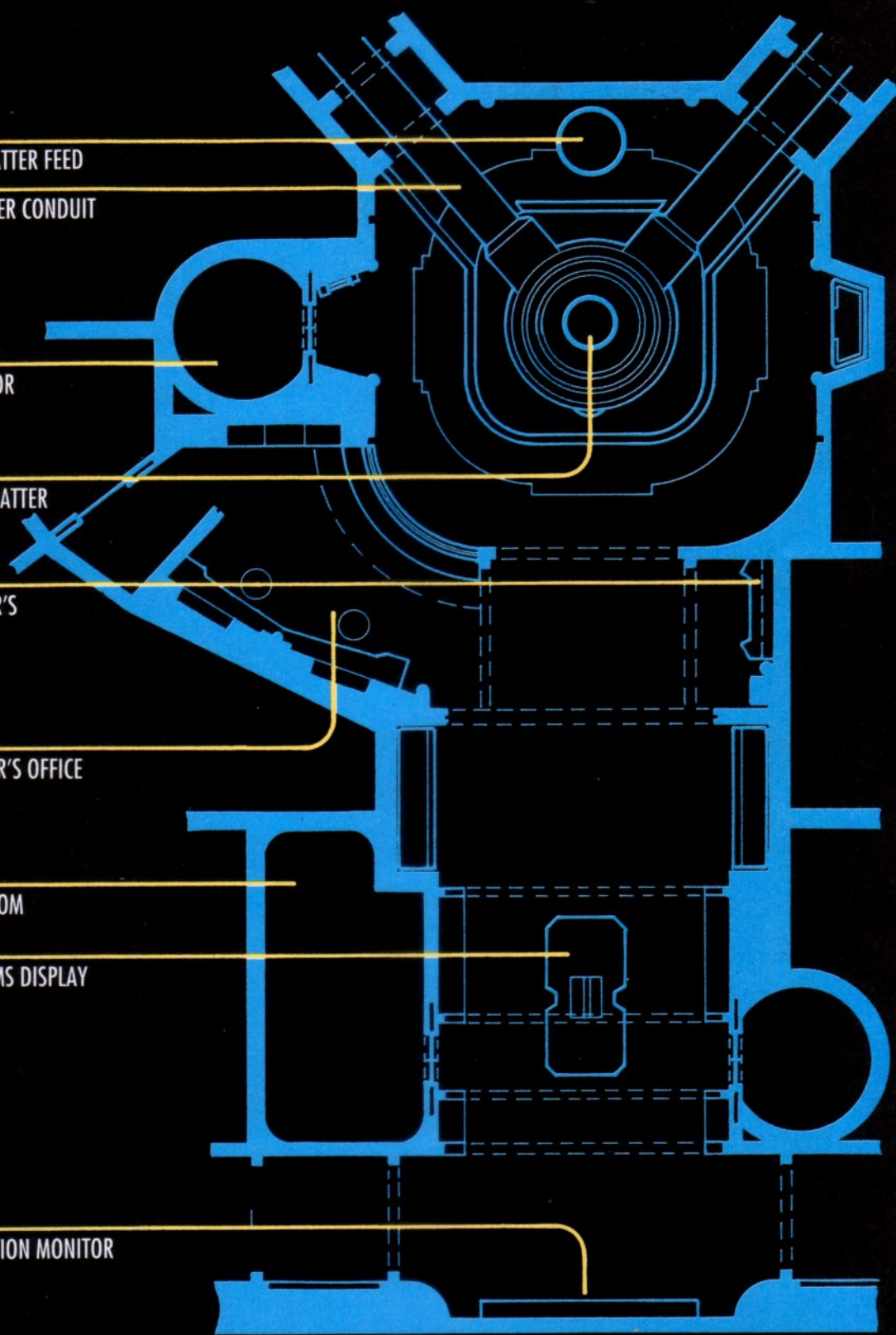

MAIN VIEWPORT

UPPER SENSOR ARRAY

ACCESS PANEL

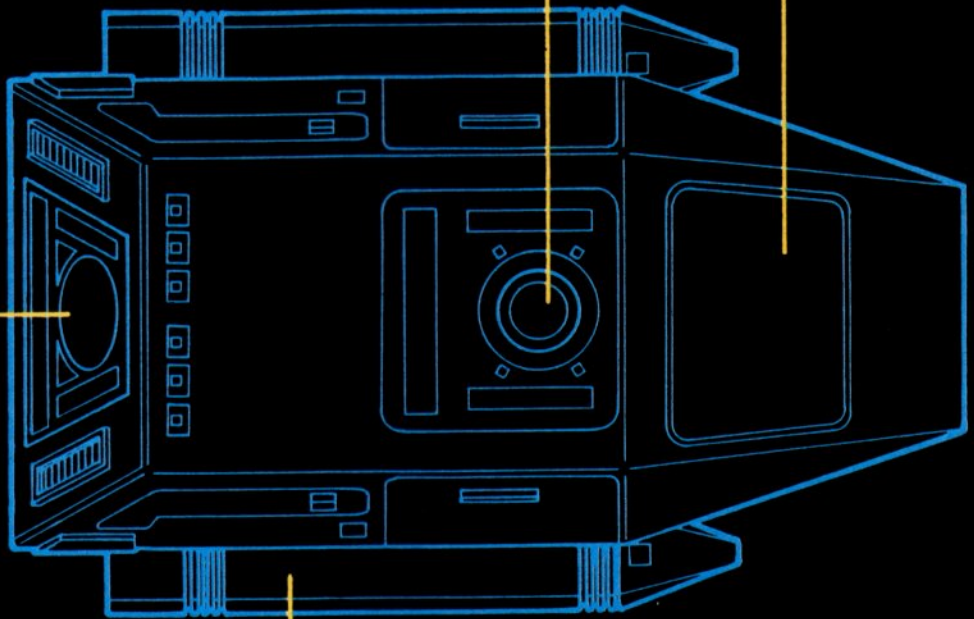

IMPULSE DRIVE UNIT

EMERGENCY PURGE VENT

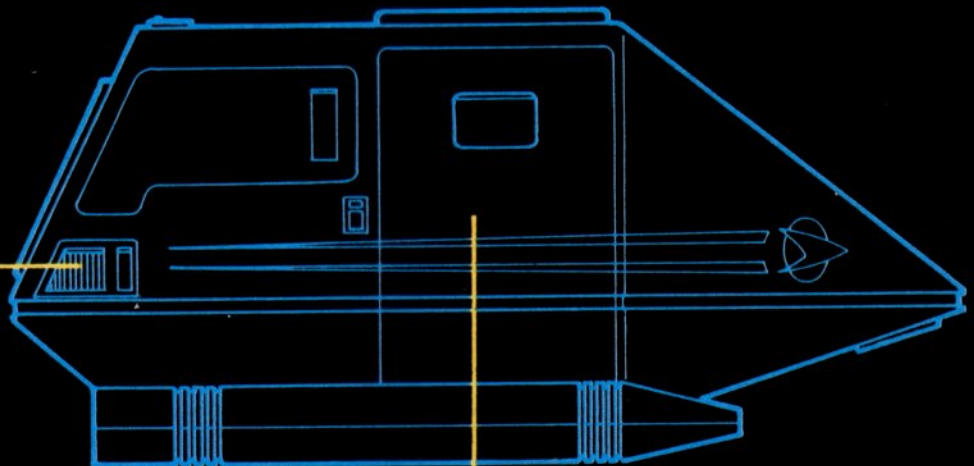

INGRESS/EGRESS HATCH



EDGE OF BALCONY OVER

TRACTOR BEAM UNIT (EXTENDED)

BULKHEAD DOOR

MAINTENANCE BAYS

CONTROL CONSOLE

INNER BAY DOOR

OUTER BAY DOOR

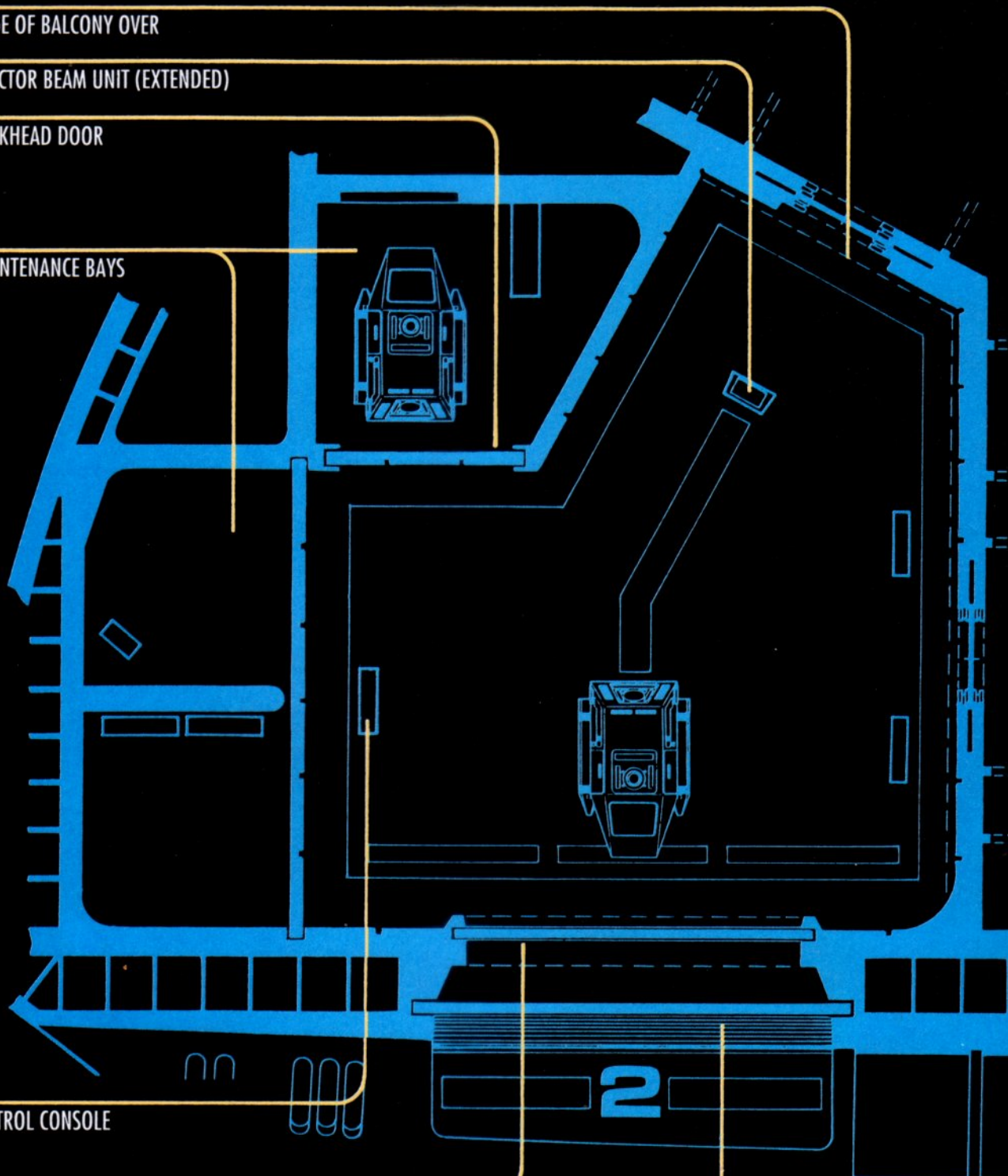

RANK PINS

COMMUNICATOR

DEPARTMENT TUNIC

FITTED SLACKS (BLACK)

REGULATION DUTYBOOTS

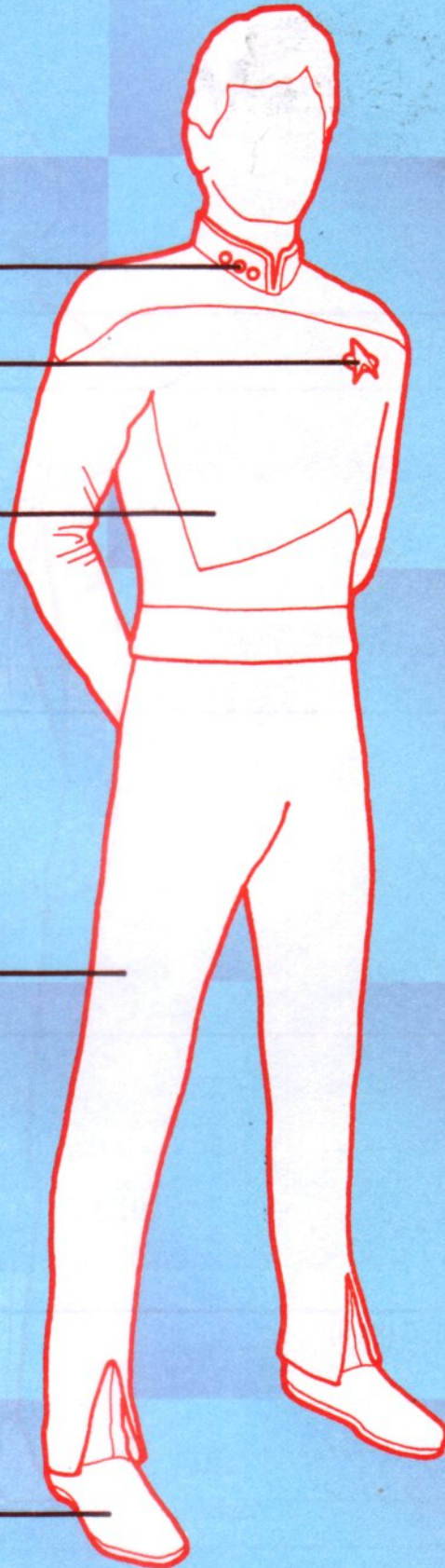

Miniskirt "skant" uniform has fallen into disuse and has been taken out of service. When it was worn, however, it was used by both men (in a slightly longer version) and women.

RANK PINS

COMMUNICATOR

DEPARTMENT TOP

PANTYHOSE (NUDE)

REGULATION DUTYBOOTS (HIGH)

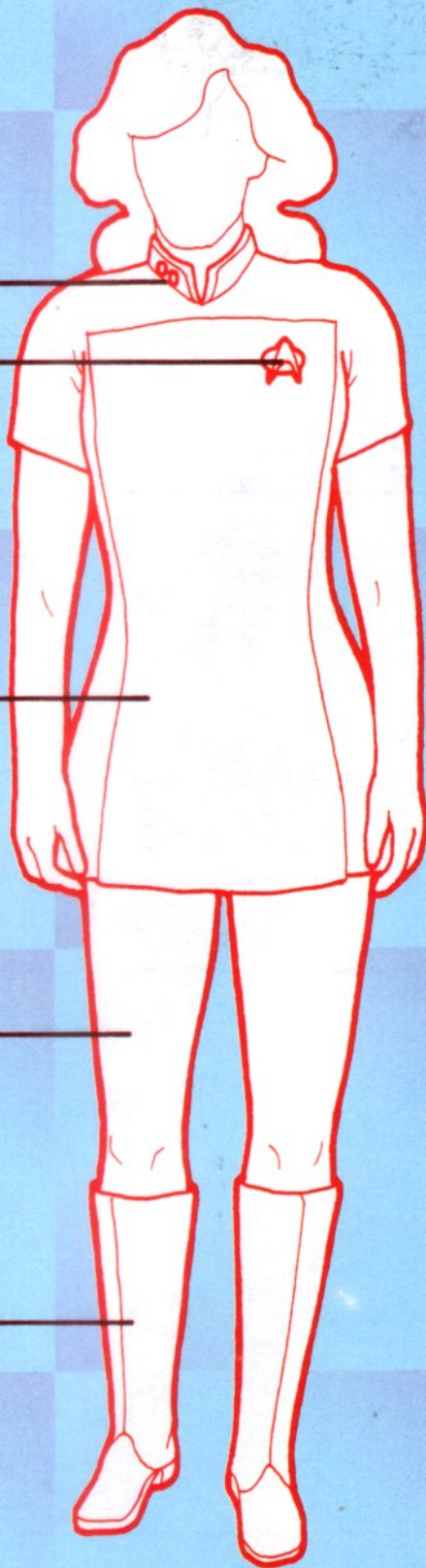

RANK PINS

COMMUNICATOR

GREY DUTY TUNIC

DEPARTMENT JACKET

FITTED SLACKS (BLACK)

REGULATION DUTYBOOTS

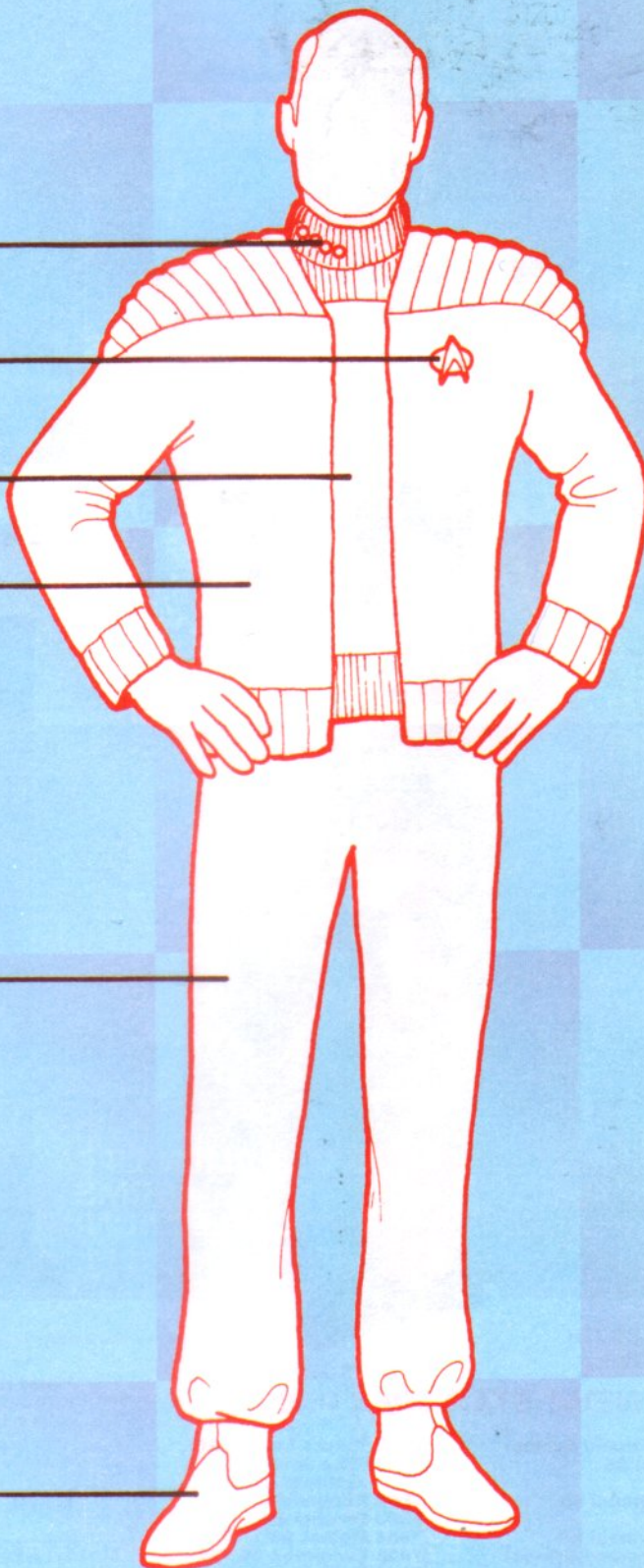

RANK PINS

COMMUNICATOR

DEPARTMENT DRESS TUNIC

FITTED SLACKS (BLACK)

REGULATION DUTYBOOTS

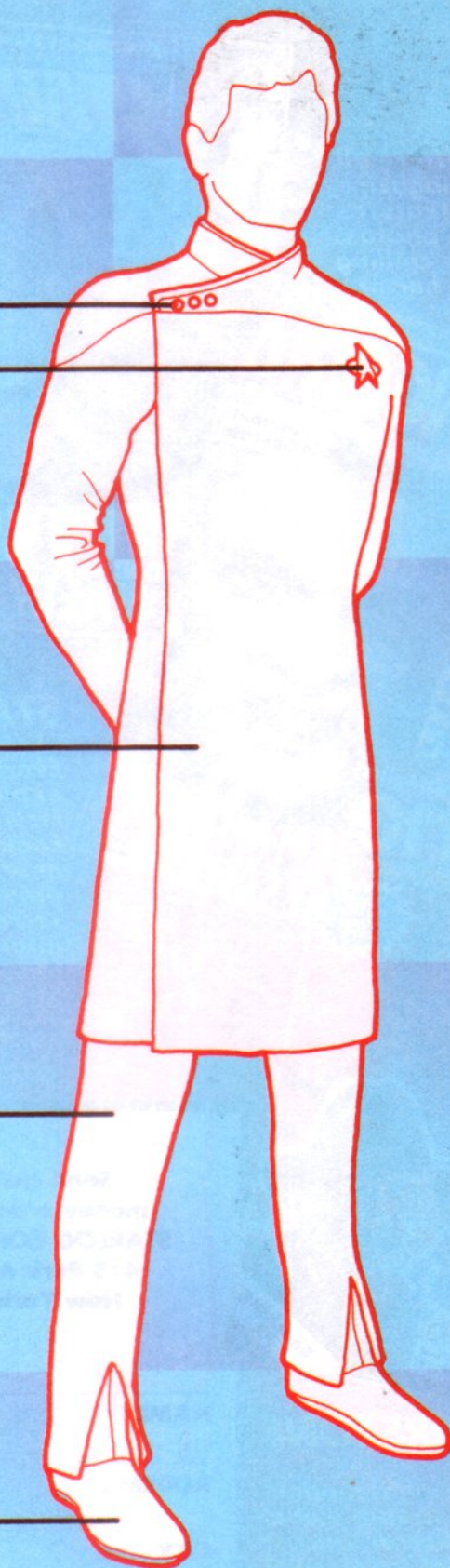

COMMODORE



CAPTAIN



COMMANDER



LIEUTENANT COMMANDER



LIEUTENANT COMMANDER



LIEUTENANT JUNIOR GRADE



ENSIGN



ENSIGN JUNIOR GRADE



RANK BARS—TWO REQUIRED
(SEE DETAIL)

GOLD BRAID

COMMUNICATOR

FITTED SLACKS (BLACK)

GOLD BRAID

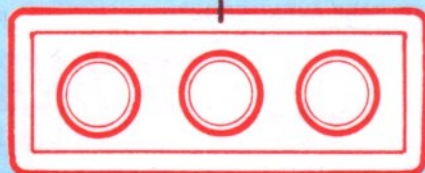

REGULATION DUTYBOOTS

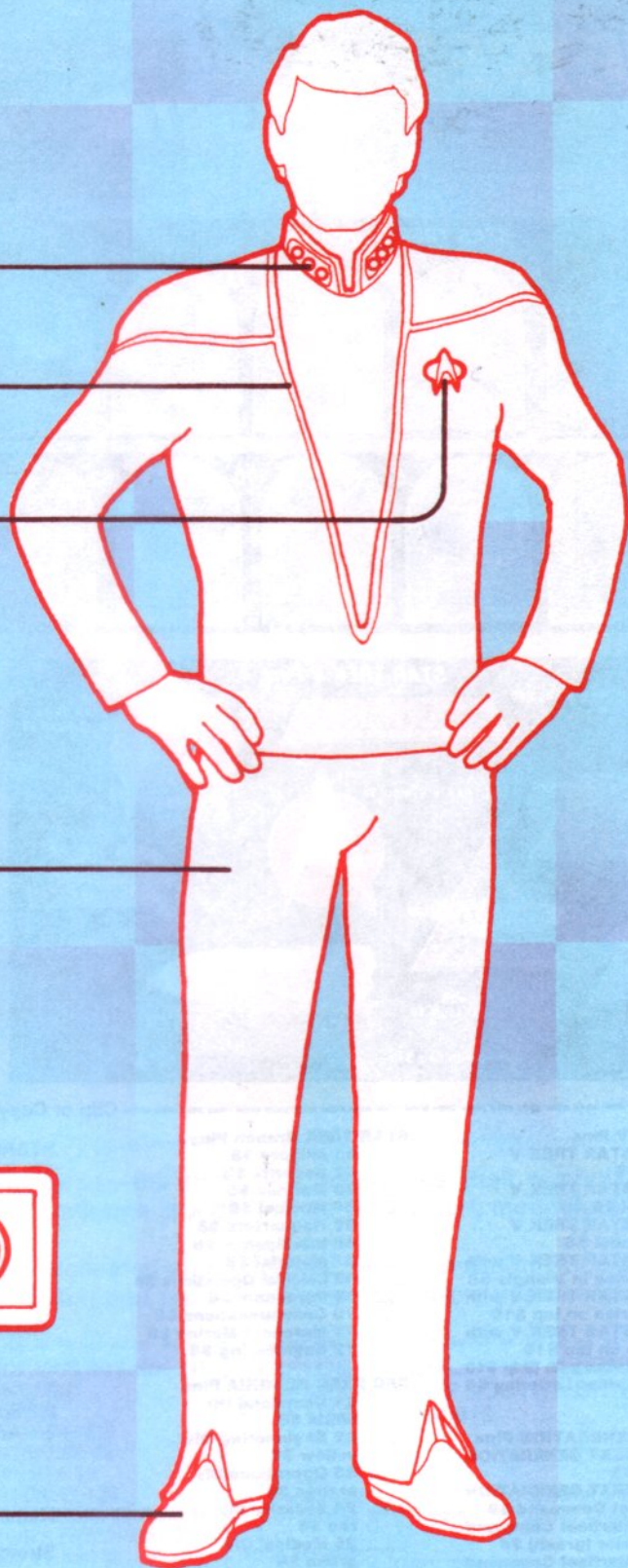

DEPARTMENT UNIFORM JUMPSUIT

UTILITY POCKETS

JUMPSUIT PANT

REGULATION DUTYBOOTS

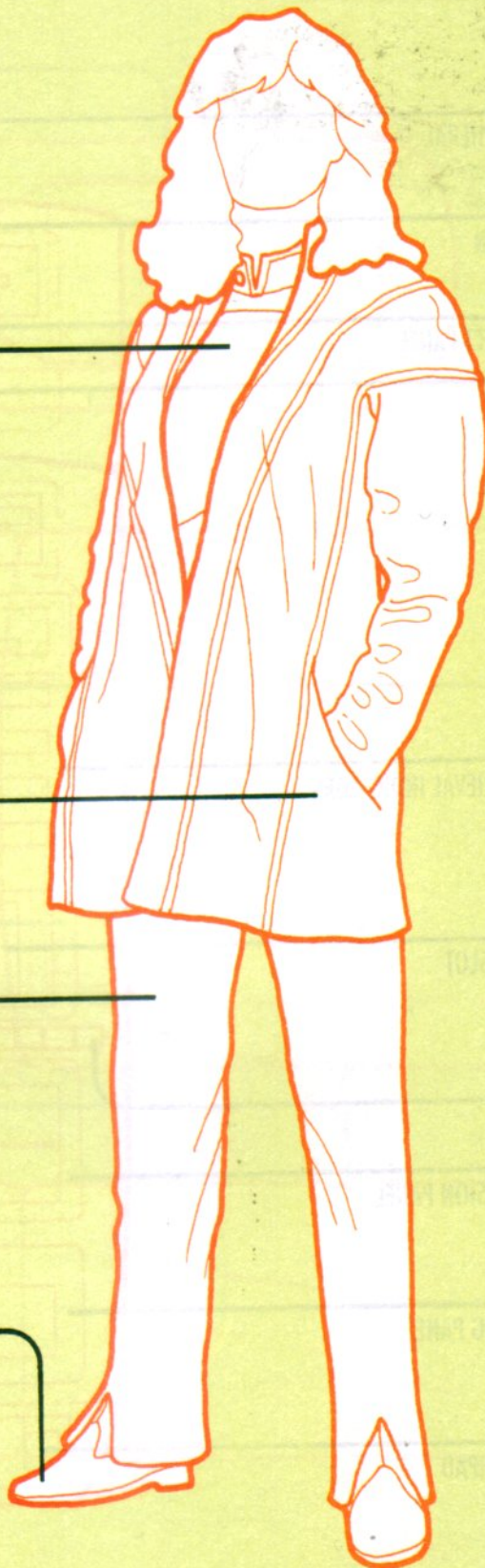

MEDICAL PERIPHERAL

DISPLAY SCREEN

FUNCTION SELECT PANEL

POWER SWITCH

DATA REC/RETRIEVAL INDICATORS

MEMORY CHIP SLOT

HINGE

DATA TRANSMISSION PANEL

DATA RECORDING PANEL

USER I.D. TOUCHPAD

MODEL NUMBER PLATE

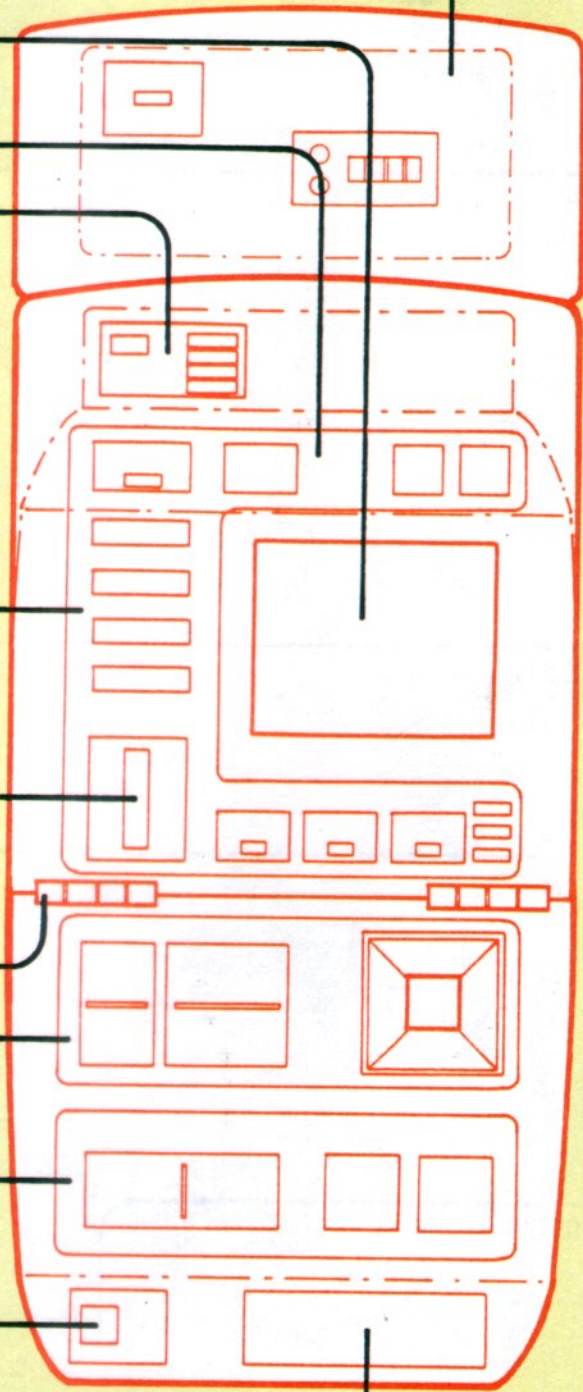

HAND SENSOR

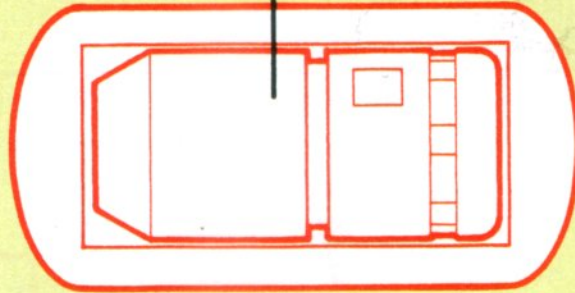

HINGE POINT

POWER SWITCH

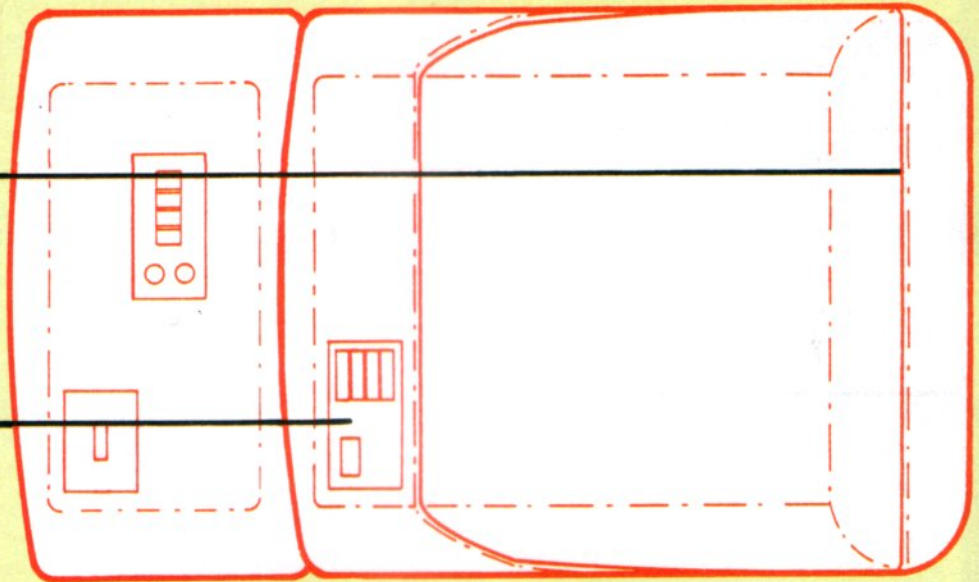

LOWER MODULE (CLOSED)

MEDICAL PERIPHERAL

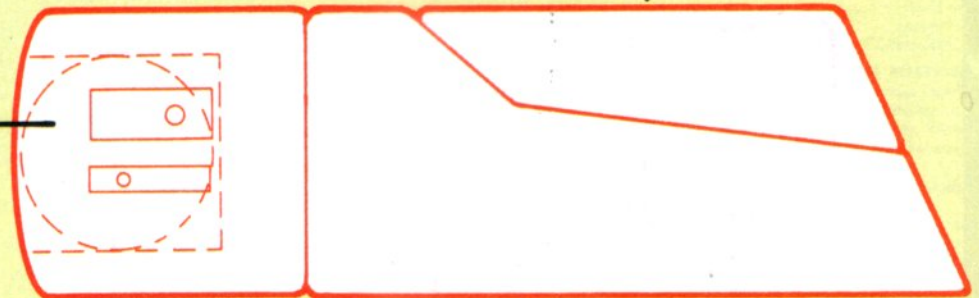

ACTIVATION TRIGGERS

SPRAYHEAD

PRESSURIZATION UNIT

SALINE CHAMBER

GRIP

MEDICATION AMPULE

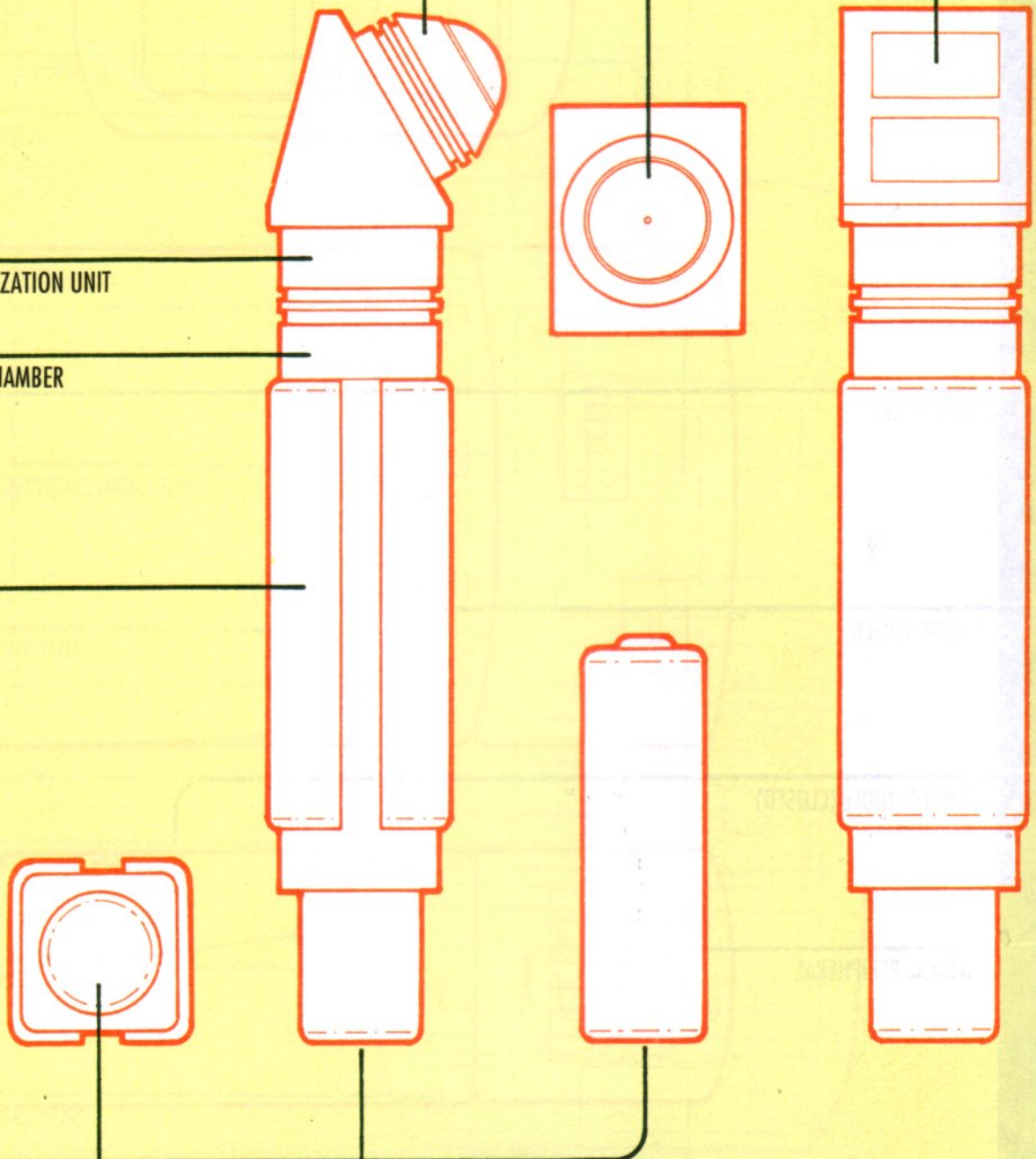

DERMAL SENSOR TOUCHPAD



DURANIUM CASING

SARIUM KRELLIDE POWER CELL

SUBSPACE TRANSCIEVER ASSEMBLY (STA)

SPEAKER PLATE

MANUAL FREQUENCY CONTROL

MANUAL GAIN CONTROL

MANUAL VOLUME CONTROL

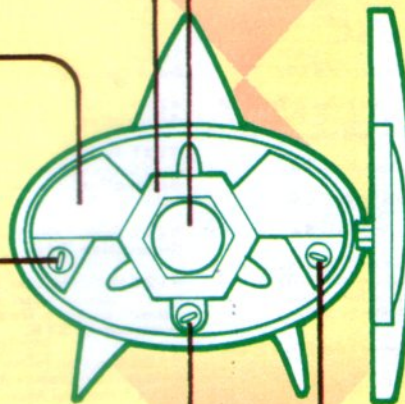

SENSOR ARRAY

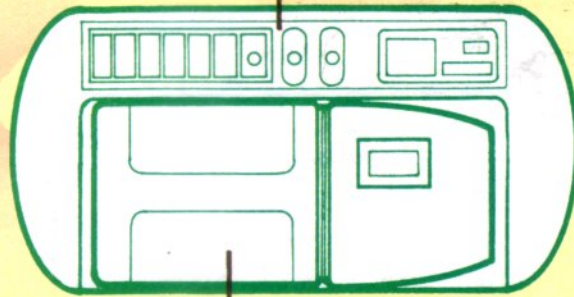

HAND SENSOR

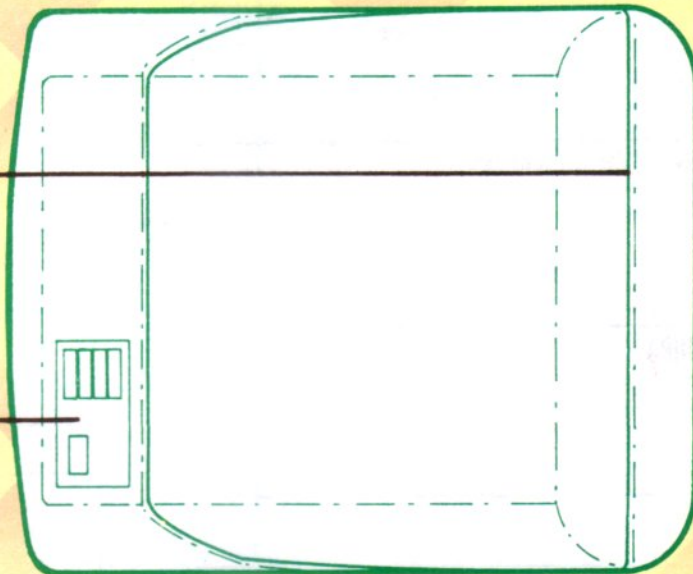

HINGE POINT

POWER SWITCH

LOWER MODULE (CLOSED)

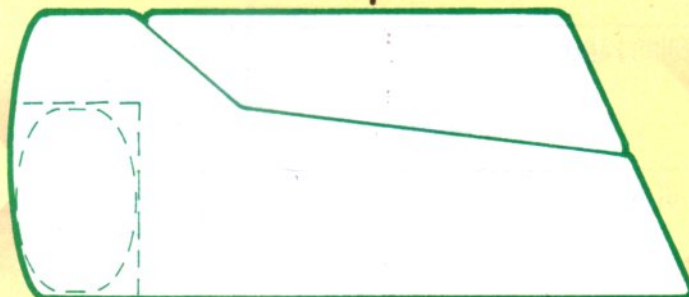

DISPLAY SCREEN

FUNCTION SELECT PANEL

POWER SWITCH

DATA REC./RETRIEVAL INDICATORS

MEMORY CHIP SLOT

HINGE

DATA TRANSMISSION PANEL

DATA RECORDING PANEL

USER I.D. TOUCHPAD

MODEL NUMBER PLATE

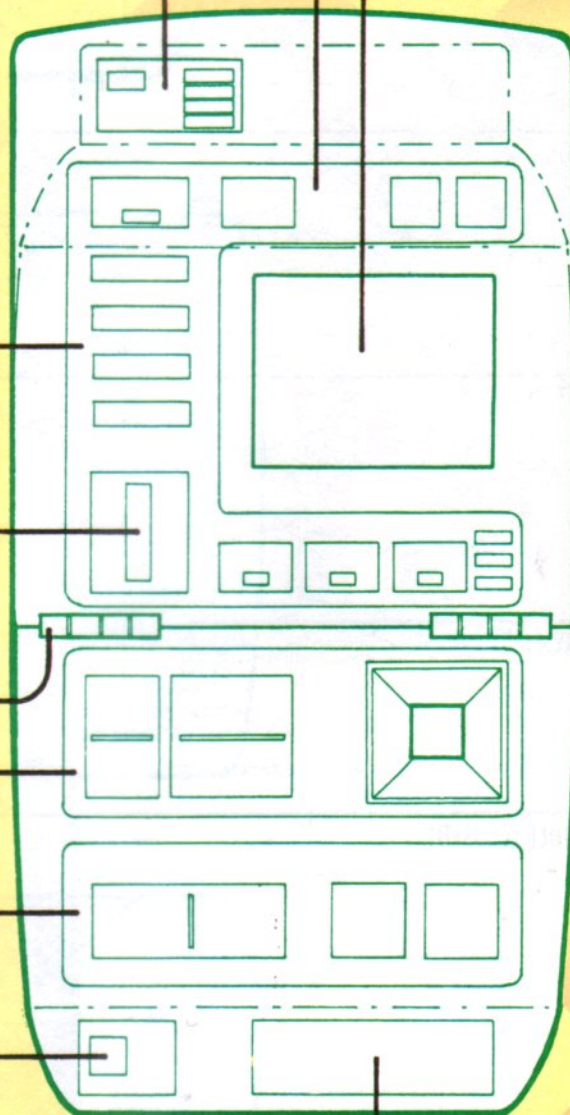

HEAT SINK

DISPLAY SCREEN

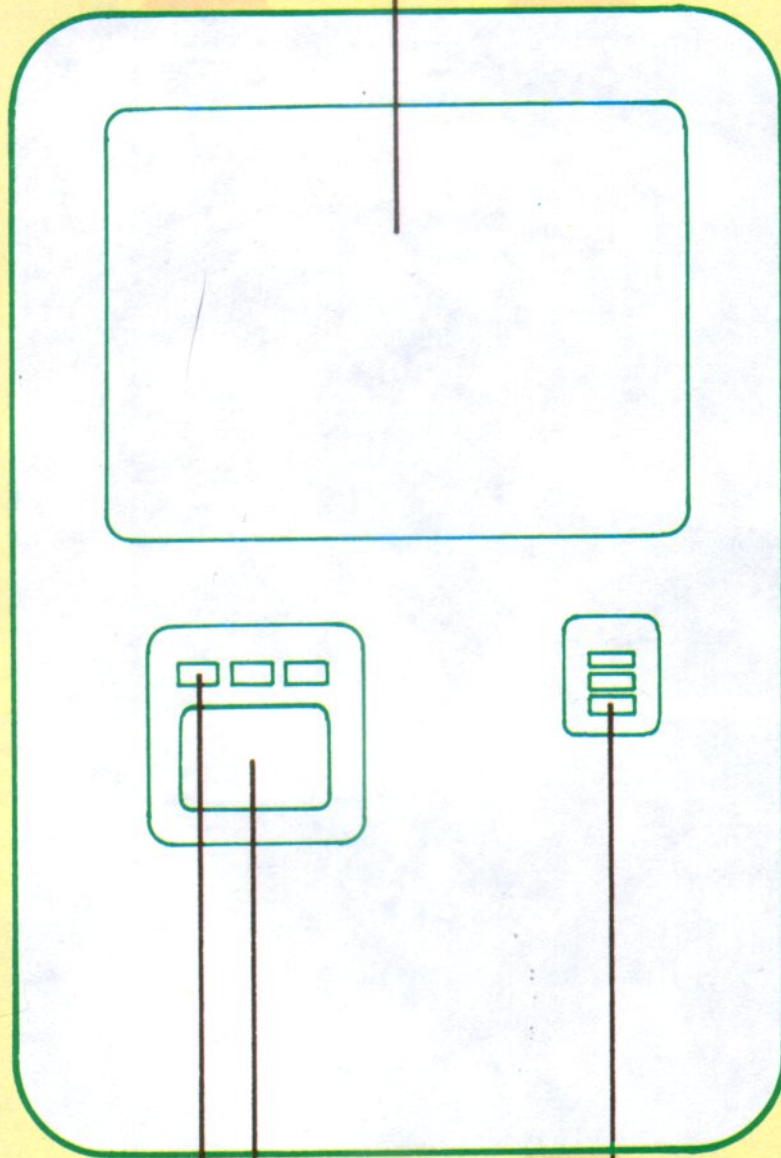

FUNCTION DISPLAY LIGHTS

POWER SWITCH

COMPUTER LINK DISPLAY



GALAXY CLASS STARSHIPS

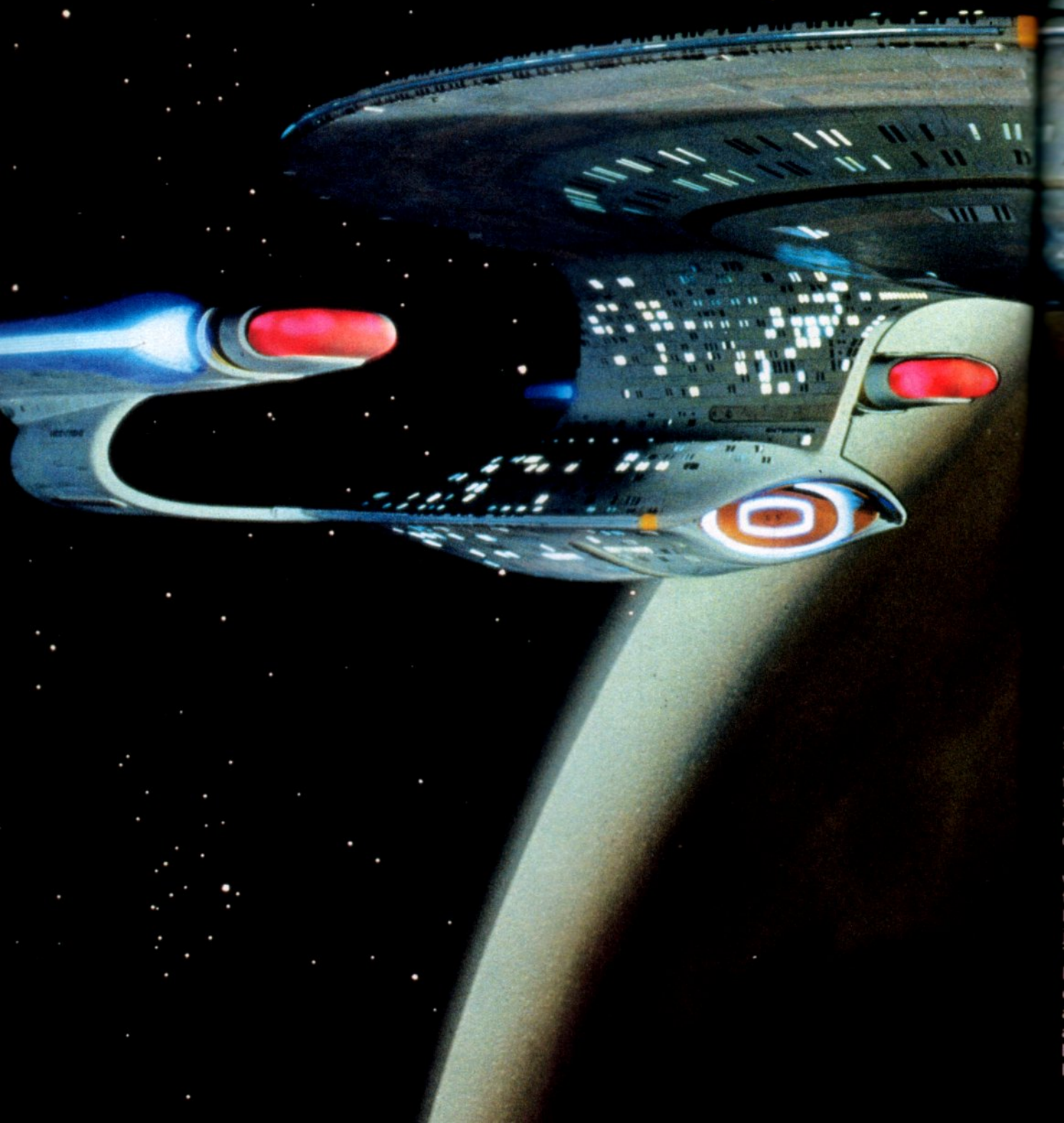

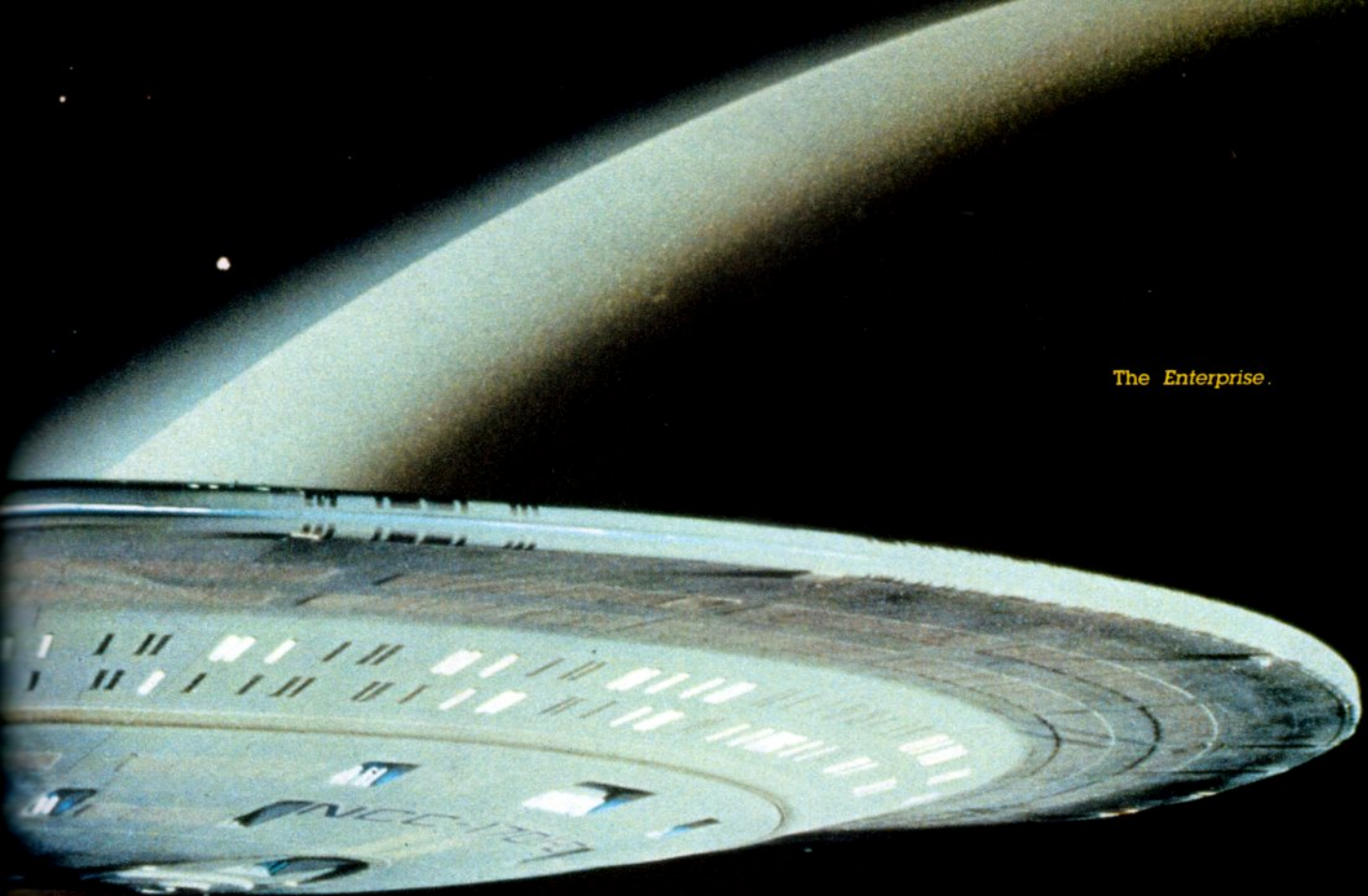

The Enterprise.

The culmination of Federation warp vessel technology is represented today in the new line of Galaxy Class ships, built in Mars orbit by the Utopia Planitia Starfleet Yards. Unlike any previous hull design, the Galaxy Class reflects the graceful, sweeping lines made possible only by the most recent innovations in war field configuration dynamics. These massive vessels, larger than any previously constructed, do, however, reflect the classic Starfleet primary hull/secondary hull/twin warp drive nacelle structure first introduced a century ago in the Constitution Class.

Three Galaxy Class vessels have been constructed to date, with others approved and awaiting dock time. The starships *Galaxy* (the prototype) and *Enterprise* are still in service, but the third Galaxy Class vessel, *Yamato*, suffered catastrophic intermix failure and was destroyed following massive computer control breakdown.

Like the Ambassador Class, in which the concept was first made feasible, the Galaxy Class has separable hull sections which can be re-joined by rendezvous and docking. These hulls, referred to as the Saucer Module, and the Battle Section, are operationally self-contained with separate power, life-support, weapons and propulsion systems. Only the Battle Section, however, following hull separation, is equipped for warp

drive as it houses the vessel's intermix/nacelle complex.

Both hull sections contain full impulse drive systems, which also furnish power for life-support, gravity and minimal weapons use. The Saucer Module, using aerodynamic deflector manipulation, is planetfall capable but is not designed for liftoff and ascent once a landing has been made.

Located at various points on the vessel's outer hull are transporter emission/receptor matrices and tractor beam arrays. Transporter signal emission is still line-of-sight in nature, but the complex arrangement of matrix pads on the ship's surface permits simultaneous beaming of separate persons/objects in different directions and over widely disparate distances.

The vessel's bridge is designed for maximum efficiency while maintaining a high level of comfort for the ship's crew. A huge three-dimensional viewing screen dominates the forward bulkhead of the room, overlaying on demand any computer data or navigational graphics required atop images picked up by the ship's visual sensors. The CONN and OPS stations, from which the ship's course, speed, and realtime sensor analyses are controlled, are located just forward of the bridge's command area, from which the vessel's CO and First Officer direct all command functions.

Behind the Captain's chair, ele-

vated upon the aft station platform, is the tactical station from which weapons fire and defensive systems are controlled. The aft bulkhead of the room is made up of the main science and engineering stations, which feature pull-out seating and large computer interface displays.

Two standard turbolifts service the port side of the main bridge, one forward and one aft. An emergency direct-route turbolift on the forward starboard wall provides immediate command access to the vessel's battle bridge, from which Battle Section operations are controlled following hull separation.

A portside door accesses the Captain's ready room, an office from which the CO can carry out his/her secondary duties while maintaining immediacy to the main bridge. As the CO will often spend much of any given duty shift in this room, a desk, computer terminal, couch, food dispenser and private head are provided, as is an aft-facing outer viewport.

A corridor to the starboard aft of the main bridge leads to the main conference lounge. Here, most meetings of the command staff take place. Seven huge viewports provide a spectacular, uninterrupted view of the vessel and space beyond, looking aft.

The Galaxy Class is outfitted with six standard personnel transporters. Four are located on Deck 6 of the Saucer Module, with the remaining

The Romulan War Bird is roughly equivalent to a Starfleet Galaxy class vessel.

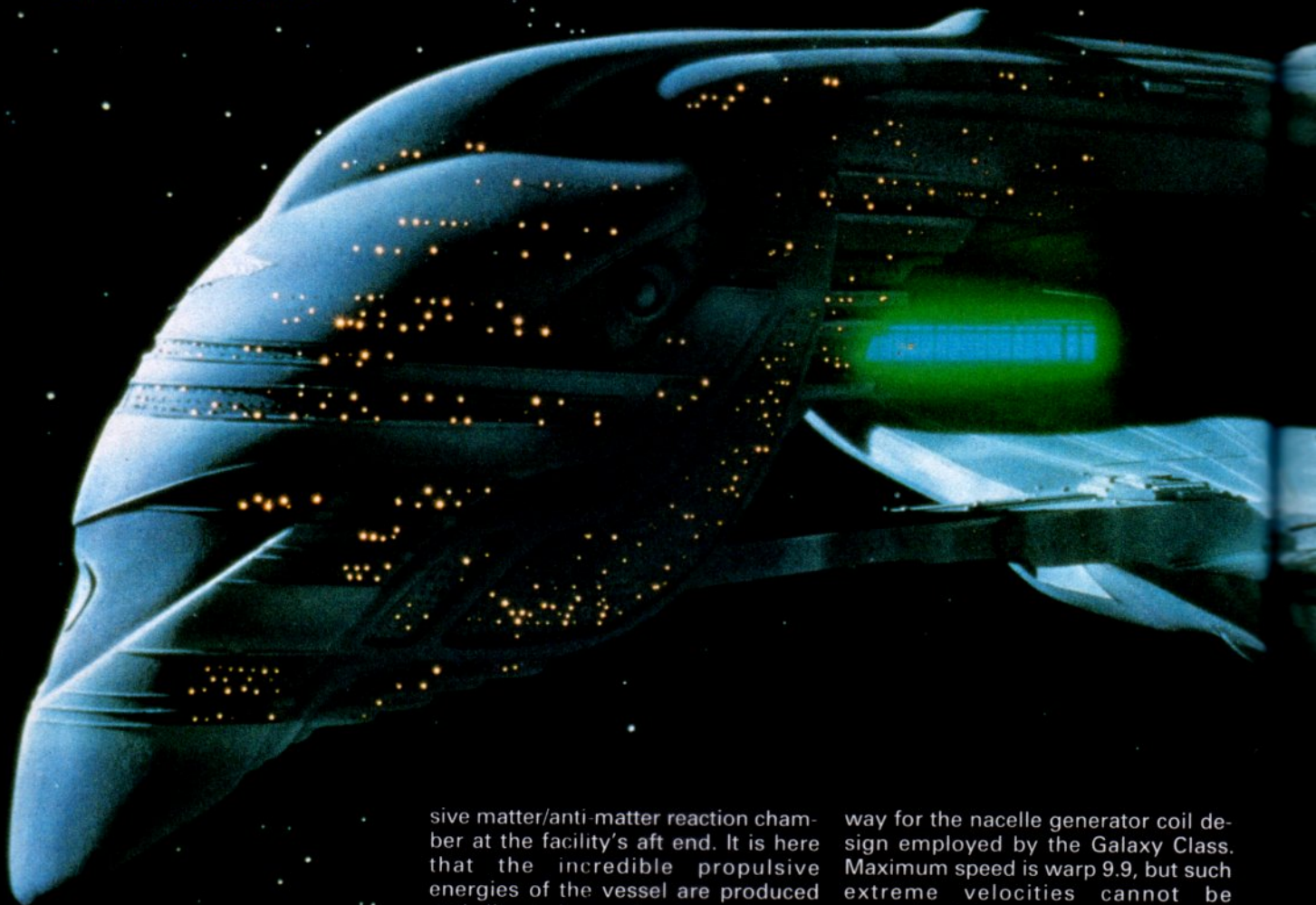

two in the Engineering section on Deck 14. In addition, eight cargo transporters and six emergency personnel transporters are installed in various locations throughout the ship. These facilities operate largely as Federation transporter systems always have, with only slightly greater range than on previous models. Major improvements have taken place, in the areas of signal purity, dense-matter penetration capability, and biohazard limitation.

Each personnel transporter room features the familiar, circular transport platform and free-standing control pedestal. To one side, an access corridor wall is dominated by a transporter controller subprocessor, which oversees all transport functions and houses the system's primary iso-linear optical chip array.

Main Engineering is the domain of the ship's Chief Engineering Officer, and all vessel propulsion and power distribution systems are controlled from this point. Located on Deck 36, the room's main feature is the ship's primary intermix unit/dilithium crystal housing, contained within the mas-

sive matter/anti-matter reaction chamber at the facility's aft end. It is here that the incredible propulsive energies of the vessel are produced and directed, creating the subspace wave bubble through which the ship is able to attain faster than lightspeed.

The Chief Engineer's office, located to one side of the main intermix area, offers continuous and immediate visual data pertaining to the functioning of all engine and power systems. The free-standing master systems display, located in the center of the main entry corridor, gives engineering personnel an immediate picture of the overall condition of the vessel's many power-feed complexes and can be reconfigured, when necessary, to provide emergency control of the ship's flight and power distribution networks.

The propulsion system of the Galaxy Class starship employs field configuration techniques derived from decades of research into the properties of those engines built into earlier vessel designs. Even the transwarp matrix system originally designed for the Excelsior Class, first put into service some 80 years ago, has proven valuable, despite its having been abandoned so quickly. Field stress and hull support experiments carried on during initial tests of the transwarp and advanced warp units installed on early Excelsior and Enterprise Class vessels paved the

way for the nacelle generator coil design employed by the Galaxy Class. Maximum speed is warp 9.9, but such extreme velocities cannot be maintained for prolonged periods of time, due to the generation of structural stresses beyond the compensation ability of the vessel's structural integrity fields.

Vessel armament consists of both phaser and photon torpedo firing systems. Twelve linear phaser clusters provide lightspeed beam defense in all X, Y and Z axis firing arcs. Guided photon torpedo projectile weapons may be launched from either of two firing tubes, one forward and one aft, providing a formidable warp speed defense. These same launching tubes may be used to deploy a wide range of specialized sensor probes and marker buoys.

The Galaxy Class Medical Unit is among the finest in Starfleet, rivaling even those found in the most advanced Starbase facilities. Located on Deck 12 in the Saucer Module, the ship's hospital consists of primary and secondary units located port and starboard of the ship's central computer complexes. The primary unit houses the Chief Medical Officer's office and is generally understood by crew personnel to be the area meant by the terms 'sick bay' or 'medical.'

Also located in the primary section is an extensive biomedical laboratory

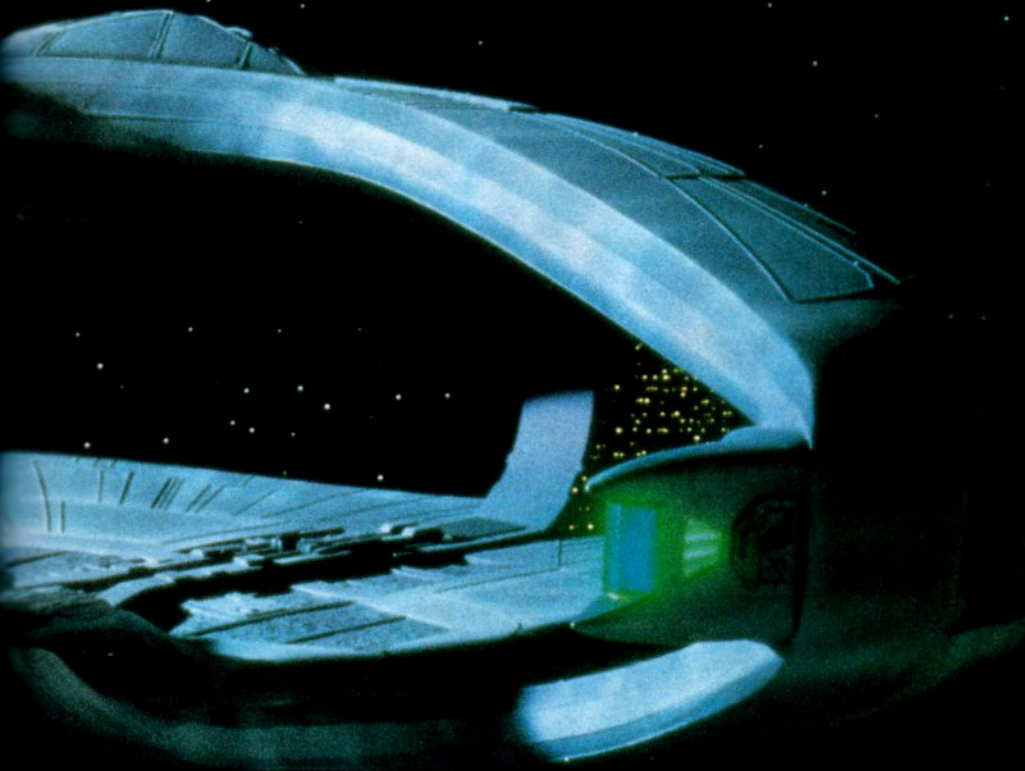

with extended computer simulation capabilities. Virtually any disease progression or physical cellular process can be observed on a theoretical basis, making patient diagnosis more accurate and less time-consuming than in the past. Cryogenic storage units and full tissue incubation modules permit actual sample analysis with sensor resonance imaging, culture growth observation and genetic substructure reconfiguration.

Two intensive-care units are located here, each equipped with advanced biobed technology. Like never before, patient condition can be determined with only a 0.6 percent margin of error, with speed previously seen only at Starfleet Medical Central using the Farrasen Medical Diagnostic Logic System. A primary biobed unit, located in the center of each ICU, utilizes a further overhead sensor array for the study and diagnosis of life forms for which the standard biobed units have not been previously programmed.

A secondary corridor accesses additional recovery rooms, nurse's duty quarters, private examination rooms, a nursery, and obstetric facilities.

Three shuttlebays provide small craft with approach and landing access to the ship. The main bay rests atop the Saucer Module, just aft of the bridge module. Hangar facilities located here can accommodate vari-

ously-designed shuttlecraft from across Federation space with the specific fuels and supply replenishments they require.

Shuttlebays Two and Three are located at the rear of the dorsal structure of the Battle Section. Shuttlebay Two, the smallest aboard the ship, is generally used for vessel outer hull maintenance using two shuttlepod spacecraft hangared there. Larger shuttlecraft generally enter through the larger spacedoors of Shuttlebays One or Three.

Shuttle approach and landing facilities are located overlooking the floors of all three shuttlebays, accessible via balcony platforms. Retractable tractor beam units controlled either from the landing control rooms or from free-standing consoles on the shuttlebay floor, aid in shuttle approach.

Galaxy Class vessels, designed primarily for extended deep-space exploration, have been equipped with a wide variety of diversionary options for off-duty crew members and their on-board families. Foremost among these are four main holographic environment simulation facilities, or holodecks, located on Deck 11 of the Saucer Module. Additional personal holographic simulators, much smaller in size, have been installed on Decks 12 and 33.

Using a combination of three-dimensional holographic imagery and

manipulated physicalities, the holodeck is capable of recreating any place, time and environment the user wishes. Real and fictional locations can be presented with equal ease, permitting a crew member to act out the role of any historical personality or fictitious character in suitable surroundings. Fabricated personalities, operated as high-tech marionettes via micro-precise forcebeams, interact through computer manipulation and appear to the holodeck user to be actual persons living within the context of the programmed holographic environment. Holodeck programs can be saved in the computer's memory, allowing crew members to re-enter favorite simulations without the need for repeated re-programming.

Gymnasiums, gamerooms, theaters, target simulation ranges and concert facilities are also provided for the use of those aboard ship. For simple gatherings and off-duty socializing, a favorite "watering hole" is the Ten-Forward lounge. Located as the name implies at the forward rim of the Saucer Module's Deck 10, this bar/restaurant provides its patrons with a spectacular row of full-length viewports which can be enjoyed from one's table seat. Synthelol and a wide variety of other beverages from across Federation space are readily available at the bar, as is a selection of small appetizers and light meals. □

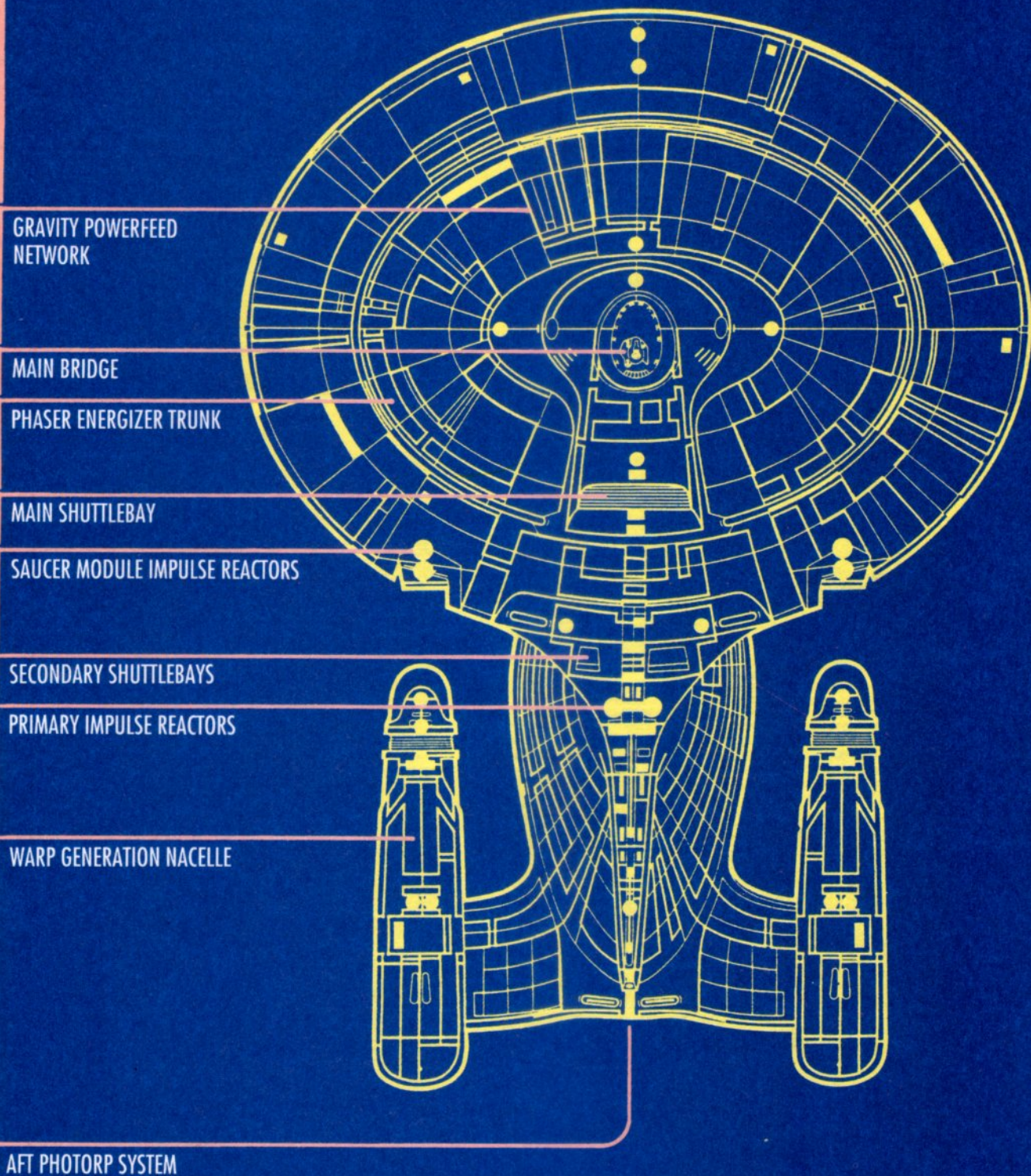

GALAXY CLASS 9350

SYSTEMS DIAGRAM

IMPULSE POWER SYSTEM
FUSION REACTORS
ACCELERATORS
DRIVE COILS
DEUTERIUM
VECTOR COILS



ENVIRONMENTAL SUPPORT
SYNTHETIC GRAV GENERATION
INERTIAL DAMPENING (PRIMARY)
INERTIAL DAMPENING (SECONDARY)
ATMOSPHERIC PROCESSING
THERMAL MANAGEMENT
FRESH WATER RECYCLING

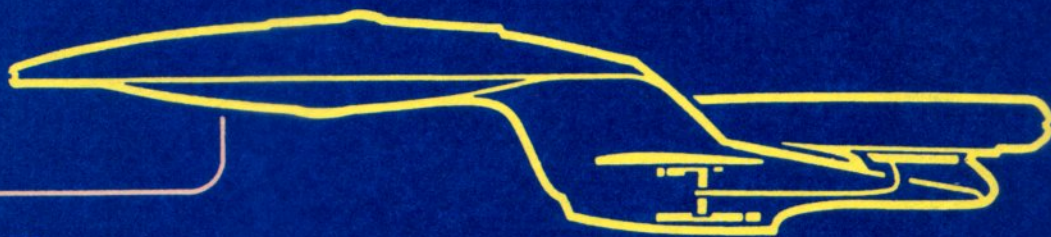
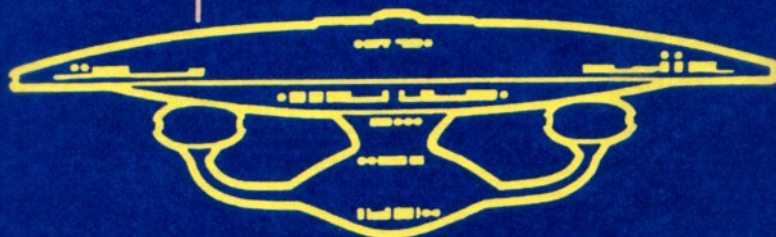

WARP DRIVE SYSTEMS
MATTER/ANTIMATTER REACTOR
DILITHIUM CHAMBER
POWER TRANSFER TUNNELS
DEUTRONIUM CONTAINMENT
ANTI-PROTON GENERATION

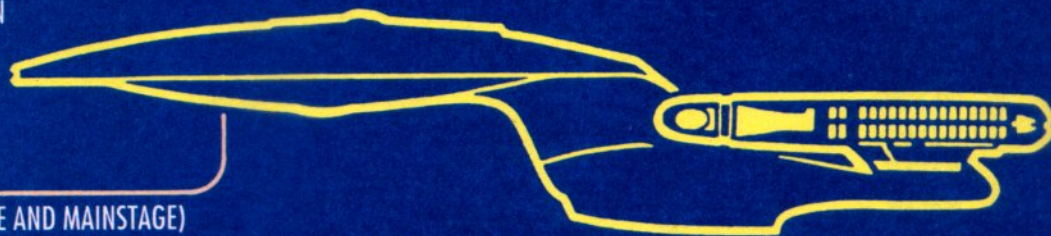

FLUX CHILLERS (PRESTAGE AND MAINSTAGE)
PLASMA INJECTORS
WARP COILS (PRIMARY)
INTERCOOLERS
WARP COILS (SECONDARY)
BUSSARD COLLECTOR
SUBSPACE FIELD COMPENSATION



AUXILIARY POWER DISTRIB NET
(SECONDARY HULL)
AUX POWER GENERATION
RESERVE POWER GENERATION
RESERVE BATTERY BANKS (MAIN)
RESERVE BATTERY BANKS
(EMERGENCY)
WARP DRIVE SYSTEM TIE-IN
IMPULSE SYSTEMS TIE-IN (PORT)
IMPULSE SYSTEMS TIE-IN (STBD)
RESERVE BATTERY BANKS
(WEAPONS SYSTEMS)

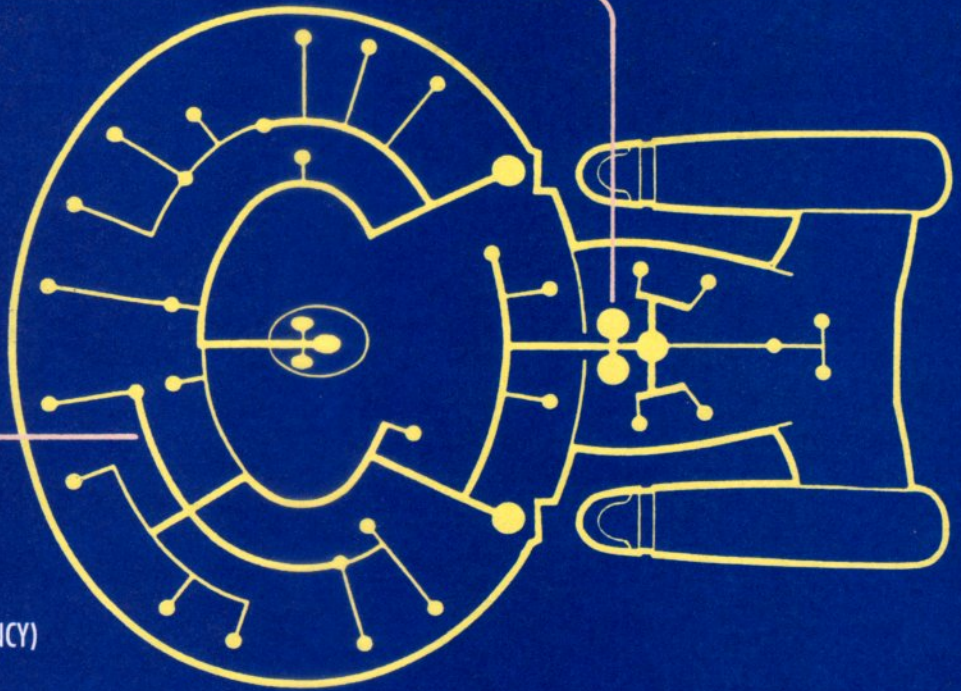

AUXILIARY POWER DISTRIB NET
(PRIMARY HULL)
AUX POWER GENERATION
RESERVE POWER GENERATION
RESERVE BATTERY BANKS (MAIN)
RESERVE BATTERY BANKS (EMERGENCY)
IMPULSE SYSTEMS TIE-IN (PORT)
IMPULSE SYSTEMS TIE-IN (STBD)
RESERVE BATTERY BANKS
(ENVIRONMENTAL)

CARGO/SHUTTLE FACILITIES (SECONDARY)
LANDING BAY SYSTEMS
SHUTTLE TRAFFIC CONTROL
SHUTTLE HANGAR BAY
CARGO BAYS
CARGO TRANSPORTER
MAINTENANCE BAYS

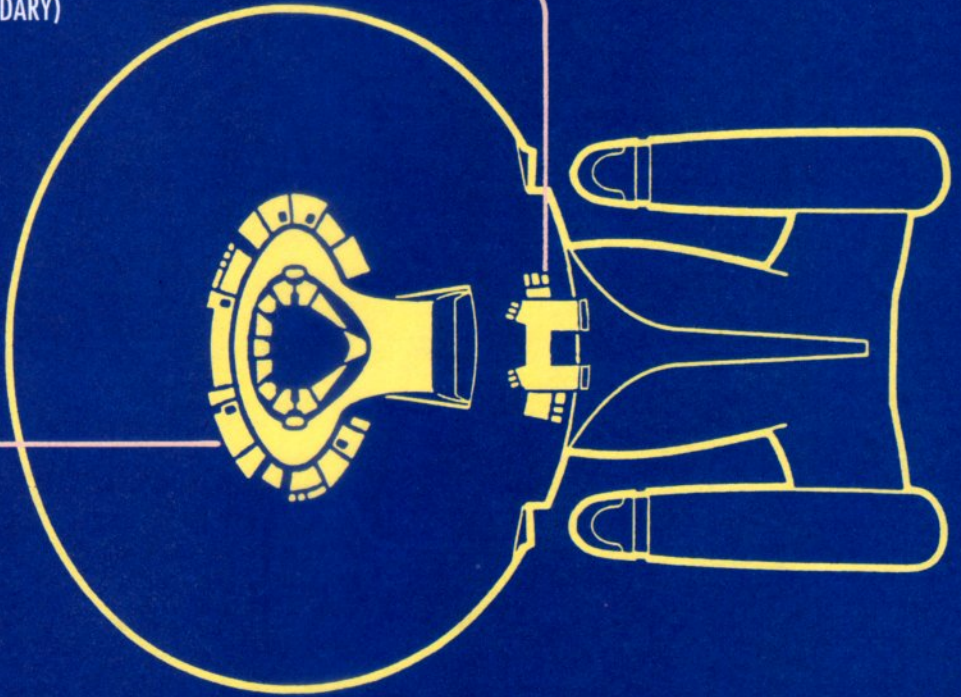

CARGO/SHUTTLE FACILITIES
(PRIMARY)
LANDING BAY SYSTEMS
SHUTTLE TRAFFIC CONTROL
SHUTTLE HANGAR BAYS
CARGO BAYS
CARGO TRANSPORTERS
MAINTENANCE BAYS



STARFLEET DATA 7371

PHASER I

BEAM WIDTH ADJUST

ACCESS PLATE

TRIGGER

BEAM INTENSITY ADJUST

POWER LEVEL INDICATOR

SARIUM KRELLIDE POWER CELL

PRE-FIRE RINGLIGHT

BEAM EMITTER

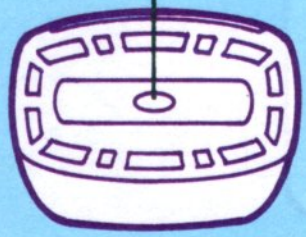
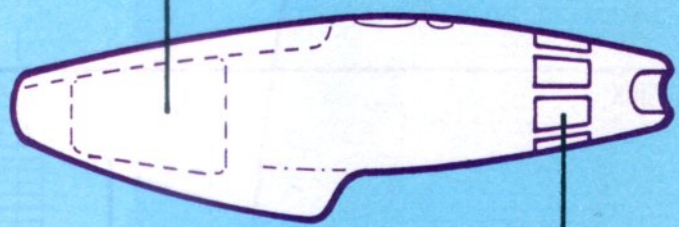
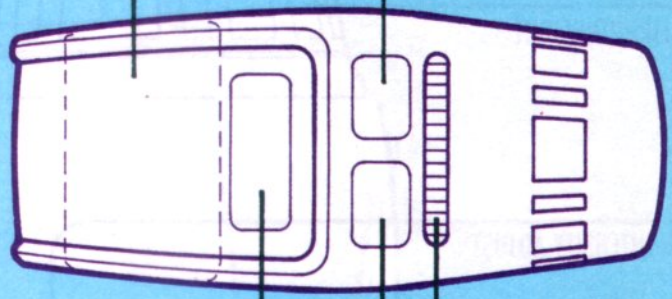

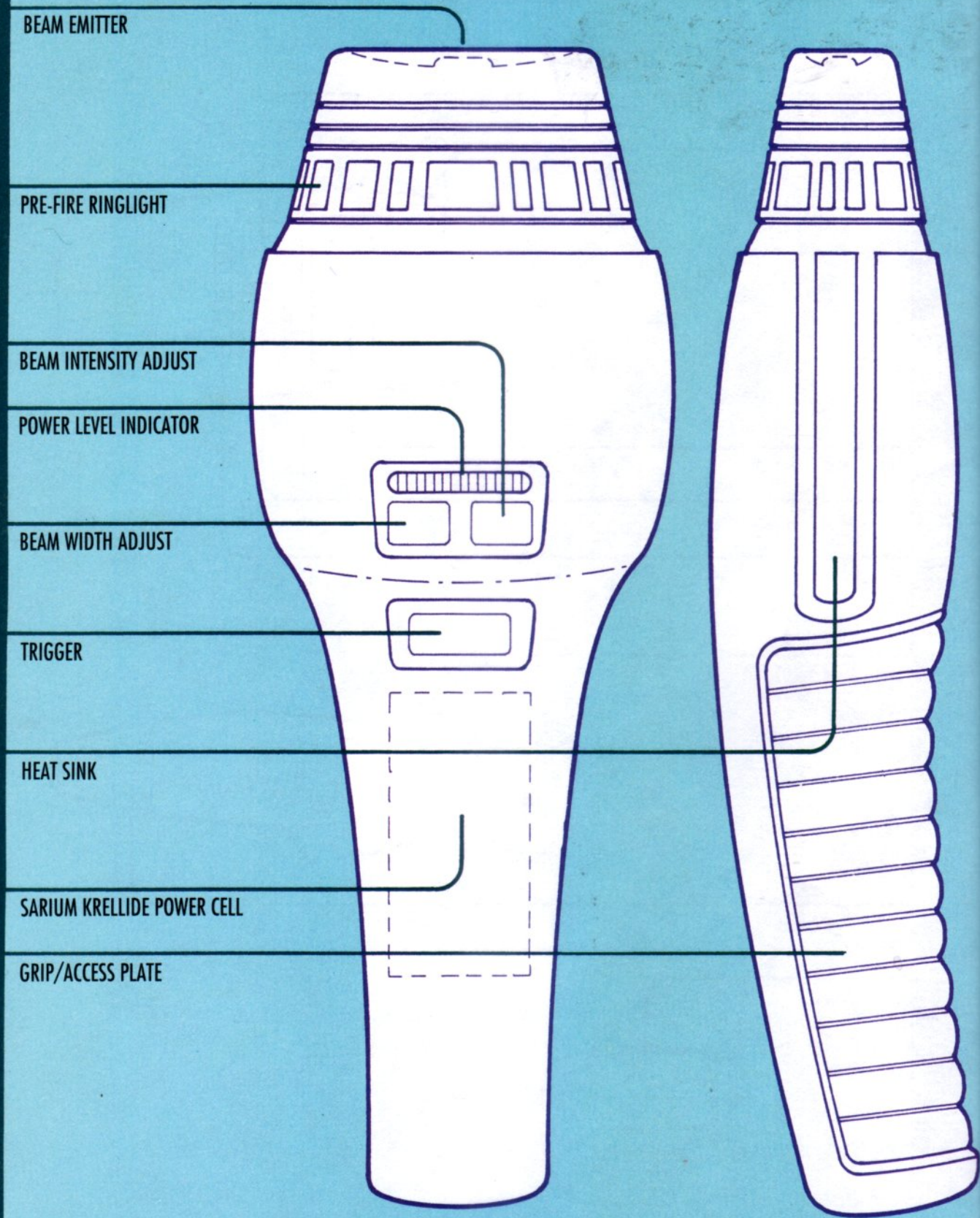

BEAM EMITTER

ACCESS PLATES

POWER LEVEL INDICATOR

BEAM INTENSITY

BEAM WIDTH

TRIGGER

POWER PACK/GRIP

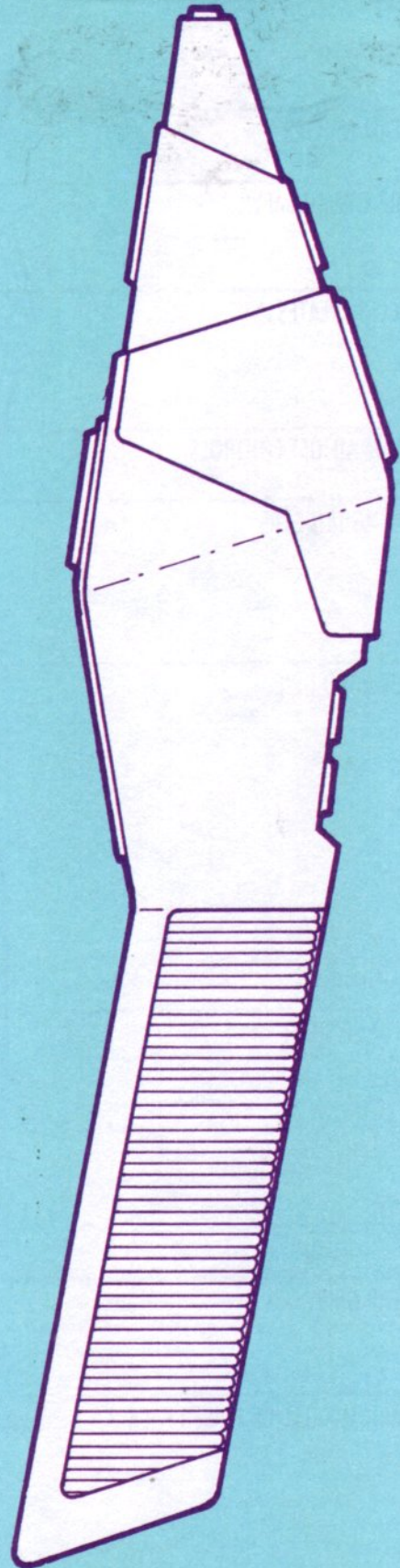
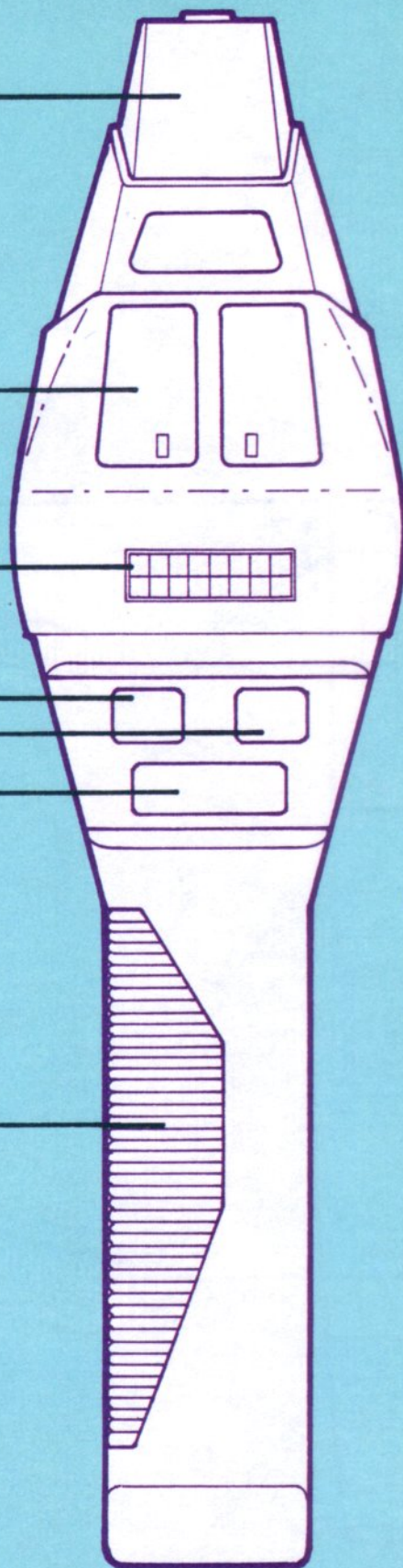

BEAM EMITTER

PRE-FIRE CHAMBER

ACCESS PLATES

BEAM ADJUST CONTROLS

FIRING TRIGGERS

FORWARD GRIP

FLIP-UP SIGHT

REAR GRIP

SARIUM KRELLIDE POWER PACK

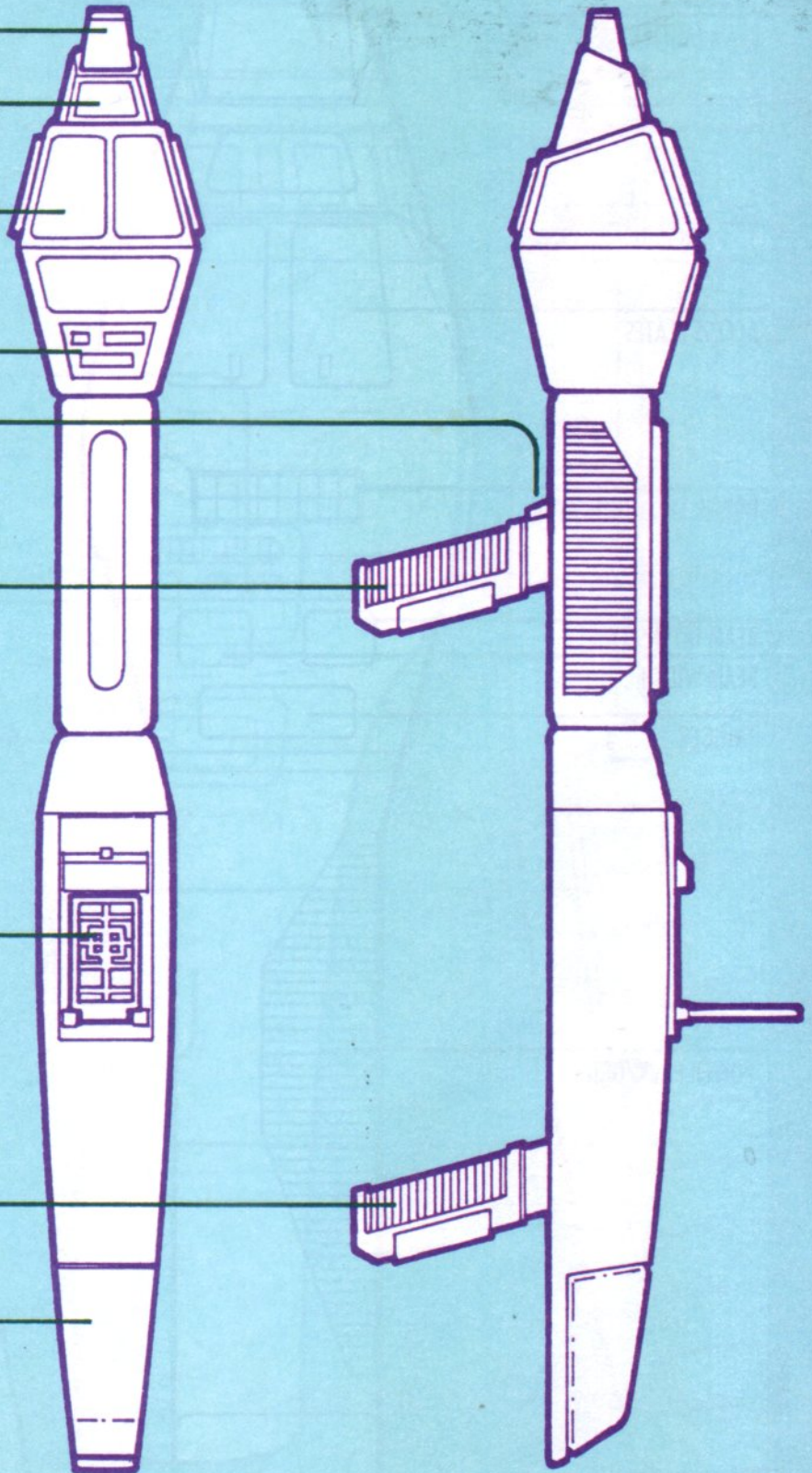

THE BORG

Bearing a fleeting societal resemblance only to the Bynars of the Federation, the Borg have risen overnight to become perhaps the greatest single threat not only to the Federation, but to every galactic culture.

Possessing a hive computer mind, the Borg is a race of mechanically-enhanced cybernetic beings that act and think as one. Perhaps millions in number, they exist only to absorb the technologies of those unfortunate civilizations they come into contact with. Emotion and personal considerations mean nothing to the relentless Borg, who will pursue their goals of conquest until they achieve them—or are destroyed trying.

Individual Borg drones begin life as normal humanoid infants, but are quickly “adapted” to their assigned life-long duties by the implantation of bionic components. This addition of technological parts continues until adulthood, when the individual is finally ready to be placed into its assigned place in the whole. Theory

suggests that the Borg may have developed a method for accelerating the humanoid growth process, perhaps taking each Borg drone unit from infancy to adulthood in mere months. Their vessels, of a design dictated purely by function with no consideration for aesthetics, are immense cube-shaped structures capable of incredible firepower and speeds greater than can be accounted for by any stretch of conventional Federation scientific imagination.

The Borg appear to be centered in an area of space beyond the far side of the Romulan Empire. An intervention into Starfleet procedures by the “Q” has made the Borg aware of the Federation’s existence long before such an encounter would have occurred naturally, opening the constant threat that further Borg intrusions into Federation space may occur.

The Federation possesses a level of technology irresistibly attractive to the Borg—a technology they must absorb at any cost. □

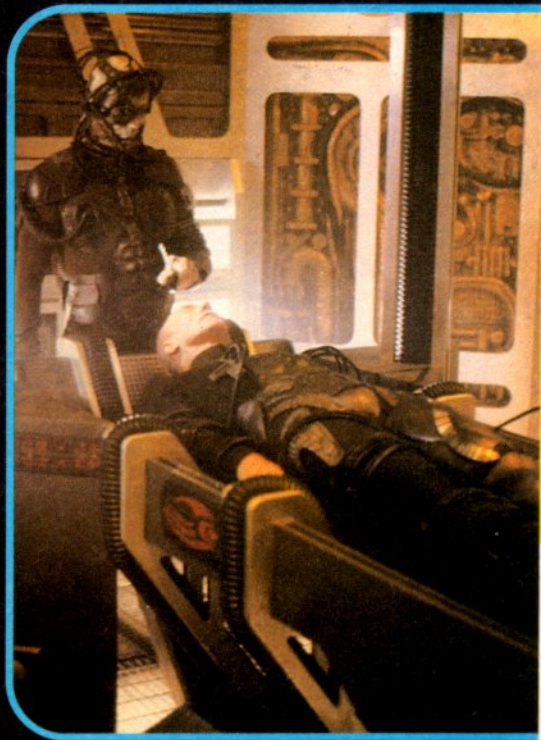

THE ROMULANS

First encountered by Starfleet vessels in a battle that took place almost two centuries ago, the Romulans are an aggressive, cunning, territorial people who wish only to expand their share of space by whatever means is necessary. That first encounter was ended purely by primitive subspace radio treaty, and it was not until decades later, following another confrontational incident, that the physical nature of the Romulan race was made known to Federation science. Shortly thereafter, it was concluded that the Romulan homeworld circled a star listed in Federation catalogues as Romulus, the larger of the Romulus/Remus stellar pair.

The Romulan Empire has grown through interstellar conquest. Member worlds are ruled with an iron fist, their own governments supplanted by newly-installed Romulan ruling parties. While the Romulans are emotional beings, they are strangely devoid of all compassion for those whom they subjugate.

Facial appearance strongly suggested an ancestral link to the Vulcan

race, and further historical and genetic research proved that the Vulcans and Romulans had indeed been one people at a point in Vulcan’s turbulent past. The Romulan people are descended from a rebel Vulcan colony group which broke away from its homeworld ties before the Vulcan race turned away from violence and warfare toward its present racial philosophy of logic and peace. Current Starfleet intelligence indicates that a growing movement within the Romulan society may be planting the seed that will one day result in a Romulan return to the Vulcan heritage they share.

The Romulan people pride themselves on their intellect, however warlike, and this fact contributed greatly to the dissolution of their alliance with the Klingons, whom they considered too barbaric to be fully trusted. The Romulans are increasingly uncomfortable with the current Federation/Klingon alliance and wish to see it dissolved, fearing the combined military power of both entities. Several attempts have already been made by Romulan

military intelligence to undermine the peaceful co-existence of the two superpowers, but all have proven unsuccessful.

Romulan starship technology now equals that of the Federation, despite a slow start. Sensor scans of the Romulan Neutral Zone have recently shown a dramatic increase in the number of Romulan starship patrols on their side of the Zone, suggesting that they may feel that a Federation invasion is a possibility. Their newest Warbird design is impressive in its size and power and has become the mainstay of their space forces.

Larger than Starfleet’s Galaxy Class and equipped with an improved cloaking system, the Warbird is the single greatest vessel threat to Federation security. While this massive ship employs full disruptors rather than ship-mounted phaser banks, these weapons are equally destructive due to a modification in their resonant frequency amplification process. The vessel is also, of course, equipped with multiple photon torpedo launch units—the photon torpedo was a Romulan innovation. □

RANK/CEREMONIAL SASH

INSULATED TUNIC

WAIST BELT

DUTY TROUSERS

HEAVY BOOTS

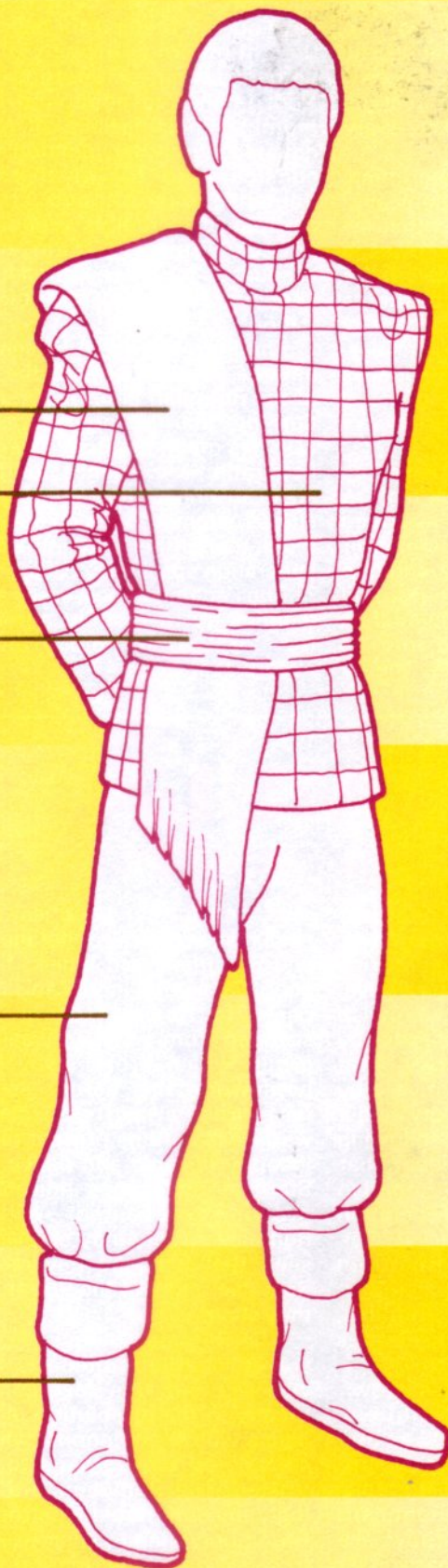

MAIN BRIDGE

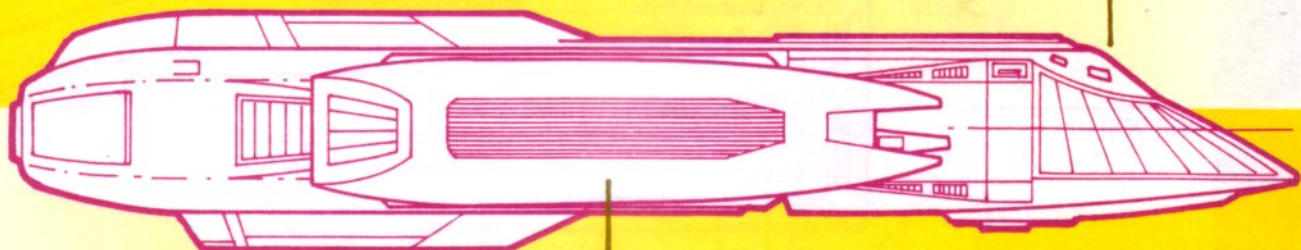

WARP NACELLE

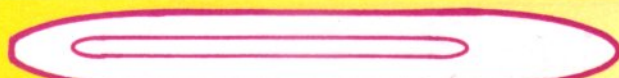

DEFLECTOR PLATING

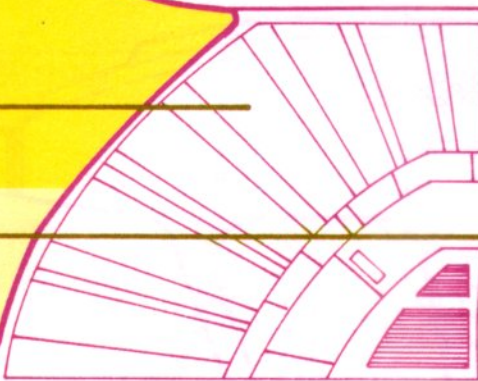

VIEWPORTS



THRUSTERS

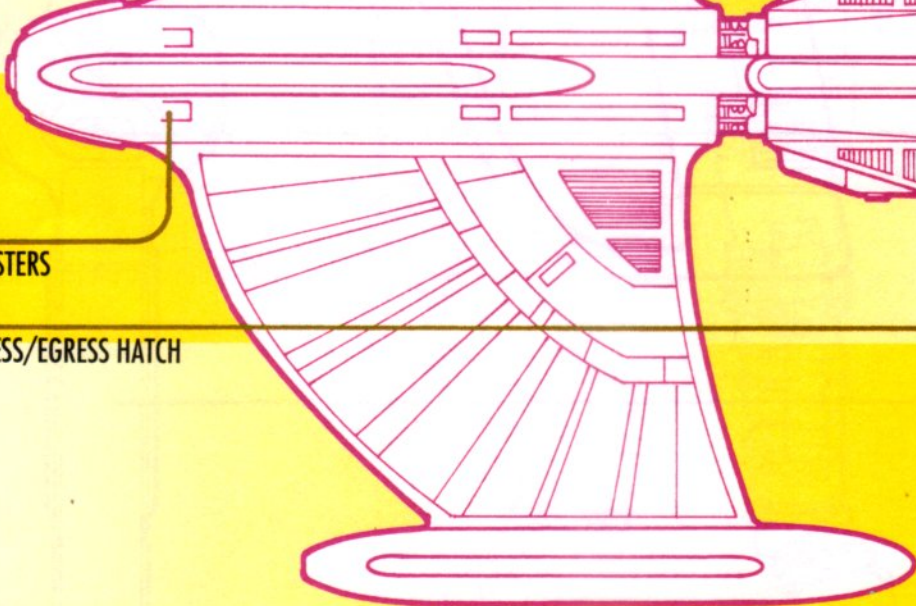

INGRESS/EGRESS HATCH



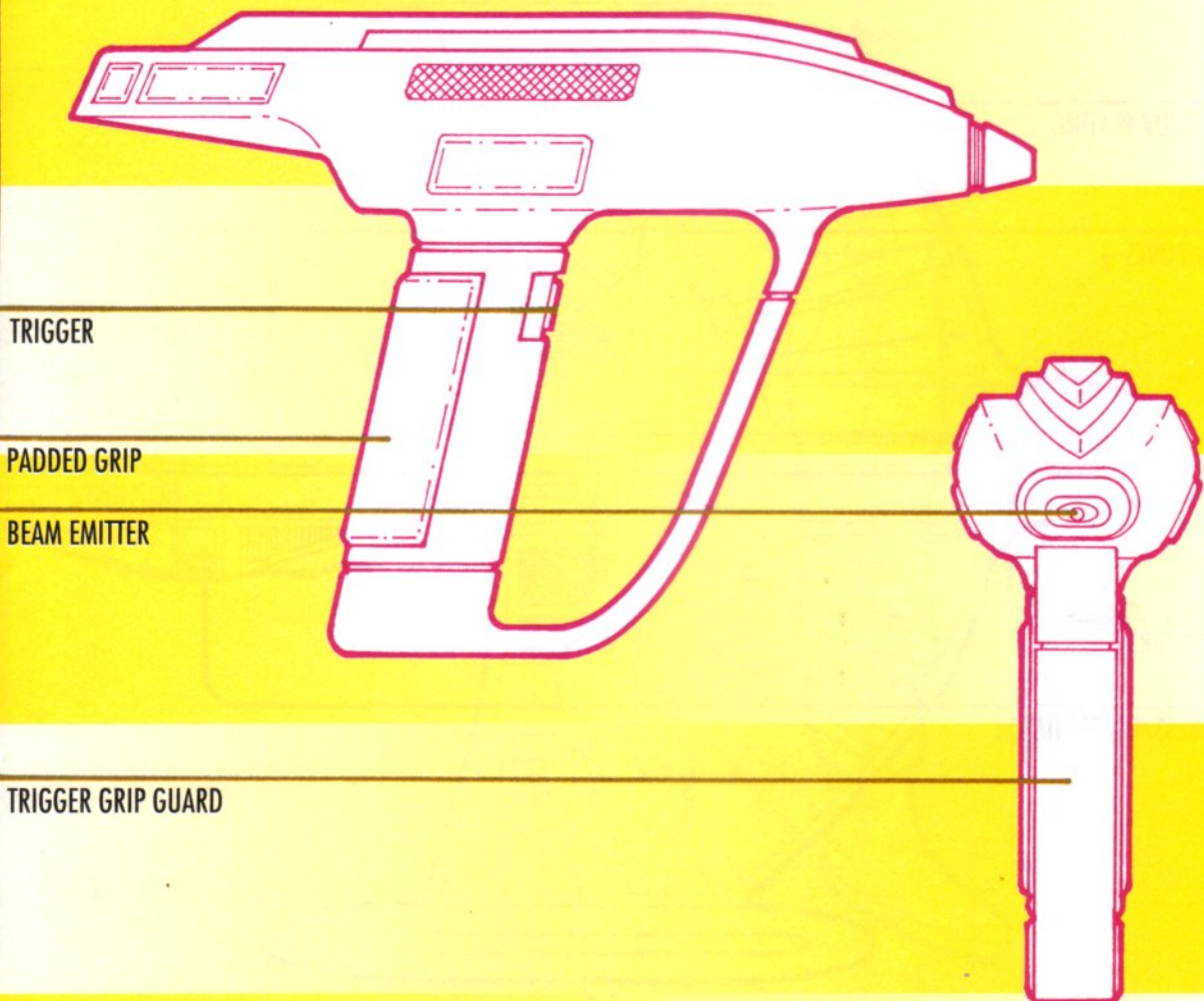
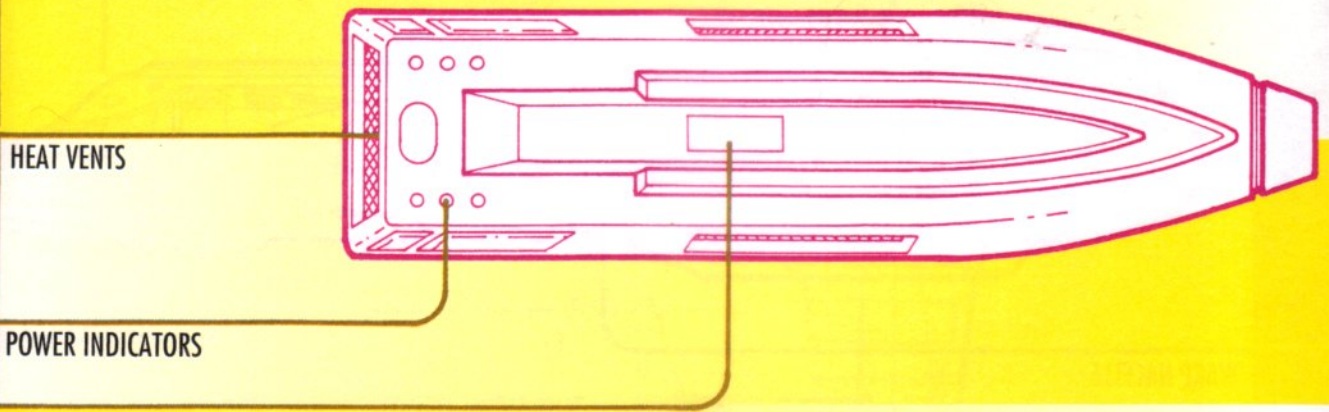

AUDIO/VISUAL ENHANCEMENT ARRAY

SHIELD GENERATOR COILS

MUSCULAR ENHANCEMENT SYSTEM

POWER DISTRIBUTION LOGIC SYSTEM

ARM UTILITY MODULE

SPECIALIZED MANIPULATION ARRAY

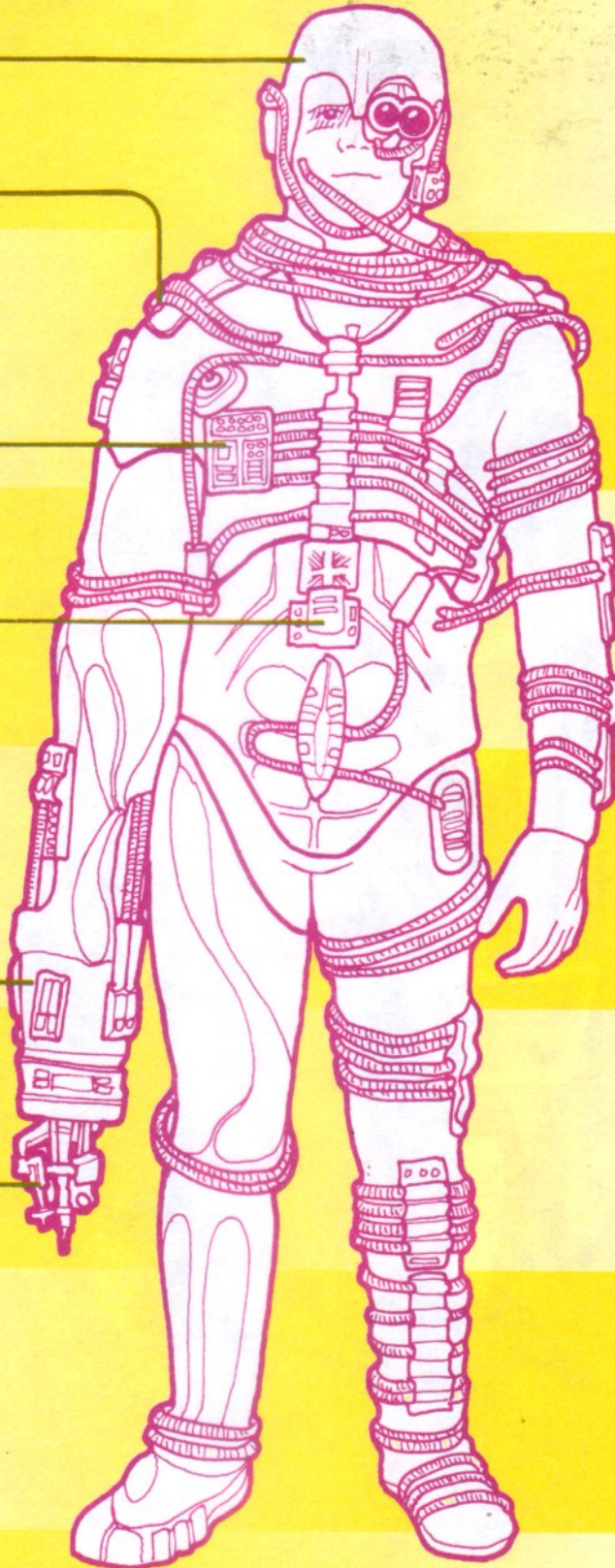

THE KLINGONS

Captain Kargan
of the Klingon
vessel *Parh*.



Once the Federation's most formidable enemy in space, the Klingon Empire has proven time and again to be a valuable ally. While thinly-spread bands of militant Klingon zealots still resist the alliance, the central

government of the Empire has stood shoulder-to-shoulder with that of the Federation through many interstellar crises and has repeatedly offered aid to Starfleet vessels engaged in potentially hazardous missions.

The Klingon/Romulan alliance,

which was dissolved more than five decades ago, led to great scientific advances for both cultures. The Romulans gained several Klingon D-7 battle cruisers, from which they acquired warp-drive technology, in exchange for which they shared secrets of their cloaking systems. One of the most common Klingon spacecraft in use today, the familiar Bird of Prey attack cruiser, is perhaps the most concrete reminder of this past alliance.

Honor and ritual tradition play an important part in Klingon culture. Family heritage sets the pattern for generations to follow, giving Klingon bloodlines great continuity in the establishment of both private and governmental leadership structure. Rites of passage and tests of warrior skill are revered signposts of Klingon maturity, often involving to-the-death combat with primitive blade and blunt weaponry. While their technological level has long since evolved toward more efficient weapon and combat systems, most Klingon 'disagreements' are still settled using the ancient hand-to-hand methods of their ancestors.

For those occasions when long-distance or wide-damage weaponry is more suitable to the task at hand, Klingon science has provided a variety of high-efficiency disruptor units. These devices, generally pistol-like in form, lack the disintegration capability of phasers but produce a higher destructive effect per reserve energy unit used. Larger ship-mounted versions of these disruptors are the primary weapons of the Klingon fleet, but are attuned specifically to be effective against enemy vessel shields and hulls. Also available to Klingon vessels are variations upon the photon torpedo, but these are based not upon Federation science but upon those units acquired during the brief Klingon/Romulan alliance.

Physically, the Imperial Klingon race is as imposing as it is aggressive. Both males and females have a greater muscle mass ratio than do most humanoid forms. They also generally grow taller and reach full adult height at an earlier age than Terran humans. Perhaps the single most striking feature of Klingon anatomy is the ridged forehead crown evident in genetically pure individuals, a characteristic missing in the few Klingon/human genetic fusions still serving in some parts of the Empire. Each cranial structure, much like the human fingerprint, is unique. □

RANK EMBLEM

SHOULDER ARMOR

INSULATED UNDERSUIT

UTILITY BELT

WRIST ARMOR

HOLSTERED WEAPON

HEAVY BOOTS

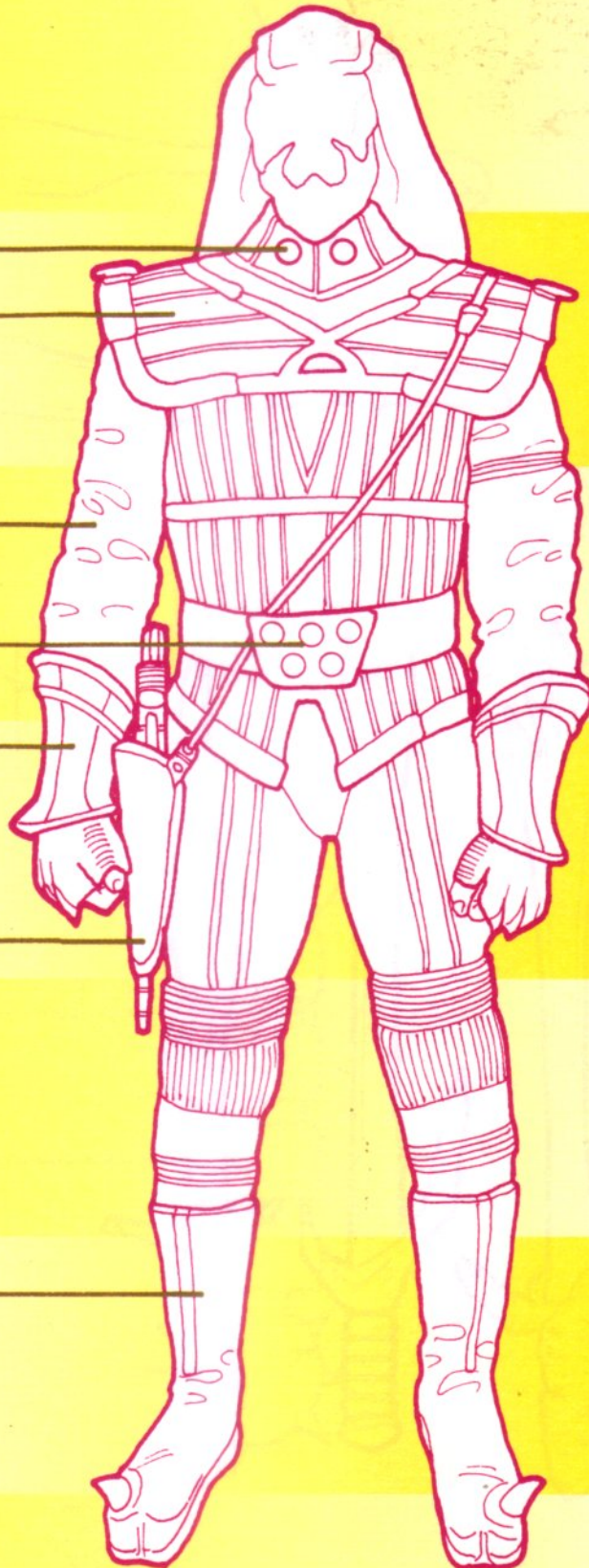

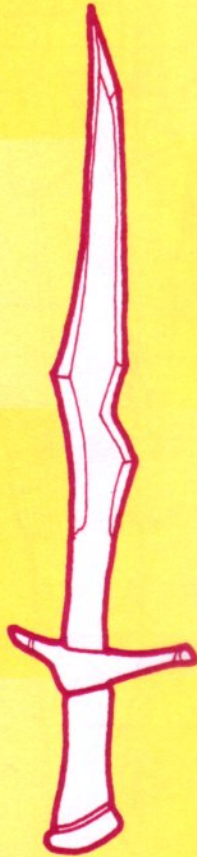
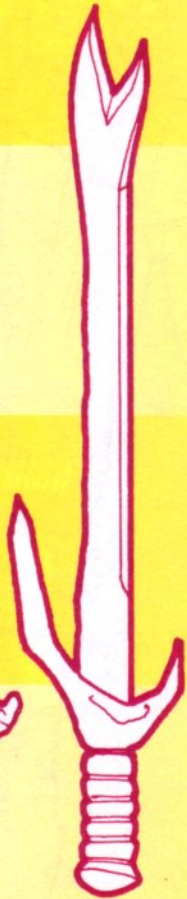

TEMPERED DYRILLIUM BLADE

RETRACTABLE BLADES

BLADE MECHANISM HOUSING

BLADE TRIGGER SWITCH

HANDLE GRIP

MACE HEAD

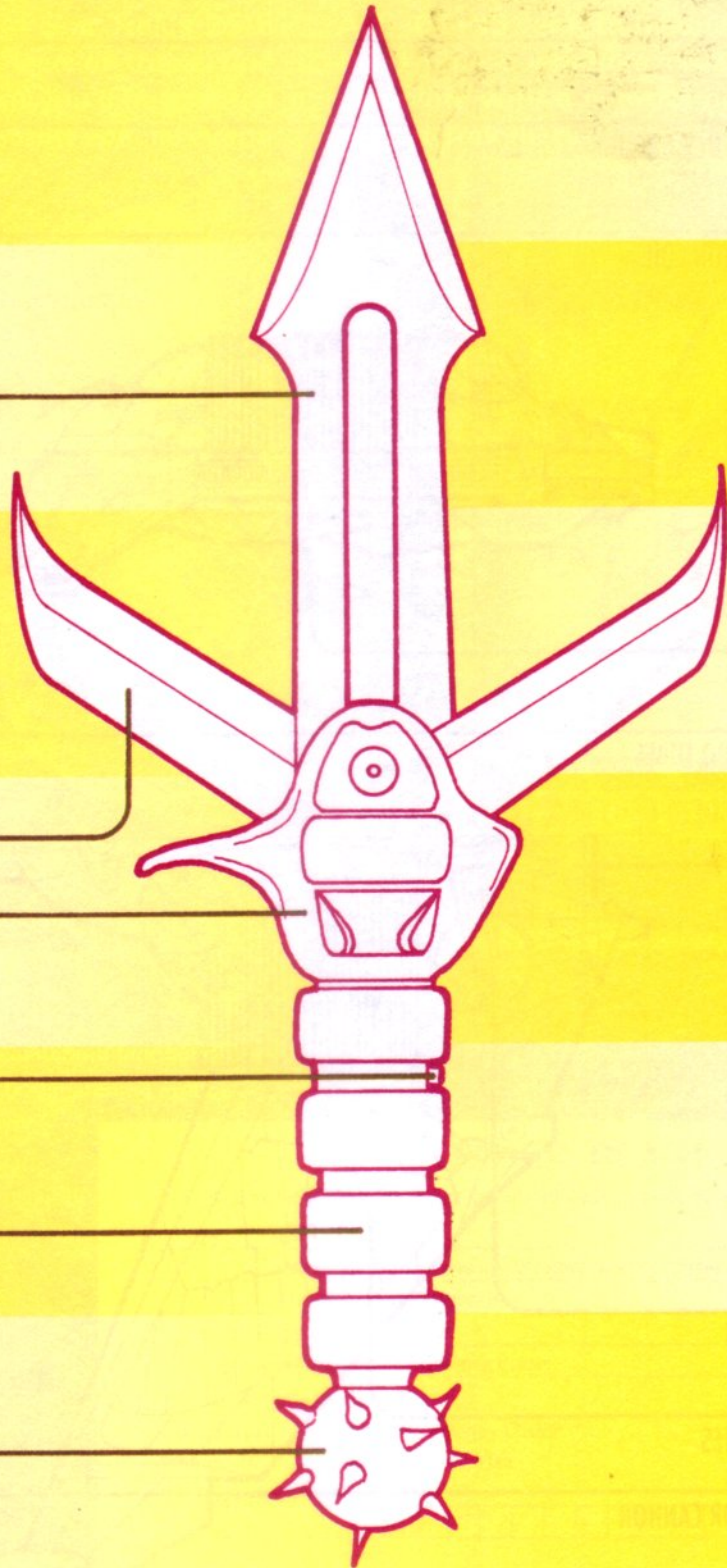

MAIN BRIDGE

BRIDGE EMERGENCY HATCH

CLOAK GENERATOR COIL

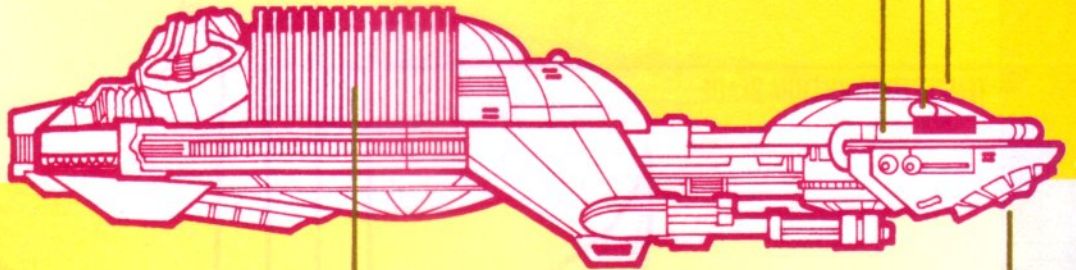

WING BAFFLES

PHOTON TORPEDO TUBES

DRIVE SYSTEM

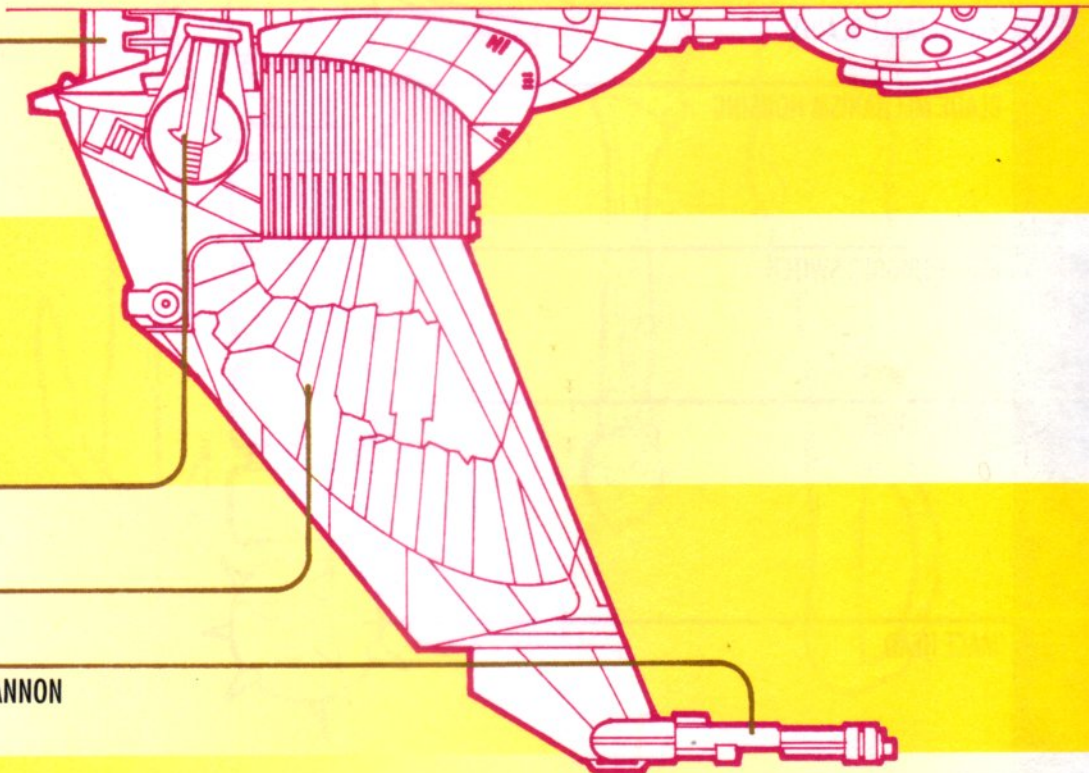

MAIN REACTORS

DEFLECTOR PLATES

WING DISRUPTOR CANNON



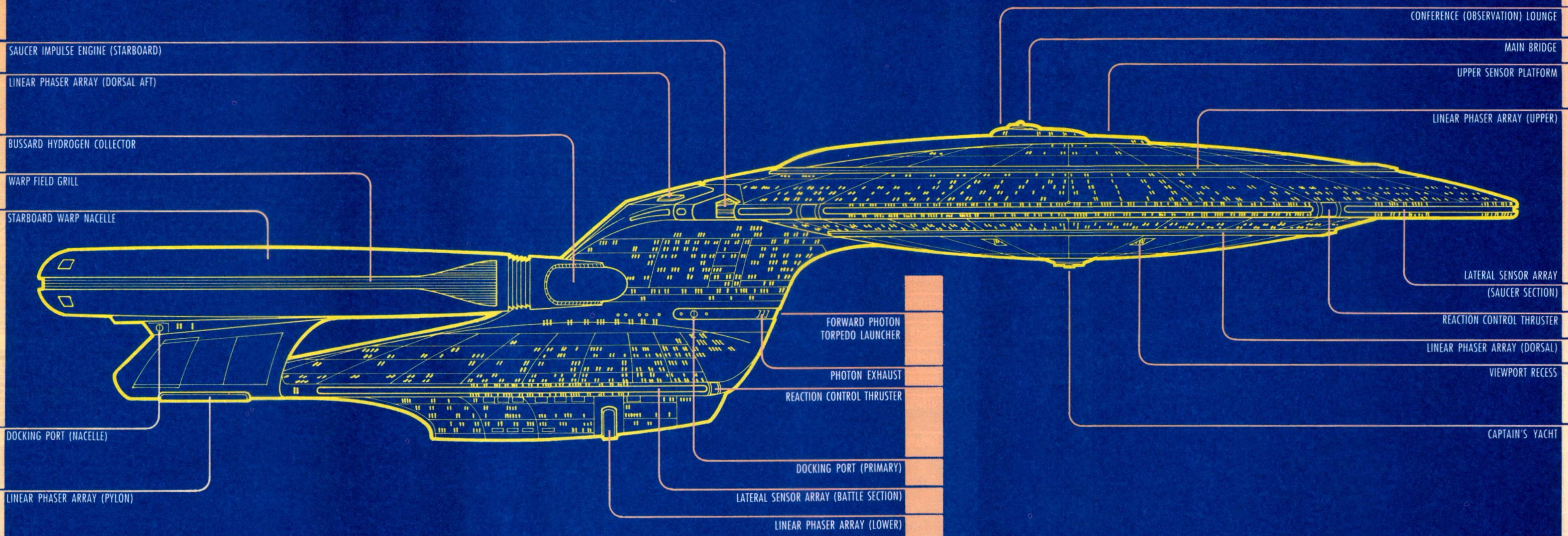

STARBOARD PROFILE

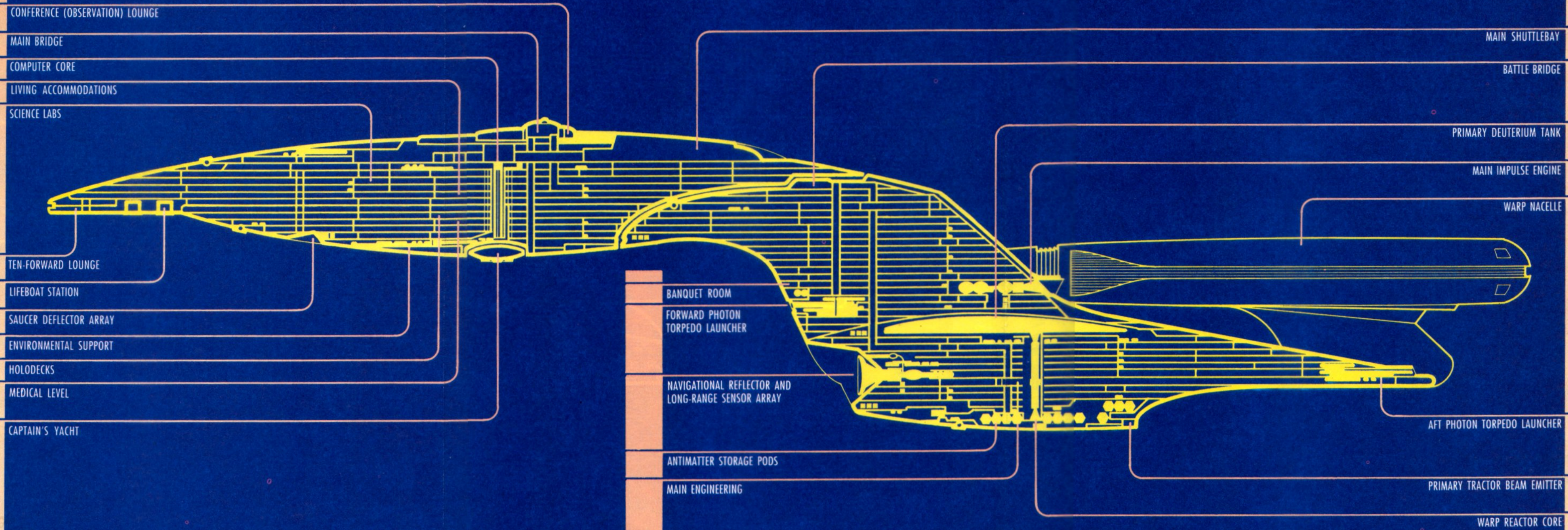

SIMPLIFIED CROSS-SECTION

