

STAR FLEET

UNIFORM RECOGNITION

MANUAL

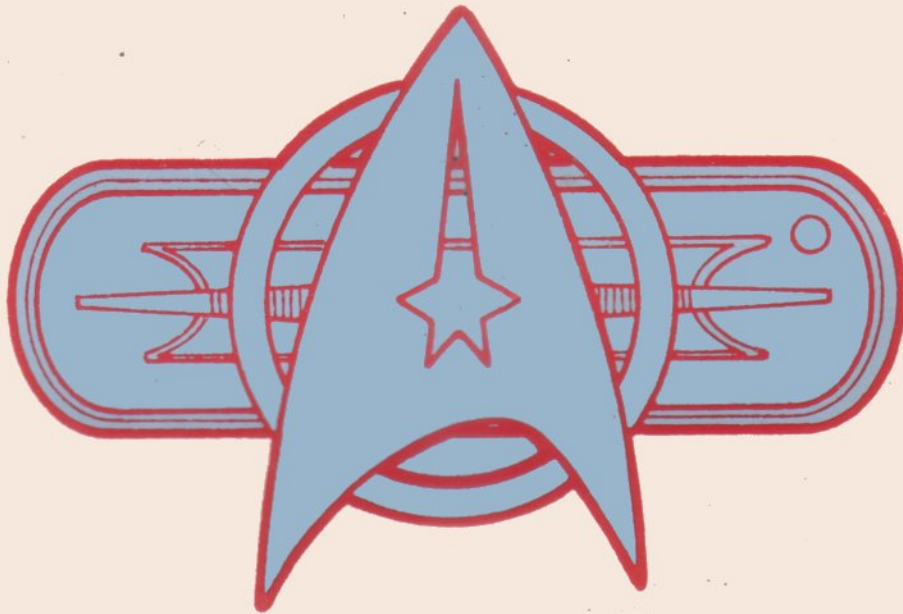

THE NORON GROUP

- FIRST BOOK OF ITS KIND EVER PUBLISHED!
- EIGHTY PAGES OF ACCURATE, DETAILED PLANS FROM THE BEST OF SF FILM AND TV
- PERFECT FOR COSTUMERS

LAYOUT AND ILLUSTRATIONS BY
SHANE JOHNSON

\$11.95

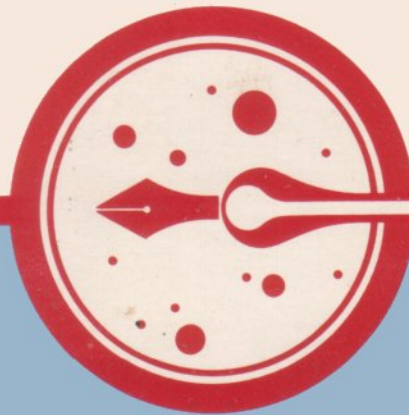

STAR FLEET UNIFORM RECOGNITION MANUAL

THE NORON GROUP

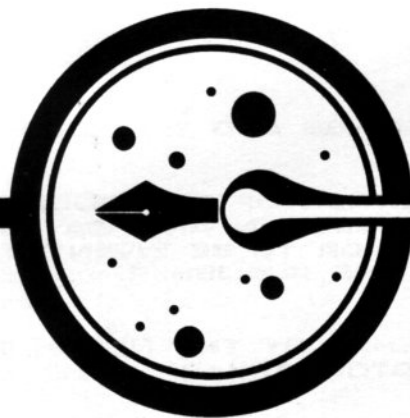

**LAYOUT AND ILLUSTRATIONS BY
SHANE JOHNSON**

**RESEARCHED AND COMPILED BY
SHANE JOHNSON
AND KATHY JOHNSON**

ADDITIONAL MATERIAL

**STEVE McCLELLAN
SHAUN JOHNSON**

SPECIAL ACKNOWLEDGEMENTS

MIKE KOTT

BOB BURNS

BARRY SMITH

BOB KLEM

MARK ELROD

KYLE CAREW

JAMES CHAMBERS

ALAN BECKNER

DAVID MERRIMAN

TRACY

RET MARTIN

GEORGE HALVORSON

LARRY AESCHLIMANN DAVID HOLT

SPECIAL THANKS TO WALTER KOENIG

RENDERINGS AND TEXT COPYRIGHT © 1985 THE NORON GROUP

**NO PORTION OF THIS BOOK, IN WHOLE OR IN PART, MAY BE
REPRODUCED IN ANY WAY OR BY ANY COPYING DEVICE NOW
KNOWN OR TO BE INVENTED, WITHOUT WRITTEN PERMISSION
FROM THE PUBLISHER.**

**PUBLISHED BY THE NORON GROUP, P.O. BOX 13332,
ARLINGTON, TEXAS 76013**

**SECOND PRINTING: JANUARY 1986
PRINTED IN U.S.A. BY T-M GRAPHICS**

**THIS BOOK IS DEDICATED TO MY SON
DANIEL CHRISTIAN JOHNSON**

TABLE OF CONTENTS

FEDERATION COLOR CODES 7

INSIGNIA AND RANK 9

UNIFORM INSIGNIA [OBSOLETE]

RANK STRIPES [OBSOLETE]

HISTORICAL DATA

INSIGNIA PINS

RANK PINS

SERVICE BARS

BELT BUCKLES

SHOULDER PATCH

SHOULDER STRAP

UNIFORMS [OBSOLETE] 25

DUTY UNIFORM [MALE]

DUTY UNIFORM [FEMALE]

**COMMAND WRAPAROUND TYPE 1
TYPE 2**

MEDICAL TUNIC

DRESS UNIFORM [MALE]

DRESS UNIFORM [FEMALE]

ANTI-EXPOSURE SUIT

ENVIRONMENTAL SUIT

(CONT'D)

UNIFORMS [CURRENT]

45

HISTORICAL DATA

DUTY TUNIC W/PANTS [UNISEX]

DUTY TUNIC W/SKIRT [FEMALE]

FIELD VEST

FIELD JACKET

OFF-DUTY JACKET

DIPLOMATIC DRESS UNIFORM

CHIEF MEDICAL OFFICER'S DUTYSUIT

CADET JUMPSUIT

RADSUIT

INTELLIGENCE REPORT

67

HISTORICAL DATA [KLINGON]

KLINGON WARLORD

KLINGON/HUMAN FUSION

SPACESUIT [S.S. BOTANY BAY]

FEDERATION COLOR CODES

STAR FLEET SPECIFICATION

01 SILVER	21 VIOLET
02 ANTIMONY	22 CORN
03 GOLD	23 TAN
04 BRONZE	24 BROWN
05 COPPER	25 NUDE
06 WHITE	26 PURPLE
07 IVORY	27 OXIDE
08 SAND	28 TAUPE
09 BLOOD	29 PLATINUM
10 RED	30 GRAY
11 ORANGE	31 BLUEGRAY
12 YELLOW	32 BLACK
13 TENNE	33 SILVER BLUE
14 OLIVE	34 GRAY-GREEN
15 GREEN	35 SALMON
16 SKY BLUE	36 BUFF
17 ULTRAMARINE	37 PEARL
18 BLUE	38 MAHOGANY
19 INDIGO	39 NAVY
20 MIDNIGHT	40 BURGUNDY

KEY TO SYMBOLS USED IN THIS BOOK

① NUMBER IN CIRCLE REPRESENTS ITEM COLOR

ⓓ INDICATES ITEM IS DEPARTMENT COLOR

DEPARTMENT COLORS

UNIFORMS [OBSOLETE]

14 COMMAND
18 SCIENCES
10 SERVICES (ENGINEERING, SECURITY, OTHER)

UNIFORMS [CURRENT]

06 COMMAND
16 SCIENCES
03 SERVICES (ENGINEERING, SECURITY, OTHER)
14 MEDICAL
30 OPERATIONS
10 CADET

STAR FLEET

INSIGNIA AND RANK



UNIFORM INSIGNIA

(BECAME OBSOLETE - 1800 HOURS, 15 APR 2212)

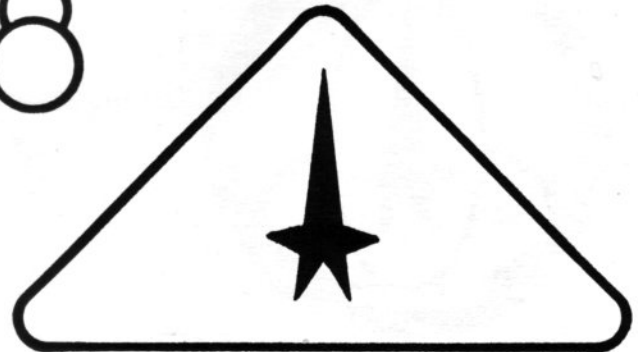
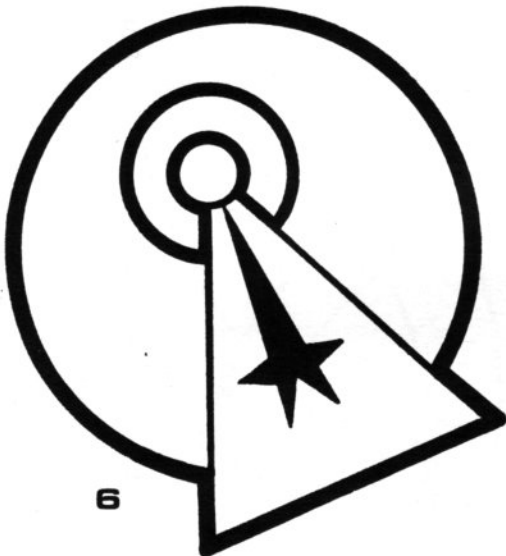
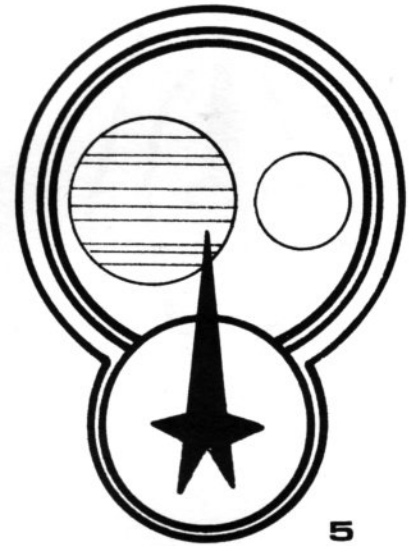
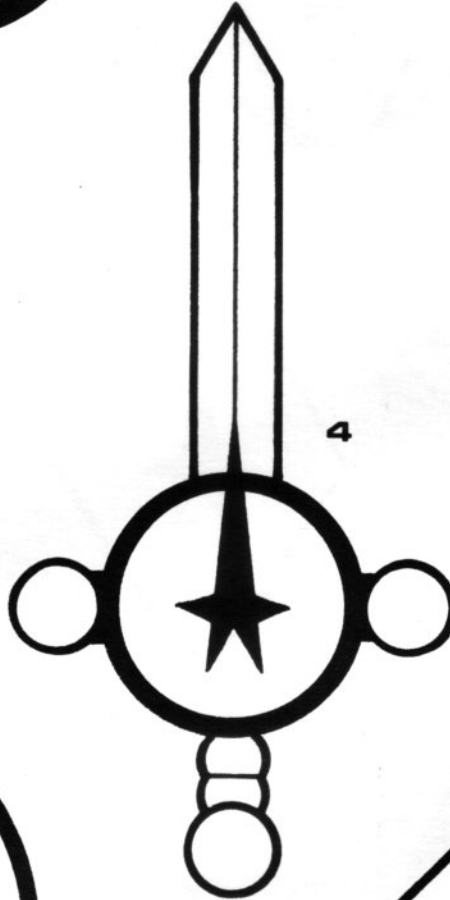
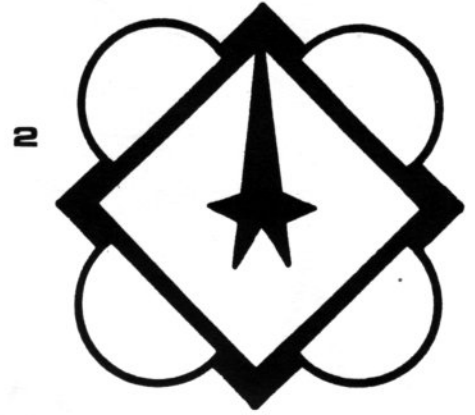
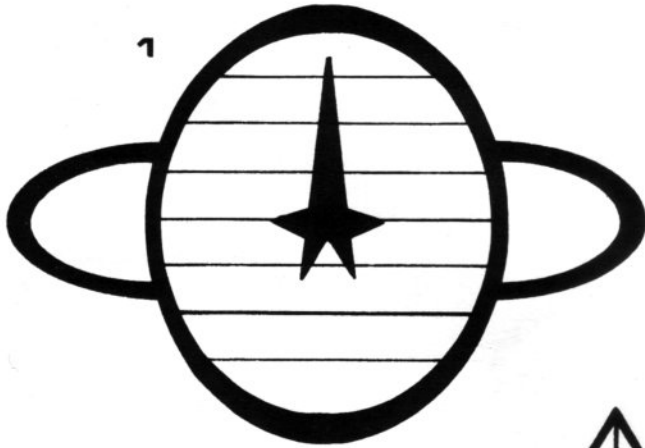

KEY ON PAGE 13

UNIFORM INSIGNIA

(BECAME OBSOLETE - 1800 HOURS, 15 APR 2212)

DEPARTMENT EMBLEMS



A



B



C



D



E



F

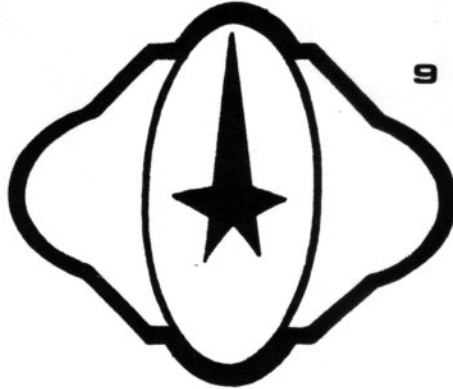

9



8

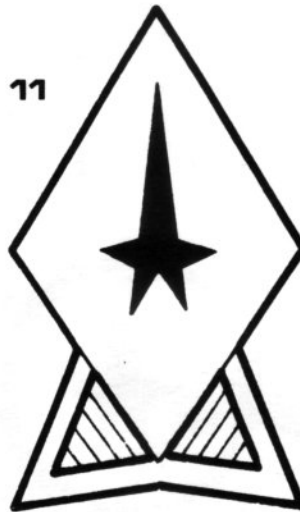

11

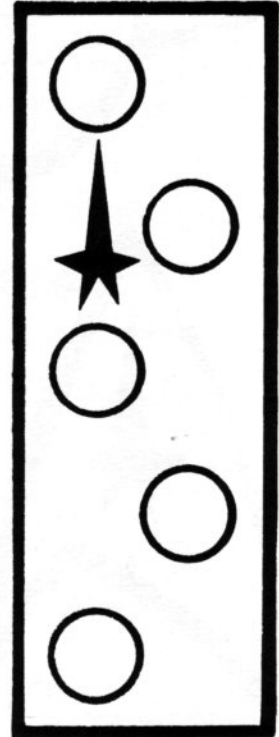

10



12

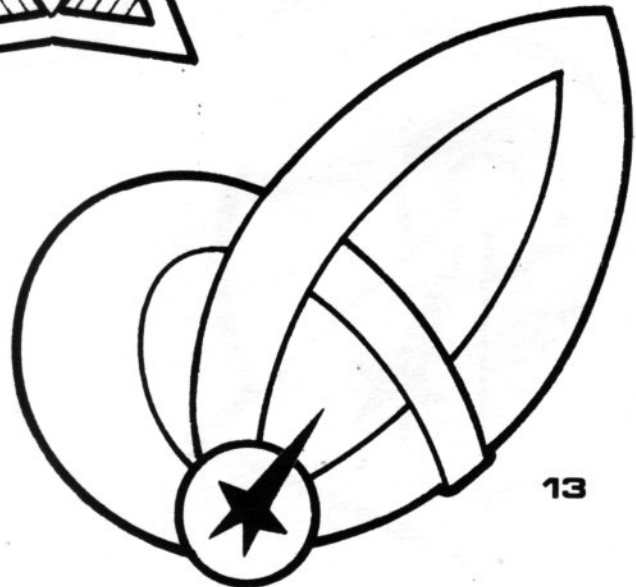

13

KEY ON PAGE 13

UNIFORM INSIGNIA

(BECAME OBSOLETE - 1800 HOURS, 15 APR 2212)

14

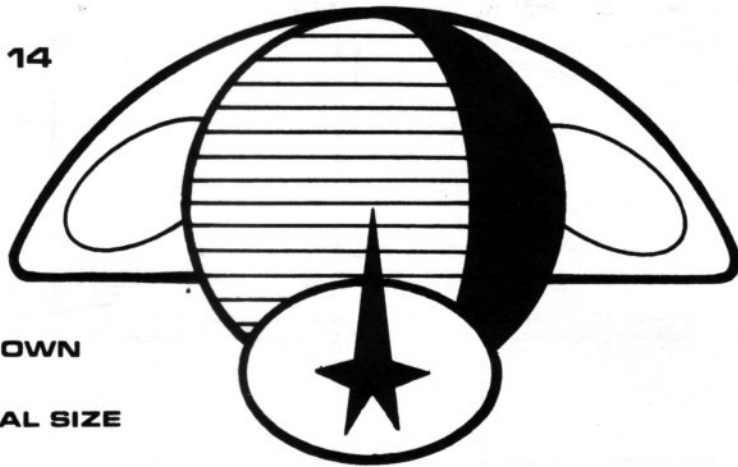

COMMAND EMBLEM SHOWN
ON ALL INSIGNIA

INSIGNIA SHOWN ACTUAL SIZE

CONSTITUTION CLASS STARSHIPS:

- 1 CONSTITUTION NCC-1700
- 2 LEXINGTON NCC-1703
- 3 ENTERPRISE NCC-1701
- 4 EXCALIBUR NCC-1705
- 5 FARRAGUT NCC-1702
- 6 INTREPID NCC-1708
- 7 YORKTOWN NCC-1704
- 8 DEFIANT NCC-1764
- 9 POTEMKIN NCC-1711
- 10 EXETER NCC-1706
- 11 REPUBLIC NCC-1371
- 12 HOOD NCC-1707
- 13 CONSTELLATION NCC-1017

OTHER VESSELS:

- 14 AURORA NCC-C1200
- 15 ARIEL NCC-CT5709

DEPARTMENT EMBLEMS:

- A COMMAND
- B SCIENCES
- C SERVICES (ENGINEERING, SECURITY, OTHER)
- D MEDICAL (EMBLEM IN RED)
- E TRANSPORTER SPECIALIST
- F LIFE SCIENCES

15

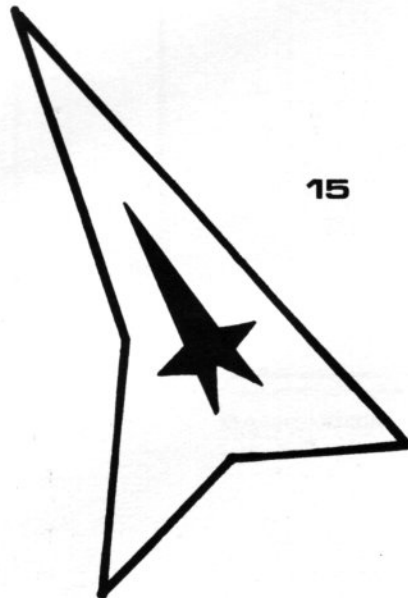

ALL INSIGNIA ARE BLACK EMBROIDERY ON GOLD BACKGROUND

RANK STRIPES

STAR FLEET SPECIFICATION

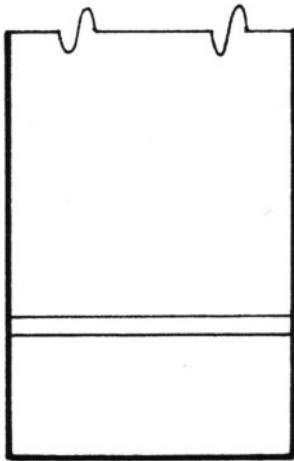

WARRANT OFFICER

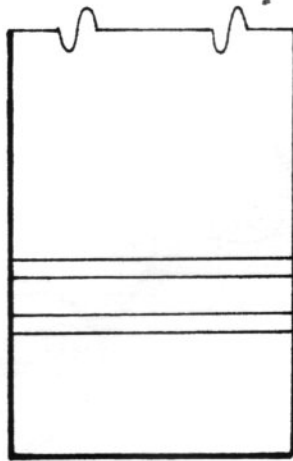

CHIEF WARRANT OFFICER

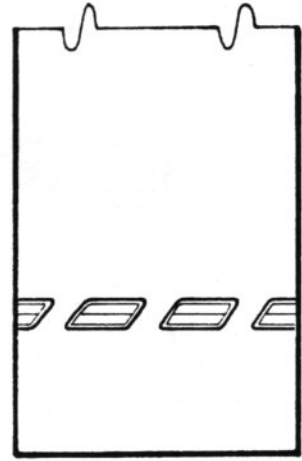

CADET

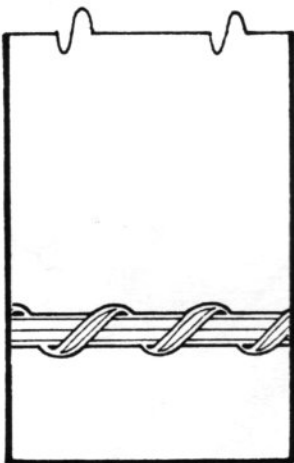

MIDSHIPMAN



ENSIGN

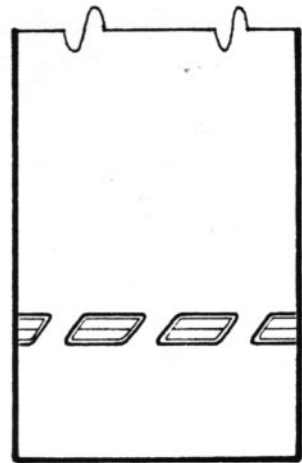

LIEUTENANT JG

WARRANT AND CHIEF WARRANT OFFICERS' STRIPES ARE SILVER METALLIC
CADETS' AND MIDSHIPMEN'S BRAID IS SILVER METALLIC
ENSIGN RANK HAS NO BRAID

RANK STRIPES

STAR FLEET SPECIFICATION

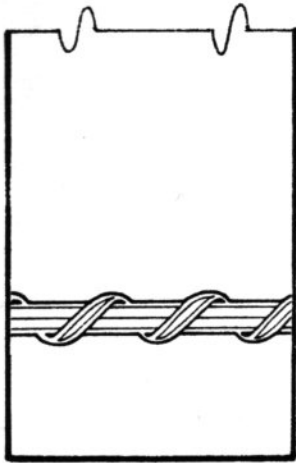

LIEUTENANT

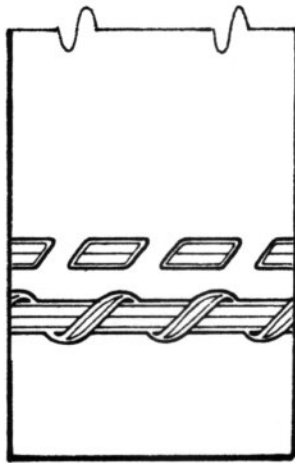

LIEUTENANT COMMANDER

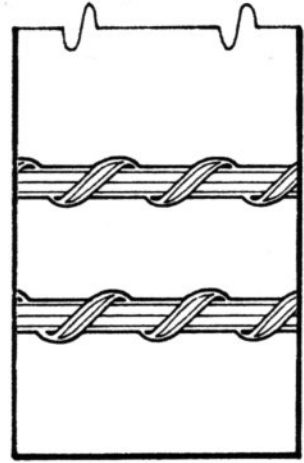

COMMANDER

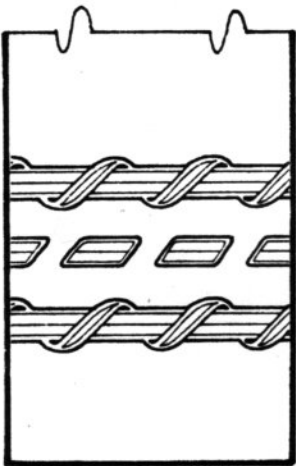

CAPTAIN

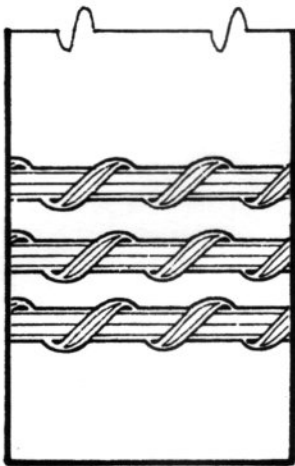

FLEET CAPTAIN

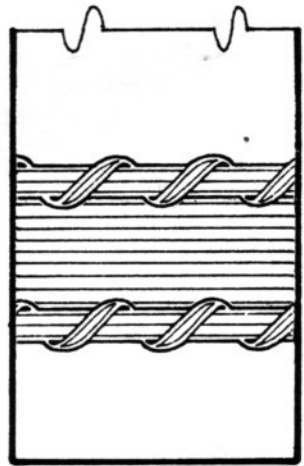

FLAG OFFICER

STANDARD BRAID (ACTUAL SIZE)

GOLD METALLIC

FULL BAR

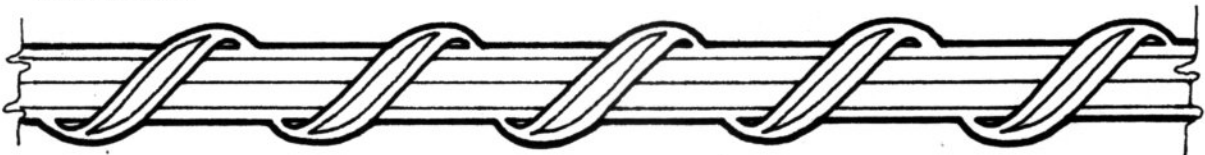

HALF BAR

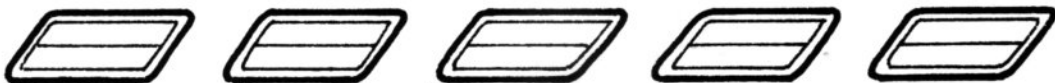

HISTORICAL DATA DATABANK HARDCOPY

WHEN THE U.S.S. ENTERPRISE RETURNED FROM ITS FIFTH FIVE-YEAR MISSION ON 7 APRIL, 2212, IT EARNED A DISTINCTION UNEQUALLED IN STAR FLEET HISTORY -- OF THE THIRTEEN CONSTITUTION CLASS STARSHIPS LAUNCHED, ONLY ENTERPRISE RETURNED FULLY INTACT. IN CONTRAST TO THE TWELVE VESSELS WHICH WERE EITHER COMPLETELY DESTROYED OR DAMAGED TO THE POINT OF REQUIRING MAJOR REFITTING, ENTERPRISE SUSTAINED ONLY MINOR DAMAGE TO HER DILITHIUM COUPLINGS.

THE SUCCESS OF THE ENTERPRISE MISSION WAS CREDITED TO CAPTAIN JAMES T. KIRK, COMMANDER SPOCK, AND LT. COMMANDER MONTGOMERY SCOTT. ANALYSIS OF THE ENTERPRISE COMPUTER LOG REVEALED THAT ON SEVERAL OCCASIONS, THE WISDOM AND BRAVERY OF THESE THREE MEN PREVENTED THE SEEMINGLY CERTAIN DESTRUCTION OF ENTERPRISE.

TO HONOR THE SHIP AND HER CREW, STAR FLEET COMMAND UNANIMOUSLY ELECTED TO DROP THE INDIVIDUAL SHIP EMBLEM SYSTEM AND ADOPT THE INSIGNIA OF ENTERPRISE [COMMAND DIVISION] AS THE OFFICIAL INSIGNIA OF STAR FLEET. THE DECISION WAS MADE AS ENTERPRISE WAS ON FINAL COURSE FOR EARTH, AND WAS INITIALLY PUT INTO ACTION ON 15 APRIL, 2212.

SIX YEARS LATER, ON 31 OCTOBER, 2218, THE REPLACEMENT OF THE UNPOPULAR JUMPSUIT UNIFORM USED FOR TWO YEARS BROUGHT WITH IT A NEW SYSTEM OF RANK DESIGNATION AS WELL. THE LONG-STANDING SYSTEM OF SLEEVE STRIPES AS INDICATING RANK WAS REPLACED ON THE NEW UNIFORM WITH A RANK PIN OF GOLD AND SILVERPLATE. THIS PIN IS WORN ON BOTH THE SHOULDER STRAP AND THE LEFT SLEEVE OF THE NEW DUTY TUNIC.

INSIGNIA PINS

STAR FLEET ISSUE

[SHOWN ACTUAL SIZE]

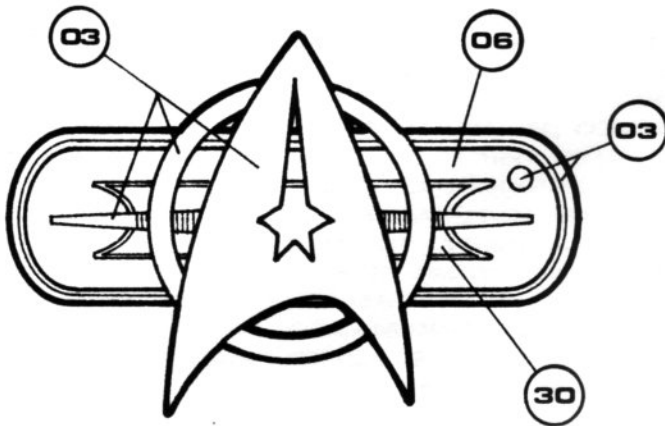

OFFICERS' TUNIC PIN

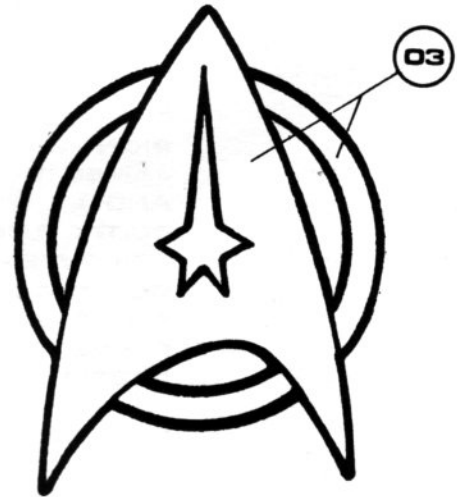

CADETS' CHEST PIN
[SERVICES DEPARTMENT]

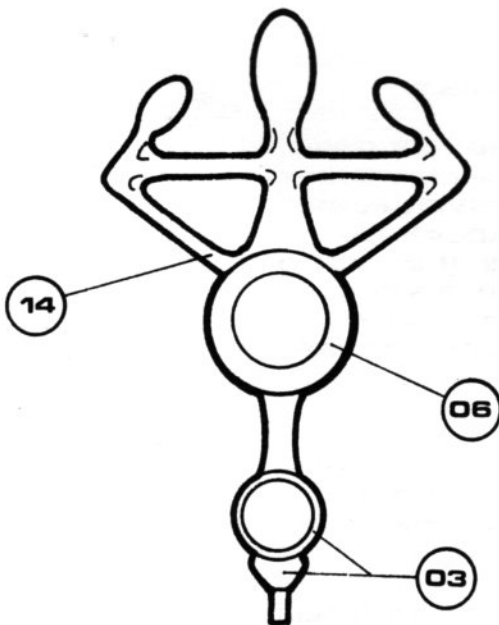

MEDICAL DEPARTMENT CHEST PIN

RANK PINS

STAR FLEET ISSUE

[SHOWN ACTUAL SIZE]

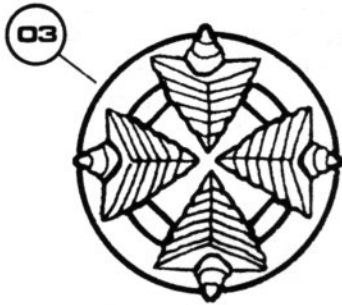

FLEET ADMIRAL

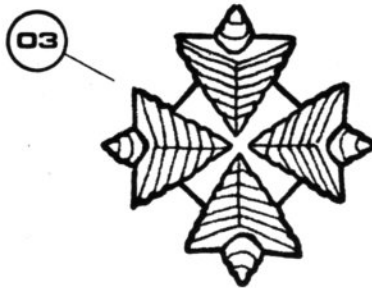

ADMIRAL

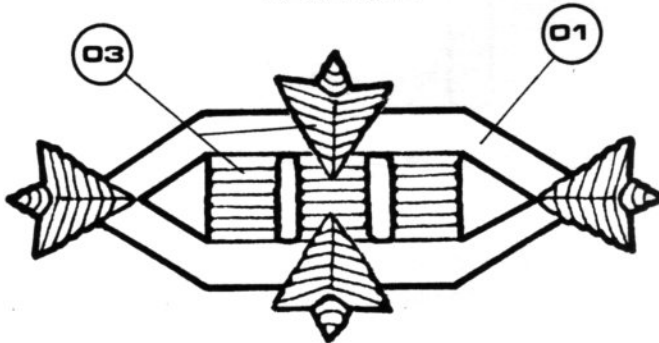

COMMODORE

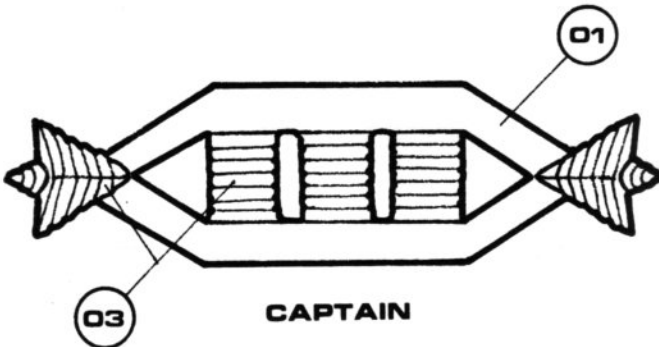

CAPTAIN

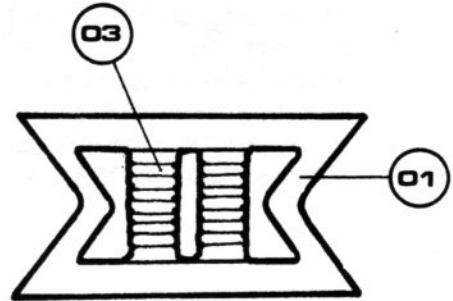

COMMANDER

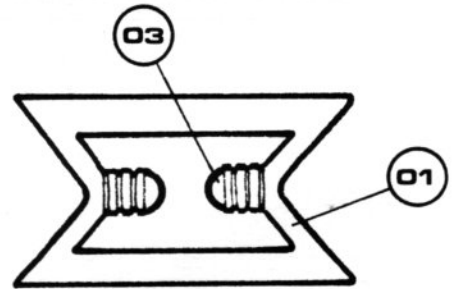

LT. COMMANDER

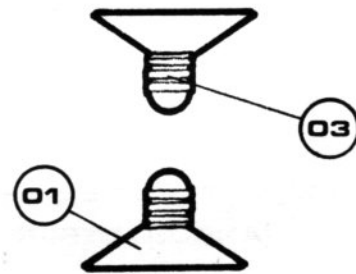

LIEUTENANT

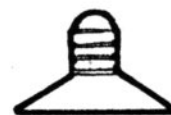

LIEUTENANT JG

ENSIGN RANK HAS NO PIN

SERVICE BARS

STAR FLEET ISSUE

SERVICE BARS DENOTE EACH OFFICER'S NUMBER OF YEARS OF ACTIVE SPACEFLIGHT DUTY (FOR FLAG OFFICERS, MAY ALSO DENOTE YEARS OF ACTIVE GROUND ASSIGNMENT). PINS MAY BE ARRANGED AT OFFICERS' DISCRETION ALONG OUTER SERVICE BAR. CADETS' AND MIDSHIPMEN'S PINS REPRESENT NUMBER OF YEARS OF COMPLETED ACADEMY TRAINING. OFFICERS' PINS ARE GOLD. CADETS' AND MIDSHIPMEN'S PINS ARE SILVER.

SERVICE BAR WITH PINS DISPLAYED [PINS DENOTE NINETEEN YEARS OF SERVICE]

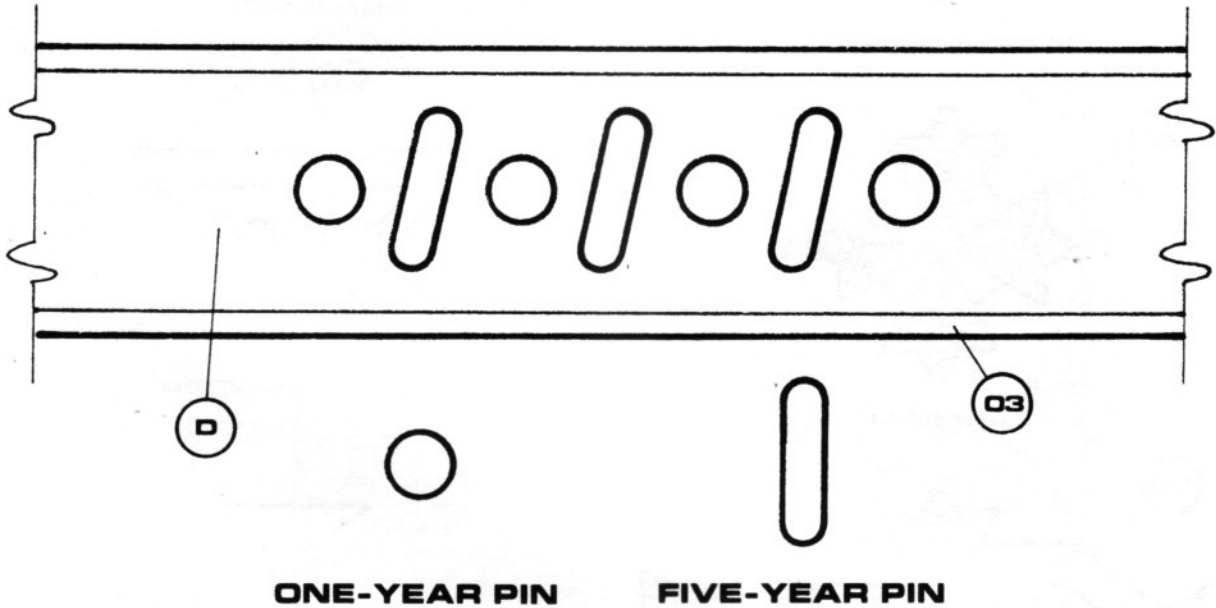

FIRST YEAR SERVICE BAR [ANGLED STRIPE IS OFFICER'S DEPARTMENT COLOR]

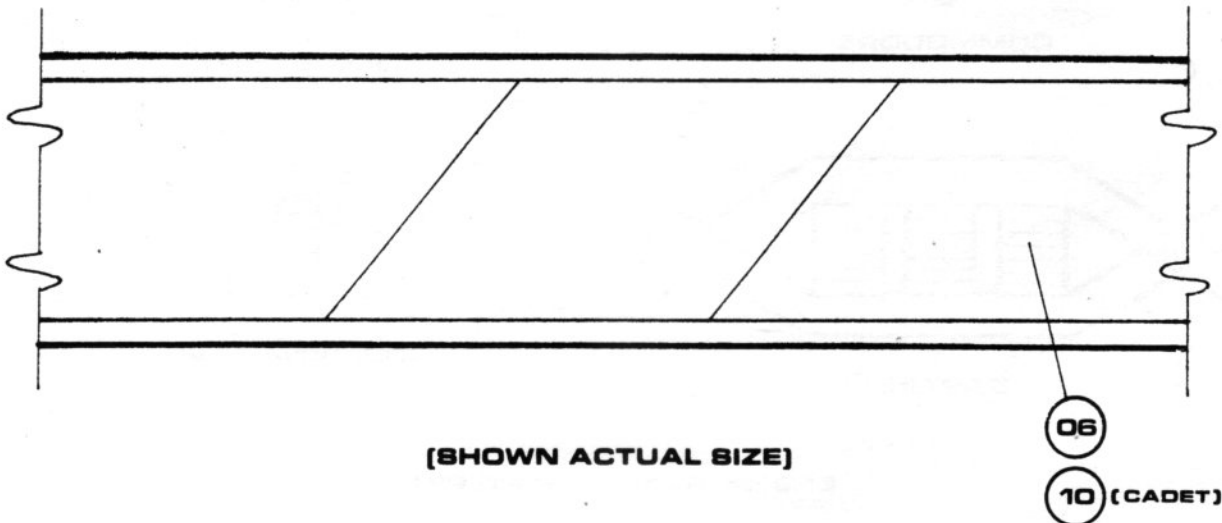

[SHOWN ACTUAL SIZE]

BELT BUCKLES
STAR FLEET ISSUE

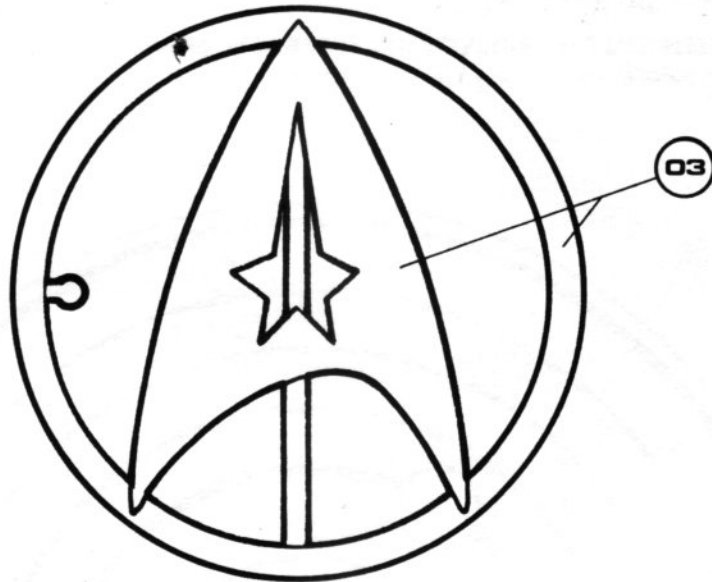

STANDARD UNIFORM BUCKLE

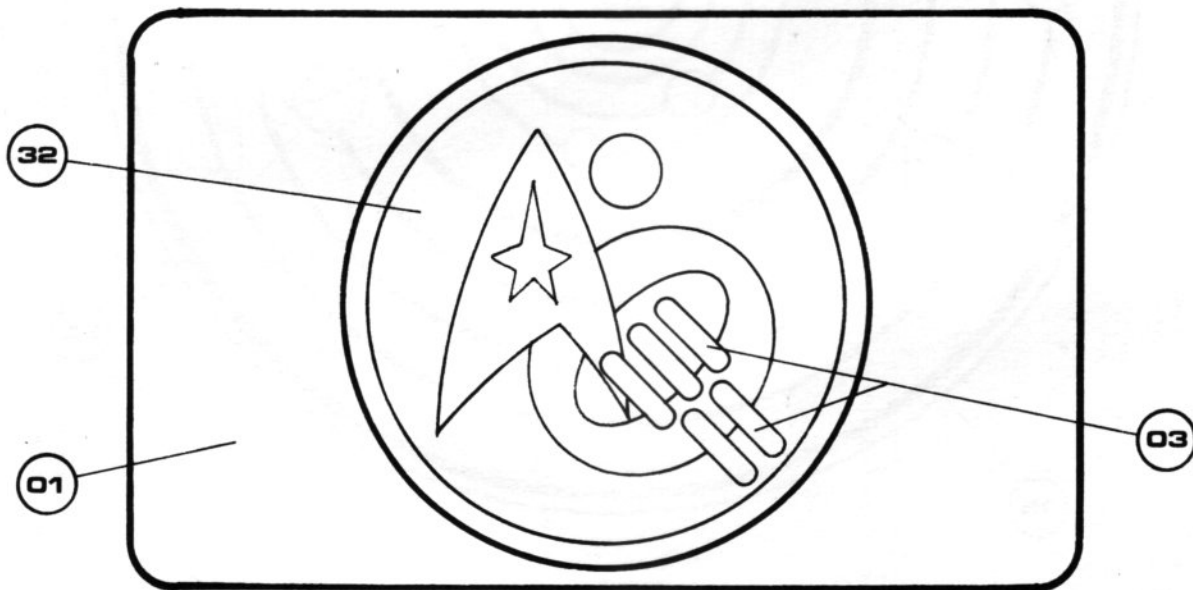

25-YEAR BUCKLE
[AWARD UPON COMPLETION OF 25 YEARS OF SERVICE]

[SHOWN ACTUAL SIZE]

SHOULDER PATCH

STAR FLEET ISSUE

PATCH REPRESENTS GRAPHIC OVERVIEW OF SHIP'S HOME SYSTEM
[WORN ON LEFT SLEEVE OF FIELD JACKET]

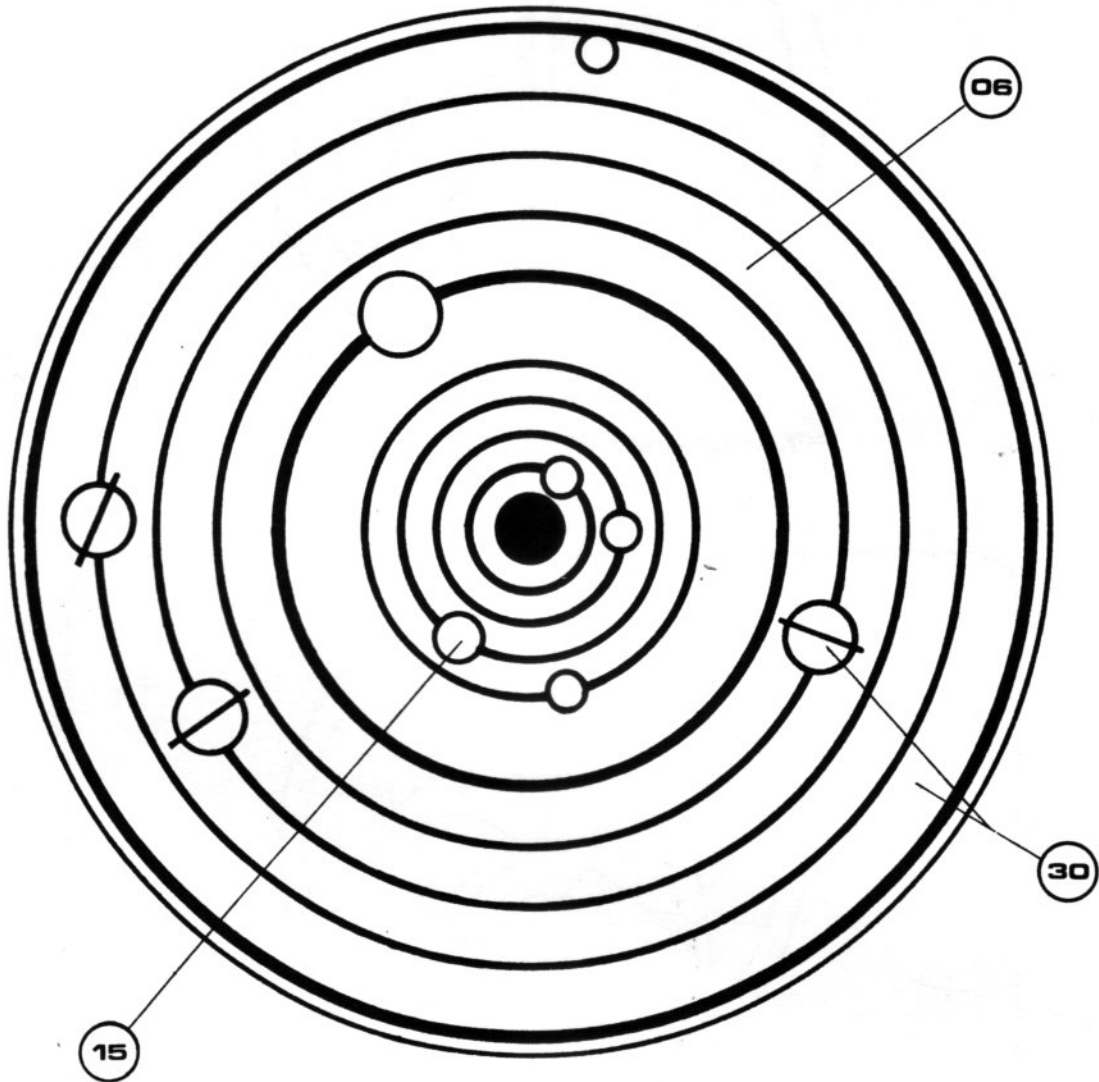

SOL SYSTEM PATCH
[SHOWN ACTUAL SIZE]

SHOULDER STRAP DUTY TUNIC COMPONENT

[SHOWN ACTUAL SIZE]

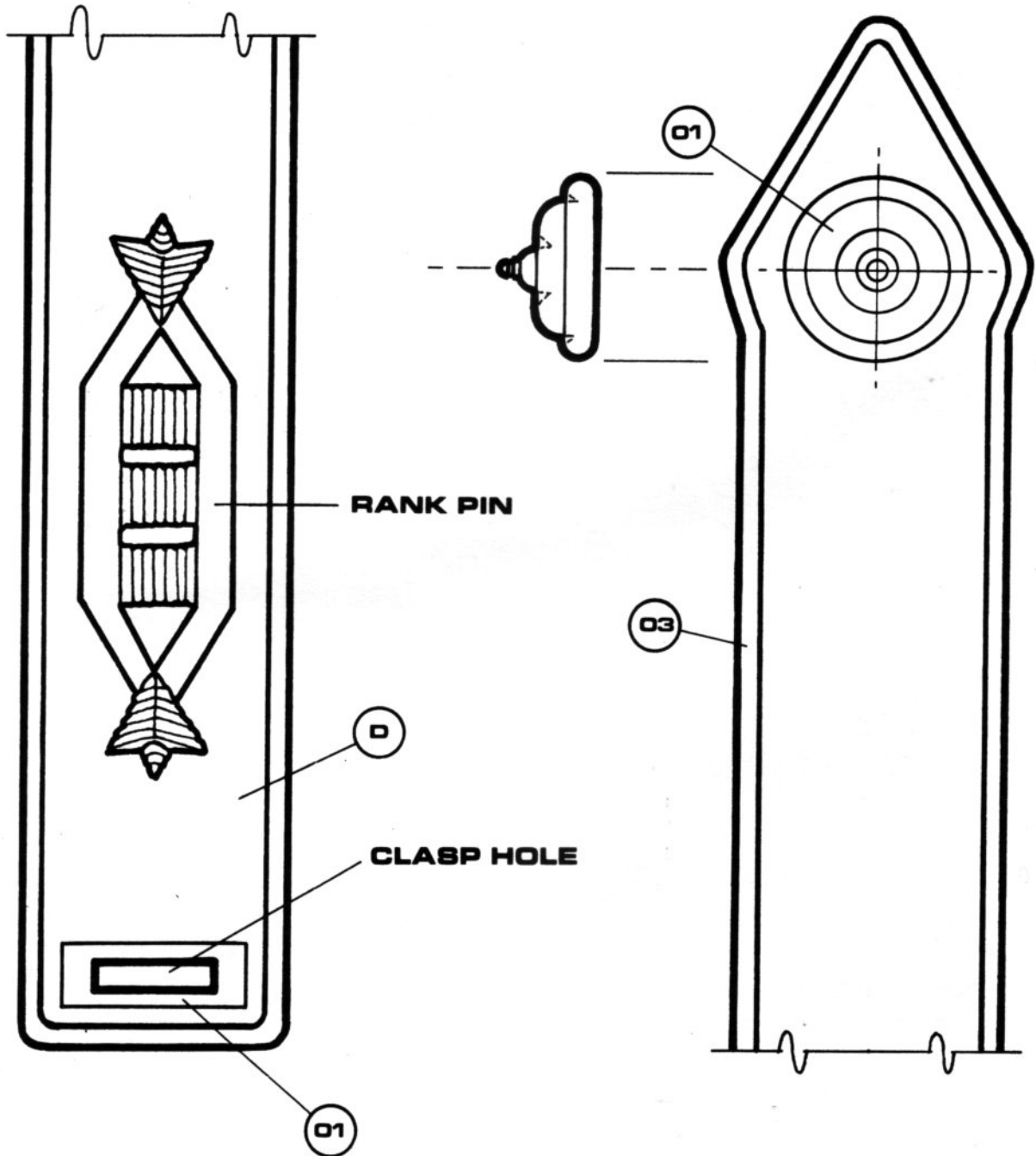

STAR FLEET

UNIFORMS (OBSOLETE)

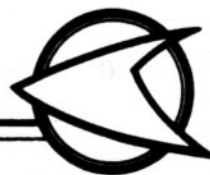

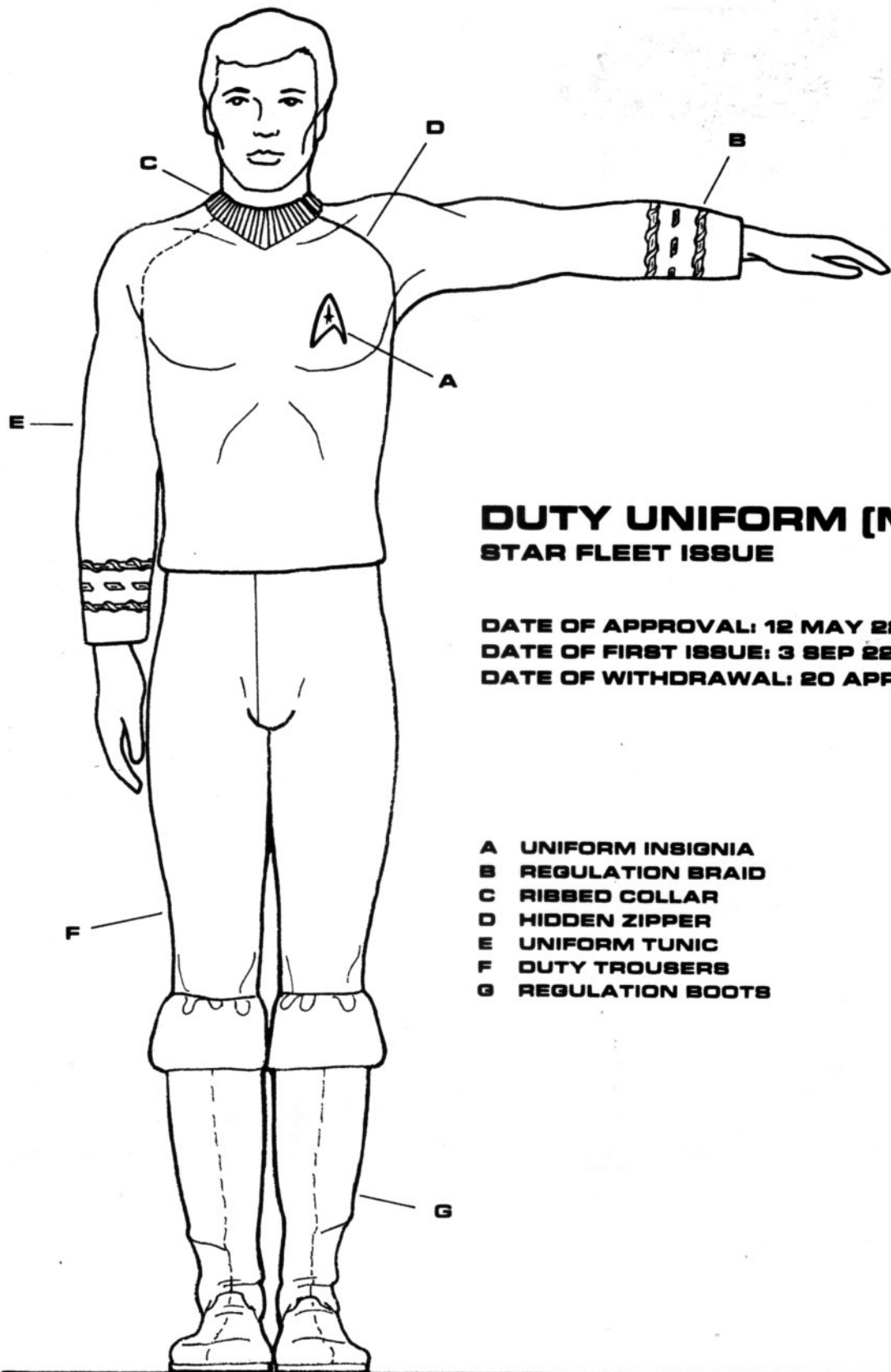

**DUTY UNIFORM (MALE)
STAR FLEET ISSUE**

**DATE OF APPROVAL: 12 MAY 2207
DATE OF FIRST ISSUE: 3 SEP 2207
DATE OF WITHDRAWAL: 20 APR 2214**

- A UNIFORM INSIGNIA**
- B REGULATION BRAID**
- C RIBBED COLLAR**
- D HIDDEN ZIPPER**
- E UNIFORM TUNIC**
- F DUTY TROUSERS**
- G REGULATION BOOTS**

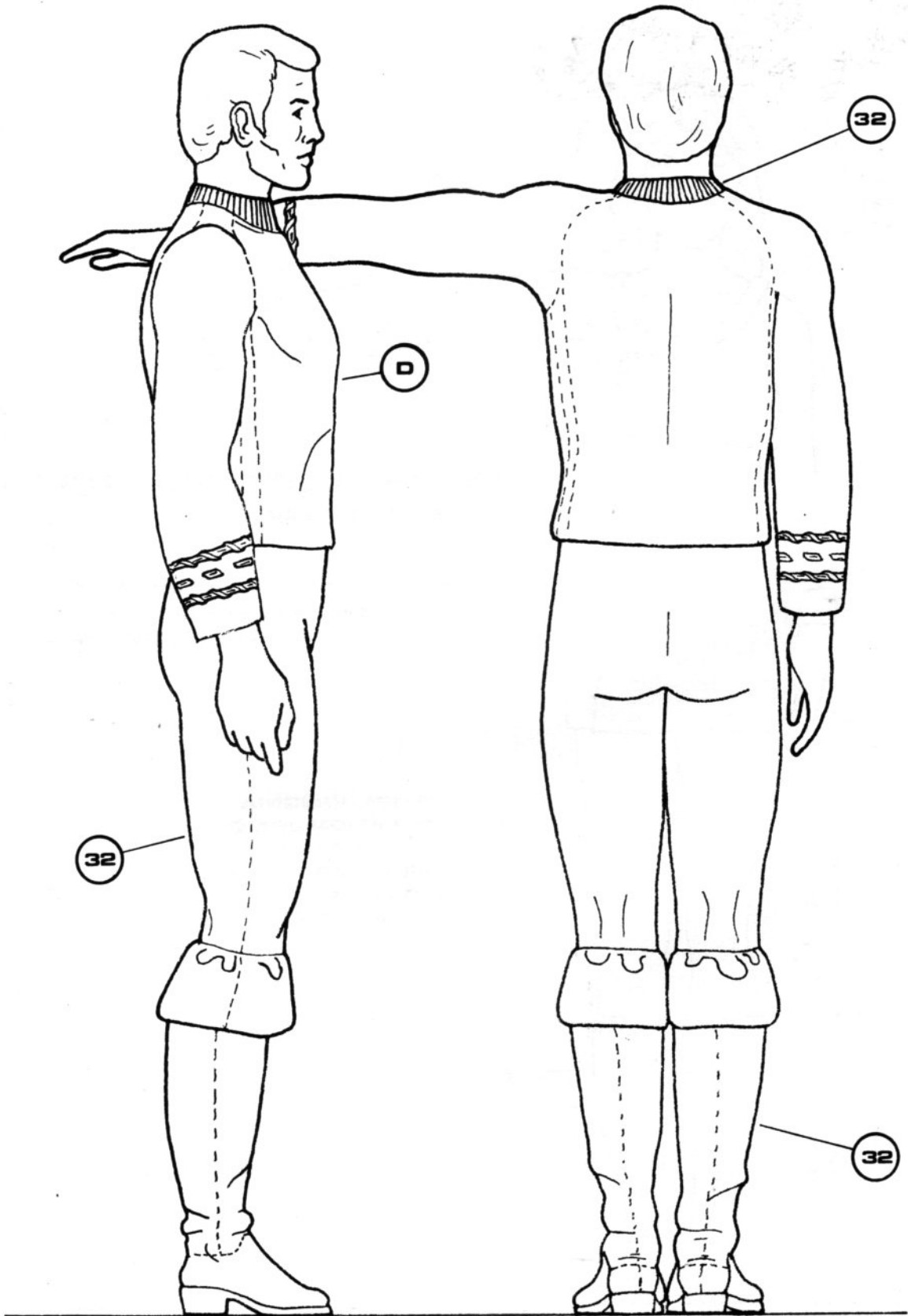

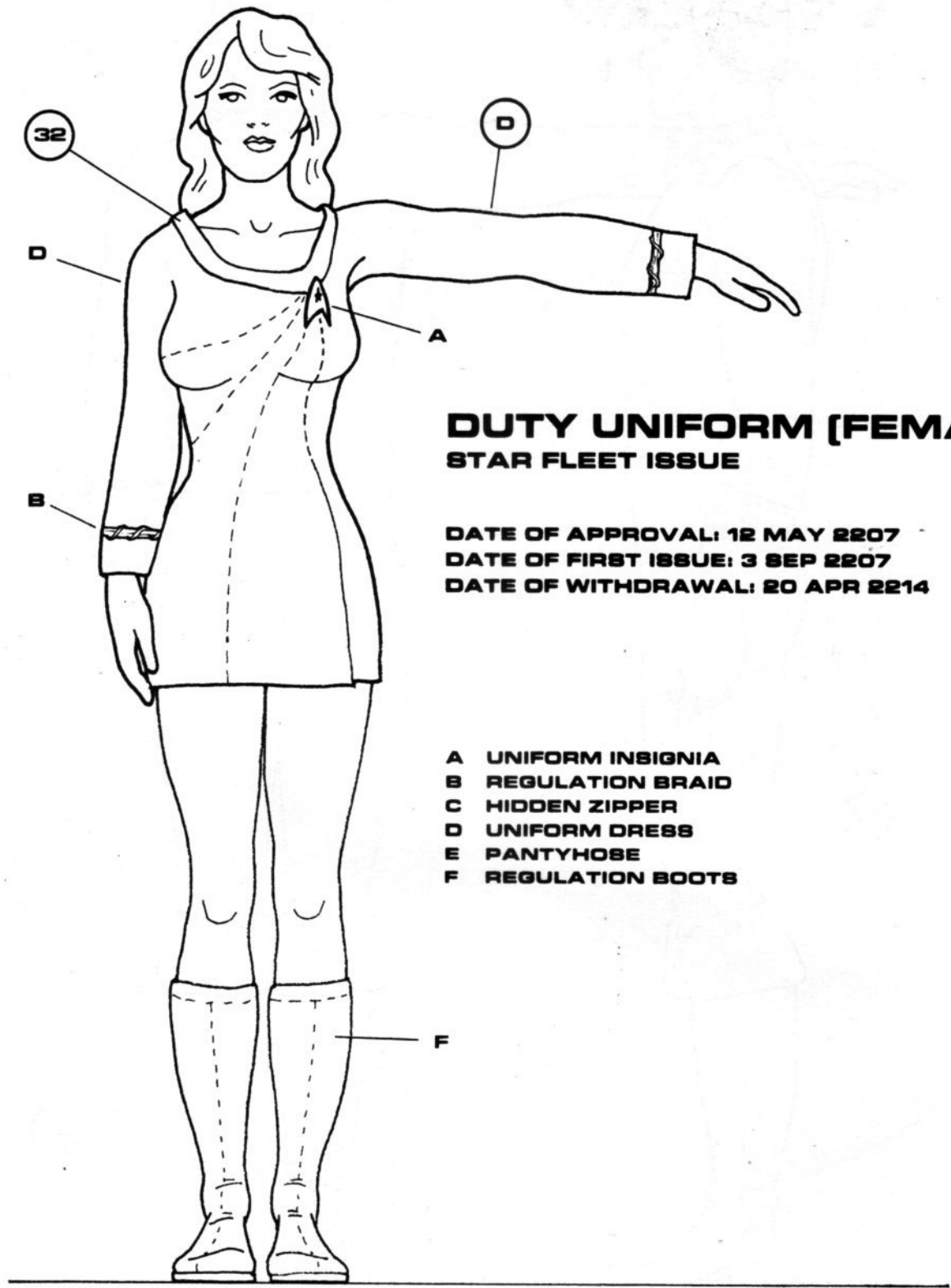

**DUTY UNIFORM [FEMALE]
STAR FLEET ISSUE**

**DATE OF APPROVAL: 12 MAY 2207
DATE OF FIRST ISSUE: 3 SEP 2207
DATE OF WITHDRAWAL: 20 APR 2214**

- A UNIFORM INSIGNIA**
- B REGULATION BRAID**
- C HIDDEN ZIPPER**
- D UNIFORM DRESS**
- E PANTYHOSE**
- F REGULATION BOOTS**

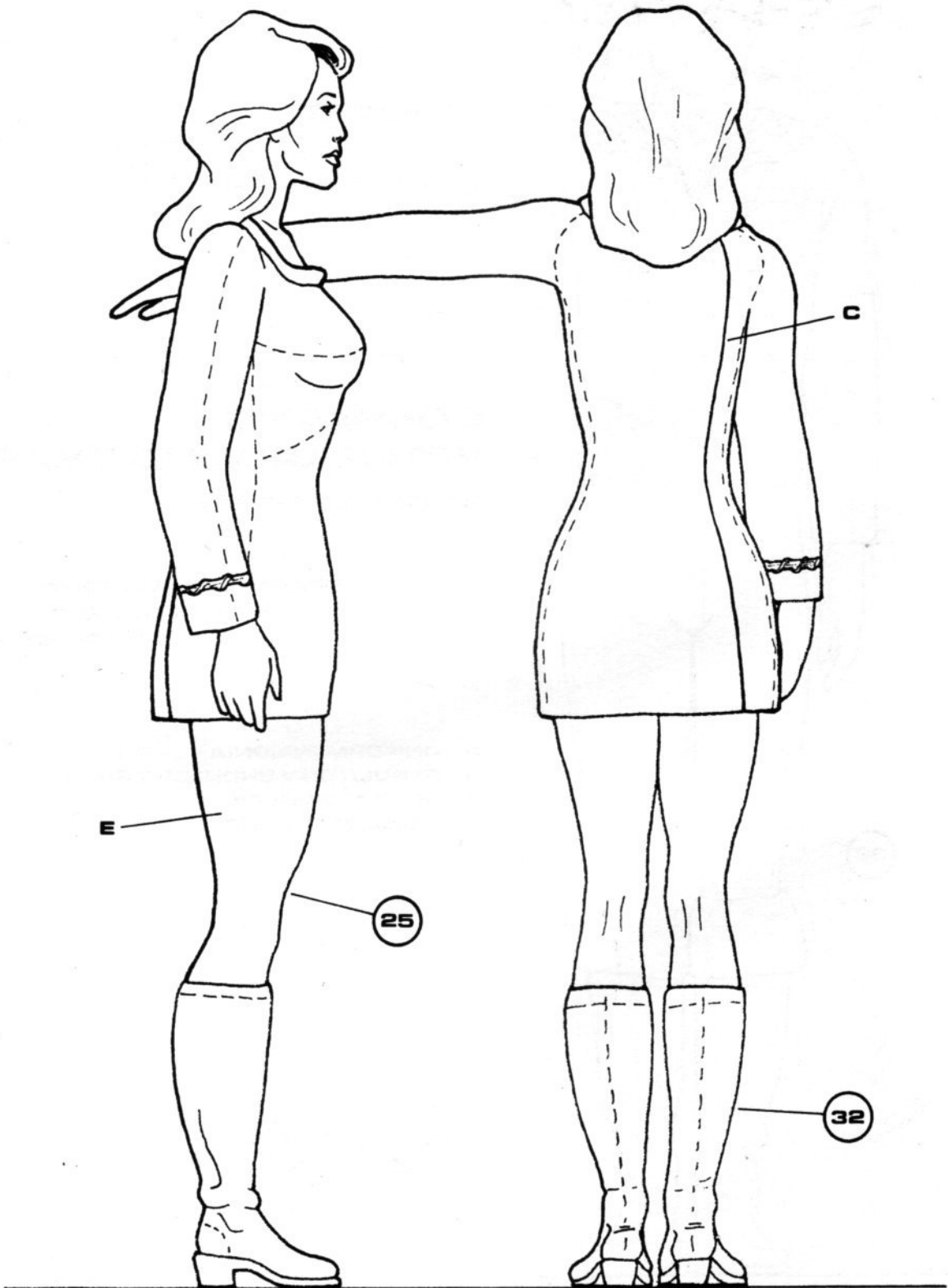

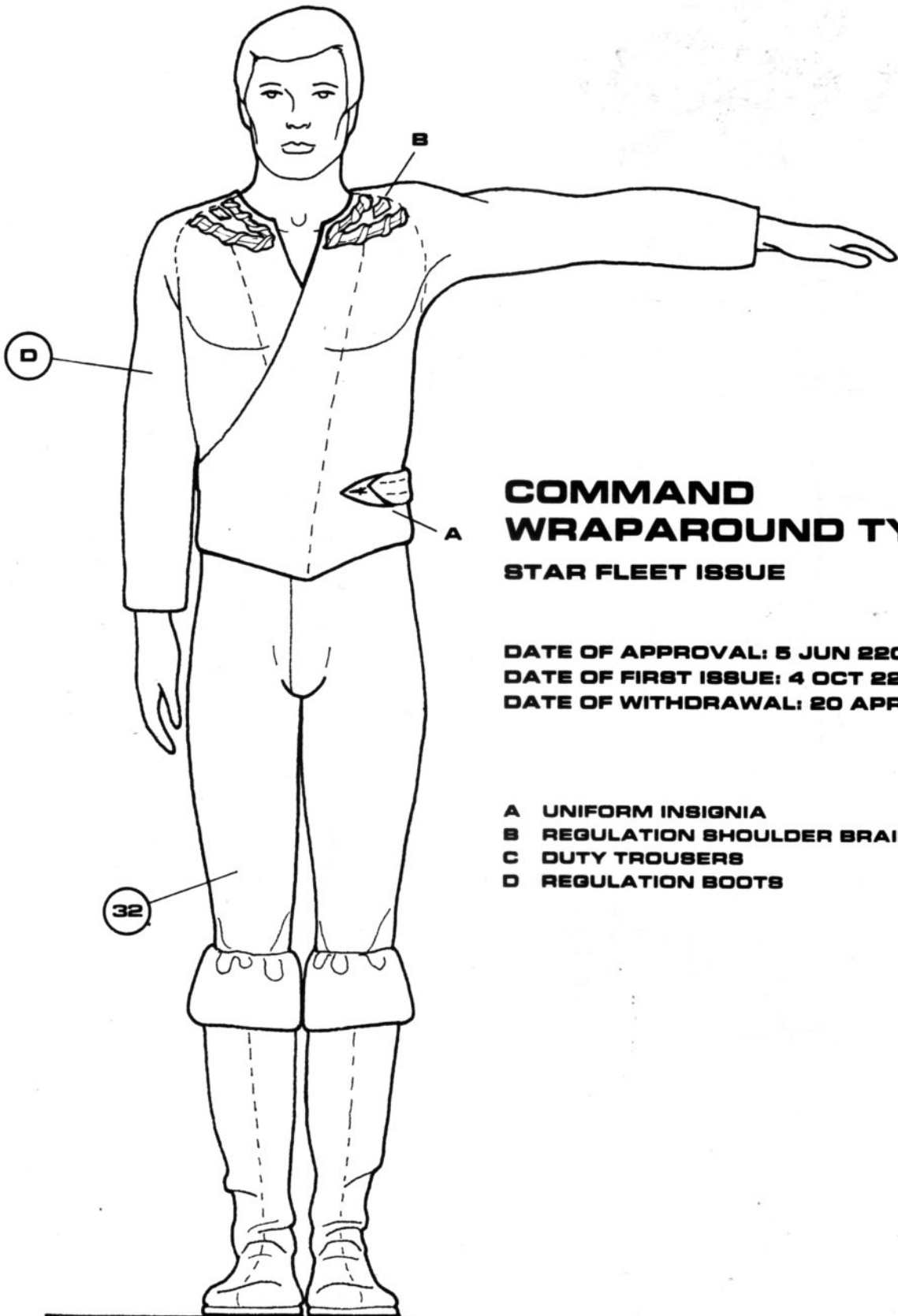

**COMMAND
WRAPAROUND TYPE 1
STAR FLEET ISSUE**

DATE OF APPROVAL: 5 JUN 2207

DATE OF FIRST ISSUE: 4 OCT 2207

DATE OF WITHDRAWAL: 20 APR 2214

- A UNIFORM INSIGNIA**
- B REGULATION SHOULDER BRAID**
- C DUTY TROUSERS**
- D REGULATION BOOTS**

32

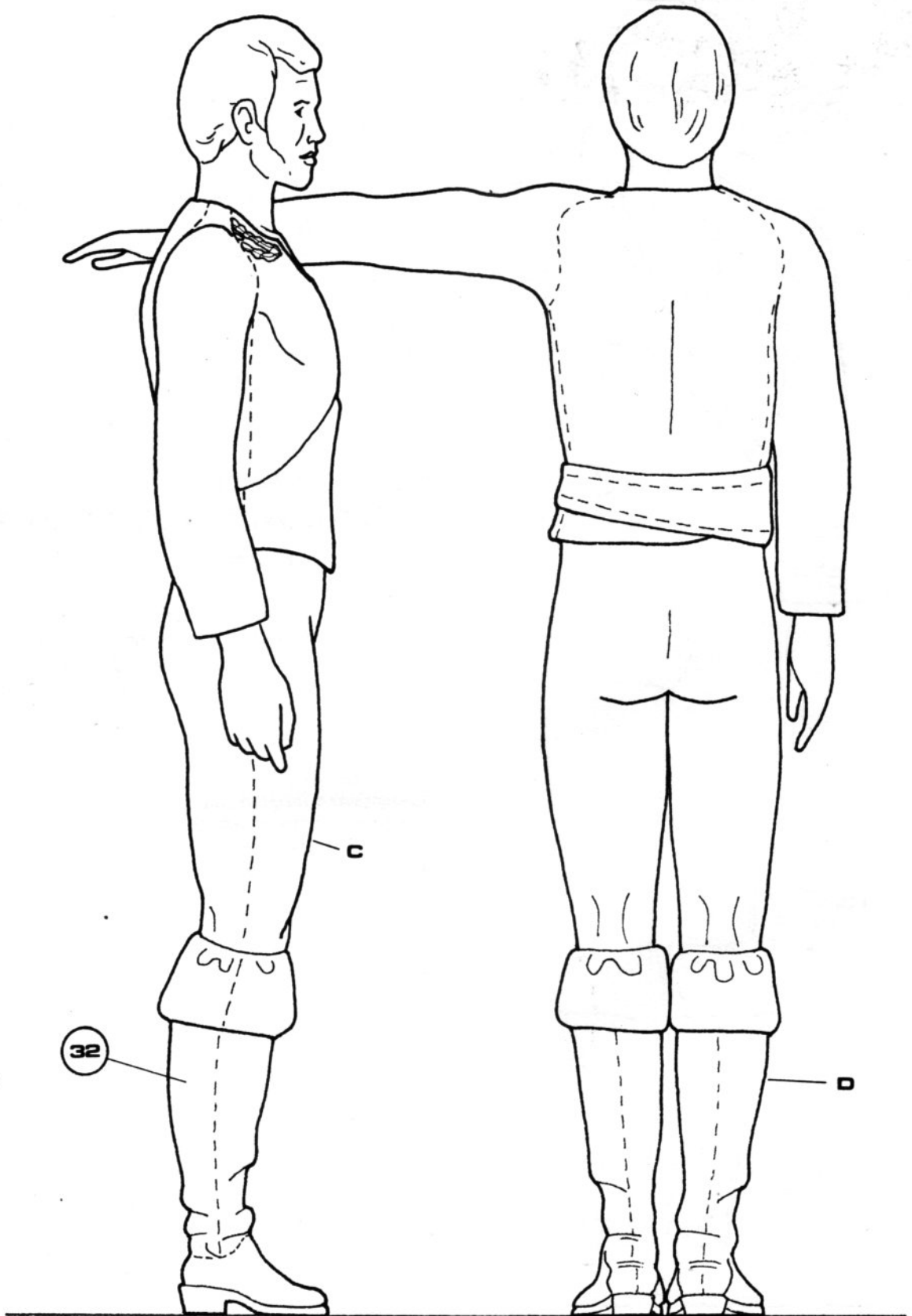

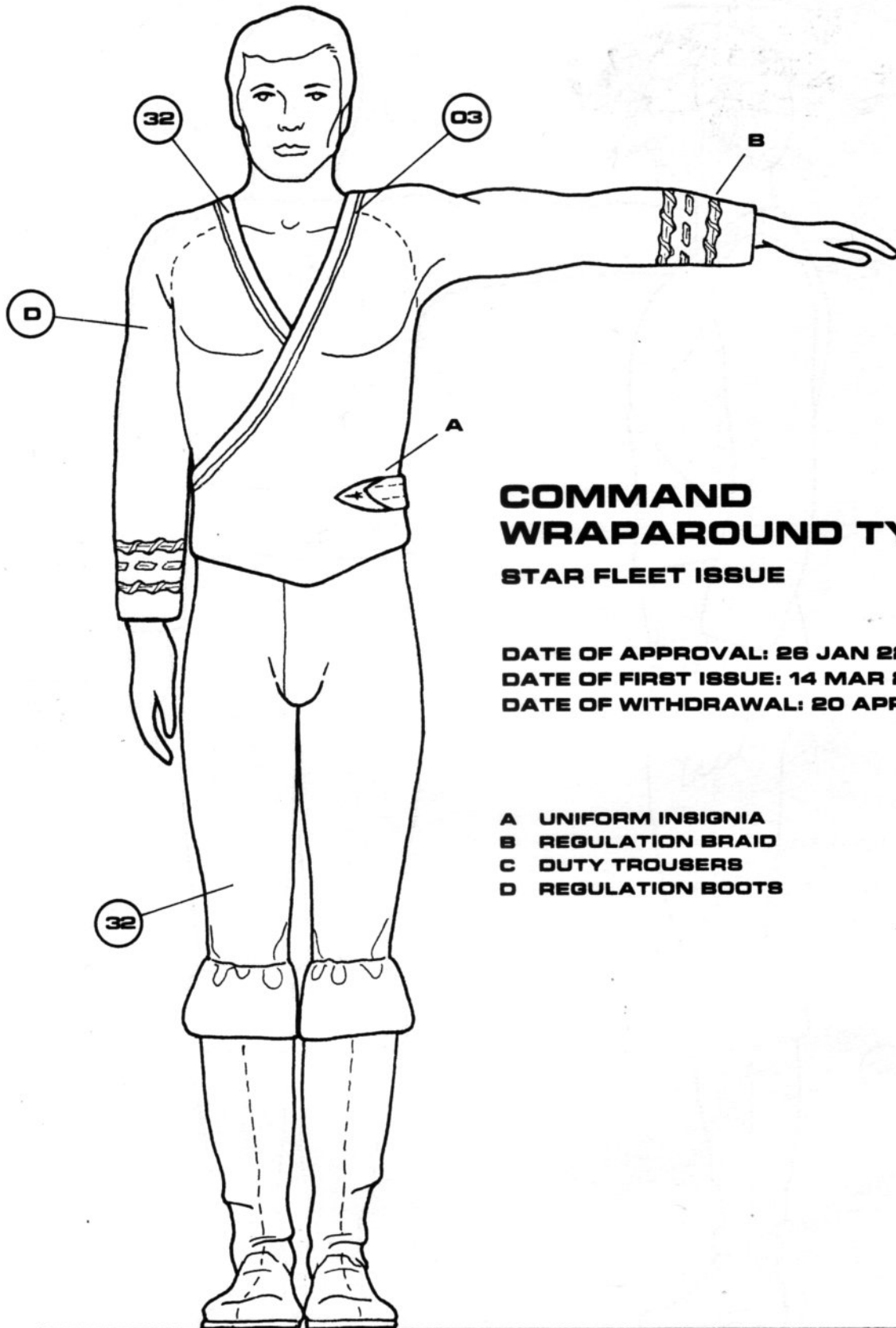

**COMMAND
WRAPAROUND TYPE 2
STAR FLEET ISSUE**

**DATE OF APPROVAL: 26 JAN 2208
DATE OF FIRST ISSUE: 14 MAR 2208
DATE OF WITHDRAWAL: 20 APR 2214**

- A UNIFORM INSIGNIA**
- B REGULATION BRAID**
- C DUTY TROUSERS**
- D REGULATION BOOTS**

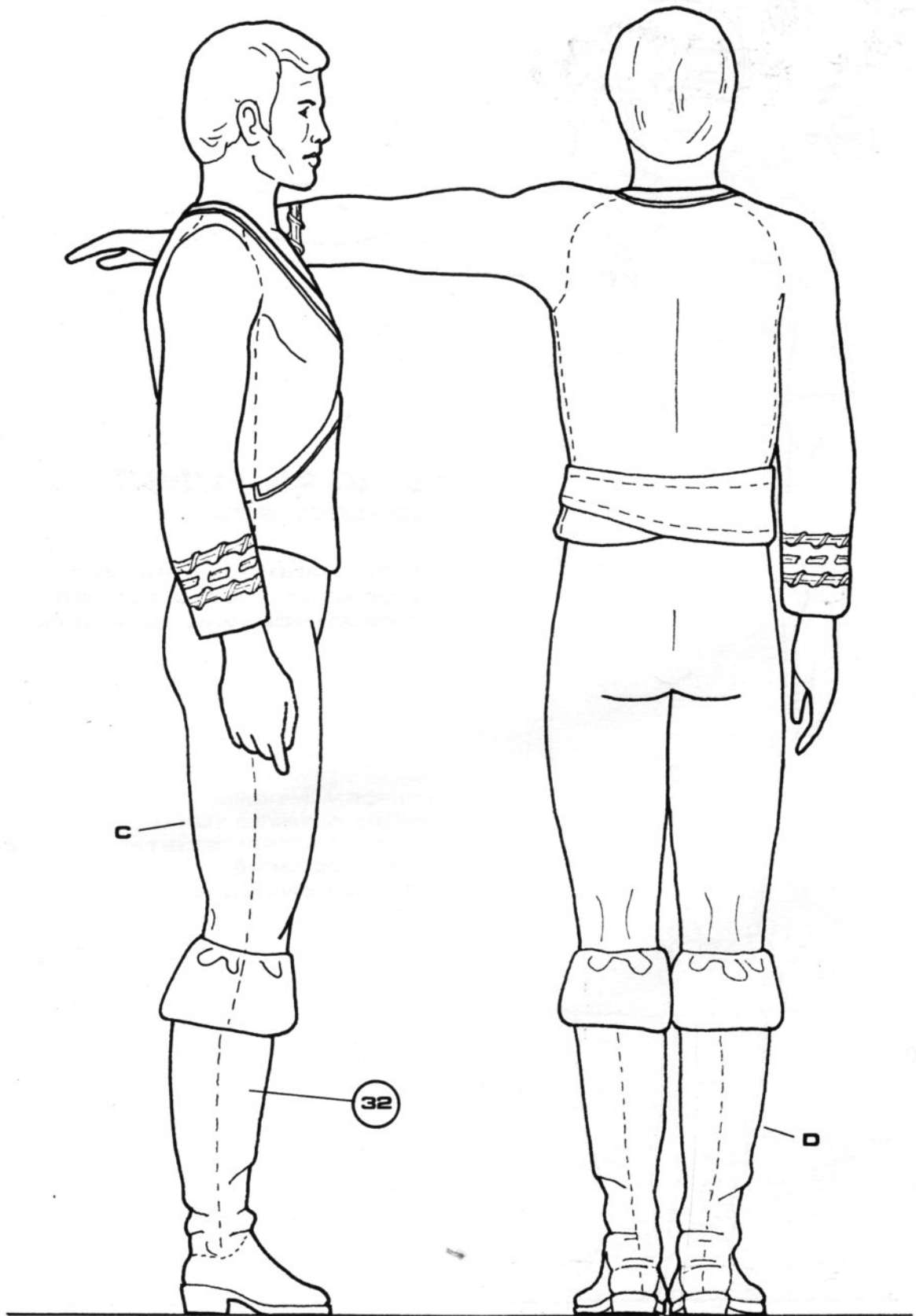

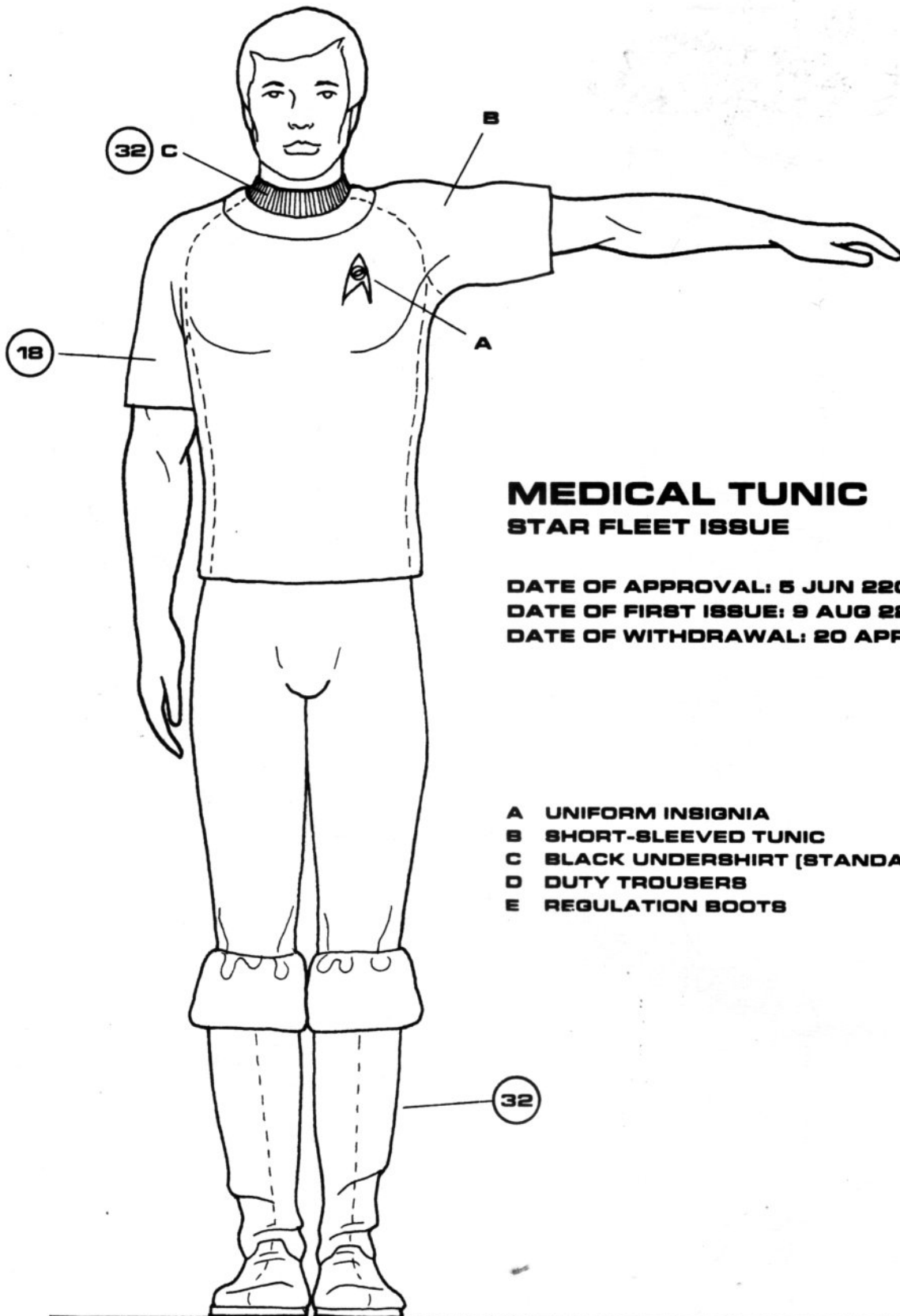

MEDICAL TUNIC STAR FLEET ISSUE

DATE OF APPROVAL: 5 JUN 2207

DATE OF FIRST ISSUE: 9 AUG 2207

DATE OF WITHDRAWAL: 20 APR 2214

- A UNIFORM INSIGNIA**
- B SHORT-SLEEVED TUNIC**
- C BLACK UNDERSHIRT (STANDARD ISSUE)**
- D DUTY TROUSERS**
- E REGULATION BOOTS**

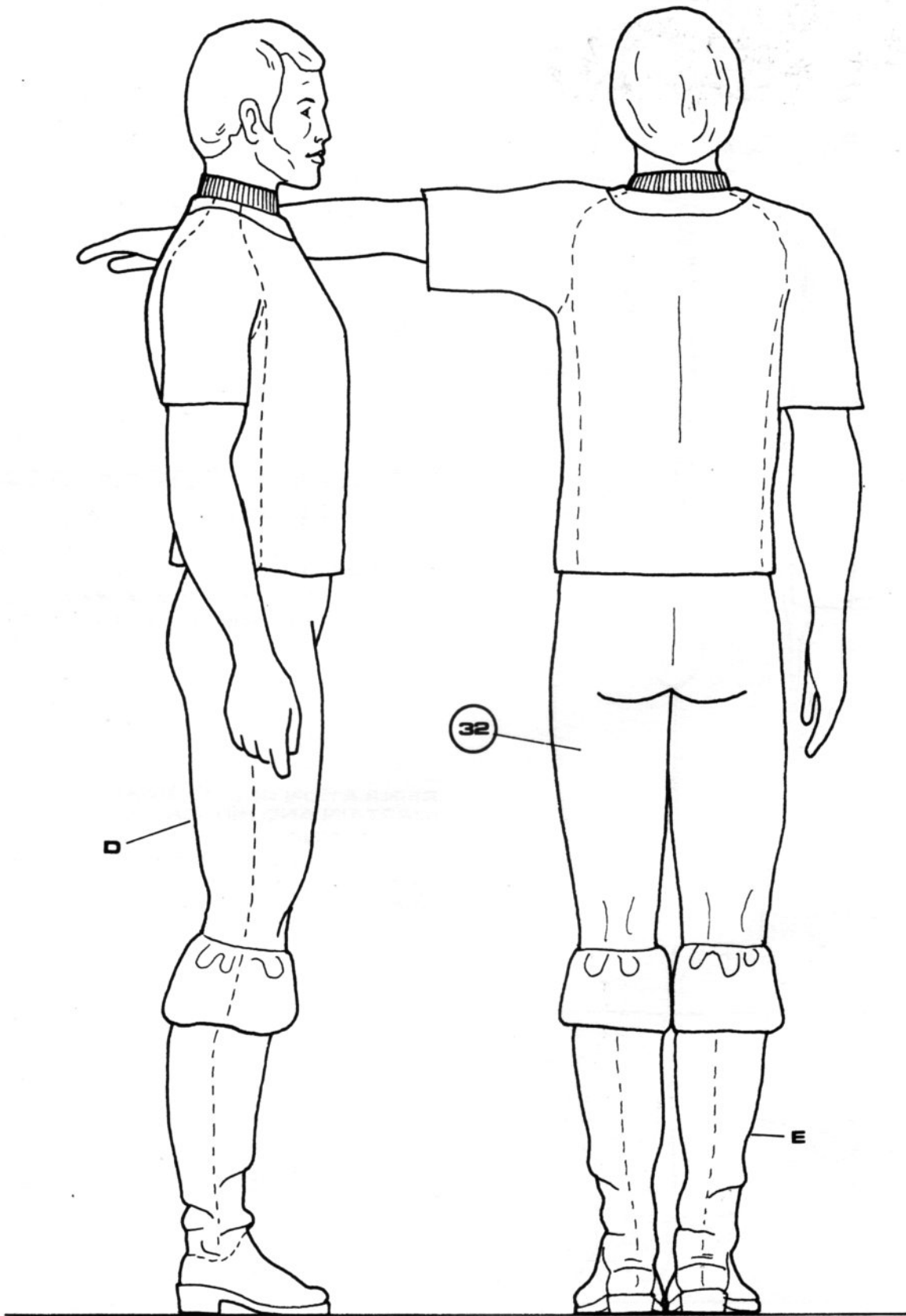

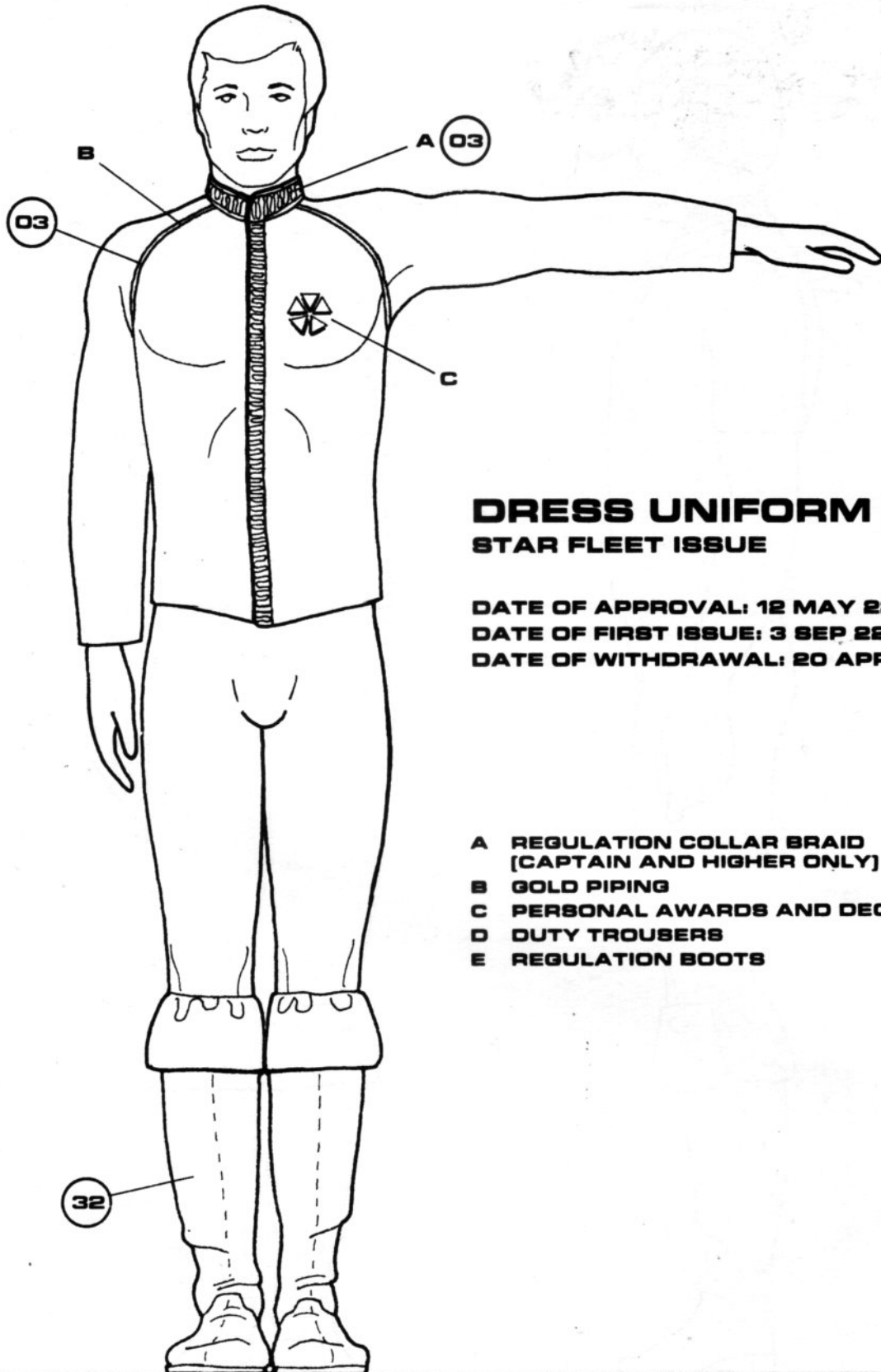

DRESS UNIFORM (MALE)

STAR FLEET ISSUE

DATE OF APPROVAL: 12 MAY 2207

DATE OF FIRST ISSUE: 3 SEP 2207

DATE OF WITHDRAWAL: 20 APR 2207

- A REGULATION COLLAR BRAID
(CAPTAIN AND HIGHER ONLY)**
- B GOLD PIPING**
- C PERSONAL AWARDS AND DECORATIONS**
- D DUTY TROUSERS**
- E REGULATION BOOTS**

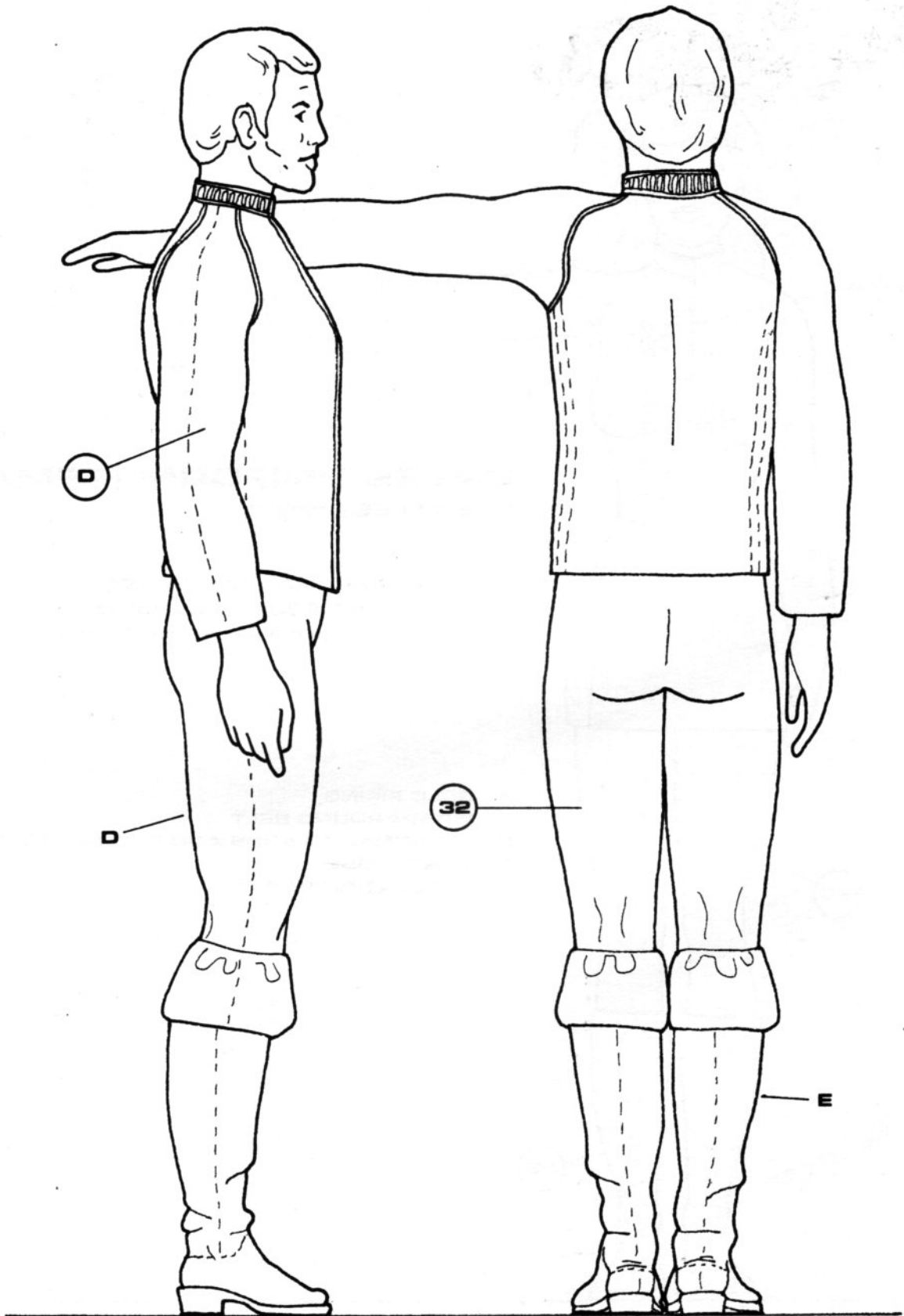

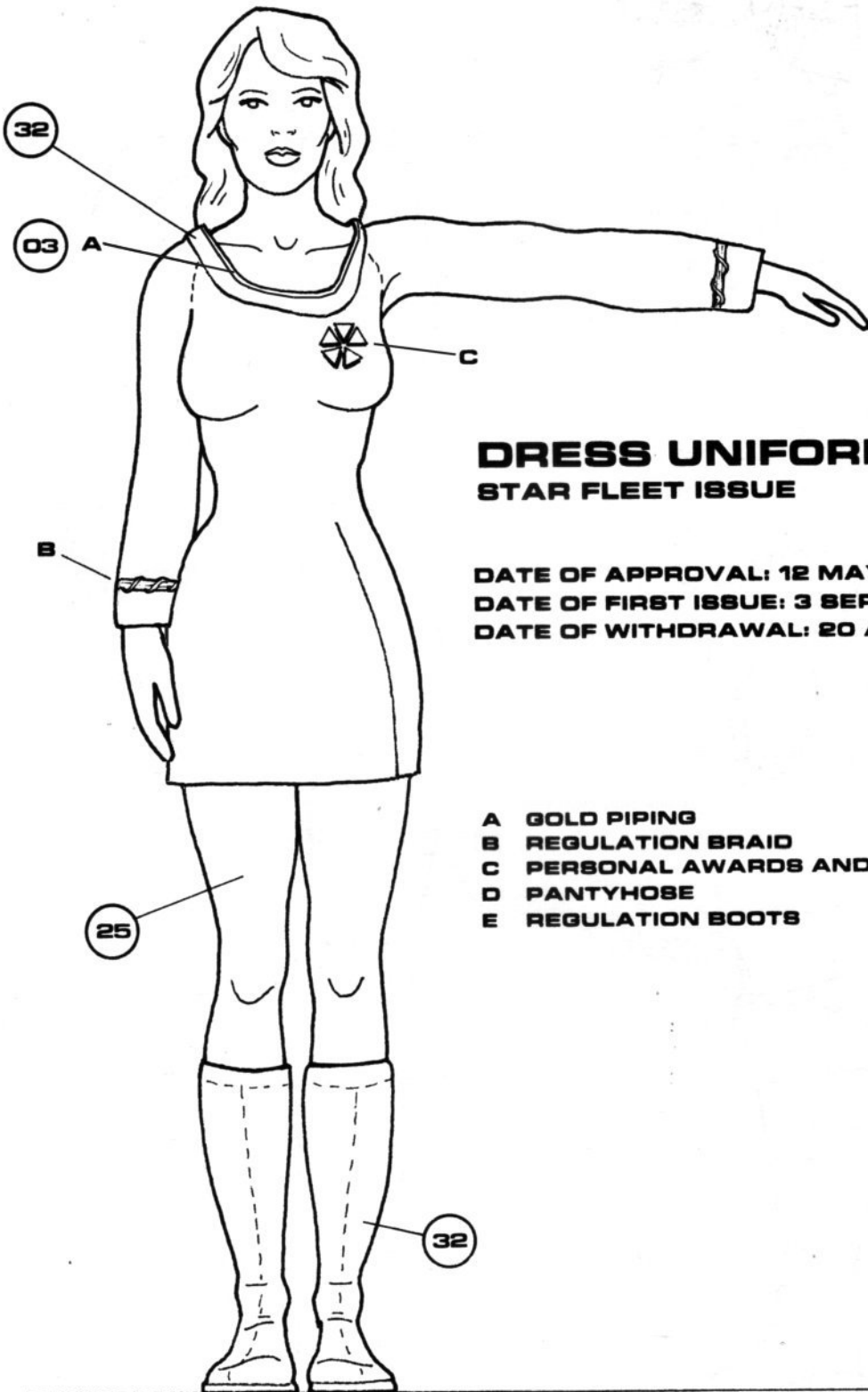

**DRESS UNIFORM (FEMALE)
STAR FLEET ISSUE**

**DATE OF APPROVAL: 12 MAY 2207
DATE OF FIRST ISSUE: 3 SEP 2207
DATE OF WITHDRAWAL: 20 APR 2214**

- A GOLD PIPING**
- B REGULATION BRAID**
- C PERSONAL AWARDS AND DECORATIONS**
- D PANTYHOSE**
- E REGULATION BOOTS**

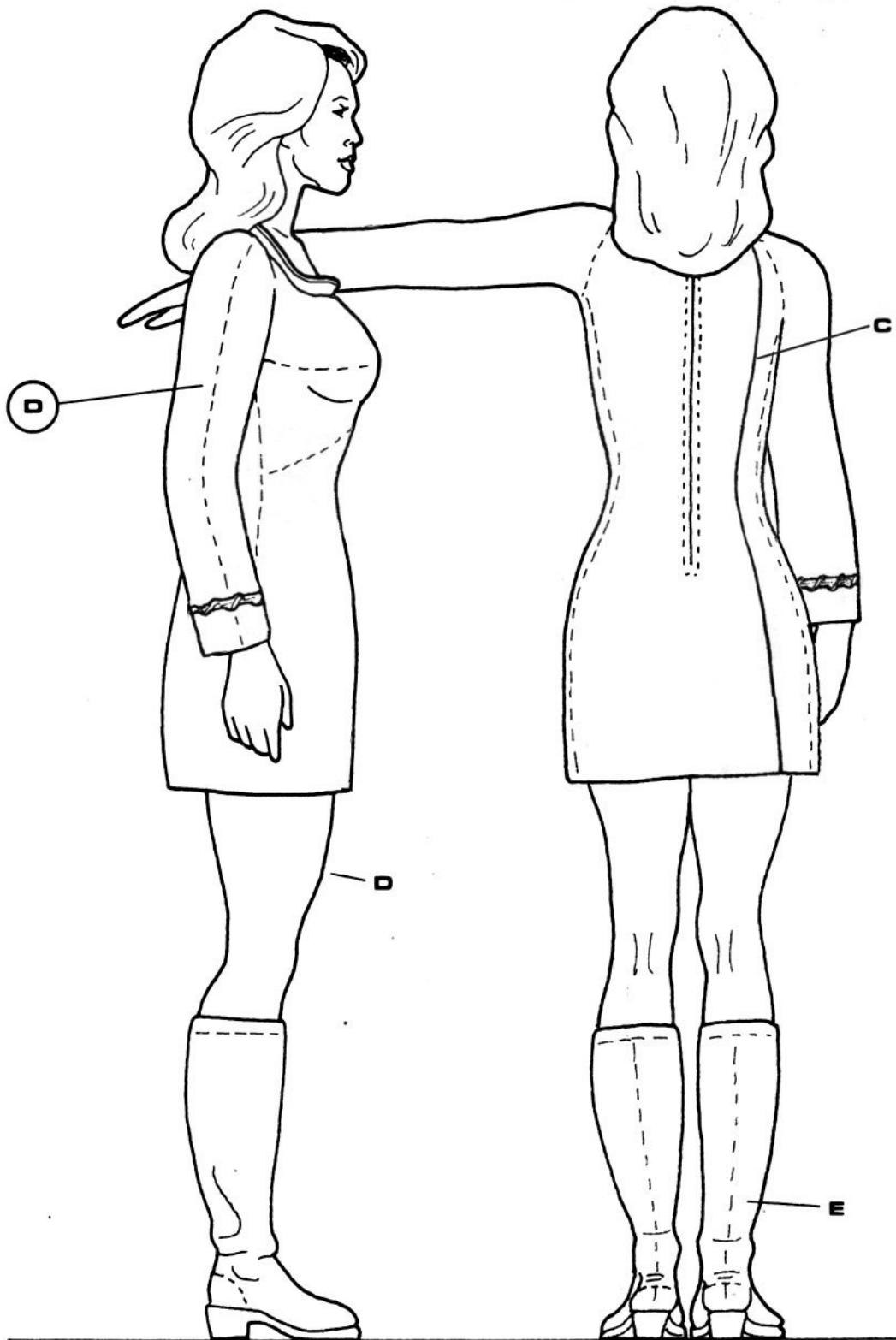

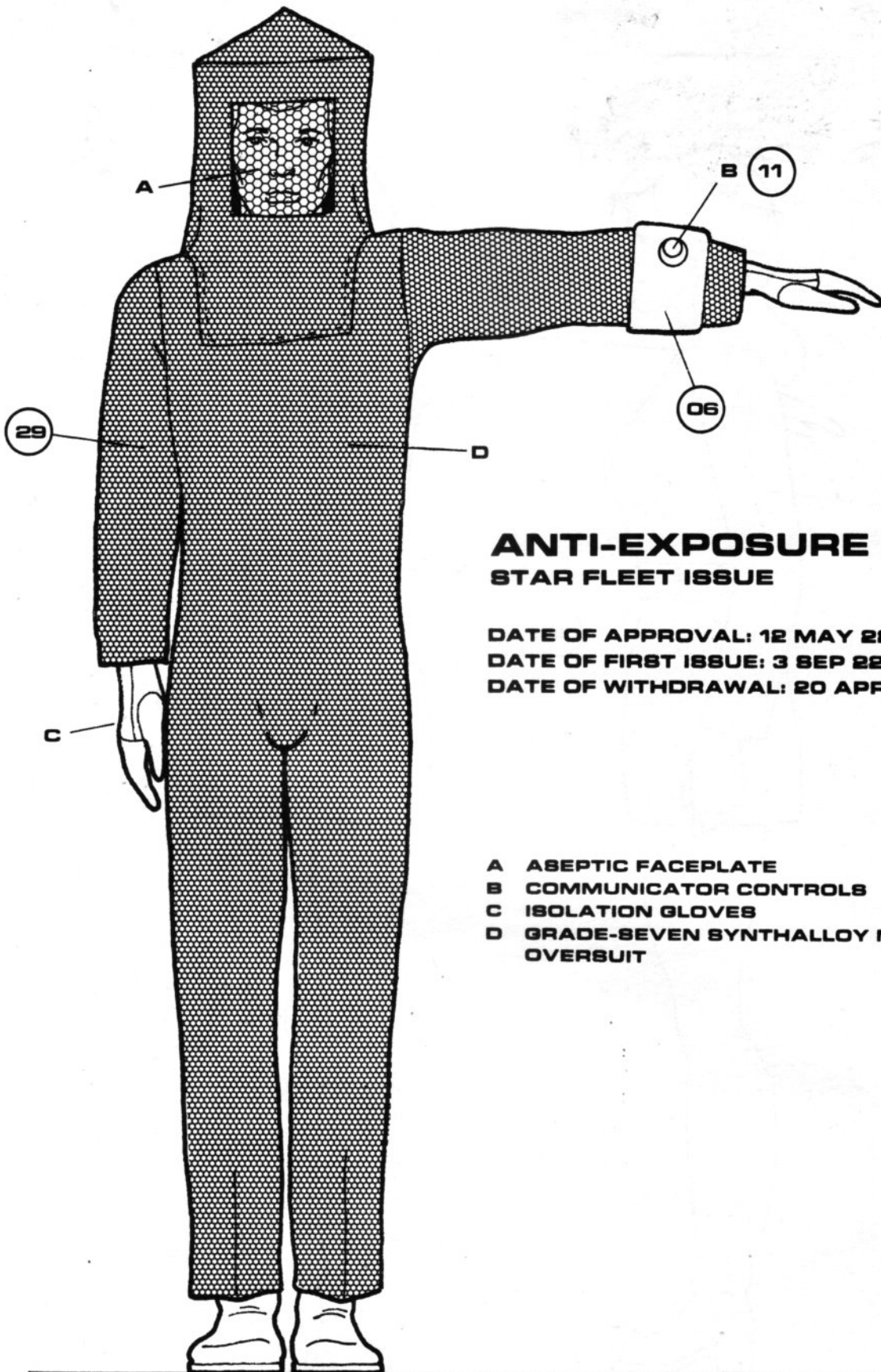

ANTI-EXPOSURE SUIT STAR FLEET ISSUE

DATE OF APPROVAL: 12 MAY 2207

DATE OF FIRST ISSUE: 3 SEP 2207

DATE OF WITHDRAWAL: 20 APR 2214

- A ASEPTIC FACEPLATE**
- B COMMUNICATOR CONTROLS**
- C ISOLATION GLOVES**
- D GRADE-SEVEN SYNTHALLOY MESH
OVERSUIT**

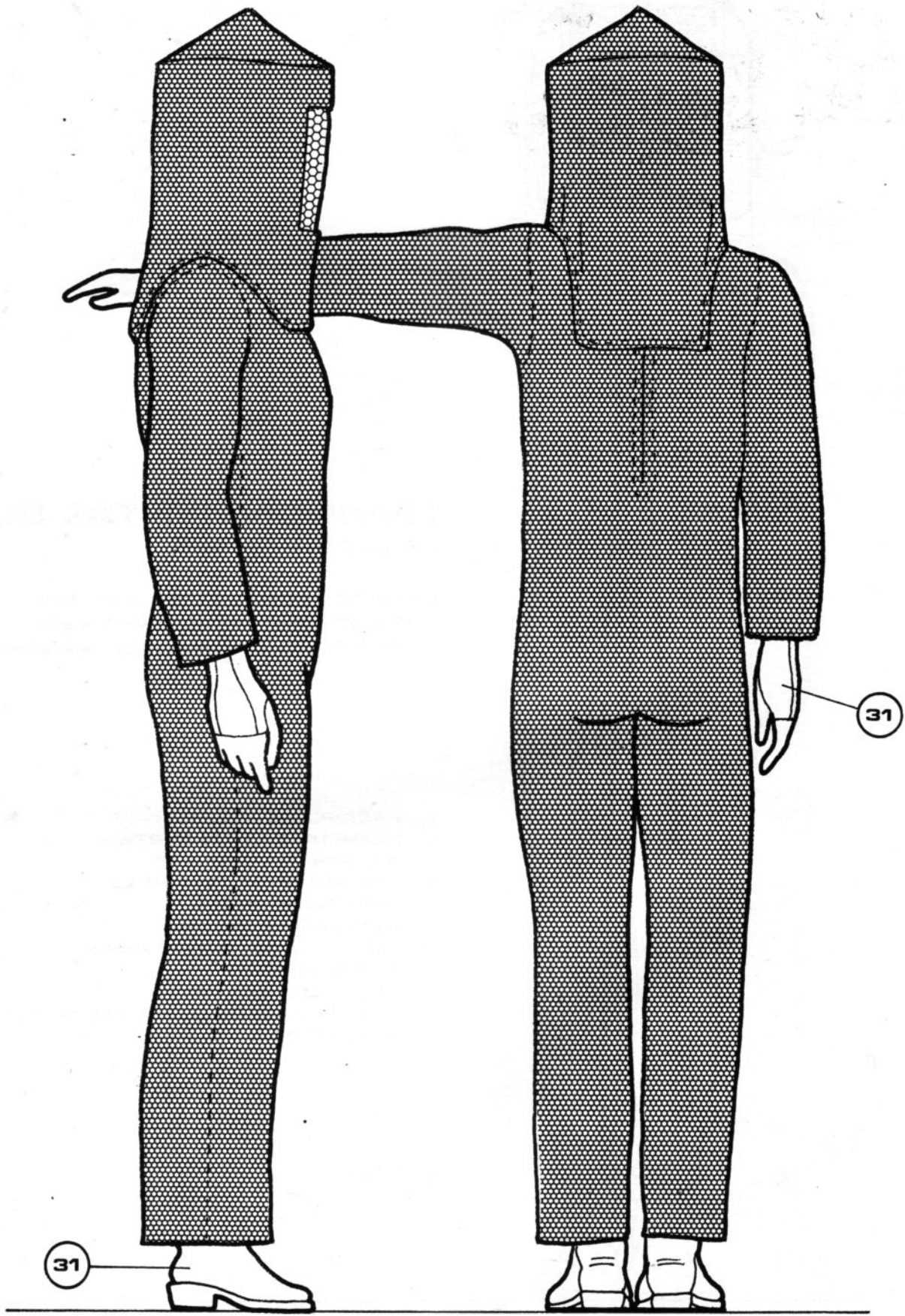

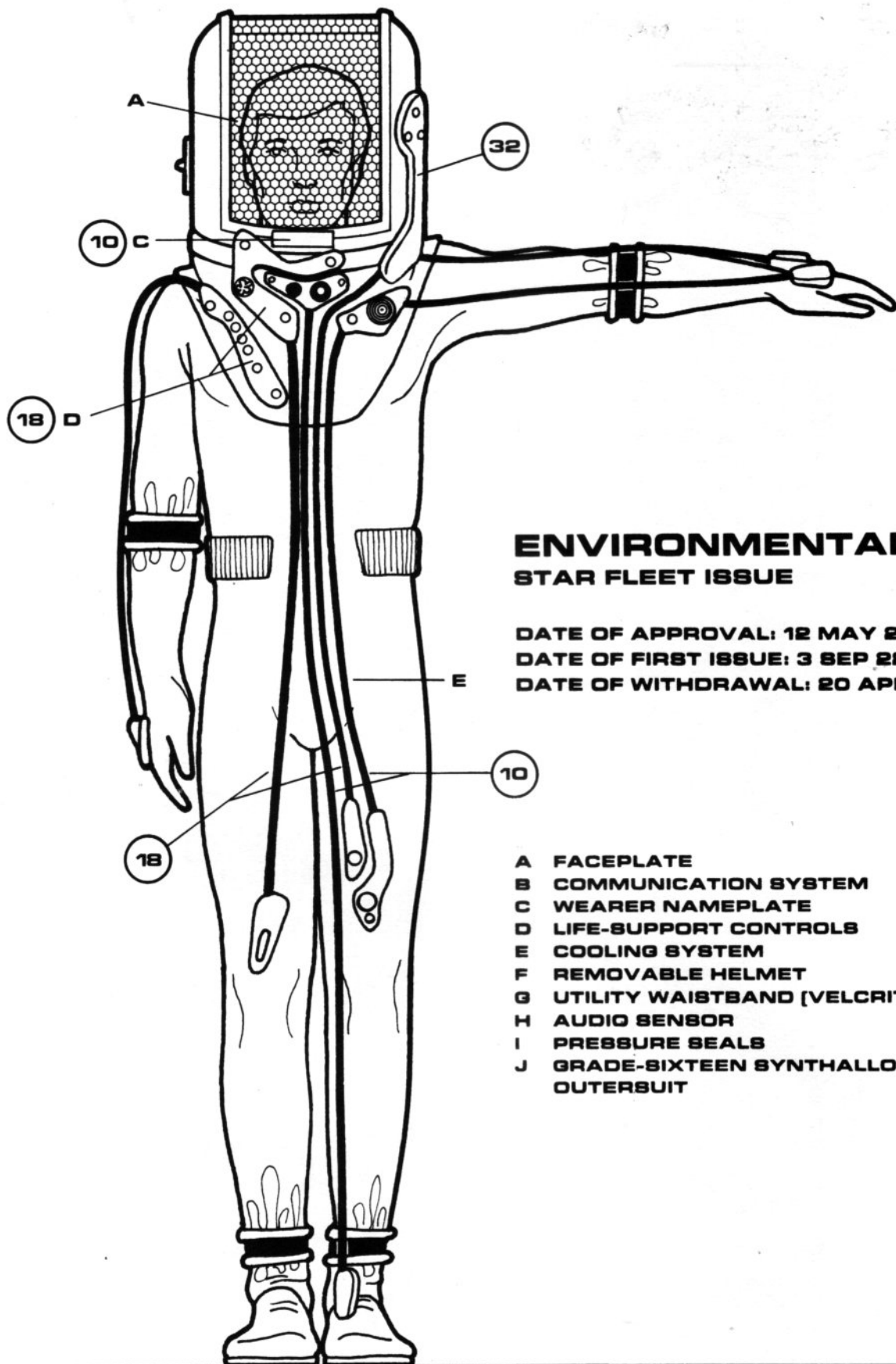

ENVIRONMENTAL SUIT STAR FLEET ISSUE

DATE OF APPROVAL: 12 MAY 2207

DATE OF FIRST ISSUE: 3 SEP 2207

DATE OF WITHDRAWAL: 20 APR 2214

- A FACEPLATE
- B COMMUNICATION SYSTEM
- C WEARER NAMEPLATE
- D LIFE-SUPPORT CONTROLS
- E COOLING SYSTEM
- F REMOVABLE HELMET
- G UTILITY WAISTBAND (VELCRITE)
- H AUDIO SENSOR
- I PRESSURE SEALS
- J GRADE-SIXTEEN SYNTHALLOY MESH
OUTERSUIT

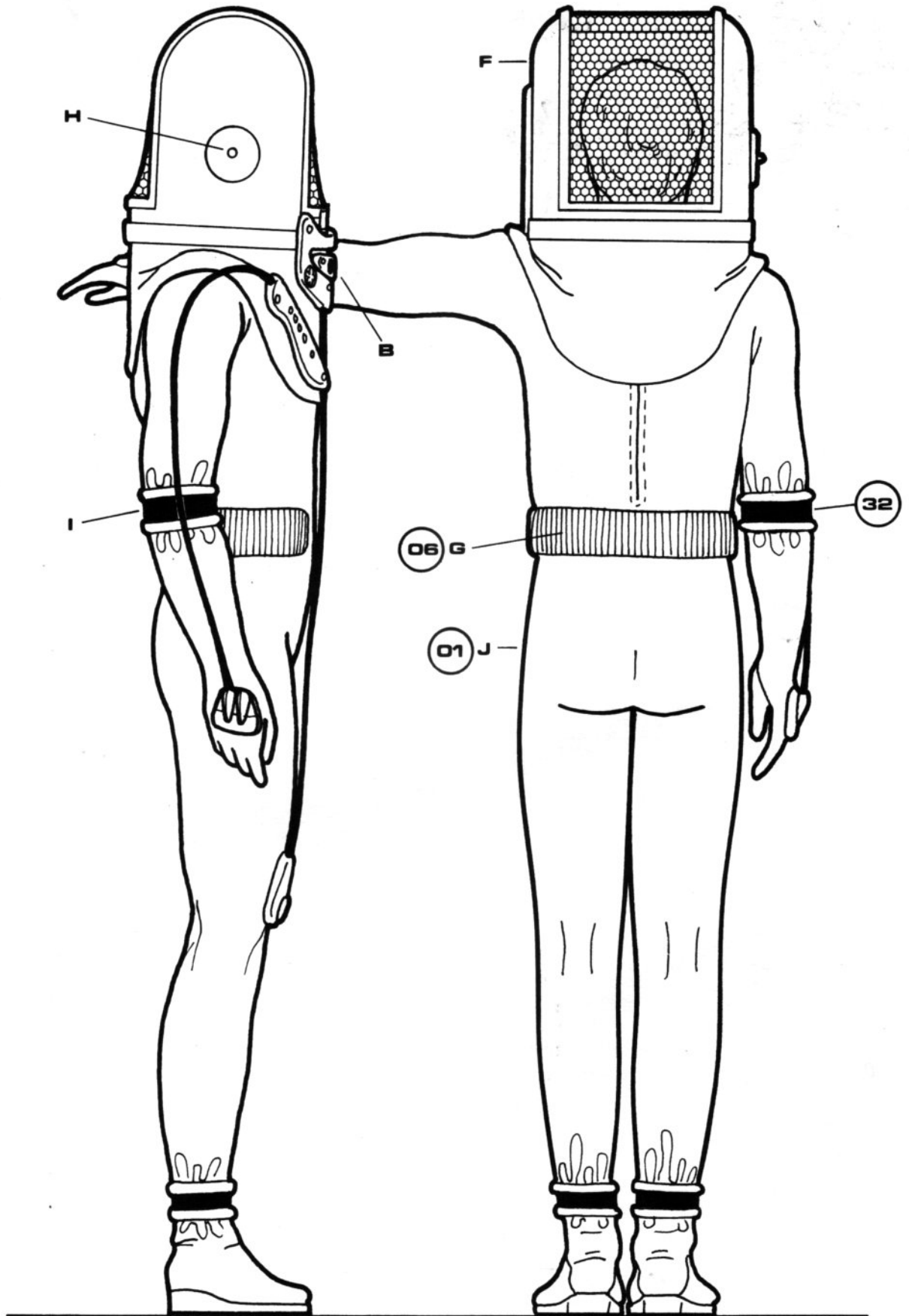

STAR FLEET

UNIFORMS [CURRENT]



HISTORICAL DATA DATABANK HARDCOPY

ON 31 OCTOBER, 2218, STAR FLEET REPLACED THE UNIFORM STYLE USED DURING THE V'GER INCIDENT WITH A NEW SERIES OF DUTY GARMENTS. UNLIKE THE PREVIOUS FORM-FITTING JUMPSUIT, THE NEW SHIRT/TUNIC/TROUSER COMBINATION WAS VERY WELL RECEIVED BY BOTH STAR FLEET PERSONNEL AND THE CIVILIAN POPULATION AS WELL.

ALL FIELD UNIFORM ITEMS ARE COMPLIMENTARY IN BOTH COLOR AND DESIGN, PRESENTING A DESIRABLE FIRST IMPRESSION TO THOSE ENCOUNTERING FEDERATION LANDING PARTIES, AS WELL AS TO VISITING FOREIGN PERSONNEL. THIS DUTY UNIFORM SYSTEM IS STILL IN USE AT THE PRESENT TIME.

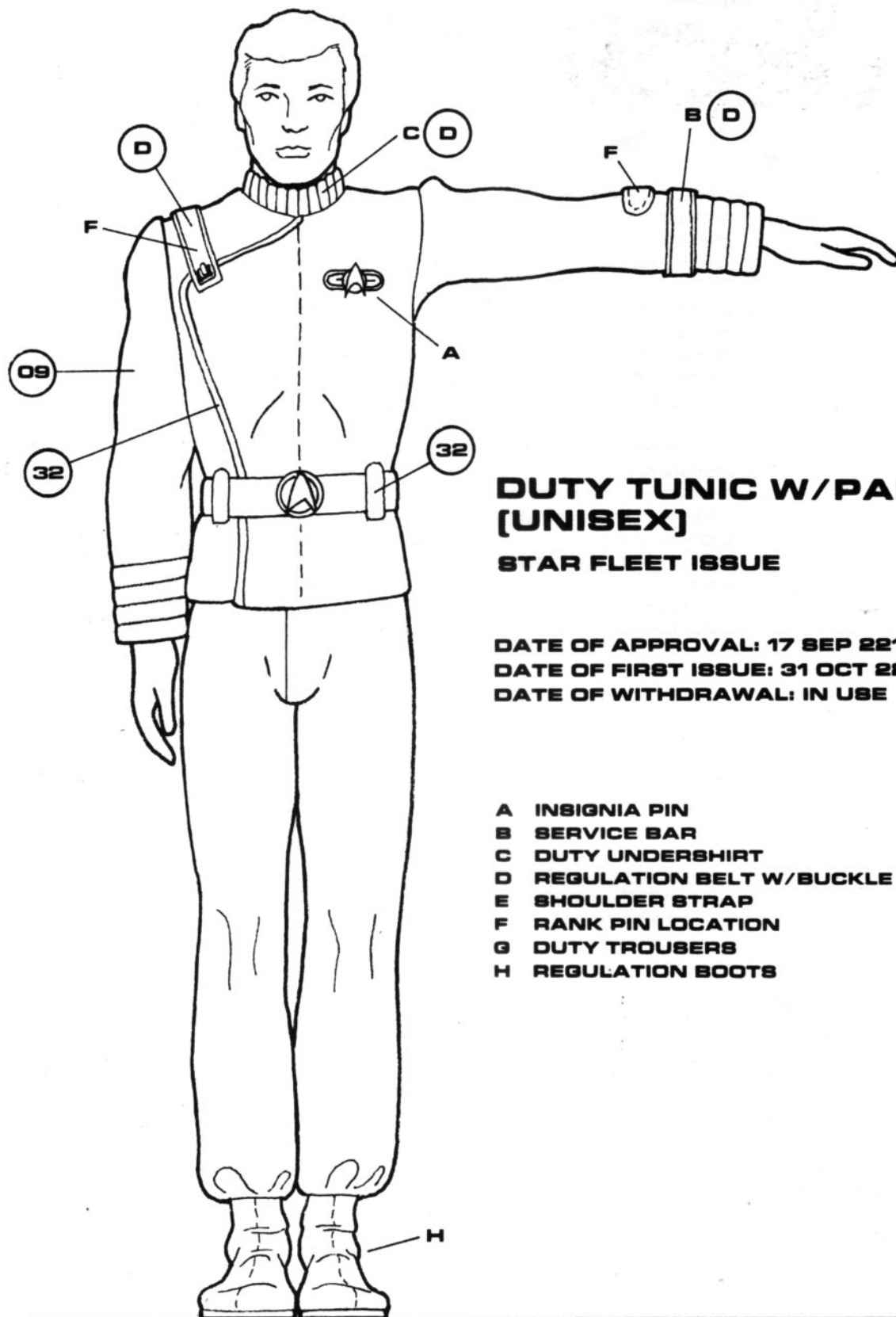

DUTY TUNIC W/PANTS [UNISEX]

STAR FLEET ISSUE

DATE OF APPROVAL: 17 SEP 2218
 DATE OF FIRST ISSUE: 31 OCT 2218
 DATE OF WITHDRAWAL: IN USE

- A INSIGNIA PIN
- B SERVICE BAR
- C DUTY UNDERSHIRT
- D REGULATION BELT W/BUCKLE
- E SHOULDER STRAP
- F RANK PIN LOCATION
- G DUTY TROUSERS
- H REGULATION BOOTS

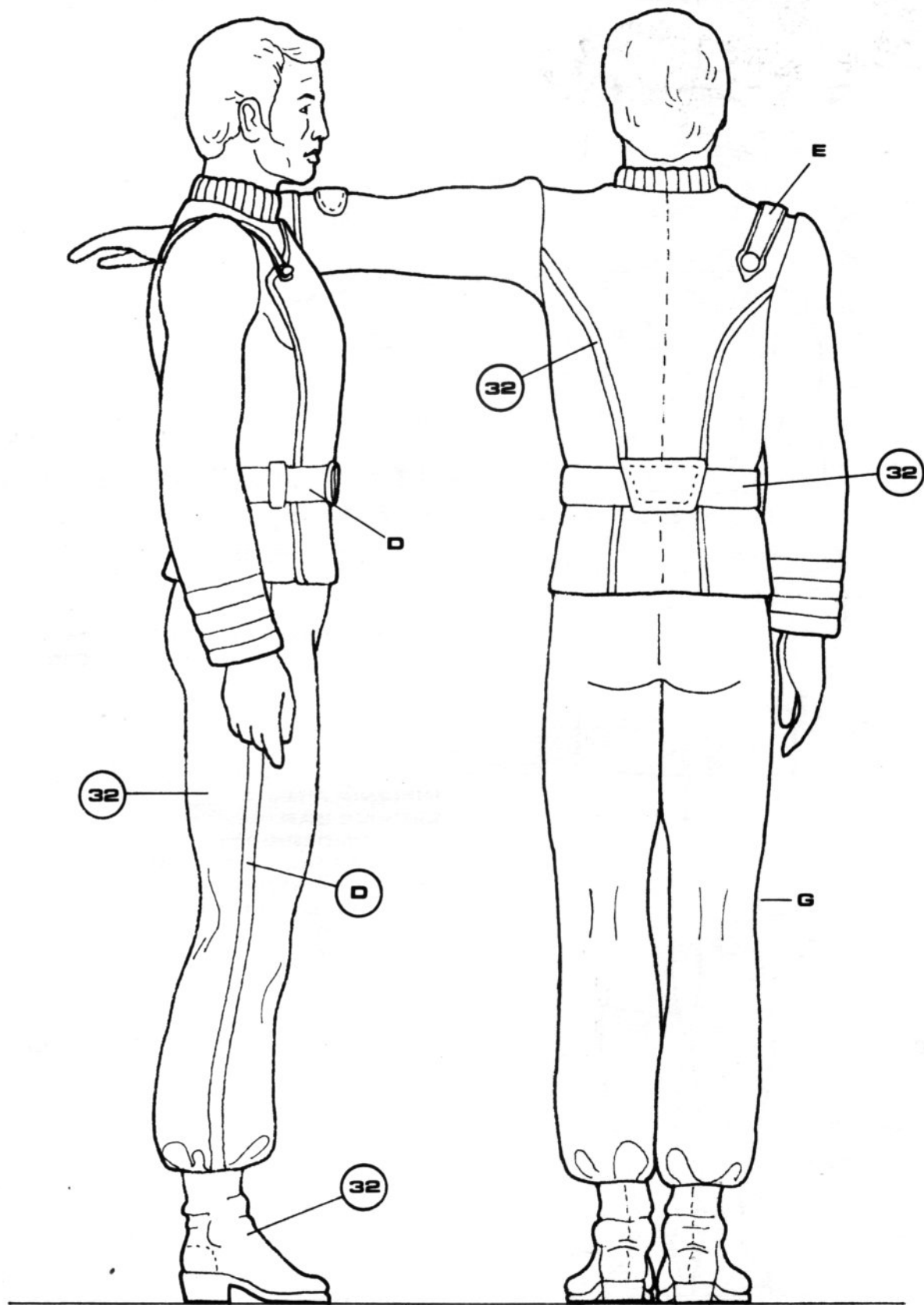

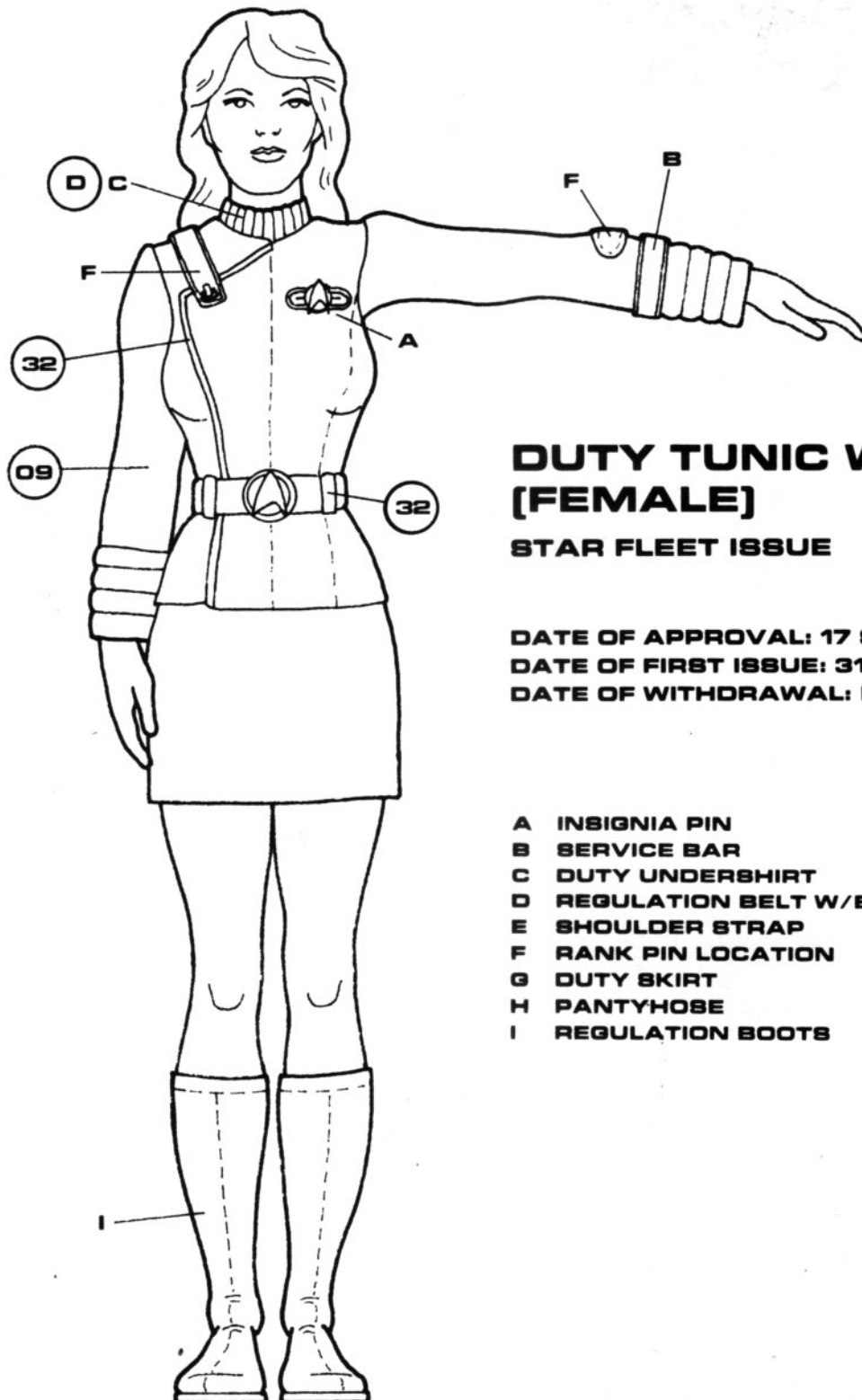

DUTY TUNIC W/SKIRT [FEMALE]

STAR FLEET ISSUE

DATE OF APPROVAL: 17 SEP 2218

DATE OF FIRST ISSUE: 31 OCT 2218

DATE OF WITHDRAWAL: IN USE

- A INSIGNIA PIN
- B SERVICE BAR
- C DUTY UNDERSHIRT
- D REGULATION BELT W/BUCKLE
- E SHOULDER STRAP
- F RANK PIN LOCATION
- G DUTY SKIRT
- H PANTYHOSE
- I REGULATION BOOTS

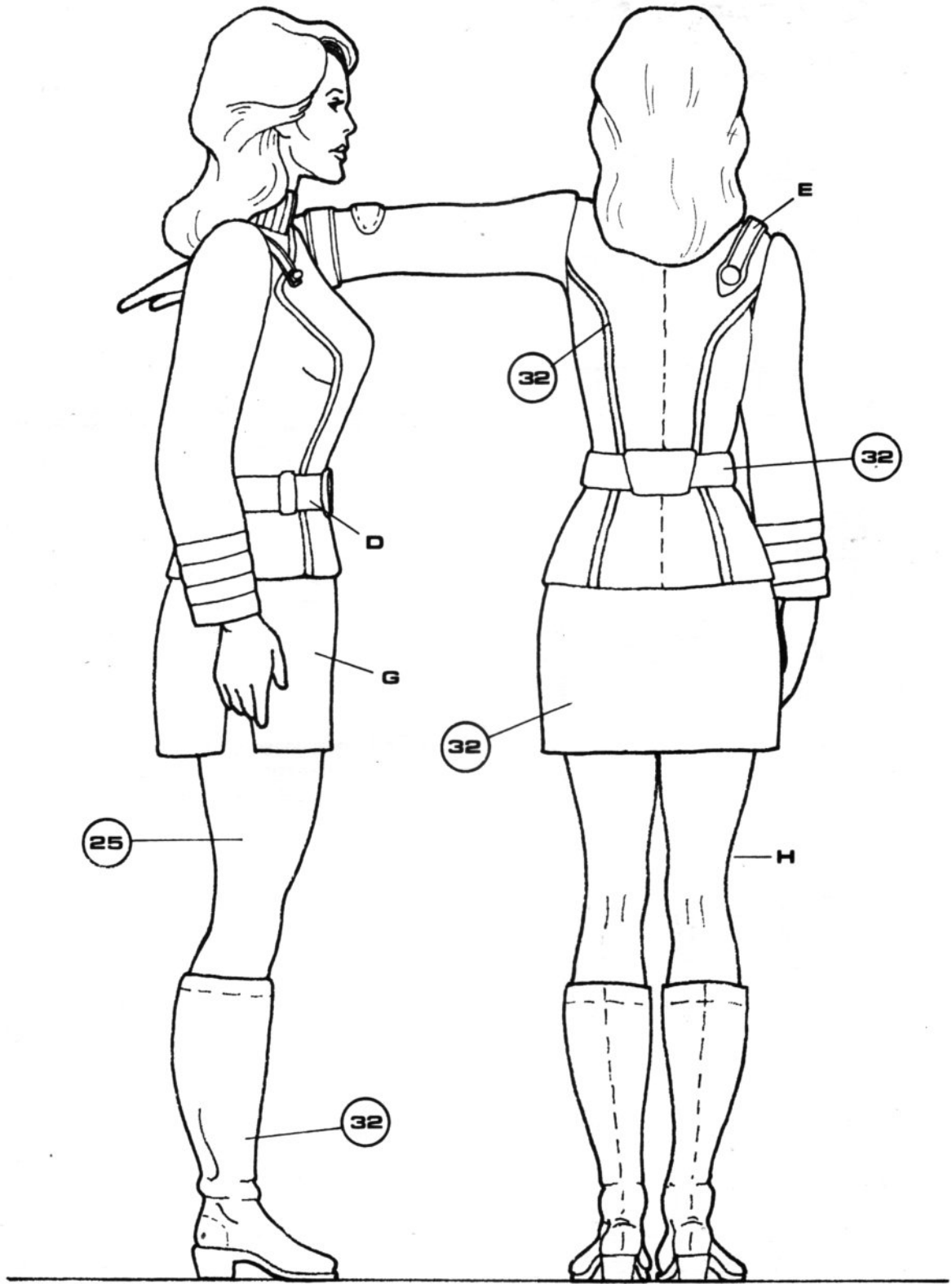

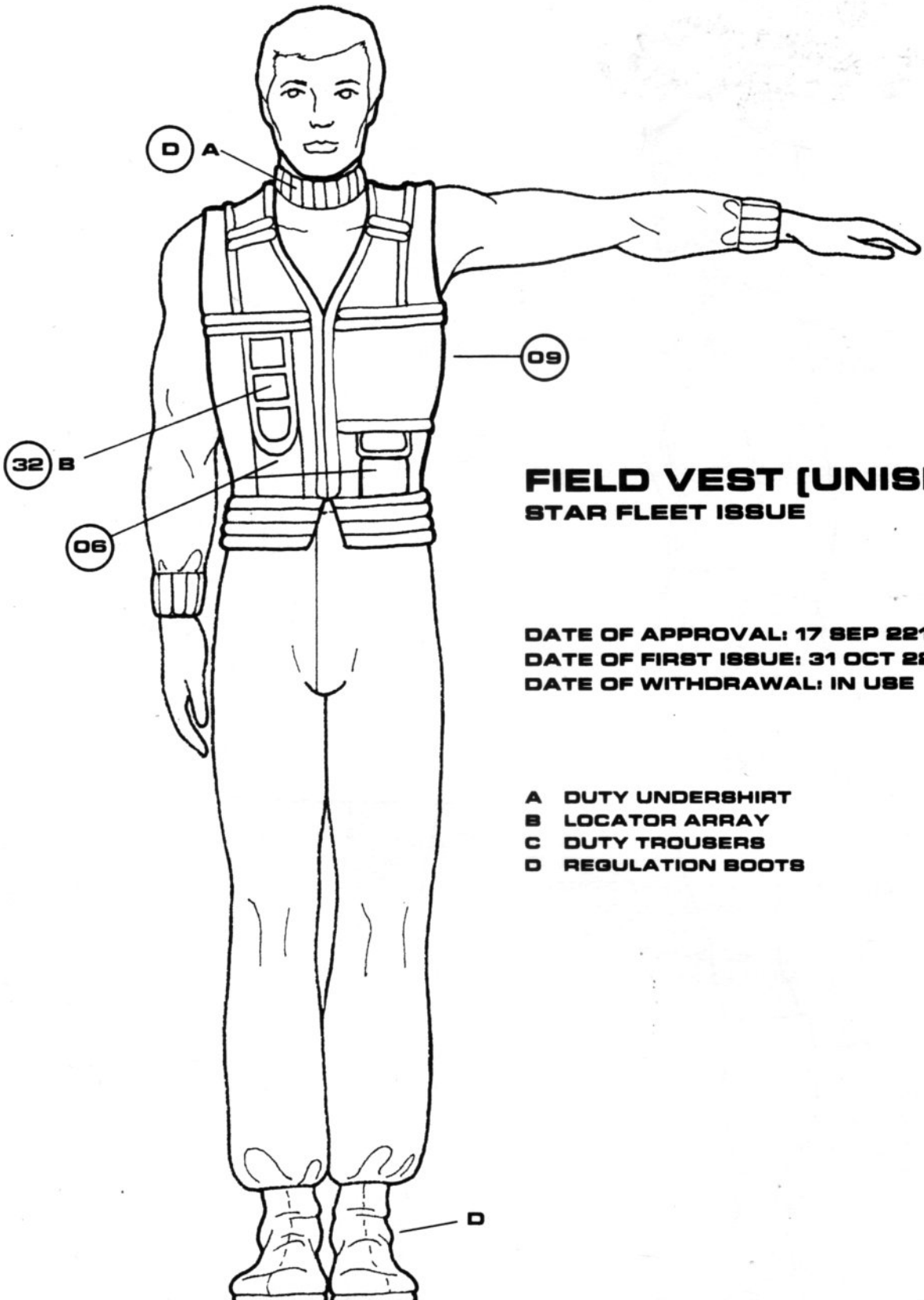

**FIELD VEST (UNISEX)
STAR FLEET ISSUE**

**DATE OF APPROVAL: 17 SEP 2218
DATE OF FIRST ISSUE: 31 OCT 2218
DATE OF WITHDRAWAL: IN USE**

- A DUTY UNDERSHIRT**
- B LOCATOR ARRAY**
- C DUTY TROUSERS**
- D REGULATION BOOTS**

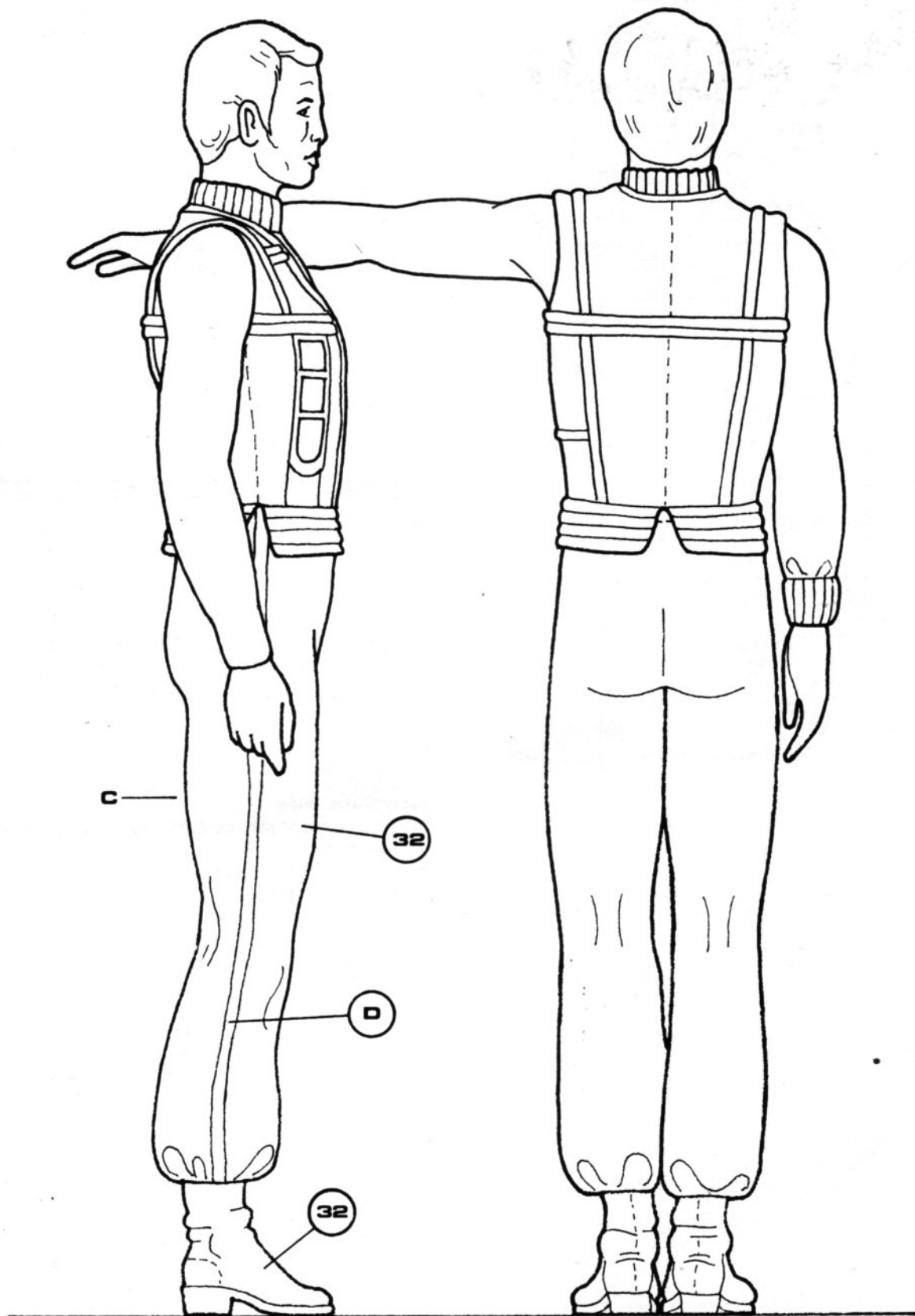

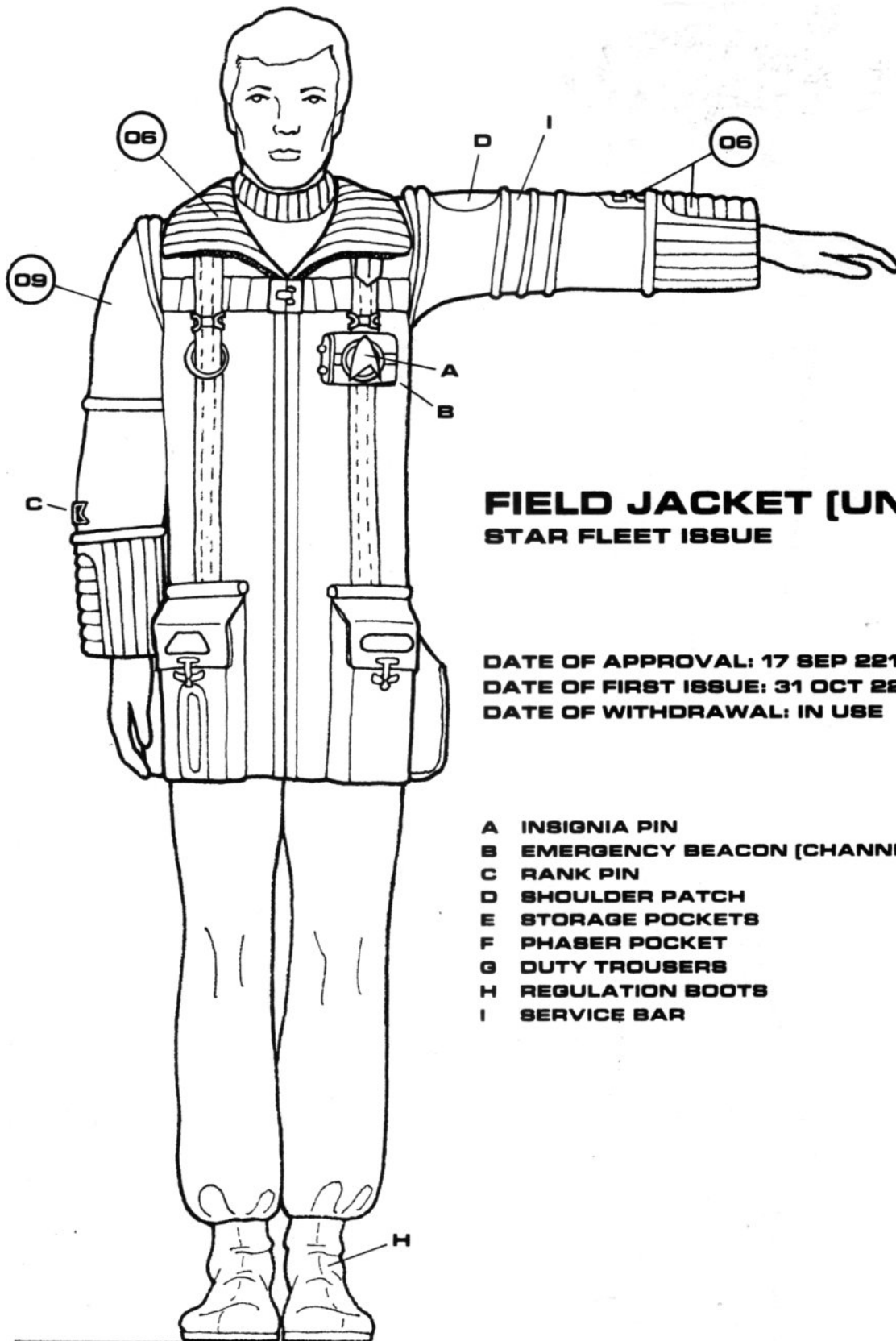

**FIELD JACKET (UNISEX)
STAR FLEET ISSUE**

**DATE OF APPROVAL: 17 SEP 2218
DATE OF FIRST ISSUE: 31 OCT 2218
DATE OF WITHDRAWAL: IN USE**

- A** INSIGNIA PIN
- B** EMERGENCY BEACON [CHANNEL K-44]
- C** RANK PIN
- D** SHOULDER PATCH
- E** STORAGE POCKETS
- F** PHASER POCKET
- G** DUTY TROUSERS
- H** REGULATION BOOTS
- I** SERVICE BAR

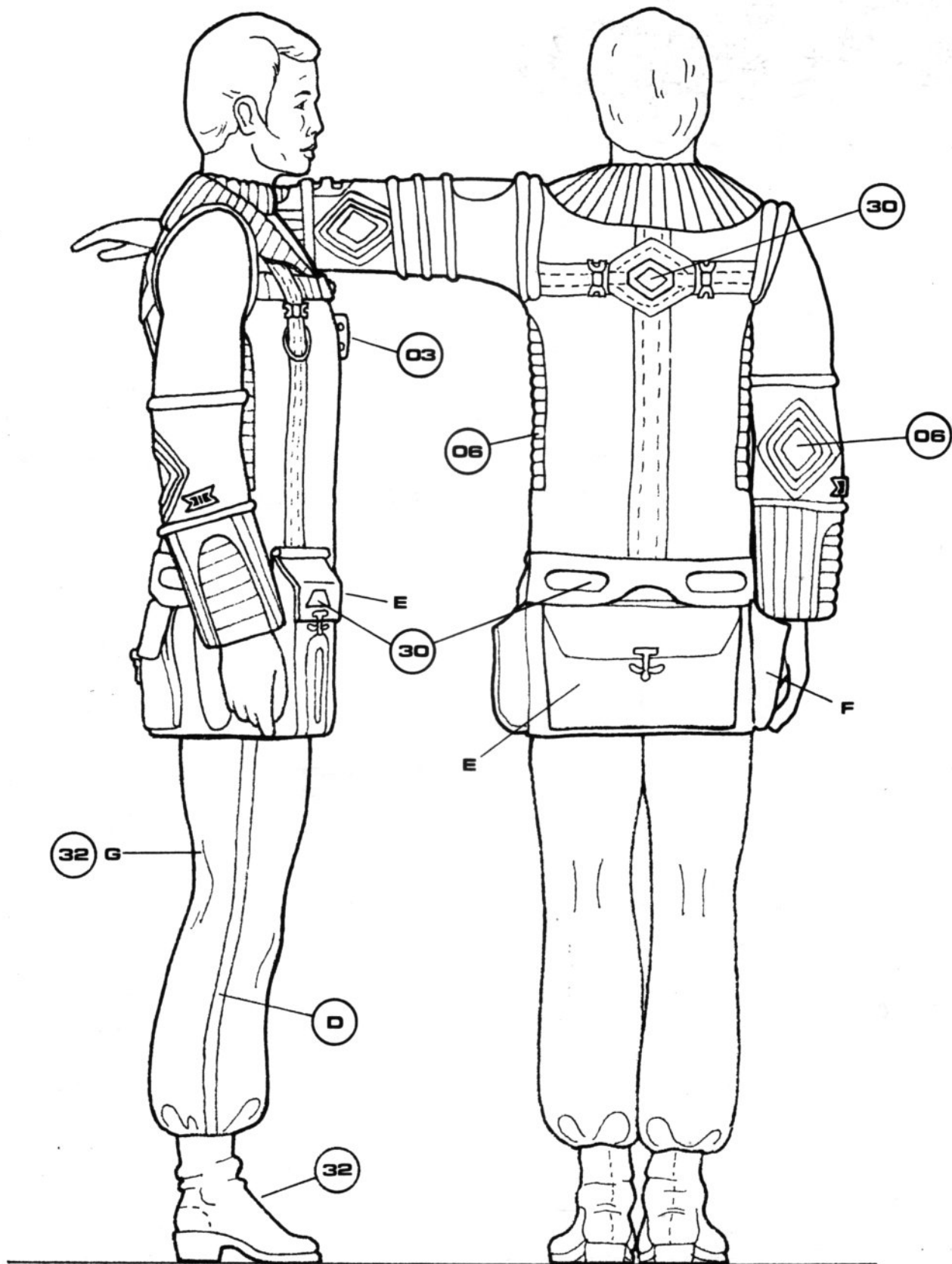

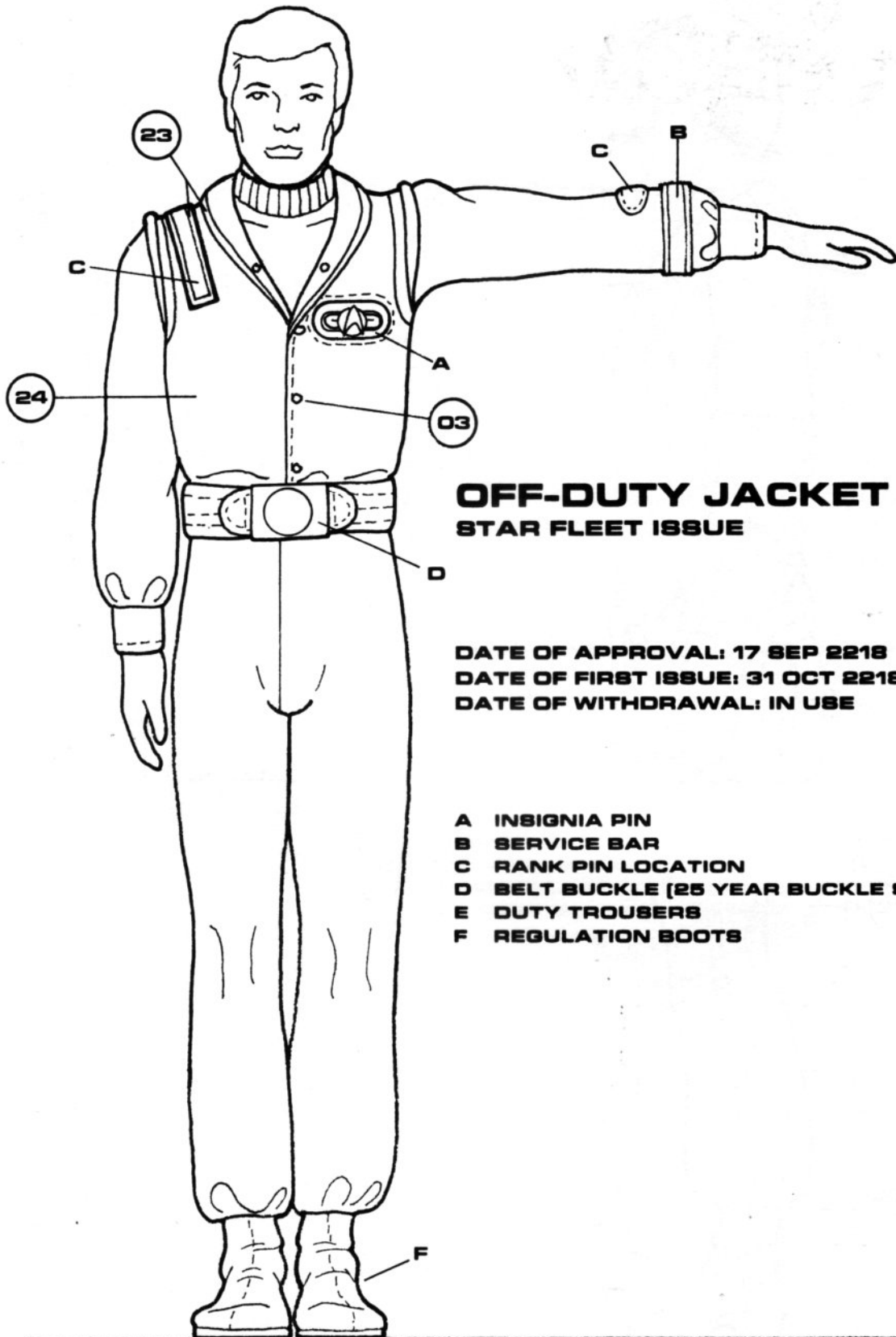

**OFF-DUTY JACKET (MALE)
STAR FLEET ISSUE**

**DATE OF APPROVAL: 17 SEP 2218
DATE OF FIRST ISSUE: 31 OCT 2218
DATE OF WITHDRAWAL: IN USE**

- A INSIGNIA PIN**
- B SERVICE BAR**
- C RANK PIN LOCATION**
- D BELT BUCKLE (25 YEAR BUCKLE SHOWN)**
- E DUTY TROUSERS**
- F REGULATION BOOTS**

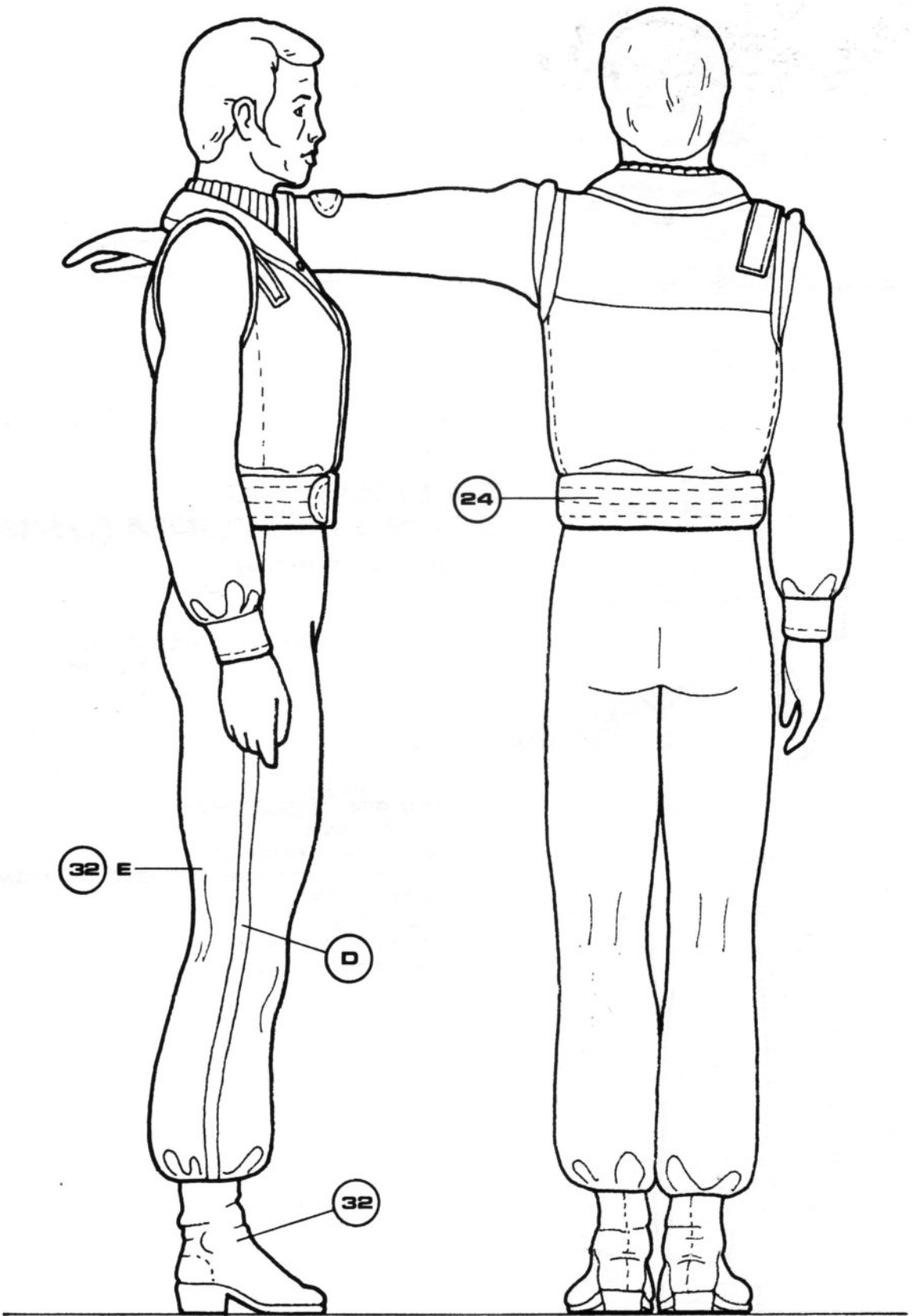

24

32 E

32

32

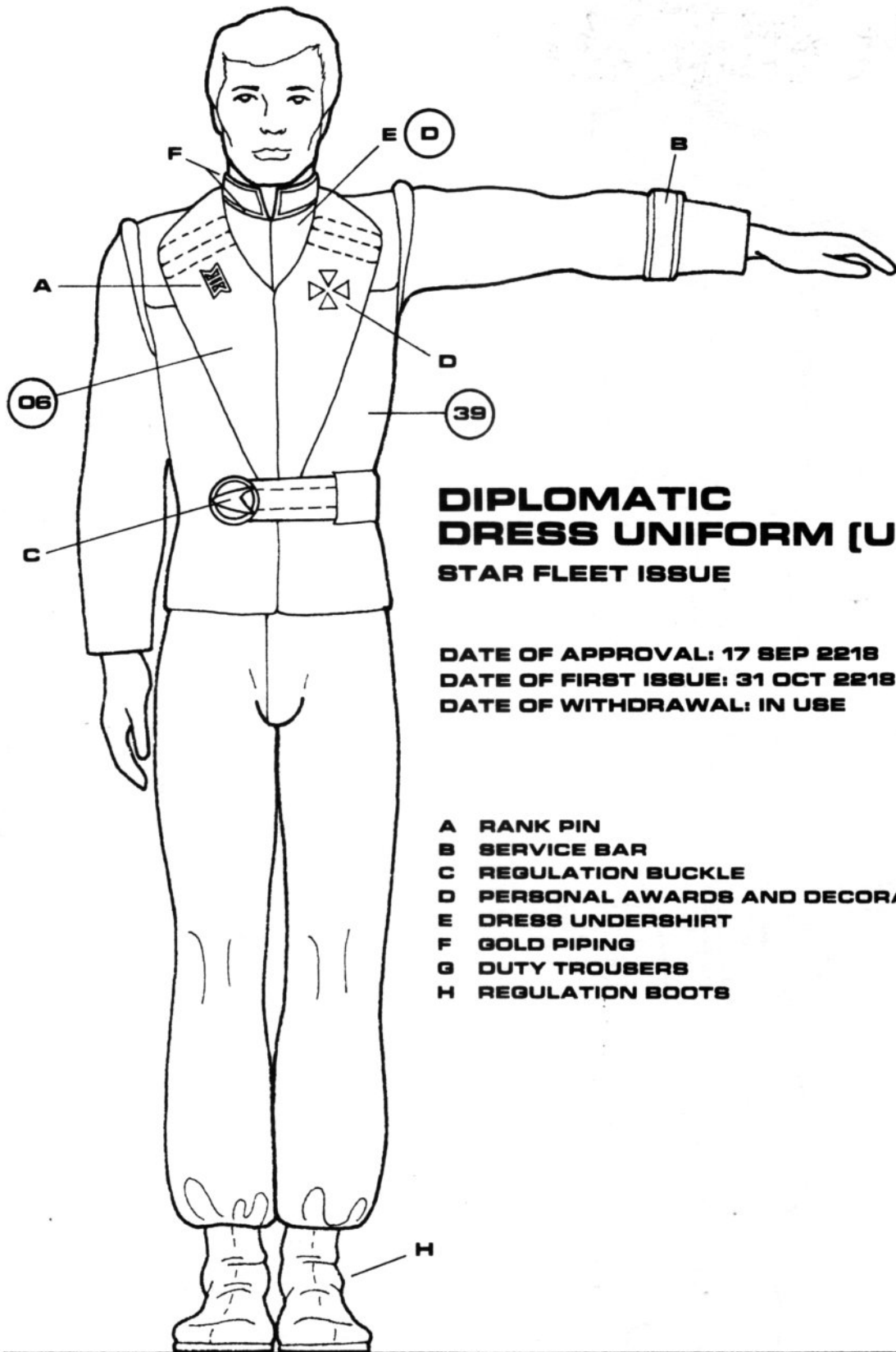

**DIPLOMATIC
DRESS UNIFORM [UNISEX]
STAR FLEET ISSUE**

**DATE OF APPROVAL: 17 SEP 2218
DATE OF FIRST ISSUE: 31 OCT 2218
DATE OF WITHDRAWAL: IN USE**

- A RANK PIN**
- B SERVICE BAR**
- C REGULATION BUCKLE**
- D PERSONAL AWARDS AND DECORATIONS**
- E DRESS UNDERSHIRT**
- F GOLD PIPING**
- G DUTY TROUSERS**
- H REGULATION BOOTS**

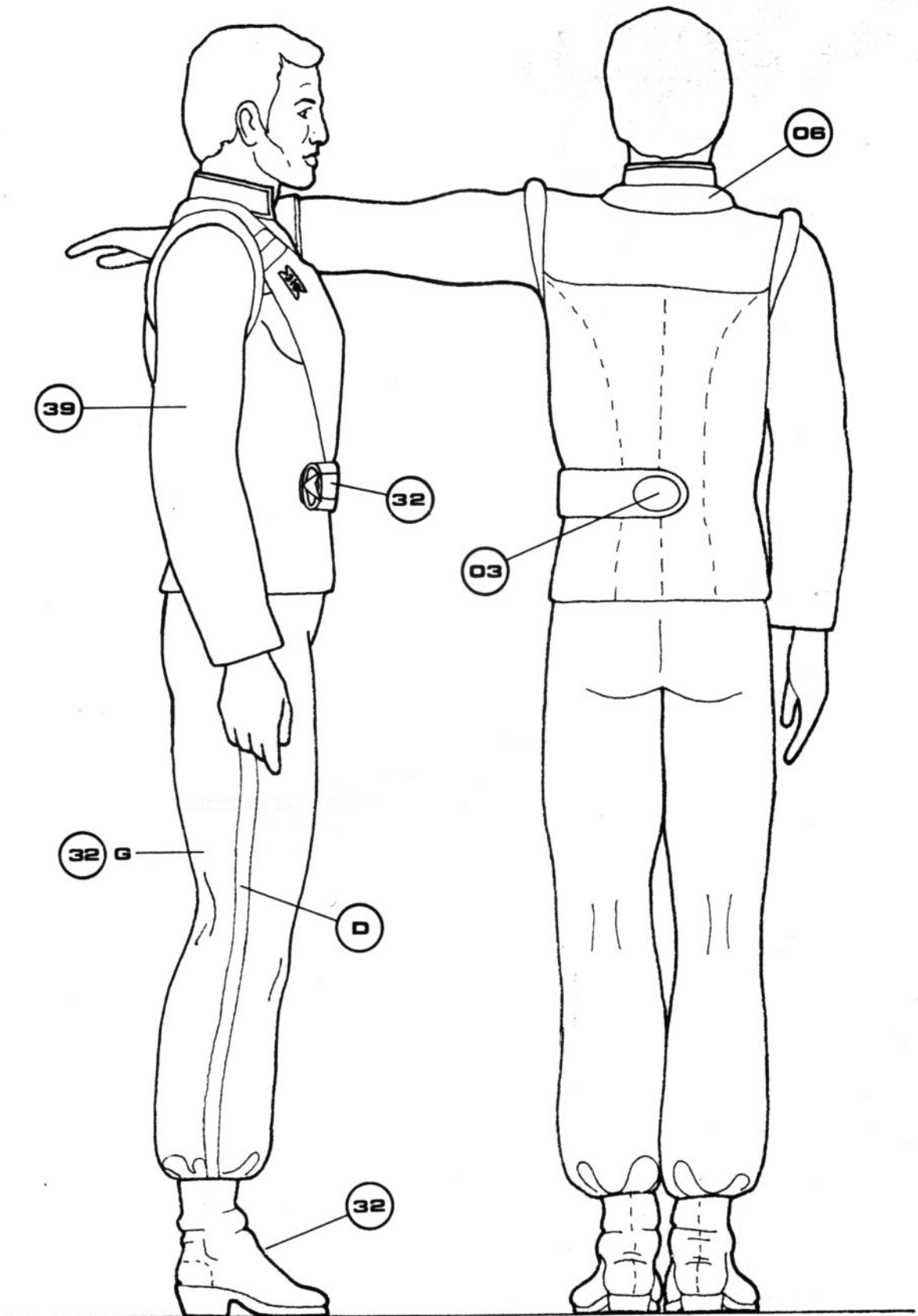

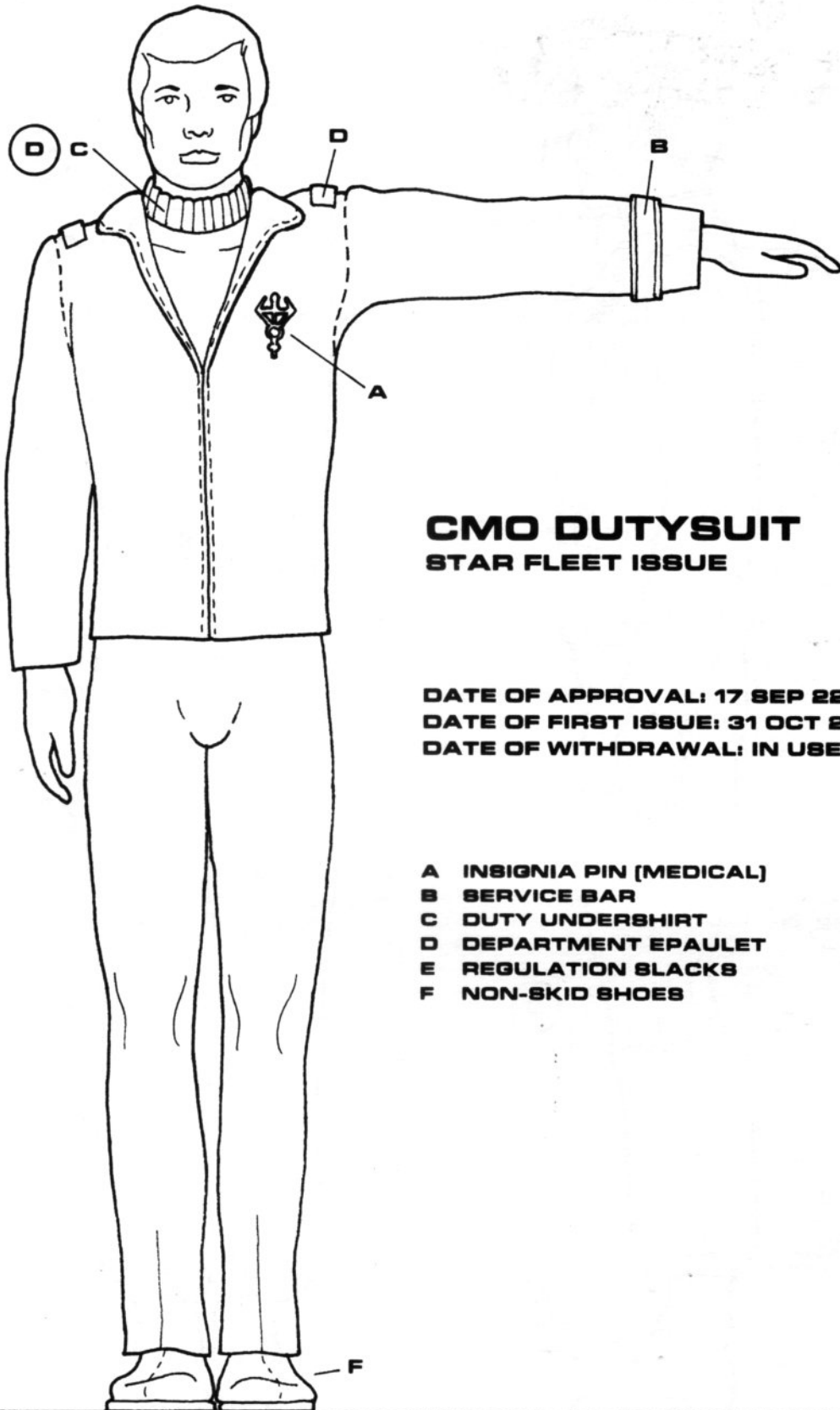

**CMO DUTYSUIT
STAR FLEET ISSUE**

**DATE OF APPROVAL: 17 SEP 2218
DATE OF FIRST ISSUE: 31 OCT 2218
DATE OF WITHDRAWAL: IN USE**

- A INSIGNIA PIN (MEDICAL)**
- B SERVICE BAR**
- C DUTY UNDERSHIRT**
- D DEPARTMENT EPAULET**
- E REGULATION BLACKS**
- F NON-SKID SHOES**

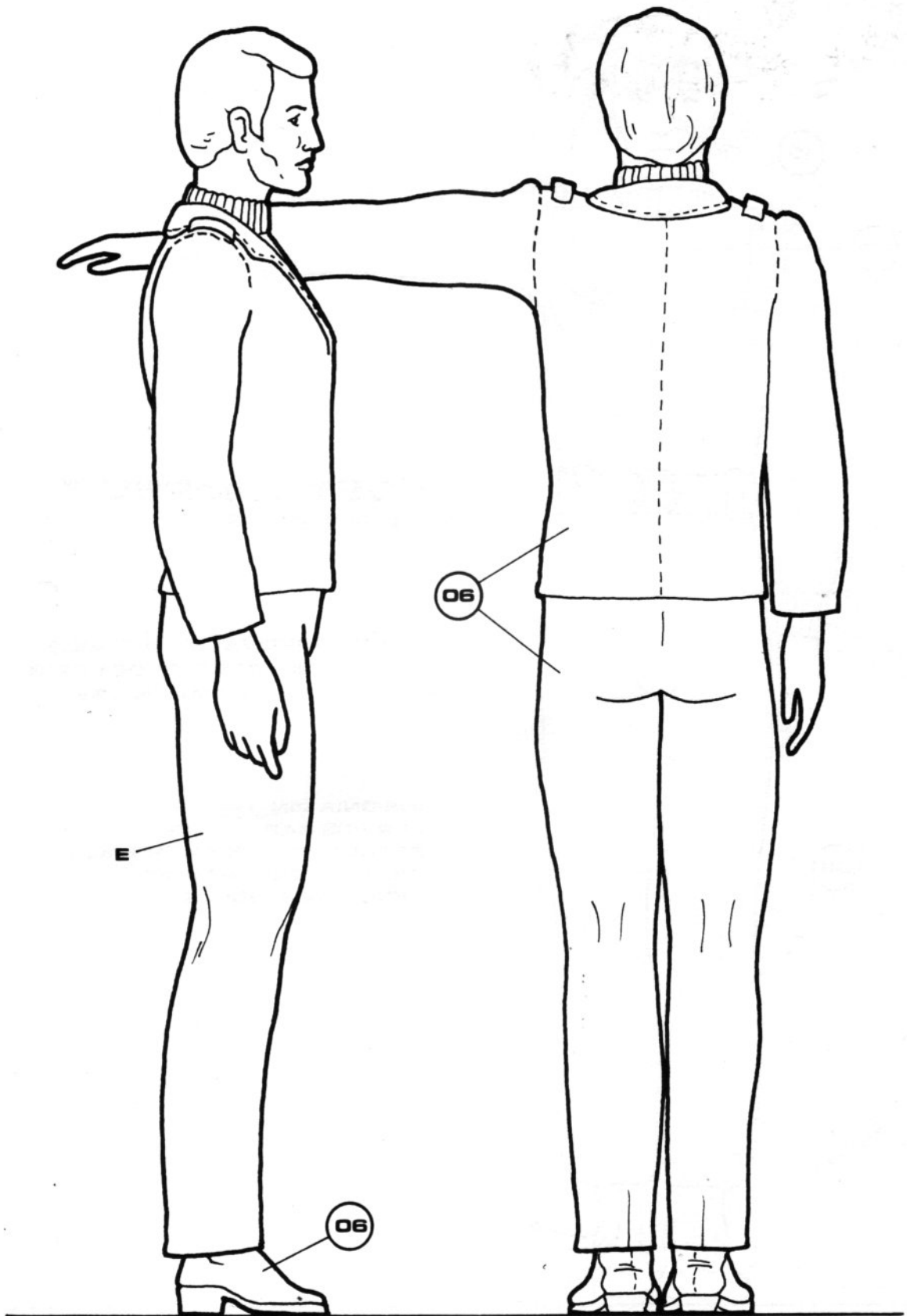

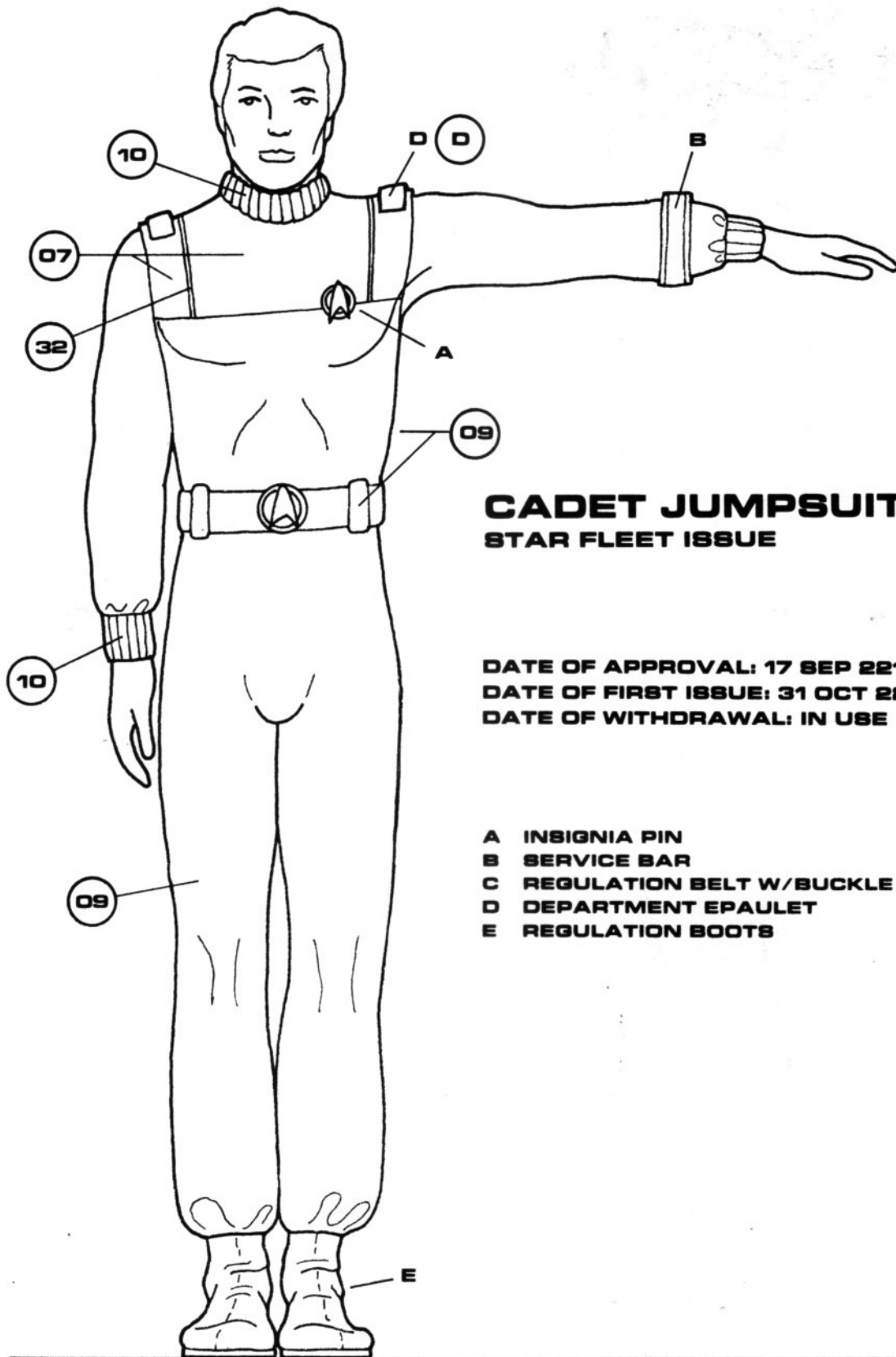

**CADET JUMPSUIT
STAR FLEET ISSUE**

**DATE OF APPROVAL: 17 SEP 2218
DATE OF FIRST ISSUE: 31 OCT 2218
DATE OF WITHDRAWAL: IN USE**

- A INSIGNIA PIN**
- B SERVICE BAR**
- C REGULATION BELT W/BUCKLE**
- D DEPARTMENT EPAULET**
- E REGULATION BOOTS**

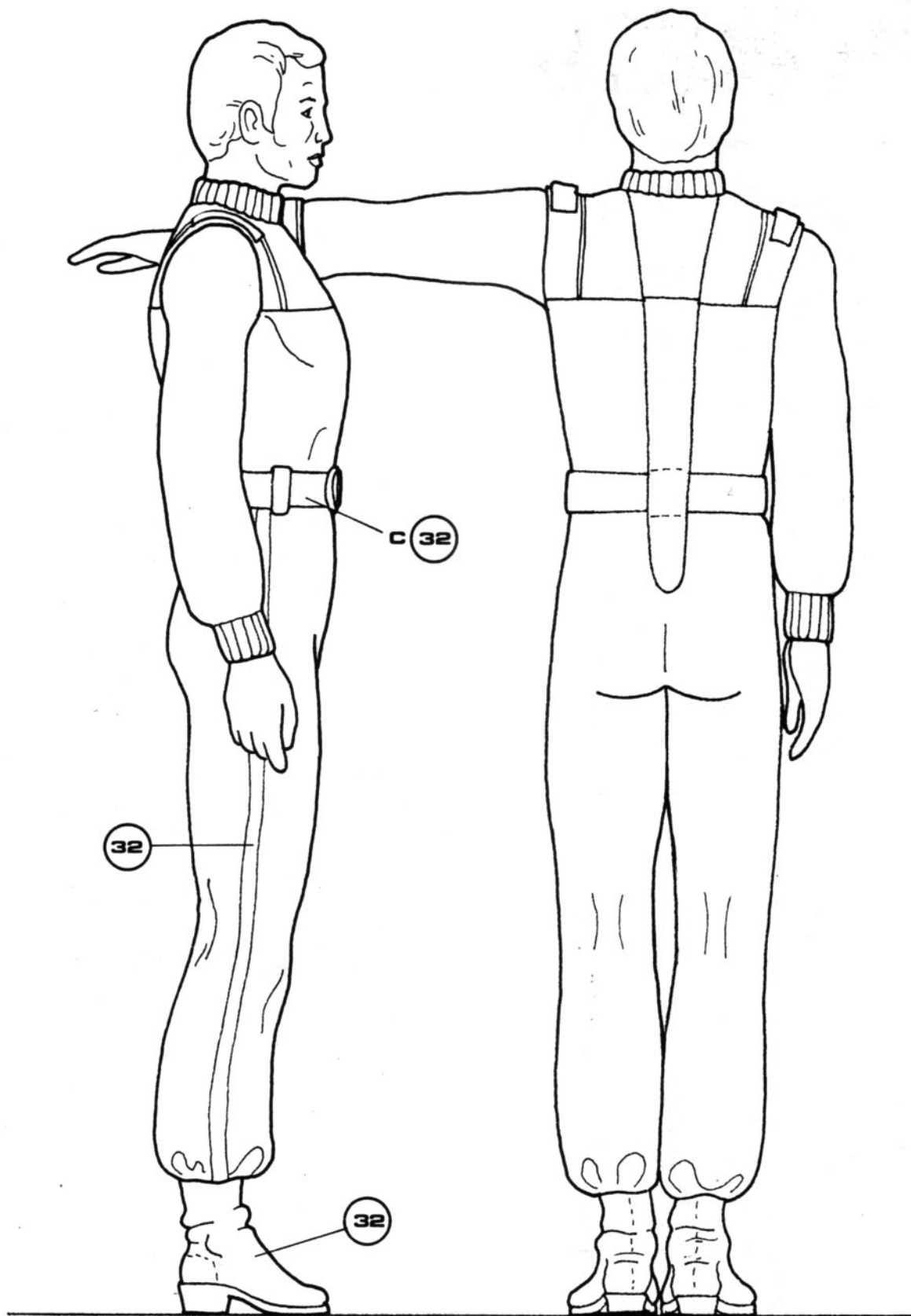

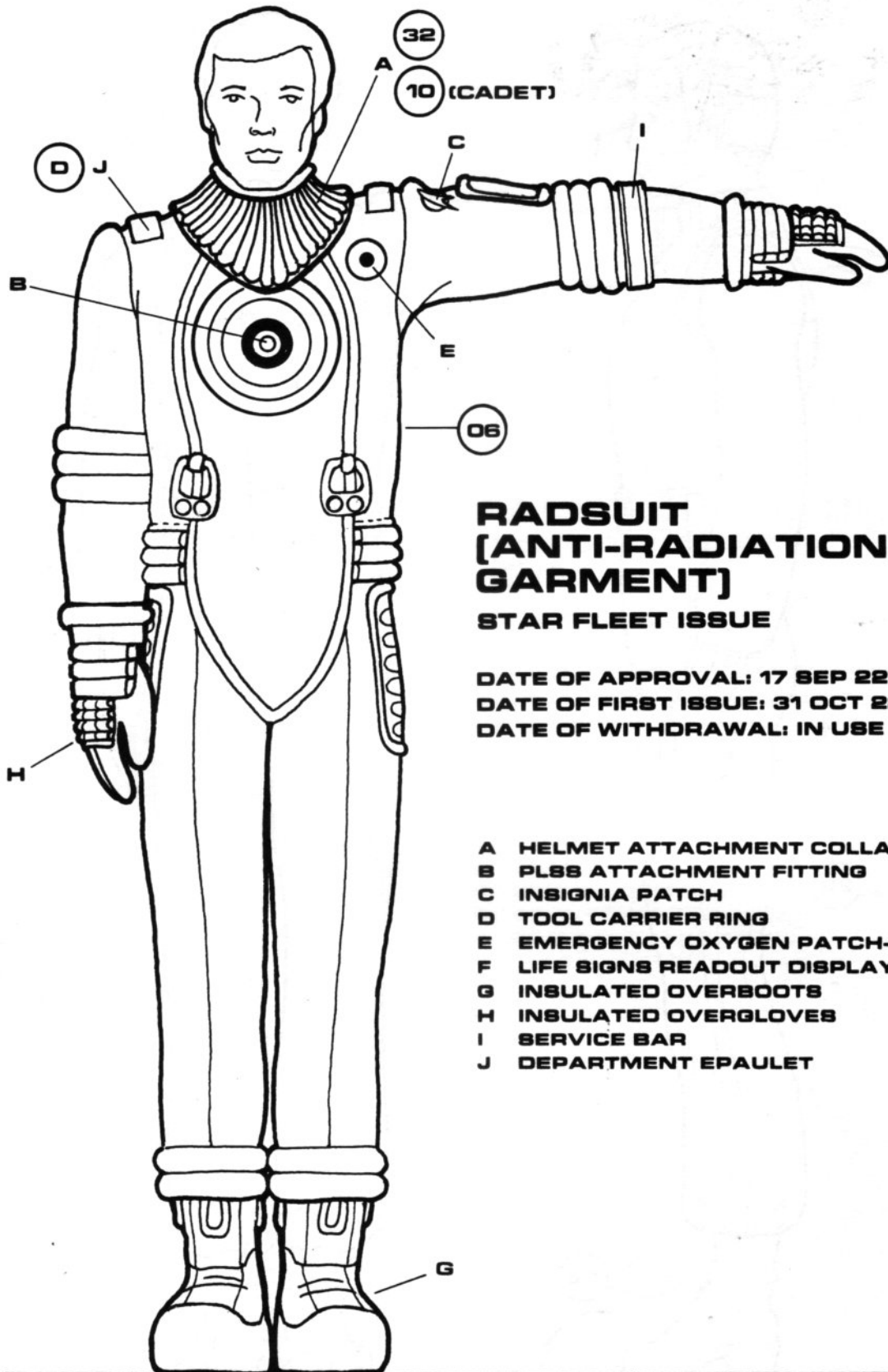

RADSUIT [ANTI-RADIATION GARMENT]

STAR FLEET ISSUE

**DATE OF APPROVAL: 17 SEP 2218
DATE OF FIRST ISSUE: 31 OCT 2218
DATE OF WITHDRAWAL: IN USE**

- A HELMET ATTACHMENT COLLAR**
- B PLSS ATTACHMENT FITTING**
- C INSIGNIA PATCH**
- D TOOL CARRIER RING**
- E EMERGENCY OXYGEN PATCH-IN**
- F LIFE SIGNS READOUT DISPLAY**
- G INSULATED OVERBOOTS**
- H INSULATED OVERGLOVES**
- I SERVICE BAR**
- J DEPARTMENT EPAULET**

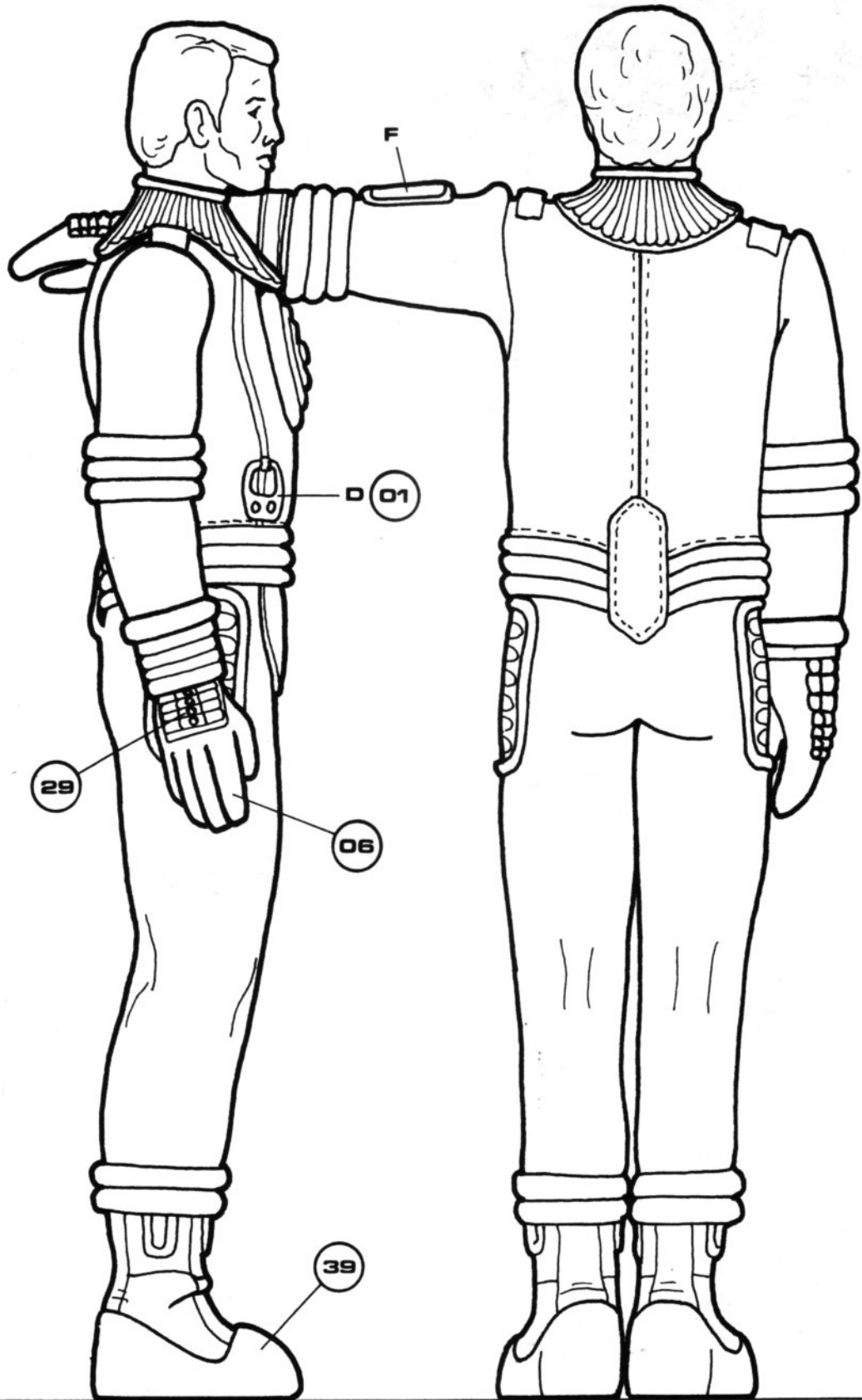

STAR FLEET

INTELLIGENCE REPORT



HISTORICAL DATA (KLINGON)

DATABANK HARDCOPY

UNTIL THE INTERCEPTION OF THE AMAR TRANSMISSION IN APRIL OF 2217, STAR FLEET COMMAND WAS UNAWARE OF THE TRUE NATURE OF THE KLINGON RACE. BEFORE THAT TIME, ANY KLINGON REPRESENTATIVE ENCOUNTERED WAS QUITE HUMAN IN APPEARANCE AND STATURE AND IT WAS ASSUMED THAT THIS WAS DUE TO THE PLANTING OF HUMANOID RACES THAT HAS BEEN THEORIZED TO HAVE TAKEN PLACE LONG AGO.

HOWEVER, NEW INTELLIGENCE HAS SHED LIGHT UPON THE MATTER. THE ORIGINAL IMPERIAL RACE, SEEN IN THE AMAR TRANSMISSION, HAS DEVELOPED THE SCIENCE OF GENETIC MODIFICATION BEYOND EVEN FEDERATION CAPABILITIES. THE HUMAN/KLINGON FUSION WHICH WAS PREVIOUSLY ASSUMED TO BE TRULY KLINGON WAS SPECIFICALLY CREATED [USING A PRESUMABLY CAPTURED HUMAN] FOR INTERACTION WITH THE NEWLY DISCOVERED HUMAN RACE. IT HAS BEEN LEARNED THAT FOLLOWING THE KLINGON/ROMULAN ALLIANCE A SUB-RACE HAS EMERGED WHICH HAS PHYSICAL CHARACTERISTICS OF BOTH RACES.

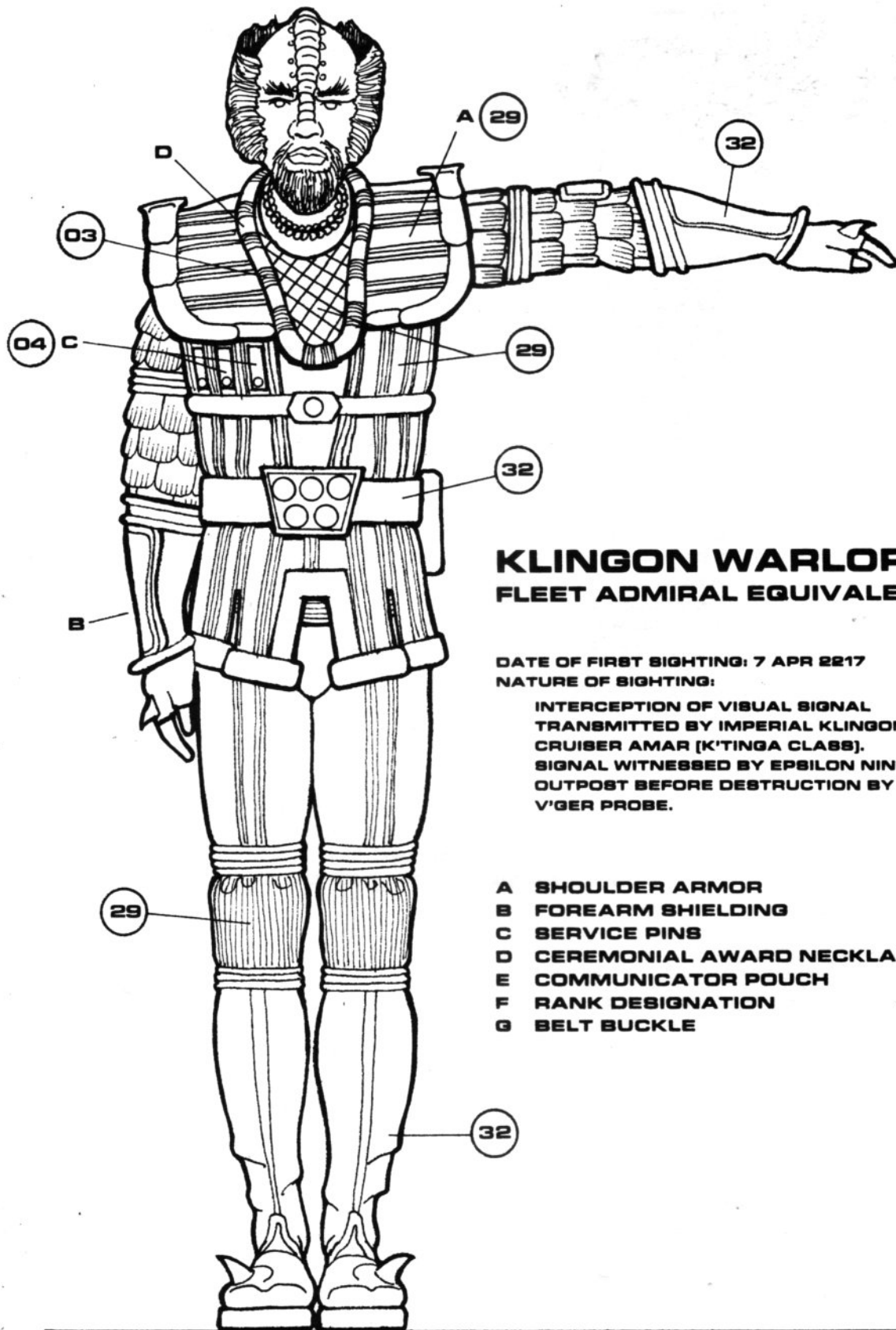

KLINGON WARLORD FLEET ADMIRAL EQUIVALENT

DATE OF FIRST SIGHTING: 7 APR 2217

NATURE OF SIGHTING:

INTERCEPTION OF VISUAL SIGNAL
TRANSMITTED BY IMPERIAL KLINGON
CRUISER AMAR (K'TINGA CLASS).
SIGNAL WITNESSED BY EPSILON NINE
OUTPOST BEFORE DESTRUCTION BY
V'GER PROBE.

- A SHOULDER ARMOR
- B FOREARM SHIELDING
- C SERVICE PINS
- D CEREMONIAL AWARD NECKLACE
- E COMMUNICATOR POUCH
- F RANK DESIGNATION
- G BELT BUCKLE

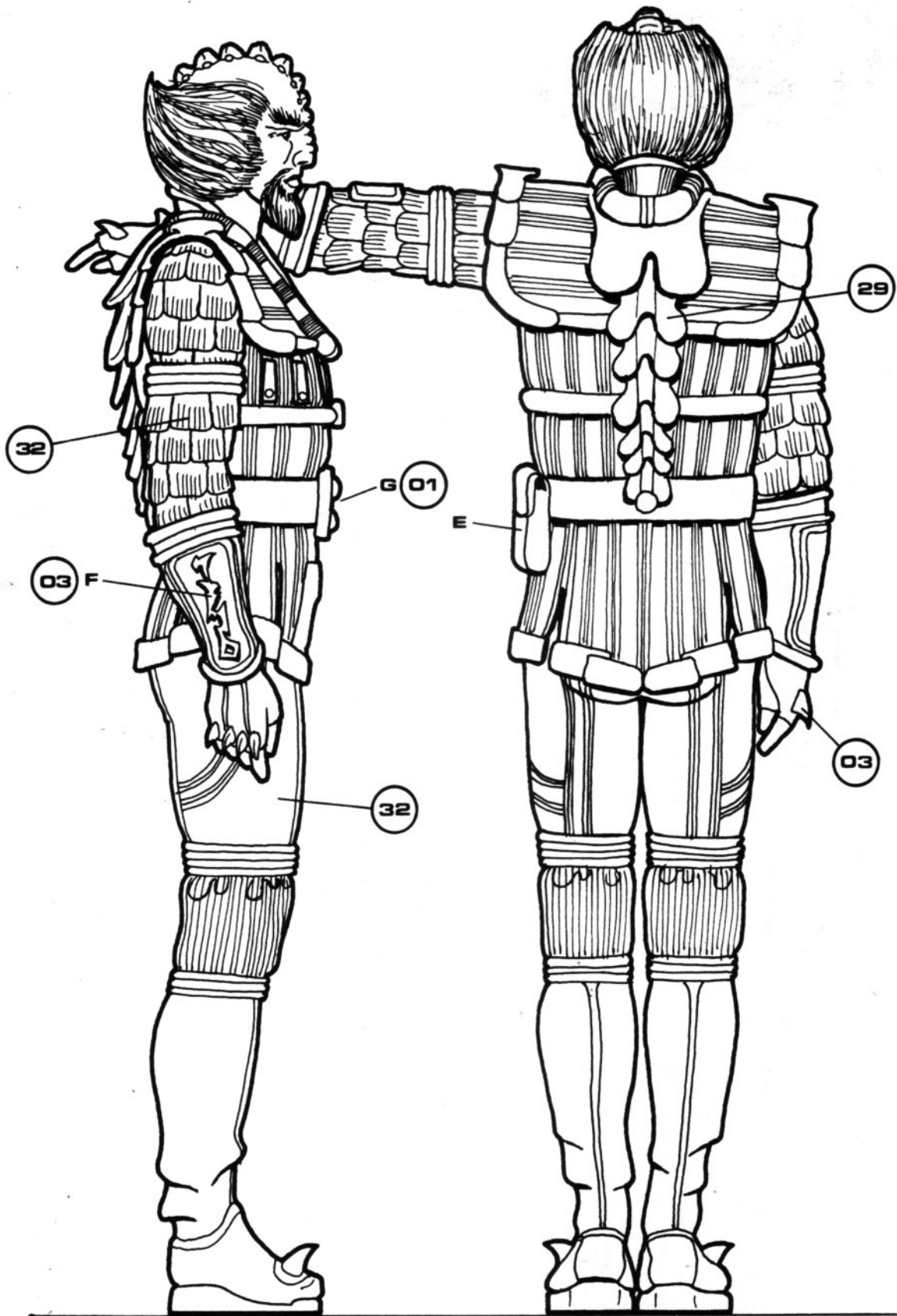

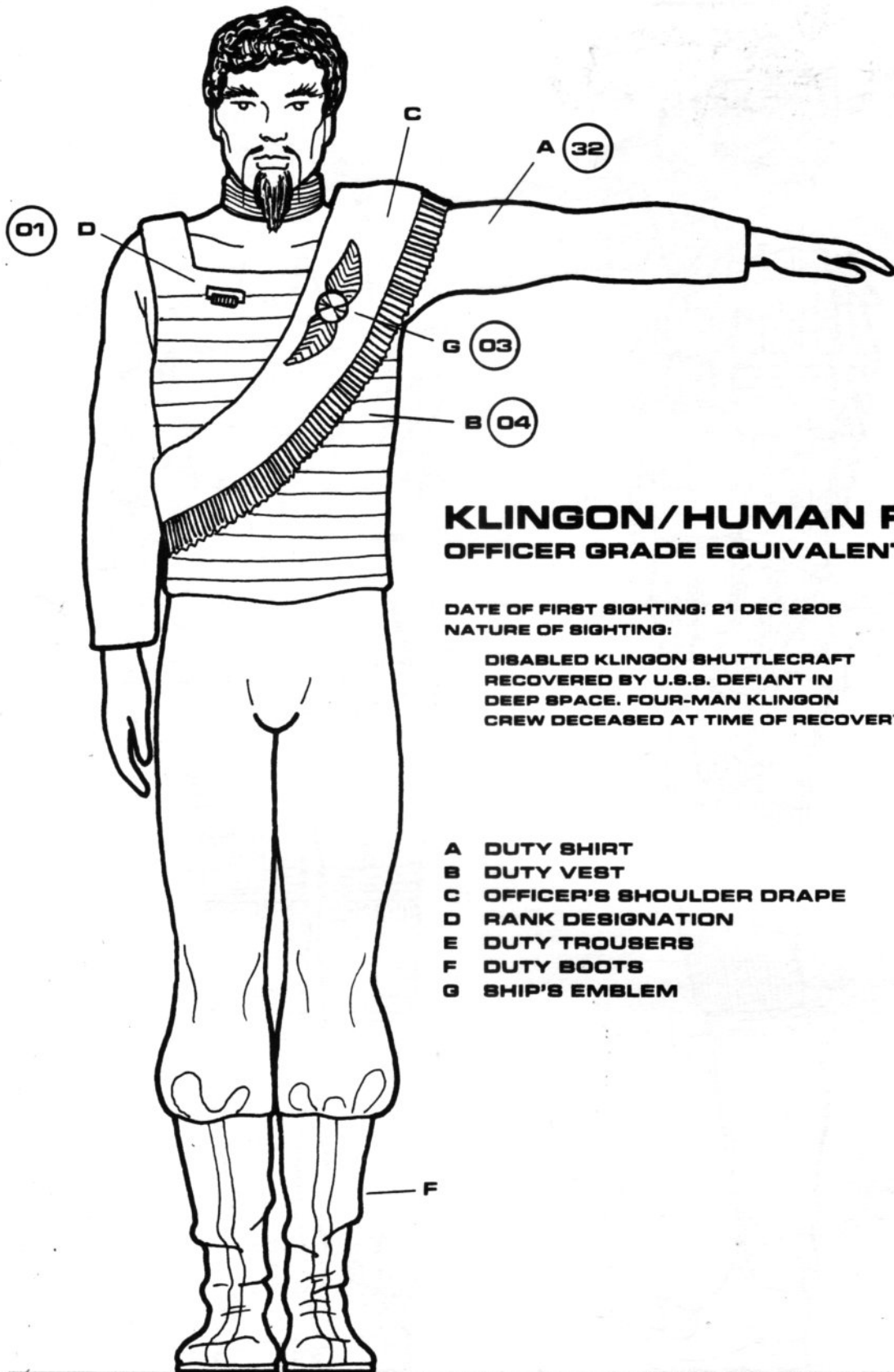

KLINGON/HUMAN FUSION OFFICER GRADE EQUIVALENT

DATE OF FIRST SIGHTING: 21 DEC 2205
NATURE OF SIGHTING:

DISABLED KLINGON SHUTTLECRAFT
RECOVERED BY U.S.S. DEFIANT IN
DEEP SPACE. FOUR-MAN KLINGON
CREW DECEASED AT TIME OF RECOVERY.

- A DUTY SHIRT
- B DUTY VEST
- C OFFICER'S SHOULDER DRAPE
- D RANK DESIGNATION
- E DUTY TROUSERS
- F DUTY BOOTS
- G SHIP'S EMBLEM

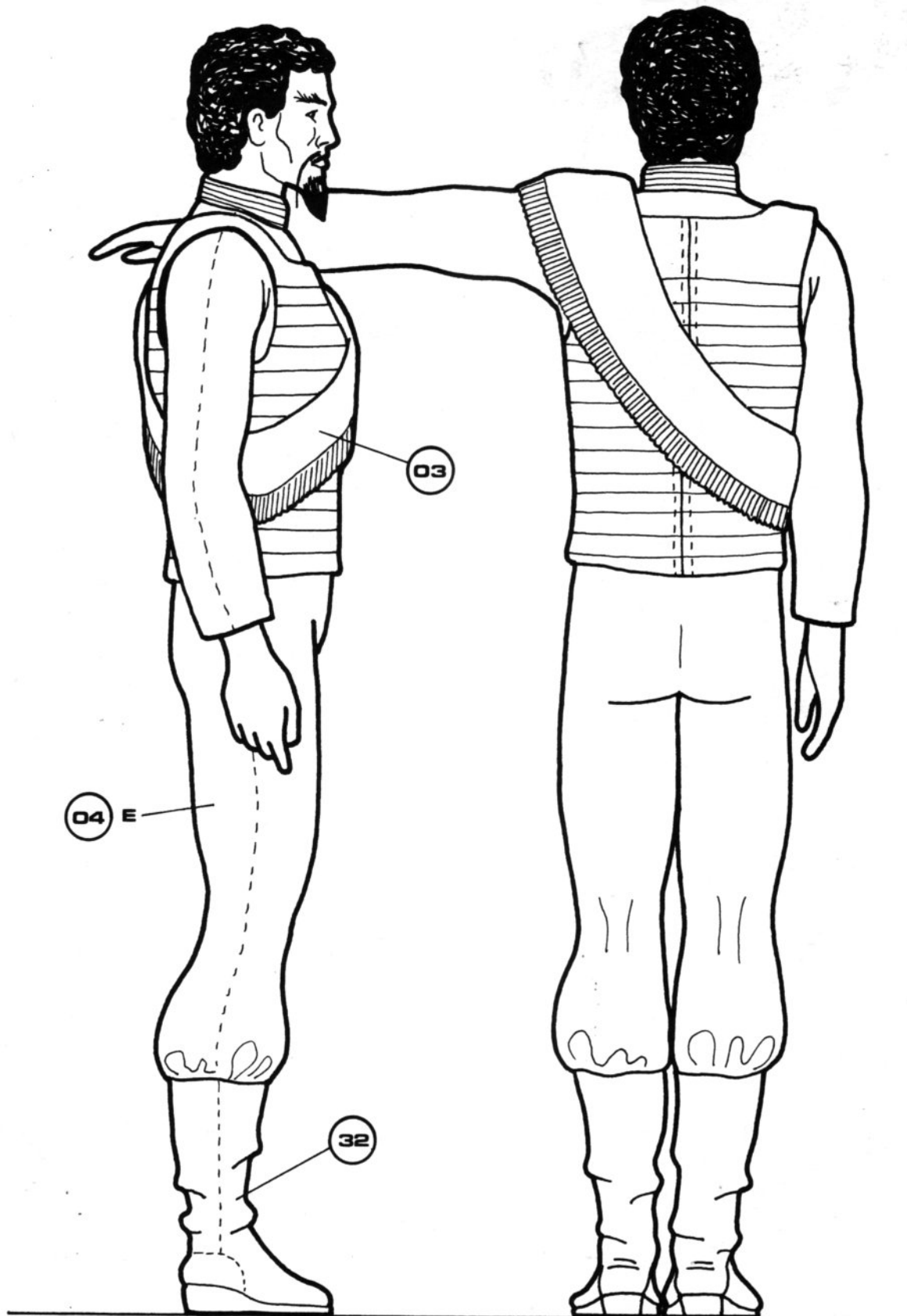

HISTORICAL DATA DATABANK HARDCOPY

UNTIL THE U.S.S. ENTERPRISE SUCCESSFULLY RETURNED THE S.S. BOTANY BAY TO EARTH, ONLY THE VERY BASICS WERE KNOWN ABOUT THE DY SERIES SPACECRAFT. DATA GATHERED FROM THE RECOVERED DY-100 VESSEL HAS GONE FAR TO FILL THE GAPS IN EXISTING RECORDS OF 1990-1996 TECHNOLOGY.

MANY OF THE BOTANY BAY'S SUPPLIES WERE LEFT WITH THOSE WHO HAD STOLEN HER WHEN THE GROUP WAS EXILED TO CETI ALPHA V. AMONG THE ITEMS LEFT BEHIND WERE SPACESUITS WHICH HAD BEEN DESIGNED SPECIFICALLY FOR USE WITH THE DY SERIES. THE REMAINS OF ONE SUCH SUIT WAS SEEN IN RECORDINGS OF RELIANT'S TRANSMISSIONS TO ENTERPRISE, AND WAS WORN BY KHAN NOONIAN SINGH.

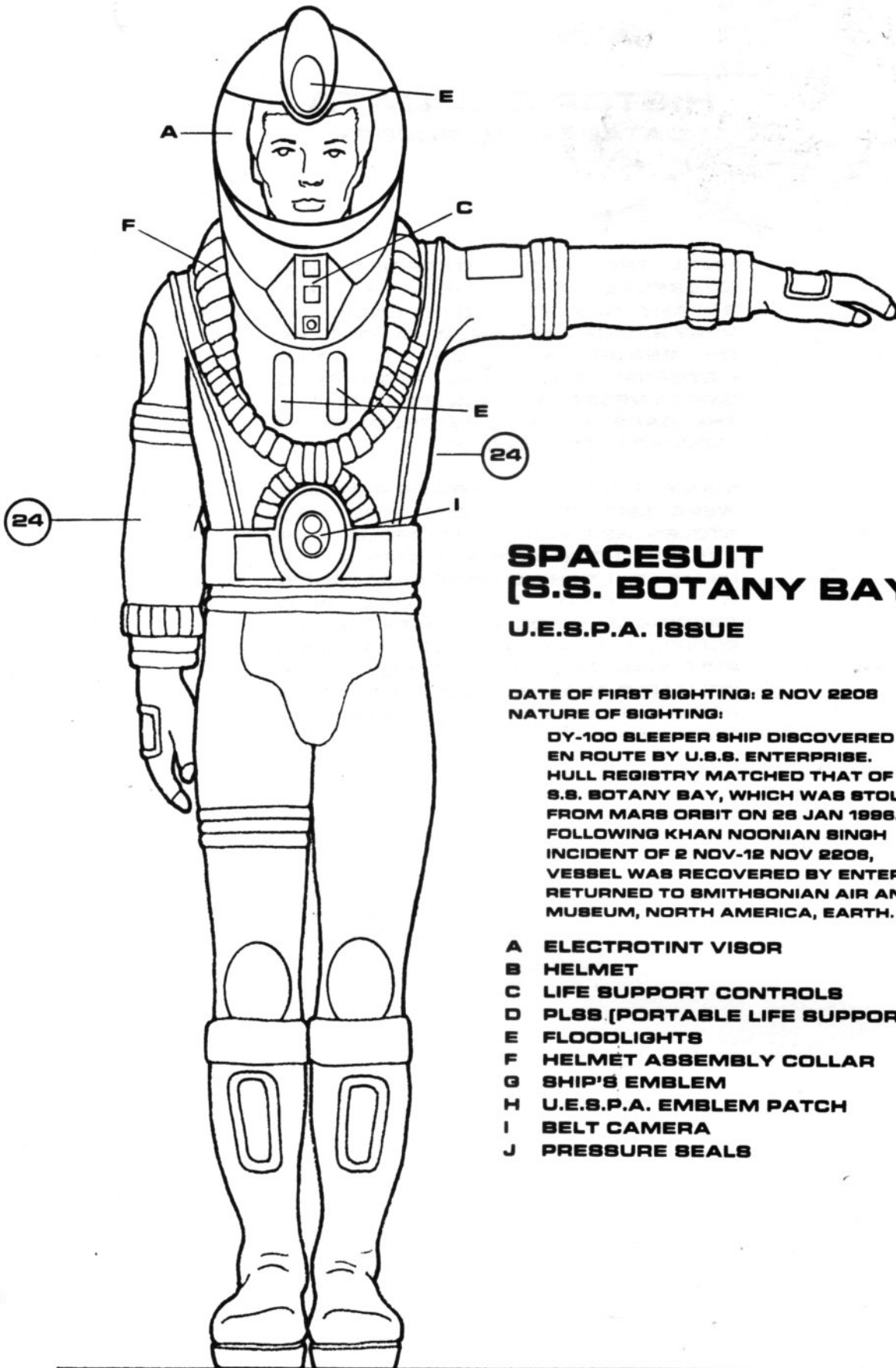

**SPACESUIT
[S.S. BOTANY BAY]
U.E.S.P.A. ISSUE**

**DATE OF FIRST SIGHTING: 2 NOV 2208
NATURE OF SIGHTING:**

**DY-100 SLEEPER SHIP DISCOVERED
EN ROUTE BY U.S.S. ENTERPRISE.
HULL REGISTRY MATCHED THAT OF
S.S. BOTANY BAY, WHICH WAS STOLEN
FROM MARS ORBIT ON 26 JAN 1996.
FOLLOWING KHAN NOONIAN SINGH
INCIDENT OF 2 NOV-12 NOV 2208,
VESSEL WAS RECOVERED BY ENTERPRISE AND
RETURNED TO SMITHSONIAN AIR AND SPACE
MUSEUM, NORTH AMERICA, EARTH.**

- A ELECTROTINT VISOR**
- B HELMET**
- C LIFE SUPPORT CONTROLS**
- D PLSS (PORTABLE LIFE SUPPORT SYSTEM)**
- E FLOODLIGHTS**
- F HELMET ASSEMBLY COLLAR**
- G SHIP'S EMBLEM**
- H U.E.S.P.A. EMBLEM PATCH**
- I BELT CAMERA**
- J PRESSURE SEALS**

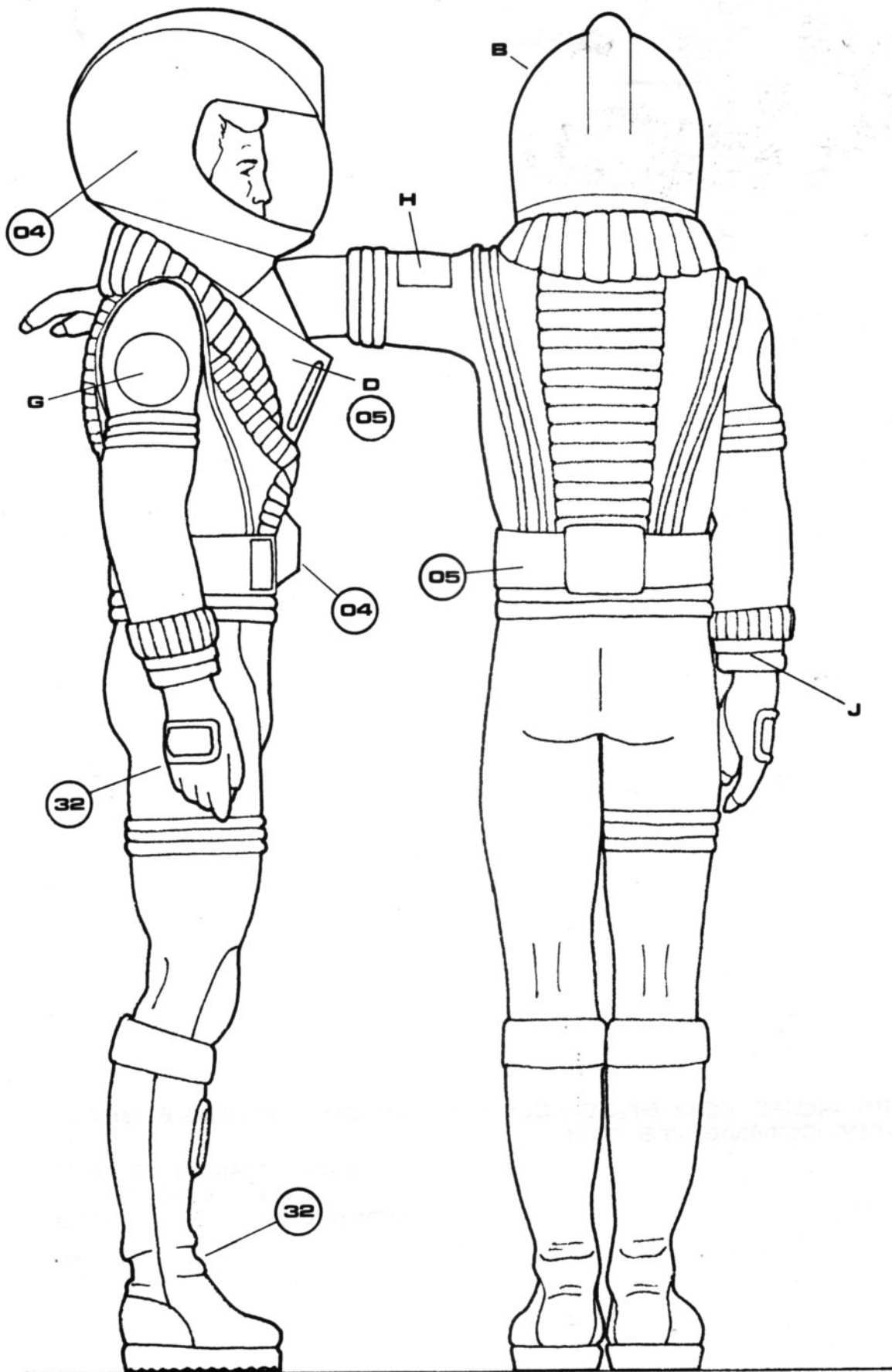

**WE HOPE YOU ENJOYED THIS BOOK. PLEASE SEND
ANY COMMENTS TO:**

**THE NORON GROUP
P.O. BOX 13332
ARLINGTON, TX 76013**

THE NORON GROUP

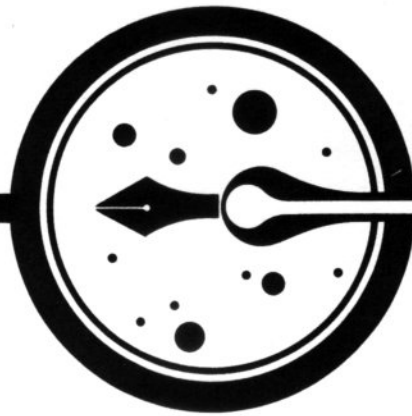

THE NORON GROUP

