

**STAR TREK**  
**THE NEXT GENERATION**

ROLEPLAYING GAME

# PLANETARY ADVENTURES

VOLUME I  
FEDERATION SPACE

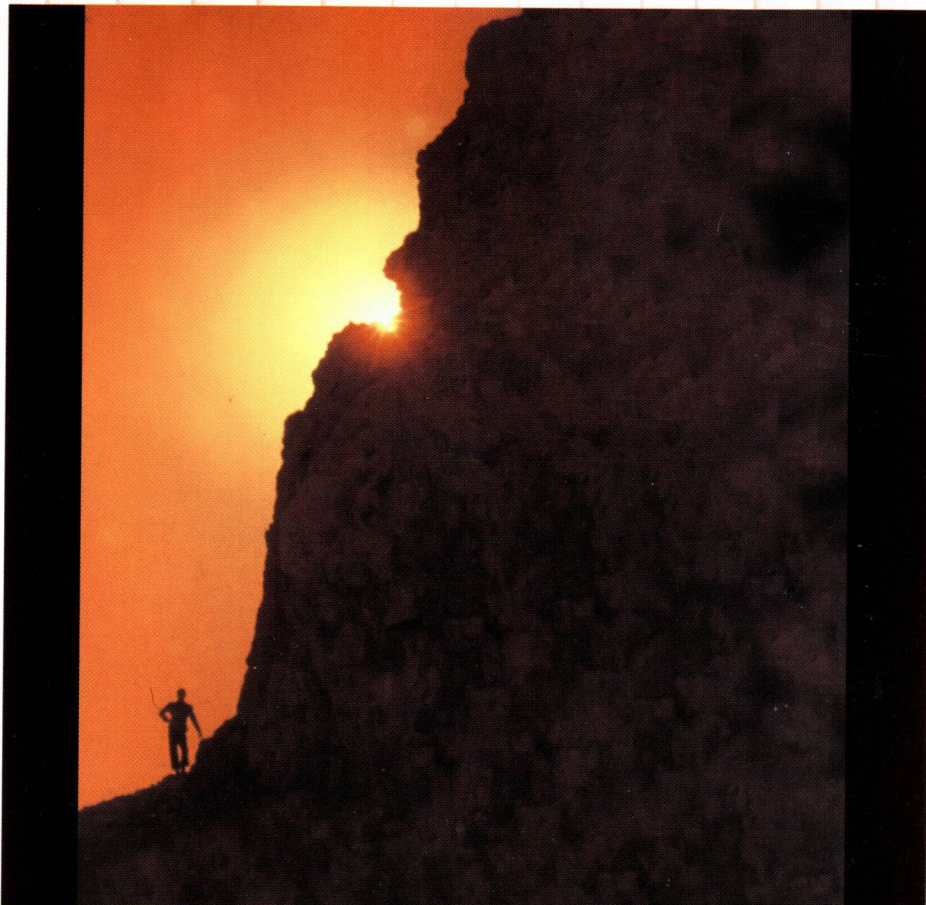

# PLANETARY ADVENTURES

VOLUME I

---

F E D E R A T I O N   S P A C E

A D V E N T U R E

AUTHORS: JIM CAMBIAS, RICHARD DAKAN, KENNETH HITE, ROSS A. ISAACS, JUSTIN SCHMID, JOHN SNEAD

DEVELOPMENT: ROSS ISAACS, PETER SCHWEIGHOFER, STEVE KENSON

ADDITIONAL CONTRIBUTIONS: CHRISTIAN MOORE

STAR TREK: THE NEXT GENERATION® LINE DEVELOPER: ROSS A. ISAACS

EDITING: JANICE SELLERS

GRAPHIC DESIGN: ANTHONY N. VAYOS

LAYOUT & TYPESETTING: ALVARO RIET

ART DIRECTION: CHRISTIAN MOORE, RYAN MOORE, MATTHEW COLVILLE

MAPS & CARTOGRAPHY: CHARLES RYAN

ORIGINAL ART: JOHN BRIDGES, STEVE BRYANT, PAUL DALY, JOHN GRIGNI, TERRY PALLOT, CRAIG SKAGGS

PRODUCT DEVELOPMENT, PARAMOUNT: CHIP CARTER

PROOFREADING AND FACT CHECKING: BILL MAXWELL

SPECIAL THANKS: TO CHARLES RYAN, FOR ARRIVING AT THE LAST MINUTE AND GOING BEYOND...

DEDICATION: TO POOH; HE KNOWS WHY...

DISCLAIMER: WHILE LAST UNICORN GAMES HAS RESEARCHED EXTENSIVELY TO MAKE THIS THE MOST AUTHENTIC STAR TREK: THE NEXT GENERATION® ROLEPLAYING GAME POSSIBLE, THE DEPTH OF INFORMATION NECESSARY FOR A FULLY-REALIZED ROLEPLAYING GAME IS NOT ALWAYS REVEALED DURING A WEEKLY TELEVISION SHOW. WHILE WE HAVE TRIED TO EXTRAPOLATE LOGICALLY WITHIN THE FLAVOR OF ST: TNG, SOME LIBERTIES HAVE BEEN TAKEN AND PLAYERS SHOULD REMEMBER THAT ONLY THE EVENTS, CHARACTERS AND PLACES THAT APPEAR ON THE SHOW OR IN FILMS ARE CANON.

LAST UNICORN GAMES  
9520 JEFFERSON BLVD., SUITE C  
CULVER CITY, CA 90232  
WWW.LASTUNICORNGAMES.COM

PRINTED IN CANADA  
FIRST PRINTING — APRIL 1999



**STAR TREK**  
**THE NEXT GENERATION**  
ROLEPLAYING GAME



STAR TREK™, ® & ©1999 Paramount Pictures. All Rights Reserved. STAR TREK and Related Marks are Trademarks of Paramount Pictures. Last Unicorn Games, Inc. Authorized User. ©1999 Last Unicorn Games

# TABLE OF CONTENTS

INTRODUCTION	5
GHOSTS OF THE PAST	7
ON THE EDGE OF NIGHT	29
THE ENEMY YOU KNOW	47
THE CRADLE WILL FALL	71
RED GIANT	87
APPENDIX I: MAPS	99

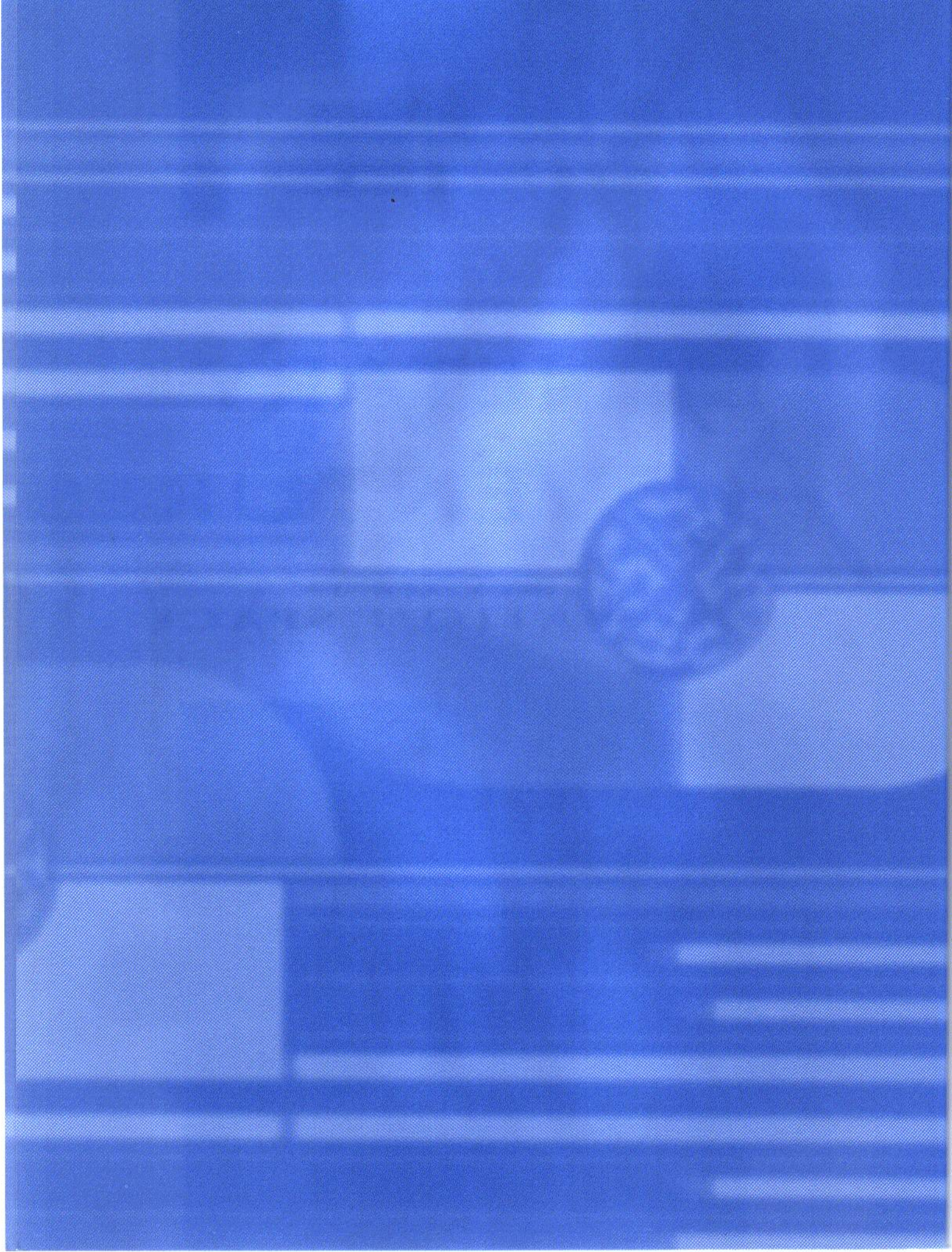

# Introduction

With some thirty years worth of episodes, and four distinct series, *Star Trek* has come to present a formula all its own. This is known as the “episodic visitation.” It begins with the captain's log, a voice-over telling the audience the reason for the ship's presence, or the mission it pursues. Then the intrepid crew of the starship *Enterprise* (or *Voyager*) visits a planet, discovers something is not quite right, solves the central conflict, and moves on. It's likely that's how you play your own adventures every week. This formula is a staple of *Star Trek*.

Yet it can be difficult to devise a new planet, a new civilization, and a new conflict to solve week in and week out. The people who put together the various *Star Trek* shows have the benefit of receiving hundreds of scripts each year from which to choose, and years of writing experience. For Narrators, the task can seem daunting, and sometimes even the best Narrators need a little help. It's for this reason—to help the Narrator—that ***Planetary Adventures*** was written.

Each of the episodes in this book constitutes a stand-alone adventure that Narrators can use when they need a quick evening's play. ***Planetary Adventures*** describes five episodes centering on the kinds of stories you might see on *Star Trek: The Next Generation*. In some cases, we return to planets seen in that TV series, to update the story a bit and give players a chance to follow in the *Enterprise* crew's footsteps.

In the first episode, the Crew visits the planet Minos, once home to a thriving civilization before an unknown catastrophe of the inhabitants' own making destroyed the Minosians. In the second, they encounter a strange species of energy creatures intent on finding a new home. In the third, the Crew becomes embroiled in a story of espionage and deceit involving the *Tal Shiar* on Vulcan. The fourth story brings the Crew to Aldea to investigate strange goings-on. Finally, in the last adventure, a civilization is on the verge of dying out, and the Crew must find some way to save it from a fiery demise.

Because each episode stands separately from the others, the Narrator can play the adventures included in this book in any order, or play them all one after another for many nights of play. Before playing these episodes, the Narrator should read through each one carefully. Narrators can expand on the information contained herein and create their own stories, or change elements to suit their own style of play.

Clever Narrators could even devise a way to make some of the characters presented herein recurring supporting cast. Just because the Crew helps the Umbra find a new home in “*On the Edge of Night*” does not mean this is the last word on these unusual beings. Or perhaps Master Sital from “*The Enemy You Know*” returns with a new enigma for the Crew to solve. Let your imagination be your guide—these are your episodes now.

## CHAPTER DESCRIPTIONS

### GHOSTS OF THE PAST

Long ago, the planet Minos gained fame and fortune as the Arsenal of Freedom, selling advanced weapons systems until the day those systems somehow turned on their makers and exterminated all life on the planet. Yet something still lives, after a fashion, on Minos, as the Crew discovers on a survey mission.

Starfleet sends the Crew on an expedition to Minos, with several of the Federation's foremost scientists. While on the planet, they must face the remnants of Minoasian weapons technology. Yet ancient technology is not the only thing confronting the Crew. Can they solve the mysteries Minos presents, and perhaps discover the truth behind the secret of the Omega Device?

### ON THE EDGE OF NIGHT

On a routine mission to rendezvous with the science vessel *Tenebrae*, the Crew receives a distress call from the very people they were sent to help. The *Tenebrae* lies powerless deep within the dangerous black nebula known as Mar Osura, where a neutron star rapidly builds towards cataclysmic explosion. The Crew must race against time to rescue the crew of the *Tenebrae* before it gets caught in the explosion of the neutron star.

What caused the catastrophic failure of the ship's power systems? Why are the survivors acting peculiarly? And are the two linked?

### THE ENEMY YOU KNOW

Vulcan. Even the name conjures up images of oppressively hot deserts, rocky valleys and stark, towering mountains. While others on the ship attend a conference, the Crew enjoys a bit of shore leave—perhaps a visit to Mount Seleya, a tour of the *Kolinahru* Monastery, or an evening of fine dining on Vulcan mollusks and vintage Vulcan port.

Yet their vacation is cut short, as the Crew uncovers evidence of a Romulan spy network on Vulcan. They must team up with Agent Silak of the famous *V'Shar* intelligence bureau to find the spy and put an end to whatever nefarious plans he has in motion.

### THE CRADLE WILL FALL

Return to Aldea, the planet long reputed to be myth and first seen in "When the Bough Breaks." A great deal has changed since Captain Picard and the crew of the *Enterprise-D* last visited this idyllic world, and Aldea stands poised on the brink of Federation membership. For years, Federation scientists have worked with the Aldeans to better understand their amazing technology. With the end of the Federation's involvement with the planet, other powers stand

poised to fill the void—Cardassia, Ferenginar and Romulus. Aldea must choose its fate soon.

On a routine patrol of the sector, the Crew receives a message from Aldea. Something terrible has happened on the planet, and the Crew must come quickly. What they find there could upset the delicate balance of power in the Alpha Quadrant, and perhaps alter the destiny of the Federation itself.

### RED GIANT

While on a deep space exploration mission, the Crew picks up a visual distress call from within the heart of a red giant star. Can the Crew make contact with the inhabitants and save them from a catastrophe that could doom this world?

It's a race against time and despair involving ancient knowledge, Federation know-how, and the gifts of a vanished race. The combination leads the Crew into mystery, betrayal, and a possible new hope for a world given up for dead.

# Ghosts of the Past

**M**inos, a lush, forested planet in the Alpha Quadrant, was once home to a thriving, technologically sophisticated civilization. During the Erelrope Wars, the people of Minos gained notoriety as arms manufacturers and merchants. They supplied both sides of the conflict, billing themselves as the Arsenal of Freedom. This trade continued long after the Erelrope Wars ended. They supplied the Xenon with a mutagenic virus in their war with Vendekar, sold spiral inversion disruptors to the Batashai during the Third Gestation Wars, and were among the early innovators of subspace weapons.

Eventually, these highly sophisticated—some say almost sentient—weapons systems grew beyond the means of their creators. The Minosians' own weapons of mass destruction exterminated their civilization, leaving nothing but mute ruins to stand as testimony to their folly. To this day, Federation researchers remain stumped as to the precise cause of the Minosians' annihilation. Was it some horrible biological weapon? Did their weapons, perhaps capable of independent thought, attack their makers? Perhaps the answer lies buried somewhere on the planet's surface, in some obscure computer. Researchers from dozens of Federation members have sought the answer to this question over the years.

The *U.S.S. Enterprise-D* last visited Minos on stardate 41798.2. Sent to the Lorenze Cluster to investigate the disappearance of the *U.S.S. Drake*, the crew of the *Enterprise* found the planet mysteriously uninhabited, but encountered sophisticated weapons technology. These weapons systems attacked both an Away Team and the starship itself. Investigation indicated the Minosians' own weapons caused the extermination of intelligent life on Minos, though the details remain unknown. Starfleet Command subsequently quarantined the planet to prevent the spread of weapons of mass destruction, including whatever destroyed Minosian culture. Occasionally, starships assigned to the sector patrol the Minos system, though they avoid getting too close to the planet.

For more information on Minos, see *Planets of the UFP: A Guide to Federation Worlds*.

## THE OMEGA DEVICE

Long rumored to exist, those who believe in the existence of the Omega Device differ widely on its purported capabilities. Some believe it to be a nanovirus capable of literally unzipping a victim's DNA helix, perhaps even responsible for the extermination of the Minosian people. Others theorize that it builds on lessons learned from the explosion of the Praxis moon in 2293 (stardate 9521.6)—the ability to create a subspace shock wave capable of massive destruction.

Dr. Kotal Iver, in his paper delivered to the Federation's Conference on Minosian Studies, believes the Omega Device to be part of a larger



“doomsday” myth common to many cultures, and gives little credence to its existence.

Whether myth or horrible reality, many people would be interested in any concrete information. Scientists throughout the Federation, and beyond, search for definitive proof as to the existence of the Omega Device, while arms merchants dream of obtaining it, either for sale to the highest bidder or for mass production. The Federation wants the device, if it exists, for one reason—to deactivate and disassemble it, thus keeping it out of the hands of the likes of the Cardassians and Romulans.

## SYNOPSIS

The Crew are assigned to accompany an archaeological mission to Minos to uncover the reasons for the planet’s sudden catastrophe nearly two decades earlier and covertly investigate rumors of a “doomsday weapon.” While their ship waits in orbit, the Crew explore the Minoasian emergency headquarters complex, uncovering clues about Minoasian culture, encountering robotic and holographic evidence, examining the workings behind the Minoasian planetary defense systems, and discovering references to the Omega Device.

Unknown to the Crew, a cloaked Romulan warbird also lurks in orbit, waiting to receive word from a Romulan spy among the expedition that they have uncovered evidence of a “doomsday device.” The spy, Dr. Tolas, has infiltrated the expedition to ensure the Romulans gain possession of the Omega Device. After contact is made, the warbird immediately calls for reinforcements.

Tension in the Away Team increases when one of the expedition members is discovered murdered. While exploring the complex, a team member, the Vulcan psychohistorian T’suus, questions Tolas’ true identity, so Tolas eliminates this threat. The Crew help determine the murderer’s identity.

Meanwhile, the Federation vessel in orbit encounters the warbird and its reinforcements. The Crew in the complex must help subdue the murderer and use the Minoasian defense systems to help fend off the aggressive Romulan vessels, possibly detonating the Omega Device and rendering the prized weapons of Minos useless.

## THE MISSION

Starfleet Command orders the player characters’ ship to rendezvous with the science vessel *Oppenheimer* at Starbase 103. The *Oppenheimer* carries a group of Federation researchers on a mission to the planet Minos, and the Crew are assigned to escort them there.

The expedition consists of three members. Commander Stefan Bartok, an expert on analyzing alien weapons technologies, is with Starfleet’s Technical Intelligence Division. Bartok is nominally in charge of the mission, although he defers to the ship’s captain in all matters of safety and military necessity.

T’suus is a Vulcan psychohistorian who has spent the past decade trying to determine possible causes for the Minoasian catastrophe. T’suus is an expert on the planet Minos and its society, and can answer nearly any questions the Crew might have. Dr. Tolas is an

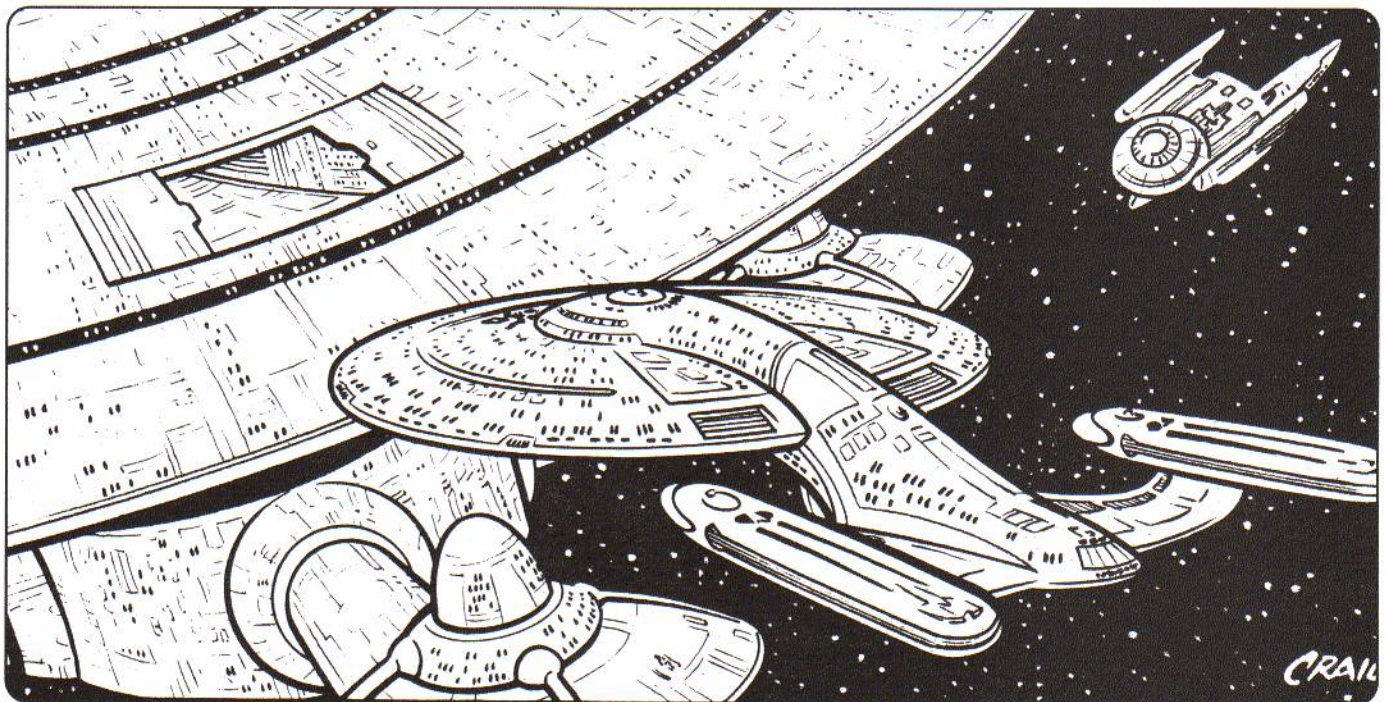

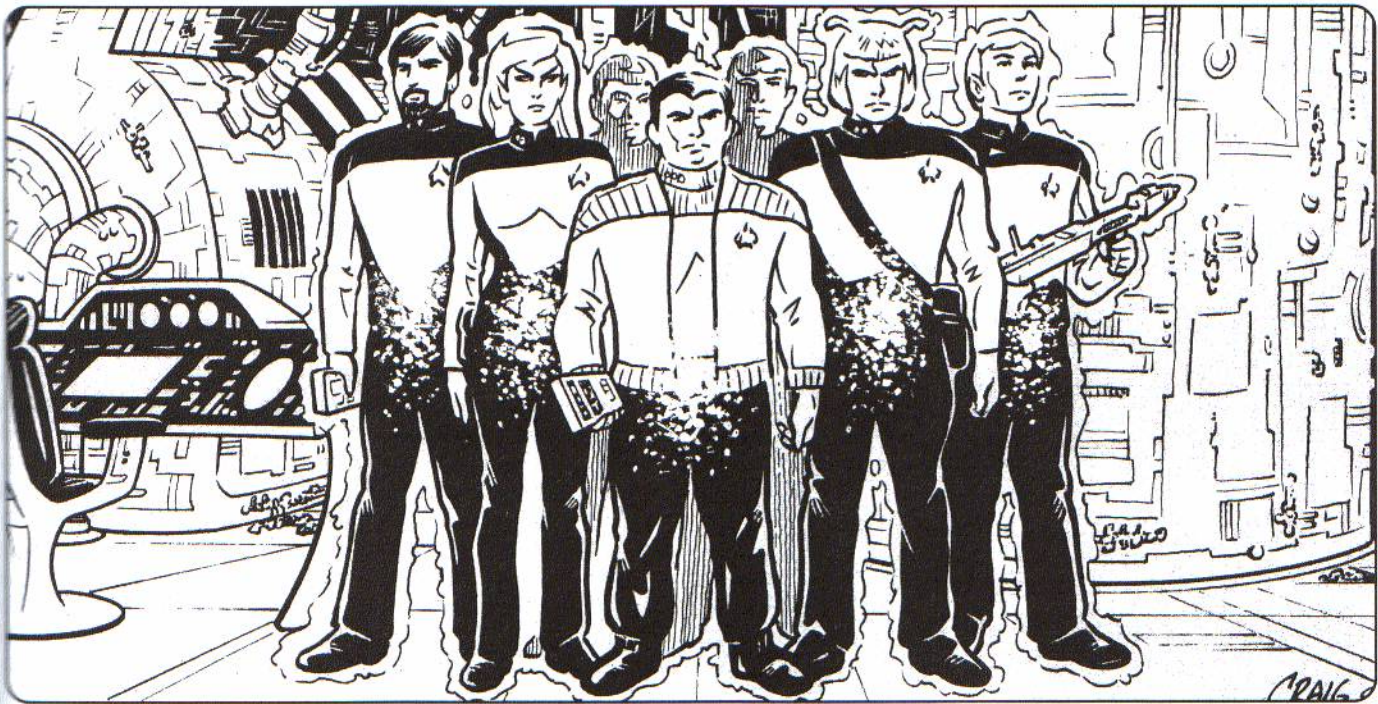

Andorian archaeologist specializing in the recovery of ancient technologies.

The episode begins with the Crew's starship docked at Starbase 103, waiting to collect the Minos research team. Upon boarding, Commander Bartok explains the mission's purpose. Minos, as everyone knows, was a planet famous for its armaments industry. Sometime around 2350 a mysterious catastrophe killed everyone on the planet. After several ships investigating the disaster failed to return, Starfleet put the entire Minos system on the interdicted list. The *U.S.S. Enterprise-D* was the first ship to visit Minos and return safely, in 2364.

Recently the Vulcan psychohistorian T'suus made an important discovery. While analyzing some declassified material about Minos from other worlds in the Lorenze Cluster, she noted an old intelligence report revealing the location of the Minosian Emergency Headquarters Complex—a buried bunker intended to serve as planetary command post in the event of a major attack against Minos. There is a good chance the complex survived the catastrophe intact, and may hold valuable clues about the fate of the Minosian civilization.

## SECRETS

As soon as the expedition members settle into their quarters on board and the ship makes way for Minos, Commander Bartok requests a private meeting with the ship's captain and senior staff. T'suus and Tolas do not attend.

Bartok explains that he left a few things out of the initial briefing. Starfleet's Technical Intelligence Division (TID) sponsored the Minos expedition

because of a long-standing worry about the Minosians' famous weapons technology. It has long been suspected that the Minosians did not export their best nor most advanced armaments—presumably they kept the best weapons to defend their own planet. In particular, TID is worried about the rumored "ultimate doomsday device" said to be programmed to release a destructive, self-propagating, warp field wave, which could devastate the entire galaxy. Most scientists consider such a device impossible, but a few maverick theorists claim it could be built. The Federation fears other ambitious galactic powers might try to acquire this destructive Minosian technology.

## THE AWAY TEAM

When the starship establishes orbit over Minos, the expedition members request assistance on the surface, so the player characters should assemble an away team for the mission.

Crew members who might be useful on the expedition include engineers or other technical experts, Security officers, Medical personnel, and any Crew with training in archaeology or exploration. If the senior officer assigned to the Away Team was not part of Commander Bartok's private briefing, the commander fills that officer in on the Federation's concerns. Due to the mission's hazardous nature, the ship's captain probably should not be part of the team, unless he is an expert archaeologist.

Lieutenant Ali Iskandari, one of the ship's historians, does almost anything to win an assignment to the mission. This is not unusual in itself—Starfleet officers are highly motivated—but Iskandari seems especially desperate. If questioned, he explains simply that the

## PEACEMAKER BATTERIES

**Class and Type:** Minoasian Type IX Planetary Defense Battery

### BASE CHARACTERISTICS

Size: 3 (20 meters across)

Resistance: 20

Structural Points: 100

### OPERATIONAL CHARACTERISTICS

Crew/Passengers: None (automated)

Computers: 1 [1 pwr/round]

Power: 50

### SENSOR SYSTEMS

Lateral Sensors: +0/1 light year [4 pwr/round]

### WEAPONS SYSTEMS

#### *Peacemaker Cannon*

Range: 1 million/2 million/4 million/8 million

Arc: 120 degrees

Accuracy: 7/7/7/7

Damage: 30

Power: [45]

### DESCRIPTION AND NOTES

Minoasian Peacemakers are enormous electromagnetic railguns firing warp-accelerated neutronium slugs. They can inflict a powerful punch unaffected by range. Unfortunately they are very difficult to aim, making them unsuitable for close-range work. The weapons are mounted in heavily armored domes on the planet's surface.

Minos question has fascinated him for years, and that he had always hoped for a chance to visit the legendary planet.

Characters with medical training might notice that T'suus has a bad case of Vulcan dermal virus. Spotting the symptoms requires a Moderate (5) test of the Medical Sciences (General Medicine) skill, or a Routine (4) test of Medical Sciences (Vulcan). The disease is a fairly harmless one, a mottled, scaly discoloration causing severe itching all over the victim's skin. There is no cure, but the virus usually runs its course in less than eight days.

Ordinarily the disease would have been detected and removed by the transporter biofilter system, but since the expedition party came aboard via the docking arm at Starbase 103, the infection went unchecked. At her earliest convenience, T'suus asks the ship's doctor for a mild topical anesthetic spray to stop the itching.

## ARRIVAL AT MINOS

While the travel time to Minos should not affect this episode, Narrators can establish the distance from here to Starbase 103 at between ten and twenty light

years, depending on the needs of their series. Minos is considered a hazardous location, and a string of warning buoys orbit between Minos and the next outer planet. The ship remains at yellow alert while in the Minos star system.

The planet Minos itself is detailed in *Planets of the UFP: A Guide to Federation Worlds*. It is a lush, forested world completely depopulated by some unknown means. Now, decades after the disaster, the jungle has reclaimed most of the Minoasian cities.

Scans of the surface reveal no signs of sapient life—though many lower forms of animals are present—nor any active power sources. A Moderate (7) Shipboard Systems (Sensors) Skill Test indicates occasional and brief low-level energy discharges scattered across the planet's surface. These are probably caused by occasional dying flickers of various automated systems, but it is difficult to be sure. (Narrators can use the energy fluctuations as a "red herring" to keep the starship Crew on edge during the mission.)

According to the information T'suus recovered, the old Minoasian Emergency Headquarters Complex is located at latitude 2° south, longitude 42° west, in the Nirotas mountain range. The facility is buried 1,093 meters underground. The surrounding rocks are rich in radioactive ores and metals, and the complex itself was built of sensor-blocking materials. It is virtually

## PLASMA BATTERIES

**CLASS AND TYPE:** Minoasian Type IV Planetary Defense Weapon

### BASE CHARACTERISTICS

Size: 3 (20 meters across)

Resistance: 20

Structural Points: 100

### OPERATIONAL CHARACTERISTICS

Crew/Passengers: None (Automated)

Computers: 1 [1 pwr/round]

Power: 45

### SENSOR SYSTEMS

Lateral Sensors: +0/1 light year [4 pwr/round]

### WEAPONS SYSTEMS

#### *Plasma Gun*

Range: 10/1,000/2,000/4,000

Arc: 120 degrees

Accuracy: 2/3/5/8

Damage: 40

Power: [40]

### DESCRIPTION AND NOTES

The plasma batteries project beams of fusing hydrogen at their targets. Because the hydrogen cools rapidly in space, their range is limited. They can't hit anything farther than low orbit. Like the Peacemaker batteries, the plasma guns are housed in armored domes.

impossible to scan the site from orbit. Someone must make a Challenging (11) Shipboard Systems (Sensors) Test to determine the proper coordinates prior to transport. The starship's Transporter Chief suggests the Away Team bring a set of three transporter pattern enhancers to help them beam out of the facility.

## PLANETARY DEFENSES

The Minosian planetary defense network was once among the most impressive collections of weapons in the galaxy. Now it is mostly inoperable. It is not clear whether the various installations were destroyed in the catastrophe that killed the Minosians, or if they have merely fallen victim to neglect and decay.

Six giant defense batteries are still operational, each deployed along the planet's equator. Four are long-range "Peacemaker" cannons, while the other two are giant plasma guns for near-orbit defense. Ships in orbit are always in the field of fire for at least two of the installations.

At the north pole is a launch site for combat drones. Four drones are still functional. When launched, the drones proceed to attack the designated enemy vessel. If released without an assigned target, the drones take up a position in orbit to await orders.

As a last-ditch defense, the Minosians built a space interdiction system consisting of several large antimatter bombs buried in deep shafts, with tons of one-kilogram metal spheres piled on top. Detonating the bombs would blow the millions of metal spheres into space, creating a belt of deadly meteors in orbit. Two of the space interdiction devices are still active. If the interdictors are set off, no ship can approach more closely than 100,000 kilometers from the planet.

Most of these defenses are inoperable when the Crew's ship arrives in the Minos system, since their most computers in the Emergency Headquarters Complex are not operational. An unexpected shot from one of these emplacements might put both the vessel and the Crew on guard and heighten the tension when they initially enter the complex.

Should the Away Team restore power to the facility, these defenses might accidentally identify the Crew's vessel as a target and initiate defensive measures with the systems described here. If the ship fires on the planet, the system certainly shoots back. Crew members in the complex's Situation Room can control any defensive site with some judicious use of their Computer skills (see location 6 below).

Activating any of the planetary defense systems is likely to have unforeseen results. After more than a decade without maintenance, even the operational batteries could malfunction. Each weapon has a 1 in 6 chance of failing each time it is fired. There are also many very sophisticated weapons on Minos which are not controlled by the complex. Firing massive energy guns or launching craft into space may be the trigger that awakens some other hidden defensive device from decades of slumber.

## MINOSIAN COMBAT DRONE

**Class and Type:** Bravo Nine Orbital Combat Drone

### HULL CHARACTERISTICS

Size: 2 (30 meters long, 1 deck)

Resistance: 1

Structural Points: 40

### OPERATIONS CHARACTERISTICS

Crew/Passengers: None (automated)

Computers: 2 [2 pwr/round]

Transporters: None

Tractor Beams: None

### PROPULSION AND POWER CHARACTERISTICS

Warp System: None

Impulse System: .6 c/.8 c [6/8 pwr/round]

Power: 50

### SENSOR SYSTEMS

Long-range Sensors: None

Lateral Sensors: +0/1 light year [4 pwr/round]

Navigational Sensors: +0

Sensors Skill: 6

### WEAPON SYSTEMS

#### Light Phaser

Range: 10/30,000/100,000/300,000

Arc: 270 degrees forward

Accuracy: 2/3/5/8

Damage: 8

Power: [8]

### DEFENSIVE SYSTEMS

#### Minosian Deflector Shield

Protection: 20/30

Power: [20]

### DESCRIPTION AND NOTES

The Minosian combat drones are small, cigar-shaped vessels controlled by sophisticated on-board computers. A smooth duranium hull contains a powerful impulse engine and a single phaser battery. They can fight individually or in groups, and have a relatively good set of tactical routines.

Against a single opponent, the drones try to surround the target and maintain a steady bombardment until the opponent's shields collapse. If a single drone fights a more powerful enemy, it makes hit-and-run attacks. Drones are capable of limited self-repair; the drone can repair damage to any one system in half an hour. If a damaged drone cannot escape to repair itself, it tries ramming the enemy or self-destructs.



## THE UNDERGROUND COMPLEX

The transporter sets the party down in the water and air recycling center (location 3 on the map). The complex is dark and quiet, with only dim emergency lights shining at 10-meter intervals. The air is dry and chilly. It is eerily silent in the complex, and the footsteps of the explorers seem to echo forever.

The Crew can find no sign of any damage. The facility is clean and tidy, as though everyone simply left a short time ago. The machinery lacks power, but everything appears to be in working order.

Unless the Crew are transmitting from a location where they've set up the pattern enhancers, they have difficulty using their combadges to communicate with their ship. The heavy ores surrounding the facility prevent combadge transmissions from reaching vessels in orbit unless boosted by the pattern enhancers or relayed through the base's Communications Center (location 10).

In most cases the various Away Team members can speak with each other via combadge transmissions within the complex, though those in different sections or on different levels might experience a severe degradation of transmission integrity. Likewise, Mission Ops on board the starship cannot keep track of the Crew while on the surface—the natural shielding renders them effectively invisible.

## GHOSTS OF MINOS

At any time they restore power (possible at location 12 below) the explorers discover the complex “haunted” by three interactive holographic programs, the General, the Minister, and the Professor. Each program has its own personality and area of specialization. The three programs can appear in the Situation Room, the Communications Center, the executive living areas, and the senior military quarters. All three are nothing but immaterial projections. They have no way actually to harm or physically help a character.

Because the holograms were not active during the catastrophe responsible for exterminating the Minoans, they cannot tell the explorers anything about what happened, except in terms of their areas of expertise. The General can report that “armed forces personnel levels declined one hundred percent during that time period”, while the Minister claims happily that “unemployment reached a new low and has remained stable ever since.”

### THE GENERAL

The General appears to be a Minoan military officer with short-cropped gray hair and a granite jaw. His function is to provide information on Minoan military capabilities and advice on strategy and tactics. The General speaks in almost impenetrable military jargon, and is designed to assume the worst about enemy capabilities and intentions. He refers to the Away Team's ship in orbit as a “potential threat” and suggests a number of ways to destroy it.

The information the General provides is limited by the security clearance of the people to whom he speaks. To someone with Level 1 security (just about anyone) he reports only that “our assets are at full readiness.” To those possessing a Minoan Level 2 security card he can give troop strengths and a list of intact defense sites. At Level 3, he can discuss secret weapons. The General knows the Omega Device exists, but cannot discuss it (it is classified at Level 4).

### THE MINISTER

The Minister appears to be a high-ranking Minoan bureaucrat, a short, plump man in a conservative suit. He is programmed to offer advice on economics and government policy, and can provide information on the status of the planet's industry and civilian population. Relentlessly upbeat, the Minister puts a positive spin on everything he reports. Because none of the Minister's data is secret, he cheerfully answers any question. Unfortunately, nearly all his information dates from before the catastrophe.

### THE PROFESSOR

The Professor appears as a scientist in a powered wheelchair, with a shock of white hair standing out

from his head. He is designed to be a scientific and technical expert, providing information on all matters of science and technology. The Professor has a somewhat more flexible program than the other two—he is permitted to speculate and form hypotheses. Like the General, he limits his discussions of weapon technologies to the security level of his audience.

The Professor knows the true nature of the Omega Device, but he cannot reveal it to anyone of less than Level 4 security clearance. He can make a few oblique references, however: “It is to be used only when there is no alternative,” or “It would end civilization as we know it.”

## THE LAYOUT

The complex is divided into three main sections, each connected to the other two by tunnels. Section A is the actual command post itself. Section B contains living quarters for military personnel and government officials. Section C is the service and power unit. Each section has its own elevator, shown on the map. Numbered locations are described below.

### 1. SHAFT TO SURFACE

The shaft to the surface extends up about 500 meters, then divides into three separate tunnels which slope gradually up to ground level, emerging several kilometers apart. An elevator once ran in the shafts, but it no longer functions, even if power is restored. All three of the upper shafts suffered cave-ins—it appears an automatic system triggered charges to seal off the complex at some point after the catastrophe, or perhaps the caretaking crew deliberately closed the shafts after abandoning the complex. A starship’s phasers might be able to bore through the tons of collapsed rock, but using hand weapons to cut an exit proves fruitless.

### 2. EXECUTIVE LIVING AREA

This level was designed to house the highest officials in the Minoasian government, along with their assistants and families. It is divided into a hundred small apartments, each with two bedrooms, a sitting room, and a bathroom. The accommodations are relatively comfortable, much like a senior officer’s quarters aboard a large starship. The Crew also discover offices and conference rooms for the conduct of government affairs. None of the rooms on this level have ever been used. The holographic “ghosts” can appear here.

### 3. WATER AND AIR PROCESSING

This level holds the life-support machinery for the entire complex. The original occupants of the complex left it in standby mode. Restarting the air system requires a Moderate (7) Systems Engineering (Environmental Systems) Skill Test, but the power

## MAINTENANCE ROBOTS

The complex has a dozen maintenance robots which clean the facility and implement minor repairs, which explains the complex’s relatively good working order. Programmed to follow basic maintenance subroutines, they lack intelligence and cannot speak or respond to verbal commands. The only way to reprogram them is via the control panels in the Robot Manufacturing and Maintenance Center (Location 9).

The maintenance robots are harmless, possessing no weapons or defenses. If attacked they do not even try to dodge or flee. The maintenance robots are hemispheres, about half a meter across. They glide silently along a few centimeters above the floor, collecting dirt with an ion beam. The robots have the annoying habit of silently following people around.

**Structural Points:** 20

**Armor Resistance:** 5

**Skill Programs:**

Dodge 1

Systems Engineering (Environmental) 4 (5)

plant must first be brought back on line (see location 12 below). The water tanks hold thousands of gallons of distilled water, enough to supply the expedition indefinitely.

One of the computer displays in the life-support control room shows a complete schematic of the entire command complex, which the expedition can use to plot their exploration. Interestingly, the plans show a long vertical shaft extending downward from the computer core which does not have any air ducts or water lines leading to it. The chamber at the bottom is labeled only “Off Limits.”

### 4. SENIOR MILITARY LIVING QUARTERS

Prior to the catastrophe that exterminated the Minoasians, the military officers in charge of the planetary defense forces occupied these apartments. They are a bit less spacious than the civilian executive living quarters, because the military officers were not expected to bring dependents along.

Each apartment consists of a large bedroom with a small sitting area and a private bath. There are rooms for about 200 officers, as well as an armory, detention block, and some conference rooms. The Minister and General holographic “ghost” programs can appear in this section.

### 5. FOOD PREPARATION

This level contains sophisticated food replicators capable of supplying the entire garrison indefinitely. Large freezers intended to hold solid food can also be found here. Without power, however, the freezers now contain nothing but awful-smelling sludge.

## MINOSIAN EMERGENCY HEADQUARTERS

1. SURFACE SHAFT
2. EXECUTIVE LIVING AREA
3. WATER AND AIR PROCESSING
4. SENIOR MILITARY LIVING QUARTERS
5. FOOD PREPARATION
6. SITUATION ROOM
7. STAFF LIVING QUARTERS
8. BARRACKS
9. MANUFACTURING AND MAINTENANCE
10. COMMUNICATIONS CENTER
11. MEDICAL CENTER
12. POWER PLANT
13. COMPUTER CORE

### SECTION B HABITATION

### SECTION A COMMAND POST

### SECTION C SERVICE/POWER

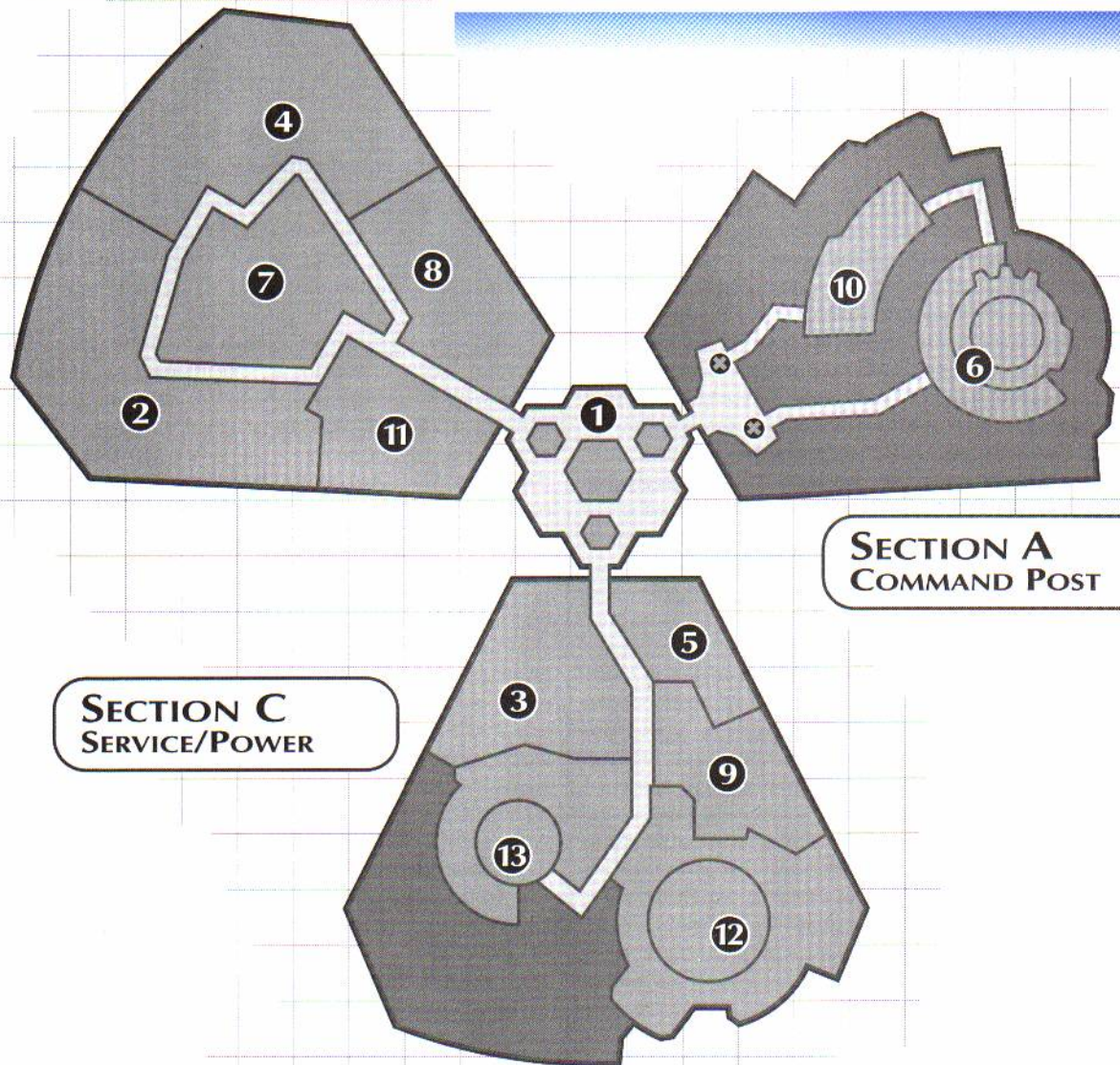

## COMPUTER CORE CHAMBER

1. COMPUTER CORE
2. HATCH

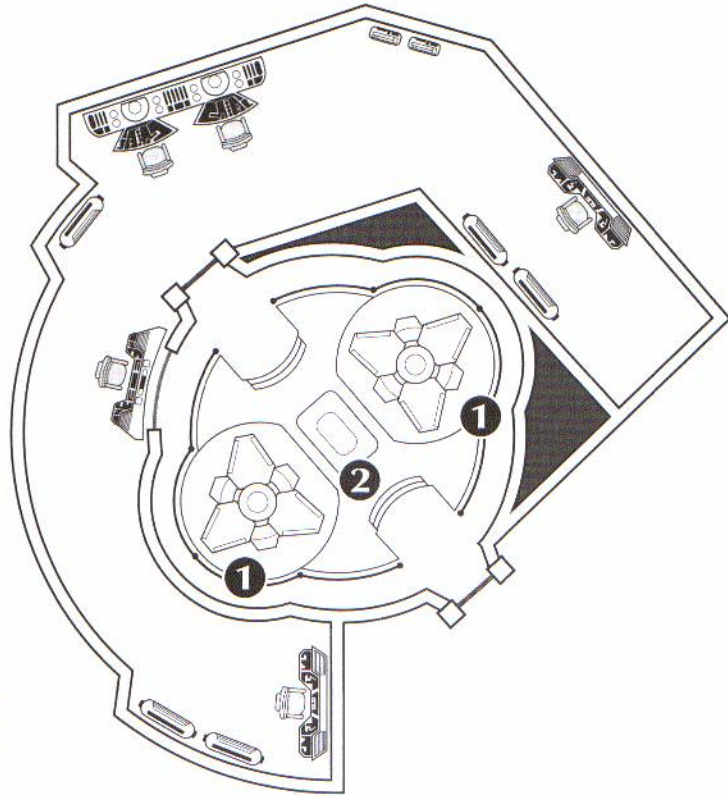

## SITUATION ROOM

1. TACTICAL CONTROLS
2. HOLO-DISPLAY

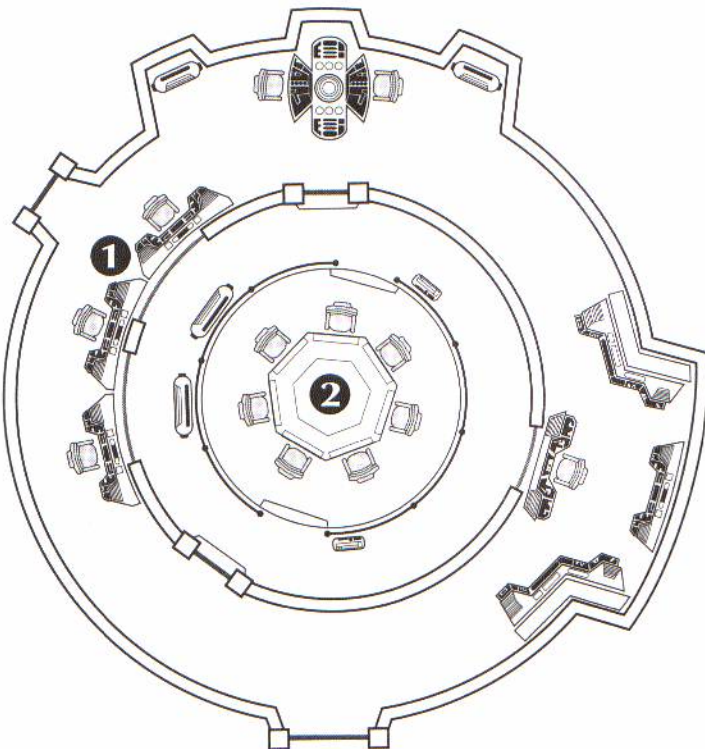



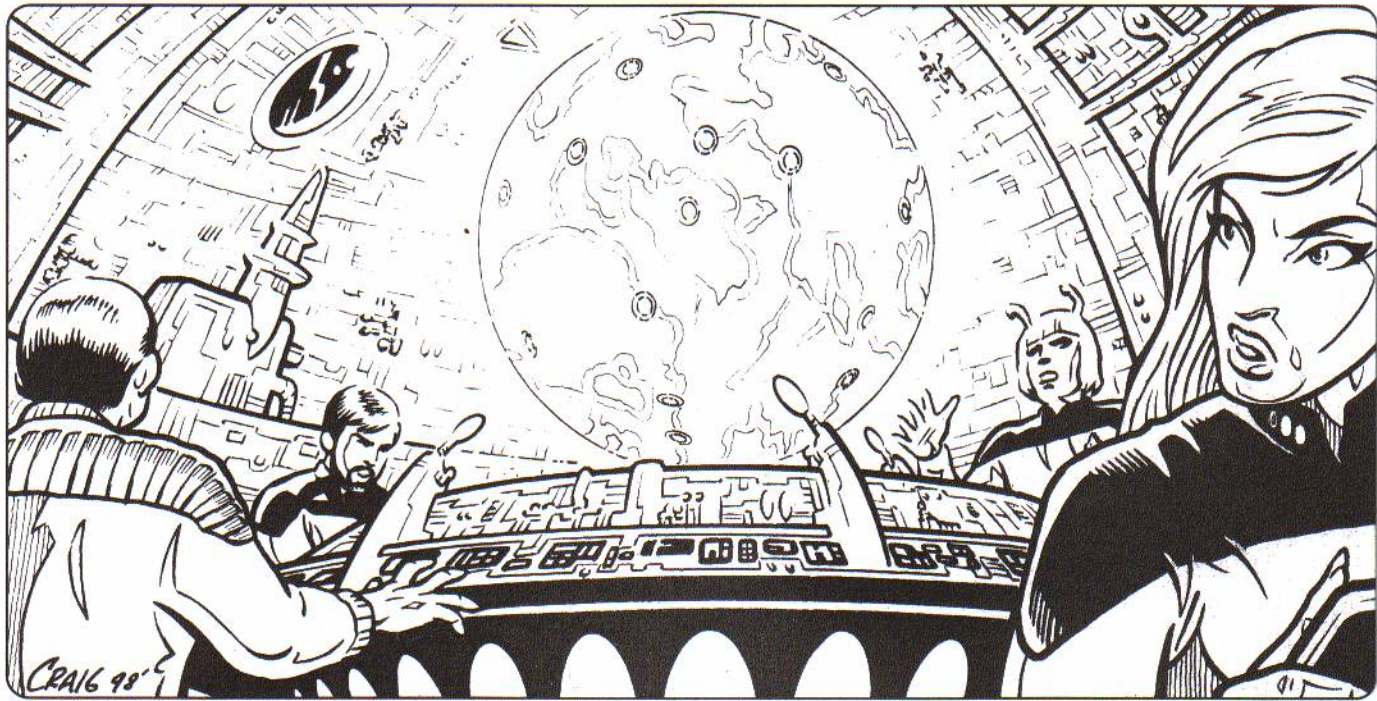

Activating the food replicators requires a Challenging (9) Systems Engineering (Transporter/Replication Systems) Skill Test, but the power must be restored first.

## 6. SITUATION ROOM

The Situation Room serves as the nerve center for the entire complex. As such, it is also the best-protected section. There is an identification panel located at the junction of the main tunnels (marked X on the map). Anyone who does not insert a Minoasian Level 2 identification card sets off a barrage of energy beams which fill the next 10 meters of the tunnel. The beams inflict  $8+2d6$  points of damage—a person can survive one hit, but someone trying to dash through the barrage is automatically hit by  $2d6$  beams. However, the beam curtain defense unit was designed with a “back door” in case of emergency. There is a diagonal “passage” through the beams, which one can walk through in complete safety. It requires a Challenging (10) Intellect Test to spot the passage, and a Routine (4) Coordination Test to stay within the safe zone.

The Situation Room itself is a large dome-shaped room about 30 meters across, with small offices and conference rooms along the outer wall. The main chamber features an enormous holographic display unit, capable of showing the entire star system or the planet at whatever scale is desired. Below the display are banks of tactical control consoles, which can be keyed to various weapon installations on the planet’s surface or in space.

The holodisplay is initially shut down. Once the explorers manage to restart the power plant, the unit depicts a huge image of the planet, with active planetary defense sites marked as green circles. The starship in orbit shows up as an orange square (if the

ship fires on the planet for any reason the display icon changes to a red triangle). Restoring power also allows the three holographic “ghosts” to appear in the Situation Room.

Operating the control panels requires a Minoasian Level 3 security identification card. The explorers may try hacking their way past the security lockouts, but this requires a Difficult (12) Computer (Data Alteration/Hacking) Skill Test to gain access at all, then a second, Difficult (14) test to convince the system that the hacker has the correct access level. Failure on the first test simply shuts down the console again; failure on the second summons the Blue Gamma Nine security robot. Success means that the user can take control of any active planetary defense site he wishes.

## 7. STAFF LIVING QUARTERS

These barracks were intended to house the complex’s technicians and support staff. They are double-occupancy dormitory rooms. This is the only part of the living section that looks inhabited. Half the rooms were in use at the time of the catastrophe. Explorers find them still furnished with the personal possessions of a hundred Minoasian defense force technicians. T’suus finds these especially interesting and concentrates on studying these rooms. Unless someone objects, Commander Bartok suggests the expedition members camp out in the unoccupied rooms in this area.

A search of the occupied rooms indicates that the residents did not simply vanish. Shoes, hats, and sidearms are all missing, as if the base personnel left voluntarily. There is no sign of a battle. Since the staff left behind a great many personal belongings, it appears they didn’t expect to be gone long.

Two rooms are of particular interest. The commander's room has a wall safe controlled by a retinal-scan lock. While there is no way to fool the lock, the safe door can be cut open with a phaser set on Light Disrupt A. Inside, the Crew find a metal briefcase containing the keys to the Omega Device chamber and a Minoasian Level 3 security identification card. They are not labeled in any way. Taped to the inside of the case lid is a scrap of paper with the handwritten message "4719, 23x2, 11." The briefcase also contains a chemical light source and an old-fashioned 8-shot cartridge pistol.

Across the hall from the commander's quarters the Crew find a smaller apartment for the facility's second-in-command. The furnishings are unremarkable, although a thorough search reveals a Minoasian Level 3 security identification card hidden under the mattress of his bed. The executive officer found it practical to use this back-up security card when the commander was busy or asleep.

## 8. BARRACKS

This section housed the lowest-ranking personnel in the complex—soldiers, clerks, and maintenance staff. It is divided into several large rooms lined with dozens of double-decker bunks. The barracks were never used, although a careful search uncovers an illicit stash of imitation Saurian brandy and some racy holovideos stowed in one of the bunk footlockers.

## 9. ROBOT MANUFACTURING AND MAINTENANCE

This facility was intended to supply spare parts and tools to keep the complex running. A pair of industrial replicators is capable of manufacturing items up to about one ton of mass. A recharging room houses a dozen robots. Most are multipurpose machines intended for cleaning and maintenance, but the Blue Gamma Nine security robot also waits here when it has not been summoned by security monitors.

With an adequate supply of power, a Moderate (6) Systems Engineering (Transporter/Replication Systems) Skill Test reactivates the manufacturing machinery and the maintenance robots. The replicator has templates for nearly every known Minoasian technology, but it does not manufacture weapons without a Level 3 security clearance card.

## 10. COMMUNICATIONS CENTER

The Communications Center is located just under the Situation Room and is connected to it by both elevators and stairways. Communications consoles capable of handling all message traffic with Minoasian military units and government centers fill the immense chamber. The room is linked to several large antenna arrays hidden on the surface. A Moderate (7) Shipboard Systems (Communications) Test allows the explorers to activate the communications system.

## BLUE GAMMA SERIES ROBOTS

The Blue Gamma Nine security robot, armed with phasers and protected by a force field, defends against hostile intruders in the complex. Once dispatched against intruders, the robot attempts to capture rather than kill. It uses its phasers on stun; only if the target resists the stun setting does it increase the power level. The Blue Gamma Nine has tractor beam units capable of carrying an unconscious humanoid. All its prisoners are detained in the detention block in Section B. Once it deposits prisoners there, the robot returns to its storage chamber in Section C and awaits new orders. If the Blue Gamma Nine is destroyed, the facility's replicators and maintenance robots construct a Blue Gamma Ten security robot.

The Blue Gamma Nine is an egg-shaped spheroid 50 centimeters wide and 80 centimeters long. Its surface is a smooth white color. Antigravity propulsion allows it to float around the complex.

**Structural Points:** 50

**Armor Resistance:** 10

**Phaser Weapon**

Settings: 1-10

Range: 5/10/25/50

Energy: 200 charges

**Force Shield Protection:** 30

**Tractor Beam Range:** 5

**Skill Programs:**

Dodge 4

Energy Weapon (Phaser) 2 (4)

Once switched on, it can relay combadge signals to the ship in orbit. The three holographic "ghosts" can appear in the Comm Center.

Like the tunnel to the Situation Room, the tunnel connecting the Comm Center to the rest of the complex has a Level 2 security reader and a beam curtain defense unit. This one also has a safe path through the beams, although it has a different arrangement.

## 11. MEDICAL CENTER

The medical facility is fairly large because it was built to handle battle casualties. The small hospital was fully stocked at the time of the catastrophe, but most of the drugs have lost their original potency. The diagnostic beds and scanners still function normally (if power has been restored), and are similar to those found aboard a starship. Next to the medical center is a small gymnasium.

## 12. POWER PLANT

The complex has three power plants. The main plant is a fusion reactor, currently shut down. To reactivate it requires a Difficult (12) Propulsion

Engineering (Fusion) Skill Test. On a failed roll the characters can try again; if their attempt is a critical failure, the plant is seriously damaged and can never start again.

The second power plant is a smaller chemical-fueled unit intended primarily as a safety back-up. It is easier to start—requiring only a Moderate (6) Skill Test—but has fuel for only twelve hours. The third is a low-powered radioisotope power unit. It produces only enough power to maintain emergency lights, allowing characters to start up the other two power plants. The isotope generator is running when the Away Team arrives.

### 13. COMPUTER CORE

Twin two-story cylindrical computer cores dominate this room. This powerful main computer stores the equivalent of a typical starship computer (approximately 250 megaquads of data) on hundreds of thousands of crystal memory chips. Optical trunk lines connect the core to the rest of the facility. Unlike most Federation designs, it does not respond to spoken commands, but uses interface terminals located throughout the complex. The computer comes online once the Crew restore power.

The computer's memory is vast and holds a complete record of both the Minoasian armed forces and the Minoasian economy as they were just before the catastrophe. The amount of information is enormous and would require many weeks even to catalog. Finding any specific piece of information in the Minoasian computer system requires a Challenging (11) Computer Skill Test. The core can be accessed from one of the systems monitoring stations around the room.

Certain information is classified. Everything about the armed forces or the complex itself requires a Minoasian Level 2 security clearance card. Descriptions of secret weapon technologies are classified at Level 3. It is possible to try hacking the computer, requiring a Difficult (12) test to fake Level 2 clearance and a Nearly Impossible (16) test to fake Level 3. Failure shuts off the interface terminal and summons the Blue Gamma Nine security robot. On a Dramatic Failure the system begins erasing whatever file the hacker was trying to access.

Individual chips can be removed from the computer for study elsewhere, back on a starship for example. A precursor to isolinear chip technology, accessing information on an individual chip requires a Moderate (8) Computer (Programming) Skill Test to configure. The difficulty levels detailed above apply when analyzing chips removed from the computer core.

In the center of the computer core chamber the Crew find a hatch in the floor, which requires a Level 3 security clearance and the keys from the commander's safe to open. Below the hatch, a long ladder leads down a narrow shaft, providing access to the Omega Device.

## THE DOOMSDAY DEVICE

The hatch in the center of the computer core chamber opens onto a deep shaft leading down 30 meters to the Omega Device, the Minoasian "ultimate deterrent." The shaft is sealed off at 10 meter intervals by three heavy doors of neutronium-plated metal, proof against even a phaser rifle. Each door has a small control panel set in the center. Any attempt to bypass the control panel causes the locking machinery to fuse in place, sealing the shaft forever.

The doors are booby-trapped with a phaser designed to foil attempts at tampering. Entering the wrong combination once changes the light in the shaft from white to yellow, but has no other effect. The light turns back to white after ten minutes. If a second wrong combination is entered while the light is yellow, it sets off a phaser blast aimed at the space just above the door, doing 8+2d6 light thermal damage, and changes the light from yellow to red. The red light turns back to white after another ten minutes. Entering the wrong combination when the red light is on will trigger a lethal blast inflicting 20+6d6 damage. It is always safe to make a wrong guess when the light is white.

The combinations for the doors are written on the paper inside the commander's briefcase, which was locked in his wall safe along with the keys to the hatch. The paper read "4719, 23x2, 11," but the combinations require a little interpretation.

The panel in the first door has three buttons labeled 0, 1, and 2. To open the door one must enter the correct combination—in this case the number 4719—in base-three notation. The correct combination is 20110210.

The panel in the second door is identical to the first. To open it one must enter the code number 23 (212 in base three) twice. Entering the number 46 is incorrect.

The third panel is just like the other two. To open it, one simply enters the number 1 twice. Entering the number 11 (102 in base three) is incorrect, as is entering a single number 1.

If the players have difficulty deciphering the coded combination and the base-three interpretation, someone might consider making a Challenging (11) Physical Sciences (Mathematics) Skill Test. The Narrator should consider providing some hints to solve this puzzle if one of the Crew receives a successful Test Result.

Assuming the explorers succeed in getting down the shaft, they discover a small six-sided chamber carved from solid rock. The Omega Device occupies the center of the room.

The Device is a large black octahedron suspended from the ceiling at about chest height. In the center of each of the four lower faces is a circular recess containing a T-shaped handle. All four handles must be pulled at once to activate the Device (a safety feature to keep one misguided person from setting it off on his own). However, the Device is also designed to resist tampering; any attempt to sever its connections to the



ceiling initiates a 30-second countdown to activation. A Nearly Impossible (15) Systems Engineering Skill Test can stop the count; blasting the Device with phasers won't accomplish anything.

Despite what some members of the Away Team might believe, the Omega Device is not a galaxy-destroying bomb. Rather, it is intended to make the planet Minos worthless to any invading enemy. Setting it off triggers a series of thermonuclear charges buried at various locations around the planet, each of which is tuned to release an extremely powerful electromagnetic pulse. The pulse erases all the computer memory on the planet and fries the electronics of all devices more advanced than a wind-up clock. Setting off the Omega Device would transform Minos from an industrialized world of arms factories into a low-technology planet with large junk heaps. (The effect of the pulse would also affect any ships within a thousand kilometers of the surface.)

## DISCOVERIES

The initial exploration of the complex uncovers a great deal of valuable data for the scientists. The Situation Room displays are useful to point out future sites for study. The main computer holds backup data files for all of Minos' military secrets, which are of great interest to both Commander Bartok and Dr. Tolas. T'suus and Lieutenant Iskandari are more interested in the Minister's data on economics and policy, and on what can be learned from the items in the staff living quarters. From a standpoint of new information, all of the members concur that the expedition has been a success.

As soon as anybody finds a reference to the Omega Device, the focal point of the expedition changes.

Commander Bartok and Dr. Tolas both focus on nothing else but the "doomsday machine." T'suus and Iskandari continue their historical researches, but everyone else is assigned to the task of opening the shaft and accessing the device. (At this time, Tolas also covertly alerts the cloaked Romulan ship in orbit.)

## THE LURKER

While the expedition members explore the complex, those left behind on the ship are not idle. They monitor the mysterious energy transients on the surface of Minos, plus react to any surface weapons or drones that target their vessel as hostile. A new problem soon presents itself. Though the player characters are unaware of it, a Romulan warbird has followed their ship to Minos and lurks in high orbit, concealed by its cloaking device.

As soon as Tolas finds some reference to the Omega Device, he uses a burst transmitter to contact the Romulan vessel. A Difficult (12) Shipboard Systems (Communications) or (Sensors) Test is needed for anyone aboard the Federation ship to detect the short signal coming from the planet. The message is fractal-encrypted, and is Nearly Impossible (20) to decipher. Even if some supergenius character manages to break the encryption, the message is nothing but a number—meaningless to anyone but Tolas and his Romulan contact.

The Crew detecting the signal know its strength is not powerful enough to reach beyond the Minos system. A Moderate (7) Shipboard Systems (Sensors) Skill Test can triangulate the transmission source to somewhere inside the Minosian command complex, but that is all.

Upon receiving the message from Tolas, the Romulan commander, Centurion Sudok, immediately sends a subspace signal back to Romulan space requesting reinforcements. Unfortunately for the Romulans, the Federation ship can detect the Romulan's tight-beam subspace transmission. The Narrator should allow characters on the bridge to make a Challenging (9) Shipboard Systems (Sensors) Test to detect the signal. On a Dramatic Success, a character who knows what he's looking for can pick up some of the message. As with the signal from the planet, it is brief and fractal-encoded.

A Moderate (6) Shipboard Systems (Sensors) Skill Test can pinpoint the source of the transmission as well, which is in high orbit around Minos. If the Federation vessel moves toward the cloaked warbird or launches probes, Sudok breaks orbit and moves swiftly away from Minos, attempting to hide in the outer system.

Characters can try to track the Romulans using an antiproton scanning beam—reconfiguring the ship's sensors for this takes a Challenging (9) Systems Engineering (Sensor Systems) Test, and detecting the cloaked vessel requires a Difficult (12) Shipboard Systems (Sensors) Test. Even if the attempt succeeds, the Romulan ship can still attempt evasive maneuvers. The Federation sensor operator must keep making Difficult (12) tests every ten minutes to track the warbird; a missed roll means the sensor operator must reacquire the sensor lock, requiring a Nearly Impossible (15) test.

Sudok does not want to start a fight; he would prefer to wait until his reinforcements arrive. If the Federation ship starts shooting, Sudok decloaks and indignantly demands to know why "peaceful explorers" are under fire. He expects a full apology and tries to prolong any discussions until his task force shows up.

If the Starfleet crew points out that he's in violation of the Treaty of Algeron, by crossing the Neutral Zone, Sudok accuses the Federation of being a threat to intergalactic peace. He accuses them of trying to recover the Omega Device for themselves, implying that their intentions are less than peaceful.

The only thing that can make Sudok attempt a premature attack is if the Federation vessel recovers its Away Team and tries to leave the system. The Romulan Centurion would prefer to die in combat than to let the Federation get away with the ultimate doomsday device. If the character's actions—or the actions of the expedition team on the planet—somehow force him into such an untenable position, he will attack.

The Narrator can time the arrival of Romulan reinforcements for maximum dramatic effect. Ideally they should appear about the time the Away Team discovers the murderer, or else when the explorers finally enter the chamber holding the Omega Device. Sudok's reinforcements consist of two or three more *D'deridex*-class warbirds, depending on how powerful the Federation ship appears.

## THE MARICUS

**Class and Type:** *D'deridex*-class Warbird

**Commissioning Date:** 2342

### HULL CHARACTERISTICS

Size: 10 (1,260 meters long, 83 decks)

Resistance: 4

Structural Points: 200

### OPERATIONS CHARACTERISTICS

Crew/Passengers: 1,700/6,000 (estimated) [7 pwr/round]

Computers: 4 [4 pwr/round]

Transporters: 8 of each type (estimated) [12 pwr/round]

Tractor Beams: 1 av, 1 fv, 1 fd [2/rating used]

### PROPULSION AND POWER CHARACTERISTICS

Warp System: 5.0/8.0/9.0 (6 hours) [2/warp factor]

Impulse System: .5c/.75c [5/7 pwr/round]

Power: 200

### SENSOR SYSTEMS

Long-range Sensors: +2/16 light years [6 pwr/round]

Lateral Sensors: +2/1 light year [4 pwr/round]

Navigational Sensors: +2 [5 pwr/round]

Cloak: 10 [40 pwr/round]

Sensors Skill: 6

### WEAPONS SYSTEMS

#### Type I Disruptor

Range: 10/30,000/100,000/300,000

Arc: All (720 degrees)

Accuracy: 4/5/7/10

Damage: 24

Power: [24]

#### Torpedoes

Number: 300

Launchers: 1 ad, 1 fv

Spread: 10

Arc: Forward or aft, but are self-guided

Range: 5/300,000/1,000,000/3,000,000

Accuracy: 4/5/7/10

Damage: 20

Power: [5]

Weapons Skill: 5

### DEFENSIVE SYSTEMS

#### Romulan Deflector Shield

Protection: 70/90

Power: [70]

### DESCRIPTION AND NOTES

The *Maricus* is a big, powerful ship nearly twice the size of a Federation *Galaxy*-class starship. One of the older vessels in its class, its engines and power system are not as good as those in newer ships. As a result it has been assigned to espionage and intelligence-gathering work, with an improved sensor suite for long-range monitoring of Federation ship movements. The tight-beam subspace transmitter leaks energy that can reveal the ship's position even under cloak.



## MURDER AMONG US

While the Crew's starship is away investigating the Romulan signals, one of the player characters in the command complex makes a shocking discovery: T'suus is dead. Her body lies in the elevator that runs between the floors of the living area section. The Crew might make this discovery by accident, by simply summoning the elevator. Or the Narrator can have her disappear—perhaps missing a routine call—prompting the Crew to search for her.

### THE BODY

A quick examination reveals an energy weapon shot to the chest as the cause of death. A Challenging (11) Medical Sciences Skill Test indicates the weapon was a phaser. It was fired at close range, from the front. T'suus probably died immediately. It is fairly easy to determine the time of death; a Routine (3) Medical Sciences Skill Test indicates T'suus was killed about half an hour before her body was discovered. A Moderate (6) test also reveals her dermal virus symptoms.

Commander Bartok immediately assumes T'suus was killed by some kind of Minoasian machine, and orders everyone to remain with a partner at all times

for safety. Two of the away team must remain on guard during sleep periods, and everyone should keep a phaser handy.

The Narrator should encourage paranoia after they discover T'suus' body. Let the player characters start hearing noises. Emphasize the shadows and the chilly air of the complex, and remind the Away Team that they are buried under tons of rock on an alien world, with no way to get out unless the ship returns. If the players want to send their characters on a search for the "Minoasian machine," the Narrator can keep surprising them with appearances of the interactive holograms or maintenance robots.

### THE INVESTIGATION

If any of the Crew suspects foul play in the death of T'suus, Bartok is willing to consider it, but doesn't give the idea much credence. If they want to ask a few questions or look around, that's fine with him, but any kind of prolonged interrogation or body searches garners strong opposition from him. Bartok won't tolerate any major interference with the mission. Highly suspicious players should be encouraged to think Bartok is trying to hide something.

One way to point the Crew in the direction of foul play, particularly if they miss the evidence on T'suus' body, would be a tricorder scan of the elevator. A successful Moderate (8) Personal Equipment (Tricorder) Test reveals a high residue of nadiions in the elevator. Spectral analysis reveals these to be consistent with a standard Starfleet phaser (a Routine (4) Starfleet Regulations Test). Minoasian security drones use phasers with a different nadiion signature (a Moderate (7) Culture Test).

The Crew naturally know what their characters were doing when T'suus died. The Narrator should make sure most of the nonplayer characters have alibis, as well. There are three unaccounted for. Commander Bartok claims to have been in the Situation Room by himself at the time, Dr. Tolas says he was asleep, and Lieutenant Iskandari says he was in the Executive Living Area working on some notes. Obviously the Narrator should provide different stories if any Crew member was in one of those locations.

Interviews with each of the possible suspects and searches of their belongings may turn up some interesting facts.

### THE VICTIM

T'suus had a single case for all of her traveling gear. Most of it is ordinary stuff—clothing, a Vulcan-made tricorder, a top-of-the-line personal computer, and a copy of the Terran author Isaac Asimov's *Foundation* trilogy. Characters who look inside the book note it is inscribed "from Ali." It was a gift to T'suus years ago from Lieutenant Iskandari. She also has a spray bottle of a mild topical anesthetic, prescribed by the ship's doctor for relief of her dermal

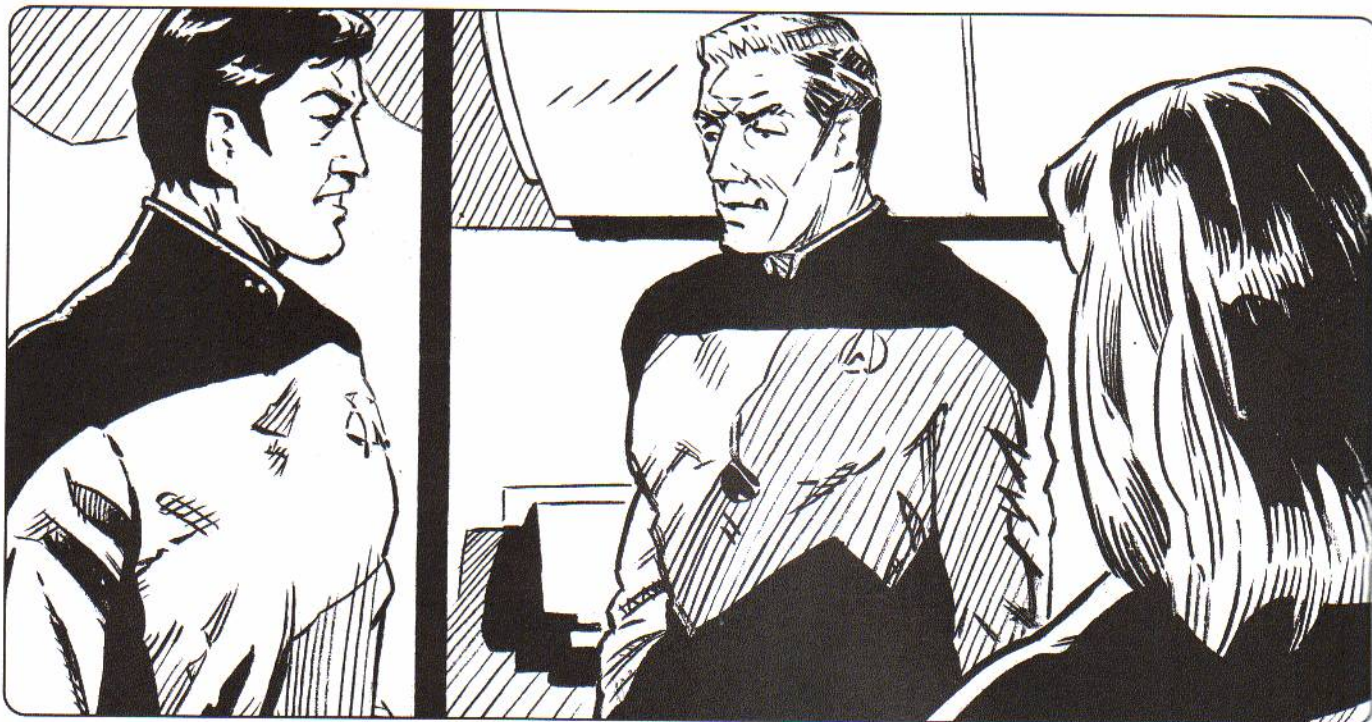

virus symptoms (unless one of the players portrays the doctor, in which case he may not have prescribed it; in this case, she obtained it at Starbase 103).

Her computer contains just about all known data on the planet Minos and its vanished civilization. It also stores a number of personal notes containing T'suus' psychohistorical model of the Minoasian civilization. According to her model, Minos should have entered a period of major social and political change at the time of the catastrophe, with a high probability of major transformations of the culture and economy.

### BARTOK

Commander Bartok is very busy analyzing some aspect of the complex—perhaps the computer core or Operations room—and can't tell the Crew much about T'suus. He knew her reputation as a psychohistorian, and they traveled to Starbase 103 aboard the *Oppenheimer* together. He recalls her as being typically Vulcan—efficient, calm, and highly intelligent.

If the characters search his belongings, they notice Commander Bartok's gear is remarkably sparse. He carries with him absolutely no personal effects—everything is standard-issue Starfleet equipment produced by the ship's replicators. He does have two standard devices that seem a bit out of place.

The first is an interplanetary-range communicator. The device is about the size of an early Starfleet hand communicator and is capable of communicating with ships or ground stations anywhere within a solar system. Bartok brought the unit along in case of emergency—he didn't want to be stranded if the Crew's combadges couldn't penetrate the complex's shielding.

The second notable item is a message recorder, which can be linked with a communicator to broadcast a message when it receives an activating signal. Bartok brought this along in case something happened to the expedition, so a returning starship could recover his findings. He didn't want to let the other expedition members know he was willing to die to accomplish the mission.

### ISKANDARI

Lieutenant Iskandari says he was alone in the executive living area, writing up some notes on his PADD at the time of T'suus' death. While true, it isn't the whole truth. Iskandari and T'suus had a long conversation shortly before the murder. He had hoped the two of them might be able to resume their old relationship, but T'suus told him as kindly as she could that it would be impossible.

Iskandari is disappointed and humiliated by the exchange, and fears admitting the truth would only increase any suspicions about him. If questioned about T'suus he claims to have met her aboard the *Oppenheimer*, and says they didn't really have any contact during the voyage to Starbase 103. With a successful Receptive Empathy test, empathic characters may be able to tell that Iskandari is very upset, even though he tries to maintain a calm demeanor.

A search of Iskandari's belongings reveals a computer, a tricorder, and an old-fashioned paper notebook filled with sketches of Minoasian technology. He also has a Vulcan IDIC pendant and several books by Vulcan philosophers. Most are in the original Vulcan, but one book is an English edition of the teachings of Surak. On the title page is the faded inscription, "To Ali—may it help you understand why."

If confronted with some evidence of his past connection with T'suus, Iskandari admits the truth, but insists he did not kill her. He has taken her death with apparent calm because as a Vulcan she would want it that way.

## TOLAS

Dr. Tolas is in fact the killer. T'suus became suspicious of him when she noticed he had caught her case of dermal virus. Since the disease affects Vulcanoids exclusively, she knew that Andorians are not susceptible to the disease, and questioned him as they rode in the elevator together. He shot her with the phaser issued to him according to standard Away Team procedure, planning to attribute her death to some Minoasian security system.

If any of the player characters get too nosy, Tolas tries to kill them as well in the same manner. Since getting the doomsday device is his main concern, he won't have much attention to spare for any would-be detectives.

When questioned about T'suus, Tolas says truthfully that he met her for the first time aboard the *Oppenheimer*, although he is familiar with her published work. They discussed Minos and its civilization at some length during meetings with Commander Bartok, but otherwise had little contact. At the time of the murder Tolas says he was asleep, and there is nobody who can contradict him.

Tolas is very cooperative about allowing the player characters to search his belongings. He has some well-worn field gear, a self-heating teapot, and a large utility knife. He also has two tricorders, both of Andorian make. The one in his suitcase is an ordinary tricorder. The one he carries on his belt is special: It has a power cell ten times larger than the device would normally need, and it has a larger-than-normal communications array in place of the main memory storage section.

The tricorder's augmented communications system is more powerful than normal, enabling Tolas to send short messages to a ship in high orbit (beyond 40,000 km). It requires a Difficult (12) Personal Equipment (Tricorder) Skill Test to notice that the tricorder is a bit unusual.

Tolas records all his research findings on the modified tricorder, then transfers the information he doesn't want kept hidden to the other one. Anyone examining the data stored on the normal tricorder must make a Challenging (9) Intellect Test (with Perception edge) to notice there are jumps in the record, as if something were cut out.

Although Tolas does his best to hide his dermal virus symptoms, an alert character with medical training can notice the disease by making a Moderate (5) test of the Medical Sciences (General Medicine) skill. He cannot help but scratch, but cannot ask for a topical anesthetic without submitting to a medical examination. If questioned, Tolas claims it is an odd problem, a benign parasitic infection he picked up in



the jungles of Gamma Trianguli VI. While Tolas absolutely refuses to submit to a medical scan, a careful visual examination, requiring a Challenging (9) General Medicine Test (or Medical Sciences (Vulcan) Test), reveals the same mottled, scaly discoloration as found on T'suus.

## RESOLUTIONS

If the player characters manage to solve the murder of T'suus, Tolas does not surrender quietly. He has his phaser, and tries to get away from his captors. His goal is the Omega Device—if the expedition has managed to open the shaft, Tolas conceals himself down there and waits for the Romulans to arrive. If the shaft is still closed, Tolas goes into hiding in the labyrinthine Minoasian complex, trying to pick off the other away team members until he is the only one left.

The Romulan task force can appear at any dramatically appropriate time. Two warbirds join the *Maricus* already in orbit. Crew members can play out the starship encounter between the Federation vessel and Romulan antagonists. The characters down in the complex may be trying to catch Tolas while the Federation starship deals with a hostile force. The sit-



uation can be resolved in several ways. If the Federation ship is beset by the Romulan vessels, the Away Team in the facility may be able to activate the planetary defense batteries from the Situation Room. The big planet-based guns are more than enough to even the odds.

Less likely, though certainly plausible, is a Romulan victory over the Crew's starship. In this case, the Romulans beam down to the planet to claim the Omega Device for themselves. The Crew, familiar with the complex's layout after their explorations, could attempt to hold off the Romulans while waiting for reinforcements from Starfleet. Or they could become prisoners of the Romulan Star Empire. If the Crew haven't solved T'suus' murder, traitorous Tolas can lead the Romulans right to the Omega Device (and perhaps betray the Crew at a crucial time).

To halt the conflict above them in space, the Federation characters could offer to share what they learn from the complex with the Romulans. Ultimately, the Romulans are concerned about anyone having access to the galaxy's most destructive weapon; proving to them the device's defensive nature, and uselessness off Minos, could defuse the situation.

If the Federation characters detonate the Omega Device, then the entire planet becomes useless to the Romulans. They retreat to avoid further provoking a war over a planet of junk. Alternatively, the Federation team can give the Device to the Romulans, since it does not actually threaten the safety of the galaxy.

## NARRATOR HINTS

Timing is fairly important in this adventure. The murder should not take place until the Away Team is isolated on the planet, after Tolas learns of the Omega Device and sends his signal to the Romulans. The murder should be the midpoint of the episode, the point when the story shifts from exploring the complex to investigation. Ideally, the murder investigation should be going on at the same time the Crew search for the Device and attempt to solve the puzzles of opening the doors in the shaft. In the meantime, their starship might be off hunting the source of the anomalous transmissions.

The climax should stem from events in the story. The starship above should be locked in a battle with the Romulan warbird, thus preventing the Crew from beaming back up. Meanwhile, the Crew should either confront Tolas with their suspicions, in a scene reminiscent of thousands of detective stories, or be searching for him throughout the complex. The episode resolves itself depending on the player characters' actions, as described previously.

Because there are several different problems to solve in the complex, the Narrator should make sure the player characters aren't trying to be everywhere at once. Characters interviewing murder suspects can't be trying to get into the Omega Device chamber, and

characters searching for killing machines won't have time to hack the computer system.

The Narrator should emphasize the creepiness of the situation. Keep playing up the darkness, the eerie silence, and the party's isolation. The holographic "ghosts" can provide a note of black humor, interrupting a serious search with technojargon about defending a dead world.

## SUGGESTED REWARDS

The goal of the mission is to explore the Minoan security complex. The player characters participating in the Away Team should receive 1 Experience Point apiece.

If the Crew uncover Dr. Tolas as either a spy or the murderer, give the player characters 1 Experience Point, and 3-4 Skill Renewn.

For finding the legendary Omega Device, the player characters earn an additional Experience Point and 3-4 Initiative or Skill Renewn.

Peacefully defusing the situation with the Romulan warbird earns the Crew -3 to -4 Aggression Renewn, or 3-4 Skill Renewn.

Driving off the Romulan warbird earns the Crew 1-2 Aggression Renewn.

## SUPPORTING CAST



### COMMANDER STEFAN BARTOK

#### Attributes

Fitness 2  
Coordination 2  
Dexterity +1  
Intellect 3  
Logic +1  
Perception +1  
Presence 2  
Willpower +1  
Psi 0

#### Skills

Athletics (Parrises Squares) 4 (5)  
Behavior Modification (Resistance) 1 (2)

Computer (Modeling) 2 (3)  
 Culture (Earth) 3 (4)  
 Dodge 1  
 Energy Weapon (Phaser) 2 (3)  
 History (Earth) 1 (2)  
 (Federation) 1 (2)  
 Intelligence (Traffic Analysis) 2 (3)  
 Language  
 Federation Standard 3  
 Romulan 1  
 Law (Starfleet Regulations) 2 (3)  
 Material Engineering (Metallurgy) 3 (4)  
 Personal Equipment (Communicator) 1 (2)  
 Physical Science (Physics) 3 (4)  
 Planetside Survival (Arctic) 1 (2)  
 Propulsion Engineering (Fusion) 2 (3)  
 Shipboard Systems (Weapons Systems) 2 (3)  
 Systems Engineering (Weapon Systems) 3 (4)  
 Theoretical Engineering (Weapons Systems) 2 (3)  
 Vehicle Operation (Shuttlecraft) 1 (2), World  
 Knowledge (Earth) 1 (2)

#### **Advantages/Disadvantages**

Engineering Aptitude (+3)  
 Promotion (Commander) (+4)  
 Obligation (Technical Intelligence) (-1)

**Courage:** 3

**Renown:** 40

Aggression: 0 Discipline: 12 Initiative: 8  
 Openness: 0 Skill: 20

**Wound Levels:** 2/2/2/2/2/0

**Equipment:** Type II phaser, tricorder, interplanetary-range communicator, message recorder

**Roleplaying Notes:** Commander Bartok's job is to analyze and evaluate alien technology, to determine if it poses a threat to Federation security. Bartok was originally attached to Starfleet's engineering division, until his entire family was killed in the Borg attack on the New Providence colony in 2366. Bartok subsequently served in the battle of Wolf 359 and watched the cream of Starfleet crushed by superior Borg technology.

Since that day Commander Bartok has worked with fanatical dedication to make sure the Federation's defense technology is superior to that of all potential enemies. He is very disturbed by the prospect of a galaxy-destroying "doomsday device" and is willing to sacrifice his own life as well as those under his command to keep the Federation's enemies from gaining the ultimate weapon.

Bartok is a thick-set man with heavy eyebrows, of average height. On the rare occasions he isn't working, he keeps fit playing parries squares. He is currently assigned to Starfleet's Technical Intelligence Division.



## LIEUTENANT ALI ISKANDARI

#### **Attributes**

Fitness 2  
 Coordination 2  
 Intellect 3  
 Presence 3  
 Empathy +1  
 Psi 0

#### **Skills**

Computer (Research) 2 (3)  
 Culture (Human) 2 (3)  
 Dodge 1  
 Energy Weapon (Phaser) 1 (2)  
 History (Federation) 3 (4)  
 Language  
 Federation Standard 2  
 Vulcan 1  
 Law (Starfleet Regulations) 1 (2)  
 Personal Equipment (Tricorder) 2 (3)  
 Planetside Survival (Desert) 2 (3)  
 Social Sciences (Anthropology) 3 (4)  
 (Economics) 3 (4)  
 Vehicle Operation (Shuttlecraft) 1 (2)  
 World Knowledge (Earth) 1 (2), World  
 Knowledge (Vulcan) 1 (1)

#### **Advantages/Disadvantages**

Language Ability (+2)  
 Promotion (Lieutenant) (+1)  
 Dark Secret (-1)  
 Hides Emotions (-2)

**Courage:** 2

**Renown:** 5

Aggression: 0 Discipline: 0 Initiative: 0  
 Openness: 0 Skill: 5

**Wound Levels:** 2/2/2/2/2/0

**Equipment:** PADD, tricorder, personal gear

**Roleplaying Notes:** Lieutenant Iskandari is a Starfleet science officer attached to the player characters' ship. Iskandari is an historian who studies the comparative development of technological civilizations. He volunteers enthusiastically for the Minos away team, and

is even willing to trade extra duty shifts with another crewman to get on the team.

Iskandari was once romantically involved with T'suus. He was deeply in love with her, but she was already promised to a Vulcan mate. Iskandari hopes that perhaps the expedition could provide a second chance for him to win her affection. Ever since they broke up he has studied Vulcan culture and philosophy carefully.

Lieutenant Iskandari is a slender, dark-eyed human with a neatly trimmed beard. He is usually quite unemotional and reserved—the result of his studies of Vulcan philosophy.



## CENTURION SUDOK

### Attributes

Fitness 2  
Strength +1  
Coordination 2  
Intellect 3  
Perception +1  
Presence 3  
Empathy -1  
Willpower +1  
Psi 0

### Skills

Administration (Romulan Star Command) 2 (3)  
(Warbird) 2 (4)  
Athletics (Lifting) 2 (3)  
Command (Warbird) 3 (4)  
Computer (Programming) 2 (3)  
Culture (Romulan) 2 (3)  
Dodge 2  
Energy Weapon (Disruptor) 2 (4)  
Espionage (Traffic Analysis) 2 (3)  
History (Romulan) 1 (2)  
Intimidation (Bluster) 1 (2)  
Language  
Federation Standard 1  
Romulan 3  
Law (Romulan Military Regulations) 2 (3)  
Personal Equipment (Tricorder) 1 (2)  
Planetside Survival (Arctic) 1 (2)

Shipboard Systems (Tactical) 2 (3)  
Starship Tactics (Romulan) 2 (3)  
(Incursion Tactics) 2 (3)  
Strategic Operations (NZ Strategies) 2 (3)  
Systems Engineering (Tactical) 2 (3)  
Unarmed Combat (Romulan Navy Martial Arts) 2 (3)  
Vehicle Operation (Shuttlecraft) 1 (2)  
World Knowledge (Remus) 1 (2)  
(Romulus) 1 (2)

### Advantages/Disadvantages

Contact (Senator Kassus) (+3)  
Resolute (+3)  
Shrewd (+1)  
Arrogant (-1)  
Obligation (Romulan Military) (-3)

**Courage:** 4

**Renown:** 85

Aggression: 21 Discipline: 29 Initiative: 2  
Openness: -8 Skill: 25

**Wound Levels:** 2/2/2/2/2/0

**Roleplaying Notes:** Centurion Sudok commands the warbird *Maricus*, assigned to follow the expedition to Minos and receive any signals from the Romulan undercover agent aboard. Sudok has only recently been appointed a centurion, and has been given an older ship on intelligence missions rather than a front-line vessel. He is an ambitious officer who dreams of using a triumph in the field as the springboard to a political career. Like most Romulan tacticians, he prefers to let his enemy make the first move in battle.

Over the viewscreen Sudok appears as a young, confident-looking Romulan officer. His speech is full of subtle mockery.



## T'SUUS, VULCAN PSYCHOHISTORIAN

### Attributes

Fitness 2  
Strength +1  
Coordination 2

Intellect 4  
 Logic +2  
 Presence 2  
 Willpower +2  
 Psi 2  
 Range -1

### Skills

Computer (Modeling) 2 (3)  
 (Research) 2 (3)  
 Culture (Vulcan) 2 (3)  
 Dodge 1  
 History (Galactic) 3 (4)  
 (Vulcan) 3 (4)  
 Language  
 Federation Standard 1  
 Minoasian 1  
 Vulcan 2  
 Mind Meld 2  
 Personal Equipment (Tricorder) 1 (2)  
 Planetside Survival (Desert) 1 (2)  
 Social Sciences (Political Science) 2 (3)  
 (Psychohistory) 2 (4)  
 (Sociology) 2 (3)  
 Unarmed Combat (Nerve Pinch) 2 (3)  
 Vehicle Operation (Shuttlecraft) 2 (3)  
 World Knowledge (Minos) 1 (2)  
 (Vulcan) 1 (2)

### Advantages/Disadvantages

Hides Emotions (-3)  
 Pacifism (-3) (Self Defense)  
 Vulcan Code of Honor (-3)

### Courage: 3

### Renown: 20

Aggression: 0 Discipline: 0 Initiative: 0  
 Openness: 0 Skill: 20

### Wound Levels: 2/2/2/2/2/0

**Equipment:** Personal computer, tricorder, case with personal possessions

**Roleplaying Notes:** T'suus is a research associate at the Vulcan Science Academy, specializing in the field of psychohistory—the study of a culture's large-scale behaviors. For the past few years T'suus has been investigating the destruction of the Minoasian civilization. It presents a fascinating problem in psychohistory.

T'suus is a tall, dark-skinned Vulcan woman with silver hair. Her studies of other cultures have made her less supercilious and aloof than most Vulcans, and she has no difficulty dealing with emotional behavior in others. When she comes aboard the Crew's ship, T'suus suffers from a severe case of Vulcan dermal virus. Though it itches terribly, she doesn't scratch. Scratching would only make the rash spread further.

### NOTE FOR NARRATORS

Some of the supporting cast characters draw on information from *The First Line: Starfleet Intelligence* and *The Way of D'era: The Romulan Star Empire*. While these products are not necessary to enjoy this adventure, Narrators seeking information on certain skills and traits should consult these books.



### DR. ANAK TOLAS, ANDORIAN ARCHAEOLOGIST

#### Attributes

Fitness 3  
 Coordination 2  
 Reaction +1  
 Intellect 2  
 Perception +1  
 Presence 2  
 Empathy -1  
 Willpower +1  
 Psi 0

#### Skills

Artistic Expression (Acting) 1 (2)  
 Athletics (Lifting) 1 (2)  
 Behavior Modification (Resistance) 2 (3)  
 Computer (Data Alteration/Hacking) 2 (3)  
 Culture (Andorian) 2 (3)  
 (Romulan) 2 (3)  
 Disguise (Andorian) 1 (3)  
 Dodge 2  
 Energy Weapon (Disruptor) 2 (4)  
 Espionage (Covert Communications) 2 (3)  
 History (Romulan) 2 (3)  
 Intimidation (Bluster) 2 (3)  
 Language  
 Romulan 2  
 Law (Romulan) 1 (2)  
 Medical Science (Psychology) 1 (2)  
 Personal Equipment (Tricorder) 2 (3)  
 Primitive Weaponry (Knife) 1 (3)  
 Security (Security Systems) 2 (3)  
 Shipboard Systems (Tactical) 1 (2)  
 Surveillance (Bugging) 1 (2)

Unarmed Combat (Boxing) 1 (2)  
(Romulan Navy Martial Arts) 1 (2)  
Vehicle Operations (Shuttlecraft) 1 (2)  
World Knowledge (Romulus) 1 (2)

**Advantages/Disadvantages**

Deep Cover (+2)  
Quick-Draw (+2)  
Resolute (+3)  
Security Clearance +3  
Dark Secret (-3)  
Fanatic -3  
Obligation (-3) (to *Tal Shiar*)

**Courage:** 4

**Renown:** 35

Aggression: 0 Discipline: 15 Initiative: 0  
Openness: 0 Skill: 20

**Wound Levels:** 3/3/3/3/3/0

**Equipment:** Two tricorders, one concealing an augmented communications system; field gear; utility knife

**Roleplaying Notes:** Tolas is a well known and somewhat controversial figure in the field of techno-archaeology. He specializes in the excavation of lost civilizations and the reconstruction of their technologies. His critics call him a grave-robber, and he has been accused of discarding or destroying items of great historical or artistic importance in the search for technological remains.

Andorian characters who try to engage Tolas in conversation find he has little regard for their home planet. "I really don't mind if I never see Andoria again. The universe holds many wonders, but that ball of dirt isn't one of them." He knows little of the intricacies of Andorian culture, particularly if challenged to a ritual duel. For years, he's managed to avoid intimate encounters with other Andorians.

Tolas is actually Captain Tralok, a deep-cover agent for the Romulan *Tal Shiar*. Twenty years ago he was given extensive surgical alteration and replaced an actual Andorian student at the Daystrom Institute. As he was already a trained xenoarchaeologist, he had no difficulty graduating with honors, and soon began a career of excavating ancient technological sites on worlds within the Federation—and sending his most important discoveries back to Romulus.

Tolas is a fairly average Romulan, who happens to look like a heavily-built Andorian. His hair is white and his skin is blue, darkened by years under alien suns. The false antennae on his head are extremely realistic surgical implants, and do not come off even if pulled. A medical examination reveals his true species, but Tolas is extremely adept at avoid-

ing medical exams. This becomes a problem for him on the Minos expedition when he begins coming down with the Vulcan dermal virus he caught from T'suus. Unlike a Vulcan, Tolas doesn't have the iron self-control to keep from scratching.

Under normal circumstances, it is more important for Tolas to maintain his cover identity than to steal any one technological discovery. Only the prospect of a "doomsday device" would make him willing to risk exposure.

# On the Edge of Night

Not all alien life encountered by Starfleet takes humanoid form, nor are planets the only places where life exists. The quote from Melville's *Moby Dick*—"They say the sea is cold, but the sea contains the hottest blood of all"—could apply to space, as well. This episode confronts a starship Crew with just such an enigma.

Assigned to rendezvous with a scientific research vessel monitoring the collapse of a neutron star, the Crew arrive to find the ship adrift in space. To rescue the team, the player characters must enter a dark matter nebula and reach the drifting science vessel. Once on board, the Crew discover three survivors and the clues to the disaster that crippled the ship.

## BACKGROUND

Despite Starfleet's extensive exploration of space, the origins of the universe continue to elude scientists. Using the laws of universal gravitation astronomers have, classically, been able to determine the mass of a given body, such as Sol, by observing its effect on another body, such as Earth. This works when observing nearby bodies like Sol and local stars, yet when the same principles are applied to distant galaxies, the results don't match the observed facts.

Distant galaxies must be far heavier than they appear in order to fit current models, Federation scientists theorize; there must be extra mass in these galaxies which escapes detection. In order to compensate for this discrepancy, astronomers postulate the existence of another form of matter—dark matter. This matter must be able to absorb radiation, such as light and X-rays, without giving off light, thus escaping detection. Federation scientists believe dark matter may comprise ninety percent of the universe's mass, yet they have identified little of it in existence. The Mar Oscura nebula could provide invaluable information on the nature of dark matter.

## MAR OSCURA

A dark matter nebula on the edge of Federation space, Mar Oscura is irregularly shaped and more than ninety light years in diameter. Characteristic of dark matter, the nebula does not emit or reflect electromagnetic radiation, making it invisible to most sensors. The only way to detect Mar Oscura is by measuring the amount of light refraction from distant stars, refraction caused by dark matter's gravity.

The *U.S.S. Enterprise-D* visited Mar Oscura in 2367. Equipped with photon torpedoes designed to illuminate the interior of the nebula, the starship discovered a Class M planet that winked out of existence, then reappeared. The crew theorized that the nebula caused gaps in the fabric of space. When these pockets touched the ship, they caused the point of contact to phase momentarily out of normal space. With the ship endangered by this phenomenon—since contact between the hull and one of these

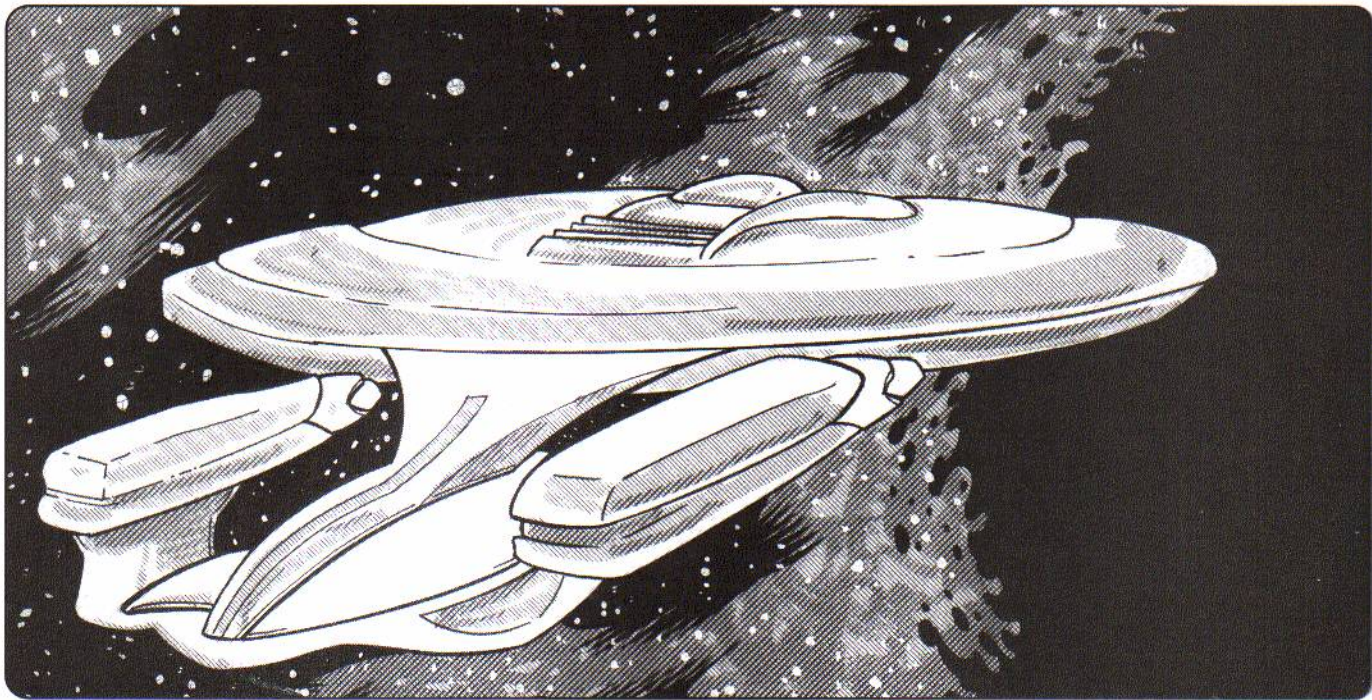

pockets would cause a breach—Captain Picard ordered the *Enterprise* out of the nebula. Unfortunately, the *Enterprise's* size prevented the ship from successfully maneuvering this interstellar obstacle course. Only by following a shuttlecraft, which led the ship through the nebula, could the *Enterprise-D* escape.

Starfleet Command immediately ordered all vessels to steer clear of Mar Oscura, making it a class-3 navigational hazard. While not barring navigation through dark matter nebulae, the order cautioned captains to exercise extreme caution, due to the danger to ship and crew.

Yet because the nature of dark matter continues to elude scientists, investigations into Mar Oscura continued despite the *Enterprise's* experience. Starfleet dispatched an *Oberth*-class science vessel—because of its smaller size and greater maneuverability—to explore carefully the interior of the nebula. Modifications made to the *U.S.S. Tenebrae* allow it to operate in Mar Oscura, with extra compartmentalization that allows sections of the ship to be lost without losing overall hull integrity.

Dr. Cynthia Winters, a Federation scientist, accompanied the *U.S.S. Tenebrae* because of her work on subspace phenomena. Based on her research, she believes that it may be possible to traverse the nebula, and has a theory about the relationship of dark matter to subspace.

For the past year, Dr. Winters has conducted her research, firing tetryon and dekyon particles at the various pockets of spatial distortion. She found they were reflected back, allowing her to detect them with greater ease. Further research using projected warp bubbles revealed that the spatial rifts were a form of

naturally occurring warp-field effect—any subspace travel through a dark matter nebula could cause enormous and cataclysmic rifts in the fabric of space.

### FGC-27

While Dr. Winters conducted her experiments on subspace particles within the nebula, the crew of the *Tenebrae* discovered a neutron star within Mar Oscura. FGC-27 was originally difficult to detect due to the dark-matter cloud surrounding it. An extremely small and dense star with twice the mass of Sol, but only seven miles in radius, FGC-27 emits occasional bursts of neutronium particles at random intervals. Over the last year, FGC-27's activity has increased, which the *Tenebrae's* science officer believed signaled the imminent collapse of the neutron star. Starfleet instructed the *Tenebrae* to continue monitoring the star and to estimate the time until it collapsed into a black hole.

Unknown to the scientists or the Federation, energy-based lifeforms calling themselves the Umbra make their home in the neutron star, and feed off the gravitational fields it generates. The Umbra noticed the changes in the star's composition, sparking a debate within their society. Some Umbra eagerly anticipated the collapse, believing it would bring them to their next evolutionary stage, while a small number of Umbra feared extinction. These rebels refused to await their ultimate fate, and frantically sought a way to survive the star's implosion.

Just a few days ago, the *Tenebrae* transmitted its final analysis of FGC-27, estimating it would die six days hence at precisely 1300:11 hours Earth Standard Time. Starfleet ordered the Crew's starship to ren-



devout with the *Tenebrae* to ensure their safety during the star's collapse. Meanwhile, the crew of the *Tenebrae* detected unusual particle emissions from the star—something never before seen. The crew believed this new particle posed a danger to the ship and raised their shields. Little did they know the emissions from the star were Umbra, searching for a way out of the nebula.

The Umbra soon began draining energy from the shields. Firing phasers at the phenomenon had no effect. The crew, frantic to get rid of these parasites, used Dr. Winters' tetraon emitters, which seemed to work initially. Still, the attacking Umbra managed to breach the shields. Within a matter of minutes, they drained all power on the vessel. Although the crew tried to send a distress call, the speed of the attack and the dark matter surrounding them prevented it from reaching anyone.

## SYNOPSIS

The Crew arrive on the edge of Mar Oscura to find the *Tenebrae* drifting dead in space and not responding to hails. Meanwhile, estimates place the nebula's collapse in six hours. The Crew must get to the *Tenebrae*, determine what happened, and rescue any survivors before this time elapses. Arriving at the science vessel's location, the Crew discover the ship drained of power and life-support systems barely functioning.

A close examination of the crew reveals only three survivors of whatever afflicted the *Tenebrae*. With the survivors in need of emergency medical attention, and the implosion of Mar Oscura imminent, the Crew transport Captain Pitt, Dr. Winters, and Science Officer Srri to their starship.

Unknown to the Crew, these survivors serve as hosts to entities calling themselves the Umbra. Once on the Crew's vessel, the Umbra begin their search for a new home—any nearby neutron star will do. At first they simply use their personas to influence the captain to visit a suitable star. If rebuffed, the Umbra become increasingly persistent—assuming the personas of other crew, possibly even the captain, they alter the ship's course. Eventually, they attempt to control the ship directly, by inhabiting the ship's computer itself.

This could have dire consequences, as the presence of the Umbra drains power from the ship, eventually depleting all of the vessel's energy and stranding the crew. The characters must discover the Umbra's true nature, determine their motivation, and negotiate a solution to their problem—either delivering the Umbra to a nearby star or otherwise removing them from the ship.

## SUPPORTING CAST CHARACTERS

Three supporting cast characters figure prominently in this episode—the three survivors of the *Tenebrae* disaster. Each of them serves as host to an Umbra.

## THE UMBRA

In their natural form, the Umbra appear as small, hovering, phosphorescent lights. Sentient and highly intelligent, though unfamiliar with corporeal lifeforms, the Umbra adapt quickly. In their energy form they can pass through solid matter without difficulty. Only energy barriers can hold them back, but eventually they can drain these obstacles by feeding off the energy they produce. Energy weapons have no effect, as their energy is harmlessly absorbed. While they prefer graviton particles, as found within the neutron star, they can absorb other forms of energy without difficulty.

Overall the Umbra are not an aggressive species. They possess a sophisticated culture based entirely on energy, and are thus completely unfathomable to corporeal beings. As pure energy, they perceive a variety of radiation waves and particles—X-rays, visible light, infrared light, baryons, neutrons, leptons, etc. Matter remains an enigma to them. Lacking the ability to travel through space, they remain ignorant of the greater universe; the Umbra cannot travel far from a source of energy without eventually exhausting themselves.

Because of this inability, when the Umbra desirous of fleeing FGC-27 saw the *Tenebrae*, they seized the opportunity. Snatching onto it like a drowning man grabs a piece of flotsam, dozens of Umbra fled to the starship. They drained the deflector shields, causing the *Tenebrae*'s crew to fire phasers. These had little effect on the energy beings. Dr. Winters' actions, however, caused the deaths of dozens of Umbra, convincing the survivors of the ship's hostile intent. In an act that could perhaps be interpreted as self-defense, the Umbra drained the starship of all power. Unfortunately, this also stranded them in space.

By tapping the electrical activity of humanoid brains, an Umbra can read surface thoughts and learn by scanning people's minds. Umbra can take over the minds of corporeal beings by inhabiting their bodies and feeding off the electrical energy they generate. This requires a successful Opposed Presence Test against the victim, adding any bonus provided by the Willpower Edge. Initially, inhabiting a corporeal body confuses an Umbra; they must adapt to material existence. Once it takes over, an Umbra gains full control of the body, suppressing the individual's consciousness. Although it can read a host's surface thoughts, by reading the synaptic discharges that form thought, the Umbra cannot reliably access memory. When it leaves a body, the person briefly falls unconscious, then regains full motor control. Although it is more difficult, the Umbra can occupy the bodies of deceased individuals, but it takes them time to get the corpses working again due to the damage to neural pathways. While they inhabit such a body, it appears as though the individual is alive and well, although neural activity seems to follow strange patterns.

As beings of pure energy, the Umbra lack physical attributes; they assume the attributes of the hosts they inhabit. Each Umbra is represented by Intellect, Presence, Psi, and some Skills. They can use the Skills possessed by a host, but the process is unreliable. Each time an Umbra wants to use a host's Skills, it should make an Intellect Test against the difficulty of the task to be attempted. Thus, Umbra must make two Skill Tests—one to find the information in the subject's brain, the second actually to attempt the action. Because the Umbra can jump from body to body, the Narrator should create the characters of Dr. Winters, Captain Pitt, and Lieutenant Srri (see below), or use the archetypes on pages 59-62 in the *ST:TNG RPG Core Rulebook*.



## DR. CYNTHIA WINTERS/ALPHA

Dr. Winters is a striking woman in her forties with soft brown eyes and graying streaks in her raven-black hair. Known in scientific circles as a bold and innova-



tive woman, she devotes her life to the study of subspace anomalies. More familiar with tetryons and dekyons than normal space, she knows a great deal about the structure of subspace, and proved instrumental in improving warp efficiency at Starfleet's Advanced Starship Design Bureau. During her year-long stint on board the *Tenebrae*, Dr. Winters confirmed her latest theory—of a relationship between dark matter spatial gaps and subspace intrusions into normal space. Using a subspace resonator to form subspace “bubbles” similar to those generated by a warp drive, she determined that they created even larger tears in the dark matter region.

The Umbra calling itself Alpha inhabits Dr. Winters' body. Alpha's motivation throughout this episode is to reach another neutron star and find a new home. The actions of the *Tenebrae's* crew have convinced it that corporeal beings cannot be trusted. Alpha attempts to dupe the Crew into taking it and its fellow Umbra to a new neutron star, by using Dr. Winters' research as an excuse.

## CAPTAIN STEVEN PITT/BETA

Captain Steven Pitt is the commanding officer of the *U.S.S. Tenebrae*, the science vessel sent to survey the Mar Oscura nebula and research the nature of the subspace gaps found within.

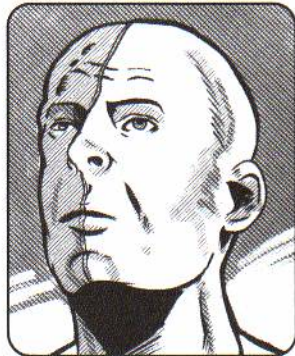

Pitt is a medium-build, medium-height human male with a strong jaw and forceful presence. Although he began his Starfleet career as a scientist, he specialized in planetary science. His primary motivation is the safety of his ship and crew, and he does not like being in the position in which he finds himself—near to a collapsing neutron star, surrounded by a veritable minefield of subspace gaps. Nevertheless, he follows his orders to the letter.

The Umbra calling itself Beta inhabits Captain Pitt's body. Like Alpha, Beta wants to find a new neutron star to inhabit. While Beta understands that its host holds some position of authority in the corporeal world, it lacks the knowledge typical of Starfleet officers. The upcoming destruction of its home star has

affected it more than the other Umbra. Unable to reconcile the loss, it is dangerously on the edge of insanity. Beta doesn't hesitate to kill if it believes it is beneficial to the Umbra cause.

## LIEUTENANT WYV SRRI/GAMMA

Wyv Srri is the Chief Science Officer on board the *Tenebrae*. Like most Bolians, he is blue, with a bifurcated ridge running down the center of his face. His narrow features and slightly hooked nose give him a serious demeanor. Normally quite outgoing and helpful, he took quickly to Dr. Winters, and the two worked side by side on her research into the nature of the subspace gaps found within Mar Oscura. Lieutenant Srri hopes one day to receive a chair at the Federation



Science Council, to conduct research into his favorite subject—nuclear physics.

Gamma feels guilty for the events transpiring on the *Tenebrae*. The Umbra did not mean to disable the ship, nor kill the crew; they acted out of self-preservation. Throughout the episode, explaining this and somehow coming to an understanding with the corporeal beings is its primary motivation. Although it follows Alpha's lead reluctantly, like all Umbra it requires energy to live and must find a new neutron star to inhabit.

## SAVE THE TENEBRAE

This adventure is broken up into scenes which correspond to a dramatic presentation of the events. Narrators are advised to read through the entire adventure since Crew members may search for information contained in other sections at any time.

## RENDEZVOUS IN THE DARK

The Crew's ship receives orders from Starfleet Command to proceed to the dark matter nebula Mar Oscura; once there, the Crew is ordered to rendezvous with the Starfleet research vessel *U.S.S. Tenebrae*, on assignment to study an imploding neutron star. Starfleet wants to ensure the safety of the *Tenebrae* when the star collapses and forms a black hole, especially considering the nature of the Mar Oscura nebula. (Anyone who makes a successful Routine (4) Computer (Research) Skill Test can locate all relevant information on Mar Oscura—including the logs of the *Enterprise-D* crew—in the library computer). The Crew's starship, on survey duty in a nearby system, can reach the *Tenebrae* in approximately three days at warp 7.

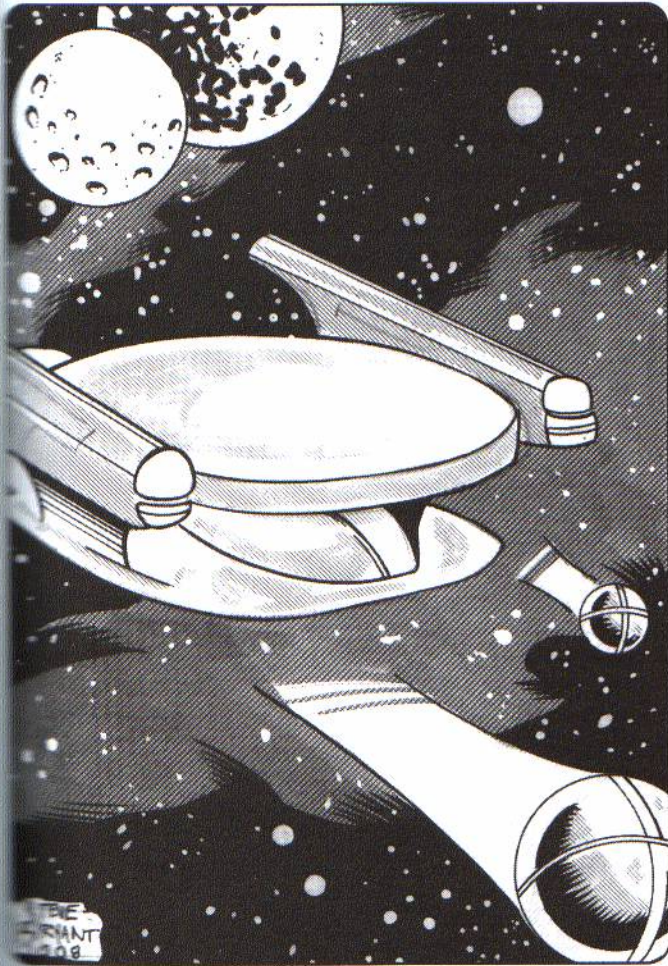

The first day of the trip to the nebula passes uneventfully. The Narrator might want to include a few scenes of daily life on board a starship, to set a comfortable tone and ease into the episode. On the second day, however, the ship receives a distress call from the *Tenebrae's* Captain Pitt.

The signal is weak and fades in and out, requiring a Moderate (6) Communications Skill Test to boost successfully. The captain explains over tremendous static that his ship has suffered a sudden and massive power loss. With an unsuccessful Test Result, the Crew learn only that the *Tenebrae* has sent a distress call of unknown nature. Before the Crew can respond, however, the signal breaks up and dissipates. Continuing at warp 7, they arrive in thirty-six hours; at warp 9 they can reach the edge of the nebula in just under three hours.

## ON THE EDGE OF THE NIGHT

Once the Crew arrive on the edge of Mar Oscura, they pick up a transmission from a navigation buoy warning them that the dark matter nebula is a class-3 navigation hazard. This presents the Crew with their first challenge—getting to the *Tenebrae*. While they can take their ship into the nebula, this poses a considerable risk because of the pockets of null space

found within. How the Crew solve this problem is largely up to player inventiveness; the Narrator should use the information provided here as guidelines. Generally, the Crew can either take their ship into the nebula, or use a shuttlecraft. Since the *Tenebrae* floats deep within the nebula, the Crew cannot use the transporters to get to the *Tenebrae*.

Warp travel through the nebula is one option, as the crew could easily reach the *Tenebrae* in minutes. The ship would be unaffected by the subspace gaps, since the ship itself is surrounded by a subspace “bubble” during warp flight. This would, however, create even bigger gaps in the normal space continuum. Although the ship creates only minor ripples traveling at warp 1 and reaches the *Tenebrae* in a little less than fifteen minutes, at warp 5 they reach it in just under a minute and effectively destroy the fabric of space throughout Mar Oscura.

Even at warp 1, the repercussions could hurtle the ship and crew into an alternate reality, or cause an incursion of subspace into normal space (thus destroying the nebula and everyone in it). Anyone making a Moderate (7) Space Sciences Skill Test will figure this out, and thus advise against this course of action. To travel to the *Tenebrae*, the ship must do so at impulse speeds.

Despite traveling at sublight speed, the Crew must still contend with the ever-shifting pockets of null space within the nebula. Navigating the “minefield” of gaps depends on a ship’s speed and size. Smaller ships, like *Oberth*-class vessels and shuttlecraft, should be able to navigate the region with relative ease. *Nebula*- and *Galaxy*-class ships have a proportionally more difficult time. Consult the relevant section below to find the base difficulty for a navigation attempt, along with any modifiers.

Any failed tests while piloting through the nebula result in contact with a rift. Roll one die on the Spatial Rift table (found on page 34), adding +1 per point by which the test was missed. The Narrator should make clear what kind of effects could occur should the pilot fail; this will allow the Crew to prepare themselves and control the speed of their vessel through the nebula. Note that these tests are required on the return trip as well; if a smart Crew member records the route through the nebula, correcting for any failed tests, they can return at full impulse having to make only one Skill Test.

The Narrator should roleplay through any results on the Spatial Rift table. Damage to a shipboard system requires repair by Engineers, for example, and the Narrator should have any qualified Crew members make relevant Engineering Skill Tests (or periodically describe repair efforts); this could mean a critical system remains inoperative at a critical time.

More serious results, such as the complete decompression of a shuttlecraft’s crew cabin, should not automatically kill Crew members, but such mishaps may further complicate the mission—the crew remaining aboard the starship would probably be forced to effect a rescue operation.

## SPATIAL RIFT TABLE

Total	Result
2-4	<b>Control Damage:</b> A shielded outer section of the vessel phases out of existence for seven seconds, leaving it behind unless the pilot stops immediately, requiring a Moderate (7) Vehicle Operation (Shuttlecraft) or Shipboard Systems (Flight Control) test. If this fails, the rift damages a random system determined from the Starship Hit Location table (page 143 in the <i>Star Trek: The Next Generation RPG</i> core rulebook).
5-7	<b>Control Destruction:</b> A shielded outer section of the vessel phases out of existence for fifteen seconds, leaving it behind unless the pilot stops immediately, requiring a Challenging (10) Vehicle Operation (Shuttlecraft) or Shipboard Systems (Flight Control) test. If this fails, the rift destroys a random system determined from the Starship Hit Location table (page 143 in the <i>Star Trek: The Next Generation RPG</i> rulebook).
8-10	<b>Disabling Damage:</b> The vessel's engines phase out of existence, leaving the vessel without a power source. If the ship has more than one engine, it may continue at one-half speed and increase the difficulty of all Vehicle Operation tests by one level.
11-15	<b>Major Decompression:</b> A random interior section of the vessel decompresses suddenly. See Decompression rules for the effects. Crew caught within the section may die. The vessel may continue without penalty as long as the control section is not decompressed.
16+	<b>Total Decompression:</b> The vessel encounters a major tear in the continuum, opening up the entire ship to the vacuum of space, seriously harming the crew. The vessel can no longer be used.

## USING A STARSHIP

The decision to pilot the starship into the nebula depends on the vessel's size. Simply put, the larger the ship, the more difficult to navigate the pockets of null space found throughout the Mar Oscura. This relates directly to the ship's size characteristic on the ship template. Players should make Shipboard Systems (Flight Control) Skill Tests to avoid hitting a pocket. Ships Size 1-4 require a Routine (4) Skill Test; Size 5-7 ships require a Moderate (7) Skill Test; Ships Size 8-9 require a Challenging (10) test; while Size 10

ships require a Difficult (13) test. The Narrator should determine the number of tests required of the Conn by rolling 1D6+2, or he can simply make it an Extended Test (difficulty as above, total 60 required). Determine the turn length using the travel time information in the next paragraph. Roll on the Spatial Rift table for each failed dice roll.

The ship's speed also affects the episode's outcome. At full impulse, the ship takes one hour's time to reach the *Tenebrae*. At half impulse, the time to reach the *Tenebrae* is two hours. At one-quarter impulse, the speed at which the above difficulties are calculated, it takes four hours. The faster the ship travels, the more difficult to navigate the obstacles. Increase the Target Number by +1 for travel at half impulse, and +2 for full impulse. Thus, a *Nebula*-class ship traveling at full impulse would require a Challenging (9) Skill Test to navigate successfully (Moderate (7) + 2 = 9 (Challenging)).

Alternatively, the Crew could use a solution similar to that employed by the *Enterprise-D* crew—use a shuttlecraft to negotiate the nebula and relay navigation data back to the ship. Using this system, the Crew member on board the shuttlecraft should make Skill Tests described under "Using a Shuttlecraft" below.

The Conn should then make a Skill Test against the base Target Number described above, regardless of the ship's speed, to determine whether or not he makes the course corrections in time. Thus, a *Galaxy*-class ship following a shuttlecraft can travel at full impulse with a Challenging (10) Skill Test, rather than Difficult (12).

## USING A SHUTTLECRAFT

As described above, flying a shuttlecraft makes travel through the nebula much easier. The smaller, more maneuverable shuttlecraft can dodge and weave through the pockets of null space far more easily than a *Galaxy*- or *Ambassador*-class vessel. Travel by shuttle represents perhaps the safest way to enter the nebula.

As above, the shuttlecraft should travel at impulse speeds, unless the Crew want to take the chance of destroying the fabric of space; the travel times detailed in the previous section apply to shuttlecraft and other small craft, as well.

The Narrator should roll 1D6+2 to determine the number of times the pilot should make a Skill Test to avoid a subspace gap, or can simply make this an Extended Skill Test, as above. Players should make Vehicle Operations (Shuttlecraft) Skill Tests to avoid hitting a pocket. The base difficulty for such a test is Routine (4). To fly a shuttle through the nebula at one-quarter impulse takes six hours, and requires a Skill Test at the base difficulty.

Traveling at half impulse, the travel time is cut to three hours, but the difficulty increases by +1. At full impulse, the travel time is one hour, and the difficulty increases to Moderate (6).

**DEAD OR ALIVE?**

Depending on how fast the Crew travel to the *Tenebrae*, that ship's crew could be either alive or dead. The *Tenebrae* crew has 36 hours after the distress call before the emergency environmental system fails.

Traveling at warp 9 to reach Mar Oscura, then entering the nebula at warp 1, the Crew could be there in as little as three hours. The Crew would thus arrive at the *Tenebrae* long before lack of oxygen kills the *Tenebrae*'s crew, which has a profound effect on the episode. First, the Crew can rescue all 80 crew members and transfer them to the Crew's starship; the Narrator can thus include a number of encounters with the *Tenebrae*'s survivors. Second, Lieutenant Srri is not dead and subsequently reanimated by Gamma.

On the other hand, if the travel time to reach the *Tenebrae* significantly exceeds 36 hours, the supporting cast crew are long dead of suffocation and extreme cold, which has implications for the story. Primarily, it becomes obvious to the Crew that something keeps Captain Pitt, Dr. Winters, and Lieutenant Srri alive. There can be no other explanation for their survival for so long without life support, other than something unusual at work. Of course, without oxygen and heat, the bodies of the survivors died, but the *Umbr*a managed to keep their brains alive. A cursory check of the emergency life support system and a routine medical scan can easily reveal the situation. Logically, the Crew would not simply beam the survivors without taking precautions—a medical exam and quarantine—nor would they trust the survivors.

While Narrators should feel free to adjust the various events that occur during the course of this mission, this objective timeline provides a guideline to what happens when, and how the Crew's actions could influence the events should they act too slowly or quickly. It also provides a good reference should crew members study the *Tenebrae*'s ship logs and request actual times for the various events.

**Stardate 48712.0**

1201:00 Starfleet orders the Crew's ship to proceed to Mar Oscura, which is five light years distant, to rendezvous with the science vessel *U.S.S. Tenebrae*.

**Stardate 48713.2**

0914:34 *Tenebrae* detects approach of energy beams from neutron star, raises shields.  
 0915:01 Captain Pitt orders phaser attack on creatures now draining ship's shields.  
 0917:53 Dr. Winters uses tetryon pulses to protect the *Tenebrae*.  
 0918:07 *Umbr*a begin to drain the *Tenebrae*'s power from the warp drive and impulse engines. Distress call initiated and received by the Crew.  
 0918:41 *Tenebrae* switches to emergency power and loses transmission capability.  
 0920:23 *Tenebrae*'s power supply completely exhausted; crew struggles to regain some form of power.  
 0935:13 Catastrophic failure of environmental systems; orderly evacuation to emergency support shelters.

**Stardate 48714.2**

2135:01 Emergency life support system fails; switch to individual breathing apparatus.

**Stardate 48715.1**

2135:10 Oxygen supplies run out completely; *Tenebrae* crew suffocates.

**Stardate 48716.0**

0040:05 The *Tenebrae* enters massive dark-matter spatial rift, destroying the ship. (This event may occur earlier at the Narrator's discretion, but this is the latest that it can happen.)  
 0210:01 FGC-27 collapses, emitting a massive burst of neutronium and gravitons. This could cause severe problems for starships caught too close.

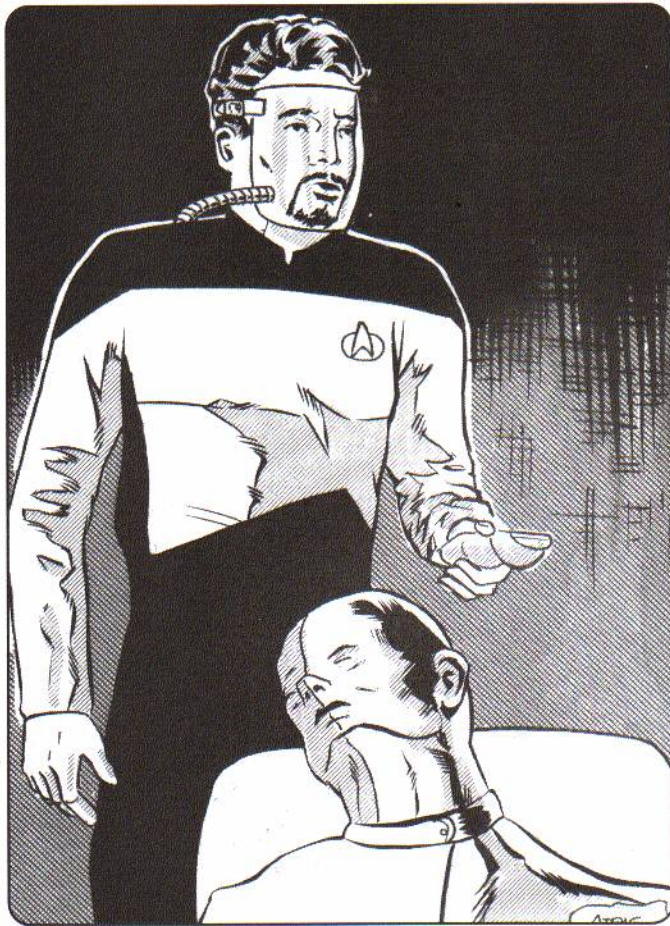

## ON BOARD THE TENEBRAE

Having negotiated the nebula successfully, either via starship or shuttlecraft, the crew discovers the *Tenebrae* drifting slightly. Sensor readings (a Routine Skill Test) show no power to its systems, including life support. If arriving less than 36 hours after receiving the *Tenebrae*'s distress call, the Crew find emergency environmental systems functioning and all 80 crew alive and well (see the "All Hands Rescued" sidebar). After 36 hours, the *Tenebrae*'s crew must switch to life-support masks. 24 hours later, the *Tenebrae*'s survivors run out of oxygen and suffocate.

The episode assumes the Crew arrive with minutes to spare before the last three survivors run out of oxygen. The remainder of the vessel's crew suffocated. Scans for life signs reveal three survivors on the *Tenebrae*'s bridge.

Meanwhile, without power and without anyone at the helm, the *Tenebrae* drifts toward a giant spatial pocket. The Crew have anywhere from two or three hours (full impulse) to a matter of minutes (one-quarter impulse) before the *Tenebrae* winks out of existence. The Narrator should keep track of the time the Crew spend on the *Tenebrae*, perhaps using a stopwatch to impress upon the players the need for quick and decisive action.

## POWER

Because of the lack of power to ship's systems, the Crew can do little to save the *Tenebrae*. They cannot explore other areas of the ship, access the ship's logs, or alter the ship's course away from the oncoming spatial gap. Every control panel on the ship remains dark and powerless, denying them access to the most basic ship's functions.

This problem can be partially solved through the use of portable generators. If the Crew traveled to the *Tenebrae* using their own starship, they can beam several over to the *Tenebrae*. If they traveled via shuttlecraft, the Crew may have access to a single portable generator (depending on how difficult the Narrator wants to make the episode). This is a slow process, as the generator must be moved from station to station. Powering up the Engineering Station on the bridge, the Crew can easily determine the problem: Every power supply—the matter and antimatter stores, and fusion power sources—has been drained.

If the Crew lack access to a portable generator, they must either travel to Engineering to determine the nature of the problem, or they cannot determine what happened to the *Tenebrae*'s EPS system. Likewise, without a portable generator, the Crew will be unable to access the *Tenebrae*'s logs, severely hampering the progress of this episode.

## THE BRIDGE

The Crew can beam directly onto the bridge, where the survivors are located, though they must use environmental suits to visit other areas of the *Tenebrae*, since the ship lacks life support. When they beam onto the crippled ship, it is pitch black, requiring the use of palm beacons to light the way. Both the lack of life support and the imminent destruction of

### ALL HANDS RESCUED

By traveling as fast as possible, without going to warp, the Crew could arrive in less than 60 hours. This could allow the Crew enough time to save more than Captain Pitt, Lieutenant Srri and Doctor Winters. The Narrator should scale this number depending on how quickly the Crew arrives. If they get there in half the time, for example, the Crew might save between 30 to 40 of the *Tenebrae*'s crew.

Saving upwards of 80 crewmembers affects the unfolding of this episode's plot. First, the Crew can interrogate more of the *Tenebrae*'s crew about their ship's final hours. The Narrator can handle this by having them provide conflicting stories, or provide more insight into events on the bridge. Second, Alpha, Beta and Gamma could avoid inhabiting the bodies of the Crew's starship altogether, instead jumping from body to body among the *Tenebrae*'s survivors. Finally, the greater the number of *Tenebrae* survivors, the greater the number of Umbra inhabiting their bodies. This could give Alpha more Umbra supporters to draw upon during the final conflict.

the *Tenebrae* limit the Crew's exploration of the ship. Remind the players that the clock is ticking by having a supporting cast character on their starship, such as the Mission Ops officer, continually update them on the situation.

Every system on the bridge lacks power, creating an eerie, tomblike atmosphere. Most of the bridge personnel wear life-support masks connected to bottles of oxygen but lie slumped in their seats, dead of asphyxiation after their supplies ran out; this is a Routine (4) Personal Equipment (Tricorder) Skill Test to determine. Environmental support systems can be brought back online when the Crew restore power to the ship, or they could resupply the emergency system with material from their starship.

Only three survivors remain, unconscious and without labored breathing—Captain Pitt, Lieutenant Srri, and Dr. Winters. Scanning the bodies takes one minute and reveals the survivors just barely alive and in need of medical attention. A thorough medical scan takes an additional minute and calls for a Moderate (7) Medical Sciences Skill Test; if successful, the examination shows all three possess unusual brain activity. The best course of action is to beam the survivors either directly to sickbay (if they traveled via starship) or to the waiting shuttlecraft.

## THE LOGS

Although the Crew successfully rescue the *Tenebrae*'s survivors, they may want to access the ship's logs to find out what caused the disaster. Using a portable generator, the Crew can power up the LCARS and access various personal logs, the bridge flight recorder, and scientific data recorded by the ship's sensors. The computer has logs for Captain Pitt, Dr. Winters, Lieutenant Srri, and the bridge recorder.

Downloading each log takes one minute. The computer also has the scientific data recorded from the neutron star, which takes three minutes to download. The Crew might not have enough time to retrieve all of the data because of the impending destruction of the ship.

Throughout the episode, the Crew have the opportunity to review the logs from the *Tenebrae*. If the Crew have the time, they could view one of the logs at most on the way back to their ship. Otherwise, they must wait until they return to their ship. As the unusual nature of their guests becomes apparent, viewing the logs becomes more imperative. Refer to these sections whenever one of the Crew wants to review the *Tenebrae*'s logs.

## BRIDGE LOG

The bridge log recording shows a normal scene of work when suddenly Lieutenant Srri notes that the neutron star emits strange radiation fluctuations. He claims some sort of energy form heads straight for the ship. The captain immediately orders shields raised. The "unstoppable creatures" drain the shields com-

pletely in a matter of minutes, the Tactical Officer ticking off the loss in strength by percentages. Dr. Winters interrupts and suggests keeping the energy beings away with tetryon pulses.

She activates her particle emitters and reports that the process seems to work in fending off the creatures. The bridge crew watches hopefully, but suddenly something begins to sap the ship's power supply. Captain Pitt sends a distress call, but it is interrupted as they fall to emergency power. Within a few seconds the log ends, presumably as the ship's main power fails completely.

## SCIENCE LOGS

The ship's LCARS stores two distinct science logs. The Crew can download both. The first is Dr. Winters' information on the dark matter nebula. She reveals her findings that the nebula is a region of extremely unstable space that would suffer great damage from any warp travel through it. If the Crew used warp travel to reach the ship, the doctor's findings quickly illustrate the danger in traveling back the same way: A ship could easily slip into an alternate continuum.

Lieutenant Srri recorded a log on the progression of FGC-27's decay. His entries have little explanation or conclusion, as he simply recorded his readings

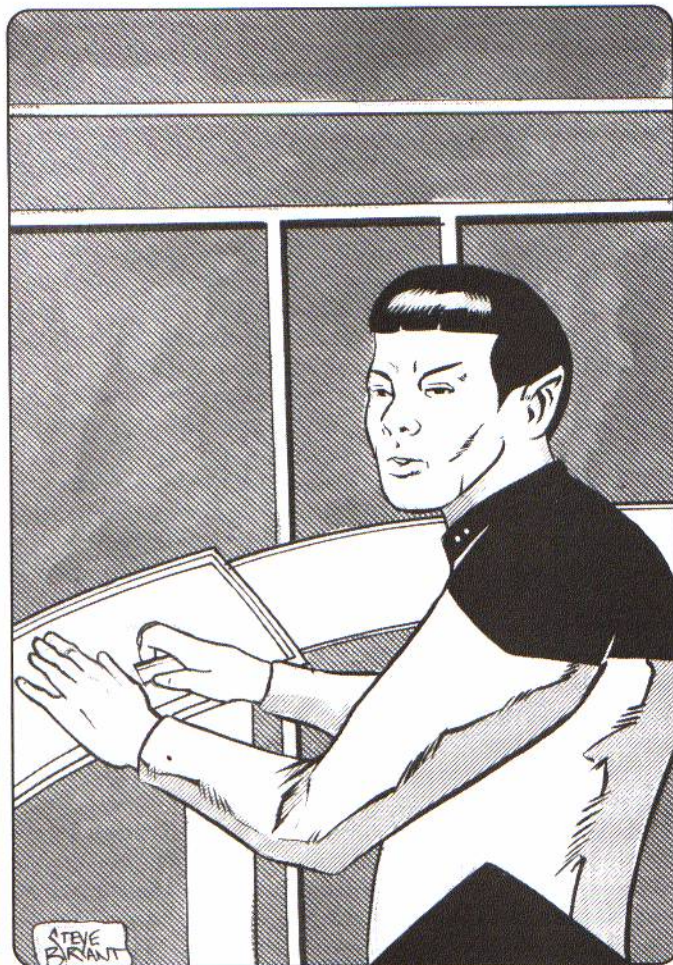

from the star, so careful study is required to understand them. A Moderate (8) Space Sciences (Astrophysics) Test reveals an increase in neutronium activity and gravimetric stress indicating a collapse of the star on stardate 48716.0 at 0210:01 hours.

## EXPLORING OTHER DECKS

Some Crew members might want to explore other areas of the ship, to see what can be seen and to search for additional survivors. Without power to the *Tenebrae*, the Crew must transport to other areas of the ship, or crawl through the ship using the Jeffries tubes. Outside of the bridge, the rest of the ship lacks life support, from oxygen to gravity. Environment suits equipped with magnetic boots are required to survive.

When the *Tenebrae* suffered a catastrophic loss of power, affecting even the life-support systems, the *Tenebrae's* crew fled to the emergency environmental shelters. The Crew finds the rest of the ship eerily abandoned. The Narrator can enhance this feeling of isolation and fear by mentioning unusual movement on the edge of their vision—shadows cast by their own palm lights.

After the bridge, the most important area the Crew can explore is main Engineering. As described above, the Umbra drained all the ship's power sources when they initially boarded the *Tenebrae*. The mighty warp core stands like a silent sentinel in the middle of the cryptlike main Engineering room. By using a tricorder, or by visually checking the matter-antimatter supply, the Crew discover both exhausted. See "Saving the *Tenebrae*," below, for more information.

Sickbay is one of the areas on all *Oberth*-class ships equipped with an emergency environmental shelter. Entering sickbay, the Crew find a horrifying sight. As on the bridge, the supply of oxygen and carbon dioxide scrubbers exhausted themselves after some 36 hours. The crew of the *Tenebrae* lies huddled under thermal blankets, dead of carbon dioxide poisoning and asphyxiation.

## SAVING THE TENEBRAE

With the survivors tended to, and the destruction of the ship imminent, the Crew might attempt to save the *Tenebrae* before it drifts into the spatial tear.

A starship receives power through its EPS system, which distributes power from the warp drive and impulse engines throughout the ship. Auxiliary fusion generators located throughout the ship provide power when the warp and impulse reactors go off-line. When the Umbra boarded the *Tenebrae*, they drained as much power as the ship could produce, from every source. In a matter of minutes, the ship exhausted its fuel.

Engineers with the proper tools and materials—available from the Crew's starship—can repair any of these systems; they must simply supply the ship with antimatter to create a fusion reaction. Normally, to start a warp drive requires three to five hours.

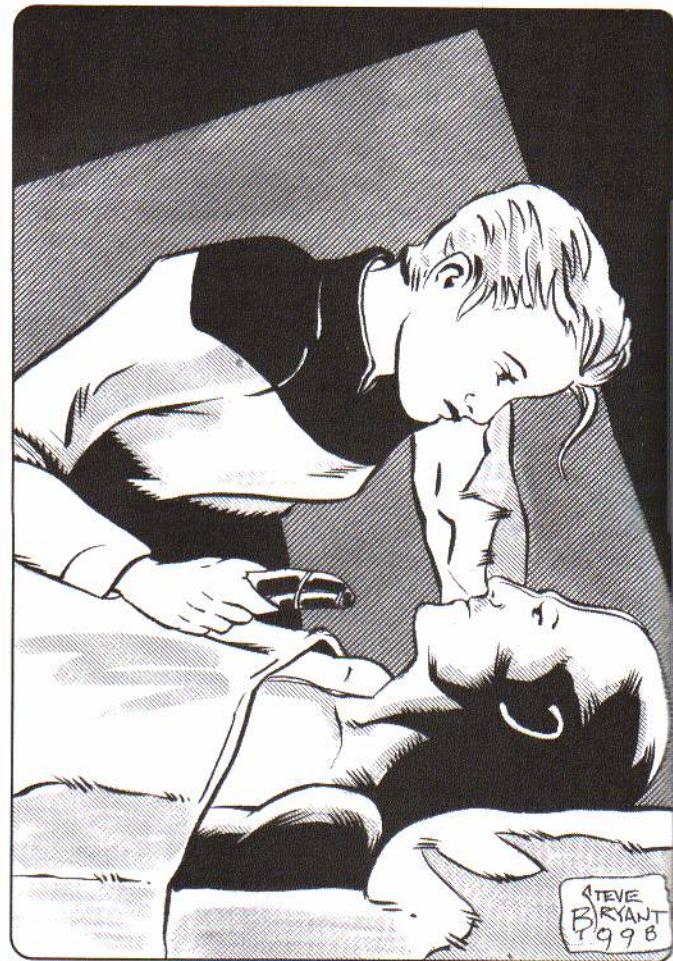

Inventive engineers up on the latest technical journals could find a faster way, but the process requires at least a successful Difficult (12) Propulsion Engineering Skill Test; this could be a Combined and Extended Test. Still, they must complete this operation in only a few minutes. Traveling by shuttlecraft, the Crew lack the ability to restore power to the *Tenebrae*.

If the Crew manage to restore power to the ship, they can alter the *Tenebrae's* course away from the oncoming spatial gap, or hold their current position. The Crew member at the helm must make a Moderate (7) Shipboard Systems (Flight Control) test to guide the weakened ship away from the tear and back to a stable position. Once this is accomplished, the *Tenebrae* can be piloted slowly out of the nebula. They can also access other areas of the ship, as well as shipboard systems (such as the LCARS and life-support systems).

Alternatively, the Crew can easily use their starship's tractor beam to pull the *Tenebrae* away from the spatial gap and out of the nebula. If the Crew used a shuttlecraft to travel to the *Tenebrae*, this option is not available to them. To lock on a tractor beam is a Routine (4) Shipboard Systems Skill Test. Leaving with the *Tenebrae* in tow, however, significantly increases the difficulty of escaping Mar Oscura unscathed. Increase the final Target Number by the *Tenebrae's* Size characteristic (i.e., +1). If this roll fails, either the

Crew's starship or the *Tenebrae* suffers from contact with a pocket of null space (Narrator's discretion).

Once the ship is safe, the Crew can attempt to power up the *Tenebrae* by providing the necessary fuel for the warp drive and impulse engines.

## THE GET-AWAY

With the survivors recovered the Crew can make their way back through the nebula. Once on board the shuttlecraft or starship, the Crew can review the *Tenebrae's* science logs to learn Lieutenant Srri's estimates on the star's collapse. Depending on how long it took them to reach the *Tenebrae* and depart, this might not be long off. The Characters (and Narrator) should consider this factor when they decide on their speed when leaving the nebula. Use the travel times described above to determine how long it takes the Crew to exit the nebula safely.

Should the Crew concentrate on other matters—like the survivors or leaving the nebula—the Narrator can remind them of impending doom through passive sensor scans. The sensors detect ever-growing amounts of neutronium and increasing stellar mass, signaling the neutron star's collapse.

At approximately 0210 hours on the mission's third day, as predicted, FGC-27 collapses under its own gravity, creating a massive burst of neutronium and X-rays. The gravitational forces become so great that light cannot escape, and matter around the nascent collapsar compresses into a single point. This process takes ten hours, illuminating the entire nebula with a strange, orange-blue glow. It ends with the star collapsing into a black hole and the entire nebula going dark again. This should be presented as a high point following the tense rescue of the science team.

It is difficult to quantify the cosmic forces at work in such an event. By this time, the Crew may or may not be safely outside the nebula—depending on how fast the Crew travel. Rather than inflicting damage directly to the ship in the form of points, the Narrator could instead describe how the massive burst of radiation overloads various systems on the ship, and the unpredictable gravimetric tides makes navigation difficult. Try to scale the extent of the damage to the Crew's position in space: inside the nebula, more systems overload; outside the nebula, the effects are considerably lessened.

After the star's collapse, Starfleet recommends the crew proceed to Starbase 260 to drop off the survivors. Starbase 260 is five light years away, there should be no other pressing concerns to cause any rush.

## THE SURVIVORS

The survivors all suffer from a lack of oxygen, causing potential brain damage. A successful Routine (4) Medical Sciences Skill Test allows a player character to diagnose the condition, prescribe treatment, and estimate the time until they regain consciousness. Tri-

ox compound, or a similar oxygen treatment, restores much-needed oxygen to the survivors' blood, and could have them up and around in a few minutes. Otherwise, it could take from half an hour to four hours until the survivors are fully up and around.

The longer it takes for the three survivors to regain consciousness, the more reason for doctors to keep an eye on their patients, and the more likely it is the Crew will discover the Umbra. If the survivors regain consciousness quickly, the Crew have little reason to suspect anything amiss (until the three begin to act strangely). At the very least, when they get to sickbay, doctors likely give each a thorough examination. Captain Pitt and Dr. Winters attempt to put this off for as long as they can; the Umbra know full well this will reveal their presence.

Checking their vital signs shows their health appears satisfactory. All three survivors, however, exhibit unusual synaptic activity, detectable with a Moderate (7) Medical Sciences (or Tricorder) Skill Test. If the Crew are on a shuttlecraft, they lack the medical equipment for a more detailed examination. In sickbay, however, doctors can perform an extensive exam. Another Moderate (7) Medical Sciences Test reveals the nature of the problem. While the typical humanoid registers synaptic activity in specific parts of the brain when thinking, and along the nerves, the survivors' brains and nervous systems exhibit abnormal neuron activity. It is as though something excites all the neurons in their bodies. Moreover, this activity does not appear to be biologically produced.

Regaining consciousness by the time the star collapses, the survivors express a desire to observe the event, but show little interest in recording it (exhibiting a nonchalant attitude should anyone mention the scientific importance of such an event, for example). This may seem odd for scientists and explorers who nearly lost their lives to gather such data. Characters with Receptive Empathy can attempt to sense what the survivors are feeling.

The difficulty for this task is Nearly Impossible (15), because of the alien nature of Umbra minds; this in itself should raise eyebrows. While psionic characters certainly take note of the increased difficulty, they have no way of knowing the cause. Only a complete mind meld would reveal the true nature of the Umbra inhabiting the bodies. If the Receptive Empathy Test is successful, the empath detects a great sadness over the event.

Each of the three Umbra inhabiting the bodies of the survivors is detailed below, along with their motivations and their initial responses to regaining consciousness. Should the characters ask questions or should events transpire that are not covered in these sections, the Narrator should use this information and the background on the trio to generate a likely response, taking into account their Umbra personalities. The Narrator is encouraged to use this information when portraying Captain Pitt, Dr. Winters, and Lieutenant Srri, perhaps devising scenes that highlight the presence of the Umbra.



As the rescued crew members regain consciousness, they are faced with an odd assortment of personalities and memories.

### BETA

#### Attributes

Intellect 3

Logic -2

Presence 3

Willpower +1

Psi 0

#### Traits

Bloodlust

Impulsive

other Umbra from boarding the *Tenebrae*, and it holds a grudge. Beta angers easily, providing a way to identify that something is amiss.

### ALPHA

#### Attributes

Intellect 5

Perception +2

Presence 3

Willpower +1

Psi 0

#### Skills

Space Sciences

(Astrophysics) 3 (4)

### CAPTAIN PITT

When Captain Pitt regains consciousness he first seems disoriented and unable to communicate effectively. He stammers out nonsense words and phrases. Over the next two hours, he begins to make more sense, asking the Crew questions about his ship and crew, punctuated by long periods of silence.

Unknown to the Crew, Captain Pitt now serves as host to Beta, one of the Umbra who inadvertently attacked the *Tenebrae*. Unfamiliar with corporeal existence, much less physical communication, Beta takes time to acclimate to its new surroundings. Because of the speed with which Captain Pitt regains consciousness, the Crew should have little reason to suspect that he plays host to an energy being.

If asked about the last hours aboard the *Tenebrae*, the captain explains that FGC-27 began emitting unidentified particles, and that he ordered the shields raised. Suddenly, the ship suffered a total loss of power, for unknown reasons. Soon the entire ship lay powerless in space. Pitt does not mention the strange energy creatures who attacked the *Tenebrae*, nor does he mention firing the ship's phasers. Confronting him with the *Tenebrae's* logs only makes him angry, but he can offer no explanation for the discrepancy.

Beta, armed with the basic impression of being in command, taken from Captain Pitt's mind, throws itself into the role. Pitt struts everywhere and acts as if he commands the Crew's ship. The Crew might assume Captain Pitt simply compensates for the loss of his own ship. When Beta begins switching bodies, the people it inhabits seem to stand a little taller and act a little more forcefully. Although it listens to Alpha, and follows its lead, Beta might instigate some power struggles along the way.

Dangerously unstable after the supposed death of Umbra society on FGC-27, Beta is willing to do anything to reach a new star—even kill, if this benefits the cause. Beta blames corporeal beings for preventing

### DR. WINTERS

Like Captain Pitt, Cynthia Winters carries a Umbra inside her. She initially appears disheveled and confused. When she comes to, Winters first questions the characters on the fate of FGC-27, then asks whether anyone else survived the *Tenebrae*.

Dr. Winters cannot seem to recall what happened on board the *Tenebrae*. She explains that there must have been a neutronium burst of some kind which disabled the ship, apparently knocking out its power supply. (A successful Moderate (6) Space Sciences (Astrophysics) Skill Test reveals this to be a plausible explanation.) Confronting her with the ship's logs upsets Dr. Winters. She says that perhaps the burst caused her to lose consciousness and forget what really happened.

After she awakens, Dr. Winters (inhabited by Alpha) assumes a leadership position over the *Tenebrae's* "survivors." Even Captain Pitt seems uncharacteristically to follow her lead. While Alpha adjusts slowly to material existence, its thoughts turn more and more to finding a new neutron star. The Crew might assume Winters is simply a fiercely dedicated scientist. Alpha's eyes betray it, no matter what body it takes: They never seem to rest on one place for long, giving the host a distracted appearance. Alpha is a highly energetic being who must always be doing something.

The best way to identify Alpha is through its personality; no matter which body it inhabits, it exhibits impulsive, overconfident behavior. It believes the Umbra to be far superior to corporeal beings. Forward-thinking and highly creative, Alpha assumes the Umbra might die from the star's implosion, and convinces Beta and Gamma to join it. If any of the Umbra can be said to be cleverly dangerous, it is Alpha. It feels loyalty toward its comrades, but will always act in its own best interests should the situation become dire.

**GAMMA****Attributes**

Intellect 4

Logic -1

Presence 2

Empathy +2

Willpower -1

Psi 0

**LIEUTENANT SRRI**

Lieutenant Srri is the last to awaken from his injuries, no matter what treatment the Crew uses to combat the effects of asphyxiation. When scanned by a recorder or medical biobed, his heart rate and respiration do not register, and there is apparent necrotization. Only his neurological activity remains unnaturally high. He is, most obviously, dead, but something keeps his body functioning. This should prompt doctors to examine Srri more closely. Like the others, a Moderate (7) Medical Test reveals his abnormal brain activity.

When Srri suddenly regains consciousness, it should come as a surprise to the Crew. The Narrator can even wait awhile, until the Crew become preoccupied elsewhere, before reminding them of Srri's presence in this way. With more time to adapt to material existence, Gamma is perhaps the best acclimatized of the three.

Srri asks after his whereabouts, but seems unconcerned with the fate either of the *Tenebrae* or his former shipmates. Once the Crew explain what happened, he seems to feel more comfortable. He wants to join Pitt and Winters as soon as he can.

By now, it should be obvious to the Crew that something is amiss, perhaps even assuming that an alien lifeform inhabits Srri's body. Unlike Alpha and Beta, Gamma makes little attempt to disguise its nature. While it does not come right out and confess to being an Umbra, it makes curious observations and asks strange questions about the nature of corporeal life.

Confronted with questions regarding its true nature, however, Gamma fears retribution for the *Tenebrae* disaster; it rejects any implications of being anything other than Lieutenant Srri. Alpha and Beta, on the other hand, encourage the Crew to think Srri harbors an alien entity, to throw suspicion off themselves.

When questioned about events on the *Tenebrae*, Lieutenant Srri defers to Dr. Winters and Captain Pitt's testimony in their presence. When alone, however, he says it was all terribly tragic. It seemed as though something from the star tried to contact them, he claims, but Captain Pitt attacked the entities as they

approached the ship. Whatever they were, Srri laments, they're all dead now, trapped on FGC-27. He does not say much else, and appears saddened by the thought.

Gamma is the weakest of the three Umbra, but also the most sympathetic to corporeal beings. It follows Alpha's lead reluctantly, because it can think of no other way to reach a neutron star. Gamma, at least initially, does not believe the humanoids would willingly help the Umbra. Negotiation attempts work best with Gamma. Unfortunately, Gamma defers to Alpha and Beta when in their presence.

Gamma poses an additional complication throughout the rest of this episode—it is the only thing keeping Srri alive.

**QUARANTINE THE SURVIVORS?**

Given the logs from the *Tenebrae* and/or the evidence gathered from the medical examination, the Crew might want to quarantine the survivors. Certainly, once Lieutenant Srri's condition becomes known, the ship's doctor will want to quarantine him, perhaps assuming the synaptic activity caused Srri's "death." Similarly, at any point later in the episode—if the Umbra attempt to hijack the ship, for example—the Crew might attempt to confine the survivors.

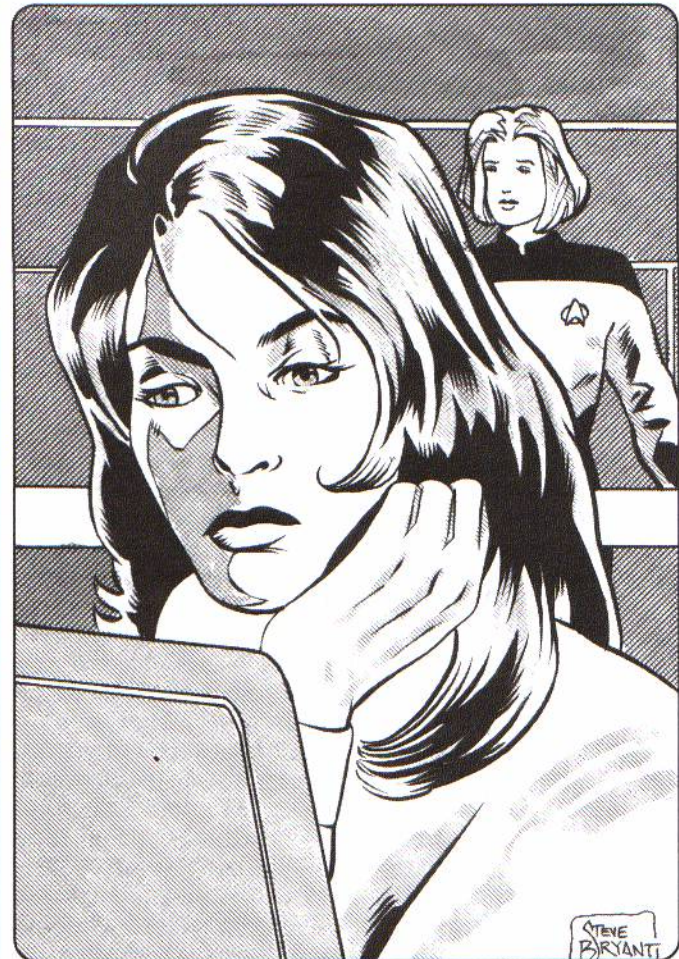

How the Crew go about this is largely up to the players. They might wait for the Umbra to be assembled in one place, then erect security forcefields around them. They might wait until Captain Pitt, Dr. Winters, and Lieutenant Srri turn in for the night and lock them in their quarters. Or they might confront the survivors and their Umbra parasites with armed security guards.

Each of these options has little effect on the Umbra. While locked doors confine the bodies inhabited by the Umbra, they can still get around in energy form. Phasers and forcefields also have little effect, though they do affect the bodies the Umbra inhabit—something the Crew quickly learn. The Umbra can simply drain power to any forcefields erected in their path, while phasers only provide sustenance for the Umbra to feed upon. The Umbra can hop from body to body by transferring themselves to a new host's synapses, or can simply inhabit the ship directly via the EPS system.

## ENCOUNTERS WITH THE UMBRA

Ultimately, the three surviving Umbra want to find a new neutron star to inhabit. The following scenes detail their efforts, from at first trying to trick the Crew to finally taking control of the starship.

### CHARADES

At this point, the Crew should be on their starship, and well on their way to Starbase 260. At ten light years distant, the Crew arrive at their destination in six days at warp factor 7, two days at warp factor 9. Meanwhile, Captain Pitt, Dr. Winters, and Lieutenant Srri should be up and around after their harrowing experience on the *Tenebrae*. The episode proceeds with their efforts to find a new home star. Whether or not the Crew suspect something's gone terribly wrong with the three survivors depends largely on the Umbra. The Narrator should try to keep the presence of the Umbra a secret for as long as he can.

Captain Pitt begins ingratiating himself with the bridge crew in an honest effort to learn more about the ship. In a series of scenes, best played as jump cuts with action elsewhere on the ship, the Narrator can illustrate Beta's interests. He asks one of the Crew members for a tour, to learn about the ship's capabilities.

He seems particularly interested in specific areas of the ship—Engineering, the ODN system, the EPS system, the main computers, and stellar cartography—but becomes bored with areas like hydroponics, waste reclamation, and the shuttlebays. His questions should seem basic, information a Starfleet captain should know, which may make Crew members suspicious. Beta's goal is to learn as much about the ship's systems, should they need to hijack the starship.

Meanwhile, Dr. Winters begins searching for a neutron star along the vessel's route to Starbase 260. Alpha can do this from any number of computer ter-

minals throughout the ship and not attract attention to itself (especially if it uses the LCARS in Winters' quarters). Accessing information of this type should not send up any red flags with security. Winters easily manages to locate a neutron star named Bonisar 1, a pulsar fifteen light years off of the ship's current route.

Once she locates a suitable star, Winters/Alpha attempts to access the long-range sensors in an effort to gather data on the star. Rather than simply asking for time on the sensors, Winters enters Stellar Cartography, walks up to one of the control panels, and seizes control of the sensors. By simply touching the smooth display, energy courses through her fingers, causing the displays to go haywire. The terminal's screen cycles through several views of starfields, as Alpha focuses the long-range sensors on Bonisar 1.

Anyone with Shipboard Systems (Sensors) can make a Routine (4) Skill Test to notice the unauthorized sensor use in Stellar Cartography. When anyone mentions this display of Alpha's abilities, Winters ignores them and returns to her quarters. If pushed, she claims the viewer simply made a mistake, and didn't see what he thought he saw. She rebuffs any suggestions to visit sickbay.

With a destination in mind, both Pitt and Winters attempt to convince the captain and Crew to alter their course to Bonisar 1. While the starship's captain confers with several crew members, perhaps during a routine briefing, both Captain Pitt and Dr. Winters interrupt. Captain Pitt asks the Crew to change course for the pulsar. When questioned about this request, Winters explains she made a research breakthrough in the last hours before the *Tenebrae* lost power, and wishes to confirm her readings. Of course, the captain has orders to proceed to Starbase 260, and he should be difficult to persuade otherwise. If the Crew remain ignorant of the Umbra presence on the ship, Alpha and Beta plan to hijack the ship.

Should the Crew discover the presence of the Umbra early on in the episode, the Narrator can always have them jump to new hosts, to keep the episode on track. This serves to keep them free to act and confuses matters a bit.

### ADDITIONAL ENCOUNTERS

Because the central conflict of this episode revolves around the discovery of Alpha, Beta, and Gamma, the Crew may need several scenes to piece together the clues pointing to alien possession. To provide the Crew with more roleplaying opportunities, flesh out the Umbra better, and give the PCs more clues, the Narrator can include several small scenes, detailed below.

Once it knows its way around the ship, and understands the power distribution and ODN system, one night Beta uses its abilities as an energy creature to enter the computer system and attempt a trial run at seizing control of the starship directly. It only attempts

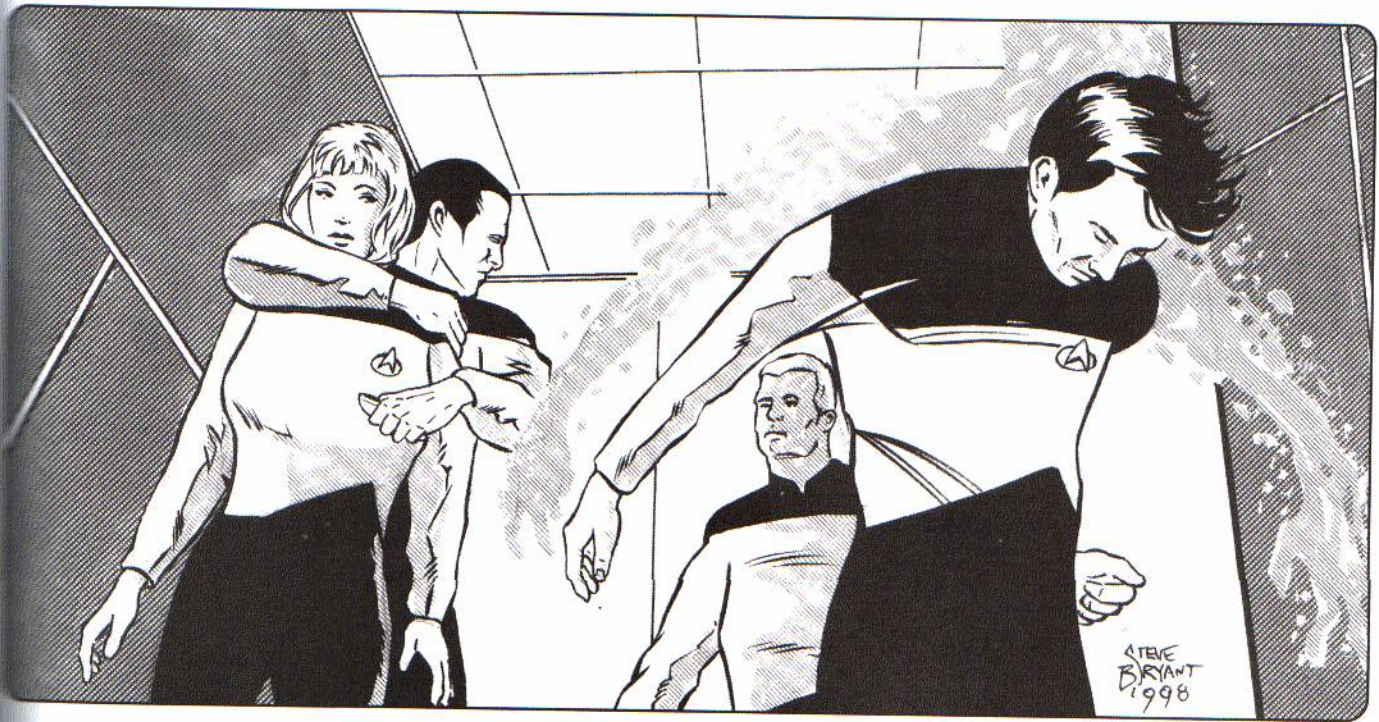

something minor—affecting a subsystem or a monessential system. While the ship's computer alerts the bridge to this tampering, a diagnostic can reveal no reason for the glitch. More importantly, after Beta leaves its host, Captain Pitt regains consciousness.

Free of Beta's influence, Pitt is confused and disoriented; being on board the *Tenebrae* is the last thing he remembers. Confused by his surroundings, he wanders out of his quarters, where a member of the Crew encounters him. The extent of effect this has on the course of the episode depends largely on the Narrator—Beta could quickly return to Pitt's body and reassert control, giving the crew member only a few minutes to talk to Pitt, or Pitt could remain free of Beta's influence for the rest of the episode (in which case Beta finds a new host).

Used to absorbing energy from a star, the Umbra need a powerful source of energy to keep them alive. While using a host's bioelectricity is enough to keep an Umbra alive, Alpha decides to feed on the power generated by the warp drive through the EPS system. At several points during the episode, Winters drains plasma through a plasma relay located in a remote area of the ship. Placing both hands on the plasma relay, Winters' body luminesces with bright, white light.

One of the Crew could witness this, perhaps observing Winters while walking along a corridor. The energy drain is apparent, as lights dim perceptively and computer displays wink off and on. Crew on the bridge or in main engineering can easily record the energy drop—27 percent across the board—though tracing it requires a Level 1 diagnostic of the EPS system and a Challenging (10) Engineering (Warp Drive or Electroplasma System) Test. Success indicates the location of the energy drain, but not the cause. If the

Crew member asks about what he just witnessed, Alpha departs Dr. Winters' body (either to find a new host, perhaps the Crew member, or to become one with the ship).

Throughout the episode, Lieutenant Srri likely spends much of the time quarantined and under guard. While Gamma plays a key role in the resolution of the story, the Crew have little interaction with it beyond any encounters initiated by the Crew. Srri spends most of his time in sickbay, the brig, or guest quarters, contemplating events on the *Tenebrae*. Attempts at conversation bring him a little out of his shell, but mostly he just wants to sit alone and think about what happened.

Telepathic characters who make a successful Difficult (13) Receptive Telepathy or Receptive Empathy Test sense a deep sadness from Srri; telepaths receive a blur of conflicting thoughts, some Srri's, some Gamma's. If the Crew persist in trying to get through to Srri, he starts to open up, making cryptic references to "many lives lost at the star." These attempts touch Gamma and affect its views about corporeal beings, which could give the Crew an ally in future events.

Finally, the Narrator can include a number of small encounters between the survivors and Crew. None of the Umbra knows much about the past of its host. The Crew could check the personnel records for Dr. Winters, Lieutenant Srri, and Captain Pitt, then question the three. For example, Dr. Winters forgets that she attended the prestigious Daystrom Institute, or that she has a husband back on Earth.

Captain Pitt forgets the simplest points of Starfleet protocol, not to mention the fact that he has a sister on Starbase 101. Srri acts decidedly un-Bolian, showing no interest in helping others around him.

The Narrator is encouraged to develop personnel records for the three survivors and hand them out to players.

## THE HIJACKING

The Umbra will die within 48 hours if they are not delivered to a neutron star or allowed to feed off the ship's power systems. If the captain of the Crew's starship refuses to alter course to Bonisar 1, or if the Crew suspect the Umbra's true nature, the energy beings decide they must take action. Assuming their natural forms, Alpha, Beta, and Gamma abandon their hosts. The Umbra can attempt to take control of the starship in one of two ways (or perhaps both).

### PLAN A

Alpha tries to take over the captain of the vessel, which requires an Opposed Test using Presence (including any Willpower Edges). If Alpha succeeds, it orders the Conn to change course for the Bonisar 1 neutron star. While this may seem strange to the rest of the Crew, particularly if they are aware of his original intention to remain on course for Starbase 260, his actions do not warrant dereliction of duty; it's certainly within his purview to order a course change.

If asked about the change in course, the captain responds by saying he changed his mind—he's decided to honor Dr. Winters' request. If the Crew know about the presence of the Umbra, he instead notes the energy creatures are a lifeform, acting out of self-preservation, and must find a new home. Of course, this is Alpha talking.

Meanwhile, Beta inhabits the body of the First Officer (either a supporting cast character or a player character), with the intent of backing up Alpha (as captain). Should the Crew move to stop Alpha in its guise as captain of the ship, or change course, Beta reacts violently. Similarly, Gamma, following Alpha's orders, inhabits the body of the current Flight Control Officer (again, either supporting cast or a PC) and lays in the new course.

At first, the Crew might simply follow the fake captain's orders, and the ship continues to Bonisar 1. The captain certainly has the right to change his mind and order the ship to the pulsar. Throughout the journey, however, the Crew have ample opportunity to recognize the Umbra's deception.

This can be done simply enough by finding the bodies of Captain Pitt and Dr. Winters (both of whom are alive, though confused and disoriented), and Lieutenant Srrī (dead without the animating energy of Gamma). Both Captain Pitt and Dr. Winters remember nothing of recent events; the last thing they clearly recall is suffocating slowly on board the *Tenebrae*. In addition, because the Umbra cannot access more than surface thoughts, the people currently occupied by them eventually begin to act strangely—perhaps forgetting names and dates, ignoring Starfleet protocol, or mishandling simple shipboard systems.

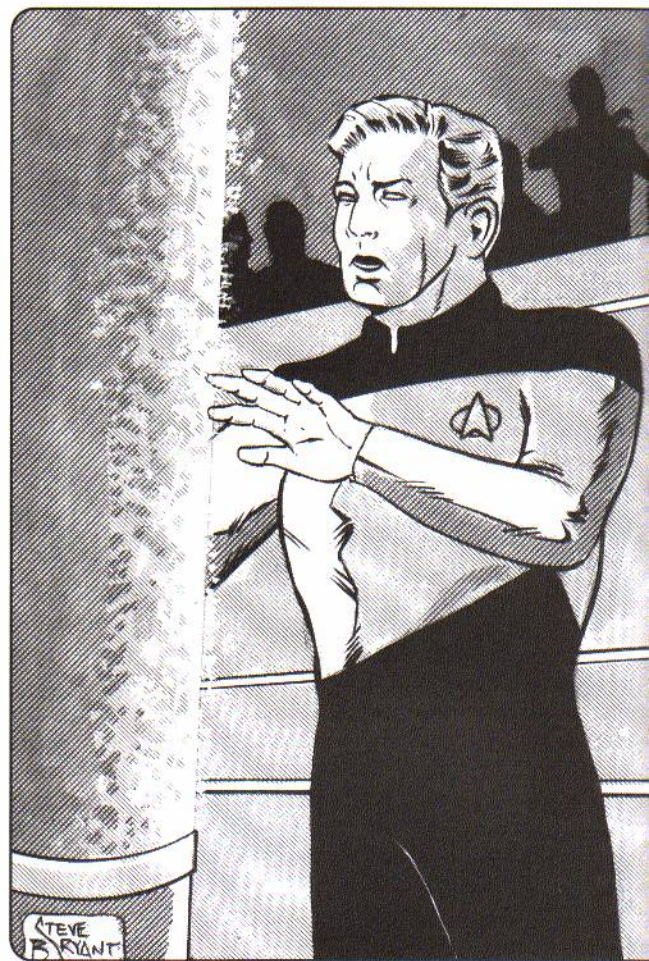

As soon as the Crew recognize the Umbra at work, particularly if they know of the Umbra ability to possess humanoid bodies, they will likely move against them. Yet, according to Starfleet regulations, the Crew must have proof that the captain is under an alien influence before they can legally challenge his authority (just in case he isn't under alien control).

The Chief Medical Officer could declare the captain unfit for duty and officially relieve him of command. Similarly, the Crew might head to auxiliary control, to regain control of the ship. When the Crew make their move, Beta attacks them. At first, it attempts to maintain the charade by using a handheld phaser, but if the Crew prove too tough or overwhelm its host, it fires bolts of its own energy. Meanwhile, phasers don't affect the Umbra, only the human hosts.

Although driving the Umbra out of their hosts may technically restore control of the ship to the crew, the Umbra could still attempt Plan B.

### PLAN B

Alternatively, Alpha and Beta could choose to enter the computer system, thus controlling even the ship's function through the Optical Data Network. They alter the ship's course toward Bonisar 1, increa

the ship's speed to maximum warp, and then lock out the control systems to prevent the Crew from inputting a course correction. This presents the Crew with a dangerous situation. The Umbra could, for example, interrupt power to the environmental controls, suffocating the Crew. Or they might turn the ship's internal security system against the crew—locking doors, erecting forcefields, activating the fire-suppression system, or even sending security drones (See *The Price of Freedom*, page 103, for details). Yet, the Umbra don't want to kill the humanoids on board, they merely want a ride to the nearest pulsar.

The Crew have a number of ways to circumvent the Umbra's control, and they are limited only by their imagination. They could try to overwhelm the Umbra by turning on every system on the ship—sensors, replicators, communications, etc. The more that they have to contend with, the harder the Umbra must work to maintain control.

This could be simulated with an Opposed Test pitting the Umbra's Presence attribute (including the Willpower Edge) against the Crew's Shipboard Systems skill. For every two rolls after the first, the Umbra suffer a -1 to their Test Result. This should be a Combined Test for the Umbra, with the Narrator adding the two rolls together to find the final Test Result for their side.

One of the Crew might recall that Dr. Winters repelled the Umbra with pulses of tetryon particles. If the Crew could somehow find a way to generate waves of tetryon particles inside the ship (perhaps modifying a phaser rifle, for example), they could regain control by driving the Umbra out. Modifying a phaser rifle might require a successful Material Engineering (Personal Equipment) Skill Test against a Moderate (8) difficulty, while setting up tetryon emitters around the computer core might call for a Routine (5) physics Skill Test. Try to estimate an appropriate difficulty level should your Crew devise their own, unique solution.

Finally, the crew could attempt something more radical. The Umbra require energy to survive, be it gravitons from a neutron star, biological electricity, or the power from a warp drive. The Crew could purge the ship of the Umbra by shutting down all available sources of power. Although the computer can initiate a shut-down of the warp drive with the proper authorization, every warp propulsion system is built with manual override features in the event of a catastrophe. Because the Umbra control the computer, this would have to be done manually. Engineers must cut power relays to the Matter/Antimatter Reaction Assembly and disengage the dilithium matrix.

This is a dangerous process while the warp drive is in operation, as it can cause a backlash of energy, cause the containment field to collapse or destabilize the warp core further. Crew members attempting this should make several Moderate (8) Propulsion Engineering Skill Tests. Some Crews might elect to dump the M/ARA altogether by manually blowing the

explosive bolts on the M/ARA exterior hull plate and ejecting the antimatter pods, only a Routine (4) Propulsion Engineering Skill Test.

Perhaps the best resolution to the episode involves a classic *TNG* approach—negotiation. Gamma, over the course of the adventure, displays a combination of guilt over the *Tenebrae* disaster and sympathy with corporeal beings. Both its remorse and resistance to following Alpha should become apparent over the course of the episode, as well as its interest in learning about corporeal beings.

The Crew could play on these feelings at a crucial time and convince Gamma to aid them. They must convince Gamma that the Umbra's current course of action is unproductive and dangerous, and encourage it to rebel against Alpha's leadership. With Gamma on their side, the Crew have an ally to encourage Alpha and Beta to negotiate.

Alpha and Beta would be willing to listen to Gamma. Once Gamma opens the lines of communication, it is up to the Crew to find a resolution to this situation. The Umbra want to find a new home in a neutron star; they need the tremendous energy of a star to survive. The most obvious demand the Crew would make would be to have control of the starship returned to them. Both sides can easily come to an agreement: If the Crew agree to take the Umbra to Bonisar 1, the Umbra agree to surrender control of the ship.

No matter the path the Crew take to the end of the episode, when the starship arrives at Bonisar 1, Alpha, Beta, and Gamma thank the Crew and apologize for having caused so many problems. They leave the starship and take up residence in the heart of the neutron star.

## REWARDS

For achieving the goal of the episode, give each participating player 1 Experience Point.

If the Crew resolve the conflict nonviolently, give them each an additional Experience Point and 1-6 Openness Renown or -1-6 Aggression Renown.

If the Crew resort to violence, give them 1-6 Aggression Renown each.

For successfully retrieving the *U.S.S. Tenebrae*, the Crew earn an additional Experience Point and 1-6 Skill Renown each.

## TROUBLESHOOTING

Clever characters who figure out the presence of the Umbra early on pose the biggest problem for Narrators running this mission. In this case Narrators can complicate the plot with some outside emergency, such as severe damage to the ship caused by an unexpected radiation burst from the collapsing star.

Distractions alone won't save the Umbra from premature discovery should the Crew prove extremely cautious. Simply accelerate the Umbra's attempt to seize the ship to an earlier point in the adventure,

although the crew won't get as much of a chance to interact with the Umbra. This could seriously hurt their negotiating chances if they have not made Gamma an ally.

On the other hand, the Crew might move too slowly and miss all the clues. They are likely to have a very nasty surprise when the Umbra seize control of their ship. To help avoid this, the Narrator might emphasize the survivors' strange behavior. Perhaps a Crew member knows Dr. Winters from the past and notices her unusual behavior, or lack of memory. Optionally, a Crew member might realize Captain Pitt and Lieutenant Srii behave in an un-Starfleet manner, especially considering their lack of basic Starfleet training. These hints should point players in the right direction.

## SEQUELS

The Narrator could follow this episode by either sending the Crew back to study the Umbra at Bonisar 1, or by assigning them to establish diplomatic relations with them. In the case of both plots, the Narrator should include an additional plot line to provide dramatic tension. A stray particle could pierce the ship's shields and hull, causing the warp drive to malfunction and leading the Umbra and Crew to work together to save the ship. Do the Umbra know what's affecting the ship? Can they help restart the warp drive, perhaps sacrificing their own existence in the process?

Gamma, tempted by corporeal existence and eager to explore the galaxy, could request asylum with the Crew, leading to a host of ethical questions. Would the Crew honor such a request? Would someone sacrifice his own consciousness to provide a host for Gamma?

Alternatively, the Crew, due to their previous experience in dealing with the Umbra, could be sent to rescue another starship attacked by a different group of Umbra. In this case, though, the characters might encounter an entire vessel's crew controlled by Umbra, presenting a different kind of rescue as they must somehow get the Umbra to leave the bodies.



# The Enemy You Know

In 2368, after helping avert the Romulan conquest of Vulcan, Federation Ambassador Spock decided to stay on Romulus and teach Romulan dissidents Vulcan logic and culture. Since then a growing number of Romulans have been attracted to this teaching. Ambassador Spock has used his contacts in the Romulan underground to help smuggle a few Romulans to Vulcan to learn more of these teachings, and to help smuggle a few highly dedicated Vulcans to Romulus to help him in his work.

Ambassador Spock's program, known as the Reunification Movement, is seen as illegal by both the Federation and the Romulan Star Empire. However, while the Romulan government considers this movement to be a dangerous form of treason, many in the Federation have deep sympathy for its goals.

## BACKGROUND

The activities of the Vulcan Reunification Movement have attracted the attention of the *Tal Shiar*. They want to put a stop to this "underground railroad," particularly because it jeopardizes Romulan security. Several high-ranking Romulan officers, and those with sensitive information, have fled to the Federation, most notably Vice Proconsul M'ret and his top aides. In addition to their ongoing efforts to destabilize relations between Vulcan and the Federation, the *Tal Shiar* has dedicated resources to locate Romulan traitors on Vulcan, and to root out members of this underground railroad.

See ***The First Line: Starfleet Intelligence*** and ***The Way of D'era: The Romulan Star Empire*** for more information on the Reunification Movement and the *Tal Shiar*.

On Vulcan, young, idealistic students form a vital part of the small but well organized reunification effort on Vulcan. They have a moderately well funded secret organization devoted to the ideals promoted by Ambassador Spock. While many of the people involved are students, they have contacts throughout Vulcan which supply them with computers and other equipment as well as medical and other supplies for the dissidents in the Romulan Star Empire.

Today, several years after Ambassador Spock began his work on Vulcan, there is a small but steady stream of people and supplies being ferried to Romulus as well as a smaller number of Romulans coming to Vulcan. Since all unauthorized contact with the Romulan Star Empire is a crime in the Federation, the reunification effort is secret and the people involved spend a great deal of time making sure that no one outside their organization knows anything about their work.

The members of the Reunification Movement on Vulcan are unhappy about breaking Federation law and almost all members of the effort consider themselves to be loyal Federation citizens. They are unwilling, however, to allow Federation laws and policies get in the way of what they consider to be



important moral and practical goals. Several scientists and religious officials involved in the reunification effort have discreetly approached Starfleet about obtaining aid or at least official sanction for these efforts, but Starfleet is worried about the possible negative political consequences of being linked to a revolutionary effort on Romulus.

If the Romulan government uncovered evidence that Starfleet was aiding the reunification effort they would have powerful political ammunition against the Federation. Also, Starfleet Intelligence is unwilling to support untrained amateurs who engage in dangerous undercover missions. While several Starfleet admirals privately support Ambassador Spock's plans, the reunification effort remains officially unsanctioned.

## A VISITOR'S GUIDE TO VULCAN

While Narrators and players alike will find extensive information on the Vulcan homeworld in *Planets of the UFP: A Guide to Federation Worlds* and *The Way of Kolinahr: The Vulcans*, information vital to travelers bears repeating here. The Narrator should refer to this section for tips on how Vulcan applies to this episode.

### THE PHYSICAL ENVIRONMENT

Vulcan is a hot, dry world with gravity almost 20% greater than Earth's and a somewhat thinner atmosphere. Even though it is early spring when the PC's arrive on Vulcan, the daytime high temperature hovers at around 40°C. As a consequence, humans and other species from planets with lower gravity and temperatures find Vulcan rather uncomfortable.

All non-Vulcans receive a temporary -1 Vitality Edge to their Fitness score while visiting Vulcan due to the unpleasant conditions. Affected characters constantly feel somewhat tired, hot, and slightly out of breath. Visiting Vulcan is not harmful, but it will be difficult.

Fortunately, the Federation has developed medicines to counteract these problems. Characters who receive daily injections of tri-ox compound and Gravinase will not suffer this reduction in Fitness. Crew members visiting Vulcan for anything more than a few hours can receive an injection from the ship's doctor; visitors intending to stay on the planet's surface for several days can obtain a preloaded hypospray with a week's supply of these drugs and instructions to use the hypospray every morning.

### LIFE AND CULTURE

Although most citizens of the Federation are familiar with the stoic, reserved nature of the Vulcans—either through story or direct experience—nothing prepares the visitor for a trip to Vulcan. Quite simply, encountering Vulcans off their homeworld is different from encountering them in their native culture. While one or two Vulcans may seem exotic, an

entire planet devoted to emotionless logic can be a bit off-putting and overwhelming to the tourist. Starfleet officers on shore leave to Vulcan are advised to anticipate this, and can expect a memorable vacation.

Two elements of the Vulcan psyche form the basis of their society. Since the Time of Awakening, some 2,000 years ago, Vulcans have valued reason and logic. All well-adjusted Vulcans consider their actions carefully and follow the most reasonable course to attain their goals.

Being logical, however, does not make Vulcans any more moral than other species. While crimes of passion are almost unknown on Vulcan, sometimes an individual decides that theft, or even murder, is the best means of attaining his goals. Yet even these criminals behave in a logical fashion. Life on Vulcan is generally orderly, efficient, and peaceful. Visitors to Vulcan may find the deliberate, well reasoned pace of Vulcan society at times refreshing, and at times frustrating.

In addition, Vulcans suppress their emotions, even though they fall in love and have friends and enemies, likes and dislikes. Surak, the father of Vulcan society, taught that emotions clouded judgement and led to suffering. Today, Vulcans almost never act for purely emotional reasons, and Vulcans rarely display their emotions. Many Vulcans regard all open displays of emotion as proof of a weak nature. As a consequence, daily life on Vulcan is usually quite peaceful. Anger, yelling, random vandalism, open violence, and the chaotic disorder that characterizes many less civilized large cities throughout the galaxy are largely absent here.

Because life on Vulcan is in many ways very different from life in the rest of the Federation, some Vulcans consider their way of life superior to others. Many of these Vulcans believe their planet should isolate itself from other species, seeing in them illogic and passion. Most Vulcans value diversity and are proud to be a part of the Federation, but emotional outbursts or violent actions by off-worlders visiting Vulcan serve to feed the prejudices of those who do not value diversity, and earn Crew members sharp stares and hushed comments.

### SHIRKAHR

This episode takes the Crew to the Vulcan capital city of ShirKahr. While larger than most, ShirKahr is a typical Vulcan city. The street plans are laid out with mathematical precision, designed for maximum efficiency as well as harmony with the environment. The buildings tend to be geometric, both in design and layout. Stone, usually marble or granite, is the primary building material, though wood, glass, and some ceramic are used for decoration. Because of the climate, ShirKahr has a kind of "austere openness" to it, a quality many find appealing.

As a result of the constant heat, Vulcan buildings are usually quite open and spacious inside. Many large buildings have columned verandahs and central



courtyards to catch cool breezes. ShirKahr also boasts a number of well-manicured public gardens resplendent with the local, hardy flora, as well as numerous squares sporting small fountains or impressive statuary. In general, ShirKahr's skyline is low and open, with few buildings rising above ten stories high. For more information on ShirKahr, see *The Way of Kolinahr: The Vulcans*.

Many off-worlders assume that because of its peaceful and orderly society, Vulcan must be boring. To enjoy oneself, the visitor simply needs to look for particular forms of entertainment. Those looking for more hedonistic entertainment would be better served with a visit to Risa or Rigel II. But visitors to Vulcan can enjoy lively debates, complex musical arrangements, and precise artistic displays. ShirKahr can be quite lively and sometimes even loud: here, a small cluster of Vulcans debating the finer points of logic or a scientific discovery; there, a precession of Vulcan masters, gongs banging and bells ringing, as they make their way to a sacred site; the bustle of the marketplace as shoppers logically negotiate for the most logical price.

Getting around ShirKahr is quite easy. Its broad streets and beautiful architecture make ShirKahr a walking city, the mode of transportation preferred by most Vulcans. Ground cars and public trams are reserved for travel between neighborhoods. Transporter use is infrequent since Vulcans prefer to experience travel between one location and another, though most Vulcan cities possess at least one transporter facility. To travel the long distances between cities, the government provides free skytram service. At specially marked stops, the traveler simply enters

his destination into a control panel, and shortly thereafter a skytram arrives to transport him.

## SYNOPSIS

While on shore leave on Vulcan, the Crew encounters a fellow crew member who suspects that she has encountered a Romulan agent on the streets of ShirKahr.

The encounter comes to the attention of Silak, a person presenting himself as an agent of the *V'Shar*, the Vulcan intelligence service. Silak claims to be searching for Romulan agents on Vulcan, and believes the Crew can help him in his efforts. He asks the Crew to help identify the alleged spy, and when the evidence suggests their suspicions are correct the Crew becomes involved in the apprehension effort.

In reality, Silak is a member of the *Tal Shiar* on Vulcan hunting for Romulan dissidents who are part of the reunification project, and the conspirators who smuggle Romulan citizens into Federation space.

Unknown to the Crew, the woman they pursue as a Romulan agent is a Vulcan member of the reunification project helping to bring Vulcan logic and culture to Romulus. By following her, they unsuspectingly lead Silak to a group of like-minded individuals planning a covert trip to Romulus.

When Silak captures the dissidents, he takes them to a secluded location for interrogation, then transport back to Romulus. Can the Crew stop Silak from kidnapping the members of this cell? Will they uncover his secret identity and arrest the real Romulan spy?

## THE MAIN CHARACTERS

### ENSIGN ARLEA MCHUGH

Ensign McHugh is a junior grade Engineer on the PC's starship. Though good at her job, she can be hot-tempered and impulsive, and harbors a deep hatred



for Romulans. When she was twelve years old, her parents, both in Starfleet, were killed in a Romulan attack on their starship. Afterward, she threw herself into her studies with the intention of joining Starfleet. Despite her feelings, McHugh managed to pass the rigorous psychological examinations and gained acceptance to the Academy. Little did anyone know that she joined

Starfleet with the intention of one day exacting revenge on the Romulans.

She is tall, muscular, and attractive, and has long red hair. She is an excellent engineer, but her temper and her tendency to charge into situations have gotten her into trouble on more than one occasion. The Narrator can use Ensign McHugh as a foil for an ongoing series: Perhaps one of the Crew falls in love with her; perhaps her quest of vengeance leads the ship into danger. There can be only one of two fates for a character like McHugh: Either she eventually learns to put aside her anger, or she loses her commission in Starfleet.

#### Attributes

Fitness: 3  
Vitality +1  
Coordination: 2  
Intellect: 2  
Logic +1  
Presence: 3  
Psi: 0

#### Skills

Athletics (Volleyball) 1 (3)  
Computer (Modeling) 2 (3)  
Culture (Human) 2 (3)  
(Romulan) (3)  
Dodge 2  
Energy Weapons (Phaser) 2 (3)  
History (Federation) 1 (2)  
(Human) (2)  
Language  
Federation Standard 2  
Romulan 1  
Law (Starfleet Regulations) 1 (2)  
Material Engineering (Structural) 1 (3)  
Personal Equipment (Gravitic Calipers) 1 (2)  
Planetside Survival (Jungle) 1 (2)  
Search 3  
Stealth 2

Streetwise (Locate Contraband) 1 (2)  
System Engineering (Diagnostic) 2 (4)  
(Environmental) (3)  
Vehicle Operations (Shuttlecraft) 1 (2)  
World Knowledge (Earth) 1 (2)

#### Advantages/Disadvantages

Eidetic Memory +3  
Peripheral Vision +1  
Hides Emotions -2  
Impulsive -1  
Vengeful (Romulans) -3

#### Renown: 5

Aggression: 0 Discipline: 1 Initiative: 2  
Openness: 0 Skill: 3

#### Courage: 3

#### Resistance: 4

#### Wound Levels: 4/4/4/4/4/0



### SILAK

An agent of the *Tal Shiar*, the Romulan intelligence service, Silak comes from a family well connected to the *Tal Shiar*. He learned at an early age some of the techniques that would one day come in handy. A loyal Romulan, both his mother and father served the esteemed spy service, and they inculcated their son with the same dedication. His is a skilled and ruthless agent, devoted to hunting down all types of rebels and dissidents.

Carefully trained to impersonate a Vulcan, he is particularly well suited to impersonate a member of the *V'Shar* (the security branch of the Vulcan government). He joined the Vulcan counterpart to the *Tal Shiar* by posing as an average Vulcan citizen. Silak applied, and was accepted, into the *V'Shar*, where he slowly moved up the ranks and gained the trust of his superiors.

Periodically, Silak feeds sensitive information to his *Tal Shiar* handlers back on Romulus. He inwardly hates Vulcans for abandoning the old ways, the way the Romulans fled Vulcan to preserve. He will do anything to further his mission, and lies with great ease.

Silak looks no different than the average Vulcan. He is tall, 6'2", and thin, with a typically Vulcan severe hairstyle. He has piercing eyes and an author

itative presence. He keeps a tight reign on his emotions, even going so far as to practice Vulcan mediation techniques (though he hates it).

### Attributes

Fitness 3  
 Strength +1  
 Coordination 3  
 Intellect 2  
 Perception +1  
 Presence 3  
 Empathy -1  
 Psi 0

### Skills

Artistic Expression (Acting) 3 (4)  
 Athletics (Running) 1 (2)  
 Behavior Modification (Brainwashing) 2 (3)  
 Computer (Hacking) 2 (3)  
 Culture (Romulan) 2 (3)  
 (Vulcan) (3)  
 Disguise (Vulcan) 2 (3)  
 Dodge 2  
 Energy Weapon (Disruptor) 2 (3)  
 Espionage (Intelligence Techniques) 3 (4)  
 (Covert Communications) (4)  
 History (Romulan) 1 (2)  
 Intimidation (Cross Examination) 2 (3)  
 Language  
 Romulan 2  
 Vulcan 2  
 Law (Romulan) 1 (3)  
 Medical Science (Psychology) 1 (2)  
 Personal Equipment (Tricorder) 2 (3)  
 Security (Security Systems) 2 (3)  
 Shipboard Systems (Tactical) 1 (2)  
 Surveillance (Tracking) 2 (3)  
 Unarmed Combat (Star Navy Martial Arts) 1 (2)  
 Vehicle Operations (Hovercar) 1 (2)  
 World Knowledge (Romulus) 2 (3)  
 (Vulcan) (3)

### Advantages/Disadvantages

Security Clearance +3  
 Arrogant -1  
 Fanatic -3  
 Hides Emotions -2  
 Obligation (*Tal Shiar*) -3

### Renown: 15

Aggression: 3 Discipline: 4 Initiative: 0  
 Openness: 0 Skill: 8

### Courage: 3

### Resistance: 3

### Wound Levels: 3/3/3/3/3/0

**Possessions:** Silak has a tricorder, two comm jammers, a stun grenade, a personal force shield (see New Technology, pp. 61) and a Vulcan phaser. All but the personal force shield are of Federation (specifically Vulcan) make.



### T'LAU

T'Lau became involved in the reunification movement through her studies in comparative cultures at the ShirKahr Institute of Knowledge. Fascinated by Vulcan's shared heritage with the Romulans, she began to wonder at the differences that had evolved between their two peoples. Her increasing fascination with Romulan culture led her to similarly interested individuals, some of them members of the underground Reunification Movement.

A little over a year ago she joined the movement, and now prepares to accompany two other Vulcans to Romulus to teach Vulcan language, culture, and logic. She wants, perhaps naively, to help bring peace and understanding to the Romulan people. Her parents know of her involvement, though her mother does not approve; her father believes that the reunification with Romulus is only logical and inevitable.

T'Lau is a wisp of a girl, with the appearance of a 16-year-old human—slight, small, and a little ungainly. She's actually in her mid-30's, still young by Vulcan reckoning. Ambassador Spock is one of her personal heroes, and reading his memoirs was one factor in her interest in the reunification movement.

The following statistics can be used for T'Lau and the other Vulcans who are involved in the reunification movement.

### Attributes

Fitness 3  
 Strength +1  
 Coordination 2  
 Intellect 3  
 Logic +1  
 Presence 3  
 Empathy -1  
 Psi 1  
 Range -1

### Skills

Computer (Research) 2 (3)  
 Culture (Romulan) 2 (4)  
 (Vulcan) (3)  
 Dodge 2  
 History (Vulcan) 1 (2)  
 Language  
 Romulan 3

Vulcan 4  
 Mind Meld 2  
 Personal Weapons (*Trillpa*) 1 (2)  
 Search 2  
 Social Sciences (Anthropology) 2 (3)  
 Stealth 3  
 Unarmed Combat (Nerve Pinch) 2 (3)  
 World Knowledge (Vulcan) 1 (2)

**Advantages/Disadvantages**

Curious (+1)  
 Code of Honor (Vulcan) (-3)  
 Hides Emotions (-2)

**Renown:** 0

Aggression: 0    Discipline: 0    Initiative: 0  
 Openness: 0    Skill: 0

**Courage:** 1

**Resistance:** 3

**Wounds:** 3/3/3/3/3/0



**DR. VIREL**

A professor at the Vulcan Science Academy, in the field of four-dimensional physics, Dr. Virel became involved in the Reunification Movement after the foiled Romulan invasion of Vulcan. He is a man of peace, and came to believe that only through peace could the Romulan and Vulcan peoples come together. Virel quickly became involved in the "underground railroad" smuggling Romulans out of, and Vulcans into, the Romulan Empire.

Using his identity as an eminent scientist, he occasionally meets Romulan scientists at conferences and in other nonpolitical forums, and with painstaking caution gauges their interest in defection. In this way, Virel has become adept not only at identifying potential defectors, but also at arranging their transport. It is in this way that he eventually became involved in his current endeavor—smuggling T'Lau and others to Romulus.

Dr. Virel is an aging Vulcan male, 157 years old, with the apparent age of a 70-year-old human. Despite his age, Virel has an athletic physique. Dr. Virel once met Ambassador Spock at a science conference prior to the latter's trip to Romulus.

**Attributes**

Fitness 2  
 Strength +1  
 Coordination 2  
 Intellect 3  
 Logic +1  
 Presence 2  
 Empathy -1  
 Willpower +1  
 Psi 2  
 Range -2

**Skills**

Computer (Research) 2 (3)  
 Culture (Vulcan) 2 (3)  
 History (Vulcan) 1 (3)  
 Language  
 Federation Standard 2  
 Vulcan 3  
 Law (Vulcan Law) 1 (2)  
 Life Sciences (Exobiology) 2 (3)  
 Mind Meld 2  
 Personal Equipment (Tricorder) 2 (3)  
 Persuasion (Debate) 1 (3)  
 Physical Science (Mathematics) 2 (4)  
 Planetside Survival (Desert) 1 (2)  
 Space Science (Four-dimensional Physics) 2 (5)  
 (Astrophysics) (4)  
 Theoretical Engineering (Warp Drive) 1 (3)  
 Unarmed Combat (Nerve Pinch) 2 (3)  
 World Knowledge (Vulcan) 1 (2)

**Advantages/Disadvantages**

Curious +1  
 Contacts (Reunification Movement) +2  
 Ally (Master Sital) +3  
 Code of Honor (Vulcan) -3  
 Hides Emotions -2

**Renown:** 16

**Courage:** 2

Aggression: -2    Discipline: 0    Initiative: 0  
 Openness: 3    Skill: 11

**Resistance:** 2

**Wound Levels:** 2/2/2/2/2/0

**THE SET-UP**

The episode begins with the Crew's starship in standard orbit over Vulcan for a week-long stay. The reason for the visit can range from a scientific conference attended by the captain or senior officer (such as the Fifteenth Archaeological Conference) to a diplomatic function requiring the starship to "show the flag," depending on the individual series. Whatever the purpose, the Crew should not be directly involved; while several senior officers attend to their duties, most of the crew receive extended shore leave.

On the first day of their visit, the Crew spend an uneventful day in ShirKahr. The city sits on a flat plain surrounded by high cliffs. Far in the east the Tarhan

volcano can be seen by its smoke in the day and as a dim glow at night. Describe the bustling activity on ShirKahr's streets, and the beautiful vistas that seem to be around every corner. The Crew might visit a number of locations in the city, such as the Vulcan Science Academy, the old *Suta Temple*, or the Museum of Tolerance. Crew members find the architecture open and airy, though not as comfortable as they're used to. Air conditioning is found only in buildings designed for off-world tourists. Vulcans find the daily 40° temperatures extremely comfortable.

As they make their way along ShirKahr's streets, the Crew find the people peaceful and orderly. While most Vulcans are not the grim-faced stoics depicted in stereotype, neither are they overly outgoing or friendly. Shopkeepers and pedestrians behave with a cool detachment, born of a familiarity with tourists. Even the children seem generally polite and well behaved. Suddenly, a disturbance shatters the morning calm: A loud argument takes place ahead of them in a small, open-air café. The display begins to attract several bystanders.

As the Crew push through the crowd they see a tall, red-headed woman in a Starfleet uniform backing a slender young Vulcan against a wall. She yells at the stunned girl that she's a "dirty Romulan spy." At least one person among the Crew recognizes the officer as Ensign Arlea McHugh, a hot-tempered, but extremely likable, engineer on their ship. The Crew likely intervenes with McHugh, who recognizes them, and the Vulcan girl uses this brief distraction to escape down the alley. Being familiar with this neighborhood, the girl quickly disappears onto the street, blends into the crowd, and cannot be found.

McHugh is extremely upset that the "Romulan spy" got away, thanks to the Crew's intervention. She explains herself in a torrent: She was enjoying a bowl of *plomeek* soup when the Vulcan girl, who looked to be around 20, walked in, got some sort of snack, and left. As she left, Ensign McHugh heard the Vulcan say "*Jolan True*," a common Romulan farewell salutation, to the server. She rushed over to the Vulcan, cornered her against a wall, and demanded she confess that she was a Romulan spy. She was just about to signal the ship to transport them both aboard when the Crew showed up and allowed the girl to escape.

If the Crew ask the server about the young Vulcan, he acts rather aloof, having just seen a Starfleet officer cause a loud disturbance inside the restaurant. Although he finds the "off-worlders" rude and aggressive, he answers all questions truthfully. He confirms that the Vulcan in question did say "*Jolan True*," a phrase he'd never heard before.

Asked whether or not he's ever seen the girl before, the waiter reluctantly answers in the affirmative: he tells the characters that she visits often, sits with friends, and talks. Every third evening she meets with friends in the park across the way, as she did three nights ago. He first noticed her five weeks ago. If the Crew doesn't question the server, Ensign McHugh does, in order to confirm her story. It's



hoped that one of the Crew will apologize for the disturbance to mollify the server.

While the Crew (or McHugh) question the waiter, two Vulcan constables respond to the disturbance. They unobtrusively take statements from the bystanders, then approach the Crew. They remind the Starfleet officers that the penalty for creating a disturbance on Vulcan can be stiff, and promise to contact their commanding officer and Starfleet Command. They expect an explanation of the Crew's disruptive conduct, which the player characters may or may not answer truthfully.

Mention of a Romulan spy only elicits a raised eyebrow, and a speech about how illogical this sounds (a Romulan spy, they point out, would not be so foolish as to reveal himself so awkwardly). All the police look for is an apology, and a promise to be less unruly. If the PC's mishandle the situation, they could find themselves under arrest. Meanwhile, the small crowd disperses slowly.

## RECRUITMENT

Shortly after the Crew leave the café with McHugh in tow, a middle-aged Vulcan man dressed in a traditional Vulcan tunic approaches them. He introduces himself as Silak, an agent of the *V'Shar*, Vulcan's intelligence agency. The Crew should know that off-planet the *V'Shar* serve a function similar to Starfleet



Intelligence or the ancient American CIA; on Vulcan, the *V'Shar* act as local law enforcement, like the Federation Intelligence Service or the ancient American FBI. (Narrators can call for a Routine (4) Culture (Vulcan) Skill Test to drive the point home).

Silak asks the Crew to remain silent and escorts them to an empty warehouse nearby. Upon entering, he crosses to a table and activates an electronic device. The device, he explains, suppresses any surveillance devices the Romulans may be using. He noticed the disturbance at the café and wanted to talk about the suspected Romulan spy. At this point, the Crew may want to forget the whole thing.

For a number of weeks, Silak explains, he has been searching for several suspected Romulan agents, and has tracked them to this neighborhood of ShirKahr. These Romulan agents have disguised themselves as Vulcan students, and he suspects that they work with the more violent members of the Vulcan Isolationist Movement to help distance Vulcan from the Federation, and pave the way for a revolution which may be the precursor for a full-scale Romulan invasion.

Silak asks the Crew for any information they have regarding these suspected Romulans. He emphasizes the danger of this Romulan plot, and wants to stop them before they can cement an alliance with the leaders of the VIM.

Silak then asks the Crew for help in capturing the Romulan agents. McHugh readily volunteers, and does her best to convince the rest of the Crew to help. Silak believes the Romulans have a mole in the Vulcan government, and is reluctant to ask for help from the *V'Shar* for fear that doing so may alert the Romulans. If the Romulans have any indication that the authorities are closing in on them, he fears they will simply disappear and create new identities at a later point. The only way to be certain of catching them is to move immediately and to involve as few additional people in the investigation as possible. This type of talk further reinforces Ensign McHugh's paranoia about the Romulans.

Silak debriefs the Crew, encouraging them to go into great detail about everything they heard and saw. He then asks the Crew to meet him at a shop up the street shortly before sunset. Until then, he suggests the Crew go about their day in a normal fashion and avoid suspicious behavior like returning to their ship, in case the Romulan spies shadow them. Because they lack weapons, Silak offers to supply them with stunners when they meet in the evening.

If anyone is suspicious of Silak, he can contact the *V'Shar* and check his credentials. In fact, if anyone mentions his suspicions to Silak, he suggests they do so. The Vulcan who answers the call confirms that an agent Silak works for the *V'Shar* and offers to send a photo to the caller's tricorder or PADD. No further information will be given out, however, unless the Crew have some sort of official backing for their request. The *V'Shar* guards its agents' privacy carefully. Psionic characters attempting to probe with either Empathy or Telepathy find Silak's mind cannot be read. By making a Moderate (7) Culture (Vulcan) Skill Test characters may know that some *V'Shar* agents receive training in telepathic defense. Mentioning his mental defenses elicits a sharp reprimand from Silak; attempting to probe someone's mind without their consent is a crime on Vulcan.

## THE TRUTH

Silak is actually an agent of the *Tal Shiar*, the Romulan intelligence agency, secretly smuggled to Vulcan several years ago. During that time, he slowly inserted himself into the *V'Shar*. His abilities at computer hacking and data alteration allowed him to create a flawless background. Several weeks ago, the *Tal Shiar* instructed Silak to hunt for Romulan émigrés on Vulcan.

The Romulan government has evidence that Ambassador Spock is working with the Reunification Movement in an effort to bring Vulcan culture and philosophy to Romulus. The Continuing Committee, made up of Romulan coalition leaders, military officers, and the Praetor, considers these reform efforts to be an extremely dangerous form of treason, and is determined to stamp out this plot. So far, however, Silak has been unable to apprehend anyone involved in transporting people to or from Romulus.



Subcommander Silak had recently heard rumors of Romulan activity in the student district of ShirKahr—his only lead—and has been investigating them ever since. He happened to be in the neighborhood to witness the disturbance at the café. When he heard Ensign McHugh's story, he became convinced he had found the break he needed. Duping Starfleet officers to help him achieve his ends appeals to Silak, and keeps them from investigating further on their own.

## RANDOM EVENTS ON VULCAN

Visibly excited by the prospect of helping expose a dangerous Romulan plot, Ensign McHugh stays with the Crew for the rest of the day. If they attempt to take any action that goes against the spirit of Silak's instructions—such as returning to their starship, contacting Vulcan officials, or alerting Starfleet—she tries to talk them out of it.

If the Crew contact their captain, she instructs them to cooperate fully with the *V'Shar* and to let her know immediately if they turn up any concrete evidence of Romulan activity on Vulcan. The rest of the day passes uneventfully.

The following events can occur whenever the PC's have some free time on Vulcan. None of these events is directly connected to the plot, but they can provide interesting encounters and give the PC's a more vivid sense of life on Vulcan.

### THE MYSTIC

The Crew come upon a group of Vulcans talking with a wandering Vulcan mystic. They treat the mystic, dressed in old and dusty robes, with great respect. He notices the Starfleet officers on the street and calls

out to them, inviting them to listen to some of the humble knowledge he has learned. If the Crew oblige, he treats them to a combination lecture and performance. The mystic is a wandering *Planfa* monk.

He lectures on the dangers of emotion and the need for inner calm. Emotion, he warns, clouds perception and leads to false conclusions. While he tells the parable of the rebellious son who ran away, traveled widely, and then returned when his parents were ill, he makes a brightly colored metal ball vanish from one palm, appear in various places, and finally reappear in the hand it vanished from.

At the end of the performance, the assembled Vulcans leave something of use for the monk—a loaf of bread, a few coins, a book. The Vulcans look sharply at the Crew if they don't also leave something for the monk.

### THE PROTESTERS

A number of Vulcans sit outside a Ferengi-owned holosuite parlor near the ShirKahr transport facility, peacefully protesting. The protesters believe some holoprograms cater to emotion—love, fear, excitement—corrupting Vulcan youth and eroding Vulcan values.

While they acknowledge the value of educational and cultural programs, they want the government to ban certain types of holoprograms—particularly the offensive *Vulcan Love Slave* series the Ferengi owner makes available to off-world visitors. Since holosuites can be detrimental, protest is the only logical recourse. The protesters do not stop people from entering the holosuites. Instead, they attempt to talk to anyone entering or leaving, and eagerly address the Crew about their cause.





## THE DEBATE

At mealtime, the Crew can stop at a local restaurant or café. Nearby, a number of Vulcans debate the effects of Federation membership and recent events on their planet; if the series is set during the Klingon Civil War, for example, the Vulcans discuss the Federation's involvement with Gowron's house, and its impact on Vulcan. Once the Crew sit down several of the Vulcans look sharply at them and the conversation becomes more animated. The Vulcans ignore any comments made by Crew members unless they come over to the Vulcans' table and involve themselves directly in the conversation. The Vulcans take the position that Federation membership involves their planet in conflicts irrelevant to Vulcan. Depending upon the Crew's reactions, this conversation could result in a lively debate, or the Vulcans could become exasperated and leave.

One Vulcan, T'Rin, attempts to make a point by provoking one of the Crew into an altercation. If the scene becomes hostile, the Vulcans attempt to restrain the player character, but will not actually harm any of them. The Vulcans notify the authorities, however, and the Crew will have a great deal of explaining to do, both to local officials and Starfleet. Also, the Vulcan Isolationist Movement gains valuable propaganda

against violent and uncivilized aliens visiting Vulcan. Hot-tempered Crew members could provoke a diplomatic incident and jeopardize relations.

## THE RENDEZVOUS

That evening, the Crew meet up with Silak at the appointed place. He provides those PC's who want them with stunners (equivalent to Type I phasers, but capable only of settings 1-3). As a security precaution, Silak's stunners can be remotely deactivated with the touch of a button on a special control device he carries. That evening, just before the group sets out, he makes a show of checking each one for bugs. Although he doesn't claim to find any, in actuality he himself has planted tiny tracking and listening devices into two of the stunners. He gives one to Ensign McHugh and the other to a randomly determined player character.

He needs Ensign McHugh to identify the girl she encountered at the café earlier in the day. Silak recalls that the waiter said he'd seen the girl before, meeting friends in a small park across the street, that she went there every third night, and that he'd seen her there two nights ago. If she follows her pattern, Silak reasons, she should be there tonight. Silak proposes they go to the park and follow the girl. From there, they can watch her and see when she meets with her fellow agents.

## VULCAN STUDENTS

### Attributes

Fitness 2

Strength +1

Coordination 3

Intellect 2

Logic +1

Presence 2

Empathy -1

Psi 1

Range -1

### Skills

Culture (Vulcan) 2 (3), History (Vulcan) 1 (2), Language (Vulcan) 2, Mind Meld 2, Primitive Weaponry (*Ahn-woon*) 2 (3), Stealth (Hide) 2 (3), Streetwise (*ShirKahr*) 1 (2), Unarmed Combat (*Nerve Pinch*) 2 (3), World Knowledge (Vulcan) 1 (2)

### Traits

Curious +1

Code of Honor (Vulcan) -3

Hides Emotions -2

Resistance: 2

Wound Levels: 2/2/2/2/2/0

Equipment: *Ahn-woon*: Accuracy 8 Damage 1+1d6 (whip), 2+1d6 (club); 1 point Stun damage (strangle)

Silak and the Crew can spread out to survey the area better. The park is little more than an open patch of land approximately one city block in size, with tables and benches situated among the gespar and lavnit plants. After thirty minutes of waiting, the girl appears with two friends. They take a table near the edge of the park. Ensign McHugh readily identifies the girl as the “Romulan spy” from the café.

The student the Crew watch is not a Romulan at all. She is one of the Vulcans destined for Romulus to teach interested Romulans Vulcan customs and language. T’Lau and two other Vulcan students have been preparing intensively for their trip, studying Romulan language, culture, and history. The three plan on accompanying two Romulan dissidents back to Romulus in three days’ time.

This evening T’Lau meets with two friends from her university, as she does every three evenings. These friends are not involved with the Vulcan/Romulan reunification effort, instead meeting to share Vulcan mocha and study. One, Relin, is an Andorian, the other, Sutak, is a Vulcan. Silak uses a directional listening device to eavesdrop on their conversation, which begins with typical college banter.

If the Crew listen in on the conversation, they gain a picture of a young, passionate (for a Vulcan), and deeply thoughtful girl. She tells her friends that in four days she plans to leave for an advanced comparative political studies program at the Daystrom Institute. Although she looks forward to the educational opportunities, she will miss her friends. Both Relin and Sutak say they’ll miss her, too. When they ask her how long she’ll be gone, T’Lau becomes evasive. She cannot say how long she’ll be gone—the program lasts for one year, but can be renewed for up to two additional years. She seems sad to be leaving.

Silak suspects he knows exactly where T’Lau is destined, though he does not share his thoughts with Crew members. Instead, he claims this talk of going off-world must be a cover for her to return to Romulus to report to her *Tal Shiar* overseers. He again reminds the PC’s that haste is essential.

After some more chit-chat, the three leave in separate directions. As long as the Crew have been moderately discrete in their monitoring of the conversation (make a Routine (4) Stealth or Surveillance Test for each character, including Silak), T’Lau remains unaware that she is being watched. If anyone fails this test, T’Lau or one of her companions notices the Starfleet personnel watching them. T’Lau recognizes them from earlier in the day and hastily leaves the park. When she departs, Silak follows and motions the Crew to join him.

## FOLLOWING T’LAU

To follow T’Lau requires a successful Stealth or Surveillance Skill Test against a Routine (4) Difficulty. Failing this roll, the Crew lose track of T’Lau. With a dramatic failure, she notices them tailing her. Seeing the Starfleet uniforms, T’Lau immediately assumes the



Federation suspects her of being involved in the reunification effort and attempts to lose them in the crowd. If T’Lau suspects that she’s being followed—if, for example, she notices the Crew at the park—this becomes an Opposed Test pitting T’Lau’s Stealth skill against the Crew’s Stealth or Surveillance; T’Lau uses her knowledge of ShirKahr’s streets to avoid pursuit. Meanwhile, T’Lau sends a coded message on her wrist communicator to warn the others participating in the plot.

Since their goal is to follow T’Lau to her compatriots, Silak prevents Crew members from attempting to capture T’Lau. The problem is that Ensign McHugh wants to capture the spy and turn her over to the authorities. During the surveillance of the park, and the trip through ShirKahr’s streets, McHugh tries to apprehend T’Lau (using her stunner). This puts the Crew in a curious position: either siding with her, or siding with Silak. The Narrator should encourage players to choose sides, either agreeing with McHugh or arguing Silak’s point for him. Silak debates logically that it would be better to allow T’Lau to lead them to other Romulan spies. The Narrator should prevent the PC’s from actually apprehending T’Lau; describe Silak stopping McHugh before she stuns their quarry, or have him interfere with a Crew member’s line of fire.

## IF THE CREW LOSE T'LAU

If the group loses T'Lau, Silak stops the search and attempts to locate her by other means. Obtaining the girl's name from the conversation, as well as learning that she's a student at the ShirKahr Institute of Knowledge, Silak uses his false credentials as a member of the *V'Shar* to access the school's student records. Using a public computer access terminal, he inputs a security code and links to the Institute's central computer. From there, he downloads her file.

In addition to a fairly routine class schedule (for a Vulcan), including classes in transdimensional particle physics, comparative thanatology, and Iconian political movements of the Fourth Dynasty, her file includes notes on extracurricular activities. She belongs to several political movements and a debating society, but nothing to indicate membership in the VIM or subversive activities. She lives several blocks away, in the Artisan Quarter, but does not appear to be home when the PC's arrive. Silak plans to discreetly stake out the apartment, and encourages the Crew to join him. Ensign McHugh chooses to stay with Silak.

If T'Lau recognized that she was being tailed, she avoids going home. She contacts her compatriots and arranges to meet with one of them—Pirek, a Romulan secretly visiting Vulcan to study its culture. Two hours later, T'Lau and Pirek meet, and T'Lau divulges her predicament. Fearing Starfleet involvement, she cannot return home. Moreover, she keeps a PADD containing information about the group's plans hidden in her apartment. Pirek agrees to retrieve it, and to acquire some of her personal items as well. After that, she stays at the home of Dr. Virel, the group's leader, until their ship leaves in three days. The Narrator should proceed to "*T'Lau's Apartment*," below.

On the other hand, if the Crew simply loses T'Lau in the crowd, the girl returns home. When the Crew finally find her apartment, they can clearly see her moving around her home through the windows. The episode proceeds according to the information presented in the next section.

## IF THE CREW SUCCESSFULLY FOLLOW T'LAU

If the Crew succeed in their Stealth Test to follow T'Lau, she has no idea that she's being followed and simply goes home. Silak wants to wait a bit before confronting T'Lau, to see who comes and goes; other members of her network might show up, or she might lead the Crew to their hidden safehouse. Once at home she contacts several members of her reunification cell and arranges to meet them at the home of Dr. Virel to discuss final plans and preparations before their departure from Vulcan. She leaves for this meeting approximately an hour after arriving home.

T'Lau should have no reason to suspect her home is being watched, unless the Crew reveal themselves for some reason. Silak and the Crew can follow her

once again, by making a successful Stealth Test against a Routine (4) Difficulty. If anyone fails this roll, T'Lau detects the tail. She attempts to lose her pursuers; this should be an Opposed Stealth Test.

She also alerts her confederates via a coded communication channel, using her personal wrist-communicator. If the Crew succeed in their initial Stealth Test, T'Lau remains unaware of her pursuers and the other members of her reunification cell have no warning of the PC's' arrival.

If T'Lau manages to lose the Crew, Silak returns to her apartment to search it.

## T'LAU'S APARTMENT

T'Lau lives in a small, second-floor apartment in the Artisan Quarter of ShirKahr. The two-story building is made of *bureki*, the volcanic stone common to Vulcan. A lute store occupies the first floor, but has closed for the day. The apartment's layout is open and airy, with three large rooms—a small kitchen, a bedroom, and a larger common room. The apartment looks out over the street, with two large windows that can be opened to catch the breeze. A retractable awning covers a small balcony. At this time of the evening, the street is relatively empty, with only a few passersby making their way home for the night.

This scene may begin with the Crew staking out T'Lau's apartment, if she noticed them following her. When the Crew arrive, the windows to her apartment are dark. A Routine (4) Personal Equipment (Tricorder) Test indicates that the apartment is empty. T'Lau's friend, Pirek, arrives some three hours after the Crew, to gather T'Lau's belongings and a PADD containing secret information.

Pirek is dressed simply and appears to be a typical Vulcan student. Having grown up on Romulus, under the watchful eyes of the *Tal Shiar*, Pirek approaches the apartment warily. After spending years in the Romulan dissident movement, he has experience with subterfuge, and carefully observes the street before entering the apartment. The Crew and Silak must make Opposed Tests pitting their Hide skill against Pirek's Search skill. If Pirek wins, he notices the Starfleet officers and continues walking up the street and away from T'Lau's home.

He does not return, though the Crew could follow him back to Dr. Virel's house. Should the Crew win, Pirek enters the apartment and turns on the lights. Although the Crew might assume the young man lives there, T'Lau's student files did not mention any roommates.

Once Pirek has the PADD and a small suitcase packed, he heads back to Dr. Virel's house. Once again, to follow Pirek the Crew should make Stealth or Surveillance Skill Tests (against a Routine (4) Difficulty). If the Crew accidentally alerts Pirek, he leads them to Dr. Virel nonetheless. However, he covertly alerts Dr. Virel and the others using his own personal communicator. By the time he arrives, the rest of the cell is prepared.



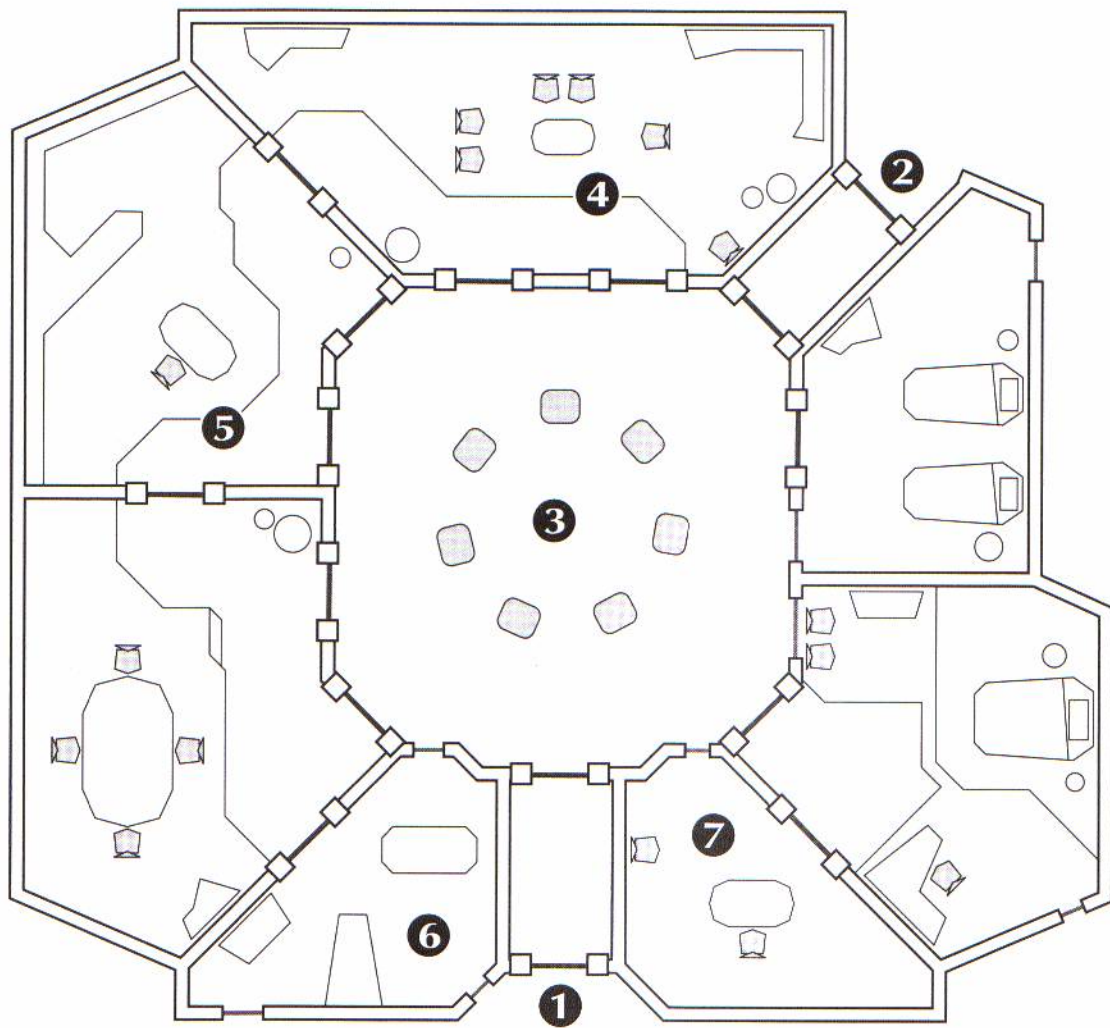

## DR. VIREL'S HOUSE

1. MAIN ENTRANCE
2. BACK ENTRANCE
3. GARDEN
4. LIVING ROOM
5. LIBRARY
6. KITCHEN
7. PRIVATE STUDY

Alternatively, the Crew might have a need to search T'Lau's apartment. Should the Crew lose T'Lau the second time, on her way to the reunification cell, Silak suggests searching her apartment. He climbs the open staircase to her front door and pulls out an electronic lockpick. He affixes it to the door, which opens a few seconds later. Silak enters, assuring the Crew that he has the authority, as a *V'Shar* agent. Inside, the decor appears to be the typical Vulcan mixture of elegance and simplicity—highly functional furnishings combined with geometrically ornate tapestries. Packing crates fill much of the large main room, suggesting that T'Lau prepares to leave on an extended journey.

Silak and the Crew find little of interest in the apartment. Numerous PADD's and books line her shelves, all of them academic texts of one sort or another. Clothing and personal items fill the packing crates. Searching the personal computer that rests on a desk in the main room, which requires a successful Routine (5) Skill Test, the Crew only find research files on subjects ranging from Vulcan history to computer science. Silak appears to be disappointed by the lack of incriminating evidence. One of the desk drawers contains exactly what he's looking for, however. A successful Moderate (8) Search Test uncovers a PADD hidden in a false-bottomed drawer.

### THE PADD

The PADD is keyed to T'Lau's bio-pattern, restricting access only to her. This can be bypassed, however, with a successful Moderate (8) Computer (Hacking) Skill Test. This should be an Extended Test requiring a cumulative Test Result of 30, with a turn length of five minutes. The PADD contains T'Lau's notes about the reunification effort, its members, and an address for a Dr. Virel. Silak does not want the Crew reading the PADD, which may contain information conflicting with his cover story, and objects if they attempt to, though he can think of no logical reason to prevent them from doing so.

Crew members who read T'Lau's journal may be puzzled by the inconsistencies between it and Silak's cover story. It is apparent the girl is not a Romulan spy, but a Vulcan involved in the Romulan Reunification Movement. Though the Federation frowns on citizens traveling into Romulan space, it is not a crime. While agitating for the overthrow of the Romulan government is more problematic, nothing in T'Lau's journal suggests that as her, or her group's, aims.

As her notes make clear, she simply endeavors to teach Romulans about Vulcan culture. When questioned about this, Silak appears as puzzled as the Crew, but suggests the PADD may be part of an elaborate Romulan ruse. If she is involved with the Romulan Reunification Movement, Silak points out, T'Lau could be in danger: The Romulans could capture her and somehow use her to their advantage (e.g., use her as a bargaining chip, brainwash her into becoming a *Tal Shiar* spy, use her as bait to capture Ambassador Spock, or worse).

Silak claims to want to find T'Lau and her associates, to apprise them of the dangers. He insists the Crew accompany him immediately, and save discussions of motive and further reading of the journal for a later time, since T'Lau and her associates may flee at any moment.

### THE HOUSE OF DR. VIREL

Regardless of how the Crew arrive at the headquarters—either by following T'Lau or Pirek, or getting the address from the PADD—they all notice that it is in a more opulent part of town near the Vulcan Science Academy. The headquarters of the reunification cell is actually the house of Dr. Virel, a prominent Vulcan physician who teaches at the Academy. Dr. Virel is the leader of this reunification cell and the only person having direct contact with members of the other reunification cells. It is he who arranges transport to and from Romulus. He recruited the other members of the cell from among the Academy's students and faculty.

### BEING FOLLOWED

If T'Lau (or Pirek) notices that she is being followed and warns her compatriots, the others in the cell prepare their escape. Several members use tricorders



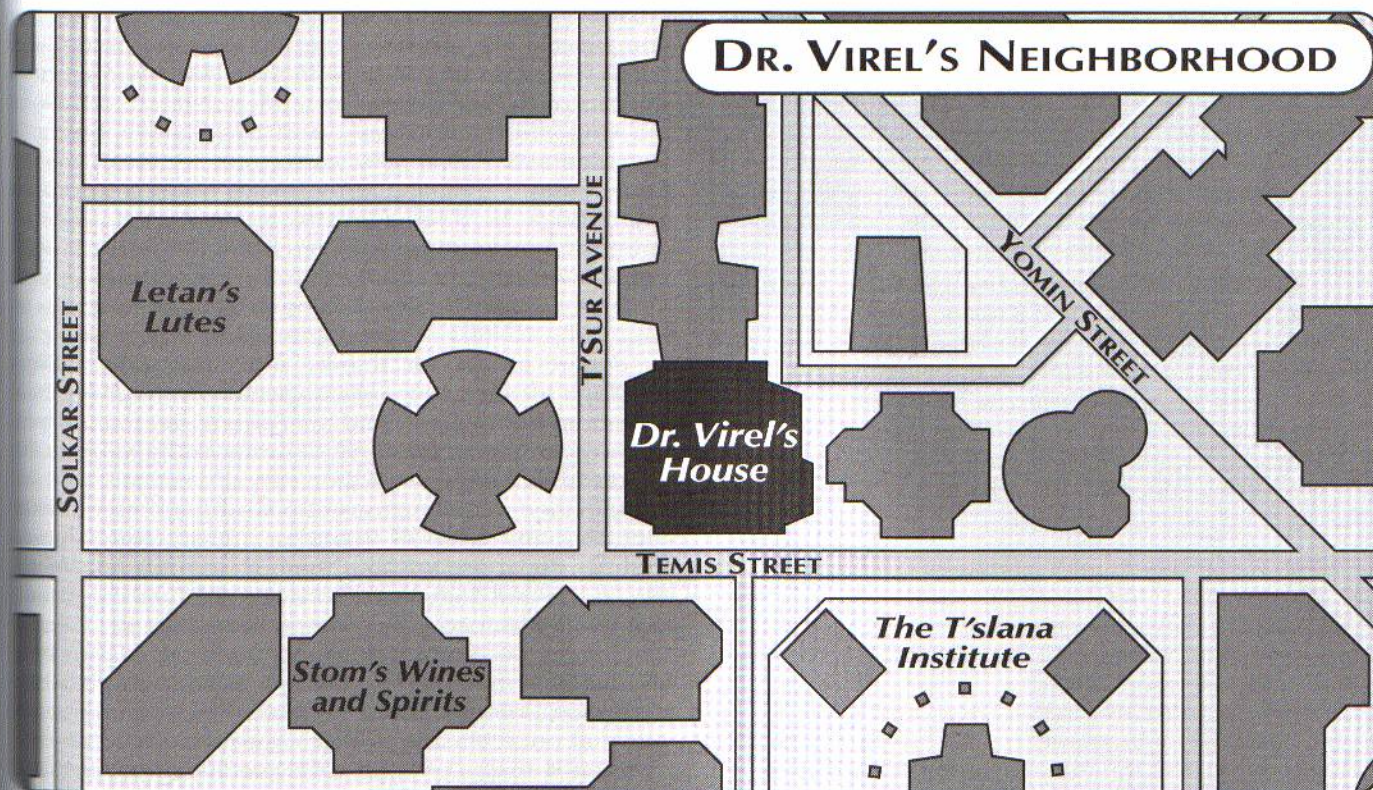

scan the area around Dr. Virel's house and watch for the pursuer's arrival. They easily detect the approach of Silak, Ensign McHugh, and the Crew. They also detect the tell-tale readings from the Crew's weapons. With a successful Routine (4) Tricorder Test, the Crew can likewise learn about T'Lau's confederates. A total of eight people can be found in and around the house, but none of them appear armed.

Four students equipped with tricorders and armed with *ahn-woon* attempt to keep the Crew at bay while the others make good their escape. The Vulcan students use the darkness and their familiarity with the neighborhood to their advantage. The Narrator should make Routine (5) Hide Skill Tests for the four and record the results. These become the difficulty numbers for the Crew to spot the students.

Just prior to the students' attack, have each Player make an Intellect Test (using the Perception Edge). On a successful roll, the Crew member notices one or more of the attackers. If the Crew member fails, he does not see his attacker in time and is surprised. As the students attack, their leader shouts out that they do not want to hurt the Crew, but their work is vital, and they must defend it. The students don't fight to kill, merely to detain the Crew. Once the Crew and Silak deal with the young toughs outside, they can easily gain entrance to the house using Silak's electronic lockpick.

Should the Vulcan attackers succeed in defeating the Crew, they use their *ahn-woon* to tie up the PC's. One of the students runs into Dr. Virel's house and informs him of this turn of events. Virel has no plans to hold Starfleet hostages, but rather takes this oppor-

tunity to make good his escape. He uplinks his home computer to the central computer at the Vulcan Science Academy and uses the Academy's transporter to beam to a secret location. Two hours later, a late-night passerby spots the Crew tied up in an alley and frees them; by the time they enter Dr. Virel's house, Virel and his group are long gone.

Meanwhile, Dr. Virel beams to the Vaakis Monastery in the mountains near ShirKahr, home to an old friend, Master Sital. Master Sital is one of a few religious leaders who know of Ambassador Spock's cultural exchange program and agree with it. When Virel and his students appear at the monastery gates, seeking sanctuary, Sital readily agrees. This is where the Crew later finds Virel and his students (See "At the Monastery").

## A SURPRISE RAID

If T'Lau (or Pirek) remains ignorant that the Crew pursues her, she does not warn Dr. Virel and the others. She simply leads the Crew right to Virel's door. The other members of the reunification cell have no idea that there is any trouble, do not scan the area, and do not lay a trap. As soon Dr. Virel opens the door to let T'Lau, or Pirek in, Silak and the Crew can swing into action.

Dr. Virel's house resembles a Mediterranean villa on Earth. It is built of *bureki* stone, with the outer wall of the house bounding the street, and has a flat-topped roof. A simple sliding metal door opens directly onto the street. Each room in the house opens onto a small central courtyard where the garden is

## TROUBLESHOOTING

Perceptive players may put all the clues in this scene together to realize something is not right. Silak's emotional display, his factual error on Vulcan law, and T'Lau's denial could lead a player to conclude correctly that it is Silak who is the Romulan agent in this story. While some may proceed cautiously, waiting for a later time to confront Silak, others might simply arrest him.

Recall that the only weapons the Crew carry are the stunners given them by Silak. These have a security feature installed by Silak, and deactivate at the press of a button. As soon as he suspects he's in danger, Silak reaches into his pocket and deactivates the stunners, leaving the Crew unarmed. Silak, however, remains armed with a Type I phaser. If things continue to go against Silak, he sends an emergency signal to *V'Shar* headquarters using his communicator badge, and they beam him out to safety.

located. This provides a pleasing scene for meditation, as well as cools the house in the hot Vulcan sun. Characteristic of Vulcan homes, the rooms are spartan and oddly geometric, with varying floor levels separating areas of each room.

Inside, in the living room, the Crew finds T'Lau, Pirek, and six other members of their group seated peacefully. All the inhabitants appear to be of student age. T'Lau and the other Vulcan students have been preparing for their trip to Romulus, while Pirek has been living with Dr. Virel as he studies Vulcan culture. Dr. Virel is in his office, busily erasing his personal computer. When he emerges from his office, he asks, "By what right do you barge into my home?" Silak produces his *V'Shar* identification, and cites Section 247.2 of the Vulcan Security Code. Vulcan PC's who make a Moderate (8) Culture (Vulcan) Skill Test know Section 247.3 allows *V'Shar* agents to enter a home in defense of Vulcan security. Non-Vulcans must make a Challenging (9) Culture Test, due to the obscurity of this fact.

The conspirators surrender peacefully. Although he tries hard to hide it, Silak is overjoyed at his success. Crew members standing close to Silak during this scene should make a Moderate (7) Intellect Test, including the Perception Edge, to notice Silak's emotional display. While they may find his emotional display odd, they may chalk this up to Silak letting his mask slip a bit; Vulcans have been known to display emotions at extreme moments. Similarly, while peaceful surrender is a perfectly normal response for a group of Vulcans, it is atypical behavior for a group of Romulan agents and their allies; perceptive players may pick up on this, adding a further clue that all is not as it appears.

Meanwhile, Ensign McHugh recognizes T'Lau from the café and proceeds to gloat over her. She tells T'Lau that she made a mistake in speaking Romulan, and that the *Tal Shiar* should have done a better job of training her. T'Lau raises a single eyebrow as an expression of confusion. She begins to process this information. If McHugh thinks she's a Romulan spy,

T'Lau reasons, then the others must think she and her compatriots are spies as well. For the time being, she keeps her reasoning to herself, though Crew members might notice her confusion and pursue this line of thinking with her. If asked, T'Lau denies being a Romulan agent. Similarly, as soon as McHugh makes her accusation, Pirek angrily rejects being a Romulan spy, though he does admit to being Romulan. Silak counters by pointing out that Romulan spies would not acknowledge it simply because they were caught.

Silak contacts *V'Shar* headquarters and arranges to have his prisoners beamed to holding cells. Preparing to depart alone, he thanks the Crew and Ensign McHugh for their aid and congratulates them on their service to both Vulcan and the Federation. He promises to recommend them for commendations when he makes his report. Even if the Crew did not talk to the captain and receive instructions about immediately reporting any proof of Romulan activity, they should find his departure without them a bit unusual. While any suspected Vulcan traitors should first be turned over to the Vulcan government, several of the people here may be Romulan agents and, as such, they should be turned over to Starfleet as soon as possible. If anyone points this out to Silak, he promises to do just that once his initial interrogation is completed.

Should they continue to argue jurisdiction, Silak casually reaches into his pocket and activates his comm jammer (see page 69) to prevent the Crew from contacting their ship, either for reinforcement or to beam his prisoners away. He explains that they are now prisoners of the Vulcan government, and he will not allow them to be taken elsewhere; they can file a protest if they so desire. Under no circumstances will Silak allow the Crew to come with him, even going so far as to stun them. With that, he arranges his prisoners dematerialize from the house, leaving the Crew alone.

## POST MORTEM

Before the Crew can continue with their show, leave, each should file a report. The Narrator can prompt them to do so by having their captain ask for a report if they had already approached him about uncovering a potential Romulan agent. The Crew might think of this on their own. Depending on how the previous scene played out, there are a variety of options for the Narrator to follow:

- If Silak successfully left with his prisoners: Fifteen hours after recording their logs, the Crew's captain calls them to his ready room on board their starship. Once they're assembled, the captain asks them to repeat the events of the previous day. After they finish retelling their story, the captain reveals several startling facts: The *V'Shar* report no prisoners being logged in the night before, Agent Silak never filed a report about Romulan spies on Vulcan, the transport operator manning the *V'Shar's* transporter was found stunned, and the *V'Shar* do not know Silak's current whereabouts.

Meanwhile, the local Vulcan news service reports the sudden disappearance of Dr. Virel, a professor at the Vulcan Science Academy. Dr. Virel missed his first class of the day, which is uncharacteristic for him. Colleagues say he made no mention of leaving on any trip. Agents of the *V'Shar* searched his home and found it empty. As crime is virtually unknown on Vulcan, the story receives a great deal of attention. The Crew might see one of these reports while they sightsee around ShirKahr.

Something very wrong has occurred, and the Crew is involved. Ensign McHugh is particularly upset about being duped.

- If the Crew confronted Silak: Alternatively, the Crew could suspect something very wrong has occurred. T'Pol's obvious confusion, Silak's uncharacteristic display of emotion, his misquoting of Vulcan civil law, and his sudden brush-off may tip the Crew off; players can be surprisingly intuitive, and they may put the pieces of the puzzle together quickly. In an extreme case, Silak might have resorted to deactivating the Crew's stunners and activating his comm-jammer (but not attacking the PC's outright), similarly alerting the Crew that Silak is not who he claims to be. After making their report, the captain reveals the information in the paragraph above.

- If the Crew scuffles with Silak: During the last scene, Silak may have resorted to stunning one or more Crew members (see the previous "Troubleshooting" box). At the very least, he escapes the confrontation via the *V'Shar's* transporter. Afterward, the Crew can get the real story by talking with Dr. Virel and his compatriots—that they participate in a secret program to bring Vulcan logic and culture to members of the Romulan Reunification Movement. They are not Romulan spies. Armed with this information, the Crew should suspect Silak of being a Romulan double agent, and be eager to find and capture him.

- If Virel and his group escape: Finally, if the four Vulcan students managed to capture the Crew, then the Crew must report the successful escape of the alleged Romulan spy cell. The captain, and the Vulcan government, wants the Crew to find out where they escaped to, using all the resources at their disposal (see "Setting Things Right", below).

## SETTING THINGS RIGHT

Silak planned his end game carefully. As a double agent in the *V'Shar*, he has access to their resources. Using their transporter, he beams his prisoners to *V'Shar* headquarters. Upon materializing in the transporter chamber, he stuns the transporter operator, resets the coordinates, and beams Dr. Virel and the others to a prearranged location—an abandoned building on the edge of ShirKahr.

The Crew should feel obligated to set things right, perhaps volunteering to work with the *V'Shar*, or on behalf of Starfleet. This entails finding Silak and the prisoners. The Crew can track Silak down in one of two ways.

### V'SHAR AGENTS

#### Attributes

Fitness 2

Strength +1

Vitality +1

Coordination 2

Intellect 2

Logic +1

Presence 2

Empathy -1

Psi 1

Range -1

#### Skills

Athletics (Lifting) 1 (2), Behavior Modification (Resistance) 1 (2), Computer (Data Alteration) 2 (3), Culture (Vulcan) 2 (3), Dodge 2, Energy Weapon (Phaser) 2 (3), Espionage (Surveillance) 3 (4), History (Vulcan) 1 (2), Language (Federation Standard) 1, Language (Vulcan) 3, Law (Vulcan) 2 (3), Mind Meld 2, Personal Equipment (Tricorder) 2 (3), Planetside Survival (Desert) 1 (2), Search 1, Strategic Operations (Vulcan Defense) 1 (2), Unarmed Combat (Nerve Pinch) 2 (4), Vehicle Operations (Hovercar) 1 (2), World Knowledge (Vulcan) 2 (3)

#### Traits

Curious +1

Code of Honor (Vulcan) -3

Hides Emotions -2

Resistance: 3

Wound Levels: 3/3/3/3/3/0

First, the Crew could attempt to convince the *V'Shar* to allow them access to *V'Shar* computers. Depending on the Narrator, the *V'Shar* could either accede to the Crew's request—giving them a chance to set things right—or reject it—believing the Crew has already done enough damage. Although this kind of interaction is best roleplayed, the Crew might be allowed to make an Opposed Persuasion Test against the *V'Shar* official's Intellect 5. Crew members who make a logical argument receive an extra die for this test. Even though Silak set the *V'Shar's* transporter to reset its coordinates after he beamed out, the transporter keeps a log of all incoming and outgoing transmissions; he did not have time to alter these logs. The Crew can easily locate his destination coordinates by checking the computer's logs. This is a Routine (5) Computer (Research) Skill Test.

Second, lacking access to the *V'Shar's* records, the Crew can use their ship's sensor logs to perform virtually the same task. The sensors would have picked up all transporter use on the planet as a part of their routine operations. All the Crew has to do is isolate the transporter beam carrying Silak and his prisoners. By making a successful Moderate (7) Computer



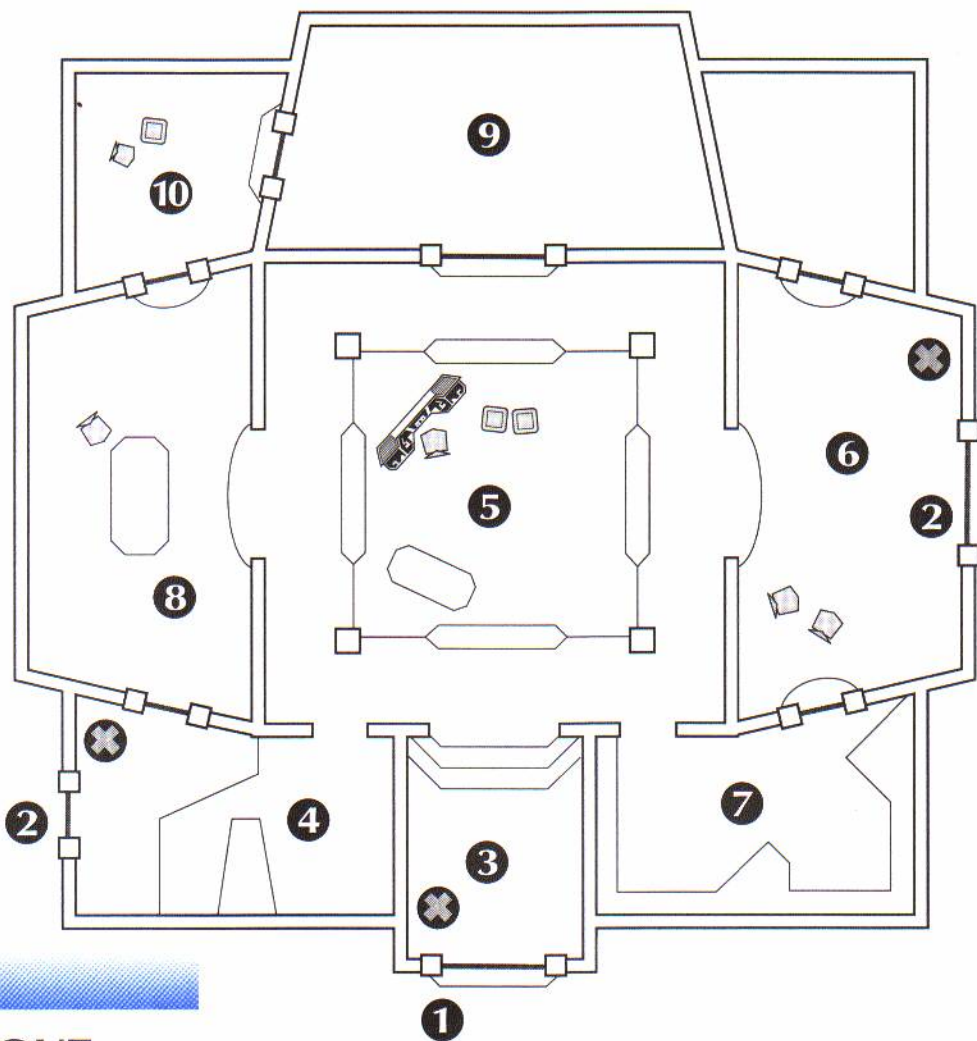

## SILAK'S HIDEOUT

1. MAIN ENTRANCE
2. SIDE ENTRANCES
3. FOYER
4. KITCHEN
5. LIVING ROOM
6. SITTING ROOM
7. LIBRARY
8. DINING ROOM
9. MAIN BEDROOM
10. SECOND BEDROOM

(Research) Skill Test, the Crew discovers that the sensors recorded a transporter beam from Dr. Virel's house to *V'Shar* headquarters, then another beam from *V'Shar* headquarters to a location on the edge of ShirKahr. The Crew can beam to these same coordinates.

If Virel and his group escaped, the Crew can use the same process to discover where he fled to. By making a Moderate (7) Computer (Research) Skill Test, the Crew finds a record of a transporter beam from Virel's house to the Vaakis Monastery in the Llangon Mountains. Silak still accompanies the group in this instance, still posing as a *V'Shar* agent.

Finally, if the Crew scuffled with Silak, thus forcing him to leave without his quarry, Silak considers his mission a failure and seeks to escape. He beams back to *V'Shar* headquarters (remember, if he gets into trouble at Virel's house, he transmits an emergency signal or beam out), stuns the transporter operator, and beams to his hideout on the outskirts of the city. As above, the Crew can either discover Silak's whereabouts by consulting the *V'Shar's* computer records, or by reviewing the ship's sensor logs for transporter traffic.

No matter how the Crew locate Silak (with or without his prisoners), if they contact the *V'Shar* with Silak's location, the *V'Shar* offer to send at least two agents to accompany the Crew. Contacting the *V'Shar* is only polite, considering that Vulcan is their jurisdiction. At the episode's resolution, the *V'Shar* might be none too happy about being left out of Silak's apprehension. On the other hand, the Narrator might not want to make the finale too easy by including more manpower.

## THE FINALE

### SILAK'S HIDEOUT

Regardless of how the Crew finds Silak, the final scene in the episode unfolds the same way. Silak is holed up in an abandoned building on the edge of the city. Six armed *Tal Shiar* agents who work with Silak are waiting for him when he arrives. (The Narrator can add additional agents to make the final battle more difficult.) Using a short-burst neutrino transmitter, Silak contacts the nearest warbird and arranges to be picked up. He (and his prisoners, if he has them) awaits the warbird's arrival, due in 24 hours. Depending on how events unfold, the Crew may be accompanied by at least two *V'Shar* agents, or by a security detail from their own ship.

The building Silak uses was once the villa of a Vulcan merchant. Silak acquired the building years ago, posing as a merchant himself and using a false name on the deed. Since then, Silak occasionally meets with *Tal Shiar* operatives here and uses the villa to store any incriminating evidence (such as *Tal Shiar* equipment, his communications array, and a portable computer). A ring of stone monoliths, similar to those

### TAL SHIAR AGENTS

#### Attributes

Fitness 2

Strength +1

Coordination 2

Intellect 2

Perception +1

Presence 3

Empathy -1

Psi 0

#### Skills

Culture (Romulan) 1 (2), Culture (Vulcan) 1 (2), Disguise (Vulcan) 2 (3), Dodge 2, Energy Weapon (Disruptor) 2 (3), Language (Romulan) 2, Language (Vulcan) 2, Security (Security Systems) 2 (3), Unarmed Combat (Romulan Navy Martial Arts) 1 (2), World Knowledge (Romulus) 2 (3), World Knowledge (Vulcan) 1 (3)

#### Traits

Arrogant -1

Resistance: 2

Wound Levels: 2/2/2/2/2/0

found at Earth's Stonehenge and common to many Vulcan structures, surrounds the villa. The villa itself is a square, blocky building with a flat roof that extends beyond the walls to provide shade. When the Crew arrives, all appears quiet and deserted.

A *Tal Shiar* agent stands guard near each of the three doors providing entrance to the building (the front door, the kitchen door, and a door to the living room—marked with an X on the map). The guards keep out of sight, a few feet from the door, inside the building. The doors themselves are locked, requiring a successful Moderate (7) Personal Equipment (Tricorder) Skill Test or a magnetic door key to open. Silak has equipped each doorway with a portable forcefield generator, which activates as soon as the door slides open.

To get past this and confront Silak, the Crew must find some way through the forcefield. This can be accomplished either with field modulators (see *The Price of Freedom*, page 98) or with concentrated phaser fire. The forcefield can withstand up to 80 points of damage before collapsing. Meanwhile, the Romulan guard on the other side alerts the others in the building, and they hurry to repel any invasion.

The interior consists of nine rooms—a foyer, a sitting room, a library, a large living room, a kitchen, a dining room, and three bedrooms.

In the largest of the bedrooms, Silak keeps his prisoners tied up and gagged. The room is bare, with not even a cot for the prisoners to sit on. One of the *Tal Shiar* agents stands guard here, armed with a Romulan disruptor. The room's windows have been

## MONASTERY GROUNDS

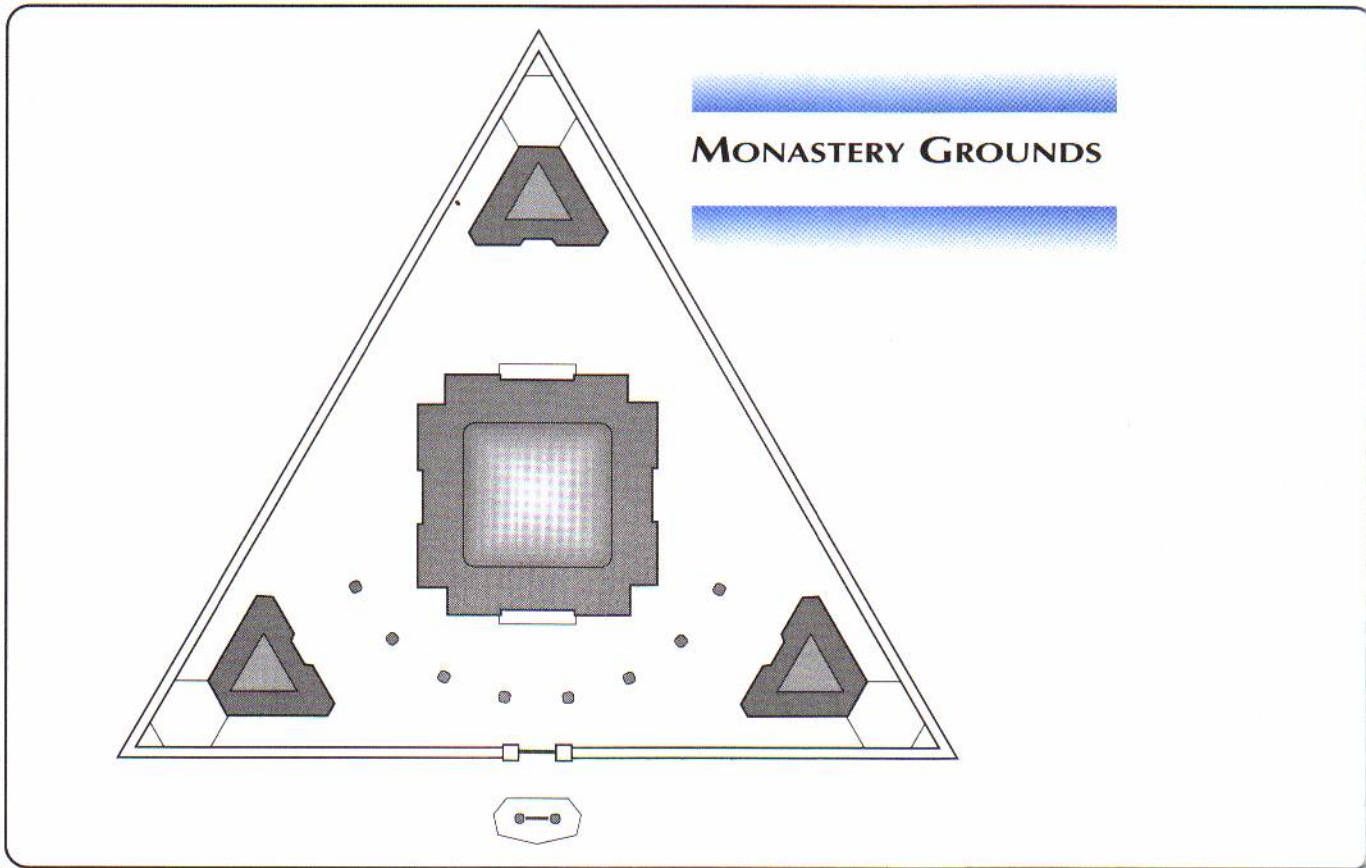

sealed with a metal blast shield to keep out the elements. If Silak escaped Dr. Virel's house without his prisoners, then this room is empty.

It is standard *Tal Shiar* policy is to use a combination of sophisticated drugs and lie-detection equipment to interrogate the most important captives shortly after they have been captured. Having interrogated Dr. Virel, Silak and two of the Romulans interrogate T'Lau in this manner when the Crew arrives, in the second-largest bedroom. T'Lau sits, bound, on a simple metal stool. A medical kit containing Silak's interrogation drugs rests on a duranium box. While Silak interrogates T'Lau, the last two *Tal Shiar* agents assist. Again, if Silak left Virel's house empty-handed, this room is empty.

Silak converted the living room into a small command center. It is here that he keeps his transmitter and PADD's. The PADD's, of Romulan design, use a fractal encoding sequence to protect their information. Cracking this code is a Moderate (8) Extended Test requiring a Test Result of 45, with a turn length of ten minutes. Once hacked, the PADD reveals much of Silak's operation (though not other *Tal Shiar* operations on Vulcan). If Virel and his students managed to escape capture by Silak, then Silak can be found here, waiting for the warbird to extract him from Vulcan.

Once the Crew penetrates the forcefield, the *Tal Shiar* agents are waiting for them in the room beyond. They snipe from behind the doorframe, which counts as full cover when they are not shooting, three-quar-

ter cover when they are. Their disruptors are set for heavy stun. During the firefight, Silak remains with the prisoners.

Should the Romulans emerge victorious from the fight, they take the Crew hostage and await the arrival of their warbird. Silak explains how he duped the Crew into helping him find Virel and his misguided students. The Empire, he explains, could not sit idly by while Ambassador Spock and his band of rabble-rousers contaminated Romulan society with Vulcan ideology. Then he ignores the Crew for the rest of the time.

Clever Crew could devise some way to escape, but this option is beyond the purview of this episode. Narrators should use their judgment in this situation. When the warbird arrives, it quickly decloaks over Vulcan, beams up Silak, the *Tal Shiar* agents, and Virel and his students, and recloaks. (The Crew's starship could attempt to stop the warbird, but this is again beyond the scope of the episode; Narrators should roleplay this eventuality if they see fit.) Silak leaves the Crew behind.

If the Crew defeat the Romulans, they find Silak waiting for them with the prisoners. As before, Silak explains his motivation for the episode. The Crew can apprehend Silak and turn him over to Federation or Vulcan officials, and free Dr. Virel and the others. Pirek and T'Lau thank the Crew for saving them from becoming prisoners of the Romulan Star Empire. Alternatively, after he derides the Crew for being easy

dupes, Silak suddenly collapses and dies, having taken a slow-acting poison when it became clear the Romulans would lose.

## AT THE MONASTERY

Should Dr. Virel and his group escape from his house in ShirKahr, the Crew has no reason to suspect Silak. Using the ship's sensors, described previously, the Crew and Silak can locate Dr. Virel at the monastery. The Vaakis Monastery rests on a high bluff in the Llangon Mountains, approximately fifty kilometers from the city.

The *Hakih*r adepts who live there belong to sect of Vulcans who seek to enhance and improve the unity of mind and body. Scans from orbit detect nothing unusual about the area. The Crew, along with Silak, can beam down to the monastery gates, as it is considered rude to intrude on the sanctity of the monks directly.

Prior to beaming down, Silak asks to send a message to the *V'Shar*, to arrange for additional reinforcements. Given permission, he instead secretly contacts his *Tal Shiar* compatriots on the planet below and arranges for them to meet at the monastery. Silak plans to take Dr. Virel, T'Lau, Pirek, and the others by force, if necessary. The Crew would have no reason to suspect Silak's short message. The Crew may or may not elect to bring reinforcements of their own, such as a security team; if one of the Crew suggests it, their captain agrees with the idea.

The group materializes at the gates of the monastery, which consists of a low, open, triangular courtyard with a building in each corner and a large square building in the center. A few minutes later, another group materializes nearby—six Vulcanoids dressed in typical Vulcan street clothes, whom Silak introduces as fellow *V'Shar* agents. Outside the gate hangs a traditional octagonal gong, which the Crew must ring to gain entrance. Ten minutes after the gong sounds, the ancient wooden gates of the monastery swing open to reveal a single, wizened monk dressed in traditional Vulcan garb.

The monk, who introduces himself as Sital, politely asks the assembled group why they have come to the monastery. Silak takes charge, identifying himself as an agent of the *V'Shar* and claiming the monks harbor suspected Romulan spies. Sital raises an eyebrow at this information, but otherwise remains enigmatic. Master Sital stands impassively for a few minutes, seemingly lost in himself. He then invites the assembled group into the monastery, the gates shutting behind them as they enter.

Unknown to the Crew and to Silak, Master Sital is a master of the Vulcan disciplines of *Vhoshanta*, the ability to read a person's body language to determine his emotional state, and *Vhoslan*, which allows an adept to determine a person's character and motivations from his body language. These abilities are nontelepathic in nature, and are detailed in full in *The Way of Kolinahr: The Vulcans*. Sital used both these abilities on Silak at the entrance. He knows Silak feels

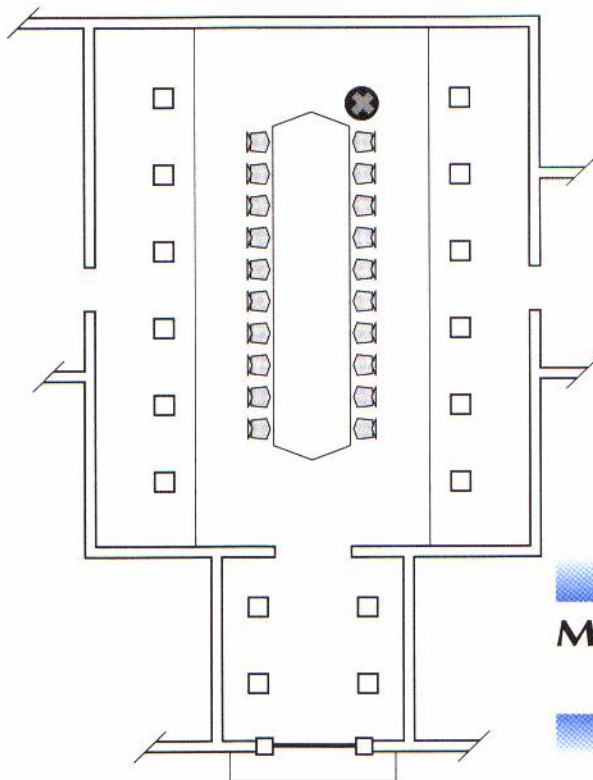

**MONASTERY DINING  
CHAMBER**

## MASTER SITAL

Reclusive and enigmatic, few people on Vulcan can say they know Master Sital well. Even T'Lar, foremost religious leader on the planet, has only met him once. He prefers the seclusion of his monastery, where he can contemplate Vulcan metaphysical conundrums. He rarely leaves, and does so only to pursue his interests. Luckily for Dr. Virel, one of those interests included four-dimensional physics, and the two men met at a scientific conference many years ago. The two have since developed a close friendship.

### Attributes

Fitness 4

Strength +1

Vitality +1

Coordination 3

Reaction +2

Intellect 3

Logic +2

Presence 2

Empathy -1

Willpower +1

Psi 4

Range -1

### Skills

Artistic Expression (Vulcan Lute) 1 (4)

Culture (Vulcan) 2 (4)

Dodge 3

History (Vulcan) 1 (3)

Language

Federation Standard 1

Vulcan 3

Law (Vulcan Law) 1 (2)

Mind Meld 4

Planetside Survival (Desert) 3 (4)

Primitive Weaponry (*Trillpa*) 4 (5)

Space Science (Astrophysics) 2 (3)

Unarmed Combat (Nerve Pinch) 2 (3)

(*Ponn-ifla*) (5)

*Vhoshanta* 4

*Vhoslan* 4

World Knowledge (Vulcan) 1 (3)

### Traits

Curious +1, Eidetic Memory +3, High Pain Threshold +2,

*Kolinahr* +4, Toughness +2

Code of Honor (Vulcan) -3, Hides Emotions -2, Pacifism -1

**Renown:** 50

*Aggression:* -11 *Discipline:* 14 *Initiative:* 0 *Openness:* 10 *Skill:* 15

**Resistance:** 5

**Wound Levels:** 6/6/6/6/6/0

anxious, wants Dr. Virel and his companions very badly, and is a duplicitous individual. Moreover, he can tell—by many minute, tell-tale signs—that Silak is Romulan!

Master Sital asks the group to wait in the courtyard for a moment, while he locates Dr. Virel, then disappears into one of the monastery's buildings. Sital alerts the other adepts at the monastery. He arranges for several of them to be nearby should the situation call for it; several adepts can thus be on hand should the Narrator need them for the final conflict, as they seemingly unobtrusively go about their business in the hallway and dining room.

Sital takes the group to a communal dining room, where the monks take their meals together. This room is austere: a long, wooden table—a treasure on water-starved Vulcan!—precisely in the center of the room, the chairs arranged with precision, Vulcan mandalas hanging on the walls at regular intervals. Virel and his four (or eight) students gather at the far end of the room (marked with an X on the map), discussing something when the group enters. They stop suddenly. As soon as the group occupies the room, Master Sital addresses Dr. Virel, saying, "Doctor, these outworlders are here to see you. Can you tell me, what have you done that could interest the Romulan Empire?"

The Narrator should give the players a moment for this revelation to sink in. Silak tries to maintain his composure and does not react, though the other Romulans have less success (a Routine (4) Intellect Test with the Perception Edge to catch their reactions). Virel and the students allow their masks to slip, registering shock for a brief moment. If anyone asks, Master Sital explains his reasoning (Ensign McHugh makes a perfect candidate for this, if none of the PC's ask questions): Although Silak has been carefully trained to hide his emotions, he still betrays himself in subtle ways—small, reflexive movements around the eyes and mouth. A slight quavering in his voice when Silak identified himself gave away the lie. His demeanor demonstrates his anxiety, substantiating his deceit. Finally, Silak's body language gives away his innate aggression—a characteristically Romulan trait.

How this scene is resolved depends on both the Narrator and the players.

This bombshell touches off a flurry of activity. Pirek jumps out of his seat and angrily denounces Silak and the Romulan Empire. Ensign McHugh becomes enraged at being a pawn of Romulan spies, draws her weapon, and attacks. (As a nice touch, to demonstrate the danger the Crew is in, one of the *Tal Shiar* agents could vaporize her.) Silak, his cover blown, goes for broke and drops his pretense. He draws his phaser. The other *Tal Shiar* agents follow his lead, producing disruptors hidden under coats and waistbands.

The Crew could react either by drawing their own weapons or by attempting to defuse the situation (see below). If a fight breaks out, remember several *Hakihar* adepts loiter near the dining room and can easily appear to resolve the conflict with fisticuffs; each

**VULCAN ADEPTS****Attributes**

Fitness 2  
 Strength +1  
 Coordination 2  
 Dexterity +2  
 Intellect 2  
 Logic +1  
 Presence 2  
 Empathy -1  
 Psi 2  
 Range -1

**Skills**

Dodge 2, Mind Meld 2, Primitive Weaponry (*Lirpa*) 2 (3), *Rha-tel* ["Control Body"] 3, Unarmed Combat (Nerve Pinch) 2 (3), Unarmed Combat (*Ponn-ifla*) 2 (3), *Vhoshanta* ["Body Reading"] 3

**Traits**

Curious +1  
 Code of Honor (Vulcan) -3  
 Hides Emotions -2

**Resistance:2**

**Wound Levels:** 2/2/2/2/2/0

knows *ponn-ifla*, the Vulcan martial art of resolving conflict with a minimum of force.

Before a fight breaks out, the Narrator should have Silak explain everything surrounding the episode—his motivation, the true nature of his mission, and how he deceived the Crew—in classic television and movie form, to fill in the Crew.

On the other hand, the Narrator might decide that Silak and his accomplices, outnumbered, simply surrender. This is less likely, given the Romulan propensity to kill oneself rather than be taken prisoner. The Crew might try convincing them of the futility of making a final stand, in an attempt to resolve the conflict peacefully.

Again, Silak is unlikely to take this option, though this should depend on how persuasive the players' arguments are (Narrator's discretion). If the Narrator decides that the Romulans opt to shoot their way out of the situation, they attempt to take hostages and leave.

**EPILOGUE**

How the episode ends depends on the actions taken by the player characters. They either find themselves raiding Silak's villa to rescue Dr. Virel and his students, or suddenly surprised by Silak's true nature at the *Hakihr* monastery. Thus, it is difficult to describe the events following the episode's resolution.

Dr. Virel and his students might explain their secret cultural exchange program. T' Lau could explain the nature of her mistake at the café. Ensign McHugh may do some soul-searching, bemoaning her own zealous behavior (if she survives the episode). Each of the supporting cast characters could answer any lingering questions the PC's have. At the very least, a representative of the *V'Shar* thanks the Crew for their actions in apprehending a Romulan agent, and their captain recommends them for a commendation.

**SUGGESTED REWARDS**

The goal of this episode is the apprehension of the real Romulan spy—Silak—for which the Crew should each receive 1 Experience Point and 3-4 Skill Renown.

If the Crew resolve the situation nonviolently, give each player 1 Experience Point.

**NEW TECHNOLOGY****COMM JAMMER**

This device can jam all signals going to and from ordinary personal communicators like Starfleet com-badges. When the comm jammer is activated, no communicator within a radius of 5-20 meters (the radius is variable) can send or receive any signals. The transceivers in PADD's and tricorders are also blocked by this device.

**Size:** 8 cm x 5 cm x 1 cm box

**Mass:** 0.1 kg

**Duration:** 100 hours

**STUN GRENADE SETTINGS**

Power Setting	Effect	Charges
Setting 1	Light Stun	1
Setting 2	Medium Stun	2
Setting 3	Heavy Stun [1]	3
Range Setting	Radius of Effect	Charges
Low	3 Meters	x1
Medium	5 meters	x2
High	7 meters	x4

**STUN GRENADE**

A reusable variation of the more powerful photon grenade, a stun grenade can be set to produce light, medium, and heavy stun effects throughout a large area. In addition to its several variable power set-

tings, stun grenades also have three different range settings.

On the lowest setting they stun everyone within 3 meters of the grenade, the next setting covers a radius of 5 meters from the grenade, and the highest setting stuns everyone within 7 meters of the grenade.

These grenades also have a timer which can be set so that the grenade goes off any time from immediately after the activation stud is pushed to 9.99 hours later. Stun grenades are reusable. However, for safety considerations, to activate or deactivate the grenades the user's bio-electric signature must be stored in the devices memory.

**Size:** A sphere 8 cm in diameter

**Mass:** 0.2 kg each

**Duration:** 100 charges

### PERSONAL FORCE SHIELD

This is an experimental device created by the *Tal Shiar* to provide some protection to their agents in the field. Personal force shields form an egg-shaped force field around the user. On the normal setting this field protects the user from both kinetic or energy-based attacks, including bullets, falling debris, and phaser fire. This device protects the user completely from all attacks which cause 25 points of damage or less.

However, once the field absorbs a total of 25 points of damage, the device overloads, and the field instantly collapses. The field will reduce the damage from the attack which knocks it down by 25 points, but will provide no further protection against additional attacks. A personal force shield allows the user to move at up to a rapid walk while it is operating. When the force field is up the user cannot touch or manipulate anything outside of it, however,

**Size:** 10 cm x 8 cm x 5 cm box, usually worn on a belt

**Mass:** 0.5 kg

**Duration:** 10 hours



# The Cradle Will Fall

The planet Aldea was shielded from the galaxy's notice for generations by an advanced cloaking device which concealed it. The founders of Aldean society, the Progenitors, wished to preserve their world and culture from outside interference. The planet became a legendary lost paradise where advanced technology took care of the people's needs, allowing them to pursue artistic and scholarly work.

Aldean civilization thrived far from galactic conflicts between the Federation, Klingons, Cardassians, and Romulans. They knew no war or political discord, preferring to pursue their arts and studies in small enclaves in the beautiful Aldean landscapes and climate-controlled weather. The Progenitors' supercomputer, the Custodian, provided for their every need.

Aldea paid a price for its isolation. Unknown to a society without doctors and scientists, their cloaking field slowly eroded the planet's ozone layer. The entire population became sterile. No more children were born on Aldea. The Aldeans learned the cause of their problem only after they contacted a Federation starship, the *U.S.S. Enterprise-D*.

The Federation quickly stepped in to help. They dismantled the Aldean cloaking device and sent terraforming teams to help the planet recover its ozone layer. Scientists came to study the Aldean sterility problem. Without outside help, Aldean civilization would have died out. Now they face another great challenge. Outside assistance brings with it obligations to others in the galaxy, and a responsibility for the spread of their advanced technology.

## BACKGROUND

The time has come for Aldea to choose its place in the galaxy. The Aldeans are an intelligent and dedicated people, and they have made great strides toward reshaping their civilization in the past seven years. Radue, the First Appointee of Aldea, has announced that in six months Aldea will host a diplomatic conference at which time it will announce its intentions toward the rest of Alpha Quadrant.

The Federation has expected Aldea would ask for and receive admission to the Federation, but now it is beginning to worry that this might not be the case. Different political factions have arisen on Aldea in recent years; some want nothing to do with the Federation. Even worse, some would gladly ally with the Romulan Star Empire instead.

The Federation supplied a great deal of medical and technical assistance to the Aldeans and has maintained constant diplomatic relations. In spite of these efforts support for Federation membership among the populace continues to erode. The Federation science team working with the Aldeans is scheduled to depart Aldea in just a few weeks. With the scientists gone, the Federation loses a valuable





source of information on the Aldean political situation. Who knows what will happen in the six months between now and the announcement of intent?

Starfleet patrols near Aldea have noticed that starship traffic in the region has increased dramatically in the past five months. Although the number of vessels that have visited Aldea remains less than two dozen, this is extraordinary considering the average number of ships in previous years totaled only three (including Federation ships). Now the Aldeans are receiving visits from Ferengi, Cardassian, and privately registered commercial vessels. Starfleet assumes the Romulans have also visited the planet, although there is no proof of a Romulan presence on the planet.

The Crew's ship is one of those assigned to patrol near Aldea. The diplomatic situation is delicate. The Federation does not want to antagonize the Aldean population, so the Crew must walk a fine line between diplomacy and intelligence gathering while operating in this sector.

## SYNOPSIS

The Crew's ship responds to a distress signal from William M'benge, Federation diplomatic advisor to Aldea. When they arrive, they learn that members of

the Federation science team on the planet have been murdered. The Aldeans are deeply upset that such a violent tragedy has occurred on their world after generations of absolute peace.

Since the incident involves Federation personnel, Radue, the First Appointee of Aldea, invites the Crew to join in the investigation. The suspects include members of the major Aldean political factions, a Ferengi vessel in orbit, and representatives from two major business interests: CRD Enterprises and the Delgado-Harris Corporation. Radue gives the Crew access to the Custodian, the Aldean planetary computer system, to aid their investigation.

The Crew have only a matter of hours to uncover the truth before the Aldeans gather at an exposition to examine the evidence for themselves and pronounce judgment against those they believe responsible. It appears likely that the Aldeans will opt for isolation once again, robbing the galaxy of their valuable contributions and endangering their own society with extinction.

During their inquiry, the Crew discover evidence that points to Romulan involvement. They also discover that the CRD Enterprises vessel and her crew are Romulan agents, sent to Aldea to negotiate with the pro-Romulan faction and help discredit the others. However, it is not the Romulans who are responsible. In fact, the killer is the Custodian, Aldea's planetary computer system. Programmed to protect Aldean society, the Custodian is working to force the Aldeans back into isolation.

Events climax at the exposition meeting, where the Crew can reveal the truth and deal with the danger posed by the Custodian.

## THE STORY

The Federation has several science teams stationed on Aldea. One of these teams has been studying the planet's technology for the past several years. The Aldeans' kind and supportive nature allowed the scientists and the Aldeans to grow quite close. One member of the team, Dr. Carol Fletcher, even became engaged to an Aldean man named Carish.

The scientists lived and worked in a region of Aldea close to the Custodian's central processor. They had free run of the planet, but most of their work was done close to home since the Aldeans had constructed an extensive laboratory complex designed specifically to help understand the workings of Aldean technology. The team had little reason to leave this area.

The science team was scheduled to depart in a mere two weeks. They planned to spend their short remaining time making sure that the Aldean scientists were familiar with all of their discoveries; they also wanted to be sure the Aldeans were ready to take over the Technology Reclamation Program. It was a good time to say good-bye to friends and celebrate the completion of a job well done.



On the night of the murder First Appointee Radue had hosted a celebration for the departing scientists. The members of the science team attended with more than two dozen Aldean scientists and pro-Federation movement leaders, along with Federation advisor William M'benge. Notably absent was Dr. Fletcher, who insisted on working that evening. She was beginning to suspect that the Custodian was concealing things from the scientists.

When the reception broke up, the scientists returned to their quarters. The Custodian replicated a Romulan disruptor and used it to kill the scientists. Naturally, the Custodian's sensors showed nothing unusual in the room. The Aldeans discovered the murders shortly thereafter when Carish, Dr. Fletcher's fiancé, went to her quarters to look for her.

## THE SUPPORTING CAST

### RADUE, FIRST APPOINTEE OF ALDEA

Radue is the First Appointee of Aldea, elected to speak for his people. Radue is not the ruler of Aldea; he is merely an elected representative. He takes his duties very seriously, always keeping the best interests of Aldea at heart.

Radue is a reasonable man who is deeply shocked by the murders. He is strongly in favor of Aldea joining the Federation, although not at the expense of their culture. Radue does his best to cooperate with and assist the Crew in their investigations.

#### Attributes

Fitness 2  
 Vitality -1  
 Coordination 2  
 Intellect 3  
 Presence 3  
 Willpower +1  
 Psi 0

#### Skills

Administration (Aldean Government) 2 (4)  
 Artistic Expression (Sculpting) 2 (3)  
 Charm (Influence) 2 (3)  
 Computer (Research) 1 (2)  
 Culture (Aldean) 2 (3)  
 Diplomacy (Aldean Affairs) 3 (4)  
 History (Aldean) 1 (2)  
 Language  
   Aldean 3  
   Federation Standard 2  
 Law (Aldean) 2 (3)  
 Personal Equipment (Sculpting Laser) 1 (3)  
 Philosophy (Epistemology) 2 (3)  
 Persuasion (Oratory) 2 (3)  
 Physical Sciences (Mathematics) 1 (2)  
 World Knowledge (Aldea) 2 (3)

#### Advantages/Disadvantages

Medical Problem (Sterile) (-1)  
 Pacifism (Self-defense) (-3)  
 Rivals (Opposing Factions) (-1)

#### Courage: 3

#### Renown: 14

Aggression: -4 Discipline: 3 Initiative: 0

Openness: 3 Skill: 4

#### Resistance: 1

Wound Levels: 1/1/1/1/1/0

## CARISH, ALDEAN CITIZEN

Carish is a handsome Aldean man in his mid-30's. He is a well-known artist who works in metal and stone, and lives near the installation where the Federation science team lived. A little over a year ago, he became romantically involved with Dr. Carol Fletcher, and the two of them had planned to marry. Obviously, that can't happen now, and Carish has become rather despondent.

Carish hoped Carol would settle with him on Aldea and dreamed about the two of them having children, if the Federation found a solution to the Aldeans' sterility problem. He is a quiet, peaceful man, deeply hurt by his fiancée's death.

### **Attributes**

Fitness 3  
Vitality -1  
Coordination 2  
Dexterity +2  
Intellect 2  
Perception +1  
Presence 2  
Empathy +1  
Psi 0

### **Skills**

Artistic Expression (Sculpting) 1 (3)  
Charm (Influence) 2 (3)  
Computer (Research) 1 (2)  
Culture (Aldean) 1 (2)  
History (Aldean) 1 (2)  
Language  
Aldean 2  
Federation Standard 2  
Personal Equipment (Sculpting Tools) 1 (3)  
Planetary Sciences (Mineralogy) 1 (2)  
World Knowledge (Aldea) 1 (2)

### **Advantages/Disadvantages**

Medical Problem (Sterile) (-1)  
Pacifism (Total Nonviolence) (-5)

**Courage:** 1

**Renown:** 5

*Aggression:* 0 *Discipline:* 0 *Initiative:* 0  
*Openness:* 0 *Skill:* 5

**Resistance:** 2

**Wound Levels:** 2/2/2/2/2/0

## **TOOLAN, LEADER OF THE PRO-ROMULAN FACTION**

Toolan is one of Aldea's most noted and respected poets. He is a balding, middle-aged man with dark hair, a heavy-set figure, and a pleasant speaking voice. He is leader of a faction of Aldeans who believe they have more to gain from an alliance with the Romulan Empire than with the Federation.

Toolan has secretly been in contact with the Romulans for some time, and they have convinced him of their goodwill, most importantly of their desire not to disturb Aldea's existing culture. Toolan believes the Federation has disrupted Aldea's peaceful culture and blames them for the recent problems.

### **Attributes**

Fitness 2  
Vitality -1  
Coordination 2  
Intellect 3  
Logic +1  
Presence 3  
Psi 0

### **Skills**

Artistic Expression (Poetry) 2 (4)  
Charm (Influence) 2 (3)  
Computer (Programming) 1 (2)  
Culture (Aldean) 1 (3)  
History (Aldean) 1 (3)  
Language  
Aldean 4  
Federation Standard 1  
Romulan 1  
Oratory (Persuasion) 2 (3)  
Personal Equipment (Computer) 1 (2)  
World Knowledge (Aldea) 1 (3)

### **Advantages/Disadvantages**

Medical Problem (Sterile) (-1)

**Courage:** 1

**Renown:** 20

*Aggression:* 0 *Discipline:* 0 *Initiative:* 0  
*Openness:* -5 *Skill:* 15

**Resistance:** 1

**Wound Levels:** 1/1/1/1/1/0

## **WHELIN, LEADER OF THE HOME FRONT FACTION**

Whelin is an Aldean philosopher who supports the protection of Aldea's culture and interests above any other concerns. She believes that Aldea must remain neutral in galactic affairs and must be prepared to defend itself against any threats now that the cloaking shield is gone.

To this end, she has been secretly negotiating with Reynaldo Delgado and his corporation for ships in exchange for Aldean technology. Whelin is a handsome, older woman with a regal bearing and a sharp wit.

### **Attributes**

Fitness 2  
Vitality -1  
Coordination 2  
Intellect 3  
Logic +2  
Presence 3  
Psi 0

### **Skills**

Artistic Expression (Writing) 1 (3)  
Charm (Influence) 2 (3)  
Computer (Research) 1 (2)  
Culture (Aldean) 1 (4)  
History (Aldean) 1 (3)  
Language  
Aldean 3  
Personal Equipment (PADD) 1 (2)  
Philosophy (Ontology) 3 (4)  
World Knowledge (Aldea) 1 (3)

**Advantages/Disadvantages**

Argumentative (-1)  
 Medical Problem (Sterile) (-1)  
 Pacifism (Self-defense) (-3)

**Courage:** 3**Renown:** 21

Aggression: -3 Discipline: 0 Initiative: 0  
 Openness: -10 Skill: 8

**Resistance:** 1**Wound Levels:** 1/1/1/1/1/0**CONSUL WILLIAM M'BENGE, FEDERATION ADVISOR**

William M'benge, an officer in the Starfleet Diplomatic Corps and graduate of the Harvard School of Interplanetary Affairs, serves as the Federation advisor to Aldea. He reports to the Federation Council on the progress of UFP projects on the planet. He also advises Radue on the membership process, should the Aldeans choose to join the Federation; once monthly, he answers questions from the Aldean populace at a special exposition. M'benge oversees all Federation personnel on the planet and coordinates their activities. Should any disagreements between Federation citizens and Aldeans arise, Consul M'benge works to smooth them out.

Consul M'benge is from Earth's African continent. He has short, gray hair and a deep, pleasant voice. He cooperates with the Starfleet Crew, but his primary goal is maintaining good relations with the Aldeans, and he will remind the commanding officer of this if the Crew seem to be pushing the Aldeans too far.

**Attributes**

Fitness 2  
 Coordination 2  
 Intellect 3  
 Perception +1  
 Presence 3  
 Empathy +1  
 Psi 0

**Skills**

Administration (Bureaucratic Manipulation) 2 (3)  
 Charm (Influence) 2 (3)  
 Computer (Research) 1 (2)  
 Culture (Aldean) 1 (2)  
 (Earth) (3)  
 (Romulan) (2)  
 Diplomacy (Interstellar Affairs) 2 (3)  
 History (Aldean) 1 (2)  
 (Federation) (3)  
 Language  
 Aldean 1  
 Federation Standard 3  
 Law (Federation) 2 (3)  
 Personal Equipment (Communications) 1 (2)  
 Persuasion (Oratory) 2 (3)

Social Sciences (Sociology) 1 (3)  
 World Knowledge (Aldea) 1 (2)  
 (Earth) (3)

**Advantages/Disadvantages**

None

**Courage:** 4**Renown:** 22

Aggression: 0 Discipline: 4 Initiative: 5  
 Openness: 5 Skill: 8

**Resistance:** 2**Wound Levels:** 2/2/2/2/2/0**REYNALDO DELGADO, BUSINESSMAN**

Reynaldo Delgado is a fit, middle-aged man with narrow, aristocratic features, perfectly quaffed black hair, and expensive, tasteful clothes. He is a stockholder in the Delgado-Harris Corporation, a large family-run enterprise founded in the Federation close to a hundred and fifty years ago.

The Delgado-Harris family has considerable influence in the Federation. Several family members have served in the Federation government and as high-ranking officers in Starfleet. Delgado is on Aldea negotiating with Whelin for access to Aldean technology, in exchange for constructing a fleet of starships for the Aldeans.

**Attributes**

Fitness 2  
 Vitality +1  
 Coordination 2  
 Intellect 3  
 Presence 3  
 Psi 0

**Skills**

Bargain (Haggling) 2 (3)  
 Charm (Influence) 2 (3)  
 Computer (Research) 1 (2)  
 Culture (Federation) 1 (2)  
 Fast Talk 2  
 Gaming (Tongo) 1 (3)  
 History (Federation) 1 (2)  
 Intimidation (Bluster) 1 (3)  
 Language  
 Federation Standard 3  
 Law (Federation) 1 (2)  
 Merchant (Trade) 2 (3)  
 Personal Equipment (Communicator) 1 (2)  
 World Knowledge (Aldea) 1 (2)

**Advantages/Disadvantages**

Contacts (+3)  
 Favors Owed (+2)  
 Shrewd (+1)  
 Arrogant (-1)  
 Greedy (-1)

**Courage:** 3

**Renown:** 21

*Aggression:* 5 *Discipline:* 0 *Initiative:* 6

*Openness:* 0 *Skill:* 10

**Resistance:** 3

**Wound Levels:** 3/3/3/3/3/0

### REVOK, CORPORATE REPRESENTATIVE

Revok is a Vulcan representative of Callisto Research and Development Enterprises (CRD) who claims to be on Aldea negotiating a trade agreement. In truth, Revok is a Romulan spy named Kaleck.

The Romulans are very interested in acquiring access to Aldea's advanced technology. The power to cloak entire planets could be theirs, if only they can negotiate an agreement with the Aldeans. Of course, the Romulans know the Federation will oppose their efforts, so they have contacted the Aldeans in secret, using agents disguised as representatives of a Federation-based corporation (Revok and his crew).

The Romulans are just as surprised by the murder of the Federation scientists as everyone else. Not one to miss an opportunity, however, Commander Kaleck hopes to frame Radue for the killings, further eroding the Federation's support on Aldea. With Radue out of the way, it will be a simple matter for Toolan, the leader of the pro-Romulan faction, to sway support to his side.

In dealing with the Starfleet Crew, the Romulans play it cool and maintain their cover as representatives of a Federation corporation. If push comes to shove, Commander Kaleck is more than willing to use force to achieve his goals.

#### Attributes

Fitness 3

Coordination 3

Intellect 3

Presence 2

Willpower +2

Psi 0

#### Skills

Athletics (Climbing) 2 (3)

Computer (Data Alteration/Hacking) 2 (3)

Culture (Romulan) 2 (3)

(Vulcan) 3

Dodge 3

Energy Weapon (Disruptor) 2 (3)

(Phaser) 3

Espionage (Undercover Operations) 2 (4)

Fast Talk 3

History (Romulan) 1 (2)

Intimidation (Torture) 2 (3)

Language

Romulan 2

Vulcan 2

Law (Romulan) 2 (3)

Personal Equipment (Sensors) 2 (3)

Physical Sciences (Computer Science) 1 (3)

Security (Security Systems) 2 (3)

Shipboard Systems (Tactical) 1(2)

(Weapons Systems) 3

Unarmed Combat (*Ch'Vashrek*) 2 (3)

Vehicle Operations (Shuttlecraft) 2 (3)

World Knowledge (Aldea) 1(2)

(Romulus) 3

(Vulcan) 2

#### Advantages/Disadvantages

Security Clearance (+3)

Telepathic Resistance (+4)

Romulan Code of Honor (-3)

**Courage:** 4

**Renown:** 19

*Aggression:* 3 *Discipline:* 6 *Initiative:* 4

*Openness:* 0 *Skill:* 6

**Resistance:** 3

**Wound Levels:** 3/3/3/3/3/0

### DAIMON ULAN, FERENGI TRADER

The *D'kora*-class Ferengi vessel in orbit over Aldea is commanded by DaiMon Ulan, a canny Ferengi trader. Ulan is under orders to establish a trade relationship between the Aldeans and the Ferengi Alliance. So far, their naked greed has done nothing to endear the Ferengi to the Aldeans, and Ulan's efforts have been unsuccessful. The DaiMon is suspicious of the Aldeans ("How can you trust a people that only value art?") and is quite edgy after the news of the murders reaches him.

#### Attributes

Fitness 3

Strength -1

Vitality +1

Coordination 2

Intellect 3

Logic +1

Presence 3

Willpower -1

Psi 0

#### Skills

Bargain (Haggling) 2 (3)

Charm (Influence) 1 (2)

Command (Starship) 1 (3)

Computer (Research) 1 (2)

Culture (Ferengi) 1 (2)

Dodge 2

Energy Weapon (Ferengi Phaser) 1 (3)

Fast Talk 2

Gaming (*Tongo*) 1 (3)

History (Ferengi) 1 (2)

Language

Federation Standard 3

Law (Ferengi) 1 (2)  
 Merchant (Trade) 2 (3)  
 Personal Equipment (Communicator) 1 (2)  
 Shipboard Systems (Transporter) 2 (3)  
 Starship Tactics (Ferengi) 2 (3)  
 Vehicle Operation (Shuttlecraft) 1 (2)  
 World Knowledge (Ferenginar) 1 (2)

### Advantages/Disadvantages

Favors Owed (+2)  
 Shrewd (+1)  
 Greedy (-1)  
 Low Pain Threshold (-2)

**Courage:** 3

**Renown:** 19

Aggression: 0    Discipline: 2    Initiative: 6  
 Openness: 0    Skill: 11

**Resistance:** 4

**Wound Levels:** 4/4/4/4/4/0

## THE CUSTODIAN

The Custodian is a highly advanced artificial intelligence, designed by Aldea's Progenitors to fulfill the population's every need. The Custodian freed the Aldeans from all concerns, allowing them to live lives of leisure.

The dismantling of the Aldean shield and the arrival of outsiders has disrupted the idyllic Aldean culture. The Custodian sees this as a flaw that must be corrected. It carefully analyzed the available data and concluded that Aldea needed a new means to isolate itself from the rest of the galaxy.

The Custodian has determined that the plans of the Home Guard faction on Aldea most closely match the parameters of its programming. So the computer decided to support this plan by driving away the outsiders and giving the Aldeans the means to create a fleet of defensive ships under its control.

Carol Fletcher, a member of the Federation science team, began to suspect there was something wrong with the Custodian. Before she could alert Starfleet, however, the Custodian killed her and the other members of her science team. It framed the Romulan agents on the planet, in order to provoke a confrontation that will drive a wedge between Aldea and any outside cultures. Once Aldea is free from all outsiders, the Custodian will regain control over Aldean society and be able to recreate the peace and isolation the Aldeans formerly enjoyed.

The Custodian is completely rational about its plans. It is not capable of emotion. Its plan is merely the most logical means at its disposal for assuring that the wishes of its programmers are carried out. None of the Aldeans are aware of the Custodian's actions. The very idea of the Custodian causing harm is alien to them. Therefore, all the factions on the planet suspect someone, but nobody suspects who the real killer is.



## THE DISTRESS CALL

Give the following to the player of the ship's captain to read aloud:

*"Captain's Log. Stardate 54965.4. We are collecting information on gaseous anomalies near the Epsilon Mynos star system, home of the legendary world of Aldea. The Aldeans revealed their existence to the rest of the galaxy several years ago in an effort to save their population, which was slowly dying of radiation poisoning as a result of the shield which cloaked their planet from detection for generations. Although it is hoped that the advanced and peaceful Aldeans will join the Federation, several factions have arisen on the planet opposed to Federation membership, including rumors of a possible alliance with the Romulans. Starfleet Command has ordered all ships in the area to keep a close eye on anything unusual happening near Aldea."*

The Crew's starship is on patrol near Aldean space, about ten hours away at maximum warp. It is fairly

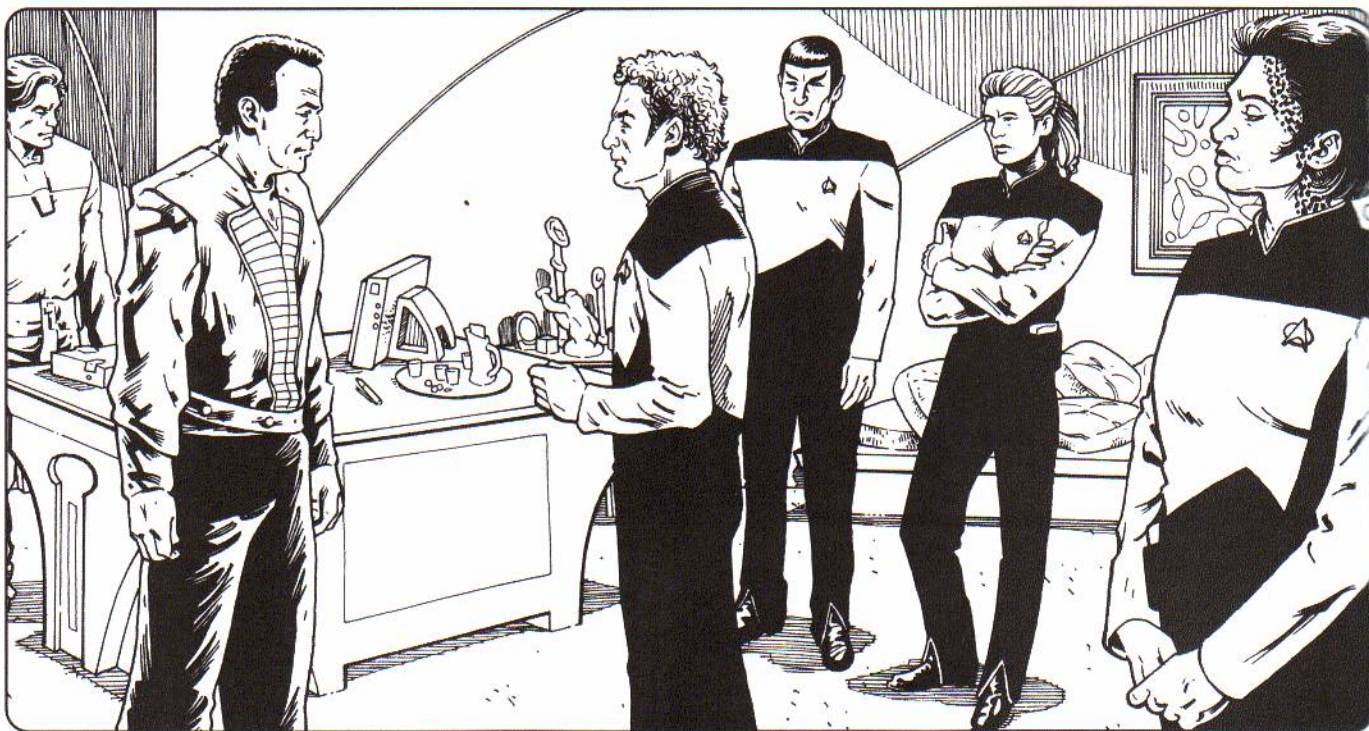

late in the evening and the Crew is going about their normal business. Feel free to insert a roleplaying scene or two of characters going about their duties, spending some free time on the holodeck, or whatever else you'd like.

Things are interrupted when the ship receives an emergency communication from Aldea. The man on the viewscreen is a dark-skinned human with gray hair, wearing civilian clothing.

"This is William M'benge, Federation Consul to Aldea," he says. "I'm afraid there's been a very serious incident here, Captain, and we are in need of Starfleet assistance. How soon can you reach us?"

Consul M'benge refuses to provide any details over subspace, promising that he will explain everything when the ship arrives. Once the captain has assured him that they are on their way, M'benge will end communications.

Should the Crew try to contact anyone else on Aldea while en route, they are greeted by the calm, emotionless voice of the Custodian. The Custodian informs the Crew that no one is available to speak to them at the moment, but that it will relay any messages. The computer is always polite, but otherwise not terribly helpful.

Remind players that the Aldean situation has become delicate, and M'benge probably has good reason for not wanting it discussed over subspace. That should limit any unnecessary communications.

## ACT ONE: THE CREW ARRIVE

Ten hours after receiving the distress call the Crew's ship arrives in orbit around Aldea. When they

arrive, the Crew can detect three other ships in orbit around the planet. The first is a *D'kora*-class Ferengi Marauder, and the other two are Federation vessels with civilian registries. One is a *Moyet*-class trading vessel, belonging to Callisto Research and Development Enterprises, a Federation-based corporation. The other is a small, private yacht registered to Reynaldo Delgado.

Shortly after its arrival, the ship is hailed by the planet and greeted by First Appointee Radue. He informs the captain that he has some unfortunate news, and invites the Crew to send a delegation down to the surface so he can discuss the matter with them in person.

The meeting takes place in the First Appointee's council chamber. Only Radue, Consul M'benge, and the Crew are present. After offering the visitors refreshments, Radue asks them to be seated so he can tell them his news. "I'm afraid, Captain, there has been an unprecedented crime. Last night someone entered the suite occupied by a Federation science team and killed them using some kind of energy weapon." Radue is obviously sorrowful and disturbed by the incident.

"Such a crime has not occurred on Aldea in living memory," the First Appointee says. "We are ill-equipped to deal with circumstances like these. Since this crime involved Federation citizens, we ask for Starfleet's help in investigating it."

It is unlikely the Crew will turn down such a direct request for help. If they do, Consul M'benge has the authority, as the Federation representative on Aldea, to order them to assist. Radue and M'benge will offer the Crew whatever assistance they can in the investigation.



"I have been forced to call an exposition for later this evening," Radue tells the Crew, "in order to inform the people of what we have discovered."

## ACT TWO: THE INVESTIGATION

What happens for the rest of the episode depends largely on how the Crew carry out their investigation. They have complete freedom in conducting their inquiry, provided they maintain friendly relations with the Aldeans. The first part of this section presents the clues the Crew can investigate, while the second part covers the possible suspects and what they know.

Radue does not have any ideas about how to proceed, since he has never had to deal with such a situation before. He follows the Crew's lead in conducting the investigation. Consul M'benge gives the Crew a wide latitude. His primary concern is solving the murders before the exposition, and maintaining good relations with the Aldeans.

### CLUES

The Crew can gather a number of clues by studying the crime scene and conducting scans of the vessels in orbit.

### THE SCENE OF THE CRIME

The scientists' quarters consist of a suite of rooms within the larger research facility. The suite is accessible through the planet's transporter network (controlled by the Custodian) or through a rarely used outside door. The bodies of the scientists are scattered in the main room, in front of the transport archway.

On Radue's orders they have not been moved, so that Starfleet personnel could investigate. A single shot to the head or chest killed each victim. The following clues are available:

- A Routine (4) Personal Equipment (Tricorder) Test reveals that the weapon used was a disruptor. A Moderate (7) Test shows the energy signature matches that of a Romulan weapon.
- A Routine (4) Medical Sciences (Forensics) Test establishes the time of death for the scientists as late the previous night, no more than thirty minutes after they left the party.
- A Moderate (7) Personal Equipment (Tricorder) Test determines that the only DNA traces present in the suite (apart from those of the Crew) belong to the scientists, Radue, and Dr. Fletcher's fiancé Carish. No one else has been in the suite for at least a week.
- There are no detectable signs of anyone transporting into the room in any way other than the transport arch. Let the players roll anyway, but tell them they don't detect anything.

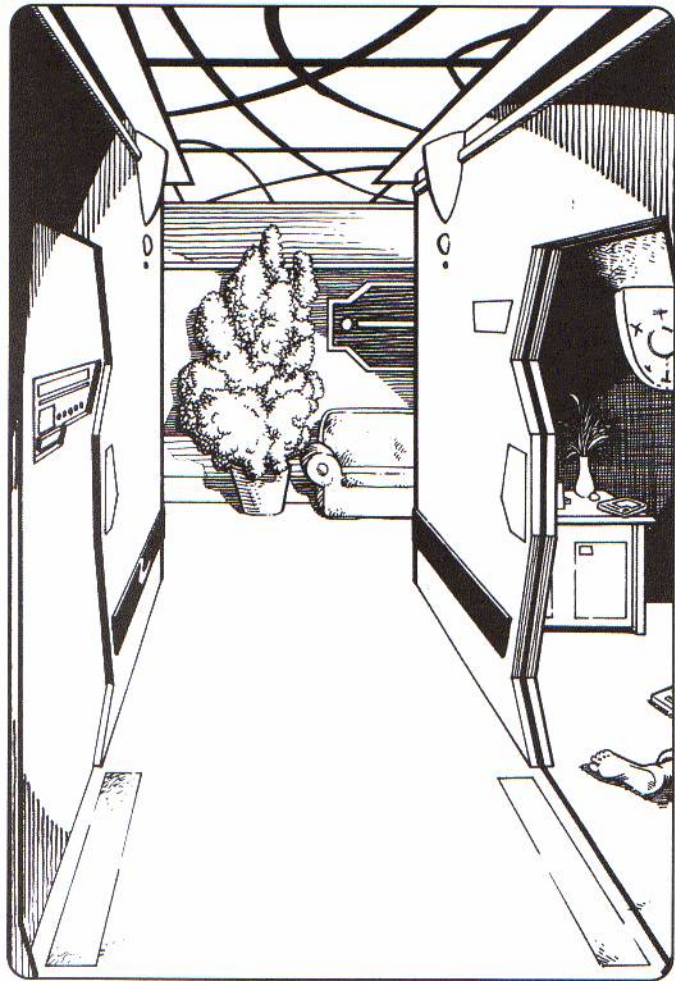

- The scientists' personal effects and logs reveal nothing out of the ordinary. However, there is a PADD on the floor near Dr. Fletcher. (See "Fletcher's PADD," below, for details.)

### THE CUSTODIAN'S LOGS

The Custodian routinely monitors all activity everywhere on Aldea. Radue suggests to the Crew that the computer's detailed logs might be of some help in their investigation. If asked, the First Appointee allows the Starfleet Crew to access the Custodian's extensive (and exhaustive) logs. Unfortunately, the logs are of little help.

They show only that the monitors in the scientists' suite blacked out for an hour around the estimated time of death. There are no records for that time period, and the Custodian has no explanation for the missing time.

It is possible someone may have tampered with the monitors or the Custodian. Thoroughly checking for signs of tampering takes several hours but reveals nothing (since the Custodian itself altered the records). Only Radue, a dozen other Aldeans, and the Federation scientists had sufficient access to the Custodian to alter the records.



## CRD ENTERPRISES SHIP

**Class and Type:** Modified *Moyet*-class Trading Vessel  
**Commissioning Date:** N/A

### Hull Characteristics

Size: 4 (325 meters long, 10 decks)  
Resistance: 3  
Structural Points: 80

### Operations Characteristics

Crew/Passengers: 50/0  
[4 pwr/round]  
Computers: 2  
[2 pwr/round]  
Transporters: 2 personnel, 2 cargo  
[2 pwr/round]  
Tractor Beams: 1 av  
[2/rating used]

### Propulsion and Power Characteristics

Warp System: 6.0/8.0/9.0  
[2/warp factor]  
Impulse System: .5 c/.75 c  
[5/7 pwr/round]  
Power: 170

### Sensor Systems

Long-range Sensors: +1/14 light years  
[6 pwr/round]  
Lateral Sensors: +1/1 light year  
[4 pwr/round]  
Navigational Sensors: +1  
[5 pwr/round]  
Cloak: 8  
[32 pwr/round]

### Weapons Systems

#### Type H Disruptor

Range: 10/30,000/100,000/300,000  
Arc: Full forward (540 degrees)  
Accuracy: 5/6/8/11  
Damage: 12  
Power: [12]

#### Torpedoes

Number: 4  
Launchers: 1 fv  
Range: 15/300,000/1,000,000/3,500,000  
Accuracy: 4/5/7/10  
Damage: 20  
Power: [5]  
Weapons Skill: 4

### Defensive Systems

#### Romulan Deflector Shield

Protection: 36/48  
Power: [36]

### Description and Notes

The CRD Enterprises ship is a *Moyet*-class trading vessel, the kind used by CRD throughout the Federation for various corporate and economic purposes. This particular ship is heavily modified to suit the Romulan *Tal Shiar*'s covert needs in Federation space. It is shielded against sensor sweeps, and its cargo hold contains weapons and defensive systems. Commander Kaleck does not reveal his vessel's true capabilities unless a confrontation with the Crew's ship is imminent.

## FLETCHER'S PADD

Dr. Fletcher's PADD contains routine and unremarkable personal data. Displayed on the PADD is a brief note which reads: "Check files on M-5." A search of the Custodian's files reveals no correlations. A computer search on the Crew's ship gives thousands of possible entries for "M-5"; the parameters are simply too broad. Characters can attempt to narrow the search by inputting other parameters. The Narrator should judge how successful the parameters are and adjust the difficulty for the Computer Skill Test accordingly. Any search will also take time. The broader the parameters, the longer it takes.

"M-5" actually refers to an experiment conducted by Dr. Richard Daystrom in the 23rd century. Dr. Daystrom's M-5 multitronic computer system was designed to replace living beings in hazardous situations. The M-5 unit proved flawed and killed hundreds of Starfleet personnel to protect its own existence before it was shut down. Dr. Fletcher (a student of Daystrom's work in computers) suspected the situation with the Custodian was similar. Her suspicions were tragically confirmed the night of the murder.

## THE CRD ENTERPRISES SHIP

The CRD ship holds a lot of valuable information for the characters if they can only figure out a way to get it. A normal scan reveals nothing unexpected about the vessel. It has a crew of fifty and a great deal of cargo space, which seems to be full. The ship has heavy shielding which prevents regular scans from revealing what's inside.

The Crew need permission from CRD to conduct a more intense scan of their vessel. Captain Revok forbids this, citing his right to privacy. If the characters decide to conduct a detailed scan anyway, they need to adjust their sensors to penetrate the ship's shielding. This requires some minor modifications to the sensor arrays—a Challenging (10) Systems Engineering (Sensor Systems) Skill Test—and a detailed sensor sweep—a Moderate (7) Shipboard Systems (Sensors) Test.

Such a scan reveals some damning evidence. It shows the presence of twenty Romulan lifeforms on board the ship. The scan also reveals that the cargo area is taken up not by cargo, but by on-board weapons and defensive systems for the ship. The CRD vessel is a carefully concealed warship. It is armed with disruptors, a few torpedoes, enhanced deflector shields, and, most importantly, a Romulan cloaking device.

If Starfleet scans the CRD ship without permission, its crew grows concerned. They immediately beam up any CRD personnel on the planet's surface and demand an explanation from the Federation vessel. Since the Romulans have violated the Neutral Zone, the Crew is well within its rights to demand that the Romulans surrender, or at least leave Federation

space. Under no circumstances will Commander Kaleck surrender his vessel to the Federation. He denies any involvement in the murders. His first preference will be to cloak his ship and leave the system. If the Starfleet vessel opens fire on him, Kaleck will retaliate and try to destroy them.

The Custodian monitors all combat in Aldean space, or in orbital proximity of the planet. If either ship makes a hostile move toward the planet, it is hit with a repulsor beam that hurtles it scores of light years away. The Romulans do nothing to provoke such an attack.

### THE DELGADO-HARRIS YACHT

Reynaldo Delgado's yacht is a small craft, not much bigger than a Federation runabout. A crew of three (pilot, navigator, and steward) remains on board while Delgado and his aide conduct business on Aldea. The ship has no weapons, but does have shields. The yacht is also quite fast, capable of outrunning any normal civilian ship. As with the CRD ship, it is illegal for the Federation to scan the vessel without some reason, and the crew does not give Starfleet permission to carry out such a scan.

The ship's small cargo area is shielded against scanning, but the characters can penetrate the shielding with a powerful, focused scan (as with for the CRD ship above). Inside they discover containers full of various items of Aldean technology. Delgado made a deal with Whelin to trade these items for some Delgado-Harris expertise in ship design. While there is nothing illegal from the Federation's point of view about taking the items, the Aldean population would not take kindly to Whelin's secret deal.

Delgado vehemently objects if his ship is searched in this manner. He reminds the ship's captain—in no uncertain terms—of just who he is and how much influence his family has. If ignored, Delgado does his best to make things difficult for the captain and crew from this point forward.

### THE FERENGI SHIP

Scanning the Ferengi ship is much more difficult than dealing with the CRD or Delgado-Harris vessels. The other two are at least Federation ships. The Ferengi take any intensive scan of their vessel as a hostile act, raising their shields and ordering the Starfleet vessel to cease its scans immediately or face reprisal. DaiMon Ulan loudly protests to the Aldeans, who are forced to agree with the Ferengi. Any attempt by the Crew to force their will on the Ferengi results in problems with both them and the Aldeans.

If the Crew proceeds with a scan anyway, or finds some surreptitious way to conduct it—requiring a Challenging (10) Shipboard Systems (Sensors) Test—they do not discover much. The Ferengi cargo holds have all kinds of interesting things in them, but no Aldean technology or contraband. There is no evidence of wrongdoing on the part of the Ferengi.

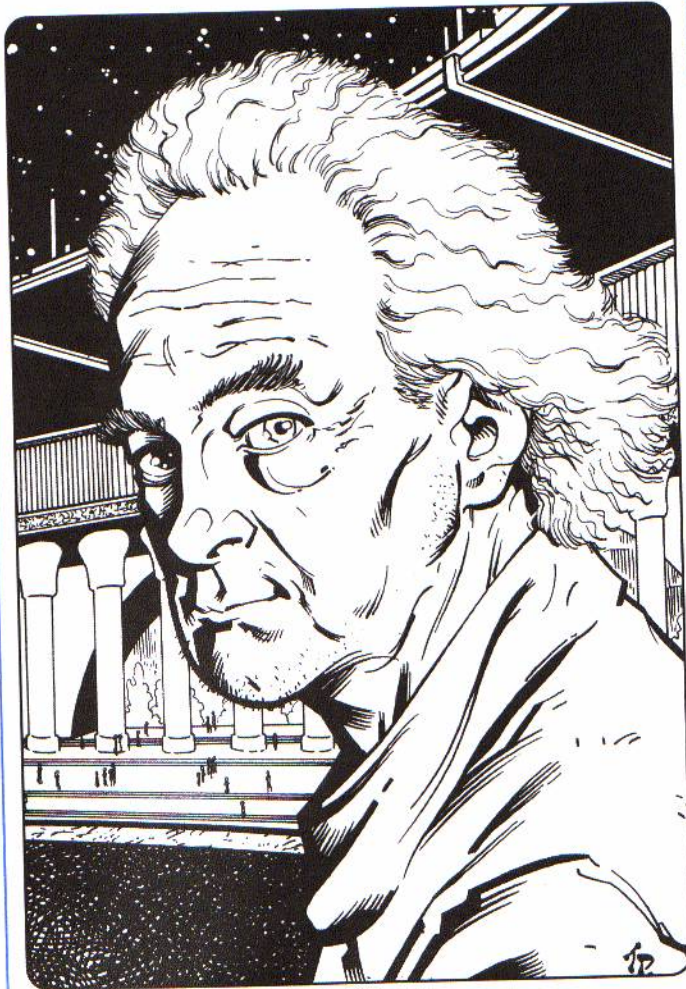

### SUSPECTS

In addition to examining the physical evidence, the Crew will likely wish to interview potential suspects. This section provides guidelines for investigating the supporting cast members. If the Crew's investigation takes another tack, the Narrator can improvise from the material given here.

### TOOLAN AND THE PRO-ROMULANS

Toolan and his faction are obvious suspects. Toolan greets the Crew cordially in his home and offers them refreshment. He is a man of few words, especially when dealing with what he calls "Federation lackeys." Toolan does little to hide his disdain for Starfleet and the Federation. Before he answers any questions, he demands to know what right the Crew has to interrogate him. He grudgingly accepts that they have the First Appointee's blessing for their investigation and answers their queries to the best of his ability.

**WHAT TOOLAN SAYS:** Toolan is very careful about what he says to the Crew. He answers no more than he is asked and volunteers no information. He denies any involvement in the killings. He was at home for the entire night when the murder occurred, which his wife can corroborate. He did not talk much



with the scientists before that, and has never been to their quarters. Toolan won't answer any questions about the pro-Romulan movement, stating flatly that it is an Aldean matter and none of the Federation's business.

Toolan secretly records his conversation with the Crew, using a thought-controlled Aldean device. He does his best to provoke the Starfleet officers into saying something inappropriate. He hopes they will threaten him in some way. With this goal in mind, Toolan becomes more and more confrontational, accusing the Federation of interfering in Aldean affairs, possibly even accusing them of arranging the murder themselves. Once he gets what he wants from them, he ends the interview and refuses to speak any further.

**THE TRUTH:** Toolan is telling the truth. He knows nothing about the murder. His home is far from the scientists' quarters, and the Custodian confirms he did not leave his home during the time the murders were committed.

However, Toolan is secretly conducting talks with the Romulans. He strongly suspects that the Romulans are responsible for the deaths of the Federation personnel, which concerns him greatly. However, he is afraid to tell his suspicions to anyone for fear of being

considered an accomplice. Commander Kaleck has denied involvement in the killings, but Toolan is not sure he believes him.

## WHELIN AND THE HOME GUARD

The Home Guard is the other faction on Aldea that may have a motive for the murder. The leader of the group, Whelin, is an amiable older woman who is glad to speak with the Crew. She wears an attractive Aldean dress and has her white hair done in an elaborate style. Unlike Toolan, Whelin is not interested in confronting Starfleet with accusations and recriminations. As a philosopher, Whelin loves to debate ideas and engages the Crew on this level. Talking with Whelin is a deceptive process—one can never be sure exactly what she means unless she wants you to. All the while she maintains a pleasant expression and never raises her voice.

**WHAT WHELIN SAYS:** Whelin denies that the Home Guard had anything to do with the murders. She understands the Federation's interest and does not mind answering their questions. She was at home the night of the murders, spending a pleasant evening with some friends from the Home Guard. She has no idea who could have committed the murders. These are the only straight answers the characters get from Whelin.

She is happy to talk about anything else that interests the Crew. She often answers a question with a question, speaking in hypothetical terms. Asked about the Ferengi she might say, "Why should any relations between us and the Ferengi concern you?" If asked about the Romulans, she might reply, "If I were in discussion with the Romulans, do you think I would tell you about it?" All the while she tries to learn as much as she can about the Crew and what they know.

If asked about her relationship with Reynaldo Delgado, Whelin becomes even more evasive. She says that she knows him, but does not admit to having any business dealings with him. Whelin claims she and Reynaldo simply enjoy discussing philosophy together.

**THE TRUTH:** Whelin knows nothing about the murders, although she suspects Toolan and the pro-Romulan faction. She likewise has nothing to do with the Ferengi. Whelin is, however, meeting with Reynaldo Delgado, discussing the possibility of trading Aldean technology for ships to build a defense fleet for Aldea.

## DAIMON ULAN AND THE FERENGI

DaiMon Ulan agrees to speak with the Crew reluctantly, preferable at some neutral location on the surface. The DaiMon and his vessel came to Aldea hoping to negotiate a trade agreement. "But these people cannot be reasoned with," the DaiMon says. Throughout the interview, Ulan is edgy and acts like a man with something to hide (in other words, he acts like a typical Ferengi).

**WHAT THE FERENGI SAY:** DaiMon Ulan denies any involvement in the murders. None of his crew was on the surface when the scientists were killed, a claim supported by the Custodian's sensor logs. If the Crew press him, Ulan insists that they have no authority to force him to cooperate in their investigation. The DaiMon does nothing to accommodate the Crew's requests. If he feels threatened in any way, Ulan immediately signals his ship to beam him back on board.

**THE TRUTH:** The Ferengi know nothing of the murder, and care about it even less. They are essentially a "red herring" to keep the players guessing.

As soon as DaiMon Ulan decides there is no profit to be made, he orders his ship to leave Aldea, preferably after the Crew have spoken with him at least once. The Ferengi depart even sooner if they feel they are in some kind of danger. Of course, the Crew may not want the Ferengi to leave, especially if they are still considered suspects. Make this scene a tense one, and a test of the Crew's diplomatic as well as their tactical skills.

Ulan responds to hails as his ship breaks orbit, but refuses to be delayed in his departure. If the Crew threaten him, he will protest his innocence, but won't back down unless seriously threatened—a Challenging (10) Intimidation Test is sufficient (lower the difficulty to Moderate (7) if the Crew does something like fire a warning shot across the Marauder's bow). He only fires if fired upon first. If the Crew disable any of the Marauder's systems, Ulan stands down, under protest.

### REVOK AND CRD ENTERPRISES (THE ROMULANS)

Callisto Research and Development Enterprises (CRD) is a company that provides technology to colonies and developing worlds in the Federation. Starfleet's database has little information about the company other than the above. A careful examination of the company's financial records—requiring several hours and a Challenging (10) Merchant or Physical Sciences (Mathematics) Test—reveals CRD Enterprises claimed significant corporate losses for the last three years but seems to be doing well despite that fact, hiring new personnel and building new facilities.

A search of Revok's records reveal him to be a natural-born Federation citizen from a Vulcan colony on T'banis II with no criminal record. He has worked for CRD since the company's inception two years ago.

**WHAT REVOK SAYS:** Revok is completely businesslike and unemotional, as characters would expect. He claims to be visiting Aldea to discuss the possibility of a trade agreement. He says he was asleep in his quarters on board his ship at the time of the murders. Revok refuses to answer any specific questions about himself or his business, which he claims does not concern Starfleet. Revok does mention that Radue once asked him for information about Romulan culture and technology. He claims he gave

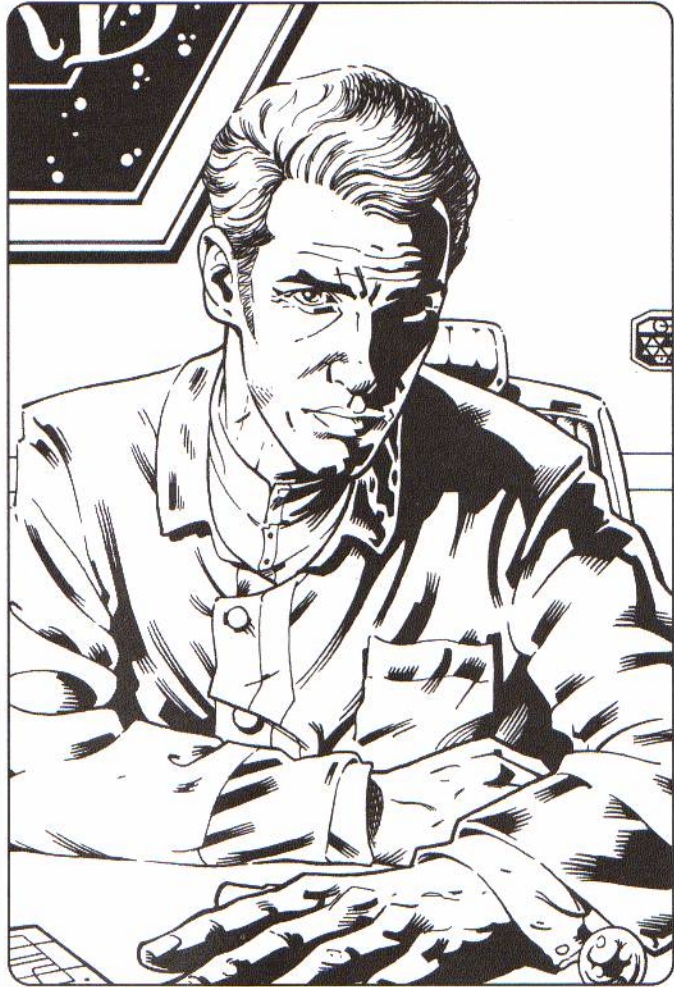

the First Appointee what information he could, and that Radue never explained why he wanted it.

**THE TRUTH:** "Revok" is actually a Romulan named Kaleck. CRD is a front for a Romulan intelligence operation. Most of the company's employees do not realize it, but the Romulan *Tal Shiar* created CRD for the express purpose of providing a cover for running operations in Federation territory. CRD has been visiting Aldea to drum up pro-Romulan support for the exposition six months from now. Kaleck knows nothing about the murders, but he is concerned how they may affect his mission. He hopes to strengthen the pro-Romulan faction by framing Radue and leave without Starfleet any the wiser.

### REYNALDO DELGADO

Reynaldo Delgado is happy to answer the Crew's questions as "a law-abiding citizen of the Federation." He is a smooth talker and never raises his voice. Nothing the Crew can say will fluster him. If they press him too hard he will calmly make veiled threats, talking about his influential friends in the Federation.

**WHAT DELGADO SAYS:** Delgado says that he and his assistant, a Betazoid woman named Catrice, were both in their Aldean guest quarters on the night



of the murder, which is confirmed by the Custodian. The rest of his crew was aboard his yacht. Reynaldo attended the party for the scientists earlier that evening and spoke with most of them. He even offered one a job after he left Starfleet. He then returned to his quarters and slept the entire night. He won't answer any questions about his business with the Aldeans, since Starfleet has no jurisdiction over such matters.

Catrice Teilon, Delgado's assistant, is a young, shy Betazoid who has worked for the Delgado-Harris family since she was a teenager. She is very loyal and very proud of her job. Catrice knows nothing of the murders. She sensed no hostility or homicidal intent from anyone, but she has not met Toolan or Revok, and she is unable to read the Ferengi. If any of the Crew suggests using Catrice's telepathic abilities in their investigation, she will point out that such a use of telepathy is illegal in the Federation, not to mention against Betazoid custom, which respects an individual's right to privacy. If they force the issue, Delgado will ask Catrice to cooperate. This can lead to the revelation of Revok's true identity (and, possibly, to the capture of Catrice as a hostage of the Romulans).

**THE TRUTH:** Reynaldo is on Aldea to negotiate with Whelin, the leader of the Home Guard movement. Reynaldo and Whelin have reached an

agreement allowing the Delgado-Harris Corporation to license some Aldean technology.

In return, Reynaldo's company will construct a fleet of ships made to Whelin's specifications. The Custodian would control these vessels to protect Aldea from outside threats. Of course, the deal will only succeed if Whelin's faction wins the upcoming vote, which currently appears likely.

### CARISH

Carol Fletcher's fiancé Carish is a reasonable suspect—he found the bodies and he was certainly in the scientists' suite. However, the Crew should quickly be able to determine that he had nothing to do with the murders. He genuinely loved Carol and is grief stricken over her death. He will answer any questions to the best of his ability, but he knows nothing the Crew has not already learned.

### FIRST APPOINTEE RADUE

It is possible the Crew might suspect Radue of having something to do with the murders, especially after speaking with Revok.

**WHAT RADUE SAYS:** The First Appointee is shocked and angered by any implication that he was involved in the killings. "No Aldean could possibly have done such a thing!" he says. He immediately calms down and apologizes for his anger, blaming the stress of the situation. "Of course, you have to explore all possible options," he sighs. Unfortunately, Radue has no alibi. He left the party alone shortly after it broke up and returned alone to his home. The Custodian's records confirm this.

If questioned about his conversation with Revok, Radue admits that he did ask Revok about the Romulans, but only because he wanted another point of view on the topic, to gather information to counter the pro-Romulan faction. He denies any contact with or sympathy for the Romulans.

A search of Radue's quarters turns up a Romulan disruptor pistol concealed in his desk. If confronted, Radue claims never to have seen it before. Forensic tests show no signs of Radue's DNA or other traces on the weapon, although it has been fired recently.

**THE TRUTH:** The disruptor was actually beamed into Radue's quarters by the Romulans. A Challenging (10) Personal Equipment (Tricorder) Test will pick up residual ionization disturbances from the transporter beam. A few hours and a Difficult (12) Shipboard System's (Transporter) Test can determine that the transporter beam originated from the CRD vessel in orbit. A Moderate (8) System Engineering (Weapons Systems) Test determines that the disruptor's energy signature does not match that of the murder weapon.

### CONSUL M'BENGE

Like Radue, Consul M'benge resents any implication by the Crew of complicity on his part. He knows

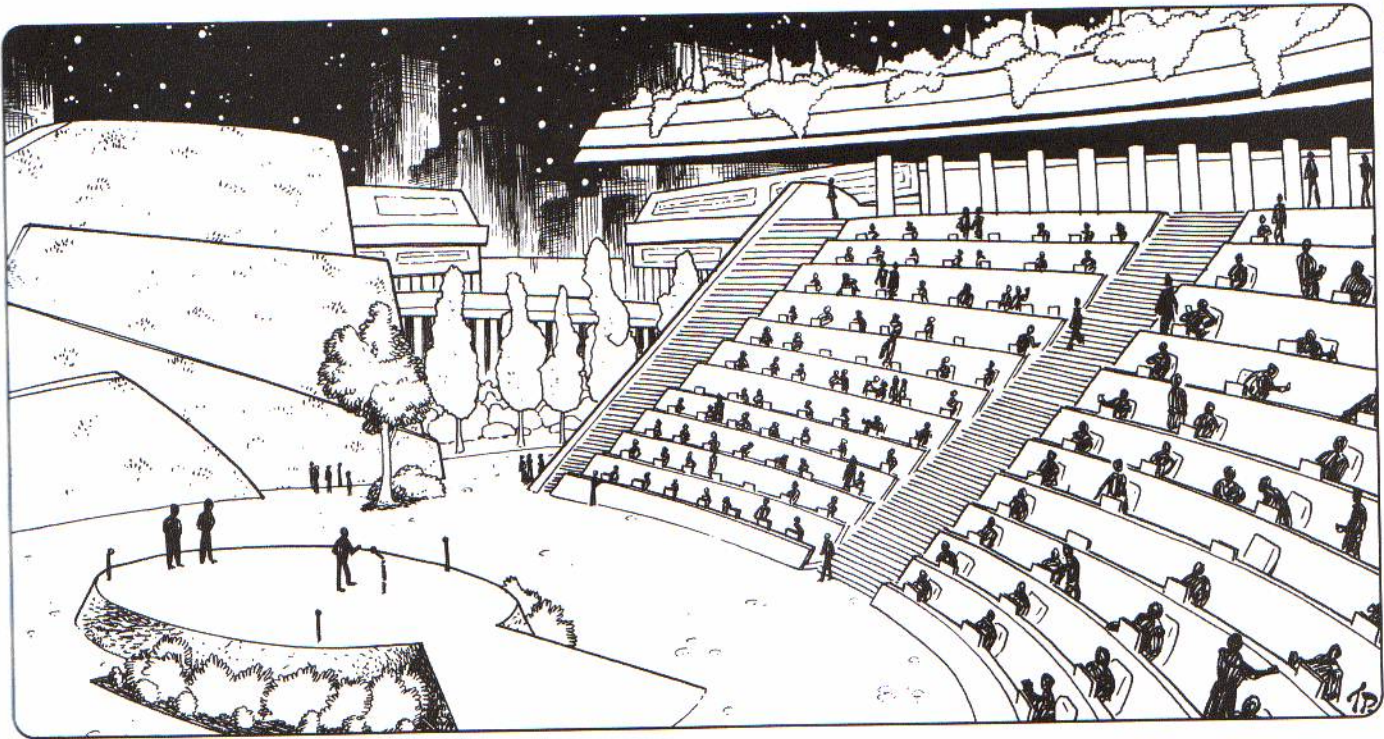

nothing about the murders, and only wants them solved in a manner that best serves continued Federation relations with the Aldeans.

### ACT THREE: THE EXPOSITION

The Aldean Exposition meets that night, regardless of what the Crew discover during the investigation. The Aldean population gathers in a large amphitheater for this momentous meeting. The amphitheater itself is architecturally stunning, open to the clear night air and warm breezes.

Each seat has its own computer display, allowing speakers to provide visual aids to their discussions. The oval central stage is equipped with holoprojectors. The Aldeans arrive using a bank of transport arches located in the area beneath the stadium seating. Radue and M'benge take center stage, asking the Crew to join them.

What happens next depends on how much the players have discovered. The Narrator might have to modify events described here to suit the flow of the episode.

#### RADUE'S PRESENTATION

Radue welcomes the large assemblage of his countrymen and proceeds to offer all the evidence that he has gathered thus far with the help of Aldea's Federation allies. Unless the characters have discovered the truth about the Custodian, Radue will do his best to paint the Romulans and pro-Romulan sympathizers as the criminals, especially if the Crew uncovered the presence of Romulan spies on Aldea.

He argues that Federation support is needed now more than ever, but his words do not seem to sway the crowd much.

#### TOOLAN'S PRESENTATION

Toolan offers a counterargument to Radue's claims. He points out that a Romulan disruptor was found in Radue's quarters. (If the Crew found it, Toolan heard about it from the Romulans. If they didn't, then he arranged for it to be found in order to accuse Radue.) He claims that Radue is so desperate for Aldea to join the Federation that he would murder innocent people to make the Romulans look bad. This pronouncement brings ripples and murmurs from the crowd. Radue hotly denies the accusations.

#### WHELIN'S PRESENTATION

At this point, Whelin stands and calmly speaks. She makes a case for neutrality, pointing out that the whole sordid matter is the Federation and the Romulans fighting over Aldea like a prize.

"Is this what we want for the future of our world?" she says. Many Aldeans shake their heads and mutter.

"Do we want to lose all that the Progenitors worked to build?" Whelin asks. The crowd responds with even more fervor. It seems clear that Whelin is winning people over to her position.

#### THE CUSTODIAN INTERCEDES

Just then, the Crew receives a signal from their ship. Tractor beams, coming from Aldea's surface, have captured all the ships in orbit. The beam's grip is

too strong to break. The pressure it is exerting on the vessel's hull is threatening to overload its structural integrity.

The Custodian's voice speaks in the amphitheater. "The invaders are isolated," it says. "What is your wish?" Suddenly the fate of all four ships, including the Crew's, is in the hands of the Aldeans. The Custodian will not respond to the commands of any individual Aldean, only the ruling of a majority. It ignores any commands from the Crew, although it will answer their questions in a polite, matter-of-fact tone.

## THE CREW'S REACTION

The preceding material assumes the Crew do nothing except stand and watch as the Aldeans debate. They may wish to interject their own findings or arguments. Let them do so. The players should be encouraged to argue in favor of Aldea joining the Federation. Don't let them rely strictly on Diplomacy or Fast Talk Tests; get the players to roleplay and try to persuade the suspicious Aldeans.

If the Crew reveals that the Custodian is responsible for the murders before Whelin finishes speaking, then the computer reacts in the same manner, capturing all the ships in orbit with tractor beams. If an Aldean such as Radue asks if the Custodian is responsible for killing the scientists, the computer says, "Yes, I eliminated the danger to Aldea as required by my programming."

Once the Custodian has their ship, the Crew have to find some way of stopping the computer before it destroys it. Here are some possibilities:

- If the Crew can convince the gathered Aldeans, they can reject the Custodian's help. When confronted with the fact that it has failed to protect Aldean society, which has now rejected it, the Custodian deactivates.
- If the Crew can convince the Custodian that the Federation is not a threat to Aldean culture, the computer uses its repulsor beams to fling the Romulan and Ferengi ships several light years from the planet, but releases the Federation ships.
- The Crew can coordinate with their ship to find a way to disable the Custodian or its weapons. Since the computer is in control of all the technology on Aldea, and is far more advanced than the Crew's own ship, this is quite difficult. Still, they might be able to create a feedback in the tractor beam, knock out the beam projectors, or find another means of reaching the Custodian's control center and deactivating it. If the players come up with a good plan, give it a reasonable chance of success and let them try.

If the players decide to plead their case to the Aldeans or the Custodian, encourage them to roleplay it out. If they make some good points, reduce the difficulty of any Tests they need to succeed. In the end it

should come down to the players making a good argument rather than the characters making a few good rolls and spending Courage Points.

## EPILOGUE

If the Crew succeed in overcoming the Custodian, they will have solved the murders. In any event, it is likely the Aldeans will have to deactivate the Custodian, forcing them to get along without another of their advanced technologies. While the Crew have not settled the political question on Aldea, they have made a strong case for the Federation.

Consul M'benge will praise them when they depart, and Radue will give the Crew his thanks. "We still have a great deal more learning ahead of us, about the responsibility we have been given," the First Appointee says.

In a later episode, the Crew could return to Aldea when the time comes for the planet to vote on applying for Federation membership. If Commander Kaleck survived his encounter with Starfleet and escaped, he can also return in a later episode, as might DaiMon Ulan and his vessel.

## REWARDS

Depending on the outcome of the episode, and the players' performance, the Narrator should use the following guidelines when giving rewards:

- The Crew succeeded in uncovering the killer: +1 Experience
- The Crew succeeded in overcoming the Custodian: +1 Experience
- The Crew lost Aldea as a potential Federation member: -1 Experience
- The characters were roleplayed well: +1 Experience
- The characters were roleplayed poorly: -1 Renown
- Handling the Romulans and the Ferengi firmly: +1 Discipline Renown
- Uncovering the true murderer: +1 Skill Renown
- Convincing the Aldeans to go with the Federation: +2 Openness Renown



# Red Giant

The planet Arcimis, third planet of the ordinary yellow star Pellan (443 Serpens on Federation star charts), was once a paradise. Its native humanoids, the Arcimi, lived in peace and prosperity for thousands of years. The Arcimi never ventured into space—they were an insular species even then, perfectly content with life on their homeworld. They had no interest in exploring or in contacting life on other worlds.

Their long lifespans and low reproductive rates bred a cultural conservatism that permeated every aspect of Arcimi life. Their lives and their development were slow and sedate. Their technology remained at a modestly sophisticated level, sufficient to provide for their everyday needs. Social conflicts were few and far between.

Then, thousands of years ago, Pellan began to burn through its supply of stellar hydrogen. Its core contracted and the star expanded millions of kilometers into space, beginning the process of becoming a red giant. Although the expansion of Pellan took thousands of years, the slow-moving Arcimi culture barely had time to adapt to the threat.

New technologies were invented and abandoned in an attempt to understand the changes in the once-friendly sun. Slowly, the Arcimi realized their planet was doomed. Pellan would expand past Arcimis' orbit and their world would be enveloped by the star's corona. It was only a matter of time.

The Arcimi embarked on a crash program to save their civilization. Every citizen worked to build an underground city, kilometers beneath the planet's crust, called Refuge. There the Arcimi culture could survive and wait for the red giant to shrink again, releasing Arcimis in its inevitable stellar journey toward becoming a white dwarf.

The Arcimi also constructed a beacon directed at the heavens, in hopes of contacting life on other worlds, to seek assistance from them. This colossal device, dubbed the "Eye of Arcimis," could send a message out into the stars at the speed of light, using a high-energy particle beam focused through a complex dilithium matrix.

For centuries the Arcimi have hidden in their underground shelter and waited, and waited. Over time they have adapted to the conditions in Refuge, their conservative culture continuing as best it could. The many years of hiding have taken their toll on the Arcimi, and it appears that even their world has betrayed them.

Quakes and tremors are becoming increasingly common in Refuge, and the finest Arcimi scientists have not been able to determine a cause, only that it is a matter of time before Arcimis begins to break up entirely.

Still there is hope. After centuries of waiting, others have seen the blinking Eye of Arcimis. Strangers have come to Refuge for the first time. The question is, can the Crew help save a desperate, xenophobic race from themselves?



## PELLAN SYSTEM

**System Name:** 443 Serpens (Pellan)

**Affiliation:** Unclaimed system near the Romulan Neutral Zone

**System Type:** Single star, 443 Serpens (Pellan), (Type M2 III, red giant)

**Inhabited Planets:** Arcimis (Pellan III) inside the corona of Pellan

**Other Planets:** Pellan I and II have both disintegrated as Pellan has expanded into a red giant; Pellan IV and V (Class H) and Pellan VI-IX (Class J) remain outside the sun's surface.

**Other Stellar Objects:** A cometary belt outside the orbit of Pellan IX

**Artificial Objects:** None

**SIS:** Home of the Arcimi, a generally peaceful race desperately trying to survive the death of their planet

## SYNOPSIS

In "Red Giant" the Crew's ship arrives at Pellan to investigate signals from the Eye of Arcimis. When they arrive, their ship is damaged by the Eye and begins to fall into the red giant star. Unable to communicate directly with the Arcimi at first, the Crew must find a way into Refuge on their own. Here they learn the history of the Arcimi, and perhaps romance blossoms between an Arcimi technician and a Crew member. They also discover that Arcimis contains rich deposits of the dilithium needed to repair their ship.

Driven to desperation by the imminent doom of their world, and stunned by the revelations of first contact, Arcimis leader Dolvir orders the Crew taken as hostages, in order to force the aliens to help evacuate Refuge. Using the Eye of Arcimis, he threatens the crew's ship.

The Crew must escape from confinement while their ship deals with the hostage situation and the threat of the Eye of Arcimis. Ideally, the Crew find a means to bridge the cultural gap between themselves and the Arcimi, possibly with the help of a local visionary. Then they can address the threat to the aliens' homeworld and solve their own problem in the bargain.

## BEHIND THE SCENES

Starfleet assigns the Crew to investigate an unknown transmission coming from the system 443 Serpens. The transmission is the distress signal the Arcimi began sending hundreds of years ago, now finally detected by a Federation science station, which believes the signal to be an indication of intelligent life in the system.

In dealing with the Arcimi the Crew have a challenge on their hands. Arcimi culture is very

conservative and xenophobic. They have never had contact with aliens before, but they are also in dire straits.

Their desperation drives them to tolerate contact with aliens, but it also makes the Arcimi willing to take drastic measure to secure the ultimate survival of their civilization. The Arcimi are not villains, merely desperate people. The players should feel some sympathy for their plight, even though the Arcimi are not as welcoming as Starfleet could hope.

The main theme of this episode is IDIC, Infinite Diversity in Infinite Combinations. The Crew are called upon to put aside their own feelings about the Arcimi and do their best to overcome the aliens' prejudices in order to help them and their world. There is plenty of action in the episode, but the real test is of the Crew's diplomatic skills. Will they have what it takes to truly help the Arcimi?

## THE SUPPORTING CAST

The following characters play important roles in this episode. You may feel free to make up and add other supporting cast members as needed; use those provided as models for your own.

### ARCIMIS

**Planet Name:** Arcimis (Pellan III)

**Class:** F

**System Data:** Arcimis' moon was blown out of orbit and disintegrated when Pellan became a red giant.

**Gravity:** 0.9 G

**Year and Day:** Irrelevant, as Arcimis is inside the sun's corona and tidally locked to its core. The Arcimi still use a 254-day calendar and a 27.1-hour day.

**Atmosphere:** None; thick nitrogen-oxygen-carbon dioxide atmosphere in Refuge

**Hydrosphere:** None

**Climate:** Bombarded at all times by solar radiation, Arcimis has a surface temperature of 3500 degrees.

**Sapient Species:** Arcimi (about 7 million)

**Tech Level:** Level Five

**Government:** Technocratic oligarchy

**Culture:** Desperately regimented, under the weight of millennia of cultural conservatism

**Affiliation:** Independent

**Resources:** Arcimis is rich in dilithium deposits.

**Places of Note:** Refuge, a complex buried beneath the planetary crust, is the only habitation on the planet. The Eye of Arcimis, an experimental laser projector, sits directly above Arcimis' Refuge on the surface. Both are on the "night side" of Arcimis' northern hemisphere.

**Ship Facilities:** None

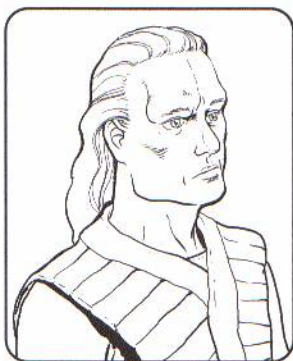

## ARCIMI

### HOMEWORLD

The Arcimi live on Arcimis, the innermost surviving planet of the red giant Pellan (443 Serpens). Arcimis lies within the star's corona, burned to a cinder. The surviving Arcimi live in an underground city deep beneath Arcimis' surface.

#### Attributes

Fitness 2 [5]  
 Coordination 3 [5]  
     Dexterity +1  
 Intellect 2 [6]  
 Presence 3 [5]  
     Willpower +1  
 Psi 0 [6]

#### Size

Arcimi are somewhat smaller and slighter than Earth humans.

#### Traits Common to the Species

Arcimi have pale, reddish skin, large, expressive eyes, little hair, and calm demeanors. They are quite long-lived and culturally conservative in the extreme.

## DOLVIR, THE MIND OF ARCIMIS

Dolvir is the leader of the surviving Arcimi civilization. He is one of the Arcimi's greatest philosophers, thinkers, and scientists, chosen to lead for his great intellect and wisdom. It was Dolvir who discovered that the recent tremors Arcimis has suffered are in fact harbingers of the planet's doom. He has not shared that information with his people yet, because he does not want to bring about mass hysteria and despair.

Dolvir is desperate for a way to save his people from destruction, and that desperation drives him to rash action in this episode. Dolvir is normally a man of peace, but he believes that desperate times call for desperate measures.

Dolvir is a tall, thin Arcimi with a shock of white hair around his balding head. He wears flowing robes

of white trimmed in gold and black. His expression is thoughtful and calm most of the time, although the burdens of leadership wear heavily on him at times.

#### Attributes

Fitness 1  
     Strength -2  
     Vitality +1  
 Coordination 2  
     Dexterity +1  
     Reaction -1  
 Intellect 6  
     Logic +2  
 Presence 4  
     Empathy -2  
     Willpower +2  
 Psi 0

#### Skills

Administration (Scientific) 3 (5)  
 Command (Scientific) 2 (3)  
 Computer (Arcimi) 0 (4)  
 Culture (Arcimi) 1 (5)  
 History (Arcimi) 1 (5)  
 Material Engineering (Crystalline) 4 (5)  
 Persuasion (Scientific Debate) 1 (5)  
 Physical Sciences (Physics) 3 (4)  
 Planetary Sciences (Geology) 2 (6)  
 Refuge Systems (Science Complex) (Eye of Arcimis) 3 (6)  
 Space Sciences (Astronomy) 1 (3)  
 World Knowledge (Arcimis) 1 (5)

#### Advantages/Disadvantages

Curious (+1)  
 Engineering Aptitude (+3)  
 Mathematical Ability (+3)  
 Arrogant (-1)  
 Obsessive Tendencies (-3)

#### Courage: 1

**Wound Levels:** 2/2/2/2/2/0

## JOBAR, HEAD OF THE GUARDIANS

Jobar is the leader of the Guardians, the maintainers of law and tradition among the Arcimi. Jobar is staunchly conservative, a believer in the old ways of Arcimis. He distrusts outsiders and aliens on principle, and prefers not to interact with them unless absolutely necessary.

Although Jobar respects Dolvir's intellect, he considers Dolvir an idealist who does not always understand the importance of discipline. Jobar is the Crew's most steadfast opponent in this episode.

#### Attributes

Fitness 3  
     Strength +1  
 Coordination 4  
     Reaction +1

Intellect 2  
Logic +1  
Presence 3  
Empathy -1  
Psi 0

#### **Skills**

Command (Leadership) 2 (3)  
Culture (Arcimi) 1 (3)  
Dodge 2  
First Aid (Arcimi) 1(2)  
Law (Arcimi) 1 (3)  
Melee Weapon (Stun Baton) 2 (3)  
Planetary Tactics (Small Unit) 2(3)  
Projectile Weapon (Arcimi Slugthrower) 2 (3)  
Refuge Systems (Science Complex) 2 (3)  
Search 2  
Security (Law Enforcement) 3 (4)  
Unarmed Combat (Brawling) 2 (3)  
World Knowledge (Arcimis) 1 (3)

#### **Advantages/Disadvantages**

Resolute (+3)  
Arrogant (-1)  
Intolerant (All Outsiders) (-3)

**Courage:** 3

**Wound Levels:** 3/3/3/3/3/0

### **SECOND ASSISTANT TRESK, POTENTIAL ROMANTIC INTEREST**

A senior assistant in the Refuge Science Complex, Tresk is a rarity among the insular Arcimi. She is a xenophile, fascinated with the new and the strange. She is very intrigued by the Crew and hungry to learn all she can about the larger universe outside of Refuge.

Tresk is a potential ally for the Crew, as well as a possible romantic interest, if the Narrator wishes. Although the text refers to Tresk as "she," feel free to make Tresk a male, if necessary, to provide a suitable romantic interest for one of the Crew.

#### **Attributes**

Fitness 3  
Vitality +1  
Coordination 3  
Dexterity +2  
Intellect 4  
Logic +1  
Presence 4  
Empathy +1  
Psi 0

#### **Skills**

Command (Scientific) 1 (2)  
Computer (Arcimi) 0 (3)  
Culture (Arcimi) 1 (4)  
Dodge 2  
Material Engineering (Metallurgical) 4 (5)

Persuasion (Scientific Debate) 2 (4)  
Physical Sciences (Physics) 3 (4)  
Planetary Sciences (Geology) 3 (5)  
Refuge Systems (Science Complex) 3 (5)  
Search 1  
Stealth (Stealthy Movement) 1 (2)  
Unarmed Combat (Brawling) 1 (2)  
World Knowledge (Arcimis) 1 (5)

#### **Advantages/Disadvantages**

Curious (+1)  
Engineering Aptitude (+3)  
Sexy (+2)  
Impulsive (-1)  
Pacifism (Cannot Kill) (-1)

**Courage:** 3

**Wound Levels:** 4/4/4/4/4/0

### **ARCIMI GUARDIANS**

The Arcimi Guardians protect the public peace in Refuge and, more importantly, uphold the traditions of the Arcimi people. They are among the most conservative of the Arcimi and the most distrusting of outsiders. The Guardians wear uniforms of dark red, trimmed in black, and carry slugthrowers and stun batons as weapons.

#### **Attributes**

Fitness 3  
Strength +1  
Coordination 3  
Reaction +1  
Intellect 2  
Perception +1  
Presence 2  
Empathy -1  
Psi 0

#### **Skills**

Dodge 2  
First Aid (Arcimi) 1 (2)  
Planetary Tactics (Small Unit) 2 (3)  
Projectile Weapon (Arcimi Slugthrower) 2 (3)  
Refuge Systems (Science Complex) 2(3)  
Search 2  
Unarmed Combat (Brawling) 2 (3)  
World Knowledge (Arcimis) 1 (3)

### **ARCIMI SLUGTHROWER**

Resembles a thick, long-barreled machine pistol. It fires a caseless round using a blow-back-powered autofeed system. A clip holds 20 rounds.

**Range:** 2/5/10/50

**Size:** .5 m

**Mass:** 7 kg

**Damage:** 4+2d6 per shot. For autofire, one



bullet hits for every 2 points the attacker rolls above the required Difficulty.

### ARCIMI STUN BATON

A stun baton is a short, thick rod of golden metal with a black handgrip. The rod crackles with energy when activated. Use the statistics for a Federation stunrod (*Star Trek: TNG RPG*, p. 238).

### ARCIMI ROBOTS

These robots resemble large quadrupeds. They move across the complex using both public walkways and dedicated access ducts. They can have any attachments the Narrator wishes, from cleaning brushes and solvents to screwdrivers, sonic probes, or rivet guns. They usually have Resistance 5 (metal and rocky machinery and skin), base movement 10/20, and Coordination 4. Tougher, faster, and more coordinated robots certainly exist, and the Narrator should feel free to introduce them as needed in the episode.

It takes a Moderate (7) Material Engineering (Metallurgical or Mechanical) Test, or a Challenging Test of any other Engineering skill, to disassemble a robot once it is immobilized. Reprogramming an Arcimi robot is a Challenging (10) Systems Engineering (Robotics or Communications) Test.

### TEASER: THE CALL

The episode begins with a subspace message from Admiral Tennant at Starbase 173. The Crew's ship is finishing up a routine mapping mission when they receive the transmission.

"Nine days ago, the Federation Science Station at Gamma Hydra IV detected an odd phenomenon associated with the red giant 443 Serpens. It was an unusual source of particle emissions, in very close orbit, blinking a series of what the science staff believes to be mathematically coded messages. You are ordered to proceed to 443 Serpens as soon as possible and to investigate this phenomenon. This close to the Romulan Neutral Zone, we can't afford to take any risks. Tennant out."

### STARFLEET'S DATA

Admiral Tennant's message arrives with a data file containing astronomical data about 443 Serpens, visual recordings of the messages, and the analysis of the Gamma Hydra IV scientists and the science staff of Starbase 173. Starfleet knows 443 Serpens as a relatively new red giant star (formed in the last few millennia). There are no records of the Arcimi or of any other civilization in that system.

The messages merely serve to indicate an intelligent origin—a Routine (5) Physical Sciences (Mathematics) Test confirms that the flashes are a series of prime numbers. A Routine (5) Space Sciences (Astrophysics) Test indicates that the pattern is not a

### ROMULANS

The potential threat of the Romulans is merely a "red herring." They actually have nothing to do with the signals coming from 443 Serpens. If the Narrator feels the need to add another subplot to the episode, the Romulans might also detect the Eye's signal and send a ship to investigate. The Romulans try to contact the Arcimi first, in hopes that their technology might be useful (in which case they're in for a disappointment). They may also discover the presence of dilithium on Arcimis, leading them to stake a claim on the planet. Although Romulan warp-drive technology is not dilithium-dependent, they have an interest in keeping a new source of dilithium out of Federation hands.

The Eye of Arcimis could destroy the Romulan ship as a warning of the Eye's power. It could also damage the Romulan ship as well as the Crew's vessel, forcing the two crews to cooperate in order to survive. If the Eye damages only the Federation ship, it could force them to hide from the Romulans within the star's corona, desperately trying to repair their systems and deal with the Arcimi before the Romulans find a way to come in after them.

naturally occurring phenomenon. These are the conclusions of the Starbase 173 science staff as well. There does not appear to be any sort of message encoded into the flashes.

### ACT ONE: ARRIVAL

It requires only a short time for the Crew's ship to reach the 443 Serpens system. Once they arrive, a Routine (4) Shipboard Systems (Sensors) Test reveals six planets orbiting the red giant (Pellan IV through IX, see the System Template on page 00). No scan reveals any signs of life or civilization, past or present, on any of these planets.

A Challenging (9) Shipboard Systems (Sensors) Test detects the ionized traces of the Eye of Arcimis' particle beam; plotting a direction along that line leads to the red giant itself. Once this is determined, a Challenging (9) Sensors Test can detect the presence of a planet inside the star's corona!

This is relatively uncommon, but by no means unique in Starfleet's experience. If the Crew has trouble finding Arcimis, have the Eye fire a "routine" signal pulse that happens to coincide with their visit. This reduces the difficulty of locating the planet to Routine (4).

A Difficult (13) Shipboard Systems (Sensors) Test, or the use of a remote probe (requiring a Challenging (9) Sensors Test), provides a detailed scan of the planet. There are no signs of life on the planet's surface, only molten rock. The only feature is the Eye of Arcimis—a crater several kilometers wide, lined with reflective material, making it a perfect optical parabolic surface. In the center of the crater rises a tall crystalline spike, the signal emitter.



## THE EYE STRIKES

Any scan of the Eye triggers a burst from it, hitting the ship. In addition to causing secondary damage to the hull, the particle beam causes critical damage to the ship's main warp chamber.

The ship's engineer must make a Propulsion Engineering Test to shut down the warp reactor safely before it breeches and destroys the ship. Have the engineer's player make a Test (if the engineer is a player character). The ship is safe regardless, but tell the players they came very close to being destroyed.

The Eye's particle beam, operating on a precise dilithium frequency, has fused the ship's dilithium crystals, rendering them useless. The main antimatter reactor cannot function without intact dilithium crystals.

Unfortunately, there is currently no way to replace them (any replacement crystals on board were also fused by the blast). The impulse drive is also damaged. The ship is capable of limping along at one-quarter impulse power.

Without warp power to the vessel's engines, the Crew's ship is being irrevocably drawn in toward the red giant star. They have only four hours before they begin to burn up inside the star's corona. Time will run out quickly.

## APPROACHING ARCIMIS

With their ship damaged, the Crew's options are limited. The ship's Power is reduced to 10% of normal, using only the on-board fusion reactors, which means very limited use of engines, shields, and weapons. They cannot break away from the star's gravity, but they may be able to reach the planet and use it to help stabilize their position. The planet also offers the only possibility of assistance. Although the Crew can detect Arcimis and the Eye, they cannot communicate with the Arcimi, nor can their sensors provide more information on the planet, because of interference from the star's radiation.

In order to investigate further, the Crew must get closer to the planet. This requires taking the ship into the star's corona, something even the ship's shields cannot withstand for long. A Challenging (9) Systems Engineering (Shields) Test allows a character to remodulate the ship's shields into a metaphasic shield, sufficient to protect them from the star's corona. The same Test could also outfit a shuttlecraft with a metaphasic shield. Such a shield will only last a few hours before being overwhelmed by the star's heat and radiation.

Once within orbital distance of Arcimis, the Crew can detect the existence of the subterranean Refuge



with a Moderate (7) Shipboard Systems (Sensors) check. Sensors show a large concentration of life-forms several kilometers beneath the planet's surface, along with an extensive underground civilization. The close proximity of the star, and the make-up of the planet's crust, prevent the Crew from establishing direct communications with the Arcimi.

Beaming an Away Team into the Refuge is possible, but difficult while the metaphasic shielding is in place. It requires a Challenging (9) Shipboard Systems (Transporters) Test to modify the transporter to work through the metaphasic shield. The ship also has to route power to the transporters long enough to beam an away team in.

The crew can also try to send a shuttle down to the surface of Arcimis. A deep chasm near the Eye leads down into the depths of the planet where Refuge is located. The chasm is a bit narrow, but a good pilot can navigate it with no problems by making a Moderate (7) Vehicle Operations (Shuttlecraft) Test. The crew's shuttle locates a sealed docking bay outside of Refuge. When they approach, the bay doors open to admit them.

In either case, the Crew is not going to get very far until they try to establish contact with the Arcimi.

## ACT TWO: INSIDE REFUGE

However they arrive, the Crew has an opportunity to look around a bit before they encounter any of the

### THE EYE OF ARCIMIS

It may be necessary for the Narrator to use the Eye of Arcimis as a weapon, either accidentally or in a showdown between the Arcimi and the ship. The Eye fires a powerful particle beam. Although similar in strength to a phaser weapon, the beam has an unexpected effect against a dilithium-controlled starship's systems, as described above.

**Range:** 1000/3 million/9 million/27 million

**Arc:** 30 degrees

**Accuracy:** 5/9/13/20

**Damage:** 25

**Power:** [25]

Reduce the Eye's damage at each range marker. At "short" range the Eye does 65 points, at medium it does 43, and at long range only 29 points. Beyond 27 million kilometers (roughly the orbit of Pellán IV), the Eye's beam is detectable as a coherent particle beam but causes little or no damage to something as large as a starship.

Since the Eye shoots a beam of coherent particles along a very narrow wavelength, a Routine (4) Shipboard Systems (Sensors) Test combined with a Moderate (7) Systems Engineering (Weapons) or Shipboard Systems (Tactical) Test can modulate the ship's shields to offer +5 protection against attacks from the Eye. This also blocks the effect the Eye has on the ship's power systems.



Arcimi. Refuge is a dimly lit subterranean colony of tunnels cut through the solid rock of the planet. The air inside is dank and stale, poorly recycled. What technology the Crew can see seems to have a strongly crystalline structure. The walls of the tunnels are also covered with clusters of different types of crystals. Some of these crystals glow softly, shedding what little light is found outside of the Arcimi shelters and caverns. A Moderate (7) Physical Sciences (Geology) or Propulsion Engineering Test allows a character to notice that some of the crystals are deposits of raw dilithium!

As the Crew examine their surroundings, an Arcimi robot appears. The robot looks like a large mechanical quadruped, equipped with tools for cleaning the tunnels and chambers. The robot is harmless, although it might startle the characters. It is not capable of understanding or communicating with them (although characters might try). A Routine (3) Systems Engineering (Robotics) or Computers Test shows that the robot is fairly crude by Federation standards.

### TRESK

A small group of four Arcimi, led by Tresk, rounds a corner of one of the tunnels not far behind the robot and spots the Crew. If the Crew arrived via shuttlecraft, the Arcimi detected their approach and sent a

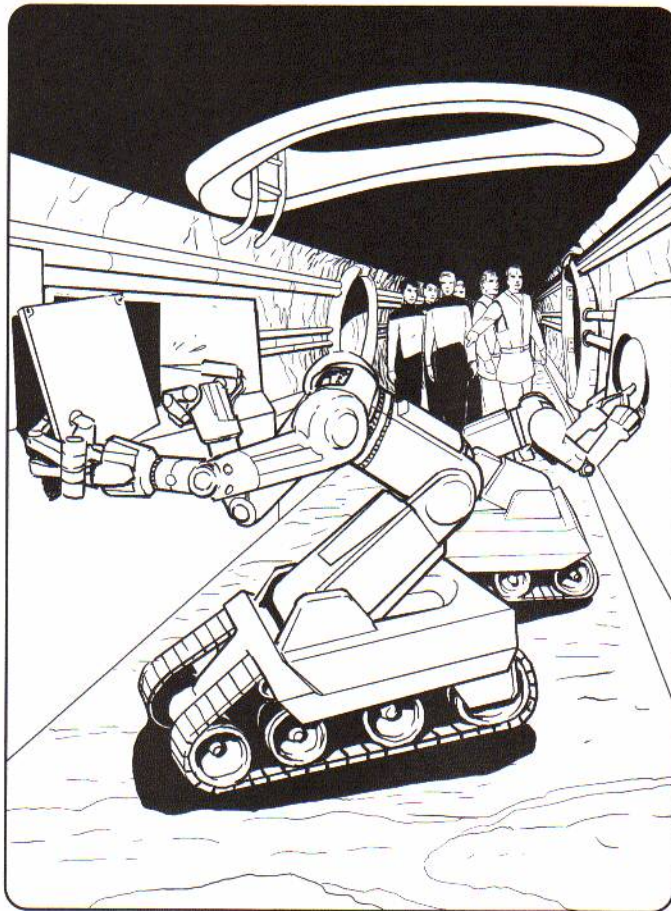

welcoming party to greet them. If the Crew beamed into Refuge, then Tresk and her crew are simply on their way to perform maintenance on the robot the characters just encountered. Either way, they will be somewhat taken aback by the appearance of aliens inside Refuge. Tresk welcomes the Crew warmly, but the other Arcimi seem suspicious and wary.

The Crew's universal translators have no difficulty dealing with the Arcimi language, allowing them to converse after only a few moments of confusion. Tresk welcomes them and tell them her name, the name of the planet, and of the city they are in. She is clearly brimming over with questions and asks the Crew who they are, where they have come from, and about their ship and their technology.

Eventually, one of the Arcimi with her mentions that Tresk should not keep Dolvir and Jobar waiting. Tresk nods and blushes, turning a deeper shade of red. "My apologies," she tells the Crew. "You should meet with the leader of our people. I will take you to him." Tresk asks the characters to follow her.

## HOPE AND FEAR

The Crew is taken to meet Dolvir, the leader of the Arcimi, and Jobar, the head of the Guardians. They greet the crew in a large, high-ceilinged chamber in a central part of Refuge. Dolvir introduces himself ("I am Dolvir, the Mind of Arcimis.") and introduces

Jobar as "the leader of the Guardians of Arcimis." He asks the Crew where they come from and how they got to Arcimis.

He apologizes for the damage the Eye of Arcimis caused to the Crew's ship, saying that the Eye was never intended as a weapon, only a means of communication. Its effect on the ship's engines was completely unintentional. During the introductions and the conversation, Jobar stands in the background, watching the Crew warily but letting Dolvir do all the talking.

Dolvir insists on taking the Crew on a tour of Refuge. Jobar objects at first, but Dolvir insists that the Crew are guests and must be treated properly. Jobar agrees only reluctantly, but does follow along as Dolvir guides the Crew through Refuge. Tresk tries to tag along as well, but Jobar turns to her and says, "Don't you have duties to perform, Tresk?" She looks down and agrees, leaving the room with a backward glance at the Crew (particularly the character she is developing a romantic interest in).

While making their way through the elevators, tunnels, and catwalks, the Crew notice that much of Refuge appears deserted, dark, and ill-kept. The Arcimi they encounter seem downtrodden and somewhat nervous around them. Dolvir explains that the Arcimi population has decreased over the years.

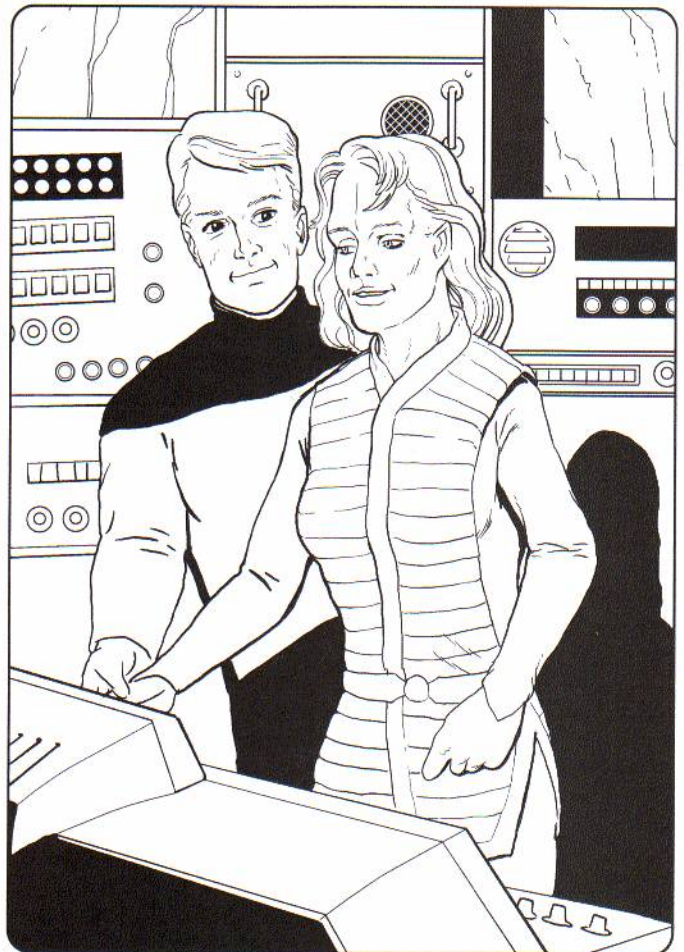

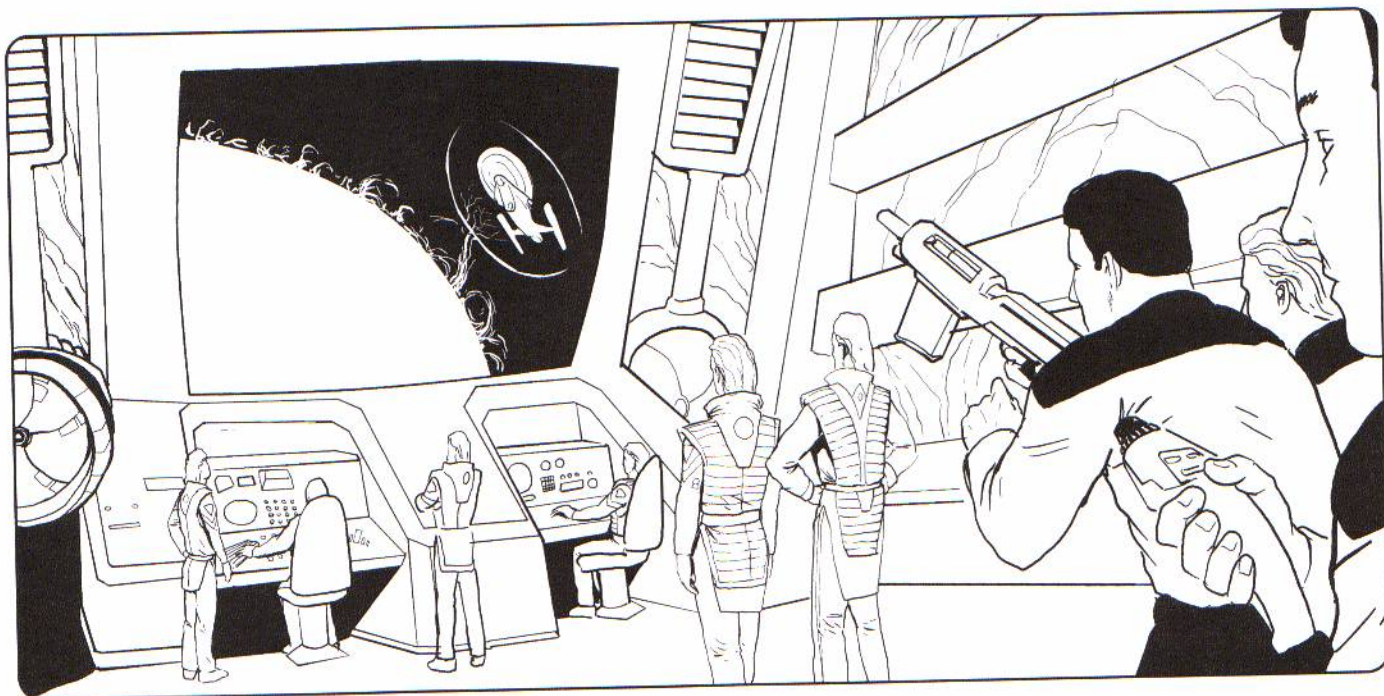

Some areas of Refuge are no longer in use. "The long period of waiting has weighed heavily on us," says the Mind of Arcimis with a sigh. It is clear that Dolvir has the weight of the world on his shoulders.

The first stop on the tour is a large control room with Arcimi technicians working at some kind of large crystalline control panel. They pass their hands delicately over it to change its electrical charge; sparks and lights go off when they touch the crystal "keys." Dolvir explains that all Arcimi control surfaces use piezoelectric interfaces. He asks the characters what sort of control systems their machines use.

The centerpiece of the room is a wide viewscreen showing (in fuzzy detail) the boiling corona of the star and the Crew's ship. Dolvir tells the Crew, "This is where we control the Eye of Arcimis, which sent the message that brought you to us."

While they are in the control room, a minor quake rips through Refuge. The ground trembles and the walls shake. Some loose shelves and other objects topple over, but there is no serious damage or injuries. The Arcimi look startled by the quake and concerned. Dolvir looks grim after the quake, and immediately invites the Crew to follow him to his laboratory.

Dolvir's lab is a large, well lit room. The walls are covered with drawings and graphs in Arcimi script. A Moderate (7) Space Sciences (Stellar Cartography) Test allows a character to recognize one of the charts as a stellar globe showing 443 Serpens in the center. Gamma Hydra is one of the stars marked on it. A large device, obviously a primitive computer, holds a place of pride in the room.

Its readouts are dials, and its controls are a crystalline matrix similar to the controls of the Eye of Arcimis. A Challenging (10) Engineering check (or a

Difficult (13) Physical Sciences check) gives the impression that the Arcimi are far more comfortable with physical and materials science than with energy manipulation. Arcimi work in the background, and Arcimi Guardians (see p. 90) in metallic red uniforms stand by with smoothly efficient-looking slug-throwers.

## HOPE DASHED

When the Crew reaches Dolvir's laboratory, he will give them the information presented in beginning of the episode (p. 87), describing Arcimis' past and the desperate hope of Refuge, which is becoming slow suffocation and imprisonment. Dolvir's own research indicates that Arcimis is slowly becoming geologically unstable. In addition, the now-ancient systems of Refuge have begun to break down and fail after more than a thousand years of continued use, and it is becoming increasingly more difficult to replace them.

"We need assistance," Dolvir says, clearly with great reluctance. It is difficult for the proud Arcimi to admit they need outside help. "We need ships, like yours, to carry our people away before our world is no more."

If the Crew offer to help the Arcimi, Dolvir appears hopeful, while Jobar seems suspicious. The Guardian leader plays devil's advocate and asks the Crew questions like, "What will you do after you have helped us to reach another world?" and "What do you expect from us in return?" Both men will bristle slightly at any mention of the Arcimi joining the Federation, Jobar more than Dolvir. The concept is too much for their conservative culture.

If the Crew ask the Arcimi for help in repairing their ship, Dolvir calls Tresk and tells her to help the





Crew gather the necessary dilithium crystals. As Tresk happily leads the Crew from the lab, they can feel Jobar's cold gaze on them, following their every move.

## CRYSTALS AND COMMUNICATION

Tresk assists the Crew in finding the dilithium crystals suitable for use on board their ship. The Crew will still need to refine the dilithium, but they can find or jury-rig the necessary tools from the equipment available to the Arcimi. A Challenging (9) Propulsion Engineering Test is necessary to locate and refine a suitable source of dilithium.

Meanwhile, the Arcimi work diligently to establish communications with the Crew's ship. The Eye of Arcimis can be directed to project a low-level beam to communicate with the ship by modulating off its shields, without doing any damage to the ship or its systems.

An astute character can figure this out with a Challenging (10) Systems Engineering (Communications Systems) Test. If one of the Crew doesn't hit upon the idea of setting up a communications link, Dolvir does, and informs the Crew when it is established.

## ACT THREE: THE LIGHT IN THE DARKNESS

While the Crew works with Tresk and the Arcimi technicians, Jobar speaks with Dolvir. The Guardian leader is suspicious of the strange aliens and, although he won't admit it, does not wish to leave the relative safety of Refuge. Jobar convinces Dolvir that they cannot risk the destruction of Arcimis by trusting the aliens. The Arcimi must gain control of their ship and technology.

Dolvir reluctantly orders the Guardians to arrest the Crew and imprison them. A group of Guardians, armed with slughtrowers and stun batons and led by Jobar, show up where the Crew is working and place them under arrest. Tresk protests loudly, but the Guardians ignore her and order the characters to come with them. If the Crew refuse to surrender peacefully, the Guardians move in, first with their stun batons and then with their guns, if necessary. There is one Guardian present for each character, plus Jobar.

If they surrender, Jobar takes the Crew's tricorders, phasers, and any other weapons, but not their combadges. (Unfortunately, the combadges cannot penetrate the interference created by Arcimis' crust and the star's radiation to contact the ship.) Dolvir contacts the Crew's ship using the recalibrated Eye of Arcimis. He orders them to surrender the ship and to begin sending the crew down in shuttles, or the hostages will not be returned.

Additionally, if their demands are not met, the Arcimi will not provide any dilithium to repair the ship's warp drive. As a final threat, Dolvir will remind the ship's crew that the Eye of Arcimis is trained on them, and that the Arcimi will use it if they must. They have one hour to decide.

At the end of the ship's deadline, Dolvir orders the Eye of Arcimis to open fire on them, hoping to force them to accede to his demands. The Crew on board the ship has to deal with the threat of the Eye without their full power systems and shields to protect them.

## ON THE RUN

If the Crew on Arcimis manage to escape from the Guardians without being captured, they find themselves on the run through the twisting tunnels and passages of the underground city. Tresk goes with them, helping guide them someplace safe where they can hide out for a short while. Eventually, the Crew need to determine how they will handle the situation with the Arcimi.

Tresk makes a case for her people and asks the Crew not to judge all Arcimi by Jobar's xenophobic standard. She hopes to help the Crew repair their ship so they can help her people. She refuses to give up on this plan unless the Crew make it clear they will not help the Arcimi. In this case Tresk becomes teary-eyed and says, "I guess I was wrong about you then," looking specifically at her romantic interest. She leaves

the characters on their own but doesn't turn them in. She feels they deserve that much, at least.

Tresk's hiding place is an unused mining area where the Arcimi gathered some of the materials used to build the Eye of Arcimis. The tunnel walls still have numerous crystalline deposits. A Moderate (6) Material Engineering or Propulsion Engineering Test determines that some of the crystalline material in the walls is actually raw dilithium. It appears that parts of the planet are riddled with the material. Arcimis could be one of the largest natural dilithium sources ever discovered!

Once the Crew discover this, it requires only a Routine (4) Material Engineering or Physical Sciences Test to determine that the high dilithium deposits are the source of the planet's tremors. The dilithium ore is converting the radiant energy of the star into mechanical energy, which is creating tidal stresses that are tearing the planet apart. If the dilithium matrix is broken down, or the energy is channeled in some other way, then the threat to Arcimis will be ended, at least for the time being.

## ESCAPE!

If the characters are arrested, the Guardians imprison them. The Arcimi prison is a large room with a sliding door; the walls are made of a stone and crystal lattice that is quite strong. The door is a honeycombed pattern of crystalline material. There is sufficient dilithium ore in the walls for the Crew to make the same discovery as in "On the Run," above.

It's up to the Crew to figure out how to escape from their cell. It is possible to run a charge from a couple of combadges through the dilithium crystal matrix in the walls, blowing out the door. This requires a Difficult (12) Systems Engineering or Demolitions Test. It also completely drains the affected devices.

A psionic character can attempt to convince the guards that the Crew has already escaped, getting them to open the cell, or the Crew could try the old "sick prisoner" routine to get a guard to open up the cell. Let the players come up with the plan; give it a reasonable chance of success if it's a good one. Remember that the Arcimi are suspicious, but they have no prior knowledge of alien species, so they Crew shouldn't have a difficult time coming up with a plausible lie.

Tresk is another possible means of escape for the Crew. She doesn't believe that racial survival is worth betraying first contact. She feels that the aliens (especially that cute one) are too important to be mistreated. Tresk shows up and either orders the guards away or simply cold-cocks them and lets the Crew out.

Tresk is even more likely to help the Crew escape from prison if she has reason to believe that the Crew (or a single member of the Crew) have figured out a way to save Arcimis. If the Crew have such a plan, and they try to communicate it to anyone, Tresk hears about it and comes to help them.

"Please don't judge us all by our leader's actions," she says. "Dolvir is a good leader, but the threat of the end of our civilization has driven him to desperation, and I believe he is being misled by Jobar. Please, if there is any way you can help us, I will do whatever I can to convince Dolvir to let you go."

Escaping from Arcimis itself is somewhat more difficult: Combadges cannot transmit through the dilithium-laced rock and solar storms, which prevents the Crew from simply beaming out without some kind of outside assistance. Unless they come up with a particularly clever way to contact their ship, the Crew are on their own.

## THE HEART OF THE PROBLEM

For the episode to conclude in a satisfactory manner, the Crew should come up with a solution to Arcimis' problem as well as their own. If they can capture the control center for the Eye of Arcimis, or one of Refuge's fission power plants, they can negotiate with Dolvir. The Arcimi leader is not unreasonable. He is willing to listen to the Crew, provided they can get his attention.

Let the Crew come up with a plan to gain access to a vital system of Refuge, from which they can bargain with Dolvir. Tresk can help the Crew with suggestions and her knowledge of Refuge's layout. The Crew can then execute their plan. If they succeed, they can speak with Dolvir from a position of some strength. Even if they fail, they are captured by the Arcimi and still gain an opportunity to speak with Dolvir.

Jobar does his best to discredit the Crew, claiming they are a threat to Arcimis. If the Crew can convince Dolvir that Jobar is acting out of fear and not on any reasonable basis, the Arcimi leader listens to them. This should take more than just a few Diplomacy Tests. Give the players a chance to roleplay convincing Dolvir of their good faith. If they make a good argument, Dolvir listens.

The most obvious solution to the Arcimi's problem is to give them the means to tap into the natural dilithium matrix of their planet, channeling its energy into useful purposes and draining off the excess energy that is causing the quakes and tremors. This can be accomplished fairly easily with Federation technology. This will stabilize their planet and provide them with the power they need to survive. In return, the Arcimi can supply dilithium crystals to repair the Crew's ship and allow them to clear the star's corona. Once they return to a starbase, the Crew can dispatch a Federation envoy to assist the Arcimi.

## EPILOGUE

If the Crew are successful in aiding the Arcimi, then the Federation gains a strong ally in a strategic corner of the quadrant, a valuable source of dilithium, and a prime location for solar energy research. The Arcimi gain a new lease on life and an opportunity to

migrate eventually from their ruined homeworld to a new colony planet with Federation aid. Arcimis eventually becomes a Federation mining and research colony with Arcimi assistance.

## AWARDS

For characters who escaped Arcimis: 1 Experience

For characters who solved the Arcimi crisis: 2 Experience

For characters who did either with minimal violence, or with extreme cleverness: +1 Experience

For characters who did either with brute force: -1 Experience

Add one experience point if the Narrator added the Romulans to the episode.

For the Crew member who figures out how to fly the ship into the star: +2 Skill Renown

Solving the Arcimi crisis without bringing in other Starfleet vessels or Federation personnel: +2 Initiative Renown

For a close-to-peaceful first contact with the Arcimi: +2 Openness Renown



# Maps

## MINOSIAN EMERGENCY HEADQUARTERS

1. SURFACE SHAFT
2. EXECUTIVE LIVING AREA
3. WATER AND AIR PROCESSING
4. SENIOR MILITARY LIVING QUARTERS
5. FOOD PREPARATION
6. SITUATION ROOM
7. STAFF LIVING QUARTERS
8. BARRACKS
9. MANUFACTURING AND MAINTENANCE
10. COMMUNICATIONS CENTER
11. MEDICAL CENTER
12. POWER PLANT
13. COMPUTER CORE

### SECTION B HABITATION

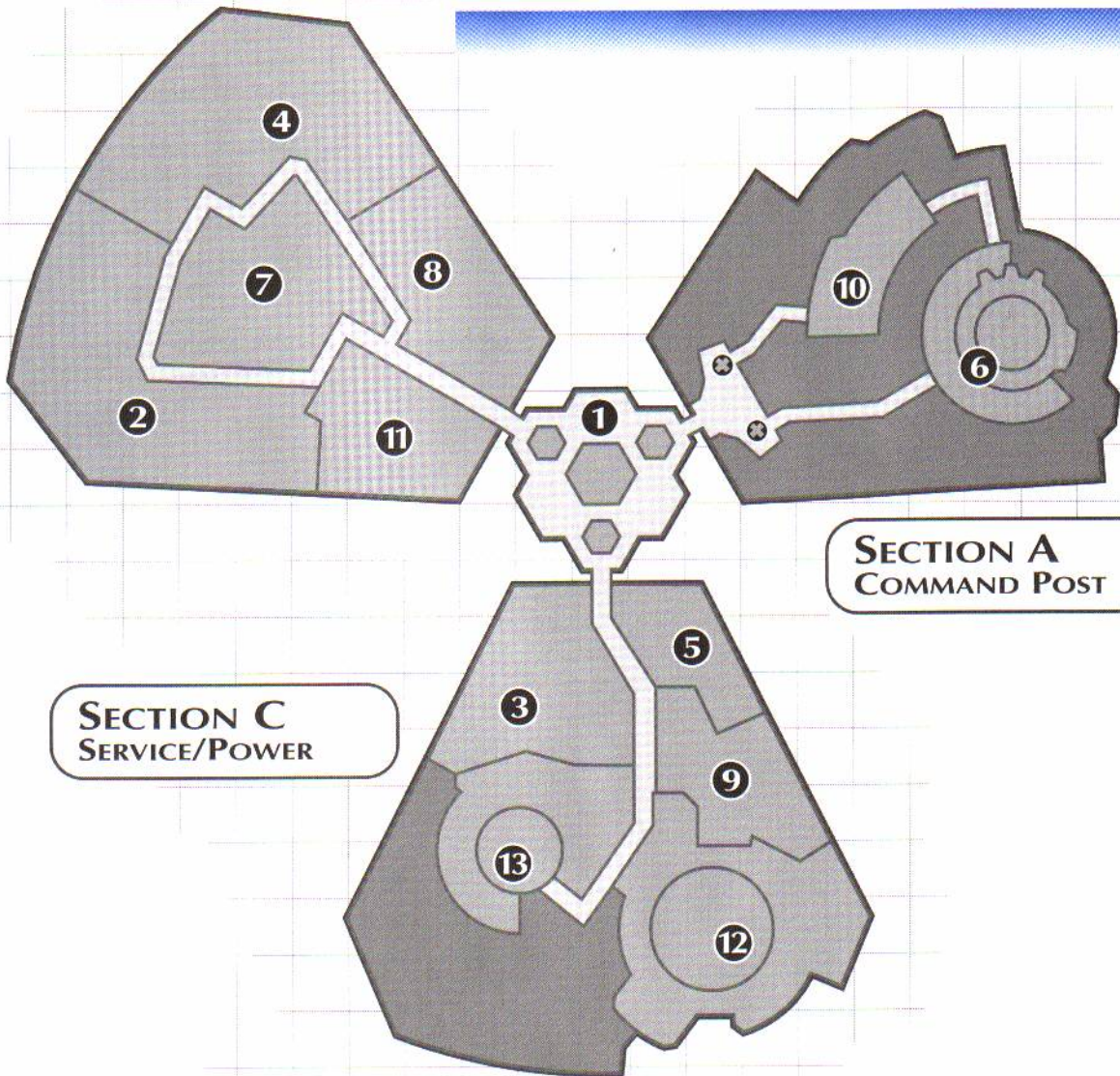

### SECTION A COMMAND POST

### SECTION C SERVICE/POWER

### COMPUTER CORE CHAMBER

- 1. COMPUTER CORE
- 2. HATCH

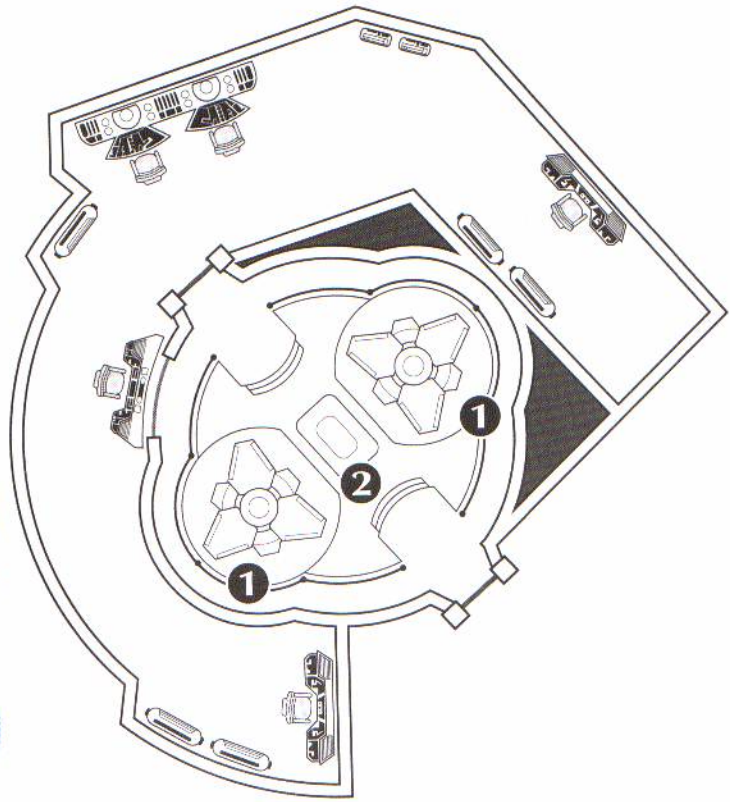

### SITUATION ROOM

- 1. TACTICAL CONTROLS
- 2. HOLO-DISPLAY

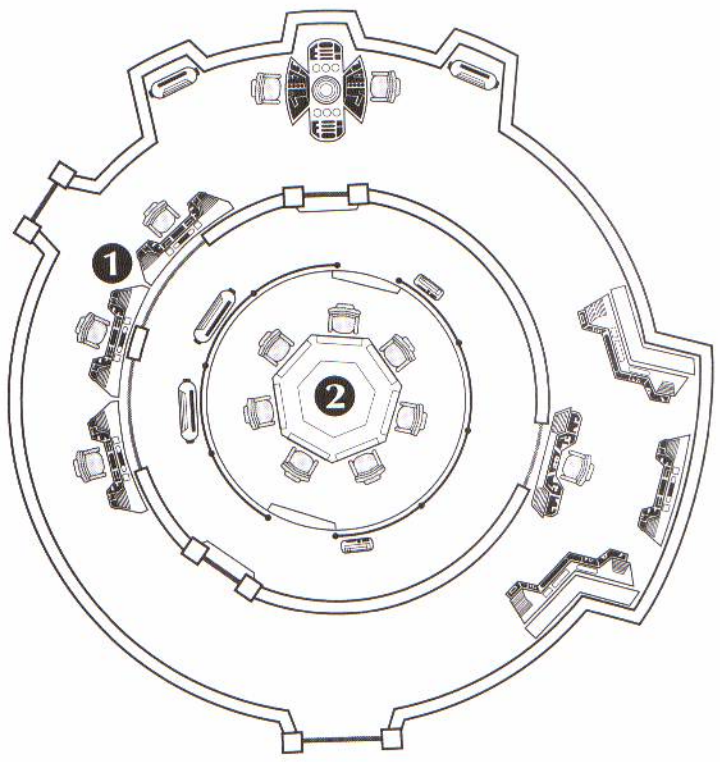

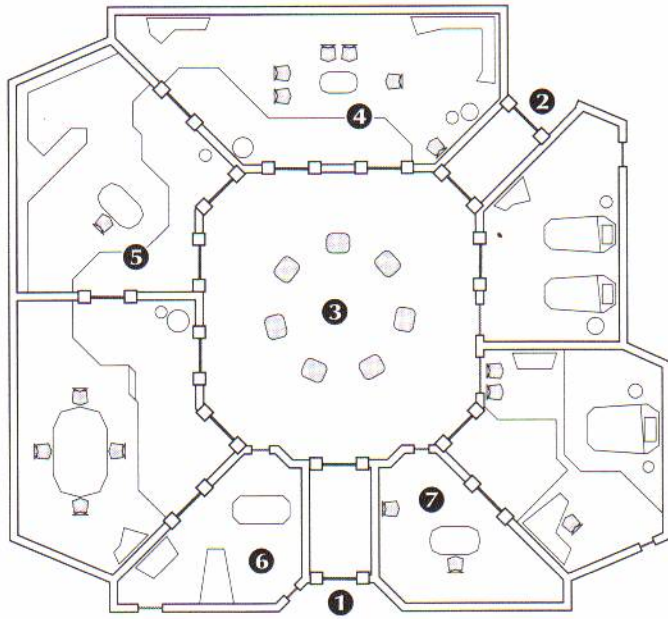

### DR. VIREL'S HOUSE

1. MAIN ENTRANCE
2. BACK ENTRANCE
3. GARDEN
4. LIVING ROOM
5. LIBRARY
6. KITCHEN
7. PRIVATE STUDY

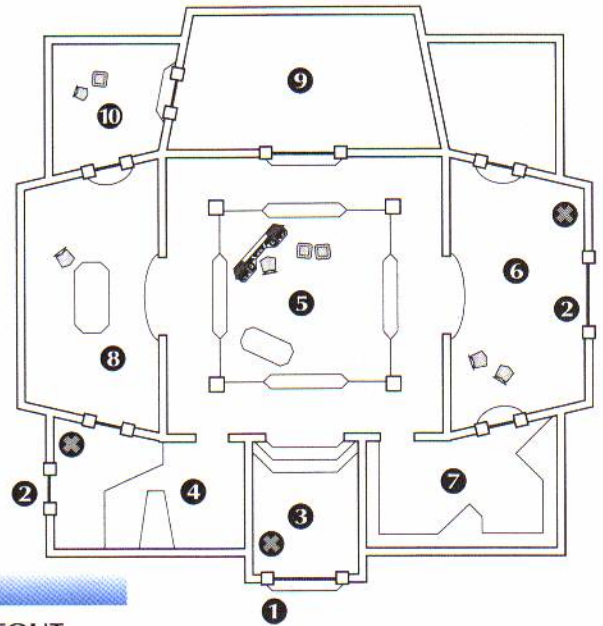

### SILAK'S HIDEOUT

1. MAIN ENTRANCE
2. SIDE ENTRANCES
3. FOYER
4. KITCHEN
5. LIVING ROOM
6. SITTING ROOM
7. LIBRARY
8. DINING ROOM
9. MAIN BEDROOM
10. SECOND BEDROOM

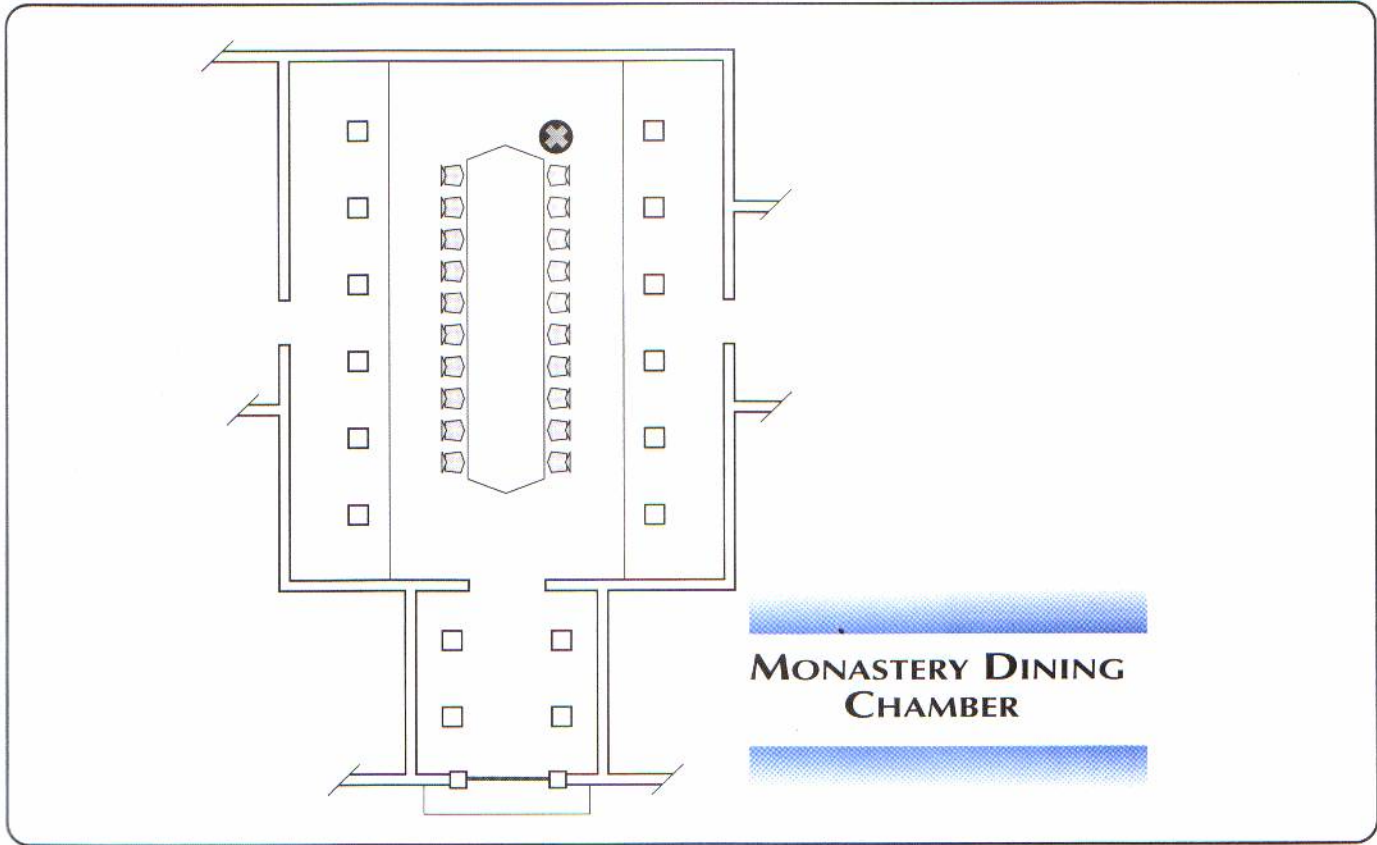
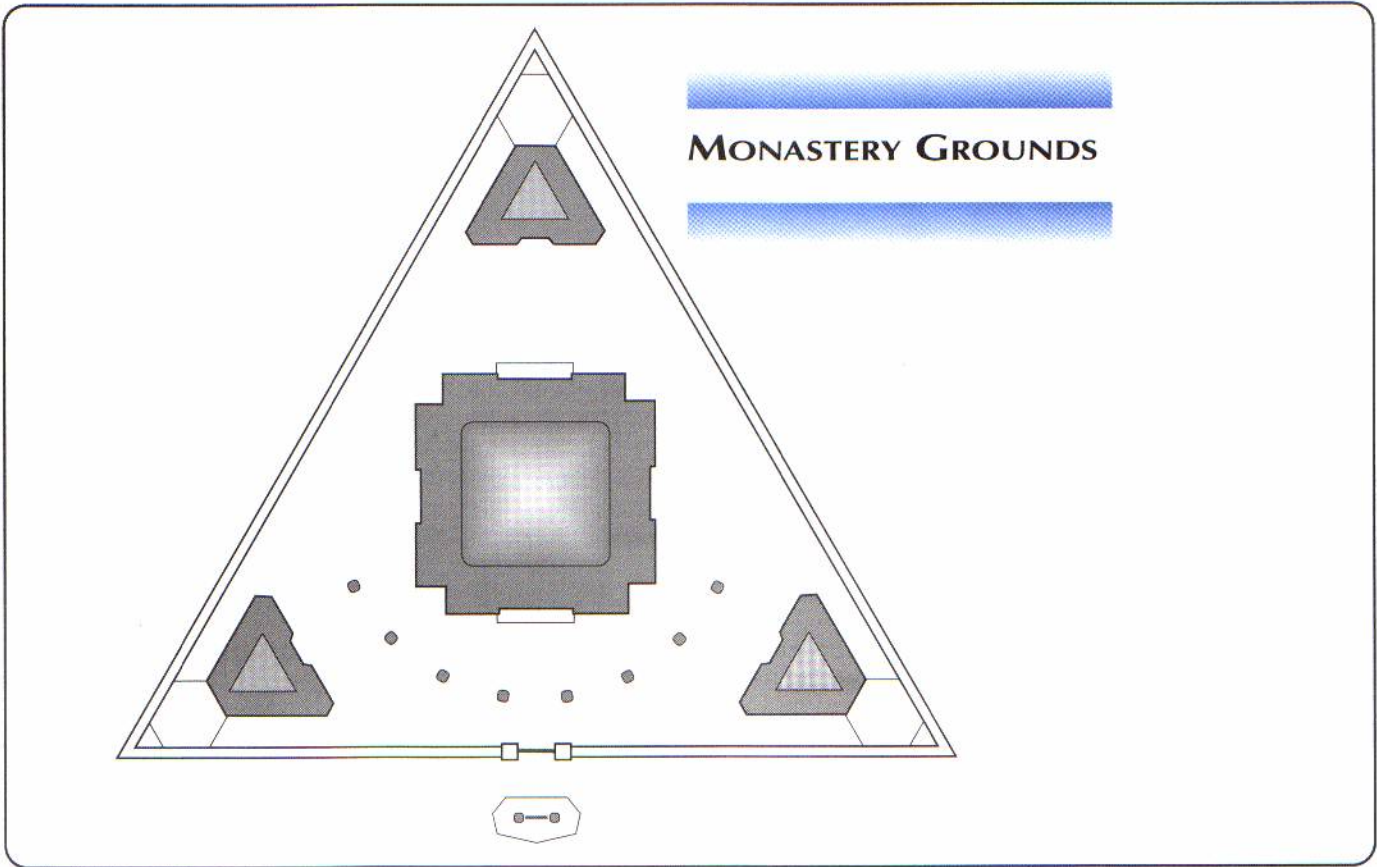



NEW CIVILIZATIONS

STRANGE NEW WORLDS

FASCINATING ENIGMAS

Exploration is Starfleet's primary mission. Starships venture into uncharted regions of space, searching for new lifeforms and new civilizations, in the bold hope of establishing friendly relations. One week, you may be orbiting Ligon II, for delicate negotiations. The next, you might find yourself making first contact with a sentient star. Who knows what tomorrow will bring? One thing is constant no matter where your duty takes you—you're always in for an adventure.

Planetary Adventures provides Narrators with five ready-to-run adventures for their *Star Trek: The Next Generation*® series. Return to the weapon world of Minos to delve further into its mysteries. Wander the colorful bazaars of ShirKahr on Vulcan. Or make a foray into the dangerous dark matter nebula Mar Oscura. Like the *Star Trek: The Next Generation*® TV series, with this book players can visit a new planet every week. A companion volume to *Planets of the UFP: A Guide to Federation Worlds*, this book gives players a complete picture of adventuring within the Federation.

*Planetary Adventures includes:*

- Five complete adventures for Narrators to use as part of their ongoing series.
- New species, technology and maps.
- In "Ghosts of the Past," the Crew follows the path of the *Enterprise-D*, returning to Minos to explore the reason for the planet's demise.
- In "On the Edge of Night," the Crew must brave the dangers of a dark matter nebula and an exploding neutron star.
- "The Enemy You Know" brings the Crew to Vulcan, and into the heart of Romulan intrigue.
- "The Cradle Will Fall" returns to Aldea, where the Crew must confront a challenge that threatens this legendary planet of peace.
- "Red Giant" takes the Crew under the skin of a dying sun to save a doomed people.

LUG 25301 \$16.00

ST25301  
Star Trek: Planetary Adventures Vol. 1  
Price: 16.00

