

STAR TREK

ROLEPLAYING GAME



ENTERPRISE SOURCEBOOK



This e-book is a non-profit venture and for the promotion of the Star Trek RPG line by Decipher. Star Trek and related are the property of Paramount Pictures, a Viacom company. The Coda engine for which the RPG uses is also the property of Decipher, Inc. No copyright infringement is intended.

CREDITS and THANKS

Volker Maiwald (for allowing a port of his Enterprise Sourcebook for Icon)

Don Mappin, Steve Long, Jesse Heinig, and the rest of the crew for the creation of the Star Trek RPG line for Decipher, Inc.

N.B.

If you like to contribute to this endeavor please email me at mfamith@msn.com or if you see any discrepancies, also contact me.



WRITERS:
J. GALLOPS
EINAR RICHTER
VOLKER MAIWALD
"ANTONSB214"
"SPACE_CADET"
"SNAKE_PLISKEN"
"ICEGIANT"



TABLE OF CONTENTS

INTRODUCTION	5
SETTING	6
ALIENS	12
DENOBULANS	13
KZINTI	15
XINDI	17
EQUIPMENT	21
PERSONAL	22
WEAPONS	23
SHIP SYSTEMS	25
SHIPS	26
STARFLEET	27
VULCAN	29
ANDORIAN	31
KLINGON	32
XINDI	38
SULIBAN	45
THOLIAN	50
INDEPENDENT	51
GAMEMASTERING	55
APPENDIX	58

FIRST EDITION

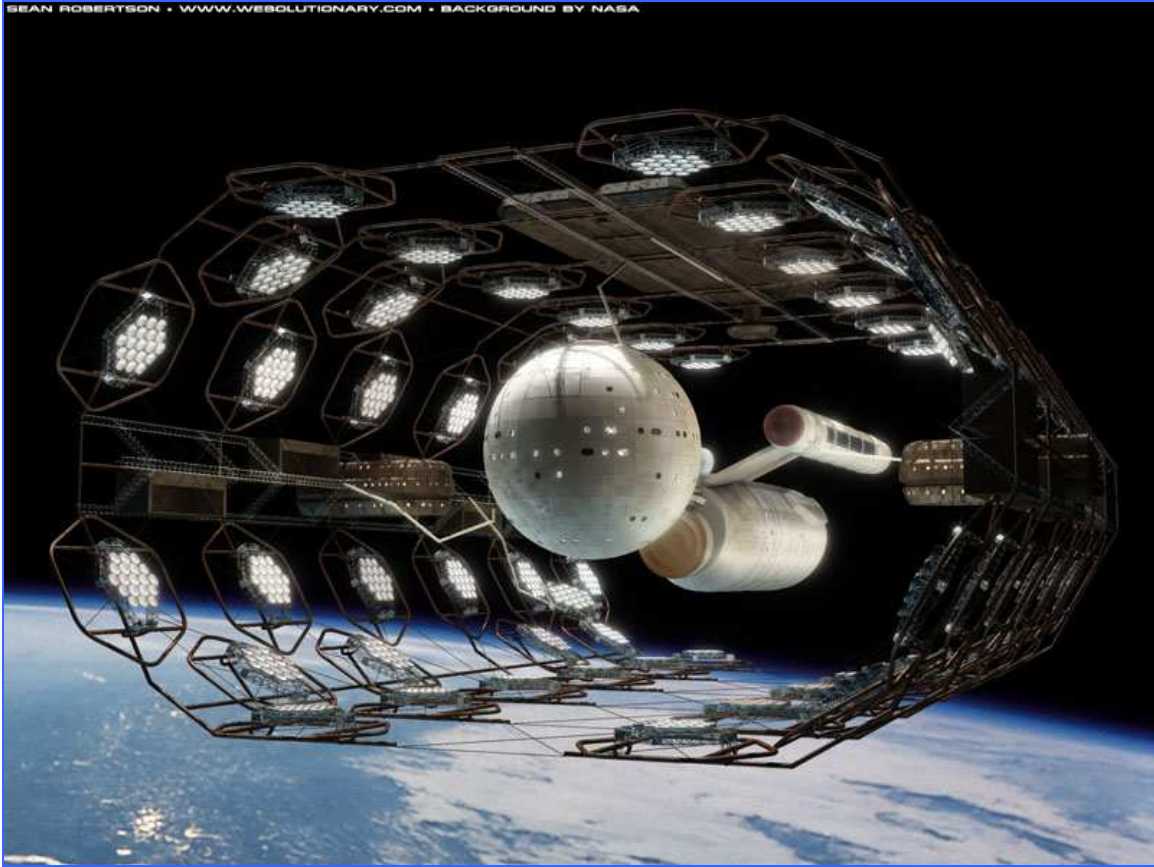

INTRODUCTION

So why role-play in the 22nd century? Well, it offers a chance for players a challenge not usually present when role-playing in the latter centuries. Technology and science is not quite advanced and therefore not the usual savior in the game. The history and inter-species relations are not yet established, which opens non-trek gamers to the Star Trek RPG who usually don't have knowledge of Star Trek universe. The attitudes and politics of space faring civilizations are less mature, not to mention that Starfleet personnel are like modern day humans in mannerisms. The galaxy is like the "wild the west" waiting to be explored.

The purpose of this sourcebook is to provide information on running a campaign in the 22nd century in one e-book. Unfortunately, the *Player's Guide* and *Narrator's Guide* by Decipher came out around the time *Enterprise* first premiered, our first glimpse into the 22nd century of the Star Trek universe, so information is limited. Ultimately, several sourcebooks touched upon this century. Any stats or information already present in the current line will not be touched upon in this sourcebook.

To fully use this material, you must already have the [Player's Guide](#) and [Narrator's Guide](#). [Starships](#) is also required if you need stats on 22nd century ships along with guidelines on building your own starship. [Starship](#) has the stats for the NX-01, Raptor class, Shuttlepod One, and a few more ships. [Aliens](#) contains information on most of the relevant aliens featured on *Enterprise* including the Suliban, and [The Starfleet Operations Manual](#) contains some brief information on 22nd century Starfleet and related equipment, like the universal translator.

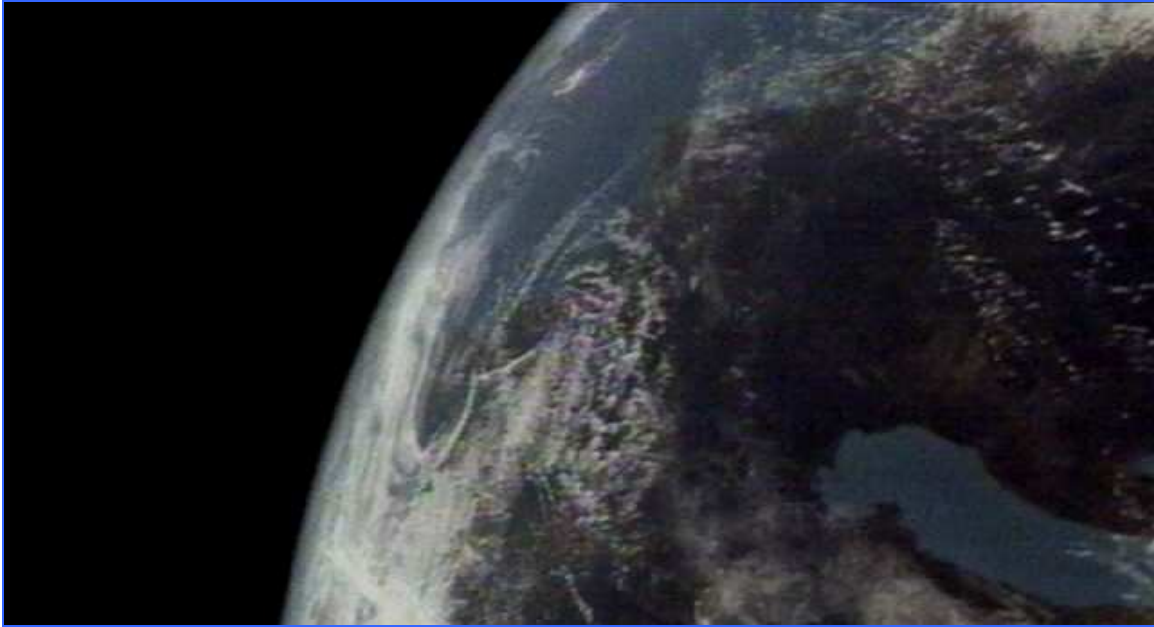

SETTING EARTH

Earth, the once to be capital of the UFP, is quite different from what it will be in the future. With the World War III not too long ago, the long lasting effects of this war are still sensible. Thanks to the Vulcans the more dramatic side effects of nuclear weapons could be prevented, as they helped to stop genetic mutations and vicious diseases like cancer.

HISTORY



Earth had several more or less advanced high cultures in the past, among them the Egyptians, the Romans and Aztecs. After the fall of the Roman Empire in the 5th

century A.D., the Middle Ages or more appropriate the Dark Ages began. Humanity raged in war against each other and several powerful Empire rose and fell during that time. In the 16th century, humanity remembered its philosophical ideas of ancient times and it began to develop scientific interest and with it centers of research and made new developments. Although still several wars broke out, humanity began to use reason to judge situations, rather than some supernatural influences or emotion. This process caused the industrialization and e.g. the French Revolution that influenced other countries as well, e.g. the later United States of America.

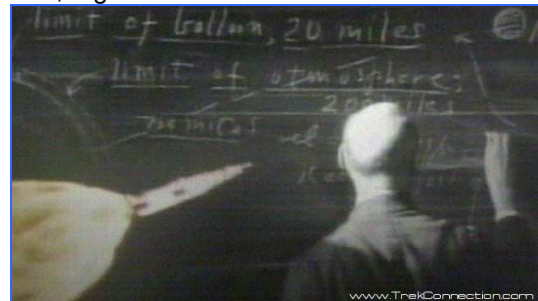

But Earth had not seen its darkest times yet. In the early 20th century, the first World War began causing several millions dead and much more suffering. Although after that time the first steps towards Earth' Union began, only 20 years later World War II started and lasted for half a decade.

Genocide and other crimes were part of that war, but at least caused several conventions to set up international laws to prevent that in the future, including the installment of the so-called United Nations. In the late 20th century, a new conflict arose. Humanity had discovered genetics and what first was used for medical care, was then misused as method to enhance human abilities and create a caste of 'super-humans'. These super-humans began to rise up against their masters, overthrew the governments and began battling themselves as warlords. In 1996 humanity was able to get rid of these warlords and ended the Eugenic Wars. In mid 21 century the third and last World War broke out. It was a nuclear war and killed more people than the other two world wars combined. During the aftermath of this war, which had thrown Earth into new Middle Ages - diseases, which had been overcome since decades, were fatal again.



A new hope arose. In 2063 Zephram Cochrane modified a nuclear missile and built Earth's first warp vessel, the Phoenix. Its maiden voyage was more than historic. During that flight, first contact with the Vulcans was made and a time of peace and welfare began. Earth recovered from the war with the help of the Vulcans and soon the long lasting effects were forgotten either. Additionally humanity explored space more than in the times before and the SS Valiant launched in 2064 as the first deep space starship. Half a century later the first colony of Earth settled on Mars, lead by the Picard family. In 2113 the American and European continent founded the United Earth Republic and with it the United Earth Space Probe Agency. The last continent to join was Australia, which did so in 2150. Thanks to the union process, humanity was able to coordinate its exploration of space and in early 22nd century the so-called 'Warp 5 complex' was founded in San Francisco under the lead of Henry Archer. In 2151 Earth made first contact with the Suliban and the Klingons,

which caused the first human ship, equipped with a warp five engine to launch, Enterprise, captained by Henry Archer's son, Jonathan Archer.

TECHNOLOGY

Earth is at the edge of the technology level 6, to describe its technology shortly. The humans have made several new developments in the past decades since the Vulcans arrived on Earth for the first time. Medical technology has rendered most illnesses harmless and there are no longer problems like famines or pollution. Energy production is based on fusion engines and communication is already accomplished at high speed, making it possible to communicate with Mars or other outposts in real-time, with the help of plasma monitors. Additionally there are slower ships, especially freighters who travel between the few human colonies and also Vulcan. Transportation on the planet is done by MagLev Trains, using a magnetic field to travel at speeds of 800 kph. There are flying transports either connecting the continents with each other. But there are also less advanced types of transport, like ships or automobiles using solar energy. A few shuttles have set up regular travels between the inner-system colonies.

GOVERNMENT



Earth is governed by a democracy based upon a constitution. The government's head is the President, holding the executive power. The Republic Council, the parliament, makes most decisions, e.g. about laws and economic conditions or scientific developments. Additionally there is the Board of Ministers, secretaries that have certain special tasks, like economy, education, defense and the like. The judicative power was given to the Republic Court. Membership in the Earth Republic

makes the individual states as members of an economic, scientific and military alliance.

The Republic's constitution guarantees all human rights to its inhabitants. After whole Earth was part of the Republic, all military was dissolved and Starfleet was entrusted with the former military duties. Additionally there is a military and civil intelligence service working e.g. against anti-Vulcan movements or possible extra-terrestrial threats. Local security services are responsible for criminals and the like.

LOCATIONS

Most important on Earth is Paris, its capital. It has a history of around two millennia and was home to kings, emperors and other leaders. There are many historic buildings, e.g. the Eiffel Tower or the Arc de Triomphe. A large cone-like tower holds the President's office at its top as well as several conference rooms, embassies and lower bureaucrat's offices.

INHABITANTS

Earth's native species are Humans, a humanoid species. They developed some several millennia ago and became the dominant species on the planet. There are two genders, male and female that differs slightly visually and biologically.

However there not all humans look alike. The color of skin ranges from white to black and e.g. bone structure differs, either depending on the origin of the individual. There are as many different hair colors as colors of skin. Humanity developed high arts and technology and eventually space flight technology.

SPACE TRAVEL



Earth has explored space since the mid 20th century and even more so after World War III. Earth has launched several smaller vessels to explore its own solar system and

there are some scientific outposts in the system. There is a small outpost at Pluto holding only 20 persons and scanning different space phenomena from there. It coordinates in-system traffic and sends welcome messages to all unknown vessels reaching the system. There are colonies on Mars and Earth uses several satellites to monitor its sun and other planets.

STARFLEET



Starfleet is Earth's science and exploration corps alike. It is the counterpart of the United Earth Space Probe agency and was founded the same year. While UESPA is the civil branch of space exploration and e.g. uses probes and other smaller vessels, Starfleet builds large ships and has also manned-exploration duties.

UESPA



The United Earth Space Probe Agency was founded together with the Earth Republic. It is a civil ministry and lead by the Minister of Space Exploration. Almost every science lab, performing research on space and related subjects, is part of UESPA or at least is supported by it. All telescopes on Earth and the probes and satellites in orbit are

maintained by UESPA and UESPA and Starfleet scientists alike review its data. UESPA and Starfleet are partly the same and partly different organizations. Starfleet is if you like the 'astronaut corps' of UESPA, although it is possible to find civil scientists onboard its ships – but only as guests.

UESPA is subject to the minister of Space Exploration, so are Starfleet's science missions. In terms of defense it is lead by the Minister of Defense, who may overrule any decision of his colleague in case of emergencies. Earth' president is superior to both ministers.

MACO



The MACOs, short for Military Assault Command Operations, was designed as Earth's elite special forces consisting of men and women from all regions of the globe. Their mission ranges from rescue, defense, sabotage, covert and other aspects of asymmetric warfare. They are well trained for any situation, though limited in the space environment, and well equipped, being a couple of years ahead of Starfleet technology. Whenever there is a call for "extra muscle", chances are the MACOs will be available for support.

GENERAL ORDERS

The General Orders of Starfleet are based on similar regulations of Earth' past and experiences made by the Vulcans.



General Order I describes Starfleet's task to defend Earth. The other orders describe Starfleet's contact with alien

vessels, first contact situations and behavior in case of weapons fire exchange.

There is nothing like the Prime Directive and no rule forbids contact with other species, although the Vulcans have tried to convince the Humans to include a regulation like that. However Earth' enthusiasm was stronger than Vulcan logic – humanity was eager to meet new aliens.



[Vulcan insignia]

RANK STRUCTURE

The rank structure of Starfleet is based upon naval militaries of Earth' past. There are three kinds of Starfleet members: Flag Officers, Line Officers and Enlisted Personnel. There are some sub-categories with different responsibilities and authorities, but these are the main parts of Starfleet. Flag Officers are the highest-ranking members of Starfleet. They oversee large parts of the fleet, perform bureaucratic work and create strategies. Not seldom are the duties of the 'Admiralty' also of political nature.

The highest rank is the Fleet Admiral, which is reserved for the Commander-in-Chief of Starfleet, the highest member of Starfleet and only the Ministers and the President are at a higher position in the hierarchy. Commodores are the lowest Flag Officers and they sometimes still command starships – the rank is given to very experienced Captains. Line Officers are 'Field Personnel' following the orders given by e.g. Flag Officers. Some Line Officers are also assistants of their higher-ranking counterparts.

Captains are the most senior Line Officers and are most often Commanding Officers of starships or outposts. Smaller bases or ships even have only Lieutenants as COs, but normally the minimum rank is Lt. Commander. An Ensign is the lowest Officer rank in Starfleet. It's the first step in the career of a cadet.

Enlisted crewmembers have a more specialized training than Officers. They are lead by the Officers but especially compared to younger Officers, Enlisted crewmembers have more experience in the 'field' and thus

an Officer should always listen to advice given by subordinates.

Onboard Starfleet facilities, there are several Senior Officers (Commanding Officer, First Officer, Chief of Security, Tactical Officer, Chief Medical, Chief of Science, Chief of Communications, Chief of Flight Control) who share the same responsibilities for their departments. The First Officer usually has a second occupation and acts as CO in case the Captain is not present.

At any time the center of operations has to be manned by an officer (or if needed enlisted personnel) who is in command. Additionally to ranks, Starfleet is divided into three branches: Command, Science and Operations. The first one is occupied by the leading' personal and Navigation. Science includes Medical personnel, Communications and all crewmembers with scientific duties. The operations personnel are responsible for the daily ship operations. Engineers, security details and e.g. computer specialists. Flag Officers belong always to the Command Branch.

APPEARANCE

Starfleet has a range of uniforms for different purposes. The standard duty uniform is a dark blue overall. Depending on the branch, there are colored stripes at the shoulders. Command has yellow color, Operations red and Science uses blue. The rank insignia are at the right shoulder; while at the right upper arm there is a badge with the according facility's insignias. Additionally to the basic uniform, there are caps, with the ship's logo and heavy field jacket, which are more protective regarding the weather.



But there are more specialized uniforms, either. For use in desert environments, Starfleet has introduced 'Tropical' uniforms. They are sand colored and have some basic survival equipment in large pockets. Along with them, the

crewmembers use sunglasses, which are closed at the side to protect the eyes from sand and dust. Flag Officers have different uniforms either. Instead of departmental colors, they have a dark red and white stripe at the shoulders and feature rank insignia on both shoulders. Under the black uniform jacket, an Admiral wears a white shirt and a tie.

The rank insignia is quite basic – simple silver and black squares. The Ensign has one square, a Lieutenant j.g. has a silver and a black one, while the Lieutenant has two silver squares. This system is followed up to Commander, while the Captain has four silver squares.

Admirals have their rank insignias in pairs at each shoulder. It starts with the Commodore with one square at each shoulder and ends with the Fleet Admiral having five squares.

2151 A.D.



While the Enterprise project is certainly the most important missions, it is certainly not the only one. Most important in the past was the 'Warp 5 complex' under the leadership of Henry Archer. It was supported by UESPA and performed research on a new kind of engine, which should make it possible to launch a deep space mission with reasonable effort. It took several decades until this goal was reached but finally Enterprise was commissioned in 2151 – the first Human vessel capable of traveling at warp 5.





ALIENS

With countless number of stars, it is hard to imagine none of them with sentient life forms. Space-faring civilizations are not without the contact of other alien life forms during their voyages. With humans, there are hardly any relations of Earth with other species. The most prominent species are of course the Vulcans. Since first contact in 2063, Vulcans helped humanity to overcome its worst problems, e.g. diseases, crime, corruption and the like. However they refused to share their technology or scientific developments. Some humans believe that the Vulcans do no right by holding back technology. They perceive them as arrogant and unfair. However the general attitude towards the Vulcans is thankful and they are often regarded as mentors.

There are also other species, e.g. the Denobulans that even have set up an exchange program with Earth. Thanks to the efforts of Enterprise, Earth has made contact with several other species. Among these are most prominent the Klingons and the Andorians. The Klingons regard Earth not much more than a primitive world, no match for the Klingon Empire. However they warned Earth not to interfere in Klingon actions. The Andorians view Earth more suspiciously. Although Earth is at the moment neutral and actually unraveled a secret Vulcan listening post, they may become allies of the Vulcans. Actually many already regard the Humans as puppets of the Vulcans.

The following chapter covers some of the notable aliens featured on Star Trek: Enterprise and possible species present in this era. Some species have already been covered in the current line (Andorians, Klingons, Nausicans, Humans, Vulcans, Romulans, etc) and will not be repeated in this chapter.

DENOBULANS

SPECIES ADJUSTMENTS: +1 Intellect. Denobulans are renowned as scientists and thinkers.



SPECIES ABILITIES:

BONUS EDGE: CULTURAL

FLEXIBILITY: Denobulans are open-minded about other cultures and encourage others to be the same. They receive the Cultural Flexibility edge for free.

BONUS FLAW: SPECIES ENMITY (ANTARANS):

Although their open conflict with the Antarans ended three hundred years ago, there is still very bad blood between the Denobulans and the Antarans. This ranges from believing outrageous superstitions about the other species to exchanging verbal slurs. On a few occasions there have even been known to be physical violence, although this is rare.

EXCELLENT CLIMB:

Denobulans have a unique grip for climbing enabling them to climb difficult slopes very quickly

and easily. They gain +4 species bonus to Athletics (Climb) tests and can climb up to five meters per round.

HALLUCINATIONS: In extremely stressful situations, Denobulans experience hallucinations. However, such experiences are considered to be safe and natural ways of releasing nervous energy.

The Narrator ultimately decides which situations warrant hallucinations, but examples should include prolonged events where life and death hangs in the balance or prolonged times of isolation. During each experience, the Denobulan character makes a Willpower roll with the following results:

Extraordinary Success: The character is able to ward off any hallucinations and reacts normally.

Superior Success: The character hears sounds but quickly realizes that he or she is hallucinating.

Examples include hearing "bumps in the night."

Complete Success: The character briefly sees persons and objects that aren't really there. An example includes seeing "someone" out of the corner of his eye, maybe standing in the doorway. The incident is brief and as with Superior Success, the character knows he or she is hallucinating.

Marginal Success: The character engages in non-threatening situations with hallucinations. Maybe the Denobulan has an entire conversation with a friend or ally who's not really there. The conversation is generally peaceful.

Failure: The Denobulan sees or hears something that produces a slight sense of fear in him: the character is convinced an opponent is beginning to close in on his location. The Denobulan receives a -2 penalty on all tests for 1d6 rounds because of that fear.

Complete Failure: The Denobulan sees or hears something that produces a stronger sense of fear in him. Maybe he thinks his opponent is almost on top of him with the Denobulan character unprepared for the attack. All he can think of is looking for adequate protection even if that means forsaking his previous main objective. The Denobulan receives a -5 penalty on all tests for 1d6 rounds.

Disastrous Failure: The Denobulan is so convinced of his hallucination that he is absolutely paralyzed with fear! The character collapses to the ground (he cannot even run for shelter) and must make a Stamina check (TN=15). Failure means the character suffers from a heart attack or like ailment and loses 2d6 points of damage every round until stabilized or until the character dies.

HIBERNATION: Unlike most species, Denobulans do not sleep as a part of their daily cycle. Instead, they hibernate for a full six days per year, although some can reduce this period time by various degrees. A Denobulan sleep period is handled similarly to the Fatigue rules found on pages 95-96 of the Narrator's Guide. When the hibernation period arrives, a Denobulan cannot help but collapse, and he or she will improve one fatigue level per day (see Table 6.27). Ending a hibernation period in fewer days requires the Denobulan to make a Stamina test. Failure means that the Denobulan remains asleep and must continue resting for another day in which he can roll again.

Another character can also attempt to revive the Denobulan prematurely, by making a successful First Aid (Denobulan) test (TN=10), beginning with on the second day. The character

NUMBER OF DAYS EARLIER	TN
5	18
4	14
3	12
2	11
1	10

that is doing the reviving must use a hypospray. However, if successful the Denobulan character still suffers from the Fatigue-level penalties: -8 for 5 days earlier, -4 for 4, -2 for 3, -1 for 2 and 0 for 1 (although a First Aid check is still required).

RESISTANCE: The Denobulan physiology gives them certain physical and psychological bonuses. For example, Denobulans are able to withstand certain stellar phenomena that might be harmful to other species. Technology, such as Borg nanoprobes, also has a delayed effect on them.



KZINTI

PERSONALITY: When first encountering Kzinti, the first thing noticeable is that they are highly aggressive. Any perceived slight would be taken as an insult and a challenge issued instantly right before the offender is attacked. The loser is always consumed by the victor, as Kzinti are strict meat eaters. (Kzinti who deal with other federation species suppress this urge as sentient consumption is considered barbaric if not illegal on most federation planets) A Kzinti's word is his honor. A loss of honor usually results in a loss of one or both ears. They will not give out idle commitments or hollow promises. Like Klingons scars are worn proudly and give a Kzin certain "status" in their society.

PHYSICAL DESCRIPTION: Kzin are bipedal carnivores averaging 2.4 meters in height. With a weight of 200kg they seem like thick tabi cats. They have a long hairless rat-like tail, and folding "umbrella" ears that reflects the Kzinti's current mood, which is folded onto the skull when in combat. Their fur covers all of their body but their tails and bottoms of their hands, which are covered in tough leathery covering. They have 4 digits on each hand and retractable claws. Their eyes are human-like but with gold colored irises, and their mouth is filled with teeth they use to eat with and in unarmed combat.

Homeworld: Kzin is the fourth planet of the 61 Ursa Majoris system. It is a relatively dry world with only 50% of it covered by water. Most of the land surface is rolling grassy plains and colourful jungle. The mountainous out back region is highly unpopulated as is most coastal industrial centers as Kzin have a deep dislike of water. The average temperature is 7 degrees Celsius, much cooler than earth norm but with a slightly higher gravity. 3 Moons circle the planet giving the night sky an interesting panorama.

CULTURE: Kzinti have 80-year life spans but rarely live that long due to duels or other warfare. They have a long history of conquest and their "Empire" was 3 times the size it is now before they encountered humans. The Kzin fought 4 wars with the Kzin losing everyone. With each new loss they lost more of their territory to compensate the humans. The Kzin use a feudal style system of rulership called the Patriarchy. It is an aristocracy run by the patriarch and the collection of nobles.

Kzinti females are never seen abroad as they have been essentially bred to the point of a non-sentience and are very docile. They are treated as property and a male Kzin may keep as many females as he can support and defend from rivals. Due to the high mortality rate among the Kzin the females are kept pregnant as often as possible to ensure continued heirs.

Young Kzins are taught their basic hunting and survival skills in huge "game-reserves" where they hunt down and kill live prey to be eaten with tooth and claw. They find the concept of eating vegetable to be repulsive and find human food smells like "garbage"

LANGUAGES: Hero Tongue, Federation Standard

COMMON NAMES: Kzinti must earn their "true" names, Kzin start their lives with "occupational names denoting what they do for a living. E.g. "Speaker-to-Animals", "Warp-drive student".

FAVORED PROFESSION: Warrior, theirs is a warrior culture. All males are taught from birth unarmed and armed combat. They are also very good tacticians.

SPECIES ADJUSTMENTS: +4 Strength, -2 Presence

SPECIES ABILITIES:

BONUS EDGE: SKILL FOCUS (KEEN SMELL): Kzinti have an acute sense of smell.

BONUS EDGE: MARTIAL ARTIST: Kzinti are taught to use both clawed hands in combat so are allowed to make one extra attack action at -2 instead of the standard penalty of -5.

SPEED: Kzinti are extremely fast, allowing them to travel at twice their normal speed.

NATURAL WEAPON (TEETH): Kzinti mouths are full of sharp teeth they use in combat. They do 1d6 + STR damage in combat and gain Unarmed Combat (Teeth) 1.

NATURAL WEAPON (CLAWS): Kzinti hands have retractable claws. They do 1d6 +4 + STR damage in combat and gain Unarmed Combat (Claws) 1.

Kzinti place a high value on their honor, and will seek to avenge any slight upon it, through a duel. Kzin with a high personal Honor (measured by Renown) can persuade other Kzinti more easily and have great respect among the clans. When making Influence, Negotiate, and Persuade tests involving other Kzinti, the character adds his Renown modifier automatically to the skill test. If a Kzinti has a stain upon their honor, they cannot add their Renown modifier automatically, and other Andorians will react poorly to the character, reducing all social interaction stance categories towards the character by one step worse (see "Social Tests", page 101).

BONUS FLAW: ARROGANT: Kzinti consider themselves destined to rule the galaxy and past events as "minor setbacks". You cannot spend courage on social tests.

BONUS FLAW: BLOODLUST: Kzin are fierce fighters and once engaged in combat they find it very difficult to disengage out of it. In any combat situation, while both you and your opponent are standing, you must spend 1 courage point to voluntarily stop fighting, no matter how wounded you are. Influence skill tests to convince you to stop attacking are at -3. Negotiate and Persuade automatically fail.

BONUS FLAW: DULLARD: Kzin are of average intelligence but are not known for any scientific breakthroughs. You cannot spend courage on academic tests.

BONUS FLAW: INFAMY (HOSTILITY): Kzin are infamous for their hostility to all others encountered. Others stance to interact with you is one worse. (See "social tests", page 101. Players Guide)

BONUS FLAW: PROUD: Kzinti are a proud people who take slight at the smallest insult. You suffer -1 to all social tests.

XINDI



XINDI-AQUATICS

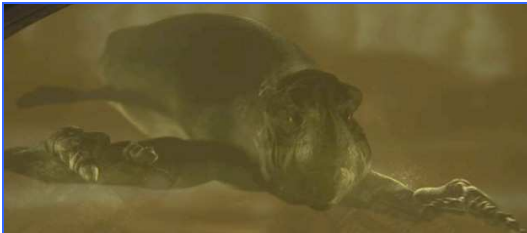

SPECIES ADJUSTMENTS: +4 Strength, -3 Presence. Because of their massive frames, Aquatics are extremely powerful. However, they simply care very little about the fates of other races unless it affects them personally.

SPECIES ABILITIES:

BONUS FLAW: PACIFIST: Because it takes so long for them to reach decisions (see below), Aquatics are naturally hesitant when it comes to making attacks.

EXCELLENT SWIMMERS: Because Aquatics live in the water, they receive a +5 to Athletics (Swim) tests and can move at speeds up to 3 meters as a single action or up to 9 meters as a full-round action.

INDECISIVE: Aquatics tend to over-analyze in making every decision. Even when someone has presented them with a well-put-together argument, it's not unusual for the Aquatics to remain unconvinced all the same. An old Xindi saying claims that "it is easier to count the stars in the sky, than for the Aquatics to reach a decision."

Aquatics receive a +10 Savvy bonus when someone tries to convince them of something through verbal arguments alone. However, when visual evidence is presented, this bonus can be reduced to +3 to +9 at the Narrator's discretion.



SONAR: Aquatics switch to sonar while talking in the past tense, a feat that can give them an added bonus when investigating their surroundings. They receive a +4 bonus to all Investigate (Inspect) and Observe (Listen) tests when communicating this way.

WATER BREATHERS: Aquatics have gills allowing them to breathe only water. When submerged, they may function normally; however, they begin “drown” when out of a water environment. See the Narrator’s Guide, p. 228.

XINDI- ARBOREALS



SPECIES ADJUSTMENTS: +1 Intellect, +2 Presence. Arboreal primarily focus on academic pursuits. They are also the most sympathetic of the Xindi species, which adds them in building trust with others.

SPECIES ABILITIES:

BONUS EDGE: METICULOUS: Arboreal have a methodical approach to their work. They receive the Meticulous edge for free.

BONUS FLAW: PACIFIST 2: Out of all the Xindi species, the Arboreal are the most pacifistic. They tend to speak in hushed tones and do not like developing technology that could be used in harming others. Their ships, for example, are the weakest of the Xindi in tactical capabilities. Because of this, however, other Xindi have been known to mislead and outright lie to the Arboreal when those species find it necessary.

HYDROPHOBIA: Arboreal are afraid of collective amounts of water. When approaching an area that is large enough for them to be submerged in (even if they are protected from it, as in dealing with the

Aquatics), they must make a Willpower test (TN=10). Failure indicates the Arboreal must leave the scene or experience fear, receiving a -2 penalty to all tests. Complete failure results in a -5 penalty, and Disastrous failure results in a -10.

SHARP FINGERNAILS: While they may not like to use them for combat, Arboreal have sharp fingernails that can do 1d6+3 cutting damage.

XINDI- INSECTOIDS



SPECIES ADJUSTMENTS: +3 Strength, -3 Presence. Despite their appearances of being frail, Insectoids are quite the opposite. They have no problems in holding down species, such as humans. Unfortunately, their arrogance tends to distance them from others.

SPECIES ABILITIES:

ASEXUAL: Insectoids are genderless, reproducing asexually through the laying of eggs, which are suspending from the ceiling. Located near these egg sacs are tubules capable of creating psychological-imprints on those passing by. When affected, the target must succeed in making a Willpower test (TN=15) of gain the flaw: Devotion (Insectoid infants). The target will then care for the infant Insectoids, as a parent to a child, with suicidal devotion, if necessary. Only through a Medicine test (TN=20), made by a fellow crewmember, can a remedy be developed to free the target from this flaw.

COMPOUND EYES: Insectoids have compound eyes that aid them visually. They receive a +5 bonus to Investigate (Inspect) and Observe (Spot) tests.

EXOSKELETON: The Insectoid exoskeleton provides additional protection from physical attacks. Treat this as natural armor, absorbing 5 points of damage per attack. See the Narrator's Guide, p. 91-92.



RASH BEHAVIOR: Like the Reptilians, Insectoids are extremely paranoid. This causes them to make rash decisions and choose sides rather quickly.

XINDI-PRIMATES

SPECIES ADJUSTMENTS: +2 Intellect. Although very similar to humans, the Xindi-Primate's brain is slightly more advanced, making them better suited for intellectual endeavors. The Primates are considered the most intellectual of all Xindi.



SPECIES ABILITIES:

BONUS EDGE: THINKER: Primates are creative thinkers, receiving the Thinker Edge for free.

DEFIANT SPIRIT: Like Humans, Xindi-Primates have a bold spirit, allowing them to receive one additional Courage point.

PROFESSIONAL FOCUS: Because of their focus on their profession, Primates receive 5 additional picks for skill levels or specialties as apart of their professional development. The Primate must already have skill ranks in a skill when increasing the levels this way.

XINDI-REPTILIANS



SPECIES ADJUSTMENTS: +2 Strength, -3 Presence. Because of their soldier training, Reptilians are physically powerful. However, like the Insectoids, their arrogant behavior, prevents them from connecting with others.

SPECIES ABILITIES:

AGGRESSIVE PARANOIA: Reptilians are extremely paranoid of others species. Instead of cowering away from them, however, they tend to hide their emotions through their aggressive behavior. Reptilians use everything from physical violence to verbal threats to quick alterations in their plans to protect their interests. Even in dealing with allies, they will often look for opportunities to protect their interests, seeing others' incompetence and failure to act as a threat.

COLD-BLOODED: Like the reptilian species found on Earth, Xindi-Reptilians are cold-blooded. When in cool weather (1-10 C), they receive a -5 penalty to all physical

tests. In freezing environments (0 C and lower), they remain in a hibernated state, preventing them from doing any activity or being consciously aware of the world around them.



DEVOTION: Reptilians display a strong devotion to all of the Xindi. Even when they do not agree with the other species, they still look out for their interests (or, at least, what there interests *should be* according to the Reptilians). With this mindset, all Reptilian soldiers have a gland surgically implanted in them that will release a neurotoxin if they are captured.

THICK HIDE: The Reptilians' scaly skin provides additional protection in oncoming attacks. Treat this as natural armor, absorbing 7 points of damage per attack. See the Narrator's Guide, p. 91-92.



XINDI-AVIANS

DESCRIPTION: Not much is known about this particular species due to their extinction. Their extinction is the result of the civil war amongst Xindi species. Xindi-Avians are best described as humanoid in form with bird-like features. This species is supposedly capable of flight and once dominated the skies of the Xindi's former home world.





EQUIPMENT

Lengthy space journeys require supplies and equipment for survival and success of their missions. Unfortunately, replicators are not available so sometimes travelers may resort to bartering or trading with other alien cultures. Personal and armed equipment, as well as starship facilities are essential for deep space missions.

There is a wide range of technology available to Starfleet Officers. While the technology of the mid 22nd century is not as advanced as in later centuries it is still sophisticated enough to accomplish most problems the crew is meant to encounter.

Pre-TOS weaponry is somewhat a controversy since *Enterprise* aired. It's been shown in the first *Star Trek* pilot that lasers were the standard hand weapons before the switch to phasers in the next few episodes. Which leads to the question, why the phase pistols and plasma weapons in *Enterprise* and where are the "lasers"? Worf, in TNG episode, "A Matter of Time", stated that phasers were invented in the 22nd century, so perhaps lasers did not exist. Or perhaps, "lasers" were meant to be "phasers" in the first *Star Trek* episode. Either way, it's a small detail that is best left alone, such as the appearance of the Klingon foreheads after TOS ended and described as a production decision.

The following chapter details equipment that is exclusive to the mid-22nd century. Some of the items are similar to those featured in 23rd and 24th century, but less sophisticated than their descendants.

PERSONAL EQUIPMENT

COMMUNICATOR



Specification: 12 cm x 5 cm x 3.5 cm

Description: The communicator is used for transmissions between ship and away team or among the team itself. The communicator also sends a faint signal, which makes it possible to track the away team with the ship's sensors. When combined with a tricorder it can access the ship's computer an e.g. transmit data to it.



(w/ Universal Translator; see rules in SOM)

Rules: These early communicators do not translate known languages unless fitted with UT component

Duration: 500 hours

Range: 2000 km

TRICORDER



Specification: 12 cm x 6 cm x 4.5 cm

Description: Tricorders are highly developed sensor devices that are used to investigate the surroundings of the operator.

Rules: Refer to PG for rulings

Duration: 100 hours

Range: 5/15/125/1000/+0

ENVIRONMENTAL SUITS



Specification: 12kg

Description: These space suits are used whenever a Starfleet Officer needs to enter any kind of dangerous environment, be it space or e.g. a toxic atmosphere. The suits are heavy and are not armored but enable the wearer to walk through vacuum or heavy atmospheres. A heavy vest at the torso contains the life support system and any controls to operate the suits systems and gravity boots.

Rules: Refer to PG for rulings

Duration: 10 hours

BASEBALL CAP



Description: Some styles just do not die out. Each starship personnel have a baseball cap with their starship's registry embroidered on the front. The hat is black with red lettering for the starship registry and has an adjustable band to fit all.

WEAPONS

PLASMA WEAPONS

Specification: varies

Description: Plasma based weapons were a staple in defense in the 22nd century and common in all parts of the quadrant. Everyone, including some farmer in Oklahoma, Earth, had a variation of it. Plasma weapons fire a bolt of energy in a pulse like fashion. Starfleet personnel have access to pistol (EM-33) and rifle (Class-3). The plasma rifle comes in two flavors in Starfleet; the one difference is the nozzle that has two barrels (bottom barrel fires a pulse-like beam and the top barrel fires a phased beam, particularly for long range usage) while the other has one barrel. MACO Special Forces have their own plasma rifle, which is said to be an improved version and has a targeting module.



EM-33

Duration/Energy: See "Laser Pistol" in PG
Range: See weapon table for "Laser Pistol"



Class-3 Pulse Rifle [double barrel variation]

Settings: See weapon table for "Laser Rifle" [Including 1 and 5 (see chart)]
Duration/Energy: See "Laser Rifle" in PG
Range: See weapon table for "Laser Rifle" [See phase pistol for top barrel range]



MACO Pulse Rifle with Targeting Module (see PG)

Settings: See weapon table for "Laser Rifle" in addition to setting 1

Duration/Energy: Refer to "Laser Rifle"

Range: See weapon table for "Laser Rifle"

PHASE PISTOLS

Specification: 20 cm x 4 cm x 18 cm; 0.75 kg

Description: Phased pistols are more flexible sidearm for Starfleet and the predecessor of the 23rd century phaser. But unlike its ancestor, this weapon has only two settings, "stun" and "kill". Besides defense, it is also used for cutting metal or providing a source of controlled heat. While still in the experimental stage, it has its drawbacks. Phase pistols consume more energy than plasma weapons, making it less reliable as a defense option. Its technology has been incorporated onto the Class-3 Plasma Pulse Rifle (see above).

Settings: 1 and 5

Duration/Energy: 62

Range: 5/ 20/ 32/ 64 +0



DISRUPTORS



Specification: Varies

Description: Many of the future members of the Federation (Andorians and Vulcans) and non-members (Klingons) relied on disruptors as sidearms. Some disruptors are bulkier and carried similar to a rifle or Uzi, like the Andorian version.



Few races, such as the Xindi, have developed a rifle variation in addition to a hand-held disruptor. See description in the [Player's Guide](#) for additional information and rules.

Settings: see PG for info.

Duration: see PG for info.

Range: see PG for info.



Disruptor Rifle [Xindi variant]

Specification: varies [55 cm x 10 cm x 15 cm]

Settings: same

Duration: same [unlimited power source]

Range: 5/20/40/64/+20 meters



STARSHIP SYSTEMS

TRANSPORTERS

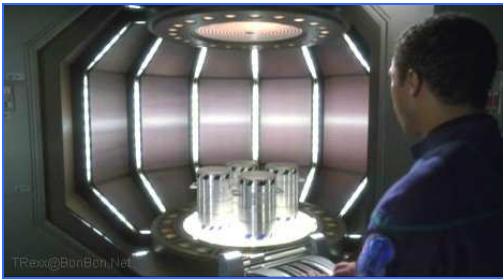

Description: Only a few cultures have yet mastered the transporter technology. Starfleet currently uses it only for transport, although living creatures are permitted to “beam” how this process is called. Transporters dematerialize the subject’s matter into energy, sent the data wherever it is needed and assemble the subject again at its destination.

Range: 2000 km

AIRLOCK-DECOMPRESSION CHAMBER



Description: Even though transporters are not the popular form of transport between ship-to-ship, the airlock serves as a reliable form of commute of personnel. Most ships of this era are equipped with an airlock and compression chamber. A ship docks with

another ship that also has a chamber for boarding.

DETOXIC SYSTEMS



Description: While this function is normally related to transporter systems, which have a bio-filter, that render all bacteria or any virus undangerous, this has to be done manually if not using systems like that. *Enterprise* uses a special chamber for that, which is equipped with UV-Light beamers, killing bacteria and the like. Additionally a jelly-cream is used to for the same purpose and to protect the skin from the radiation. Without this chamber, there would be the peril that new unknown diseases could spread throughout the ship.

GRAPPLER



Description: Only a select few cultures have developed tractor beams, but the rest, like the humans have a space aged version of a harpoon. Grapplers are ‘claw’-like machines connected to the ship via a cable. They can be used to attach to any object desired, including other starships. They are e.g. useful during rescue operations and to salvage starship wrecks.

Range: 1000m



SHIPS

Faster- than-light technology has made it possible for different civilizations to travel in far reaching areas in space. Zephran Cochrane's experimental spacecraft made that possibility a reality, and eighty-something years later mankind developed vast number of warp capable starships to explore the final frontier. Though Starfleet and its contemporaries may have limited starships at their disposal in the pre-TOS era, some, like the Vulcan's, have a large fleet for scientific and defense purposes.

Starship technology is also somewhat primitive around this era. Some cultures do not have transporters or others are beginning to experiment with it, like Starfleet and the Klingon Empire. The fastest warp speed observed is warp six while most organizations will claim that warp five is the maximum speed achievable in their fleet. Facilities like replicators and holodecks are non-existent so life on a starship is bare-boned and somewhat comparable to old sea ships of the explorer era on Earth. Unlike the 23rd or 24th century, starships in the 22nd century are far from the "cruise" ships of tomorrow.

The ships detailed in this section cover most of the relevant vessels featured on Star Trek: Enterprise. The data for the warp factors are OCU (Old Cochrane Units) with the exception of the Xindi Vortex Drives that use MCU (Old Cochrane Units)*. Some starships as mentioned in the introduction are already available in the current line, like the Daedulus class in [The Starfleet Operations Manual](#). The other ships are detailed in the preceding pages.

* Episodes of Star Trek: Enterprise has depicted the Xindi traveling at least 2 light years within 1 hour with their vortex technology, given to them from aliens from the future. Even though the technology is highly advanced for its time, it has been revealed that it is incompatible with Starfleet ships. It remains to be seen whether the Xindi will remain reclusive during the forming of the Federation and the latter years or whether the Federation "time cops" will fix this. Despite this advantage, it has its drawback as being susceptible to damage and unreliable.

INTREPID CLASS

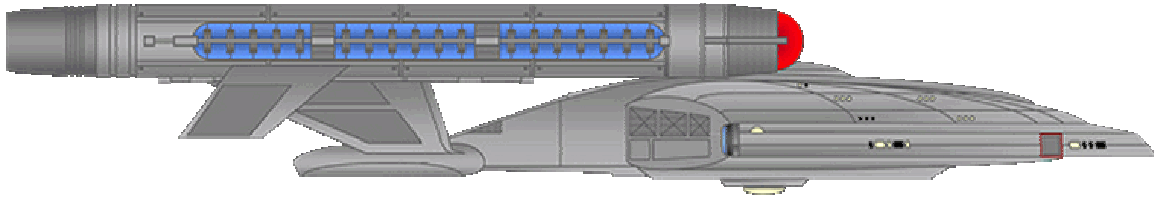

PRODUCTION DATA:

Origin: Earth (Terra, Sol System)
 Class and Type: Intrepid-class cruiser
 Commissioning Date: 2147 (refit 2153)
 Lead Engineer: Anton Spletstoser

HULL DATA:

Structure: 25
 Size/Decks: 5/6
 Length: 198m / Height: 25m / Beam: 150m
 Complement: 75 (8 officers, 67 enlisted)

OPERATIONAL DATA

Atmosphere Capable: No
 Cargo Units: 50
 Operations System: Class 2 (C)
 Life Support: Class 3 (D)
 Sensor Systems: Class 2 +2/+1/0/0/0 (C)
 Separation System: No
 Shuttlebays: 1 aft ventral (two shuttlepods are kept on ready standby, 2 more are "mothballed")
 Tractor Beams: 1 Grapppler system in aft ventral turret, can only be used at point blank range and only on vessels of size 4 or less.
 Transporters: No

PROPULSION DATA

Warp System: WE-2c, Warp 1/1.4/1.8 (A)
 Impulse System: SBC, .5c (B)

TACTICAL DATA

Plasma Weapons: TDM-36.2 (X2, B)
 Penetration: 3/2/2/0/0
 Torpedo Launchers: FST MK-III Spatial Torpedoes (X2, B)
 Penetration: 2/2/2/0/0
 Deflector Shield: HPG MK-2 Hull Polarization Generator System (B)
 Protection/Threshold: 10/1

MISCELLANEOUS DATA

Maneuver Modifiers: +1 C, +1 H, +2 T

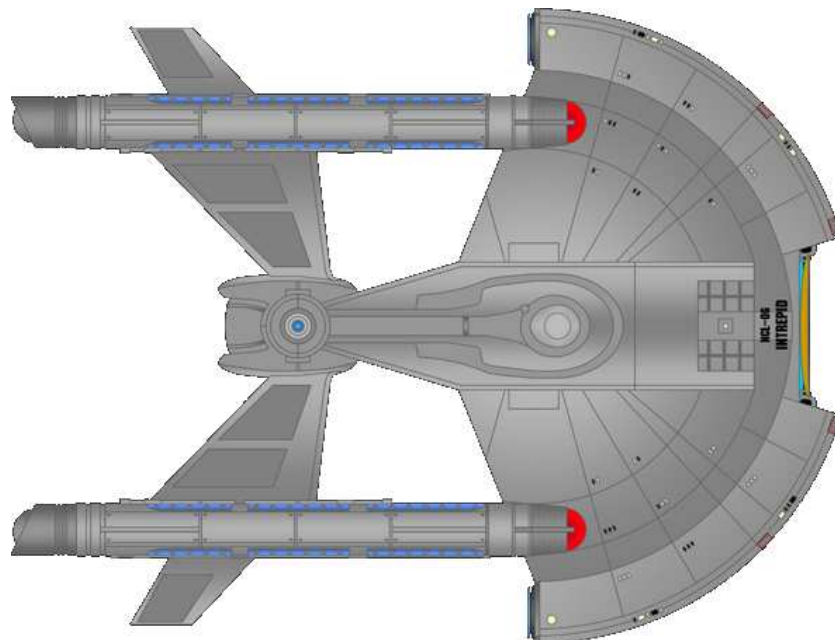

COLUMBUS CLASS CRUISER



<p>PRODUCTION DATA Origin: Earth Class and Type: Columbus class cruiser Year Launched: 2145; [Upgrade 1 in 2151]; [Upgrade 2 in 2154]</p>	<p>PROPULSION DATA Impulse System: Type SBC (.5c) (B) Warp System: WE-2c (WARP 1/1.4/1.8) (A) [WE-2c (WARP 2/2.4/2.8) (A)] [WE-5 (WARP 3/4/5)(B)]</p>
<p>HULL DATA Structure: 25 Size/Decks: 5/6 Length/Height/Beam: 180/25/109 Complement: 60</p>	<p>TACTICAL DATA Plasma/Phase Cannons: TDM-28 (x2) [PC-10a (x2)] Penetration: 2/2/2/0/0 (A) [2/2/2/0/0 (A)] Torpedo Launchers: FST Mk II (x2) [FST Mk III (x2)] [MK 1 IF (x2)] Spatial Penetration: 1/1/1/0/0 (A) [2/2/2/0/0 (A)] [2/2/2/2/0 (A)] Polarizing Generators: HPG Mk 2 (B) Protection/Threshold: 10/1</p>
<p>OPERATION DATA Atmosphere Capability: yes Transporter: none Cargo Units: 55 [50] [50] Shuttle Bay: 1av Shuttlecraft: 2 size worth Tractor Beam (Grapppler): 1fv Sensor System: Class 2 (+2/C) Operation System: Class 2 (C) Life Support: Class 3 (D)</p>	<p>MISCELLANEOUS DATA Maneuvers Modifiers: +2 C, 0 H, +2 T</p> <p>EDGES AND FLAWS * Enhanced System (Warp +1 wf)</p>



Background: The Columbus class cruiser was designed to assist in Earth's colonization efforts. As such these vessels were built with the finest systems available at the time, using many systems designed for the upcoming NX class in order to "field test" some of the new technologies. After Earth was attacked by the Xindi in 2153, Star Fleet recalled all Columbus class vessels to be refitted with the WE-5 warp drive, PC-10a Phase Cannons, and the new Mk I IF Photonic Torpedo systems. Columbus class ships feature a saucer section slightly smaller than that of the NX class, there is a small engineering section extending aft from the Main hull. The Warp nacelles extend downward from the engineering section making these vessels the earliest known precursors to the Miranda and Nebula class starships of the 23rd and 24th centuries. All Columbus class vessels to date have been named for historical Explorers and Astronauts.

Fleet Data: Columbus (2145 [Mk I], **2153 [Mk III]**), Lewis (2145 [Mk I], **2153 [Mk III]**), Clark (2146 [Mk I], **2153 [Mk III]**), Gagarin (2146 [Mk I], **2153 Mk III**), Glenn (2147 [Mk I], **2153 [Mk III]**), Leonov (2147 [Mk I], **2153 [Mk III]**), Grissom (2148 [Mk I], **2154 [Mk III]**), Shepard (2148 [Mk I], **2154 [Mk III]**), Armstrong (**2150 [Mk II]**, **2154 [Mk III]**), Aldrin (**2150 [Mk II]**,

2154 (Mk III).



SURAK LIGHT EXPLORER

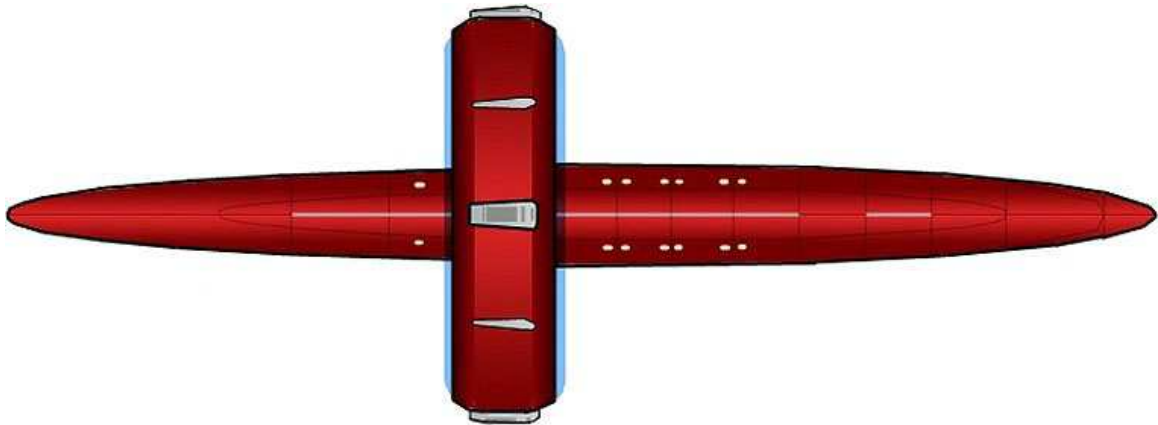

<p>PRODUCTION DATA Origin: Vulcan Class and type: Surak-Class Light Explorer Year launched: 2145</p>	<p>PROPULSION DATA Impulse system: SBD (0.5c/B) Warp system: WE-5 (warp 3.4/6.4/6.9) (OCU) (B)</p>
<p>HULL DATA Structure: 30 Size/decks: 6/17 Length/Height/Beam: 390/102/102 Complement: 210</p>	<p>TACTICAL DATA Beam primary: PC-10a (x3/B) Penetration: 3/3/3/0/0 Deflector shield: HPG Mk2 (B) Protection/threshold: 11/2</p>
<p>OPERATION DATA Atmosphere capable: No Transporters: 2 standard Cargo units: 95 Shuttlebay: 1 AD Shuttlecraft: 6 size worth Tractor beams: 1 FV, AV Separation system: None Cloaking system: None Sensor system: Class 2 (+4/C) Operations system: Class 3 (D) Life support: Class 4 (E)</p>	<p>MISCELLANEOUS DATA Maneuver modifiers: +2 C +0 H +2 T</p> <p>EDGES AND FLAWS Prototype (+2 warp speed); prototype (+1 shield protection); enhanced system (warp drive) x 2; enhanced system (sensors); enhanced system (shields)</p>

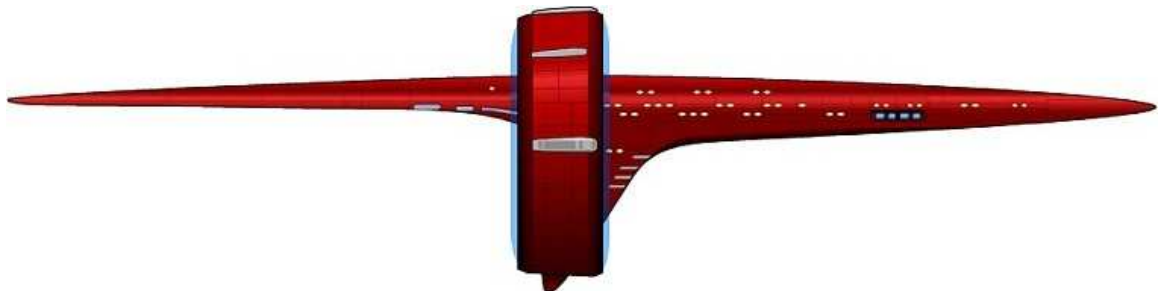

D'YKR VULCAN COMBAT CRUISER

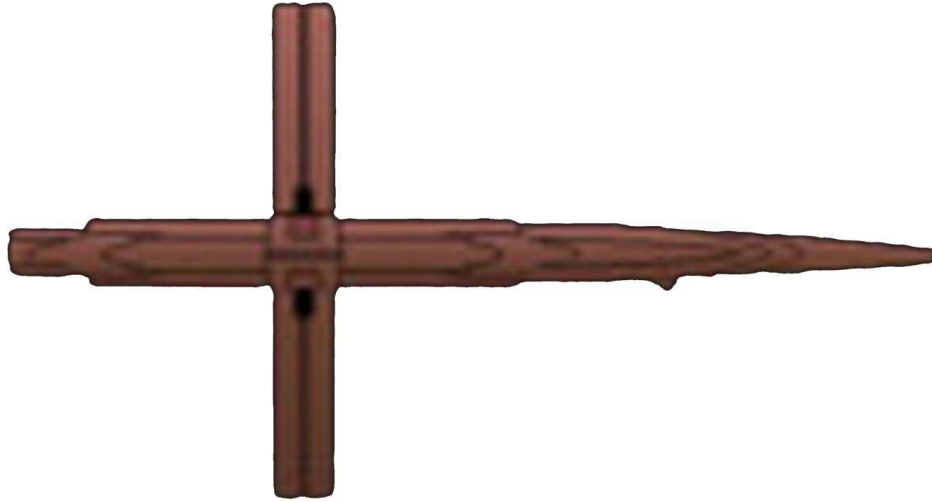

PRODUCTION DATA

Origin: Vulcan
 Class and type: Vulcan Heavy Cruiser
 Year launched: 2150

HULL DATA

Structure: 35
 Size/decks: 6/18
 Length/Height/Beam: 398/116/116
 Complement: 170

OPERATION DATA

Atmosphere capable: No
 Transporters: 2 standard
 Cargo units: 95
 Shuttlebay: 1 AD
 Shuttlecraft: 6 size worth
 Tractor beams: 1 FV, AV
 Separation system: None
 Cloaking system: None
 Sensor system: Class 2 (+2/C)
 Operations system: Class 3 (D)
 Life support: Class 4 (E)

PROPULSION DATA

Impulse system: SBD (0.5c/B)
 Warp system: WE-5 (warp 3/6/6.5) (OCU) (B)

TACTICAL DATA

Beam primary: PC-10a (x6/B)
 Penetration: 4/3/3/0/0
 Deflector shield: HPG Mk3 (C)
 Protection/threshold: 12/2

MISCELLANEOUS DATA

Maneuver modifiers: +1 C +1 H +2 T

EDGES AND FLAWS

Prototype (+2 warp speed); prototype (+1 shield protection); enhanced system (shields)

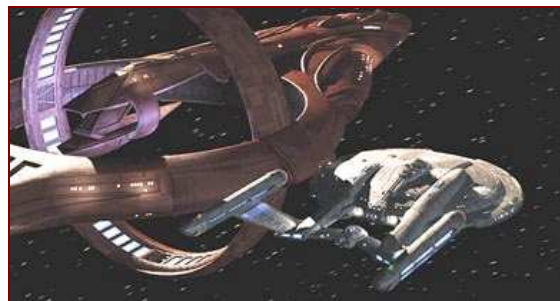

ANDORIAN WARSHIP

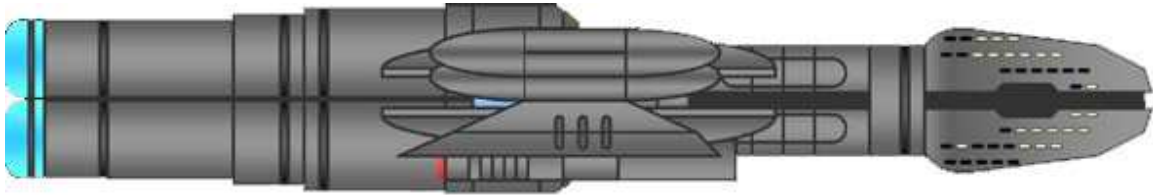

<p>PRODUCTION DATA Origin: Andorian Imperial Guard Class and type: Light Cruiser Year launched: 2146</p> <p>HULL DATA Structure: 30 Size/decks: 5/10 Length/Height/Beam: 278/42/152 Complement: 150</p> <p>OPERATION DATA Atmosphere capable: No Transporters: None Cargo units: 50 Shuttlebay: 1 AV Shuttlecraft: 5 size worth Tractor beams: 1 AV Separation system: None Cloaking system: None Sensor system: Class 1a (+2/AA) Operations system: Class 1R (BB) Life support: Class 3R (DD)</p>	<p>PROPULSION DATA Impulse system: SBC (0.5c/B) Warp system: WE-5 (warp 3/4/5) (OCU) (B)</p> <p>TACTICAL DATA Beam primary: PC-10a (x4/B) Penetration: 3/3/3/0/0 Missile primary: FST Mk3 (x2/B) Penetration: 2/2/2/0/0 Deflector shield: HPG Mk2 (B) Protection/threshold: 11/1</p> <p>MISCELLANEOUS DATA Maneuver modifiers: +2 C -1 H +3 T</p> <p>EDGES AND FLAWS Prototype (+1 shield protection) Prototype (+1 sensor bonus)</p>
---	--

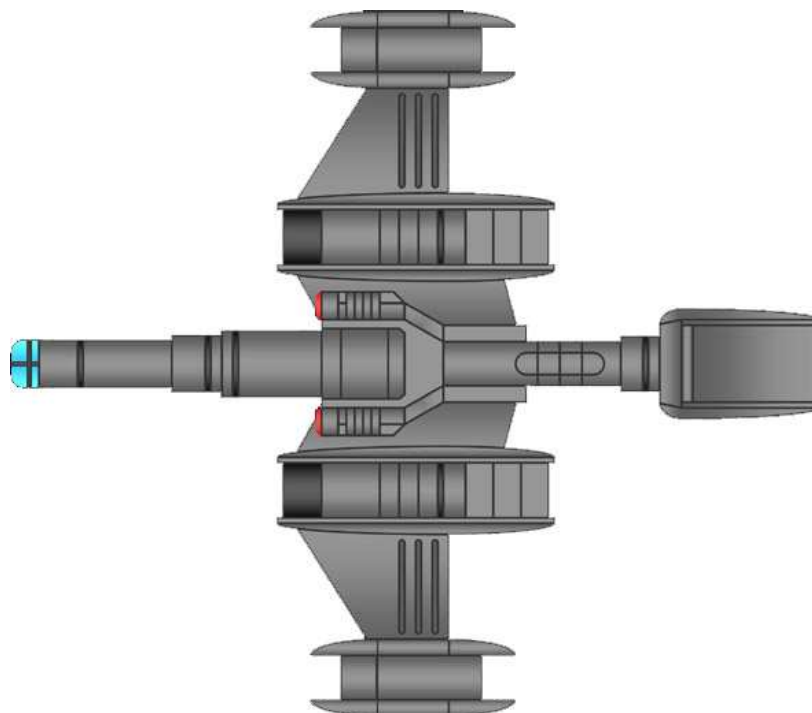

O-7 BATTLECRUISER (22ND version)



PRODUCTION DATA

Origin: Klingon
 Class and type: Battlecruiser
 Year launched: 2150

HULL DATA

Structure: 45
 Size/decks: 6/
 Length/Height/Beam: / ? / ?
 Complement:

OPERATION DATA

Atmosphere capable: No
 Transporters: 3 personal, emergency, cargo
 Cargo units: 60
 Shuttlebay:
 Shuttlecraft:
 Tractor beams: 1
 Separation system: None
 Cloaking system: None
 Sensor system: Class 2 (+2/C)
 Operations system: Class 3 (D)
 Life support: Class 3 (D)

PROPULSION DATA

Impulse system: K-HEU-2 (.5c/B)
 Warp system: STN-3 (5/6/7) (AA)

TACTICAL DATA

Beam Cannons: GDM-2 (x4/AA)
 Penetration: 4/4/3/0/0
 Plasma Torpedoes: KTY (x1/A)
 Penetration: 2/2/2/2/0
 Deflector Shields: HPG MK3
 Protection/threshold: 11/1

MISCELLANEOUS DATA

Maneuver modifiers: +1 C 0 H +3 T

EDGES AND FLAWS

Prototype Warp System (+2 speed, -2 reliability)

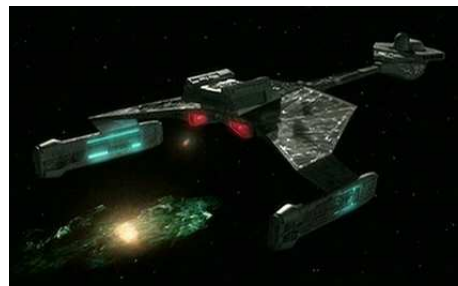

D-2 BIRD-OF-PREY SCOUT**PRODUCTION DATA**

Origin: Klingon Empire
Class and type: D-2-Class Scout
Year launched: 2143

HULL DATA

Structure: 20
Size/decks: 3/2
Length/Height/Beam: 86/16/40
Complement: 18

OPERATION DATA

Atmosphere capable: Yes
Transporters: None
Cargo units: 30
Shuttlebay: None
Shuttlecraft: None
Tractor beams: 1 AV
Separation system: None
Cloaking system: None
Sensor system: Basic (+0/A)
Operations system: Class 1 (B)
Life support: Basic reinforced (AA)

PROPULSION DATA

Impulse system: K-HEU-1 (0.4c/A)
Warp system: STN2 (warp 2/3/4.5) (OCU) (A)

TACTICAL DATA

Beam primary: K-GDM-1 (x1/B)
Penetration: 2/2/0/0/0
Missile primary: KT-W (x1/B)
Penetration: 1/1/1/0/0
Deflector shield: Type III hull plating
Protection/threshold: 9/0

MISCELLANEOUS DATA

Maneuver modifiers: C -1 H +4 T +0

EDGES AND FLAWS

Nimble



D-5 CRUISER

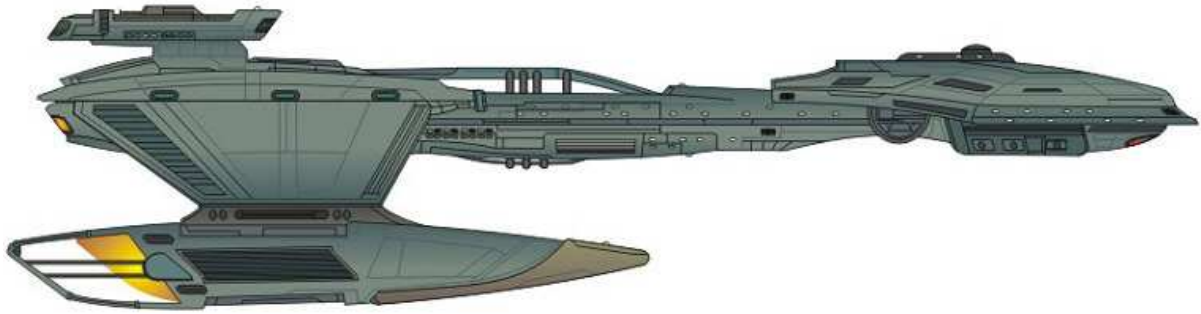

PRODUCTION DATA

Origin: Klingon Empire
 Class and type: D-5-Class Cruiser **[armed tanker version]**
 Year launched: 2150

HULL DATA

Structure: 35 **[30]**
 Size/decks: 5/10
 Length/Height/Beam: 182/37/127
 Complement: 348

OPERATION DATA

Atmosphere capable: No
 Transporters: 1 standard
 Cargo units: 50 **[110]**
 Shuttlebay: 1 AD
 Shuttlecraft: 5 size worth
 Tractor beams: 1 AV, 1 AD **[1 FV, 1 AV, 1 AD]**
 Separation system: None
 Cloaking system: None
 Sensor system: Class 2 (+2/C)
 Operations system: Class 2R (CC)
 Life support: Class 2R (CC)

PROPULSION DATA

Impulse system: K-HEU-1 (0.4c/A)
 Warp system: STN2 (warp 3/4/6) (OCU) (A)

TACTICAL DATA

Beam primary: K-GDM-1 (x2/B)
 Penetration: 3/3/2/0/0
 Missile primary: KT-X (x1/B) **[remove torpedoes]**
 Penetration: 2/2/2/2/0
 Deflector shield: HPG Mk3 (C)
 Protection/threshold: 11/2 **[11/1]**

MISCELLANEOUS DATA

Maneuver modifiers: C +2 H +0 T +2

EDGES AND FLAWS

Enhanced system (shields) **[D-5 cruiser version only]**; hardened system (propulsion); prototype (+1 warp speed)

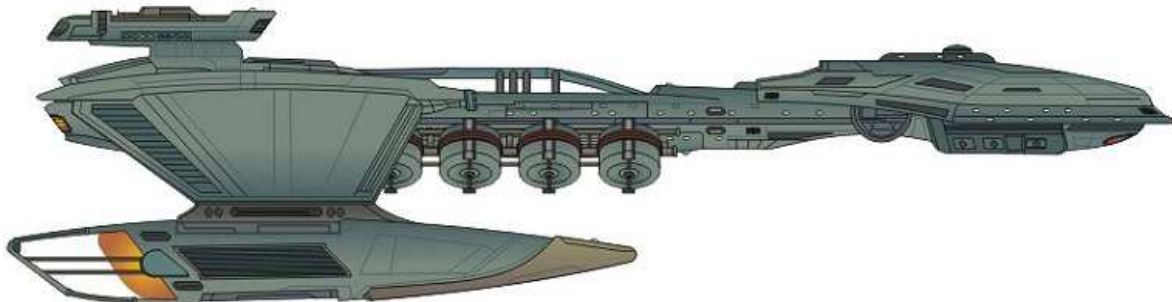

(tanker version)

KLINGON ARMORED TRANSPORT

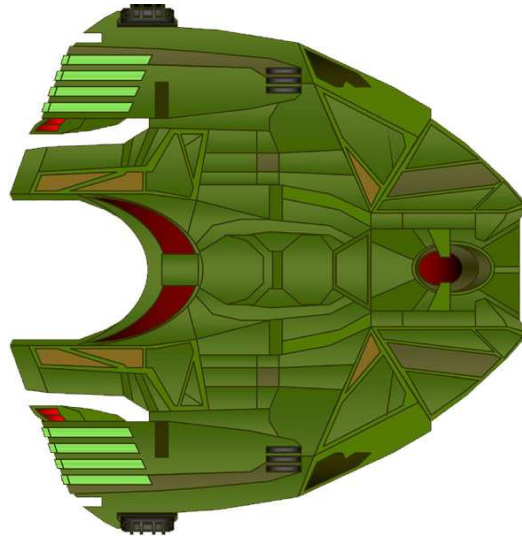

PRODUCTION DATA

Origin: Klingon
 Class and type: Armored Transport
 Year launched: 2140s

HULL DATA

Structure: 40
 Size/decks: 5/
 Length/Height/Beam: 225m/84m/229m
 Complement:

OPERATION DATA

Atmosphere capable: yes
 Transporters: 2 personal, emergency, cargo
 Cargo units: 120
 Shuttlebay: None
 Shuttlecraft: None
 Tractor beams: 1
 Separation system: None
 Cloaking system: None
 Sensor system: Class 1a (+2/AA)
 Operations system: Class 3 (D)
 Life support: Class 3 (D)

PROPULSION DATA

Impulse system: K-HEU-1 (.4c/A)
 Warp system: STN-2 (2/3/4.5) (BB)

TACTICAL DATA

Beam Cannons: GDM-1 (x2/B)
 Penetration: 3/2/2/0/0
 Plasma Torpedoes: KTX (x1/A)
 Penetration: 1/1/1/1/0
 Deflector Shields: HPG MK2
 Protection/threshold: 10/0

MISCELLANEOUS DATA

Maneuver modifiers: +1 C 0 H +3 T

EDGES AND FLAWS

Enhanced System (Transporters)



ROMULAN BIRD-OF-PREY (first version)



<p>PRODUCTION DATA Origin: Romulan Star Empire Class and type: Bird-of-Prey-Class Frigate Year launched: 2152</p>	<p>PROPULSION DATA Impulse system: RIA-1 (0.45c/A) Warp system: RPD-M (warp 4) (OCU) (A) *see notes</p>
<p>HULL DATA Structure: 20 Size/decks: 4/5 Length/Height/Beam: 128/28/45 Complement: 164</p>	<p>TACTICAL DATA Missile primary: RNF-X (x2/A) Penetration: 4/4/0/0/0 Deflector shield: HPG Mk2 (B) Protection/threshold: 10/1</p>
<p>OPERATION DATA Atmosphere capable: Yes Transporters: None Cargo units: 40 Shuttlebay: None Shuttlecraft: None Tractor beams: 1 FV Separation system: None Cloaking system: Class 1 (rating 16) Sensor system: Class 1 (+1/B) Operations system: Class 1R (BB) Life support: Class 2 (C)</p>	<p>MISCELLANEOUS DATA Maneuver modifiers: C +0 H +1 T +2</p> <p>EDGES AND FLAWS Design defect (cloaking device)</p> <p>*Romulan 'magnetic bottle' warp drive rules:</p>

The drive is the latest in Romulan warp technology and is a refinement over the standard 'magnetic bottle' principle. The ship is fitted with warp drives but they can only be used twice before being recharged at a base. Each time it is used the ship can travel at a maximum of warp 4 (OCU). When the 2 charges have been depleted then the ship can no longer go to warp. The system is vulnerable to enemy fire- whenever 'propulsion' is hit and IF THERE is still a charge left, a D6 must be rolled- the result equals the # of damage points the structure suffers.

Note:

The Bird-of-Prey is fitted with a cloaking device that makes the ship invisible to the naked eye and

makes it difficult to detect by sensors. It is however a very crude device even compared to TOS standards. Even a Starfleet shuttlecraft from the TOS era could easily detect it with its sensors.



XINDI BATTLE CRUISER

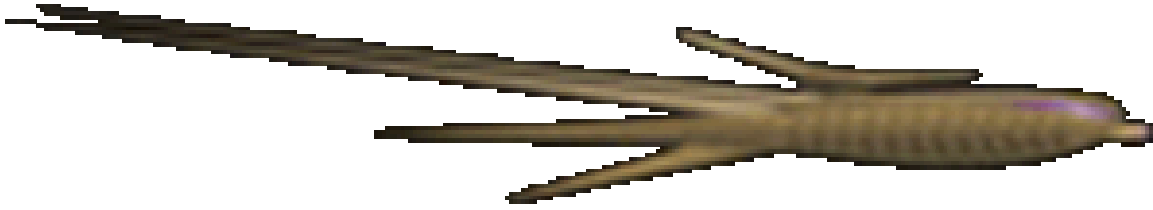

PRODUCTION DATA

Origin: Xindi-Reptilian
 Class and type: Type I Battle Cruiser
 Year launched:

HULL DATA

Structure: 25
 Size/decks: 5/
 Length/Height/Beam: 150m/ /
 Complement: 22

OPERATION DATA

Atmosphere capable: No
 Transporters: 2 personal, emergency, cargo
 Cargo units: 40
 Shuttlebay: 1
 Shuttlecraft: up to 4 size worth
 Tractor beams: None
 Separation system: None
 Cloaking system: None
 Sensor system: Class 1a (+1/B)
 Operations system: Class 3 (D)
 Life support: Class 3 (D)

PROPULSION DATA

Impulse system: Type III (0.6c/B)
 Warp system: Xindi Vortex Drive* (warp 9.5) (B)

TACTICAL DATA

Beam primary: XC-54/2 (x2/B)
 Penetration: 3/3/3/0/0
 Plasma Torpedoes: Type I (x3/B)
 Penetration: 4/3/2/1/0
 Deflector Shields: XPG MK III (C)
 Protection/threshold: 11/1

MISCELLANEOUS DATA

Maneuver modifiers: +2 C -1 H +2 T

EDGES AND FLAWS

Prototype Vortex Drive (-3 speed, -1 reliability)
 Vulnerable System (Propulsion)
 *Similar to Quantum Slipstream Drive

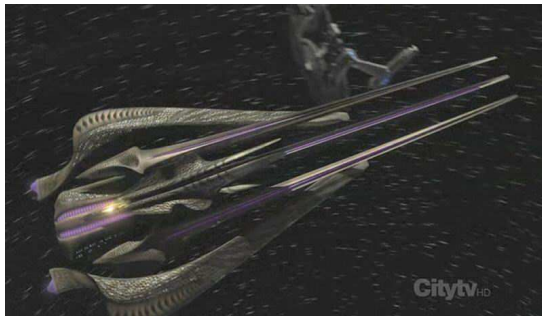

XINDI FAST ATTACK SHIP

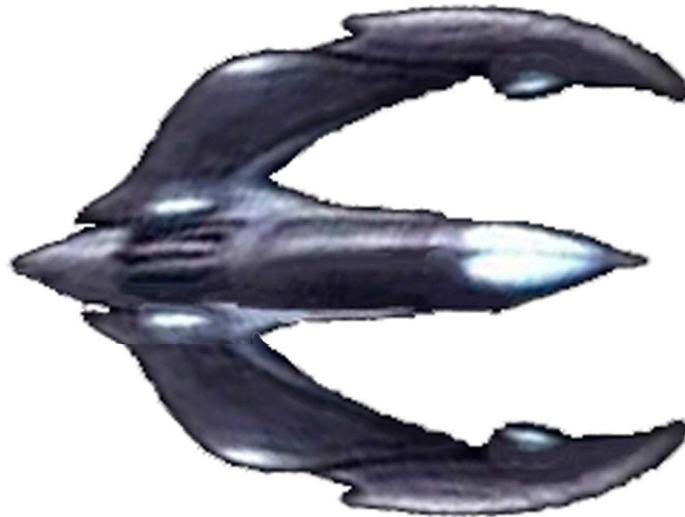

PRODUCTION DATA

Origin: Xindi-Insectoids
 Class and type: Type II Fast Attack Ship
 Year launched:

HULL DATA

Structure: 20
 Size/decks: 4/
 Length/Height/Beam: 120m / 90m /90m
 Complement:

OPERATION DATA

Atmosphere capable: Yes
 Transporters: 1 personnel, emergency, cargo
 Cargo units: 30
 Shuttlebay: 1
 Shuttlecraft: Size 2 worth (see assault shuttle)
 Tractor beams: 1
 Separation system: None
 Cloaking system: None
 Sensor system: Class 1a (+1/B)
 Operations system: Basic (A)
 Life support: Basic (A)

PROPULSION DATA

Impulse system: Type III (0.6c/B)
 Warp system: Xindi Vortex Drive* (warp 9.5) (B)

TACTICAL DATA

Beam Weapon: XC-10a** (x3/B)
 Penetration: 4/2/1/0/0
 Beam weapon: XC-54/2 (x1/A)
 Penetration: 3/2/2/0/0
 Deflector Shields: XPG MK II (B)
 Protection/threshold: 10/1

MISCELLANEOUS DATA

Maneuver modifiers: +3 C -3 H +3 T

EDGES AND FLAWS

Prototype Vortex Drive (-3 speed, -1 reliability)
 Vulnerable System (Propulsion)
 Unique System (XC-54/2)

**Pulse Weapon Upgrade (XC-10a)

***Similar to Quantum Slipstream Drive**



XINDI SCOUT



PRODUCTION DATA

Origin: Xindi-Insectoids
 Class and type: Type IV Fast Scout
 Year launched:

HULL DATA

Structure: 10
 Size/decks: 2/
 Length/Height/Beam: / /
 Complement: 3

OPERATION DATA

Atmosphere capable: Yes
 Transporters: 1 personnel, emergency, cargo
 Cargo units: 20
 Shuttlebay: 1
 Shuttlecraft: size 2 worth (see assault shuttle)
 Tractor beams: None
 Separation system: None
 Cloaking system: None
 Sensor system: Class 1a (+1/AA)
 Operations system: Basic (A)
 Life support: Basic (A)

PROPULSION DATA

Impulse system: Type IIa (0.5c/B)
 Warp system: Xindi Vortex Drive* (warp 9.6) (B)

TACTICAL DATA

Beam primary: XDM-36.2 (x1/A)
 Penetration: 2/2/0/0/0
 Plasma Torpedo: Type I (x1/A)
 Penetration: 3/2/1/0/0
 Deflector Shields: XPG MK II (B)
 Protection/threshold: 10/1

MISCELLANEOUS DATA

Maneuver modifiers: +0 C +1 H -1 T

EDGES AND FLAWS

Prototype Vortex Drive (-2 speed, -1 reliability)
 Vulnerable System (Propulsion)
 Nimble

***Similar to Quantum Slipstream Drive**



XINDI ASSAULT SHUTTLE (Insectoid)



PRODUCTION DATA

Origin: Xindi-Insectoids
 Class and type: Shuttle
 Year launched: ?

HULL DATA

Structure: 5
 Size/decks: 1/?
 Length/Height/Beam: 7 m/?/?
 Complement: 2

OPERATION DATA

Atmosphere capable: Yes
 Transporters: None
 Cargo units: 1
 Shuttlebay: None
 Shuttlecraft: None
 Tractor beams: None
 Separation system: None
 Cloaking system: None
 Sensor system: Class 1 (+1/B)
 Operations system: Basic (A)
 Life support: Basic (A)

PROPULSION DATA

Impulse system: Type IIa (.5c/B)

TACTICAL DATA

Beam primary: Type I (x3/A)
 Penetration: 2/1/0/0/0
 Plasma Torpedo: Type I (x1/A)
 Penetration: 3/2/1/0/0
 Hull: Type III
 Protection/threshold: 9/0

MISCELLANEOUS DATA

Maneuver modifiers: -1 C +3 H +0 T

EDGES AND FLAWS

Unique System (Type 1 Plasma Torpedo) x 2
 Vulnerable System (Propulsion)



XINDI COURIER



PRODUCTION DATA

Origin: Xindi-Primate
 Class and type: Courier
 Year launched:

HULL DATA

Structure: 10
 Size/decks: 2/
 Length/Height/Beam: 35 m/14m/16m
 Complement:

OPERATION DATA

Atmosphere capable: Yes
 Transporters: Yes
 Cargo units: 12
 Shuttlebay: None
 Shuttlecraft: None
 Tractor beams: None
 Separation system: None
 Cloaking system: None
 Sensor system: Class 1 (+1/B)
 Operations system: Class 3 (D)
 Life support: Class 3 (D)

PROPULSION DATA

Impulse system: Type III (.6c/B)
 Warp system: Xindi Vortex Drive* (warp 9.6) (A)

TACTICAL DATA

Beam primary: Type I (x1/A)
 Penetration: 2/2/0/0/0
 Plasma Torpedoes: Type I (x2/A)
 Penetration: 4/3/2/1/0
 Deflector Shields: XPG MK II (B)
 Protection/threshold: 10/1

MISCELLANEOUS DATA

Maneuver modifiers: 0 C +2 H +0 T

EDGES AND FLAWS

Prototype Vortex Drive (-2 speed, -1 reliability)
 Unique System (Type I Missile)

***Similar to Quantum Slipstream Drive**



XINDI FRIGATE (ARBOREAL)

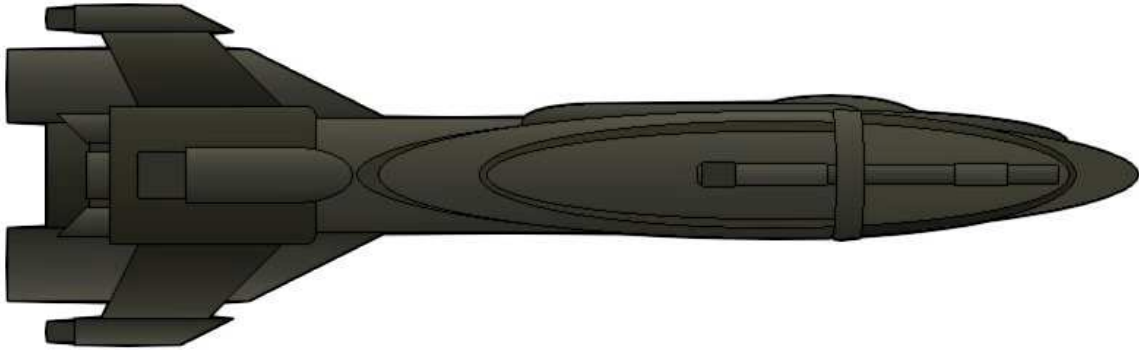

PRODUCTION DATA

Origin: Xindi- Arboreal
 Class and type: Xindi Frigate
 Year launched:

HULL DATA

Structure: 15
 Size/decks: 3/
 Length/Height/Beam: m/ m/ m
 Complement:

OPERATION DATA

Atmosphere capable: No
 Transporters: 1 cargo, personnel, emergency
 Cargo units: 30
 Shuttlebay: 1
 Shuttlecraft: 3 size worth
 Tractor beams: 1
 Separation system: None
 Cloaking system: None
 Sensor system: Class 1a (+1/AA)
 Operations system: Class 1R (BB)
 Life support: Class 1R (BB)

PROPULSION DATA

Impulse system: Type IIa (.5c/B)
 Warp system: Xindi Vortex Drive* (warp 9.4) (B)

TACTICAL DATA

Beam primary: XC-10a (x2/A)
 Penetration: 2/2/2/0/0
 Plasma Torpedoes: Type I (x2/A)
 Penetration: 3/2/1/0/0
 Deflector Shields: XPG MK III (C)
 Protection/threshold: 11/1

MISCELLANEOUS DATA

Maneuver modifiers: +2 C, +0 H, +1 T

EDGES AND FLAWS

Prototype Vortex Drive (-4 speed, -1 reliability)
 Vulnerable System (Propulsion)
 Enhanced System (Sensors)
 *Similar to Quantum Slipstream Drive



XINDI BATTLESHIP

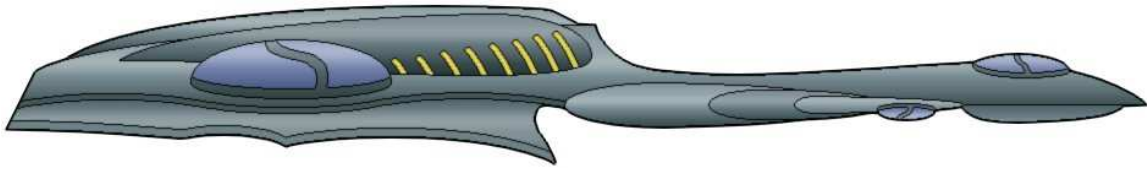

PRODUCTION DATA

Origin: Xindi-Aquatics
 Class and type: Xindi Battleship
 Year launched:

HULL DATA

Structure: 50
 Size/decks: 10/
 Length/Height/Beam: 995m/ 139m/ m
 Complement:

OPERATION DATA

Atmosphere capable: No
 Transporters: 5 cargo, personnel, emergency
 Cargo units: 140
 Shuttlebay: 1
 Shuttlecraft: 10 size worth
 Tractor beams: 1
 Separation system: None
 Cloaking system: None
 Sensor system: Class 2 (+2/C)
 Operations system: Class 3 (D)
 Life support: Class 3 (D)

PROPULSION DATA

Impulse system: Type III (x6) (.6c/B)
 Warp system: Xindi Vortex Drive * (warp 9.4) (B)

TACTICAL DATA

Beam primary: XC-54/2 (x5/AA)
 Penetration: 5/5/5/1/1
 Plasma Torpedoes: Type I (x4/B)
 Penetration: 5/4/3/2/1
 Deflector Shields: XPG MK III (C)
 Protection/threshold: 11/3

MISCELLANEOUS DATA

Maneuver modifiers: +5 C, -4 H, +5 T

EDGES AND FLAWS

Prototype Vortex Drive (-4 speed, -1 reliability)
 Vulnerable System (Propulsion)
 Enhanced System (Shields x2)
 Enhanced System (Beam)
 Battle Tested

***Similar to Quantum Slipstream Drive**

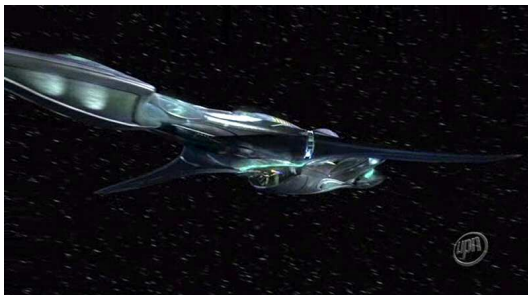

SULIBAN CELL SHIP



PRODUCTION DATA

Origin: Suliban
Class and Type: Cell-Class Attack Ship
Year Commissioned: 2120

HULL DATA

Structure: 10
Size/Decks: 1/1
Length/Height/Beam: 3.5/3.5/3.5
Complement: 1

OPERATIONAL DATA

Atmosphere Capable: Yes
Cargo Units: 1
Life Support: Class 1 (B)
Operations Systems: Class 1 (B)
Sensor Systems: Class 1 (+1/B)
Separation System: None
Shuttlebay: None
Shuttlecraft: None
Tractor Beams: 1 av
Transporters: None

PROPULSION DATA

Impulse System: SBB (.5c) (A)
Warp System: SE-6 (3/4.5/6) (A)

TACTICAL DATA

Particle Weapons: SPC-2 (A)
Penetration: 2/1/0/0/0
Hull Plating: Type IV
Protection: 10

MISCELLANEOUS DATA

Maneuver Modifiers: -2C, +2H, +2T

EDGES AND FLAWS

Stealth Field, acts as Mono-refracting plating except the field works in a nebula.



SULIBAN STEALTH CRUISER



PRODUCTION DATA

Origin: Suliban
 Class and Type: Stealth-Class Light Cruiser
 Year Commissioned: 2142

HULL DATA

Structure: 20
 Size/Decks: 4/2
 Length/Height/Beam: 50/7/12
 Complement: 20

OPERATIONAL DATA

Atmosphere Capable: No
 Cargo Units: 40
 Life Support: Class 2 (C)
 Operations Systems: Class 2 (C)
 Sensor Systems: Class 2 (+2/C)
 Separation System: None
 Shuttlebay: 1
 Shuttlecraft: 4 size worth (Usually 4 cell ships)
 Tractor Beams: 1 fv, 1 av
 Transporters: None

PROPULSION DATA

Impulse System: SBD (.6c) (B)
 Warp System: SE-6 (3/4.5/6) (B)

TACTICAL DATA

Particle Weapons: SPC-2 (x4/B)
 Penetration: 3/3/3/0/0
 Hull Plating: Type IV
 Protection: 10

MISCELLANEOUS DATA

Maneuver Modifiers: +1C, +1H, +1T

EDGES AND FLAWS

Stealth Field, acts as Mono-refracting plating except the field works in a nebula



SULIBAN LONG CELL SHIP

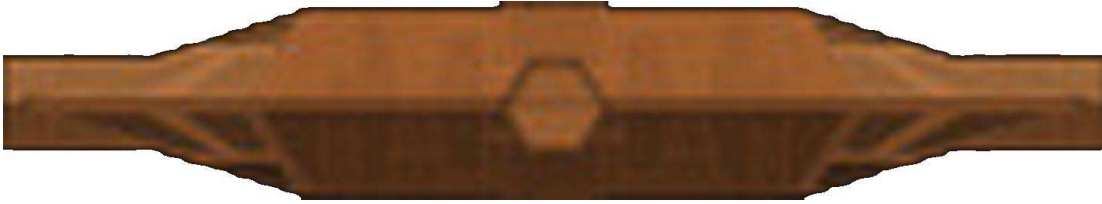

PRODUCTION DATA

Origin: Suliban
Class and Type: Long Cell-Class Attack Ship
Year Commissioned: 2135

HULL DATA

Structure: 10
Size/Decks: 2/1
Length/Height/Beam: 12/7/7
Complement: 4

OPERATIONAL DATA

Atmosphere Capable: Yes
Cargo Units: 2
Life Support: Class 2 (C)
Operations Systems: Class 2 (C)
Sensor Systems: Class 1 (+1/B)
Separation System: None
Shuttlebay: None
Shuttlecraft: None
Tractor Beams: 1 av, 1 fv
Transporters: None

PROPULSION DATA

Impulse System: SBB (.5c) (A)
Warp System: SE-6 (3/4.5/6) (A)

TACTICAL DATA

Particle Weapons: SPC-2 (x2/A)
Penetration: 2/2/2/0/0
Hull Plating: Type IV
Protection: 10

MISCELLANEOUS DATA

Maneuver Modifiers: -2C, +2H, +2T

EDGES AND FLAWS

Stealth Field acts as Mono-refracting plating except the field works in a nebula.



SULIBAN SALVAGE VESSEL

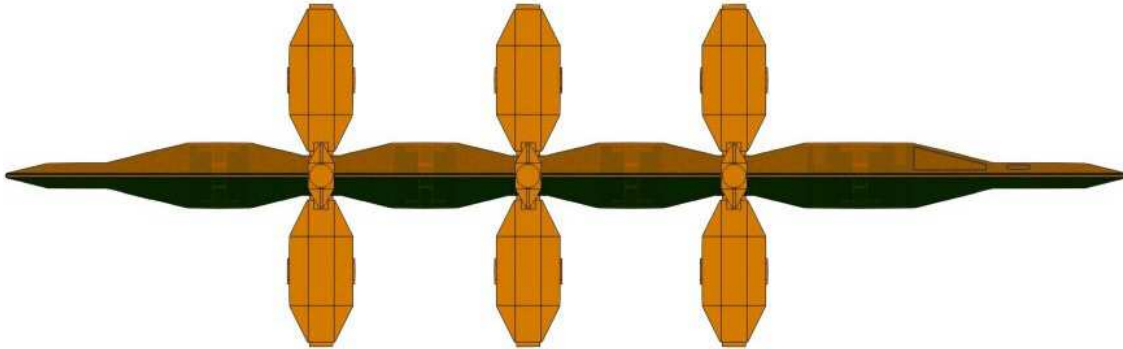

PRODUCTION DATA

Origin: Suliban
Class and Type: Salvage-Class Transport
Year Commissioned: 2138

HULL DATA

Structure: 20
Size/Decks: 4/2
Length/Height/Beam: 48/31/31
Complement:

OPERATIONAL DATA

Atmosphere Capable: No
Cargo Units: 60
Life Support: Class 2 (C)
Operations Systems: Class 3 (D)
Sensor Systems: Class 2 (+2/C)
Separation System: None
Shuttlebay: 1
Shuttlecraft: 4 size worth
Tractor Beams: 1 fv, 1 av
Transporters: None

PROPULSION DATA

Impulse System: SBD (.6c) (B)
Warp System: SE-5 (3/4/5) (B)

TACTICAL DATA

Particle Weapons: SPC-2 (x2/A)
Penetration: 2/2/2/0/0
Hull Plating: Type IV
Protection: 10

MISCELLANEOUS DATA

Maneuver Modifiers: -1C, +3H, -1T

EDGES AND FLAWS

Stealth Field acts as Mono-refracting plating except the field works in a nebula.



SULIBAN HELIX SPACE STATION

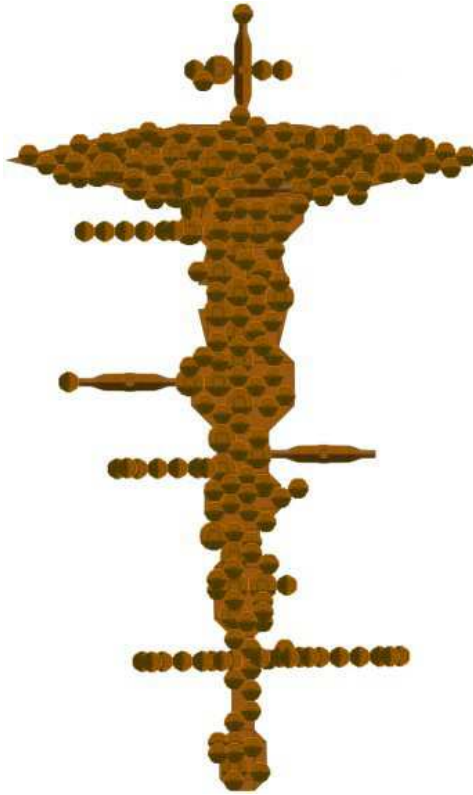

PRODUCTION DATA

Origin: Suliban
 Class and Type: Helix-Class Space Station
 Year Commissioned: 2145

HULL DATA

Structure: 50
 Size/Decks: 7/34
 Length/Height/Beam: 375/225/225
 Complement: 3,000

OPERATIONAL DATA

Atmosphere Capable: No
 Cargo Units: 100
 Life Support: Class 3 (D)
 Operations Systems: Class 3 (D)
 Sensor Systems: Class 2 (+2/B)
 Separation System: None
 Shuttlebay: None
 Shuttlecraft: None (100's of cell ships attach to the hull)
 Tractor Beams: 6 fv, 6 av
 Transporters: None

TACTICAL DATA

Hull Plating: Type V
 Protection: 12

MISCELLANEOUS DATA

Manuever Modifiers: +5C, -7H, +2T

EDGES AND FLAWS

Stealth Field acts as Mono-refracting plating except the field works in a nebula.
 Hardened System (Life Support, Operations, Tactical)

THOLIAN SCOUT



<p>PRODUCTION DATA: Origin: Tholian Assembly Class and Type: Shard-class Scout Year Launched: Unknown</p> <p>HULL DATA: Structure: 15 Size/Decks: 3/6 Length/ Height/ Beam: 55/20/20 Complement: 30</p> <p>OPERATIONAL DATA: Transporters: 3 Standard, 3 Emergency Cargo Units: 30 Shuttlebay: None Tractor Beam: 1 aft Sensor System: Class 2 (C) Operations System: Class 2 (C) Life Support: Class 2 (C)</p>	<p>PROPULSION DATA: Impulse System: Class IIIa (.6c)(C) Warp System: Class IIIa (3/6/6.5) (C)</p> <p>TACTICAL DATA: Phaser Banks: Type IV (X3/B) Penetration: 5/3/3/0/0 Tholian Web: Type I (B)* Energy Dampening Field Deflector Shield: Class 2a (B) Protection/Threshold: 13/2</p> <p>MISCELLANEOUS DATA: Maneuver Modifiers: +0 C, +3 H, +0 T</p> <p>EDGES AND FLAWS Unique System (Web Generator) Enhanced System (Beam Weapon)</p>
--	---

* The Web weapon requires two ships to work. When two ships join their aft sections together they can cast a web around an immobile or slower vessel. This requires several helm maneuvers to cast a web around another ship, the number of rounds is equal to the size of the ship. This "web" will trap any ships caught in it. It creates an energy-dampening field, all ships caught begin to loose power to all systems until finally life support fails. The web can be used to tow whatever is in the web. Trying to pull free only makes the web stronger. This could be like the booby trap asteroid field.



NAUSICAAAN RAIDER



PRODUCTION DATA

Origin: Nausicaan
Class and type: Fast Attack Ship
Year launched: 2140s-2150s

HULL DATA

Structure: 15
Size/decks: 3/
Length/Height/Beam: / /
Complement:

OPERATION DATA

Atmosphere capable: Yes
Transporters: none
Cargo units: 60
Shuttlebay:
Shuttlecraft:
Tractor beams:
Separation system: None
Cloaking system: None
Sensor system: Class 1 (+1/B)
Operations system: Class 1 (B)
Life support: Class 1 (B)

PROPULSION DATA

Impulse system: SBD (.6c/B)
Warp system: STN-2 (2/3/4.5) (BB)

TACTICAL DATA

Plasma Cannons: TDM-28 (x2/A)
Penetration: 2/2/2/0/0
Hull Plating: Type III
Protection/threshold: 9/0

MISCELLANEOUS DATA

Maneuver modifiers: +2 C, -1 H, +2 T

EDGES AND FLAWS

Nimble



INDEPENDENT FREIGHTER J-CLASS

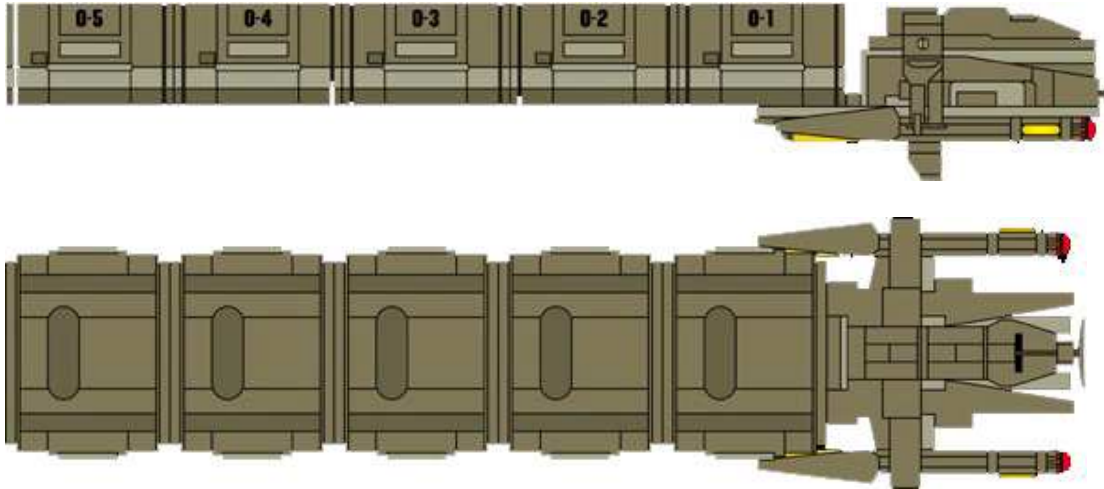

<p>PRODUCTION DATA Origin: Earth/Independent Class and type: J-Class Cargo Carrier Year launched: 2101</p>	<p>PROPULSION DATA Impulse system: SBB x 2 (.5c/A) Warp system: WE-2 (1/1.2/1.5) (A)</p>
<p>HULL DATA Structure: 35 Size/decks: 5/ Length/Height/Beam: 230m/ 37.5m / 57.6m Complement:</p>	<p>TACTICAL DATA Low-Yield Plasma Cannons: LCS-8 (x2/A) Penetration: 2/0/0/0/0 Hull Polarization: HPG MK I (AA) Protection/threshold: 10/0</p>
<p>OPERATION DATA Atmosphere capable: Yes Transporters: none Cargo units: 410 Shuttlebay: none Shuttlecraft: none Tractor beams: none Sensor system: Class 1 (+1/B) Operations system: Class 1 (B) Life support: Class 1 (B)</p>	<p>MISCELLANEOUS DATA Maneuver modifiers: +2 C, 1 H, +0 T</p> <p>EDGES AND FLAWS Design Defect (Impulse and Warp Drives)</p>



INDEPENDENT FREIGHTER Y-CLASS

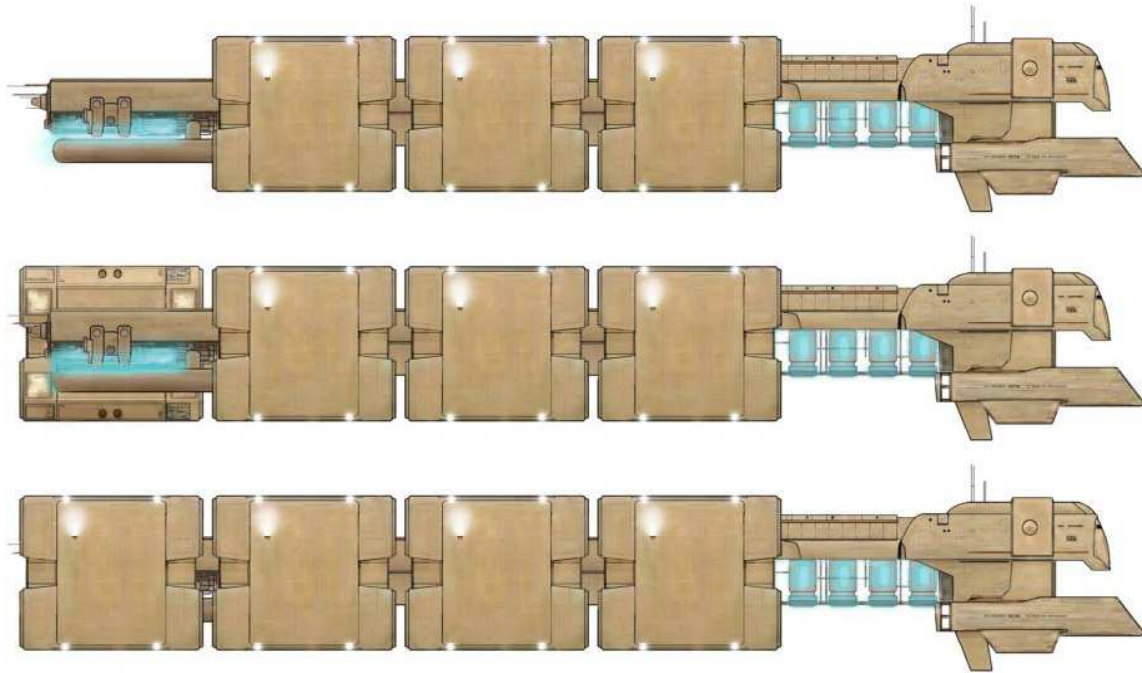

PRODUCTION DATA

Origin: Earth/Independent
Class and Type: Y-class freighter
Year Launched: 2135

HULL DATA

Structure: 35
Size/Decks: 5/
Length/Height/Beam: 280m/52.9m/86.6m
Complement: 23

OPERATION DATA

Atmosphere Capability: yes
Transporter: none
Cargo Units: 400
Shuttle Bay: none
Shuttlecraft: none
Tractor Beam (Grappler): none
Sensor System: Class 1 (+1/B)
Operation System: Class 1 (B)
Life Support: Class 1 (B)

PRODPULSION DATA

Impulse System: SBC (.5c/B)
Warp System: WE-2c (1/1.4/1.8) (A)

TACTICAL DATA

Low-Yield Plasma Cannons: LCS-8 (x2)
Penetration: 2/0/0/0 (A)
Hull Polarization Generator: HPG Mk I (AA)
Protection/Threshold: 10/0

MISCELLANEOUS DATA

Maneuvers Mod: +2 C, +1 H, +0 T

TRAITS

Design Defect (Impulse and Warp Drive)



TELLARITE TRADE SHUTTLE



<p>PRODUCTION DATA Origin: Tellar Class and type: Tellarite Trade Shuttle Year launched: 2133</p>	<p>PROPULSION DATA Impulse system: SBB (0.5c/A) Warp system: WE-2c (warp 1/1.4/1.8) (OCU) (A)</p>
<p>HULL DATA Structure: 10 Size/decks: 2/1 Length/Height/Beam: 24/5/15 Complement: 1 pilot + 4 passengers</p>	<p>TACTICAL DATA Beam primary: LCS-42 (x1/A) Penetration: 2/1/0/0/0 Deflector shield: HPG Mk1 (A) Protection/threshold: 10/0</p>
<p>OPERATION DATA Atmosphere capable: Yes Transporters: None Cargo units: 11 Shuttlebay: None Shuttlecraft: None Tractor beams: 1 FV Separation system: None Cloaking system: None Sensor system: Class 1 (+1/B) Operations system: Class 1 (B) Life support: Class 1 (B)</p>	<p>MISCELLANEOUS DATA Maneuver modifiers: C +0 H +2 T +0</p> <p>EDGES AND FLAWS Prototype (+1 beam) Jury-rigged (shields)</p>





GAMEMASTERING

There are countless possibilities for a game set in the Enterprise-Era of Star Trek. But first a Narrator should create a basic idea of the campaign, before presenting it to the players.

When creating a prequel campaign for the Star Trek RPG, the setting seems to be obvious. It's simply a younger Star Trek universe, with more primitive technology but still there are the same villains and dangers.

While this may be true, this still keeps up many possibilities. Enterprise shows us how the Trek universe was like a century before we visited it for the first time. Now we can see how the different species and political conditions developed. We learn more about humanity's past as well as the history of Vulcan and Andoria.

To catch this mood, the Narrator can introduce self-created species from campaigns set in the future. If you had a species being the major threat in your DS9-Campaign, why not foreshadow it in a prequel adventure? If done well, the players will remind this event a long time and you have the possibility to further develop your favorite species.

Of course your prequel can have a totally different mood. Another option could be to center on e.g. the Romulan-Earth War, an event probably not too different from the Dominion War. Whatever you do, a prequel gives you the chance to let your players participate in historic events, which are important for the Star Trek setting in general and maybe for your players' future characters.

When planning your campaign, you should decide what kind of crew you use. If you use Starfleet Officers, they can be stationed on a starbase, a ship, the Academy or whatever. You should remember that it's difficult to transfer them, as Starfleet's resources are very limited compared to its future counterparts.

Alternately you could want to have you players use Vulcan characters.



This would give them access to more advanced technology. More tension in the crew could be created if one of the characters is a Human exchange officer, or a rogue Vulcan who does not deny emotions, even if only in secret. Another angle could be to use a completely different species, e.g. Tellarites, Centaurans or maybe even Bajorans, using one of their Solar-Sailing ships.

But of course you characters need not to play explorers. Another option for play would be to let the players man a mercenary or merchant ship, which has to get through space with even less developed technology and resources.

THE STORY

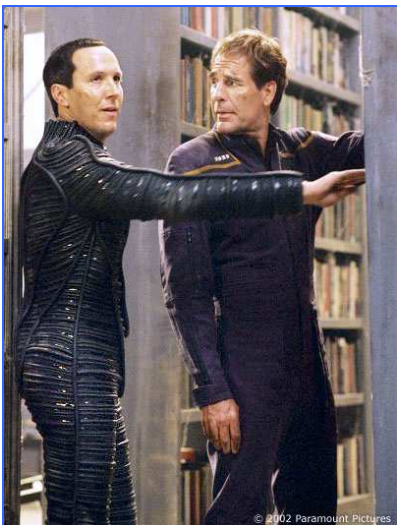

Of course the story is directly linked with the setting, but still you might want to consider about one major plot line in your campaign, like the Temporal Cold War in Enterprise. Depending on your setting, this

plot may vary. If your characters are merchants, the main plot could be to gain control of one major trade route, or get the monopoly of one certain good. The adversaries could be another freighter's crew, or e.g. the Ferengis, who would not only use 'fair' methods of trade.



The characters could be involved in the Romulan-Earth War or any other conflict, e.g. between the Vulcans and Andorians.



Another option would be that the characters find hints to a very potent species during their traveling – the climax could be that they actually meet this species, whether it is friend or foe.

ENTERPRISE



You might want your characters be involved with the events of Enterprise in any one way. If you do so, you should first of all decide whether you stick to canon or not. If

you want to stick to the events of the series, it is difficult to involve the characters and works best if they are low ranking crewmembers, you do not appear on the screen and so could do some work behind the scenes, e.g. do some research and the like. This gives the characters the opportunity to interact with the crew of the show, however it is also restricting.

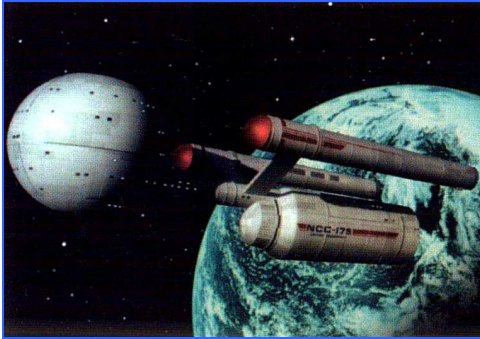

If you decide to do something on your own, only loosely based on Enterprise, you can easily exchange parts of the crew with your characters, if not the whole or you can have the characters take part in prominent events. But this would make it difficult for your campaign to follow the series, because some events are strictly connected to certain characters or events, which may not be present in your campaign. Connecting the story of your campaign to one set in the future of the Star Trek universe, is especially rewarding. Your characters might be ancestors of future ones or could make certain events of the future possible, e.g. by inventing new technology or discovering certain phenomena. This would give the players the feeling to be an essential part of something very large.





APPENDIX

RANKS/COLORS

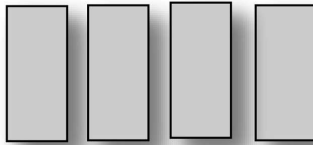

CAPTAIN

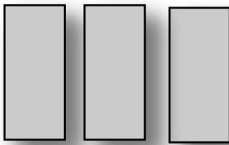

COMMANDER

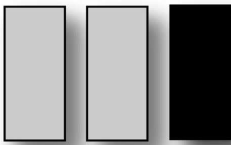

LT. COMMANDER

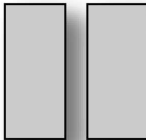

LIEUTENANT

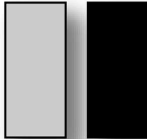

LIEUTENANT (J.G.)



ENSIGN



CHIEF WARRANT OFFICER

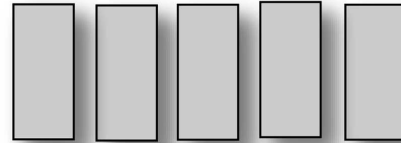

FLEET ADMIRAL

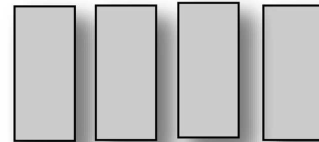

ADMIRAL

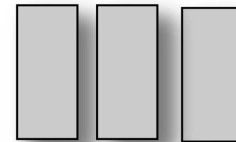

VICE ADMIRAL

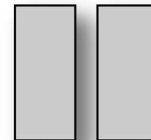

FLEET CAPTAIN



COMMODORE

DEPARTMENT COLORS



SCIENCE & COMMUNICATION



ENGINEERING & SECURITY



COMMAND & HELM

Line Officers wear the rank on the right shoulder and Flag Officers on both the right and left shoulders.

TABLES

WARP SPEED TABLE

Speed	KM/H	Multiple of c.	Earth to Moon	Across Sol System	To Nearby Star	Across Sector
Full Impulse	270 million	0.25c	5.38 sec	44 hrs	20 yrs	80k yrs
Warp 1	1 billion	1	1.34 sec	11 hrs	5 yrs	20 yrs
Warp 2	8 billion	8	0.16 sec	1.37 hrs	7.5 months	2.5 yrs
Warp 3	27 billion	27	49.6 ms	24 min	2.2 months	8.8 months
Warp 4	64 billion	64	21 ms	10 min	28.5 days	4 months
Warp 5	125 billion	125	11 ms	5 min	2 weeks	2 months
Warp 6	216 billion	216	6 ms	2.9 min	8.4 days	34 days
Warp 7	343 billion	343	3 ms	109 sec	5.3 days	21 days
Warp 8	512 billion	512	1.25 ms	73 sec	3.5 days	14 days
Warp 10	1 trillion	1000	0.64 ms	37 sec	1.8 days	7 days
Warp 14	2.74 trillion	2744	0.23 ms	12 sec	16 hrs	2.5 days

STARFLEET SHIP LAYOUT

BRIDGE & SICKBAY

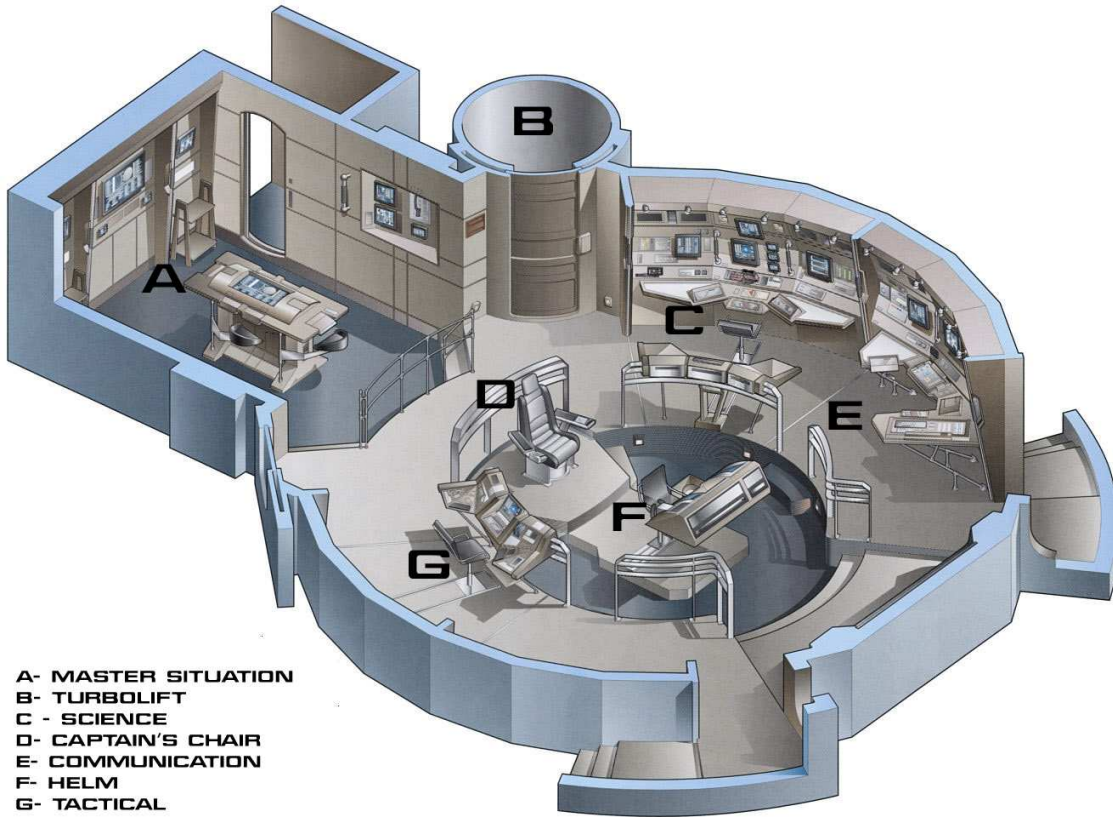

- A- MASTER SITUATION
- B- TURBOLIFT
- C - SCIENCE
- D- CAPTAIN'S CHAIR
- E- COMMUNICATION
- F- HELM
- G- TACTICAL

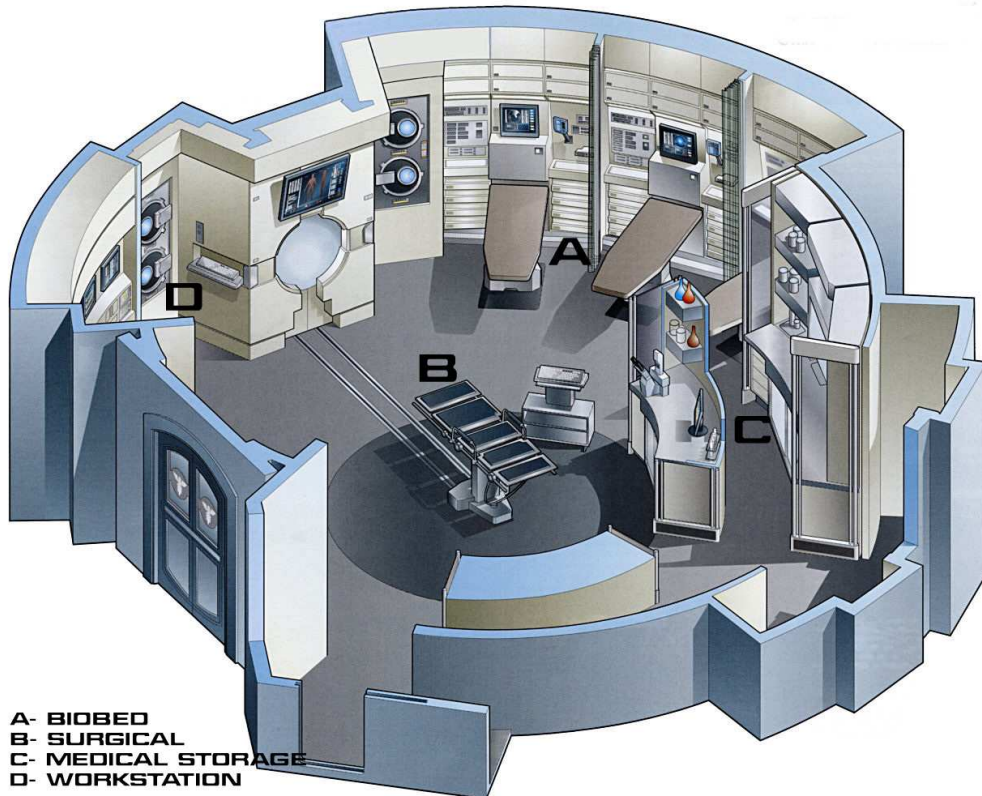

- A- BIOBED
- B- SURGICAL
- C- MEDICAL STORAGE
- D- WORKSTATION

SUPPORTING CAST

CREWMAN ELIZABETH CUTLER



Species: Human

Species Abilities: Adaptable, Human Spirit, Skilled

Attributes: STR 6, AGL 6, INT 8, VIT 5, PRE 8, PER 6, PSI 0

Reactions: QUIK 1, SAVY 1, STAM 0, WILL 1

Professional Abilities: Starship Duty, Field Research

Skills: Athletics 3, Computer Use 5, Engineering: Systems 3, First Aid 5, Knowledge: Culture 3, Knowledge: Earth 3, Knowledge: History 3, Knowledge: Law 3, Language: English 3, Medicine: General Medicine 4, Ranged Weapon: Energy Weapon 2, Repair (Tricorder) 4, Science: Life 6, Science: Physical 4, Survival 2, System Operation 5

Edges: Curious

Flaws:

Health: 9 **Courage:** 4 **Renown:** 0

Background: Elizabeth Cutler belongs to the science department of Starship Enterprise and is head of Exobiology. After some month onboard she began training as paramedic under tutelage of Dr. Phlox. She took part on several away missions with the doctor and took his place during the Denobulan's hibernation. While it first seemed she would be interested in a romantic relationship with her mentor, she soon realized they just should be friends. Among the lower ranks, Crewman Novakovich is one of her closest friends. When off-duty Elizabeth Cutler likes to be head of a session of a self-created role-playing game, among the players are Novakovich and Ensign Mayweather, or she takes part in the weekly movie night.

ADMIRAL FORREST



Species: Human

Species Abilities: Adaptable, Human Spirit, Skilled

Attributes: STR 8, AGL 6, INT 10, VIT 8, PRE 8, PER 10, PSI 0

Reactions: QUIK 3, SAVY 2, STAM 1, WILL 2

Professional Abilities: Starship Duty, Commanding Presence, Starship/Starbase Protocol, Command

Skills: Administration 4, Athletics 3, Persuade (Starfleet) 7, Computer Use 3, Knowledge: Culture (Human) 3, Negotiate 2, Ranged Combat: Energy Weapon 3, Influence 2, Knowledge: History (Human) 3, Language: English 3, Knowledge: Law (Starfleet) 6, Engineering: Structural 4, Repair 2, Science: Physical 3, Survival 3, Engineering: Propulsion 3, System Operation 2, Science: Space 2, Tactics 4, Engineering: System 2, Vehicle Operation 2, Knowledge: Specific World (Earth) 3

Edges: Contact (Vulcan Ambassadors, Jonathan Archer), Skill Focus (Engineering), Promotion 10

Flaws: Intolerant (Vulcan)

Health: 9 **Courage:** 4 **Renown:** 37

Background: Admiral Forrest is one of the highest members of Starfleet Command. He was one of the early supporters of the "Warp 5" project and a friend of Henry Archer. He began his Starfleet career as an engineer and later became head of starship development projects of Starfleet, before becoming CO of Earth's shipyard.

STAR TREK RPG BOOKS

*required core books

** contains information relevant to Enterprise-era

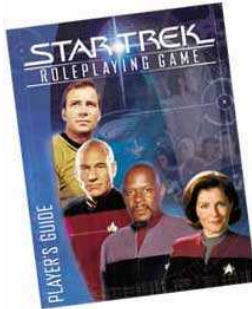

PLAYER'S GUIDE *

This full-color large-format book introduces the all-new Star Trek RPG, with everything you need to create a player character and head out on your own adventures in any era, any place in the Star Trek universe. Illustrated with images from all four television series and many of the films, the Player's Guide is packed with richly detailed background information and a comprehensive history of the Star Trek universe. Start off with a ready-made character archetype or build your own using the extensive collection of character features ... then prepare to boldly go where no one has gone before!

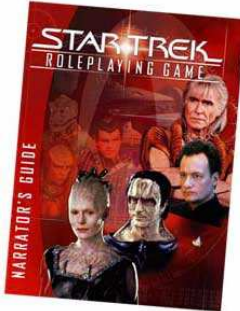

NARRATOR'S GUIDE *

You've read the Player's Guide and now you're prepared for the next step – you're ready to become a Star Trek narrator. This full-color guide, matching the Player's Guide in format, will provide you with detailed guidelines for creating and running your own "episodes" in the Star Trek universe. Includes creation rules for starships, planets, creatures, hazards, and aliens, as well as tips for linking your episodes into series and "seasons" of adventure for your players.



NARRATOR'S SCREEN

The full-color, four-panel Narrator's Screen is designed to make your job as Narrator more smooth and enjoyable. Packed with all of the most important charts, tables, and forms from the RPG, this is one product no Narrator should be without!



STARFLEET OPERATIONS MANUAL**

Welcome to Starfleet! You are the best the Galaxy has to offer: the men, women, and aliens of Starfleet. With the Starfleet Operations Manual, you have the wisdom of more than two centuries of five-year missions distilled into one place. Your Star Trek Role-playing Game characters can use the guidelines, hints, and rules in this sourcebook to keep their starships flying smoothly, to meet challenges on their own terms, and to outwit the most devious Romulans – or the most cunning Narrators!

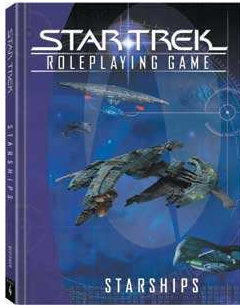

STARSHIPS **

This invaluable sourcebook for the Star Trek RPG is also a great reference book for all lovers of Star Trek starships. This fourth full-color hardcover for the role-playing game provides tactical, propulsion, hull, and operational data, as well as features, background, and a ships in service listing on over 40 classes of starships, including warships, freighters, cruisers, shuttles, and more. Covered in their own sections are the starships of Starfleet, the Klingons, the Romulans, and the Cardassians. Additionally, there are over 40 pages covering other vessels of the Borg, Breen, Jem'Hadar, Ferengi, Species 8472, and more. A true encyclopedic reference tome not to be missed.



ALIENS **

Plan your next first contact! This full-color sourcebook for the Star Trek Role-playing Game is an invaluable guide to the inhabitants of many far-flung galaxies. From the aliens of the Alpha Quadrant to the denizens of Delta, this book provides you with the information you need to know.

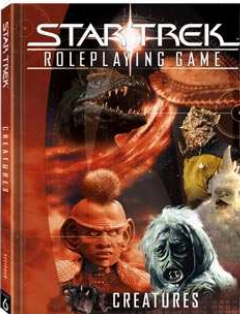

CREATURES

As enemies or pets, dozens of alien beasts have graced the Star Trek screen. From the Mugato to the Klingon Targ, this book covers them all with background and game statistics. Whether you are looking to add pre-generated creature chaos to your Star Trek role-playing campaign, or just an aficionado looking for information on the wild and wonderful 'critters' of the show, this is the reference book for you.



EXPANDED SPACECRAFT OPERATIONS

This is a fan created sourcebook that enhances the rules regarding starships, starship combat, and new starships, including the Scimitar. This sourcebook is free and can be downloaded at <http://rpg.lionelkw.com/trek>



WWW.TREK-RPG.NET
WWW.DECIPHER.COM
WWW.STARTREK.COM
WWW.STARBASE-CODA.COM

"..i can reach any star.."
faith of the heart
by diane warren