

STAR TREK™

ADVENTURES

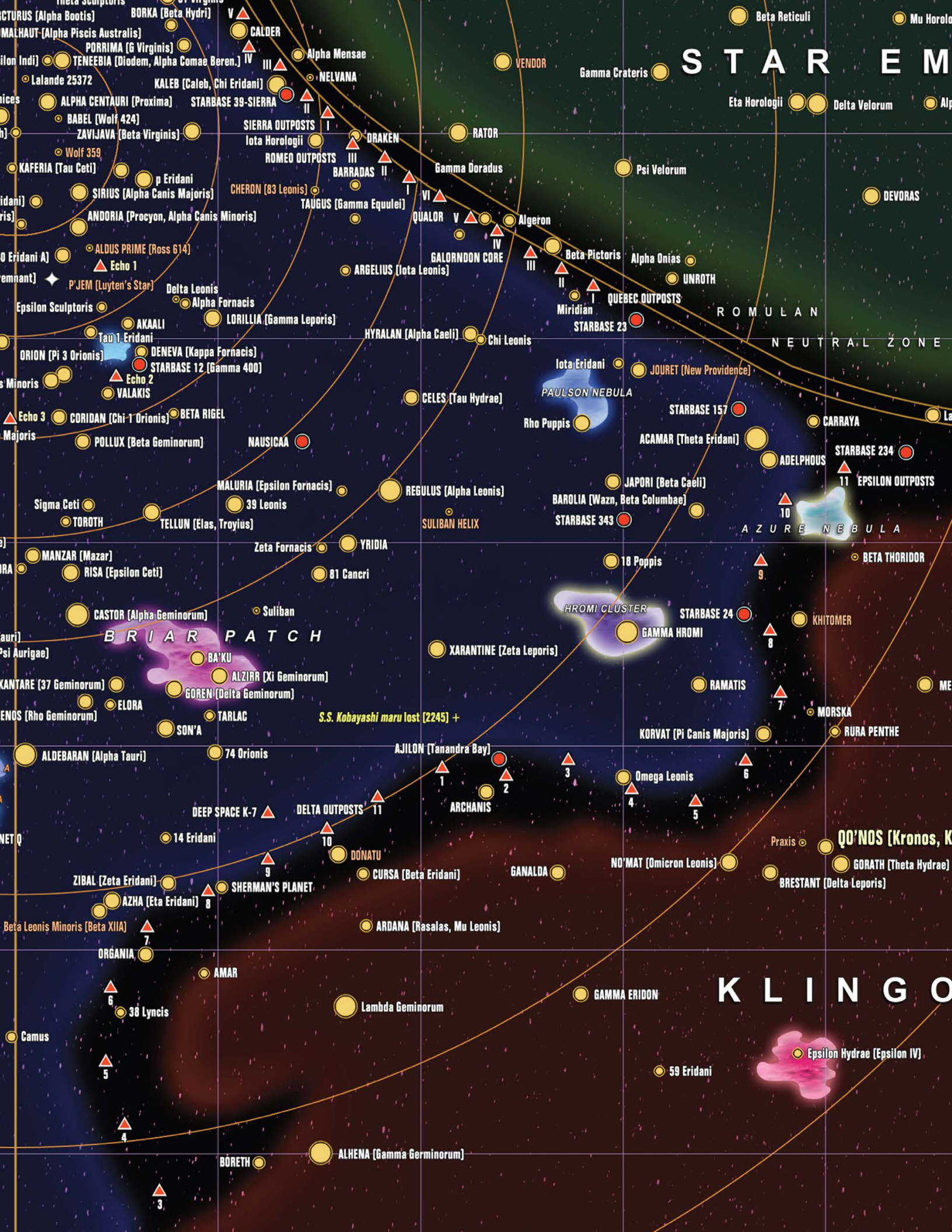

BETA QUADRANT
SOURCEBOOK



STAREM

ROMULAN NEUTRAL ZONE

KLINGON

S.S. Kobayashi maru lost [2245] +

BRIAAR PATCH

HROMI CLUSTER

AZURE NEBULA

PAULSON NEBULA

EPSILON OUTPOSTS

SIERRA OUTPOSTS

ROMEO OUTPOSTS

TAUGUS

QUALOR

GALORNDON CORE

HYRALAN

ORION

STARBASE 12

CORIDAN

NAUSICAA

MALURIA

ZETA FORNACIS

YRIDIA

SULIBAN

CASTOR

ALZIRRA

GOREN

TARLAC

SON'A

ALDEBARAN

DEEP SPACE K-7

ZIBAL

AZHA

ORGANIA

AMAR

BORETH

ALHENA

XARANTINE [Zeta Leporis]

ARCHANIS

ARDANA [Rasalas, Mu Leonis]

Lambda Geminorum

ALHENA [Gamma Geminorum]

STARBASE 24

GAMMA HROMI

RAMATIS

KORVAT [Pi Canis Majoris]

OMEGA LEONIS

NO'MAT [Omicron Leonis]

GAMMA ERIDON

59 ERIDANI

59 ERIDANI

59 ERIDANI

59 ERIDANI

59 ERIDANI

59 ERIDANI

59 ERIDANI

STARBASE 157

ACAMAR [Theta Eridani]

JAPORI [Beta Caeli]

BAROLIA [Wazn, Beta Columbae]

18 Poppis

STARBASE 24

GAMMA HROMI

RAMATIS

KORVAT [Pi Canis Majoris]

OMEGA LEONIS

NO'MAT [Omicron Leonis]

GAMMA ERIDON

59 ERIDANI

59 ERIDANI

59 ERIDANI

59 ERIDANI

59 ERIDANI

59 ERIDANI

ADELPHOUS

STARBASE 234

BETA THORIDOR

KHITOMER

MORSKA

RURA PENTHE

QO'NOS [Kronos, K]

GORATH [Theta Hydræ]

BRESTANT [Delta Leporis]

Praxis

QO'NOS [Kronos, K]

GORATH [Theta Hydræ]

BRESTANT [Delta Leporis]

Praxis

QO'NOS [Kronos, K]

GORATH [Theta Hydræ]

GORATH [Theta Hydræ]

BRESTANT [Delta Leporis]

Praxis

QO'NOS [Kronos, K]

GORATH [Theta Hydræ]

BRESTANT [Delta Leporis]

Praxis

QO'NOS [Kronos, K]

GORATH [Theta Hydræ]

BRESTANT [Delta Leporis]

Praxis

QO'NOS [Kronos, K]

GORATH [Theta Hydræ]

BRESTANT [Delta Leporis]

Praxis

QO'NOS [Kronos, K]

GORATH [Theta Hydræ]

BRESTANT [Delta Leporis]

Praxis

QO'NOS [Kronos, K]

GORATH [Theta Hydræ]

BRESTANT [Delta Leporis]

Praxis

QO'NOS [Kronos, K]

GORATH [Theta Hydræ]

BRESTANT [Delta Leporis]

Praxis

QO'NOS [Kronos, K]

GORATH [Theta Hydræ]

BRESTANT [Delta Leporis]

Praxis

QO'NOS [Kronos, K]

GORATH [Theta Hydræ]

BRESTANT [Delta Leporis]

Praxis

QO'NOS [Kronos, K]

GORATH [Theta Hydræ]

BRESTANT [Delta Leporis]

Praxis

QO'NOS [Kronos, K]

GORATH [Theta Hydræ]

BRESTANT [Delta Leporis]

Praxis

QO'NOS [Kronos, K]

GORATH [Theta Hydræ]

BRESTANT [Delta Leporis]

Praxis

QO'NOS [Kronos, K]

GORATH [Theta Hydræ]

BRESTANT [Delta Leporis]

Praxis

QO'NOS [Kronos, K]

GORATH [Theta Hydræ]

BRESTANT [Delta Leporis]

Praxis

QO'NOS [Kronos, K]

GORATH [Theta Hydræ]

BRESTANT [Delta Leporis]

Praxis

QO'NOS [Kronos, K]

GORATH [Theta Hydræ]

BRESTANT [Delta Leporis]

Praxis

QO'NOS [Kronos, K]

GORATH [Theta Hydræ]

BRESTANT [Delta Leporis]

Praxis

QO'NOS [Kronos, K]

GORATH [Theta Hydræ]

BRESTANT [Delta Leporis]

Praxis

QO'NOS [Kronos, K]

GORATH [Theta Hydræ]

BRESTANT [Delta Leporis]

Praxis

QO'NOS [Kronos, K]

GORATH [Theta Hydræ]

BRESTANT [Delta Leporis]

Praxis

QO'NOS [Kronos, K]

GORATH [Theta Hydræ]

BRESTANT [Delta Leporis]

Praxis

QO'NOS [Kronos, K]

GORATH [Theta Hydræ]

BRESTANT [Delta Leporis]

Praxis

QO'NOS [Kronos, K]

GORATH [Theta Hydræ]

BRESTANT [Delta Leporis]

Praxis

QO'NOS [Kronos, K]

GORATH [Theta Hydræ]

BRESTANT [Delta Leporis]

Praxis

QO'NOS [Kronos, K]

GORATH [Theta Hydræ]

BRESTANT [Delta Leporis]

Praxis

QO'NOS [Kronos, K]

GORATH [Theta Hydræ]

BRESTANT [Delta Leporis]

Praxis

QO'NOS [Kronos, K]

GORATH [Theta Hydræ]

BRESTANT [Delta Leporis]

Praxis

QO'NOS [Kronos, K]

GORATH [Theta Hydræ]

BRESTANT [Delta Leporis]

Praxis

QO'NOS [Kronos, K]

GORATH [Theta Hydræ]

BRESTANT [Delta Leporis]

Praxis

QO'NOS [Kronos, K]

GORATH [Theta Hydræ]

BRESTANT [Delta Leporis]

Praxis

QO'NOS [Kronos, K]

GORATH [Theta Hydræ]

BRESTANT [Delta Leporis]

Praxis

QO'NOS [Kronos, K]

GORATH [Theta Hydræ]

BRESTANT [Delta Leporis]

Praxis

QO'NOS [Kronos, K]

GORATH [Theta Hydræ]

BRESTANT [Delta Leporis]

Praxis

QO'NOS [Kronos, K]

GORATH [Theta Hydræ]

BRESTANT [Delta Leporis]

Praxis

QO'NOS [Kronos, K]

GORATH [Theta Hydræ]

BRESTANT [Delta Leporis]

Praxis

QO'NOS [Kronos, K]

GORATH [Theta Hydræ]

BRESTANT [Delta Leporis]

Praxis

QO'NOS [Kronos, K]

GORATH [Theta Hydræ]

BRESTANT [Delta Leporis]

Praxis

QO'NOS [Kronos, K]

GORATH [Theta Hydræ]

BRESTANT [Delta Leporis]

Praxis

QO'NOS [Kronos, K]

GORATH [Theta Hydræ]

BRESTANT [Delta Leporis]

Praxis

QO'NOS [Kronos, K]

GORATH [Theta Hydræ]

BRESTANT [Delta Leporis]

Praxis

QO'NOS [Kronos, K]

GORATH [Theta Hydræ]

BRESTANT [Delta Leporis]

Praxis

QO'NOS [Kronos, K]

GORATH [Theta Hydræ]

BRESTANT [Delta Leporis]

Praxis

QO'NOS [Kronos, K]

GORATH [Theta Hydræ]

BRESTANT [Delta Leporis]

Praxis

QO'NOS [Kronos, K]

GORATH [Theta Hydræ]

BRESTANT [Delta Leporis]

Praxis

QO'NOS [Kronos, K]

GORATH [Theta Hydræ]

BRESTANT [Delta Leporis]

Praxis

QO'NOS [Kronos, K]

GORATH [Theta Hydræ]

BRESTANT [Delta Leporis]

Praxis

QO'NOS [Kronos, K]

GORATH [Theta Hydræ]

BRESTANT [Delta Leporis]

Praxis

QO'NOS [Kronos, K]

GORATH [Theta Hydræ]

BRESTANT [Delta Leporis]

Praxis

QO'NOS [Kronos, K]

GORATH [Theta Hydræ]

BRESTANT [Delta Leporis]

Praxis

QO'NOS [Kronos, K]

GORATH [Theta Hydræ]

BRESTANT [Delta Leporis]

Praxis

QO'NOS [Kronos, K]

GORATH [Theta Hydræ]

BRESTANT [Delta Leporis]

Praxis

QO'NOS [Kronos, K]

GORATH [Theta Hydræ]



PIRE

KLINGON EMPIRE

SHACKLETON EXPANSE

UNITED FEDERATION OF PLANETS

EMPIRE



ha Pictoris

Eta Antliae

CHALTOK

GASKO

Zeta Pictoris

NEQUENCIA

mbda Hydrae

H'ATORIA

BETA LANKAL

QU'VAT

ling)

EMPIRE

Alpha Monocerotis

Delta Doradus

STARBASE 173

KHAZARA

Iconia

Iccobar

Dinasia

TYRELLIA

Dewa

D'DERIDEX

TRANOME SAR

BALDUK

STARBASE 123

ZALDA

STARBASE 364 NARENDRA STATION

NARENDRA

ARCHER

PHEBEN

STARBASE 105

K'TINGA

OUTPOST MZ-5

UNITED FEDERATION OF PLANETS

KOSTOLAIN

TESSEN

MOSELINA

STARBASE 117

HALEE

B'MOTH

VALT

KRIOS

STARBASE 36

IKALIA

TY'GOKOR

AMARGOSA

CREDITS

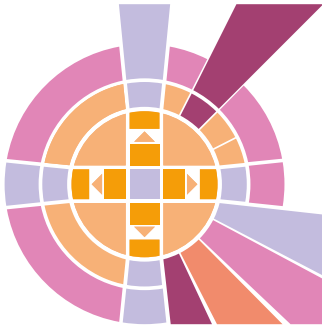

1732011

SYSTEM DESIGN
NATHAN DOWDELL

COVER ARTWORK
TOBIAS RICHTER

PRODUCED BY
CHRIS BIRCH

LINE DEVELOPMENT
SAM WEBB

INTERNAL ARTWORK
CHRIS ADAMEK, MICHAL E. CROSS,
DAREN DOCHTERMAN, RICHARD L. GALE,
TOMA FEIZO GAS, RODRIGO GONZALEZ,
NICK GREENWOOD, DAVID METLESITS,
ÁNGEL ALONSO MIGUEL, WAYNE MILLER,
DAVID R. MORTON, GRZEGORZ PEDRYCZ,
TOBIAS RICHTER, ALAIN RIVARD,
RICK STERNBACH, MAURICIO TEJERINA,
VITALI TIMKIN, AND ADAM WILLIAMS

OPERATIONS MANAGER
GARRY HARPER

WRITING
JENNIFER BAUGHMAN, JIM JOHNSON,
GARETH MICHAEL-SKARKA, AARON POLLYEA,
AND SAM WEBB

PRODUCTION MANAGER
STEVE DALDRY

EDITING
SCOTT PEARSON, MIKE BRUNTON,
SAM WEBB, AND JIM JOHNSON

COMMUNITY SUPPORT
LLOYD GYAN

191984

ART DIRECTION
SAM WEBB

FOR CBS STUDIOS
JOHN VAN CITTERS, MARIAN CORDRY,
VERONICA HART, AND KEITH LOWENADLER

221084

PROOFREADING
ARIC WIEDER

GRAPHIC DESIGN
MATTHEW COMBEN

WITH THANKS TO

INDEX BY
BILL HERON

LAYOUT
MICHAL E. CROSS AND RICHARD L. GALE

**PERFECT WORLD AND
THE STAR TREK ONLINE TEAM**

AUX SYS



Published by Modiphius Entertainment Ltd.
2nd Floor, 39 Harwood Road, London, SW6 4QP, England.
Printed by SKN Druck und Verlag GmbH & Co. KG

INFO@MODIPHIOUS.COM
WWW.MODIPHIOUS.COM
STARTREK.COM

Modiphius Entertainment Product Number: MUH051067
ISBN: 978-1-910132-91-3

The 2d20 system and Modiphius Logos are copyright Modiphius Entertainment Ltd 2018. All 2d20 system text is copyright Modiphius Entertainment Ltd. Any unauthorised use of copyrighted material is illegal. Any trademarked names are used in a fictional manner; no infringement is intended. This is a work of fiction. Any similarity with actual people and events, past or present, is purely coincidental and unintentional except for those people and events described in an historical context. TM & © 2018 CBS Studios inc. © 2018 Paramount Pictures Corp. *STAR TREK* and related marks and logos are trademarks of CBS Studios inc. All Rights Reserved.

Artwork and graphics © and ™ CBS Studios Inc. All Rights Reserved., except the Modiphius Logo which is Modiphius Entertainment Ltd. This is a work of fiction. Any similarity with actual people and events, past or present, is purely coincidental and unintentional except for those people and events described in an historical context.

CONTENTS

CHAPTER 01 003
INTRODUCTION

01.10 Welcome to the Beta Quadrant

CHAPTER 02 007
THE BETA QUADRANT

- 02.00 Briefing from Narendra Station.....
- 02.10 The United Federation of Planets.....
- 02.20 Federation Worlds
- 02.30 The Klingon Empire
- 02.40 Klingon Worlds
- 02.50 The Romulan Empire.....
- 02.60 Romulan Worlds.....
- 02.70 The Orion Syndicate
- 02.80 The Gorn Hegemony.....

CHAPTER 03 075
SPECIES OF THE BETA QUADRANT

03.10 New Lifepath Options

CHAPTER 04 087
STARSHIPS OF THE BETA QUADRANT

- 04.10 Klingon Starships
- 04.20 Romulan Starships
- 04.30 Orion Starships
- 04.40 Gorn Starships
- 04.50 Civilian Starships.....

CHAPTER 05 101
ENCOUNTERS AND ADVERSARIES

- 05.10 The Romulan Neutral Zone
- 05.20 The Briar Patch
- 05.30 The Klingon Border
- 05.40 The Shackleton Expanse.....





30982000527890
28853020133

01.10 WELCOME TO THE BETA QUADRANT 004

INTRODUCTION

WELCOME TO THE BETA QUADRANT

“THERE ARE 400 BILLION STARS IN OUR GALAXY. WE’VE ONLY EXPLORED A TINY FRACTION OF THEM. WE HAVE A LOT TO DO.”

— CAPTAIN JONATHAN ARCHER

Welcome to Narendra Station, Captain.

Perhaps you would have preferred a station somewhere in the Alpha Quadrant, or as part of the planned exploration through the Bajoran wormhole. The Beta Quadrant, after all, has not been a primary focus of exploration for the Federation. Although the Quadrant is home to three of the four founders of the Federation, it’s more usually considered a source of trouble: large swaths of the Quadrant are claimed by the Klingon and Romulan Empires, respectively. The Beta Quadrant was the Federation’s military frontier, and exploration of the region was secondary to ensuring the security of our borders.

For the majority of the Federation’s existence, political necessities have directed our explorations into the Alpha Quadrant. There seemed no need to unnecessarily antagonize the Klingons and Romulans when there was so much unclaimed space to the galactic west of Earth. So, while Sol sits on the dividing line between the two quadrants, the Federation has traditionally considered itself an Alpha Quadrant power.

Recent events have made Federation exploration in the Beta Quadrant a much more attractive proposition. The alliance with the Klingon Empire means that Federation starships can make the passage to the unexplored region of the Quadrant without the risk of straying into the Romulan Neutral Zone or encountering hostile Klingon warships. While the Romulans are not pleased with the alliance, their attempts to subvert one or more Klingon families has thus far yielded minimal results.

In addition, the Borg’s projected invasion route crosses the Beta Quadrant toward Sector 001: Earth. Recent discoveries by the *U.S.S. Enterprise* NCC-1701-D indicate that the Borg use a previously-unknown type of spatial anomaly to cross distances that would take even the most advanced Federation starship centuries, and advanced scouts have detected energy readings that suggest similar anomalies may exist in the Shackleton Expanse.

The Beta Quadrant has need of your skills, Captain. We trust that you’re up to the challenge.

SUPPLEMENT STRUCTURE

This campaign sourcebook contains everything you’ll need to play a game of *Star Trek Adventures* in the Beta Quadrant.

Chapter 2: The Beta Quadrant is the heart of this book, and describes the major powers in the Beta Quadrant. It begins with the United Federation of Planets, paying special

THE MILKY WAY GALAXY

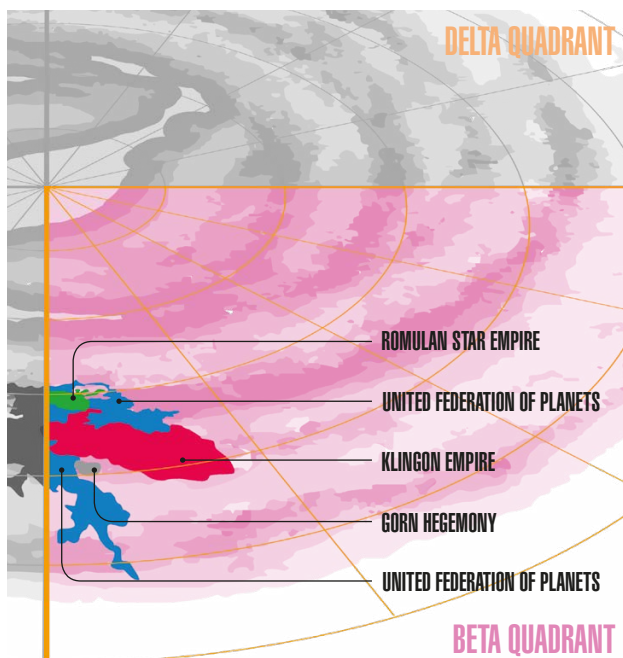

STELLAR CARTOGRAPHY



attention to several Federation planets located in the Beta Quadrant. It then shifts focus to the Klingon Empire — Federation allies, for the moment — examining the tangled internal politics of the Klingon Houses and providing an overview of several of the Empire’s major planets, including Qo’noS, the Klingon homeworld. Next, the secrets of the mysterious Romulan Empire are revealed, wrested from the grasp of the Tal Shiar; including the common origin of the Romulans and the Vulcans, and the long history of deceit in their galactic affairs. The Orion Syndicate is next, with a look at the criminal underworld, pirate operations on the frontiers of known space, and its continued pursuit of the slave trade. A brief discussion of the Gorn Hegemony rounds out this chapter.

Chapter 3: Beta Quadrant Characters introduces new playable species that are representative of Starfleet officers in Beta Quadrant. In addition to the playable species available in the core rulebook, Players may now choose from a selection of species including Benzites, the Boliangs, Klingons, Risians, and Xindi. These additional species add diversity to both Player Characters and Non-Player Characters.

Chapter 4: Starships of the Beta Quadrant contains almost twenty new starships for the adventurous Gamemaster. In this chapter can be found warships, scout ships, and shuttlecraft in use by the Klingons, Romulans, and others.

Finally, *Chapter 5: Encounters and Adversaries* introduces capsule descriptions of those regions of the Quadrant likely to see action: the Romulan Neutral Zone, the Klingon Border, and the so-called Briar Patch (or, as the Klingons call it, Klach D’kel Brakt). Included in these descriptions are new adversaries to be found in those contested areas: cunning Romulan commanders sneaking in and out of the Neutral Zone, Orion slavers haunting the fringes of civilized society, fierce Klingons — allies with their own agendas — patrolling their own border. Each of these descriptions concludes with several encounter hooks to help launch your own missions.

CAMPAIGN USAGE

The information presented in the Beta Quadrant sourcebook brings a new depth to the *Star Trek* universe. Instead of repeating material most *Star Trek* fans are already familiar with, Beta Quadrant offers new perspectives on old history. Cultures that were only briefly mentioned in the occasional episode are here fleshed out and brought to life, and old favorites have new mysteries revealed. Every chapter provides a wealth of ideas which Players and Gamemasters alike can use to create their own *Star Trek* adventures.

YESTERDAY'S ENTERPRISE

The default setting of *Star Trek Adventures* is the year 2371 (Stardates 48000-48999). The Klingons are allies, though undergoing some political upheaval. The Romulans are operating behind the scenes, working to undermine the stability of the Klingon Empire and the Federation. Meanwhile, the Klingons and the Federation have joined forces to explore the newly-named Shackleton Expanse, a large area of unexplored space beyond the farthest reach of the Klingon Empire.

Games set in the Enterprise era will, of necessity, be restricted to a smaller volume of space due to slower warp drives. By 2151, the farthest an Earth starship had ventured was Risa, 90 light-years away. The Gamemaster might decide to play out the Earth-Romulan War; alternatively, the Player Characters could engage in first-contact missions with some of the species seen in the classic era and later. The Orions are extremely active in the Quadrant, as are Nausicaan pirates, and the Klingons are expanding toward the Federation.

Games set in the Original Series era might focus on the Federation's clashes with the Klingon Empire and the Romulans. The nature of the Romulans is a mystery to the Federation until 2266, when the *U.S.S. Enterprise* NCC-1701 prevents a Romulan ship from destroying the Neutral Zone outposts. A large portion of the Klingon population still possesses the Human characteristics passed on to them by the Augment virus. Outright battle between Klingons and the Federation is possible until the Treaty of Organia, in 2267 — though the Orgonians might overlook minor incidents of violence, such as the occasional bar fight.

Both the Enterprise era and the classic era are characterized by a greater element of freedom; the subspace buoy network is still being emplaced, and it's not unusual for a starship to be out of

contact with Starfleet for months at a time. Starship commanders are expected to make independent decisions based on their best judgment. The greater element of freedom is counterbalanced by a greater element of risk. Starships in these eras are all alone in the depths of space; far from help, they can only rely on themselves.



Players could play crewmembers on the *Excelsior* during Captain Sulu's three-year mission cataloging gaseous spatial anomalies in the Beta Quadrant in 2290; this may have been the first time the Federation encountered the Shackleton Expanse. Relations with the Klingons will be chilly until the Khitomer Accords are signed in 2293.

The post-Khitomer era is marked by a continued low-level tension between the Federation and Klingons; meanwhile, relations between the Klingons and the Romulans deteriorate. While there is occasional contact between Federation and Klingon vessels and personnel, it is not until the *Enterprise* NCC-1701-C's valiant defense of Narendra III in 2344 and the Federation's rescue of the Khitomer Massacre's few survivors that a true alliance is forged.

Gamemasters wishing to run missions during different time periods will have no trouble using the rules as presented. If an item of equipment or technological advance is unavailable in a certain era (such as transporters, replicators, etc.) there will be a note in a sidebar like this one.

CONSTITUTION-CLASS STARSHIP

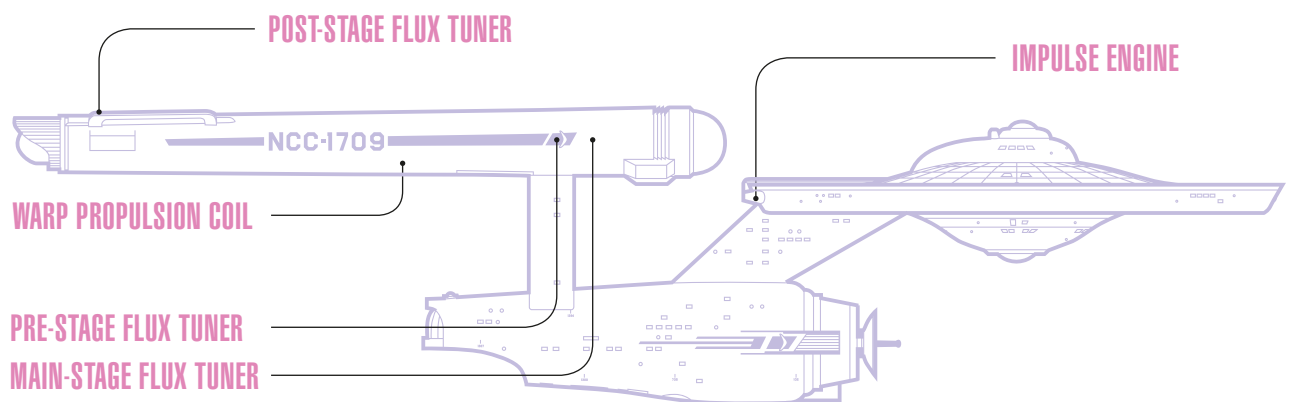

PROPULSION

THE BETA QUADRANT



11204408238204
28845930255

02.00	BRIEFING FROM NARENDRA STATION	008	02.40	KLINGON WOLDS	045
02.10	THE UNITED FEDERATION OF PLANETS	009	02.50	THE ROMULAN EMPIRE	049
02.20	FEDERATION WORLDS	022	02.60	ROMULAN WORLDS	064
02.30	THE KLINGON EMPIRE	034	02.70	THE ORION SYNDICATE	066
			02.80	THE GORN HEGEMONY	070

BRIEFING FROM NARENDRA STATION

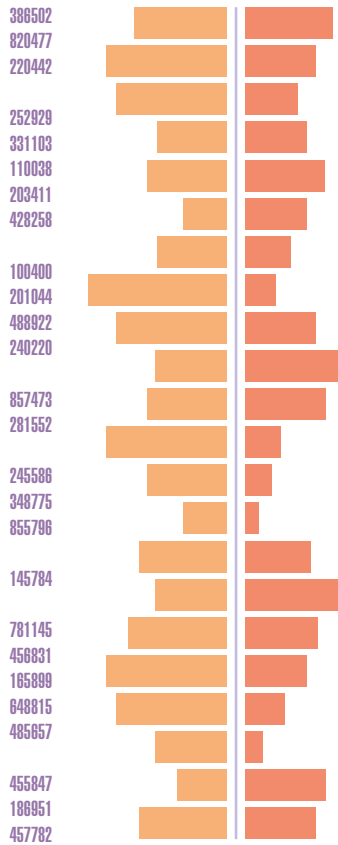

Not what you were expecting? We hear that a lot. Narendra Station is a joint project between the Federation and the Klingon Empire, and there were compromises made in its construction. As a consequence, no one's entirely comfortable here. That's not a bad thing. It keeps people on their toes. This starbase is the last stop before the Shackleton Expanse, right on the edge of the unknown. There's a lot of space between here and home.

While you received a general overview of the galactic situation when you took command of your ship, that information was compiled before you were ordered to come here. We'll provide you with the latest intelligence and an in-depth briefing on the movers and shakers in the Quadrant rather than a general overview. Don't worry, you'll be back out in space before you know it.

The major powers in the Beta Quadrant are the Klingon Empire, the Romulan Empire, and the Federation. The Orion Syndicate operates more-or-less openly in disputed and unclaimed regions of space. We suspect that they are covertly operating in and around Federation and Klingon space. The Gorn Hegemony and the Metron Consortium are to the galactic south of the Quadrant. To galactic east, beyond the areas claimed by the Klingons and Romulans, lies the largely-unexplored Shackleton Expanse.

Starfleet underwent a major re-evaluation of its priorities after Wolf 359. We have always been a deep-space exploration and defense force, but the defense role has always taken second place to the exploratory one. The Borg demonstrated that that had to change. The Federation is surrounded by hostile powers, and we're responsible for protecting 150 planets over 8000 light years. Never forget that one of those hostile powers is here in the Beta Quadrant, only forty light years away. We're fortunate to have one of

the new *Akira*-class ships, the *U.S.S. Thunderchild*, stationed here.

The Romulans have been intriguing since before the Federation was founded. Their instigation of the recent Klingon civil war almost destroyed the alliance. Before the discovery of the Dominion, we expected to see another attempt to destabilize the alliance, most likely by exploiting internal divisions among the Klingons. The appearance of the Dominion on the other side of the Bajoran wormhole may change that assessment, but it's too soon to determine how they're going to act.

Meanwhile, our alliance with the Klingons isn't as stable as we'd like. Chancellor Gowron is currently keeping their war party in check, but several key members and supporters of the House of Duras are still at large. The Romulans have been providing them covert support for at least twenty-five years, so we can anticipate that their ability to cause trouble is not hurt by their exile. Fortunately, relations between the Federation and the Klingons here are on solid footing, and we anticipate a solid partnership in our exploration of the Shackleton Expanse.

The Orion Syndicate is a problem. Federation expansion over the past 150 years has forced them underground. They have quietly absorbed a vast number of existing criminal networks and, if our intelligence is correct, they are now effectively the criminal underworld in both the Alpha and Beta Quadrants. They keep their heads down in Federation territory, but they operate openly beyond our borders.

As always, Starfleet has more missions than ships. We expect that you'll be filling a number of roles during your mission here. There will be science and exploration missions, but you may also be called away to patrol the Romulan Neutral Zone or deal with Orion pirates and slavers. We'll make sure you go out there with as much preparation as possible.

THE BETA QUADRANT

THE UNITED FEDERATION OF PLANETS

“THE FINAL FRONTIER BEGINS IN THIS HALL. LET’S EXPLORE IT TOGETHER.”

— CAPTAIN JONATHAN ARCHER

THE FOUNDING OF THE FEDERATION

The United Federation of Planets was founded 210 years ago from an unlikely alliance of four planets, three of whom had been mortal enemies a decade before. By the 2360 census, that number had grown to over 150 planets, spread over 8,000 light years. By any standard you care to use, the Federation is one of the region’s leading powers.

ASTROGRAPHY

The Federation stretches across 8,000 light years of space in an amoeba-like shape. Eastward of the Sol system the border is an almost perfect curve, bending around the Romulan Neutral Zone (as set out in the Treaty of Algeron) to the north and south. Federation territory stretches northeast of Sol in a thin tendril, between the uncharted Typhon Expanse and the Neutral Zone, all the way to Zakdorn. To the galactic south, the border meanders as Federation space gives way to Klingon territory. Farther east, north of the Klingon Empire, is an enclave of Federation space on the edge of the Shackleton Expanse. To the west, in the Alpha Quadrant, the border is more nebulous. Federation territory is somewhat constricted along the east-west axis running from Sol to Theta Draconis. The Cardassian Union, the Tzenkethi Coalition, and the Ferengi Alliance are found west of an imaginary line curving southwest from Delta Aquilae to Theta Draconis, then southeast to the Tendaras Cluster. Beyond them lurk the Breen, a species even more reclusive and dangerous, perhaps, than the Romulans.

Sol is the capital of the Federation, a choice with both political and astrographic reasons. Years of interstellar conflict ensured that Andor, Tellar, and Vulcan would not agree on any other site; by a happy coincidence, Sol also lies roughly between the other three systems. In a similar manner, it was decided that the galactic prime meridian would run through Sol and, although the Sol system sits on

TRANSCRIPT

GENERAL THY’LEK SHRAN, ANDORIAN IMPERIAL GUARD, FROM HIS STARFLEET ACADEMY COMMENCEMENT ADDRESS, 2181

We didn’t think much of humans in our first encounter. They were clearly ingratiating themselves with the Vulcans — why else make a voluntary visit to a Vulcan monastery? Pink-skinned, soft, with unnaturally-smooth heads, and hiding behind the Vulcans, or so we thought. I could not have been more surprised when Captain Archer — and his science officer — gave us the evidence that revealed the duplicity of the former Vulcan High Command.

I repaid that debt. Soon after, I found myself in a position in which I needed his assistance. We kept doing each other favors and, as I observed at the time, that is how alliances are born.

It takes either courage or madness to explore the Galaxy in a fragile, primitive ship that was outclassed by everyone from the Tellarites to the Klingons. If it was madness, it was a strange one that makes friends of enemies and brings peace instead of war.

We four species that originally founded this Federation all brought our own strengths to it. Andorians: the strength of the sword; Vulcans: their science and intellect; Tellarites: an unparalleled ability to see all sides of a situation, if only so they can argue about it. And you humans, you bring a refusal to accept the impossible — and in that refusal, you often achieve the impossible. And now more worlds have joined, bringing their own strengths.

This Federation is not perfect, nor will it ever be. But twenty years ago, no one thought it possible. In twenty more years, what impossibility will we have achieved?

the border between Alpha and Beta Quadrants, it’s usually considered part of the Alpha Quadrant. For the purposes of today’s briefing, however, Sol will be treated as part of the Beta Quadrant.



POLITICAL STRUCTURE

The United Federation of Planets is a constitutional representative republic. Member planets have sovereignty over their local affairs but contribute to, and are answerable to, a central government. Federation members have a lot of latitude in planetary governance, provided they adhere to the basic principles of the Federation: all sentient beings are possessed of certain fundamental rights; that chief among these rights is the right to self-determination; that these rights apply without distinction as to caste, culture, gender, species, or religious belief; that these rights are to be upheld by a system of interplanetary law; that armed force shall not be used except in the defense of those rights. Member planets contribute knowledge, expertise, and resources to promote social progress, scientific development, space exploration, and defense. They can conduct their own diplomacy with fellow Federation members, although external diplomacy is reserved to the central government. The rights and responsibilities of Federation members are enshrined in the Charter, originally ratified in 2161 by Andor, Earth, Tellar and Vulcan, and by every planet that has joined the Federation since.

The president of the Federation is both the head of state and the head of the government. The president is ultimately

responsible for the day-to-day operations of the government, defining and pursuing foreign policy, and allocation of resources. The president is also the official commander-in-chief of Starfleet.

The Federation Council is the legislature of the Federation, and is a single-chamber body of elected representatives from each Federation planet. While foreign affairs are handled by the executive branch, the Council holds the power to declare war (when necessary) and ratify treaties, and makes the final decision regarding the admittance of new planets to the Federation. The Council also operates in an oversight role: at its own discretion, the Council may investigate Federation executive agencies and planetary governments. In extreme cases, the Council may restrict or revoke the membership of a planet that fails to uphold the Federation Charter. Finally, on rare occasions, the Council may act as the jury in special cases of court-martial.

The judiciary is headed by the Federation Supreme Court, which adjudicates and interprets the laws of 150 planets. Each member planet has its own Supreme Court, the final arbiter of planetary laws (provided those laws do not conflict with Federation law). The Federation Supreme Court primarily accepts cases dealing with conflicts between multiple planetary legal systems, or cases dealing with Federation law.

EXECUTIVE AGENCIES

The president delegates the routine administration to a number of departments, each responsible for a different specialization. The heads of each department make up the cabinet, the president's special advisory council. While a full accounting of the executive departmental organization is outside the scope of this brief, it's worth touching on a few agencies who may have oversight on operations in the Shackleton Expanse.

FEDERATION ARCHAEOLOGY COUNCIL

Where there are planets, there are often ruins. And where there are ruins, there are archaeologists. The Federation Archaeology Council oversees archaeological digs in Federation space. Most exploratory starships have at least one archaeologist assigned to the science department. These scientists are assigned through the Daystrom Institute's Archaeological Council, which provides an interface between the Federation Archaeology Council and Starfleet. Tomb robbers and treasure hunters remain the archaeologist's bane and, depending on the importance of the ruins, it's possible that an Archaeology Council will call upon Starfleet to assist in investigations, or to offer some protection.

FEDERATION DIPLOMATIC CORPS

The Federation Diplomatic Corps facilitates relations between Federation members and represents the interests and policies of the Federation to external powers. The foreign affairs branch of the FDC includes embassies and consulates. They provide assistance to Federation citizens outside of Federation territory.

Ambassadors are usually involved in the negotiation of the entry of new planets into the Federation (subject to Council approval). They may also be called upon as a neutral outside party to mediate disputes between non-Federation

members. To facilitate our alliance with the Klingons, there are Diplomatic Corps representatives specially trained in Klingon relations on board Narendra Station.

The internal branch of the FDC manages relations between Federation member planets. While many planets in the Federation maintain their own diplomatic corps, the FDC can always assist in negotiating everything from trade agreements to extradition treaties. The FDC prefers to provide neutral arbiters when dealing with Federation members with difficult histories.

FEDERATION SCIENCE BUREAU

The Federation Science Bureau is the Federation's key scientific organization. The bureau allocates resources to research projects and disseminates scientific discoveries to research and academic institutions. The FSB publishes journals on every branch of science, and research papers chosen for publication are extensively vetted and rigorously peer-reviewed. The FSB does, however, have something

PERSONAL LOG

DR. CAROL MARCUS, STARDATE 8142.1

What was once a nebula has now coalesced into a star system, complete with life-bearing planets. The Genesis device was never expected to operate on such a scale. I designed it to terraform planets, not create entirely new star systems. That it had such an effect is — astonishing. There is nothing in my designs that accounts for this — what have I made here? It's going to take years of study to unravel this.

INTERCEPTED TRANSMISSION

SYNDICATE VESSEL *PROFIT'S GRASP*

This is why I never witnessed for you.

Twenty years of work ruined, because your agent got caught. Twenty years, framing the Tellarites for our mining operations on Coridan, infiltrating the Andorian diplomatic corps, gently reigniting the flames of hatred between the three old enemies. It was a blade poised to strike at the heart of the Federation! It was a work of art, and your agent botched it. 'Thelev' couldn't even kill the Vulcan, and he was half-dead of a heart attack!

Now we're going to have to abandon most of the Coridan mining operations, and we're not going to be able to replace those easily — Coridan's the most dilithium-rich planet this side of Direidi! What's worse is that our silent partners — you know, the ones who contributed half the funding for this little expedition? They aren't going to be happy. They're going to want the one responsible, and they're probably going to cut him into tiny little pieces.

I've given them the last known coordinates to your ship and the signature of your ion trail. Enjoy the last few days of your life.

985309195

TEMPORAL TRANSMISSION

TEMPORAL AGENT JRH-1901, DATE UNKNOWN

Sam,

Here's my informal analysis of Krinnik's proposed plan to purge the timeline of all temporal anomalies: I haven't heard anything so asinine since Sollivan decided to try to kill Kirk in 1930 to "clean the timeline of his influence." Do you have any idea how much of our timeline developed due to temporal incursions? Let's start with *Samuel Clemens*, whose books are still read today. Then there's the 23rd-century tricorder left in 1930; even half-destroyed, it provided a boost to Allied scanning technology during the Second World War. There was the Ferengi incident at Roswell that probably helped the United States develop orbital nuclear technology. And the *Enterprise's* involvement in the failed launch in 1968. And the whale incident of 1986. Are you beginning to see a pattern here? Do you remember the phrase, "stable causal loop"? The fact is, we aren't ever going to completely clean the timeline. It's not practical, and, if we want to maintain *our* temporal continuum, it's not *possible*.

The formal report will be along shortly. I'll be nice.

JRH

INTERCEPTED TRANSMISSION

PARTIALLY-DECRYPTED SUBSPACE TRANSMISSION STARDATE 48327,01

TO: [unintelligible]

FROM: [unintelligible]

We have reason to believe that the Vulcan scientist [unintelligible], recently arrived on Narendra Station, is a mid-level agent of the *Tal Shiar*. Investigate quietly. If our suspicions are confirmed, notify Section *immediately*.

You are not authorized to terminate the agent at this time.

of a history in failing to consider negative consequences of research they support (the M-5 incident and the Genesis Program come to mind).

DEPARTMENT OF TEMPORAL INVESTIGATIONS

The Shackleton Expanse, as we've noted, is full of spatial anomalies and these sometimes end up having odd effects on the nature of space-time. Should you and your ship be involved in a temporal incident, you'll receive a visit from the Department of Temporal Investigations. They're the worst-kept secret in the Fleet: it doesn't matter how highly classified their operations are, *everyone* knows about them. They monitor and investigate events involving time-travel and prevent contamination of the timeline. The DTI have developed a set of guidelines that should be followed when you find yourself in such situations. DTI agents aren't known for a sense of humor, and they take their jobs very seriously, but... we're still here, so they must be doing something right.

OFFICIAL MEMORANDUM

JANUARY 21, 2155

TO: ADMIRAL GARDNER, STARFLEET COMMAND, SECTOR 1

FROM: COMMODORE SUNITHA BHARANI, UTOPIA PLANITIA FLEET YARDS

RE: SAUCER STRUCTURAL INTEGRITY TESTS

In response to your memo of January 3: I am entirely serious. The next batch of *NX*-class ships are going to incorporate the new generation of trisilicate polymers and duranium polyalloys. These materials need to be field-tested prior to deployment. I am familiar with the lab reports, but I've seen too many incidents where something worked well in the lab and failed under field conditions to be comfortable relying just on the laboratory data. We need to know the true capabilities of these new materials, without structural integrity fields, without hull plating polarization, without anything but the metal.

The best way to do that is still "test to destruction". So yes, Gard, I want to crash a saucer hull into a planetoid. Do I expect one of these starships to crash-land on a planet? Damned if I know...

Yours,
Sunny

STARFLEET MEDICAL

Although Starfleet Medical is an arm of Starfleet, it acts as an executive oversight agency for all Federation medical research. Starfleet includes members of almost every species in the Galaxy, and Starfleet physicians must be able to recognize and diagnose injuries and illnesses in any crew member. They must also be ready to offer medical support and analysis to species never before encountered by the Federation. The demands of interstellar medicine has made Starfleet Medical the premier medical organization in the Federation, and the Starfleet Medical Academy the finest medical school. Starfleet Medical personnel pride themselves on their creativity, their capability, and their utter rejection of institutional politics. In addition, they work closely with Starfleet and Federation legal personnel to defend medically-ethical treatments, and to prosecute those who are ethically suspect.

STARFLEET

There's very little we could tell you about Starfleet that you don't already know. You've been taught Starfleet doctrine and history from the first day at the Academy. No matter

what happens, the mission remains to explore the cosmos, to make first contact with unknown civilizations, and to defend the Federation and its ideals. We expect a great deal of our captains. They are explorers, scientists, diplomats and tacticians, all wrapped up in a single package.

CAPTAIN'S LOG

CAPTAIN ERIKA HERNANDEZ, *COLUMBIA, NX-02*
MAY 18, 2156

Five Romulan ships have just dropped out of warp within attack range of Algeron IV, and all communications are jammed. Accordingly, I have ordered *Excalibur* to return to the nearest Federation outpost at full warp, carrying as many of the civilian personnel from the base as possible. Sensor scans from *Columbia*, *Excalibur*, and the base are attached, and *Excalibur* is carrying a copy of *Columbia's* logs. We don't expect to come back from this one, but we're not giving Algeron up without a fight.

Godspeed.

STARFLEET POST-INCIDENT ANALYSIS

THE BATTLE OF CHERON

By mid-2159, Starfleet Intelligence became aware that Omicron Gruis II, also known as 'Cheron,' was the staging area for a massive Romulan fleet operation. At the same time Romulan ships were actively attacking shipping in and around Vulcan and Andorian space. Strategic analysis suggested that these probes were a feint to draw Coalition ships out of position allowing a direct attack at Sol itself.

The Coalition engaged in a dangerous stratagem of their own. A number of communique were sent, using codes that the Romulans were suspected of having broken, exaggerating the tensions between members of the Coalition and indicating that allied fleets were being disbanded. The "accidental" Romulan discovery of a firefight between Tellarite and Andorian forces near Beta Hydri provided additional proof, as did carefully-leaked snippets of a "duel of honor" between General Shran and Admiral Archer. Finally, the ruse was cemented by allowing a Romulan probe to discover the air-bleeding wreck of a

Terran courier ship, whose dead pilot was carrying an intelligence packet too sensitive to be entrusted to subspace communications. The packet contained just enough genuine data to convince the Romulans of its authenticity, but was primarily comprised of false fleet dispositions.

Indications that the ruse was successful came in late 2159, when the Romulans diverted a significant portion of the forces amassing at Cheron to counter the false Coalition fleet movements. At that point, the fleet assembled at Cheron out-numbered Earth's fleet two to one, although itself outmatched by the united Coalition fleet.

Coalition fleets departed Andoria, Vulcan, Sol, and Tellar in a staggered sequence designed to ensure their simultaneous arrival at Cheron. The attack came as a complete surprise; the Cheron fleet was caught completely off-guard and destroyed with minimal Coalition casualties. The Coalition, not interested in pursuing a war for territory, sued for peace one week later.

Recently-acquired historical documents from the Empire indicate that the few surviving commanders of the Romulan fleet presented a severely altered version of the battle to the Senate. Even so, they were "encouraged" to commit honorable suicide over the debacle, and the entire Romulan intelligence apparatus underwent a period of upheaval, finally reconfiguring into the *Tal Shiar* we know today.

COMMANDER'S LOG

G. CASEY, MILITARY ASSAULT COMMAND OPERATIONS
NOVEMBER 18, 2161

This is my final log as MACO's commanding officer; as of 0800 tomorrow, MACO no longer exists as a separate organization, but has been folded into the Federation Starfleet. It is my understanding that MACO will not be maintained as a separate arm of Starfleet. Many of its officers are being offered Starfleet commissions, and the bulk of the non-commissioned personnel are being routed into the tactical track.

I will be taking a position at the new Starfleet Academy as a senior instructor in strategy and tactics. This was a difficult decision — I cannot, in good faith, condone the dissolution of the organization I have worked so hard to build. Nevertheless, I have come to feel that resigning my commission is the wrong decision. It would be a profound disservice to the future members of Starfleet to deny them the benefit of my training and expertise which they will no doubt come to need, regardless of Starfleet's preference to minimize their military background.

At its heart, Starfleet is a space navy, and I intend for that navy to have teeth.

INTERCEPTED REPORT

THE KLINGON HIGH COUNCIL

Rynar, commanding, *I.K.S. Hegh'ta*. All glory to the Empire!

Why do we even consider an alliance with the Romulans? Are we so weak that we need their help against this new "Federation"? No! The Romulans are the weaklings here — the Humans handed them a defeat that they will be decades recovering from. An alliance benefits them much more than it benefits us. In the end, we shall support the rebuilding of their fleet, and they will stab us in the back.

Rest assured, I will abide by our agreements, but I shall never turn my back on those *taHqeqpu'*.



OFFICIAL MEMORANDUM

OFFICE OF THE PRESIDENT, STARDATE 8393.2

Admiral Cartwright,

In its century of service to the Federation, Starfleet has demonstrated steadfastness, courage, and loyalty in ways that, in its beginnings, could never have been imagined. The actions of Captain (formerly Admiral) Kirk and his command crew are in the finest Starfleet tradition. I do not believe I am overstating the case when I say that Kirk never should have been promoted to Admiral.

To my mind, Admiral, one of Starfleet's biggest faults is their adherence to military traditions and norms long past the time when they cease to be appropriate. One of those traditions is the idea that Starfleet personnel should constantly be seeking promotion: the so-called "up-or-out" policy. A review of Starfleet records suggest that this policy has cost Starfleet several fine officers. Many chose private service or transfer to the Merchant Marine in order to remain on a command deck, rather than be promoted into a role they neither wanted nor suited. Furthermore, on more than one occasion it has caused Starfleet's upper ranks to become far too top-heavy. Starfleet should not have so many flag officers that they have no real roles for them. Kirk is not the only admiral who should never have

been promoted off of a command deck. He is simply the most notorious.

I strongly encourage Starfleet to abolish the up-or-out policy. The Federation will continue to expand, and Starfleet will continue to build ships. There will be no lack of positions for skilled starship captains. Meanwhile, promotion to flag rank should occur when there is a position and need, and Starfleet can then promote the best possible individual to fill the role. Starfleet will also reap the benefits of reliable, experienced command crews in their starships, where they are most needed.

Signed,

President of the Federation



CAPTAIN'S LOG

**KIRK, JAMES T., CAPTAIN. SC 937-0176 CEC
U.S.S. ENTERPRISE NCC-1701
STARDATE 3198.2**

As the Enterprise departs Janus VI, I continue to be astonished and delighted at the myriad of ways that life shows itself. According to both Mr. Spock and Dr. McCoy, scientists considered the possibility of silicon-based life to be a fantasy, at best. Needless to say, I have asked them to provide a full report on the Horta to the Federation Science Council. It is not only silicate life, but sentient silicate life. In the meantime, I am recommending to Starfleet that all exploratory personnel be reminded to consider the possibility of life as we had never imagined it. In the meantime, I look forward to the day we see a Horta in Starfleet.

SUBSPACE TRANSMISSION

K'MPEEC, CHANCELLOR OF THE KLINGON HIGH COUNCIL

At my personal request, your Starfleet has agreed to forward this message to the families of the personnel of the *U.S.S. Enterprise*. Your families died fighting a doomed battle against terrible odds, defending the homes of a people who were, if not quite your enemies, certainly not your friends. I tell you, their deaths were not in vain. Their sacrifice has made possible a true alliance between my Empire and your Federation. Your loved ones died in glory and honor, and their names will never be forgotten so long as there is an Empire.

For Narendra!

Qapla'!

TRANSMISSION

COMMANDER SHELBY, STARDATE 44011.4

Admiral Gustavson,

I understand that Starfleet Command wants someone to blame for the disaster at Wolf 359. But attempting to place that blame on the shoulders of Captain Picard is short-sighted, and does not address the underlying problems that allowed Wolf 359 to happen.

Admiral, Fleet Command has become complacent in Starfleet's ability to cope with the unknown, even if that unknown is both powerful and hostile. We've been fighting the Cardassians for twenty years, with no end in sight. Within the past three years Starfleet Command was almost completely overtaken by neural parasites and the only reason we remain here and human was due to a coalition of starship commanders who saw what was happening and attempted to intervene, at the cost of several thousand lives. And now, the Borg.

Medical analysis of the Borg implants removed from Captain Picard indicates that the first implant a Borg victim receives is a neural transceiver. This transceiver allows the Borg hive mind to override the victim's physical and mental control over their own body, while adding the victim's knowledge, skills and memories to its own. From that point on, the assimilated victim is a part of the hive mind. Which means, Admiral, that Captain Picard did not betray the Federation.

He was an unwilling victim.

From a legal and historical standpoint, Admiral, there are sixty-eight recorded instances of Starfleet officers succumbing to external mental control. The only instances in which charges were brought were instances in which the officer's actions both contributed to their loss of control and those actions were contrary to Fleet regulations. As Captain Picard was kidnapped from the bridge of his own vessel, while attempting to slow the Borg cube's advance on Earth, his actions clearly do not match those circumstances.

Admiral, I realize the position you're in. There are people buying for Picard's blood, both inside and outside Starfleet. We cannot, on a legal or an ethical level, allow him to become a scapegoat for Wolf 359. And on a pragmatic level, Starfleet needs him right where he is.

Respectfully,

Commander Shelby, Tactical Command

The Federation's basic principle that all sentients have a right to determine their own beliefs and destiny ensures that there is no single "Federation" culture. The only common elements are cooperation and tolerance for other cultures and beliefs. Starfleet personnel in particular are expected to be familiar with the cultural practices of as many species as practical; they are also expected to tolerate mistakes made by others.

Federation cultures range from the highly traditional and reserved, such as the Vulcans, to the hedonism of the Risians. Pacifist planets, such as Risa and Betazed, co-exist

alongside more martial cultures such as the Andorians. While such a wide spectrum of beliefs could cause conflict, the Federation makes it a virtue, and creates something that transcends the sum of its parts.

The Federation prefers to use similarities between disparate cultures to facilitate understanding and cultural exchange. This approach has been demonstrated to ease interspecies interactions. Food and arts are frequent mediums of cultural exchange. Apart from specific allergies, most Federation citizens enjoy other species' cuisines and find familiar techniques or flavors, even in dishes that originated light years away. Similarly, artists of various cultures and species share a passion for craft and technique, a trained eye, and a keen hand for technique.

This cultural interchange is apparent in the homes of Federation citizens and in the small intricacies of life. A family dinner may come from the replicator, but the meal itself may unite disparate ingredients such as earthy Andorian tubers sliced and deep-fried in the manner of Earth french fries, topped with Klingon grapok sauce, or a pulled Klingon *krada* leg rubbed with Vulcan redspice, all served with Betazoid uttaberry juice.

The artwork upon the walls may consist of Vulcan calligraphy and expressionist Betazoid mood-paintings, while Risian stone sculpture and Andorian bone charms adorn a low table (itself of exquisite Tellarite make). The background music could range as widely: a classical Vulcan string quintet, a Klingon operatic rendition of early 21st century Earth metal music, or a harpsichord cover of Risian Lohlunat night-song.

Another area where this cultural exchange and fusion is apparent is fashion. Fashionistas pair 20th-century revival jackets with Andorian silk scarves and neckcloths. Feather-light Vulcan robes sewn from translucent Earth Jamdani silk are popular wedding gifts, especially in Risa. Klingon jewelers attract apprentices of all species who wish to master the challenging and beautiful granulation and lost-wax techniques perfected in distant ages on Qo'noS. Estonian-style knit mittens have become ubiquitous around Andorian spaceports, and Risian cosmetics have made a splash on various catwalks for their waterproof and staying properties.

Other, more intangible forms of cultural exchange also occur. Several tea ceremony masters from Kyoto travelled to Vulcan to experience and understand Vulcan tea ceremony and aesthetics. A small Vulcan delegation returned that interest by journeying to Earth and studying tea ceremony in a Kyoto retreat. Tea sets and calligraphic scrolls were exchanged at each meeting. It has now become fashionable for progressive Vulcan households to hang a calligraphy scroll up near the entranceway of a home in similar manner to the Japanese *tokonoma*. The masters hope to repeat the experiment with the Klingons.

TAL SHIAR INTERNAL COMMUNIQUE

Chairman,

The Imperial Fleet has already provided the Senate with a summary of the actions at Narendra III. The battle was a tactical success and a political failure. I believe the Imperial Fleet's assessment is too pessimistic. From a military standpoint, certainly, the alliance between the Federation and the Klingons is a nightmare, and promises to humble the Imperial Fleet for a generation. However, from an intelligence perspective, this is not truly the disaster the Fleet believes it to be.

This new alliance may prove to be more of a weakness than a strength. We currently possess a significant amount of experience in exploiting the rivalries between the Klingon Houses. The House of Duras, in particular, is willing to accept our aid if it provides them a greater portion of power within their Empire. The soft hearts in the Federation may also prevent the Klingons from raiding on our side of the Neutral Zone, which is all to our advantage.

In addition, as noted in the Fleet's report, the recovery of Federation survivors has proven to be an intelligence windfall. I have already arranged for the prisoners to be transferred into *Tal Shiar* custody. In the meantime, it appears that the Senate has ordered the Fleet to pull back within the Neutral Zone for the time being. I recommend we take full advantage of the situation. In time, the memory of the Federation's "glorious defense" of Narendra III will fade, and the inevitable differences between the Klingons and the Federation will reassert themselves. When that happens, we will be ready to strike.

Jolan tru,
General Sevek





Citizens of the Federation are exposed to other ideas via exchanges of fiction and nonfiction publications; the *Kir'Shara*, the foundational Vulcan philosophic text, has become recommended reading in high-level collegiate philosophy classes, along with verse translations of the Klingon *Songs of Kahless*. Translations of the Andorian *Parables of Ice* and the Betazoid *Book of the Chalice* are forthcoming. The *Kama Sutra* and the biblical *Song of Songs* have inspired poetry and music on Betazed and Risa. Earth author Herman Melville's *Moby-Dick* has a strong Klingon following; the novel has become a Klingon stage play, with Captain Ahab as the doomed hero-protagonist.

Andorians and Klingons alike adore the sport of ice hockey (for dissimilar reasons), and several Andorian players have already signed up as free agents in the Federation Hockey League. After a recent controversy, the Federation Hockey League has ruled that deliberately injuring an Andorian player's antennae will result in a season-long suspension. Risian event planners are *au courant* for diverse and special occasions such as Andorian weddings, Klingon betrothals, and in one case, a Betazoid funeral. Similarly, Betazoid therapists and counselors are much in demand in Federation space due to their telepathic and empathic abilities.

SUBSPACE TRANSMISSION

THROUGH OTHER EARS: AN APPRECIATION OF EARTH MUSIC

PRESENTED BY THE FEDERATION ARTS COUNCIL

- *Prelude and Fugue in F minor*, Johann Sebastian Bach, adapted for the Vulcan lute — T'Vala, ShiKahr Conservatory
- "The Ascension", *Nightmares Made Flesh*, Bloodbath — K'Tarla, Korila, R'Tani, Modrok, Klingon Imperial Opera Company
- "When the Levee Breaks", Kansas Joe McCoy and Memphis Minnie — Thilir Shralara, Andorian Academy
- *Song of the Butterfly Lovers*, traditional Chinese opera, Liang Zhu — Karthag and Solia, Klingon Imperial Opera Company
- *Zoku*, traditional Japanese taiko — The Tellarite Naval Band
- Selections from the *Mathwani*, Jalal Al-Din Al-Rumi — The Suraya Bay Quintet, Risa

TRANSMISSION

STARDATE 38325.3

TO: T'Para, Marcia, Evan, J'Hara, Syrak, Eralle, Kimiko, Telass

FROM: Melissa

SUBJECT: Friday Evening Knitting Circle Yarn and Fiber Swap

Hey, everyone. It's a brand-new Monday in New Berlin, which means that we're going to have our fortnightly knitting meeting in four days, yay! It's going to be at my place as usual. I just want to confirm snacks and beverages and stuff.

Evan, you've promised to bring your amazing chocolate brownies, and I know most of us are going to love them. T'Para, if you're still interested in bringing a flask of *plomeek* tea I'd love to try it. I'll be making deviled eggs myself, and J'hara will be bringing bloodwine coolers in case anyone wants to knit tipsy.

Syrak, I'd love it if you gave us a brief lecture on Vulcan spinning techniques, and if you could, please bring a spare spindle so we can try it out for ourselves. Eralle, you *must* show me the Risian lace stole your grandmother gave you, I'd love to puzzle the stitches out.

Also, welcome Telass to our little group! She's just come here from Andoria, and she has brought with her some of the most fluffy, luscious fiber ever. It's the soft hairs combed from the belly of an Andorian bull, and that stuff is finer than Earth *qiviut*. Strands of it have tested out at 6 to 8 microns, and it has a ridiculous staple length. The small clump she gave me to play with feels like a puff of warm air in the hand. This stuff isn't from the replicator, by the way. It's from her family's flock back on the homeworld.

She's willing to swap her Andorian bull fiber for stuff she can't get easily from a replicator, so everyone, search your stashes and bring out your finest!

A human citizen of the Federation has recently relocated from Earth to Qo'noS and opened an establishment serving delicacies such as barbecued *targ*, *gladst* slaw, *bregit* lungs braised in a bloodwine reduction and *gagh* with apple-mustard relish. The restaurant has been booked solid since opening, and informal *bat'leth* duels have occurred outside the premises to resolve conflicting reservations.

THE NEW WORLD ECONOMY

The Federation economy is best described as a centralized, post-scarcity, resource-based economy based on mutual interlocking responsibilities. The Federation Charter specifies that member planets are to promote social progress and better standards of living, an aim that is undermined by economic systems that encourage income inequality.

Widespread replicator technology ensures that no citizen of the Federation needs to fear a lack of food or shelter. Federation resources are held in common for the benefit of Federation citizens, and administered by the executive branch of the Federation government. A Federation citizen is guaranteed a share of their planet's total resources sufficient to live a comfortable and healthy life. While much is provided in the form of food, housing, and other basic needs, this share includes a certain amount of resources on account to be used at the citizen's discretion. The citizen is free to invest these resources as they see fit: they may trade in commodities traded between Federation members or in interstellar trade, build a business, or pursue whatever career appeals to their interests and abilities. Citizens, in return, are expected to devote some of their time and capabilities to supporting their community and society, such as serving in a governmental office or Starfleet. Citizens who make public service their career are granted a greater share of resources, as a recognition of their contributions to society. While it remains technically possible for a Federation citizen to pursue the acquisition of wealth, it is no longer the societal norm. Social and economic progress is no longer measured by consumption, but in the welfare of all the citizenry.

By the 24th century, the Federation does not use money, nor does it print currency. The "Federation Credit" officially exists only as a unit of accounting. Its value is fixed to a tiny percentage of the total production of the four founding members of the Federation as of December 31, 2161, and it is primarily used for budgetary purposes and as a medium of trade with cultures that still use money-based economies. Credit chips can still be found occasionally along the Federation's frontiers as relics of the past or as trade artifacts.

FEDERATION ARTS COUNCIL

TUVAL MEMORIAL AWARD FOR LITERATURE SHORTLIST

Of Plomeek and Cardamom: A Biography of My Mother, Fatima Mootassem

Behind the Sun, Th'lera Shria

The Sehlat of Mt. Seleya, Sulan

STARFLEET ACADEMY LECTURE

SUBJECT: EARLY 21ST CENTURY EARTH HISTORY LESSON 16

By the early decades of the 21st century, the failings of unregulated capitalism had become clear. Less than 3% of the world's money was printed and backed by governmental entities; the remainder was generated by the banks. By making loans, the banks "created" money in the form of debt. They did not, however, create the money necessary to pay the interest on that debt. As the cycle continued the amount of debt increased, but the amount of money available to pay the debt did not. As loans were paid off, the money created by the loans and the interest paid disappeared, reducing the amount of money in circulation. A shrinking money supply invariably led to economic downturns. Economic activity had to continually increase to offset the reductions caused by debt repayment.

After the Eugenics Wars, the United States loosened restrictions on corporations and banks in an attempt to foster an economic recovery. While these measures seemed to be successful, the unfortunate side effects soon made themselves felt. So-called "free" markets were open to exploitation by those who could most afford it. Businesses engaged in monopolistic behavior, capturing markets by virtue of their size and, in classic rent-seeking behavior, used their wealth and power to exclude competitors from the market. Corporations whose only responsibility was to make money were encouraged to offload the deleterious effects of their industrial processes onto the government or the people, often

in the form of industrial pollution. Government fell more and more into the hands of the wealthy, and wealth was distributed toward the powerful via low capital gains taxes, tax loopholes, corporate subsidies, or outright transfers of state-owned industries.

As power and wealth concentrated in a small percentage of people, middle-class incomes fell and the percentage of the population in poverty increased. Conspicuous consumption was encouraged by artificially low prices on consumer goods, while the price of basic necessities such as food, housing, and medical care rose sharply. Employment law in many parts of the globe favored employers, and insufficient social safety nets combined with low wages ensured that families could be ruined by a severe illness or a job loss.

By the 2020s, industrial automation and the export of manufacturing meant that a massive percentage of the population lacked jobs and homes. "Sanctuary Districts," originally created to help and protect this population, quickly became nothing more than prisons for the disenfranchised and the destitute. That particular social experiment was terminated after a series of riots in 2024. The United States economy began to crumble, and many of the Western nations that depended on a stable dollar followed suit. It was this worldwide economic collapse that helped set the stage for World War III.

SCIENCE AND TECHNOLOGY

Federation science is the result of the brightest minds from over a hundred planets.

TRANSPORTERS

Transporter technology has advanced significantly since humans first developed it in the 22nd century. From its humble beginnings as a means of cargo transportation, transporter use is now routine on Federation planets, bases, and starships. Most Federation planets possess a planetary transport network. Hubs in major cities and orbital facilities provide mass-transport capabilities from hub to hub, and each hub serves as the center of a regional transport network. Currently, many Federation planets are in the midst of upgrading their transport networks: regional areas may still be using Mark VI transporters, while the major hubs have been updated to use the Mark VII technology.

Transporter technology of the 22nd and 23rd centuries could cause an incurable illness known as transporter psychosis; technology improvements in the early 24th century eliminated this illness. Transporters are not a perfected technology and there are extremely rare side effects. These include passenger duplication, foreign object damage, de-aging, re-aging, dimensional transport and time travel.

WEATHER CONTROL

The Federation sees control of planetary weather and climate as routine. A system of satellites, linked through a central station, provide real-time monitoring capabilities. The satellites release highly specialized, aerosolized, self-levitating nanoparticles into the high atmosphere. The motion and rotation of these nanoparticles is controlled by lasers. Depending on need, the nanoparticles are capable of adjusting the heating or cooling of the atmosphere by manipulating the amount of solar energy that reaches the atmosphere. A second type of nanoparticle manipulates humidity via attraction

TRANSMISSION

RAMESH RAGHAVAN, LEAD TECHNICIAN, WEATHER CONTROL
SUBNET TWO, STARDATE 42121.2

Shivaji,

This is the last time I am going to tell you this: no, I am *not* going to adjust the weather so that it will not rain on your birthday. You live in Mumbai, and your birthday is in June! Which, as you are *well aware*, is during *monsoon season*. Even if I wanted to — *which I don't* — it would be a major climactic re-organization, requiring the approval of the Parliament. Parliament hasn't authorized climate action of that scale in a century, and certainly not for such a frivolous reason. If you want sun on your birthday, spend the day in Texas; they've got all the sun you can stand.

Do *not* ask me again.

R. Raghavan

or repulsion of water molecules. These nanoparticles degrade over time, although this loss is included in the weather control algorithms.

Most planets, Earth among them, reserve weather control for the prevention of disasters, such as hurricanes, tornadoes, and flooding. Weather control systems are frequently seen on colony worlds, where they serve as an adjunct to terraforming technology. Risa is a notable exception to the typical Federation restraint: the Risians have modified their climate for centuries, and turned a gray, wet, dismal climate into a tropical paradise.

COLONY WORLDS

Part of Starfleet's mandate is to seek out new worlds for potential colonization. Preference is given to Class-M worlds, although even on these worlds some terraforming is usually necessary. The Federation Council reviews and grants colony charters. In rare cases, they also revoke colony charters usually because of unforeseen planetary dangers, but occasionally because of mismanagement. Colonies start small, usually as a single town, and are expected to expand carefully and responsibly. Colonists tend to be hardier than core-world citizens, and most are prepared for the effort required to create a self-sufficient colony.

Once a Federation colony reaches self-sufficiency, it may continue to be governed by the mother planet or seek independent Federation membership. To date, most colonies are content to be governed by their mother planets. That situation is likely to change thanks to the Federation-Cardassian Treaty of 2370. Federation colonies

were handed over to the Cardassians as part of the treaty, and populations were given the choice to relocate or remain under the new Cardassian government. The population of many of affected colonies have rejected both alternatives. Calling themselves the Maquis, they have declared themselves independent of the Federation and Cardassia, and have taken up arms in a guerilla war against both sides. This movement is supported by a number of former Starfleet officers, including the crews of several starships. We do not expect to have to deal with the Maquis directly, as their theater of operations is in the Alpha Quadrant, but the political repercussions may extend into our region of space. Many colony worlds now question whether they can be fairly governed when far from their founding planet, and some are re-considering Federation membership.

While the Federation ensures that colonies are provided with an appropriate amount of resources and technology, others are not so lucky. The diasporas of the 21st and 22nd century resulted in a high number of ships simply disappearing. In some cases, the ships found suitable colony worlds in areas the Federation has not yet explored. In others, spontaneous colonies formed around a ship crash site or other disaster. Starfleet continues to discover such colonies even now, and there is no doubt that other such colonies exist. As always, Captain, we rely on your discretion when making contact with these lost colonies. Many colonists left their homeworlds for good reason, and their descendants may not be interested in rejoining the fold.

FREE TRADERS AND CARGO SHIPS

During the 22nd century, Earth and its colonies were served by the Earth Cargo Service. This agency was responsible for oversight and licensing of Earth's interstellar cargo vessels. ECS ships were slow and stolid, unable to reach warp 2. Thus, the crews of ECS ships tended to be multigenerational and crew members lived their entire lives on a single ship. These space-faring citizens, known as 'boomers', tended to be tough, stubborn, and fiercely independent. The boomer lifestyle lasted almost a century before dying out, as engines capable of warp 3 and above reduced travel time from years to weeks or months.

After the foundation of the Federation, the ECS and similar services operated by the other member planets were subsumed into the Federation Merchant Marine. The Merchant Marine operated civilian cargo ships and survey vessels, and personnel often transferred from the Merchant Marine to Starfleet (and vice versa).

Free traders tend to gravitate to the fringes of the explored galaxy. Many of them prefer a life with as few strings as possible. Others want to avoid entanglements with the law. Most free trader ships are old, sometimes unreliable, and usually lacking significant arms and armor. Free traders are accustomed to living by their wits, without support from Starfleet or the Federation.

MEDICAL TECHNOLOGY

Federation medical technology is capable of producing almost miraculous cures. Over the centuries, Federation scientists and doctors have almost entirely eradicated the vast majority of illnesses caused by poverty, poor sanitation, malnutrition. Many causative biological agents exist now only as stored gene-scans. Advanced surgical techniques allow surgeons to repair injuries that would have been impossible to treat even fifty years ago. Organs that cannot be repaired can be replaced with sophisticated artificial versions, and development continues on a genetic replicator designed to replace organs *in situ*.

Not all disease has been eliminated. Some micro-organisms are extremely difficult to destroy, and others are highly mutagenic, adapting quickly to treatment regimes. Cross-species illnesses also present challenges: Levodian flu, for example, has managed to crop up on every planet in the Federation, and has been reported in Klingon space as well. More troublesome are an entire host of degenerative disorders, many of which are under active research, but have no cure. Disorders of the neurological systems are particularly difficult to treat, as full organ replacement is impossible. Genetic diseases can also be difficult to treat, due to the legal restrictions on genetic engineering. Current Federation law allows the use of DNA resequencing only for the purpose of correcting life-threatening birth defects (usually, a treatment performed *in utero*). Genetic enhancement remains illegal.

The Federation has developed a number of treatments and therapies that do not require the use of genetic recombination. Important advances have been made recently in bioactive interfaces and cybernetic regeneration. Research continues into nanotechnological approaches as well, leading to a thriving black market trade in Borg nanoprobes.

Starfleet vessels constructed in the past year have been outfitted with a new technology, called an Emergency Medical

Hologram. In the event that a ship's physician is unavailable, the EMH is programmed to administer over five million forms of medical treatment. As this technology is still in its infancy, Starfleet is requesting that chief medical officers submit their evaluations of the EMH on a regular basis.

SUBSPACE TRANSMISSION

**DR. NAOMI TRINH, CHIEF MEDICAL OFFICER,
U.S.S. ARIES, STARDATE 47574.5**

Dan,

We made it to Deep Space 9 without falling apart, retrofits and all! I've learned more Andorian curses in the past week than I did in the Academy — Commander Trilas isn't happy with the performance of the new phaser augmentation circuit. He says it's just like the Klingons: crude, overpowered, and likely to blow up at the slightest provocation.

As for me, I experienced the joy of working with the new Emergency Medical Hologram. Mettias was down with the Levodian flu, and Safa had just finished a double shift, so I was down a nurse. The EMH is supposed to be able to provide support, so I tried it out.

Never again, Dan! I've worked with Tellarites that are less obnoxious. I don't know if the personality is supposed to be what some idiot thinks a doctor's supposed to act like, or if it's a deliberate act of sabotage, because I'm not turning it on again. The crew can use it if I'm dead.

Anyway, duty calls, as usual. Give Lexie a kiss for me and tell her Neemee loves her!

Naomi

LCARS 01-3200

02-0012

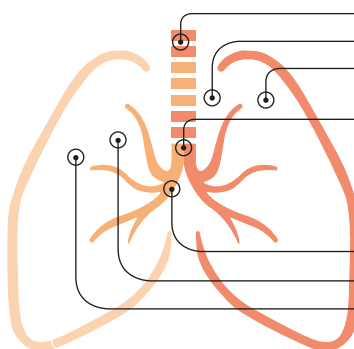

6380-0027	10898	284900	10-349920	1270	26665
2280-0167	22279	274022	12-292800	11870	20290
3601-2770	28900	318290	9-236312	18930	123770
1200-2920	193442	839900	15-550280	2940	21892
3077-2901	23344	200229			
1220-4992	8889	89499			
2077-1830	20300	180733			

31-2890

33-2993

MEDICAL ANALYSIS

SICKBAY

THE BETA QUADRANT FEDERATION WORLDS

ANDORIA

PLANETARY BACKGROUND

Andoria is not a planet, but an inhabited moon. It orbits the gas giant Andor, which itself orbits a binary star made up of a white type F5 star and a white dwarf companion. Andor's orbit is at the far edge of the system's habitable zone and, as a result, Andoria is a chilly ice world. While technically class-M, Andoria is an extreme outlier.



Andoria's life has evolved to be highly resistant to cold. Adaptations range from thick insulating fur and blubber to blood that functions as antifreeze. The moon's barren surface may lead visitors to believe that Andoria is a lifeless place, but nothing could be further from the truth.

Andorian cities are built beneath the first layers of ice, shielded from punishing winds. Andorian children are taught to use the *ushaan-tor*, an ice miner's tool, from an early age. Cities are connected to each other via tunnels bored through the ice. Andorian architecture makes unique use of ice/filler mixtures to create sturdy structures around layers of scaffolding driven into the surrounding caverns.

These cities are not cold, miserable places, for the moon remains volcanically active underneath the layers of ice and snow. These natural sources of heat create warm, mineral-rich lakes in melted ice caverns where life flourishes. Chemosynthetic life forms thrive around the hot vents in those waters, and thermosynthetic plants such as the famous Andorian cabbage, grow in a rich soil created from the freeze-and-thaw cycle breaking down volcanic rock and ash.

No Andorian city is very far away from a vent-lake, for they give a wealth of food, minerals, building materials, energy, and liquid water. These vent-lakes are also popular vacation spots where various citizens of the Federation may enjoy Andorian-style steam baths and volcanic mud massages.

TWO PEOPLES, ONE PLANET

Many planetary and system populations contain many ethnic and national cultures within their home systems. Andoria, interestingly, is home to two separate but interfertile humanoid species: the Andorians and the Aenar. During the Andorian pre-history, the two species lost contact with each other. Contact resumed barely two centuries ago.

The blue-skinned Andorians live just under the surface of the icy moon. As endotherms, they evolved a high metabolic rate in order to maintain a comfortable body heat. They are physically robust and are capable of functioning in temperatures as high as 100 °C. An Andorian's flexible antennae are important vestibular organs: an Andorian whose antennae are injured will have impaired balance and

spatial awareness until the tissue regenerates. Andorian blood is extremely non-viscous; this is partially an adaptation to cold, as their blood perfusion rate increases as the temperature decreases. Major blood vessels are entirely sub-muscular; this peculiarity means that Andorians cannot receive intravenous treatments. Combined with their high metabolism, it also makes them vulnerable to injuries that impair perfusion, such as burns and disruption or phase weapon wounds.

The Aenar have a comparatively small population. They live in ice caves and crevasses far beneath the packed snow of the moon's surface. Millennia spent deep underground have caused the loss of skin pigmentation, and their slow metabolisms are well-suited to the cold. Many Aenar are completely blind but they do not consider this a problem as they are highly developed telepaths. This adaptation allows Aenar to navigate the darkness of the ice tunnels with ease. Otherwise, they are physiologically similar to (and genetically compatible with) Andorians.

Andorians and Aenar are culturally distinct. The Aenar are pacifists, preferring to live in peaceful anarchy. When necessary, they appoint a temporary representative (known as a Speaker) to serve as their voice. Andorians, on the other hand, are characterized as culturally fierce, aggressive and militaristic. They are typically straightforward and honorable, although they will not hesitate to use deception as a means to victory. The Andorians aren't xenophobic, having co-evolved while sharing their homeworld with the Aenar.

Andorians are a passionate and deeply emotional people. Life in the ice is short and they choose to live to the fullest. Conflicts between individuals and clans were not uncommon, and duels to the death were a preferred means to resolve serious disagreement. Over time, these duels evolved into the formal *Ushaan*. The Code of the *Ushaan* is a vast, complex honor code meant to address both the demands of honor and to minimize the potential societal damage from duels. Many of the amendments were explicitly written to ensure the clan's survival, regardless of the outcome of the *Ushaan*: the right to postpone in the absence of children, for example. Other amendments ensure that duels of honor are not merely legalized murder: the right of substitution allows a challenged party to appoint a substitute champion, so that a challenger cannot simply kill a much weaker opponent. Finally, the dueling parties are tethered together, and released only when one party is unable to continue the fight.

Ushaan duels are fought solely with the *ushaan-tor*. Andorians learn the use of the *ushaan-tor* from early childhood, which ensures that both duelists are familiar with the weapon. This does leave non-Andorians at somewhat of a disadvantage, of course. More important than familiarity is the symbolism. The *ushaan-tor* is tool and weapon, offense and defense, and in older days, to be without the *ushaan-*

HISTORICAL DOCUMENT

THE TEN VIRTUES

1. **Hospitality:** Turn no visitor from your door, lest you be turned away in turn. Even an enemy deserves shelter from the ice.
2. **Family:** From your clan do you come, and to your clan will you return. A single Andorian dies in a windstorm. Many Andorians can share their warmth and endure.
3. **Courage:** Leave no clanmate behind. It is a worthy death to fall defending the many, so the clan may survive.
4. **Fairness:** Everyone eats, or no one eats. Do not hoard your wealth. Share with your clanmates and they will share with you in turn.
5. **Honor:** An Andorian is as good as their word.
6. **Graciousness:** Blood-feuds end with the *ushaan*. Shed blood clears all debts.
7. **Protection:** No warrior fights alone, no hunter hunts alone. Protect those weaker than you, for you will need protection in turn.
8. **Respect:** Respect your clanmates and those around you. Respect the Ice for what it gives and what it can take.
9. **Justice:** A wicked clanmate harms the entire clan. Do not let family bonds influence punishment. Do not use family ties to protect the wicked.
10. **Duty:** As you owe duty to your clanmates, so they owe duty to you. Do not shirk your rightful labor, for in doing so you steal from your own mouth.

tor was to be dead. In a similar way, the tethering of duelists has two purposes. Tethered combatants have a limited reach; a combatant cannot use a duel to attack a third-party observer, nor can they retreat without ending the duel. Symbolically, the tether represents the cause of the duel, and it binds the two parties together in bloodshed. Severing the tether releases the two, and the affair is ended.

EMPIRE OF ICE

Both Andorians and Aenar maintain strong family bonds which contributed to their survival in pre-industrial times. Before Andoria was a united world, its citizens were divided into nations, which were themselves divided into clans, all organized in a similar hierarchy. The Andorians replicated their family bonds in their political structures, characterizing

the chancellor as head of the family, with various arms of government filling the roles of parents, aunts, and uncles to the citizenry.

Ask an Andorian what the Andorian Empire is based on, and they will answer: "Passion and honor." Nothing exemplifies this philosophy better than the Wall of Heroes. The Wall of Heroes stands in a great cavern adjacent to the capital city. It is a massive frozen wall of deep blue ice, streaked very faintly with other colors. According to custom, a fallen Imperial Guard's blood is collected and returned to the homeworld. There, it is poured upon the top of the Wall, where, freezing, it forms yet another layer upon the monument. Some courageous aliens have earned the honor of being memorialized upon the Wall of Heroes. These individuals have demonstrated an understanding of the Andorian spirit. Often, they either died in service to the Andorian people, or served alongside the Andorian Imperial Guard for a significant time. The first Human to receive this honor was Jonathan Archer, whose blood was added to the Wall after his death.

ANDORIANS RUN FROM NO ONE

Andorians live by a complex code of honor and law. Non-Andorians often believe (mistakenly) that there exists a single, homogenous body of law observed by every Andorian. Nothing could be further from the truth. There are multiple legal codes, each applicable in different contexts. The honor code that most outsiders encounter is the imperial code, which dates back to the unification of Andoria, and is an amalgamation of several of the clan codes.

Historically, each code was a diverse set of laws transmitted orally from clan leader to each new generation. These laws varied from clan to clan, and from city-state to city-state. Each clan committed a dizzying array of subjects to honor and law: the sharing and portioning of game; the specific thickness of pillars required in each dwelling; the proper conduct of duels; the proper formats for marriage contracts and separations. Purity or dietary taboos existed in ancient *ushaan* texts. Clan Thy'lek, for example, famously forbade the consumption of certain staple ice mosses due to a hereditary enzyme deficiency. When the deficiency was addressed with modern medicine, the clan dropped the food restriction from their clan code.

Clan-specific clauses were excluded from the honor codes observed by the nation-states. After unification these state codes were organized and codified into a single, overarching code meant to ensure proper conduct for all law-abiding citizens. Despite the wide variance in honor codes among clan, city and state, each code contains ten core virtues, which guided the conduct of every Andorian.

UFP FOUNDING MEMBER

Andoria has been a critical part of the Federation since its founding. Sentients from scores of planets vie for a place in the Andorian Academy, whose graduates are frequently

considered the best artists in the Federation. Similarly, Andorians have served in Starfleet and in Federation government from the Federation's very beginning.

Andorians are often the first to counsel aggressive action against a perceived threat. This does not always sit well with more peaceful peoples such as the Vulcans or Betazoid. Some Andorians are known for being easily insulted and the Andorian government usually ensures that such individuals are restricted to Andoria or their colonies. Federation law forbids dueling among its members, but it is an open secret that the *ushaan* is still practiced in some parts of Andorian society. So long as the practice does not leave Andorian soil, the principle of self-determination protects participants from legal retribution.

Early relations between Andoria and two of the other Federation founders, Tellar and Vulcan were hostile. All three powers were engaged in territorial expansion, causing frequent conflicts where borders clashed. Hostilities came to a head in 2154, when the Romulans attempted to foment all-out war between the three powers. While the three civilizations were able to set aside their differences and join together against the common threat, the legacy of distrust has been hard to abandon. The nearly-successful Orion plot to derail the Babel Conference of 2268 by setting the three species against each other revealed that the wounds of the 22nd century were still not healed.

BENZAR (DELTA PAVONIS)

PLANETARY BACKGROUND

Benzar is a marginal Class-M with a humid, ammonia-heavy atmosphere. Its primary is Delta Pavonis, a yellow dwarf similar to Sol but one on the verge of becoming a red giant. Benzar is the second planet of the system and its orbit is currently in the middle of its system's habitable zone. Benzar has an axial tilt of approximately 30%, with an average oscillation of 3.2% over a roughly 50,000 year period. Some 85% of Benzar's surface is covered in oceans, the water tinted deep brown from dissolved alkaline metals. The combination of pronounced axial tilt and large oceans makes Benzar prone to violent weather, especially hurricanes.

The landmass consists of island chains and archipelagos covered in rich, black vegetation. The plant life gets its color from alkaline and metal salts in the soil which the plants break down for energy. Most of the fauna of Benzar is amphibious or entirely aquatic.

UNDER THE DOME

Benzites primarily live in geodomes. These large domed cities are built over ocean platforms, granting them easy access to water. The domes were originally designed to

withstand the violent and regular hurricanes that Benzar experiences. As an additional benefit, they trap humid air in cold, dry latitudes for the comfort and wellbeing of their residents.

Benzites' smooth, hairless skin allows them to glide easily through water. Their facial barbels are sensory organs that allow them to sense electric fields while immersed, an adaptation that helps navigation in Benzar's dark, mineral-tinted water. Benzite ears are ringed with muscle, allowing them to close underwater. Ear closure does not affect a Benzite's underwater hearing. The vibrations caused by sound in a liquid medium transmit directly to the Benzite's auditory nerves. Benzite skin gains coloration and texture from the specific mineral content of the water where the Benzite is spawned. This causes citizens from the same geodome to bear a remarkable resemblance to each other, often to the point where offworlders cannot tell them apart. This may have evolved as a way of communicating water quality and content in the Benzites' pre-sapient ancestors. The difficulty non-Benzites have in differentiating between Benzites is something they generally accept with equanimity.

Benzite society is precise, but not authoritarian. Benzites are quite gregarious, especially among others of their dome. They communicate through pheromones and body language and speech is used merely for emphasis. The effect is more pronounced underwater, as a group of Benzites can act as a unit with an almost telepathic precision.

The Benzite government is a fluid meritocracy. Benzites achieve governmental positions by excelling in an avocation



related to that position. The primacy of each ministry changes depending on the situation. One might be in the midst of negotiations with the Planetary Ministry one day, only to find that an anticipated coronal mass ejection has placed

RESPIRATION

THE BENZITES AND GENETIC ENGINEERING

Genetic engineering is strictly regulated within the Federation, and permitted only to treat existing genetic illnesses. How, then, did the Benzites overcome their species-wide requirement for respirators in oxygen/nitrogen atmospheres, without being censured for genetic engineering?

The Benzite government concealed the true nature of the enhancements performed upon its spacefaring citizens. Their previous reliance on respirators was explained as a consequence of the Benzites' requirement for high levels of humidity. The enhancements were described as purely cybernetic implants designed to retain moisture in a Benzite's gill chambers, which were indeed necessary for a Benzite's comfort and wellbeing in a drier atmosphere.

Dr. Morshni, the project's head geneticist, had developed a transgenic treatment to augment the cybernetic implants. The treatment adjusted the Benzite lungs' capability to absorb oxygen to compensate for the higher oxygen levels in the typical Federation atmosphere. The Federation's inevitable discovery of the truth almost cost Benzar their Federation membership. Morshni justified the treatment on the grounds that a reversible, non-heritable transgenic adjustment to the respiratory system was not an enhancement, but a valid medical treatment to allow Benzites to function in standard oxygen-nitrogen environments. The Federation reluctantly agreed. However, medical corps and legal officials plan to keep a much closer eye on Benzar's medical science for the foreseeable future.

the Space Ministry in charge during the next day. More than one Federation diplomat has observed that dealing with one Benzite minister means dealing with them all.

Despite the apparently chaotic nature of Benzar's government, corruption is all but absent. Benzar's legal code, which has roots in their nomadic past, is one of the most intricate in the Federation. Benzite litigators have few equals in spotting legal loopholes and contradictions, and to call a contract water-tight is high praise among them. While this propensity drives some Federation members to distraction, Benzite contract lawyers are invaluable when negotiating with the Ferengi. Top-ranked Benzite litigators have a jurisprudential responsibility that extends far beyond the usual duties of lawyers on other planets. They are granted broad authority to annotate and interpret the law, provided that their interpretation is justified by previous commentary and precedent. Law is a particularly prestigious career on Benzar, and a cause for celebration by progenitors whose child qualifies.

Benzites are guided toward a career from their first years in school. Careful tests measure the children's intellectual capacity, emotional capacity, interests and talents. Each student is set a personalized curriculum which adapts to the student's continuing development. Students are taught in small groups, each focusing on a specific part of their curriculum, and move between groups as the course of study changes. Study groups are not segregated by age, and any group may have students of wildly differing ages.

NEWCOMERS TO THE FEDERATION

Benzar has been a Federation member for less than a decade, and there are still some adjustments to be made on both sides. Benzites are precise, meticulous, and, accustomed to operating with a high level of independence. While they respect authority, many Benzites see nothing wrong with jumping up the chain of command when necessary. This is exemplified by the Benzite regulation that states that Benzite officers, when encountering an unknown situation, are to take full responsibility for its analysis and provide a resolution before reporting it to superiors. This has caused at least one diplomatic incident, and Benzar and Starfleet have found it necessary to re-address these cultural differences.

Benzites also interpret Federation law extremely strictly. A Terran might interpret a law differently depending on circumstances, citing "the spirit of the law", a Benzite would never do so. To a Benzite, the spirit of the law is expressed in the words of the law, no more and no less. There are several areas of law in which both Benzar and Starfleet are finding it necessary to re-interpret and clarify laws and their intent.

EARTH

PLANETARY BACKGROUND

Earth is a Class-M planet in the third orbit of the Sol system. The capital of the Federation and site of Starfleet Command and Starfleet Academy, Earth is the home to millions of species of life, and at least two sentient genera, humans and cetaceans. For over two hundred years, the peoples of Earth have been united in peace and progress, and today Earth is as close to a paradise as sentients can make it.

A TUMULTUOUS PAST

Earth's pre-warp history is filled with conflict. It wasn't until the 20th Century, however, that industrial progress made it possible for a single civilization to put the entire world at risk. In 1945, the United States ended the Second World War through the use of atomic weapons and ushered in the modern age.

The First and Second World Wars left the world largely divided into two political blocs, each centered on one of the two dominant powers of the time (often referred to as the Eastern Bloc, dominated by the Union of Soviet Socialist Republics, and the Western Bloc, dominated by the United States). The United States had used atomic weapons to end the Second World War; due to fears that an open confrontation between the two blocs would lead to a third, atomically-fueled World War, they instead engaged in a half-century-long "Cold War."

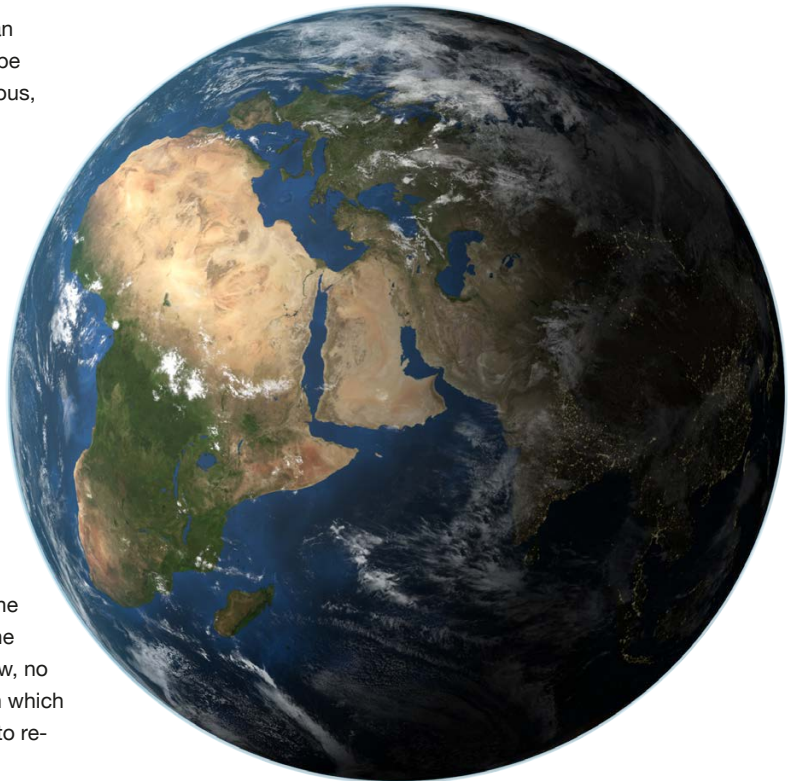

The Cold War was characterized by a policy of nuclear one-upmanship, a series of proxy wars involving less-developed and less-powerful nations, a high level of espionage, and scientific projects (often of dubious merit) designed to provide some sort of advantage. The Augments were the result of one of these programs, although the details of the program were lost in the chaos of the following century.

The Eastern Bloc had nuclear platforms in orbit in 1968; a failed launch of a similar platform by the United States caused both sides to agree to a new, stricter international agreement to prevent the use of such weapons. Disarmament talks in the 1970s reduced the nuclear stockpiles of both blocs; however, there still remained sufficient nuclear weapons to destroy civilization. Development of orbital platforms continued by both sides, replacing nuclear weaponry with kinetic energy weapons and early pulse weapons designed for point defense.

The fall of the Soviet Union in 1991 provided a power vacuum which the Augments were happy to fill; indeed, there is some speculation that its fall was engineered by one or more Augments in order to create the circumstances necessary for them to assume power. The Eugenics Wars lasted only four years, but their impact on Earth was horrific. Entire populations were bombed out of existence, primarily in Central Asia, South America, and Africa. Records of the era are sparse, but there are indications that orbital kinetic weapons were used to suppress Augment air power in the latter half of the wars.

A period of economic and international uncertainty followed. The United Nations was reorganized, to little effect. The United States' economy was in a state of collapse, while Europe was succumbing to xenophobia and Balkanization. Many of the countries of East Asia banded together under China's lead to form the Eastern Coalition. By 2026, tensions between the Eastern Coalition and the Western powers had reached the point of conflagration, but it was the genocidal would-be despot Colonel Phillip Green whose acts of eco-terrorism set the world aflame.

World War III lasted twenty-seven years, and was fought with both nuclear and conventional weapons. At least some of the military forces of the time were controlled via the use of combat drugs. Six hundred million were killed, and most governments collapsed. Remarkably, despite the war, humanity was still attempting to explore the cosmos. Manned missions were launched throughout the war, including Ares IV and the *Charybdis*.

The period after World War III is known as the "post-atomic horror," although records of the period suggest that some regions suffered much more than others. Green, responsible for millions of deaths during the war, ordered the "purification" of the human race by killing hundreds of

THE WARM EQUATIONS

EXCERPT, *BACK FROM THE BRINK: WORLD WAR III AND THE NEW HUMAN RENAISSANCE*

Contemporary historians ask, "What prevented the Earth's total destruction during the wars of the 21st century?" The answer to that question continues to be hotly debated, even today. We examine one hypothesis in the first chapters of this work.

Some cite first contact with the Vulcans as the true turning point, but in truth the Vulcans did little to help Earth until it became evident that humans would not fall back into war. Instead, recently-recovered historical records point to an unlikely source of intervention.

In the wake of the late 1960s treaty regulating orbital platforms, both superpowers explored other options. Among these was Systema "Perimeter", an automated weapons system intended to remove human decision-making from the deployment of the then-USSR's nuclear arsenal. Initially a relatively-simple computerized switching and launch network, Perimeter underwent continuous upgrades during the years leading up to the nuclear holocaust.

The Eastern Bloc claimed that Perimeter could simulate, calculate, and virtually fight any conceivable wartime scenario in a matter of seconds, so advanced were its circuits. At the time, many believed this statement to be mere propaganda. However, records suggest that Perimeter benefited greatly from early developments in the USSR's artificial intelligence program. In a race to defeat the West, the Eastern Bloc inadvertently equipped Perimeter with what may have been a functional predecessor to the ground-breaking, yet ultimately unsuccessful, multitronic computer developed by Dr. Richard Daystrom.

The historical record estimates that a mere 2-3% of the superpowers' nuclear arsenals achieved their intended targets. An unusually high percentage of missiles were destroyed by Eastern Bloc missile defenses, and there are indications that those missile defenses targeted their own missiles as well as the enemy's. In addition, during the final stages of the nuclear assault, Perimeter was destroyed by a ground-penetrating thermonuclear device launched by the Eastern Bloc themselves.

But why would they destroy their primary line of defense?

We must ask ourselves difficult questions — when the war began, did Perimeter come to the conclusion, logically based on a billion virtual simulations of a war that ended in annihilation, that it must prevent that outcome? Is it possible that a machine, designed to defend one small part of the world, chose to extend that defense even unto its enemies?

Is it possible that a system designed to exterminate life chose warm, rather than cold, equations?

thousands of people who were suffering radiation sickness. He was ultimately brought to justice, but his words and acts were not forgotten. In other parts of the world, law and order collapsed completely. And in Bozeman, Montana, Zefram Cochrane built and launched the Phoenix, the first warp-capable spacecraft, resulting in Earth's meeting with the Vulcans, known thereafter as First Contact.

The cruelties of the post-atomic horror were the final straw — an extinction burst of violence — for the people of Earth. One by one, the nations of Earth sent their ambassadors to San Francisco to stand united. One by one, the last of the despots died, and humans reclaimed their battered world. Eighty-seven years and one human lifetime later, the last independent nations joined the world government, making it a United Earth in truth.

HEART OF THE FEDERATION

Today, Earth has recovered from the scars of the 21st Century. Its population enjoys a comfortable, peaceful, productive existence. Vast tracts of land area have been designated as wilderness areas and left to grow wild. Other areas are agricultural. A network of weather satellites, launched in the early 22nd Century, has corrected the climate aberrations from the nuclear winter. Today, Terrans prefer a light hand with the weather, and only generally intervene to prevent a full-fledged disaster.

The wars of the 21st Century inadvertently encouraged the redesign of most major cities. Most cities today are a

combination of the old and the new. As ruined suburbs and urban centers were reclaimed, many of them were converted to parkland and common areas. Historic city centers are maintained, their roads converted to pedestrian use. Population centers are no longer designed around the need to support millions of personal vehicles. Most people don't own such conveyances, preferring the convenience of the planetary transport network.

Urban populations primarily live in arcologies. These huge, mixed-use buildings include residential and industrial areas, hydroponic gardens and dedicated open spaces, and can be several hundred stories tall, and provide urbanites with comfortable homes in an ecologically-sound footprint. There is no uniformity to the design of these arcologies. While each city may have a similarity of style, each arcology is unique, and many of them are works of art.

Many Terrans choose not to live in cities, a choice made possible by the wide reach of the planetary communications and transport network. Some are able to pursue their careers from their home, conducting their business on a remote basis. If a job requires a physical presence, however, it's as easy to transport halfway across a world as it is to walk across a boulevard. Modern technology allows homes to be entirely self-contained, and citizens can live as easily on the edge of the wilderness as they can in the city. Sentients of all species can be found in Earth's cities. Some are there on business, some for pleasure, and some choose to make their home among humanity.

STARFLEET ACADEMY LECTURE (TRANSCRIPT)

GUEST LECTURER T'CAEL OF THE SHIKAHR ACADEMY, THE PARADOX OF LOGIC

When outworlders refer to Surak and his philosophy, the word most often used in translation is logic. We do not speak here of the logic of mathematics or philosophy, but the pursuit of reason. This pursuit of a logical, rational mindset gives rise to a number of misunderstandings about Vulcans. The most fundamental of these is the idea that we have no emotions.

We have emotions. Some of us even possess a sense of humor.

Vulcans have emotions, and those emotions are powerful, irrational, and frequently violent. That is the problem Surak faced. As he mastered his feelings, he discovered the capability to see the world as it truly was, without the distortion of emotional excess. In the casting out of fear, he discovered the wonders of diversity.

From these beginnings came the three pillars of logic: the acceptance of reality, for good or ill; the embrace of diversity, and the change and growth that diversity offers; and the emotional control that makes the first two possible. It is no accident that the IDIC symbol is a triangle atop a circle -- the rational shaping the irrational, the threefold path of logic allowing the Vulcan soul to become whole.

Surak hoped that one day we could live with our emotions in peace, and he had faith we would discover the way to attain that state from the diversity of the universe. And yet, in that hope, we find a paradox for these are not logical beliefs. A purely rational analysis suggests that it should be impossible for one man to change the way of thought of an entire planet. Yet he persisted -- not out of logic, but because he loved his people too much to allow them to destroy themselves.

Earth's oceans support a thriving aquaculture industry. With support and assistance from the cetacean citizens of Earth, billions of tons of biomass are produced each year to provide raw material for industrial replicators. The replicator has made industrial agriculture a thing of the past. Modern agriculture is primarily artisanal, combining modern capabilities with traditional techniques. Earth's farms are small and highly-specialized, producing items that either cannot be replicated or that have particular cultural significance. French wine, traditionally grown wasabi, and artisanal dishes of *banku* and *okro* stew are only a few examples.

PARIS

The Federation president's office is situated in Paris, France. At the top of a tall, graceful tower overlooking the Seine, the president has an unparalleled view of a millennia of history. At one end of the city, the Arc de Triomphe stands, the eternal flame beneath it re-lit in 2070 and nurtured ever since. Across the Seine rises the Eiffel Tower, restored and re-dedicated on the date that France joined United Earth. The great Avenue des Champs-Élysées stretches from the Arc to the Grand Palais and, finally, the Louvre. The Louvre remains one of Earth's premier museums; much of the collection was stolen during and after the war, but the majority was recovered relatively intact. It became apparent after the war that a significant portion of the thefts were motivated by a simple desire to protect the priceless treasures.

The citizens of Paris are proud of their history, and have worked hard to ensure that the city retains the ambience of times past. The original medieval layout of Paris can still be seen in its street map, which has not changed in hundreds of years. Paris has always rigorously controlled their urban development, and new construction within the central quarters of the city is restricted to a height of 37 meters. This may, on the discretion of the city government, may be raised to 50 meters if necessary. Exceptions are rare. Architectural styles are expected to combine harmoniously with the existing historic buildings. This makes Paris visually and culturally unique among Terran cities.

SAN FRANCISCO

San Francisco is nestled in the rolling hills at the tip of the peninsula that separates San Francisco Bay from the Pacific Ocean. First gaining prominence as a port during the gold rush of the 19th Century, San Francisco became a diplomatic and financial center in the 20th. A massive earthquake in 1906, and another in 2043, both resulted in massive rebuilding. San Francisco is therefore a very modern city. Areas such as the Mission District and the Embarcadero retain their historic character, and are the sites of a number of restaurants, night-spots, and cafés.

San Francisco has been the site of several major attempts at unification, both of Earth and of the Federation. Both

versions of the United Nations were inaugurated in the city. United Earth was born here out of the peace treaty that ended World War III. The United Earth Starfleet sited its headquarters along the bay coast north of the city, and multiple alien embassies and compounds were built in the surrounding area. San Francisco hosted the signing of the Federation Charter in 2161, and every new member of the Federation adds their signature to the charter in the very same hall.

Starfleet Headquarters and the Starfleet Academy are located on the site of the former Presidio, at the north tip of the peninsula, just south of the Golden Gate Bridge. The Federation Council chambers can also be found in this area. Starfleet also maintains and operates towers in the former Financial District, where each division conducts day-to-day operations. The San Francisco Fleet Yards, in geostationary orbit over San Francisco, also have their headquarters in the city.

VULCAN

PLANETARY BACKGROUND

Vulcan is a Class-M planet in the triple-star system 40 Eridani. Vulcan is in the second orbit around the K1 dwarf 40 Eridani A, near the inner edge of the habitable zone. 40 Eridani B and C are incapable of supporting life-bearing planets. Any planets orbiting Eridani B would have been destroyed when it collapsed into a white dwarf, and Eridani C is a red dwarf whose flares are lethal to M-class planets. 40 Eridani A, although of slightly lower magnitude than Sol, appears brighter from Vulcan due to the closer orbit.

Vulcan is half of a double planet. It orbits a barycenter approximately two-thirds of the way between it and its planetary companion, T'Khut. T'Khut is smaller and less massive than Vulcan, has very little metal content and its core is no longer tectonically active. Unusually, the Vulcan system contains a second Class-M planet, this one near the outer edge of the habitable zone. Vulcan has never colonized this small, forbidding ice world, due to its tectonic instability and predatory fauna, considered vicious even by Vulcan standards. Due to the small extent of 40 Eridani A's habitable zone, there are times when a person on the ice planet could potentially see the surface of Vulcan.

Vulcan is an arid world with a thin atmosphere and high gravity. Most water on Vulcan is contained in underground aquifers. A mere 10% of the surface is water, primarily a pair of seas about the size of Earth's Mediterranean. Despite its current desert climate, there are geological indications that Vulcan possessed significantly more water in its early history. Many planetologists believe that Vulcan's lack of water is a result of exposure to Eridani C's periodic and violent solar flares. Vulcan and Eridani C are

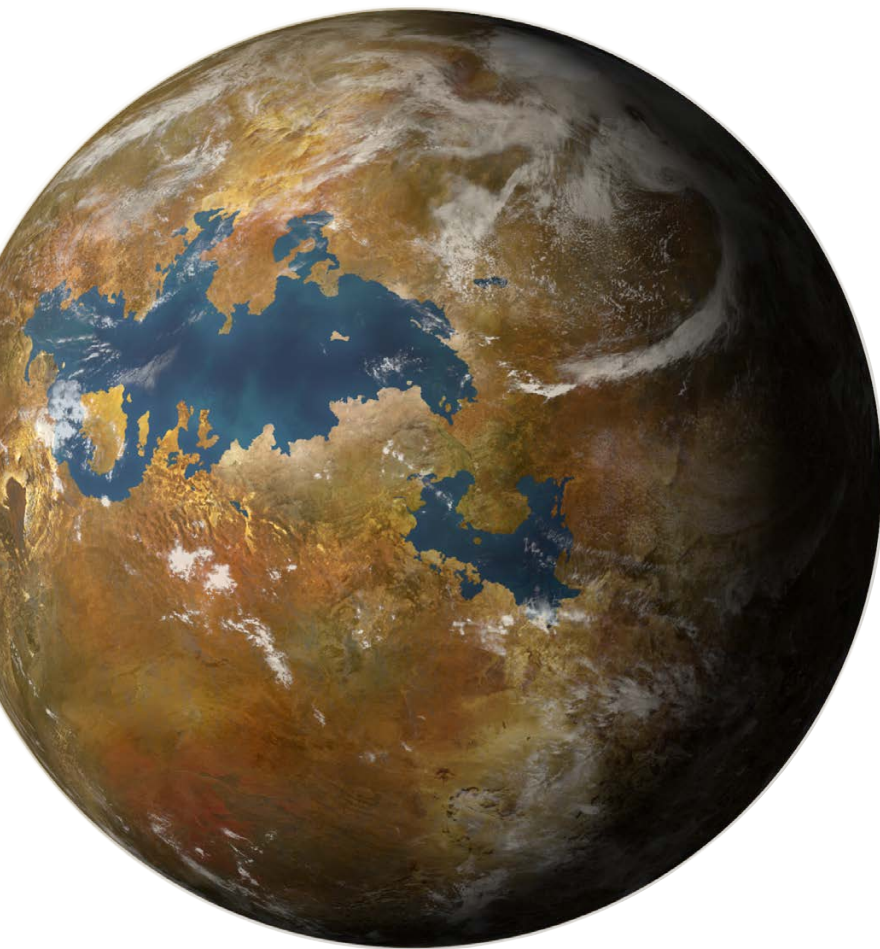

currently at their maximum separation but there have been times when the planet has been at the outer edge of C's flare zone. That it never comes closer is evident because the planet still has an atmosphere (however thin) and surface water (however scarce).

Life on Vulcan evolved to be strong, tough, and cruel. Most diurnal animals possess an inner eyelid, adapted to protect

KOLINAHR

Surak hoped that the Vulcans would someday be able to master their emotions, rather than be mastered by them. He also recognized that some Vulcans would never be able to live with their emotions. Either those emotions were too strong, or their psionic sensitivity was too high. The discipline of *Kolinahr* was intended for those who could not master their emotions in any other way. *Kolinahr* masters are highly respected for their discipline, their sacrifice, and their complete devotion to Surak's ideals. However, there are some Vulcans who have demonstrated that Surak's hope was not without foundation. The half-human Ambassador Spock is known for both his control and his occasional masterful expression of emotion. Surak's celebration of diversity has borne fruit at last.

against its fierce primary star, while their respiratory systems are particularly efficient in extracting oxygen from the atmosphere. Plants and animals alike can go for significant amounts of time without water, and most Vulcan life possesses some resistance to hard radiation.

RED SAND, GREEN BLOOD

Vulcan history before the Time of Awakening is a tale of savage, brutal war. Access to water, scarce and precious, was an early cause of contention. As Vulcan technology was driven forward by the needs of weapons development, other resources soon became equally valuable. Vulcan religious rituals were fierce and passionate, and Vulcans were as quick to lose themselves in religious ecstasy as they were to wage war. It was not uncommon to see two Vulcan clans fight a war of mutual annihilation, only for others to repeat the tragedy.

By the 4th Century C.E., Vulcan had reached a tipping point. They were capable of space flight and had developed atomic weapons. Not only could they destroy themselves, but they could carry their wars to the stars. Some attempts to rein in the Vulcan propensity toward violence had occurred in the past, but none had been successful. It was into this world that Surak was born.

No one knows what caused Surak to turn from the chaos that was Vulcan society of his time, but turn away he did. Alone, he undertook a pilgrimage across Vulcan's fiercest desert, where his path led him to Mount Seleya. Alone, he re-made himself in the fires of Vulcan's Forge and, in so doing, found the way to re-make his world.

Surak advocated a philosophy of pacifism and reason. He developed and taught techniques of meditation and mental discipline that allowed Vulcans to control or eliminate their emotions. His teachings were based in a deep appreciation for the diversity of the universe and a profound respect for life. He preached reason and logic, made of himself an emissary of peace to warring factions and, over a century, his teachings began to take root. The legend that, by logic, he cooled the Plain of Blood from the heat of battle is likely a poetic reference to one or more of these missions of peace. As he gained followers, they, too, tried to bring peace to the warring world. Many died, but gradually, peace began to spread.

Not all Vulcans were interested in following the way of logic and peace. Some saw an opportunity to strike against opponents who would not fight back. Foremost were "those who marched beneath the Raptor's wings." Neither clan nor nation, these Vulcans were an organization of mercenaries. Ostensibly, they fought for pay, in the cause of whoever would hire them. In reality, they relished the blood lust and violence. Vulcans, they believed, were meant for war. A death in war was the only honorable death, and to fight and survive was the greatest of joys. Logic threatened all they believed in.

Surak's writings contain no reference to his final days, and records are sparse, but the general sequence of events is known. The children of the Raptor struck, swiftly and savagely. When the atomic weapons launched, Mount Seleya — and Surak — was the first target. Though he did not die in the initial onslaught, he was exposed to massive amounts of radiation. He lived long enough to retreat to the T'Karah Sanctuary, where many of his people had taken refuge in the underground vaults. There, he died, and his *katra* was preserved and carefully hidden, along with his original writings.

Logic suggests that those who knew of the location of Surak's writings and *katra* died in the final battle. Through the centuries required to rebuild Vulcan civilization, those who followed translated and disseminated his teachings to their students. Over time, Surak's teachings became corrupted.

By the early 22nd Century, knowledge of his philosophy had degraded to a point where the High Command could effectively seize control of the planetary government, guiding Vulcan into a period of militarism and Vulcan superiority. Modern analysis suggests that one or more members of the High Command were influenced by Romulan agents, as a step towards reunification. In a historical irony, the corrupt administrator of the High Command set his own downfall in motion. He arranged the bombing of the Terran Embassy, planning to use it as an excuse to attack the Andorians. Humans and Vulcans working together to find the truth exposed his duplicity and restored Surak's original writings to the Vulcan people.

THE PURSUIT OF LOGIC

Over the past two centuries, Vulcan society has returned to the true teachings of Surak. In many ways, however, Vulcans remain who they have been for centuries. They are a people bound by tradition, of their own choice. Their tight adherence to the strictures of logic often appears to be mental or societal rigidity. They are an intensely private people, and do not readily invite outsiders into their confidence. This reserve is often mistaken for standoffishness or arrogance. They are considered cold and forbidding, often compared to machines.

None of this is true. Vulcans do have a high regard for tradition, but for good reason. Their traditions saved their civilization from total destruction. Not all Vulcans follow the path of logic in the same way, however. Surak anticipated as much in his writings: "All people are different; no one walks twice in their own footsteps." In addition, two centuries after the revelation of Surak's original writings, modern philosophers have offered different interpretations. Some Vulcans emphasize emotional control, and these are more likely to pursue the ritual of *Kolinahr*. Others are more interested in exploring the diversity of the universe. The only consensus is that each Vulcan must experience Surak's philosophy for themselves.

PERSONAL LOG

JONATHAN ARCHER, JULY 12, 2154

The *Enterprise* is currently undergoing repairs, courtesy of the new Vulcan government. Meanwhile, I'm getting used to being alone in my own head again. After some discussion with T'Pol and T'Pau, I've decided that Starfleet doesn't need to know that I spent several days sharing my brain with the father of Vulcan philosophy. Dr. Phlox has assured me that I haven't suffered any neurological damage from the experience, and I can rely on his discretion.

I'm not sure how to describe it. Syrran could have survived long enough to pass the *katra* on to T'Pol, but he, or Surak, chose me for a reason. And I don't think it was just because humans still remember the fear of nuclear annihilation. He never said it outright, but I think he wanted to remind Vulcans that diversity also comes in packages that make them uncomfortable. To show both of our peoples that we're not that different under the surface. A reminder that not even he could change a planet alone. It takes all of us.

No two Vulcans are exactly alike, though there are some societal tendencies. Vulcans are usually less impulsive than other species. When possible, they prefer not to act until they have all the facts. Conversely, they are often more willing to enter dangerous situations, given a rational assessment of the risks. They are an extremely reserved people, and non-Vulcans must learn to interpret their body language in the context of that reserve. For a Vulcan, the touch of fingers can be the equivalent of a full-body embrace.

Vulcans have a reputation for being reluctant to spend time among other species, especially those lacking emotional control. This reputation has a basis in fact because a Vulcan untrained in the philosophical techniques of emotional and psychic control is vulnerable to the influence of others' emotions. For Vulcans, strong emotions are literally contagious. Many of the ancient Vulcan religious practices evolved to exploit this tendency, inducing highly ecstatic emotional states. This sometimes allows Vulcans to sense highly emotional events at a large distance, such as Commander Spock becoming aware of the death of the *U.S.S. Intrepid's* all-Vulcan crew in 2268 from light-years away. Vulcans who are unsure of their emotional control prefer to remain among Vulcans rather than risk an emotional onslaught.

Pre-Awakening architecture is usually imposing, with mighty stone fortresses towering above the desert and carved out of the living rock. Even today, many of these edifices remain habitable and in use. One notable example is the Hall of Ancient Thought on Mount Seleya. Post-Awakening architecture can be divided into two general



eras: before and after regaining the capability for space travel. Pre-space buildings lack the sheer grandiosity of their predecessors and instead reflect a new humility and practicality. Instead of building up, they built down, using the insulating properties of stone to their advantage. Older Vulcan cities look odd to human eyes. When one stands

on the surface of the planet, one only sees the occasional roof. Modern Vulcan architecture takes full advantage of the technologies available to it, and tall, graceful buildings rise far above the surface, towers sweeping to a peak. Sharp corners are eschewed in favor of sinuous curves. Buildings are ornamented simply, using straight lines to break up or emphasize the curves.

REMEMBRANCE STONES

In the days before Surak, travelers would carry small gems which had been intricately carved with their family sigil and lineage. The value and craftsmanship of these stones was an indication of the family's wealth and status. These stones were presented like calling cards, and they could also be returned to the holder's family in an unspoken demand for ransom.

They continued to be created after the final war, although for very different reasons. Most such stones date from the first postwar century. They are made of the substance that humans call "Trinitite," glass formed in the furnace of an atomic bomb. Vulcans know them as "Surak's Tears," and they can still be found in the Forge. These stones were carved as silent testimony that one had survived the final war, and as a warning to never forget the madness that Vulcans had one embraced.

Vulcans tend toward the minimalist in their personal spaces. Surak's philosophy states that a Vulcan should not burden themselves with excessive possessions. One should own only things that are useful or that are beautiful. Thus, Vulcan rooms are rarely cluttered and those pieces of furniture that are necessary are placed harmoniously with objects of beauty.

Even today, little is known about Vulcan religious beliefs. They are considered the most private practices of an intensely private species. In ancient times, Vulcans were a polytheistic people with a host of decadent religious practices. Surak himself was not a priest, and rejected attempts to cast him as such. Yet many of the rituals and disciplines of modern Vulcan are viewed as sacred, in particular those involving the katra. These rites are always overseen by priests, as is the final passage of *Kolinahr*.

PLACES

ShiKahr is the capital city of Vulcan, and one of its oldest continuously-occupied cities. Although the generally

accepted spelling is ShiKahr, variant transliterations include Shi'Kahr, ShirKahr, Shirkar, and several others. It grew up around one of the rare natural artesian springs. The pre-Awakening fortress built to defend the precious spring is still in existence, and is now used by the Vulcan High Council and Vulcan Science Academy as a lecture and meeting hall for very large audiences. ShiKahr was also one of the first cities to accept logic: Surak founded the T'Karath Monastery nearby on the outskirts of the Forge. Formerly the site of the High Command, ShiKahr is also home to the Vulcan Science Academy and the Shirkahr Academy.

Vulcan's Forge is the harshest desert on the planet. Surface water is inaccessible, save to the native wildlife, and the only shelter is a network of caves. Geomagnetic anomalies and sandfire (highly ionized sandstorms) disrupt modern technology, such as communicators, transporters, and weapons. Those lost in the Forge are rarely rescued, as even sensors cannot penetrate the area. Despite the forbidding terrain and the danger of wild *sehlats*, the Forge has become a place of pilgrimage in the past two centuries. Since the discovery of the Kir'Shara, Vulcans have come to Gateway to follow in Surak's footsteps.

Mount Seleya rises from Vulcan's Forge. It was a sacred place of retreat even before the time of Surak, and it was there that Surak developed his philosophy. The ancient monastery on Seleya's slopes was largely destroyed in the final war. It was rebuilt a century later as the Hall of Ancient Thought. It, and the Hall of *Katras* within, was intended to be the resting place of Surak's *katra* and his final writings. Both were lost in the aftermath of the war, and only since their re-discovery have they taken their appointed place.

OTHER PLANETS

RISA

Risa is one of the Federation's most famous pleasure planets, and was known as such even before it became a Federation member. Risa's natural state is cold, gray, rainy, and seismically unstable. Through the use of sophisticated weather and seismic control systems, the Risians have transformed their planet into a sunny tropical paradise. Risa is a popular location for seminars, tournaments, and weddings. The planet offers a variety of activities designed to appeal to the widest possible spectrum of sentients. Balmy beaches, trendy urban nightclubs and wilderness adventures: Risa has it all. The Risian people are generous, openly sexual and hedonistic, and they freely invite their visitors to partake "All that is ours is yours."

The Risians are a peaceful people and their planet is likewise peaceful as weapons are entirely banned. That said, Risa is not a perfect planet. Crime is not unknown in the urban areas, and travelers are advised not to drop their guard completely. The Risians take the relaxed attitude that the occasional minor crime adds spice to an outing,

and that property can easily be replaced. Because the Risians welcome all comers, and do little to monitor the activities of their visitors, Risa has also become a haven for spies, similar to Old Earth's Vienna. Agents of all species can make discreet contact under the guise of a libidinous vacation.

CORIDAN

Coridan is extremely rich in dilithium and other metals, and so has been the target of interstellar predation from before the Federation's founding. In the 22nd Century, Coridan was wracked by dissent. Poverty was widespread, and there were numerous rebellions against the elected government. While their political differences were genuine, the conflict between the government and the rebel forces was made worse by the Vulcans (who backed the government) and the Andorians (who supported the rebels). Both were willing to interfere for the sake of Coridan's dilithium exports.

Coridan was part of the negotiations to create a Coalition of Planets in 2155, largely to defend against the Romulan threat. They refused to join the Coalition due to their trade ties with the Orion Syndicate, and were not invited to join the Federation six years later. Meanwhile, their political situation continued to disintegrate. Over the next century, civil wars and piracy caused a significant population decline, while Orion traders worked illegal mines using slave labor.

Coridan's request to join the Federation in 2268 almost opened old wounds among the Federation founders instead. An Orion spy, disguised as an Andorian, murdered the Tellarite ambassador and tried to pin the blame on the Vulcan ambassador. The crew of the Federation starship transporting the diplomatic entourage solved the murder and uncovered the spy, and the negotiations continued. Today, Coridan is a full member of the Federation, and remains one of the most valuable sources of dilithium in the Quadrant.

NAUSICAA

Little is known about the Nausicaan homeworld, as the Nausicaans do not allow outworlders planet-side. Some suspect it to be just short of a "death world", with high gravity, extreme temperatures, and ferocious wildlife. The Nausicaans themselves are ill-tempered and violent, and take pleasure in inflicting and enduring pain.

Nausicaan pirates were a scourge of civilized worlds in the 22nd Century. Operating in organized groups, their piracy was a business. In the intervening two centuries, such groups disintegrated, possibly due to a governmental or societal collapse. Nausicaans continued to be a blight on the civilized galaxy, hiring themselves out as thieves, bodyguards, and mercenaries. They are often hired by the Orion Syndicate as muscle.

THE BETA QUADRANT

THE KLINGON EMPIRE

“WE ARE SIMILAR AS A SPECIES. HERE WE ARE ON A PLANET OF SHEEP, TWO TIGERS, PREDATORS, HUNTERS . . . KILLERS. AND IT IS PRECISELY THAT WHICH MAKES US GREAT. AND THERE IS A UNIVERSE TO BE TAKEN.”

— KOR, DAHAR MASTER

INTRODUCTION

Our relationship with the Klingons goes back longer than nearly all others with different species. First contact with the Klingons, via the Broken Bow Incident in 2151, predates the Federation’s foundation itself. For most of the two centuries that followed, the relationship between our two governments was one of tension and occasionally open warfare.

An unprecedented era of cooperation began with the signing of the Khitomer Accords in 2293, one which continues to the present day. The Empire remains one of the Quadrant’s major powers, and the key to engaging successfully with the Klingons lies in a Captain’s understanding of them. This briefing, hopefully, is a beginning to that long process of learning.

ASTROGRAPHY

Starfleet is not entirely sure of the total expanse of the Klingon Empire, because it has never definitively ascertained how far Klingon space extends into the Beta Quadrant.

This uncertainty is made worse by official Imperial policy: the Empire lays claim to broad swathes of territory, but there is simply no way for another power to tell whether a claimed star system has merely been explored by Klingons, or whether it now hosts a settlement. For that matter, it is difficult to say if a settlement is a simple colony, or a major manufacturing center with fortifications. The only possible confirmation would come from first-hand observation, and the Klingons certainly have not invited anyone to explore within their distant borders.

What can be directly observed is that the Klingon Empire lies to the galactic southeast of Federation space, along a border 700 light years long (as simplified on a two-dimensional star chart), and demarcated by a region of space roughly 1.5 light years across. By the terms of the Treaty of Organia in 2267 this was designated as a Neutral Zone between the powers. The border has not been a Neutral Zone since the signing of the Khitomer Accords, but the region remains unclaimed by both sides thanks to tradition and as a sign of amity and respect.

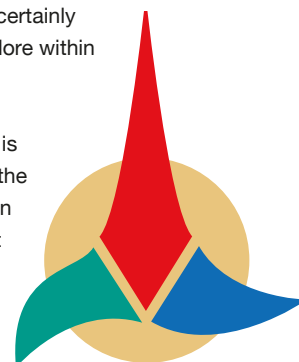

THE OLD WAYS

“The old Klingon ways are passing. There was a time, when I was a young man, the mere mention of the Klingon Empire made worlds tremble. Now, our warriors are opening restaurants and serving *racht* to the grandchildren of men I slaughtered in battle. Things are not what they used to be, not even a blood oath.”

— Kang, Dahar Master.

Directly to the north of the Klingons is the Romulan Empire with the border marked — at Romulan insistence — by a continuation of the treaty-defined Neutral Zone between the Romulans and the Federation. This border has been the site of multiple clashes between the Klingon and Romulan Empires over the years; Klingon expansion in an attempt to flank the Romulans to their galactic east (towards the Shackleton Expanse) has been somewhat curtailed by Federation claims in this area. The joint Klingon/Federation project of Narendra Station, now the launching point for the exploration of the Expanse, has been started with the intent, on the Klingons’ part, of continuing a push eastward.

On the Klingons' southwestern border lies the Gorn Hegemony. There are records of Klingon battles against the Gorn, but the Gorn seem content to stay on their side of the border. After a few encounters, the Klingons seem content with the status quo.

THE RISE OF AN EMPIRE

The Klingon Empire has existed for nearly one and half millennia. It was founded in Earth's 9th Century by Kahless the Unforgettable, who overthrew the tyrant Molor and united the homeworld for the first time. Kahless was a mighty warrior and an effective leader as well as a philosopher, and his words and actions established the code of honor that became the template for Klingon society.

Late in life, Kahless told his subjects that he had to leave them, to journey to Sto-vo-kor, the Klingon afterlife. He promised that he would return. Pointing to a star on the horizon, he said "Look for me there, on that point of light." The star pointed out by Kahless was Boreth to the Klingons named, and the system became a sacred place. Kahless wandered out into the wilderness and was never seen again, but the House of Kahless ruled the Empire for generations.

KLINGON DRINKING SONG

*'ej HumtaH 'ej DechtaH 'lw
'ej Doq SoDtaH ghoSpa' Sqral bIQtlq
'e' pa' jaj law' mo' jaj puS
jaj qeyllS molar mlgh HoHchu'qu'*

Translation:

*"And the blood was ankle deep.
And the River Skral ran crimson red.
On the day above all days.
When Kahless slew evil Molor dead."*

In the 14th century, Qo'noS, the Klingon homeworld was invaded by an alien species, called the *Hur'q* (the "outsiders") by the Klingons. The *Hur'q* were raiders, who sacked Qo'noS, and stole much of the planet's wealth and many cultural artifacts, before they were driven into space by the outraged Klingons. The Klingons were able to reverse-engineer captured alien weapons, ships and devices, which led to a leap forward in technology. At the same time, first



contact with an alien species and the initial sting of defeat came as a great cultural shock to the Klingon people, bringing great changes to Klingon society. The old religion of the Klingons was largely abandoned as meaningless in the face of this new reality. To this day, Klingons often poetically describe this period as the time when the Klingons killed their gods, having decided that they were more trouble than they were worth.

The First Dynasty of Kahless had been broken during the Hur'q invasion, with the death of Emperor Mur'Eq. A Second Dynasty was founded, with the oldest male cousin of Mur'Eq taking the throne as Emperor Korva. The Second Dynasty period was marked by slowly rebuilding from the depredations inflicted by the Hur'q.

After 200 years, the Second Dynasty came to a violent end, when General K'Trelan assassinated Emperor Reclaw and executed the entire Imperial Family. The coup d'état resulted in the first and only Klingon experiment in democracy, as K'Trelan turned over authority to a council elected by the people. This period is referred to by Klingon historians as "The Dark Time," and only lasted briefly — about a decade — before being overthrown by the Third Dynasty, a group of Klingons who, after victory, gave themselves the names and titles of the original Imperial Family, in order to create the illusion of an unbroken line.

During the Third Dynasty, the Klingons began to venture into space using the *H'urq* technology, exploring outside their solar system and creating a mining colony on the

moon of Praxis. Their technological advances continued, leading to their development and increased understanding of warp travel into the 21st Century, and the period of Klingon expansion and conquest began. The memory of their humiliation at the hands of the *Hur'q* had become part of the Klingon psyche, and they swore, as a people, to never experience such abasement again. As they discovered new worlds, they took what they could, becoming the raiders who brought fear to others. If a world was uninhabited, they established a colony, thereby insuring that no invasion of their homeworld would ever again threaten the survival of the Klingon race. If the world was inhabited, they conquered it, making its population subjects of the Empire, ruled by Klingon masters.

Over the decades, the true power in the Empire was more and more concentrated in the hands of the High Council, rather than the Emperor. In the mid-21st Century, the last emperor of the Imperial line, Koth, died without an heir. The Chancellor of the High Council, Mow'ga, simply didn't bother to look for a distant relative to replace him. There was no longer an Emperor. The High Council, headed by the Chancellor, now governed the Empire.

A CLASH OF POWERS

Following the *Hur'q* invasion, the Klingons did not encounter another alien species that could best them until the 22nd Century. They came up against the Romulans. The Klingons had no technology that matched the Romulan cloaking device. Klingon ships were faster, more powerful and better armed, but it made no difference against an enemy they could not detect. The Romulans did not seem interested in conquest, only in preventing a Klingon incursion into their space. After many clashes, the High Council decided to halt Imperial expansion, but a treaty with the Romulans was not formalized until after the end of the Earth-Romulan War in 2160. The Romulans offered a mutual non-aggression pact via subspace radio, going so far as to offer the Klingons a clearly-defined border that extended from the Neutral Zone established with the Humans. The declaration was beneficial to the Klingons, giving them control of additional systems which had been considered contested previously, and the High Council agreed to the pact.

FIRST CONTACT

First Contact with Earth occurred in 2151, following a Klingon crash-landing in Broken Bow, Oklahoma. A Klingon courier, Klaang, was shot by a human farmer, and severely wounded. Going against Vulcan advice, the Humans chose to return the wounded Klaang to Qo'noS, unaware that doing so would be considered an insult. This violation of Klingon values set the tone for the relationship between the two species for the next century and a half.

THE WARRIOR'S ANTHEM

*Qoy qeylls puqloD.
Qoy puqbe'pu'.
yoHbogh matlhbogh je Suvwl'
Say'moHchu' may' 'lw.
maSuv manong 'ej maHoHchu'.
nl'be' ylnmaj 'ach wovqu'.
batlh maHeghbej 'ej yo' qljDaq vavpu'ma' DImuv.
pa' reH maSuvtaHqu'.
mamevQo'. maSuvtaH. ma'ov.*

Translation:

*"Hear! Sons of Kahless.
Hear! Daughters too.
The blood of battle washes clean
The Warrior brave and true.
We fight, we love, and then we kill.
Our lives burn short and bright,
Then we die with honor and join our fathers in the Black Fleet where
we battle forever, battling on through the Eternal fight."*

With continued exploration by United Earth Starfleet, it became inevitable that they would find themselves encroaching upon territory claimed by the Empire. There were regular clashes between Klingon and Human vessels and, with each encounter, enmity grew up between the two species. For the Klingons, however, these incidents remained largely a matter for individual houses, rather than the Empire itself. The High Council had ruled that encroachment into the territory of a particular house was considered an internal matter, thanks to the Klingon view of the time that Earth was a backwater, a nuisance really, rather than a true strategic threat. At the time, the Empire was also mired in power struggles and closer to civil war than it had been since the Dark Time. As a result, Chancellor M'Rek often influenced events via decisions which kept the houses busy, in the belief that this channeled their aggression to useful purpose, avoiding a full-blown civil war.

The Klingon view of Earth changed significantly, however, with the formation of the Coalition of Planets, the action then taken by that Coalition against the Romulans in the Earth-Romulan War, and the Coalition's transformation into the United Federation of Planets in 2161. In the space of 10 years, the Klingons had gone from first contact with a brash, young species from a minor world, to seeing them become the linchpin in a major strategic threat.

For the remainder of the 22nd Century, and into the 23rd, a state of "Cold War" existed between the Empire and the Federation. From time to time, the tense situation boiled over into open combat between the two powers. Skirmishes were fought over disputed systems: Archanis, Donatu, Capella, Tellun and more, and the overall situation deteriorated. The cold war grew hot in 2255 with the Battle at the Binary Stars, touching off open hostilities and a months-long state of war between the two powers during an attempt to unite the 24 Klingon great houses into a more unified empire. Eventually equilibrium was restored, but conflict and resentment on both sides remained.

ORGANIA

By 2267, relations with the Federation had broken down completely and the Empire invaded, moving quickly to secure key planets all along the border. Klingon troops under the command of Kor occupied Organia, coming into conflict with the Federation Starship *Enterprise*, under the command of James T. Kirk. The combatants were stunned to discover that the Organians were non-corporeal beings, who forced an immediate end to the war. The Organian emissary, Ayelborne, appeared simultaneously to the Federation Council and the Klingon High Council and announced the imposition of the Treaty of Organia. No conflict would be permitted by the Organians, and the terms of the treaty spelled out a process for the resolution of border disputes by means of each side demonstrating they were more able to develop any disputed world than their opponent.

INTERCEPTED TRANSMISSION

FROM BRIGADIER KERLA, KLINGON DEFENSE FORCE

"This is Brigadier Kerla, speaking for the High Command. There has been an incident on Praxis. However, everything is under control; we have no need for assistance.

Obey treaty stipulations and remain outside the Neutral Zone. This transmission ends now."

With the Empire in a period of uneasy peace, it briefly turned to the Romulans, and proposed a strategic alliance against the Federation. The alliance was short-lived, but lasted long enough for the sharing of technology between the two governments. The Romulans gained access to the powerful Klingon ship designs, while the Klingons gained cloaking technology. Before long, however, the alliance dissolved in mutual distrust and recriminations.

PRAXIS

Everything changed with the destruction of Praxis, the moon of Qo'noS, in 2293. The moon, which had been the primary producer of energy for Qo'noS, was obliterated in a massive explosion caused by over-mining and a lack of safety procedures. The explosion resulted in a subspace shock wave that reached light-years from Qo'noS, with the planet taking the brunt of the damage, as well as deadly pollution from lunar debris. Scientists quickly determined that the environmental damage to Qo'noS could lead to complete de-oxygenation of the planet's atmosphere within 50 years.

Gorkon, Chancellor of the High Council, realized that the Empire could not afford the costs of the necessary environmental clean-up while maintaining the vast military budget which had escalated during the conflicts with the Federation. He proposed a new treaty, which would allow the Empire to dismantle its border fortifications, cut its military spending, and, hopefully, allow the acquisition of some of the Federation's vaunted environmental technologies, which would aid in the effort to save Qo'noS.

However, a conspiracy of career soldiers from both the Empire and the Federation saw this as a threat, and assassinated Gorkon on his way to the talks. Captain James Kirk and Doctor Leonard McCoy of the *U.S.S. Enterprise* were framed for the crime and imprisoned on Rura Penthe. The crew of the *Enterprise* uncovered the conspiracy, rescued their comrades and, with the crew of the *U.S.S. Excelsior*, managed to prevent the Federation President being assassinated as well.

INTERCEPTED REPORT

FROM COUNCILOR KRATH, TO CHANCELLOR K'MPEC

All Glory to the Empire!

The loss of our colony on Narendra III is impossible to bear, especially given the cowardly methods used by the Romulan *Ha'DibaH*. Vengeance must be taken. Honor demands it.

But it is not vengeance that I speak of today. I am sure that we will see to that in good time. I am sending this message because I wish to make special note of the honorable sacrifice of the Federation ship. The *Enterprise* threw herself into a battle that her crew must have known they could not win, in an attempt to

save people not of their kind. This was a warrior's death, and must be honored as such. Perhaps we have been mistaken in holding the Federation at arm's length. If its people are capable of such great honor, it is possible we have misjudged them.

I recommend that we arrange for a warrior's tribute to be made in the names of the crew of the *Enterprise*. Their families should know that we saw their glory, and it is remembered.

Qapla', my Chancellor.

Gorkon's daughter, Azetbur, claimed the Chancellorship via the Rite of Succession, and she is the only woman to date who has held the position. She and Federation President Ra-ghoratreii signed the first Khitomer Accords, beginning an age of cooperation between the two great powers at the dawn of the 24th Century. The lessened tension with the Federation was replaced in the 24th Century by an increase in conflict with the Cardassians (after first contact in 2308) and renewed hostilities with the Romulans.

NARENDRA III

In 2344, four Romulan warbirds decloaked and began orbital bombardment of the Klingon settlement on Narendra III. The outpost was poorly-defended; its only guardian had been an aging D7-class cruiser on picket duty, and it did not survive the first volley of fire from the warbirds. Narendra III sent out a distress call, as the Romulans continued to hammer the colony from orbit.

The *U.S.S. Enterprise* NCC-1701-C, under command of Captain Rachel Garrett, received the distress call, and without hesitation, proceeded to Narendra III at maximum warp. By the time the *Enterprise* had arrived at the planet, the Klingon settlement was almost entirely destroyed, and although they were seriously outgunned and outnumbered, they made a valiant effort to protect what few Klingons remained. The *Enterprise* was able to successfully eliminate two of the Romulan warbirds but, in the end, defeat was inevitable. The *Enterprise* was destroyed, defending the Klingons on Narendra III.

The Khitomer Accords had begun as a *détente*, but the Battle of Narendra III and the sacrifice of the *Enterprise* in defense of Klingons brought the two powers much closer together, forming more of a true alliance. This alliance between the Federation and the Empire put the Romulans at a definite strategic disadvantage. They redoubled clandestine efforts to

weaken both of their opponents. One such effort successfully drove the Klingon Empire into a civil war.

The Klingon Civil War was a conflict fought from 2367–2368, between factions vying for the Chancellorship of the High Council following the poisoning of K'mpec. Duras, leader of one of the factions, was revealed to have collaborated with the Romulans in attempting to secure the chancellorship, and was killed. Gowron became chancellor, yet the matter was not settled. Lursa and B'Etor, the sisters of Duras, claimed that Gowron had used Federation influence (namely the actions of Captain Jean-Luc Picard as the Arbiter of Succession) to illegitimately become chancellor. The factions supporting the house of Duras and the factions supporting Chancellor Gowron broke into open war.

The war ended in a victory for Gowron, but it was only achieved through assistance from the Federation in exposing the covert Romulan support for the Duras family. With the most powerful of his enemies now disgraced and defeated, Gowron's rule over the Empire is strong. It was certainly strong enough to withstand the apparent return of Kahless, when the clerics of Boreth produced a clone from Kahless' original DNA. For the first time since the 21st Century, there is an Emperor of the Klingon people. The clone, now known as Kahless, Son of Kahless, sits on the throne as a cultural and religious leader. He is an example for Klingons to follow, while the High Council continues to rule under the firm direction of Chancellor Gowron.

POLITICAL STRUCTURE

The Klingon Empire is a feudal monarchy, ruled by an Emperor and their descendants. Eventually, the role of

the Emperor was subsumed into the High Council, initially created as an advisory body of two dozen representatives from the most powerful Houses in the Empire. The High Council became the *de facto* ruling body of the Empire, under the leadership of its chancellor. By the mid-21st Century, the position of Emperor was abandoned, and the Empire was openly governed by the Chancellor and the High Council. Recently an Emperor has been re-introduced, albeit purely in a cultural and religious capacity. Power still rests with the Chancellor.

The Empire relies on a system of overlapping rituals, traditions and strict codes of conduct. Despite this, various factions, led by individual great Houses and their vassals, have often challenged for leadership of the Empire, and conflicts between Houses are commonplace. Officially, the High Council stays out of inter-house rivalries but, realistically, the complex network of factions usually means that bad blood between Houses is reflected by political maneuvering within the Council.

The practical, day-to-day administration of the Empire is left to the Houses themselves, with each governing their own territory, possessing their own military, and handling their own internal affairs. They defer to the Chancellor and the High Council when required. The Chancellor expects the Houses to provide warriors and ships to the Klingon Defense Force. Loyal Klingons are expected to serve the Empire when called, and serve their House at all other times.

THE GREAT HOUSES

Klingon society is organized along extended family lines, or houses, forming networks of mutual obligation and support. Each great House (*tuqmey*) is usually led by the eldest male of the core ruling noble family of the House, with female-led households something of a rarity. When the head of a house dies with no male heir, the High Council can arrange special dispensation for a female to head the house, who holds the position of mistress. The mistress of a house typically runs the household and approves all marriages into the family.

Not all members of a House are members of the same family by blood kinship. By consent of the house's head, members may join a house purely via the fealty they owe to the House, or through a familial tradition of support.

When a great House is diminished by losses through either warfare or disaster, the holdings, property and surviving members (if any) of the weakened House are often claimed by other Houses. The same fate may occur to Houses that have been disbanded by order of the High Council, for disgracing themselves or committing grave acts of dishonor. Disbandment of a great House is not undertaken lightly, and is a punishment ordered by the chancellor in only the direst of circumstances.

Despite the shared name, not all great Houses are alike in power. Some are merely minor clans, with little authority and territory, although such small Houses are usually either conquered or absorbed by larger ones. Each great House directly governs their holdings, in a feudal structure. They are run almost as separate nations, bowing only to the High Council in matters that directly affect the entire Empire. As such, great Houses have their own militaries and their own starships, with which they exert control over their territory.

Conflict between great Houses is commonplace, and generally, it is the official position of the High Council to stay out of such inter-house matters, until called upon to act as an impartial arbiter, or if the struggle threatens the Empire as a whole. Open warfare between great Houses no longer occurs; most rivalries are limited to political maneuvering, but if blood is required, there will be individual duels of honor.

THE HIGH COUNCIL

The ruling body of the Klingon Empire is comprised of roughly two dozen representatives of the most powerful and influential great Houses. Membership in the High Council changes over time, as Houses wax and wane in stature but the majority of the *tuqmey* have maintained their status for centuries. By tradition, only Klingon males serve on the High Council although Gowron offered a woman, Federation ambassador K'Ehleyr, a seat on the High Council. She turned it down. It remains to be seen if this tradition will be maintained in future.

JEGHPU'WI'

SUBJECT OF THE EMPIRE

The Klingon Empire covers a vast territory, similar in scope to the Federation. Whereas the Federation is comprised of many different species, the Klingon Empire is solely comprised of Klingons. Klingons run the government, and only Klingons are citizens.

This is not to say that other races do not exist within Klingon territory. These species are known in the Empire as *Jeghpu'wi'*, which is a Klingon word meaning "conquered people." Their worlds are subject to Klingon rule, but they generally do not socialize or intermingle with Klingons.

In the past, the Klingons kept slaves (*kuve*) from conquered races or captured enemies, but the practice has all but died out now. The term *Jeghpu'wi'* conveys a social status which is higher than a slave, but less than a citizen. Federation linguists have determined that the best match for the social status of the *Jeghpu'wi'* would be "subject." Their worlds are subject to Klingon rule, but they are not citizens. Only Klingons may be citizens.

KLINGON PROVERB

*noH QapmeH wo' Qaw'lu'chugh yay chavbe'lu',
'ej wo' choqmeH may' DoHlu'chugh lujbe'lu'.*

Translation:

*Destroying an Empire to win a war is no victory.
And ending a battle to save an Empire is no defeat.*

The choice of Chancellor is governed by a complex collection of rules, guidelines and rituals collectively known as the Rite of Succession. The Rite is administered by the Arbiter of Succession, an individual named by the preceding Chancellor. Various tests and competitions are required to be performed by prospective candidates in order to be considered for the role of governing the Empire, in a process which could often take months to complete. The victor appears before the High Council in the Great Hall of the First City on Qo'noS where the Arbiter would name the candidate as the new Chancellor of the Klingon Empire.

The High Council acts as a legislature, making the laws and policies that govern the Empire and its citizens. The Council has a number of commissions that oversee particular aspects of Imperial policy: science, defense, intelligence, and more. Individual Council members serve on one or more of these commissions, and these commissions present their recommendations to the entire High Council for debate and vote.

The Chancellor is the head of the government of the Klingon Empire, and has been since the 21st Century. But the Chancellor is no longer the head of state. That role, as it was before the 21st Century, is filled by the Emperor.

THE EMPEROR

Traditionally, the Emperor was a male descendent of Kahless The Unforgettable. Various Houses claiming that bloodline put Emperors on the throne over the years until the 21st Century, when the Emperor died with no heir, and the throne remained empty. However, this changed two years ago when the clerics of Boreth used DNA traces from an ancient dagger said to be stained with the blood of Kahless to create a clone. The clerics imprinted the contents of the Klingon sacred texts into the clone's mind: all the stories and teachings of Kahless. They wished to give the impression that this was Kahless returned from *Sto-Vo-Kor* to lead his people as he had promised.

The revelation of Kahless' apparent return threatened to shatter the Empire. Factions began to take sides: those who wished to follow Kahless, and those who remained loyal to Chancellor Gowron. In order to save the Empire from chaos, it was decided to openly announce the origins of the new Kahless. He would assume the role of Emperor as a moral leader, cultural exemplar and ceremonial head of state. The clone himself argued that what truly mattered was Kahless' words and teachings, not the man himself, as long as the Klingon people remembered and strove to live by those words. He ascended to the throne as Kahless, Son of Kahless, serving as an essential reminder of what had made the Empire great: the honor of the Klingon people.

MILITARY

The Great Houses all maintain their own military forces, which can be called for Imperial service by order of the High Council. Administration of Imperial forces occurs under the banner of the Klingon Defense Force. The KDF is a command structure that exists independently of any House military, standing ready to assume full command when the call is sent forth. The Military Commission of the High Council responsible for the administration of the Klingon Defense Force is known as the High Command, and is the most prestigious and influential of all the government departments within the Council. By tradition, the High Command is headed by the Chancellor, who does not serve on any other commissions.

The Defense Force has two elements, the first being the Deep Space Fleet which consists the regular forces comparable to Starfleet or the Romulan military. This is the element created by combining the forces of the various great Houses. The second element is the Internal Security Force; unlike the Deep Space Fleet this is staffed at all times. Vessels are seconded to the Internal Security Force from House fleets via standing orders from the High Council. The duties of the Internal Security Force include border patrol, customs regulatory enforcement, policing, anti-piracy operations and

RANK COMPARISONS

KLINGON RANK	FEDERATION EQUIVALENT RANKS
General	Admiral
Brigadier	Vice Admiral
Colonel	Commodore/Rear Admiral
Captain	Senior Captain/Fleet Captain
Commander	Captain/Commander
Lieutenant	Lieutenant Commander/Lieutenant
Sergeant	Ensign/Chief Petty Officer
Bekk ("Warrior")	Crewman/Petty Officer

The Klingon Defense Force is a combined service, operating both in space and groundside. As such, the direct translations of the Klingon ranks tend to feature ranks mixed from both naval and army terminology, which may lead to confusion for Starfleet personnel.

search/rescue. The ISF tends to use smaller vessels: the *B'rel*-class bird-of-prey, for example, is an ISF workhorse.

The Klingon military, both at the House level and in the Defense Force, is governed by a strict system of hierarchy not solely limited to rank. The highly-structured nature of Klingon beliefs surrounding honor and duty ensures that all personnel view the successful execution of their mission as a matter of personal as well as collective honor. For example, the first officer of a Klingon vessel is expected to kill his captain if that individual is unable to perform his duties through injury, infirmity, weakness or dishonor. Below the ranks of senior officers assassination is not the preferred method. Any crew member feeling that their direct superior was not living up to their duty could make a challenge, which is logged, and these challenges adjudicated by the commanding officer (either at a departmental level, or of the ship or unit — traditions vary) at a time of their choosing, and in whatever manner the commanding officer decides.

CULTURE

Klingon culture has been shaped by centuries of tradition. The foundations of their society were laid out by Kahless the Unforgettable after the establishment of the Empire and it is defined by a complex system of familial and personal honor, interwoven with traditions and ritual. The observances of all these are sacrosanct. Violations of these strictures bring shame to the offender, and by extension, their family. This shame could last for generations depending upon the severity of the offense. The highest shame was that of discommendation, a verdict of the High Council which essentially strips a Klingon of their family name, so making them, in effect, a non-person. Other Klingons treat the discommended as pariahs, cutting off all contact and even referring to the offender as an object, rather than a person. The descendants of an offender share in the dishonor of the offense; a child is considered guilty of his father's crimes.

With most families being patrilineal, males traditionally dominate Klingon public life, and take the leading roles in politics and the military. Traditionally women are seen as the forces behind the administration of the great Houses, as well as serving in the military. Klingon women are considered equals in most things, with the exception of politics, where they are barred by law from serving on the High Council, and lines of inheritance. In all other aspects of life — aggression, honor, duty — they are expected to exhibit the same virtues as Klingon men.

Death is not feared nor is it a cause for sorrow in Klingon culture. The honored dead are not mourned, they are celebrated, and the average Klingon hopes to die in a way that brings honor to themselves, their family, and the Empire.

TRANSCRIPT

EMPEROR KAHLESS II, FROM HIS CORONATION SPEECH, 2369.

"As it was promised, Kahless has returned. I am not he, and yet I am. I am of his blood and bone and sinew. My thoughts and soul are both his and mine. My heart is his, and mine — and yours. Our hearts are Klingon! Let us all remember what that means! Let us all remember what has made us great! It is our heart, the unconquerable heart of the Klingon people, clothed in honor, armed in strength, and forged in fire, that has made us what we are.

And so begins a new golden age for the Empire! Fortified by the lessons of the past, eager to face the battles to come, there is no limit to the glories that await!"

CASTES

At one time, Klingon society was rigidly caste-based. Castes were based primarily upon one's profession, and that profession was determined by a combination of family tradition and personal aptitude. A son from a family of scientists, for example, could become a member of the warrior class, should he display enough of an aptitude (and appetite) for combat.

By the dawn of the 21st Century, however, the warrior caste had come to dominate all levels of Klingon society, and the distinctions blurred. If everyone is a warrior, then who are the teachers? As a result, non-warrior professions, especially those of science, medicine and education were undervalued in society. By 2154, for example, medical sciences were not considered a priority by the High Council, and so the Empire lacked the sufficient medical expertise to deal with the Augment virus without the assistance of outside parties.

HONOR

The most critical component of Klingon culture is honor. This is an abstract concept: a quality of respectability, worthiness and value of an individual, family or institution, effecting everything from social standing to career prospects to the Klingons' view of the afterlife.

Paradoxically, the notion itself varies widely from individual to individual, and the lessons of Klingon philosophy often provide contradictory answers regarding the essential nature of honor. For example, Romulans, as a rule, are widely considered by the Klingons to be the most dishonorable species, due to their reliance upon subterfuge. Klingon use of cloaked vessels is not considered dishonorable, nor is springing an ambush, so long as the tactic resulted in victory. A passage from the writings of

HISTORICAL DOCUMENT

EXCERPT FROM THE CODE OF KAHLESS, FROM THE SECTION PERTAINING TO HONOR:

- A warrior does not cheat.
- A warrior does not take prisoners.
- A warrior does not allow himself to be taken prisoner.
- A warrior proclaims himself loudly.
- A warrior does not use poison, or kill from behind.
- A warrior does not surrender.
- A warrior dies standing up.

Kahless reads “*Nothing is more honorable than victory,*” which could be read as a wry admission that history is written by the victors, and so honor is whatever leads to the most desirable outcome.

The code of honor acts as a control on the Klingons’ natural aggression, preventing society from devolving into utter chaos. The expected behavioral norms are considered both proper and aspirational.

In many ways, a concept of dishonor drives Klingon actions even more than honor. Having seen examples of behavior condemned by society as dishonorable, a Klingon will go to great lengths to avoid undertaking the same actions. Often, the fear of the mere appearance of dishonor will prompt a Klingon to take an immediate and opposite action to avoid it.

This is not to say that all Klingons live by the code. There are those who follow the path of honor more in word than by deed, using society’s expectations of honor as cover for their own selfish desires and goals. In this way, Klingon honor is much like Human morals.

RITUAL

The importance of ritual in the daily life of Klingons cannot be overstated. There are rituals for everything in life, from birth, achieving adulthood, marriage and mating, settling of disputes, warfare, and death. What follows are some of the more notable Klingon rituals.

There is a saying that a Klingon youth was considered an adult on the day they could first hold a blade. The main ritual of adulthood, however, is the Age of Ascension, and this is meant to represent the passage from one level of life to the next. It is often observed before a Klingon’s 13th year. The rite begins with the *kor’tova* candles. They represent the fire that burns within the heart of a warrior. When the ascendant lights theirs, they declare an intention to become a warrior. The second rite must be practiced within ten years, on the anniversary of their original Age of Ascension, to dedicate themselves spiritually.

A Klingon daughter is given a *jinaq* when she is old enough to take a mate. It is a traditional amulet signifying womanhood, and is often an heirloom passed down through a family. Klingons traditionally mate for life and, when a prospective mate is found, the rituals governing courtship begin with sniffing one another’s right hand or arm, and continue with the drawing of blood. This would be followed by a complex courtship, and eventually marriage. Whereas a full Klingon marriage involves many guests and a ritual reenactment

KLINGON MARRIAGE CEREMONY

TRANSLATED EXCERPT FROM THE RITUAL RE-ENACTMENT OF THE KLINGON CREATION MYTH

“With fire and steel did the gods forge the Klingon heart. So fiercely did it beat, so loud was the sound, that the gods cried out, ‘On this day we have brought forth the strongest heart in all the heavens. None can stand before it without trembling at its strength.’ But then the Klingon heart weakened, its steady rhythm faltered and the gods said, ‘Why have you weakened so? We have made you the strongest in all of creation.’

And the heart said ‘I am alone.’

And the gods knew that they had erred. So, they went back to their forge and brought forth another heart.

But the second heart beat stronger than the first, and the first was jealous of its power. Fortunately, the second heart was tempered by wisdom.

‘If we join together, no force can stop us.’

And when the two hearts began to beat together, they filled the heavens with a terrible sound. For the first time, the gods knew fear. They tried to flee, but it was too late. The Klingon hearts destroyed the gods who created them and turned the heavens to ashes. To this very day, no one can oppose the beating of two Klingon hearts.”

of the Klingon creation myth, a briefer oath, requiring nothing but the consent of the two Klingons involved, is still considered binding both legally and socially. The words “*jIH dok*” (“my blood”) are spoken to one’s mate, and the mate replies “*maj dok*” (“our blood”). This exchange seals a common marriage vow.

The *Hegh’bat*, translated as “the time to die” is ritualized suicide, undertaken when a warrior can no longer stand and face his enemies. The warrior ensures himself an honorable death via killing themselves with a dagger provided by their eldest son or a close friend. A dishonored Klingon may also have their honor restored at death if they are killed via the *Mauk-to’Vor* ritual, although this is reserved for the disgraced, not for the merely infirm.

Upon the death of a Klingon, the fallen warrior’s eyes are pried open and his comrades gather around him. They then collectively raise their heads to the skies and let out a ferocious howl, not of pain or sorrow, but of victory for the fallen. It is a literal warning to the afterlife that a Klingon warrior is about to arrive.

RELIGION

In the ancient Klingon religion, the original gods who created the first Klingons were killed by their own creations. Little of Klingon religion remains, as it was largely abandoned in the aftershock of the *Hur’q* invasion in the 14th Century. The only part of the original religion which survives is a belief in the afterlife.

The Klingon afterlife is believed to be comprised of two separate fates. Klingons who have died honorably supposedly go to *Sto-Vo-Kor*, where they joined the honored dead in the service of the Black Fleet, battling forever in a glorious and joyous existence. *Sto-Vo-Kor* is where Kahless was said to wait for them, as he promised, ahead of his return. This has led to Kahless, Son of Kahless taking on the role of a messianic figure and being an object of worship despite the Klingons having no gods. Klingons seem prone to belief in messiahs: a sect of Klingons left the Empire in the mid-23rd Century, searching for the *Kuvah’magh* “the savior of our people”, a messiah figure written of in several obscure religious texts.

Klingons who die in a state of dishonor find themselves aboard the *Barge of the Dead*, a ship captained by Kortar, the first Klingon. It was he who killed the gods, alongside his mate. Kortar is now condemned to ferry the dishonored to *Gre’thor* as a punishment, to be greeted at *Gre’thor* by *Fek’Ihr*, a demonic, bestial figure. Often, friends and family of a Klingon who died without honor will undergo some quest or dedicate a battle in the memory of the deceased, in the hopes of earning their dead comrade enough honor to be released from the *Barge* before it reaches *Gre’thor*.

HISTORICAL DOCUMENT

VERSE 18, STANZAS 7-9, “THE SONG OF KRENN.”

*“...And though I had slain a thousand foes less one,
The thousandth knife found my liver; The thousandth enemy said
to me,
‘Now you shall die, now none shall know,’
And the fool, looking down, believed this,
Not seeing, above his shoulder, the naked stars,
Each one remembering.”*

SCIENCE AND TECHNOLOGY

Despite the dominance of the warrior caste in Klingon society, the Klingons are fairly advanced from a scientific and technological standpoint. They received something of a “head start” by using technology left behind after the *Hur’q* invasion. This has led to uneven advancement between scientific fields and disciplines: for example, where Klingon engineering had an earlier start than many other races, their medical sciences lag behind. Klingon transporters are not as advanced as Federation models, having a shorter range, less precise targeting, and are lacking in many safety features.

STARSHIPS

Starships have always been a point of pride with Klingons, and are quite advanced when compared to those of most other species. By the mid-22nd Century, Klingon ships were capable of reaching warp factor 6 (the fastest Earth ships of the time could barely manage warp 5). In addition, Klingon vessels were equipped with photon torpedoes, tractor beam emitters and deflector shields well before those systems appeared on Human vessels.

By the 23rd Century, the Klingon D7 class battle cruiser was perhaps the most advanced vessel in the known Galaxy, boasting more power, armament and speed than any ship in the Federation or the Romulan Empire. A brief alliance with the Romulans around that time gave the D7 design to the Romulans, in return for cloaking technology which became standard issue on most Klingon vessels.

Today, if you encounter a Klingon ship, you can assume that it will be better armed, faster and tougher than almost anything else out there. Even with their shields down, the Klingons can hang in a fight for a long time, due to hulls reinforced with coherent molecular alloy. The modern *Vor’cha* class is now the main Klingon cruiser and is very heavily armed. They were initially only in use as flagships, but now we’re seeing more of them. The Klingons have

ramped up production, and we're hearing reports of something even bigger on the fleet drawing boards.

CLOAKING DEVICES

The Klingons' brief treaty with the Romulan Empire brought them an early model of the cloaking device; their cloaking technology has been at least a generation behind those of the Romulans ever since. Rendering a ship invisible to both sensors and visual searches takes an inordinate amount of power. A cloaked vessel cannot run their deflector shields and the cloak simultaneously. This remains a major weakness in cloaked vessels: there are moments of vulnerability after dropping the cloak before the shields go up. The power requirement of a cloak is too much for the operations of weapons at the same time.

Experiments during the late 23rd Century, while successful in producing vessels that could fire while cloaked, were discontinued when it was discovered that an inability to regulate power flow resulted in the crew being exposed to deadly ionizing radiation whenever they used the ships weapons while cloaked.

You should be aware that Klingon cloaks will be generally easier to detect than their Romulan counterparts. The Klingons never managed to get a handle on the metaphasic sweep issues, for example, leading to visual distortions that can be spotted by eagle-eyed officers. Klingon scientists have not discovered a way of counteracting momentum through a non-vacuum medium. If you can manage to get a cloaked vessel to pass through a gas cloud or other particulate field, you should be able to track their location by the motion of the particles as the cloaked vessels passes through.

INTERCEPTED TRANSMISSION

SEGMENTS OF A PARTIALLY DE-ENCRYPTED TRANSMISSION FROM B'MOTH TO QO'NOS

...construction remains on schedule. The new warp core design should result in an increased power output sufficient to...

...Chancellor Gowron's demands notwithstanding, we feel confident that the first of the Negh'Var should exceed most expectations... will make a most impressive flagship. My sole concern at this juncture is that we...

...for the time being. Another report will follow in three days.

DISRUPTORS

The disruptor is the primary directed energy weapon of Klingons, both as a personal sidearm and as ship-to-ship armament. Whereas phasers work via creating a beam of focused rapid nadions at the subatomic level, a disruptor is a simpler technology. It causes damage by disrupting and destabilizing the molecular bonds of the target.

While they are simple weapons, that comes at the cost of having less versatility than phasers. Phasers can be adjusted in both beam width and output, allowing for many applications, including stun settings. Disruptors have a single use: they destroy. This is a job for which disruptors are very well designed. Do not make the mistake of underestimating the potential of a "less advanced" weapon. After all, Klingons still use blades, and very effectively, as well.

DETECTING A CLOAKED VESSEL

Detecting a cloaked ship can be a tricky prospect at the best of times. There's an arms race between cloak technology and sensor technology, so each new method for detecting a cloaked ship is usually countered by the next generation of cloaking devices.

Under normal circumstances, attempting to detect the presence of a cloaked vessel is a Difficulty 5 Task. The details of this Task — what it represents, and thus what Attribute and Discipline it uses — will vary, and are left to the Gamemaster's discretion. Environmental factors, such as gas or dust clouds displaced by a cloaked ship, will reduce this Difficulty by 1, as will cloak-related Complications, such as those suffered when the ship cloaked.

Attempting to detect a Klingon vessel with a cloaking device reduces the Difficulty by 1 as well, as Klingon understanding of cloak technology is less nuanced and sophisticated than that of the Romulans. Romulan advances in cloaking technology often mean that they will adjust the configuration of a cloaking device in use. This can be represented by spending Threat or creating Advantages to increase the Difficulty of Tasks to detect a cloaked ship.

Once a cloaked vessel has been detected, it may be attacked. However, the cloak still impedes targeting, increasing the Difficulty of attacks by 1, and preventing the attacker from targeting specific systems aboard the cloaked vessel.

THE BETA QUADRANT

KLINGON WORLDS

QO'NOS

PLANETARY BACKGROUND

Qo'noS (pronounced "Kronos") is the Klingon homeworld and the capital of the Klingon Empire. It is a Class-M world in orbit around an orange bright sub-giant (Type K1 IV) star, which is larger and dimmer than Sol. Qo'noS orbits fairly closely to the star, and so is slightly warmer than Earth on average. The planet has a single massive landmass dominating the majority of the habitable surface, dotted by small seas and with a single large ocean.

The terrain of Qo'noS consists primarily of high, rocky, mountains, jagged cliffs, active volcanoes and rivers of lava, all the result of extremely active and unstable tectonics. A greenhouse effect caused by volcanic ash keeps the oxygen-nitrogen atmosphere fairly thick, and the interaction of warm air colliding with cold air over the poles and larger bodies of water gives rise to intense storms, which last a long time in the thick atmosphere. Non-Klingon visitors to the homeworld report being easily fatigued from the combination of the oppressive atmosphere and the gravity which, at 1.2g, is higher than the Earth-normal 1g maintained on Federation starships.

Qo'noS previously had one moon, Praxis, but this was destroyed in 2293 in an explosion caused by over-mining. This caused a massive subspace shockwave, and damaged Qo'noS' ozone layer. Over the past 78 years, the Klingons have managed to avoid the utter de-oxygenation of their atmosphere thanks to Federation-provided atmospheric technology. Pollution has not completely abated and there are still pollutant-level warnings in most cities on the planet from time to time. A debris field, the Praxis Belt, comprised of the remnants of Praxis still orbits Qo'noS, and this is mined by the Klingons. Occasionally, debris from the belt falls into the atmosphere to threaten the planet's inhabitants below.

THE FIRST CITY

The First City (Klingon: *veng wa'Dich*) is the capital city of the Klingon Empire and predates Kahless and the Empire. This ancient city surrounds a fortress in the cliffside of the mountain range that raises the First City from the valleys below. After Kahless united the Klingons it became the

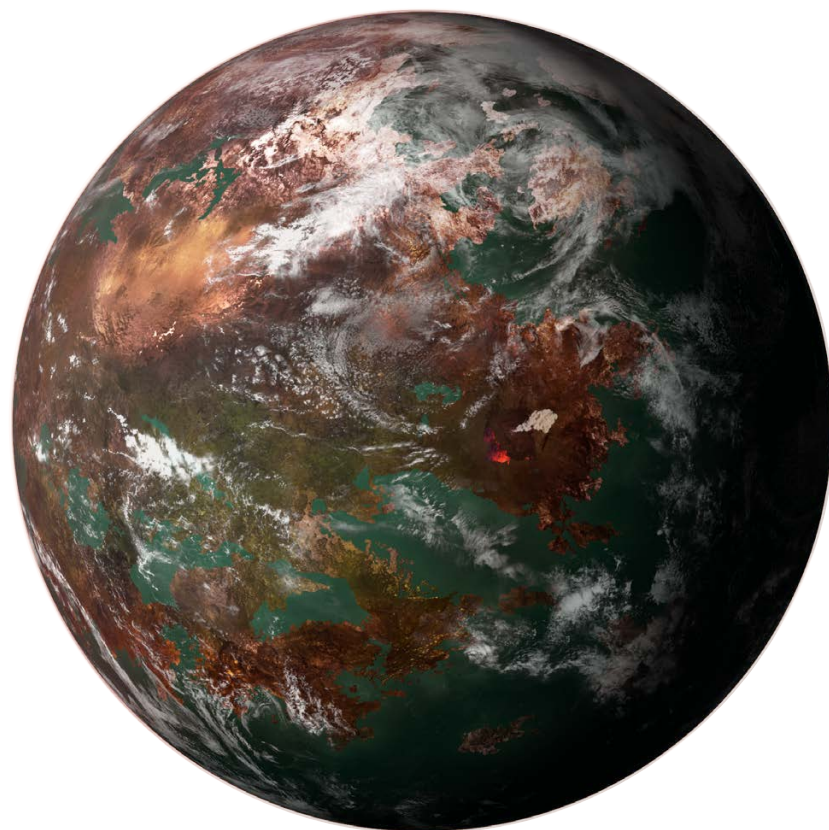

planet's seat of power, with the fortress becoming the Great Hall and a city growing out around it.

The city is divided into quarters: the Old Quarter is the earliest settlement, now somewhat run down and disreputable; the New Quarter is only new by comparison to the Old; the Bazaar is the original site of the trader's market as the city began to grow; and the Burned Quarter is a part of the city which burned to the ground centuries ago, and was rebuilt.

QAM-CHEE

Another city which pre-dates the foundation of the Empire, Qam-Chee was where Kahless and Lady Lukara alone fought five hundred soldiers of the tyrant Molor when the city garrison fled. The two legendary Klingons defeated Molor's forces, and began a great romance which is still celebrated in story and song.

THE STORY OF THE WIND OF QUIN'LAT

FROM THE SACRED TEXTS

Long ago, a storm was heading for the city of Quin'lat. Everyone took protection within the walls except one man who remained outside. Kahless went to him and asked what he was doing. "I am not afraid," the man said. "I will not hide my face behind stone and mortar. I will stand before the wind and make it respect me."

Kahless honored his choice and went back inside. The next day the storm came and the man was killed. The wind does not respect a fool.

QUIN'LAT

This city is on the coast of the Sea of Gatan, and is known for the violent storms which regularly blow in from its waters, and for being the location of a fable of Kahless The Unforgettable.

KETHA

A lowland area on Qo'noS, primarily given over to agriculture. The province has a reputation as something of an unsophisticated rural hinterland, with simple, plain-speaking people.

KRI'STAK VOLCANO AND THE LAKE OF LUSOR

This is a site famous in Klingon legend. According to the story, Kahless forged the first bat'leth by thrusting a lock of his hair into a river of lava from the volcano's summit. He then plunged the burning mass of hair and lava into the nearby Lake of Lusor. As the object cooled, Kahless twisted and worked it into a sword, the Sword of Kahless.

Today, the Kri'stak Volcano is no longer active but the site, on the shores of the Lake of Lusor, is still a popular destination for spiritual pilgrimages. Klingons go there for the Rite of *MajQa*, during which they mediate in the heat of lava caves beneath the mountain in the hopes of receiving visions. Special significance is attached to any vision of one's father, or a vision of Kahless himself.

BORETH

PLANETARY BACKGROUND

Boreth is a marginal Class-M world, rocky and inhospitable. The surface of the world is quite cold. The planet holds a special place in the history of the Klingon Empire. When Kahless the Unforgettable left for *Sto-Vo-Kor*, he pointed to a

star on the horizon, and promised he would return. "Look for me on that point of light", he is reported to have said. That point of the light was the bright Class-M star of the Boreth system.

Once the Klingons achieved warp travel, Boreth was one of the earliest colony worlds settled due to the spiritual importance it held. A monastery was established which grew in importance as the spiritual center of the Empire. For centuries, warriors have come to Boreth to seek visions and guidance at the monastery where the clerics, referred to as guardians, dedicated themselves to the preservation of the Klingon sacred texts.

It was at Boreth monastery that Korothe and his fellow guardians created the clone of Kahless in 2369, in an attempt to bring about a spiritual change in the "declining" Empire. After their ruse was discovered, the Kahless clone was permitted to assume the mantle of Emperor as a cultural head of state and religious figure. Korothe and the other guardians are now the attendants to the new Emperor.

Despite the "return" of Kahless, the Boreth monastery remains a popular destination for Klingons on a spiritual quest: a place to find peace and look inward.

KHITOMER

PLANETARY BACKGROUND

Khitomer is a small Class-M planet in Klingon space, very near to the borders with both the United Federation of Planets and the Romulan Empire. The planet has played a vital role in the history of the Klingon-Federation alliance, having been both the site of the Khitomer Conference of 2293, as well as the location of a Romulan sneak attack in 2346, where Lieutenant Commander Worf and Kahless were rescued by the *U.S.S. Intrepid*, further strengthening the bonds between the Federation and the Klingon Empire.

The colony at Khitomer has been rebuilt over the past decade. A memorial marker, in the form of a large black obelisk, marks the site of the original settlement, honoring the 4,000 inhabitants of the colony who died in the Romulan attack.

NARENDRA III

PLANETARY BACKGROUND

This is a long-standing Klingon settlement, dating back to the late 21st Century. Narendra is a binary star system comprised of a primary class K star and a secondary class A star. Narendra III is third planet, Class-M, orbiting within the habitable zone of the primary star.

The first visit by Humans to Narendra III was in 2152, when Captain Jonathan Archer was put on trial for allegedly conspiring against the Klingon Empire. He was sentenced to Rura Penthe, but was rescued by his crew. Twenty-seven years ago, Romulans launched a surprise attack on Narendra III, completely destroying the colony, as well as the *U.S.S. Enterprise-C*, which had responded to the distress signal. This honorable sacrifice served to reinforce a then-tenuous Federation-Klingon alliance.

The colony has been rebuilt, and currently has a population of nearly 50,000 Klingons. The main settlement features a Great Hall, and above the doors of the hall are inscribed the words from the unprecedented message sent to the families of the *Enterprise-C* crew from Chancellor K'mpec:

"Your loved ones died in glory and honor, and their names will never be forgotten so long as there is an Empire."

RURA PENTHE

PLANETARY BACKGROUND

The Beta Penthe system contains no habitable planets — just three Class-J gas giants, one Class-H planet with an unbreathable atmosphere, one high-pressure high-radiation Class-Y planet, and an extensive asteroid belt. The system itself is binary, with a pair of F2 stars of similar mass at the center.

The Rura Penthe colony is a Class-D, dilithium-rich asteroid. It has a breathable atmosphere, and large deposits of water ice on the surface, but the extremely low surface temperature makes it uninhabitable by most life forms, so mining operations are located underground.

THE ALIENS' GRAVEYARD

The dilithium mines on Rura Penthe are a penal colony for the Klingon Empire. The installation is widely known as "the alien's graveyard" due to the one-year average life expectancy of prisoners sent there. Being sent to the mines is one of the most feared punishments throughout the Galaxy.

The penal colony has no guard towers or fence. It has only a magnetic shield that extends over a significant part of the asteroid surface, preventing transporter use. No other security is necessary, beyond the presence of armed guards. The mines are located below ground, drawing heat from the radiation of the dilithium deposits. The asteroid itself is not geologically active. The most common form of punishment given to prisoners is banishment from the mines to the asteroid's freezing surface, where they do not survive for long.

To date, three Starfleet officers have escaped from Rura Penthe, and they are among a very small number of

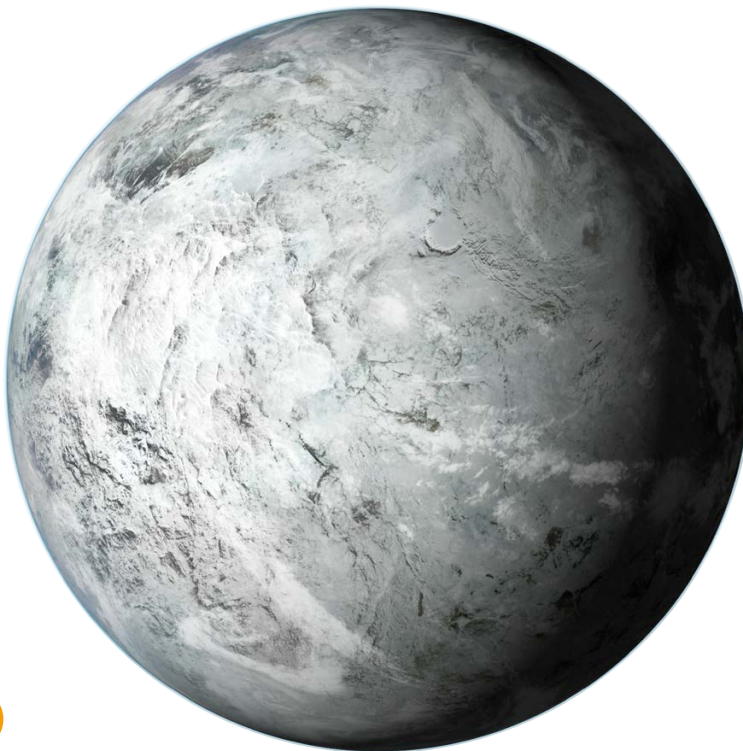

beings that have ever done so. In 2152, Captain Jonathan Archer was condemned to a life sentence on the asteroid for his role in assisting a group of refugees who had fled from a Klingon-controlled world, and Captain Archer's crew came to his aid. In 2293, Captain James T. Kirk and Doctor Leonard McCoy were sentenced to Rura Penthe after being found guilty of the assassination of Chancellor Gorkon. While there, an attempt was made on their lives: a Chameloid prisoner named Martia arranged for them to escape to the surface, where they could be shot while escaping, or fall victim to the cold. The shapeshifter's plot was eventually discovered, and Kirk and McCoy were rescued by Captain Spock and the crew of the *U.S.S. Enterprise-A*.

TY'GOKOR

PLANETARY BACKGROUND

Ty'Gokor is a fortified Class-K planetoid located in an asteroid belt deep in Klingon space. It was one of the first out-system worlds established by the Klingon Empire after they achieved warp travel. During times of war, Ty'Gokor has served as headquarters for the Chancellor and the High Command of the Klingon Defense Force. It is therefore the most heavily fortified installation in the Empire. The planetoid is defended by shielding, multiple orbital weapons platforms, and the presence of dozens of warships at any given time. After the Klingon Civil War a tachyon detection grid was also installed in the system, using the same technology which allowed the Federation fleet to detect cloaked Romulan



TACHYON EMISSION ANALYSIS

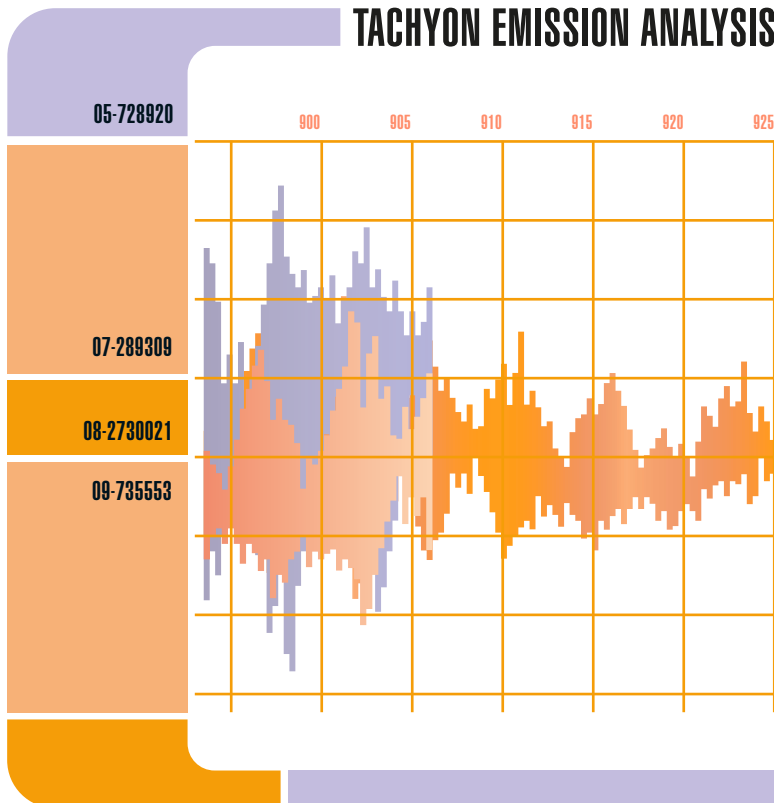

warbirds attempting to cross into Klingon space to aid the House of Duras.

The Order of the *Bat'leth* (Klingon: *betleH 'obe'*), an ancient order founded by Lady Lukara, Widow of Kahless, to uphold and maintain her husband's vision of honor, is headquartered on Ty'Gokor. The Order serve as exemplars of honor within the Empire, a fellowship of the greatest warriors at any given time. They meet, when called, in the Hall of Warriors.

THE HALL OF WARRIORS

The Hall of Warriors is an ancient meeting hall in the headquarters of the Klingon Defense Force on Ty'Gokor. The Hall is lined with giant statues of famous warriors from Klingon history, from the founding of the Empire to the present day. The two most recent statues, installed just last year, are those of the Dahar Masters Kang and Koloth. The Hall serves as a combination shrine, assembly space, and banquet chamber. The center of the large, vaulted room is dominated by a large platform containing a brazier burning an eternal flame. Legend has it that if the flame is ever extinguished, the Klingon Empire will fall.

THE BETA QUADRANT

THE ROMULAN EMPIRE

“THEY SEEM TO BE CREATURES OF EXTREMES. ONE MOMENT VIOLENT BEYOND DESCRIPTION, THE NEXT TENDER. THEY ARE RELATED TO THE VULCANS, BUT AS EACH RACE DEVELOPED, THEIR DIFFERENCES GREW WIDER. THEY ARE INTENSELY CURIOUS. THEIR BELIEF IN THEIR OWN SUPERIORITY IS BEYOND ARROGANCE. FOR SOME REASON THEY HAVE EXHIBITED A FASCINATION WITH HUMANS AND IT IS THAT FASCINATION, MORE THAN ANYTHING ELSE, THAT HAS KEPT THE PEACE.”

— COUNSELOR DEANNA TROI

BENEATH THE RAPTOR'S WINGS

Romulans. A people so xenophobic and insular that, even after a five-year-war, their opponents had never once seen them. In the Federation the name is a byword for treachery and deceit. Throughout the Federation's history, the Romulans have emerged from their self-imposed exile to trouble those around them. Usually that trouble takes the form of destroyed border outposts or colonies.

FIRE ON THE FORGE

The story of the Romulan civilization begins in the early 4th Century CE with Surak and his philosophy of peace and logic. It also begins with a coalition of mercenary groups known collectively as “those who marched beneath the raptor's wings.” War was not only their business, it was their joy. As more and more Vulcans embraced Surak's message and learned to control their emotions, these groups saw the end of their way of life.

Like any threatened creatures, those who marched beneath the raptor's wings had two options: retreat or attack. Led by a Vulcan soldier named Apnex, they chose to do both. They stole a handful of generation ships that had been built for a colonization effort that had, predictably, been halted by yet another war. By the time the ships were ready for launch, the success of Surak's pallid philosophy seemed inevitable. At least half of the nations and families of Vulcan had accepted the way of logic. It did not seem to matter how many of Surak's disciples died in the attempt to bring peace to still-warring nations. They persisted. It was only a matter of time before logic would take hold across the planet. And then it would be possible to advocate nuclear disarmament.

Apnex and his people agreed with this conclusion. The raptor's children, the final remnant of old Vulcan's warrior people, would take their heritage into the night. They carried with them ancient weapons, including the Stone of Gol. Vulcan would become a planet of peace but and when the time was right the children of the raptor would return as conquerors. Or so they planned.



No one is certain if Apnex ordered an atomic attack on Mount Seleya. Perhaps it was a distraction from their launch, perhaps it was a fit of pique, perhaps it was the only possible way to strike directly at Surak. Though the records of almost the entire journey remain in the Romulan Hall of Ancestors, meticulously cared for and restored, no records exist of that critical first day. Later log entries shed no light on the incident. Did they intend to trigger the atomic war that would drive Vulcan almost back to the Stone Age? Records are clear that they didn't anticipate that their exile would last two millennia. And Apnex's people did not know that they had been successful in killing Surak, their great enemy, but not his logic.

They were secure in the knowledge that they represented all that was left of the true Vulcan. As the crimson orb of their birth world receded, they settled on a new name for themselves. They would call themselves the Steadfast: those who had never faltered in the ancient ways.

THE SLOW EXODUS

The stolen ships were equipped with ion drives and antimatter reactors, and the Steadfast had trouble with them from the beginning. While the basic craftsmanship



was good the exiles had completed them in haste, and their engineers did not fully understand the technology. Exotic radiation leaked from poor reactor shielding, and the best velocity their primitive particle shields allowed was .7c. Over the course of their journey, they averaged half that. Their ultimate destination was a planet some sixty light-years away that Vulcan astronomers suggested would be suitable for colonization. The Steadfast knew their ships had not been designed to travel that far, and that they would have to planet-hop. They aimed in the general direction of the Calder system, but a navigational error instead led them to Barradas.

Within the first year, Apex gathered the mercenary captains and the ship captains (who were not necessarily the same individuals) into a governing committee. He never claimed any special position for himself on the committee, although records make it clear that he was considered “first among equals.” Some committee members claimed it was temporary, and that free elections would follow in good time. They didn’t. The longevity of the “temporary” committee did not go unnoticed and over time it became known as the “Continuing” Committee, and the name stuck. By the time Apex died, the Committee’s origins were forgotten, but it carried on.

Apnex formed the Committee just in time. Men and women whose only commonality was the love of battle found reasons enough to fight. Even small disagreements were inflated to massive proportions by people who could not get away from each other. Such disputes killed 10% of the travelers in the first year of the journey. Radiation, either as radiation sickness, or through mutated illnesses such as lunglock fever, tripled that loss.

The Committee took quick, decisive action. In order to maintain the population, draconian birth policies were enacted. Fertility treatments (such as *in vitro* fertilization) ensured that multiple births were common, and early forced-growth technology cut the latency period in half. In the short term, the policies kept them alive. The long-term damage was more insidious.

To quell the violence, a corps of peacekeepers was created and given wide discretionary powers. There were only two punishments for crimes. Murder was generally punished by death. For other crimes, the perpetrator was indentured to the victim for a time proportional to the crime’s severity. The crime rate dropped precipitously, and a new underclass developed.

LONG LOST LOVERS

CULTURAL ARCHIVE

“We fell into the world as long-lost lovers meeting for the first time.”

— Trevela, Romulan poet

Forty-five years after departing Vulcan, the struggling fleet reached Barradas III. It is a temperate Class-M planet with ample water, but is extremely resource-poor. It was also too close to Vulcan for the exiles' comfort. Nonetheless, they had no choice but to make planetfall and assess their options. Though old and ill, Apnex remained as ferocious as ever: they would continue on, come what may. The hard truth was that their ships were in no shape to do so. The ships still contained the equipment intended for the original colony group, and a growing number of the travelers advocated founding a colony there.

The Committee instead decided to cannibalize the two worst ships to repair the others and move on. They left behind a small colony group and the colonization equipment from one of the defunct ships (all of it in less-than-pristine condition). The colonists were comprised of the disaffected, troublemakers, and the critically ill. This was the origin of the Debrune.

By the time they reached Calder II, the Steadfast were in a precarious state. Their ships were falling apart and they lacked the means to make even temporary repairs. A more desperate issue was the decline of their population below minimum viability for survival. Their genetic diversity had been limited in the beginning, and further reduced by the travails of the past several decades. If not for the chance discovery of the Sakethans, the Steadfast would likely have died out on Calder II, and the political landscape of the galaxy would be significantly different. Instead, the Sakethans' technological base was sufficient to allow the Steadfast to complete critical repairs. Even more fortunately, the Sakethans were themselves Vulcanoid, a “lost colony” from Vulcan's first wave of colonization. Interbreeding with the healthy Sakethan population stabilized the Steadfast gene pool.

By the time the ships moved on, Steadfast aggression had merged with Sakethan subtlety to become the seed of modern Romulan culture. In addition, they had diverged from the Vulcan physical norm. The brow ridges borne by most Romulans today are most likely a mutation passed down from the Sakethans.

The exiles followed the same routine through the next millennium. They advanced from one inhabitable planet to another and by the mid-18th Century, the Steadfast reached Romulus. Over the centuries, it had taken on an almost mythical quality in their minds. No one was as surprised as they to find the reality exceeded their expectations. Romulus was a sparkling gem of a world with verdant forests and sun-dappled seas. It could not have been less like Vulcan and still be habitable. A second (barely) inhabitable planet existed in the same system, and sensor readings suggested that planet possessed an unusual amount of metallic and exotic substances, including a crystalline mineral of particular interest to several engineering teams working on a faster-than-light drive.

The Romulans that finally landed on the planet's surface fell in love with the world the first time they breathed the warm, humid air.

The world's biochemistry was compatible with Vulcan life, requiring only minimal modifications. The biggest problem the Romulans had in the first decades was a sharp rise in respiratory ailments caused by Romulus' much higher humidity. The Romulans considered this a small price to pay for a paradise, and went about the business of adjusting the Romulan genome to cope.

With the brute necessities of survival overcome, the Romulans turned their attention to the exploitation of the mineral-rich planet. Mining operations would have to be conducted along the terminator and on the night side, but the Romulans were confident that would pose no real problems.

They did not expect the planet to be inhabited, nor that the planet's inhabitants would put up a fight. Though the Remans were primitive barbarians without advanced weaponry, the Romulans found it an unexpectedly difficult task to bring them to heel. Physically, the Remans are even stronger than the Romulans, and the majority of them possessed at least rudimentary telepathic ability (which helped enormously in setting ambushes). In addition, they were extremely well-adapted to operating in the darkness of the habitable zones. Remus' surface ran green with Romulan blood before the Romulans took their opponents seriously.

It was the late 19th Century before the planet was pacified. by that time, the Romulans had developed warp drive. Reman dilithium was now a priceless commodity, and the Remans were both useful slaves to work the mines, and shock troops for the Romulans' endless wars. The Romulans spent the next two centuries exploring and colonizing the planets in their new home's stellar vicinity. At some point during that period, they came into contact with the Klingons. Although they had better ships, the Klingons had better weapons, and the initial clashes between the two empires were inconclusive. The Romulans decided to seek easier prey, and their eyes turned back to their old home.

ASTROGRAPHY

The Romulan Empire is completely contained in the Beta Quadrant. It is surrounded by the Federation and the Klingon Empire to the galactic west and south. On a standard galactic map, the Empire looks much like a giant jellyfish; the rounded “body” of the Empire is surrounded by the Federation and Klingon Empire, while multiple tendrils extend toward the Delta Quadrant. The main body of the Empire spans 115 light-years at its widest point, from Cheron in the galactic northwest to D’Deridex, twenty light-years north of the Narendra system. Along the borders of the Federation and the Klingon Empire, it is bounded by the Neutral Zone.

INTERCEPTED TRANSMISSION

Praetor D’deridex,

My work on Vulcan has been undone by the incompetence of V’Las. I warned you that it was dangerous to rely completely on a single individual, no matter how powerful. In the end, his own ambassador conspired with the Terrans to save the Syrrannite leader and restore the writings of Surak to their people. Praetor, I urge you to rethink the means of reunification. If our cousins have become so soft as to be influenced by a species that has barely achieved space flight, we should reconsider the possibility of outright conquest.

Jolan tru,

Subcommander Talok

The Romulus system is near the northwest edge of the Empire, about ten light-years from the Neutral Zone. Though far from the Klingon Empire, it lies uncomfortably close to the Federation. Currently, Romulan territory does not extend into the Shackleton Expanse. Since the Expanse lies in the only direction the Romulan Empire can expand, it is likely that the Federation-Klingon joint force will encounter Romulan territorial expansionism at some point during their exploration.

A HISTORY OF DECEIT

The Romulans became aware of humanity long before humanity became aware of them. The Romulan intelligence service had infiltrated Vulcan sometime in the late 21st Century. Agents embedded in the High Command monitored Vulcan interactions with the other spacefaring peoples of the region. They were probably responsible for the militarization of Vulcan society in the mid-22nd Century. It seems likely, in retrospect, that their original plan was to maneuver Vulcan and Andoria into a short, destructive war, then arrive as Vulcan’s saviors. In so doing, they would prove once and for all their superiority to their cousins.

The plan failed. An unanticipated alliance of Vulcans and Humans removed the Romulan puppet from power, and restored the original writings of Surak to the planet. Humanity, at first just a curiosity, had become a threat thanks to their meddling.

THE EARTH-ROMULAN WAR

Early encounters with the Klingons caused the Romulans to rethink their overall military strategy. The political caste, in particular, lost the taste for a stand-up fight. Instead of meeting force with force, they would weaken their enemy via subterfuge, only attacking when they had a clear advantage.

REPORT TO THE ROMULAN HIGH COMMAND

It is my duty to inform you that Sub-Commander Neved is no longer in command of the *Shrike*. At some point during our mission to Vendor, he was replaced by a Vendorian shapechanger. The Vendorian plot was uncovered when the “Sub-Commander” refused to report to sickbay for his routine physical. Security attempted to stun the false commander, but the stun setting on our disruptors had no effect on the creature. The creature was killed by several full-power disruptor shots. Its body remained intact enough for my surgeon to conduct a necropsy.

Any reports or logs sent from the *Shrike* after we departed the planet must be considered disinformation. I am returning to Vendor at full

military power. If they do not return the Sub-Commander to us, I will turn their planet into a cinder.

The necropsy report and internal security files are included in this transmission.

Jolan tru.

– Warbird *Cuirass*, Centurion S’ral commanding.

(Addendum: *Cuirass* subsequently disappeared in deep space, presumed lost with all hands.)

This did not please many Romulan starship commanders of the time, but a few assassinations brought them into compliance.

The Romulans had failed to start a war between Vulcan and Andoria, but they were not done with meddling. Militaristic, prickly Andoria, a major power in the region, had made enough enemies that it remained a prime target for Romulan manipulation. The contentious Tellarites were the perfect goad. And once again, humanity overcame two species' hatreds to expose the Romulan plot.

The Romulans struck back. Not only had humanity interfered in their affairs but they were still weak, having only recently become an interstellar power. They manufactured a diplomatic incident over the new Earth base at Algeron, and destroyed the base and the two ships stationed there.

Again, the four powers united against the Romulan threat. The four-year war was bitter, savage, and quarter was neither asked nor granted. The weapons of the time did not allow for "soft kills". The Romulans also preferred to destroy their own ships rather than be captured or boarded. For the duration of the war, and well after, members of the Coalition never saw a living Romulan. Even the peace treaty was conducted entirely via subspace audio. Romulan space was defined and circumscribed by a Neutral Zone, four hundred light years long and one and a half light-years wide. Entry into the Zone by either side would be an act of war.

PLOT AND COUNTER-PLOT

Within a decade the Romulans determined that the Federation would not violate the treaty. This gave them a free hand to do whatever they wanted behind the shield of the Neutral Zone. They consolidated and pacified Romulan space, during a century of bloody warfare. Their ruthless campaign drove no fewer than three Orion fleets to the brink of ruin, and may also have been responsible for breaking the back of the Nausicaan pirate cartels. Habitable planets were colonized or conquered, their inhabitants enslaved. They encountered particularly fierce opposition along their border with the Klingon Empire. After a string of engagements with no conclusive victory, the Romulans withdrew from that border as well, and seeded the disputed area with sensor buoys and mines.

For some Romulans, the endless wars began to pall. Sometime around the turn of the century, one particularly successful commander suborned a significant portion of the Fleet and staged a coup. She managed to kill most of the Committee and cowed the Senate by threatening to fire on the Senate building from orbit. For thirty years, she ruled as Empress. The Empress claimed that her rationale was to prevent Romulan lives from being thrown away in pointless wars. If that was her true intent, she

was profoundly disappointed, as her reign was marked by almost endless civil war. She was overthrown sometime in the early 23rd Century, her name completely eradicated from Romulan history.

23RD CENTURY

By the 2250s, war-weariness had permeated the Imperial Fleet. Even the commander of the Talon, the Romulan flagship, was suspected of this malaise. The Praetor, undeterred, sent the Talon into Federation space to send a message: no longer were the Romulans content to hide behind the Neutral Zone. The mission was ultimately unsuccessful, the Talon destroyed by the *U.S.S. Enterprise*. As the last transmission sent from the Talon had been a coded message that claimed success, the Romulans came to the obvious conclusion that the transmission had been falsified by the Earth starship to lure the waiting Romulan fleet into an ambush. The invasion expected to follow the successful test of the Federation's defenses never happened.

Instead, the Romulans swarmed their side of the Neutral Zone with warbirds. Federation starships might be able to destroy a single warbird, but not a group of them. This was demonstrated in 2268, when the *Enterprise* violated the Neutral Zone at what appeared to be the orders of a madman. Instead, it was a ruse to make possible the theft of the latest cloaking device, one that made a ship invisible to all tracking sensors. Only that theft and the successful integration of the device into the *Enterprise's* systems allowed the ship to escape. The captains of two ships involved in the incident were executed. The task force commander was captured by the *Enterprise* and repatriated; she, too, was expected to face the same fate. Much to the surprise of her enemies, she returned with small but valuable pieces of Federation technology, which were enough to spare her life. She was suspected to have the Praetor's ear, and whether this was gained through bedding or blackmail, his favor saved her career.

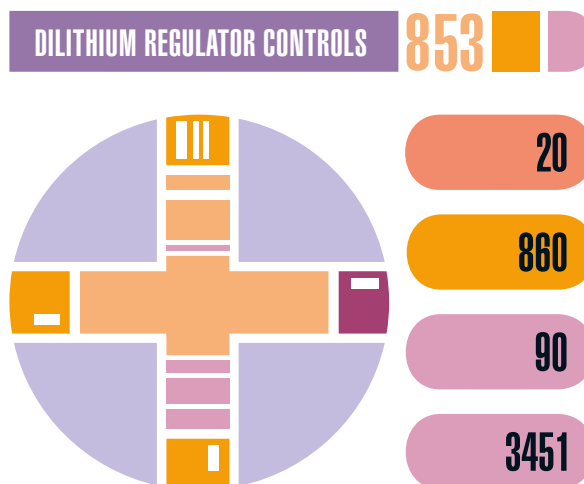



In the same year, a Romulan research colony located at Chaltok IV was destroyed by an experimental polaric ion device. Chaltok IV was left uninhabitable, and the result was a treaty banning all future research into polaric ion energy. This treaty may have been the only success of the diplomatic initiative at Nimbus III, the so-called “planet of peace.”

The Empire and the Federation continued to clash throughout the remainder of the 23rd Century. Isolated incidents along the Neutral Zone never became quite important enough to declare war. In what was meant to appear as a show of good faith, the Empire even opened an embassy on Earth. That embassy did not last more than a decade before the Romulans were made persona *non grata* in Federation space, and their ambassador expelled for conspiring with Federation and Klingon officers to assassinate the Klingon Chancellor. According to the Romulan government, Ambassador Nanclus returned to the Empire in disgrace and was executed with all due ceremony. We discovered some years later that the “ambassador” was a *Tal Shiar* agent. He was promoted, and then given a new identity and mission.

Tensions between the powers continued to grow, as Admiral Alidar Jarok conducted what would be called the “Norkan Campaign” by Romulans, and the “Norkan Massacres” by the Federation. Jarok was known for inventive,

unconventional battle tactics, such as re-tuning the cloak on one of his ships to produce sufficient emissions to impersonate an entire strike force. Over several years, he and his forces exploited the advantage given them by the cloaking device. Multiple small, fast fleets of warbirds darted in and out of the Neutral Zone, attacking poorly-defended targets.

The Norkan Campaign was ended by the Tomed Incident. Tomed had no inhabitable planets, but was the site of both a Federation research station and a dilithium mining operation in the asteroid belt. The *Miranda*-class *U.S.S. Saratoga* NCC-1887 was also in-system. It provided both patrol capability and science support for the research station. No sensor logs remain to explain exactly what happened, but analysis of what was left has provided a working hypothesis. One of Jarok’s ships was tasked to make a high-speed attack run on the dilithium mining operation. The ship suffered a navigational failure. Instead of emerging from warp at a safe distance above the ecliptic, it emerged in the asteroid belt. The result was catastrophic as the ship impacted a dilithium-rich asteroid at least 200 meters in diameter. When the warp core containment failed, the antimatter explosion caused a chain reaction to propagate through the asteroid belt. The resultant blast destroyed every ship and station in the system, as well as the vast majority of the dilithium in the belt.

It became clear during the ensuing diplomatic negotiations that the attacks had been targeted to cripple Federation efforts to replicate the cloaking device. As part of the Treaty of Algeron, the Federation agreed to halt all present and future research into the cloaking device. Once the treaty was ratified, the Romulans withdrew into the Neutral Zone once more.

The timing was fortuitous. Relations with the Klingons, always difficult, were disintegrating. The Romulans may also have been dealing with internal unrest. Contemporary documentation suggests that, at some levels of the Klingon government, the Romulans were considered allies. It is possible that the Klingons were collateral damage in an internecine war, possibly between the *Tal Shiar* and the Romulan military. And it is certain that they did not expect the peace treaty with the Klingons as the consequence of Narendra III.

In the past decade, the Romulans have conducted numerous intelligence operations, many of which succeeded in their intent. The discrediting and death of Alidar Jarok and the successful retrieval of Major Selok are among the most noteworthy. The Romulans have also meddled in Klingon politics, the details of which are covered in your briefing on the Klingon Empire.

POLITICAL BACKGROUND

EMPIRE OF INTRIGUE

From the Federation perspective, Romulan politics are highly reminiscent of the human Byzantine period. Government officials watch the currents of power to determine their own courses, and the power bloc behind any given Committee member changes on a daily basis. A surprising percentage of government officials do actually believe in their service to the Empire, despite the temptations of power and the pervasive atmosphere of distrust. They are a quiet majority, for the moment, walking a narrow path between the Praetor on one side and the *Tal Shiar* on the other. Former Vice-Proconsul M'ret was one such individual, and it is likely that the underground is in contact with others.

Romulan politics are characterized by duplicity and paranoia. In part this is a side effect of their violent emotions. Over the centuries, Romulan traditions channeled those emotions away from unrestrained violence. Their passions were channeled into service to the Empire, and their innate paranoia changed into the cool duplicity practiced by the Romulans even today. Among the political caste, intrigue comes as naturally as breathing. Advancement within and between social castes always comes at someone else's expense. This ensures that members of the lower castes remain disunited and powerless. Trust is not a useful currency in Romulan politics.

INTERCEPTED TRANSMISSION

Soral,

Letoth needs to be dealt with. He still insists that the Chaltok IV colony was transported through time and space to end up on Calder II centuries before we reached it. At first, it was a fairly harmless lunacy, even if there is absolutely no proof. Now, he's talking about re-creating the experiment that caused the explosion in the first place. You know that can't be allowed to happen, but no one here has the standing to tell him "no." If you can't get him to stop, he's going to have a "lab accident" one day soon. No one wants that. Aside from this obsession, he's made valuable advances in high-energy physics.

Always your student,

Telok

But there's more to Romulan paranoia than biology. Dissent is a capital crime, and anyone could be an informer. It takes very little to attract the attention of the *Tal Shiar*, and the best one can hope for is to be dragged away in the night. Often dissent is punished by the degradation of the offender into a lower caste, or even slavery. While Romulan citizens theoretically enjoy the Right of Statement, those that avail themselves of that right condemn their family along with them. Most, faced with such a choice, instead choose to die honorably, to spare their family disgrace. In theory, blood washes away all crimes; in practice, tainted families are marked for further attention. Not even an official as mighty as the Vice-Proconsul is safe.

CONTINUING COMMITTEE

The Continuing Committee was the very first governmental institution created by the proto-Romulans, and has existed in one form or another ever since. Its size has varied between five and twelve, but is currently set at eight including the Praetor. Most of the Committee members are civilian officials, although the head of the *Tal Shiar* may or may not hold a seat. Very few Committee members hold military positions. This is a policy of the Committee designed to counterbalance the Praetor's control of the Imperial Fleet.

When a seat becomes available there is intense competition between candidates including assassinations. Committee members are intelligent, ruthless, powerful, and have demonstrated that they are the masters of Romulan intrigue. Collectively, they are the most powerful people in the Romulan Empire, accustomed to meting out life and death with a word.

ROMULAN MILITARY VICTORIES

STARFLEET ACADEMY INTERNAL COMMUNICATION

G'vrel, I heard that if you ask the library computer to search for "Romulan military victories" it asks you if you meant "Romulan military defeats." I don't know if some engineering senior has been messing with it or whether the librarians don't know just how funny that is! Try it for yourself next time you've got a free period.

The Continuing Committee functions in an executive capacity. They have the power to accept or veto Senatorial decrees and legislation, and they set policies for the Empire. Additionally, when Senators or other high officials are accused of crimes, the Committee acts as both judge and jury. Committee members are more than simply advisors to the Praetor. Each of them heads one or more governmental departments, and the support of the Committee can make or break a Praetor. In fact, a Praetor may be overridden by a unanimous vote of the Committee. This happens very rarely, as it is difficult to get all the Committee members to agree on anything.

The Praetor is theoretically the most powerful person in the Empire. He is the head of the government and the commander-in-chief of the Imperial Fleet. However, the balance of power on the Continuing Committee is always shifting, and past Praetors have been chosen for their weakness or their susceptibility to manipulation by one or more power blocs. The current Praetor has held onto the office for over a decade, but is showing the signs of age. His position has also been damaged by the failure of several recent large-scale operations, such as the invasion of Vulcan and the Klingon Civil War. He has managed to spread much of the blame for both failures to the *Tal Shiar*, but this does not seem to distress Chairman Koval.

The current Praetor has been sufficiently distracted by minor crises that other members of the Committee have been able to pursue their own agendas with impunity. Many of them involve the Federation in one way or another: be aware that Romulan activity along the border and the Neutral Zone may not be officially sanctioned.

IMPERIAL SENATE

The Senate is also led by the Praetor, though most of the day-to-day matters are in the hands of the Proconsul and Vice-Proconsul. The Proconsul presides over Senate sessions in the absence of the Praetor and is responsible for the day-to-day operations of the Imperial Fleet. She

has no vote in Senate deliberations but, in the Praetor's absence, she exercises his proxy vote. The Vice-Proconsul's role is that of a neutral arbiter. He chairs subcommittee meetings, mediates disputes between political opponents, and casts a tie-breaking vote when necessary. Long tradition has it that such votes should be cast in favor of further debate (if possible), or for the status quo (if not). The Senate is fundamentally conservative, and their belief is that if a change is not supported by a true majority, it should not be passed.

The Senate is responsible for debating and passing legislation. Potential laws do not have to originate in the Senate. They may also be proposed by members of the Continuing Committee or the Praetor. The division of Senate responsibilities seems odd to those accustomed to the Federation model. Functionally, the Senate contains two legislative houses in a single body. Half of the Senate, known as the Establishing House, makes or presents legislative proposals. The other half, the Expunging House, holds only veto power. The Expunging House is also responsible for examining old legislation. They may abolish existing laws that they feel no longer meet the needs of the Empire. To become (or remain) law, legislation under consideration must receive at least half the votes of the Establishing House, and must also have more votes than vetoes in the Expunging House. These laws may be overridden by Praetorian fiat or a majority vote of the Continuing Committee. This rarely happens, as Senators who hold Committee memberships go to great lengths to ensure that legislation distasteful to the Committee is never presented.

The Senate presents the appearance of democracy, but closer examination reveals that this is an illusion. Although each district elects a Senator by popular vote, candidates are carefully chosen by the current Senate (and, at times, the Continuing Committee). One of the most reliable ways to become a new Senator is to serve as the aide to an existing Senator. Competition for such roles often become quite fierce, particularly as aides to Senators on the Committee.

CONQUEST AND OVERTHROW

Romulan foreign policy springs from a fundamental facet of the Romulan character. They are absolutely certain that no other species is their equal. They are equally certain that all other species are simply biding their time, patiently waiting for an opening to attack. These beliefs have shaped their strategies and tactics on a fundamental level. Strategically, the Romulans prefer to set opposing factions of their adversaries against each other. This was seen as far back as the Babel Crisis. Romulans instigate and encourage civil wars and rebellions, undermining rivals and allies through acts of deception. And they strive to deny their enemies any scrap of information that might illuminate Romulan motives, even to the point of concealing their physical appearance and racial heritage.

Tactically, Romulans prefer covert action and ambush. On more than one occasion, they have sent a single cloaked, heavily-armed Bird-of-Prey into enemy territory to test defenses. They consider that, in the worst case, the sacrifice of a single ship is an acceptable loss. They also exploit the cloaking device to its fullest advantage to strike from ambush: the assault on Algeron IV in 2156 is a classic example of this tactic.

When Romulans are forced into a stand-up fight, they prefer to overwhelm the enemy with numbers. Current Romulan doctrine mandates at least a two-to-one advantage in numbers and/or firepower; three-to-one is ideal. This is not due to inferior hardware; Romulan warships have been formidable opponents since the 22nd Century, easily capable of destroying Federation starships. The Romulans simply prefer conflicts ended as quickly and decisively as possible, with minimal risk to themselves.

Romulan policy toward the Klingons and the Federation, for over a century, has been to impede any attempts to forge a lasting peace between the two polities. Once the alliance could not be stopped, they shifted their efforts to undermine

it. These efforts accelerated over the past decade, although the fallout from the Klingon Civil War seems to have slowed them down. Currently, Starfleet Intelligence considers Romulan interference in the Maquis rebellion to be a significant risk. It is likely to take the form of military supplies and intelligence, possibly through Orion intermediaries.

The Romulans have had diplomatic relations with the Cardassians for some years. The nature of the relationship remains murky. Cardassian ambitions are likely to become a threat to the Romulans at some point in the next decade, and how the Romulans will respond to that remains a mystery. This is, ultimately, exactly as they wish it.

REUNIFICATION

The Romulans continue to be obsessed with the idea of re-unifying with the Vulcans, but on their terms. The entire Vulcan government was shaken by the revelation that one of their most reputable ambassadors was a Romulan deep-cover agent and the subsequent invasion attempt. Now that they know how deeply they have been penetrated, the Vulcans, with Starfleet Intelligence, are trying to clean house. That may be difficult, however,

OFFICIAL COMMUNICATION

AMBASSADOR V'LIN OF VULCAN, STARDATE 47165.3

Minister Satok,

I have completed my analysis of T'Pel's activities as ambassador. She participated in sixty-four missions over thirty-seven standard years. Of those sixty-four missions, she was the primary diplomat in twenty-three, and provided significant input into another nine. Her participation in the remaining missions was that of a junior diplomat.

Nineteen of T'Pel's primary missions concluded in a satisfactory manner. The remainder were resolved in a way that appeared logical at the time, but ultimately resulted in further conflict. This is not an unusual outcome when dealing with other species. Our logic, no matter how perfect, is not always capable of overcoming the illogic of others. The revelation of T'Pel's true identity demanded a closer inspection of those missions, which I have now completed. I have compared records of each mission from the other participants against T'Pel's official reports. There are differences between each set of records that cannot be adequately explained by fallible memory or alien perspective. In all cases, T'Pel manipulated the disputants via implied promises and ambiguous passages inserted into the treaties. Ultimately, the agreements in question were revoked, and the Federation took the blame for the failed mediation. This resulted

in one minor war, two trade embargos, and a failed Federation membership application.

I have attached a list of individuals who were known to have extensive contact with T'Pel. You will note that my name is on that list. I was the junior diplomat on five of T'Pel's missions, including Antica's first attempt to join the Federation in 2345. The list includes most of the diplomatic staff, as is logical given T'Pel's position. Curiously, one of the names in the list is T'Paal, who I believe is a prominent member of the Vulcan Isolationist Movement. I can think of no logical reason for T'Pel to have been in contact with T'Paal, as the isolationist movement is an internal security matter.

It is logical to conclude that I may be one of T'Pel's collaborators. If I were so minded, I could manipulate the report to shield myself and others from scrutiny. Therefore, I offer to mind-meld with you or a security officer of your choosing. I can think of no other way to fully remove myself from suspicion.

At your service,

T'Vala
Ambassador-at-Large



as initial analyses suggest that the Romulans infiltrated Vulcan centuries ago. It is entirely possible that Romulan agents were seeded into several of the Vulcan Houses, thus providing their descendants with the perfect cover: genuine legitimacy. This strategy is similar to one practiced by the old Soviet Union during Earth's Cold War.

While the Romulans have taken no further overt actions toward a forced reunification, we have learned that they are at their most dangerous when they appear passive. Fortunately, the Federation has developed new sources of information from within the Empire, thanks to Ambassador Spock. His visit to Romulus has been retroactively approved by the Federation Diplomatic Corps. They were tired of the rumors that he defected. By current reports he is still on Romulus, providing support to the Romulan underground. At his direction, the underground has reached out to Starfleet for assistance on a few occasions. Usually this involves extracting a defector, but the possibility exists that we may be asked to do more.

Officially, our standing orders are to take no action that would cause a war. Unofficially... Ambassador Spock is a hero of the Federation, and of Starfleet in particular. If he needs help, and if, in your judgment, you can provide that assistance without triggering outright war... do what needs to be done.

TAL SHIAR

POWER BEHIND THE THRONE

The *Tal Shiar* is considered to be one of the most formidable intelligence agencies currently active, respected and feared across two quadrants. They are extremely skilled at extracting information from enemies, and their draconian control over the Romulan Empire ensures that very little information escapes. The *Tal Shiar's* mandate is to protect the security of the Romulan Empire. They are alert to threats both external and internal. Among themselves, they refer to themselves as the "Shield and Sword of the Empire" and they are absolutely ruthless.

They operate with a broad authority that places them both outside and above traditional chains of command. *Tal Shiar* agents can and do assume authority over military commanders, although they possess their own fleet for covert operations. The sheer scope of their operations, combined with the incredible amount of information they amass, makes them a potent force in the Empire.

The *Tal Shiar* are responsible for all intelligence and counter-intelligence operations in the Romulan Empire. Internally, they monitor the people for any sign of dissent, and they have recruited many informants. Most of them are not actual operatives: some believe they are acting for the benefit of

the Empire, some enjoy the power they have over their fellow citizens, and some are unwilling collaborators. The former Vice-Proconsul M'ret has said that at least one informant is placed in every housing complex, industrial plant, and government office in the Empire. Potential sources of dissent such as schools and military bases usually have more.

The *Tal Shiar* are more than willing to use assassination when it suits their purposes. They generally aren't interested in taking credit for a killing, though. They like to exploit the air of ambiguity that surrounds an unexplained sudden death or mysterious suicide. While they certainly have the capability and the authority to make dissidents disappear, they prefer more subtle actions. They are masters of psychological warfare, often using a method known as "corrosion" to undermine their targets. "Corrosion" is nothing less than the slow disintegration of a target's life, bit by bit. His work suffers mysterious failures. His friends or family come into possession of information that damages their trust in him. His reputation begins to suffer. At the same time, he begins to experience incidents that make him question his hold on reality. Eventually, he is driven into a complete breakdown. Often this results in a violent outburst during which he is killed by security personnel for everyone's safety. By that time, his death is a relief to the people in his life: the target is not a martyr, just someone whose instabilities got the better of him.

They conduct external intelligence and counter-intelligence operations with a similar craft. The *Tal Shiar* is particularly fond of sending agents into the Federation disguised as Vulcans. This has historically been an extremely effective disguise, as Vulcans are considered one of the most trustworthy species in the Federation. Despite their distaste for "lesser species," the *Tal Shiar* have also been known to breed slaves and prisoners of war to create operatives who are only part-Romulan. Such individuals tend to be fanatics, as they strive to demonstrate that they are no less Romulan for being half-blooded.

There is a great deal of mutual distrust between the *Tal Shiar* and the regular military. Agents have the authority to issue orders to starship commanders without explanation, and this has gotten more than one Romulan military officer killed, which exacerbates tensions. More generally, *Tal Shiar* agents outrank military officers of a similar position. The military, however, is the more prestigious service and offers a higher social caste for the officer and family. This seems to be yet another of the dynamic tensions that characterize the Empire.

In the last several years, the *Tal Shiar* has been building a fleet of starships. This may be in order to minimize interdisciplinary conflicts or, more likely, to deal with sedition in the Imperial Fleet. The *Tal Shiar* has not yet placed political officers on Fleet ships but, as they to crack down on dissent, that may change. Such an action will certainly not improve relations between the two services.

TAL SHIAR COMMAND STRUCTURE

Not much is known about the *Tal Shiar*'s command structure. The Romulans' tendency to suppress any and all information makes it extremely difficult to learn about non-critical areas of their civilization, let alone anything secretive. Moreover, the *Tal Shiar* keeps secrets from their own people. Intercepted transmissions suggest that most *Tal Shiar* agents report directly to the Chairman. If so, the lack of formal hierarchy would be extremely unusual for the Romulans, but would be particularly suited to an elite organization of agents given a great deal of authority and latitude in their operations.

Majors in the *Tal Shiar* may be relatively inexperienced, while colonels seem to have the same authority as Imperial Fleet commanders. Confusingly, some *Tal Shiar* agents appear to possess naval ranks. This may show that the agent started out in the Fleet, or that the agent is assigned to full-time fleet operations. This may explain Commander Sela, who is certainly authorized to carry out full-scale intelligence operations. In an odd way, this also supports the idea that the *Tal Shiar* rank structure is relatively flat, due to the need to "borrow" rank designations for their own fleet.

It is uncertain to whom the Chairman reports. The Praetor does not exercise direct control over the *Tal Shiar* as he does with the Imperial Fleet, and neither does the Senate. While the *Tal Shiar* sometimes report operations to the Senate, they often work without the Senate's direct knowledge, and sometimes in direct opposition to the Senate's wishes. It is believed that the Chairman answers only to the Continuing Committee, and often has a seat on the Committee.

KNOWN OPERATIONS

Through the efforts of Starfleet Intelligence, our contacts in the Klingon intelligence service, and our sporadic contacts with the Romulan underground, we have some insight into recent *Tal Shiar* activities. Internally, they have increased efforts to suppress the Romulan dissidents, and would consider it a major coup if they were able to bring Ambassador Spock into custody. Imperial Fleet patrols have increased along the Romulan side of the Neutral Zone, and we believe that many of those ships are *Tal Shiar*. They are, naturally, monitoring our exploration efforts in the Shackleton Expanse, and we can be certain that they still want to drive a wedge between us and the Klingons.

We are certain that they continue to have significantly penetrated the Vulcan government, operating via spy networks that have been in place for over two centuries. The Vulcans are still investigating a possible connection to the recent activities of the Vulcan Isolationist Movement. They were responsible for the attempted invasion-by-stealth of Vulcan in 2368, and for numerous attempts to destabilize the Klingon government over the past several years.

MILITARY STRUCTURE

Members of the Romulan military are second in prestige only to high Imperial officials, and equal to most regional officials. This makes military service extremely attractive to the lower castes, as they see the military as a way to improve their own and family status. The minimum term of enlistment is 50 years. Most Fleet members work their way up the ranks, though the family members of high-ranking commanders and political officials may be admitted directly to the Academy. Even these favoured individuals, as part of their military education and training, spend a minimum of two years in low-ranking positions so that they understand the realities under which every member of the Imperial military operates. The Fleet emphasizes the need for each soldier to know their place, to correctly perform the requirements of their position, and to trust their fellow crewmembers to do the same.

The Romulan Guard used to refer to the entirety of the Imperial ground forces. Now, the name refers only to the old Praetorian Guard. Actual ground combat operations are performed by specialized units of the Imperial Fleet, roughly what the Federation would call marines. Ground combat is not a preferred specialty among Fleet members and, as a result, most Romulan ground forces are mixed-race units consisting of Romulan security platoons directing Reman shock troops.

The Praetorian Guard began as an elite group of soldiers trained as bodyguards for high officials such as the Praetor, members of the Continuing Committee, and Senators. During the last two centuries, Romulan officials came to prefer Remans as bodyguards, and the Guard became the dumping ground for incompetents and scions of the political caste who wish to gain “military experience” without risk. The Guard’s line units were folded into the Imperial Fleet, and now the Guard consists only of a ceremonial unit. The

Guard Prefect is usually someone too politically important to dismiss from the regular armed forces, but who is unfit to serve further on the line.

The Romulan military is much more highly regimented than Starfleet. Each position has a strictly-defined set of responsibilities, and a crewman stepping outside the bounds of their position has violated regulations. Most experienced commanders ignore such regulations unless the violation is particularly egregious: a runaway warp core doesn’t care if the person managing containment is a centurion or an uhlan.

The Romulan chain of command is not divided into commissioned and non-commissioned officers. Most Romulan military officers are what human armies used to call “mustangs”: officers who worked their way up through the ranks. The newly enlisted begin their career as rankless soldiers, known as militi. One step up from militi are uhlands. The vast majority of the Imperial military is made up of these low-ranking personnel. Above uhlands are sublieutenants and, under most circumstances, a Romulan soldier can advance no further without attending the Academy. An exception is made for skilled specialists such as doctors and engineers who may become Centurions without attending the Imperial War College. These are the Romulan equivalent to Starfleet staff officers, and are not in a unit’s chain of command.

In order to be admitted to the War College, a sublieutenant must have at least five and preferably ten years’ experience and be sponsored by their current commander. The sublieutenant’s performance in the War College affects the commander’s reputation, so prospects are chosen carefully. Commanders cannot simply refuse to sponsor junior officers. They are expected to sponsor potential officers to the War College during their service, as they themselves were sponsored.

The War College term for entering sublieutenants is three years. This is extended to five years for those few who are admitted without previous military experience. Each year in the classroom is separated by a year in the field. The actual curriculum is broadly similar to the Starfleet curriculum, but with a larger emphasis on tactical and strategic training. The majority of officers graduate with the rank of Lieutenant, though the most exceptional officers in each cohort may jump to Subcenturion.

Beyond Centurion, promotion is as much a matter of political savvy as military skill. All promotions to subcommander or higher ranks require Senate approval, although most subcommanders are promoted without scrutiny. The aspiring Commander, however, needs friends in high places. Most high-ranking Fleet officers have at least one patron at the Senatorial level, and even better are connections to the Continuing Committee.

RANK COMPARISONS

ROMULAN RANK	FEDERATION EQUIVALENT RANK
Admiral	Admiral
Commander	Senior Captain/Flag Captain/Commodore*
Subcommander	Captain*
Centurion	Lieutenant Commander
Subcenturion	Lieutenant
Lieutenant	Ensign
Sublieutenant	Chief Petty Officer
Uhlan	Petty Officer
Militus	Crewman

*Subcommanders and commanders are both known to command starships. Subcommanders are usually found in command of smaller or older ships. The newest, most powerful ships are captained by full commanders. A Commander may also be in charge of small task groups, a role the Federation has reserved for commodores and above.

Romulan uniforms are some of the most distinct in the known galaxy. The elaborate patterning and varied colors identify not just a soldier's rank, but their specialty, their caste and, where appropriate, their family connections. The uniforms of two commanders standing side-by-side might appear identical to the untrained eye, but a Romulan could tell that one of them is from a Praetorian family now fallen on hard times, while the other comes from a mining family on a colony world.

CULTURE

When anyone thinks of the Romulans, they think of a people who are violently militaristic, deceptive and arrogant, with a pronounced belief that they are superior to all other peoples in the galaxy. For better or worse, that is the face the Romulans present to outsiders. It does not, however, represent the whole of the Romulan people.

The best word to describe the Romulan people is "passionate." That extends into all areas of their life and culture. In fashion, Romulans prefer vivid, saturated colors and sharp geometric patterns. What humans perceive as dull, monochrome fabrics become something quite different when seen with Romulan eyes (Romulan eyesight extends slightly into the ultraviolet). Their love of geometrics extends into art: they prefer abstract art to concrete. Some high-ranking officials have smuggled in prints of Mondrian, T'Veth, Govral, R'lk't'k and Shela for their personal enjoyment, though they would never admit their provenance.

Their flair for the artistic can also be seen in their shipbuilding. Whatever else they are, warbirds are works of art. Every warbird built is painted with a bird-of-prey pattern that is unique to that ship. Old commanders can identify a warbird from its markings before ever seeing its name.

They are equally passionate about their cuisine. While they tend to be fond of bold, robust flavors, they find flavor and

texture contrasts to be equally appealing. Unlike their Vulcan cousins, they have no trouble eating meat. A staple on every table is a herd beast native to Romulus, found in both wild and domesticated varieties, known as a hlai.

A discussion of Romulan food would not be complete without Romulan ale! Some variants are blue, some are green, but all are extremely potent. Romulans, like Vulcans, are resistant to the effects of unadulterated alcohol, but Romulan ale is known to intoxicate any hominid who drinks it, including Vulcans. The secret of its exceptional potency is a measurable amount of plant alkaloids, which act on the Vulcanoid nervous system much like alcohol. The alkaloids are generally harmless to most other hominids, mostly causing headaches and intensified hangovers, but a rare few find them poisonous. Romulan wine has the same effects, but to a greater degree, and is not exported.

Even their language is a work of art. Several years into the journey, once the initial scramble to create some sort of order was past, someone suggested that if they were going to leave Vulcan behind, perhaps they should leave the language behind as well. The Committee was not entirely enthusiastic about the idea (they did, after all, plan to return) but, by the time it gained their attention, it had garnered the support of a surprising proportion of the travelers. Over the next several decades, they created a new language for themselves, by taking the Old High Vulcan roots and developing them in a different way. The Vulcan language was not entirely forgotten: as pressure mounted for all the Steadfast to adopt the new tongue, the old was hidden away.

The glaring exception in Romulan art is architecture. The oldest architecture on Romulus clearly shows its Vulcan antecedents. The Senate chamber, in particular, when stripped of Romulan iconography, could be placed at the foot of Mount Seleya and not be out of place. Other government

INTERCEPTED TRANSMISSION

Elim,

I regret that we never had the opportunity to exchange farewells, but people like us go where our masters bid, when they bid. Still, I have made bold to send this message through your embassy, in hopes that it will find you wherever you may have gone. I remembered how fond you were of my burnt toast recipe (which I have attached), but I don't know if you'll be able to replicate it away from here. It requires bread

made from *s'lipath*, which I think only grows on Romulus. Other breads just turn dry and hard; there's something about the *s'lipath* that makes the bread's crust melt and crystallize around that delicious creamy interior.

On the other hand, you're a gardener. If I send you some seeds, perhaps you could grow some of your own! If you have the opportunity, send me a message and I'll see what I can arrange.

Jolan tru,
Vashana

buildings are reminiscent of the towers at ShiKahr. More recent construction is built along starkly practical lines, as fortresses for the modern age.

The Romulans have developed a peculiar family structure. Monogamy is the norm. Married couples cohabit away from the extended family. Most households consist of parents and their children, no more than four or five individuals. Occasionally, a revered elder will be invited to live with a small family but, in general, families keep their households well separate. Allowing all members of a household sufficient personal space is one of the accommodations the Romulans have made to live with their emotional extremes. By and large, it works, and even in large housing complexes people usually manage to get along.

Although they prefer small households, Romulan families in general are large and wide-spread. A couple usually has several children in their lifetimes, spacing them out over half a century. Like their Vulcan cousins, Romulans believe that children should be brought into the world to be cherished, not to fulfill some need of the adult. Family members have specific responsibilities to each other, and these responsibilities extend out in an intricate kinship network.

Despite the stereotypes, Romulans possess a sense of honor. It tends toward the flexible and pragmatic, but it exists. One's honor is in one's actions, in service to family and the state. Courtesy to social inferiors is expected, but is often observed more in the breach than the observance. Likewise, courtesy to honorable enemies is considered a virtue. Of course, that largely depends on the definition of "honorable enemies." A Romulan keeps their honor not only for themselves, but in trust for their families. Ultimately, one's honor is their willingness to preserve the Empire, and to die for it, if necessary. Almost any action is acceptable if it preserves or strengthens the Empire. The *Tal Shiar* considers many of the older forms of honor to be hopelessly antiquated at best, and a sign of dissent at worst, but the underground continues to teach them as a quiet act of defiance.

SCIENCE AND TECHNOLOGY

The Romulans are proficient technologists and scientists. Their work in high-energy physics and optics are, in some ways, well ahead of the Federation. They are less advanced in the biosciences. Their knowledge of genetic engineering was sufficient to keep their genome from collapsing during the journey, but they abandoned it once they had settled Romulus. There is a mostly-unspoken belief that excessive reliance on medical intervention is a display of weakness. The military are an exception as they see reliance on medicine not as weakness, but necessary to ensure battle readiness.

THE CLOAKING DEVICE

The Romulan cloaking device may be the single most notorious piece of technology in two quadrants. Both the

Federation and the Star Empire have violated the Neutral Zone over its secrets. The Klingons managed to trade ships for an early variant of the device, but their cloaking devices have historically been at least a generation behind those of the Romulans. The Romulans believe so strongly that the cloaking device is key to their defensive strategies that they have been willing to conduct all-out war to prevent the Federation from developing their own version. While the Federation signed the Treaty of Algeron to allay that particular fear, that decision was not well-received in some parts of Starfleet. Just last year, the *U.S.S. Enterprise-D* was involved in an incident that revealed that a number of Starfleet officers, including the Chief of Starfleet Security, had been developing a cloaking device of our own in defiance of the treaty.

Practical invisibility takes a great deal of processing capability and equally large amounts of power. Additionally, the cloaking device uses the same subsystems as the deflector grid. A ship cannot have both the cloak and deflectors active at the same time. Experienced commanders can have their shields back up within a few seconds, but on some older ships there may be a second or two of vulnerability as the ship goes into cloak.

Fortunately, there are ways to detect ships under cloak. Older devices are vulnerable to a metaphasic sweep, an active scan that changes phase erratically in order to overload the visual processors. These were commonly seen on Klingon ships around the turn of the century, and most likely are no longer in service. Other means of detecting a ship under cloak include laying down a pattern of photon torpedoes to ignite a ship's plasma exhaust. This flaw has been corrected in modern cloaking systems.

The primary means in use today are a combination of gravitic sensors and tachyon sensors. We discovered three years ago that the Romulans had discovered a way to partially shield themselves from the existing gravitic sensor net. Since then, it has been upgraded to a tachyon detection grid. The arms race continues, Captain: they find a new way to hide, we find a new way to find them.

Alongside cloaking technology, the Romulans have developed extremely sophisticated holographic technology, which has been used in the past to disguise a drone ship as any one of a number of enemy ships. We believe this technology is no longer in active use, but the Romulans will revive it if they think it useful.

WARBIRDS

Hear the phrase "Romulan starship," and one immediately thinks of a compact, predatory-looking warship shaped like a stylized bird-of-prey. Known as "warbirds", these ships have always packed a punch disproportionate to their size and their latest incarnation is a formidable foe. Rather than build the nacelles above the hull, as in a typical Starfleet

design, the nacelles in a warbird are slightly below the ship's centerline. This gives the ship its typical "winged" appearance. Engineering specifications for the *D'deridex*-class Warbird will be provided in a later briefing.

Romulans have been known for their stylized bird-of-prey ships since they first appeared on the galactic stage. Despite a number of upgrades and enhancements to the basic design, warbirds are known for their clean lines and resilient engineering. The standard Romulan warbird was superior to the Klingon warships of the 23rd Century, though somewhat less heavily-armed. Why, then, did the Romulans use Klingon ships to expand their fleet? Theories abound, though the current belief in Starfleet Intelligence is that, after centuries of war, the Star Empire was overstretched and did not have the manpower to build ships. It is unlikely to be coincidence that the Klingons acquired cloaking technology around the same time that the Klingon vessels began to appear in the Romulan fleet. Regardless of the reason, by the beginning of the 24th Century, Klingon vessels were phased out of the Romulan fleet. The Romulan actions of the 24th Century were all carried out by warbird flotillas.

The *D'deridex*-class warbirds are powered by an artificial black hole. The ever-increasing power demands of the cloaking device spurred the Romulans into pouring resources into power generation technologies. The resultant forced quantum singularity is extremely efficient, providing more useful energy per gram of matter than even matter/antimatter reactions. The magnetic and gravitic distortion effects of even a small singularity are easily detected, so these distortions are offset by nullifier cores that generate precisely-tuned counter-distortions. The technology is still delicate, however, and even a slight misalignment causes magnetic distortions to become visible through the cloak.

Romulans prefer disruptor-type energy weapons to phased energy weapons. Unlike phasers, which can reliably be set to stun, Romulan disruptors cause significant damage even

on a low-power setting. The weapon is aptly named, as it functions by disrupting the molecular bonds of its target. At low power, this results in burns and widespread cellular damage, though recovery is possible with modern medical treatment. At high power settings, hand-held disruptor weapons cause their target to disintegrate. Starship disruptor banks function in a similar manner, but such weapons rarely cause complete disintegration. Disruptors are usually attenuated by shields and hull alloys to the point where most of the damage is purely mechanical, the effect of large amounts of energy applied to very small areas. The disruptors currently in use by the Star Empire are powerful and flexible weapons. The disruptor array of a *D'deridex*-class warbird is capable of firing in both beam and pulse modes.

For a short time in the 22nd Century, the Romulans deployed a weapon system designed to mimic the weapon signatures of other species' ships. The triphasic emitter technology was known to be able to mimic the particle cannon signatures of both the Andorians and the Tellarites, as well as the phase cannons of the NX-class ships. This weapon was used in conjunction with sophisticated holographic emitters to frame various species for attacks on their traditional rivals. Starfleet has not encountered any ships possessing improved variants of this technology. The idea may have been abandoned, or it may still be in use on ships involved in covert actions.

A discussion of Romulan shipboard weaponry would not be complete without mentioning plasma torpedoes. First observed on Romulan ships in 2266, the plasma torpedo is an extremely powerful weapon with homing capabilities and capable of following a ship into warp for short periods of time. Plasma torpedoes require massive amounts of energy to create the magnetic fields that contain the plasma; even modern Romulan power plants do not produce enough power to fire them from a cloaked ship. Currently, Romulan tactics emphasize disruptors over plasma torpedoes, but there are rumors that new a planetary defense installation incorporates the torpedo technology.

ROMULAN DISRUPTOR

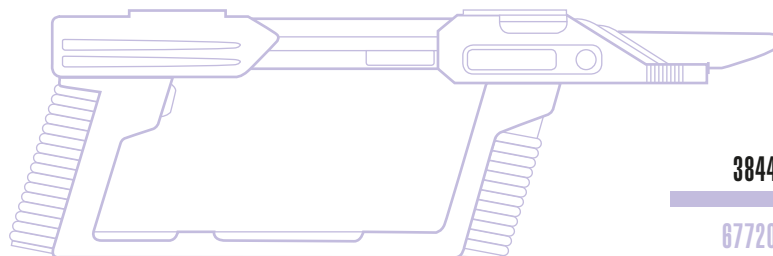

11-30029

14-39990

16-25005

4799-2722 2320 224002 29-274-00 2482 204114
2922-2042 2901 120330 65-274-55 29400 429901

3844

67720

380002

20913

12

2011-32 0120

987-12 0020

128-21 3844

17-2880

21-5540

SECURITY

THE BETA QUADRANT

ROMULAN WORLDS

ROMULUS

PLANETARY BACKGROUND

Romulus is an M-class planet in the second orbit of its primary. The nature of Romulus' primary has been a mystery for some time, as astronomical observations were inconsistent. Early observations suggested that the star was in fact a D-class white dwarf, in a binary relationship with another, similar star. Other readings indicated that it was an M-type accompanied by a K-class star. The mystery has been resolved: video evidence taken from Romulan orbit in 2368 confirms spectral readings consistent with an F-type

star. Long-range sensors still give conflicting readings and astrophysicists are arguing over the reasons. The current hypothesis seems to be a dust cloud in or around the system that causes sensor distortions. If true, the composition of the dust cloud would be a substance entirely unknown to the Federation.

It might also be the reason for the splendid sunsets. By all accounts, Romulus could be a resort world similar to Risa, if the Romulans were so minded, and without the aid of weather modification systems. The few Romulan defectors we've spoken with all agree that the planet is unusually beautiful.

Romulus is a temperate world, with enough of an orbital tilt to provide discrete seasons, but not so much as to cause temperature extremes. Large-scale storm systems such as hurricanes are rare. Romulus does possess many seas, but most of them are relatively small and do not support the conditions required for a hurricane to develop.

The Apnex Sea, named after the first leader of the Vulcan exiles, is the largest on Romulus. It has a Mediterranean-type climate consisting of warm, wet winters and hot, dry summers. The Romulans endure the first and enjoy the second. Ki Baratan is situated on the sea's western shore, perfectly positioned to enjoy the prevailing winds. The Apnex is ecologically diverse, and supports a thriving aquaculture industry along its northern shore. The southern shore of the Apnex, well south of Ki Baratan, the capital, is where most of the Senate and Committee have their winter vacation homes. They enjoy the warmer temperatures and the beautiful views.

Ki Baratan, the capital city of Romulus, is on the edge of the Apnex Sea. Built in concentric rings on an artificial island, it is completely surrounded by a wide stretch of water. Bridges link the central metropolitan area to the mainland on three sides. Demolition charges are embedded in all three in case of invasion or siege. The spare, brutal walls that now contain the heart of the Imperial government initially marked Ki Baratan's outer edge. Over the years, it spread outward, first covering the rest of the island, then spilling over onto the mainland. The walls remained, and over the years, the government

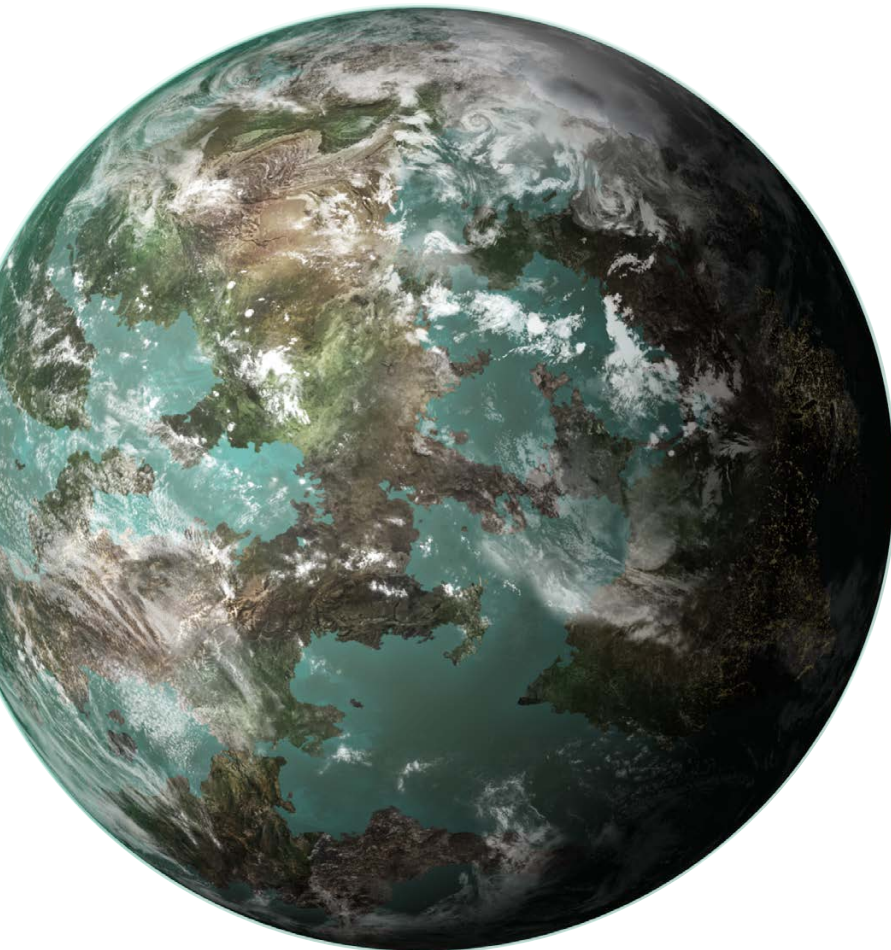

complex gradually swallowed the entire area. Today, it is officially called the Imperial Court, although colloquially referred to as “The Hidden City.” No one is admitted inside the walls unless on official government business: to trespass is death.

Even for a planet of breathtaking beauty, the Firefalls of Gal Gath'thong are exceptionally glorious. A sheer cliff rises above an arid plain, uplifted and sheared by some massive tectonic event. From its heights, a stream of fire pours down in an ever-shifting kaleidoscope of flame. Beneath the plain lies an enormous reservoir of light hydrocarbons and natural gasses, which has found its outlet at the top of the cliffs. Some long-ago lightning strike set it ablaze, and it has burned ever since. It was burning when the Romulans settled the world and, if they have their way, it will burn until the reservoir is no more.

REMUS

PLANETARY BACKGROUND

Remus is the cooled metallic core of a gas giant whose atmosphere was stripped away by a close approach of a so-called “rogue star.” The incident that stripped away the atmosphere also destabilized its orbit. What was left, after a hundred thousand years or so, settled into a new orbit in the habitable zone, a tidally locked Class-L planet rich in exotic materials. It is generally believed that the Remans are not native to the planet, as the next-most advanced life form on the planet is a lichen analogue. How they arrived, however, remains a mystery. No ships or debris have been located on the planet’s surface, and the Remans themselves were technologically primitive, organized in barbarian tribes on Remus’ nightside. Given the usefulness of the Remans as slave labor, the Romulans haven’t investigated the matter too intensely.

THE DILITHIUM MINES

Remus is the Star Empire’s primary industrial base. Its wealth in dilithium and other exotic materials makes it an ideal location for the associated factories and refineries. The mines are worked by Reman slaves, and the extremely hazardous work means their average life expectancy is thirty years. Many mining slaves never leave a single mine: they are born in the mine, work their life in the mine, and die in the mine.

The Romulans do provide a certain amount of safety and protective gear, but this is not to protect the miners, only the dilithium. Fortunately, Remus is tectonically inert, so it is relatively safe from the stresses caused by the piezoelectric generator effect. However, an explosion that is minuscule on a planetary scale is still devastating on a sentient scale. Static-damping gear is a must in the depths of the mines.



IMPERIAL RESEARCH AND DEVELOPMENT FACILITY

Buried among the other industrial complexes that have grown around the dilithium mines is the Imperial Research and Development Facility: an arms complex, in other words. We believe that this facility is the primary site for development of the cloaking device. It is unlikely that high-energy experimentation takes place on Remus, due to dilithium’s extreme sensitivity. The Star Empire performed high-energy experimentation on Chaltok IV up until a century ago; an experiment using polaric ions destroyed the majority of the colony.

REMANS

Remans are extremely physically robust. Their strength and endurance may even exceed that of the Romulans. They possess some telepathic ability, but its extent remains unknown. What is known is that the Remans fought the Romulans to a stand-still for the better part of a century after the Romulans arrived on Remus. It was only the Romulans’ ability to exploit the Remans’ vulnerability to light that enabled them to bring the war to an end.

This history means the Romulans look on the Remans with a mixture of respect and contempt: respect for their ability as warriors, and contempt at their eventual defeat. This contradiction extends to the Romulan treatment of the Remans. Some Remans are groomed to become elite bodyguards for members of the Senate and Continuing Committee, but the vast majority are doomed to work in the dilithium mines. The Romulans believe that the warrior Remans are not in any contact with the Reman mining slaves but, when dealing with a race of telepaths, who can be sure?

THE BETA QUADRANT

THE ORION SYNDICATE

“THE SYNDICATE WANTS YOUR HEAD, CAPTAIN, AND THEY DON’T REALLY CARE WHETHER OR NOT IT’S ATTACHED TO YOUR BODY.”

— HARRAD-SAR

INTRODUCTION

The Orion Syndicate is the most dangerous criminal organization that you’ll encounter during your command, Captain. For as long as there have been ships, there have been pirates and smugglers and it does not matter if those ships travel the oceans or between the stars. The Syndicate is the largest network of these criminals, created and maintained by the Orions. The Syndicate is responsible for piracy, slave-trading, racketeering, smuggling, illegal gambling operations, arms dealing, extortion and assassination across the Alpha and Beta Quadrants, and perhaps even beyond. We don’t know how far their influence extends, and there are some experts who claim that it is not outside the realm of possibility that they have a presence in the Delta and Gamma Quadrants as well.

The situation is made even more complicated by the officially-recognized neutrality of the Orion worlds, and the legitimate operations of the Orion Trade Union. A law-abiding merchant that you encounter at one port could be the pirate who was raiding freighters the previous week. The only way to be certain is to catch them in the act. With no official central government with whom we can partner, addressing the issue of the Orion Syndicate is a difficult process and one that is, more often than not, left to individual starship Captains.

ASTROGRAPHY

The Orion worlds are an independent collection of non-member worlds that lie entirely within Federation space, approximately 25 light years from Earth, near Starbase 12. Originally, these worlds were the territory controlled by what archaeologists now call the Orionic Empire, a highly-advanced civilization centered on the planet Orion. After the collapse of the Empire, many of these worlds were controlled by various Merchant Houses: private Orion-run mercantile companies, similar to powerful groups like the English, Dutch and French East India Companies of Earth’s 16th-19th Centuries. At times those organizations had more influence than their governments. Over time, many of these worlds have petitioned for entry into the United Federation of Planets, which has angered the Orions and resulted in several confrontations, notably the Babel Conference incident over the question of membership of Coridan (Chi 1 Orionis, 5 light years from the Orion homeworld).

There was a time when the Orion worlds stretched from Orion all the way to Klingon space, a region of territory then known as the Borderland. By the 24th Century most of these worlds have become Federation members, although by treaty the Orions maintain trade outposts on these worlds.

OLD STARFLEET ACADEMY JOKE

How can you tell an Orion merchant ship from an Orion pirate ship?

If you have phasers, it’s a merchant ship.

ORION HISTORY

The Orion people are the descendants of a highly-advanced civilization, referred to by Federation archaeologists as the “Orionic Empire” (to distinguish them from the present-day Orions). Much of the achievements of that society have been lost over the centuries due to official histories being altered by various Orion rulers in the thousands of years since the

ORION COLONIES

OPEN PORTS AND PIRATE HAVENS

collapse of that Empire, and the reluctance of present-day Orions to allow non-Orions to carry out research on their homeworld. Those few scientists who have been granted access, or have made discoveries on now-independent Orion colony worlds, have uncovered science and technology far in advance of perhaps any other species in the Alpha and Beta Quadrants during the same period. For example, in the mid-23rd Century, noted archaeologist Doctor Roger Korby translated ancient Orionic medical records which completely revolutionized modern immunology, and his findings are now required reading at Starfleet Medical.

Thousands of years ago, the Orionic Empire collapsed, and there has been no central Orion government since. The Empire splintered into competing clans, waxing and waning in power over the centuries, each altering or falsifying historical records to fortify their claims of power, or to implicate rivals in scandal or wrongdoing. These clans eventually developed into the various Orion merchant houses, great trading conglomerates that were initially clan-based but, over time, they have become analogous to multinational corporations, doing business throughout the Alpha and Beta Quadrants.

ORION FREE TRADERS

THE TRADE UNION

The merchant houses would regularly war against each other, over resources, trading contracts, or just over matters of bad blood. In the 21st Century, the Orion Merchant Prince Abbran-Tadji sent a communiqué to all the other merchant houses, no matter how small, with a proposal. He suggested that conflict between the houses was an unnecessary drain on resources and an interruption of vital commerce which prevented all houses, even those fighting, from earning to their full potential. He proposed a trade organization, with representatives from every merchant house, to work out disputes before they spilled over into open warfare and to encourage cooperation which would benefit all. He called it the Orion Trade Union, and within a decade it had become the de facto governing body of Orion space. Each world was independent, under its own planetary government, and each merchant house (or “free traders”, as they started to call themselves) was its own entity. Negotiations between them all took place under the auspices of the Trade Union, at least officially.

The true reason why the Trade Union, a proposal from only one of many merchant princes, was unanimously adopted so rapidly was that Abbran-Tadji was already well-known and feared, throughout the Orion holdings. He was the boss of a criminal syndicate which had members on every Orion world, in every merchant house. Princes who interfered with Syndicate operations often found their houses suffering crippling losses of capital and personnel, and those princes that didn't get the message swiftly were simply killed. The proposal of the Trade Union was not viewed by the other princes as a suggestion: it was an order from the head of the Syndicate.

As more and more of the worlds in Orion space and the Borderland petitioned to join the Federation, the Syndicate resisted. This resulted in several major confrontations between Starfleet and the Orions. Eventually, the merchant princes realized that direct opposition to the Federation was becoming an unacceptable risk to the Syndicate, and so the order went out that the Syndicate would no longer oppose the independence of any world, provided that the Orions could maintain a colony on that world as a trading port.

These colonies, on worlds like Coridan III, Dessica II, Farius Prime, the Rigel system and others, each have an Orion spaceport, either on the planet's surface or in orbit. By treaty they are all designated as open ports: neutral territory, open to trade. Starfleet is aware that these facilities are locations rife with illicit trade in both smuggled and pirated goods but, since the colonies are officially independent Orion territory, Starfleet has no authority over the colonies themselves. Starfleet often maintains a picket vessel, tasked with patrolling at the treaty-demarcated distance from the port (which varies from planet to planet according to individual treaties) and generally keeping watch, ready to intercept vessels suspected of illegal activity once they enter Federation space.

HISTORICAL RECORD

FRAGMENT OF CORRESPONDENCE BETWEEN ABBRAN-TADJI AND KATTAN-MUR, NOVEMBER 14TH 2057 (EARTH DATING)

...should result in a definite increase in trade along the Chessauni Reach. The fewer escorts we need to send with the caravans, the more freight we can move, as I'm sure you've already ascertained.

It will be an honor to serve alongside the great Merchant Prince Kattan-Mur in the Trade Union, a tale which I will proudly recount to my children in my years of retirement.

Speaking of children, please allow me to express my condolences on the loss of your eldest son. A horrible accident, to be sure. Fate is fickle.

I look forward to seeing you at the first conclave of the Union on Orion,

— Abbran-Tadji

THE SYNDICATE

The Orion Syndicate operates in a secure cell structure. The rank and file members of a Syndicate crew only know the other members of their crew, and so are not in a position to betray the entire Syndicate if compromised. The ranking member of a crew is a member of a higher crew, comprised of the leaders of other cells, who answer to the leader of that higher crew, who is a member of an even higher-placed crew, and so on, up the chain.

To be brought into a crew, a prospective member must be vouched for by an existing member, a process known as “witnessing.” Any member who witnesses for a recruit is held responsible if that recruit proves disloyal, and will be killed along with the errant recruit. Through the cellular organization of the various operational groups, and the ruthless punishment of any disloyalty, the Syndicate maintains a tight control over its membership.

Initially, the Orion Syndicate was solely comprised of Orions but by the 24th Century the Syndicate had expanded throughout the Alpha and Beta Quadrants, and either eliminated or absorbed other criminal networks, including the “Terra Nostra” of Earth, the Makur-Shen of Andoria, and a myriad of smaller groups. The result is that the present-day

Orion Syndicate has members from a variety of worlds, which makes profiling potential operations even more difficult for Starfleet.

THE TRUE RULERS OF ORION

Information about the highest ranks of the Orion Syndicate is nearly impossible to obtain. Starfleet believes that the Syndicate is governed by a ruling committee referred to as “The Commission”, comprised of the leaders of the most powerful Syndicate groups. The Commission appears to have a leader, although who that leader is remains unknown. No names have ever appeared in any intercepted communications; not even a title has been mentioned.

Starfleet Intelligence thinks that the members of The Commission are all merchant princes of powerful houses, and use the Trade Union as a legitimate cover for their operations. At this point, the legal business of the various free traders and the illegal operations of the Syndicate are so intertwined as to be indistinguishable. For example, items being smuggled by the Syndicate are often secreted within entirely legitimate cargoes.

SLAVERS

From the 21st through the 23rd Centuries, the Orion Syndicate was notorious for one crime in particular: slavery. Orion slavers traded in sentient beings, including



members of their own species, especially the females of their species. The slave trade thrived in the Borderland but, as the Federation and other governments settled further and further into space, and the frontier spaces began to diminish, the slave trade waned. Slavery was abhorred by all major governments (including the Klingons, after a time). By the 24th Century, the slave trade had been pushed into the distant reaches of unclaimed space, and it is now a faint shadow of the widespread scourge that it once was.

POWER BEHIND THE THRONE

The greatest secret of the Orion people was uncovered in the mid-22nd Century. It is known that Orions possess powerful pheromones which can have a strong affect upon the sensory neurons in humanoid brains, prompting feelings of attraction. Among Orion women, however, these pheromones are so potent as to potentially override conscious thought, bringing about an extreme suggestibility similar to the effects of intoxication. These pheromones have a marked effect on the males of various humanoid species, but their effect on Orion males is particularly pronounced. Orion males subject to female pheromones are essentially without any willpower to resist given commands. The "Orion Slave Girls" sold in Syndicate bazaars in the 22nd and 23rd Centuries were, in fact, being placed with their "owners" as intelligence operators. They not only gathered information for the Syndicate, but also influenced events on a galactic scale by subtle manipulation of their "masters."

This revelation uncovered the reality at the heart of Orion society: it is, in fact, a matriarchy, with the women as the final authority, and the males operating publicly as the instruments of their rulers' desires. This is not regarded as a secret in Orion society. The public role of males in implementation of the orders given by the females in private is merely part of the traditional gender roles of Orion culture. It is seen as no more unusual than a Klingon would regard the ability of women to serve in the Klingon Defense Force.

SCIENCE AND TECHNOLOGY

The technological heights achieved by the ancient Orionics are long past. Today, Orions use similar technology as other galactic powers. They, like the Klingons and Romulans, tend towards the use of disruptors as weapons, but have transporter technology comparable to Federation standards. The main area of technology, where the Orions truly excel, is starship engineering.

Orion ships are, hands-down, the fastest vessels produced in the Alpha or Beta Quadrants. In the 23rd Century, Orion ships were capable of reaching speeds of Warp 10 and higher (by the old Warp Factor scale), which made them far faster than any other vessel of that period. Their reputation for speed and maneuverability has persisted until the present day.

LOG EXTRACT

"Incredible, aren't they? They can make you forget most of your troubles. Of course, creatures such as these come with troubles of their own. But women are the same throughout the Galaxy, aren't they?"

— Harrad-Sar

LOCATIONS OF NOTE

As stated earlier, the majority of Orion holdings are now merely colonies placed on other worlds. In fact, any planet or station along a well-travelled trade route will have an Orion presence of some kind. The locations below, however, are purely Orion worlds.

ORION

Orion is a Class-M planet in the Pi 3 Orionis system, and is the homeworld of the Orion species. The system lies along the juncture of several well-travelled trade routes that stretch across both the Alpha and Beta Quadrants, making Orion a vital center of interstellar trade for centuries.

The planet was once home to the ancient Orionic Empire, as described above. Orion is the central world of the various Orion holdings. Although Orion space has no central government, it is considered the most important planet, due to its status as the homeworld, a trading hub, and being the headquarters of the Orion Trade Union.

VEREX III (14 ERIDANI)

Verex III is barely a Class-M planet: barren, arid, and almost devoid of vegetation. It is located in the 14 Eridani system, part of what was once the Borderland region between Orion and Klingon space, approximately 10 light years from Deep Space Station K-7. The planet was the site of a major slave market in the mid-22nd Century, and as such was a vital hub of commerce for the Orion Syndicate.

The Orions voluntarily shut down the slave market in the late 23rd Century to maintain their neutrality, as the Federations and Klingons expanded their territory. Today, Verex III is the primary port of trade between the Federation and the Klingon Empire, owing to its proximity to the border.

THE BETA QUADRANT

THE GORN HEGEMONY

“...A GORN... LARGE, REPTILIAN. LIKE MOST HUMANS, I SEEM TO HAVE AN INSTINCTIVE REVULSION TO REPTILES. I MUST FIGHT TO REMEMBER THAT THIS IS AN INTELLIGENT, HIGHLY ADVANCED INDIVIDUAL, THE CAPTAIN OF A STARSHIP, LIKE MYSELF, UNDOUBTEDLY A DANGEROUSLY CLEVER OPPONENT.”

— CAPTAIN JAMES T. KIRK

INTRODUCTION

The Gorn Hegemony is the most remote and isolationist power in the Beta Quadrant. The Gorn seldom interact with the other species and prefer to stay within their borders, as relations with warm-blooded species are often influenced by most mammals' unconscious fear of reptiles. The few interactions between the Hegemony and the Quadrant's other powers have been marked by distrust and conflict.

The Gorn are large, heavily muscled reptiles, who are significantly stronger than most humanoids, although slower and less agile. Unknown to many outside the borders of the Hegemony, the Gorn are actually not one but several distinct reptilian species who all evolved on the same homeworld.

First contact between the Federation and the Gorn Hegemony occurred in 2267 with a pre-emptive Gorn attack on the Federation outpost at Cestus III. The Gorn considered the system part of their territory. Through the interference of a highly-advanced species known as the Metrons, Captain S'slee of the cruiser *Gress'sril* and Captain James T. Kirk of the starship *USS Enterprise* were made to fight in single combat. Although Kirk defeated S'slee, he refused to kill him when he had the opportunity. The Hegemony considered this an act of contempt rather than mercy: the human saying that the Gorn wasn't worth killing. The Hegemony formally dropped their claim to Cestus III, and withdrew their borders five light-years as a sign of their defeat. S'slee was executed for his failure.

ASTROGRAPHY

Heading directly southward from Deep Space Station K-7 for nearly 80 light years will bring you to the Gorn border. This course would take a ship through Klingon space which extends westward in this area, nearly to the Alpha Quadrant. The Hegemony's territory is “taller” (core-edge extension) than it is “wide” (circumference extension), lying just short of the border with the Alpha Quadrant and is approximately 50 light years wide at its widest point.

The Gorn Hegemony has a closed border; they tolerate no incursions of any kind into their space. Their fleet regularly patrols the borders, and any attempt to penetrate the territory will be intercepted quickly. Vessels are warned away and any that ignore warnings are fired upon. The isolationism of the Gorn is so complete, in fact, that if a border patrol vessel detects an attempt to scan across the border, they will project extremely powerful electromagnetic interference to jam the scan. Even with this secrecy, persistent study and monitoring over the decades has uncovered some details about Gorn society and government.

INTERCEPTED TRANSMISSION

GORN CRUISER KKETHSS TO U.S.S. DERRINGER,
STARDATE 46852.2

Sensors have indicated your vessel's presence within one light-second of our border. Do not cross into Gorn space. You have been warned. Any attempt to cross the border will be regarded as a hostile incursion. Alter your course accordingly.

Make no attempt at long-range scans across the border. Any attempt to do so will be neutralized.

Response is not required.



CULTURE

Gorn society is a meritocracy, with leadership positions going to the Gorn who has demonstrated themselves as the most capable within a particular field, regardless of their gender, family, or political association. All Gorn species are extremely long-lived with a lifespan of approximately 300 years, and that has contributed to a culture that values considered, deliberate decision-making. The meritocratic culture is a result of this tendency to think things through.

A Gorn wishing to be considered for a particular role in society will formally present themselves, and recite a litany of their qualifications. This has been likened by Federation xenoanthropologists to the ancient Norse practice of ritualized boasting. Other candidates present their qualifications, and a decision is debated and arrived at within the group affected, or by the potential superiors of the candidate.

A side effect of this meritocracy, however, is a near-zero tolerance for failure. If a Gorn fails in their assigned task, they are, at minimum, removed from their position. In the Gorn military the penalty for failure, depending upon the severity of the situation, can range from demotion to execution.

Beyond this general cultural tendency, Gorn societies are as varied as those found on Earth, with distinct cultural

differences. In the case of the Gorn, however, this is attributable not merely to differences in location or ethnicity, but because the Gorn are actually a collection of several different reptilian species which all evolved on the same world. Xenobiologists have positively identified the two major Gorn species, and anecdotal evidence points to as many as four others. The two species who have most extensively been documented and encountered are the Russth and the Ssessekh.

THE RUSSTH

The Russth are the smaller of the two most commonly encountered Gorn species, standing 2 meters tall. They are less heavily muscled than their cousins, although still possessed of prodigious strength. Russth can be identified by their legs, which are of digitigrade design (meaning that they walk on their toes, like birds, dinosaurs, canines and felines, giving a “crooked-legged” appearance.). The Russth also possess a longer neck than the Ssessekh, and a more tapered head, more like the Velociraptor of prehistoric Earth. Their eyes are golden, with a reptilian slitted pupil, and their hands are three-fingered, and clawed.

THE SSESEKHX

The Ssessekh are the species who have been encountered the most, starting with the first contact with the Federation in 2267. Whether this is a factor of their prevalence in the Gorn military, or due to them simply being more numerous as a

percentage of the overall Gorn population, nobody beyond the Gorn knows. The Ssessekh are nearly 3 meters tall, and massively muscled. They are easily identified by three distinct features: The hands of the Ssessekh are three-fingered, with large claws, and their eyes are silver-hued and segmented like those of an insect. Additionally, Ssessekh legs and feet are of plantigrade design (meaning they walk on the soles of their feet, giving a “straight-legged” appearance, like those of a humanoid).

POLITICAL STRUCTURE

The Gorn Hegemony is an alliance among several distinct species. The various Gorn species evolved on Gornar, and all those species eventually moved out from their homeworld to set up independent colonies on other planets. Each of these Gorn worlds is essentially self-governing, but all are considered member worlds of the Hegemony, and they all provide a delegation of representatives to the center of the Hegemony government on Gornar.

THE ASSEMBLY

The deliberative and legislative body of the Gorn Hegemony is known as the Assembly. The Assembly is comprised of delegations from each Gorn world, and each delegation has several diplomats with individual areas of expertise. They are available for debate and deliberation when the Assembly is called to address a particular topic. Each delegation votes among their own members to designate a leader, known as a Speaker, who addresses the Assembly on their behalf.

By the 24th Century, the Assembly includes over 60 delegations, one from each of the major Gorn planets. Smaller settlements, like space stations, moons or newly-established colonies, are considered to be represented by the delegation of their parent planet.

THE IMPERATOR

Once every 25 years, the Assembly votes on the position of Emperor: the executive of the Assembly, and the ruler of the Gorn Hegemony. Any member of a delegation may put forth their qualifications and be considered for the role, including the current Emperor. After deliberation, the Assembly votes, and the Emperor takes office.

The duty of the Emperor is to serve as Chairman of the Assembly, to administer the meetings, propose topics for deliberation, and call for votes. They are the ultimate authority of the Gorn Hegemony. The Emperor may, according to the law, override a decision of the Assembly, overturning the result of a vote, but to do so would represent an extreme risk to their position. If the Emperor’s decision leads to a failure, they would be removed from office. As a result, a reversal of the Assembly’s decision has

seldom happened in the history of the Hegemony. Instead, Emperors rely upon their influence within the Assembly itself to sway votes toward their preferred outcome.

MILITARY

The Gorn Hegemony’s member worlds maintain local militias of differing strength, depending upon the policies of that particular world. By Gorn law a certain percentage of planetary militia personnel are sent to serve in the main military force of the Hegemony, the Gorn Space Command.

The Gorn Space Command is smaller in size than either the Federation Starfleet or the Klingon Defense Force. They do not appear to emphasize any scientific duties, as is the case with Starfleet, or raiding or expansion outside of their territory, as is the case with the Klingons. The sole duty of the Gorn Space Command is defense of Gorn space and worlds, and maintain the patrol on the Gorn border.

Gorn who demonstrate particular competence while serving in the Space Command are chosen to remain in service, rather than returning to planetary militia duty at the end of their allotted term. As such, the caliber of personnel serving aboard Gorn vessels is very high, and they are comparable to Starfleet personnel. Even within the high standard of the Gorn Space Command, however, there is an elite unit, comprised of the very best the Space Command has to offer. The Black Crest is a squadron of vessels tasked with the defense of Gornar, the Emperor and the Assembly, and with occasional special operations, as ordered.

SCIENCE AND TECHNOLOGY

It is a mistake to assume that the Gorn are simply large, strong reptiles, but that is often an instinctual reaction when they are encountered. They are, in fact, highly advanced, and in some areas even more advanced than any other Alpha or Beta Quadrant power.

GORN STARSHIPS

The starships of the Gorn Space Command have a higher power output than those of their closest neighbors. Gorn vessels feature a quad-nacelle design, yet despite the additional power generated, the ships feature roughly the same speed performance as those of other species. The surplus power is used primarily for charging extremely potent shields. The Gorn dropped the use of polarized hull plating in favor of duranium composites, which in combination with modern shields, makes Gorn vessels extremely tough and hard to damage. Even with the high-power demands of their defensive systems, Gorn vessels still supply enough energy to power disruptors and their powerful sensor-jamming gear.

GORN DISRUPTORS

Gorn weapons were described by a survivor of the Cestus III attack as “like phasers, only worse.” It was soon discovered that the Gorn use disruptors as well as phasers, both more powerful than those used by the Klingons or Romulans, although their targeting systems are far less precise.

GORN JAMMERS

Gorn sensor technology is slightly less effective than that of the Federation, but their ability to disrupt sensors is the most advanced technology they possess. Every Gorn vessel is outfitted with a jamming device which can disrupt active scanning at extreme range. This device does draw a great deal of power, which makes it unsuitable for combat operations, as it could render a Gorn vessel nearly defenseless. There have been rare engagements, however, where a pair of Gorn vessels operating together use the jammer on one vessel to blind an opponent, while the second goes in for the kill. This maneuver has a high risk of failure as it leaves the jammer defenseless. The Gorn are unlikely to use such a chancy tactic except in the most extreme circumstances.

incursions into their space. Over the years, however, Starfleet has pieced together bits of information about the capital of the Hegemony, the Gorn homeworld, Gornar.

GORNAR

PLANETARY BACKGROUND

Gornar is the homeworld of the various Gorn species. Each of those species has their own language, and so it took some time for Federation scientists to realize that references to Gornar, Agornu, S’sgaron, Garag, Koreb, and Shekkis all referred to a single planet, the capital of the Gorn Hegemony. Gornar is the ninth planet of what Earth astronomers named the Tau Lacertae system. It is a tropical jungle world, with forty-five percent of the planet being usable land, and the rest covered by swamps and oceans. It’s a larger world than Earth, with a gravity measured at 1.4g.

Gornar’s atmosphere traps heat and its low degree of axial tilt results in a fairly uniform high temperature planet-wide. Reptiles are the prominent life-forms (both the various species of Gorn, and a variety of dinosauroid animals). Small mammals exist largely as prey species.

The Gorn build their cities near large swamps, with the cities often sharing the name of the landmark. These cities are built as much below ground as above, and transportation between the cities is almost always via underground transit systems, to maintain as much as possible of the surface of Gornar as pristine jungle.

LOCATIONS OF NOTE

As stated previously, little is known about the Gorn worlds, as the Hegemony has a closed border and permits no

PLANETARY SCAN

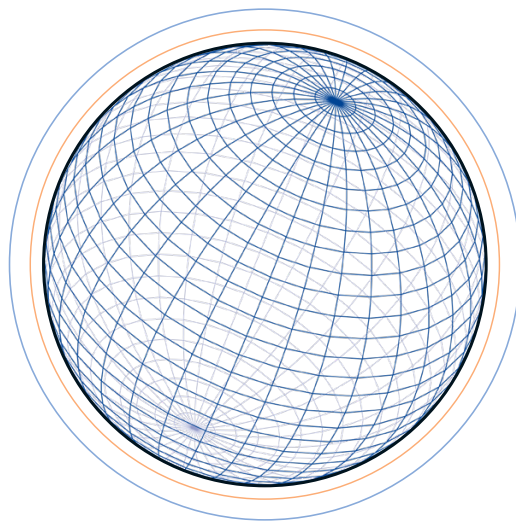

103280
20-359-22
20422
481005
370
3009-22710
234
2840-2
M-CLASS

ATMOSPHERIC COMPOSITION
7-14007 83-2999 2720
8-15999 36-0059 2922
1-01008 00-2830 5980
35-499 277

66028 284 217010
90 12000
6480 283 880550
193300 1933
12830 543 284040
1207 270 46590
13001 190 164689
2953 18 99780
310
13999 103 66050
229 28 120300
285 284893
183 6600

11-30029

14-39990

16-25005

12-17032

4002-4789 38802 103280 20-359-22 20422 481005 284022 370 3009-22710 234 2840-2 5021-3478-2880 373902 28-20865
4789-2722 2320 224002 28-274-00 2482 204114 4219930 2110 10389-17339 149 1190-5 700-2883-1683 299193 10-36290

STELLAR CARTOGRAPHY

MEDICAL DATABASE FILE 42179-77

976243 92435629 9 314798 • 17546 48749 4169122 971233 419848 4896 498 325 78 314124
 3955879 27865293 7 949357 • 38591 26874 3692397 297599 994825 287499 614 193 2229 434392

8996-725

5758-078

MODE

ACCESS

LCARS

SYSTEMS

02-887622

03-239586

04-756420

05-957821

06-285910

07-581940

497865298	98623598	5986	981	18287
329828981		8881	801	48
195859017		1852	452	
956105740		4028	390	
195928421		8361	195	
452854685		7492	532	
284658910	28398778	9141	948	
126598344	92789462	3768	382	0
921185759	61108591	1104	26	3
204791004				
471846719	62458019	709	181	504
948375668	91685438	486	224	9962
636777211		348	776	56782
442397892		527	213	834761
626395194		376	645	47489
238767491		828	106	7462
377937556		786	224	259
179084767		658	417	36
894748251	87582991	409	213	
092701921				

20005

VIEW

09-9371

09-9432

10-6799

11-4874

383

HUMAN ANATOMY SCAN 477

2937 • 2

5812 • 3

7031 • 4

5430 • 5

5783 • 6

8795 • 7

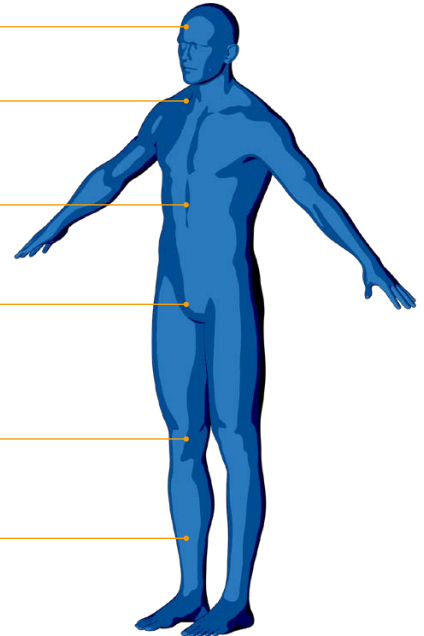

ANALYSIS COMPLETE

12-9471

13-4719

14-1170

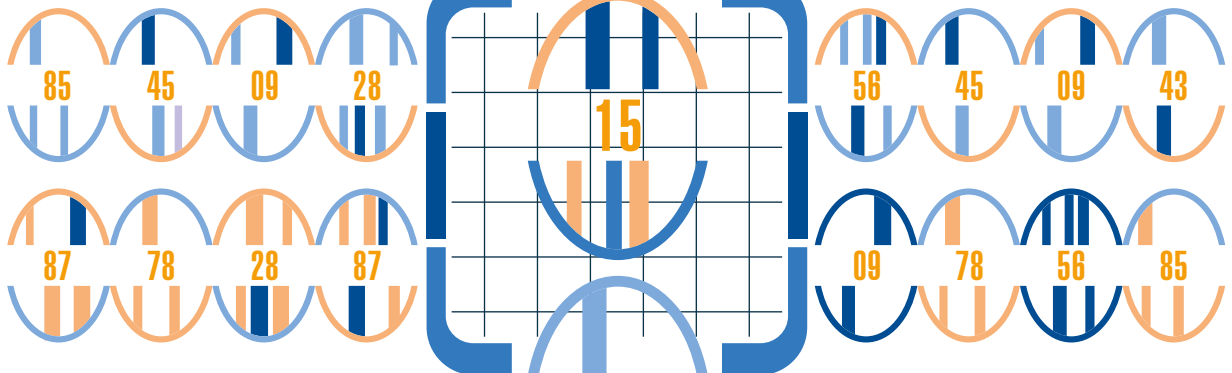

SPECIES OF THE BETA QUADRANT



1930473920383
2204774003

03.10 NEW LIFEPATH OPTIONS 076

SPECIES OF THE BETA QUADRANT

NEW LIFEPATH OPTIONS

“YOUR WILL TO SURVIVE, YOUR LOVE OF LIFE, YOUR PASSION TO KNOW ... EVERYTHING THAT IS TRUEST AND BEST IN ALL SPECIES OF BEINGS HAS BEEN REVEALED TO YOU. THOSE ARE THE QUALITIES THAT MAKE A CIVILIZATION WORTHY TO SURVIVE.”

— LAI THE VIAN

ARDANAN

THE ORIGINAL SERIES AND THE NEXT GENERATION ERAS ONLY

Ardanan citizens have a long history of societal division. The two castes that still hold sway over an Ardanan's potential are the city-dwellers of the floating city, Stratos, and the surface dwelling Troglytes. While anatomically no different, for years the Troglytes suffered from conditions and mental difficulties that reduced their higher brain functions. This was due to exposure to the zenite mines where they labored and, once the Federation Bureau of Industrialization got involved, breathing apparatus was quickly made mandatory. In contrast the beautiful City of Stratos, floating in the lower atmosphere of Ardana, is home to a people entirely devoted to art, government and culture.

EXAMPLE VALUE: *Nothing Is More Beautiful Than a City in the Sky*

- **ATTRIBUTES:** +1 Fitness, +1 Presence, +1 Reason
- **TRAIT:** Ardanan. Ardana natives from either caste are hardy individuals, whose duality of art and culture, and resource mining and management, make them excellent all-rounders. Without the exposure to zenite gas many Troglytes reach a level of academic and artistic ability on par with the city-dwellers, making the Ardananans both a people of stout endurance and cultural excellence.
- **TALENTS:** The character receives access to the following talents:

ABOVE THE CLOUDS

REQUIREMENT: Ardanan, or Gamemaster's permission. While engaged in Social conflict in a lavish environment (or one of excess), you reduce the Difficulty of any *Persuade* Tasks by 1 to a minimum of 1.

ZENITE IN THE SOUL

REQUIREMENT: Ardanan, or Gamemaster's permission. Your ancestry is steeped in toil in the mines on Ardana's surface and, you roll one additional d20 whenever using Engineering or Science in relation to geology, mining or mine equipment.

SAMPLE NAMES:

Male names: Anka, Midro, Plasus
Female names: Droxine, Vanna

MIXED-HERITAGE CHARACTERS

Many Starfleet Officers have parents from different species. To create characters of mixed-heritage, choose two species, one of which will be the primary species. The character is treated as a member of the primary species for attribute bonuses; most mixed-heritage characters take more after one parent than another. The character gains the species Traits of both parent species, and may select Talents from both parent species.

BENZITE

THE NEXT GENERATION ERA ONLY

Benzite physiology gives this species' skin a hairless blue-to-green complexion. The Benzite skull has a thick protrusion that extends over the brow and nose, with two facial tendrils above the lip. Until 2370 Benzites in Starfleet had trouble breathing a standard nitrogen/oxygen atmosphere and relied on breathing apparatus. Their apparent change in condition, which allows the species to go without breathing aids, is rumored to be thanks to genetic engineering, though reports are unconfirmed. Highly meticulous, a Benzite Starfleet officer is a valuable resource when it comes to exploration and investigation.

EXAMPLE VALUE: *Report Only What You Know*

- **ATTRIBUTES:** +1 Control, +1 Insight, +1 Reason
- **TRAIT:** Benzite. A Benzite's average body temperature is several degrees lower than an average, warm blooded humanoid, though the Benzite themselves are not cold blooded. Their blood being mercury and platinum based. Benzites also have 2 apposable thumbs on each hand, aiding their dexterity. Before 2370, Benzites also require a breathing apparatus in Class-M atmospheres. If playing before this time, add the Trait '**Breathing Apparatus**'.
- **TALENTS:** The character receives access to the following talents:

METICULOUS ANALYSIS

REQUIREMENT: Benzite, or Gamemaster permission.
When you encounter unidentified phenomena through sensors, you may immediately make a Swift Task, without the need to spend Momentum or an increase in Difficulty. This Task may only be used to attempt to analyze the preliminary data you have received using **Reason + Science** and a relevant Focus.

ALL FINGERS AND THUMBS

REQUIREMENT: Benzite.
When you succeed at a Task using a computer console (including a bridge station), you gain one bonus Momentum. This bonus Momentum cannot be saved into the group pool.

SAMPLE NAMES:

Male names: Mendon, Mordock
Female names: Hoya



BOLIAN

THE NEXT GENERATION ERA ONLY

From the planet Bolarus IX, Bolians are well known for their hospitality and outgoing personalities. Identified by a cartilaginous ridge that extends down their head, vertically, down the center of the face to the chest, with skin color ranging from light blues, to dark greens and muted purples with darker banding across the head. They are predominantly bald, though some females are known to have hair on their heads. Bolian marriages have more than two partners, of both sexes, but procreation with other species isn't all that common, given the Bolians' incompatibility with others. Humans, in particular, have noted several side effects of inter-species relations, including nausea, fatigue, and inflammation.

EXAMPLE VALUE: *A Broad Smile and Warm Heart*

- **ATTRIBUTES:** +1 Control, +1 Insight, +1 Presence
- **TRAIT:** Bolian. Bolians are able, thanks to their cartilaginous tongues, to consume substances unsafe to other species, such as acids or decaying meat. Bolian hearts are on the right side of their body, moving blue blood around their circulatory system. Bolians are an understanding, hospitable species, often forward-facing in their duties in customer relations or diplomatic service.
- **TALENTS:** The character receives access to the following talents:

WARM WELCOME

REQUIREMENT: Bolian, or Gamemaster's permission.

A cheerful, outgoing personality is the perfect thing to put diplomatic guests at ease. Whenever assisting another character the Bolian may use their Presence Attribute instead of their own. Further, both the Bolian and the character being assisted may ignore any increases in Complication Range for the Task.

BORN NEAR A WARP CORE

REQUIREMENT: Bolian, or Gamemaster's permission.

Bolian traditions say that a child born near an active Warp Core has an improved, more positive, disposition. Optimism and an upbeat attitude certainly lends credence to this tradition, allowing the Bolian to weather misfortune. When they suffer a Complication from a Task, roll 1 ▲; if the result is an Effect, the Complication is ignored. Once a Complication has been ignored in this way, the Bolian may not ignore another Complication for the remainder of the scene.

SAMPLE NAMES:

Male names: Ardon, Hars, Boq'ta, Brathaw, Chell, Rixx, Zim

Female names: Golwat, Lysia, Mitena

Family names: Adislo, Arlin, Brott



DELTAN

THE ORIGINAL SERIES AND THE NEXT GENERATION ERAS ONLY

These humanoids from the Delta system differ in appearance only slightly from Humans, with very little hair across their bodies, aside from eye brows and lashes. As a telepathic and empathic species, the Deltans rank themselves alongside the Vulcans and Betazoids as able to read and communicate via thoughts and feelings. Indeed, some Deltan genealogists have theorized Betazoids are a distant cousin species.

With some of the most potent pheromones the Federation has ever encountered, many other species find the Deltans very sexually appealing. The vast majority of Deltans in Starfleet, therefore, take an oath of celibacy, ensuring their sexuality is not a distraction to their colleagues. By all accounts this is a good thing, as the Deltan act of intimacy involves not only their bodies but also their telepathic minds, possibly endangering the mental health of other species.

EXAMPLE VALUE: *Bodies and Minds as One*

- **ATTRIBUTES:** +1 Control, +1 Insight, +1 Presence
- **TRAIT:** Deltan. Deltans are considered to be beautiful individuals, with powerful empathic abilities and heightened sensuality. The pheromones they excrete are a natural aphrodisiac in most species throughout the Federation, and while serving aboard Starfleet they must be very careful with their natural physiology, using chemical suppressants to cancel the effect.
- **TALENTS:** The character receives access to the following talents:

DELTAN PHEROMONES

REQUIREMENT: Deltan.

The character excretes a natural aphrodisiac pheromone. Whenever they attempt a Task using Presence to influence an attracted creature, they gain one bonus d20. However, they also increase their Complication Range by 2, as the effect can be distracting or lead to unwanted consequences. This talent can be switched off, losing both the bonus and the drawback, by applying chemical suppressants.

EMPATH

REQUIREMENT: Betazoid, Deltan, or Gamemaster's permission. Character creation only.

The Deltan can sense the emotions of most nearby living beings, and can communicate telepathically with other empaths and telepaths, as well as those with whom they

are extremely familiar. Not sensing the nearby emotions is impossible, except for those who are resistant to telepathy. It may require serious effort and a Task to pick out the emotions of a specific individual in a crowd, or to block out the emotions of those nearby. Increase the Difficulty of this Task if the situation is stressful, if there are a lot of beings present, if the target has resistance to telepathy, or if the Gamemaster decides there are other relevant factors.

SAMPLE NAMES:

Male names: Jedda, Clarze

Female names: Ilia, Zinaida

Family names: Adzhin-Dall

UNUSUAL OR UNIQUE CHARACTERS

This chapter adds a dozen new species available as character lifepaths. They represent only a few of the Beta Quadrant species eager to adapt their particular talents to the United Federation of Planets' vision of alliance and exploration. Compared to tense coexistence with the Klingon Empire, or the paranoid shadow of Romulan duplicity, Starfleet offers a welcoming, structured opportunity for access to advanced scientific resources. Academy graduates come not only from species which are formal members of the Federation, but from a wide variety of other worlds, and in addition to the new Beta Quadrant species detailed here, players and Gamemasters may like to introduce species of their own creation never before seen on-screen. More details on unusual and unique characters can be found in the Core Rulebook, page 111.

STARFLEET RANDOM SPECIES TABLE

SPECIES	D20 ENTERPRISE	D20 THE ORIGINAL SERIES	D20 THE NEXT GENERATION
Andorian	1-2	1-2	1
Bajoran	–	–	2-3
Benzite	–	–	4
Betazoid	–	–	5-6
Bolian	–	–	7
Denobulan	3-4	3-4	8
Efrosian	–	5-6	9
Human	5-16	7-14	10-15
Tellarite	17-18	15-16	16
Trill	–	17	17
Vulcan	19-20	18-19	18-19
Zakdorn	–	20	20

This table reflects most common rather than all Starfleet races.

EFROSIAN

THE ORIGINAL SERIES AND THE NEXT GENERATION ERAS ONLY

Hailing from the planet Efros Delta, Efrosians are renowned musicians and historians. Their society is dedicated to oral teaching, most notably in the form of a musical language that all Efrosian children are taught in some form or another. They are also excellent navigators and are often sought out as helm and navigation officers, as well as translators thanks to being natural linguists and communications experts. While their cranial ridges bear some similarity to Klingon physiology (though less pronounced), a male's hair is almost always white from birth while females exhibit darker colors. Males grow long moustaches and both male and female Efrosians grow their hair out down their backs.

EXAMPLE VALUE: *Specialization Furthers Knowledge*

- **ATTRIBUTES:** +1 Fitness, +1 Presence, +1 Reason
- **TRAIT:** Efrosian. As the natives to a planet of harsh freezing storms, Efrosians have natural resilience and survival instincts. They have two stomachs to break down any tough foodstuffs and protect from infection, while their naturally poor eyesight is made up for by their enhanced senses of smell and taste. Interestingly, even though they have poor vision compared to other humanoids, they can perceive a greater portion of the light spectrum than most.
- **TALENTS:** The character receives access to the following talents:

VISUAL SPECTRUM

REQUIREMENT: Efrosian.

An Efrosian can see beyond what others think of as the visual spectrum, from some infra-red to ultra-violet light. Any Tasks in which detecting those parts of the spectrum is useful reduce in Difficulty by 1. Circumstances, such as low light levels, do not affect the Difficulty of Tasks, as long as those Tasks do not relate to perceiving minutiae of a subject.

ORAL SCHOLAR

REQUIREMENT: Efrosian, or Gamemaster's permission.

Efrosians are taught and learn through oral practices or 'by rote'. Any *Obtain Information* Momentum spends that relate to their own knowledge using Reason or Insight may ask one additional question, for free, in addition to those bought with Momentum.

SAMPLE NAMES:

Male names: Ra-ghoratreii, Xin Ra-Havreii, Ra-Yalix

Female names: Hu'Ghrovlatrei, Fellen Ni-Yaleii



KLINGON

THE NEXT GENERATION ERA ONLY

With its capital at Qo'noS, the Klingon Empire is almost as large as the Federation, and larger than the Romulan Empire. Distinguishable by the sagittal crest over their foreheads and crowns, Klingons are taller and stronger than most humanoid species, something that helps enhance their reputation as warriors. The hardy Klingons have been both allies and enemies throughout their years of contact with the Federation. Now, as staunch allies, this proud people have begun to exchange officers with Starfleet. Not only that but Worf, son of Mogh, created a precedent as the first Klingon to graduate of Starfleet Academy. This has brought more applications from Klingons, especially those of mixed heritage who don't feel at ease in the Klingon Empire. Klingons embody pride and honor above all. Many dedicate their lives to the warrior ethos for the honor of house and family.

EXAMPLE VALUE: *Honor is More Important Than Life*

- **ATTRIBUTES:** +1 Daring, +1 Fitness, +1 Presence
- **TRAIT:** Klingon. There is a great redundancy in Klingon organs, with two livers, multiple stomachs, three lungs, and an eight-chambered heart. Their skeletal structure also has several redundancies that mitigate injuries that would prove fatal to other humanoids.
- **TALENTS:** The character receives access to the following talents:

TO BATTLE!

REQUIREMENT: Klingon, or Gamemaster's permission.

Whenever a Klingon buys additional dice for a melee attack using Threat, for each Threat added to the pool, you gain 1 bonus Momentum that can only be spent on *Bonus Damage*, increasing the damage of the attack by 1 per Momentum spent.

BRAK'LUL

REQUIREMENT: Klingon.

Various physiological redundancies mean that wounds that would kill other humanoid species don't affect Klingons as badly. The character gains +2 Resistance against all Non-lethal attacks. In addition, whenever the Klingon is target of a *First Aid* Task, reduce the Difficulty of that Task by 1, to a minimum of 1.

R'UUSTAI

REQUIREMENT: Klingon, or Gamemaster's permission.

This Klingon has lit candles, spoken words to honor their parents, and given their house's sash to another, joining in a fellowship with another person, and becoming members of the same house (the original house of either party). The *R'uustai* Talent grants a Klingon an additional Value, which must reflect their relationship with the ritual sibling. In addition, whenever the Klingon assists, or is assisted by another, the character offering assistance may re-roll their die.

SAMPLE NAMES:

Male names: be'etor, cheng, mogh, qeng, torgh

Female names: 'a'Setbur, HuS, lurSa', mara



RIGELLIAN CHELON

THE ORIGINAL SERIES AND THE NEXT GENERATION ERAS ONLY

Chelons are a hardy race, sharing their home solar system of Rigel with Rigellian Jelna. They are descendants of saber-toothed turtles and, though bipedal, they have retained their ancestral beaks, claws and hard shells. Chelons are androgynous and take on masculine or feminine societal roles at varying points in their lives, reproducing like most reptilians by laying eggs and fertilizing those eggs. Some traditionalists within Chelon society maintain a neutral gender, and refuse to take on male or female roles.

EXAMPLE VALUE: Real Power is in the Service of Others

- **ATTRIBUTES:** +1 Daring, +1 Fitness, +1 Insight
- **TRAIT:** Rigellian Chelon. The Chelon species retains a lot of characteristics from its ancestral species, a type of saber-toothed turtle. They have beaks, and a strong (if clumsy) bite; some have trained to use this in close-quarters combat. During times of stress or physical combat they also emit a deadly toxin through their skin. This can be used with their claws so that the toxin reaches an opponent's blood. They are skilled swimmers and prefer a warm, humid climate. They are also resistant to ultraviolet radiation and, to a lesser extent, other radioactivity. This is probably due to the shells that extend over much their bodies.
- **TALENTS:** The character receives access to the following talents:

CHELON SHELL

REQUIREMENT: Rigellian Chelon.

The hard shell extending over a Chelon's body provides added protection from physical and radioactive threats. This natural armor gives the character a Resistance of 1. They may also ignore any Complications from radiation sources.

TOXIC CLAWS

REQUIREMENT: Rigellian Chelon.

In times of danger Chelons excrete a contact toxin onto their claws that can be used to debilitate foes. Their Unarmed Strike is replaced with a melee attack Claw Strike (Melee, 1▲ Piercing 1, Debilitating, Non-lethal).

SAMPLE NAMES:

Male names: T'k-agma, Genn, Stek'ghen

Female names: Salka, Ash'lak, Dakla'

RIGELLIAN JELNA

THE ORIGINAL SERIES AND THE NEXT GENERATION ERAS ONLY

The Jelna, like the Chelon, are natives of the Rigel system and come from Rigel V. A diligent and hard-working species, the Jelna were the first Rigellians to engage in space flight. Although they took to commerce and system-wide government quicker than the Chelon, the Jelna weren't aggressive, and they made sure that of democratic representation for all Rigellian species on the Governing Board and the Rigellian Trade Commission. The humanoid Jelnas have four genders: two male and two female genders. Male and female exosexes contain an additional Z chromosome, and they outnumber the endosexes 2 to 1. Exosexes are the more resilient and physically adept members of the species, while endosexes are more comparable to the male and female sexes typically found in other humanoid species.

EXAMPLE VALUE: Governance and Trade for the Prosperity of All

- **ATTRIBUTES:** +1 Fitness, +1 Presence, +1 Reason
- **TRAIT:** Rigellian Jelna. The Jelna on Rigel V evolved along similar lines to most humanoids, aside from their four sexes. Endosexes are comparable to other humanoids, while exosexes possess a more robust physique and aggressive tendencies. Endosexes have exclusively gray skin and red eyes and are more suited to nurture and care; exosexes have a pale brown complexion.
- **TALENTS:** The character receives access to the following talents:

EXOSEX

REQUIREMENT: Rigellian Jelna.

The character possess a Z chromosome that strengthens their physical and survival instincts and abilities. Whenever attempting a Task using Fitness or Daring, roll 1 additional d20 and gain one bonus Momentum on such Tasks.

INDUSTRIOUS MIND

REQUIREMENT: Rigellian Jelna, or GM's permission.

The Jelna are naturally enterprising and industrious, and have an affinity for technological developments and industrial engineering. When succeeding an Engineering or Science Task relating to fixing or adapting technology, and spending 2 or more Momentum, a Jelna may add an Advantage related to that technology for free.

SAMPLE NAMES:

Male names: Jemer, Shalma

Female names: Lahvon, Velkal

Family names: Pahtel, Zehron

RISIAN

ALL ERAS OF PLAY

Risa was a planet of fierce storms and tectonic instability before the Risians took it upon themselves to essentially terraform their planet. It is now colloquially known throughout the Federation as a “pleasure planet.” It’s a wonder the Risians evolved into the ceremonial society they have today, with tradition and ceremony being central to Risa society.

Risians have an honest and open attitude to sexuality, renowned throughout the Galaxy. Potential mates with a sexual appetite display ceremonial icons, called a *horga’hn*, that invite partners to participate in the sexual rite *jamaharon*.

EXAMPLE VALUE: *All That is Ours is Yours*

- **ATTRIBUTES:** +1 Control, +1 Insight, +1 Presence
- **TRAIT:** Risian. Risians appear much like Humans, save a decorative gold emblem in the center of the forehead. They have open and adventurous personalities but also have a great patience with others.
- **TALENTS:** The character receives access to the following talents:

PEACEFUL EXISTENCE

REQUIREMENT: Risian, or Gamemaster’s permission. Your upbringing in a peaceful society, one that promotes harmony and has an outright ban on weapons, has developed the Risian ability for peaceful resolutions. Whenever a Risian attempts a Task to dissuade another individual or group from resorting to conflict, they reduce the Difficulty of that Task by 1.

OPEN AND INSIGHTFUL

REQUIREMENT: Risian, or Gamemaster’s permission. Risian open, and often frank, discussion of problems and personal opinion enables conversation and understanding when working in a team. Whenever a Risian assists another character using Insight or Reason they may re-roll a single d20 in their dice pool. In addition, if the lead character succeeds in the Task using Insight or Reason, they gain 1 bonus Momentum.

SAMPLE NAMES:

Male names: Doranis, Melek, Oran

Female names: Aradnis, Elianjah, Joval

XINDI-ARBOREAL

THE NEXT GENERATION ERA ONLY

The intelligent Arboreal species of the Xindi are a contrast some of their cousins on Xindus in that they are known to have an incredibly calm demeanor, some would call them lethargic. But with a relaxed pace comes an appreciation for logical thought and considered discussion. Since becoming members of the Federation, Xindi-Arboreals have worked in Starfleet and the Federation as mediators, counsellors, diplomats and administrators.

EXAMPLE VALUE: *Calm Focuses the Mind*

- **ATTRIBUTES:** +1 Control, +1 Insight, +1 Reason
- **TRAIT:** Xindi-Arboreal. Covered in hair, and with distinctive ridges on their nose and cheekbones, the Arboreals are evolved from creatures similar to that of the Earth sloth. They possess sharp claws and have slightly longer arms than the average humanoid. With a naturally calm, rational mind, they do not panic or stress easily though they do fear large bodies of water. Their dark eyes allow them to see easier in low light conditions compared to other humanoids.
- **TALENTS:** The character receives access to the following talent:

CALM UNDER PRESSURE

REQUIREMENT: Xindi-Arboreal, or Gamemaster’s permission. Arboreals possess an unwaveringly calm nature, allowing them to ignore the stress of a crisis. When attempting Tasks with Control to resist stress or mental affliction they may re-roll one die in your pool.

SAMPLE NAMES:

Male names: Janner, Gralik

Female names: Adela, Rolindis

Family names: Durr

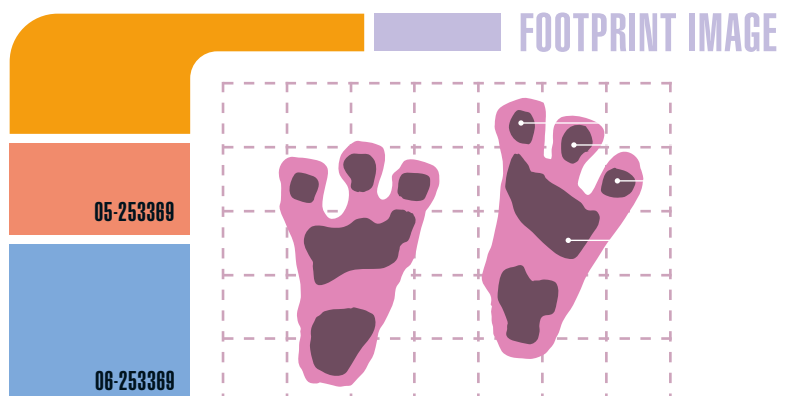

XINDI-PRIMATE

THE NEXT GENERATION ERA ONLY

Xindi-Primates were the second Xindus species to evolve intelligence, after the Xindi-Aquatics. Primates are talented engineers and are often fair, honest and trusted. The Xindi inclusion into the United Federation of Planets in 2311 enabled Xindi-Primates to enhance their learning, and find positions in design, architecture, engineering, along with research and development. They, more than most species to attend the Academy, find themselves in the command division upon graduation, given their adaptability and audaciousness.

EXAMPLE VALUE: *Honesty Never Makes a Problem Worse*

- **ATTRIBUTES:** +1 Daring, +1 Presence, +1 Reason
- **TRAIT:** Xindi-Primate. With a similar physiology to humans, Primates share their characteristic internal organ structure and metabolism, as well as their sensory perceptions. Their facial structure is markedly different, however, with pronounced foreheads and ridged cheekbones like other Xindus species. Amongst other Xindi, Primates have a reputation for fairness and honesty. Many people beyond Xindus have come to regard Xindi-Primates as trustworthy and decent.
- **TALENTS:** The character receives access to the following talent:

A MIND FOR DESIGN

REQUIREMENT: Xindi-Primate, or Gamemaster's permission.

Xindi-Primates are natural engineers and scientists, pushing at the frontiers of design and construction. When following the Scientific Method, they may suggest an additional Focus, which they do not have to possess, as 'The Good Way'. Every Task they attempt in an Extended Task related to the Scientific Method automatically gains the Piercing 1 effect.

SAMPLE NAMES:

Male names: Degra, Ragnar, Toki

Female names: Bryn, Guyda, Hreidur

XINDI-REPTILIAN

THE NEXT GENERATION ERA ONLY

The Reptilian species from Xindus rival the insectoids in aggression, and are likely to resort to force to achieve their goals. They're also notably dishonest and impatient when it comes to dealing with other species, including other Xindi. It is rare for Reptilians to apply to Starfleet Academy, and rarer still for them to be accepted, as their temperament can lead to confrontations. Those Xindi-Reptilians who do join Starfleet rival the Klingons in martial prowess, Tellarites in aptitude for debate, and Zakdorn in tactical expertise.

EXAMPLE VALUE: *Patience is for the Dead*

- **ATTRIBUTES:** +1 Daring, +1 Fitness, +1 Presence
- **TRAIT:** Xindi-Reptilian. These are cold blooded individuals who prefer hotter climates. Scales, ridges and spikes cover their body and they have vertical slit eyes, for adapting to low light conditions and judging depth. A carnivorous, protein-heavy diet gives them muscular tone and definition that enhances their strength and endurance. They have a reputation amongst other Xindi for being aggressive, impatient, stubborn, and untrustworthy.
- **TALENTS:** The character receives access to the following talent:

STUN RESISTANCE

REQUIREMENT: Xindi-Reptilian.

Reptilians are naturally resistant to energy weapons stun settings. They gain +1 Resistance against Non-lethal attacks from energy weapons. They may always *Avoid an Injury* from a Non-lethal attack with a cost of 1 Momentum (Immediate), even if they have already *Avoided an Injury* during the scene.

SAMPLE NAMES:

Male names: Dankra, Guruk

Female names: Igak, Krell

Family names: Dolim

XINDI-INSECTOID

THE NEXT GENERATION ERA ONLY

Among Xindus species, Xindi-Insectoids are considered one of the most aggressive and decisive. They, and the Reptilians are responsible for the destruction of their original homeworld, after detonating vast explosions beneath several seismically active points. Their language is the most complex among the Xindi species with 67 different dialects of clicks and chirps that other species find hard to replicate. Insectoid names grow longer as the individual ages, carrying more meaning and life history than many other species' given names.

EXAMPLE VALUE: *Protect your Off-spring at the Expense of Self*

- **ATTRIBUTES:** +1 Daring, +1 Fitness, +1 Reason
- **TRAIT:** Xindi-Insectoid. Reproduction is asexual with a single adult laying a clutch of eggs. Life expectancy is very short compared to other species with 12 years as the average. Their insectoid bodies grant them enhanced abilities, such as crawling and climbing, while their cheek ridges distinguish them as Xindus natives.
- **TALENTS:** The character receives access to the following talent:

PROTECTIVE INSTINCT

REQUIREMENT: Xindi-Insectoid.

Insectoids have a profound instinct to defend your eggs and their off-spring, and this transfers onto teams or groups with which they develop a close bond. Whenever an Insectoid attempts a Guard Task in combat, and confers the benefits to another Main Character, ignore the increase in Difficulty when attempting the Task.

SAMPLE NAMES:

Xindi-Insectoid names are an incredibly intricate series of clicks and chirps, and while amongst other species often choose a name to be known as by their crewmates, favoring short names that work well with their consonant heavy language.

ZAKDORN

THE NEXT GENERATION ERA ONLY

Seen as easily the best tactical minds in the Galaxy, the Zakdorn excel at complex strategic thinking. This asset has enabled the Federation to streamline its defensive policy over the years, with Zakdorn officials overseeing training exercises and “war games” for Starfleet. Their personal confidence and conviction is often considered boasting and hubris, particularly given that no rival species has ever tested the Zakdorn military. Zakdorn strategists have, however, helped Starfleet and the Federation immeasurably since they joined in the early 24th Century.

EXAMPLE VALUE: *A Coherent Strategy is the First Line of Defense*

- **ATTRIBUTES:** +1 Insight, +1 Presence, +1 Reason
- **TRAIT:** Zakdorn. Zakdorn tend to be of shorter stature than most humanoids and have distinctive wrinkles of fatty tissue over their faces and bodies. This fatty layer enables Zakdorn to survive without food for much longer periods than normal humanoids. Their analytical brains give them an edge in logic and reasoning that rivals even Vulcans.
- **TALENTS:** The character receives access to the following talents:

TACTICAL VOICE

REQUIREMENT: Zakdorn, or Gamemaster's permission.

In command positions, the speed of Zakdorn tactical calculations enables them to give concise orders to their crew. During combat, a Zakdorn leader may use the Direct Task one additional time per scene (so, twice per scene overall). Further, when they use the *Swift Task* Momentum Spend for an extra Task, the cost is reduced to 1 Momentum, so long as the second Task is the *Assist* or *Direct* Task.

MASTER STRATEGIST

REQUIREMENTS: Zakdorn, or Gamemaster's permission.

Zakdorn strategic sense is unparalleled in contemporary military theory. Whenever a Zakdorn attempts a Task to Create an Advantage related to strategy or tactics (as opposed to spending Momentum), reduce the Difficulty by 1.

SAMPLE NAMES:

Male names: Gruhn, Jir, Koll, Sirna

Female names: Bel, Myk, Orym

Family names: Azernal, Bunkrep, Kolrami, Roplik

22-9021

21-8390

LCARS 02-0970

FF-01-8022

0H-01-0210

LA-02-2190

39366298	298421	553058	229451	455295	27383937
30265519	34792	620198	326899	260493	27044612
20343360	320901	236103	15032	273029	24730282
24369201	843920	175073	234921	138430	11239403
24994020	3892	23392	107052	193402	17394550
17504262	580792	259502	12377	529500	59322203

32-2088	7480	8720	1003	08-9667
27-9966	2099	11890	1287	07-2070

VESSEL STATUS

12-3788

17-2880

19-3300

21-5540

LEVEL 4 DIAGNOSTIC

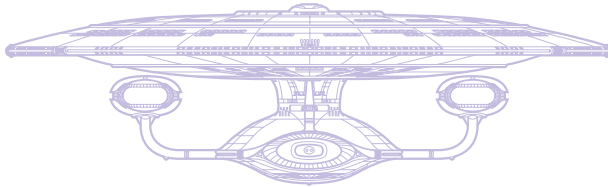

12099	23045	4029	3226	12300
9088	11289	29900	25903	80
41440	9830	3442	440	22058
773	12002	16380	2378	4408
9980	107	10900	29911	

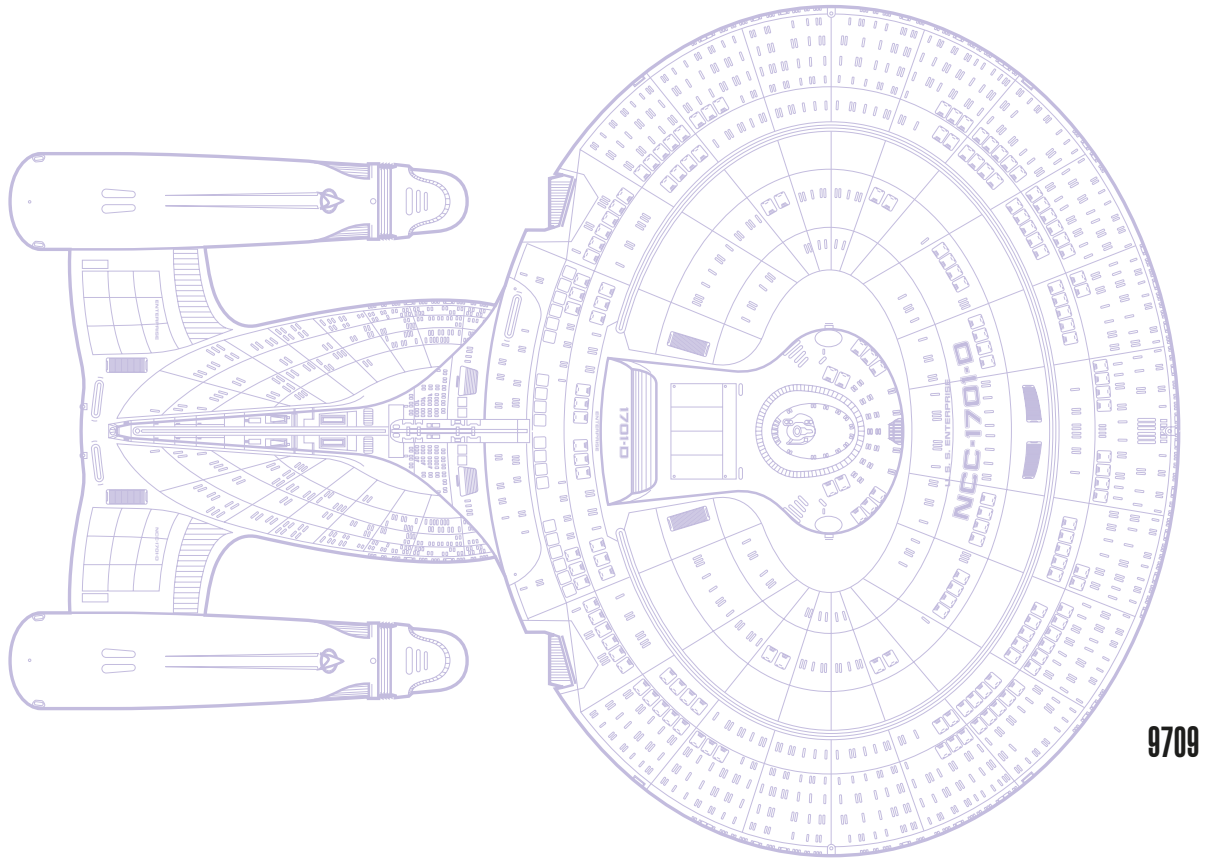

9709

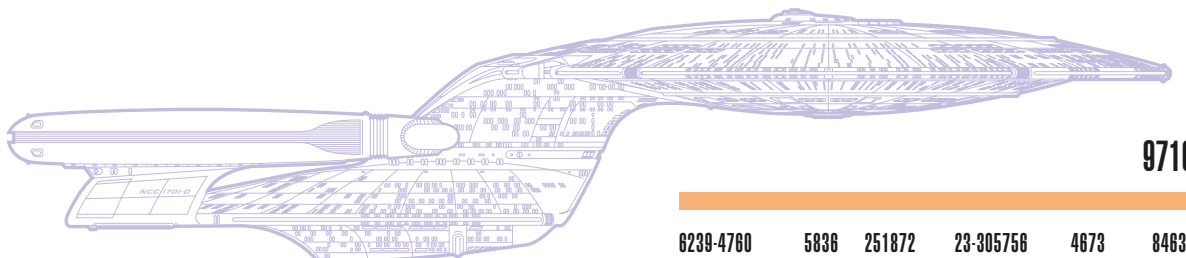

9710

8239-4760	5836	251872	23-305756	4673	84632
4938-2056	33839	220284	65-273396	21012	104585
5637-8200	28340	645640	28-265205	6203	850566

STARSHIPS OF THE BETA QUADRANT

4437946200456
2023046499



04.10	KLINGON STARSHIPS	088
04.20	ROMULAN STARSHIPS	091
04.30	ORION STARSHIPS	094
04.40	GORN STARSHIPS	096
04.50	CIVILIAN STARSHIPS	098

STARSHIPS OF THE BETA QUADRANT

KLINGON STARSHIPS

“HAVE YOU EVER BEEN ON A KLINGON SHIP? IF YOU THINK THE DEFIANT IS CRAMPED AND UNCOMFORTABLE, TRY SPENDING A WEEK ON A BIRD-OF-PREY.”

— LT. COMMANDER JADZIA DAX

D5 BATTLE CRUISER

OVERVIEW: Designed in the time before the Klingon Empire had encountered United Earth and Humans, the D5 battle cruiser was useful as a raiding vessel and border patrol craft. After first contact with Earth it quickly became apparent that the D5 was far more advanced than the top-of-the-line *NX* class of Starfleet, but as the chancellor assumed Vulcan assistance being given to United Earth, precautions began to ensure tactical superiority would continue. The Klingon Defense Force began deploying D5 battle cruisers in two to three ship squadrons to patrol the space between Earth and Qo’noS all the while performing a fast-tracked refit program.

CAPABILITIES: The D5 shares many similarities to later Klingon starship designs including the semi-isolated command and control pod at the forward end of a long, detachable boom that attached to the designs’ engineering and support section. The D5 had advanced propulsion systems capable of warp 6 and had warp nacelles on the end of its wing-like pylons that could have their pitch and yaw slightly adjusted making it a very stable vessel at warp speeds. The D5’s weapon systems were extremely versatile with a port on the front of the command section that had a torpedo launch system ringed by disruptor emitters, giving it a dual-use primary weapons system. The vessel also included a turret with two smaller pulsed disruptor cannons capable of a full rotation. The D5 also had advanced defensive systems compared to Starfleet vessels of the time, with both ablative armor plating and energy shielding capable of shrugging off the spatial and photonic torpedoes of the era. The D5 would continue to be used by the Klingon Defense Force through the late 23rd century as a patrol craft and heavy-interceptor, rarely seen outside the borders of the Empire.

TRAITS: Klingon battle cruiser

SYSTEMS

COMMS 06

ENGINES 07

STRUCTURE 07

COMPUTERS 07

SENSORS 06

WEAPONS 08

DEPARTMENTS

COMMAND 01

SECURITY 02

SCIENCE 01

CONN 02

ENGINEERING 02

MEDICINE 01

POWER: 7

SCALE: 3

SHIELDS: 9

RESISTANCE: 4

CREW: Proficient (Attribute 9, Discipline 2)

ATTACKS:

- Disruptor Cannons (Energy, Range Close, 7▲ Vicious 1)
- Photon Torpedoes (Torpedo, Range Long, 5▲, High-Yield)

SPECIAL:

- Improved Warp Drive
- Improved Hull Integrity

RAPTOR SCOUT

OVERVIEW: The early 22nd century saw a Klingon Defense Force without a significant number of fast and easily produced vessels with a focus on exploration and intelligence gathering. This wasn’t seen as a large problem until word began filtering back through Vulcan sources of multiple species spinward of the Empire. The KDF needed more scouts, and the *Raptor* class was designed.

CAPABILITIES: The *Raptor* shared some traits with its contemporary design, the D5. Approximately the same size, it required a smaller crew, close to a dozen members. This

wasn't due to improved technology or even less equipment on board, but instead because of the Klingon idea that a scout ship was dishonorable duty, expected to be destroyed by the Empire's new enemies. To improve the crew's living conditions, the Empire included a *targ*-pit to allow hunting and sport. The vessel itself was well-suited for exploration with multi-spectral sensor arrays equivalent to those on Starfleet's *NX* class and a relatively high sustained speed of warp 6. The *Raptor* class was also well equipped for combat roles, with energy shielding, three disruptor turrets, and a forward mounted torpedo launcher on the command section. To keep the vessel mass down and to allow it both high warp and impulse speeds, ablative armor was kept to a minimum and no small craft docking or recovery systems were included. The *Raptor* class was still in use in the mid 23rd-century as a courier or as a small attack vessel for the minor houses of Qo'noS.

TRAITS: Klingon scout

SYSTEMS

COMMS	06	ENGINES	07	STRUCTURE	07
COMPUTERS	06	SENSORS	07	WEAPONS	06

DEPARTMENTS

COMMAND	01	SECURITY	02	SCIENCE	01
CONN	04	ENGINEERING	01	MEDICINE	01

POWER: 7 **SCALE:** 3
SHIELDS: 9 **RESISTANCE:** 3

CREW: Proficient (Attribute 9, Discipline 2)

ATTACKS:

- Disruptor Cannons (Energy, Range Close, 7▲ Vicious 1)
- Photon Torpedoes (Torpedo, Range Long, 5▲ High-Yield)

SPECIAL:

- Improved Reaction Control System
- Advanced Sensor Suits

K'T'INGA BATTLE CRUISER

OVERVIEW: The rapid advance of technology in the 2270s and '80s wasn't only seen in the Federation. Improved structural integrity fields, refined shield systems, and a more robust warp core design allowed the venerable D7 to have a refit as extensive as its Federation counterpart, the *Constitution* class. The *K't'inga* class would act as the flagship of the Klingon Empire from the 2290s through to the 2340s and would see continued use as second-line assault vessels and primary use starships for the minor houses of Qo'noS.

ABLATIVE ARMOR

In this case, Ablative Armor is used as a Talent to represent the thickness of the *Raptor* class' hull. While ablative armor wasn't in use by the Federation until 2371, we've used it here to increase the *Raptor's* Resistance by 2.

CAPABILITIES: The *K't'inga*-class refit was smaller than the D7. This was possible through the removal of many bulkheads made unnecessary by the advances in structural integrity fields and the removal of external armor plating to allow the improved shield emitters to be installed along the surfaces of the engineering hull. The reduced size and weight made the *K't'inga* class not only more maneuverable at sub-light speeds, but also gave it a higher warp capability without needing to upgrade anything more than the safety systems of the matter/ antimatter core. The mass savings allowed for the inclusion of a rear facing photon torpedo launcher, and in some later models produced in the 24th century, the inclusion of disruptor arrays along the leading edge of the secondary hull were seen as necessary to keep up with the rapid pace of technological development. As of 2371, they can be seen on the outer edges of Klingon formations, leading attacks on heavily defended positions, as they hope to die honorably.

TRAITS: Klingon battle cruiser

SYSTEMS

COMMS	08	ENGINES	09	STRUCTURE	09
COMPUTERS	07	SENSORS	07	WEAPONS	09

DEPARTMENTS

COMMAND	04	SECURITY	03	SCIENCE	01
CONN	02	ENGINEERING	01	MEDICINE	01

POWER: 8 **SCALE:** 4
SHIELDS: 12 **RESISTANCE:** 4

CREW: Talented (Attribute 10, Discipline 3)

ATTACKS:

- Disruptor Arrays (Energy, Range Medium, 7▲ Vicious 1, Area or Spread)
- Photon Torpedoes (Torpedo, Range Long, 6▲ High-Yield)
- Tractor Beam (Strength 3)

SPECIAL:

- Command Ship
- Cloaking Devices

NEGh'VAR WARSHIP

OVERVIEW: Reliance on the *K't'inga* class for a flagship and a 'ship of honor' in the Klingon Defense Force caused arguments in the High Council during the 2360s as the design was approaching a century in service. By the late

2360s with the upcoming launch of the first of the *Vor'cha*-class attack cruisers, the honor of the great generals of the Empire was felt to be under threat leading fleets from the aging *K't'inga* class. A new battleship capable of taking on the best vessels of the enemies of the Empire was designed, specifically with giving the opportunity for the officers and greatest warriors of the Empire the ability to maintain, and even achieve greater feats than before. The *Negh'Var* class was the result.

COMMON KLINGON SPECIAL RULES

CLOAKING DEVICE: This vessel is equipped with a cloaking device, allowing the ship to effectively 'disappear' from visual and sensor detection methods. To cloak, a crewmember at the tactical station is required to attempt a **Control + Engineering Task** with a Difficulty of 2, assisted by the ship's **Engines + Security**. This Task has a Power requirement of 3.

If successful, the ship gains the Cloaked Trait. While cloaked, the ship cannot be the target of any attack nor can it use any of its attacks. While cloaked the ship has Shields 0. It requires a Minor Action to decloak.

CAPABILITIES: *Negh'Var*-class warships are designed to intimidate and impress. They are larger than the Federation's Galaxy class and carry over double its crew. Much of the extra crew compared to Starfleet vessels is due to less automation in Klingon systems, but this still allows accommodations for nearly five hundred warriors that are used as honor guards or for ground assaults and boarding parties. The overwhelming firepower that is standard on all *Negh'Var*-class vessels includes multiple disruptor, phaser, and torpedo systems, as well as point defense phaser and disruptor emplacements. In order to effectively use these systems, the design includes the largest computer system currently in use by the Klingon Defense Force with two separate isolinear cores for the ship's own systems and a dedicated battle computer for use to network incoming sensor feeds from other Klingon vessels. Few of these vessels are



currently active, the most notable being the flagship of the Klingon Empire, *I.K.S. Negh'Var* under the command of General Martok.

TRAITS: Klingon warship

SYSTEMS

COMMS	09	ENGINES	10	STRUCTURE	10
COMPUTERS	10	SENSORS	09	WEAPONS	12

DEPARTMENTS

COMMAND	03	SECURITY	04	SCIENCE	01
CONN	02	ENGINEERING	02	MEDICINE	02

POWER: 15 **SCALE:** 6
SHIELDS: 14 **RESISTANCE:** 7

CREW: Exceptional (Attribute 11, Discipline 4)

ATTACKS:

- Disruptor Array (Energy, Range Medium, 10▲ Vicious 1, Area or Spread)
- Disruptor Cannon (Energy, Range Close, 12▲ Vicious 1)
- Photon Torpedoes (Torpedo, Long Range, 7▲ High-Yield)
- Tractor Beam (Strength 5)

SPECIAL:

- Cloaking Device
- Fast Targeting Systems
- Secondary Reactors (included above)
- Extensive Shuttlebays
- Improved Hull Integrity
- Command Ship

CHAPTER
04.20

STARSHIPS OF THE BETA QUADRANT

ROMULAN STARSHIPS

BIRD-OF-PREY (22ND CENTURY)

OVERVIEW: Known to all historians interested in the beginnings of the Federation and the last major war fought by United Earth, the Romulan bird-of-prey has a special place in many Humans' minds. Most will recall the stories and images of these vessels appearing and destroying helpless civilian vessels or massing attacks, vaporizing the best of brightest of Starfleet throughout the Earth-Romulan War. The bird-of-prey concept was so successful to the Romulans that they continued its use through the 23rd century. The concept held that a starship should strike fast and run before any counter-attack could be planned, and the 22nd century bird-of-prey accomplished this with ease.

CAPABILITIES: The bird-of-prey is a single-hulled vessel with two wide wings that taper into the first non-toroidal warp system developed by the Romulans. This allowed the design to maneuver at warp speeds much more easily than equivalent Vulcan designs of the time, putting them on par with the Starfleet *NX* class, but with a higher maximum

sustained warp speed. The design did have defensive shielding, but power generation in combat was prioritized to propulsion systems, making the shielding weak and able to be brought down after a short amount of time. Its offensive systems were extensive with a powerful pulse disruptor enhanced with warp plasma (not quite the plasma torpedoes of the 23rd century, but a small technological step from them), and disruptor cannons. Most importantly, the bird-of-prey was the testbed for the first fully operational cloaking device. This piece of equipment would allow the vessel to hide itself from active and passive sensors more thoroughly than even the best Starfleet electronic warfare systems at the time. The system was power hungry and the bird-of-prey was unable to go to warp, raise its shields, or even charge weapons while the device was in use. By the end of the Earth-Romulan War these vessels were out of date and outgunned by *Daedalus*-class Starfleet vessels. The design would continue to see use through the early 23rd century before being replaced by the upgraded bird-of-prey.

TRAITS: Romulan bird-of-prey



SYSTEMS

COMMS	06	ENGINES	09	STRUCTURE	06
COMPUTERS	06	SENSORS	08	WEAPONS	08

DEPARTMENTS

COMMAND	03	SECURITY	01	SCIENCE	01
CONN	02	ENGINEERING	02	MEDICINE	01

POWER: 9

SCALE: 3

SHIELDS: 7

RESISTANCE: 3

CREW: Proficient (Attribute 9, Discipline 2)

ATTACKS:

- Disruptor Banks (Energy, Range Medium, 5▲ Vicious 1)
- Disruptor Pulse (Torpedo, Range Long, 4▲, High-Yield)

SPECIAL:

- Cloaking Device
- Backup EPS Conduits

SCOUT SHIP

OVERVIEW: Much of the ship building capacity of the Romulan Empire was consumed with building the large *D'deridex*-class warbirds in the 2340s and 50s. Before even more resources were taken away from other projects, officers of both the navy and *Tal Shiar* convinced the Senate to allocate drydock facilities to smaller and more agile vessels suited to stealthy exploration and covert operations. The smallest of these vessels was designated Project G82 and was given the name 'scout ship' by Starfleet on first encountering it.

CAPABILITIES: The scout ship is slightly larger than a standard Starfleet *Danube*-class runabout with a typical crew compliment of two to four and the ability for its life support systems to handle up to twelve standard humanoids for less than a day. When it was designed, the vessel was too small to utilize the artificial singularity powering the larger vessels of the Imperial Navy, and instead used a matter/antimatter warp core and fusion reactors for impulse power. The vessel also included three small radioisotope thermoelectric generators capable of powering only the life support systems if the crew needed to operate on low-power mode and the

neutrino emissions from the fusion reactors may give their position away. The design included a cloaking device that was as effective as other models installed on larger vessels, but when powered up, the scout could only achieve a warp speed of close to three rather than its maximum of five.

TRAITS: Romulan scout

SYSTEMS

COMMS 07 ENGINES 09 STRUCTURE 07
 COMPUTERS 07 SENSORS 08 WEAPONS 07

DEPARTMENTS

COMMAND 01 SECURITY 01 SCIENCE 02
 CONN 03 ENGINEERING 01 MEDICINE 01

POWER: 5 **SCALE:** 2

22ND CENTURY SHIELDING

The bird-of-prey (see p.91) does not have deflector shielding, but rather is equipped with layers of hull plating. This functions in the same way as Shields do, with one difference: the ship suffers a Breach if four or more damage is suffered after deductions for Resistance.

SHIELDS: 4 **RESISTANCE:** 2

CREW: Proficient (Attribute 9, Discipline 2)

ATTACKS:

- Disruptor Cannons (Energy, Range Close, 5▲, Vicious 1)

SPECIAL:

- Cloaking Device
- High Resolution Sensors

ROMULAN SCOUT

3890	450	11899
37800	29400	1350
1840	37990	21060
990	1600	38000

21-8825

22-5280

25-5590

28-0058

12-0348

10-3883

09-3870

08-2229

STARFLEET INTELLIGENCE

STARSHIPS OF THE BETA QUADRANT

ORION STARSHIPS

ORION SCOUT SHIP

OVERVIEW: When Vulcans made first contact with the Orions they found an already advanced civilization that had developed warp drive decades previous, but had yet to leave their home system with its many planets and moons. After this contact, the Orions began a rapid push outward, not as colonists, but as merchants. Conflicts with other species with extensive trade networks made the Orion Syndicate order the design of a powerful attack vessel that could also double as a deep-space explorer, allowing new markets to be opened before other species could find them. Research on the warp systems took far longer than initially expected and it would be the mid-23rd century before the first scout ship was launched.

CAPABILITIES: The scout ship used ideas and technology stolen or developed from many species including the Vulcan-like toroidal warp drive, but improved using two counter-rotating subspace impellers that generated a standing subspace wave in the warp coils present in the outer propulsion ring. This gave the vessel an incredible top warp speed in excess of warp 10 (at the scale used at the time, approximately warp 8 in the modern scale). While this speed made travel between systems fast, any course corrections using such a system were impossible beyond minor shifts unless the vessel dropped from warp and readjusted its course. The hull of the scout ship had a thin layer of rare trititanium, making sensor locks difficult to acquire. The design contained a moderate amount of weaponry for a ship of its size, primarily avoiding combat by using its speed to flee.

TRAITS: Orion scout

SYSTEMS		
COMMS	06	ENGINES
		10
		STRUCTURE
		06
COMPUTERS	06	SENSORS
		07
		WEAPONS
		06
DEPARTMENTS		
COMMAND	01	SECURITY
		01
		SCIENCE
		02
CONN	03	ENGINEERING
		01
		MEDICINE
		01

POWER: 10
SHIELDS: 7

SCALE: 3
RESISTANCE: 3

CREW: Proficient (Attribute 9, Discipline 2)

Attacks:

- Phaser Array (Energy, Range Medium, 4▲, Versatile 2, Area or Spread)
- Photon Torpedoes (Torpedo, Range Long, 4▲, High-Yield)

SPECIAL:

- Improved Warp Drive

ORION INTERCEPTOR

OVERVIEW: The Orion interceptor was based on the first Orion vessel to achieve warp speed, *Flight*. Both share an avian-like appearance, but that is where the similarities end as the interceptor was specifically designed to be an attack ship by the ruling cartel in the early 22nd century. The design spread to other shipbuilding concerns and the vessel became ubiquitous with Orion criminal elements operating in space frequented by United Earth and its allies.

CAPABILITIES: As an attack vessel, priority was given to providing the interceptor with both speed and firepower. The interceptor could achieve speeds of warp 6.2, not as fast as most Vulcan vessels of the pre Earth-Romulan War era, but fast enough to run down starships of other species. Its primary weapon system was a large particle accelerator and emitter mounted on the dorsal hull and forward facing. This weapon had a limited firing arc due to extensive power couplings leading to the necessity of a multi-vectorized impulse drive that made the vessel highly agile and able to bring the weapon to bear on its target. These systems made the interior of the small vessel very cramped and the interceptor was typically crewed by 20-30 personnel with few comforts. In an attempt to alleviate boredom and provide some entertainment many crews of interceptors would convert one of the vessels two small cargo bays into a 'pleasure den' containing many of the vices, including slaves, that they missed from home.

TRAITS: Orion interceptor

SYSTEMS

COMMS 07

ENGINES 09

STRUCTURE 07

COMPUTERS 07

SENSORS 07

WEAPONS 08

DEPARTMENTS

COMMAND 01

SECURITY 03

SCIENCE 01

CONN 04

ENGINEERING 01

MEDICINE 01

POWER: 9

SCALE: 3

SHIELDS: 10

RESISTANCE: 3

CREW: Proficient (Attribute 9, Discipline 2)

ATTACKS:

- Particle Beam (Energy, Range Medium, 6▲, Versatile 2)

SPECIAL:

- Improved Reaction Control System
- Improved Impulse Drive

ORION BLACKGUARD

OVERVIEW: Filling the role of both cruisers and battleships in the navies of the Orion cartels is the Blackguard. These vessels have been in use since the mid-22nd century and have continually seen refits and upgrades over the centuries allowing them to continue to be relevant on the changing galactic scene. The low amount of actual hard service these vessels see allows them long service lives and many of the *Blackguard*-class vessels in service in the 24th century were in use during the Earth-Romulan War guarding illegal battlefield salvage operations and guarding weapons shipments between neutral star systems.



CAPABILITIES: The *Blackguard* isn't used in a similar manner to most fleets' cruisers and more like battleships and escorts, rarely straying far from the Orion home-system and only then to escort valuable convoys of goods important to the Syndicate with the indication of illegality and rarity given by the number of vessels present. As escorts, the design has little emphasis on speed and maneuverability, with even 24th century refits of this class only having a maximum sustained warp factor of 7. These ships contain a variety of weaponry from Federation style phaser emitters, to disruptor pulse cannons, and photon torpedoes.

TRAITS: Orion cruiser

SYSTEMS

COMMS 08

ENGINES 07

STRUCTURE 11

COMPUTERS 09

SENSORS 09

WEAPONS 09

DEPARTMENTS

COMMAND 02

SECURITY 03

SCIENCE 01

CONN 01

ENGINEERING 02

MEDICINE 02

POWER: 7

SCALE: 4

SHIELDS: 14

RESISTANCE: 5

CREW: Proficient (Attribute 9, Discipline 2)

ATTACKS:

- Phaser Array (Energy, Range Medium, 7▲, Versatile 2, Area or Spread)
- Disruptor Cannons (Energy, Range Close, 9▲ Vicious 1)
- Photon Torpedoes (Torpedo, Range Long, 6▲, High-Yield)
- Tractor Beam (Strength 3)

SPECIAL:

- Improved Hull Integrity
- Command Ship

PLEASURE BARGE

OVERVIEW: Ostensibly not for military use, the typical Orion pleasure barge is used not only as a roaming trade station for the cartels, but also as a base of operations for Orion criminals and intelligence assets. Each pleasure barge is unique in appearance, often with garish colors on its hull and fantastical interior decorations and rooms, reflecting the personality of the vessel's current owner.

CAPABILITIES: This design is slow compared to even a *Blackguard*-class Orion starship, but speed is almost unneeded by these vessels as their intent is to draw in visitors even from barely warp capable societies.

Weapon ports are hidden behind false hull plating so visitors don't think that there is any threat from the ship's hidden rapid-fire disruptors. Inside the vessel, sections are dedicated to typical ships functions; command and control, sickbay, engineering, etc. These sections of the ship are small compared to the public areas that are accessed through transporter systems or the expansive shuttlebay; casinos, brothels, drug dens, slave auction houses, fighting arenas, holosuites, and drug production labs. The crime these vessels bring to Federation space makes them unwelcome, but they are often seen operating inside the Orion home system and in border regions of the Federation, plying their trade.

TRAITS: Orion barge

SYSTEMS

COMMS 08	ENGINES 06	STRUCTURE 10
COMPUTERS 08	SENSORS 09	WEAPONS 07

DEPARTMENTS

COMMAND 03	SECURITY 03	SCIENCE 01
CONN 01	ENGINEERING 02	MEDICINE 04

POWER: 6 **SCALE:** 5
SHIELDS: 13 **RESISTANCE:** 6

CREW: Proficient (Attribute 9, Discipline 2)

ATTACKS:

- Disruptor Cannons (Energy, Range Close, 10▲ Vicious 1)
- Tractor Beam (Strength 4)

SPECIAL:

- **Pleasure Suites** (function as Diplomatic Suites)
- **Improved Hull Integrity**
- **Extensive Shuttlebays**
- **Hidden Emplacements:** Hull plating disguises the weapons aboard this ship. These weapons are not immediately detectable, and when hidden require an **Insight + Security Task** assisted by a ship's **Sensors + Security** with a Difficulty of 3, to detect. Before attacking, the crew must spend a Minor Action to ready the emplacements. To hide them also requires a Minor Action.

STARSHIPS OF THE BETA QUADRANT

GORN STARSHIPS

GORN RAIDER

OVERVIEW: Designed to be either a rapid response vessel or a light attack vessel, the Gorn raider was the primary starship in the Hegemony during the mid to late 23rd century. Some aspects of the raider are similar to Starfleet designs, suggesting either technological espionage undertaken by the Hegemony or its allies, or a remarkable case of parallel development between the two groups of engineers.

CAPABILITIES: The raider was about half the size of the *Constitution*-class starship, but this wasn't due to needing high sub-light accelerations or low power needs, it was due to the Hegemony's primitive warp coils of the time. The sub-space field generated by the coils was unstable, so a smaller field was necessary to achieve warp speeds. The coils were also prone to melting down, so Gorn designers included four separate warp nacelles. Much like the later *Constellation* class, two of the nacelles would be in use at any given time, while the others were kept active at minimum power to act as warp field stabilizers.

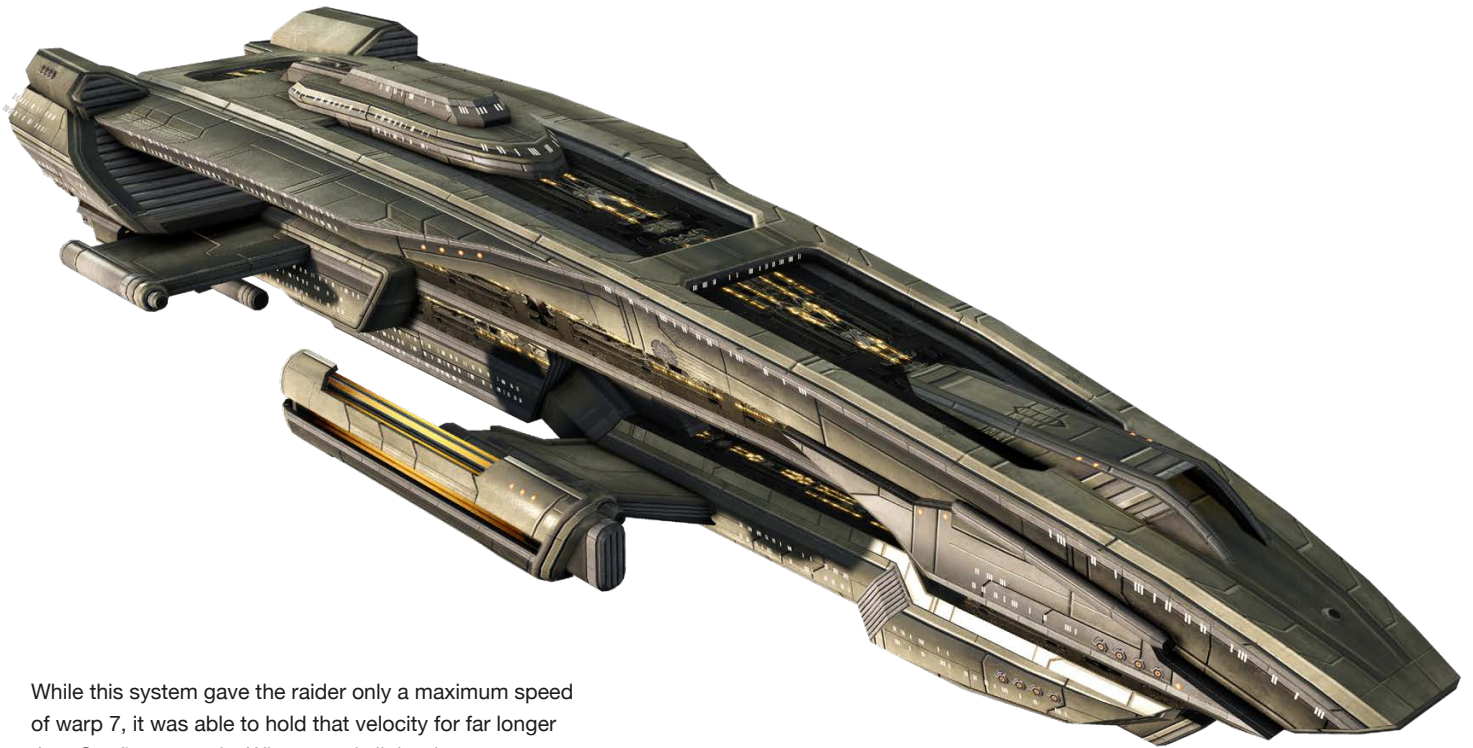

While this system gave the raider only a maximum speed of warp 7, it was able to hold that velocity for far longer than Starfleet vessels. When at sub-light, the warp core could directly power the vessels disruptor systems, giving the Raider devastating amounts of firepower for its mass, rivaling Starfleet's heavy cruisers. The raider would be taken out of service by the late 23rd century in favor of larger and more heavily armed vessels.

TRAITS: Gorn raider

SYSTEMS

COMMS 07

ENGINES 08

STRUCTURE 07

COMPUTERS 07

SENSORS 08

WEAPONS 09

DEPARTMENTS

COMMAND 01

SECURITY 02

SCIENCE 01

CONN 02

ENGINEERING 03

MEDICINE 01

POWER: 8

SCALE: 3

SHIELDS: 9

RESISTANCE: 3

CREW: Proficient (Attribute 9, Discipline 2)

ATTACKS:

- Disruptor Array (Energy, Range Medium, 5▲ Vicious 1, Area or Spread)
- Photon Torpedo (Torpedo, Range Long, 5▲, High-Yield)
- Tractor Beam (Strength 2)

SPECIAL:

- Improved Warp Drive
- Backup EPS Conduits

GORN VARANUS BATTLESHIP

OVERVIEW: Rarely seen outside of the Hegemony and never without smaller escorts, the Gorn Varanus battleship is the largest vessel used in an active role by the Gorn. The defender is used typically as a patrol vessel, so when it is deployed to an uninhabited and unclaimed star system, it's likely the Hegemony will be claiming that system for themselves. These vessels are also used as escorts for the Hegemony's mobile shipyards and nest ships, and many can be found in the home system of the Hegemony undergoing maintenance, upgrade and providing an honor guard for the queen and her court.

CAPABILITIES: First seen in 2351, the *Varanus* battleship was over twice the size of the *Ambassador*-class *U.S.S. Clearwater* that encountered it. The vessel is crewed by between two and four thousand Gorn with some crew stationed in the designs' two warp nacelles. The vessel is slow in both sub-light and warp speeds, with maximum velocities observed of warp 7.2. Its armaments are equivalent to Starfleet's later *Galaxy* class, but where the *Varanus* stands out is its defenses. Much of the vessel's power is dedicated to shielding, structural integrity fields, and deflector arrays. In addition, the exterior of the hull is lined with thick plates of layered duranium composite that can shrug off weapons fire even after the vessels shields have collapsed. Speed and agility are clearly not a priority for the *Varanus* as the mass of the armor plate alone makes the vessels' impulse decks labor to move it.

TRAITS: Gorn battleship

STARSHIPS OF THE BETA QUADRANT

CIVILIAN STARSHIPS

SYSTEMS

COMMS 08

ENGINES 07

STRUCTURE 12

COMPUTERS 09

SENSORS 08

WEAPONS 09

DEPARTMENTS

COMMAND 02

SECURITY 03

SCIENCE 02

CONN 02

ENGINEERING 03

MEDICINE 02

POWER: 7

SCALE: 6

SHIELDS: 15

RESISTANCE: 8

CREW: Talented (Attribute 10, Discipline 3)

ATTACKS:

- Disruptor Array (Energy, Range Medium, 9▲ Vicious 1, Area or Spread)
- Photon Torpedo (Torpedo, Range Long, 6▲, High-Yield)
- Tractor Beam (Strength 5)

TALENTS:

- Redundant Systems
- Rugged Design
- Duranium Armor Plating: The ship's Resistance is increased by 2.

FREIGHTERS

OVERVIEW: Civilian freighters are a widely varying group of designs ranging from the tiny warp capable *Gnat*-class agricultural freighter to the massive and slow *T'lika*-class bulk ice hauler. Federation Merchant Marines have standardized classes of freighters that allow ease of maintenance and give manufacturers as well as Starfleet a clear picture of how much they can move between systems. These vessels are distinct from transports as freighters focus solely on shipping cargo.

TRAITS: Freighter

SYSTEMS

COMMS 07

ENGINES 07

STRUCTURE 09

COMPUTERS 07

SENSORS 08

WEAPONS 06

DEPARTMENTS

COMMAND 01

SECURITY 01

SCIENCE 01

CONN 01

ENGINEERING 02

MEDICINE 02

POWER: 7

SCALE: 3

SHIELDS: 10

RESISTANCE: 3

CREW: Basic (Attribute 8, Discipline 1)

ATTACKS:

- Phaser banks (Energy, Range Medium, 5▲, Versatile 2)

SPECIAL:

- Rugged Design

TRANSPORTS

OVERVIEW: Transports built in and beyond the Federation all tend to serve the same purpose, the transportation of people from one star system to the other. As such these vessels typically have no weaponry, minimal defensive shielding, and highly redundant life support systems and comfortable quarters, and warp drives able to maintain high cruising speeds.

TRAITS: Transport

SYSTEMS

COMMS 06

ENGINES 08

STRUCTURE 07

COMPUTERS 06

SENSORS 07

WEAPONS —

DEPARTMENTS

COMMAND 01

SECURITY 01

SCIENCE 01

CONN 02

ENGINEERING 02

MEDICINE 02

POWER: 7

SCALE: 3

SHIELDS: 8

RESISTANCE: 3

CREW: Basic (Attribute 8, Discipline 1)

SPECIAL:

- Improved Warp Drive

COLONY SHIPS

OVERVIEW: Colony ships exist in a middle ground between transports and freighters as they are designed to carry both personnel and equipment, large quantities of both, of interstellar distances. Most colony vessels are smaller than imagined, with groups of these vessels working in tandem to colonize a world.

TRAITS: Colony ship

SYSTEMS

COMMS 07

ENGINES 08

STRUCTURE 09

COMPUTERS 07

SENSORS 07

WEAPONS —

DEPARTMENTS

COMMAND 01

SECURITY 01

SCIENCE 02

CONN 01

ENGINEERING 02

MEDICINE 02

POWER: 8

SCALE: 3

SHIELDS: 10

RESISTANCE: 3

CREW: Basic (Attribute 8, Discipline 1)

SPECIAL:

- Extensive Shuttlebays

SURVEY SHIPS

OVERVIEW: Civilian Survey ships come in two varieties: retired Starfleet science vessels such as the *Oberth* class, or as specially constructed vessels used by research organizations and universities across the Federation. Survey ships can be used in many of the same ways as Starfleet science or exploration vessels, but without the need for weaponry, heavy shielding, or the most robust systems available, more of the vessel can be dedicated to pure research.

TRAITS: Survey ship

SYSTEMS

COMMS 07

ENGINES 07

STRUCTURE 07

COMPUTERS 10

SENSORS 11

WEAPONS —

DEPARTMENTS

COMMAND 01

SECURITY 01

SCIENCE 04

CONN 01

ENGINEERING 01

MEDICINE 02

POWER: 7

SCALE: 3

SHIELDS: 8

RESISTANCE: 3

CREW: Proficient (Attribute 9, Discipline 2)

SPECIAL:

- Advanced Sensor Suites
- Modular Laboratories

XHOSA FREIGHTER SCAN

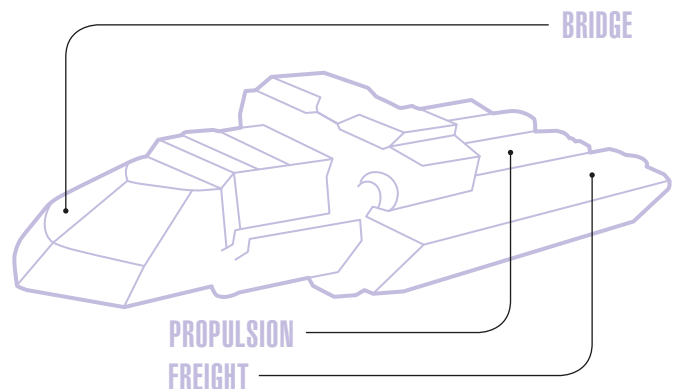

2185-3580	1885	188743	18-300-50	1480	10220	320800	320
1818-3068	1988	205350	20-327-45	21550	357850	212908	3450
1929-4040	18583	50388	27-435-58	45520	24890	459780	4560



VULCAN SCIENCE ACADEMY SURVEY VESSEL

OVERVIEW: Respected across the Federation and beyond, the Vulcan Science Academy has one of the largest fleets of actively used survey vessels of any institution of higher learning known. This large fleet is typically used to train students in practical astrophysics, geophysics, subspace theory, quantum mechanics, and biology. With this wide range of possible assignments, the VSA requested a new design for a survey vessel in 2340 from the ShiKar Orbital Shipyards, the first of the new class entering service in 2346.

CAPABILITIES: Like many Vulcan designs, the VSA survey vessel uses a toroidal subspace-field generation system in lieu of the more standard dual warp nacelle designs seen elsewhere in the Federation. This gives the vessels a highly stable warp field at the expense of being able to change course at superluminal velocities. While at warp, the warp torus is perpendicular to the main hull of the vessel, but rotates so it is parallel to hull at sub-light speeds. Sensor networks designed to monitor the sub-space fields in the torus, while not being used to maintain warp speeds, aid the vessel's already impressive sensor suite by adding a fine resolution sub-space scan to all surveys. The survey vessel typically maintains an active crew of fifteen that always serve as teachers and act as officers for the vessel in addition to the thirty students on board. The vessel lacks many features including weapons, defensive shielding, and even a shuttlebay, with the Science Academy preferring a strictly

monitored environment on the ship to any learning on the surface of alien worlds. Any movement to and from the vessel is accomplished via transporter.

TRAITS: Vulcan starship

SYSTEMS

COMMS 07

ENGINES 08

STRUCTURE 07

COMPUTERS 11

SENSORS 12

WEAPONS —

DEPARTMENTS

COMMAND 01

SECURITY 01

SCIENCE 04

CONN 01

ENGINEERING 02

MEDICINE 01

POWER: 8

SCALE: 3

SHIELDS: 0

RESISTANCE: 3

CREW: Talented (Attribute 10, Discipline 3)

SPECIAL:

- **Modular Laboratories**
- **Advanced Sensor Suites**
- **High Resolution Sensors**
- **No Shuttlebay:** The starship cannot support any small craft.

ENCOUNTERS AND ADVERSARIES



34362070473892
12849304474

05.10	THE ROMULAN NEUTRAL ZONE	102
05.20	THE BRIAR PATCH	108
05.30	THE KLINGON BORDER	116
05.40	THE SHACKLETON EXPANSE	121

ENCOUNTERS AND ADVERSARIES

THE ROMULAN NEUTRAL ZONE

"I REGRET THAT WE MEET IN THIS WAY. YOU AND I ARE OF A KIND. IN A DIFFERENT REALITY, I COULD HAVE CALLED YOU FRIEND."

— ROMULAN COMMANDER

DESCRIPTION

In astrographic terms, the Romulan Neutral zone is a volume of space one light-year wide and 600 light-years long with a roughly egg-shaped cross section. Its very name conjures up thoughts of adventure and peril in the dark: perhaps a plucky Federation starship playing hide-and-seek with a cloaked Romulan cruiser; or a stalwart border garrison holding the line against an imminent invasion. To the Romulans, the Neutral Zone is a mixed blessing. Several times in their history, they have found it convenient to withdraw into their empire, with the Zone as their shield. At other times it has been a hindrance to their business, whether that be espionage or expansion. To Starfleet the Neutral Zone is the end of Federation space: entering it, except under specific circumstances, is an act of war. There have been times in the past that captains on both sides have found a possible war to be an acceptable risk.

ENCOUNTER SEEDS

KOBAYASHI, REVISITED

The Player Characters' ship is on routine patrol near the Neutral Zone when they receive a distress call from just inside the Zone. The call apparently comes from a Romulan colony ship full of noncombatants. They have a problem with their warp core: the dilithium is decrystallizing and, in a matter of hours, the core will go critical. Sensor scans bear out the story. The ship's captain claims that there are no Romulan patrol vessels in the area, and that she would even accept Klingon help if it would save her people.

There are several possibilities for this seed. Perhaps the Player Characters are cadets taking a new variant of the *Kobayashi Maru* test. The distress call may be legitimate, but the ship itself cannot be saved: do the Player Characters risk taking several hundred enemy citizens aboard their starship?

And even a legitimate distress call could be used by a cloaked Romulan patrol ship to lure a Federation vessel into the Zone to be captured.

CLOAK AND DISRUPTOR

Starfleet has been contacted by the Romulan underground. They have somehow acquired the plans to a new version of the cloaking device, one that is believed to be able to evade the tachyon sensor net. As always, Starfleet wants to acquire the plans or a working example as soon as possible to develop countermeasures.

The Player Characters are sent into Romulan territory on a stolen ship to make contact with the informant and acquire the plans. If they are captured, the Federation will disavow them and their activities. Perhaps it is a *Tal Shiar* trap, designed to reveal members of the underground. Or the contact may be legitimate but the plans are false, meant to send Federation scientists down plausible, but fruitless, lines of research. Of course, the situation could be entirely legitimate but the *Tal Shiar* have become aware that the plans have been stolen. Getting out of Romulan space will be more difficult than getting in...

DIPLOMATIC INSANITY

The Romulans have requested a rendezvous in the Neutral Zone to open up the possibility of diplomatic talks. The purpose of the talks, they claim, is to regularize Ambassador Spock's status on Romulus. Naturally, he has been invited to participate. The Romulans have promised safe passage and diplomatic immunity to all involved.

After a diplomatic event held on the Player Characters' ship, one of the Romulan diplomats is found dead. In an uncanny echo of the Coridan negotiations a century earlier, it appears that Spock is the killer. His whereabouts cannot be confirmed, and any computer records that might shed light on the situation have been destroyed. The Player Characters must bring the true murderer to light before the Federation is forced to either hand over Spock or an interstellar war breaks out.

SCOUTSHIP PILOT [MINOR NPC]

Scoutship pilots are skilled pilots and engineers: they often operate in remote areas without support, and have to be able to make their own repairs. They are also tough enough to perform flight maneuvers under cloak. The power demands of the cloaking device leave very little spare energy for the inertial dampeners.

TRAITS: Romulan

ATTRIBUTES



DISCIPLINES



STRESS: 11 **RESISTANCE:** 0

ATTACKS:

- Unarmed Strike (Melee, 2▲ Knockdown, Size 1H, Non-lethal)
- Dagger (Melee, 2▲ Vicious 1, Size 1H)
- Disruptor Pistol (Ranged, 4▲ Vicious 1, Size 1H)
- Escalation** Disruptor Rifle (Ranged, 5▲ Vicious 1, Size 2H, Accurate)

SPECIAL RULES:

- One With the Ship:** Whenever the Scoutship Pilot attempts a Task to pilot their ship, they may reduce the Difficulty by one, to a minimum of zero.
- Wary:** Whenever the Scoutship Pilot attempts a Task to notice or detect an enemy or hazard, they may re-roll one d20.

UHLAN TECHNICIAN [MINOR NPC]

An *uhlan* technician is a low-ranking crewmember assigned to basic maintenance and operation of a ship system. While they are willing to fight if necessary, they are not skilled combatants.

TRAITS: Romulan

ATTRIBUTES



DISCIPLINES



STRESS: 8 **RESISTANCE:** 0

ATTACKS:

- Unarmed Strike (Melee, 1▲ Knockdown, Size 1H, Non-lethal)
- Dagger (Melee, 1▲ Vicious 1, Size 1H, Deadly, Hidden 1)
- Disruptor Pistol (Ranged, 3▲ Vicious 1, Size 1H)
- Escalation** Disruptor Rifle (Ranged, 4▲ Vicious 1, Size 2H, Accurate)

SPECIAL RULES:

- Technical Acumen:** Whenever an *Uhlan* Technician attempts a Task to notice or repair a problem with a shipboard system, they may re-roll one d20.

ALPHA 2 OVERRIDE PROTOCOL ENABLED

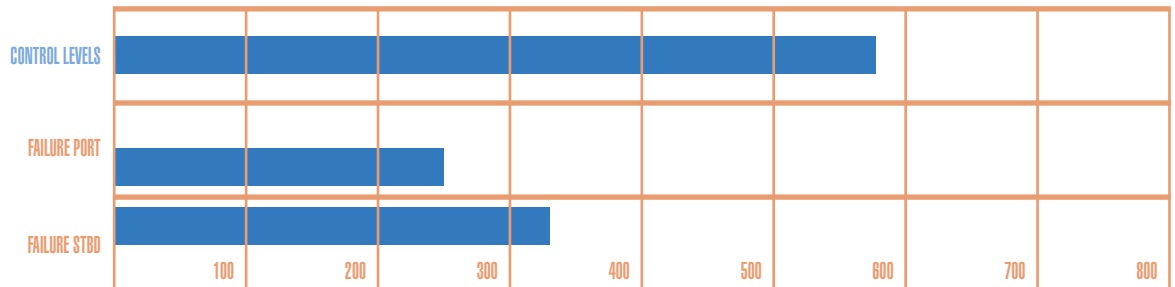

56-589236

TAL SHIAR SABOTEUR [MINOR NPC]

The *Tal Shiar* are known for dirty tricks. Some have become quite skilled at infiltrating enemy installations, causing technical damage or planting explosives, and then escaping as silently as they came.

TRAITS: Romulan

ATTRIBUTES

CONTROL 10 FITNESS 09 PRESENCE 07
 DARING 09 INSIGHT 08 REASON 08

DISCIPLINES

COMMAND — SECURITY 02 SCIENCE 01
 CONN — ENGINEERING 02 MEDICINE 01

STRESS: 11 **RESISTANCE:** 0

ATTACKS:

- Unarmed Strike (Melee, 3▲ Knockdown, Size 1H, Non-lethal)
- Dagger (Melee, 3▲ Vicious 1, Size 1H, Deadly, Hidden 1)
- Disruptor Pistol (Ranged, 5▲ Vicious 1, Size 1H)
- **Escalation** Disruptor Rifle (Ranged, 6▲ Vicious 1, Size 2H, Accurate)

SPECIAL RULES:

- **Guile and Cunning:** When attempting to remain hidden or unnoticed, the Saboteur may spend one Threat to increase the Difficulty of enemy Tasks to detect them by one.
- **Hidden Weakness:** When sabotaging the systems of an enemy, the *Tal Shiar* Saboteur may spend 2 Threat to re-roll any number of d20s on their Security rolls.

MEDICAL SUB-CENTURION [MINOR NPC]

Romulan medical officers undergo a great deal of on-the-job training, and slow learners are often escorted to the next life by angry patients. Romulan doctors who have reached Sub-Centurion rank are usually capable of keeping people alive, come what may. They also know a little bit about taking enemies apart.

TRAITS: Romulan

ATTRIBUTES

CONTROL 08 FITNESS 09 PRESENCE 09
 DARING 07 INSIGHT 09 REASON 09

DISCIPLINES

COMMAND 02 SECURITY 01 SCIENCE 01
 CONN — ENGINEERING — MEDICINE 02

STRESS: 10 **RESISTANCE:** 0

ATTACKS:

- Unarmed Strike (Melee, 2▲ Knockdown, Size 1H, Non-lethal)
- Dagger (Melee, 2▲ Vicious 1, Size 1H, Deadly, Hidden 1)
- Disruptor Pistol (Ranged, 4▲ Vicious 1, Size 1H)
- **Escalation** Disruptor Rifle (Ranged, 5▲ Vicious 1, Size 2H, Accurate)

SPECIAL RULES:

- **Quick and Dirty:** Medical Sub-Centurions are accustomed to working in sub-standard conditions. When attempting a Medicine Task, they ignore any increase in Difficulty for working without the proper tools or equipment.

104-4894

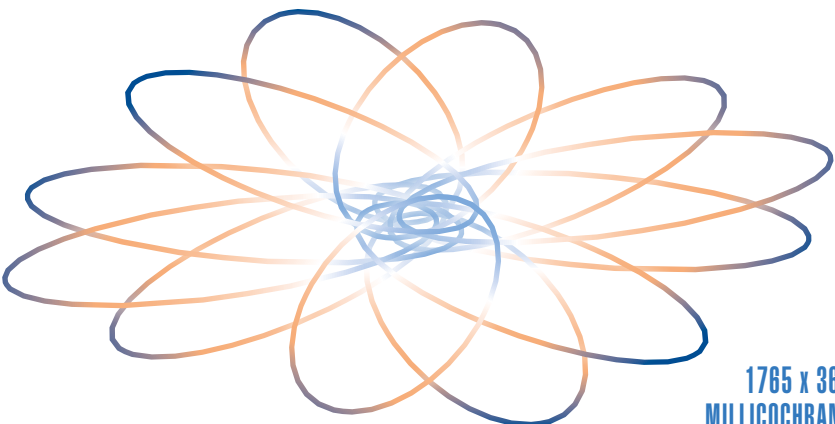

1765 x 3686
MILLICOHRANES

104-4895

4896

4897

4897

4898

6239-4760	5836	251872
23-305756	4873	84832
264938	2826281	889513
127180	789456	16089
936-2056	33839	220284
65-273396	21012	104585
1147593	2505	7499
2600370	32-990	173002
5637-8200	28340	645640
29-285205	6203	650566
43424	2860	26299091

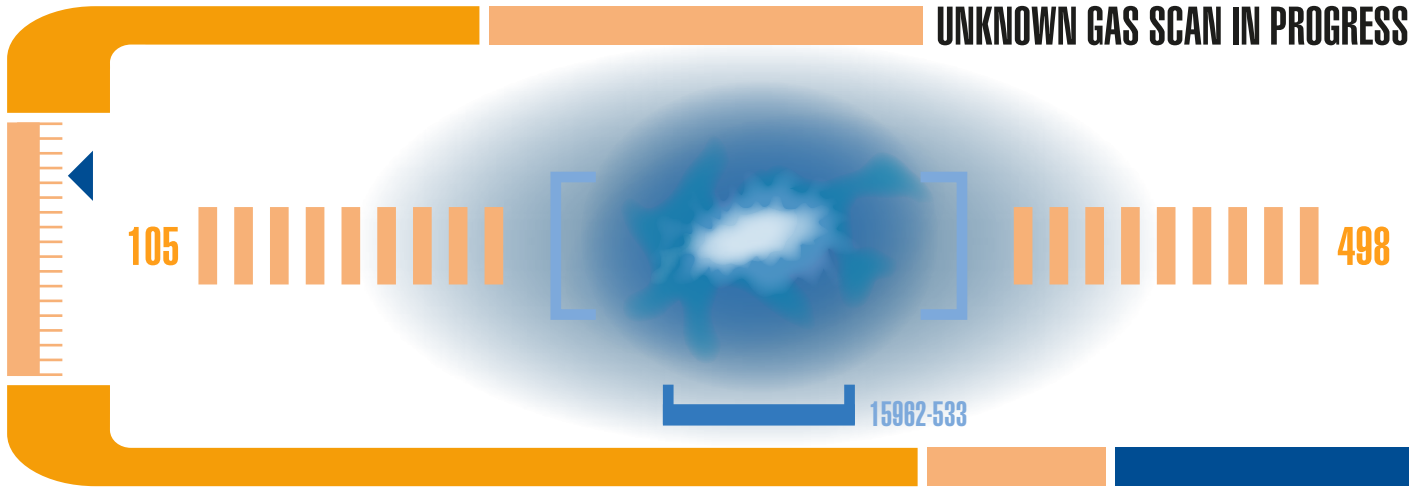

TAL SHIAR INTERROGATOR [MINOR NPC]

The *Tal Shiar* often find it necessary to “encourage” captives to provide information. This encouragement includes carefully-chosen words, the precise application of physical distress, and the usage of carefully-calibrated chemical compounds.

TRAITS: Romulan

ATTRIBUTES

CONTROL	08	FITNESS	10	PRESENCE	08
DARING	09	INSIGHT	07	REASON	09

DISCIPLINES

COMMAND	—	SECURITY	02	SCIENCE	—
CONN	01	ENGINEERING	01	MEDICINE	02

STRESS: 12

RESISTANCE: 0

ATTACKS:

- Unarmed Strike (Melee, 3▲ Knockdown, Size 1H, Non-lethal)
- Dagger (Melee, 3▲ Vicious 1, Size 1H, Deadly, Hidden 1)
- Disruptor Pistol (Ranged, 5▲ Vicious 1, Size 1H)
- Escalation** Disruptor Rifle (Ranged, 6▲ Vicious 1, Size 2H, Accurate)

SPECIAL RULES:

- Sense Vulnerability:** Whenever a *Tal Shiar* Interrogator attempts a Task to coerce information from an enemy, they may re-roll one d20.

LEAD SCIENTIST [MINOR NPC]

While scientists are usually found in highly-classified, well-hidden laboratories, there are always situations in which a scientist needs to experiment out “in the wild.” Such individuals are skilled scientists with the fortitude needed to spend long hours performing experiments under less-than-optimal conditions.

TRAITS: Romulan

ATTRIBUTES

CONTROL	09	FITNESS	10	PRESENCE	07
DARING	07	INSIGHT	08	REASON	10

DISCIPLINES

COMMAND	02	SECURITY	01	SCIENCE	02
CONN	01	ENGINEERING	—	MEDICINE	—

STRESS: 11

RESISTANCE: 0

ATTACKS:

- Unarmed Strike (Melee, 2▲ Knockdown, Size 1H, Non-lethal)
- Dagger (Melee, 2▲ Vicious 1, Size 1H, Deadly, Hidden 1)
- Disruptor Pistol (Ranged, 4▲ Vicious 1, Size 1H)
- Escalation** Disruptor Rifle (Ranged, 5▲ Vicious 1, Size 2H, Accurate)

SPECIAL RULES:

- Learning Through Adversity:** The Lead Scientist is skilled at extracting success from failure. They may roll an additional d20 on a Science Task, as long as they failed at a Science task in the same scientific field earlier in the current mission.

REMAN BODYGUARD [NOTABLE NPC]

It is a matter of prestige for a Romulan high official to possess a Reman bodyguard. Reman bodyguards are ferocious fighters and are often trained in basic piloting and medicine, the better to ensure the safety of their principal.

TRAITS: Reman

VALUE: My Life for my Charge

ATTRIBUTES

CONTROL	09	FITNESS	10	PRESENCE	07
DARING	10	INSIGHT	09	REASON	09

DISCIPLINES

COMMAND	01	SECURITY	03	SCIENCE	—
CONN	02	ENGINEERING	01	MEDICINE	02

FOCUSES: Hand-to-Hand Combat, Threat Assessment

STRESS: 13 **RESISTANCE:** 0

ATTACKS:

- Unarmed Strike (Melee, 4▲ Knockdown, Size 1H, Non-lethal)
- Dagger (Melee, 4▲ Vicious 1, Size 1H, Deadly, Hidden 1)

- Disruptor Pistol (Ranged, 6▲ Vicious 1, Size 1H)
- **Escalation** Disruptor Rifle (Ranged, 7▲ Vicious 1, Size 2H, Accurate)

SPECIAL RULES:

- **Bodyguard:** When taking action to protect the person they are guarding, and buying additional d20s with Threat, a Reman Bodyguard may re-roll a single d20.
- **Wary:** Whenever a Reman Bodyguard attempts a Task to notice or detect an enemy or hazard, they may re-roll one d20.

WARBIRD COMMANDER [NOTABLE NPC]

By the time Romulan officers rise to command a ship, they are not strangers to fierce combat or political maneuvering. Even the most fervent young officers can find their enthusiasm tempered by decades of conflict in one arena or another. Whatever any private reservations, however, Warbird Commanders still serve.

TRAITS: Romulan

VALUE: My Portion is Obedience

ATTRIBUTES

CONTROL	10	FITNESS	09	PRESENCE	07
DARING	08	INSIGHT	10	REASON	10

DISCIPLINES

COMMAND	03	SECURITY	02	SCIENCE	—
CONN	01	ENGINEERING	02	MEDICINE	01

FOCUSES: Starship Tactics, Leadership

STRESS: 11 **RESISTANCE:** 0

ATTACKS:

- Unarmed Strike (Melee, 3▲ Knockdown, Size 1H, Non-lethal)
- Dagger (Melee, 3▲ Vicious 1, Size 1H, Deadly, Hidden 1)
- Disruptor Pistol (Ranged, 5▲ Vicious 1, Size 1H)
- **Escalation** Disruptor Rifle (Ranged, 6▲ Vicious 1, Size 2H, Accurate)

SPECIAL RULES:

- **Ambush:** When attacking an opponent who is unaware, the Warbird Commander may spend two Threat. This allows the Warbird Commander and any Romulans under their command to re-roll any number of d20s on their attack rolls for one round.

REMAN CHARACTERS

ALL ERAS OF PLAY

Remans are a nocturnal species subjugated by the Romulan Star Empire. They are enslaved by the Empire, employed both as indentured miners within the Reman mines, and as expendable shock troops and bodyguards serving the Romulan military. Little is known about the Remans outside of the Romulan Empire, due mainly to the Romulans' secrecy.

- **ATTRIBUTES:** +1 Daring, +1 Fitness, +1 Insight
- **TRAIT:** Reman. Remans are tall, powerfully built beings, stronger and more durable even than Romulans. Their nocturnal nature means that they cannot easily tolerate bright light. A proportion of Remans have telepathic abilities, allowing them to read the minds of others and to project their thoughts to others, though using these powers effectively takes skill and training.

- **Use My Experience:** Once per scene, when the Warbird Commander succeeds at a Task during combat or another perilous situation, they may spend two Threat to give a subordinate assistance on their next Task attempt, using the Warbird Commander's **Presence + Command**.
- **Wary:** Whenever a Warbird Commander attempts a Task to notice or detect an enemy or hazard, they may re-roll one d20.

SENATOR MALAR [MAJOR NPC]

One of the Senators to have been a successful military commander, Malar is known for her ambition, her ruthlessness, and her ability to command significant loyalty from subordinates. She reached the rank of Commander before a combat injury left her unable to continue her military career. It is an open secret that she aspires to the Continuing Committee. It is a deeply-hidden secret that she is a conduit between the Romulan underground and disaffected members of the Imperial Fleet. This is a secret she will die to protect.

TRAITS: Romulan, Permanent Limp

VALUES:

- My People Should Be Free
- War is Bought with Blood
- Sacrifice Makes Us Strong
- Outlanders are People, Too

ATTRIBUTES

CONTROL 10 FITNESS 08 PRESENCE 12

DARING 09 INSIGHT 10 REASON 10

DISCIPLINES

COMMAND 05 SECURITY 02 SCIENCE 02

CONN 03 ENGINEERING 02 MEDICINE 02

FOCUSES: Composure, Deception, Persuasion, Paranoia, Shipboard Tactics

STRESS: 10 **RESISTANCE:** 0

ATTACKS:

- Unarmed Strike (Melee, 3▲ Knockdown, Size 1H, Non-lethal)
- Dagger (Melee, 3▲ Vicious 1, Size 1H, Deadly, Hidden 1)
- Disruptor Pistol (Ranged, 5▲ Vicious 1, Size 1H)
- **Escalation** Disruptor Rifle (Ranged, 6▲ Vicious 1, Size 2H, Accurate)

STYROLITE ISOLATION

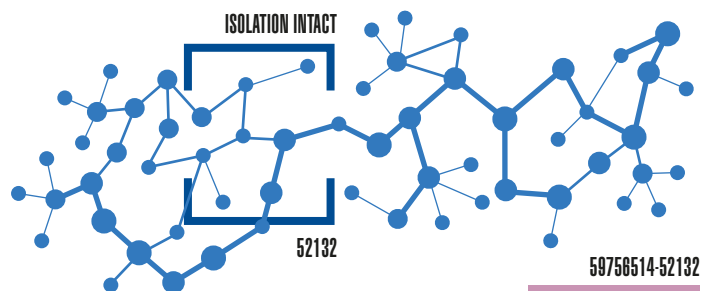

SPECIAL RULES:

- **Wary:** Whenever Malar attempts a Task to notice or detect an enemy or hazard, she may re-roll one d20.
- **Ruthless and Determined:** Senator Malar may spend two Threat (rather than the normal three) to gain the effects of a point of Determination.
- **Senatorial Presence:** Whenever one of Malar's subordinates attempts a Task to resist persuasion, intimidation, or interrogation, Malar may spend two Threat to allow that Romulan to roll as if they had the benefit of her assistance using **Control + Command**, even if she is not present in the scene herself.
- **Reman Bodyguard:** Senator Malar has a Reman bodyguard who is completely devoted to her well-being. If attacked while in the presence of her bodyguard, she may use the bodyguard's **Fitness + Security** for purposes of Stress, providing they are within Reach.



ENCOUNTERS AND ADVERSARIES

THE BRIAR PATCH

DESCRIPTION

The Briar Patch is one of the most dangerous areas in the Beta Quadrant. The remnant of a long-ago supernova, it is now a region of stellar debris, gas pockets, unstable spatial anomalies and metaphasic radiation. Ships traveling through the region make no better than one-third impulse power to avoid overloading the impulse manifolds. It is possible, however, to modify impulse drive assemblies to protect the impulse manifolds and operate at full impulse power.

Known to the Klingons as *Klach D'kel Brakt*, it is the site of the famous battle. (see *Chapter 2: The Klingon Empire*, page 34) There are currently at least two habitable planets within the region: first contact has not yet been made with any indigenous populations. The inhabitants of Son'a, just outside the Briar Patch, are an aggressive species known to have conquered nearby primitive planets. They are suspected of using isolytic subspace weapons, outlawed by the second Khitomer Accords due to their tendency to damage the fabric of subspace.

Today, the Briar Patch is an area often used by less-than-legitimate parties to evade detection and pursuit. It is also an area of intense scientific investigation as the concentration of spatial anomalies and exotic radiations rivals that of the Shackleton Expanse in complexity, if not extent.

ENCOUNTER SEEDS

ARTIFACTS AND CROSSBONES

The Player Characters are called upon by Starfleet to assist in investigating and suppressing pirate activity around a newly-established Federation archaeological station on SLV-5171, deep within the Briar Patch.

The station is located on a rogue dwarf planet whose star has long-since been destroyed. Planetary conditions mean that the majority of the expedition's work is done underground. Starfleet suspects the pirates want any artifacts found in a vast city located beneath the planet's surface, but irregularities in the expedition's reports warrant further investigation.

This could be straightforward: everything is exactly as it appears. Orion pirates want any artifacts found in the vast alien city on SLV-5571, and they're trying to harass the expedition off-world to loot it. If not stopped, the situation will explode into a deadly ground battle between the scientists, their Starfleet Security detachment, and the pirates. Perhaps the expedition has fallen under the influence of the city itself, imprinted with the personalities of the long-dead Iconian builders, and they have seeded the reports with inconsistencies specifically to draw a starship within range to provide more hosts. The "pirates" are the remnants of an obscure alien race who died out over the past 200,000 years, a time spent hunting down and destroying all traces of the Iconian civilization. Or maybe the problem isn't the pirates themselves, but a saboteur on the station that seeks to frighten the expedition away by wrecking equipment, provoking random sensor readings, and causing other weird phenomena. Is it the city itself, some surviving inhabitant, or an enemy of the Federation taking advantage of the situation?

TEMPORAL TEMPTATIONS

The Player Characters' ship is summoned to settle a dispute between a group of Federation salvagers and some old "friends" who have not been seen for quite some time: the Suliban! A very old, apparently non-functional, piece of technology is floating around in the Briar Patch, and it is advanced enough to interest both parties.

Investigation reveals that the device is emitting highly-unstable chronitons. If these emissions continue, they will undoubtedly destabilize local time in the Briar Patch! The Suliban may be simply modern-day salvagers, looking for a way to reverse the long, slow decline of their people. They could be Cabal terrorists from the 22nd Century, stranded in the current time by the collapse of the Temporal Cold War. If they succeed in reactivating the conduit, will it start a new war? Or perhaps it has nothing to do with time travel at all, and the "Federation" salvage team is, in truth, a team of highly-trained operatives from the Mirror Universe. They want the conduit to start a full-bore invasion!

THE DARK INSIDE

The Player Characters are sent to investigate a civilian vessel that, after an unscheduled passage through the



Briar Patch, arrives at its destination on computer control. The ship's crew and passengers are dead or insane, and the only coherent phrase they seem capable of saying is "The dark inside..." The Player Characters must discover why the ship entered the Briar Patch in the first place, what happened to the ship once inside, and if there is a way to bring the survivors back to sanity. Potential causes are numerous: spatial distortions, dimensional rifts, energy beings, weird radiation, rogue telepaths...

ORION SLAVER OVERSEER [MINOR NPC]

The Overseers are charged with enforcing discipline among the slavers themselves and obedience from the enslaved. While they have a brutish appearance, Overseers are intelligent, capable, and manipulative.

TRAITS: Orion

ATTRIBUTES

CONTROL 07

FITNESS 08

PRESENCE 10

DARING 09

INSIGHT 09

REASON 08

DISCIPLINES

COMMAND 01

SECURITY 02

SCIENCE 01

CONN 02

ENGINEERING —

MEDICINE —

STRESS: 9

RESISTANCE: 0

ATTACKS:

- Unarmed Strike (Melee, 3▲ Knockdown, Size 1H, Non-lethal)
- Dagger (Melee, 3▲ Vicious 1, Size 1H, Deadly, Hidden 1)
- Disruptor Pistol (Ranged, 5▲ Vicious 1, Size 1H)

SPECIAL RULES:

- **Vicious:** The Overseer knows how to use cruelty to motivate others. When enforcing discipline using threats or violence and buying additional d20s with Threat, the Overseer may re-roll a single d20.

ORION SLAVER MEDIC [MINOR NPC]

The Orions, despite their frequently brutal treatment of slaves, prefer not to bring damaged goods to the markets. Damaged slaves mean lower profits. Slaver medics look after the health of the “merchandise,” ensuring that slaves are protected from disease and disfiguring injuries and that they are in prime condition for a sale.

TRAITS: Orion

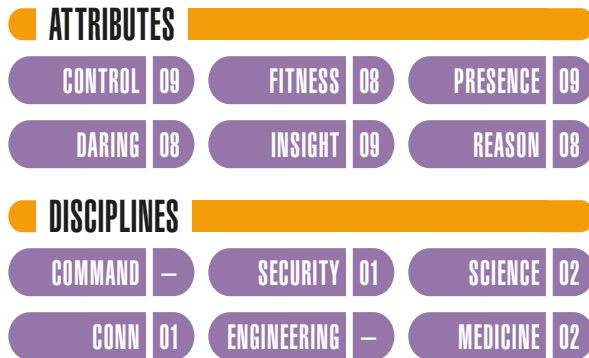

STRESS: 9

RESISTANCE: 0

ATTACKS:

- Unarmed Strike (Melee, 2▲ Knockdown, Size 1H, Non-lethal)
- Dagger (Melee, 2▲ Vicious 1, Size 1H, Deadly, Hidden 1)
- Disruptor Pistol (Ranged, 4▲ Vicious 1, Size 1H)

SPECIAL RULES:

- **Hands-on Training:** The Orion Medic has had experience treating a wide variety of ailments on a wide variety of species. When attempting a Task to tend wounds or illness using **Reason + Medicine**, the Medic reduces the Difficulty by 1 (to a minimum of zero).

ORION BUCCANEER [MINOR NPC]

Buccaneers — the title was adopted from Terran history and literature — consider themselves the swashbucklers of the spaceways. “To dare is to truly live,” is their motto. While many are pirates, some Buccaneers have broken away from the Syndicate, and now actively oppose Orion piracy and slavery... all with panache and derring-do.

TRAITS: Orion

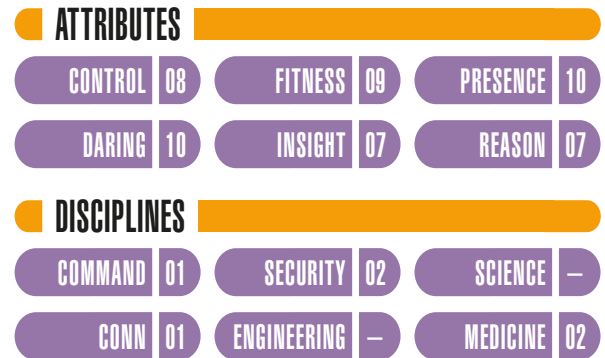

STRESS: 11

RESISTANCE: 0

ATTACKS:

- Unarmed Strike (Melee, 3▲ Knockdown, Size 1H, Non-lethal)
- Dagger (Melee, 3▲ Vicious 1, Size 1H, Deadly, Hidden 1)
- Disruptor Pistol (Ranged, 5▲ Vicious 1, Size 1H)

SPECIAL RULES:

- **Bold:** The Buccaneer is nothing if not daring. When performing a Task using the Daring Attribute and buying additional d20s with Threat, they may re-roll a single d20.

ORION CHARACTERS

ALL ERAS OF PLAY

Orions are an independent species, the remnants of an advanced civilization from the system of the same name. They are known for their distinctive green skin, and for the effect that their body chemistry can have on other species. Orion males are typically bald, and tend to be both taller and more muscular than the average Human male. Orion females are considered to be extremely alluring, although a great deal of this reputation comes from the effect of their pheromones on other humanoids. In Orion society, the males are slaves to the females, but they maintain a patriarchal façade in relations with other species.

- **ATTRIBUTES:** +1 Daring, +1 Fitness, +1 Presence
- **TRAIT:** Orion. Orions produce pheromones which can affect humanoid brains to a certain degree. The pheromone produced by Orion males can generally make them seem attractive to other humanoids, but not to the same degree as that produced by Orion females.

ORION BREACHER [MINOR NPC]

Breachers lead boarding parties of pirates that take ships for the Syndicate. A combination of marine and sapper (combat engineer), they command teams of ordinary pirates while using their skills to cripple vessels.

TRAITS: Orion

ATTRIBUTES

CONTROL 09

FITNESS 10

PRESENCE 09

DARING 09

INSIGHT 07

REASON 07

DISCIPLINES

COMMAND 02

SECURITY 02

SCIENCE 01

CONN —

ENGINEERING 01

MEDICINE —

STRESS: 12

RESISTANCE: 0

ATTACKS:

- Unarmed Strike (Melee, 3▲ Knockdown, Size 1H, Non-lethal)
- Dagger (Melee, 3▲ Vicious 1, Size 1H, Deadly, Hidden 1)
- Disruptor Pistol (Ranged, 5▲ Vicious 1, Size 1H)

SPECIAL RULES:

- No Quarter:** When commanding a boarding action and assisting the soldiers under his command by giving them orders, the Breacher may re-roll a single d20.

ORION EXECUTIVE OFFICER [MINOR NPC]

Executive Officers act as lieutenants for high-ranking members of the Orion Syndicates. They are skilled with a broad range of ship operations, and capable of fending off boarding attacks, piloting a vessel, and commanding underlings in battle.

TRAITS: Orion

ATTRIBUTES

CONTROL 07

FITNESS 08

PRESENCE 07

DARING 09

INSIGHT 09

REASON 08

DISCIPLINES

COMMAND 02

SECURITY 02

SCIENCE 01

CONN 01

ENGINEERING —

MEDICINE —

STRESS: 10

RESISTANCE: 0

ATTACKS:

- Unarmed Strike (Melee, 3▲ Knockdown, Size 1H, Non-lethal)
- Dagger (Melee, 1▲ Vicious 1, Size 1H, Deadly, Hidden 1)
- Disruptor Pistol (Ranged, 5▲ Vicious 1, Size 1H)

SPECIAL RULES:

- Advisor:** The Executive Officer knows the way the world works. When assisting another character using the Command Discipline, the character being assisted may re-roll a single d20.

ORION SCIENCE OFFICER [MINOR NPC]

Orion science officers fulfill a strange variety of roles: they verify the quality of illicit substances; analyze artifacts for profit or utility; and provide information on potential targets. They often serve as executive officers on salvage vessels.

TRAITS: Orion

ATTRIBUTES

CONTROL 09

FITNESS 09

PRESENCE 09

DARING 08

INSIGHT 07

REASON 09

DISCIPLINES

COMMAND 01

SECURITY —

SCIENCE 02

CONN —

ENGINEERING 01

MEDICINE 02

STRESS: 9

RESISTANCE: 0

ATTACKS:

- Unarmed Strike (Melee, 1▲ Knockdown, Size 1H, Non-lethal)
- Dagger (Melee, 1▲ Vicious 1, Size 1H, Deadly, Hidden 1)
- Disruptor Pistol (Ranged, 3▲ Vicious 1, Size 1H)

SPECIAL RULES:

- A Little Bit Extra:** An Orion Science Officer is always on the lookout for something interesting, profitable, or valuable. Whenever performing a Task with Science, the Orion Science Officer gains 1 bonus Momentum, that they can only spend on *Obtain Information*.

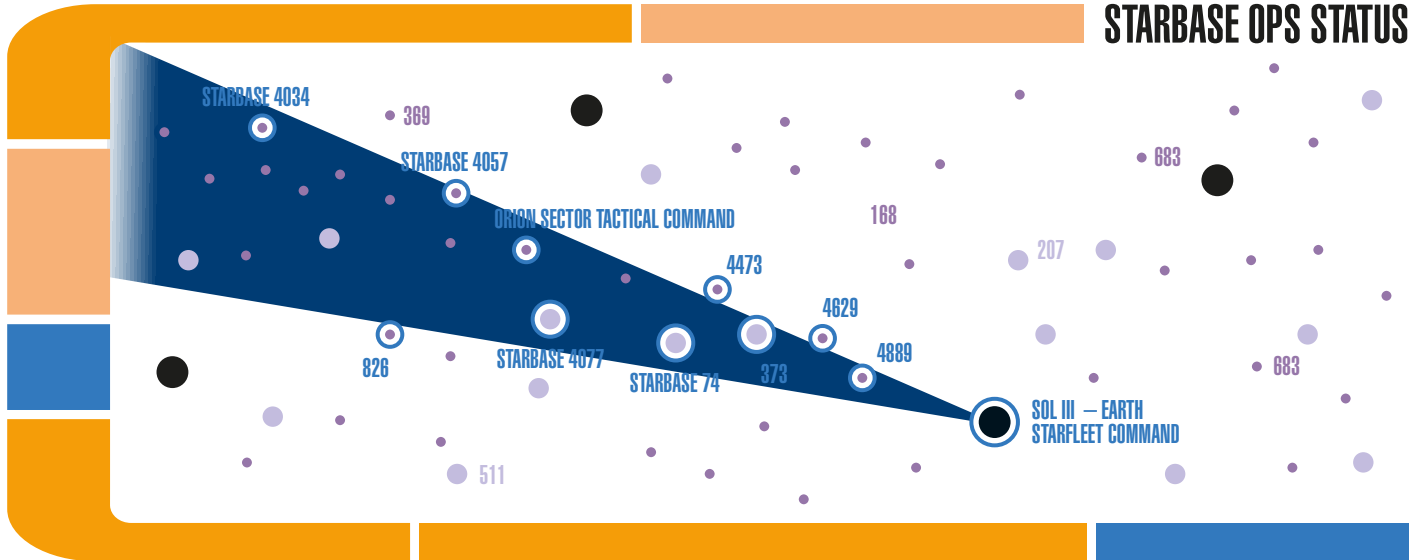

ORION ENGINEER [MINOR NPC]

Engineers maintain Orion vessels and equipment. They're brutal taskmasters and perfectionists, and shirking of duty among underlings is unacceptable when it comes to maintaining any space-going equipment.

TRAITS: Orion

ATTRIBUTES

CONTROL	08	FITNESS	08	PRESENCE	08
DARING	10	INSIGHT	08	REASON	09

DISCIPLINES

COMMAND	02	SECURITY	01	SCIENCE	01
CONN	—	ENGINEERING	02	MEDICINE	—

STRESS: 9 **RESISTANCE:** 0

ATTACKS:

- Unarmed Strike (Melee, 2▲ Knockdown, Size 1H, Non-lethal)
- Dagger (Melee, 2▲ Vicious 1, Size 1H, Deadly, Hidden 1)
- Disruptor Pistol (Ranged, 4▲ Vicious 1, Size 1H)

SPECIAL RULES:

- **Percussive Maintenance:** An Orion Engineer keeps the ship running, no matter what it takes. When making repairs to a ship system and buying additional d20s with Threat, the Overseer may re-roll a single d20.

ORION PIRATE CREWMAN [MINOR NPC]

Orion pirates tend to operate in frontier zones with little or no support from the Syndicate or the Trade Union. They are particularly independent examples of an already independent species. They ambush merchant vessels, steal cargo, and travel as quickly as possible to an open port to sell their stolen goods. Then, it's back "on the account" as these corsairs call it. Back in deep space, and looking for new prey...

TRAITS: Orion

ATTRIBUTES

CONTROL	09	FITNESS	09	PRESENCE	08
DARING	09	INSIGHT	08	REASON	08

DISCIPLINES

COMMAND	02	SECURITY	02	SCIENCE	—
CONN	01	ENGINEERING	01	MEDICINE	—

STRESS: 11 **RESISTANCE:** 1

ATTACKS:

- Unarmed Strike (Melee, 3▲ Knockdown, Size 1H, Non-lethal)
- Dagger (Melee, 3▲ Vicious 1, Size 1H, Deadly, Hidden 1)
- Disruptor Pistol (Ranged, 5▲ Vicious 1, Size 1H)

SPECIAL RULES:

- **Cutthroat Crew:** Whenever the Orion Pirates attempt a Task related to boarding a captured vessel, and they buy additional d20s with Threat, they may re-roll a single d20.

PRASAD [NOTABLE NPC]

Prasad is a handsome buccaneer, with a friendly smile always showing through his scruffy beard. He wears well-used but functional gear in defiance of the pomp and panache one might expect of an Orion. He is mortal enemies with several Syndicate members. Time spent living in other cultures, and the “infection” they caused, has made Prasad something of an abolitionist.

TRAITS: Orion

VALUE: No One Should Live a Slave

ATTRIBUTES

CONTROL	09	FITNESS	09	PRESENCE	10
DARING	08	INSIGHT	08	REASON	10

DISCIPLINES

COMMAND	02	SECURITY	03	SCIENCE	—
CONN	01	ENGINEERING	02	MEDICINE	01

STRESS: 12

RESISTANCE: 0

ATTACKS:

- Unarmed Strike (Melee, 4▲ Knockdown, Size 1H, Non-lethal)
- Dagger (Melee, 4▲ Vicious 1, Size 1H, Deadly, Hidden 1)
- Disruptor Pistol (Ranged, 6▲ Vicious 1, Size 1H)

SPECIAL RULES:

- **Bold:** Prasad is nothing if not daring. When performing a Task using the Daring Attribute and buying additional d20s with Threat, he may re-roll a single d20.

- **Cutting Wit:** Prasad fights as much with words as with weapons. When in personal combat against an enemy who can understand him, he may use Presence instead of Daring to attack.

SHRETSH [NOTABLE NPC]

Shretsh’s face and body bear horrendous scars: these are the consequence of defying his slaver captain. He’s vowed revenge against that individual, and, by extension, the Syndicates as a whole. Uncompromising in his vengeance, Shretsh often takes risks that far outweigh any benefit, and brooks no argument once he’s settled on a course of action.

TRAITS: Orion

VALUE: I Will Destroy My Enemies

ATTRIBUTES

CONTROL	09	FITNESS	09	PRESENCE	09
DARING	11	INSIGHT	09	REASON	07

DISCIPLINES

COMMAND	03	SECURITY	01	SCIENCE	—
CONN	01	ENGINEERING	02	MEDICINE	02

STRESS: 10

RESISTANCE: 0

ATTACKS:

- Unarmed Strike (Melee, 2▲ Knockdown, Size 1H, Non-lethal)
- Dagger (Melee, 2▲ Vicious 1, Size 1H, Deadly, Hidden 1)
- Disruptor Pistol (Ranged, 4▲ Vicious 1, Size 1H)

A bipedal, reptilian species from the Beta quadrant, who have a civilization — the Gorn Hegemony — far from Federation Space. First encountered by Starfleet in 2267, the Gorn are technologically advanced to a level comparable to the Federation and other Beta Quadrant powers in most regards. Even a century after first contact, there is relatively little contact between the Gorn Hegemony and the Federation.

- **ATTRIBUTES:** +1 Daring, +1 Fitness, +1 Reason

- **TRAIT:** Gorn. Gorn are large and powerfully-built, even more so than other famously-mighty species such as the Klingons or Nausicaans. They are many times stronger than a human being, and resilient enough to ignore massive blunt force trauma or even short periods in hard vacuum. However, Gorn are not especially agile or fast. Gorn are ectothermic — cold-blooded — with their body temperature varying by external factors, and thus favour warm environments where they can be most active and effective.

GORN CHARACTERS

ALL ERAS OF PLAY

SPECIAL RULES:

- **Fuel the Flames:** Shretsh has a significant propensity, even preference, for violence. When he attempts a Task to persuade or compel others to act in a violent manner, he may add a bonus d20 to his dice pool.
- **Obsessed:** Whenever Shretsh attempts a Task to resist being intimidated or persuaded against a course of action and he buys additional d20s with Threat, he may re-roll a single d20.

JAGADISH [NOTABLE NPC]

Jagadish is a tall, rangy Orion man, who is old enough to have streaks of gray in his hair. He's one of the Syndicates' top men when it comes to manufacturing knock-off medications, drugs, and other chemical concoctions. Unbeknownst to the Syndicate he works for, Jagadish is working on a side project: A vaccine against the pheromonal control of the women of his species. So far he's risked it on a few test subjects from other species, and is currently working up the nerve to test it on himself.

TRAITS: Orion

VALUE: The Women Have Controlled Us Too Long

ATTRIBUTES

CONTROL	07	FITNESS	08	PRESENCE	09
DARING	08	INSIGHT	09	REASON	10

DISCIPLINES

COMMAND	—	SECURITY	01	SCIENCE	03
CONN	01	ENGINEERING	01	MEDICINE	02

STRESS: 9

RESISTANCE: 0

ATTACKS:

- Unarmed Strike (Melee, 2▲ Knockdown, Size 1H, Non-lethal)
- Dagger (Melee, 2▲ Vicious 1, Size 1H, Deadly, Hidden 1)
- Disruptor Pistol (Ranged, 4▲ Vicious 1, Size 1H)

SPECIAL RULES:

- **Rational:** Jagadish has spent time developing his capacity for clear thought. Whenever he attempts a Task using Reason and buys additional d20s with Threat, he may re-roll a d20.
- **Chemical Genius:** Jagadish is one of the best biochemical engineers in the Quadrant. Whenever he attempts to perform a Task related to biochemistry using **Reason + Science**, he may reduce the difficulty by 1 (to a minimum of zero).

PARTHA [NOTABLE NPC]

Partha is in her mid-twenties and already a force to be reckoned with inside the Syndicates. She is exceptional even among Orion women, and capable of wrapping the males of any species around her little finger. While she plays the role of slave to the hilt, she's also one of the Syndicate's best infiltrators and many a ship has fallen to her charms, scientific or seductive.

TRAITS: Orion

VALUE: No One Can Resist My Charms

ATTRIBUTES

CONTROL	09	FITNESS	08	PRESENCE	10
DARING	07	INSIGHT	08	REASON	09

DISCIPLINES

COMMAND	02	SECURITY	01	SCIENCE	03
CONN	01	ENGINEERING	02	MEDICINE	—

STRESS: 9

RESISTANCE: 0

ATTACKS:

- Unarmed Strike (Melee, 2▲ Knockdown, Size 1H, Non-lethal)
- Dagger (Melee, 2▲ Vicious 1, Size 1H, Deadly, Hidden 1)
- Disruptor Pistol (Ranged, 4▲ Vicious 1, Size 1H)

SPECIAL RULES:

- **Technical Persuasion:** Partha gathers information from a computer system as easily as she does from men. Whenever she attempts a Task that involves infiltrating a computer system, she may add a bonus d20 to her pool.
- **Provocative:** When performing a Task using **Presence + Command**, Partha may spend a Threat to gain some small but useful secret from her target, regardless of the Task's success or failure.

SEEMA [MAJOR NPC]

She sways in a seductive, knowing fashion, perpetually amused by something... But for those paying attention, Seema's smile is teasing, wicked, and cruel. Her public persona is that of a well-kept Orion woman, older, but no less formidable. As an interrogator for the Syndicate, Seema loves to provoke people and make them jump to her wishes. She slaps her weighted gloves into her hand, sensuously teasing before applying the neuro-lash, drugs, or worse.

TRAITS: Orion

VALUE: Orion puppet-mistress, interrogator, the power behind the power.

ATTRIBUTES

CONTROL 08	FITNESS 08	PRESENCE 10
DARING 07	INSIGHT 09	REASON 09

DISCIPLINES

COMMAND 03	SECURITY —	SCIENCE 02
CONN 01	ENGINEERING 01	MEDICINE 02

STRESS: 8

RESISTANCE: 0

ATTACKS:

- Unarmed Strike (Melee, 1▲ Knockdown, Size 1H, Non-lethal)
- Dagger (Melee, 1▲ Vicious 1, Size 1H, Deadly, Hidden 1)
- Disruptor Pistol (Ranged, 3▲ Vicious 1, Size 1H)

SPECIAL RULES:

- A Dagger Hidden in Silk:** Seema may re-roll a single d20 when using **Presence + Command** and buying additional d20s with Threat to persuade someone she is interrogating.
- False-Faced:** When deceiving others, Seema reduces the difficulty by 1, to a minimum of zero.
- Provocative:** When performing a Task using **Presence + Command**, Seema may spend a Threat to gain some small but useful secret from her target, whatever the Task's result.
- She Has Ways...:** Skilled in both interrogation and seduction, Seema may roll an additional d20 using Presence or Daring on those Tasks.
- Better Than You Know Yourself:** Seema has honed her skill at reading others to an almost-psychoic level. When using **Insight + Command** to do so, she rolls an additional d20.

AMAAR [MAJOR NPC]

Amaar works with Seema as an interrogator and brainwasher for the Syndicates. He was once a notable captain in his own right, and continues to fill that role so long as Seema allows it. Their working relationship has left him utterly under her control, willing to do anything to anyone to achieve whatever goal she's selected. He's a burned-out husk of a man, prone to fits of violent rage when the pair's victims resist.

TRAITS: Orion

VALUE: I would do anything for Seema.

ATTRIBUTES

CONTROL 08	FITNESS 08	PRESENCE 09
DARING 09	INSIGHT 10	REASON 07

DISCIPLINES

COMMAND 03	SECURITY —	SCIENCE 01
CONN 02	ENGINEERING 02	MEDICINE 01

STRESS: 8

RESISTANCE: 0

ATTACKS:

- Unarmed Strike (Melee, 1▲ Knockdown, Size 1H, Non-lethal)
- Dagger (Melee, 1▲ Vicious 1, Size 1H, Deadly, Hidden 1)
- Disruptor Pistol (Ranged, 3▲ Vicious 1, Size 1H)

SPECIAL RULES:

- Pheromonal Thrall:** Thanks to years of conditioning, exposure to Seema's pheromones, and careful manipulation by the puppet-mistress, Amaar gains an additional d20 when assisting her in Tasks where she spends Threat.
- Is It Safe?:** Amaar is nearly as vicious at torture and interrogation as his mistress, and well-versed in the ways of pain. When using these unwholesome methods, Amaar may spend Threat to reroll a single d20.
- Confidant:** There are moments when Amaar's conscience, the little that remains, peeks through the hardened layers of conditioning. When this happens, he's easier to talk to, and it's easier to let slip secrets. Amaar reduces all Difficulties to gain another's trust or extract a secret from them using Insight by 1 (to a minimum of zero).
- Terrifying Inveictive:** Something in Amaar's mind is simply broken. When a prisoner resists Seema's charms, he flies into a rage that is terrifying to behold. In such circumstances, Amaar uses Command rather than Security to determine damage in melee.

ENCOUNTERS AND ADVERSARIES

THE KLINGON BORDER

DESCRIPTION

The Klingon border is an volume of space roughly 5 light years wide, stretching for some 300 light years, between the territory of the United Federation of Planets and the Klingon Empire. During the hostilities of the 23rd Century, this area was sometimes referred to as the Klingon Neutral Zone, an analog to the Romulan zone. By treaty, the Federation and the Empire agreed to maintain the neutrality of this area, with neither advancing their border any closer to the other. The Klingon Border has a reputation of being a lawless frontier, since no government directly lays claim to it. Starfleet vessels are as likely to encounter Orion pirates in this region as they are Klingons. Everyone tends to walk on metaphorical eggshells, knowing that any provocation that results in a breakdown of the delicate power balance in the region could lead to a diplomatic incident, or worse.

ENCOUNTER SEEDS

UNDER A BLACK FLAG

The Player Characters' ship is ordered to the Klingon border; an Orion pirate has been reported to be waylaying merchant vessels. Given the official neutrality of the border territory the situation is a bit complicated, as the pirates skip back and forth over the border, depending on which fleet is after them. The PCs will also have to deal with a Klingon vessel that has been given similar orders, and may not be entirely amenable to the idea of cooperation. And what happens when it turns out that the most recent "innocent victim" of the Orion pirates is anything but innocent? How do you deal with a smuggler, who has been moving contraband between Federation and Klingon space, but who has also suffered pirate attack?

A LAWLESS PORT

Asobi Station is a lawless port, an old, 23rd Century Federation K-style station, salvaged refitted and jury-rigged together by an enterprising Human merchant named Jones. At least, that's the name he claims, but there are no matching records in Federation systems. Jones has positioned Asobi Station in deep space, well off the usual trade routes, and not within any star system, but it's smack-

dab in the middle of the border zone, equally far from Klingon and Federation space. And no laws apply there. It serves as a repair station, a place to hire crew, or sell cargo, or just relax and blow off steam between jobs. It is not the sort of place where a Starfleet crew should find themselves. But when your main chambers coil overloads, and your ship desperately needs repairs, sometimes you have no choice. But can a Starfleet crew really stay out of trouble in such a lawless place, at least until the repairs are done? No matter who else turns up at the port...

WHAT ROUGH BEAST...

The Player Characters' ship is observing an unstable wormhole which has opened in the Klingon border zone. As the wormhole collapses a massive, alien construct is ejected into normal space. It could be an utterly immense starship, or perhaps a space station of some kind. The design is entirely unfamiliar, and there appear to be no obvious sources of propulsion.

Scans indicate that it possesses a breathable atmosphere within the hull, and comfortable gravity, but the sensors are having a hard time interpreting the results. Energy output is not a recognizable variety, and lifesigns are entirely inconclusive. The object appears to be dead in space, and drifting towards the Klingon side of the border. Does the crew explore? Do they attempt to recover the object? What happens when a Klingon vessel shows up, with a salvage claim because the object is drifting towards their space? What lies within the object? And why does it "feel" haunted?

KLINGON BAT'LETH

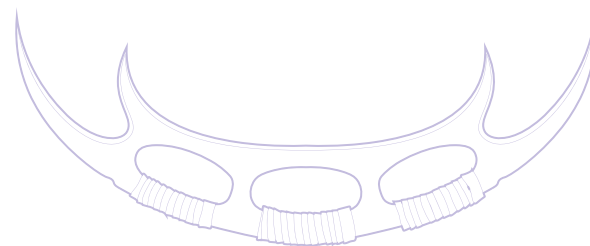

SCHEMATICS



KLINGON SCIENTIST [MINOR NPC]

Not all Klingons are warriors, and some Klingons follow what are sometimes considered less-respected paths. These types show up on the border, where they can pursue their careers without being drawn into the intrigues of the Empire.

TRAITS: Klingon

ATTRIBUTES

CONTROL 08

FITNESS 09

PRESENCE 08

DARING 08

INSIGHT 09

REASON 09

DISCIPLINES

COMMAND 01

SECURITY —

SCIENCE 02

CONN —

ENGINEERING 02

MEDICINE 01

STRESS: 9

RESISTANCE: 0

ATTACKS:

- Unarmed Strike (Melee, 1 ▲ Knockdown, Size 1H, Non-lethal)
- D'k tahg* Dagger (Melee, 1 ▲ Vicious 1, Size 1H, Deadly, Hidden 1)
- Escalation** *Bat'leth* (Melee, 3 ▲ Vicious 1, Size 2H)
- Disruptor Pistol (Ranged, 3 ▲ Vicious 1, Size 1H)

SPECIAL RULES:

- Brak'lul:** A Klingon's Resistance is increased by +2 against Non-lethal attacks.
- Brilliant Theoretician:** When the Klingon Scientist completes a successful Task using his Science Discipline, he may spend 3 Threat or Threat to assist another scientist's next scientific Task with his **Insight + Command**.

KLINGON DIPLOMAT [NOTABLE NPC]

Klingons occasionally send diplomats out to the border regions to negotiate with other powers. This was notably the case on the border world Nimbus Three, the so-called “Planet of Galactic Peace,” where representatives of the Federation, Klingon and Romulan Empires gathered to keep communication open between their governments. Diplomats they may be, but they are also Klingons!

TRAITS: Klingon

VALUE: For the Good of the Empire

ATTRIBUTES

CONTROL	07	FITNESS	09	PRESENCE	11
DARING	10	INSIGHT	09	REASON	08

DISCIPLINES

COMMAND	03	SECURITY	02	SCIENCE	—
CONN	02	ENGINEERING	01	MEDICINE	01

FOCUSES: Negotiation, Hand-to-Hand Combat

STRESS: 11 **RESISTANCE:** 0

ATTACKS:

- Unarmed Strike (Melee, 3▲ Knockdown, Size 1H, Non-lethal)
- *D’k tahg* Dagger (Melee, 3▲ Vicious 1, Size 1H, Deadly, Hidden 1)

SPECIAL RULES:

- **Brak’lul:** A Klingon’s Resistance is increased by +2 against Non-lethal attacks.
- **Cunning Negotiator:** Whenever a Klingon Diplomat attempts a **Presence Task** to influence an opponent during a negotiation, the Diplomat may re-roll one d20.

HUMAN SMUGGLER [NOTABLE NPC]

Human merchants do business all over the Galaxy, trading with the Ferengi in the Alpha Quadrant, selling Andorian icewine on Earth and much else besides. Sometimes, though, the law gets in the way. A valued customer wants some Romulan Ale, for instance, or maybe a group of Maquis want a shipment of weapons delivered from Klingon space. These things can always be arranged, for the right fee.

TRAITS: Human

ATTRIBUTES

CONTROL	08	FITNESS	10	PRESENCE	10
DARING	07	INSIGHT	09	REASON	09

DISCIPLINES

COMMAND	02	SECURITY	03	SCIENCE	01
CONN	02	ENGINEERING	02	MEDICINE	—

STRESS: 13 **RESISTANCE:** 0

ATTACKS:

- Unarmed Strike (Melee, 4▲ Knockdown, Size 1H, Non-lethal)
- Disruptor Pistol (Ranged, 6▲ Vicious 1, Size 1H)

SPECIAL RULES:

- **Slippery:** The Human Smuggler is used to playing upon his essentially harmless nature to wriggle out of trouble. The Smuggler reduces all Difficulties when trying to convince authorities to let them go using Presence by 1 (to a minimum of 0).

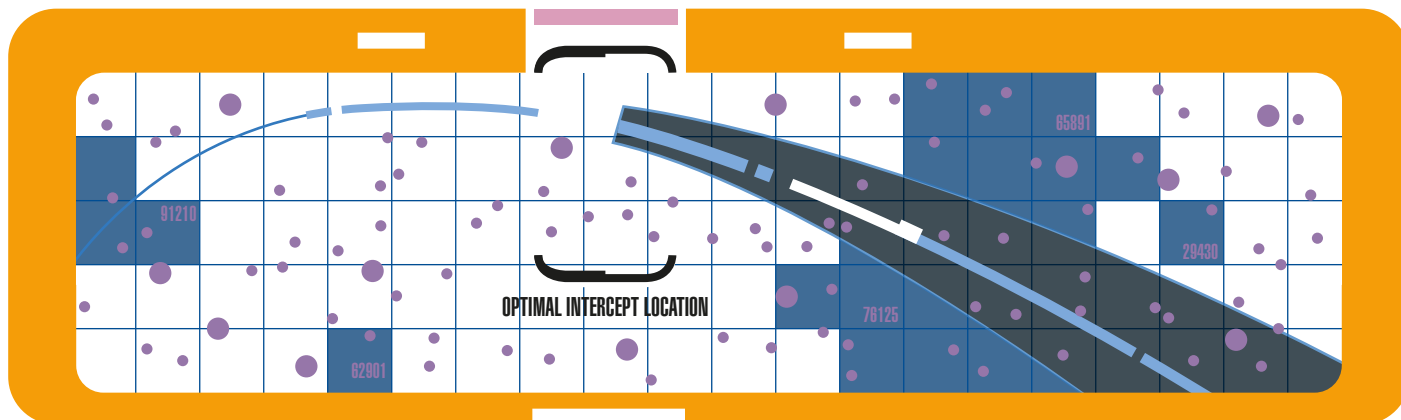

M'KETH, SON OF NONE [NOTABLE NPC]

The ultimate punishment for a Klingon is discommendation. For their crimes, the Klingon is stripped of all honor, of citizenship, even of personhood. M'Keth is a notorious outlaw along the border. He calls himself the "Son of None" because of his discommendation. He is a total wild card, raiding as he pleases, throwing wrenches into the plans of the Klingon great houses, and generally causing chaos. He commands an old *K'T'inga*-class cruiser, and leads a fanatically loyal crew who keep the aging vessel in astonishingly good working order.

TRAITS: Klingon

VALUE: Burn It All

ATTRIBUTES

CONTROL	08	FITNESS	10	PRESENCE	08
DARING	11	INSIGHT	09	REASON	07

DISCIPLINES

COMMAND	03	SECURITY	02	SCIENCE	—
CONN	02	ENGINEERING	01	MEDICINE	01

FOCUSES: Starship Tactics, Hand-to-Hand Combat

STRESS: 12 **RESISTANCE:** 1

ATTACKS:

- Unarmed Strike (Melee, 3▲ Knockdown, Size 1H, Non-lethal)
- D'k tahg* Dagger (Melee, 3▲ Vicious 1, Size 1H, Deadly, Hidden 1)
- Escalation** *Bat'leth* (Melee, 5▲ Vicious 1, Size 2H)
- Disruptor Pistol (Ranged, 5▲ Vicious 1, Size 1H)
- Escalation** Disruptor Rifle (Ranged, 6▲ Vicious 1, Size 2H, Accurate)

SPECIAL RULES:

- Tactical Genius:** Once per scene, if M'Keth succeeds at an **Insight + Command Task** to assess his opponent, he may spend two Threat to allow all under his command to re-roll one d20 on their next Task.
- Brak'lul:** A Klingon's Resistance is increased by +2 against Non-Lethal attacks.
- Warrior's Spirit:** When M'Keth attempts a Melee attack, and purchases one or more additional dice with Threat, he may re-roll any number of d20s.

DELPHINE SÉVERIN (REAL NAME: LOOR, DAUGHTER OF HEREG) [NOTABLE NPC]

The Klingons have a history of using cosmetic surgery to alter spies so that they look like members of another species. Such spies often cross the Klingon border on missions for the Empire. A medical scan will reveal their true nature, but as long as they can avoid arousing suspicion, nobody would think to ask.

TRAITS: Klingon, Disguised (Human)

VALUE: I Must Earn Back My True Face

ATTRIBUTES

CONTROL	09	FITNESS	11	PRESENCE	09
DARING	10	INSIGHT	08	REASON	07

DISCIPLINES

COMMAND	02	SECURITY	03	SCIENCE	01
CONN	02	ENGINEERING	01	MEDICINE	—

FOCUSES: Infiltration, Espionage

STRESS: 14 **RESISTANCE:** 0

ATTACKS:

- Unarmed Strike (Melee, 4▲ Knockdown, Size 1H, Non-lethal)
- Disruptor Pistol (Ranged, 6▲ Vicious 1, Size 1H)

SPECIAL RULES:

- Covert:** Loor has been surgically altered to resemble a human female, and learned the appropriate dialect and a backstory (her "legend" in espionage terms) for her cover identity. She poses as Delphine Séverin, a French journalist. Whenever Loor is required to attempt a Task to maintain her cover identity she may roll an additional d20.
- Adaptable:** Loor may spend 2 Threat to immediately gain a single Focus for the remainder of the scene.
- Brak'lul:** Even when surgically altered, a Klingon's Resistance is increased by +2 against Non-lethal attacks.

COMMANDER KARUK [MAJOR NPC]

Karuk, Son of Krell, is the commanding officer of the *I.K.S. Chal'qul*, a *Vor'cha*-class attack cruiser. His orders are to patrol the Klingon border and shadow Starfleet vessels operating in his area, keeping tabs on their operations. Karuk does not like the Federation. His father never favored the armistice and eventual treaty, and Karuk feels that the alliance will not, and need not, last much longer. If presented with a suitable opportunity, he will provoke a confrontation to drive a wedge between the Empire and the Federation.

TRAITS: Klingon

VALUES:

- The Alliance Weakens Us
- Death Before Dishonor
- Great Men Make History
- Never Trust Starfleet

ATTRIBUTES

CONTROL

11

FITNESS

10

PRESENCE

09

DARING

09

INSIGHT

11

REASON

09

DISCIPLINES

COMMAND

05

SECURITY

03

SCIENCE

01

CONN

03

ENGINEERING

02

MEDICINE

02

FOCUSES: Starship Tactics, Inspiration, Resilience, Suspicion, Hand Disruptors, Strategy

STRESS: 13

RESISTANCE: 1

ATTACKS:

- Unarmed Strike (Melee, 4▲ Knockdown, Size 1H, Non-lethal)
- *D'k tahg* Dagger (Melee, 4▲ Vicious 1, Size 1H, Deadly, Hidden 1)
- **Escalation** *Bat'leth* (Melee, 6▲ Vicious 1, Size 2H)
- Disruptor Pistol (Ranged, 6▲ Vicious 1, Size 1H)
- **Escalation** Disruptor Rifle (Ranged, 7▲ Vicious 1, Size 2H, Accurate)

SPECIAL RULES:

- **Suspicious:** In situations where Karuk is distrustful of his opponent, he can substitute his Insight for any other Attribute in Opposed Tasks against that opponent.
- **Brak'lul:** A Klingon's Resistance is increased by +2 against Non-lethal attacks.
- **Warrior's Spirit:** Karuk may re-roll any number of d20s when he attempts a Melee attack and purchases one or more additional dice with Threat.



ENCOUNTERS AND ADVERSARIES

THE SHACKLETON EXPANSE

THE EXPANSE

Largely unexplored for centuries, the Expanse hasn't been mapped to any degree beyond what was gathered from unmanned deep space probes only in the last century. Most probes stopped transmitting data shortly after entering the Expanse, so it wasn't until recently that we achieved a better understanding of what is out there. And even then, it's estimated that less than eight percent of the Expanse has been mapped: there's a lot of territory waiting to be surveyed.

What that eight percent shows us, though, is that the Expanse is well supplied with resource-rich planets, moons, and asteroid belts, along with countless interstellar features that would excite any scientist. Starfleet believes that a "gold rush" mentality might overtake potential explorers, and dozens or more species will send ships to explore, conquer, or engage in other activities within the Expanse. Starfleet needs to be there, and lead the race.

Among the challenges most vessels and probes face when entering the Expanse are the various stellar phenomena that emit indeterminate forms of electromagnetic and gravimetric distortions. These emissions wreak havoc with sensitive shipboard systems, including defensive shields, sensors, navigational deflectors, and, in some cases, inadequately shielded warp cores. We even have intelligence suggesting that the distortions interact in unfortunate ways with the artificial quantum singularities Romulans use in their warp cores. Federation scientists are hard at work developing a series of upgrades for any Federation vessel assigned to the Expanse to help counteract the disturbances.

STARBASE 364

Starbase 364, more popularly and informally known as Narendra Station, came fully online in 2369. It was named in tribute to the Klingon colonists massacred during a Romulan sneak attack against the outpost on Narendra III in 2344. It also reminds everyone of the Klingons' appreciation for the actions of the *U.S.S. Enterprise* NCC-1701-C, sacrificed while answering the colony's distress call. The

OVERVIEW

Despite continuing tensions with the Romulans and now with the recently encountered Dominion, Starfleet remains focused on its mission of exploration. A key area in achieving that end is a massive swath of unexplored territory at the edges of known space within the Beta Quadrant. Informally known as the Shackleton Expanse — after the renowned ancient Earth explorer Ernest Shackleton — this remote region spans dozens of sectors containing hundreds of uncharted systems.

Until recently, little was known about the Expanse save for what little data long-range sensor probes had collected and the stories and legends that were culled from independent traders who claimed to travel in and near the Expanse. This section provides more detail on the Shackleton Expanse and some of what may be found within it.

starbase serves as an example of Federation-Klingon cooperation and friendship.

Both Starfleet and Klingon personnel live and work here, pursuing missions relevant to their governments, as well as joint tasks that support the increased collaboration between the Federation and the Empire. Given the station's location and relative isolation from more populated areas of Federation space, the station's command staff was granted broad authority to manage missions and operations around the station and into the Expanse. The starbase also serves as a first line of defense against threats to the Federation and the Klingon Empire, whether from a known adversary or by something previously unidentified that could emerge from the unexplored depths of the Shackleton Expanse.

KEY STATION PERSONNEL

ADMIRAL APRIL HEBERT

Even though Admiral Hebert earned her flag just six months ago, following a remarkable thirty-year run as a fearless captain, she has wasted little time in establishing Narendra



Station as a bastion of Federation-Klingon relations. She has also honed the 20th Fleet into an effective first-line defense between the Federation and any threat from the Shackleton Expanse. She is an effective leader, a compassionate advocate, and a moderate voice in these challenging times. While most of her fleet's starships are scattered across many sectors of space along both the Klingon and Romulan borders, she is eager to direct her fleet's newest vessels into the Expanse.

GENERAL KARGAN

While General Kargan is a capable leader and a fearsome warrior, it is his extensive experience of Starfleet — thanks to his participation in the Officer Exchange Program during the 2360s — that brought him the chance to serve aboard Narendra Station as the Klingon Empire's highest-ranking representative. Kargan manages the day-to-day station operations with Admiral Hebert, and while their partnership is still very young and tentative, there is progress on both sides. He is a vocal defender of the Klingon population aboard the station, though he is enough of a diplomat to not blindly defend his people in every circumstance.

DR. HELENA TALIAFERRO

Doctor Taliaferro is a renowned and politically oriented Federation scientist, assigned to lead all research efforts based out of Starbase 364. Despite the Admiralty's desire to have a Starfleet scientist in the lead role, civilian authorities prevailed and secured her position aboard the station. Several Federation worlds, concerned about the Federation's expansion into the Expanse, had wanted at least one non-Starfleet official aboard the station. Taliaferro's brusque demeanor and lack of social graces — out of character for a Betazoid — are balanced by her exemplary organization skills and relentless curiosity.

LIEUTENANT OLOK

The station's chief engineer, Lieutenant Olok, is one of several younger sons of a Klingon High Councilor now forced to be creative in finding his own honor and glory. He has, as yet, had little opportunity to distinguish himself in battle, but he does leave most of his peers behind when it comes to understanding power transfer conduits and creative applications of self-sealing stem bolts.

COMMANDER N'RIA

As Chief Medical Officer aboard Narendra Station, Commander N'Ria and her medical staff receive and treat patients of hundreds of diverse species. N'Ria treats them all with the same level of indifferent competence. She has little time for coddling, even less time for filing reports, and is rumored to be deeply connected to the increased theragen addiction spreading among station personnel. So far, N'Ria has managed to avoid any direct accusations, perhaps due to her effective procedures and treatments.

THE WHISPERS

EXCERPT FROM A FIRST MATE'S PERSONAL LOG

Cap'n Tagral spun another of her wild tales tonight. Seems that one of the crews what travelled with her through the Expanse some years back all demanded to buy out at the same time, after their ship returned to Narrie Station after transporting supplies to a Federation colony. Seems they'd all heard "the whispers" out there among the swirlies. And not a one of them could figure out who was saying what or where the voices were coming from.

Cap'n emphasized that the whole crew accepted three-fifths payment rather than full shares in order to get out of their contracts early and off the ship, which seemed to suit the captain just fine. She said she hadn't heard no whispers, and figured it had to be a soft mutiny for the crew to want to all buy out at the same time.

Her story didn't seem like just a story. I think it was one of them allegories, like she was trying to send us a message. I should get to the engine room tomorrow morning to warn the techs that their talk of strange voices and ghostly forms has gotta stop before it spreads to the rest of the crew. No way am I gonna be pushed into a three-fifth. My two wives and six kids gotta have a nesting they can be proud of.

CAPTAIN AKUL

Akul is a veteran Klingon warrior, loyal to Chancellor Gowron. He is generally positive toward his Federation allies, but bristles at their apparent lack of speed when it comes to what are, to him, routine tasks. He knows what he wants when he wants it, and he does not hesitate to demand what he wants in as loud a manner as needed. Despite his harsh attitude and hatred of inefficiencies, Akul is something of an oddity among Klingons: exploration and the unknown fascinates him, which is partly why he agreed to take his ship into the Expanse to patrol alongside the Federation.

ADDITIONAL FEDERATION PRESENCE

Due to its proximity to both Romulan and Klingon space, the Expanse is of key strategic importance to the Federation and Starfleet. The Security Council recently pushed for a stronger Federation presence within the Expanse, which is why three of our top ships and crews were reassigned to the 20th Fleet. As those three pathfinder ships discover new worlds and new resources, you can expect Starfleet to commit additional vessels and resources to the Expanse.

FLEET OPERATIONS

In answering the Security Council's request, Fleet Operations assigned three starships to Starbase 364 — the *Akira*-class *U.S.S. Thunderchild* (NCC-63549), the *Galaxy*-class *U.S.S. Venture* (NCC-71854), and the *Intrepid*-class *U.S.S. Bellerophon* (NCC-74705).

These three vessels are the first Federation starships to enter the Expanse in a formal role. After undergoing minor refits intended to harden certain shipboard systems against the electromagnetic hazards prevalent within the Expanse, the vessels were almost immediately sent out on a variety of missions.

The range of missions the Expanse flotilla will undertake is extensive and should serve to challenge even the most veteran of crews. Near- and deep-space exploration, convoy escorts, planetary survey missions, first contacts, stellar cartography mapping, and many more will test their resolve and ingenuity.

INTERCEPTED INTELLIGENCE REPORT

NEW STARFLEET ASSIGNMENTS



We have received reliable reports that Starfleet Admiralty has transferred three vessels to the command of Admiral Hebert at Starbase 364. While some operatives consider this to be a preamble to a more aggressive stance toward Romulan space, I believe this move suggests the Federation is focusing exploratory efforts on the so-called Shackleton Expanse.

We have, as yet, not found any reliable intelligence to suggest why the Federation might have suddenly taken an interest into what has been, until now, a relatively quiet sector of space, but we have made it a priority. We are casting the net wide for more details on what the Federation must have discovered.

Appended to this report is a request that the Senate approve several scouting sorties into the Expanse.

THE SHACKLETON EXPANSE: NAVIGATIONAL HAZARDS

The electromagnetic and gravimetric eddies prevalent within the Expanse are Traits: "Electromagnetic Disturbances 2" and "Gravimetric Eddies 2", so the Difficulty of certain Tasks attempted within the Expanse is increased by 2. Scanning the eddies is a Difficulty 3 Task, which may be attempted using **Reason + Security**, **Sciences**, or **Engineering**, assisted by the ship's **Sensors + Science** (or some other combination as best suits the characters attempting the Task).

Success at the scan reveals that the proximity to the eddies is having a direct effect on the starship. Further, an adjustment to the ship's shield modulation should be sufficient to insulate the ship from the worst of the effects. Such an effort would be

a Difficulty 2 Task using whichever Player Character and ship statistics seem appropriate (**Reason + Engineering** with support from the ship's **Structure + Engineering** probably).

Failing the Task results in the swirls of electromagnetic energies interacting negatively with the fluctuating shield harmonics. The Complication will burn out some of the ship's shield emitters, reducing the ship's Shields value by 3. The emitters cannot be repaired in the field and must be replaced. This means the Player Characters' vessel must make do until they can complete their mission and return to Narendra Station.

ADDITIONAL KLINGON PRESENCE

Approximately 60 percent of the crew aboard Starbase 364 are Klingon, including the station's chief medical officer and chief engineer. The Klingons pushed to secure a majority presence on the station, citing proximity to their territory as a key factor. Federation diplomats chose not to challenge the issue but did secure other key roles for Starfleet personnel.

Several Klingon merchants and entrepreneurs have set up shops and restaurants on the station's Galleria, alongside dozens more merchants representing over a hundred different species and homeworlds. While the Klingon Defense Force has, as yet, assigned only one vessel to the station, we anticipate the High Council will send additional scout ships to support their Federation allies but also to further their own ends.

POTENTIAL ADVERSARIES

Given that the Expanse is a short warp from Klingon space, the Romulan Neutral Zone, and several shipping lanes, it shouldn't be surprising that you'll probably encounter any number of alien vessels during your time within the Expanse. Further, as rumors and stories about what may be found within the Expanse continue to spread throughout populated space, we expect both Narendra Station and the Expanse to draw interest from all corners of the known Galaxy. We'll briefly discuss some of the most likely candidates now, based on recent Starfleet Intelligence reports.

THE BORG

As yet, we still have limited knowledge of the Borg or whether they have a homeworld. Given that both the Klingons and Romulans suffered casualties to the Borg

in years prior to the battle of Wolf 359, there are some in Starfleet Intelligence who suggest the Borg may have originated from somewhere deep within the Shackleton Expanse. Starfleet vessels are expected to monitor the deeper regions of the Expanse for any possible Borg activity and to report it as soon as possible. We're ill-prepared for another Borg incursion, so any advance warning is better than none at all.

THE CARDASSIAN UNION

Intercepted intelligence reports suggest that the Cardassians are none too pleased about the expanded relationship between the Federation and Klingons. Despite their lack of territories within the Beta Quadrant, the Cardassians may attempt to scout sections of the Expanse in order to find new planets to mine. With the uncertainty around what the Dominion might represent, the Cardassians may well look to expand their operations well beyond the Alpha Quadrant.

THE FERENGI ALLIANCE

Ever the opportunist, the Ferengi Grand Nagus, Zek, has already started to push representatives into the Expanse to develop trade relations with unaligned worlds and to establish stable trade routes through the electromagnetic eddies. Of course, he intends to charge a toll for every safe passage. Ferengi ambassadors are working to establish a formal embassy on Narendra Station, and may well succeed in due course despite protestations from the Klingons.

THE ORION SYNDICATE

It's well known that the Syndicate has spies everywhere, and a hand in many of the underworld dealings throughout the Alpha and Beta Quadrants. While no merchant or independent trader traveling through the Expanse has confirmed the presence of Syndicate operations, it's likely that the Syndicate has eyes on the Expanse, and maybe an operation already in place. Starfleet Intelligence, with the cooperation of Fleet Operations, is rumored to be developing a series of missions designed to locate and address any such activities within the Expanse.

THE ROMULAN STAR EMPIRE

Despite slow progress toward better relations, the Romulans remain our primary adversary. They remain secretive and largely hidden behind the Neutral Zone, no doubt plotting their next move against the Federation, the Klingons, or both. Romulan ambassadors have issued informal protests to both the Federation and Klingon leaders regarding Starbase 364, though they have declined to make any formal statement. The Security Council is well aware that Narendra Station was not designed to be a front-line defense post, and are actively debating whether to upgrade the station to withstand any focused Romulan offensive.

OTHER SHIPS, OTHER STORIES

Even though just three Federation vessels have been assigned to Starbase 364 and the Shackleton Expanse to date, Gamemasters are encouraged to use one of the ships as the basis for their campaign, replace one of the three established vessels with their own campaign's starship, or simply add their campaign's starship to those ships already assigned to the Expanse. Player Characters could encounter any of the three ships' crews at the station or on a mission, or could simply replace them and take on a key role in the exploration of the Expanse.

UNALIGNED MERCHANTS AND ROGUES

In addition to the established political entities discussed earlier, countless independent merchants, traders, smugglers, and mercenaries have traveled into or through the Expanse. Some even call the wild, untamed region their home. Some are rumored to have detailed star charts detailing safe routes through the Expanse's unpredictable and uncertain electromagnetic eddies, and some even claim to have salvaged relics and pieces of ancient technologies from dozens of planets and moons contained within the Expanse.

Miradorn rogues, Pakled traders, rogue Klingon warriors, and disenfranchised beings of all species may be found lurking in the corridors of Starbase 364 or within the Expanse. Starfleet vessels and crews assigned to the Expanse must remain as vigilant as ever.

PLOT COMPONENTS

Gamemasters are encouraged to modify these plot components for use in their own campaigns and adventures. They relate specifically to the Shackleton Expanse and provide suggestions on how to use the Expanse as a focal point of a campaign, or simply an interesting place to visit during an adventure. The plot components are separated into Starfleet's three division colors, suggesting likely plot focuses for Player Characters from each division.

COMMAND PLOT COMPONENTS

Plot components ideal for Command or Conn Player Characters:

- Conducting first contact procedures with an Expanse world's populace
- Maintaining or improving Federation-Klingon relations
- Trailblazing and charting safe routes through the Expanse's dense navigational hazards
- Mapping particularly dangerous hazards and establishing safety margins for approach

OPERATIONS PLOT COMPONENTS

Plot components suitable for use with Security Player Characters:

- Escorting a supply convoy from Narendra Station to a colony or deep-space research station
- Protecting a delegate from an Expanse world during negotiations
- Gathering intelligence on alien species or on adversary ship movements within the Expanse
- Investigating ancient shielding or weapon technologies found on ruined worlds

SCIENCES PLOT COMPONENTS

Plot Components that might present opportunities for Sciences, Medical, and Engineering Player Characters:

- Scanning and researching the cause of the electromagnetic and gravimetric disturbances prevalent throughout the Expanse
- Surveying dead worlds and ancient ruins of alien species long dead
- Providing medical care to injured beings of hither-to unknown species

TO BOLDLY GO...

FURTHER ADVENTURES IN THE SHACKLETON EXPANSE

Gamemasters and Players are encouraged to visit our website to sign up for the *Star Trek Adventures* Living Campaign — set in the Shackleton Expanse — to enjoy regular releases of new missions from either The Original Series era or *The Next Generation* era. In addition, future *Star Trek Adventures* supplements will add more detail to what is already known about the Expanse and the secrets it contains.

GRAVIMETRIC DISTRIBUTION

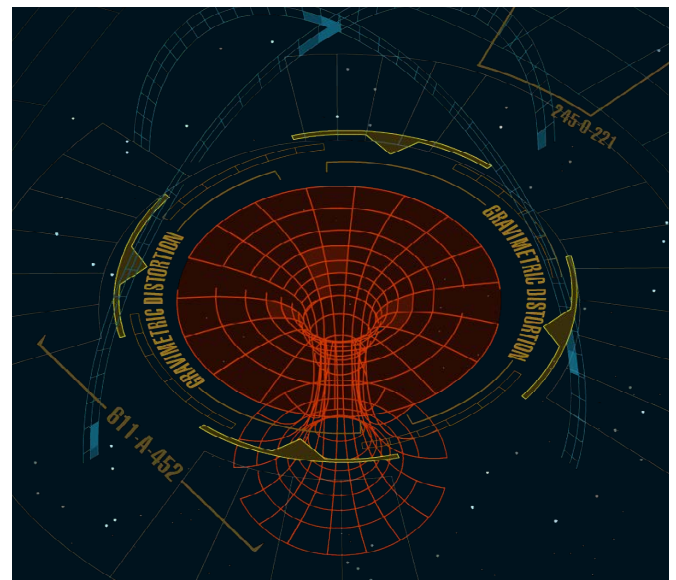

1003-5505	28903	289010	18-101-88	18535	105578	200453	450
2185-3590	1885	186743	19-300-50	1480	10220	320600	320
1818-3066	1988	205350	20-327-45	21550	357850	212996	3450
1929-4040	18563	50368	27-495-56	45520	24890	459780	4560

INDEX

22nd Century Shielding.....	93	Delta	4, 9, 24, 52, 66, 79-80	Gorn Political Structure	72
Abbran-Tadji.....	67	Deltan	79	Gorn Raider	96-97
Ablative Armor.....	89	Department of Temporal Investigations	12	Gorn Science and Technology	72-73
Aenar	22-23	Detecting a Cloaked Vessel.....	44	Gorn Varanus Battleship.....	97
Akul, Captain	123	Disruptors 44, 52, 63, 69, 72-73, 88-93, 95-98,	102-107, 109-115, 117-120	Gorn, The	1, 4-5, 7-8, 35, 70-73, 87, 96-97
Algeron, Treaty of	9, 13, 53, 55, 57, 62	Dominion, The	8, 121	Gornar	72-73
Aliens' Graveyard, the	See Rura Penthe	DTI		Gowron, Chancellor.....	8, 38-40, 44
Amaar (Orion)	115	See Department of Temporal Investigations		Great Houses, Klingon	39
Andor.....	9-10, 22	Duras, House of.....	8, 16, 38, 48	Hall of Warriors.....	48
Andoria	13, 18, 22-24, 52-53, 68	Earth Cargo Service (ECS)	20	Hebert, Admiral April	121-122
Andorian ...	9, 11, 13, 16-18, 21-24, 33, 79, 118	Earth	4, 6, 10, 13, 15-20, 26-29, 33,	Hernandez, Captain Erika.....	13
Apnex	49-51, 64	35-37, 43, 45, 52-54, 58, 66-68,	71, 73, 83, 88, 91, 94-95, 118, 121	High Council, Klingon.....	39
Archer, Captain Jonathan ...	4, 9, 13, 24, 31, 47	Earth-Romulan War	52-53	Horta.....	15
Ardana	76	Efros	80	Human Smuggler	118
Ardanan	76	Efrosians.....	80	Hur'q (Klingon, 'Outsiders')	35-36, 43
Azetbur	38	Emergency Medical Hologram (EMH)	21	Imperator (Gorn).....	72
B'Etor	38, 81	Emperor, Klingon	36, 38-41, 46	Imperial Senate (Romulan)	56
Bajoran	79	Enterprise	4, 6, 12, 15, 31,	Jagadish (Orion)	114
Bellerophon, U.S.S.	123	37-38, 47, 53, 62, 70, 79, 12		Jammers	72-73
Benzar	24-26	Eridani B	29, 69. See also Vulcan	K'mpec	15, 38, 47
Benzite.....	5, 25-26, 77, 79	Excalibur.....	13	K't'inga Battle Cruiser	89-90, 119
Betazed	16-17	Excelsior, USS.....	6, 37	Kahless.....	17, 35-36, 38, 40-43, 45-46, 48
Betazoid	16-17, 24, 79	Executive Agencies (Federation)	11-13	Kargan, General.....	122
Bird-of-prey, Romulan (22nd Century)	91-92	Federation Archaeology Council	11	Karuk, Commander	120
Bolarus	78	Federation Arts Council.....	16-18	Khitomer.....	6, 34, 38, 46, 108
Bolian	5, 78-79	Federation Charter	10, 18, 29	Kirk, James T.....	12, 14-15, 37, 47, 70
Boreth.....	35, 38, 40, 46	Federation Culture.....	16-18	Klaang	36
Borg, The	4, 8, 15, 21, 124	Federation Diplomatic Corps	11	Klach D'kel Brakt.....	See Briar Patch, The
Briar Patch, The.....	1, 5, 101, 108-109	Federation Political Structure	10-13	Klingon Astrography.....	34-35
Calder II	50-51, 55	Federation Science and Technology	19	Klingon Castes	41
Cardassia	20	Federation Science Bureau	11	Klingon Culture.....	41-43
Cardassians.....	9, 15, 20, 38, 57, 124	Federation, The	1-2, 4-22, 24-26, 28-29,	Klingon Defence Force (KDF)	41
Cartwright, Admiral.....	14	33-34, 37-40, 43, 45-47, 49, 52-60, 62, 64,		Klingon Diplomat.....	118
Casey, G (MACO)	14	66-67, 69-73, 76, 79, 81, 83-85, 89, 90-91,		Klingon Honour	41-42
Chaltok	54-55, 65	95-96, 98-100, 102, 108, 116, 118, 120-121		Klingon Marriage Ceremony.....	42
Cheron.....	13, 52	Ferengi.....	9, 12, 26, 118, 125	Klingon Military.....	40-41
Cloaking Devices.....	36-37, 43-44, 53-55,	First City, The (Qo'noS)	45	Klingon Rank Comparisons.....	40
57, 62-63, 65, 89-93, 102-103.		Free Traders and Cargo Ships (Federation)...	20	Klingon Religion	43
See also Klingon Special Rules		Freighter, Civilian	98	Klingon Ritual	42-43
Colony ship, Civilian	99	Gorkon.....	37-38, 47	Klingon Science and Technology	43-44
Colony Worlds (Federation)	20	Gorn Astrography.....	70	Klingon Scientist.....	117
Columbia NX-02.....	13	Gorn Culture.....	71	Klingon Special Rules.....	90
Constitution-Class Starship (cross-section) ...	6	Gorn Hegemony, The	1, 4-5, 7-8, 35, 70,	Klingon Political Structure	38-40
Continuing Committee, The	55-56	72-73, 96-97		Klingons.....	1-2, 4-6, 8-9, 11, 16-17, 21, 34-48,
Coridan.....	11, 33, 66-67, 102	Gorn Military.....	72	51-59, 62-63, 69, 72-73, 81, 84, 108, 116-121	
D5 Battle Cruiser	88			Kolinahr	30-32
Delta Pavonis	See Benzar			Kor.....	34-35, 37, 40, 42-43, 46

Kri'stak Volcano.....	46	Plot Components (Shackleton Expanse). 124-125	Starfleet Random Species Table.....	79
Lead Scientist, Romulan.....	105	Political Background (Romulan).....	Starfleet.....	2, 5-6, 8-16 , 18-21, 24,
Lursa.....	38, 81	Potential Adversaries (Shackleton Expanse) 124	26, 28-29, 31, 34, 37, 40, 47, 56-60, 62-63,	
Lusor, Lake of.....	46	Praetor.....	66-68, 72-73, 76-77, 79, 81, 83-85, 88-93,	
M'Keth, Son of none.....	119	Prasad (Orion).....	96-99, 102, 108, 116, 120-121	
Malar, Senator.....	107	Praxis.....	Starships, Klingon.....	44
Maquis, The.....	20, 57, 118	Proconsul (Romulan).....	Steadfast.....	49-51, 61
McCoy, Dr Leonard 'Bones'.....	15, 17, 37, 47	Qam-Chee.....	Subject of the Empire (Klingon, Jekhpu'wl') .39	
Medical Sub-Centurion, Romulan.....	104	Qo'noS . 5, 16, 18, 35-37, 40, 44-46 , 81, 88-89	Suliban.....	108
Medical Technology (Federation).....	21	Quin'lat.....	Sulu, Captain Hikaru.....	6
Metron Consortium.....	8, 70	Raptor Scout.....	Surak.....	28, 30-33 , 49, 52
Milky Way Galaxy.....	4	Reman Bodyguard.....	Survey Ship, Civilian.....	99
N'Ria, Commander.....	122	Reman.....	Tal Shiar Interrogator, Romulan.....	105
Narendra.....	1-2, 4, 6-8, 11-12, 15-16, 34, 38, 46-47 , 52, 55, 121	Remembrance Stones.....	Tal Shiar Saboteur, Romulan.....	104
Nausicaa.....	33	Remus.....	Tal Shiar.....	5, 12-13, 16, 54-56, 58-59 ,
Nausicaan.....	6, 33, 53	Rigellian Chelon.....	62, 92, 102, 104-105	
Navigational Hazards (Shackleton Expanse) 123		Rigellian Jelna.....	Taliaferro, Dr. Helena.....	122
Negh'Var Warship.....	90-91	Risa.....	Tellar.....	9-10, 13, 24
Neutral Zone, Romulan . 1, 4-6, 8-9, 16, 22, 24, 29-30, 34, 36-37, 46, 52-56, 59, 62, 65, 101-102, 116		Risian.....	Tellarite .. 9, 11, 13, 16-17, 21, 33, 53, 63, 79, 84	
New World Economy (Federation).....	18	Rite of Succession.....	Thunderchild, U.S.S.....	8, 123
Olok, Lieutenant.....	122	Romulan Astrography.....	Transporters.....	6, 19, 33, 43, 47, 69, 96, 100
Organia.....	37	Romulan bird-of-prey . 41, 57, 61-63, 88, 91-93	Transports, Civilian.....	98-99
Orion Astrography.....	66	Romulan Culture.....	Treaty of Organia.....	6, 34, 37
Orion Blackguard.....	95	Romulan Military.....	Ty'Gokor.....	47-48
Orion Breacher.....	111	Romulan Rank Comparisons.....	Typhon Expanse.....	9
Orion Buccaneer.....	110	Romulan Science and Technology.....	Uhlan Technician, Romulan.....	103
Orion Characters.....	110	Romulans.....	Venture, U.S.S.....	36, 123
Orion Colonies.....	67	36-38, 40-47, 49- 69, 73, 79, 81, 87, 91-95, 101-107, 116, 118, 121, 124	Verex III.....	69
Orion Engineer.....	112	Romulus.....	Vulcan Science Academy Survey Vessel.....	100
Orion Executive Officer.....	111	Rura Penthe.....	Vulcan.....	9-13, 16-18, 24, 28-33 , 36, 49-53,
Orion Free Traders.....	67	Russth (Gorn).....	56-59, 61-62, 64, 79, 88, 91, 94, 100	
Orion History.....	66-67	Rynar.....	Vulcan's Forge.....	33
Orion Interceptor.....	94-95	Sakethan.....	Vulcans, The.....	5, 9, 16, 24, 27-28, 30-33,
Orion Pirate Crewman.....	112	San Francisco.....	49, 52, 57, 59, 61, 79, 85, 94	
Orion Science and Technology.....	69	Scout Ship, Romulan.....	Warbird Commander, Romulan.....	106
Orion Science Officer.....	111	Scoutship Pilot, Romulan.....	Warbird, Romulan 38, 48, 52-54, 61-63, 92, 106	
Orion Scout Ship.....	94	Seema (Orion).....	Warrior's Anthem (Klingon).....	38
Orion Slaver Medic.....	110	Séverin, Delphine (Loor, Daughter of Hereg) 119	Weather Control (Federation).....	19-20
Orion Slaver Overseer.....	109	Shackleton Expanse, The... 1, 4, 6, 8-9, 11-12, 34, 52, 59, 101, 108, 121-125	Wolf 359.....	8, 15
Orion Syndicate.....	1, 5, 7-8, 24, 33, 53, 57, 66-69 , 87, 94-96, 108-116, 124	Shirkahr.....	Wormhole, Bajoran.....	4, 8, 116
Orion.....	69	Shran, General Thy'lek.....	Xindi.....	5, 83-85
Paris.....	29	Shretsh (Orion).....	Xindi-Arboreal.....	83
Partha (Orion).....	114	Sol.....	Xindi-Insectoid.....	85
Picard, Captain Jean Luc.....	15, 38	Spock.....	Xindi-Primates.....	84
Pleasure Barge, Orion.....	95-96	Ssessekh (Gorn).....	Xindi-Reptilians.....	84
		Starbase 364.....	Xindito.....	84
		Starfleet Medical.....	Xindu.....	83-85
			Zakdorn.....	9, 79, 84-85

STAR TREK™

ADVENTURES



A FULL RANGE OF BOOKS & ACCESSORIES

NCC-1701-D Limited Edition Corebook
Away Team Edition Corebook
Tricorder Starter Set
Command Division Book
Operations Division Book
Sciences Division Book
Alpha Quadrant Book
Beta Quadrant Book
Gamma Quadrant Book
Delta Quadrant Book
These Are The Voyages: Missions Vol.1

Limited Edition Borg Cube Box Set
Borg Cube Gamesmaster Screen
Command, Operations & Sciences Dice Sets
The Next Generation Miniatures
The Original Series Miniatures
Romulan Strike Team Miniatures
Klingon Warband Miniatures
Borg Drone Miniatures
Starfleet Away Team Miniatures
Star Trek Villains Miniatures
Starfleet Geomorph Deck Tiles

AVAILABLE FROM MODIPHIUS.COM/STAR-TREK
OR VISIT YOUR FRIENDLY LOCAL GAMING STORE

MODIPHIUS™
ENTERTAINMENT

TM & © 2017 CBS Studios Inc. STAR TREK and related marks are trademarks of CBS Studios Inc. All Rights Reserved.

STARTREK.COM

FFFO™

STAR TREK™

ADVENTURES

ASSEMBLE THE AWAY TEAM, NUMBER ONE!



32MM MINIATURES
THE NEXT GENERATION



32MM MINIATURES
THE ORIGINAL SERIES



32MM MINIATURES
KLINGON WARBAND



32MM MINIATURES
ROMULAN STRIKE TEAM

ENHANCE YOUR ADVENTURES WITH SETS OF EIGHT 32MM HIGH QUALITY RESIN MINIATURES PLUS GEOMORPHIC FLOOR TILES TO RECREATE SHIPS, SPACE STATIONS, LOST COLONIES, AND ANCIENT RUINS!

The Next Generation Bridge Crew
The Original Series Bridge Crew
Klingon Warband
Romulan Strike Team
Borg Drones
Starfleet Away Team

Star Trek Villains
Starfleet Geomorphic Tiles
Klingon Geomorphic Tiles
Romulan Geomorphic Tiles
Lost Colonies & Ancient Ruins Geomorphic Tiles
Borg Geomorphic Tiles

MÖDIPHIUS™
ENTERTAINMENT

TM & © 2017 CBS Studios Inc. STAR TREK and related marks are trademarks of CBS Studios Inc. All Rights Reserved.

STARTREK.COM

FFFO™

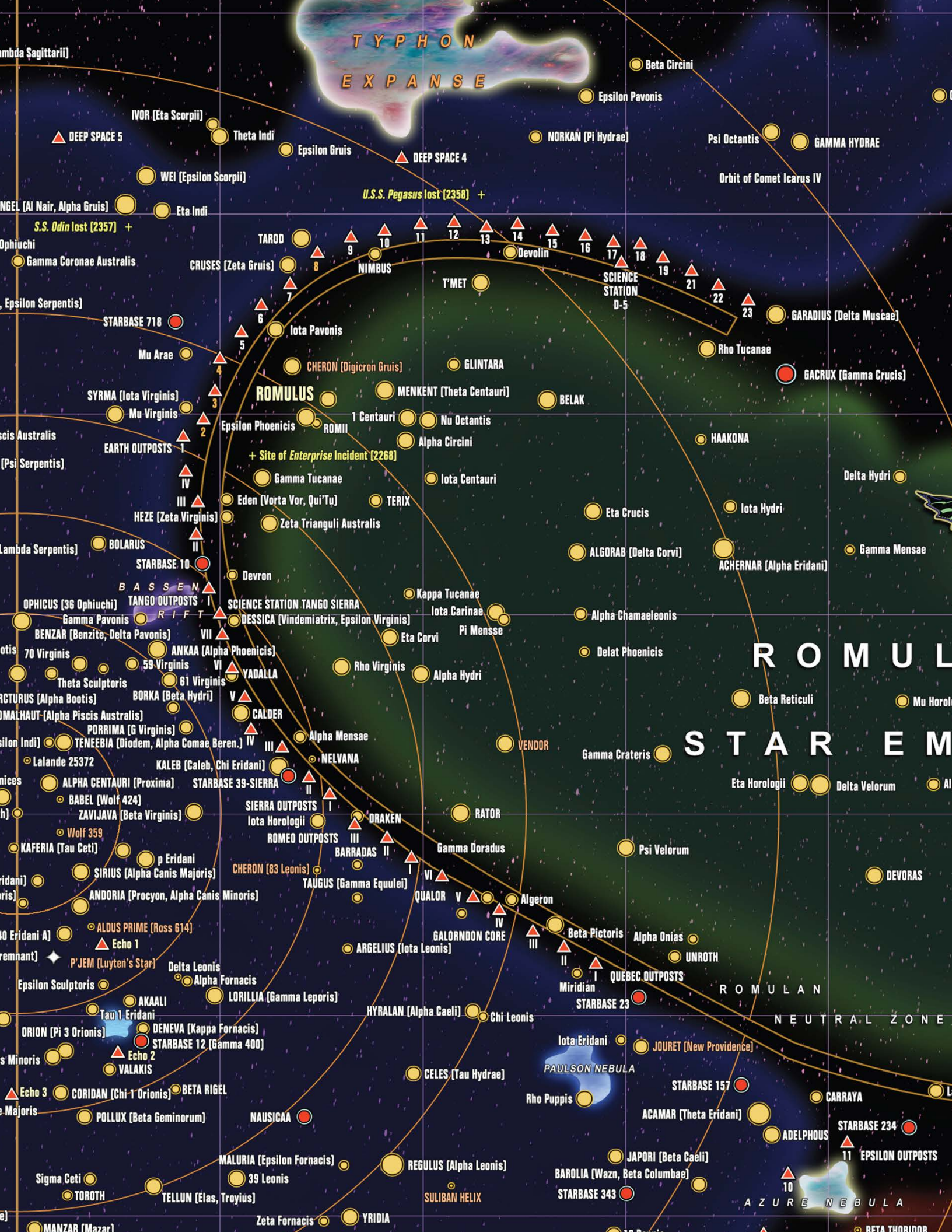



AN
PIRE

SHACKLETON EXPANSE

AMARGOSA



CROSS THE THRESHOLD

YOU JUDGE YOURSELVES AGAINST THE PITIFUL ADVERSARIES YOU'VE ENCOUNTERED SO FAR: THE ROMULANS, THE KLINGONS... THEY'RE NOTHING COMPARED TO WHAT'S WAITING.

The Beta Quadrant sourcebook provides Gamemasters and Players with a wealth of source material about the Galaxy of Star Trek. Focused on the Beta Quadrant, The Beta Quadrant sourcebook contains:

- Information on the Federation's presence in the Beta Quadrant, including the homeworlds of Andoria, Earth, and Vulcan.
 - Material about the Klingon Empire and its history, including information on its core worlds of Qo'noS, Boreth, Khitomer, and Rura Penthe.
 - Information from the Romulan Star Empire on their history and politics, and information about their worlds Romulus and Remus.
 - A host of new Federation species to choose from during character creation, including Benzite, Bolians, Efrosians, and Klingons.
 - A selection of alien starships, from the Klingon Empire, Romulan Star Empire, Gorn Hegemony, Orion Syndicate, and civilian craft.
 - Guidance for the Gamemaster on running missions and continuing voyages in the Beta Quadrant, with a selection of new Non-Player Characters to enhance encounters.
- 

This book requires the *Star Trek Adventures* core rulebook to use.



MODIPHIUSTM
ENTERTAINMENT

A-A-ATM

MODIPHIUS.COM

TM & © 2017 CBS Studios Inc.
© 2017 Paramount Pictures Corp.
STAR TREK and related marks and logos are trademarks of CBS Studios Inc.
All Rights Reserved.

STARTREK.COM

ISBN 978-1-910132-91-3



9 781910 132913 >

MUH051067

Printed in Germany

