

STAR FLEET BATTLES

FEDERATION MASTER STARSHIP BOOK

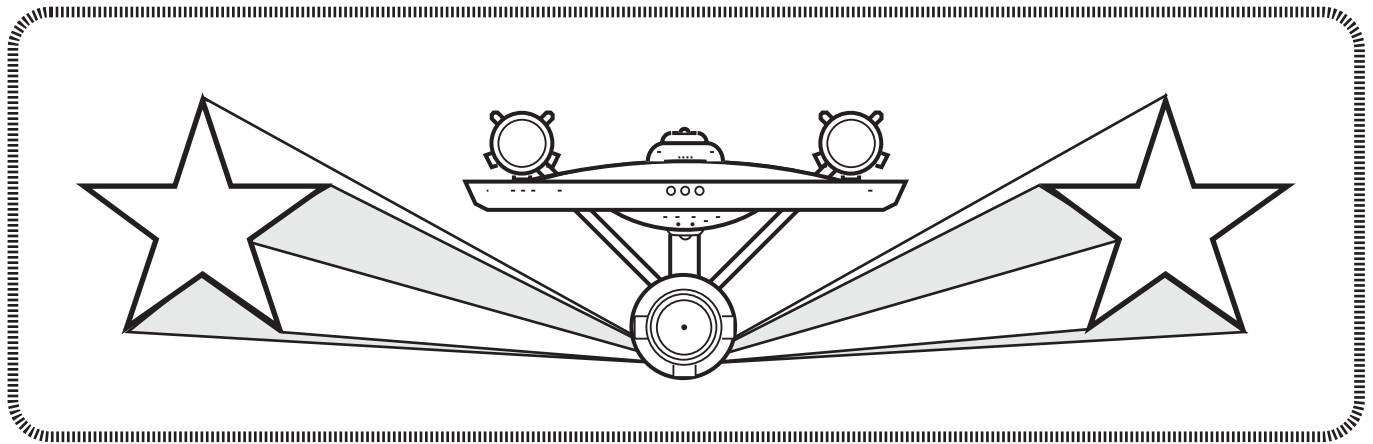

STAR FLEET BATTLES



★ CAPTAIN'S EDITION FEDERATION ★ MASTER STARSHIP BOOK

TABLE OF CONTENTS

INTRODUCTION

DESIGNER'S NOTES	2
PUBLISHER'S INFORMATION	2

FEDERATION SHIPS

PUBLISHED MAIN ERA SHIPS	3
SHIPS IN <i>CAPTAIN'S LOG</i>	68

FEDERATION FIGHTERS AND BOMBERS

PUBLISHED FIGHTERS AND BOMBERS...	82
BOMBERS AND FIGHTERS IN <i>CAPTAIN'S LOG</i>	93

FEDERATION GROUND FORCES

COMPANY AND BATTALION TO&Es	100
-----------------------------------	-----

FAST PATROL SHIPS

INTERCEPTORS.....	102
FAST PATROL SHIPS.....	102

ADVANCED TECHNOLOGY SHIPS

ADVANCED TECHNOLOGY SHIPS.....	106
--------------------------------	-----

EARLY YEARS SHIPS

EARLY YEARS ERA SHIPS.....	111
----------------------------	-----

FEDERATION GENERAL UNITS

MAIN ERA GENERAL UNITS.....	129
EARLY YEARS ERA GENERAL UNITS....	153
ADVANCED TECHNOLOGY GENERAL UNITS.....	154

(Z49.0) NOTES ON THE FEDERATION MASTER STARSHIP BOOK**(Z49.1) ORGANIZATION AND COMPONENTS**

STAR FLEET BATTLES FEDERATION MASTER STARSHIP BOOK is a modular expansion of the *SFB* game system. You will need the *SFB Basic Set* to use this material. This material will also require *Advanced Missions* and other products (e.g., *Module J, Module J2, Module K, Module M, Module R2, Modules R5 through R12, Module X1, Module X1R, and Modules Y1 through Y3*) to use it to the fullest extent. *The Federation Master Starship Book* includes this 158-page book.

(Z49.2) DESIGN CREDITS

SFB Designer.....Stephen V. Cole, PE
Federation MSSB Designer.....Steven P. Petrick, IN
 Proofreading.....Jean Sexton
 Chief of ADB Security.....Ramses
 ADB Inspector General.....Isis
 Security Guard.....Wolf
 Interior Artist.....Stephen V. Cole
 Federation Star Fleet Researchers..John Crawford, Dal
 Downing, Stewart Frazier, Ken Kazinski, Loren
 Knight, Terry O'Carroll, Ryan J. Opel.

(Z49.3) PUBLISHER'S INFORMATION

This product is published by:

AMARILLO DESIGN BUREAU, INC.
 POST OFFICE BOX 8759
 AMARILLO, TEXAS 79114-8759
 Telephone: 806-351-1950 (Fax: 806-351-2585)
 Email: Design@StarFleetGames.com
 Website: www.StarFleetGames.com

Include a stamped self-addressed envelope with all rules questions, submissions, or other inquiries. Most of the information which players seek (e.g., product schedules) is available free on our website.

All submissions are accepted only under our standard terms as published in *SFB Advanced Missions*. In summary, any submission becomes our property on receipt and may be modified at our sole discretion before publication. The author of a submission receives authorship credit and compensation at our standard rates.

ADB, Inc., products are available to individuals in retail stores, from several direct-mail outlets, from the shopping cart on our website, and directly from us. If your store does not carry our products, send us the store name and address and we will have our wholesalers contact the manager.

(Z49.4) DESIGNER'S NOTES

This product was born out of request by our customers to have all of the Federation ship descriptions, including their fighters, bombers, and fast patrol ships, included in one product to make it easier to look things up. All ships are in rule number order to make searching through the book for a specific unit as simple as any reference book.

The ship descriptions were all formatted to include all relevant refits applicable to a given unit, and all special considerations, such as special sensors or whether or not a given ship is a carrier or fast patrol ship tender, or a scout or

commando ship, or some or all of these included. Commando ships were all spelled out as to their landing forces and whether or not they could, themselves, land on planets.

Further, all information that had been published in *Captain's Logs* as of the date this product was completed were also included. Ships prior to *Captain's Log #19* had all been published, but any unit that has not been formally published from *Captain's Log #19* through *Captain's Log #49* has been included.

Further, bombers and fighters that had appeared in *Captain's Log* but not previously had a box display had their displays created and included in this book.

This book also includes all Federation ships which have been published from the Early Years, and those equipped with Advanced Technology.

As of its date of publication, this book is the most complete accounting of all Federation ships, bombers, fighters, fast patrol ships, Interceptors, and Federation ground forces organizations in the game system.

We hope that you enjoy this book and stay in touch.

You will notice on our webpage: www.StarFleetGames.com that you have several avenues to follow ADB. "Discuss" takes you to our BBS, where most of the game development takes place. "FC Forum" takes you to our Forum, which is more of a traditional forum to meet other players. You will also see that you can follow our page on Facebook (great for snippets of information and lots of art) and our Twitter account.

Want to find more players? Try our re-vamped Starlist: <http://www.starfleetgames.com/starlist.shtml> and we will send you a list of players near you.

As we say around here, "Don't be a stranger!"

DEDICATION

This product is dedicated to the Adjutants and military clerks of all nations whose tireless efforts ensure that those at the pointy end of the spear are fed, clothed, equipped, and when appropriate justly rewarded for their actions against their nation's enemies.

★ Updated 21 October 2014

(Z49.5) COPYRIGHT & LICENSING

STAR FLEET BATTLES — CAPTAIN'S EDITION — FEDERATION MASTER STARSHIP BOOK and all contents thereof are copyright © 2014 by ADB, Inc. All rights are reserved under the Pan-American, Berne, and International Copyright Conventions.

No material which is based on, for use with, incorporates elements of, or is derived from *Federation Commander, Star Fleet Battles, Federation & Empire, Star Fleet Missions, Star Fleet Battle Force, GURPS Prime Directive, Star Fleet Armada*, or the *Star Fleet Universe* background can be published by any party without the advanced written permission of ADB, Inc.

SFB is produced under license from Franz Joseph Designs, authors of the STAR FLEET TECHNICAL MANUAL.

Elements of the Star Fleet Universe are the property of Paramount Pictures Corporation and are used with their permission.

(R2.0) UNITED FEDERATION OF PLANETS**(R2.1) FEDERATION BACKGROUND**

The United Federation of Planets is the only major political unit in *Basic Set* that is not dominated by a single species of beings. (The WYN in *Module C1* and the ISC in *Module C2* also fit this description.) Several species (Human, Vulcan, Andorian, Rigelian, Alpha-Centauran, Cygnan, etc.) hold seats on the ruling council, two dozen other species are affiliate members, and colonies or stations have been established on a thousand other planets. Most ships are manned 90% by one species, with the other 10% being a mixture of all others.

The Federation's Star Fleet is dominated by the Humans, including those of Earth parentage who were born on other planets. Humans provide more than 70% of Star Fleet personnel and dominate every phase of its operations. Humans are regarded as the most militaristic, but not the most warlike, of the member species of the Federation.

The Federation is probably the most idealistic of all the empires. Federation ships never attack without warning, and while the Federation has fought wars with all of its neighbors, it has never started one. The Federation has negotiated boundaries with all of its neighbors and has never sought to expand them militarily.

Economically, however, the Federation is the most aggressive empire in the known area of the galaxy. Federation merchant ships are found almost everywhere during peacetime and the "Neutral Zones" between the Federation and its neighbors abound with Federation colonies set up within the strict letter of the relevant treaties. The Federation considers "peace" to include free access to the markets and ports of all other empires. Since the Federation has the strongest economy, it has the most money to buy things with, the most production capacity to build things with, and thus tends to dominate the galactic economy.

The Federation has treaties of alliance and friendship with the Kzintis and Gorns although ties with the Gorns appear stronger. The Federation had (at one point) mutual non-aggression pacts with the Klingons and Romulans. The Tholians indicate that they feel the best treaty is to simply never have contact.

FEDERATION MILITARY RANKS

O12 ★★★★★ ADMIRAL-IN-CHIEF: The highest rank, there are three of these officers. One is the Admiral-in-Chief of Star Fleet, the second is the Chief Marshal of the Star Fleet Marines, and the third is the nominal Chief of Staff of all of the National Guard forces of the various member planets.

O11 ★★★★★ GRAND ADMIRAL: Commands a theater of war. A Field Marshal commands an Army Group.

O10 ★★★★★ FLEET ADMIRAL: Commands a numbered fleet within a theater. In peacetime, commands an entire sector. Colonel-General commands a Field Army.

O9 ★★★ VICE ADMIRAL: Commands a wing of a fleet, about 15-25 ships, normally the largest command deployed in a single battle. Lieutenant General commands a Corps.

O8 ★★ REAR ADMIRAL: Commands a division of a fleet (5-10 ships). Major General commands a ground division.

O7 ★ COMMODORE: Commands a squadron of three or four ships, such as a carrier group or a frigate squadron. Brigadier commands a brigade of ground troops or acts as the deputy commander of a division.

O6A ●●★●● FLEET CAPTAIN (or Regimental Colonel, an honorary title): The senior captain in a numbered fleet or the senior colonel in a ground forces corps.

O6 ●●●● CAPTAIN: Commands a major starship. Colonel commands a regiment or brigade of ground troops.

O5 ●●● COMMANDER: Commands a lesser starship (destroyer or frigate) or Executive Officer of a major starship. Lieutenant Colonel commands a battalion of ground troops.

O4 ●●○ LIEUTENANT COMMANDER: Heads a major department (e.g., weapons, engineering) on a starship. The equivalent Marine Major serves as the deputy commander or tactical chief of a battalion of ground troops.

O3 ●● SENIOR LIEUTENANT: Heads a minor department (communications, administration) on a starship or the deputy head of a major department. The equivalent Marine Captain, commander of a company of ground troops.

O2 ●○ JUNIOR LIEUTENANT: An experienced working officer on a starship. Marine 1st Lieutenant deputy commander of a company of ground troops, or a senior platoon leader.

O1 ● ENSIGN: A relatively new working officer on a starship. The equivalent Marine 2nd Lieutenant is leader of a platoon of 15-25 ground troops.

O0 ○ CADET: A student at a military academy.

W WARRANT OFFICER: A temporary officer rank given to a civilian expert temporarily attached to a military unit.

E10 COMMAND MASTER CHIEF: The senior enlisted man in the Fleet. Marine COMMAND SERGEANT MAJOR, the senior enlisted man in the Corps.

E9 MASTER CHIEF PETTY OFFICER: The senior enlisted man on a starship. Marine SERGEANT MAJOR, the senior enlisted man in a battalion or larger ground unit.

E8 SENIOR CHIEF PETTY OFFICER: The senior enlisted man in a department of a starship. Marine MASTER SERGEANT, the senior sergeant in a company of ground troops.

E7 CHIEF PETTY OFFICER: The senior enlisted man in a duty section on a starship. Marine GUNNERY SERGEANT, the senior sergeant in a platoon.

E6 PETTY OFFICER 1ST CLASS, Marine STAFF SERGEANT. Supervises a group of up to 10 enlisted men.

E5 PETTY OFFICER 2ND CLASS, Marine TEAM SERGEANT: Supervises a group of up to five enlisted men.

E4 PETTY OFFICER 3RD CLASS or Marine CORPORAL: The lowest rank that supervises other personnel. This rank is usually held by a junior sub-unit leader just starting his non-commissioned officer career.

E3 CREWMAN or LANCE CORPORAL: An experienced crewman or Marine, not a leader or supervisor.

E2 CREWMAN APPRENTICE or PRIVATE FIRST CLASS: A young crewman or Marine who has completed his basic training.

E1 CREWMAN RECRUIT or PRIVATE: A recent enlistee who is taking his basic training for service in Star Fleet or the Marines.

(R2.R0) FEDERATION FLEET REFITS**(R2.R1) FEDERATION "+" FLEET REFITS**

Beginning about Y165, the Federation began updating its ships in order to maintain its military forces at a level sufficient to deter attack. Due to budget restrictions and a short-sighted attitude by the civilian administrators (who failed to foresee the coming General War), only about 20% of the fleet had been updated by the time the war began. The update program was accelerated after Y171.

These "plus" refits included various combinations of extra shielding, power, drone racks, and (almost always) a pair of phaser-3s for close-in defense against drones and fighters. If the ship did not previously have a drone rack, it also gained the ability to control a number of seeking weapons equal to its sensor rating if this refit added a drone rack to the ship. If the

ship already had one or more drone racks or plasma torpedo launchers, this refit did not further increase its seeking weapons control rating. See (F3.21) and (F3.211).

The cost and extent of these refits is shown on the SSD for each ship that received this refit (or any other for that matter). The dates that the refit was effective (squadron service; there is no prototype date) is shown in the description or on the Master Ship Chart.

Ships with this refit are designated with a "+," such as CA+, DN+, etc. The DN+ refit was so extensive that it is listed as a separate class (R2.17).

The FF+ refit is listed as the FFG; this refit preceded the other classes, starting in Y160. This refit was applied to the FF, FFD, FFM, and FFS; rarely to the FFE, FFR, and FFL; and very rarely to the FFT, FFP, or FFV.

(R2.R2) REAR PHASER REFIT: Federation CA and CA+ ships (and only that class) were fitted with rear-firing phasers. Some ships carried these as early as Y160; all had been refitted by Y175. Some received them before their (R2.R1) refit, some afterwards, and others at the same time. This refit included two phaser-1s in the rear hull with RH firing arcs. CAs with this refit are designated CAR or CAR+ as appropriate.

(R2.R3) AWR REFIT: Many Federation ships were modified with warp reactors (AWR) replacing the nuclear reactors (APR), providing more power for the photon torpedoes. This refit began in Y170, and virtually all Federation ships (those armed with photon torpedoes) were refitted by Y174, with new construction from Y170 incorporating the refit. The refit and its cost are shown on the SSDs of ships that received it. It does not apply to the fast patrol ships (which are conjectural in any case). Ships with this refit are given an "a" designator, e.g., CCa+.

(R2.R4) DRONE RACK REFIT: As the General War went on, the old type-A drone rack was found less and less suitable for the evolving combat situation. The Federation upgraded the drone racks on its ships (including pods and auxiliaries; bases have type-H drone racks and are not included) at about the start of Y175. It is assumed that this refit applies to all Federation ships as of 1 Jan Y175. It does not apply to the fast patrol ships (which are conjectural in any case).

All anti-drones (carried by relatively few Federation ships) were converted to type-G drone racks (cost two points each); all type-A drone racks were converted to type-B (cost one point each).

Unless otherwise specified in the rules, all ships (including those with no drone rack changes in Y175) have double drone reloads (no cost for the basic drones; speed and module costs are extra) as part of this refit. Type-G drone racks have three sets of reloads after this refit; the third set of reloads must be ADDs.

(R2.R5) NOTE ON ESCORTS: Federation carrier escorts, almost uniquely in the galaxy, had cargo boxes to store spare fighters, drones, warp packs (J5.42), chaff packs (D11.0), etc., allowing Federation carrier groups to remain on patrol longer than any others (so long as they avoided direct combat) and giving them a significant edge.

The spare fighters on the Master Ship Chart (Annex #3) for these escorts are stored in half of the cargo boxes. The other cargo boxes can be loaded by the owning player with

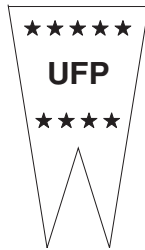

drones, warp packs, chaff packs, etc. This is at no cost although the drones must be proportional to the drones stored on the carrier. These ships use this cargo storage instead of, not in addition to, the (J4.621) supplies.

This would only be significant in a campaign game [e.g., (U4.0)] where the carrier group must complete several scenarios with whatever supplies are on board. (The existing supplies on most carriers will be adequate for most scenarios.) If a cargo box is destroyed, the contents are lost (the owner selects which specific contents are lost).

Not all Federation escorts have cargo boxes, and those that do not ignore this note. Note that some Federation carriers also use this rule, see the individual ship descriptions.

(R2.R6) OTHER REFITS: There are various other refits in the rules that either apply, or can apply to Federation ships. These are as follow:

(R2.R6A) PLASMA REFITS: Federation ships armed with plasma-F torpedoes were refitted to use plasma carronades (FP14.0) in Y175. They were also refitted to use plasma sabots (FP11.0) beginning in Y180, although some ships did not receive the sabot refit until Y181. These refits are not shown on most SSDs (they will be added as the SSDs are updated) and are found in *Module R10*.

(R2.R6B) ADVANCED SHUTTLES: In Y180 all Federation ships automatically received advanced shuttles; see (J17.0) in *Module J2*; this is at no cost in BPV. Newer SSDs have additional boxes labeled "A" for "advanced" on their shuttle tracks to reflect the increased damage these shuttles can take (they are also faster, see the rule in *Module J2*) when they are introduced.

(R2.R6C) MECH-LINK REFIT: This refit is found in *Module K* under (R1.R1). It is only available to the Federation if the conjectural fast patrol ships (R2.PF0) are used. Mech-link refits cannot be used to add "casual fighters" to Federation ships, not even F-111 (R2.F11) heavy fighters. Further, if the conjectural Federation fast patrol ships are used, the F-111, FB-111 (R2.F16) and Gorn GB-111 (R6.F01) cannot be used at all. As this refit is conjectural, it is not listed in any ship description.

(R2.R6D) PARTIAL X-REFITS: There is no one package of standard upgrades as found in (R2.R1) for this refit, and not every ship received a partial X-refit. These refits began in Y181, and players will have to refer to (XR0.0) in *Module X1R* to determine what, if any, upgrades they want to add to a given ship, or whether the ship is eligible for such an upgrade.

(R2.R6E) TRACTORS: Prior to Y140 tractor beams on Federation units which entered service after Y119 and before Y140 are type-M (YG7.64) with a maximum range of two hexes. These were replaced by type-N (YG7.65) tractor beams (maximum range of three hexes) in Y140 at no cost in BPV and all Federation units built after Y140 include type-N tractors. This includes generic units. See (YG7.0) in *Module Y1* for tractor beams on Federation units built before Y120.

(R2.R6F) TRANSPORTERS: Prior to Y140 transporters on Federation units which entered service after Y119 and before Y140 have a maximum range of four hexes (YG8.14). From Y140 the range of all transporters in Federation service is increased to five hexes at no cost in BPV and all Federation units built after Y140 include this range. This includes generic units. See (YG8.0) in *Module Y1* for transporters on Federation units built before Y120.

FEDERATION WARSHIPS

(R2.2) DREADNOUGHT (DN): Entering service in Y148, the dreadnought was the largest ship in Star Fleet, comparable to other early dreadnoughts of that period, but slightly inferior to the dreadnoughts fielded at the beginning of the General War.

The ship actually represented a breakthrough in warp engine dynamics that allowed larger and more powerful engines to be mounted in close proximity, and thus made earlier dreadnoughts (YR2.6) (most already consigned to mothballs due to the expense of operating them) obsolete and soon scrapped as no longer effective. The original design concept of the dreadnought (as was also seen in the earlier dreadnoughts) was to include more capabilities but only a minimal increase in firepower over the command cruiser (R2.3). Construction was possible in Y148: other empires fielded early dreadnoughts (see *Module R7*) with similar limitations. This design was found to be inadequate in simulations, but the Federation government refused to upgrade the ships prior to the Klingon invasion in Y171 as they believed that doing so would be seen by the Klingons as signaling an intention to attack them. Other empires had upgraded their dreadnoughts in the late Y160s including an approximate 50% increase in firepower over their respective command cruisers. After initial combat clashes with the Klingon invaders the Federation refitted its dreadnoughts (R2.17) in Y172. Each fleet is commanded by an admiral in a dreadnought, but during peacetime the dreadnought is usually docked at a starbase (R1.1) because it is too expensive to operate.

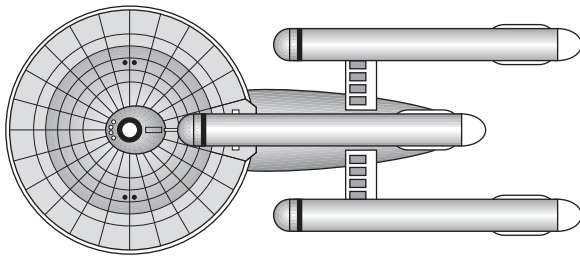

This is a base hull. Variants include the improved dreadnought (R2.17). The heavy carrier (R2.13), guided weapons dreadnought (R2.61), and light dreadnought (R2.91) are all built on drastically modified dreadnought hulls.

Seeking weapons: The dreadnought can control a number of seeking weapons equal to half its sensor rating (F3.211).

Refits: The AWR refit was available beginning in Y172 but not always installed; it was not universal by the time the last ship was upgraded to the improved dreadnought configuration (R2.17) in Y175.

SSD and counter are in *Basic Set*.

Known names: 2100 *Federation*, 2101 *Star League*, 2102 *Confederacy*, 2103 *Affiliation*, 2104 *Association*, 2105 *Combination*, 2106 *Konkordium*, 2107 *Agreement*, 2108 *Coherence*, 2109 *Concordat*, (converted to DNF) 2110 *Directorate*, 2111 *Stellar Affinity*, 2112 *Star Union*, 2113 *Alliance*, 2114 *Stellar Bond*, 2115 *Dominion*, 2116 *Stellar Communion*, 2117 *Stellar Compact*, 2118 *Stellar Concurrence*, 2119 *Consortium*.

(R2.3) COMMAND CRUISER (CC): The command cruiser is an improved variant of the standard heavy cruiser (R2.4), noted for its firepower and versatility. Normally, the admiral commands his fleet from a command cruiser during peacetime. Command cruisers (most fleets have similar ships) are usually marginally better in firepower and considerably superior in command, control, and communication facilities as compared to heavy cruisers. As the General War continued, many surviving heavy cruisers were converted into command cruisers.

The command cruiser is a variant of the heavy cruiser (R2.4).

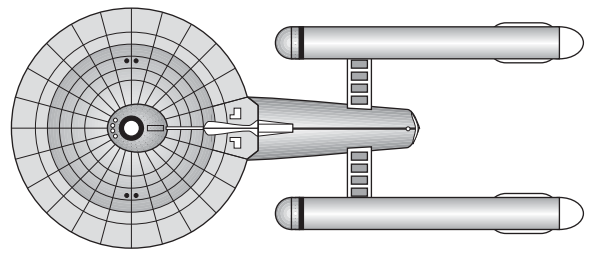

Seeking weapons: Prior to the plus refit, the command cruiser can control a number of seeking weapons equal to half its sensor rating (F3.211); after the plus refit the command cruiser can control a number of seeking weapons equal to its sensor rating (F3.21).

Refits: The plus refit was available beginning in Y165, common by Y171, and universal by Y175. The AWR refit was available in Y170; virtually all ships had it by Y174. The Y175 refit was installed in Y175.

SSD and counter are in *Basic Set*.

Known names: 1703 *Lexington*, 1705 *Excalibur*, 1710 *Kongo*, 1712 *Bon Homme Richard*, 1720 *Lafayette*, 1727 *Essex*.

The following is an earlier class of command cruisers that was upgraded to the *Constitution* class standard: 1616 *Nimitz* (converted to CVS-1951).

(R2.4) HEAVY CRUISER (CA): The workhorse of Star Fleet, the Federation heavy cruiser (known as the *Constitution* class) is probably the most balanced all-around starship in the game. In combat, this ship relies on its toughness and on a flexible use of its power. This class incorporated several incremental improvements (i.e., refits) which kept it competitive throughout its long history.

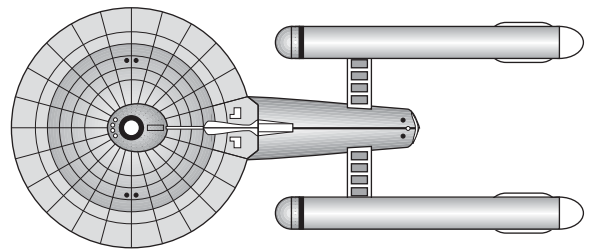

This is a base hull. Variants include the command cruiser (R2.3), strike carrier (R2.29), battle carrier (R2.29A), heavy command cruiser (R2.76), heavy drone cruiser (R2.87), interdiction carrier (R2.97), heavy fighter carrier (R2.100), heavy mauler cruiser (conjectural) (R2.127), area control ship (conjectural) (R2.129), bombardment carrier (conjectural) (R2.130), heavy fighter carrier (R2.132), division control ship (R2.133), and advanced technology command cruiser (R2.55)/(R2.201). The galactic survey cruiser (R2.16), fast cruiser (R2.82), and strike cruiser (R2.131) are built on drastically modified heavy cruiser hulls.

Seeking weapons: Prior to the plus refit, the heavy cruiser can control a number of seeking weapons equal to half its sensor rating (F3.211); after the plus refit the heavy cruiser can control a number of seeking weapons equal to its sensor rating (F3.21).

Refits: Transporters increased from Range 4 to Range 5 in Y140. Tractors increased from Range 2 to Range 3 in Y140. The rear phaser refit was available in Y160 but was rare prior to Y170 when it was accelerated, becoming common in Y173 and universal by Y175. The plus refit was available beginning in Y165, was common by Y171, and was universal by Y175. The AWR refit was available in Y170; virtually all ships had it by Y174. The Y175 refit was installed

in Y175.

SSD and counters are in *Basic Set*.

Known names: 1700 *Constitution*, 1701 *Enterprise*, 1702 *Farragut* (converted to CVS 1960), 1704 *Yorktown*, 1706 *Exeter*, 1707 *Hood*, 1708 *Intrepid*, 1709 *Valiant*, 1711 *Potemkin*, 1713 *Monitor*, 1714 *Hornet*, 1715 *Merimac*, 1716 *Endeavor*, 1717 *Defiance*, 1718 *Excelsior*, 1721 *Wasp*, 1722 *El Dorado*, 1723 *Ari*, 1724 *Saratoga*, 1725 *Tori*, 1726 *Krieger*.

The following are an earlier class of heavy cruisers that were upgraded to the *Constitution* class standard: 1601 *Agincourt* (converted to heavy drone cruiser), 1604 *Pennsylvania*, 1605 *Port Moresby*, 1606 *Antietam*, 1607 *Concord*, 1608 *Dieppe*, 1609 *Leyte Gulf*, 1610 *Lissa*, 1611 *Midway*, 1612 *Pharsallus*, 1613 *Vimy Ridge*, 1614 *Ypres*, 1615 *Defiant*, 1617 *Murfreesboro*, 1621 *Hastings*, 1649 *Arbela*.

The following are an earlier class of heavy cruisers referred to as the "R-class" that were upgraded to the *Constitution* class standard: 1371 *Republic*, 1372 *Reshadije*, 1373 *Ramilles*.

(R2.5) LIGHT CRUISER (CL): The light cruiser is a rebuilt hull whose design is over 100 years old. These ships originally fought in the First Romulan War. When warp power was developed, many of these ships were converted to use it. They formed the backbone of Star Fleet for two decades, before enough early heavy cruisers (YR2.4) came into service to assume that role. This ship is equipped with armor (D4.12), which was used before the more efficient shields were developed. This ship had a good operating speed and excellent reserve power but, until it was refitted, was vulnerable to relatively minor damage.

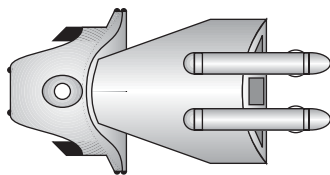

Many of these ships were converted to support missions (escort cruisers, minesweepers, survey ships, hospital ships, etc.) during their service.

This is a base hull. Variants include the escort cruiser (R2.15), aegis cruiser (R2.15A), minesweeper (R2.21), commando cruiser (R2.31), light survey cruiser (R2.39), escort carrier (R2.39A), hospital ship (R2.40), light drone cruiser (R2.88), medium carrier (R2.89), scout light cruiser (R2.A20), and light heavy fighter carrier (R2.A21). The advanced technology light cruiser (R2.A28) is a conversion of the base hull.

Seeking weapons: Prior to the plus refit, the light cruiser can control a number of seeking weapons equal to half its sensor rating (F3.211); after the plus refit the light cruiser can control a number of seeking weapons equal to its sensor rating (F3.21).

Refits: Transporters increased from Range 4 to Range 5 in Y140. Tractors increased from Range 2 to Range 3 in Y140. The plus refit was available beginning in Y165 but was not installed before Y168, was common by Y171, and was universal by Y175. The AWR refit was available in Y170; virtually all ships had it by Y174. The Y175 refit was installed in Y175.

SSD and counters are in *Basic Set*.

Known names: 0900 *Texas*, 0901 *Carolina*, 0902 *Kashmir*, 0903 *Wales*, 0905 *Bavaria*, 0906 *Lorraine*, 0908 *Apulia*, 0910 *Macedonia*, 0913 *Anatolia*, 0914 *Suffolk*, 0917 *Saskatchewan*, 0918 *Hokkaido*, 0919 *Sinkiang*, 0922 *Tasmania*, 0925 *Finnmark*, 0928 *Tanganyika*, 0929 *Leinster*,

0930 *Oaxaca*, 0931 *Patagonia*, 0932 *Falklands*, 0934 *Lithuania*, 0936 *Connecticut*, 0937 *Florida*, 0945 *Oklahoma*, 0946 *Kurdistan*, 0947 *Kamchatka*, 0950 *Madagascar*.

(R2.6) DESTROYER (DD): The destroyer was designed as a smaller and less expensive stablemate to the heavy cruiser (R2.4), but was less successful. While the version presented in *Basic Set* carries cruiser armament, it lacks the engine power of a cruiser, making full (i.e., overloaded) use of its four photon torpedoes impractical. While lacking maneuverability, its large saucer section makes it capable of taking considerable punishment without losing warp power.

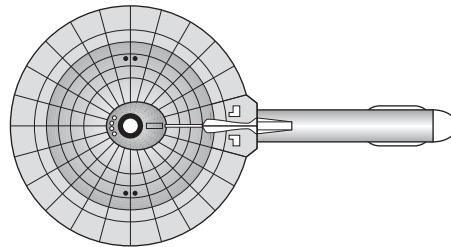

The Federation destroyer was expected, during peacetime, to carry out essentially the same research and exploration missions as the heavy cruiser class. For this reason, it had the same laboratory facilities.

Most ships of this class were constructed with only two photon torpedoes (reduce BPV by six points) (R2.A23), but at least five of the initial production run had all four photon torpedoes so they could be used as "bombardment platforms" for attacking bases. Those five ships were used in the same manner as the two-photon version during peacetime operations, i.e., it was not unusual for them to be patrolling isolated areas. Around Y160 most of the destroyers that had only two photon torpedoes were gradually upgraded to the guided weapons destroyer (R2.28) or destroyer leader (R2.27) designs to use the additional space (normally occupied by the two missing photon torpedoes). Some were also upgraded to four photon torpedoes adding to the original five.

At the outbreak of the General War, an emergency refit program (R2.R1) improved the power output of these ships (at the cost of surplus laboratory facilities), keeping them viable for many years. Production of the destroyer virtually ceased at the start of the General War in favor of the new light cruiser (R2.18). A new smaller war destroyer (R2.65) began production several years later.

It remains something of a mystery why the destroyer did not gain a drone rack (as most other Federation ships did) in its plus refit.

This is a base hull. Variants include the scout (R2.7), destroyer escort (R2.14), aegis destroyer (R2.23), destroyer leader (R2.27), guided weapons destroyer (R2.28), destroyer escort-R (R2.62), aegis destroyer-R (R2.62A), destroyer light escort carrier (R2.144), Federation Emergency Management ship (R2.A22), and Middle Years destroyer (R2.A23). The fast destroyer (R2.146), deckhouse destroyer (R2.A24), and heavy destroyer (R2.A25) were built on drastically modified destroyer hulls.

Seeking weapons: The destroyer can control a number of seeking weapons equal to half its sensor rating (F3.211).

Refits: Transporters increased from Range 4 to Range 5 in Y140. Tractors increased from Range 2 to Range 3 in Y140. The plus refit was available beginning in Y165, was common by Y171, and was universal by Y175.

SSD and counters are in *Basic Set*.

Known names: 0500 *Saladin*, 0502 *Darius*, 0503 *Alaric*, 0504 *Sargon*, 0505 *Xerxes*, 0506 *Pompey*, 0508 *Suleiman*,

0509 *Etzel*, 0510 *Tamerlane*, 0511 *Alexander*, 0512 *Hannibal*, 0513 *Ahriman*, 0514 *Rahman*, 0515 *Adad*, 0516 *Hashishiyun*, 0517 *Azrael*, 0518 *Hamilcar*, 0520 *Ares*, 0521 *Pazuzu*, 0522 *Hiawatha*, 0523 *Atilla*, 0525 *Golda Meir*, 0526 *Brigham Young*, 0529 *Skanderbeg*, 0530 *Charlemagne*, 0531 *Daniel Morgan*, 0533 *Israel Putnam*, 0534 *Eisenhower*, 0536 *R E Lee*, 0537 *Thutmoses III*.

(R2.7) SCOUT (SC): Built on a destroyer (R2.6) hull, the scout was designed to be the electronic eyes and ears of the fleet. The name can be confusing. The ship does not actually move ahead of the fleet, but uses its long-range sensors and scanners to search farther than other ships can.

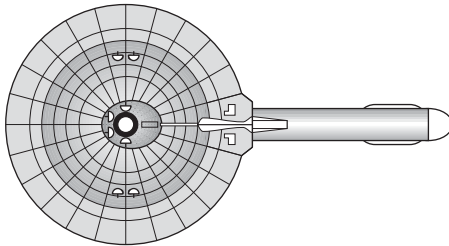

The wartime refit reduced laboratory facilities in exchange for more power for use in electronic warfare. It appears that one or two scouts retained their original laboratory facilities for several years after the General War began for scientific missions of military significance.

The large number of special sensors made this ship particularly effective on scientific missions (at least, before the wartime refit reduced the lab capabilities) and in a hostile drone environment.

The scout is a variant of the destroyer (R2.6).

Scout: It can use all scout functions (G24.0). Special sensors #1-#4 are destroyed by "torpedo" damage points, while special sensors #5-#8 are destroyed by "phaser" damage points. See (G24.35) when purchasing this unit as part of a battle force.

Seeking weapons: The scout can control a number of seeking weapons equal to half its sensor rating (F3.211). See also (F3.213).

Refits: Sensors are under Early Years restrictions (YG24.0) until Y134. Transporters increased from Range 4 to Range 5 in Y140. Tractors increased from Range 2 to Range 3 in Y140. The plus refit was available beginning in Y165, was common by Y171, and was universal by Y175.

SSD and counter are in *Basic Set*.

Known names: 0584 *Baden-Powell*, 0585 *Hermes*, 0587 *De Gama*, 0589 *Dianna*, 0590 *Gordon Cooper*, 0591 *Bridger*, 0592 *Carson*, 0593 *Yuri Gagarin*, 0594 *Cody*, 0595 *Revere*, 0596 *Yang Liwei*, 0597 *Bowie*, 0598 *Crockett*, 0599 *Barents*.

FEDERATION FLEET TUG AND PODS

(R2.8) FLEET TUG (Tug): Used by Star Fleet to transport priority military and government cargoes (civilian freighters being adequate for other loads), the tug is a full-fledged starship with limited armament suitable to its mission.

The 12 hull boxes can be hit on "forward" or "rear" hull damage points unless the tug is towing a pod, in which case these are destroyed by "forward" hull damage points and the hull or cargo or repair boxes in the pod are destroyed by "rear" hull damage points. Cargo and repair boxes on a pod would also still be destroyed by "cargo" damage points.

The Federation tug can carry one or two pods; one but not both can be a "double-weight" pod. If there is a double-weight pod, it must be in front. The movement cost chart lists "with 3 pod weights" to indicate the movement cost when

carrying one single-weight and one double-weight pods; this does not indicate that it can carry three pods.

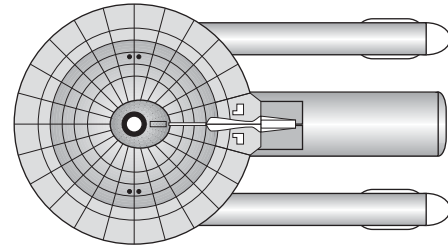

The pods are in-line, one attached to the tug and the other to the first pod. The FA firing arcs (including the FA portion of FX, LS, RS, or 360° arcs) on the rear pod are blocked by the forward pod. The RA firing arcs (including the RA portion of RX, LS, RS, or 360° arcs) on the front pod are blocked by the rear pod.

If a light battle pod (R2.58) is in the rear position, all systems on the pod are treated as cargo [double-weight pods such as the battle pod (R2.10) can never be in the rear position].

No interbay shuttle transfers (J1.59) are possible between pods, or between the pods and the shuttle bay of the tug.

Like all tugs, the movement cost and turn mode vary with the pods carried. The movement cost of the tug with two pods or one double-weight pod is 1.5 energy points per hex; the movement cost of the tug with three pod weights is two energy points per hex; see Annex #3A.

This is a base hull; there are no variants.

Seeking weapons: Prior to the plus refit, the fleet tug can control a number of seeking weapons equal to half its sensor rating (F3.211); after the plus refit the fleet tug can control a number of seeking weapons equal to its sensor rating (F3.21). The seeking weapon control rating may be improved by some pods, but the fleet tug can only combine its seeking weapon control rating with the seeking weapon control rating of carrier (R2.22), light carrier (R2.57), or heavy fighter (R2.136) pods, and only of one such pod.

Refits: Transporters increased from Range 4 to Range 5 in Y140. Tractors increased from Range 2 to Range 3 in Y140. The plus refit was available beginning in Y165, was common by Y171, and was universal by Y175. The Y175 refit was installed in Y175.

SSD and counter are in *Basic Set*.

Known names: 3801 *Ptolemy*, 3802 *Al Rashid*, 3803 *Swift Tuttle*, 3804 *Jan Oort*, 3805 *Stephen Hawking*, 3806 *Hubble*, 3807 *Dale Fields*, 3808 *Galilei*, 3815 *Copernicus*, 3816 *Kepler*, 3822 *Newton*, 3824 *Cassini*, 3830 *Messier*, 3833 *Halley*, 3834 *Wolf*.

FEDERATION PODS

A variety of pods were created for the tug.

Pods cannot be docked back-to-back unless they are inactive due to the power connections. They can only be docked back-to-front, e.g., the front of the second pod is docked to the back of the first pod. Any FA weapons on the second pod would be blocked and unable to fire unless the pod were dropped. Note that some pods may have shuttle hatches blocked by the presence of another pod. See also (R2.8).

Pods never had official names.

Generic pod counters for separated pods are in *Basic Set*.

(R2.9) STARLINER POD (P-SL): The starliner pod is designed for the transportation of 300 personnel. Too expensive to use for colonization, it usually carries relief crews to isolated stations. The starliner pod is capable of independent operations at sublight speed.

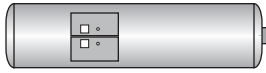

If detached, the 22 hull boxes can be destroyed by either “forward” or “rear” hull damage points. If attached to a tug (R2.8) or light tactical transport (R2.38), these 22 hull boxes are destroyed on “rear” hull damage points; the hull boxes on the tug or light tactical transport are destroyed on “forward” hull damage points. See (R2.47) when attached to a priority transport; see (R2.48) when attached to a VIP transport; see (R2.151) when attached to a battle frigate transport.

Weight: This is a single-weight pod with a towing cost of 0.3333.

Operation: The shields of this pod are combined with the shields of the tug or LTT while it is attached. This pod is capable of independent operations as a sublight ship in its own right. The impulse engines of this pod cannot be used for movement if another pod is docked behind it.

Seeking weapons: This pod can control a number of seeking weapons equal to half its sensor rating (F3.211). This control rating is not added to the tug when the pod is attached.

Landing force: When used to carry troops, the starliner pod has 54 boarding parties (D7.0), two commando teams (D15.84), and six heavy-weapons squads (D15.81). This is (roughly) two battalions of troops (R2.M1). The BPV is increased by 37 points. [There are no ground combat vehicles (D15.82) or ground assault shuttles (R1.F4) as the starliner pod was not designed for use as a troop transport.]

Refits: Transporters increased from Range 4 to Range 5 in Y140.

SSD is on the Federation pods sheet in *Basic Set*. An SSD of this pod being carried by a Federation tug (R2.8) is in *Advanced Missions*.

(R2.10) BATTLE POD (P-BP): As tugs cost as much as cruisers to build, competition between the fighting and logistical elements of the fleet for construction funds is fierce. To partially offset this, battle pods were constructed and held in storage at starbases (R1.1). A tug carrying a battle pod (the combination being called a “battle tug” and listed separately on the Master Ship Chart) is operationally similar to a dreadnought (R2.2) or heavy cruiser (R2.4). Thus, an expensive peacetime transport can be converted in hours to a serviceable warship. The battle pod weighs twice as much as other pods and counts as “two pods” for purposes of movement cost and turn mode.

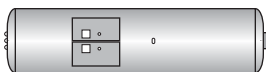

Some battle pods were improved to the battle pod+ configuration by converting their APRs to warp reactors (as well as adding a drone rack and two phaser-3s), which allowed them to fire their photon torpedoes while separated from the tug and allowed the battle tug a higher speed in combat. Without the refit, the battle pod was effective only against non-moving targets. The designations for combinations are as follows:

- BT Neither has refit.
- BT+ Battle pod has refit, tug does not
- BT++ Both have refit.

BT(+) Tug has refit, battle pod does not.

If detached, the 10 hull boxes can be destroyed by either “forward” or “rear” hull damage points. If attached to a tug (R2.8) or light tactical transport (R2.38), these 10 boxes are destroyed by “rear” hull damage points; the hull boxes on the tug or light tactical transport are destroyed by “forward” hull damage points. See (R2.47) when attached to a priority transport; see (R2.48) when attached to a VIP transport; see (R2.151) when attached to a battle frigate transport.

Weight: This is a double-weight pod with a towing cost of 0.6667.

Operation: The shields of this pod are combined with the shields of the tug or light tactical transport while it is attached. While attached, this pod increases the tug’s or light tactical transport’s command rating by two; a second pod of any type does not further increase the command rating. The command rating increase of this pod takes precedence over the increase provided by a carrier pod (R2.22), CVL pod (R2.57), or scout pod (R2.135). This pod is capable of independent operation as a sublight ship in its own right. The impulse engines of this pod cannot be used for movement if another pod is docked behind it.

Seeking weapons: Prior to the plus refit, this pod can control a number of seeking weapons equal to half its sensor rating (F2.311); after the plus refit this pod can control a number of seeking weapons equal to its sensor rating (F3.21). This seeking weapon control rating is not added to the tug while the pod is attached.

Refits: The plus refit was available beginning in Y165, was common by Y171, and was universal by Y175. The AWR refit was available in Y170; virtually all battle pods had it by Y174. The Y175 refit was installed in Y175.

The entire concept of “battle pods” was created by *Barry Jacobs*.

SSD is on the Federation pods sheet in *Basic Set*. An SSD of this pod being carried by a Federation tug (R2.8) is in *Basic Set*.

(R2.11) CARGO POD (P-CP): There are actually several types of cargo pod (liquid, break-bulk, container, pallet, dry bulk, etc.), but all are functionally identical. Cargo pods are simply cargo boxes; there is no crew or other function. When detached, any damage points scored on the pod are considered to be cargo damage points.

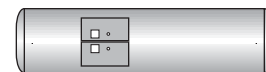

If attached to a tug (R2.8) or light tactical transport (R2.38), these cargo boxes are destroyed on “rear” hull damage points as well as “cargo” damage points; the hull boxes on the tug or light tactical transport are destroyed on “forward” hull damage points. See (R2.47) when attached to a priority transport; see (R2.48) when attached to a VIP transport; see (R2.151) when attached to a battle frigate transport.

Weight: This is a single-weight pod with a towing cost of 0.3333.

SSD is on the Federation pods sheet in *Basic Set*. An SSD of two pods of this type being carried by a Federation tug is in *Basic Set*.

ADDITIONAL FEDERATION PODS

- (R2.22) HEAVY CARRIER POD (P-CVA)**
- (R2.52) REPAIR POD (P-R)**
- (R2.53) TROOP TRANSPORT POD (P-T)**
- (R2.54) SELF-DEFENSE POD (P-SD)**

- (R2.57) LIGHT CARRIER POD (P-CVL)
- (R2.58) LIGHT BATTLE POD (P-LB)
- (R2.72) PF TENDER POD (P-PF)
- (R2.101) F-111 TRANSPORT POD (P-FCF)
- (R2.135) SCOUT POD (P-SC)
- (R2.136) HEAVY FIGHTER POD (P-HVL)

FEDERATION POLICE

(R2.12) POLICE CUTTER (POL): The police cutter (sometimes referred to as a police cruiser) is intended for customs regulation, space rescue, and law enforcement. It is not intended to stand up in combat to warships. Its design predates the Orion Raider Cruiser (R8.2), which clearly outmatches it. With some assistance (such as from the freighters of a convoy), it is a good match against an Orion Light Raider (R8.7). When heavy pirate units are expected, these ships operate in groups of three or call for the nearest Star Fleet cruiser.

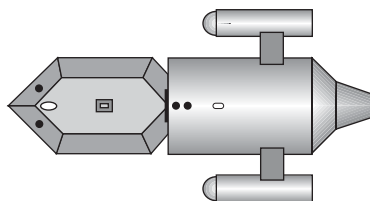

This is a base hull. Variants include the police carrier (R2.24), light police carrier (R2.137), improved police cutter (R2.A2), police corvette (R2.A3), scout cutter (R2.A35), commando cutter (R2.A36), drone cutter (R2.A37), escort cutter (R2.A38), and aegis escort cutter (R2.A38A). The police frigate (R2.121) and police destroyer (R2.A5) were built on drastically modified police cutter hulls.

This ship is nimble (C11.0).

Seeking weapons: Prior to the plus refit, the police cutter can control a number of seeking weapons equal to half its sensor rating (F3.211); after the plus refit the police cutter can control a number of seeking weapons equal to its sensor rating (F3.21).

Refits: Transporters increased from Range 4 to Range 5 in Y140. Tractors increased from Range 2 to Range 3 in Y140. The plus refit was available beginning in Y165, was common by Y171, and universal by Y176. The AWR refit was available in Y170; virtually all ships had it by Y174. The Y175 refit was installed in Y175.

SSD and counters are in *Advanced Missions*.

Known names: *Bailiff, Bobby, Constabulary, Deputy, Dagnet, Gatekeeper, Gendarme, Justice, Lawman, Militia, Mountie, Pacifier, Peacekeeper, Peacemaker, Peaceofficer, Posse, Summons, Texas Ranger, Trooper, Tucker*, (Lt Oleg) *Babak, Behan, Callahan*, Deckard*, (Alejandro) *Dominguez*, (Morgan) *Earp*, (Virgil) *Earp*, (Wyatt) *Earp, Doc Holiday, Holmes, Kojak, LeBeau* (Waco), *Malloy, Magnum*, (Mark) *Majors, Masterson, McKeehan* (Waco), (Elliot) *Ness*, (John) *Oliver, Osterhout*, (Darius) *Quimby*, (Texas John) *Slaughter*, (Richard) *Simms, Sipowicz, Sorenson*, (John) *Walsh, Watson, White, Williams* (Waco), *Willis* (Waco), (Jimmy) *Wilson*, and about 130 others.

* Class ship, i.e., the first ship of the class to enter service.

FEDERATION CARRIERS AND ESCORTS

(R2.13) HEAVY CARRIER (CVA): In responding to the construction of carriers by most of the empires bordering the Federation, the Federation Star Fleet constructed three

carefully designed “flatbeds” beginning in Y171. (Three more were planned but may not have been finished before the General War ended. One or more were finished as space control ships (R2.32) after the General War. The number of these ships in service was one of the Federation’s most closely guarded secrets, and many of the wartime records are in fact part of a Federation deception campaign.) The Federation intended to launch the best carriers ever designed and may have succeeded.

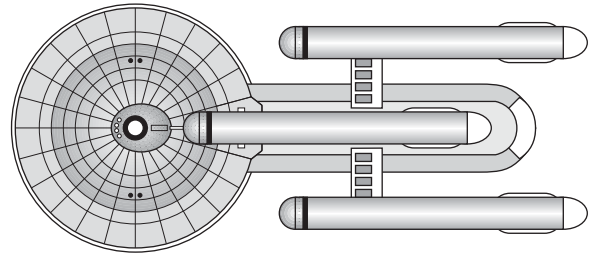

The heavy carrier retains the full forward centerline armament of the unrefitted dreadnought (R2.2), but compared with the dreadnought the side phasers have been replaced with phaser-Gs and the phasers in the rear hull with 360° phaser-1s to provide for defense against enemy fighters. Specially built escorts [initially the destroyer escort (R2.14) and escort light cruiser (R2.15) below; escorts based on the new light cruiser (R2.20), (R2.59), (R2.63), frigate (R2.41), war destroyer (R2.68), and battle frigate (R2.148) appeared later in the General War and the table below reflects their introduction] always escort the carriers.

The engines were mounted low and to the rear to leave space clear for the balconies. This also improved the side firing arcs.

The heavy carrier is a variant of the dreadnought (R2.2) but the changes were sufficiently extreme that it is considered a new class. Variants include the space control ship (R2.32) and space control ship-A (conjectural) (R2.32A).

Carrier: This ship is a true carrier; see (J4.75), (J4.93), (J10.111), (J11.13), and (J15.22).

This ship has three shuttle bays. The two bays on each side of the ship each hold 12 fighters and have six balcony (J1.53) positions (total of 12 balcony positions). The third (rear) bay holds six shuttles and is a special case (J1.57): the hatch is double sized allowing a shuttle to be launched or landed (but not both) every impulse. Mines can only be laid from the rear bay (M2.113). Transfers between the three bays are possible under (J1.592). The MRS (J8.0) and SWAC [(J9.0)/(R2.F3)] shuttles are not included within the BPV. See [(J9.531)/(R2.F3A)] for the E-3A heavy SWAC.

Year	Escorts	Fighters
Y171-Y175	ECL, 2xDE	12xF-14, 12xA-10
Y173-Y175	ECL/NEC, 2xDE or ECL/NEC, 2xDER (Rom)	12xF-14, 12xA-10
Y175	ACL/NAC, 2xDEA or NER, 2xDAR (Rom)	12xF-14, 12xA-10
Y176	ACL/NAC, 2xDEA or NER, 2xDAR (Rom)	12xF-14, 12xA-10 or 6xF-101A, 12xA-10
Y177-Y178	ACL/NAC, 2xDEA or NAC, DEA, FFA or NER, 2xDAR (Rom)	12xF-14, 12xA-10 or 6xF-101B, 12xA-10 or 12xF-14A, 6xA-20

Y179-Y184	ACL/NAC, 2xDEA or NAC, DEA or DWA, FFA or NER, 2xDAR (Rom)	12xF-14A, 12xA-10 or 6xF-101C, 12xA-10 or 12xF-14A, 6xA-20F
Y184-Y190	NAC, DEA, FFA or NAC, DWA, FFA or NAC, DWA, FBE or NAC, 2xDWA	12xF-14B, 12xA-10 or 6xF-101C, 12xA-10 or 12xF-14B, 6xA-20F
Y190-Y194	2xNAC, 1xFFA or 2xNAC, 1xFBE or 2xNAC, 1xDWA	12xF-14C, 12xA-10 or 6xF-101C, 12xA-10 or 12xF-14C, 6xA-20F
Y195+	2xNAC, 1xDWA	12xF-14D, 12xA-10 or 6xF-101C, 12xA-10 or 12xF-14D, 6xA-20F

Escort frigates (R2.41)/aegis frigates (R2.41A) were used to fill in when the supply of new destroyer escorts (R2.14) was exhausted and the supply of new aegis cruisers (R2.59) was insufficient to completely replace them. War destroyer escorts (R2.68) replaced aegis frigates and aegis destroyers (R2.23) when they became available. See (R2.65) for the war destroyer and its variants.

Escort ready racks: The ready racks of the escorts were configured for F-14 (R2.F1) fighters. Escorts cannot have ready racks for heavy fighters; see (S8.318).

F-14Bs entered service earlier on the Klingon front (R2.F1).

The *MacArthur* served almost continuously on the Romulan front until its destruction and usually operated with escorts especially designed for that front. These escorts were more difficult to build and maintain and were only used on that front. This combination is noted by the note "(Rom)." Production of the Romulan-front escort variants virtually ceased by the end of the General War. Note that only one new escort cruiser-R (R2.63), *Wainright*, was constructed and it was lost along with the *MacArthur* during Operation Remus.

Seeking weapons: The heavy carrier can control a number of seeking weapons equal to double its sensor rating (F3.212).

Refits: The AWR refit was available in Y170; virtually all ships had it by Y174. The plus refit was available in Y173; all ships had it by Y175. The Y175 refit was installed in Y175.

SSD and counter are in *Module J*.

Known names: 2200 *Napoleon*, 2201 *MacArthur*, 2202 *Zhukov*.

(R2.14) DESTROYER ESCORT (DE): Before the first Federation carriers entered service, it was realized (from observing Klingon and Kzinti operations) that special ships would be required to escort the flatbeds. (A carrier is extremely vulnerable when recovering its fighters, and those fighters, being out of weapons and probably damaged, are also extremely vulnerable.) Several destroyers were taken into dockyards and modified for this role.

While it lacked two of the destroyer's (R2.6) four photons, the drone racks and phaser-Gs (and the very high speed) made this an effective warship. Line admirals were constantly trying to "borrow" destroyer escorts for use in fleet combat

squadrons, but the extremely limited number (due to the limited availability of phaser-Gs) made this impossible.

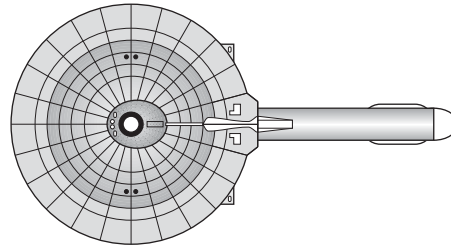

This ship has two ready racks (J4.89) and deck crews (J4.81) to support the fighters from the carrier it is escorting. The deck crews are not in addition to the deck crews provided by (J4.814), but replace them, representing their being retrained to service and arm fighters. See (R2.R5).

The destroyer escort is a variant of the destroyer (R2.6). A variant of this ship existed for the Romulan border; see (R2.62).

Seeking weapons: The destroyer escort can control a number of seeking weapons equal to double its sensor rating (F3.212) and has limited aegis (D13.4). See also (J15.332).

Refits: Full aegis and the drone rack refit were installed in Y175, resulting in the aegis destroyer (R2.23).

SSD and counters are in *Module J*.

Known names: 0543 *Atlas*, 0544 *Minerva*, 0545 *Agamemnon*, 0546 *Pericles*, 0547 *Scipio Africanus*, 0548 *Ajax*, 0549 *Cerberus*, 0550 *Oberon*, 0559 *De Zeven Provinciën*, 0560 *Reprisal*, 0561 *Canada*, 0562 *Jervis Bay*, 0563 *Neptune*, 0564 *Sirius*, 0565 *Halsey*, 0566 *Nagumo*, 0567 *Collingwood*, 0568 *Chernavin*, 0569 *Donitz*, 0570 *Bernadotte*, 0571 *Murat*, 0574 *Rokossovsky*, 0575 *Timoshenko*, 0576 *Ptolemy*, 0577 *Agrippa*, 0578 *Von Steuben*, 0579 *Hamilton*, 0580 *Old Dessauer*, 0581 *Schwerin*, 0582 *Travis*, 0583 *Joan of Arc*.

(R2.15) ESCORT CRUISER (ECL): Several of the veteran (but ancient) light cruisers (R2.5) were selected for conversion to escorts for the heavy carriers (R2.13).

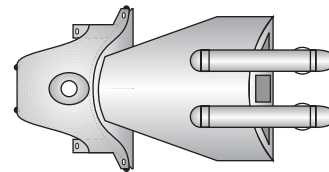

This ship has two ready racks (J4.89) and deck crews (J4.81) to support the fighters from the carrier it is escorting. The deck crews are not in addition to the deck crews provided by (J4.814), but replace them, representing their being retrained to service and arm fighters. See (R2.R5).

The escort cruiser is a variant of the light cruiser (R2.5). No variant of this ship existed for the Romulan border.

Seeking weapons: The escort light cruiser can control a number of seeking weapons equal to double its sensor rating (F3.212) and has limited aegis (D13.4). See also (J15.332).

Refits: The plus refit was available beginning in Y171, was common by Y172, and was universal by Y173. Full aegis and the drone rack refit were installed in all ships in Y175, resulting in the aegis light cruiser (R2.15A).

SSD and counter are in *Module J*.

Known names: 0951 *Harry Lee* (ex 0901 *Carolina*), 0955 *Scharnhorst* (ex 0905 *Bavaria*), 0956 *Ney* (ex 0906 *Lorraine*), 0958 *Crassus* (ex 0908 *Apulia*), 0961 *Koniev* (ex 0911 *Muscovy*), 0965 *Patton* (ex 0915 *California*), 0975 *Wisconsin* (ex 0925 *Finnmark*).

(R2.15A) AEGIS CRUISER (ACL): The few escort light cruisers (R2.15) still in service in Y175 received full aegis (D13.0) and became aegis cruisers.

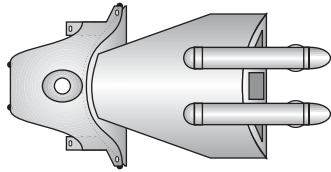

This ship has two ready racks (J4.89) and deck crews (J4.81) to support the fighters from the carrier it is escorting. The deck crews are not in addition to the deck crews provided by (J4.814), but replace them, representing their being retrained to service and arm fighters. See (R2.R5).

The aegis cruiser is a variant of the light cruiser (R2.5). No variant of this ship existed for the Romulan border.

Seeking weapons: The aegis cruiser can control a number of seeking weapons equal to double its sensor rating (F3.212) and has full aegis (D13.0). See also (J15.332).

Refits: The plus refit and drone rack refit were included as part of the aegis cruiser's design.

The SSD is combined with the escort cruiser in *Module J*. Use the escort cruiser counter found in *Module J*.

Known names: These were refits of the escort cruiser (R2.15) and did not change any names.

(R2.16) GALACTIC SURVEY CRUISER (GSC): The galactic survey cruiser is intended for long-range research and reconnaissance missions into uncharted regions. Note the larger number of lab and shuttle boxes and the addition of cargo spaces. These ships were originally built without a drone rack. In Y153, after Orion scientists developed the probe drone (FD6.0), a type-A drone rack was installed. The type-A drone rack was replaced by a type-G drone rack in Y160.

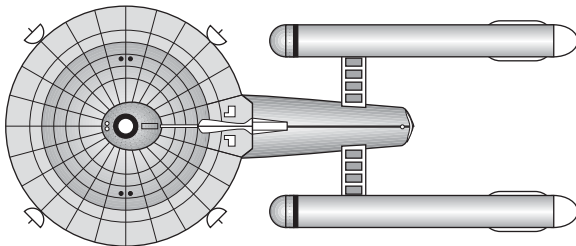

The galactic survey cruiser is a heavily modified variant of the heavy cruiser (R2.4). The galactic survey cruiser is designed to be used as a commando carrier (R2.51), but this was apparently not done prior to Y170.

Scout: It can use all scout functions (G24.0). Special sensors are destroyed by "phaser" damage points. See (G24.35) when purchasing this unit as part of a battle force.

Carrier: This ship is a casual carrier (J4.62) when operating two fighters. See also (J15.22).

In peacetime, the shuttles are usually admin [(J2.0)/(R1.F1)] types, although most carried one heavy transport shuttle (R1.F5). The ship might replace two admin shuttles with ground assault shuttles (R1.F4) in special circumstances (S3.2), such as a planet with particularly vicious wildlife. Some carried one MRS shuttle (J8.0) (MRS shuttles are not included in the ship's BPV), although supplies were limited and galactic survey cruisers did not have a high priority. During wartime, some galactic survey cruisers are used as scouts, light carriers (R2.16A), or are converted into commando carriers (R2.51). Those galactic survey cruisers not on duty as light carriers would (after fighters were

deployed) usually have two fighters (replacing admins) on board to fly escort for the research shuttles [these are not included in its BPV; treat the ship as a casual carrier (J4.62)]. There are no ready racks (J4.89) for these fighters, and they are armed and rearmed under (J4.8962). The deck crews (J4.81) shown with the fighters on the SSD are not in addition to those provided by (J4.814), but represent the deck crews having been retrained to be able to service and arm the fighters. The ships carried F-8s (R2.F7) initially and later had F-18s (R2.F5). They never carried other fighter types [F-4s (R2.F6) were carried experimentally by the galactic survey cruiser *Discovery* which proved the carrier concept, but galactic survey cruisers not operating as light carriers never operated that fighter type].

Year	Escorts	Fighters
Y171-Y174	None	2xF-8
Y175-Y178	None	2xF-18
Y179-Y181	None	2xF-18B
Y182-Y183	None	2xF-18B+
Y184+	None	2xF-18C

Seeking weapons: Prior Y153, the galactic survey cruiser can control a number of seeking weapons equal to half its sensor rating (F3.211); after Y152 the galactic survey cruiser can control a number of seeking weapons equal to its sensor rating (F3.21). See also (F3.213).

Refits: Prior to Y153 there is no drone rack (BPV is reduced by three points). From Y153 to Y159 the drone rack is a type-A drone rack, which is replaced by a type-G drone rack (no change in BPV) in Y160. The plus refit was available beginning in Y165 and was common by Y171. The AWR refit was available in Y170, and virtually all ships had it by Y174. The ship was equipped to operate two fighters as a casual carrier in Y171. The ship received the drone rack refit in Y175.

SSD and counter are in *Advanced Missions*.

Known names: 1800 *Byrd*, 1801 *Columbus*, 1802 *Darwin*, 1803 *Lewis & Clark*, 1804 *Magellan*, 1805 *Marco Polo*, 1806 *Cousteau*, 1807 *Sagan*, 1808 *Neil Armstrong*, 1809 *Challenger*, 1810 *Columbia*, and 1820 *Discovery*.

(R2.16A) LIGHT CARRIER (CVL): Galactic survey cruisers were designed for rapid reconfiguration into commando carriers (R2.51) for wartime emergencies. This was a subterfuge by the scientific departments to get the military to pay for the ships. The plan backfired in the General War when the military was able to immediately commandeer most of them. It was quickly discovered that the systems in place to allow for the rapid movement of stores to ground attack shuttles could be adapted to move stores for fighters and the galactic survey cruiser's large shuttle bay could accommodate a half squadron.

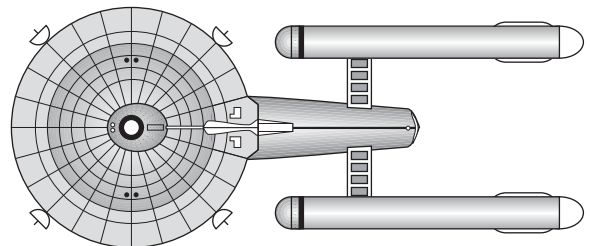

By the time the General War began, fighters had become a significant part of military operations and the galactic survey cruisers were frequently used as light carriers. [Indeed, the very first experimental Federation carrier, *Discovery* in Y167, was a "borrowed" galactic survey cruiser operating F-4s

(R2.F6). The ship was considered suitable for the experiment due to the large hangar.] The *Discovery* was also used for the initial demonstration of fighter/carrier technology to the Gorn Confederation. After the General War, the light carriers (their galactic survey cruiser designation having been forgotten by crews who entered the Academy after the General War began) were used against the Andromedans in the campaign to destroy the Rapid Transit Network (R10.1B).

The ships carried F-4s (R2.F6) initially and (after the experiment in Y167) were converted to F-8s (R2.F7). In Y168 and later they had F-18s (R2.F5) and some carried F-101s. They never carried other fighter types.

Only a few CVLs were used in front-line combat; the rest served as escorts in the survey territory. When used as a light carrier, six fighters are carried (along with one MRS (J8.0) when available and not included in the ship's BPV, and one admin shuttle [(J2.0)/(R1.F1)]) and spare drones and stores (R2.R5) are stored in the cargo spaces.

The light carrier is a modified variant of the galactic survey cruiser (R2.16).

Scout: It can use all scout functions (G24.0). Special sensors are destroyed by "phaser" damage points. See (G24.35) when purchasing this unit as part of a battle force. This ship is considered a survey cruiser for purposes of (S8.351). See (S8.25) if it is not counted in the command limit.

Carrier: This ship is a true carrier; see (J4.75), (J4.93), (J11.13), and (J15.22).

This ship has one shuttle bay.

Year	Escorts	Fighters
Y167	None	6xF-4
Y168-Y175	DE, 1-2 FFE or 2xFFE or None	6xF-8
Y173-Y175	DE, 1-2 FFE or 2xFFE or None	6xF-18
Y176-Y180	DEA/NEA, FFA or 2xFFA or None	6xF-18 or 3xF-101A
Y177-Y178	DEA/NEA, FFA or 2xFFA or None	6xF-18 or 3xF-101B
Y179-Y185	DEA/NEA/DWA, FFA or DWA, FFA or 2xFFA or None	6xF-18B or 3xF-101C
Y181-Y184	DEA/NEA/DWA, FFA or DWA, FFA or 2xFFA or None	6xF-18B+ or 3xF-101C
Y184-Y190	NAC, DWA/FFA, or 2xDWA or DWA, FFA or None	6xF-18C or 3xF-101C

Some light carriers operated independently, others were assigned one or two escorts [a third on occasions when two were escort frigates (R2.41); this happened during Y170-Y175].

Escort ready racks: The ready racks of the escorts were configured for F-8 (R2.F7) fighters in Y168-Y175 if the ship were operating that type of fighter, and for F-18 (R2.F5) fighters from Y173 on if the ship were operating that type of fighter. Escorts cannot have ready racks for heavy fighters; see (S8.318).

Seeking weapons: The light carrier can control a number of seeking weapons equal to its sensor rating (F3.21). See also (F3.213).

Refits: The plus refit was common by Y171. The AWR refit was available in Y170, and virtually all ships had it by Y174. The ship received the drone rack refit in Y175.

SSD and counter are in *Module J*.

Known names: Retained the names of the galactic survey cruisers converted to this use. Ships known to have

served as light carriers were the 1800 *Byrd*, 1802 *Darwin*, and 1820 *Discovery*.

FEDERATION DREADNOUGHT

(R2.17) IMPROVED DREADNOUGHT (DN+): Having stayed out of the Four Powers War (Y158-Y162) the Federation did not upgrade their dreadnought during the late Y160s as most other empires did. This left them at the start of the General War with a ship weaker than those opposing it as the Federation government would not authorize upgrading ships in the belief that the Klingon Empire would see doing so as an intention to attack them. While unable to secure funds to actually upgrade the dreadnoughts, the Federation Star Fleet arranged for the necessary materials for this interim upgrade to be stockpiled at starbases (R1.1) where the ships were assigned. During the opening stages of the Klingon invasion, most of the existing dreadnoughts were quickly modified to this improved class, which brought them up to the standard of pre-refit dreadnoughts in service with other empires (i.e., it was still inferior). The Federation did not have a dreadnought equivalent to those used by other empires until the appearance of the guided weapons dreadnought (R2.61).

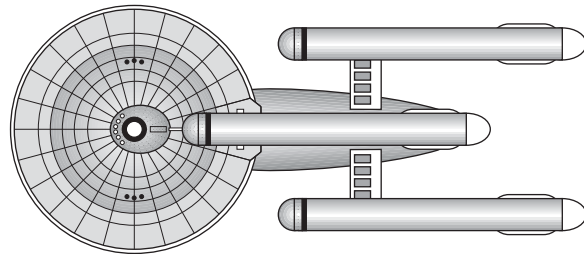

The improved dreadnought is a variant of the dreadnought (R2.2).

Seeking weapons: The improved dreadnought can control a number of seeking weapons equal to its sensor rating (F3.21).

Refits: The AWR refit was available beginning in Y172 but not always installed; it was universal by Y175. The Y175 refit was installed in Y175.

SSD and counter are in *Advanced Missions*.

Known names: These were refits of the dreadnought (R2.2) and did not change any names.

FEDERATION NEW LIGHT (WAR) CRUISER AND INITIAL VARIANTS

(R2.18) NEW LIGHT CRUISER (NCL): As the General War began to loom on the horizon, the Federation Star Fleet took a serious look at their shipbuilding program. It was noted that the excellent command cruiser (R2.3) design took too long to build and that the destroyer (R2.6) design had serious limits on its combat capability. The result was the "new" light cruiser, which entered production in Y170.

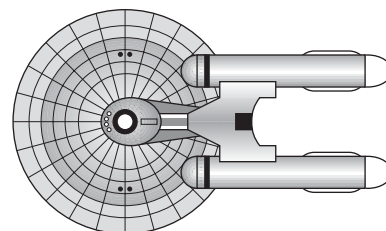

The new light cruiser used the primary hull section of the destroyer (including modifications planned for the destroyer), but instead of the single engine, it used a pair of engines of a new and more efficient design. The new light cruiser supplanted destroyers in the production program.

This is a base hull. Variants include the new scout cruiser (R2.19), new escort cruiser (R2.20), new aegis escort cruiser (R2.20A), new minesweeper (R2.30), new light carrier (R2.35), new drone cruiser (R2.36), light command cruiser (R2.37), light tactical transport (R2.38), heavy fighter transport (R2.56), PF tender (conjectural) (R2.56A), new aegis cruiser (R2.59), new strike carrier (R2.60), new escort cruiser-R (R2.63), new commando transport (R2.79), patrol carrier (R2.98), scout carrier (R2.99), new maunder cruiser (conjectural) (R2.128), and new light plasma cruiser (R2.A39). Some of these had advanced technology conversions. The new heavy cruiser (R2.77), (new) fast light cruiser (R2.139), and medium cruiser (R2.143), are built on drastically modified new light cruiser hulls.

Seeking weapons: The new light cruiser can control a number of seeking weapons equal to its sensor rating (F3.21).

Refits: The plus refit was available beginning in Y173, was common by Y175, and was universal in Y176. The AWR refit was available in Y173; virtually all ships had it by Y174. The Y175 refit was installed in Y175.

Designed by Ray Olesen.

SSD and counters are in *Advanced Missions*.

Known names: 1500 *Kearsarge*, 1501 *Reliant*, 1502 *Alabama*, 1503 *Repulse*, 1504 *Renown*, 1505 *Prince of Wales*, 1506 *Mutso*, 1507 *Nagato*, 1509 *Gneisenau*, 1510 *Scharnhorst*, 1511 *Prinz Eugen*, 1512 *Vittorio Veneto*, 1513 *Littorio*, 1514 *Caio Duilio*, 1518 *Dunkerque*, 1519 *Richelieu*, 1520 *Strasbourg*, 1521 *Rivadavia*, 1522 *Moreno*, 1523 *Minas Gerais*, 1524 *New Mexico*, 1525 *Iowa*, 1526 *Missouri*, 1527 *Kortenaer*, 1528 *De Ruyter*, 1529 *Naken*, 1530 *Glorie*, 1531 *Defence*, 1532 *Pervenetz*, 1533 *Meko*, 1534 *Vosper*, 1535 *Groton*, 1536 *Ramadan*, 1537 *Aliyah*, 1538 *Assawari*, 1539 *Michigan*, 1540 *North Carolina*, 1543 *Mikasa*, 1546 *Olympia*, 1547 *Piorun*, 1548 *Warspite*, 1551 *Kirishima*, 1552 *Rurik*, 1553 *Saugenay*, 1554 *Valiant*, 1555 *Visby*, 1556 *Aradu*, and 1557 *Wasa*. Notes: More ships of this class were built during the General War and Andromedan War.

(R2.19) NEW SCOUT CRUISER (NSC): Casualties among pre-General War destroyer-hull scouts (R2.7) mounted. With destroyer (R2.6) production largely curtailed, the Federation needed a source of new scouts and, like other empires, turned to its new light cruiser (war cruiser) design. While it had fewer channels than the scout, the new scout cruiser had more power to use them and was slightly more maneuverable.

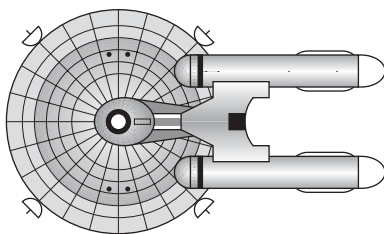

The new scout cruiser is a variant of the new light cruiser (R2.18).

Scout: It can use all scout functions (G24.0). Special sensors are destroyed by "torpedo" damage points. See (G24.35) when purchasing this unit as part of a battle force.

Seeking weapons: The new scout cruiser can control a number of seeking weapons equal to its sensor rating (F3.21). See also (F3.213).

Refits: The plus refit was available beginning in Y176 but was not always installed; it was common in Y178 and universal by Y180.

SSD and counter are in *Advanced Missions*.

Known names: 2001 *Discovery* [later converted to a new heavy scout cruiser (R2.114)], 2002 *Santa Maria* [later converted to a new heavy scout cruiser (R2.114)], 2003 *Calypso*, and 2004 *Crockett*.

(R2.20) NEW ESCORT CRUISER (NEC): Casualties among escort cruisers (R2.15) and destroyer escorts (R2.14), and the demands of new carrier groups being formed, created a demand for new escort cruisers that the dwindling supply of light cruisers (R2.5) and destroyers (R2.6) could not fill. The new light cruiser (R2.18) hull was modified for escort duty as the new escort cruiser. The new escort cruiser mounted phaser-Gs and drone racks for defense against fighter attacks.

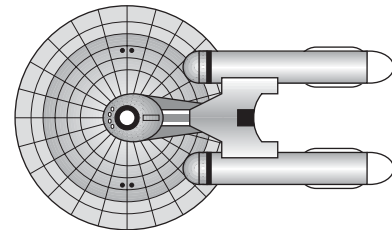

The new escort cruiser [and the new light carrier (R2.35)] were designed during a time when the Federation believed that many carriers would never come within weapons range of other carriers, but would only exchange fighter strikes. As such, the new escort cruiser is armed only to kill fighters. The lack of photon torpedoes was found to be a major handicap once the Federation "distant strike" theory proved inaccurate, and the new escort cruiser was replaced with the new aegis cruiser (R2.59). The surviving new escort cruisers and new light carriers were relegated to duty in less dangerous areas; some new escort cruisers escorted carrier tugs (R2.22) or light carriers (R2.16A).

This ship has two ready racks (J4.89) and deck crews (J4.81) to support the fighters from the carrier it is escorting. The deck crews are not in addition to the deck crews provided by (J4.814), but replace them, representing their being retrained to service and arm fighters. See (R2.R5).

The new escort cruiser is a variant of the new light cruiser (R2.18). A variant of this ship existed for the Romulan border; see (R2.63).

Seeking weapons: The new escort cruiser can control a number of seeking weapons equal to double its sensor rating (F3.212) and has limited aegis (D13.4). See also (J15.332).

Refits: The Y175 refit was installed in Y175; some ships received this refit before receiving full aegis later that same year.

SSD and counter are in *Advanced Missions*.

Known names: 1544 *Laffey*, 1549 *Clifton Sprague*, 1550 *Leon Kintberger*.

(R2.20A) NEW AEGIS ESCORT (NEA): The few new escort cruisers still in service in Y175 received full aegis (D13.0) and became new aegis escorts.

This ship has two ready racks (J4.89) and deck crews (J4.81) to support the fighters from the carrier it is escorting. The deck crews are not in addition to the deck crews provided by (J4.814), but replace them, representing their being retrained to service and arm fighters. See (R2.R5).

The new aegis escort is a variant of the new light cruiser (R2.18). A variant of this ship existed for the Romulan border; see (R2.63).

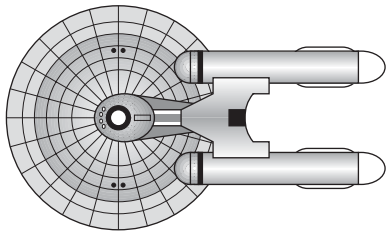

Seeking weapons: The new aegis escort can control a number of seeking weapons equal to double its sensor rating (F3.212) and has full aegis (D13.0). See also (J15.332).

Refits: The drone rack refit was included as part of the new aegis escort design.

The SSD is combined with the new escort cruiser in *Advanced Missions*. Use the new escort cruiser counter found in *Advanced Missions*.

Known names: These were refits of the new escort cruiser (R2.20) and did not change any names.

FEDERATION MINESWEEPER

(R2.21) MINESWEEPER (MS): Faced with the rapid deployment of mines along the Klingon and Romulan borders prior to the General War, the Federation felt a need for a specialist class of minesweeper/minelayer. Once again, it fell to the ancient workhorses, the old light cruiser (R2.5) class, to provide ships for conversion. Eight were converted between Y158 and Y172.

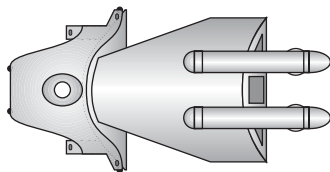

As can be noted from the SSD, the front shield was strengthened to resist the explosion of a large explosive [nuclear space (M2.0)] mine, while (almost unique to these minesweepers) shields #2 and #6 were increased enough to limit damage from such a mine to an acceptable level, a sensible feature seldom seen in other minesweepers. The science labs were reduced, and mine storage racks (M9.1) were added. Drone racks were installed due to the use of drones in anti-mine work and to provide defense from enemy fighters. One shuttle is a minesweeping shuttle (R1.F2)/(M8.3) (included in BPV). The limit of one minesweeping shuttle is an exception to (M8.312).

The minesweeper is a variant of the light cruiser (R2.5). This ship is a true minesweeper (M2.45); see also (M8.0).

Seeking weapons: The minesweeper can control a number of seeking weapons equal to its sensor rating (F3.21).

Refits: The plus refit was available beginning in Y165, and was common by Y171. The Y175 refit was installed in Y175.

Designed by Ray Olesen.

SSD and counter are in *Advanced Missions*.

Known names: 0904 *Zaire*, 0907 *Valencia*, 0909 *Tyrol*, 0916 *Isfahan*, 0920 *Jahor*, 0921 *Mindanao*, 0926 *Flanders*, 0927 *Zaparosche*.

FEDERATION CARRIERS AND ESCORTS

(R2.22) HEAVY CARRIER POD (P-CVA): Constructed as a back-up for the carriers, the heavy carrier pod was designed to turn a tug (R2.8) into a heavy carrier (R2.13). Several were constructed, but the operational use was limited. Compared with the heavy carrier, the CVT (tug with heavy carrier pod) was under-defended and under-armed.

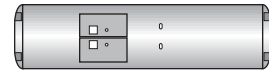

Heavy carrier pods normally carry F-18 fighters (R2.F5). If an MRS (J8.0) is available (J8.51), it is carried in the tug's hangar (an MRS shuttle is not included in the ship's BPV). A carrier tug would almost never have a SWAC [(J9.0)/(R2.F3)].

Carrier: This pod is a true carrier; see (J4.75), (J4.93), (J10.111), (J11.13), and (J15.22).

This pod has two shuttle bays, and each bay has two shuttle hatches: one in the front and one in the back; i.e., they are tunnel decks (J1.58). These hatches allow the pod to launch or land two shuttles per impulse, or launch or land up to four shuttles in any single impulse or every other impulse, or any combination not to exceed four shuttles in any two impulse period, or exceeding the ability of the given bay. This launch and land rate is halved if a second pod of any type is docked behind this pod (it is not possible to dock a pod in front of this pod on a tug). Transfers between the two bays are possible by (J1.592) one fighter per turn. While this pod is allowed two transporter-bombs, these can only be used by the tug as mines and cannot be laid from fighter bays (M2.113). The pod does not have its own transporters. Note that the tug will have its own shuttle bay giving the tug and pod combination a total of three shuttle bays. An additional pod might have its own shuttle bay.

When carried by a fleet tug the fighters and escorts were:

Year	Escorts	Fighters
Y172	ECL/NEC, 2xDE/FFE	24xF-8 or 24xF-4 or 12xF-8, 12xF-4
Y173-Y174	ECL/NEC, 2xDE/FFE	24xF-8
Y173-Y175	ECL/NEC, 2xDE/FFE	24xF-18†
Y176-Y189	NEA, 2xDEA/FFA	24xF-18† or 6xF-101A, 12xF-18†
Y177-Y178	NEA, 2xDEA/FFA or NAC, 2xDEA/FFA	24xF-18B† or 6xF-101B, 12xF-18B†
Y179-Y189	NAC, 2xDEA/FBE/FFA	24xF-18B† or 6xF-101C, 12xF-18B†
Y180-Y189	NAC, 2xDWA/FBE/FFA	24xF-18B+† or 6xF-101C, 12xF-18B+†
Y183+	NAC, 2xDWA/FBE/FFA	24xF-18C† or 6xF-101C, 12xF-18C†

When carried by a light tactical transport (R2.58) the fighters and escorts were:

Year	Escorts	Fighters
Y174-Y175	NEC, 1-2 FFE or 2xFFE	24xF-18†
Y176-Y189	NEA, 1-2 FFA	24xF-18† or 6xF-101A, 12xF-18†

Y177-Y178	NEA, 1-2 FFA	24xF-18B† or 6xF-101B, 12xF-18B†
Y179-Y189	DWA, 1-2 FFA	24xF-18B† or 6xF-101C, 12x F-18B†
Y180-Y189	DWA, 1-2 FFA	24xF-18B+† or 6xF-101C, 12xF-18B+†
Y183+	NAC, DWA	24xF-18C† or 6xF-101C, 12xF-18C†

When operating as a CVT, the tug was usually assigned escorts and fighters similar to those of a heavy carrier. (When the pod was used by a light tactical transport the combination was escorted similarly to a strike carrier.) Due to shortages, a CVT could have smaller escorts (all frigates for example) and will usually be assigned the least advanced escort ships available unless it picks up the complete escort group of a carrier lost in combat. In emergencies, some escorts were “standard” warships [e.g., FFG frigate (R2.26) instead of escort frigate (R2.41)].

Escort ready racks: The ready racks of the escorts were configured for F-8 (R2.F7) fighters in Y172-Y174 if the ship were operating that type of fighter, and for F-18 (R2.F5) fighters from Y173 on if the ship were operating that type of fighter. Escorts cannot have ready racks for heavy fighters; see (S8.318).

† When available [i.e., when a heavy carrier or space control ship (R2.32) had been lost or is undergoing major repair or conversion] F-14s (R2.F1) replaced 12 F-18s. The F-14s will be appropriate to the year, i.e., F-14 from Y174 to Y176; F-14A from Y177 to Y182; F-14B from Y183 to Y189; F-14C from Y190 to Y194; F-14D or F-14C from Y195+. Note that this happened very rarely (so no definitive period when this was done is provided), and the heavy carrier pod only operated the squadron of F-14s until a replacement heavy carrier or space control ship could be built or a damaged heavy carrier or space control ship could be returned to service.

If you do not have *Module J*, use the new escort cruiser (R2.20).

If detached, the two hull boxes can be destroyed by either “forward” or “rear” hull damage points. If attached to a tug (R2.8) or light tactical transport (R2.38), these two boxes are destroyed by “rear” hull damage points; the hull boxes on the tug or light tactical transport are destroyed by “forward” hull damage points. See (R2.47) when attached to a priority transport; see (R2.48) when attached to a VIP transport; see (R2.151) when attached to a battle frigate transport.

Weight: This is a double-weight pod with a towing cost of 0.6667.

Operation: The shields of this pod are combined with the shields of the tug or light tactical transport while it is attached. While attached, this pod increases the tug’s or light tactical transport’s command rating by one, a second pod of any type does not further increase the command rating. This pod is capable of independent operation as a sublight ship in its own right. The impulse engines of this pod cannot be used for movement if another pod is docked behind it.

Seeking weapons: The heavy carrier pod can control seeking weapons equal to its sensor rating (F3.21). When combined with a refitted tug or a light tactical transport, the combination can control a number of seeking weapons equal to double the sensor rating (F3.212). (With an unrefitted tug, the combination could control seeking weapons equal to the heavy carrier pod’s sensor rating; the tug’s minimal control

ability would be shut down in favor of the heavy carrier pod’s superior system.)

Refits: The Y175 refit was installed in Y175.

Designed by Steven Wilcox.

An SSD is in *Advanced Missions* showing this pod attached to a Federation tug; a counter is provided. A separate SSD for a separated heavy carrier pod is also included in *Advanced Missions*; use any Federation pod counter from *Basic Set*.

Known names: Pods never had official names.

(R2.23) AEGIS DESTROYER (DEA): In Y175, all surviving destroyer escort (R2.14) class ships were modified to use the full aegis system (D13.0) and redesignated aegis destroyers.

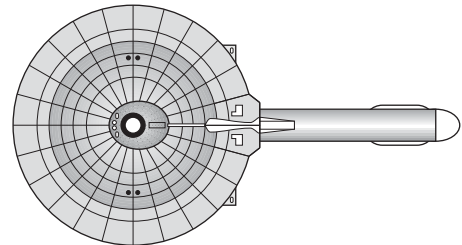

This ship has two ready racks (J4.89) and deck crews (J4.81) to support the fighters from the carrier it is escorting. The deck crews are not in addition to the deck crews provided by (J4.814), but replace them, representing their being retrained to service and arm fighters. See (R2.R5).

The aegis destroyer is a variant of the destroyer (R2.6). A variant of this ship existed for the Romulan border; see (R2.62A).

Seeking weapons: The aegis destroyer can control a number of seeking weapons equal to double its sensor rating (F3.212) and has full aegis (D13.0). See also (J15.332).

Refits: The drone rack refit was included as part of the aegis destroyer design.

The SSD is combined with that of the destroyer escort in *Module J*. Use the destroyer escort counters in *Module J*.

Known names: These were refits of the destroyer escort (R2.14) and did not change any names.

(R2.24) POLICE CARRIER (PV): In an emergency situation early in Y175, Federation Police Commissioner Robert Scorpio attached two hangar bay modules (R1.4) to a police cutter (R2.12) to create a “carrier.” Fortunately, it did not enter combat, but the brief experience with it resulted in construction of two more ships (*Sheriff* and *Marshal*) of an improved design. Even this improved design proved unsuccessful, and further conversions were canceled. The cargo boxes use the (R2.R5) rules, i.e., two of the six cargo boxes have spare fighters; the other four have supplies for the fighters.

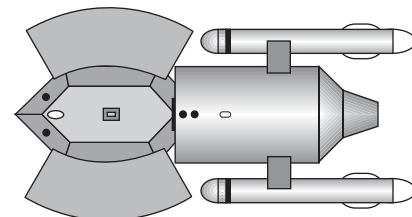

The police carrier is a variant of the police cutter (R2.12), but the changes were sufficiently extreme that it is considered a new class.

While based on the nimble police cutter, this ship is NOT nimble.

Carrier: This ship is a true carrier; see (J4.75), (J4.93), (J11.13), and (J15.22).

This ship has three shuttle bays. Mines can only be laid from the admin shuttle bay (M2.113). Transfers between the three bays are not possible.

Year	Escorts	Fighters
<i>Marshall</i>		
Y176-Y181+	1-2 POL	12xF-20‡
Y183+	1-2 POL	12xF-20C‡
<i>Sheriff</i>		
Y178	2xFFA	12xF-18B†

It carried F-20 (R2.F8) fighters (naval fighters were not then available to the police) in the bays and admin shuttles in the main ship. This was the only known case of F-20s operating from a carrier.

Escort ready racks: The aegis frigate (R2.41) escorts of the *Sheriff* were configured for F-18s (R2.F5). Escorts cannot have ready racks for heavy fighters; see (S8.318). Police cutters (R2.12) assigned as escorts never had ready racks.

‡ The last PV, *Marshall*, was scrapped in Y181 when too heavily damaged to be economically repaired. If it had survived, it presumably would have kept these escorts and fighters for as long as it remained in service.

† During its final mission in Y178, *Sheriff* was under Star Fleet Command and was provided with fleet fighters and escorts. This was during a critical point in the General War, when Federation carrier strength was at a dangerous low, and the ship was destroyed in combat with the Klingon carrier *Vindicator* (R3.28).

Historically these ships never operated heavy fighters.

Seeking weapons: The ship can control seeking weapons equal to double its sensor rating (F3.212).

Refits: The *Marshall* was unrefitted at the time of its conversion; the plus and Y175 refits were installed Y177 and the AWR refit in Y178. The *Sheriff* included the plus and AWR refits when it was converted, but did not receive the Y175 refit until Y177.

Designed by Daniel Rafoli.

SSD and counter are in *Module J*.

Known names: *Marshall, Sheriff.*

FEDERATION WARSHIPS AND VARIANTS

(R2.25) FRIGATE (FF): A contemporary of the heavy cruiser (R2.4) and destroyer (R2.6) designs, the frigate has good forward firepower but has (like most Federation ships) poor weapons arcs to the rear. The unique long-range ability of the photon meant that Federation frigates (unlike most of those of other empires) could support long-range bombardments.

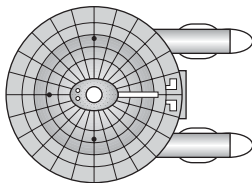

The frigate was useful in many patrol and escort roles, but the design was quickly upgraded to the FFG frigate (R2.26) for wartime use.

This is a base hull. Variants include the FFG frigate (R2.26), escort frigate (R2.41), aegis frigate (R2.41A), escort frigate-R (R2.42), aegis frigate-R (R2.42A), plasma frigate (R2.43), scout frigate (R2.44), drone frigate (R2.45), minehunter frigate (R2.46), priority transport (R2.47), VIP transport (R2.48), escort carrier (R2.49), commando frigate

(R2.80), forward carrier resupply frigate (R2.84), and police flagship (R2.86). There is an advanced technology version of the base hull, the advanced technology frigate (R2.203). The battle frigate (R2.50) is built on a drastically modified frigate hull.

Seeking weapons: The frigate can control a number of seeking weapons equal to half its sensor rating (F3.211).

Refits: Transporters increased from Range 4 to Range 5 in Y140. Tractors increased from Range 2 to Range 3 in Y140. The plus refit was available beginning in Y160, was common by Y170, and was universal by Y172; ships with this refit were designated FFGs (R2.26).

SSD and counters are in *Advanced Missions*.

Known names: 0301 *Burke*, 0302 *Hornblower*, 0303 *Perry*, 0306 *Jellico*, 0307 *Churchill*, 0308 *Beaty*, 0309 *F D Roosevelt*, 0310 *Lehman*, 0311 *De Gaulle*, 0312 *Teddy Roosevelt*, 0313 *Graf Spee*, 0314 *Tegethoff*, 0317 *Hipper*, 0321 *Zhadanov*, 0323 *Guderian*, 0325 *Ushakov*, 0326 *Ernest J King*, 0328 *Montgomery*, 0329 *Villeneuve*, 0330 *Rickover*, 0331 *Donitz*, 0332 *Mallory*, 0333 *John Paul Jones*, 0334 *Togo*, 0335 *Harwood*, 0336 *Rommel*, 0343 *Jason*, 0344 *Dewey*, 0346 *Suffren*, 0347 *Senyavin*, 0348 *Hosegawa*, 0349 *Shaw*, 0350 *Chadwick*, 0352 *Chaka*, 0353 *Cetshwayo*, 0354 (*John Fulton*) *Reynolds*, 0372 *Piet Heyn*, 0373 *Fitz John Porter*.

(R2.26) FFG FRIGATE (FFG): This is an improved version of the frigate (R2.25) with the plus refit (R2.R1). The drones improved its firepower and combat flexibility, and improved protection from rear attack.

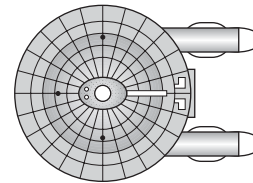

The FFG frigate is a variant of the frigate (R2.25).

Seeking weapons: The FFG frigate can control a number of seeking weapons equal to its sensor rating (F3.21).

Refits: The AWR refit was available in Y170; virtually all ships of this type had it by Y174. The Y175 refit was installed in Y175.

SSD is in *Advanced Missions*. Use the frigate counters in *Advanced Missions*.

Known names: These are new construction; refits of the frigate (R2.25) did not change any names. 0400 *Buford*, 0401 *Longstreet*, 0402 *Stand Watie*, 0403 *Auchinlek*, 0404 *O'Connor*, 0405 *Martin Luther King*, 0406 *Yi Chun*, 0407 *von Manstein*, 0411 (*Colonel Lawrence*) *Chamberlain*, 0416 *Stonewall Jackson*, 0417 *Schwartzkopf*, 0418 *Chief Joseph*, 0419 *Sitting Bull*, 0421 *Sheridan*, 0422 *Meade*, 0423 *Duke of Marlborough*, 0424 *General James Wolfe*, 0425 *General Louis-Joseph Montcalm*, 0426 *General Sir Arthur Currie*, 0427 *T.E. Lawrence*, 0428 *Harry Truman*, 0429 *Kelly Johnson*, 0430 *Moshe Dayan*.

(R2.27) DESTROYER LEADER (DDL): A pre-General War effort to improve the performance of the destroyer (R2.6), this destroyer variant utilized Gorn plasma technology which was made available under a clause of the Treaty of Algeron (Y157). Two plasma-F launchers were added to the middle years destroyer (R2.A23) instead of two additional photon torpedo tubes. This ship was one of the few cases where the problems with the original design outweighed the problems most navies had in employing foreign technology. It was thought that by using stasis-held plasma-F torpedoes, the

power requirements could be reduced. The plasma torpedoes on this ship were always swivel mounts [(FP3.2) & (D2.34)].

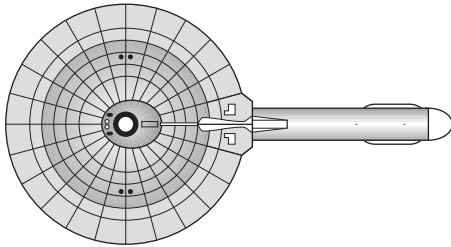

Note that the Federation initially used the “L” suffix, which usually indicates leader, for plasma-armed variants. Why the Federation picked that letter for this purpose is unknown. The ship does not have improved command abilities.

The destroyer leader is a variant of the destroyer (R2.6).

Seeking weapons: The destroyer leader can control a number of seeking weapons equal to its sensor rating (S3.21).

Refits: The plus refit was available beginning in Y165, was common by Y171, and was universal by Y175. The plasma carronade refit [this refit is not shown on older versions of the SSD; see (FP14.0)] was available in Y175 and universal by Y176. The plasma sabot refit [this refit is not shown on older versions of the SSD; see (FP11.0)] was available in Y180 and universal by Y181.

SSD and counters are in *Advanced Missions*.

Known names: 0501 *Genghis*, 0507 *Kublai*, 0524 *Zoroaster*, 0532 *Lysander*, 0538 *Leonidas*, 0539 *Marius*, 0541 *Nebuchadnezzar*, 0557 *Arthur Pendragon*.

(R2.28) GUIDED WEAPONS DESTROYER (DDG): Inspired by encounters with the Kzintis, the Federation deployed the first guided weapons destroyer as a test bed for drone technology in Y155, but abandoned the experiment because the drones available did not add enough combat power. The one guided weapons destroyer, *Czar Alexander IV*, remained in service for special scientific missions using probe drones (FD6.0) and to launch drones for target practice by other Federation units.

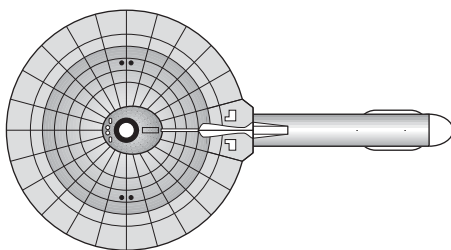

In Y167, the availability of medium-speed drones made the adding the drones worthwhile and more Middle Years destroyers (R2.A23) were converted to guided weapons destroyers. With effective drones, the guided weapons destroyer became even more effective than the four photon destroyer (R2.6) and most destroyers that remained in service as line warships were converted to this design. A few destroyers with four photon torpedoes were kept for bombardment missions, and many destroyers were converted to scouts (R2.7) or destroyer escorts (R2.14).

The guided weapons destroyer is a variant of the destroyer (R2.6).

Seeking weapons: The guided weapons destroyer can control a number of seeking weapons equal to its sensor rating (F3.21).

Refits: The plus refit was available beginning in Y165,

was common by Y171, and was universal by Y175. The Y175 refit was installed in Y175.

SSD and counters are in *Advanced Missions*.

Known names: 0519 *Shaitan*, 0527 *Sadat*, 0528 *Czar Alexander IV*, 0535 *Suvarov*, 0540 *King David*, 0542 *Jean Bart*, 0556 *Tecumseh*.

FEDERATION STRIKE CARRIERS

(R2.29) STRIKE CARRIER (CVS): A forerunner of the *Napoleon*-class heavy carrier, the strike carrier was basically a command cruiser (R2.3) with a modified secondary hull. It was built for the same mission as the Kzinti carrier: a heavy cruiser that could carry a squadron of fighters.

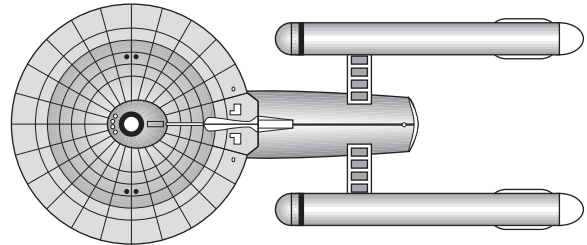

Nimitz was converted from an existing command cruiser, as were *Farragut* and *Raeder*. These ships were initially referred to as “command carriers (CCV).” Most others were new construction.

Each ship carries 12 fighters; an MRS (J8.0) (not in BPV) often replaced one of the four admin shuttles [(J2.0)/(R1.F1)]. When first built, the ships carried F-4 fighters (R2.F6) but sometimes also operated F-8s (R2.F7). However, *Nimitz* and *Yamamoto* were switched to F-18s (R2.F5); the new ships built or converted during the General War also carried that fighter. *Nelson*, *Houston*, and *Gorshkov* carried F-15s (R2.F10). [As these ships never operated F-14s (R2.F1), even after two of the heavy carriers were gone, it is presumed there was some design limitation that prevented this.]

The strike carrier is a variant of the heavy cruiser (R2.4).

Carrier: This ship is a true carrier; see (J4.75), (J4.93), (J11.13), and (J15.22).

This ship has two hatches for its shuttle bay which is a tunnel deck (J1.58), and can launch or land two shuttles every other impulse, or launch or land one shuttle every impulse.

Year	Escorts	Fighters
Y168-Y173	DE, 1-2 FFE or DE, 1-2 FFR (Rom)	12xF-4 or 12xF-8
Y173-Y175	DE/NEC, 1-2 FFE or DER, 1-2 FFR (Rom)	12xF-18
Y175-Y178	DEA/NAC, 1-2 FFA or DAR, 1-2 FRA (Rom)	12xF-18
Y176-Y177	DEA/NAC, 1-2 FFA or DAR, 1-2 FRA (Rom)	12xF-18 or 6xF-101A
Y177-Y179	DEA/NAC, 1-2 FFA or DAR/NAC, 1-2 FRA (Rom)	12xF-18 or 6xF-101B
Y179-Y181	DEA/NAC, 1-2 FFA/DWA/FBE or DAR/NAC, 1-2 FRA/DWR (Rom)	12xF-18B or 6xF-101C
Y180-Y183	NAC, 1-2 FFA/DWA/FBE or NAC, 1-2 FRA/DWR (Rom)	12xF-18B+ or 6xF-101C
Y183+	NAC, 1-2 DWA/FBE/FFA	12xF-18C or 6xF-101C

Some carriers retained three escorts throughout the General War; this is indicated by the 1-2, e.g., in Y180-Y183 a strike carrier might have a new aegis cruiser (R2.59) and one aegis frigate (R2.41A), or war destroyer escort (R2.68), or battle frigate escort (R2.148), or it might have a new aegis cruiser and two war destroyer escorts, or a new aegis cruiser and a war destroyer escort and a battle frigate escort, etc. Use the new escort cruiser (R2.20) if you do not have *Module J*. Carriers serving on the Romulan front usually operated with escorts especially designed for that front. These escorts were more difficult to build and maintain and were only used on that front. This combination is noted by the note "(Rom)." Production of the Romulan-front escort variants virtually ceased by the end of the General War.

Escort ready racks: The ready racks of the escorts were configured for F-4 (R2.F6) fighters or F-8 (R2.F7) fighters in Y168-Y173 if the ship were operating that type of fighter, and for F-18 (R2.F5) fighters from Y173 on if the ship were operating that type of fighter. Escorts cannot have ready racks for heavy fighters; see (S8.318).

Seeking weapons: The strike carrier can control a number of seeking weapons equal to double its sensor rating (F3.212).

Refits: The plus refit was available in Y170; virtually all ships of this type had it by Y174. The Y175 refit was installed in Y175.

SSD and counter are in *Advanced Missions*.

Known names: 1951 *Nimitz* (ex-1616), 1952 *Yamamoto*, 1955 *Raeder*, 1957 *Courbet*, 1958 *Conti de Cavour*, 1959 *Almirante Lattore*, 1960 *Farragut* (ex-1702).

(R2.29A) STRIKE CARRIER (CVB): Those strike carriers (R2.29) which carried F-15s (R2.F10) were referred to by the designation CVB and called "battle carriers." All data is the same as the strike carrier except for the fighters embarked [F-15s rather than F-18s (R2.F5)].

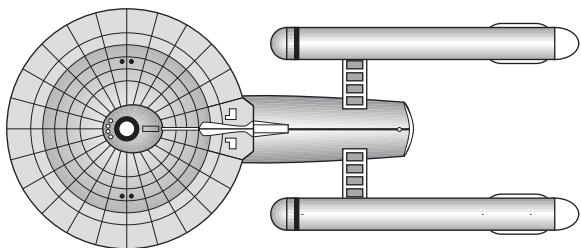

The strike carrier CVB is a variant of the heavy cruiser (R2.4).

Carrier: This ship is a true carrier; see (J4.75), (J4.93), (J11.13), and (J15.22).

This ship has two hatches for its shuttle bay which is a tunnel deck (J1.58), and can launch or land two shuttles every other impulse, or launch or land one shuttle every impulse.

Year	Escorts	Fighters
Y172-Y174	DE/NEC, FFE or DER, 1-2 FFR (Rom)	12xF-15
Y175	DEA/NAC, 1-2 FFA or DAR, 1-2 FRA (Rom)	12xF-15
Y176	DEA/NAC, 1-2 FFA or DAR, 1-2 FRA (Rom)	12xF-15 or 6xF-101A
Y177-Y178	DEA/NAC, 1-2 FFA or DAR/NAC, 1-2 FRA (Rom)	12xF-15 or 6xF-101B
Y179-Y183	DEA/NAC, 1-2 FFA/DWA/FBE or DAR/NAC, 1-2 FRA/DWR (Rom)	12xF-15 or 6xF-101C

Y183-Y186	NAC, 1-2 DWA/FBE/FFA	12xF-15C or 6xF-101C
Y186+	NAC, 1-2 DWA/FBE/FFA	12xF-15D or 6xF-101C

Some carriers retained three escorts throughout the General War, this is indicated by the 1-2, e.g., in Y180-Y183 a strike carrier CVB might have a new aegis cruiser (R2.59) and one aegis frigate (R2.41A), or war destroyer escort (R2.68), or battle frigate escort (R2.148), or it might have a new aegis cruiser and two war destroyer escorts, or a new aegis cruiser and a war destroyer escort and a battle frigate escort, etc. Use the new escort cruiser (R2.20) if you do not have *Module J*. Carriers serving on the Romulan front usually operated with escorts especially designed for that front. These escorts were more difficult to build and maintain and were only used on that front. This combination is noted by the note "(Rom)." Production of the Romulan-front escort variants virtually ceased by the end of the General War.

Escort ready racks: The ready racks of the escorts were configured for F-15 (R2.F10) fighters if the ship were operating that type of fighter. Escorts cannot have ready racks for heavy fighters; see (S8.318).

Seeking weapons: The strike carrier CVB can control a number of seeking weapons equal to double its sensor rating (F3.212).

Refits: Strike carrier CVBs always had the plus (R2.R1) refit. The Y175 refit was installed in Y175.

SSD and counter are in *Module R2*.

Known names: 1953 *Nelson*, 1954 *Gorshkov*, 1956 *Sam Houston*.

FEDERATION NEW LIGHT CRUISER VARIANT

(R2.30) NEW MINESWEEPER (NMS): As with other war cruiser variants, this class was constructed as replacements for destroyed pre-General War minesweepers, using the most readily available cruiser hull [(i.e., the new light cruiser (R2.18)] in production. The new minesweeper carries three minesweeping shuttles (R1.F2)/(M8.3) (included in BPV) and one admin shuttle [(J2.0)/(R1.F1)].

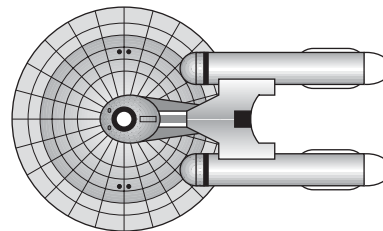

The new minesweeper is a variant of the new light cruiser (R2.18).

This ship is a true minesweeper (M2.45), see also (M8.0).

Seeking weapons: The new minesweeper can control a number of seeking weapons equal to its sensor rating (F3.21).

Refits: The plus refit was available beginning in Y175, was common by Y176, and was universal by Y177. The Y175 refit was installed in all ships of this type in Y175.

SSD and counter are in *Advanced Missions*.

Known names: 1571 *Cautious*, 1572 *Meticulous*.

FEDERATION LIGHT CRUISER VARIANT

(R2.31) COMMANDO CRUISER (CMC): Several old *Texas*-class light cruisers (R2.5) were modified for use as assault

transports for ground troops. While they could make a powered landing (P2.434) on planets (other light cruisers cannot), they could not take off again without considerable work (i.e., several weeks later, not during the same scenario). See scenario (SH7.0) for an example of a commando operation.

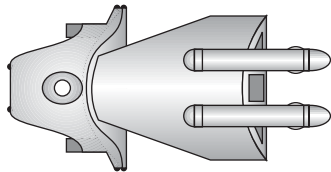

The commando cruiser is a variant of the light cruiser (R2.5).

Landing force: 27 boarding parties (D7.0) plus two commando teams (D15.84), three heavy-weapons squads (D15.81), and three ground combat vehicles (D15.82). This was roughly a battalion of troops (R2.M1) and is included in the ship's BPV.

Shuttles: Three ground assault shuttles (R1.F4), one heavy transport shuttle (R1.F5), and one admin shuttle [(J2.0)/(R1.F1)]; these shuttles are included in the ship's BPV.

Landing: Can land on planets using the powered landing system (P2.434) (other light cruisers cannot) and has the crash landing bonus (P2.4311).

Seeking weapons: Prior to the plus refit, the commando cruiser can control a number of seeking weapons equal to half its sensor rating (F3.211); after the plus refit the commando cruiser can control a number of seeking weapons equal to its sensor rating (F3.21).

Refits: Transporters increased from Range 4 to Range 5 in Y140. Tractors increased from Range 2 to Range 3 in Y140. The plus refit was available beginning in Y165, was common by Y171, and was universal by Y175. The Y175 refit was installed in Y175.

SSD and counter are in *Advanced Missions*.

Known names: 0933 *Normandy*, 0938 *Okinawa*, 0939 *Gallipoli*, 0940 *Quebec*, 0941 *Grenada*.

FEDERATION SPACE CONTROL SHIPS

(R2.32) SPACE CONTROL SHIP (SCS): The uncompleted heavy carrier (R2.13) *Julius Caesar* and the damaged heavy carrier *Napoleon* were under conversion to this design at the end of the General War. *Caesar* was eventually completed during the Andromedan Invasion and served with distinction until its heroic final battle; *Napoleon* was completed about Y190 and destroyed in Y198. *George Washington* was completed in Y186 and, after years of combat, eventually served as a museum. The intention was to create a space control ship-class vessel without resorting to the construction of fast patrol ships (K0.0).

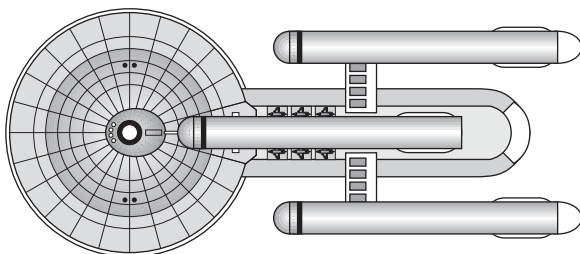

In a campaign, this ship cannot be built before Y182; no one thought of a space control ship until fast patrol ships were deployed.

The ship carries 12xF-18 (R2.F5), 12xF-14 (R2.F1), 6xA-20 (R2.F9), 2xE2 SWAC [(J9.0)/(R2.F3)], 2xMRS (J8.0), and 2xAdmin shuttles [(J2.0)/(R1.F1)]. The 2+4+1 spare shuttles include 2xAdmin, 2xF-14, 2xF-18, 1xA-20. The space control ships acquired F-14Cs in Y190, and one was carrying F-14Ds during Operation Unity (U6.0) in Y201. A space control ship will normally have the best available sub-type of each fighter type (e.g., F-18B) for the year in question. Note that the SSD shows type-I drones on the "special" rails of the A-20s. The MRS and SWAC shuttles are not included within the BPV. See [(J9.531)/(R2.F3A)] for use of an E-3A heavy SWAC.

The space control ship is a variant of the heavy carrier (R2.13).

Carrier: This ship is a true carrier; see (J4.75), (J4.93), (J10.111), (J11.13), and (J15.22).

This ship has four shuttle bays. The two bays on each side of the ship each hold 12 fighters and have six balcony (J1.53) positions (total of 12 balcony positions). The third (rear) bay holds six shuttles (admin, MRS, and SWAC shuttles) and is a special case (J1.57); the hatch is double sized allowing a shuttle to be launched or landed (but not both) every impulse. Transfers between these three bays are possible under (J1.592). The fourth "bay" is the A-20 bay and is semi-external and treated as mech-links (J1.561). Only A-20s can use this "bay." [No SCS ever carried F-111s, and records indicate that this was because the F-111 was much longer than the A-20 and could not be carried on the fore-and-aft links on this class. (Players may experiment with replacing each "column" of three A-20s with two F-111s, but the center link must be left empty. If the center link holds an F-111, the forward and aft links must be left empty.)] The boxes are hit as normal shuttle boxes. They have photon reload facilities. All six A-20s can be launched or landed (or some could be landing while others launch) in a single impulse or over multiple impulses. Mines can only be laid from the admin shuttle bay (M2.113).

Year	Escorts	Fighters
Y186-Y187	NAC, DEA/DWA/FBE, FFA	12xF-18C, 12xF-14B, 6xA-20F
Y186-Y190	2xNAC, DWA/FBE/FFA	12xF-18C, 12xF-14B, 6xA-20F
Y190-Y195	2xNAC, DWA/FBE/FFA	12xF-18C, 12xF-14C, 6xA-20F
Y195+	2xNAC, DWA/FBE/FFA	12xF-18C, 12xF-14D, 6xA-20F

The Y186 data can be used for Y184 if a space control ship becomes available earlier in a player-operated campaign.

Escort ready racks: The ready racks of the escorts were configured for F-18 (R2.F5) fighters. Escorts cannot have ready racks for heavy fighters; see (S8.318).

Seeking weapons: The space control ship can control a number of seeking weapons equal to double its sensor rating (F3.212).

Refits: The design incorporated the plus, AWR, and Y175 refits.

SSD and counter are in *Module R2*.

Known names: 2203 *Julius Caesar*, 2204 *George Washington*, 2205 *Frederick the Great*.

(R2.32A) SPACE CONTROL SHIP (SCSA): If using the conjectural Federation fast patrol ships in *Module K*, this conjectural space control ship design (with fast patrol ships replacing the A-20s) can be used. Escorts, as well as the

rules for the three shuttle bays and other data, are the same as for the standard space control ship. The MRS (J8.0) and SWAC [(J9.0)/(R2.F3)] shuttles are not included within the BPV. See [(J9.531)/(R2.F3A)] for use of an E-3A heavy SWAC.

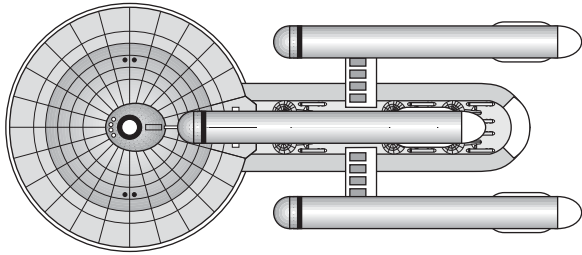

Spare shuttles are 2xAdmin [(J2.0)/(R1.F1)], 2xF-14 (R2.F1), 2xF-18 (R2.F5).

The space control ship is a variant of the heavy carrier (R2.13).

Carrier: This ship is a true carrier; see (J4.75), (J4.93), (J10.111), (J11.13), and (J15.22).

PF tender: This ship is a true PF tender (K2.0) and cannot operate heavy fighters (J10.0).

This ship has three shuttle bays. The two bays on each side of the ship each hold 12 fighters and have six balcony (J1.53) positions (total of 12 balcony positions). The third (rear) bay holds six shuttles (admin, MRS, and SWAC shuttles) and is a special case (J1.57); the hatch is double sized allowing a shuttle to be launched or landed (but not both) every impulse. Transfers between these three bays are possible under (J1.592). Mines can only be laid from the admin shuttle bay (M2.113).

Year	Escorts	Fighters
Y182	NAC, DEA/DWA/FBE, FFA	12xF-18B+, 12xF-14A
Y183-Y187	NAC, DEA/DWA/FBE, FFA	12xF-18C, 12xF-14B
Y186-Y190	2xNAC, DWA/FBE/FFA	12xF-18C, 12xF-14B
Y190-Y195	2xNAC, DWA/FBE/FFA	12xF-18C, 12xF-14C
Y195+	2xNAC, DWA/FBE/FFA	12xF-18C, 12xF-14D

Escort ready racks: The ready racks of the escorts were configured for F-18 (R2.F5) fighters.

Seeking weapons: The space control ship can control a number of seeking weapons equal to double its sensor rating (F3.212).

Refits: The design incorporated the plus, AWR, and Y175 refits.

An SSD is in *Module R2*. Use the space control ship counter.

This ship is conjectural.

Known names: These ships would have used the names of the original space control ships.

FEDERATION HEAVY BATTLECRUISERS

(R2.33) KIROV-CLASS BATTLECRUISER (BCG): As the General War progressed, it became increasingly clear that even the heavy command cruiser (R2.76) would be overtaken in the rapid competition which the General War had engendered. To maintain its leadership in cruisers, the Federation attempted to design the ultimate cruiser which could rely on existing technology. While similar to the heavy

cruiser (R2.4)/command cruiser (R2.3), the battlecruiser is not a modification or refit but a new design.

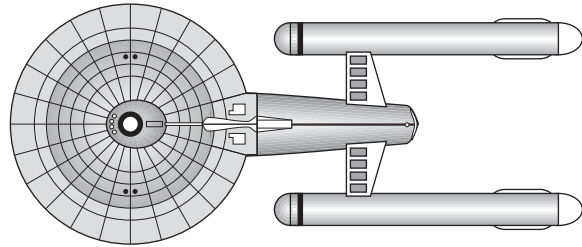

Star Fleet's specifications required the use of the standard heavy cruiser engines while improving the ship's maximum sustained combat speed for operations with new light cruisers (R2.18); this forced the designers to look to less power-hungry weapons than the photon torpedo. Type-B drone racks were selected for *Kirov*. Only 1751-*Kirov*, 1752-*Australia*, and 1753-*New Zealand* were completed (in Y177, Y179, and Y181, respectively). The class was supplanted by the improved technology cruiser (R2.55).

Other weapons in the secondary hull mounts were used to create the alternative *Bismarck* (R2.34) and the later *New Jersey* (R2.64) sub-classes. During the General War, the Federation failed to achieve its goal of maintaining cruiser superiority as the Klingons' superb C7 (R3.72) was the equal of the *Kirovs*.

These ships carry three sets of reloads for their drone racks (i.e., the Y175 refit was incorporated into their designs from the first).

This is a base hull. Variants include the *Bismarck* (R2.34) and *New Jersey* (R2.64), battle carrier (R2.74), battle control ship (R2.75), battle control ship with PFs (conjectural) (R2.75A), phaser-armed battlecruiser (R2.A31), and *Ranger*-class battlecruiser (R2.A42).

Warp pack: The two box center warp engine in the saucer can be used to generate power but cannot be used to generate movement points unless the saucer has been separated: (G12.102) and (G12.214).

Seeking weapons: The *Kirov*-class battlecruiser can control a number of seeking weapons equal to its sensor rating (F3.21).

Refits: The plus, AWR, and Y175 refits were included in the design.

SSD and counter are in *Module R2*.

Known names: 1751 *Kirov*, 1752 *Australia*, 1753 *New Zealand*.

(R2.34) BISMARCK-CLASS BATTLECRUISER (BCF): Produced concurrently with the *Kirovs* (R2.33), the *Bismarcks* are a slightly modified design using borrowed Gorn technology (plasma-F torpedo launchers) in place of the *Kirov's* type-B drone racks.

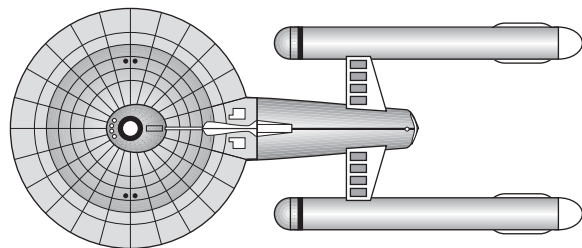

Only 1761-*Otto Von Bismarck*, 1762-*Nathan Bedford Forrest*, and 1763-*Nikolai V. Ogarkov* were completed (in Y178, Y180, and Y182, respectively). In each case, only the last name of the person was painted on the hull. The

Bismarcks are regarded by many to have been the better of the two heavy battlecruiser types produced during the General War. It is something of a curiosity that the Federation used the “F” designator for these ships instead of the “L” used on the destroyer leader (R2.27) and other plasma variants, but perhaps this denoted that plasma-F torpedoes were added [compared to the command cruiser (R2.3)] rather than replacing other weapons.

These ships carry three sets of reloads for their drone racks (i.e., they already incorporate the Y175 refit). The plasma-F torpedoes are destroyed on “torpedo” damage points on this ship, a stunning tactical advantage.

The *Bismarck*-class battlecruiser is a variant of the *Kirov*-class battlecruiser (R2.33).

Warp pack: The two box center warp engine in the saucer can be used to generate power but cannot be used to generate movement points unless the saucer has been separated: (G12.102) and (G12.214).

Seeking weapons: The *Bismarck*-class battlecruiser can control a number of seeking weapons equal to its sensor rating (F3.21).

Refits: The plus, AWR, Y175, and carronade refits [this refit is not shown on the SSD, see (FP14.0)] were included in the design. The plasma sabot refit [this refit is not shown on the SSD, see (FP11.0)] was available in Y180 and universal by Y181.

SSD and counter are in *Module R2*.

Known names: 1761 *Otto Von Bismarck*, 1762 *Nathan Bedford Forrest*, 1763 *Nikolai V. Ogarkov*.

FEDERATION NEW LIGHT CRUISER VARIANTS

(R2.35) NEW LIGHT CARRIER (NVL): When the General War erupted, the Federation shipyards could not produce enough of the excellent but expensive heavy carrier (R2.13) and strike carrier (R2.29) carriers. A crash program to design a carrier on the new light cruiser (R2.18) hull resulted in the new light carrier. While called a “light” carrier because it was built on a light cruiser hull, the ship carried a full squadron of fighters. It was never intended to come into direct combat with the enemy, hence it lacked the cruiser armament and extra seeking weapon control capabilities normally expected of a fleet carrier. Five new light carriers were built before production switched to the superior new strike carrier (R2.60). Surviving new light carriers were eventually relegated to secondary theaters and anti-piracy patrols. *Kiev*, the only new light carrier to survive the General War, was used for advanced pilot training until it was destroyed by an Andromedan raid in Y190.

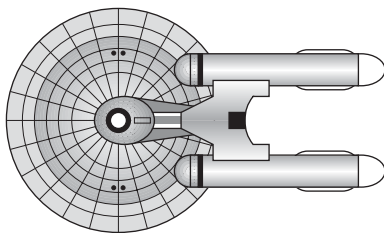

Former designation: NCVL.

The new light carrier is a variant of the new light cruiser (R2.18).

Carrier: This ship is a true carrier; see (J4.75), (J4.93), (J11.13), and (J15.22).

This ship has one shuttle bay.

Year	Escorts	Fighters
Y173-Y175	NEC, FFE or NEC, FFR (Rom)	12xF-18

Y175-Y177	NEA, FFA or NEA, FRA (Rom)	12xF-18
Y176	NEA, FFA or NEA, FRA (Rom)	12xF-18 or 6xF-101A
Y177-Y178	NEA, FFA or NEA, FRA (Rom)	12xF-18B or 6xF-101B
Y179-Y180	NEA/NAC, FFA or NEA/NAC, FRA (Rom)	12xF-18B or 6xF-101C
Y180-Y184	NAC, FFA/DWA or NAC, FRA/DWA (Rom)	12xF-18B+ or 6xF-101C
Y184+	NAC, FFA/DWA/FBE	12xF-18C or 6xF-101C

Carriers serving on the Romulan front usually operated with escorts especially designed for that front. These escorts were more difficult to build and maintain and were only used on that front. This combination is noted by the note “(Rom).” Production of the Romulan-front escort variants virtually ceased by the end of the General War.

Escort ready racks: The ready racks of the escorts were configured for F-18 (R2.F5) fighters if the ship were operating that type of fighter. Escorts cannot have ready racks for heavy fighters; see (S8.318).

Seeking weapons: The new light carrier can control a number of seeking weapons equal to its sensor rating (F3.21).

Refits: The plus refit was available beginning in Y173, was common by Y175, and was universal by Y176. The plus refit includes only phaser-3s, not the increase to the #1 shield seen in other new light cruiser (R2.18) variants, as the ship was not expected to enter direct combat. The Y175 refit was installed in all ships of this type in Y175.

SSD and counter are in *Module J*.

Known names: 1508 *Kaga*, 1591 *Kiev*, 1592 *Hosho*, 1593 *Princeton*, 1594 *Veinticinco De Mayo*.

(R2.36) NEW DRONE CRUISER (NCD): Impressed with the ability of the Klingon drone bombardment ships to provide an additional concentration of firepower, the Federation designed this long-range drone bombardment ship using the new light cruiser (R2.18) hull as a basis. Series production of this ship was delayed until Y173 due to wartime priorities, but some served as early as Y171. It did not have special sensors as it was designed to support fleet ships in combat; for independent bombardment missions, it required scout support.

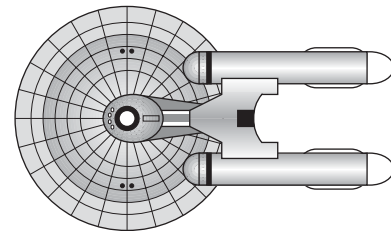

The new drone cruiser is a variant of the new light cruiser (R2.18).

Former designation: NCS.

Bombardment: This ship has two hundred spaces of spare drones stored in its cargo boxes; see (FD10.671) and (S3.222).

Deployment: See (S8.47) for deployment restrictions and conditions.

Seeking weapons: The new drone cruiser can control a number of seeking weapons equal to double its sensor rating (F3.212).

Refits: The plus refit was available beginning in Y173,

was common by Y175, and was universal by Y176. The Y175 refit was installed in all ships of this type in Y175.

SSD and counters are in *Module R2*.

Known names: 1515 *Azov*, 1516 *Groznyy*, 1517 *Gromykii*, 1541 *Sverdlov*, 1542 *Varyag*.

(R2.37) LIGHT COMMAND CRUISER (CLC): This ship was intended as a substitute for command cruisers (R2.3). Proving inadequate in that role, it was used as a command ship for new light cruiser (R2.18) squadrons.

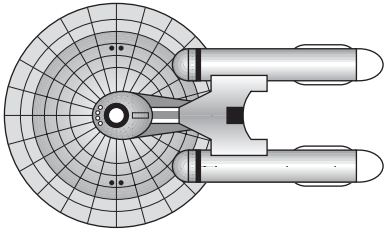

The light command cruiser is a variant of the new light cruiser (R2.18).

Seeking weapons: The light command cruiser can control a number of seeking weapons equal to its sensor rating (F3.21).

Refits: The Y175 refit was installed in all ships of this type in Y175.

SSD and counter are in *Module R2*.

Known names: 1580 *Clausewitz* (converted to NCC), 1581 *Sun Tzu*, 1582 *Jomini*, 1583 *Tacitus*, 1584 *Mahan*, 1585 *Clancy*, 1586 *Coyle*, 1587 *Webber*.

(R2.38) LIGHT TACTICAL TRANSPORT (LTT): Most empires produced a transport based on their war cruiser hull. Their limitations of size and range restricted their use to supporting military operations. Ships of this type [e.g., Klingon D5H (R3.54) and Hydran Mule (R9.38)] are treated as tugs, but have lesser capabilities.

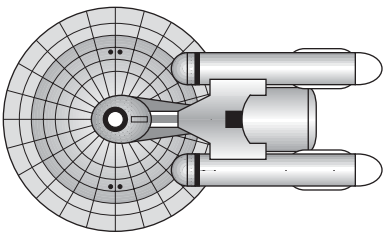

Like the larger fleet tug (R2.8), the hull boxes on the light tactical transport can be hit on "forward" or "rear" hull damage points unless the light tactical transport is towing a pod, in which case they are hit on "forward" hull damage points and the hull, cargo, or repair boxes in the pod are destroyed by "rear" hull damage points. Cargo boxes on the light tactical transport and those cargo and repair boxes on any pods can still be destroyed by "cargo" damage points.

No interbay shuttle transfers (J1.59) are possible between a pod and the shuttle bay of the light tactical transport.

Like all tugs, the movement cost and turn mode vary with the pods carried. The movement cost of the light tactical transport with one pod is 1.00 energy points per hex. The movement cost of the light tactical transport with a double-weight pod is 1.33 energy points per hex; see Annex #3A.

The light tactical transport is a variant of the new light cruiser (R2.18).

Seeking weapons: The light tactical transport can control a number of seeking weapons equal to its sensor rating (F3.21).

Refits: The plus refit was available beginning in Y173, was common by Y175, and was universal by Y176. The plus refit includes only phaser-3s, not the increase to the #1 shield seen in other new light cruiser variants, as the ship was not expected to enter direct combat. The Y175 refit was installed in all ships of this type in Y175.

SSD and counter are in *Module R2*.

Known names: 1461 *Hoffa*, 1462 *Reuther*, 1463 *Solidarity*, 1464 *Gompers*.

FEDERATION OLD LIGHT CRUISER VARIANTS

(R2.39) LIGHT SURVEY CRUISER (CLS): Two old-style light cruisers (R2.5) were converted for use as survey ships about Y125. (NCC-912 *Sinai* became NCC-962 *Viking*; NCC-924 *Alaska* became NCC-974 *Voyager*.) These continued to serve long after the specially built galactic survey cruisers (R2.16) appeared. The Vulcans provided the special sensors for these ships.

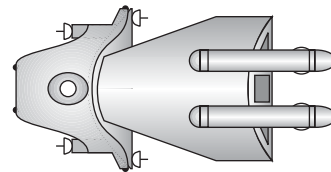

The light survey cruiser is a variant of the light cruiser (R2.5).

Scout: It can use all scout functions (G24.0). Special sensors are destroyed by "torpedo" damage points. See (G24.35) when purchasing this unit as part of a battle force.

Seeking weapons: Prior to the plus refit, the light survey cruiser can control a number of seeking weapons equal to half its sensor rating (F3.211); after the plus refit the light survey cruiser can control a number of seeking weapons equal to its sensor rating (F3.21). See also (F2.213).

Refits: Sensors are under Early Years restrictions (YG24.0) until Y134. Transporters increased from Range 4 to Range 5 in Y140. Tractors increased from Range 2 to Range 3 in Y140. The plus refit was available beginning in Y165; both ships had received the refit by Y170. The Y175 refit was installed in all ships of this type in Y175.

Designed by Ray Olesen.

SSD and counter are in *Module R2*.

Known names: 0962 *Viking* (ex 0912 *Sinai*), 0974 *Voyager* (ex 0924 *Alaska*).

(R2.39A) ESCORT CARRIER (CVE): During some crisis periods, light survey cruisers (R2.39) carried fighters as escort carriers (CVEs) or served as scouts.

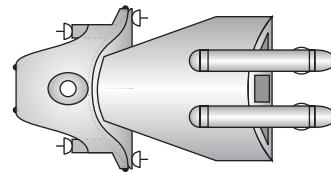

The escort carrier is a variant of the light cruiser (R2.5).

Scout: It can use all scout functions (G24.0). Special sensors are destroyed by "torpedo" damage points. See (G24.35) when purchasing this unit as part of a battle force. This ship is considered a survey cruiser for purposes of

(S8.351). See (S8.25) if it is not counted in the command limit.

Carrier: This ship is a true carrier; see (J4.75), (J4.93), (J11.13), and (J15.22).

This ship has one shuttle bay. When operating as a carrier, the following data applies:

Year	Escorts	Fighters
Y172-Y173	2xFFE or 2xFFR (Rom)	4xF-4 or 4xF-8
Y173-Y175	2xFFE or 2xFFR (Rom)	4xF-18
Y175	2xFFA or 2xFRA (Rom)	4xF-18
Y176	2xFFA or 2xFRA (Rom)	4xF-18 or 2xF-101A
Y177-Y178	2xFFA or 2xFRA (Rom)	4xF-18 or 2xF-101B
Y178-Y181	2xFFA or 2xFRA (Rom)	4xF-18B or 2xF-101C
Y181-Y184	2xFFA or 2xFRA (Rom)	4xF-18B+ or 2xF-101C
Y185+	2xFFA or 2xFRA (Rom)	4xF-18C or 2xF-101C

Carriers serving on the Romulan front usually operated with escorts especially designed for that front. These escorts were more difficult to build and maintain and were only used on that front. This combination is noted by the note "(Rom)." Production of the Romulan-front escort variants virtually ceased by the end of the General War.

Escort ready racks: The ready racks of the escorts were configured for F-4 (R2.F6) or F-8 (R2.F7) fighters in Y172-Y173 if the ship were operating that type of fighter, and for F-18 (R2.F5) fighters from Y173 on if the ship were operating that type of fighter. Escorts cannot have ready racks for heavy fighters; see (S8.318).

Seeking weapons: The escort carrier can control a number of seeking weapons equal to its sensor rating (F3.21). See also (F3.213).

Refits: The plus refit was included in the design. The ship received the drone rack refit in Y175.

Designed by Ray Olesen.

SSD is combined with the light survey cruiser in *Module R2*. Use the light survey cruiser counter in *Module R2*.

Known names: Retained the names of the light survey cruisers converted to this use.

(R2.40) HOSPITAL SHIP (CLH): Two old-style light cruisers (R2.5) (NCC 0948 *Refuge* and NCC 0949 *Sanctuary*) were converted for use as hospital ships. They were intended for peacetime use in fighting plagues or other natural disasters. Being built on warship hulls (albeit old ones), they could reach the scene of any outbreak within a fraction of the time needed by auxiliary hospital ships [(R1.61) and (R1.62)]. During wartime, the ships were used at various times to support ground assaults, friendly planets that had been devastated, or fleets. Only the Federation produced such ships; other empires used auxiliary hospital ships. The shuttles are specially fitted for medical evacuation (no game effect). The weapons could, under Federation regulations, be fired only to defend the patients; a regulation often interpreted broadly and with no real game effect.

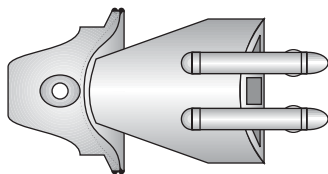

As these ships are not combat capable, they are not listed on the Order of Battle. For practical purposes, their use in *Star Fleet Battles* is confined to acting as a target in special scenarios, such as (SG27.6). They will be used more extensively in the role-playing games.

The hospital ship is a variant of the light cruiser (R2.5).

Seeking weapons: Prior to the plus refit, the hospital ship can control a number of seeking weapons equal to half its sensor rating (F3.211); after the plus refit the hospital ship can control a number of seeking weapons equal to its sensor rating (F3.21).

Refits: The plus refit was available beginning in Y165; both ships had received the refit by Y170. The Y175 refit was installed in all ships of this type in Y175.

Designed by Ray Olesen.

SSD and counter are in *Module R2*.

Known names: 0948 *Refuge*, 0949 *Sanctuary*.

FEDERATION FRIGATE VARIANTS

(R2.41) ESCORT FRIGATE (FFE): Conceived at the same time as the destroyer escort (R2.14) as a light escort for the strike carrier (R2.29), this frigate variant served in a variety of carrier groups.

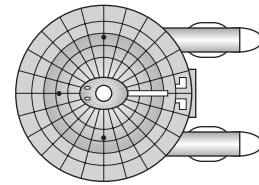

This ship has two ready racks (J4.89) and deck crews (J4.81) to support the fighters from the carrier it is escorting. The deck crews are not in addition to the deck crews provided by (J4.814), but replace them, representing their being retrained to service and arm fighters. See (R2.R5).

The escort frigate is a variant of the frigate (R2.25). A variant of this ship existed for the Romulan border; see (R2.42).

Seeking weapons: The escort frigate can control a number of seeking weapons equal to double its sensor rating (F3.212) and has limited aegis (D13.4). See also (J15.332).

Refits: The plus refit was available in Y168, but only rarely installed on these ships. Full aegis (D13.0) and the drone rack refit were installed in Y175, resulting in the FFA (R2.41A).

SSD and counters are in *Advanced Missions*.

Known names: 0337 *Barry*, 0338 *Hardy*, 0339 *Yegorov*, 0340 *Smirnov*, 0355 *Seguin*, 0356 *Bonham*, 0408 *Davout*, 0409 *Grouchy*, 0412 *Allam*, 0413 *Boyington*, 0414 *Chenault*, 0431 *Commodore Edward Preble*, 0432 *Commodore William Bainbridge*, 0433 *Admiral Jacob van Heemskerck*, 0434 *Isaac Hull*, 0435 *Milius*, 0436 *Niels Juel*, 0437 *Richard Bolitho*, 0438 *Stephen Decatur*, 0439 *Themistocles*, 0440 *Ernest E. Evans*.

(R2.41A) AEGIS FRIGATE (FFA): The escort frigates (R2.41) received full aegis (D13.0) in Y175 and was redesignated aegis frigates.

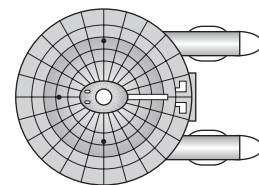

This ship has two ready racks (J4.89) and deck crews (J4.81) to support the fighters from the carrier it is escorting. The deck crews are not in addition to the deck crews provided by (J4.814), but replace them, representing their being retrained to service and arm fighters. See (R2.R5).

The aegis frigate is a variant of the frigate (R2.25). A variant of this ship existed for the Romulan border; see (R2.42A).

Seeking weapons: The aegis frigate can control a number of seeking weapons equal to double its sensor rating (F3.212) and has limited aegis (D13.4). See also (J15.332).

Refits: The drone rack refit was included as part of the aegis frigate design. This class rarely received the plus (R2.R1) refit initially, but all ships of the class had it by Y180.

The SSD is combined with that of the escort frigate in *Advanced Missions*. Use the escort frigate counters in *Advanced Missions*.

Known names: These were refits of the escort frigate (R2.41) and did not change any names.

(R2.42) ESCORT FRIGATE-R (FFR): Escort version used in carrier groups on Romulan border. These escorts were more difficult to build and maintain and were only used on that front. Their use is noted by the note "(Rom)" in the escorts column of carrier tables in ship descriptions. Production of the Romulan-front escort variants virtually ceased by the end of the General War.

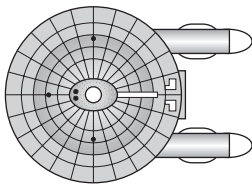

This ship has two ready racks (J4.89) and deck crews (J4.81) to support the fighters from the carrier it is escorting. The deck crews are not in addition to the deck crews provided by (J4.814), but replace them, representing their being retrained to service and arm fighters. See (R2.R5).

The escort frigate-R is a variant of the frigate (R2.25).

Seeking weapons: The escort frigate-R can control a number of seeking weapons equal to its sensor rating (F3.21) and has limited aegis (D13.4). See also (J15.332).

Refits: The plus refit was available in Y168, but only rarely installed on these ships. Full aegis and the drone rack refit were installed in Y175, resulting in the aegis frigate-R (R2.42A).

SSD and counters are in *Module R2*.

Known names: 0304 *Takagi*, 0315 *Fletcher*, 0316 *Spruance*, 0322 *Kondo*, 0327 *Lutjens*, 0351 *Langsdorff*, 0357 *Moore*, 0358 *McCaffrey*.

(R2.42A) AEGIS FRIGATE-R (FRA): The escort frigate-Rs were fitted with full aegis (D13.0) in Y175 and redesignated aegis frigate-R. These escorts were more difficult to build and maintain and were only used on that front. Their use is noted by the note "(Rom)" in the escorts column of carrier tables in ship descriptions. Production of the Romulan-front escort variants virtually ceased by the end of the General War.

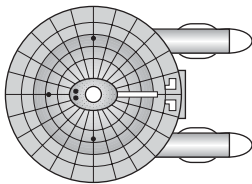

This ship has two ready racks (J4.89) and deck crews (J4.81) to support the fighters from the carrier it is escorting. The deck crews are not in addition to the deck crews provided by (J4.814), but replace them, representing their being retrained to service and arm fighters. See (R2.R5).

The aegis frigate-R is a variant of the frigate (R2.25).

Seeking weapons: The aegis frigate-R can control a number of seeking weapons equal to its sensor rating (F3.21) and has full aegis (D13.0). See also (J15.332).

Refits: The drone rack refit was included as part of the aegis frigate-R design. This class rarely received the plus (R2.R1) refit initially, but all ships of the class had it by Y180.

The SSD is combined with that of the escort frigate-R in *Module R2*. Use the escort frigate-R counters in *Module R2*.

Known names: These were refits of the escort frigate-R (R2.42) and did not change any names.

(R2.43) PLASMA FRIGATE (FFL): An experimental conversion to produce a plasma-armed frigate. The ship was considered too small to make good use of the limited number of Gorn-supplied plasma-F torpedo launchers and only one or two were built (two names appear, but both use the same NCC number which may mean that only one was actually built; records are unclear). More ships of this class were built or converted after the carronade refit became available in Y175 and were used to help hunt cloaked Romulan blockade runners and Orion ships.

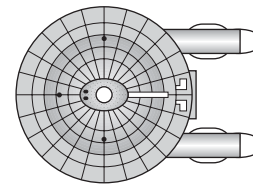

The plasma frigate is a variant of the frigate (R2.25).

Seeking weapons: The plasma frigate can control a number of seeking weapons equal to its sensor rating (F3.21).

Refits: The plus refit was available in Y165, but only rarely, if ever, installed on these ships. The Y175 refit was installed in all ships of this type in Y175 or later if they had received the plus refit. The carronade refit [the carronade refit is not shown on the SSD, see (FP14.0)] was available in Y175; it was universal by Y176. The plasma sabot refit [this refit is not shown on the SSD, see (FP11.0)] was available in Y180 and universal by Y181.

SSD and counters are in *Module R2*.

Known names: 0318 *Freyberg*, 0318 *Yi Sun Sin*.

(R2.44) SCOUT FRIGATE (FFS): Unsuccessful scout version, the scout frigate was too small to survive in fleet battles but sometimes it was used in secondary theaters. Those forced into front-line combat by temporary shortages of scout platforms were quickly smashed by concentrated enemy fire.

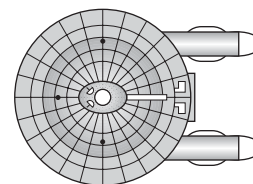

The scout frigate is a variant of the frigate (R2.25).

Scout: It can use all scout functions (G24.0). Special sensors are destroyed by "torpedo" damage points. See (G24.35) when purchasing this unit as part of a battle force.

Seeking weapons: Prior to the plus refit, the scout frigate can control a number of seeking weapons equal to half its sensor rating (F3.211); after the plus refit the scout frigate can control a number of seeking weapons equal to its sensor rating (F3.21). See also (F3.213).

Refits: The plus refit was available beginning in Y170, common by Y172, and was universal by Y175. The Y175 refit was installed in all ships of this type in Y175.

Designed by Ray Olesen.

SSD and counter are in *Module R2*.

Known names: 0375 *Sacagawea*, 0376 *Zheng He*, 0379 *Frobisher*, 0380 *Shackleton*, 0391 *Sir Edmund Hillary*, 0392 *Tensing*, 0393 *Stanley*, 0394 *Livingston*.

(R2.45) DRONE FRIGATE (FFD): Conceived simultaneously with the guided weapons destroyer (R2.28), this design proved to be an unpopular type; the drones did not make up for the total lack of photons.

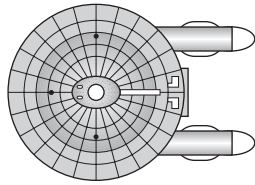

The drone frigate is a variant of the frigate (R2.25).

Deployment: See (S8.47) for deployment restrictions and conditions.

Seeking weapons: The drone frigate can control a number of seeking weapons equal to double its sensor rating (F3.212).

Refits: The plus refit was available beginning in Y168, common by Y172, and universal by Y175. The Y175 refit was installed in all ships of this type in Y175.

SSD and counter are in *Module R2*.

Known names: 0305 *Drake*, 0319 *Tanaka*, 0320 *St Vincent*, 0324 *Dunnigan*, 0341 *Doolittle*, 0342 *McClusky*, 0345 *Degrasse*.

(R2.46) MINEHUNTER FRIGATE (FFM): This was an unpopular minehunter variant, being too small to survive an attempt to breach a major minefield. It was sometimes used as a convoy escort, not because minesweeping capabilities were needed but because there was nothing more worthwhile for the minehunter frigates to do. An attempt to use the minehunter frigate *Wary* in squadron operations to hunt cloaked ships failed when a Romulan King Eagle (R4.39) uncloaked behind it and slammed a full alpha-strike into a rear shield. The ship appeared too late and was incapable of dealing with the minefields of its time.

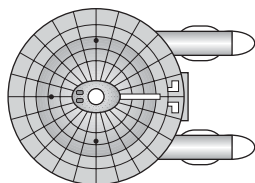

This ship carries one minesweeping shuttle (R1.F2)/(M8.3) (which is included in the BPV). The limit of one minesweeping shuttle is an exception to (M8.312).

The minehunter frigate is a variant of the frigate (R2.25).

This ship is a true minesweeper (M2.45); see also (M8.0).

Seeking weapons: Prior to the plus refit, the minehunter frigate can control a number of seeking weapons equal to half its sensor rating (F3.211); after the plus refit the minehunter

frigate can control a number of seeking weapons equal to its sensor rating (F3.21).

Refits: The plus refit was available beginning in Y170; both ships had it by Y174. The Y175 refit was installed in all ships of this type in Y175.

SSD and counter are in *Module R2*.

Known names: 0395 *Wary*, 0396 *Detailed*.

(R2.47) PRIORITY TRANSPORT (FFT): A strategic transport variant, ships of this class were also used as high-speed priority transports (when not carrying a pod), delivering key personnel or supplies to critical points at the front. Some were used as “carrier resupply ships” [see (R2.84)] to bring replacement fighters and drones forward to carriers.

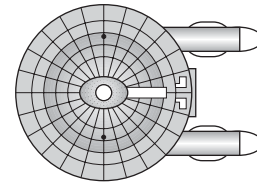

The SSD provides the data for both single-weight and double-weight pods, but any pods carried by this ship are inactive and every box in such a pod is treated as a “cargo” damage point. This priority transport can carry one pod, which can be double-weight.

Like all tugs, the movement cost and turn mode vary with the pod carried. The movement cost of the priority transport with a single-weight pod is 0.67 energy points per hex; with a double-weight pod it is 1.0 energy points per hex; see Annex #3A. Note that other frigate variants [except the VIP transport (R2.48) below] cannot carry pods.

The priority transport is a variant of the frigate (R2.25).

Seeking weapons: Prior to the plus refit, the priority transport can control a number of seeking weapons equal to half its sensor rating (F3.211); after the plus refit the priority transport can control a number of seeking weapons equal to its sensor rating (F3.21).

Refits: The plus refit was available beginning in Y165, but only very rarely installed prior to Y175. It was common thereafter and universal by Y178. The Y175 refit was installed in all ships of this type in Y175 or later if they had received the plus refit.

SSD and counter are in *Module R2*.

Known names: 0381 *Wells Fargo*, 0382 *Pony Express*, 0384 *Flying Cloud*.

(R2.48) VIP TRANSPORT (FFP): A variant of the priority transport (R2.47) equipped with accommodations for passengers rather than cargo holds. This ship was sometimes used for diplomatic missions, where the Federation thought they were demonstrating their power and security by using a smaller ship than the diplomatic battlecruisers, e.g., D7N (R3.45), used by the Klingons. They were sometimes pressed into service as “troop transport frigates” to reinforce garrisons on threatened planets or support small-scale raids on enemy held planets.

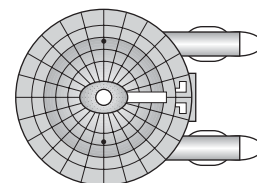

Ten of the “crew” units are passengers.

The SSD provides the data for both single-weight and double-weight pods, but any pods carried by this ship are inactive and every box in such a pod is treated as a “cargo” damage point. The VIP transport can carry one pod, which can be double-weight.

Like all tugs, the movement cost and turn mode vary with the pod carried. The movement cost of the VIP transport with a single-weight pod is 0.67 energy points per hex; with a double-weight pod it is 1.0 energy points per hex; see Annex #3A. Note that other frigate variants [except the priority transport (R2.47) above] cannot carry pods.

The VIP transport is a variant of the frigate (R2.25).

Landing force (when used as a “troop transport frigate”): 18 boarding parties (D7.0), two commando teams (D15.84), and two heavy-weapons squads (D15.81) (replacing the 10 crew units of passengers). This was roughly a half battalion of troops (R2.M1) and increases the ship’s BPV by 13 points.

Shuttles: Two admin [(J2.0)/(R1.F1)] shuttles are included in the ship’s BPV [one or both might be replaced by ground assault shuttles (R1.F4) when operating as a “troop transport frigate” using Commander’s Option Points].

Seeking weapons: Prior to the plus refit, the VIP transport can control a number of seeking weapons equal to half its sensor rating (F3.211); after the plus refit the VIP transport can control a number of seeking weapons equal to its sensor rating (F3.21).

Refits: The plus refit was available beginning in Y165, but only very rarely installed prior to Y175. It was common thereafter and universal by Y178. The Y175 refit was installed in all ships of this type in Y175 or later if they had received the plus refit.

SSD and counter are in *Module R2*.

Known names: 0383 *Orient Express*, 0385 *Bob Hope*, 0386 *Bing Crosby*.

(R2.49) ESCORT CARRIER (FFV): One of the less successful escort carriers, this conversion compromised much of the firepower of the frigate upon which it was based in exchange for relying on its fighters. It served as a convoy escort, in secondary theaters, and to supply replacement fighters to the larger carriers. During one period, an escort carrier and its escorting aegis frigate (R2.41A) were grouped with a VIP transport (R2.48) to escort a group of Federation council members to a conference with the Tholians; the group escaped Coalition notice as it appeared to be only another frigate squadron.

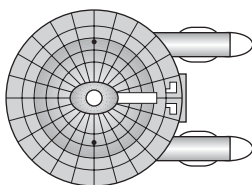

The escort carrier is a variant of the frigate (R2.25).

Carrier: This ship is a true carrier; see (J4.75), (J4.93), (J11.13), and (J15.22).

This ship has one shuttle bay.

Year	Escorts	Fighters
Y172-Y175	FFE or FFR (Rom)	6xF-4 or 6xF-8
Y173-Y175	FFE or FFR (Rom)	6xF-18
Y176-Y179	FFA or FRA (Rom)	6xF-18
Y179-Y181	FFA or FRA (Rom)	6xF-18B
Y181-Y185	FFA or FRA (Rom)	6xF-18B+
Y186+	FFA	6xF-18C

Carriers serving on the Romulan front usually operated with escorts especially designed for that front. These escorts were more difficult to build and maintain and were only used on that front. This combination is noted by the note “(Rom).” Production of the Romulan-front escort variants virtually ceased by the end of the General War. Escort carriers had a low priority for the rare Romulan border escorts and often were provided with non-Romulan border escorts when assigned to that theater.

Escort ready racks: The ready racks of the escorts were configured for F-4 (R2.F6) or F-8 (R2.F7) fighters in Y172-Y175 if the ship were operating that type of fighter, and for F-18 (R2.F5) fighters from Y173 on if the ship were operating that type of fighter.

Seeking weapons: The escort carrier can control a number of seeking weapons equal to double its sensor rating (F3.212).

Refits: The plus refit was available beginning in Y172, but only very rarely installed. The Y175 refit was installed in all ships of this type in Y175 or later if they had received the plus refit.

SSD and counter are in *Module R2*.

Known names: 0360 *Langley*, 0361 *Zuiho*, 0362 *Zeppelin*, 0363 *Moskva*, 0364 *Principe de Asturias* (later FBV), 0365 *Richthofen*, 0366 *Argus*, 0367 *Lydia Litvyak*, 0368 *Katya Budanova*, 0369 *Joachim Marseille*, 0370 *Oswald Boelcke*, 0371 *Werner Voss*.

FEDERATION BATTLE FRIGATE

(R2.50) BATTLE FRIGATE (FFB): One of two competing designs for the Federation “war destroyer project,” it was seriously considered because it could be built with frigate (R2.25) components.

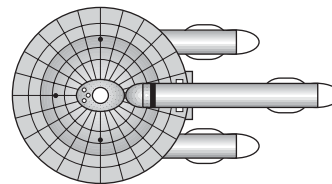

After a fly-off, it was decided that the battle frigate was too small to accommodate future developments, and the competing war destroyer (R2.65) was selected. Besides the original prototype, three more battle frigates were ordered as compensation to the contractor for his design expenses. They were used as frigate leaders; it was not necessary to put them in a single squadron because they used the same spare parts as frigates.

The design was resurrected as a way of increasing the performance of the increasingly outgunned frigates, and several variants also entered service, although war destroyer production far outpaced the numbers of battle frigates.

This ship is a variant of the frigate (R2.25) but the changes were sufficiently extreme that it is considered a new class. Variants include the battle drone frigate (R2.147) battle frigate escort (R2.148), battle frigate carrier (R2.149), battle frigate scout (R2.150), battle frigate transport (R2.151), escort battle frigate-R (R2.A41), and limited aegis escort battle frigate-R (R1.A41A).

Seeking weapons: The battle frigate can control a number of seeking weapons equal to its sensor rating (F3.21).

Refits: The plus and Y175 refits were incorporated in the design.

SSD and counter are in *Module R2*.

Known names: 0471 *Marko Ramius*, 0472 *Gunter Prien*, 0473 *Yahachi Tanabe*, 0474 *Joseph Enright*.

FEDERATION SURVEY CRUISER VARIANT

(R2.51) COMMANDO CARRIER (COV): One or two galactic survey cruisers (R2.16) were used as commando ships. This ship cannot land on planets and relies on its transporters and shuttles to put its troops on the surface.

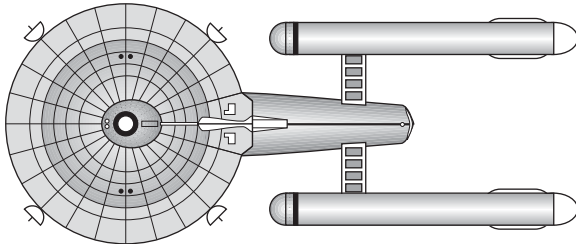

The commando carrier is a temporary reassignment of a survey cruiser by temporarily converting some of its cargo decks to barracks and replacing most of its administrative shuttles [(J2.0)/(R1.F1)] with shuttles to support a Marine landing.

Scout: It can use all scout functions (G24.0). Special sensors are destroyed by “phaser” damage points. See (G24.35) when purchasing this unit as part of a battle force. This ship is considered a survey cruiser for purposes of (S8.351). See (S8.25) if it is not counted in the command limit.

Landing force: 36 boarding parties (D7.0) plus two commando teams (D15.84), four heavy-weapons squads (D15.81), and four ground combat vehicles (D15.82). This was roughly a battalion of troops (R2.M1) and is included in the ship’s BPV.

Shuttles: Four ground assault shuttles (R1.F4), one heavy transport shuttle (R1.F5), and two admin shuttles [(J2.0)/(R1.F1)]; these shuttles are included in the ship’s BPV.

Seeking weapons: Prior to Y153, the commando carrier can control a number of seeking weapons equal to half its sensor rating (F3.211); after Y152 the commando carrier can control a number of seeking weapons equal to its sensor rating (F3.21). See also (F3.213).

Refits: Prior to Y153 there is no drone rack (BPV is reduced by three points). From Y153 to Y159 the drone rack is a type-A drone rack, which is replaced by a type-G drone rack (no change in BPV) in Y160. The plus refit was available beginning in Y165 and was common by Y171. The AWR refit was available in Y170, and virtually all ships had it by Y174. The ship received the drone rack refit in Y175.

SSD and counter are in *Module M*.

Known names: Retained the names of the galactic survey cruisers converted to this use.

ADDITIONAL FEDERATION PODS

A variety of pods were created for the tug.

Pods cannot be docked back-to-back unless they are inactive due to the power connections. They can only be docked back-to-front, e.g., front of the second pod is docked to the back of the first pod. Any FA weapons on the second pod would be blocked and unable to fire unless the pod were dropped. Note that some pods may have shuttle hatches blocked by the presence of another pod.

Pods never had official names.

Generic pod counters for separated pods are in *Basic Set*.

(R2.52) REPAIR POD (P-R): Designed to turn a tug (R2.8) or light tactical transport (R2.38) into a mobile repair facility, this pod includes repair shops and a spare parts stockpile.

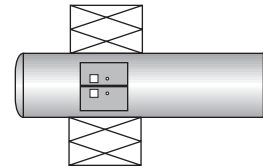

If attached to a tug or light tactical transport, the cargo and repair boxes are destroyed by “rear” hull damage points; they are also still destroyed by “cargo” damage points; the hull boxes on the tug or light tactical transport are considered “forward” hull in this case. See (R2.47) when attached to a priority transport; see (R2.48) when attached to a VIP transport; see (R2.151) when attached to a battle frigate transport.

Weight: This is a single-weight pod with a towing cost of 0.3333.

The SSD is on the Federation pods sheet in *Module R2*. An SSD of this pod being carried by a Federation tug (R2.8) is in *Module R2*.

(R2.53) TROOP TRANSPORT POD (P-T): Considerably less well appointed than a starliner pod (R2.9), the troop transport pod has a sublight movement capability and its own shields (five boxes each) which can be combined with the tug carrying it.

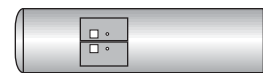

If attached to a tug (R2.8) or light tactical transport (R2.38), the cargo boxes are destroyed by “rear” hull damage points; they are also still destroyed by cargo damage points; the hull boxes on the tug or light tactical transport are considered “forward” hull in this case. Barracks boxes are always destroyed by either “forward” hull or “rear” hull damage points. See (R2.47) when attached to a priority transport; see (R2.48) when attached to a VIP transport; see (R2.151) when attached to a battle frigate transport.

Weight: This is a single-weight pod with a towing cost of 0.3333.

Operation: The shields of this pod are combined with the shields of the tug while it is attached. This pod is capable of independent operation as a sublight ship in its own right. The impulse engines of this pod cannot be used for movement if another pod is docked behind it.

Landing force: 54 boarding parties (D7.0), two commando teams (D15.84), six heavy-weapons squads (D15.81), and four ground combat vehicles (D15.81). This is roughly two battalions of troops (R2.M1) and is included in the ship’s BPV.

Shuttles: Two ground assault shuttles (R1.F4) and one heavy transport shuttle (R1.F5); these shuttles are included in the ship’s BPV.

Seeking weapons: When detached, this pod can control a number of seeking weapons equal to half its sensor rating (F3.211). This control rating is not added to the tug while the pod is attached.

This pod can use the gravity landing system (P2.432).

The SSD is on the Federation pods sheet in *Module R2*.

(R2.54) SELF-DEFENSE POD (P-SD): Introduced during the General War, the self-defense pod (like those of other empires) traded some cargo capacity for slightly improved self-defense.

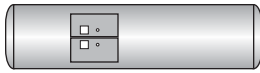

If attached to a tug (R2.8) or light tactical transport (R2.38), the cargo boxes are destroyed by “rear” hull damage points; they are also still destroyed by “cargo” damage points; the hull boxes on the tug or light tactical transport are considered “forward” hull in this case. See (R2.47) when attached to a priority transport; see (R2.48) when attached to a VIP transport; see (R2.151) when attached to a battle frigate transport.

Weight: This is a single-weight pod with a towing cost of 0.3333.

The SSD is on the Federation pods sheet in *Module R2*.

FEDERATION IMPROVED TECHNOLOGY SHIP

(R2.55) ADVANCED TECHNOLOGY COMMAND CRUISER (CX): In Y181, the command cruiser NCC-1749 *Vincennes* was converted to use new technology designed to improve its combat power.

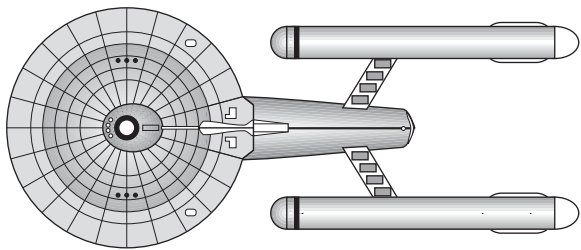

The experiment was only partly successful, but led to production of 12 more ships of this type, one every year until Y193, after which production increased. Production of battlecruisers (R2.33) was eventually terminated when the advanced technology design proved itself.

These ships, being more powerful than heavy cruisers (R2.4), formed the core of battle groups during the final days of the General War and during the Andromedan War.

The advanced technology command cruiser is a variant of the heavy cruiser (R2.4). The advanced technology heavy fighter carrier (R2.212) is a variant of this ship. The advanced technology galactic survey cruiser (R2.204) and advanced technology strike cruiser (R2.207) are built on drastically modified advanced technology command cruiser hulls.

The advanced technology command cruiser is a “first generation X-ship,” see (X0.0).

Deployment: See (S8.48) for deployment restrictions and conditions.

Warp pack: The two box center warp engine in the saucer can be used to generate power but cannot be used to generate movement points unless the saucer has been separated: (G12.102) and (G12.214).

Seeking weapons: The advanced technology command cruiser can control a number of seeking weapons equal to double its sensor rating (XF3.2) and has X-aegis (XD13.0).

Refits: None.

SSD and counters are provided in *Module X1*. The SSD in *Module X1* replaces the SSD published in *Advanced Missions*. (Later editions of *Advanced Missions* include the corrected SSD.)

Known names: As these ships were revolutionary, they were named for battles in various revolutions: NCC-1749 *Vincennes*, NCC-1771 *Revolution*, NCC-1772 *Paris Commune*, NCC-1773 *Ayacucho*, NCC-1774 *Long March*, NCC-1775 *Krasny Barikaddy*, NCC-1776 *Bunker Hill* (which led the Federation fleet in Operation Unity), NCC-1777 *Dien*

Bien Phu, NCC-1778 *Managua*, NCC-1779 *Alamo*, NCC-1780 *Cinco De Mayo*, NCC-1781 *Cowpens*, NCC-1782 *Masada*, NCC-1701A *Enterprise*.

NOTE: This information is duplicated in (R2.201).

FEDERATION NEW LIGHT CRUISER VARIANTS

(R2.56) HEAVY FIGHTER TRANSPORT (NVH): While the Federation never built fast patrol ships, it did operate heavy fighters. Two ships, *Ise* and *Hyuga*, were built as modified new strike carriers (R2.60) specifically to carry heavy fighters on mech-links (J1.561). The *Ise* carried A-20s while the *Hyuga* carried F-111s. Other heavy fighter transports were built or converted later.

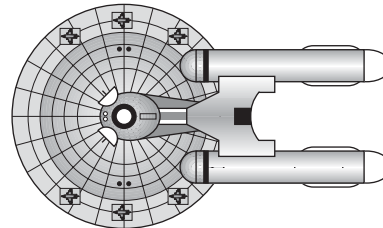

This ship has both 200 points of drone storage *and* the (R2.R5) storage. The cargo boxes hold the two spare fighters and all of the “free” (and any purchased) fighter pods (J11.0) and warp booster packs (J5.0), with the remaining space holding even more type-I drones (which do not count for drone percentage purposes).

The heavy fighter transport is a variant of the new light cruiser (R2.18).

Scout: It can use all scout functions (G24.0). Special sensors are destroyed by “torpedo” damage points. See (G24.35) when purchasing this unit as part of a battle force.

Carrier: This ship is a true carrier; see (J4.75), (J4.93), (J11.13), and (J15.22).

This ship has two shuttle bays: the one for its admin shuttles [(J2.0)/(R1.F1)], which operates normally, and the bay used by the heavy fighters. The heavy fighter bay is semi-external (J1.561) and each box includes a tractor beam (a total of six tractor beams); all six heavy fighters can be launched or landed (or some could be landing while others launch) in a single impulse or over multiple impulses. Mines can only be laid from the admin shuttle bay (M2.113).

Year	Escorts	Fighters
Y177-Y178	NAC, 1 (rarely 2) FFA or NAC, 1 (rarely 2) FRA (Rom)	6xA-20 or 6xF-111 or 6xF-101B
Y179-Y180	NAC, 1 (rarely 2) FFA or NAC, 1 (rarely 2) FRA (Rom)	6xA-20F or 6xF-111 or 6xF-101C
Y180-Y182	NAC, 1 (rarely 2) FFA or NAC, 1 (rarely 2) FRA (Rom) or None	6xA-20F or 6xF-111 or 6xF-101C
Y183+	NAC, DWA/FBE or None	6xA-20F or 6xF-111 or 6xF-101C

Carriers serving on the Romulan front usually operated with escorts especially designed for that front. These escorts were more difficult to build and maintain and were only used on that front. This combination is noted by the note “(Rom).” Production of the Romulan-front escort variants virtually ceased by the end of the General War. The heavy fighter transport was provided with the same escorts as the new strike carrier initially, but beginning in Y180 those carrying F-111s or F-101s often operated without escorts (S8.311).

Escort ready racks: The ready racks of the escorts were configured for F-18 (R2.F5) fighters. Escorts cannot have ready racks for heavy fighters; see (S8.318).

Seeking weapons: The heavy fighter transport can control a number of seeking weapons equal to its sensor rating (F3.21). See also (F3.213).

Refits: None.

SSD and counter are in *Module K*.

Known names: 1411 *Emperor Marcus Aurelius*, 1412 *General Joe Stilwell*, 1413 *Admiral Maarten Tromp*, 1414 *Admiral George Baron Anson*, 1415 *Field Marshal Viscount Allenby*, 1416 *Prime Minister Pierre Trudeau*, 1417 *Air Marshal Hugh Dowding*, 1418 *Field Marshal Count Helmuth von Moltke*, 1419 *Lord Protector Oliver Cromwell*, 1420 *Field Marshal Paul von Hindenburg*, 1421 *King Baldwin IV*, 1422 *Colonel Paul von Lettow-Vorbeck*, 1423 *Marshal Ferdinand Foch*, 1424 *Field Marshal Arthur Wellesley*, 1588 *Mogami*, 1589 *Ise*, 1590 *Hyuga*.

(R2.56A) NEW PF TENDER (NPF): If the Federation had ever built fast patrol ships, it is probable that something similar to the heavy fighter transport (R2.56) would have been used as its fast patrol ship tender. The new PF tender design is based on a conversion of the heavy fighter transport. It is unlikely that cruisers could have been spared [or old light cruisers (R2.5) remained available] for conversion to fast patrol ship tenders, although such conversions are on file and might be published.

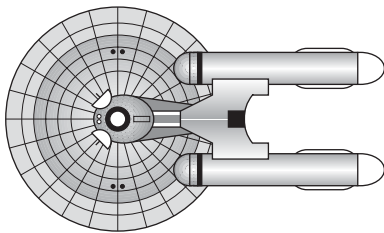

The new PF tender is a variant of the new light cruiser (R2.18).

Scout: It can use all scout functions (G24.0). Special sensors are destroyed by "torpedo" damage points. See (G24.35) when purchasing this unit as part of a battle force.

PF tender: This ship is a true PF tender (K2.0).

Seeking weapons: The new PF tender can control a number of seeking weapons equal to its sensor rating (F3.21). See also (F3.213).

Refits: None.

SSD and counter are in *Module K*.

This ship is conjectural.

Known Names: None, conjectural unbuilt variant.

ADDITIONAL FEDERATION PODS

A variety of pods were created for the tug.

Pods cannot be docked back-to-back unless they are inactive due to the power connections. They can only be docked back-to-front, e.g., front of the second pod is docked to the back of the first pod. Any FA weapons on the second pod would be blocked and unable to fire unless the pod were dropped. Note that some pods may have shuttle hatches blocked by the presence of another pod.

Pods never had official names.

Generic pod counters for separated pods are in *Basic Set*.

(R2.57) LIGHT CARRIER POD (P-CVL): This pod was "light" only in the sense that it was smaller than the "standard"

heavy carrier pod (R2.22); it was in fact the size of Klingon P-V7 heavy carrier pods (R3.67). It carries 12 fighters.

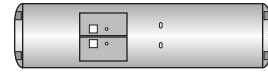

This pod was first deployed in Y167 on standard fleet tugs (R2.8) and included the earliest experimental use of phaser-Gs by the Federation. The pods on the Federation starting Order of Battle for *Federation & Empire* are of this type. With the advent of the heavy carrier pod in Y172, the light carrier pods were placed in storage or used to reinforce bases until light tactical transports (R2.58) were activated in Y174. (There are recorded cases of these pods being used on standard fleet tugs when all three heavy carrier pods were also in use, so presumably their lack of use on fleet tugs during Y172-Y174 was purely a matter of being last in line.)

Only four of a light tactical transport's cargo boxes can be used under (R2.R5) due to the configuration of the cargo bay.

Carrier: This pod is a true carrier; see (J4.75), (J4.93), (J11.13), and (J15.22).

This pod has two shuttle bays, and each bay has two shuttle hatches: one in the front and one in the back; i.e., they are tunnel decks (J1.58). These hatches allow the pod to launch or land two shuttles per impulse, or launch or land up to four shuttles in any single impulse or every other impulse, or any combination not to exceed four shuttles in any two impulse period, or exceeding the ability of the given bay. This launching and landing rate is halved if a second pod of any type is docked before or behind this pod. Transfers between the two bays are possible by (J1.592), one fighter per turn. Mines cannot be laid from fighter bays (M2.113). Note that the tug will have its own shuttle bay giving the tug and pod combination a total of three shuttle bays. An additional pod might have its own shuttle bay.

When carried by a fleet tug, the escorts and fighters were:

Year	Escorts	Fighters
Y167-Y174	DE, FFE	12xF-4 or 12xF-8
Y173-Y175	DE/NEC, FFE	12xF-18
Y176-Y177	NEA/DEA/NAC, FFA	12xF-18 or 6xF-101A
Y177-Y178	NEA/DEA/NAC, FFA	12xF-18 or 6xF-101B
Y179-Y180	NEA/DEA/NAC, FFA/DWA	12xF-18B or 6xF-101B
Y181-Y185	NEA/DEA/NAC, FFA/DWA/FBE	12xF-18B+ or 6xF-101C
Y186+	NAC, FFA/DWA/FBE	12xF-18C or 6xF-101C

When carried by a light tactical transport, the escorts and fighters were:

Year	Escorts†	Fighters
Y174-Y175	NEC, FFE	12xF-4 or 12xF-8
Y176-Y178	NEA/NAC, FFA	12xF-18 or 6xF-101A
Y178-Y181	NEA/NAC, FFA	12xF-18B or 6xF-101B
Y181-Y185	NEA/DEA/NAC, FFA	12xF-18B+ or 6xF-101C
Y186+	NAC, FFA/DWA/FBE	12xF-18C or 6xF-101C

†LTVs (light tactical transport with light carrier pod) were always last in line for escorts and would often have to make do with two escort frigates (R2.41)/aegis frigates (R2.41A) due to a shortage of new escort cruisers (R2.20)/new aegis cruisers (R2.59). The last obsolescent new aegis escorts (R2.20A) escorted LTVs.

Escort ready racks: The ready racks of the escorts were configured for F-8 (R2.F7) fighters in Y167-Y175 if the ship were operating that type of fighter, and for F-4 (R2.F6) fighters in Y167-Y175 if it were operating that type of fighter, and for F-18 (R2.F5) fighters from Y173 on if the ship were operating that type of fighter. Escorts cannot have ready racks for heavy fighters; see (S8.318).

If attached to a tug (R2.8) or light tactical transport (R2.38), the hull boxes on the tug or light tactical transport are considered “forward” hull. See (R2.47) when attached to a priority transport; see (R2.48) when attached to a VIP transport; see (R2.151) when attached to a battle frigate transport.

Weight: This is a single-weight pod with a towing cost of 0.3333.

Operation: The shields of this pod are combined with the shields of the tug while it is attached. While attached, this pod increases the tug’s or light tactical transport’s command rating by one; a second pod of any type does not further increase the command rating. This pod is capable of independent operation as a sublight ship in its own right. The impulse engines of this pod cannot be used for movement if another pod is docked behind it.

Seeking weapons: The light carrier pod can control seeking weapons equal to its sensor rating (F3.21). When combined with a refitted tug, the combination can control a number of seeking weapons equal to double the sensor rating (F3.212). A second pod of any type would not further increase the control rating. (With an unrefitted tug, the combination could control seeking weapons equal to the pod’s sensor rating; the tug’s “minimal” control ability would be shut down in favor of the pod’s superior system.)

Refits: The Y175 refit was installed in Y175.

Designed by Steven Wilcox.

The SSD is on the Federation pods SSD in *Module R2*. An SSD and counter for the LTV (light tactical transport with light carrier pod) are in *Module R2*.

(R2.58) LIGHT BATTLE POD (P-LB): As with the light carrier pod (R2.57), the term “light” was only in comparison to the heavier battle pod (R2.10) designed for the standard fleet tug (R2.8). This pod is very powerful and turns the light tactical transport (R2.38) into a more than fully capable cruiser.

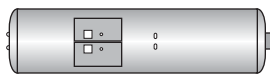

When this pod is carried on a fleet tug, it is designated BTL (battle tug, light); the BTL+ refers to a plus refit for the tug.

If detached, the five hull boxes can be destroyed by either “forward” or “rear” hull damage points. If attached to a tug (R2.8) or light tactical transport (R2.38), the hull boxes are destroyed by “rear” hull damage points; the hull boxes on the tug or light tactical transport are considered “forward” hull. See (R2.47) when attached to a priority transport; see (R2.48) when attached to a VIP transport; see (R2.151) when attached to a battle frigate transport.

Weight: This is a single-weight pod with a towing cost of 0.3333.

Operation: The shields of this pod are combined with the shields of the tug while it is attached. While attached, this pod increases the tug’s or light tactical transport’s command rating

by two; a second pod of any type does not further increase the command rating; the command rating increase of this pod takes precedence over the increase provided by a carrier pod (R2.22), CVL pod (R2.57), or scout pod (R2.135). If this pod is docked behind another pod, its photon torpedoes are blocked and cannot be fired; its drone racks and phasers operate normally. This pod is capable of independent operation as a sublight ship in its own right. The impulse engines of this pod cannot be used for movement if another pod is docked behind it.

Seeking weapons: The light battle pod can control seeking weapons equal to its sensor rating (F3.21). This pod’s seeking weapon control rating is not added to the tug or to any other pod carried by the tug. (With an unrefitted tug, the combination could control seeking weapons equal to the pod’s sensor rating; the tug’s “minimal” control ability would be shut down in favor of the pod’s superior system.)

Refits: The Y175 refit was installed in Y175.

Design by Randy Fagan.

The SSD is on the Federation pods SSD in *Module R2*. An SSD and counter for the LBT (light tactical transport with light battle pod) light battle transport is in *Module R2*.

FEDERATION NEW LIGHT CRUISER VARIANTS

(R2.59) NEW AEGIS CRUISER (NAC): Finding that its new light cruiser (R2.18)-based carrier groups lacked sufficient direct firepower and desiring a heavier replacement for the escort light cruiser (R2.15), the Federation developed a second escort variant of the new light cruiser. Unlike its predecessor, the new escort cruiser, this ship retained two of the new light cruiser’s photon tubes. New aegis cruisers replaced escort light cruisers in heavy carrier (R2.13) groups and destroyer escorts (R2.14) in strike carrier (R2.29) groups.

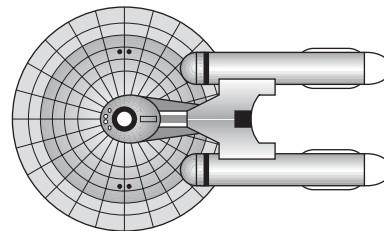

This ship has two ready racks (J4.89) and deck crews (J4.81) to support the fighters from the carrier it is escorting. The deck crews are not in addition to the deck crews provided by (J4.814), but replace them, representing their being retrained to service and arm fighters. See (R2.R5).

The new aegis cruiser is a variant of the new light cruiser (R2.18). No variant of this ship existed for the Romulan border.

Seeking weapons: The new aegis cruiser can control a number of seeking weapons equal to double its sensor rating (F3.212) and has aegis (D13.0). See also (J15.332).

Refits: The plus and Y175 refits are included in the design.

Designed by Mike West.

SSD and counter are in *Module R2*.

Known names: 1559 *Triton*, 1560 *Amazon*, 1561 *Brazen*, 1562 *Ranger*, 1564 *Hoerner*, 1565 *Chernavin*, 1566 *Soult*, 1567 *Henry H. Arnold*, 1568 *Carl Spaatz*, 1569 *Kenneth Walker*, 1570 *Chuck Yeager*.

(R2.60) NEW STRIKE CARRIER (NVS): After its initial combat performance, it was obvious that that the new light carrier (R2.35) lacked sufficient punch to support its fighter group. To remedy this problem, the Federation produced the

new strike carrier in Y175. Based on the new light cruiser (R2.18), this ship retained two of the new light cruiser's photons [as did its new escort ship, the new aegis cruiser (R2.59)].

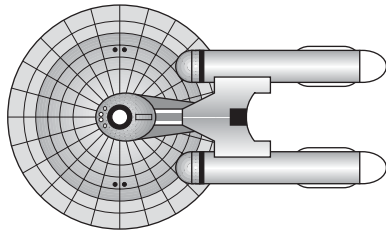

The new strike carrier is a variant of the new light cruiser (R2.18).

Carrier: This ship is a true carrier; see (J4.75), (J4.93), (J11.13), and (J15.22).

This ship has one shuttle bay.

Year	Escorts	Fighters
Y175	NAC, 1 (rarely 2) FFA or NAC, 1 (rarely 2) FFR (Rom)	12xF-18
Y176	NAC, 1 (rarely 2) FFA or NAC, 1 (rarely 2) FRA (Rom)	12xF-18 or 6xF-101A
Y177-Y178	NAC, 1 (rarely 2) FFA or NAC, 1 (rarely 2) FRA (Rom)	12xF-18B or 6xF-101B
Y179-Y180	NAC, 1 (rarely 2) FFA or NAC, 1 (rarely 2) FRA (Rom)	12xF-18B or 6xF-101C
Y180-Y183	NAC, 1 (rarely 2) FFA or NAC, DWA/FBE or NAC, 1 (rarely 2) FRA or NAC, DWR (Rom)	12xF-18B+ or 6xF-101C
Y183+	NAC, DWA/FBE	12xF-18C or 6xF-101C

Carriers serving on the Romulan front usually operated with escorts especially designed for that front. These escorts were more difficult to build and maintain and were only used on that front. This combination is noted by the note "(Rom)." Production of the Romulan-front escort variants virtually ceased by the end of the General War. The new strike carrier never carried F-14s (R2.F1), F-15s (R2.F10), or a SWAC [(J9.0)/(R2.F3)].

Escort ready racks: The ready racks of the escorts were configured for F-18 (R2.F5) fighters if the ship were operating that type of fighter. Escorts cannot have ready racks for heavy fighters; see (S8.318).

Seeking weapons: The new strike carrier can control a number of seeking weapons equal to double its sensor rating (F3.212).

Refits: The plus and Y175 refits are included in the design.

Designed by Mike West.

SSD and counter are in *Module R2*.

Known names: 1595 *Hermes* (converted to NCV), 1596 *Vikrant* (converted to NCV), 1597 *Clemenceau*, 1598 *Garibaldi*, 1599 *Tblisi*.

FEDERATION DREADNOUGHT

(R2.61) GUIDED WEAPONS DREADNOUGHT (DNG): Finding their dreadnought (R2.2) increasingly outgunned by the dreadnoughts of other empires, and finding the dreadnought+ (R2.17) upgrade an inadequate solution, the Federation undertook a re-evaluation of the original design and produced this vastly improved ship, which entered service in Y175. As noted on the SSD, a larger rear hull and a reduction of laboratory capacity provided space for the additional systems. Lowering the side engines to the level of the rear hull improved the side phaser arcs and increased the frame strength enough to improve the turn mode. The designation DNG came from the addition of drone racks (BPV includes the double reloads from the Y175 drone rack refit); adding drone racks required reducing the shuttle capacity. New construction dreadnoughts starting in Y175 were of this type, and several older dreadnoughts and dreadnought+ ships were converted to guided weapons dreadnoughts.

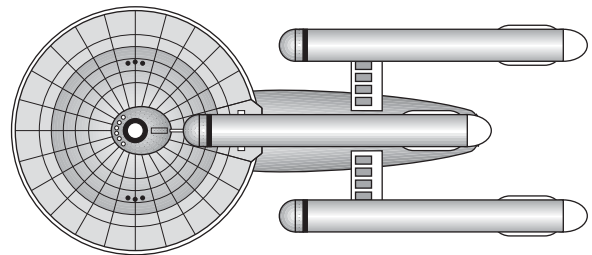

The guided weapons dreadnought is a variant of the dreadnought (R2.2), but the changes were sufficiently extreme that it is considered a new class. Variants include the heavy dreadnought (R2.90), plasma dreadnought (R2.92), and dreadnought heavy carrier (R2.A29).

Seeking weapons: The guided weapons dreadnought can control a number of seeking weapons equal to its sensor rating (F3.21).

Refits: The plus and Y175 refits are included in the design.

This ship was designed by the Committee after studying numerous proposals for Federation dreadnought upgrades. *Ray Olesen* was instrumental in gaining Committee approval for the improvements included.

SSD and counter are in *Module R2*.

Known names: dreadnoughts and dreadnought+s converted to this design retained their original names; new construction ships included 2120 *Entente* (converted to DNF), 2121 *Trusteeship* (converted to DNH), 2122 *Unification*, 2123 *Solidarity*, 2124 *Stellar Congruity*, 2125 *Stellar Fraternity*.

FEDERATION CARRIER ESCORTS

(R2.62) DESTROYER ESCORT-R (DER): A variant of the destroyer escort (R2.14) for use on the Romulan border. The destroyer escort-R has the same capabilities as the destroyer escort. These escorts were more difficult to build and maintain and were only used on that front. Their use is noted by the note "(Rom)" in the escorts column of carrier tables in ship descriptions. Production of the Romulan-front escort variants virtually ceased by the end of the General War.

The first two (*Kenney* and *Kincaid*) were built as escorts for *MacArthur*.

This ship has two ready racks (J4.89) and deck crews (J4.81) to support the fighters from the carrier it is escorting. The deck crews are not in addition to the deck crews provided by (J4.814), but replace them, representing their being retrained to service and arm fighters. See (R2.R5).

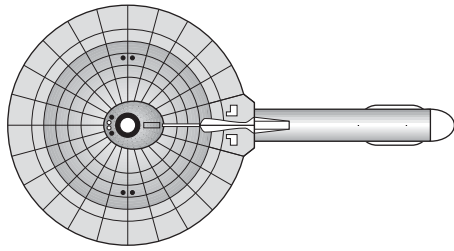

The destroyer escort-R is a variant of the destroyer (R2.6).

Seeking weapons: The destroyer escort-R can control a number of seeking weapons equal to double its sensor rating (F3.212) and has limited aegis (D13.4). See also (J15.332).

Refits: Full aegis and the drone rack refit were installed in Y175, resulting in the aegis destroyer-R (R2.62A).

Suggested by *Thomas A. Lachac*.

SSD and counters are in *Module R2*.

Known names: 0558 *Oldendorf*, 0572 *Kenney*, 0573 *Kincaid*.

(R2.62A) AEGIS DESTROYER-R (DAR): In Y175, all surviving destroyer escort-R class ships were modified to use the full aegis system (D13.0) and redesignated aegis destroyer-R. These escorts were more difficult to build and maintain and were only used on that front. Their use is noted by the note "(Rom)" in the escorts column of carrier tables in ship descriptions. Production of the Romulan-front escort variants virtually ceased by the end of the General War.

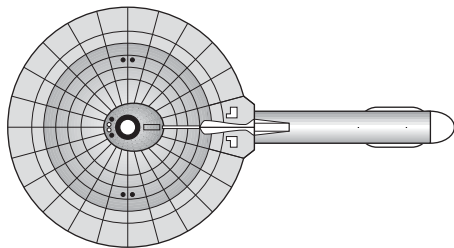

This ship has two ready racks (J4.89) and deck crews (J4.81) to support the fighters from the carrier it is escorting. The deck crews are not in addition to the deck crews provided by (J4.814), but replace them, representing their being retrained to service and arm fighters. See (R2.R5).

The aegis destroyer-R is a variant of the destroyer (R2.6).

Seeking weapons: The aegis destroyer-R can control a number of seeking weapons equal to double its sensor rating (F3.212) and has limited aegis (D13.4). See also (J15.332).

Refits: The drone rack refit was included as part of the aegis destroyer-R design.

The SSD is combined with that of the destroyer escort-R in *Module R2*. Use the destroyer escort-R counters in *Module R2*.

Known names: These were refits of the destroyer escort-R (R2.62) and did not change any names.

(R2.63) NEW ESCORT CRUISER-R (NER): This is the version of the new escort cruiser (R2.20) carrier escort (with the same capabilities) for duty on the Romulan front; only one (*Wainwright*) was built as an escort for *MacArthur* to replace the lost *Patton*.

This ship has two ready racks (J4.89) and deck crews (J4.81) to support the fighters from the carrier it is escorting. The deck crews are not in addition to the deck crews provided by (J4.814), but replace them, representing their being retrained to service and arm fighters. See (R2.R5).

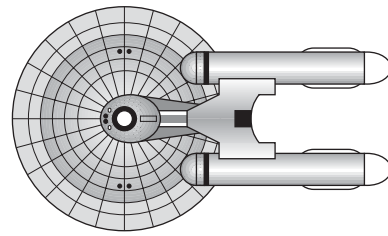

The new escort cruiser-R is a variant of the new light cruiser (R2.18).

Seeking weapons: The new escort cruiser-R can control a number of seeking weapons equal to double its sensor rating (F3.212) and has full aegis (D13.0). See also (J15.332).

Refits: The Y175 refit was included in the design. This ship did not get the shield refit of the contemporary new aegis cruisers.

Based on a suggestion by *David Porter*.

SSD and counter are in *Module R2*.

Known names: 1545 *Wainwright*.

FEDERATION HEAVY BATTLECRUISER VARIANT

(R2.64) HEAVY BATTLECRUISER NEW JERSEY (BCJ): The final version of the original battlecruiser (R2.33) design intended for improved firepower, particularly in base assaults. (Some sources indicate that the *New Jersey* was intended to lead the assault on the Klinshai defenses.)

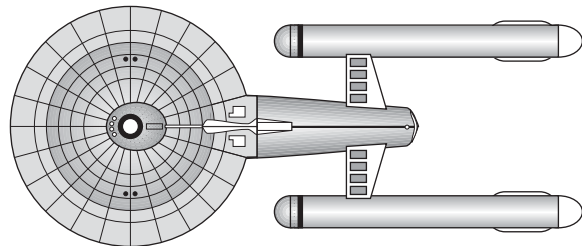

The *New Jersey* was originally ordered as the fourth BCG (*Kirov* class); the plans were changed as construction began to have photons in place of the dorsal drone racks. Completed in Y186, the *New Jersey* was too late for service in the General War. With the arrival of the advanced technology ships, the class was considered obsolescent, and work on the eighth ship (intended to be the fourth *Bismarck* class) proceeded slowly as a bargaining chip in post-General War negotiations.

When the *New Jersey* proved devastatingly effective against the Andromedans, the final (eighth) heavy battlecruiser was completed in Y189 to the design of the *New Jersey* and renamed *Montana*. Further heavy battlecruisers were not built because of the emphasis on improved technology cruisers (R2.55); the *Montana* might not have been finished if she had not been in an advanced state of construction.

These ships carry three sets of reloads for their drone racks (i.e., the Y175 refit was incorporated into their designs from the first).

The *New Jersey*-class battlecruiser is a variant of the *Kirov*-class battlecruiser (R2.33).

Shock: A *New Jersey*-class battlecruiser must roll for shock (D23.22) if it fires five or more photon torpedoes during any period of 16 consecutive impulses. In addition, the *New Jersey*-class battlecruiser receives one Shock Effect Point (D23.21) every time it fires photon torpedoes E or F as an overloaded photon (two shock effect points total if both are

fired); this does not increase the die roll for purposes of (D23.222).

Warp pack: The two box center warp engine in the saucer can be used to generate power but cannot be used to generate movement points unless the saucer has been separated: (G12.102) and (G12.214).

Seeking weapons: The *New Jersey*-class battlecruiser can control a number of seeking weapons equal to its sensor rating (F3.21).

Refits: The plus, AWR, and Y175 refits were included in the design.

SSD and counter are in *Module R2*.

Known names: 1755 *New Jersey*, 1756 *Thunderchild*, 1757 *Nevada* (never built), 1765 *Montana*.

FEDERATION WAR DESTROYER AND VARIANTS

(R2.65) WAR DESTROYER (DW): The Federation new light cruiser (R2.18) class had effectively taken over the shipyards that originally produced the destroyer (R2.6) class, ending most destroyer production before the Federation entered the General War. This left a gap between the new light cruiser and the FFG frigate (R2.26) which was covered by the steadily dwindling force of destroyers and light cruisers (R2.5). By Y174 the shortage of these classes was becoming acute, particularly with so many of them being converted to support roles, such as scouts, carrier escorts, and minesweepers.

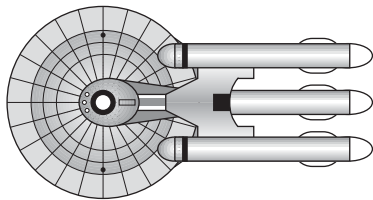

Recognizing the need for a war destroyer class, the Federation commissioned two competing designs, the war destroyer and the battle frigate (R2.50). The war destroyer was eventually selected as it was larger and more capable than the battle frigate. The first prototype (*Humberto Ortega*) appeared in Y175, and production began in Y176 with the *Enrique Bermudez*. Others included the *Savimbi*, *Slovo*, and *Saddam*.

This is a base hull. Variants include the war destroyer scout (R2.66), war drone destroyer (R2.67), war destroyer escort (R2.68), war destroyer transport (R2.69), war destroyer minesweeper (R2.70), command war destroyer (R2.71), commando war destroyer (R2.81), mobile carrier (R2.83), heavy carrier resupply ship (R2.102), light attack carrier (R2.140), war destroyer escort-R (R2.141), and plasma war destroyer (R2.A40). The heavy war destroyer (R2.85) and advanced technology war destroyer (R2.209) were built on drastically modified war destroyer hulls.

Seeking weapons: The war destroyer can control a number of seeking weapons equal to its sensor rating (F3.21).

Refits: None.

SSD and counters are in *Module R2*.

Known names: 0700 *Humberto Ortega* (Nicaragua), 0701 *Nelson Mandela* (South Africa), 0702 *Barzani* (Iraqi Kurdistan), 0703 *Khalid bin Sultan* (Saudi Arabia), 0704 *Zamora* (El Salvador FMLN), 0705 *Gemayal* (Lebanon), 0706 *Vo Nguyen Giap*, 0707 *Ahmed Jabril* (Palestine), 0708 *Manuel Perez* (Colombia ELN), 0709 *Pena Ben Ben* (Angola UNITA), 0710 *Walid Jumblait* (Lebanon Druze), 0711 *Mohammed Aidid* (Somalia), 0712 *Eduardo Dos Santos* (Angola Government), 0713 *Robert Mugabe* (Zimbabwe),

0714 *Xanana Gusmao* (East Timor Rebels), 0715 *Ali Mahdi Mohamed* (Somalia), 0716 *Fadlallah* (Lebanon Hezbollah), 0717 *John Garang* (Sudan SPLA), 0718 *Villalobos* (El Salvador FMLN), 0719 *Zviad Gamsakhurdia* (Georgia), 0720 *Premadasa* (Sri Lanka), 0721 *Turabi* (Kashmir), 0722 *Ardzinba* (Abkhazia), 0723 *Hun Sen* (Cambodia), 0724 *Tongogara* (Zimbabwe), 0725 *Enrique Bermudez* (Nicaraguan Contras), 0726 *Holden Roberto* (Angola), 0727 *Taylor* (Liberia NPFL), 0728 *Buthelezi* (Zulu), 0729 *Gringo Honasan* (Philippines), 0730 *Pundy* (Gencon), 0731 *Carroll* (Origins), 0732 *Laurent Nkunda* (Rwanda), 0732 *Eamonn De Valera* (Ireland), 0733 *Kim Jong il* (Korea), 0734 *Chaudhry* (Kashmir), 0735 *Talabani* (Iraqi Kurdistan), 0736 *Hersi Morgan* (Somalia), 0737 *Chissano* (Mozambique Frelimo), 0738 *Abamail Guzman* (Shining Path), 0739 *Iskandarov* (Tadjikistan), 0740 *Joe Slovo* (South Africa), 0741 *Omar Jess* (Somalia), 0742 *Chilingutilla* (Angola UNITA), 0743 *Jonas Savimbi* (Angola UNITA), 0744 *Haile Mengistu* (Ethiopia), 0745 *Afonso Dhlakama* (Mozambique Renamo), 0746 *Dudayev* (Chechenya), 0747 *Abdul Gafur* (Arakan Burma), 0748 *Prince Johnson* (Liberia), 0749 *Nasrallah* (Lebanon Hezbollah), 0750 *Ocalan* (Kurdish PKK), 0751 *Prabhakaran* (LTTE Sri Lanka), 0752 *Rabin* (Israel), 0753 *Ibrahim Rugova* (Kosovo), 0754 *Sangak Safarov* (Tadjikistan), 0755 *Saddam* (Iraq), 0756 *Y Peng Ayun* (Montagnard), 0757 *Kenyatta*, 0758 *Zarqawi*, 0759 *Ariel Sharon* (Israel), 0760 *Foday Sankoh* (Sierra Leone rebels), 0761 *Haile Selassie*, 0763 *Leonard Wood*, 1201 *Roland*, 1202 *William T Sherman*, 1203 *Nobunaga*, 1204 *Toussaint Louverture*, 1206 *Spitfire*, 1207 *Cardondelet*, 1208 *Hurricane*, 1212 *Phil Kearny*, 1213 *Turner Ashby*, 1214 *Kutusov*, 1215 *Wiquini* (Roman Nose, Chief of the Cheyenne), 1216 *Chickamauga*, 1217 *Aetius*.

(R2.66) WAR DESTROYER SCOUT (DWS): The Federation had an electronic warfare superiority at the time the Klingons invaded due to the powerful scout (R2.7) and galactic survey cruiser (R2.16) classes, but as the General War dragged on, more and more of the scouts in service were of the new scout cruiser (R2.19) and frigate scout (R2.44) designs. The war destroyer scout was designed to supplement these classes (and basically replace the inadequate frigate scout).

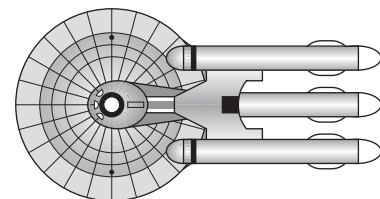

The war destroyer scout is a variant of the war destroyer (R2.65).

Scout: It can use all scout functions (G24.0). Special sensors are destroyed by "torpedo" damage points. See (G24.35) when purchasing this unit as part of a battle force.

Seeking weapons: The war destroyer scout can control a number of seeking weapons equal to its sensor rating (F3.21). See also (F3.213).

Refits: None.

SSD and counter are in *Module R2*.

Known names: 0881 *Sam Donaldson*, 0882 *Phil Donahue*, 0883 *Rush Limbaugh*, 0884 *George Will*, 0885 *David Brinkley*, 0886 *Peter Jennings*, 0887 *Vladimir Pozner*, 0888 *Tom Brokaw*, 0889 *Rather & Chung*, 0890 *Regis Philbin*, 1205 *Piri Reis*.

(R2.67) WAR DRONE DESTROYER (DWD): A variant of the war destroyer designed for drone support, this was not

designed as a bombardment platform and did not have the facilities for that mission. It was used in direct combat and was considered operationally interchangeable with the standard war destroyer (R2.65).

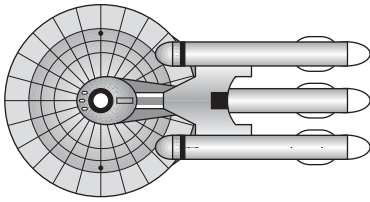

The war drone destroyer is a variant of the war destroyer (R2.65).

Deployment: See (S8.47) for deployment restrictions and conditions.

Seeking weapons: The war drone destroyer can control a number of seeking weapons equal to double its sensor rating (F3.212).

Refits: None.

SSD and counter are in *Module R2*.

Known names: 0831 *Massoud*, 0832 *Hekmatyar*, 0833 *Yunis Khalis*, 0834 *Najibullah*, 0835 *Rabbani*, 0836 *Mojadeddi*, 0837 *Dostam*, 0838 *Taliban*, 0839 *Dadullah*.

(R2.68) WAR DESTROYER ESCORT (DWA): Designed to serve in carrier groups, war destroyer escorts initially replaced the dwindling number of aegis destroyers (R2.23) and then went on to replace many aegis frigates (R2.41A) and even some of the new aegis cruisers (R2.59).

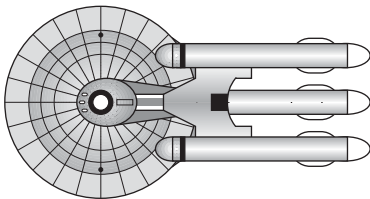

The escort variant of the war destroyer was built after the development of full aegis (D13.0), so there never was a limited aegis (D13.4) version. Players can experiment with this by using limited aegis and reducing the BPV by 10 points.

This ship has two ready racks (J4.89) and deck crews (J4.81) to support the fighters from the carrier it is escorting. The deck crews are not in addition to the deck crews provided by (J4.814), but replace them, representing their being retrained to service and arm fighters. See (R2.R5).

The war destroyer escort is a variant of the war destroyer (R2.65). A variant of this ship existed for the Romulan border; see (R2.141).

Seeking weapons: The war destroyer escort can control a number of seeking weapons equal to double its sensor rating (F3.21) and has full aegis (D13.0). See also (J15.332).

Refits: None.

SSD and counters are in *Module R2*.

Known names: 0851 *Presidents Bush*, 0852 *President Yeltsin*, 0853 *President Gorbachev*, 0854 *President Reagan*, 0855 *Prime Minister Thatcher*, 0856 *President Nixon*, 0857 *President Mitterand*, 0858 *President Kravchuk*, 0859 *Prime Minister Landsbergis*, 0860 *President Marcos*, 0861 *President Galtieri*, 0862 *President Hillary Rodham Clinton*, 0863 *President Assad*, 0864 *President Ramos*, 0865 *Chairman Shevardnadze*, 0866 *President Cristiani*, 0867 *King Sihanouk*, 0868 *Prime Minister Shamir*, 0869 *President Ulysses S Grant*, 0870 *President John F Kennedy*, 0871 *President Abraham Lincoln*, 1209 *Thunderbolt*, 1210 *Mustang*, 1211 *Wallace McIntosh*.

(R2.69) WAR DESTROYER TRANSPORT (DWT): Small transports built on warship hulls were extensively used by all empires for priority resupply missions, not least carrying fighters and expendable stores to carriers and other forward fleet elements. The war destroyer transport was built in limited numbers for missions considered too dangerous for the smaller priority transport (R2.47).

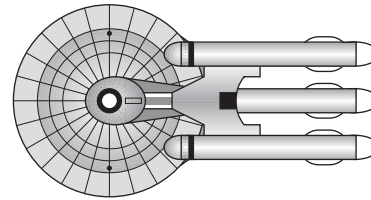

Because of the arrangement of the ship's engines, it was impossible to adapt the ship into a true "strategic transport" like the priority transport. The ship cannot operate as a tug for any purpose.

One heavy transport shuttle (R1.F5) is standard equipment.

The war destroyer transport is a variant of the war destroyer (R2.65).

Seeking weapons: The war destroyer transport can control a number of seeking weapons equal to its sensor rating (F3.21).

Refits: None.

SSD and counter are in *Module R2*.

Known names: None known.

(R2.70) WAR DESTROYER MINESWEEPER (DWM): As the General War dragged on, minefields became more and more extensive, and additional minesweepers were needed. Completion of some war destroyers to this minesweeper design provided additional numbers and tactical flexibility.

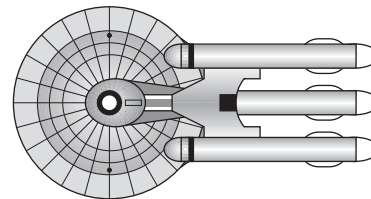

This ship carries two minesweeping shuttles (R1.F2)/(M8.3) (which are included in the BPV).

The war destroyer minesweeper is a variant of the war destroyer (R2.65).

This ship is a true minesweeper (M2.45); see also (M8.0).

Seeking weapons: The war destroyer minesweeper can control a number of seeking weapons equal to its sensor rating (F3.21).

Refits: None.

SSD and counter are in *Module R2*.

Known names: 0891 *Donald Trump*, 0892 *T. Boone Pickens*, 0893 *Ivan Boesky*, 0894 *Alfred Nobel*.

(R2.71) COMMAND WAR DESTROYER (DWC): This heavier (and more expensive) war destroyer variant was built for duty as a squadron leader. It never amounted to more than 20% of total war destroyer production, but as many war destroyers were diverted into escort, scout, and other support missions, there was usually one command war destroyer in any flotilla of three war destroyers. Note that the command rating of this ship is no higher than other war destroyers.

The command war destroyer is a variant of the war destroyer (R2.65).

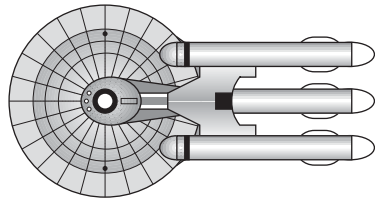

Seeking weapons: The command war destroyer can control a number of seeking weapons equal to its sensor rating (F3.21).

Refits: None.

SSD and counters are in *Module R2*.

Known names: 0801 *Menachem Begin* (Israel), 0802 *Yassar Arafat* (Palestine), 0803 *Tudjman* (Croatia), 0804 *Khieu Samphan* (Khmer Rouge), 0805 *Tony Blair*.

CONJECTURAL FEDERATION POD

A variety of pods were created for the tug.

Pods cannot be docked back-to-back unless they are inactive due to the power connections. They can only be docked back-to-front, e.g., front of the second pod is docked to the back of the first pod. Any FA weapons on the second pod would be blocked and unable to fire unless the pod were dropped. Note that some pods may have shuttle hatches blocked by the presence of another pod.

Pods never had official names.

Generic pod counters for separated pods are in *Basic Set*.

(R2.72) PF TENDER POD (P-PF): The Federation never built or even planned to use fast patrol ships. If they had, they probably would have deployed a pod similar to this one to enable their tugs (R2.8) [and light tactical transports (R2.38)] to operate as fast patrol ship tenders, or at least to transport replacement flotillas to front line tenders.

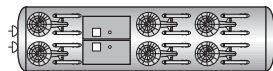

A fleet tug (R2.8) cannot operate this pod and a heavy fighter pod (R2.136) at the same time, but could operate this pod in conjunction with any other pod.

If attached to a tug (R2.8) or light tactical transport (R2.38), the cargo and repair boxes are destroyed by "rear" hull damage points; they are also still destroyed by "cargo" damage points; the hull boxes on the tug or light tactical transport are considered "forward" hull in this case. See (R2.47) when attached to a priority transport; see (R2.48) when attached to a VIP transport; see (R2.151) when attached to a battle frigate transport.

Scout: It can use all scout functions (G24.0) while attached to a tug or light tactical transport. Special sensors are destroyed by "phaser" damage points. See (G24.35) when purchasing this unit as part of a battle force.

PF tender: This ship is a true PF tender (K2.0).

Weight: This is a single-weight pod with a towing cost of 0.3333.

Seeking weapons: This pod has no intrinsic ability to control seeking weapons, but while attached to a tug or light tactical transport the combination can use (F3.213).

Refits: The Y175 refit was installed in Y175.

The SSD is on the Federation pods SSD in *Module R2*.

This pod is conjectural.

FEDERATION BATTLESHIP

(R2.73) BATTLESHIP (BB): The Federation counterpart to the Klingon B10 (R3.17) would doubtless have had equivalent weapons, i.e., eight photons FA and two RA, plus an assortment of phasers. The battleship uses a guided weapons dreadnought (R2.61) saucer, with almost all of the extra systems going into a greatly expanded rear hull.

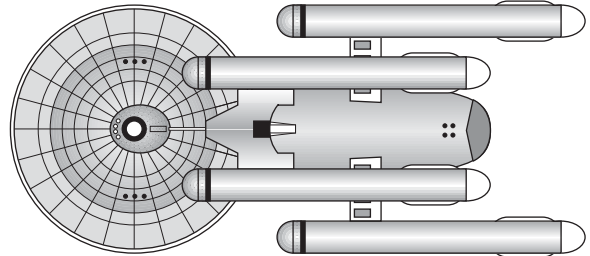

The inclusion of a half-squadron of F-15s (R2.F10) was somewhat radical, but matches the eight Z-Ys (R3.F4) on the B10. The hangar bay would not have been large enough for F-14s (R2.F1), and the ship would never carry a SWAC [(J9.0)/(R2.F3)]. There is no (J1.53) balcony.

The labs were spartan by pre-General War Federation standards, but match those on the guided weapons dreadnought and reflect wartime requirements. This was offset somewhat by the extra probe launcher. It was impossible to add more forward phasers, resulting in the unusual case of a Federation ship able to fire more phasers to the rear than the front.

The center warp engines are mounted on the saucer and would separate with it, should that be required. In the event of separation, the center engines become left and right and the forward hull becomes center hull.

This is a base hull. Variants include the battleship carrier (conjectural) (R2.93), stellar domination ship (conjectural) (R2.94), and stellar domination ship (conjectural) (R2.94A).

Carrier: This ship is a true carrier; see (J4.75), (J4.93), (J11.13), and (J15.22).

This ship has one shuttle bay.

Year	Escorts	Fighters
Y175-Y182	None	6xF-15
Y176	None	6xF-15 or 3xF-101A
Y177-Y178	None	6xF-15 or 3xF-101B
Y179-Y182	None	6xF-15 or 3xF-101C
Y183-Y184	None	6xF-15C or 3xF-101C
Y185+	None	6xF-15D or 3xF-101C

Seeking weapons: The battleship can control a number of seeking weapons equal to double its sensor rating (F3.212).

Refits: None.

Designed by Stephen V. Cole with comments from dozens of staff and playtesters and special thanks to Ray D Olesen.

SSD and counter are in *Module R5*.

This ship is conjectural.

Known names: 2151 *Ares*, 2152 *Mars*, 2153 *Nebu*, 2154 *Kali*, 2155 *Hachiman*, 2156 *Horus*, 2157 *Tyr*.

FEDERATION HEAVY BATTLECRUISER VARIANTS

(R2.74) BATTLE CARRIER (BCV): After the heavy carrier (R2.13) *MacArthur* was destroyed in Y181, the Federation ordered the next battlecruiser (R2.33) hull completed as a carrier. This became the *Shangri-La* and was completed in Y183. When the heavy carrier *Napoleon* was heavily damaged in Y183, the subsequent battlecruiser was completed as the battle carrier *Atlantis*. The design was significant as it sacrificed nothing from the basic battlecruiser design in the way of firepower or energy.

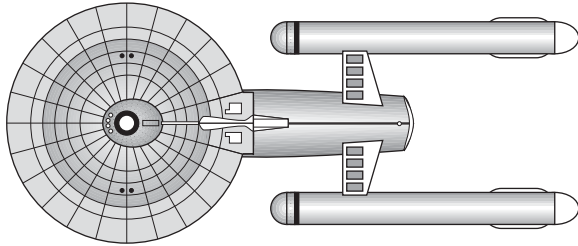

Both battle carriers had distinguished careers in the late General War years. The *Shangri-La* was known as the “ghost ship” because of its sudden appearances in various theaters. The Klingons thought (for most of Y183) that there was no such ship, simply a clever Federation deception campaign ascribing raids by several other carriers to a single ship.

Both battle carriers had drone racks in the dorsal turret; this was considered to be more efficient because of the drone-armed fighters, and there was no plasma-armed version of the battle carrier.

The battle carrier is a variant of the *Kirov*-class battlecruiser (R2.33). There is no carrier variant of the *Bismarck*-class (R2.34) or *New Jersey*-class (R2.64) battlecruisers.

Carrier: This ship is a true carrier; see (J4.75), (J4.93), (J11.13), and (J15.22).

The hangar is a “tunnel deck” (J1.58) with doors at the forward and aft end. The battle carriers carried either one MRS (J8.0) or one E2C SWAC [(J9.0)/(R2.F3)], depending on availability; MRS and SWAC shuttles are not included within the BPV. This carrier cannot use an E-3A heavy SWAC [(J9.531)/(R2.F3A)]. There is no (J1.53) balcony.

Year	Escorts	Fighters
Y183-Y189	NAC, DWA/FBE	12xF-14B or 6xF-101C
Y190-Y194	NAC, DWA	12xF-14C or 6xF-101C
Y195+	NAC, DWA	12xF-14D or 6xF-101C

Escort ready racks: The ready racks of the escorts were configured for F-14 (R2.F1) fighters if the ship were operating that type of fighter. Escorts cannot have ready racks for heavy fighters; see (S8.318).

Warp pack: The two box center warp engine in the saucer can be used to generate power but cannot be used to generate movement points unless the saucer has been separated: (G12.102) and (G12.214).

Seeking weapons: The battle carrier can control a number of seeking weapons equal to double its sensor rating (F3.212).

Refits: None.

Designed by Cole & Petrick.

SSD and counter are in *Module R5*.

Known names: 1754 *Shangri La*, 1764 *Atlantis*.

(R2.75) BATTLE CONTROL SHIP (BCS): The second battle carrier, *Atlantis*, was either completed in or converted to this configuration. (The records are unclear.) It carried six F-111s (R2.F11) on tractors in a single “bay” and had cargo storage able to use (R2.R5).

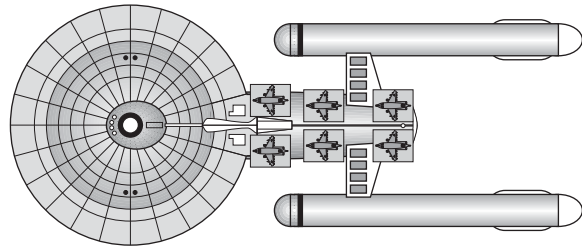

The cargo boxes use the (R2.R5) rules.

The battle control ship is a variant of the *Kirov*-class battlecruiser (R2.33). There is no carrier variant of the *Bismarck*-class (R2.34) or *New Jersey*-class (R2.64) battlecruisers.

Carrier: This ship is a true carrier; see (J4.75), (J4.93), (J10.111), (J11.13), and (J15.22).

This ship has two shuttle bays. The admin shuttle/fighter bay holds six fighters and three shuttles. This bay had only one door (to the rear) since the space for the forward portion of the bay (on the battle carrier) was taken up by cargo storage. The battle control carried either one MRS (J8.0) or one E2C SWAC [(J9.0)/(R2.F3)], depending on availability; these are not included in the ship’s BPV. The second “bay” is the F-111 bay and is semi-external and treated as mech-links (J1.561). The boxes are hit as normal shuttle boxes. All six F-111s can be launched or landed (or some could be landing while others launch) in a single impulse or over multiple impulses. Mines can only be laid from the admin shuttle bay (M2.113).

Year	Escorts	Fighters
Y184-Y189	NAC, DWA	6xF-14B, 6xF-111 or 6xF-14B, 6xF-101C
Y190-Y194	NAC, DWA	6xF-14C, 6xF-111 or 6xF-14C, 6xF-101C
Y195+	NAC, DWA	6xF-14D, 6xF-111 or 6xF-14D, 6xF-101C

The F-111s and F-14s (R2.F1) form separate squadrons and cannot be mixed in a squadron (J4.462). There was no version carrying A-20s (R2.F9) due to the power demands. All of the deck crews [listed separately to simplify conversion to a battle control ship with PFs (R2.75A)] can, of course, work on any type of fighter.

Escort ready racks: The ready racks of the escorts were configured for F-14 (R2.F1). Escorts cannot have ready racks for heavy fighters; see (S8.318).

Warp pack: The two box center warp engine in the saucer can be used to generate power but cannot be used to generate movement points unless the saucer has been separated: (G12.102) and (G12.214).

Seeking weapons: The battle control ship can control a number of seeking weapons equal to double its sensor rating (F3.212).

Refits: None.

Designed by Cole & Petrick.

SSD and counter are in *Module R5*.

Known names: 1764 *Atlantis*.

(R2.75A) BATTLE CONTROL SHIP WITH PFs (BCP): Players wishing to use the conjectural fast patrol ships may accomplish this by replacing the cargo with repair, replacing the F-111s with fast patrol ships or Interceptors, and deleting the F-111 deck crews. [Assume all mech-links are repair capable (K2.24).]

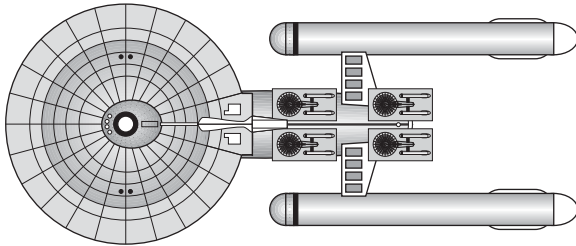

The battle control ship with PFs is a variant of the *Kirov*-class battlecruiser (R2.33). There is no carrier variant of the *Bismarck*-class (R2.34) or *New Jersey*-class (R2.64) battlecruisers.

Carrier: This ship is a true carrier; see (J4.75), (J4.93), (J11.13), and (J15.22).

PF tender: This ship is a true PF tender (K2.0) and cannot operate heavy fighters (J10.0).

This ship has one shuttle bay.

Year	Escorts	Fighters
Y184-Y189	NAC, DWA/FBE	6xF-14B
Y190-Y194	NAC, DWA	6xF-14C
Y195+	NAC, DWA	6xF-14D

Escort ready racks: The ready racks of the escorts were configured for F-14 (R2.F1) fighters. Escorts cannot have ready racks for heavy fighters; see (S8.318).

Warp pack: The two box center warp engine in the saucer can be used to generate power but cannot be used to generate movement points unless the saucer has been separated: (G12.102) and (G12.214).

Seeking weapons: The battle control ship with PFs can control a number of seeking weapons equal to double its sensor rating (F3.212).

Refits: None.

Designed by Cole & Petrick.

SSD is combined with the battle control ship (R2.75) in *Module R5*. Use the battle control ship counter in *Module R5*.

This ship is conjectural.

Known Names: None, conjectural unbuilt variant.

FEDERATION CRUISERS

(R2.76) HEAVY COMMAND CRUISER (CB): The first of these improved command cruisers (*Gettysburg*) appeared in Y175. The new design provided a 20% increase in phaser firepower, a 100% increase in drone capability, a 25% increase in reserve power, and a 7.5% increase in warp power (resulting in a warp-capable saucer when separated).

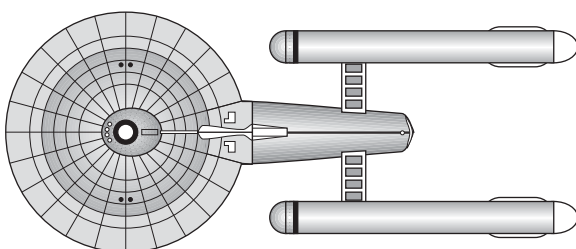

The heavy command cruiser is a variant of the heavy cruiser (R2.4).

Warp pack: The two box center warp engine in the saucer can be used to generate power but cannot be used to generate movement points unless the saucer has been separated: (G12.102) and (G12.214).

Seeking weapons: The heavy command cruiser can control a number of seeking weapons equal to its sensor rating (F3.21).

Refits: None.

Designed by Cole & Petrick.

SSD and counter are in *Module R5*.

Known names: 1728 *Gettysburg*, 1729 *Kadesh*, 1730 *Thermopolae*, 1731 *Cannae*, 1732 *Alesia*, 1733 *Isandhlwana*, 1734 *Gravelotte*, 1735 *Tannenberg*, 1736 *Kursk*, 1737 *Coral Sea*, 1738 *Inchon*, 1739 *Khe Sanh*, 1740 *Golan*, 1741 *Alfeld*, 1742 *Austerlitz*, 1743 *Panjsher*, 1744 *Suomussalmi*, 1745 *Rocroi*, 1746 *Poltava*, 1747 *Rossbach*, 1748 *Gaugamela*, 1749 *Vincennes* (converted to CX), 1750 *Basra*.

(R2.77) NEW HEAVY CRUISER (NCA): Faced with a shortage of heavy cruiser (R2.4) hulls, the Federation (like many other empires) looked to its war cruiser design and created a “new heavy cruiser” that could be assembled in shipyards that were building new light cruisers (R2.18) [leaving the heavy cruiser shipyards free to build heavy command cruisers (R2.76)]. The addition of the rear hull and the small center engine increased power, versatility, and range.

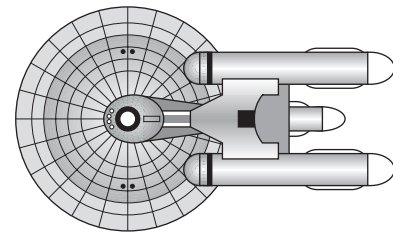

The shift in the center of gravity reduced the chances of a breakdown.

The new heavy cruiser cannot drop the rear hull but could, of course, drop its warp engines.

This ship is a variant of the new light cruiser (R2.18) but the changes were sufficiently extreme that it is considered a new class. Variants include the new heavy command cruiser (R2.106), new attack carrier (R2.107), new heavy drone cruiser (R2.109), new survey cruiser (R2.110), new division control ship (R2.111), new (plasma) cruiser (conjectural) (R2.112), new heavy fighter carrier (R2.113), new heavy scout (R2.114), new heavy aegis escort (conjectural) (R2.115), heavy scout carrier (R2.122), new heavy fighter carrier (R2.134). The advanced technology new heavy cruiser (R2.210) is a drastically modified variant of this ship. The new fast cruiser (R2.108) was built on a drastically modified new heavy cruiser hull.

Seeking weapons: The new heavy cruiser can control a number of seeking weapons equal to its sensor rating (F3.21).

Refits: None.

Designed by Cole & Petrick.

SSD and counters are in *Module R5*.

Known names: 1651 *Chicago* (converted to NHV), 1652 *New York*, 1653 *Dayton* (converted to NHV), 1659 *Mecca*, 1660 *Buenos Aires*, 1661 *Kinshasa*, 1662 *Milwaukee*, 1663 *Atlanta*, 1664 *Calgary*, 1666 *Yellowknife*, 1670 *Houston*, 1672 *Savannah*.

FEDERATION TUG AND PODS

(R2.78) BATTLE CARRIER TUG (BTV): One of the most powerful battle tug combinations in space was a Federation battle tug (R2.10) with an additional light carrier pod (R2.57), combining firepower with fighter power. The combination was, however, the slowest warship in Star Fleet and tended to be used to defend fixed installations. In one such battle, the tug (R2.8) had to abandon the pods in order to escape from a superior Klingon force.

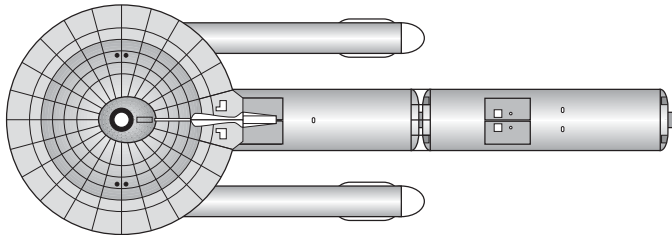

The impulse engines of the battle pod cannot be used for movement while the light carrier pod is attached, but the light carrier pod's impulse engines can be used for movement.

This ship is not a variation of any sort, but simply a tug (R2.8) with a particular combination of pods.

Carrier: This ship is a true carrier; see (J4.75), (J4.93), (J11.13), and (J15.22).

This tug and pods combination has four shuttle bays. Mines can be laid from the shuttle bays of the tug and the battle pod, but not from the bays of the carrier pod (M2.113). (The combination can lay a maximum of two mines in a turn from shuttle bays, one from the bay on the battle pod and one from the tug's bay.) The light carrier pod has two bays, which are tunnel decks (J1.58), but only the rear hatches of the bays can be used to launch and land shuttles while it is attached to the battle pod. Transfers between the two fighter bays of the light carrier pod are possible under (J1.592); transfers between any other shuttle bays of the combination are not possible.

Year	Escorts	Fighters
Y170-Y175	DE, FFE or 2xFFE	12xF-4 or 12xF-8
Y173-Y175	DE/NEC, FFE	12xF-18
Y176-Y178	NEA/DEA/NAC, FFA	12xF-18 or 6xF-101A
Y178-Y181	NEA/DEA/NAC, FFA	12xF-18B or 6xF-101B
Y181-Y183	NEA/DEA/NAC, FFA/FBE	12xF-18B+ or 6xF-101C
Y183+	NEA/DEA/NAC, DW/FBE/FFA	12xF-18C or 6xF-101C

Such a combination was used by the Federation on more than one occasion. Battle carrier tugs could have been created as early as Y167, although the first recorded incident was in Y170. [Earlier use may require operating without escorts as escort frigates (R2.41) were not available at the time the light carrier pod entered service.]

Escort ready racks: The ready racks of the escorts were configured for F-8 (R2.F7) fighters in Y170-Y175 if the ship were operating that type of fighter, for F-4 (R2.F6) fighters from Y170-Y175 if the ship were operating that type of fighter, and for F-18 (R2.F5) fighters from Y173 on if the ship were operating that type of fighter. Escorts cannot have ready racks for heavy fighters; see (S8.318).

Seeking weapons: If the tug has not received its plus refit, the combination can control seeking weapons equal to

the tug's sensor rating (F3.21) using the light carrier pod's control channels. If the tug has received its plus refit, the light carrier pod increases the seeking weapon control rating of the combination to double the tug's sensor rating (F3.212).

Refits: See (R2.8) for the refits available to the tug; see (R2.10) for refits available to the battle pod; see (R2.57) for refits available to the light carrier pod.

Designed by Cole & Petrick.

An SSD and a counter for this tug and pods combination are in *Module R5*.

Known names: tugs operating in this configuration retained their own names.

FEDERATION COMMANDO SHIPS

(R2.79) NEW COMMANDO TRANSPORT (NCT): With the supply of old light cruiser (R2.5) hulls dwindling rapidly as a result of the demands of the General War, the Federation developed this design to replace the commando cruiser (R2.31). While it lacked the commando cruiser's ability to land directly on planets and was not as well armed when the commando cruiser's refit was considered, it was better shielded, was able to operate with other new light cruiser (R2.18) hulls, and had a larger shuttle bay.

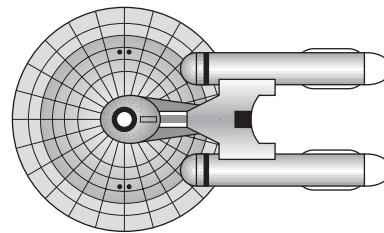

The new commando transport is a variant of the new light cruiser (R2.18).

Landing force: 27 boarding parties (D7.0) plus two commando teams (D15.84), three heavy-weapons squads (D15.81), and three ground combat vehicles (D15.82). This was roughly a battalion of troops (R2.M1) and is included in the ship's BPV.

Shuttles: Four ground assault shuttles (R1.F4), one heavy transport shuttle (R1.F5), and two admin shuttles [(J2.0)/(R1.F1)]; these shuttles are included in the ship's BPV.

Seeking weapons: The new commando transport can control a number of seeking weapons equal to half its sensor rating (F3.211).

Refits: The plus refit was available beginning in Y173 and was universal by Y175.

SSD and counter are in *Module M*.

Known names: None known.

(R2.80) COMMANDO FRIGATE (CFF): The Federation produced a commando variant of the frigate able to carry an entire Marine battalion. The design was based on the priority transport frigate (R2.47) dispensing with the tug capabilities but increasing transporter facilities to allow the ground combat vehicles (D15.82) to be landed without using the heavy transport shuttle (R1.F5).

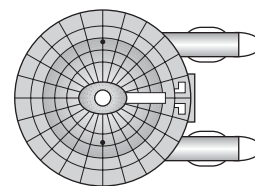

The commando frigate is a variant of the frigate (R2.25).

Landing force: 27 boarding parties (D7.0) plus two commando teams (D15.84), three heavy-weapons squads (D15.81), and three ground combat vehicles (D15.82). This was roughly a battalion of troops (R2.M1) and is included in the ship's BPV.

Shuttles: Two ground assault shuttles (R1.F4) and one heavy transport shuttle (R1.F5); these shuttles are included in the ship's BPV.

Seeking weapons: Prior to the plus refit, the commando frigate can control a number of seeking weapons equal to half its sensor rating (F3.211); after the plus refit the commando frigate can control a number of seeking weapons equal to its sensor rating (F3.21).

Refits: The plus refit was available beginning in Y165, was common by Y171, and was universal by Y175. The Y175 refit was installed in all ships of this type in Y175.

SSD and counter are in *Module M*.

Known names: 0374 *Kurt Student*, 0377 *Richmond Turner*, 0378 *Orde Wingate*, 0387 *Skorzeny*, 0388 *Kripney*, 0389 *Roger Young*, 0390 *Sulaco*, 0410 *Higgins*, 0415 *Colonel Matthew Broderick*, 0420 *Sgt 1st Class Gregory Cardott*.

(R2.81) COMMANDO WAR DESTROYER (CDW): The commando frigate (R2.80) was a pre-General War design and, in the heat of the General War, was found increasingly less capable of operating where interception was possible. Unfortunately, there were many more missions than there were commando ships to perform them, resulting in some serious losses. When the war destroyer (R2.65) hull became available, the Fleet Marine office campaigned, successfully, for some of the hulls to be diverted to this design. Larger, better shielded, and faster than the commando frigate, the commando war destroyer would soldier on well into the next century as the soulmate of the larger new commando transport (R2.79).

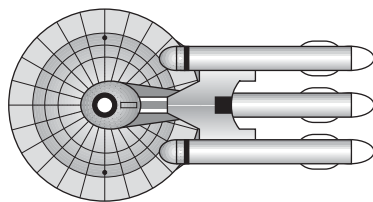

The commando war destroyer is a variant of the war destroyer (R2.65).

Landing force: 24 boarding parties (D7.0) plus two commando teams (D15.84), three heavy-weapons squads (D15.81), and three ground combat vehicles (D15.82). This was roughly a battalion of troops (R2.M1) and is included in the ship's BPV.

Shuttles: Two ground assault shuttles (R1.F4), one heavy transport shuttle (R1.F5), and one admin shuttle [(J2.0)/(R1.F1)]; these shuttles are included in the ship's BPV.

Seeking weapons: The commando war destroyer can control a number of seeking weapons equal to half its sensor rating (F3.211).

Refits: None.

SSD and counter are in *Module M*.

Known names: 0841 *Private Johnson Beharry VC*, 0842 *Leigh Ann Hester*, 0843 *Smedley Butler*, 0844 *Douglas Munro*, 0845 *Cota*, 0846 *Urquhart*, 0847 *Maxwell Taylor*, 0848 *James Gavin*, 0849 *Sosabowski*.

FEDERATION FAST CRUISER

(R2.82) FAST CRUISER (CF): These three cruisers, the *Wolverine*, *Eagle*, and *Stingray*, were built in Y167, Y168, and Y169, replacing the normal heavy cruisers (R2.4) in the production schedule for those years. These ships were, as with all fast cruisers, designed with "hot warp" engines and a reduced heavy weapons load.

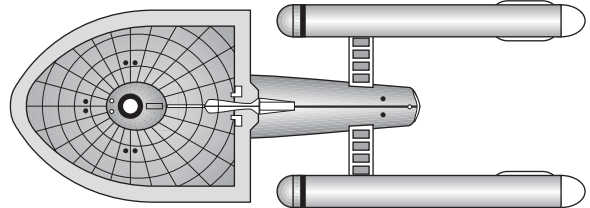

This ship is a variant of the heavy cruiser (R2.4) but the changes were sufficiently extreme that it is considered a new class. Variants include the fast carrier (R2.96) and fast fleet scout (R2.145).

Seeking weapons: The fast cruiser can control a number of seeking weapons equal to its sensor rating (F3.21).

Refits: The AWR refit was available in Y170; virtually all ships had it by Y174. The Y175 refit was installed in Y175.

Fast: This ship is a "fast" ship.

SSD and counter are in *Module R6*.

Known names: 1602 *Wolverine*, 1603 *Stingray*, 1719 *Eagle* (converted to CFS).

FEDERATION CARRIER AND SUPPORT SHIP

(R2.83) MOBILE CARRIER (DWV): Built on the hull of the war destroyer (R2.65), the mobile carrier deployed a short squadron of F-18 (R2.F5) fighters. It was used for secondary operations, such as raids, security, and patrols, and sometimes to escort critical convoys. Note that the reduced power required that one photon tube be replaced by a drone rack.

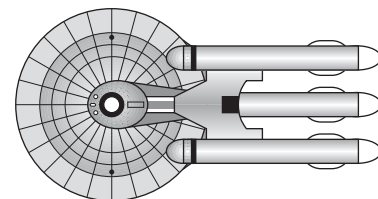

The mobile carrier is a variant of the war destroyer (R2.65).

Carrier: This ship is a true carrier; see (J4.75), (J4.93), (J11.13), and (J15.22).

This ship has one shuttle bay.

Year	Escorts	Fighters
Y177-Y180	FFA/DWA	8xF-18B
Y181-Y183	FFA/DWA/FBE	8xF-18B+
Y184+	FFA/DWA/FBE	8xF-18C

Escort ready racks: The ready racks of the escorts were configured for F-18 (R2.F5) fighters if the ship were operating that type of fighter.

Seeking weapons: The mobile carrier can control a number of seeking weapons equal to double its sensor rating (F3.212).

Refits: None.

SSD and counter are in *Module R6*.

Known names: 0762 *Charles Lindbergh*, 0821 *Cosic* (Yugoslavia), 0822 *Izetbegovic* (Bosnian Moslem), 0823 *Milan Panich* (Yugoslavia), 0824 *Slobodan Milosevic* (Serbia), 0825 *Karadzic* (Bosnian Serb), 0826 *General Mladic* (Bosnian Serb), 0827 *O'Grady*, 0828 *Kresimir Zubak*.

(R2.84) FORWARD CARRIER RESUPPLY FRIGATE (FCR):

Based on the very similar VIP transport (R2.48) but without the ability to act as a tug, the forward carrier resupply frigate added a ready rack (J4.89) and limited aegis system (D13.4) for its mission of resupplying carrier groups with new replacement fighters, pilots, and drones. The limited aegis system allowed the forward carrier resupply frigate to operate as an escort while resupplying the carrier. This ability led to some of these ships being pressed into service as temporary escorts when a carrier was missing one.

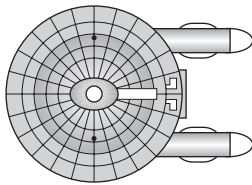

This ship has a ready rack (J4.89) and deck crews (J4.81) to prepare fighters for transfer to the carrier it is escorting. The deck crews are not in addition to the deck crews provided by (J4.814), but replace them, representing their being retrained to service and arm fighters.

The forward carrier resupply frigate is a variant of the frigate (R2.25).

Seeking weapons: The forward carrier resupply frigate can control a number of seeking weapons equal to its sensor rating (F3.21) and has limited aegis (D13.4). See also (J15.332) when used as a carrier escort.

Refits: The drone rack refit was installed in Y175.

SSD and counter are in *Module R6*.

Known names: 0441 *Flying Dutchman*, 0442 *Moonshine*.

FEDERATION HEAVY WAR DESTROYER

(R2.85) HEAVY WAR DESTROYER (HDW): This ship, typical of the late-General-War galaxy-wide class, was intended to replace all of the frigate (R2.25) and war destroyer (R2.65) variants with a single modular variant design. The center warp engine of the war destroyer was removed and replaced with two such engines mounted to the diminutive rear hull (directly under the original engines). The ship cannot separate the rear hull. As with all heavy war destroyers, the ship carries a pair of fighters for additional firepower and is treated as a "casual carrier" (J4.62) for determining supplies, but there are ready racks (J4.89) for the fighters.

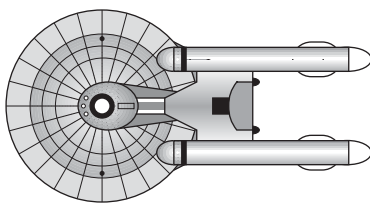

This ship is a variant of the war destroyer (R2.65) but the changes were sufficiently extreme that it is considered a new class. There are no variants except for the HDWX (R2.213) as any ship of this class might be operating in any variant mode at one time or another and then be switched to another mode; see (G33.0).

Carrier: This ship is a true carrier if it has eight size-1 or four size-2 fighters; see (J4.75), (J4.93), (J11.13), and (J15.22). This ship is a casual carrier (J4.62) if it has seven or fewer size-1 fighters or three or fewer size-2 fighters.

This ship has two shuttle bays. Transfers between the bays are not possible.

Year	Escorts	Fighters
Y180+	At least one (G33.42). If operating heavy fighters, escorts are not required	Varies, at least 8 size-1 or 4 size-2 fighters

Note: The heavy war destroyer can only operate A-20s (R2.F9) (and its variants) from internal bays. If the ship is to operate F-111s (R2.F11), the four APR* boxes and the two weapon options become semi-external shuttle bays. The four non-weapon option boxes become cargo boxes, two of which each hold one spare F-111 fighter, the other two hold 100 spaces of reload drones provided under (G33.42). Reload anti-drones, warp booster pack storage (J5.42), and the pod stockpile (J11.13) are separate from the cargo storage. If operating F-111s or carrying F-101s in the same manner as F-111s, the ship has four admin shuttles [(J2.0)/(R1.F1)]; i.e., the bay in the main hull holds three shuttles and no fighters.

Escort ready racks: The ready racks of the escorts were configured for F-18 (R2.F5) fighters. Escorts cannot have ready racks for heavy fighters; see (S8.318).

Seeking weapons: The heavy war destroyer can control a number of seeking weapons equal to its sensor rating (F3.21). It may have full aegis (D13.0) installed if configured as an escort (G33.43); see also (J15.332).

Refits: The design included the Y175 refit.

SSD and counter are in *Module R6*.

Known names: 0790 *Arab Legion*, 0791 *Grenadier Guards*, 0792 *Taman Guards*, 0793 *Leathernecks*, 0794 *Rogachev Guards*, 0795 *Old Guard*, 0796 *Iron Brigade*, 0797 *Stonewall Brigade*, 0798 *Panzer Lehr*, 0799 *Garibaldi Brigades*.

FEDERATION POLICE FLAGSHIP

(R2.86) POLICE FLAGSHIP (FLG): Dating from decades before the General War, the police flagship provided precinct commanders with a variety of support and emergency services and equipment.

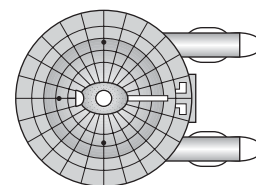

The police flagship is a variant of the frigate (R2.25).

This ship is a true minesweeper (M2.45), see also (M8.0).

Landing force: 26 boarding parties (D7.0) plus two commando teams (D15.84), three heavy-weapons squads (D15.81), and three ground combat vehicles (D15.82). This was roughly a battalion of troops (R2.M1) and is included in the ship's BPV.

Shuttles: One ground assault shuttle (R1.F4), one heavy transport shuttle (R1.F5), one minesweeping shuttle (R1.F2) [an exception to (M8.12)], and three admin shuttles [(J2.0)/(R1.F1)]; these shuttles are included in the ship's BPV. This ship is authorized to purchase an MRS shuttle (J8.0) as an exception to (J8.511).

Scout: It can use all scout functions (G24.0). Special sensors are destroyed by "torpedo" damage points. When purchased as part of a battle force use the ship's combat BPV, not its economic BPV under (G24.35).

Seeking weapons: Prior to the plus refit, the police flagship can control a number of seeking weapons equal to half its sensor rating (F3.211); after the plus refit the police flagship can control a number of seeking weapons equal to its sensor rating (F3.21). See also (F3.213).

Refits: Transporters increased from Range 4 to Range 5 in Y140. Tractors increased from Range 2 to Range 3 in Y140. The plus refit was available beginning in Y165, was common by Y169, and was universal by Y172. The Y175 refit was installed in all ships of this type in Y175.

SSD and counter are in *Module R6*.

Known names: None known.

FEDERATION DRONE BOMBARDMENT SHIPS

(R2.87) HEAVY DRONE CRUISER (CAD): The heavy cruiser *Agincourt* was badly damaged in one of the first battles of the Klingon invasion; its photon bank was entirely destroyed. Due to the demand for photon tubes by new construction, it would take too long to repair the ship. Rather than see an otherwise operable ship left in spacedock, the Federation refitted it with drone racks replacing the photons and added special sensors. Drone storage and drone control channels were increased. It served as the Federation's only heavy drone cruiser. An ambush by Klingon gunboats in Y180 resulted in the separation of the saucer, which was recovered. By Y181 the ship was back in operation with a new secondary hull, but there was some consideration of using a different rear hull (R2.130).

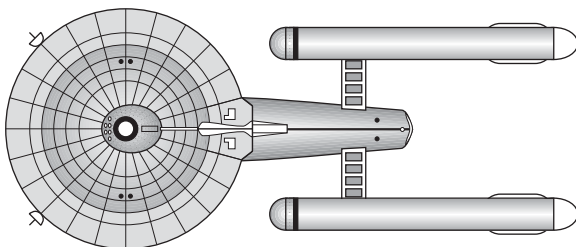

The heavy drone cruiser is a variant of the heavy cruiser (R2.4).

Scout: It can use all scout functions (G24.0). Special sensors are destroyed by "torpedo" damage points. See (G24.35) when purchasing this unit as part of a battle force.

Bombardment: This ship has two hundred spaces of spare drones stored in its cargo boxes; see (FD10.671) and (S3.222).

Deployment: See (S8.47) for deployment restrictions and conditions.

Seeking weapons: The heavy drone cruiser can control a number of seeking weapons equal to double its sensor rating (F3.212). Also see (F3.213).

Refits: The rear phaser refit was installed in Y172. The plus refit was installed in Y173. The Y175 refit was installed in Y175.

SSD and counter are in *Module R6*.

Known names: 1601 *Agincourt*.

(R2.88) LIGHT DRONE CRUISER (CLD): The Federation found the *Agincourt* useful, and it was in high demand for operational missions. To supplement its activities, two light cruisers (R2.5) (*Bosnia* and *Gran Chaco*) were converted in late Y173. The mission was, thereafter, taken over by newly

built ships of the new drone cruiser (R2.36) class, which operated in larger groups with scout support. The two light drone cruisers continued to conduct independent drone bombardment missions as they had their own targeting sensors.

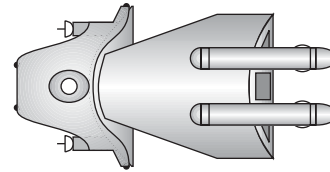

The light drone cruiser is a variant of the light cruiser (R2.5).

Scout: It can use all scout functions (G24.0). Special sensors are destroyed by "torpedo" damage points. See (G24.35) when purchasing this unit as part of a battle force.

Bombardment: This ship has two hundred spaces of spare drones stored in its cargo boxes; see (FD10.671) and (S3.222).

Deployment: See (S8.47) for deployment restrictions and conditions.

Seeking weapons: The light drone cruiser can control a number of seeking weapons equal to double its sensor rating (F3.21). See also (F3.213).

Refits: The plus refit was installed in Y174. The Y175 refit was installed in Y175.

SSD and counter are in *Module R6*.

Known names: 0923 *Gran Chaco*, 0935 *Bosnia*.

FEDERATION OLD LIGHT CRUISER VARIANTS

(R2.89) MEDIUM CARRIER (CLV): The need for carriers in the crisis period before the start of the General War resulted in the conversion of the light cruisers (R2.5) *Virginia* and *Mississippi* into carriers.

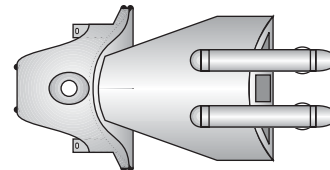

They were quickly supplanted by newly built carriers and relegated to training and convoy escort duty. They initially operated F-4 (R2.F6) or F-8 (R2.F7) fighters, but were switched to operating F-18 (R2.F5) fighters when they became available.

The medium carrier is a variant of the light cruiser (R2.5).

Carrier: This ship is a true carrier; see (J4.75), (J4.93), (J11.13), and (J15.22).

This ship has one shuttle bay.

Year	Escorts	Fighters
Y169-Y174	1-2 FFE or 1-2 FFR (Rom)	12xF-4 or 12xF-8
Y173-Y175	1-2 FFE or 1-2 FFR (Rom)	12xF-18
Y176-Y178	1-2 FFA or 1-2 FRA (Rom)	12xF-18 or 6xF-101A
Y178-Y181	1-2 FFA or 1-2 FRA (Rom)	12xF-18B or 6xF-101B
Y181-Y186	1-2 FFA/DWA/FBE or 1-2 FRA/DWA/FBE (Rom)	12xF-18B+ or 6xF-101C

Y187+	1-2 FFA/DWA/FBE	12xF-18C or 6xF-101C
-------	-----------------	-------------------------

Carriers serving on the Romulan front usually operated with escorts especially designed for that front. These escorts were more difficult to build and maintain and were only used on that front. This combination is noted by the note "(Rom)." Production of the Romulan-front escort variants virtually ceased by the end of the General War.

Escort ready racks: The ready racks of the escorts were configured for F-8 (R2.F7) fighters in Y169-Y174 if the ship were operating that type of fighter, and for F-4s (R2.F6) from Y169-Y174 if the ship were operating that type of fighter, and for F-18 (R2.F5) fighters from Y173 on if the ship were operating that type of fighter. Escorts cannot have ready racks for heavy fighters; see (S8.318).

Seeking weapons: The medium carrier can control a number of seeking weapons equal to double its sensor rating (F3.212).

Refits: The plus refit was installed in Y173. The Y175 refit was installed in Y175.

SSD and counter are in *Module R6*.

Known names: 0942 *Mississippi*, 0943 *Virginia*.

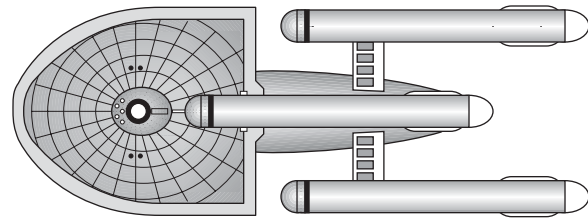

All were highly active in the opening stages of the Klingon Invasion in Y171, during which *Star Cougar* was destroyed and *Star Tiger* was so badly damaged that it did not see service for three years (and then as almost an entirely different class). *Star Lion* survived the General War, covered with battle honors. The fate of *Star Leopard* is something of a mystery; she may have met up with an Andromedan, a monster, or some other unknown force. The *Star Lynx* was never built; at various times it was proposed as a carrier or modular version of the light dreadnoughts.

This ship is a variant of the dreadnought (R2.2) but the changes were sufficiently extreme that it is considered a new class. Variants include the conjectural light dreadnought carrier (R2.95) and conjectural modular light dreadnought (R2.A10). A design study was made for an advanced technology conversion of the light dreadnought (R2.125) but this proved impossible to build. The conjectural medium dreadnought (R2.124) is based on a drastically modified light dreadnought hull.

Seeking weapons: The light dreadnought can control a number of seeking weapons equal to its sensor rating (F3.21).

Refits: None, but the design incorporated what would become the Y175 refit having three reloads for its drone racks.

Fast: This ship is a "fast" ship.

SSD and counter are in *Module R7*.

Known names: 2161 *Star Tiger* (rebuilt as DVL), 2162 *Star Leopard*, 2163 *Star Cougar*, 2164 *Star Lion*, 2165 *Star Lynx* (never built), 2166 *Star Jaguar* (never built), 2167 *Star Cheetah* (never built), 2168 *Star Panther* (never built).

FEDERATION DREADNOUGHTS

(R2.90) HEAVY DREADNOUGHT (DNH): This is an improved variant of the guided weapons dreadnought (R2.61); most of the existing dreadnoughts had been refitted to this pattern by the end of the General War.

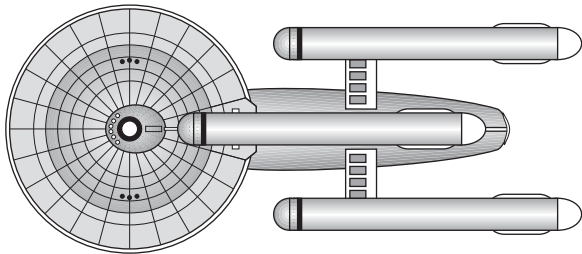

The heavy dreadnought is a variant of the guided weapons dreadnought (R2.61).

Seeking weapons: The heavy dreadnought can control a number of seeking weapons equal to its sensor rating (F3.21).

Refits: None.

SSD and counter are in *Module R7*.

Known names: Conversions of the dreadnought (R2.2) and did not change any names; this was known to include 2121 *Trusteeship* (DNG converted to DNH). New construction included 2126 *Stellar Companion*.

(R2.91) LIGHT DREADNOUGHT (DNL): Originally designed for leading raids or fast reserve forces, the four light dreadnoughts were known as "the Splendid Cats" by the pre-General-War Federation press. The inclusion of three drone racks was somewhat "visionary" as the Federation had not considered drones a major weapon, but these were included to give the ship high "alpha strike" power without requiring energy. While splendid ships, there were no further light dreadnoughts built since they would have taken up space in the only shipyards able to build true dreadnoughts.

(R2.92) PLASMA DREADNOUGHT (DNF): Following the pattern set by the *Bismarck*-class battlecruiser (R2.34), the Federation refitted the damaged guided weapons dreadnought (R2.61) *Entente* to carry two plasma-F torpedo launchers in a dorsal gunhouse in Y179.

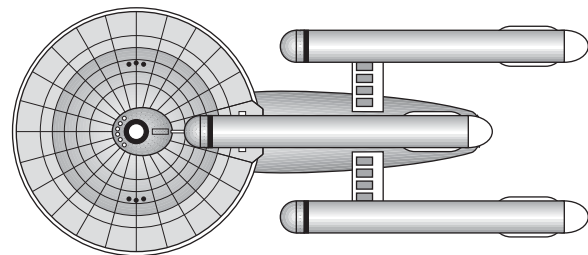

The plasma dreadnought is a variant of the guided weapons dreadnought (R2.61).

Seeking weapons: The plasma dreadnought can control a number of seeking weapons equal to its sensor rating (F3.21).

Refits: The carronade refit [this refit is not shown on the SSD, see (FP14.0)] was included in the design. The plasma sabot refit [this refit is not shown on the SSD, see (FP11.0)] was installed in Y180.

SSD and counter are in *Module R7*.

Known names: Conversions included 2109 *Concordat*, 2120 *Entente*.

FEDERATION BATTLESHIP VARIANTS

(R2.93) BATTLESHIP CARRIER (BBV): This is a conjectural variant of the conjectural Federation *Mars*-class battleship. MRS (J8.0) and SWAC [(J9.0)/(R2.F3)] shuttles are not included within the BPV. See [(J9.531)/(R2.F3A)] for use of an E-3A heavy SWAC.

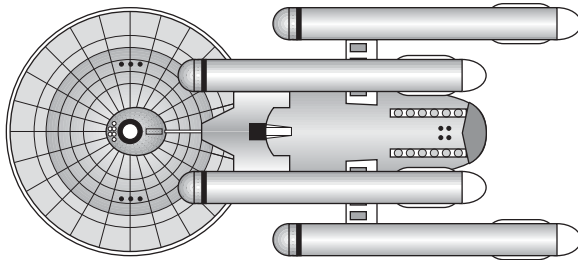

The battleship carrier is a variant of the battleship (R2.73).

Carrier: This ship is a true carrier; see (J4.75), (J4.93), (J10.111), (J11.13), and (J15.22).

This ship has one shuttle bay with 12 balcony (J1.53) positions and is a special case (J1.57): the hatch is extra wide allowing the ship to launch or land (but not both) one shuttle every impulse.

Year	Escorts	Fighters
Y177-Y179	NAC, 2xDWA/FBE or NAC, 2xDWR (Rom)	12xF-14A, 12xA-10 or 6xF-101B, 12xA-10 or 12xF-14A, 6xA-20
Y179-Y183	NAC, 2xDWA/FBE or NAC, 2xDWR (Rom)	12xF-14A, 12xA-10 or 6xF-101C, 12xA-10 or 12xF-14A, 6xA-20F
Y184-Y189	NAC, 2xDWA/FBE	12xF-14B, 12xA-10 or 6xF-101C, 12xA-10 or 12xF-14B, 6xA-20F
Y190-Y194	2xNAC, 1-2xDWA/FBE	12xF-14C, 12xA-10 or 6xF-101C, 12xA-10 or 12xF-14C, 6xA-20F
Y195+	2xNAC, 1-2xDWA/FBE	12xF-14D, 12xA-10 or 6xF-101C, 12xA-10 or 12xF-14D, 6xA-20F

Carriers serving on the Romulan front usually operated with escorts especially designed for that front. These escorts were more difficult to build and maintain and were only used on that front. This combination is noted by the note "(Rom)." Production of the Romulan-front escort variants virtually ceased by the end of the General War.

Escort ready racks: The ready racks of the escorts were configured for F-14 (R2.F1) fighters if the ship were operating

that type of fighter. Escorts cannot have ready racks for heavy fighters; see (S8.318).

Seeking weapons: The battleship carrier can control a number of seeking weapons equal to double its sensor rating (F3.212).

Refits: None.

SSD and counter are in *Module R7*.

This ship is conjectural.

Known names: None, conjectural unbuilt variant.

(R2.94) STELLAR DOMINATION SHIP (SDS): This is a conjectural variant of the conjectural Federation *Mars*-class battleship. MRS and SWAC shuttles are not included within the ship's BPV. See [(J9.531)/(R2.F3A)] for use of an E-3A heavy SWAC.

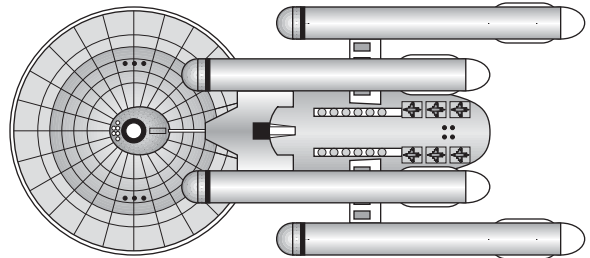

The stellar domination ship is a variant of the battleship (R2.73).

Carrier: This ship is a true carrier; see (J4.75), (J4.93), (J10.111), (J11.13), and (J15.22).

This ship has three shuttle bays. The two bays on each side of the ship each hold 12 fighters and three shuttles with six balcony (J1.53) positions (total of 12 balcony positions). Transfers between these two bays are possible under (J1.592). The third "bay" is the A-20 (R2.F9) bay on the bottom of the hull and is semi-external (J1.561); all six A-20s can be launched or landed (or some could be landing while others launch) in a single impulse or over multiple impulses. Mines can only be laid from the two side bays (M2.113).

Year	Escorts	Fighters
Y180-Y183	NAC, 2xDWA/FBE or NAC, 2xDWR (Rom)	12xF-14A, 12xF-18B+, 6xA-20F
Y184-Y189	NAC, 2xDWA/FBE	12xF-14B, 12xF-18C, 6xA-20F
Y190-Y194	2xNAC, 1-2xDWA/FBE	12xF-14C, 12xF-18C, 6xA-20F
Y195+	2xNAC, 1-2xDWA/FBE	12xF-14D, 12xF-18C, 6xA-20F

Carriers serving on the Romulan front usually operated with escorts especially designed for that front. These escorts were more difficult to build and maintain and were only used on that front. This combination is noted by the note "(Rom)." Production of the Romulan-front escort variants virtually ceased by the end of the General War.

Escort ready racks: The ready racks of the escorts were configured for F-18 (R2.F5) fighters. Escorts cannot have ready racks for heavy fighters; see (S8.318).

Seeking weapons: The stellar domination ship can control a number of seeking weapons equal to double its sensor rating (F3.212).

Refits: None.

SSD and counter are in *Module R7*.

This ship is conjectural.

Known names: None, conjectural unbuilt variant.

(R2.94A) STELLAR DOMINATION SHIP (SDA): This is a conjectural variant of the conjectural Federation *Mars*-class battleship. This one is projected to have carried the fast patrol ships which the Federation never built. The mech-links for the fast patrol ships (K2.24) are on the bottom of the hull. MRS and SWAC shuttles are not included within the ship's BPV. See [(J9.531)/(R2.F3A)] for use of an E-3A heavy SWAC.

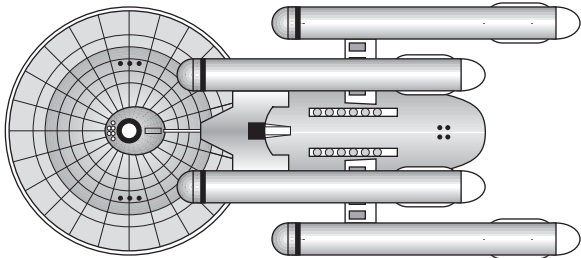

The stellar domination ship is a variant of the battleship (R2.73).

Carrier: This ship is a true carrier; see (J4.75), (J4.93), (J11.13), and (J15.22).

PF tender: This ship is a true PF tender (K2.0) and cannot operate heavy fighters (J10.0). The PFs and their repair facilities are on the bottom of the rear hull.

This ship has two shuttle bays on each side of the ship each holding 12 fighters and four shuttles. Each bay has six balcony (J1.53) positions (total of 12 balcony positions). Transfers between these two bays are possible under (J1.592).

Year	Escorts	Fighters
Y180-Y183	NAC, 2xDWA/FBE or NAC, 2xDWR (Rom)	12xF-14A, 12xF-18B+
Y184-Y189	NAC, 2xDWA/FBE	12xF-14B, 12xF-18C
Y190-Y194	2xNAC, 1-2xDWA/FBE	12xF-14C, 12xF-18C
Y195+	2xNAC, 1-2xDWA/FBE	12xF-14D, 12xF-18C

Carriers serving on the Romulan front usually operated with escorts especially designed for that front. These escorts were more difficult to build and maintain and were only used on that front. This combination is noted by the note "(Rom)." Production of the Romulan-front escort variants virtually ceased by the end of the General War.

Escort ready racks: The ready racks of the escorts were configured for F-18 (R2.F5) fighters. Escorts cannot have ready racks for heavy fighters; see (S8.318).

Seeking weapons: The stellar domination ship can control a number of seeking weapons equal to double its sensor rating (F3.212).

Refits: None.

SSD and counter are in *Module R7*.

This ship is conjectural.

Known names: None, conjectural unbuilt variant.

THE FAST CARRIERS

(R2.95) LIGHT DREADNOUGHT CARRIER (DVL): The *Star Tiger* was built as a standard light dreadnought (R2.91) for deep raids, but was heavily damaged in combat. When it was rebuilt, it emerged from the shipyard as a carrier variant designed for deep raids. The *Star Tiger* continued in this role for several years until it was destroyed by Klingon fast patrol ships in an ambush.

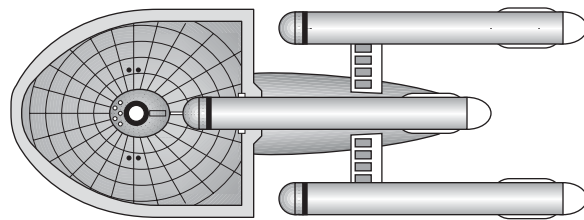

During raiding missions, the *Star Tiger* often operated without escorts as the available ships would only slow her to their speed. From late in Y177 it would sometimes be provided with escorts based on the Federation Express hull (R2.142) that could keep pace with it, but these ships were not always available. The ship was not intended for normal combat operations, but the needs of the General War saw her pressed into service as a front-line unit on more than one occasion. During these brief periods, the *Star Tiger* would be provided with whatever escorts were available. The ship was considered so valuable that providing it escorts took precedence over mere cruiser-sized or smaller carriers. Usually the escorts were one cruiser-sized hull and two smaller hulls, although during one period the ship operated with an escort of a war destroyer escort (R2.68) and two aegis frigates (R2.41A). (Players may substitute smaller escorts than those shown on the chart below.)

MRS and SWAC shuttles are not included within the ship's BPV. This carrier cannot use an E3A heavy SWAC shuttle (R2.F3A).

The light dreadnought carrier is a variant of the light dreadnought (R2.91).

Carrier: This ship is a true carrier; see (J4.75), (J4.93), (J11.13), and (J15.22).

This ship has two hatches for its shuttle bay, which is a tunnel deck (J1.58), and can launch or land two shuttles every other impulse, or launch or land one shuttle every impulse.

Year	Escorts	Fighters
Y173-Y175	NEC, 2xFFE or None (Raid)	12xF-14
Y175-Y176	NAC, 2xFFA or None (Raid)	12xF-14
Y176-Y177	NAC, 2xDWA or None (Raid)	12xF-14 or 6xF-101A
Y177-Y179	NAC, 2xDWA or None or 2xFXE (Raid)	12xF-14A or 6xF-101B
Y179-Y183	NAC, 2xDWA or None or 2xFXE (Raid)	12xF-14A or 6xF-101C
Y183-Y190	NAC, 2xDWA or None or 2xFXE (Raid)	12xF-14B or 6xF-101C
Y190-Y195	NAC, 2xDWA or None or 2xFXE (Raid)	12xF-14C or 6xF-101C
Y195+	NAC, 2xDWA or None or 2xFXE (Raid)	12xF-14D or 6xF-101C

Carriers of this type when raiding behind enemy lines would usually not be escorted, or might be provided with special "fast" escorts; this status is indicated by the note "(Raid)" in the table above.

Escort ready racks: The ready racks of the escorts were configured for F-14 (R2.F1) fighters if the ship were operating that type of fighter. Escorts cannot have ready racks for heavy fighters; see (S8.318).

Seeking weapons: The light dreadnought carrier can control a number of seeking weapons equal to double its sensor rating (R2.212).

Refits: None.

Fast: This ship is a "fast" ship.

Designed by Stephen V. Cole.
 SSD and counter are in *Module J2*.
 Known names: 2161 *Star Tiger*.

(R2.96) FAST CARRIER (CVF): What was to have been the fourth Federation fast cruiser (R2.82) was not completed before the General War began, and the major elements of it were stored as possible spares for the three fast cruisers in service. By Y173, the need for both carriers and fast raiders was becoming more evident, and a decision was made to move ahead with construction of the fourth ship as a carrier variant. The ship used the stored saucer and engines of the fourth fast cruiser and the available rear hull of a strike carrier (R2.29) that was intended for later installation in a heavy cruiser (R2.4) scheduled for conversion.

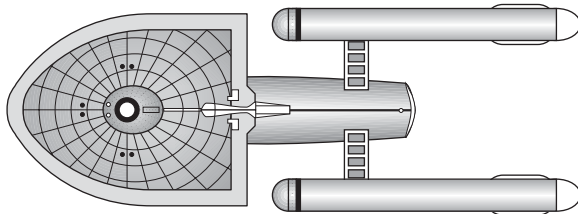

The *Gryphon* operated without escorts on the deep raiding mission and, sometimes, with escorts as a standard carrier where its higher speed was not utilized. From late in Y177 it would sometimes be provided with escorts based on the Federation Express hull (R2.142) that could keep pace with it, but these ships were not always available. The ship was trapped behind Romulan lines in Y177 and destroyed. (The escorts and fighter table below shows what escorts and fighters would have been used had the ship survived beyond Y177 or a new ship of the type had entered service.)

The fast carrier is a variant of the fast cruiser (R2.82).

Carrier: This ship is a true carrier; see (J4.75), (J4.93), (J11.13), and (J15.22).

This ship has two hatches for its shuttle bay, which is a tunnel deck (J1.58), and can launch or land two shuttles every other impulse, or launch or land one shuttle every impulse.

Year	Escorts	Fighters
Y173-Y175	DE, 2xFFE or None (Raid)	12xF-18
Y175	DEA, 2xFFA or None (Raid)	12xF-18
Y176-Y177	DEA, 2xFFA or None (Raid)	12xF-18 or 6xF-101A
Y177-Y179	DEA, 2xFFA or None (Raid) or 2xFXE (Raid)	12xF-18B or 6xF-101B
Y179-Y180	DEA, 2xFFA or None (Raid) or 2xFXE (Raid)	12xF-18B or 6xF-101C
Y180-Y183	NAC, DWA, FFA or None (Raid) or 2xFXE (Raid)	12xF-18B+ or 6xF-101C
Y183+	NAC, 2xDWA or None (Raid) or 2xFXE (Raid)	12xF-18C or 6xF-101C

Carriers of this type when raiding behind enemy lines would usually not be escorted, or might be provided with special "fast" escorts; this status is indicated by the note "(Raid)" in the table above.

Escort ready racks: The ready racks of the escorts were configured for F-18 (R2.F5) fighters if the ship were operating that type of fighter. Escorts cannot have ready racks for heavy fighters; see (S8.318).

Seeking weapons: The fast carrier can control a number of seeking weapons equal to double its sensor rating

(F3.212).
 Refits: None.
 Fast: This ship is a "fast" ship.
Designed by Stephen V. Cole.
 SSD and counter are in *Module J2*.
 Known names: 1950 *Gryphon*.

THE NEW FEDERATION CARRIERS

(R2.97) INTERDICTION CARRIER (CVD): As the General War went on and carrier tactics evolved, there were two schools of thought. One school thought that carriers should fight as line warships with cruiser-type weapons [leading to the strike carrier (R2.29)] while another school held that carriers should stay out of direct combat (although be in the battle arena) and operate their fighters as their primary weapons. Interdiction carriers were one result of this school, and the Federation was one of the first to adopt the idea. The interdiction carrier was built on a strike carrier hull, but rearranged the saucer section to eliminate the photons and some other systems and make room for a second fighter bay with a complete second squadron of fighters. These were F-18s (R2.F5) as the ship lacked the power to reload A-10s (R2.F2).

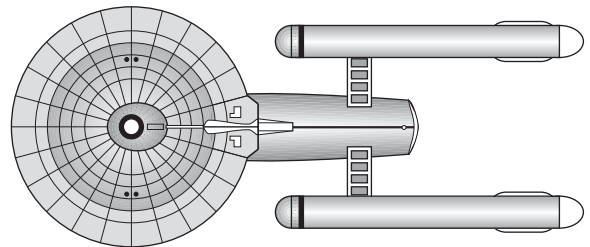

In rare cases ships of this class would be provided with a SWAC shuttle replacing one of its admin shuttles [(J2.0)/(R1.F1)]. MRS (J8.0) and SWAC [(J9.0)/(R2.F3)] shuttles are not included within the BPV. This carrier cannot use an E3A heavy SWAC shuttle (R2.F3A).

The interdiction carrier is a variant of the heavy cruiser (R2.4).

Carrier: This ship is a true carrier; see (J4.75), (J4.93), (J10.111), (J11.13), and (J15.22).

This ship has two shuttle bays. The shuttle bay in the saucer section cannot be used to lay mines (M2.113). The shuttle bay in the secondary hull has two hatches and is a tunnel deck (J1.58), and can launch or land two shuttles every other impulse, or launch or land one shuttle every impulse. Transfers between the two bays are not possible.

Year	Escorts	Fighters
Y173-Y175	DE, 2xFFE or DER, 2xFFR (Rom)	24xF-18
Y175	DEA, 2xFFA or DAR, 2xFRA (Rom)	24xF-18
Y176	DEA, 2xFFA or DAR, 2xFRA (Rom)	24xF-18 or 6xF-101A, 12xF-18
Y177-Y180	DEA, DWA, FFA or DAR, DWA, FRA (Rom)	24xF-18B or 6xF-101B, 12xF-18B
Y180-Y183	2xDWA/FBE, FFA or 2xDWA/FBE, FRA (Rom)	24xF-18B+ or 6xF-101C, 12xF-18B+
Y183+	NAC, 2xDWA/FBE	24xF-18C or 6xF-101C, 12xF-18C

Carriers serving on the Romulan front usually operated with escorts especially designed for that front. These escorts were more difficult to build and maintain and were only used on that front. This combination is noted by the note “(Rom).” Production of the Romulan-front escort variants virtually ceased by the end of the General War.

Escort ready racks: The ready racks of the escorts were configured for F-18 (R2.F5) fighters. Escorts cannot have ready racks for heavy fighters; see (S8.318).

Seeking weapons: The interdiction carrier can control a number of seeking weapons equal to double its sensor rating (F3.212).

Refits: The Y175 refit was installed in Y175.

Designed by Stephen V. Cole.

SSD and counter are in *Module J2*.

Known names: 1981 *Brazos*, 1982 *Nile*, 1983 *Volga*, 1984 *Yangtze*.

(R2.98) PATROL CARRIER (CVP): The Federation had originally believed in the concept of carriers without heavy armament, and its original new light cruiser (R2.18) carrier variant [the new light carrier (R2.35)] followed this pattern, mounting no photons and giving up the APR deck, but carrying a fighter squadron. When this design proved less than efficient, two competing designs were developed. One, the new strike carrier (R2.60), operated a squadron of 12 fighters but had half the photon firepower of a new light cruiser. The other design, the patrol carrier, had no photons but operated a larger squadron of 18 fighters. The earlier new escort cruiser (R2.20) escorts that had proven unsuited for the new strike carrier groups served out the General War guarding patrol carriers.

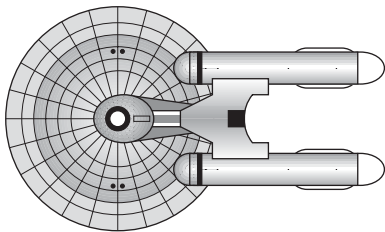

The patrol carrier is a variant of the new light cruiser (R2.18).

Carrier: This ship is a true carrier; see (J4.75), (J4.93), (J10.111), (J11.13), and (J15.22).

This ship has one shuttle bay.

Year	Escorts	Fighters
Y173-Y175	NEC, FFE or NEC, FRA (Rom)	18xF-18
Y175-Y177	NEA, FFA or NEA, FRA (Rom)	18xF-18
Y177-Y180	NEA, FFA or NEA, FRA (Rom)	18xF-18B or 6xF-101A, 6xF-18B
Y178-Y179	NEA, FFA or NEA, FRA (Rom)	18xF-18B or 6xF-101B, 6xF-18B
Y180-Y183	NEA, DWA/FBE or NEA, FBE/FRA (Rom)	18xF-18B+ or 6xF-101C, 6xF-18B+
Y183+	NAC, DWA/FBE	18xF-18C or 6xF-18C, 6xF-101C

Carriers serving on the Romulan front usually operated with escorts especially designed for that front. These escorts were more difficult to build and maintain and were only used

on that front. This combination is noted by the note “(Rom).” Production of the Romulan-front escort variants virtually ceased by the end of the General War.

Escort ready racks: The ready racks of the escorts were configured for F-18 (R2.F5) fighters. Escorts cannot have ready racks for heavy fighters; see (S8.318).

Seeking weapons: The patrol carrier can control a number of seeking weapons equal to its sensor rating (F3.21).

Refits: The Y175 refit was installed in Y175.

Designed by Stephen V. Cole.

SSD and counter are in *Module J2*.

Known names: 1471 *Andes*, 1472 *Sierra Nevada*, 1473 *Hindu Kush*, 1474 *Urals*.

(R2.99) SCOUT CARRIER (CSV): The Federation, like other empires, sought ways to increase carrier firepower and survivability and, like other empires, eventually fielded scout carriers with six heavy fighters (carried internally) and four special sensors replacing the four photons. These operated in much the same way that other empires would later operate fast patrol ship tenders, and the carrier itself was rarely involved in battle unless caught waiting for its fighter group to return.

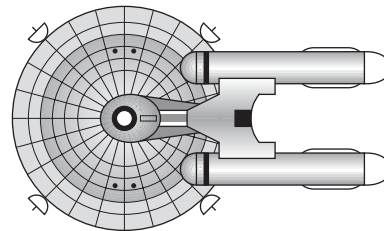

The scout carrier is a variant of the new light cruiser (R2.18).

Scout: It can use all scout functions (G24.0). Special sensors are destroyed by “torpedo” damage points. See (G24.35) when purchasing this unit as part of a battle force.

Carrier: This ship is a true carrier; see (J4.75), (J4.93), (J11.13), and (J15.22).

This ship has one shuttle bay.

Year	Escorts	Fighters
Y177-Y179	NAC, FFA or NAC, FRA (Rom)	6xA-20
Y179-Y180	NAC, FFA or NAC, FRA (Rom)	6xA-20F
Y180-Y183	NAC, FFA or NAC, FRA (Rom) or None	6xA-20F
Y184+	NAC, DWA/FBE/FFA or None	6xA-20F

Carriers serving on the Romulan front usually operated with escorts especially designed for that front. These escorts were more difficult to build and maintain and were only used on that front. This combination is noted by the note “(Rom).” Production of the Romulan-front escort variants virtually ceased by the end of the General War.

Escort ready racks: The ready racks of the escorts were configured for F-18 (R2.F5) fighters. Escorts cannot have ready racks for heavy fighters; see (S8.318).

Seeking weapons: The scout carrier can control a number of seeking weapons equal to double its sensor rating (F3.212). See also (F3.213).

Refits: None.

Designed by Stephen V. Cole.

SSD and counter are in *Module J2*.

Known names: 1481 *Falklands*, 1482 *le Shima*, 1483 *Wake*, 1484 *Betio* (converted to NSV), 1485 *Kiska*, 1486 *Malta*.

THE FEDERATION F-111 CARRIERS

While other empires developed and deployed fast patrol ships, the Federation preferred its heralded “third way” (S8.327) which included large numbers of heavy F-111 (R2.F11) fighters and ships to carry them.

(R2.100) HEAVY FIGHTER CARRIER (CVH): This was, basically, a heavy cruiser (R2.4) or strike carrier (R2.29) hull designed to carry six F-111s (R2.F11) on mech-links (J1.561). It was, perhaps, the analogue of the Klingon D6P (R3.22), another heavy cruiser hull operating heavy attrition units. Most fast patrol ship tenders (and the Federation corollaries) were built on much smaller hulls. Beginning in Y180 ships of this class often operated without escorts.

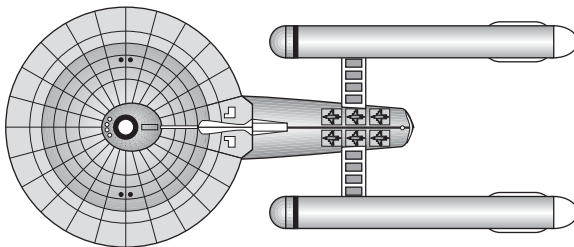

The cargo boxes use the (R2.R5) rules.

The heavy fighter carrier is a variant of the heavy cruiser (R2.4).

Carrier: This ship is a true carrier; see (J4.75), (J4.93), (J11.13), and (J15.22).

This ship has two shuttle bays: the one for its admin shuttles [(J2.0)/(R1.F1)], which operates normally, and the bay used by the heavy fighters. The heavy fighter bay is semi-external, and all six heavy fighters can be launched or landed (or some could be landing while others launch) in a single impulse or over multiple impulses. Mines can only be laid from the admin shuttle bay (M2.113).

Year	Escorts	Fighters
Y177-Y179	NAC, DWA/FBE	6xF-111 or 6xF-101B
Y179-Y180	NAC, DWA/FBE	6xF-111 or 6xF-101C
Y180+	NAC, DWA/FBE or None	6xF-111 or 6xF-101C

Escort ready racks: The ready racks of the escorts were configured for F-18 (R2.F5) fighters. Escorts cannot have ready racks for heavy fighters; see (S8.318).

Seeking weapons: The heavy fighter carrier can control a number of seeking weapons equal to double its sensor rating (F3.212).

Refits: None.

Designed by Stephen V. Cole.

SSD and counter are in *Module J2*.

Known names: 1985 *Benjamin Disraeli*, 1986 *Benjamin Franklin*, 1987 *Benjamin Harrison*, 1988 *Benjamin Netanyahu*, 1989 *Benjamin O. Davis, Jr.*

ADDITIONAL FEDERATION POD

A variety of pods were created for the tug.

Pods cannot be docked back-to-back unless they are inactive due to the power connections. They can only be docked back-to-front, e.g., front of the second pod is docked to the back of the first pod. Any FA weapons on the second pod would be blocked and unable to fire unless the pod were dropped. Note that some pods may have shuttle hatches blocked by the presence of another pod.

Pods never had official names.

Generic pod counters for separated pods are in *Basic Set*.

(R2.101) F-111 TRANSPORT POD (P-FCF): This pod was designed to carry spare F-111 (R2.F11) heavy fighters to support the various units that operated this fighter type. The pod was able to carry, but not service, two full squadrons of F-111s. The linkages on the pod provided no systems for doing anything other than repairing damage, replacing chaff packs (D11.0), or fueling a fighter in preparation for its transfer to a carrier. The pod was only used in areas of heavy combat where it was able to launch the F-111s quickly, allowing the tug (R2.8) or light tactical transport (R2.38) to then withdraw from the area. It was better able to deliver replacement F-111s without the need to break them out of cargo storage one at a time. It was not really able to launch strikes of its own (although even an Andromedan raider would think twice about tangling with a unit that suddenly disgorged a dozen F-111s). Given enough time, it would be possible for the pod’s deck crews to fully arm the fighters under the procedures of (J4.8962), perhaps assisted by replacement deck crews among the passengers. This can only be done if special scenario rules define that a unique set of circumstances has made it possible. The fighters are not normally carried in an armed configuration due the trouble of maintaining the weapons on their pod and launch rails (and there would not be enough time to arm them if an enemy was sighted). This supercedes the normal weapon status rules (S4.1) in that no F-111 on the F-111 transport pod can be armed to any level (excluding its built-in phasers and normal chaff packs) unless specifically provided for in the scenario instructions.



While referred to as the F-111 transport pod, this pod was used to transport all types of heavy fighters, and might have all F-111s, or a mix of F-111s and A-20s (R2.F9), or A-20s and F-101s (R2.FA14), or some combination of all three fighters. It might have fewer than a dozen fighters if some had already been delivered or fewer were available to be delivered.

If attached to a tug (R2.8) or light tactical transport (R2.38), the cargo boxes are destroyed by “rear” hull or “cargo” damage points; the hull boxes on the tug or light tactical transport are considered “forward” hull. See (R2.47) when attached to a priority transport; see (R2.48) when attached to a VIP transport; see (R2.151) when attached to a battle frigate transport.

Weight: This is a single-weight pod with a towing cost of 0.3333.

Operation: The shields of this pod are combined with the shields of the tug while it is attached. This pod is capable of independent operation as a sublight ship in its own right. The impulse engines of this pod cannot be used for movement if another pod is docked behind it.

Seeking weapons: The F-111 transport pod does not increase the drone control rating of the tug or light tactical transport that is carrying it, and does not have any aegis (D13.0) abilities. If detached from the tug, this pod can control a number of seeking weapons equal to its sensor rating (F3.21).

Refits: None.

Design by Stephen V. Cole.

An SSD of this pod is in *Module J2*.

FEDERATION CARRIER SUPPORT SHIPS

(R2.102) HEAVY CARRIER RESUPPLY SHIP (FCF): The Federation had operated forward carrier resupply frigates (R2.84) [built on frigate (R2.25) hulls] for a decade when F-111s (R2.F11) went into service. They found that the frigate-based forward carrier resupply frigates could not handle the huge F-111 fighters, and resorted to building two somewhat larger heavy carrier resupply ships (*Fuji* and *Nitaka*) based on war destroyer (R2.65) hulls to support the *Ise* and *Hyuga*. When heavy fighter transports (R2.56) and F-111s went into full-rate production to match Klingon fast patrol ships, more heavy carrier resupply ships were built to provide support.

The heavy carrier resupply ship has 50% more cargo space than the forward carrier resupply frigate, and while the forward carrier resupply frigate could not handle F-111s, the heavy carrier resupply ship could handle either F-18s (R2.F5), or F-111s. While the shortage of heavy carrier resupply ships meant that they were only rarely used to carry F-18s, this capability was deemed important, and the heavy carrier resupply ships had both one ready rack (J4.89) for an F-18 and one mech-link (J1.561) for an F-111. The deck crews (J4.81) are to prepare fighters for transfer to the carrier it is escorting. The deck crews are not in addition to the deck crews provided by (J4.814), but replace them, representing their being retrained to service and arm fighters. While the ships were intended to provide support to the heavy fighter transports, on more than one occasion one would be pressed into service to deliver A-20s (R2.F9), F-101s (R2.FA14), F-14s (R2.F1), and even F-15s (R2.F10) to the other carrier groups. As with the smaller forward carrier resupply frigates, the heavy carrier resupply ships had limited aegis (D13.4) for use as an emergency carrier escort; however as the ships appeared after Y175 that refit was built into the original design.

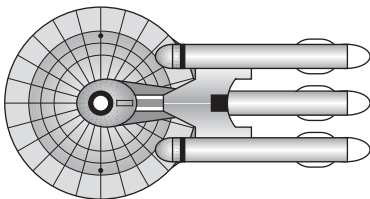

The heavy carrier resupply ship is a variant of the war destroyer (R2.65).

Seeking weapons: The heavy carrier resupply ship can control a number of seeking weapons equal to its sensor rating (F3.22) and has limited aegis (D13.4).

Refits: The drone rack refit was included in the design.

Designed by Stephen V. Cole.

SSD and counter are in *Module J2*.

Known names: 0780 *Fuji*, 0781 *Nitaka*, 0782 *Everest*, 0783 *Kilamanjaro*, 0784 *Whitney*, 0785 *Aconcagua*, 0786 *Maunaloa*, 0787 *Elbrus*, 0788 *Olympus Mons*, 0789 *Matterhorn*.

(R2.103) SMALL HEAVY AUXILIARY CARRIER (SAH): The Federation equivalent of a small auxiliary fast patrol ship tender (R1.27A), this ship was designed to operate six F-111 (R2.F11) heavy fighters. As with small auxiliary fast patrol ship tenders, the ship was simply not large enough to conduct effective operations and was eventually used only as a means of delivering replacement F-111s to the front-line heavy fighter transports (R2.56). It was, despite its size, a welcome addition to any convoy. From late in Y180 these ships often operated with no formally assigned escorts.

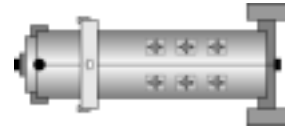

The small heavy auxiliary carrier is a variant of the small auxiliary fast patrol ship tender (R1.27A).

Scout: It can use all scout functions (G24.0). Special sensors are destroyed by "torpedo" damage points. See (G24.35) when purchasing this unit as part of a battle force.

Carrier: This ship is a true carrier; see (J4.75), (J4.93), (J11.13), and (J15.22).

This ship has two shuttle bays: the one for its admin shuttles [(J2.0)/(R1.F1)], which operates normally, and the bay used by the heavy fighters. The heavy fighter bay is semi-external, and all six heavy fighters can be launched or landed (or some could be landing while others launch) in a single impulse or over multiple impulses. Mines can only be laid from the admin shuttle bay (M2.113).

Year	Escorts	Fighters
Y178-Y180	Whatever was available	6xF-111 or 6xF-101B
Y180+	Whatever was available or None	6xF-111 or 6xF-101C

Escort ready racks: The ready racks of the escorts were configured for F-18 (R2.F5) fighters. Escorts cannot have ready racks for heavy fighters; see (S8.318).

Seeking weapons: The small heavy auxiliary carrier can control a number of seeking weapons equal to double its sensor rating (F3.212). See also (F3.213).

Refits: None.

Maneuver: The small heavy auxiliary carrier can accelerate by no more than five movement points or double its current speed. It can disengage by acceleration.

Designed by Steven P. Petrick.

SSD and counter are in *Module J2*.

Known names: None known.

(R2.104) LARGE HEAVY AUXILIARY CARRIER (LAH): The Federation equivalent of a large auxiliary fast patrol ship tender (R2.27B), this ship was designed to operate six F-111 (R2.F11) heavy fighters. To facilitate the transfer of explosive ordnance and spares from forward carrier resupply ships, the ship included two heavy transport shuttles (R1.F5). Other empires did not have this particular problem, using cargo fast patrol ships (R1.PF1) to make deliveries of supplies directly to auxiliaries or other units. Like most auxiliaries, the ship had minimal self-defense capabilities. From late in Y180 these ships often operated with no formally assigned escorts.

The large heavy auxiliary carrier is a variant of the large auxiliary fast patrol ship tender (R1.27B).

Scout: It can use all scout functions (G24.0). Special sensors are destroyed by "torpedo" damage points. See (G24.35) when purchasing this unit as part of a battle force.

Carrier: This ship is a true carrier; see (J4.75), (J4.93), (J11.13), and (J15.22).

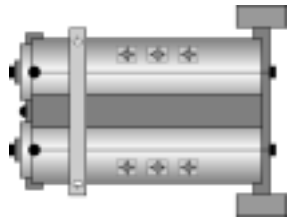

This ship has two shuttle bays for its admin shuttles [(J2.0)/(R1.F1)], which operate normally; transfers between these bays are not possible. The heavy fighter bays are semi-external, and all six heavy fighters can be launched or landed (or some could be landing while others launch) in a single impulse or over multiple impulses. Mines can only be laid from the admin shuttle bays (M2.113).

Year	Escorts	Fighters
Y178-Y180	Whatever was available	6xF-111 or 6xF-101B
Y180+	Whatever was available or None	6xF-111 or 6xF-101C

Escort ready racks: The ready racks of the escorts were configured for F-18 (R2.F5) fighters. Escorts cannot have ready racks for heavy fighters; see (S8.318).

Seeking weapons: The large heavy auxiliary carrier can control a number of seeking weapons equal to double its sensor rating (F3.212). See also (F3.213).

Refits: None.

Maneuver: The large heavy auxiliary carrier can accelerate by no more than five movement points or double its current speed. It can disengage by acceleration.

Designed by Steven P. Petrick.

SSD and counter are in *Module J2*.

Known names: None known.

(R2.105) FEDERATION AUXILIARY SPACE CONTROL SHIP (ASC): Carrying a squadron of F-111s (R2.F11) and a squadron of F-18s (R2.F5), this was the Federation equivalent of the Coalition (and allied) auxiliary space control ships (R1.31) which carried vastly superior fast patrol ships. The ships of this type ended up being used to guard fixed positions or supply replacement fighters to mobile units. The few ships of this class did prove to be useful adjuncts to convoys they sometimes traveled with en-route to their assignments, and could add significantly to the local defenses of a planet or base. Like the large heavy auxiliary carrier (R2.104), the Federation auxiliary space control ship included heavy transport shuttles (R1.F5) to facilitate the rapid transfer of stores from its attendant forward carrier resupply ships. These ships rarely operated without assigned escorts.

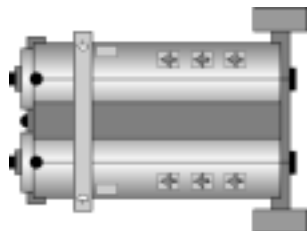

The Federation auxiliary space control ship is a variant of the generic auxiliary space control ship (R1.31).

Scout: It can use all scout functions (G24.0). Special sensors are destroyed by "torpedo" damage points. See (G24.35) when purchasing this unit as part of a battle force.

Carrier: This ship is a true carrier; see (J4.75), (J4.93), (J10.111), (J11.13), and (J15.22).

This ship has two shuttle bays for its admin shuttles [(J2.0)/(R1.F1)] and size-1 fighters, which operate normally; transfers between these bays are not possible. The heavy fighter bays are semi-external, and all six heavy fighters can be launched or landed (or some could be landing while others launch) in a single impulse or over multiple impulses. Mines can only be laid from the non-semi-external bays.

Year	Escorts	Fighters
Y181-Y183	Whatever was available	12xF-18B+, 6xF-111 or 6xF-101C, 12xF-18B+
Y183+	Whatever was available	12xF-18C, 6xF-111, or 6xF-101C 12xF-18C

Escort ready racks: The ready racks of the escorts were configured for F-18 (R2.F5) fighters. Escorts cannot have ready racks for heavy fighters; see (S8.318).

Seeking weapons: The Federation auxiliary space control ship can control a number of seeking weapons equal to double its sensor rating (F3.212). See also (F3.213).

Refits: None.

Maneuver: The Federation auxiliary space control ship can accelerate by no more than five movement points or double its current speed. It can disengage by acceleration.

Designed by Steven P. Petrick.

SSD and counter are in *Module J2*.

Known names: None known.

THE FEDERATION NEW HEAVY CRUISER VARIANTS

The Federation designers who created the new heavy cruiser (R2.77) from the new light cruiser (R2.18) did so in a way that the same power unit could be added to any new light cruiser variant, creating a heavy version of it. Doing so meant that specialist ships could be upgraded as needed to keep pace with the increasing fury of the General War, at least within the overall limit of new heavy cruiser conversions.

Note that regardless of the historical dates of these designs, any of them [excepting those with F-111s (R2.F11)] could have been built as early as Y175.

(R2.106) NEW COMMAND CRUISER (NCC): As the number of new heavy cruisers steadily mounted, the Federation found it desirable to produce a command variant of it. This variant included additional phasers and a flag bridge. A plan was considered to build all new heavy cruisers to this standard (minus the command facilities) but the added expense due to putting too many things in an already full hull made this impractical. Even so, three new heavy cruisers were completed as new command cruisers, including *USS London* in Y177 and at least one light command cruiser (R2.37), *USS Clausewitz*, was converted into a new command cruiser.

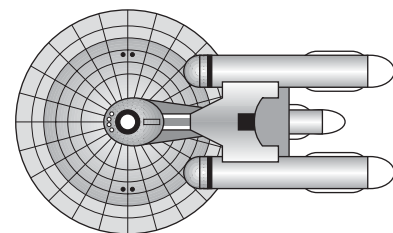

The new command cruiser is a variant of the new heavy cruiser (R2.77).

Seeking weapons: The new command cruiser can control

a number of seeking weapons equal to its sensor rating (F3.21).

Refits: None.

SSD and counter are in *Module R10*.

Known names: 1580 *Clausewitz* (converted from CLC), 1654 *Los Angeles*, 1655 *London*, 1656 *Tokyo*, 1657 *Beijing*, 1658 *Berlin*, 1665 *Philadelphia*, 1668 *Charleston*, 1673 *Toronto*.

(R2.107) NEW ATTACK CARRIER (NCV): While the new strike carrier-class (R2.60) of medium carriers formed the bulk of the Federation carrier force, the strike carrier (R2.29) class provided heavier units needed for certain missions. When strike carrier losses (some to repair yards, some total losses) pushed the available strike carrier force below the number that Star Fleet felt was required, a new strike carrier under construction was converted into the new attack carrier (delineated by the designation NCV) *Rickenbacker*. Later, new strike carriers *Vikrant* and *Hermes* were converted into the new attack carrier design, and a new carrier, *USS Richard Bong*, was completed as a new attack carrier instead of the planned new strike carrier.

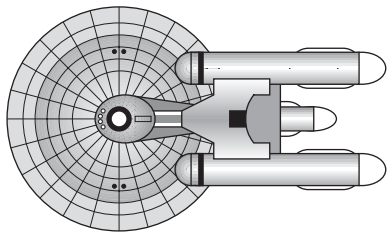

The new attack carrier is a variant of the new heavy cruiser (R2.77).

Carrier: This ship is a true carrier; see (J4.75), (J4.93), (J11.13), and (J15.22).

This ship has one shuttle bay.

Year	Escorts	Fighters
Y175-Y177	DEA, FFA or DAR, FRA (Rom)	12xF-18
Y177	DEA, FFA or DAR, FRA (Rom)	12xF-18 or 6xF-101A
Y177-Y179	DWA, FFA or 2xFRA (Rom)	12xF-18 or 6xF-101B
Y179-Y180	DWA, FFA/FBE or DWR, FRA (Rom)	12xF-18B or 6xF-101C
Y180-Y183	DWA, FFA/DWA/FBE or DWR, FRA (Rom)	12xF-18B+ or 6xF-101C
Y183+	NAC, DWA	12xF-18C or 6xF-101C

Carriers serving on the Romulan front usually operated with escorts especially designed for that front. These escorts were more difficult to build and maintain and were only used on that front. This combination is noted by the note "(Rom)." Production of the Romulan-front escort variants virtually ceased by the end of the General War.

Escort ready racks: The ready racks of the escorts were configured for F-18 (R2.F5) fighters if the ship were operating that type of fighter. Escorts cannot have ready racks for heavy fighters; see (S8.318).

Seeking weapons: The new attack carrier can control a number of seeking weapons equal to double its sensor rating (F3.212).

Refits: None.

SSD and counter are in *Module R10*.

Known names: 1595 *Hermes* (converted from NVS), 1596 *Vikrant* (converted from NVS), 1690 *Erich Hartmann*,

1691 *Richard Bong*, 1692 *James Edgar Johnson*, 1696 *Rickenbacker*.

(R2.108) NEW FAST CRUISER (NCF): The Federation continued to use its fast raiding cruisers well into the General War, but when the *Stingray* (R2.82) was lost behind Romulan lines in Y178, the next available new heavy cruiser (R2.77) was built as the fast raiding cruiser *USS Manta Ray* to replace it. The design changes are so massive that this ship can be considered a "new heavy cruiser variant" only in the most generous sense of the term, as it uses some new heavy cruiser parts (the rear hull and three enhanced new light cruiser engines). The front hull was built as an entirely new structure for this ship. To convert a new light cruiser (R2.18) or new heavy cruiser into a new fast cruiser would be tantamount to melting it down and starting over with the loose parts.

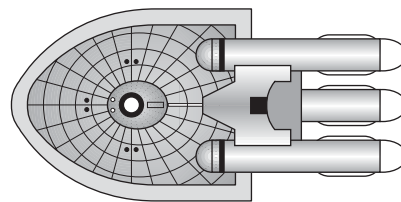

The new fast cruiser is a variant of the new heavy cruiser (R2.77) but the changes were sufficiently extreme that it is considered a new class.

Seeking weapons: The new fast cruiser can control a number of seeking weapons equal to its sensor rating (F3.21).

Refits: None.

Fast: This ship is a "fast" ship.

SSD and counter are in *Module R10*.

Known names: 1667 *Manta Ray*.

(R2.109) NEW HEAVY DRONE CRUISER (NDC): When the *Agincourt*, Star Fleet's only heavy drone cruiser, was crippled (R2.87) in a Klingon ambush in Y180, Star Fleet immediately moved to replace it by converting the next available new heavy cruiser (R2.77) hull into the new heavy drone cruiser *Crecy*. Later, an existing new drone cruiser (R2.36) was converted into a new heavy drone cruiser.

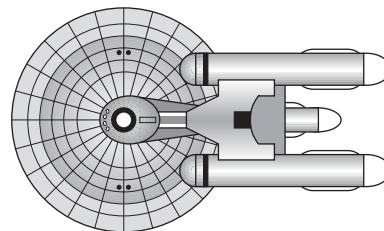

The new heavy drone cruiser is a variant of the new heavy cruiser (R2.77).

This ship has two hundred spaces of spare drones stored in its cargo boxes.

Deployment: See (S8.47) for deployment restrictions and conditions.

Seeking weapons: The new heavy drone cruiser can control a number of seeking weapons equal to double its sensor rating (F3.212).

Refits: None.

SSD and counter are in *Module R10*.

Known names: 1669 *Crecy*.

(R2.110) NEW SURVEY CRUISER (NSR): The loss of the *Marco Polo* in Y176 sent off a series of demands from the Second Fleet for the Federation council to provide a replacement. The Council recognized that even in wartime, the need to find new resources in remote areas remained of paramount interest. Rather than converting an existing heavy cruiser (R2.4) or building a new galactic survey cruiser (R2.16), Star Fleet took the easiest route by converting an incomplete new heavy cruiser (R2.77) into the new survey cruiser *Ibn Batuta*.

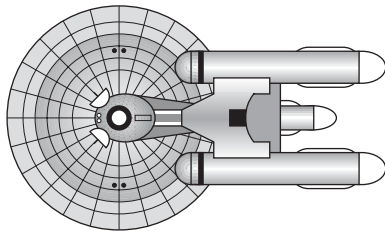

The new survey cruiser is a variant of the new heavy cruiser (R2.77).

Scout: It can use all scout functions (G24.0). Special sensors are destroyed by “phaser” damage points. See (G24.35) when purchasing this unit as part of a battle force.

Carrier: This ship is a casual carrier (J4.62) when operating two F-18s. See (J15.22).

Wartime fighter deployment would have seen two F-18s replace two of the admin shuttles [(J2.0)/(R1.F1)]. There are no ready racks (J4.89) for these fighters, and they are armed and rearmed under (J4.8962). The deck crews (J4.81) shown with the fighters on the SSD are not in addition to those provided by (J4.814), but represent those deck crews having been retrained to be able to service and arm the fighters

Year	Escorts	Fighters
Y175-Y178	None	2xF-18
Y179-Y181	None	2xF-18B
Y182-Y183	None	2xF-18B+
Y184+	None	2xF-18C

Seeking weapons: The new survey cruiser can control a number of seeking weapons equal to its sensor rating (F3.21). See also (F3.213).

Refits: The ship was equipped to operate two fighters as a casual carrier in Y175.

SSD and counter are in *Module R10*.

Known names: 1699 *Ibn Batuta*.

(R2.110A) NEW SURVEY CARRIER (NSRV): If the *Ibn Batuta* had been used in the combat theater, it might (or might not) have carried six F-18 (R2.F5) fighters in the same manner as the light carrier (R2.16A). This would have required refitting the hangar bay. The *Ibn Batuta* was in fact never given this refit.

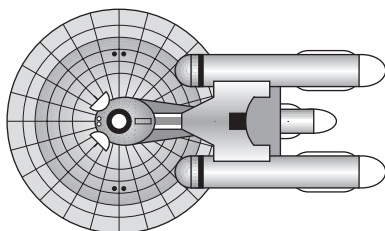

The new survey carrier is a variant of the new heavy cruiser (R2.77).

Scout: It can use all scout functions (G24.0). Special sensors are destroyed by “phaser” damage points. See

(G24.35) when purchasing this unit as part of a battle force. This ship is considered a survey cruiser for purposes of (S8.351). See (S8.25) if it is not counted in the command limit.

Carrier: This ship is a true carrier; see (J4.75), (J4.93), (J11.13), and (J15.22).

This ship has one shuttle bay.

Year	Escorts	Fighters
Y175	DEA, FFA or None or DAR, FRA (Rom)	6xF-18
Y176-Y177	DEA, FFA or None or DAR, FRA (Rom)	6xF-18 or 3xF-101A
Y177-Y178	DWA/FBE, FFA or None or 2xFRA (Rom)	6xF-18 or 3xF-101B
Y179-Y181	DWA/FBE, FFA or None or 2xFRA (Rom)	6xF-18B or 3xF-101C
Y181-Y183	DWA/FBE, FFA/DWA or None or 2xFRA (Rom)	6xF-18B+ or 3xF-101C
Y183+	NAC, DWA or None	6xF-18C or 3xF-101C

Carriers serving on the Romulan front usually operated with escorts especially designed for that front. These escorts were more difficult to build and maintain and were only used on that front. This combination is noted by the note “(Rom).” Production of the Romulan-front escort variants virtually ceased by the end of the General War.

Escort ready racks: The ready racks of the escorts were configured for F-18 (R2.F5) fighters if the ship were operating that type of fighter. Escorts cannot have ready racks for heavy fighters; see (S8.318).

Seeking weapons: The new survey carrier can control a number of seeking weapons equal to its sensor rating (F3.21). See also (F3.213).

Refits: None.

An SSD is provided in *Captain's Log #48*, use the new survey cruiser counter in *Module R10*.

Known names: 1699 *Ibn Batuta*.

(R2.111) NEW DIVISION CONTROL SHIP (NDS): The appearance of Klingon fast patrol ships on the front lines sent waves of panic through Star Fleet, inspiring them to start construction of several ships designed to carry F-111 (R2.F11) heavy fighters. The next available new heavy cruiser (R2.77) was completed as a division control ship, using advanced F-18B+ (R2.F5) fighters for fleet defense and heavy F-111 fighters for strike missions. Christened the *Pompeii*, the ship entered service in Y180 and was followed in Y183 by the *Tamerlane* [a name previously used by a destroyer (R2.6) lost in the war]. This design is extremely crowded, and with only two administrative shuttles [(J2.0)/(R1.F1)] it was never assigned to carry a MRS (J8.0) or a SWAC [(J9.0)/(R2.F3)].

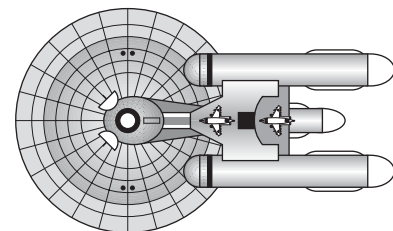

The cargo boxes use the (R2.R5) rules.

The new division control ship is a variant of the new heavy cruiser (R2.77).

Scout: It can use all scout functions (G24.0). Special sensors are destroyed by “phaser” damage points. See (G24.35) when purchasing this unit as part of a battle force.

Carrier: This ship is a true carrier; see (J4.75), (J4.93), (J10.111), (J11.13), and (J15.22).

This ship has one internal shuttle bay, which operates normally, and the bay used by the heavy fighters. The heavy fighter bay is semi-external, and all six heavy fighters can be launched or landed (or some could be landing while others launch) in a single impulse or over multiple impulses. Mines can only be laid from the internal shuttle bay (M2.113).

Year	Escorts	Fighters
Y177-Y180	DWA/FBE, 2xFFA or DWA/FBE, 2xFRA (Rom)	12xF-18B, 6xF-111 or 6xF-101B, 12xF-18B
Y180-Y183	2xDWA/FBE, FFA or 2xDWA/FBE, FRA (Rom)	12xF-18B+, 6xF-111 or 6xF-101C, 12xF-18B+
Y183+	NAC, 2xDWA/FBE	12xF-18C, 6xF-111 or 6xF-101C, 12xF-18C

Carriers serving on the Romulan front usually operated with escorts especially designed for that front. These escorts were more difficult to build and maintain and were only used on that front. This combination is noted by the note “(Rom).” Production of the Romulan-front escort variants virtually ceased by the end of the General War.

Escort ready racks: The ready racks of the escorts were configured for F-18 (R2.F5) fighters. Escorts cannot have ready racks for heavy fighters; see (S8.318).

Seeking weapons: The new division control ship can control a number of seeking weapons equal to double its sensor rating (F3.212). See also (F3.213).

Refits: None.

SSD and counter are in *Module R10*.

Known names: 1695 *Pompeii*, 1697 *Tamerlane*.

(R2.112) NEW (PLASMA) CRUISER (NAL): A proposed but never built variant, the new (plasma) cruiser would have followed the lines of the plasma-armed “leader” variants. (While called a “leader” this designation in Star Fleet meant a plasma-F-armed variant, not a command platform.) The design was revived after the General War as a ship to hunt Andromedans, but was rejected this second time in favor of advanced technology ships. There were four plasma-F torpedo armed versions of the new light cruiser (R2.A39), but none of these were converted to this design. Star Fleet captains regarded the plasma-F torpedo as a very poor substitute for photons, but adequate as a secondary weapon.

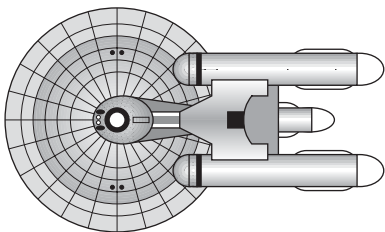

The new (plasma) cruiser is a variant of the new heavy cruiser (R2.77).

Seeking weapons: The new (plasma) cruiser can control a number of seeking weapons equal to its sensor rating (F3.21).

Refits: The carronade refit [this refit is not shown on the

SSD, see (FP14.0)] was included in the design. The plasma sabot refit [this refit is not shown on the SSD, see (FP11.0)] was available in Y180 and would have been installed by Y181.

SSD and counter are in *Module R10*.

This ship is conjectural.

Known Names: None, conjectural unbuilt variant.

(R2.113) NEW HEAVY FIGHTER CARRIER (NHV): The shock of the new Klingon fast patrol ships forced the Federation to build new carriers for the heavy F-111 (R2.F11) fighters as rapidly as possible. This included converting the damaged new heavy cruisers (R2.77) *Chicago* and *Dayton* into carriers [mounting the F-111s on external mech-links (J1.561)] in Y179 and Y180, respectively. Others were built or converted in subsequent years. These carriers never had SWAC [(J9.0)/(R2.F3)] shuttles as those did not work well with F-111s.

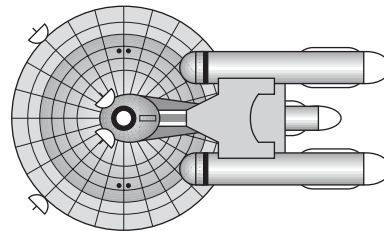

Some of these ships were configured to operate A-20s and were designated NHA (R2.134).

The cargo boxes use the (R2.R5) rules.

The new heavy fighter carrier is a variant of the new heavy cruiser (R2.77).

Scout: It can use all scout functions (G24.0). Special sensors are destroyed by “torpedo” damage points. See (G24.35) when purchasing this unit as part of a battle force.

Carrier: This ship is a true carrier; see (J4.75), (J4.93), (J11.13), and (J15.22).

This ship has one internal shuttle bay, which operates normally, and the bay used by the heavy fighters. The heavy fighter bay is semi-external, and all six heavy fighters can be launched or landed (or some could be landing while others launch) in a single impulse or over multiple impulses. Mines can only be laid from the admin shuttle bay (M2.113).

Year	Escorts	Fighters
Y177-Y180	NAC, FFA or NAC, FRA (Rom)	6xF-111 or 6xF-101B
Y180-Y183	NAC, DWA/FBE or NAC, FRA (Rom) or None	6xF-111 or 6xF-101C
Y183+	NAC, DWA/FBE or None	6xF-111 or 6xF-101C

Carriers serving on the Romulan front usually operated with escorts especially designed for that front. These escorts were more difficult to build and maintain and were only used on that front. This combination is noted by the note “(Rom).” Production of the Romulan-front escort variants virtually ceased by the end of the General War.

Escort ready racks: The ready racks of the escorts were configured for F-18 (R2.F5) fighters. Escorts cannot have ready racks for heavy fighters; see (S8.318).

Seeking weapons: The new heavy fighter carrier can control a number of seeking weapons equal to double its sensor rating (F3.212). See also (F3.213).

Refits: None.

SSD and counter are in *Module R10*.

Known names: 1651 *Chicago* (converted from NCA), 1653 *Dayton* (converted from NCA), 1693 *Rene Fonck*

(converted to an NHA), 1694 *Ivan Kozhedub* (converted to an NHA).

(R2.114) NEW HEAVY SCOUT (NHS): The Federation had long enjoyed an electronic warfare superiority over the Klingons due to their superb pre-General War scout (R2.7) class [which were modified destroyers (R2.6)]. For technical reasons, the slightly larger new scout cruiser (R2.19) class [based on the new light cruiser (R2.18)] actually had less electronic warfare capability than the older destroyer-class scouts had). Steady losses among the scout class during the General War (not to mention the increasing appearance of heavy scouts among Coalition fleets) weakened the Federation advantage, and Star Fleet (unable to improve the new scout cruiser) turned to the new heavy cruiser class to fill the gap. Two new scout cruisers (*USS Discovery* and *USS Santa Maria*), were converted into new heavy scouts in Y176 and Y177, and a third new scout cruiser was converted into a new heavy scout a few years later. Note that the name *Discovery* was used earlier for a galactic survey cruiser (R2.16) which was destroyed. The *Discovery* used for this conversion was the first of an entirely different class, a scout variant of a new light cruiser.

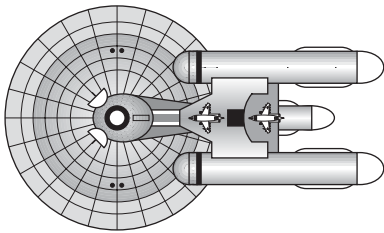

The new heavy scout is a variant of the new heavy cruiser (R2.77).

Scout: It can use all scout functions (G24.0). Special sensors #1-#4 are destroyed by "torpedo" damage points, while special sensors #5-#8 are destroyed by "phaser" damage points. See (G24.35) when purchasing this unit as part of a battle force.

Seeking weapons: The new heavy scout can control a number of seeking weapons equal to its sensor rating (F3.21). See also (F3.213).

Refits: None.

SSD and counter are in *Module R10*.

Known names: 2001 *Discovery* (converted from NSC), 2002 *Santa Maria* (converted from NSC).

(R2.115) NEW HEAVY AEGIS ESCORT (NAE): A proposed but unbuilt variant, the new heavy aegis escort was intended to provide increased strength for carrier groups in the face of the new Klingon fast patrol ships. Given the pressure on the production schedule, any new heavy aegis escorts would probably have been conversions of existing new aegis cruisers (R2.59).

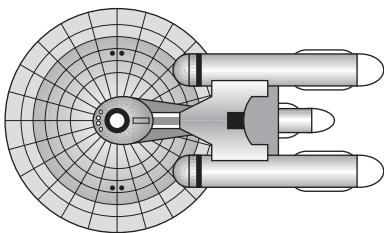

This ship has two ready racks (J4.89) and deck crews (J4.81) to support the fighters from the carrier it is escorting. The deck crews are not in addition to the deck crews provided

by (J4.814), but replace them, representing their being retrained to service and arm fighters. See (R2.R5).

The new heavy aegis escort is a variant of the new heavy cruiser (R2.77).

Seeking weapons: The new heavy aegis escort can control a number of seeking weapons equal to double its sensor rating (F3.212) and has full aegis (D13.0). See also (J15.332).

Refits: None.

SSD and counters are in *Module R10*.

This ship is conjectural.

Known Names: 1671 *San Diego* (name assigned, but no ship was actually built).

NOTES: No heavy version of a light tactical transport (R2.38) was created as the additional engine would have blocked the pod attachment position.

THE FEDERATION NATIONAL GUARD SHIPS

(R2.116) NATIONAL GUARD CRUISER (GCA): These ships were updated versions of the YCA-class (YR2.4). All of them were decades old in the General War, but served with distinction before, during, and sometimes after that conflict. There were never more than 10 of these ships, and due to some being mothballed or undergoing maintenance, it was unusual for more than eight to be in active service. Each major member planet (Earth, Mars, Vulcan, Andoria, Rigel, Cygnus, Arcturia, Alpha-Centari) was allocated one of these cruisers as the flagship of their National Guard. Some of these ships were assigned to duty in areas away from the home planet (and paid for by the Federation because the home planet did not want to pay for it to guard their home planet).

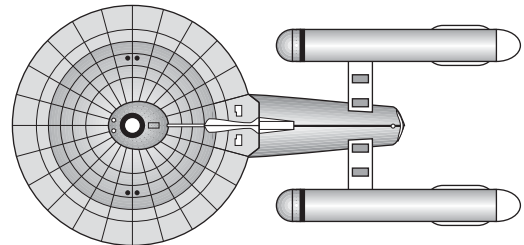

These ships had many duties, including defense of the home world, training personnel for duty with Star Fleet or membership in the Star Fleet Reserve (trained personnel who could be called to duty to crew the mothballed ships and new construction), and enhancing the prestige of the home world. When the home world established a new colony somewhere, the National Guard flagship was often dispatched (loaded with planetary officials) to "show the flag."

In wartime, these ships formed a vital part of Star Fleet, covering the Gorn borders, patrolling the off-map region, and dealing with the space monsters who hadn't noticed a war going on. One attempt to use a squadron of three of these ships in a battle against the Klingons in September Y171 ended in disaster as the ships could not maneuver or fight with the first-line ships and became easy targets.

The National Guard cruiser is a variant of the early heavy cruiser (YR2.4).

Seeking weapons: The National Guard cruiser can control a number of seeking weapons equal to half its sensor rating (F3.211).

Refits: Transporters increased from Range 4 to Range 5 in Y140. Tractors increased from Range 2 to Range 3 in Y140.

SSD and counter are in *Module R8*.

Known names: 1001 *Revenge*, 1002 *Warspite*, 1003 *Tuqareg*, 1004 *Stalwart*, 1005 *General Teloma Monora*, 1013 *Shreshalia* (converted to GVM).

(R2.117) NATIONAL GUARD DESTROYER (GDD): About 15 of these ships were in service in the various Federation National Guards in Y168, many as the flagships of member planets that could not afford (or did not want to pay for) a cruiser. All were used for home world defense, training, and prestige missions. One of these belonged to Orion and went neutral when the enclave did.

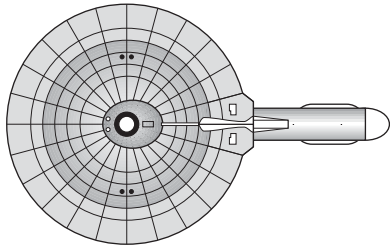

The National Guard destroyer is a variant of the early destroyer (YR2.7).

Seeking weapons: The National Guard destroyer can control a number of seeking weapons equal to half its sensor rating (F3.211).

Refits: Transporters increased from Range 4 to Range 5 in Y140. Tractors increased from Range 2 to Range 3 in Y140.

SSD and counter are in *Module R8*.

Known names: 0205 *Ligny*, 0204 *Red Cloud*, 0208 *Blenheim*, 0209 *Roncevalles*, 0214 *Almirante Grau*, 0217 *Ganymede*, 0219 *Akerlon*.

(R2.118) NATIONAL GUARD FRIGATE (GFF): About 20 of these ships were in service in various National Guards in Y168. About half were the sole starship of a minor member planet while others were the second, or third, starship in the National Guard of a major member planet. All were used for home world defense, training, and prestige missions. Those assigned to major planets did rather more time away from their homeworlds (visiting colonies sponsored by those home worlds) than the cruisers did.

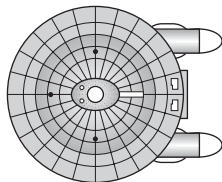

The National Guard frigate is a variant of the early frigate (YR2.8).

Seeking weapons: The National Guard frigate can control a number of seeking weapons equal to half its sensor rating (F3.211).

Refits: Transporters increased from Range 4 to Range 5 in Y140. Tractors increased from Range 2 to Range 3 in Y140.

SSD and counter are in *Module R8*.

Known names: 0107 *Howe*, 0109 *Mecklenberg*, 0111 *Kirby Smith*, 0112 *Dorsey Pender*, 0113 *Jubal Early*, 0114 *Joseph E Johnston*, 0115 *Cyrus Eaton*, 0117 *Arcturian*.

(R2.119) NATIONAL GUARD MEDIUM CARRIER (GVM): Three ships of this type existed, being owned by the National Guards of Earth (*Gaia*), Cygnus (*Shreshalia*), and Andoria (*Cooperative*). They were used for local defense and for pilot

training. The Cygnan ship used locally built fighters that were not the standard design for National Guard units. All operated with a single escort, although in wartime they were sometimes given a second escort (never a third).

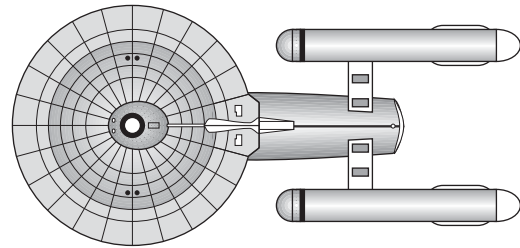

The National Guard medium carrier is a variant of the early heavy cruiser (YR2.4).

Carrier: This ship is a true carrier; see (J4.75), (J4.93), (J11.13), and (J15.22).

This ship has two hatches for its shuttle bay, which is a tunnel deck (J1.58), and can launch or land two shuttles every other impulse, or launch or land one shuttle every impulse.

YEAR	ESCORT	Earth, Andor FIGHTERS	Cygnan FIGHTERS
Y169-Y170	GDE	12xF-4	12xF-104
Y170-Y175	GDE	12xF-8	12xF-104J
Y175-Y178	GDE	12xF-16	12xF-104S
Y178-Y183	GDE	12xF-16	12xA-6D
Y183+	GDE	12xF-16C	12xA-6D

Escort ready racks: The ready racks of the escorts were configured for whichever fighter type the carrier was operating in the appropriate year. Escorts cannot have ready racks for heavy fighters; see (S8.318).

Historically, these ships never operated heavy fighters.

Seeking weapons: The National Guard medium carrier can control a number of seeking weapons equal to its sensor rating (F3.21).

Refits: None.

SSD and counter are in *Module R8*.

Known names: 1012 *Gaia*, 1013 *Shreshalia*, 1014 *Cooperative*.

(R2.120) NATIONAL GUARD ESCORT (GDE): Three of these modified destroyers existed to escort the three National Guard medium carriers (R2.119). Earth operated the *Luna*, Cygnus operated the *Capra*, while Andor operated the *Pact*.

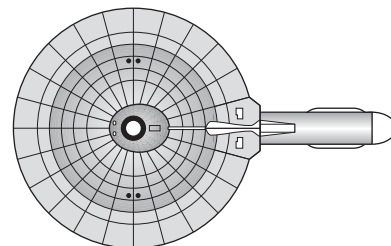

This ship has two ready racks (J4.89) and deck crews (J4.81) to support the fighters from the carrier it is escorting. The deck crews are not in addition to the deck crews provided by (J4.814), but replace them, representing their being retrained to service and arm fighters. See (R2.R5).

The National Guard escort is a variant of the early destroyer (YR2.7).

Seeking weapons: The National Guard escort can control a number of seeking weapons equal to its sensor rating (F3.21) and has limited aegis (D13.4). See also (J15.332).

Refits: None; confirming that these ships did not receive the Y175 refit and were never upgraded to full aegis.

SSD and counter are in *Module R8*.

Known Names: 0236 *Luna*, 0239 *Capra*, 0242 *Pact*.

THE FEDERATION POLICE

(R2.121) POLICE FRIGATE (PFF): Proposed by the Tacoma-Rigel shipyard, the police frigate had several design features of interest. The front of the basic police cutter (R2.12) was extended slightly to allow the installation of not just an additional photon torpedo, but also two extra phaser-1s. The phaser-3s of the plus refit were replaced with an additional type-G drone rack, and a second 360° phaser-1 was installed. Shielding was again increased as with the other proposals. The increased mass was countered in part by the addition of a third engine mounted on the centerline opposite the 360° phasers (and thus not blocking their firing arcs), while the original engines were moved slightly creating a “V” configuration layout. Despite this effort, the resulting ship was not as nimble as the original police cutter, although the design remained highly maneuverable compared to other Federation ships. The design was woefully under-powered (or extremely over-gunned depending on your point of view) having an operating speed of only Warp 2.2 (Speed 11) while arming all weapons.

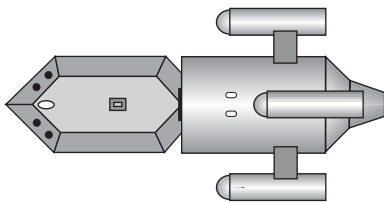

It should be noted that the Solar Turbomecha company, which also owned the Tacoma-Rigel shipyard, was the primary contractor providing the 30K MW engines used by Federation police cutters. The company had a built-in reason to seek to keep its engines in service (it should be noted that the 30K MW engine had a reputation for reliability and was a “proven design”). The company had already lost out on a bid to the Blohm-and-Vulcan shipyard, which was proposing the improved cutter, to provide engines for the new Federation war destroyer class (R2.65), new heavy cruiser class (R2.77), and heavy command cruiser class (R2.76), and was in considerable financial straits. If it lost the police cutter market for its 30K MW engines, bankruptcy would soon follow. Perhaps for this reason the design was ordered into production.

Like the other proposals, the police frigate retained the basic operational characteristics of the basic police cutter.

The police frigate is a variant of the police cutter (R2.12) but the changes were sufficiently extreme that it is considered a new class.

Seeking weapons: The police frigate can control a number of seeking weapons equal to its sensor rating (F3.21).

Refits: None, the Y175 refit was included in the design.

SSD and counter are in *Module R8*.

Known names: None known.

FEDERATION SHIPS THAT NEVER WERE

(R2.122) HEAVY SCOUT CARRIER (NSV): The Federation considered this conversion of a scout carrier (R2.99), but ultimately built only one, converting the *USS Betio*. The Federation found that the ship was ineffective as the A-20s (R2.F9) were too hard to arm, and production of A-20s was limited and could not support the number of carriers in service as it was. Given the ship’s limitations and the rapid deployment of superior [i.e., F-111 (R2.F11)] designs, no further conversions were considered.

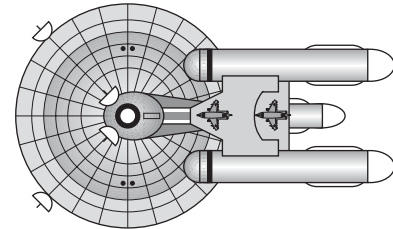

The new heavy scout carrier is a variant of the new heavy cruiser (R2.77).

Scout: It can use all scout functions (G24.0). Special sensors are destroyed by “torpedo” damage points. See (G24.35) when purchasing this unit as part of a battle force.

Carrier: This ship is a true carrier; see (J4.75), (J4.93), (J11.13), and (J15.22).

This ship has one shuttle bay.

Year	Escorts	Fighters
Y180-Y183	NAC, DWA/FBE or NAC, 2xFRA (Rom) or None	6xA-20F
Y183+	NAC, DWA/FBE or None	6xA-20F

Carriers serving on the Romulan front usually operated with escorts especially designed for that front. These escorts were more difficult to build and maintain and were only used on that front. This combination is noted by the note “(Rom).” Production of the Romulan-front escort variants virtually ceased by the end of the General War. The ship often operated independently, i.e., without escorts.

Escort ready racks: The ready racks of the escorts were configured for F-18 (R2.F5) fighters. Escorts cannot have ready racks for heavy fighters; see (S8.318).

Seeking weapons: The heavy scout carrier can control a number of seeking weapons equal to double its sensor rating (F3.212). See also (F3.213).

Refits: None.

SSD and counter are in *Module R9*.

Known names: 1484 *Betio* (converted from CSV).

(R2.123) WAR DREADNOUGHT (DNW): The appearance of the new heavy cruiser (R2.77) classes about Y175 set the minds of naval architects to thinking as to just what might be accomplished. The appearance of the Gorn dreadnought cruiser (R6.104) in Y174 had already shown that the path to dreadnoughts was not impossible. Design studies were commissioned, but it was determined that existing new light cruisers (R2.18) could not be used (due to their relatively fast production) and it would be necessary to build “standard” versions of these ships for war dreadnoughts. While this engineering work ultimately paved the way for advanced technology conversions of new light cruisers, no war dreadnoughts were built as they would have reduced the production of advanced technology destroyers (R2.202).

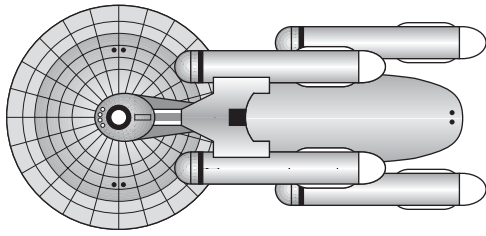

While the saucer is essentially a new light cruiser (R2.18), if it separates it operates under the rules of (G12.0), e.g., it has 20 box shields as defined by (G12.331).

The war dreadnought, while using a new light cruiser saucer (R2.18), is considered to be a base hull.

Seeking weapons: The war dreadnought can control a number of seeking weapons equal to its sensor rating (F3.21).

Refits: None.

Designed by Stephen V. Cole.

SSD and counter are in *Module R9*.

This ship is conjectural.

Known names: None, conjectural unbuilt variant.

(R2.124) MEDIUM DREADNOUGHT (DNM): When the advent of advanced technology ships made deep raids behind enemy lines even more dangerous than before, the Federation considered several options for the remaining “splendid cats” (R2.91). One option was this design, which would have increased the movement cost (ending their careers as raiders) but turned them into the equivalent of heavy dreadnoughts (R2.90) by adding a structure to the saucer (no increase to separated saucer movement cost). Tradition died hard and the last of the light dreadnoughts remained in service unchanged through the end of the General War.

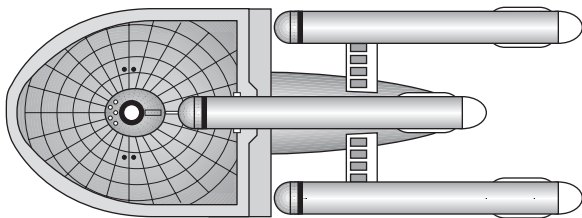

These designs were derided as “the pregnant cats.”

This ship is a variant of the light dreadnought (R2.91) but the changes were sufficiently extreme that it is considered a new class.

Seeking weapons: The medium dreadnought can control a number of seeking weapons equal to its sensor rating (F3.21).

Refits: None.

Designed by Stephen V. Cole.

SSD and counter are in *Module R9*.

This ship is conjectural.

Known names: None, conjectural unbuilt variant.

(R2.125) LIGHT ADVANCED TECHNOLOGY DREADNOUGHT (DLX): The appearance of advanced technology ships made the jobs of the light dreadnought (R2.91) and fast cruiser (R2.82) fast raiders much more difficult, as it effectively doubled, then tripled, then quadrupled the number of “fast” ships available within a year. (Admirals were reluctant to risk their untested advanced technology ships on deep raids, but found them the perfect ships to deal with enemy deep raiders.) The logical way to keep the light dreadnoughts in service was to give them X-technology, something that proved impossible due to the various

technological limits. This Federation design would have been a superb raider, if it could have been built.

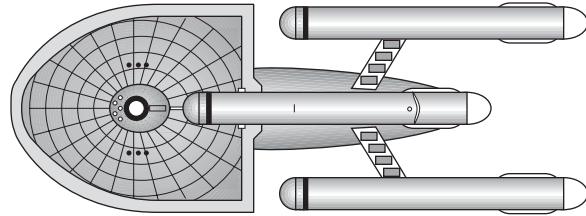

This light advanced technology dreadnought is a variant of the light dreadnought (R2.91).

The light advanced technology dreadnought is a “first generation X-ship;” see (X0.0).

Deployment: See (S8.48) for deployment restrictions and conditions.

Seeking weapons: The light advanced technology dreadnought can control a number of seeking weapons equal to double its sensor rating (F3.213) and has X-aegis (XD13.0).

Refits: None.

Fast: This ship is a “fast” ship.

Designed by Steven P. Petrick.

SSD and counter are in *Module R9*.

This ship is conjectural.

Known Names: None, conjectural unbuilt variant.

FEDERATION NATIONAL GUARD F-111 CARRIER

(R2.126) NATIONAL GUARD F-111 CARRIER (GVH): One ship of this type, the *USS Monaco*, was built along with the heavy fighter transport (R2.56) as a training carrier. It was pressed into service as an anti-piracy patrol ship. The Federation considered building more ships of this type as National Guard heavy cruisers (R2.116) were available, but experience had shown the ships were too slow and limited to be effective and there were too few F-111s (R2.F11) available to waste any on such a limited platform. One, *Seranaya* (ex-*Macao*), was converted by the Cygnans as a privately funded project but they were unable to produce heavy fighters for it and its operations were limited by the availability of replacements.

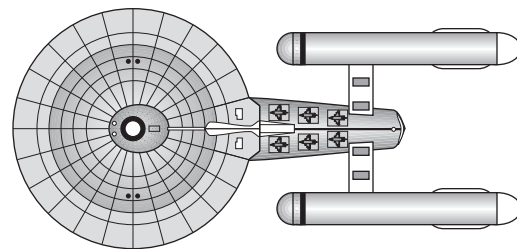

The cargo boxes use the (R2.R5) rules.

The National Guard F-111 carrier is a variant of the early heavy cruiser (YR2.4).

Carrier: This ship is a true carrier; see (J4.75), (J4.93), (J11.13), and (J15.22).

This ship has one internal shuttle bay, which operates normally, and the bay used by the heavy fighters. The heavy fighter bay is semi-external, and all six heavy fighters can be launched or landed (or some could be landing while others launch) in a single impulse or over multiple impulses. Mines can only be laid from the admin shuttle bay (M2.113).

Year	Escorts	Fighters
Y177-Y179	1-2 GDE	6xF-111 or 6xF-101B
Y180+	1-2 GDE or None	6xF-111 or 6xF-101C

Escort ready racks: The ready racks of the escorts were configured for F-18 (R2.F5) fighters. Escorts cannot have ready racks for heavy fighters; see (S8.318).

Seeking weapons: The National Guard F-111 carrier can control a number of seeking weapons equal to its sensor rating (F3.21).

Refits: None.

SSD and counter are in *Module R9*.

Known names: 1015 *Monaco*, 1016 *Seranaya* (ex-*Macao*).

FEDERATION MAULERS

(R2.127) HEAVY MAULER CRUISER (CAM): The Federation never built maulers. These were needed to attack bases (something that the Federation did not do until Y180, when late General War battle lines were powerful enough to do so without maulers). This design is provided for use in campaigns where the Federation acquires mauler technology. Roll for shock (D23.22) when firing the mauler. Saucer separation is not possible.

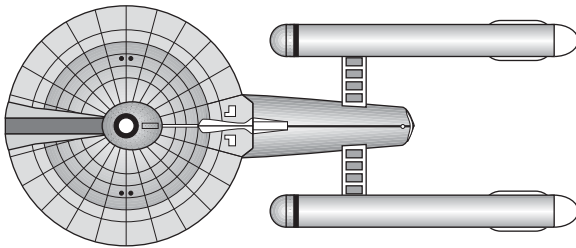

The heavy mauler cruiser is a variant of the heavy cruiser (R2.4).

Seeking weapons: The heavy mauler cruiser can control a number of seeking weapons equal to its sensor rating (F3.21).

Refits: The Y175 refit would have been installed had the ship been built.

SSD and counter are in *Module R9*.

This ship is conjectural.

Known names: 1648 *Velikovski*, 1646 *Von Daniken*, 1647 *Olshesky* (names assigned, but no ships were actually built).

(R2.128) NEW MAULER CRUISER (MCL): This is the new light cruiser (R2.18) version of the mauler cruiser; the same background as the heavy mauler cruiser (R2.127) above applies. Roll for shock (D23.22) when firing the mauler.

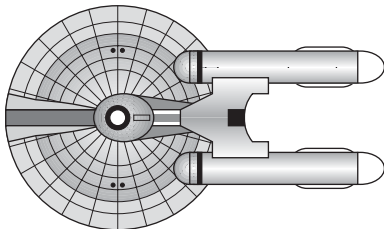

The new mauler cruiser is a variant of the new light cruiser (R2.18).

Seeking weapons: The new mauler cruiser can control a number of seeking weapons equal to half its sensor rating

(F3.211).

Refits: The plus refit could probably have been installed in the original design, but possibly not until after the ship had been in service, possibly as late as Y178.

SSD and counter are in *Module R9*.

This ship is conjectural.

Known names: 1499 *Kevorkian* (name assigned, but no ship was actually built).

FEDERATION SHIPS THAT NEVER WERE

(R2.129) AREA CONTROL SHIP (ACS): Due to the limited availability of A-20s (R2.F9), the Federation never produced this ship, but they could have (by not producing other A-20 carriers). This conjectural design may be used in campaigns with an overall limit on A-20 carriers in service.

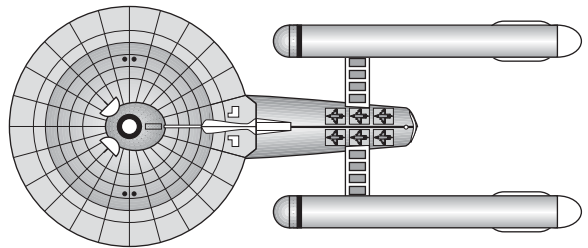

The cargo boxes use the (R2.R5) rules.

The area control ship is a variant of the heavy cruiser (R2.4).

Scout: It can use all scout functions (G24.0). Special sensors are destroyed by "phaser" damage points. See (G24.35) when purchasing this unit as part of a battle force.

Carrier: This ship is a true carrier; see (J4.75), (J4.93), (J10.111), (J11.13), and (J15.22).

This ship has two internal shuttle bays: the one for its admin shuttles [(J2.0)/(R1.F1)], which operates normally, and the bay used by the size-1 fighters; transfers between these bays are not possible. The heavy fighter bay is semi-external, and all six heavy fighters can be launched or landed (or some could be landing while others launch) in a single impulse or over multiple impulses. Mines can only be laid from the admin shuttle bay (M2.113).

Year	Escorts	Fighters
Y177-Y179	NAC, 2xDWA/FBE or NAC, 2xFRA (Rom)	12xF-18B, 6xA-20
Y180-Y183	NAC, 2xDWA/FBE or NAC, 2xFRA (Rom)	12xF-18B+, 6xA-20F
Y183+	NAC, 2xDWA/FBE	12xF-18C, 6xA-20F

Carriers serving on the Romulan front usually operated with escorts especially designed for that front. These escorts were more difficult to build and maintain and were only used on that front. This combination is noted by the note "(Rom)." Production of the Romulan-front escort variants virtually ceased by the end of the General War.

Escort ready racks: The ready racks of the escorts were configured for F-18 (R2.F5) fighters. Escorts cannot have ready racks for heavy fighters; see (S8.318).

Seeking weapons: The area control ship can control a number of seeking weapons equal to double its sensor rating (F3.212). See also (F3.213).

Refits: None.

SSD and counter are in *Module R9*.

This ship is conjectural.

Known names: 1995 *Joseph Butler* (name assigned, but no ship was actually built).

(R2.130) BOMBARDMENT CARRIER (VDB): In Y180, the Federation drone bombardment cruiser *USS Agincourt* was severely damaged in an ambush by Klingon fast patrol ships resulting in the saucer separating from the secondary hull to escape. Star Fleet considered several plans to repair the ship, one of which was to use the rear hull of a heavy fighter carrier (R2.100) rather than of a heavy cruiser (R2.4). This would have produced a ship that could launch a long-range F-111 (R2.F11) strike and support this with a drone bombardment wave; in such operations it was believed the ship would not need escorts as it was not expected to engage in direct combat. This concept overlooked the fact that many carriers launching distant strikes found themselves fighting off attacking forces while trying to recover their strike group. After some consideration, Star Fleet repaired the *Agincourt* to its original specifications (retaining it as a drone bombardment platform) and did not pursue the bombardment carrier design.

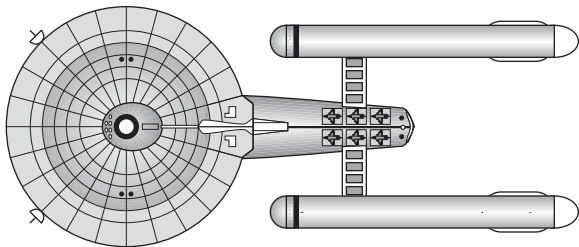

The bombardment carrier is a variant of the heavy cruiser (R2.4).

Scout: It can use all scout functions (G24.0). Special sensors are destroyed by “phaser” damage points. See (G24.35) when purchasing this unit as part of a battle force.

Carrier: This ship is a true carrier; see (J4.75), (J4.93), (J11.13), and (J15.22).

Bombardment: This ship has two hundred spaces of spare drones stored in the cargo boxes of the saucer; see (FD10.671) and (S3.222). The cargo boxes in the rear hull use the (R2.R5) rules.

This ship has one internal shuttle bay, which operates normally, and the bay used by the heavy fighters. The heavy fighter bay is semi-external, and all six heavy fighters can be launched or landed (or some could be landing while others launch) in a single impulse or over multiple impulses. Mines can only be laid from the admin shuttle bay (M2.113).

Year	Escorts	Fighters
Y180+	None	6xF-111 or 6xF-101C

Deployment: See (S8.47) for deployment restrictions and conditions.

Seeking weapons: The bombardment carrier can control a number of seeking weapons equal to double its sensor rating (F3.212). See also (F2.213).

Refits: None.

Design by John Sickels.

SSD and counter are in *Module R9*.

This ship is conjectural.

Known names: 1601 *Agincourt* (this is the name of the ship considered for conversion to this design, but no conversion was made).

FEDERATION STRIKE CRUISER

(R2.131) STRIKE CRUISER (CS): After the Four Powers War, the Federation studied several designs for new cruisers that might be produced more quickly should a wartime emergency require this. One of these studies produced the

famous new light cruiser (R2.18), another study proposed this unusual design.

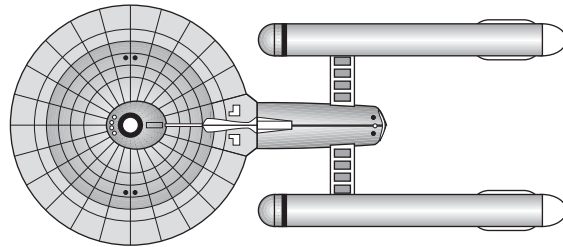

The strike cruiser began with a standard heavy cruiser (R2.4) saucer, but reduced the lab facilities and replaced them with other systems. This allowed a smaller rear hull to be used with the same engines, producing a ship that was slightly faster, could be built more cheaply, and could operate with a smaller crew. The ship had an unusual movement cost of 5/6. The rear hull mounted the engines at a flatter angle [used later by the battlecruiser (R2.33)], improving the side phaser firing arcs.

Only one ship of this type, the *Prometheus*, was completed as a prototype before the new light cruiser design was selected, although several more were subsequently constructed. The one advantage of this ship over the new light cruiser is that its slipways [the new light cruiser slipways converted from destroyer (R2.6) slipways] could have also produced strike cruisers.

The strike cruiser is a variant of the heavy cruiser (R2.4) but the changes were sufficiently extreme that it is considered a new class. There is an advanced technology conversion.

Seeking weapons: The strike cruiser can control a number of seeking weapons equal to its sensor rating (F3.21).

Refits: The plus refit was available beginning in Y165, was common by Y171, and was universal by Y175. The AWR refit was available in Y170; all ships had it by Y174. The Y175 refit was installed in Y175.

Designed by Jeremy Gray.

SSD and counter are in *Module R9*.

Known names: 1636 *Prometheus*, 1637 *Daedalus*, 1638 *Epimethius*.

FEDERATION CARRIERS

(R2.132) HEAVY FIGHTER CARRIER (CAV): When A-20 (R2.F9) fighters became available, the strike carrier *Forrest Sherman* was converted (during construction) to operate them. Initial operations of the A-20s were disappointing and there was much debate about replacing the A-20s with A-10s (R2.F2) (rejected because the A-10s were even slower than the A-20s and even harder to produce), or even mixed squadrons of F-18s (R2.F5) and A-10s. The admiralty had decided to convert the ship back into a standard strike carrier when a breakthrough in engine design made the A-20 effective.

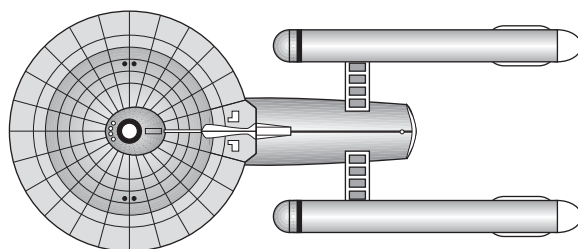

The heavy fighter carrier is a variant of the heavy cruiser (R2.4). Variants include the advanced technology heavy fighter carrier (R2.212).

Carrier: This ship is a true carrier; see (J4.75), (J4.93), (J11.13), and (J15.22).

This ship has two hatches for its shuttle bay, which is a tunnel deck (J1.58), and can launch or land two shuttles every other impulse, or launch or land one shuttle every impulse.

Year	Escorts	Fighters
Y177-Y179	NAC, DWA/FBE/FFA or NAC, DWR/FRA (Rom)	6xA-20
Y179-Y180	NAC, DWA/FBE/FFA or NAC, DWR/FRA (Rom)	6xA-20F
Y180-Y183	NAC, DWA/FBE/FFA or NAC, DWR/FRA (Rom) or None	6xA-20F
Y183+	NAC, DWA/FBE/FFA or None	6xA-20F

Carriers serving on the Romulan front usually operated with escorts especially designed for that front. These escorts were more difficult to build and maintain and were only used on that front. This combination is noted by the note "(Rom)." Production of the Romulan-front escort variants virtually ceased by the end of the General War.

Escort ready racks: The ready racks of the escorts were configured for F-18 (R2.F5) fighters. Escorts cannot have ready racks for heavy fighters; see (S8.318).

Seeking weapons: The heavy fighter carrier can control a number of seeking weapons equal to double its sensor rating (S3.212).

Refits: None.

SSD and counter are in *Module R11*.

Known names: 1965 *Forrest Sherman*, 1966 *Yamaguchi*, 1967 *Curtis LeMay*, 1968 *Henry Arnold*, 1969 *Omar Bradley*.

(R2.133) DIVISION CONTROL SHIP (DCS): Mounting the superb F-111 (R2.F11) heavy attack fighter, this ship was one of the first division control ships to enter service in the Alpha Octant. The design was a variation of the interdiction carrier (R2.97), and the first ship in the class began construction as such a ship. Changes to the interdiction carrier saucer section were minimal (involving the replacement of the forward phaser battery with special sensors), but were more radical in the secondary hull, which was slightly enlarged to better support the F-111s on mech-links (J1.561). The division control ships were considered a completely different class than the interdiction carriers, resulting in a different naming convention (ancient leaders as opposed to Terran rivers). The division control ships proved effective in hunting down the Andromedan Rapid Transit Network (R10.1B) during the Andromedan War. As with the interdiction carrier design, SWAC shuttles [(J9.0)/(R2.F3)] were sometimes assigned to these ships, but such occurrences were very rare. MRS (J8.0) and SWAC shuttles are not included within the BPV. This carrier cannot use an E-3A heavy SWAC shuttle (R2.F3A).

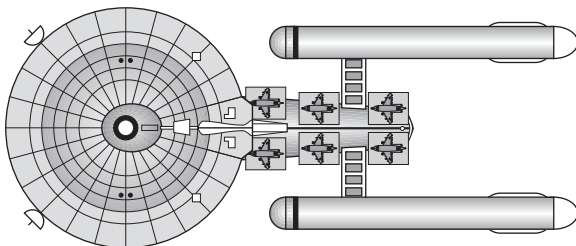

The cargo boxes use the (R2.R5) rules.

The division control ship is a variant of the heavy cruiser (R2.4).

Scout: It can use all scout functions (G24.0). Special sensors are destroyed by "phaser" damage points. See (G24.35) when purchasing this unit as part of a battle force.

Carrier: This ship is a true carrier; see (J4.75), (J4.93), (J10.111), (J11.13), and (J15.22).

This ship has two internal shuttle bays: the one for its admin shuttles [(J2.0)/(R1.F1)], which operates normally, and the bay used by the size-1 fighters; transfers between these two bays are not possible. The heavy fighter bay is semi-external, and all six heavy fighters can be launched or landed (or some could be landing while others launch) in a single impulse or over multiple impulses. Mines can only be laid from the admin shuttle bay (M2.113).

Year	Escorts	Fighters
Y178-Y180	NAC, DWA/FBE/FFA or NAC, FRA (Rom)	12xF-18B, 6xF-111 or 6xF-101B, 12xF-18B
Y180-Y183	NAC, DWA/FBE/FFA or NAC, FRA (Rom)	12xF-18B+, 6xF-111 or 6xF-101C, 12xF-18B+
Y183+	NAC, DWA/FBE	12xF-18C, 6xF-111 or 6xF-101C, 12xF-18C

Carriers serving on the Romulan front usually operated with escorts especially designed for that front. These escorts were more difficult to build and maintain and were only used on that front. This combination is noted by the note "(Rom)." Production of the Romulan-front escort variants virtually ceased by the end of the General War.

Escort ready racks: The ready racks of the escorts were configured for F-18 (R2.F5) fighters. Escorts cannot have ready racks for heavy fighters; see (S8.318).

Seeking weapons: The division control ship can control a number of seeking weapons equal to double its sensor rating (F3.212). See also (F3.213).

Refits: None.

SSD and counter are in *Module R11*.

Known names: 1970 *Vercingtorix* (Gaul), 1971 *Boudica* (Briton), 1972 *Clovis* (Frankish), 1973 *Surena* (Parthian). At least three more ships of this class were built.

(R2.134) NEW HEAVY FIGHTER CARRIER (NHA): While grouped in the ship list with the new heavy fighter carriers (R2.113), these were a separate sub-class carrying A-20s (R2.F9). The ships were otherwise identical to new heavy fighter carriers and operated in much the same manner, i.e., they never had SWAC shuttles [(J9.0)/(R2.F3)] assigned to them and used the same escorts.

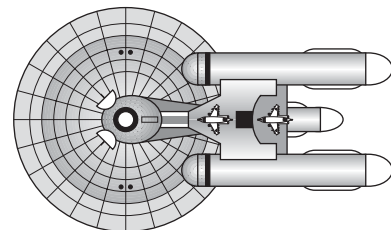

The cargo boxes use the (R2.R5) rules.

The new heavy fighter carrier is a variant of the new heavy cruiser (R2.77).

Scout: It can use all scout functions (G24.0). Special sensors are destroyed by “torpedo” damage points. See (G24.35) when purchasing this unit as part of a battle force.

Carrier: This ship is a true carrier; see (J4.75), (J4.93), (J11.13), and (J15.22).

This ship has one internal shuttle bay, which operates normally, and the bay used by the heavy fighters. The heavy fighter bay is semi-external, and all six heavy fighters can be launched or landed (or some could be landing while others launch) in a single impulse or over multiple impulses. Mines can only be laid from the admin shuttle bay (M2.113).

Year	Escorts	Fighters
Y177-Y179	NAC, DWA/FBE/FFA or NAC, FRA (Rom)	6xA-20
Y179-Y180	NAC, DWA/FBE/FFA or NAC, FRA (Rom)	6xA-20F
Y180-Y183	NAC, DWA/FBE/FFA or NAC, FRA (Rom) or None	6xA-20F
Y183+	NAC, DWA/FBE or None	6xA-20F

Carriers serving on the Romulan front usually operated with escorts especially designed for that front. These escorts were more difficult to build and maintain and were only used on that front. This combination is noted by the note “(Rom).” Production of the Romulan-front escort variants virtually ceased by the end of the General War.

Escort ready racks: The ready racks of the escorts were configured for F-18 (R2.F5) fighters. Escorts cannot have ready racks for heavy fighters; see (S8.318).

Seeking weapons: The new heavy fighter carrier can control a number of seeking weapons equal to double its sensor rating (F3.212). See also (F3.213).

Refits: None.

SSD and counter are in *Module R11*.

Known names: 1693 *Rene Fonck* (converted from an NHV), 1694 *Ivan Kozhedub* (converted from an NHV).

FEDERATION PODS

A variety of pods were created for the tug.

Pods cannot be docked back-to-back unless they are inactive due to the power connections. They can only be docked back-to-front, e.g., front of the second pod is docked to the back of the first pod. Any FA weapons on the second pod would be blocked and unable to fire unless the pod were dropped. Note that some pods may have shuttle hatches blocked by the presence of another pod.

Pods never had official names.

Generic pod counters for separated pods are in *Basic Set*.

(R2.135) SCOUT POD (P-SC): This pod was a curious pre-General War design, from a time period when no one knew what role long-range scanners and electronic warfare would play in the coming conflict. It was championed by budget-minded members of the Federation Council because of its multiple uses. In peacetime, it could temporarily improve the sensor network in a given area, helping to stop piracy and smuggling. (This proved of little help.) In wartime, it could be deposited in open space and used by an admiral to coordinate ships and other forces over a wide area. (The only attempt to actually do this proved disastrous as a Klingon fast raider destroyed the pod, disrupting control over a wide area.) It could reduce the number of ships needed to patrol a border by providing enhanced sensor coverage there. (A scout pod was assigned to the Romulan border, and the number of ships there was reduced; the pod did not help coverage and the thin border patrols were overwhelmed on the Day of the

Eagle.) It could be carried by a fleet tug (R2.8) and used as a survey ship. (Tugs could never be spared for such things.) It could be carried by a fleet tug and used as a combat electronic warfare platform (a mission considered unlikely to be needed, and led to the loss of a valuable tug when Klingon electronic jamming forced the Federation to try this). The basic design of this pod (and two pods under construction when the Klingons invaded) was modified to create the light battle pod (R2.58) to be used by the light tactical transport (R2.38).



If detached, the five hull boxes can be destroyed by either “forward” or “rear” hull damage points. If attached to a fleet tug (R2.8) or light tactical transport (R2.38), these five hull boxes are destroyed on “rear” hull damage points; the hull boxes on the fleet tug or light tactical transport are considered “forward” hull in this case. See (R2.47) when attached to a priority transport; see (R2.48) when attached to a VIP transport; see (R2.151) when attached to a battle frigate transport.

Scout: It can use all scout functions (G24.0). Special sensors are destroyed by “phaser” damage points. See (G24.35) when purchasing this unit as part of a battle force.

Weight: This is a single-weight pod with a towing cost of 0.3333.

Operation: The shields of this pod are combined with the shields of the tug while it is attached. While attached, this pod increases the fleet tug’s or light tactical transport’s command rating by one; a second pod of any type does not further increase the command rating. This pod is capable of independent operation as a “base” in its own right; it does not have positional stabilizers (G29.0).

Seeking weapons: The scout pod can control seeking weapons equal to its sensor rating when detached (F3.21). The scout pod does not increase the seeking weapon control rating of a refitted tug while attached. With an unrefitted tug, the combination could control seeking weapons equal to the pod’s sensor rating; the tug’s “minimal” control ability would be shut down in favor of the pod’s superior system. See also (F3.213).

Refits: The Y175 refit was installed in Y175.

SSD is on the Federation pods sheet in *Module R11*.

(R2.136) HEAVY FIGHTER POD (P-HVL): The Federation equivalent of a fast patrol ship tender pod turned a fleet tug into a carrier with six F-111s (R2.F11) on external mech-links (J1.561). Rule (R2.R5) does not apply (this ship description is correct and the SSD is wrong), and all of the cargo space is for expendable weapons [drones, chaff (D11.0), booster packs (J5.42), etc.]. This was an operational combat pod, unlike the F-111 transport pod (R2.101) which was used to ferry replacement F-111s to re-equip front line squadrons.



Scout: It can use all scout functions (G24.0). Special sensors are destroyed by “phaser” damage points. See (G24.35) when purchasing this unit as part of a battle force.

Carrier: This ship is a true carrier; see (J4.75), (J4.93), (J11.13), and (J15.22).

This pod has one internal shuttle bay, which operates normally, and two bays used by the heavy fighters. The heavy fighter bays are semi-external, and all six heavy fighters can be launched or landed (or some could be landing while others

launch) in a single impulse or over multiple impulses. Mines can only be laid from the admin shuttle bay (M2.113). This pod's ability to operate heavy fighters and its admin shuttles [(J2.0)/(R1.F1)] is not impacted in any way by the addition of another pod in front of it or behind it when attached to a tug. Note that the tug will have its own shuttle bay and that any additional pod might have its own shuttle bay.

A fleet tug (R2.8) could only operate one pod of this type (carrying heavy fighters) at a time. A fleet tug cannot operate this pod and a PF tender pod (R2.72) at the same time (J10.0). It could operate this pod in conjunction with a second carrier pod, either a heavy carrier pod (R2.22) or a light carrier pod (R2.57), in which case it would use the escorts for the CVT as given in (R2.22). If a fleet tug or light tactical transport (R2.38) were operating with only this pod, it might have no escorts. Whether carried by a fleet tug (R2.8) or a light tactical transport (R2.38), escorts (if assigned) and fighters were:

Year	Escorts	Fighters
Y181+	NAC, DWA/FBE/FFA or None	6xF-111 or 6xF-101C

If detached, the two hull boxes can be destroyed by either "forward" or "rear" hull damage points. If attached to a fleet tug (R2.8) or light tactical transport (R2.38), these two hull boxes and the two cargo boxes are destroyed on "rear" hull damage points; the cargo boxes could also still be destroyed by "cargo" damage points; the hull boxes on the fleet tug or light tactical transport are considered "forward" hull in this case. See (R2.47) when attached to a priority transport, see (R2.48) when attached to a VIP transport, see (R2.151) when attached to a battle frigate transport.

Weight: This is a single-weight pod with a towing cost of 0.3333.

Operation: The shields of this pod are combined with the shields of the tug while it is attached. This pod is capable of independent operation as a sublight ship in its own right. The impulse engines of this pod cannot be used for movement if another pod is docked behind it.

Escort ready racks: The ready racks of the escorts were configured for F-18 (R2.F5) fighters. Escorts cannot have ready racks for heavy fighters; see (S8.318).

Seeking weapons: The heavy fighter pod can control seeking weapons equal to its sensor rating (F3.21). When combined with a refitted tug, the combination can control a number of seeking weapons equal to double the sensor rating. A second pod of any type would not further increase the control rating. (With an unrefitted tug, the combination could control seeking weapons equal to the pod's sensor rating; the tug's "minimal" control ability would be shut down in favor of the pod's superior system.) See also (F3.213).

Refits: None.

SSD is on the Federation pods sheet in *Module R11*.

FEDERATION POLICE CARRIER

(R2.137) LIGHT POLICE CARRIER (POV): As fighters became more common, the Federation Police Service began agitating for some of the fighter production to be diverted to them. In Y171, the first of a new class of light carriers, the *Bolander*, entered service. This ship was the prototype carrying a flight of six F-8 (R2.F7) fighters. Initial tests were not satisfactory and serious consideration was given to dropping the idea. (The Federation Council was not overly interested in funding yet more fighter production in addition to what Star Fleet was demanding.) Before the ship could be scrapped, the Klingons invaded, and the *Bolander* was included in a convoy hastily assembled to take supplies to the front. The convoy was attacked by a small force of Orions,

and the *Bolander's* fighters scored several significant drone hits. (Later analysis would prove that these drone hits were a fluke; the Orions simply had not been aware that the convoy had fighters.) With more funds being made available to fight the General War, the police began acquiring more light police carriers. The new ships included the plus refit, which was retrofitted to the *Bolander* (which increased the ability of the ship to control drones from three to six).

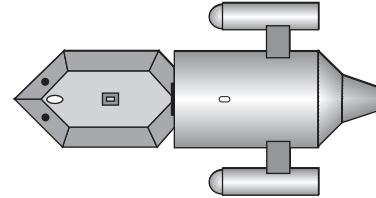

Many have commented on the unusual size of the light police carrier's shuttle bay, but the police felt that the extra shuttles allowed the ships to be customized for special roles [ground assault shuttles (R1.F4) to raid a small pirate lair, SAR shuttles (R1.F25), etc.]. The ships never received heavy fighters or first-line fighters [F-14s (R2.F1)]. They were slow to get F-18s (R2.F5), but as fighter production picked up, the delay between upgrades being made to the F-18 and those finding their way into light police carrier shuttle decks was reduced. The ships usually operated alone, but any of them might be paired with another police cutter (R2.12) to serve as its escort. Unlike the police carriers (R2.24), no light police carrier was ever assigned a fleet escort.

The light police carrier is a variant of the police cutter (R2.12).

This ship is nimble (C11.0).

Carrier: This ship is a true carrier; see (J4.75), (J4.93), (J11.13), and (J15.22).

This ship has two hatches for its shuttle bay, which is a tunnel deck (J1.58), and can launch or land two shuttles every other impulse, or launch or land one shuttle every impulse.

Year	Escorts	Fighters
Y170-Y172	None	6xF-4 or 6xF-8†
Y172-Y177	1xPol or None	6xF-4 or 6xF-8†
Y175-Y182	1xPol or None	6xF-20 or 6xF-18†
Y179-Y184	1xPol or None	6xF-20 or 6xF-18B†
Y181-Y186	1xPol or None	6xF-20 or 6xF-18B+†
Y184+	1xPol or None	6xF-20C or 6xF-18C†

† Police carriers pressed into fleet service were often provided with naval fighters.

Escort ready racks: Police cutters (R2.12) assigned as escorts had no ready racks.

Seeking weapons: Prior to the plus refit, the light police carrier can control a number of seeking weapons equal to half its sensor rating (F3.211); after the plus refit the light police carrier can control a number of seeking weapons equal to its sensor rating (F3.21).

Refits: The plus refit was not installed on the first ship until Y172, all subsequent ships included the plus refit. The Y175 refit was installed in Y175.

SSD and counter are in *Module R11*.

Known names: *Bolander, Ballard, Stivers, Russert, Pembleton, Brodie, Lewis, Giardello, Munch, Crosetti, Bayliss, and Felton.*

FEDERATION NATIONAL GUARD SURVEY CRUISER

(R2.138) NATIONAL GUARD SURVEY CRUISER (GSR): An anomalous ship in that to be effective it had to be in more continuous service than most National Guard ships. The *Amerigo Vespucci* was almost continuously on active service although it was never deployed in the Second (Exploration) Fleet zone. There was, however, a great deal of Federation space that was not completely surveyed, and the *Vespucci* spent most of its time in the region of space between the Federation capital and Gorn space. Assignment to the *Vespucci* was strictly voluntary, with the guardsmen accepting a minimum of a one year active duty commitment to serve on the ship (and that only if there was an opening for the guardsmen's specialty). Still, there were many Federation citizens who had served in the Second Fleet who found that they were not yet ready to put the thrill of discovery behind them. The *Vespucci* itself was an upgraded old early heavy cruiser hull (YR2.4) that had been converted to the design as an experiment to see if money could be saved doing such conversions rather than building newer ships. Like the survey light cruiser (R2.39), the conversion was not a satisfactory one, and the *Vespucci* was the only ship of her design. But like the survey light cruiser conversions, she eventually gave excellent service, perhaps due to the greater experience of even her lowliest crewman compared to the galactic survey cruisers (R2.16).

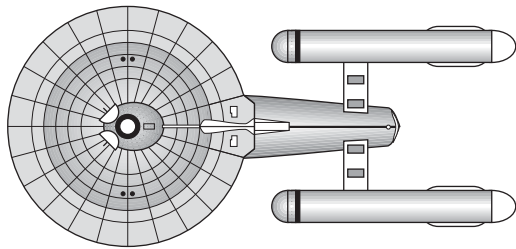

The National Guard survey cruiser is a variant of the early heavy cruiser (YR2.4).

Scout: It can use all scout functions (G24.0). Special sensors are destroyed by "phaser" damage points. See (G24.35) when purchasing this unit as part of a battle force.

In peacetime, the shuttles are usually admin [(J2.0)/(R1.F1)] types, although one heavy transport shuttle (R1.F5) was often carried. The ship might replace two admin shuttles with ground assault shuttles (R1.F4) in special circumstances (S3.2), such as a planet with particularly vicious wildlife. It might carry an MRS shuttle (J8.0) (MRS shuttles are not included in the ship's BPV), although supplies were limited and survey ships did not have a high priority. The ship was sometimes used as a scout supporting anti-piracy operations. Records do not indicate if the ship was ever used in the light carrier (R2.16A) or commando transport (R2.51) roles as the more modern galactic survey cruisers (R2.16) were.

The *Vespucci* was fitted to operate two fighters at the same time as the other survey ships to fly escort for the research shuttles [these are not included in the ship's BPV; treat it as a casual carrier (J4.62)]. There are no ready racks (J4.89) for these fighters, and they are armed and rearmed under (J4.8962). The deck crews (J4.81) shown with the fighters on the SSD are not in addition to those provided by (J4.814), but represent those deck crews having been retrained to be able to service and arm the fighters carried.

The ship carried F-8s (R2.F7) initially and later had F-18s (R2.F5), but it usually had a lower priority for the fighters due to its deployment area and National Guard status. It never carried other fighter types.

Carrier: This ship is a casual carrier (J4.62) when operating two fighters. See also (J15.22).

This ship has one shuttle bay.

Year	Escorts	Fighters
Y171-Y176	None	2xF-8
Y177-Y180	None	2xF-18
Y181-Y183	None	2xF-18B
Y183-Y185	None	2xF-18B+
Y186+	None	2xF-18C

Seeking weapons: The National Guard survey cruiser can control a number of seeking weapons equal to half its sensor rating (F3.211). See also (F3.213).

Refits: The ship was equipped to operate two fighters as a casual carrier in Y171.

SSD and counter are in *Module R11*.

Known names: 1011 *Amerigo Vespucci*.

FEDERATION NEW FAST LIGHT CRUISER

(R2.139) (NEW) FAST LIGHT CRUISER (NLF): This design was first proposed at the same time as the new light cruiser (R2.18). The concept of raiding ships was then the hot ticket item. It was not built because of questions about the strain on the engines and the hull form (borne out by problems the new light cruiser had with safely executing a high energy turn). By Y173, the concept was revived as a means of getting more raiding ships. The first ship of the class, *San Martin*, entered service in Y174.

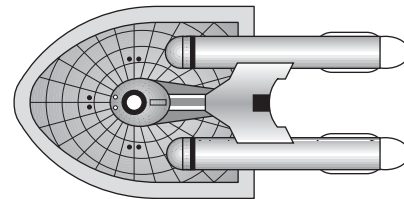

Unfortunately, the small hulls proved incapable of the deep raids of full cruisers and only a few ships of the type were produced. The ships were used to chase down raiding cruisers in an effort to engage them until other forces could be gathered. They would often be held out of the fighting near a battle area, as they were under-gunned and there was no reason to risk them, but then be used to pursue fleeing enemy cripples.

The (new) fast light cruiser is a variant of the new light cruiser (R2.18) but the changes were sufficiently extreme that it is considered a new class. Variants include the new fast escort cruiser (R2.A33).

Seeking weapons: The (new) fast light cruiser can control a number of seeking weapons equal to its sensor rating (F3.21).

Refits: The finished ship included the refits noted on the SSD, but as the ship might have been built at the same time as the new light cruiser they are shown as separate items. The plus refit was available beginning in Y172 and was common by Y175. The AWR refit was available in Y173; virtually all ships had it by Y174. The Y175 refit was installed in Y175.

Fast: This ship is a "fast" ship.

SSD and counter are in *Module R11*.

Known names: 1381 *San Martin*, 1382 *Simon Bolivar*, 1383 *Pancho Villa*.

FEDERATION WAR DESTROYER VARIANTS

(R2.140) LIGHT ATTACK CARRIER (ADW): In Y174, the prototype of the F-111 (R2.F11) (which had been on the drawing boards two years earlier) was flown. It was an impressive fighter, but at that juncture it proved to be one of the greatest design disasters (and perhaps public relations disasters) in the history of the Federation. The Federation Star Fleet had assumed that the designers were creating a fighter to operate from a carrier. The designers of the F-111 had assumed that Star Fleet was designing and would build a new carrier with a large enough shuttle bay to handle their new fighter (at least they would claim it to be so). Given the way the General War was going at that time, there was very real fear that a foul-up of this magnitude might just be enough to tip the scales of public opinion to demanding peace at any price. (Most Federation citizens were not aware that Chairman Buckner had been trying to negotiate such a peace in Y173 in the incident that cost his life and the destruction of the *Hornet*.) Too many people were in the know about the F-111 (factories were already tooling up for series production), so canceling the F-111 or even reducing “the buy” were not options.

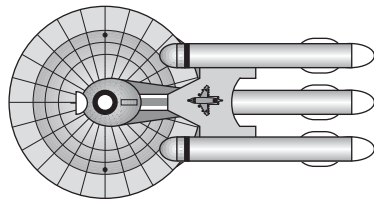

In order to conceal the mess, Star Fleet commissioned this design as a “working concept.” It was based on the new war destroyer (R2.65) design (the prototype of which had just finished its own trials). Faced with finding some means to build a shuttle bay for the F-111, the ship designers decided on the radical solution of building semi-external bays and presented it to the Admiralty board. It had never been done before, but the admirals gave their approval.

The *Pulaski* was completed and entered service in Y176 as a prototype and *Pleasanton* and *Stuart* were ordered together a year later. To everyone’s amazement, the semi-external bays that had been hastily designed were literally a complete success. (Deck crews were not, however, too sure of that, since the bays required considerable additional safety equipment.) The F-111 itself proved to be a magnificent fighter worthy of larger deployment. The semi-external bay system was quickly refitted to many other classes [and was even used to operate some A-20s (R2.F9)]. Several other ships of the class were ordered, with *Lepidus* being the first of a sustained production of one per year. They operated as light scout carriers.

The cargo boxes use the (R2.R5) rules.

The light attack carrier is a variant of the war destroyer (R2.65).

Scout: It can use all scout functions (G24.0). Special sensors are destroyed by “torpedo” damage points. See (G24.35) when purchasing this unit as part of a battle force.

Carrier: This ship is a true carrier; see (J4.75), (J4.93), (J11.13), and (J15.22).

This ship has one internal shuttle bay, which operates normally, and the bay used by the heavy fighters. The heavy fighter bay is semi-external, and all three heavy fighters can be launched or landed (or some could be landing while others launch) in a single impulse or over multiple impulses. Mines can only be laid from the admin shuttle bay (M2.113).

Year	Escorts	Fighters
Y176-Y177	FFA or FRA (Rom)	3xF-111 or 3xF-101A
Y178-Y179	FFA or FRA (Rom)	3xF-111 or 3xF-101B
Y179-Y180	FFA or FRA (Rom)	3xF-111 or 3xF-101C
Y180-Y183	FFA or FRA (Rom) or None	3xF-111 or 3xF-101C
Y184+	DWA/FBE/FFA or None	3xF-111 or 3xF-101C

Carriers serving on the Romulan front usually operated with escorts especially designed for that front. These escorts were more difficult to build and maintain and were only used on that front. This combination is noted by the note “(Rom).” Production of the Romulan-front escort variants virtually ceased by the end of the General War.

Escort ready racks: The ready racks of the escorts were configured for F-18 (R2.F5) fighters. Escorts cannot have ready racks for heavy fighters; see (S8.318).

Seeking weapons: The light attack carrier can control a number of seeking weapons equal to its sensor rating (F3.21). See also (F3.213).

Refits: None.

SSD and counter are in *Module R11*.

Known names: 1271 *Pulaski*, 1272 *Pleasanton*, 1273 *James Ewell Brown Stuart*, 1274 *Marcus Aemilius Lepidus*, 1275 *Louis-Pierre Montbrun*.

(R2.141) WAR DESTROYER ESCORT-R (DWR): A variant of the war destroyer escort (R2.68) intended for use on the Romulan border. As with most Romulan border escorts, the differentiation was found to be counter-productive and only a few were produced. After the first few ships, no more R-type escorts were built, and they were assigned interchangeably with standard escorts. While it was preferred to send war destroyer escort-Rs to the Romulan border, carriers transferring from one sector to another did not exchange escorts. Any war destroyer escort-Rs lost in combat were replaced by standard war destroyer escorts. The major difference was an increase in phasers for plasma defense and a reduction in type-G drone racks.

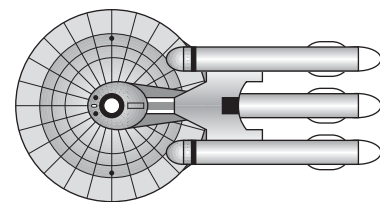

This escort variant of the war destroyer was built after the development of full aegis (D13.0), so there never was a limited aegis (D13.4) version. Players can experiment with this by using limited aegis and reducing the BPV by 10 points.

This ship has two ready racks (J4.89) and deck crews (J4.81) to support the fighters from the carrier it is escorting. The deck crews are not in addition to the deck crews provided by (J4.814), but replace them, representing their being retrained to service and arm fighters. See (R2.R5).

The war destroyer escort-R is a variant of the war destroyer (R2.65).

Seeking weapons: The war destroyer escort-R can control a number of seeking weapons equal to its sensor rating and has full aegis (D13.0). See also (J15.332).

Refits: None.

SSD and counter are in *Module R11*.

Known names: 0872 *President Gamal Abdel Nasser*, 0873 *President Gerald Ford*, 0874 *Prime Minister Indira Gandhi*, 0875 *Prime Minister Benazir Bhutto*, 0876 *Senator Barry Goldwater*.

FEDERATION FAST CARRIER ESCORT

(R2.142) FEDERATION EXPRESS ESCORT (FXE): When the fast carrier *Gryphon* (R2.96) entered service in Y173, it was believed that her fast speed would enable her to avoid interception, negating the need for escorts when operating as a fast raider. Experience with raids in Y174 soon showed that the ship was vulnerable to attack by relatively weak defense forces while trying to recover its fighters. Some consideration was given to construction of a fast destroyer escort [an escort variant of the fast destroyer (R2.146)], but the problems with producing enough of the special engines to keep the existing fast cruisers (R2.82) and light dreadnoughts (R2.91) operational made this unworkable. Diverting a (new) fast light cruiser (R2.139) to the job would have reduced the number of raiding ships available.

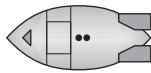

It was proposed that two Federation Express (R1.11) courier boats be converted to the mission. They were available in Y175, and included full aegis (D13.0). The drone launch capability of the boats, it was thought, would be enough to hold an intercepting force at bay until *Gryphon* could recover her fighters. Two more boats, *Deimos* and *Phobos*, were built to serve as possible replacements, but were instead assigned to the light dreadnought carrier (R2.95) *Star Tiger*.

Due to the cramped crew conditions of the design, the ships did not normally operate with the *Gryphon* until it was sent on a raid. They were held nearby with their normal operating crews, and when the *Gryphon* was tasked with a raid, they would link up with her, drawing the rest of their needed crews from the *Gryphon's* normal escorts. Once the raid was completed, the crews would re-deploy to their normal escorts. *Deimos* and *Phobos* operated in the same manner except that the operational crews (those in excess of the minimal crew needed to run a Federation Express) were drawn from the crew of the *Star Tiger* itself.

The debate about whether or not to use the escorts continued through Y177, when it was made moot by the destruction of the *Gryphon* on one of her unescorted raids into Romulan space. The *Gryphon's* Federation Express escorts were then reassigned to the *Star Tiger* as replacements in the event that some of her Federation Express escorts were lost.

This ship is nimble (C11.0).

This ship has two ready racks (J4.89) and deck crews (J4.81) to support the fighters from the carrier it is escorting. The deck crews are not in addition to the deck crews provided by (J4.814), but replace them, representing their being retrained to service and arm fighters. These ships do not use (R2.R5), but carry the normal stores for an escort under (J4.621).

The Federation Express escort is a variant of the Federation Express (R1.11).

Landing: Can land on planets using the powered landing system (P2.434) and has the crash landing bonus (P2.4311).

Seeking weapons: The Federation Express escort can control a number of seeking weapons equal to its sensor rating (F3.21) and has full aegis (D13.0). See also (J15.332).

Refits: None.

Fast: This ship is a "fast" ship.

SSD and counters are in *Module R11*.

Known names: 1096 *Urim*, 1097 *Thumim*, 1098 *Deimos*, 1099 *Phobos*.

FEDERATION MEDIUM CRUISER

(R2.143) MEDIUM CRUISER (CM): As with other empires, the Federation attempted to squeeze more power and weapons into its war cruiser design [the new light cruiser (R2.18)] to produce a more powerful ship that could still be built in a smaller dockyard than that used by the heavy cruisers (R2.4). While some empires employed paired frigate engines in place of a war cruiser engine, the Federation, as with some other empires, chose a different route. The production of the heavy command cruiser (R2.76) and battlecruiser (R2.33) saucers had included the development of a very small warp engine for "emergency use" if the saucer had to separate. The engine was small enough that it could be produced in far larger quantities than were needed to supply the heavy command cruisers and battlecruisers (which could only be built in limited numbers). It was found possible to construct a small structure under the hull of a new light cruiser where a slightly modified engine could be installed. The structure provided space for additional systems, and by moving the emergency bridge into this structure, it proved possible to double the new light cruiser's forward firing phasers.

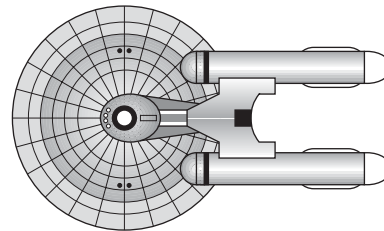

The added mass slowed down the ship, increasing the movement cost, but the new warp pack [which could be used in normal operations in an exception to (G12.102)] compensated for the increase. This was acceptable to Star Fleet, as the resulting ship could maintain the same operational speeds as the original new light cruiser, and other modern ships of the fleet.

Given the increased offensive power of the design, many (who did not understand the complexities of the situation) called for all new light cruiser production to be diverted to the new medium cruiser. This was, however, not possible, due to the complexities of the design. The new light cruiser was designed for mass production, but the more complex medium cruiser could not be built that way, requiring more tedious production methods. Total conversion of the new light cruiser assembly bays to the medium cruiser would seriously reduce the total number of hulls built, resulting in far less combat power. Cost was a minor issue; the medium cruiser cost more than the new light cruiser but the Federation economy could have funded the more expensive (and more capable) ships. Production was limited to one ship per year from Y177-Y179 and to two ships per year from Y180 through the end of the General War, such ships displacing new light cruiser production.

The center warp engine, while derived from the emergency warp engines used by the heavy command cruiser and battlecruiser, is not an emergency warp engine. The ship cannot retain the center warp engine while attempting sublight disengagement (C7.3), and must drop it with the other warp engines. The saucer section would then

be treated as a sublight new light cruiser saucer (e.g., retains full crew, combat value 15% of original value, etc.) hull.

The medium cruiser is a variant of the new light cruiser (R2.18) but the changes were sufficiently extreme that it is considered a new class.

Seeking weapons: The medium cruiser can control a number of seeking weapons equal to its sensor rating (F3.21).

Refits: None.

SSD and counters are in *Module R12*.

Known names: 1441 *Ragnarok*, 1442 *Gotterdammerung*, 1443 *Doomsday*, 1444 *Armageddon*, 1445 *Emory Upton*, 1446 *Geronimo*, 1447 *Thomas Picton*, 1448 *Chief Manuelito*, 1449 *Joachim Murat*.

FEDERATION DESTROYER LIGHT CARRIER

(R2.144) DESTROYER LIGHT ESCORT CARRIER (DDV): There was only one ship of this class. It is unclear if the reason was that the ship was considered to be unsuccessful, or if the general curtailment in the production of Federation single engine destroyers was the reason. There was much demand for the remaining destroyers (R2.6) to be converted into carrier escorts, rather than carriers in their own right.

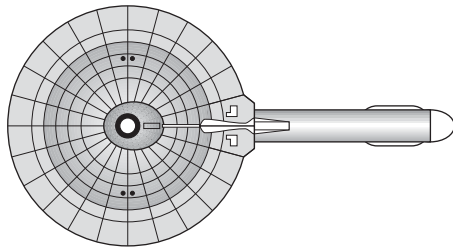

As a single ship, it suffered from a lower priority for virtually everything, and was the last carrier to be upgraded to F-18 (R2.F5) fighters. The ship operated principally in the role of an escort carrier, being assigned to provide additional cover to convoys rated important enough to have a carrier, and no other carrier was available. The ship was often assigned (its escort would be detached during these periods) to one or the other of the Federation's fighter schools to provide pilot trainees with experience landing aboard a carrier underway, and was in this role when the Federation became officially involved in the Andromedan War.

If the warp engine is dropped, the saucer section would then be treated as any other destroyer saucer (e.g., retains full crew, combat value 15% of original value, etc.), although it would remain a carrier.

The destroyer light escort carrier is a variant of the destroyer (R2.6).

Carrier: This ship is a true carrier; see (J4.75), (J4.93), (J11.13), and (J15.22).

This ship has one shuttle bay.

Year	Escorts	Fighters
Y172-Y174	FFE	10xF-8 or 10xF-4
Y175-Y177	FFA	10xF-18
Y178-Y181	FFA	12xF-18 or 6xF-101B
Y179-Y181	FFA	12xF-18B or 6xF-101B
Y181-Y185	FFA	12xF-18B+ or 6xF-101C
Y186+	FFA	12xF-18C or 6xF-101C

Escort ready racks: The ready racks of the escorts were configured for F-8 (R2.F7) fighters in Y172-Y174 if the ship were operating that type of fighter, for F-4s (R2.F6) from Y172-Y174 if the ship were operating that type of fighter, and for F-18 (R2.F5) fighters from Y175 on if the ship were operating that type of fighter. Escorts cannot have ready racks for heavy fighters; see (S8.318).

Seeking weapons: The destroyer light escort carrier can control a number of seeking weapons equal to its sensor rating (F3.21).

Refits: In Y178 the ship was given a "fighter refit" which replaced two of its admin shuttles [(J2.0)/(R1.F1)] with fighters, no change in BPV and the added fighters are not included in the ship's BPV.

SSD and counter are in *Module R12*.

Known names: *Viraat*.

FEDERATION FAST SHIPS

(R2.145) FAST FLEET SCOUT (CFS): A conversion of the damaged fast cruiser (R2.82) *Eagle*, the resulting ship was an extremely effective scout simply due to the power it had available for operating its sensors. While there was considerable interest among the "front-line" commanders for more ships of this class to be provided, no more were built. The admirals were always trying to build a larger force of fast ships to raid behind Coalition lines and were not willing to give up any hulls.

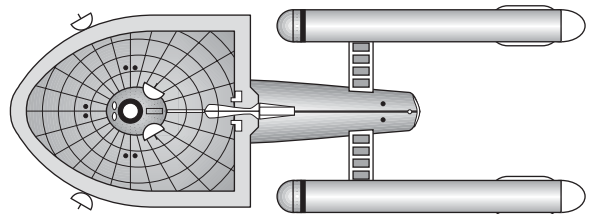

The fast fleet scout is a variant of the fast cruiser (R2.82).

Scout: It can use all scout functions (G24.0). Special sensors are destroyed by "torpedo" damage points. See (G24.35) when purchasing this unit as part of a battle force.

Seeking weapons: The fast fleet scout can control a number of seeking weapons equal to its sensor rating (F3.21). See also (F3.213).

Refits: None.

Fast: This ship is a "fast" ship.

SSD and counter are in *Module R12*.

Known names: 1719 *Eagle* (converted from CF).

(R2.146) FAST DESTROYER (DDF): Designed as a stablemate to the fast cruisers (R2.82), the *USS Two Moons* (named for a Native American warrior) used the same enlarged engine as the *Wolverine*-class, and a similar "arrowhead saucer," but of course no rear hull. Built in Y167, it was destroyed by a monster before the Klingon invasion. Plans to build more ships of this type were canceled due to problems with the supply of the special engines, which were running behind schedule.

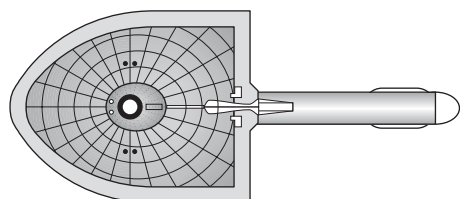

If the warp engine is dropped, the saucer section would then be treated as any other destroyer saucer (e.g., retains full crew, combat value 15% of original value, etc.).

The fast destroyer is a variant of the destroyer (R2.6) but the changes were sufficiently extreme that it is considered a new class. Variants include the fast destroyer escort (R2.A32) and fast destroyer aegis escort (R2.A32A).

Seeking weapons: The fast destroyer can control a number of seeking weapons equal to half its sensor rating (F3.211).

Refits: The plus refit was installed in Y169.

Fast: This ship is a "fast" ship.

SSD and counter are in *Module R12*.

Known names: 0551 *Two Moons*, 0552 *Konigsburg* (unbuilt), 0553 *Wotan* (unbuilt), 0554 *Thor* (unbuilt), 0555 *Brunhild* (unbuilt).

FEDERATION BATTLE FRIGATES

Any of these ships could have been produced in Y175 and have a ‡ on the SSD denoting this. The actual year in service date for the first example of each ship is listed on the Master Ship Chart.

(R2.147) BATTLE DRONE FRIGATE (FBD): The first of the battle frigates, *Marko Ramius*, was converted into a battle drone frigate during Y177. It was not the first battle drone frigate; existing frigates (R2.25) had been converted the year before. This is not a drone bombardment ship (it is too small and lacks storage or special sensors) but simply a standard combat variant.

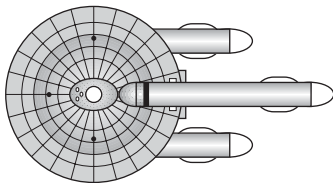

If the warp engines are dropped, the saucer section would then be treated as any other frigate saucer (e.g., retains full crew, combat value 15% of original value, etc.).

The battle drone frigate is a variant of the battle frigate (R2.50).

Seeking weapons: The battle drone frigate can control a number of seeking weapons equal to its sensor rating (F3.21).

Refits: None.

SSD and counters are in *Module R12*.

Known names: 0471 *Marko Ramius* (converted from an FFB), 0472 *Gunther Prien* (converted from an FFB); frigates converted to FBDs retained the name of the frigate.

(R2.148) BATTLE FRIGATE ESCORT (FBE): Several existing escort frigates (R2.41) had been converted into battle frigate escorts before one of the four original battle frigates was converted.

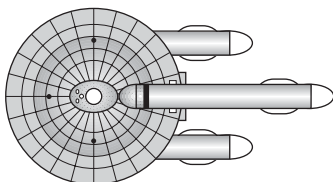

If the warp engines are dropped, the saucer section would then be treated as any other frigate saucer (e.g.,

retains full crew, combat value 15% of original value, etc.), it would still retain its escort abilities.

This escort variant of the battle frigate was built after the development of full aegis (D13.0), so there never was a limited aegis (D13.4) version. Players can experiment with this by using limited aegis and reducing the BPV by 10 points.

This ship has two ready racks (J4.89) and deck crews (J4.81) to support the fighters from the carrier it is escorting. The deck crews are not in addition to the deck crews provided by (J4.814), but replace them, representing their being retrained to service and arm fighters. See (R2.R5).

The battle frigate escort is a variant of the battle frigate (R2.50).

Seeking weapons: The battle frigate escort can control a number of seeking weapons equal to double its sensor rating (F3.212) and has full aegis (D13.0). See also (J15.332).

Refits: None.

SSD and counters are in *Module R12*.

Known names: (0473) *Yahachi Tanabe* (conversion of a battle frigate of the same name); escort frigates converted to FBEs retained the name of the frigate.

(R2.149) BATTLE FRIGATE CARRIER (FBV): In effort to get more use out of existing frigates (R2.25), the Federation began converting existing ships into battle frigates (R2.50) and variants of them as early as Y177, including an escort carrier (R2.49). The existing escort carriers had been forced out of the carrier battle groups by the increased firepower of enemy fleets and were relegated to convoy duties. As there were not enough mobile carriers (R2.83) to replace them, efforts were made to bring the existing escort carriers back into the battle fleet. The escort carrier conversion was successful and a new battle frigate carrier was built as the *USS Bryant*, FBV-475. The ships operated F-18s (R2.F5). By Y182, Klingon fast patrol ships had forced the battle frigate carriers back into convoy duty. Ironically, this made it more likely (rather than less likely) for the ships to come into contact with Klingon G1 fast patrol ships.

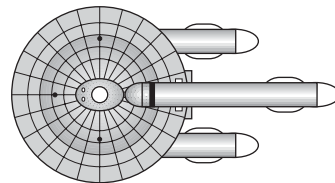

If the warp engines are dropped, the saucer section would then be treated as any other frigate saucer (e.g., retains full crew, combat value 15% of original value, etc.). It would still be a carrier.

The battle frigate carrier is a variant of the battle frigate (R2.50).

Carrier: This ship is a true carrier; see (J4.75), (J4.93), (J11.13), and (J15.22).

This ship has one shuttle bay.

Year	Escorts	Fighters
Y175-Y179	FFA or FRA (Rom)	6xF-18
Y179-Y181	FFA or FRA (Rom)	6xF-18B
Y181-Y185	FFA or FRA (Rom)	6xF-18B+
Y186+	FFA	6xF-18C

Note: The first ship of this class entered service in Y177, but data is provided for the year in service of the battle frigate design.

Carriers serving on the Romulan front usually operated with escorts especially designed for that front. These escorts were more difficult to build and maintain and were only used on that front. This combination is noted by the note "(Rom)."

Production of the Romulan-front escort variants virtually ceased by the end of the General War.

Escort ready racks: The ready racks of the escorts were configured for F-18 (R2.F5) fighters.

Seeking weapons: The battle frigate carrier can control a number of seeking weapons equal to double its sensor rating (F3.212).

Refits: None.

SSD and counter are in *Module R12*.

Known names: 0475 *Bryant*; escort carriers converted to FVBs retained the name of the escort carrier.

(R2.150) BATTLE FRIGATE SCOUT (FBS): Most of these ships were conversions of existing scout frigates (R2.44), but at least some were built as new construction, using the shipyards intended for production of FFG frigates (R2.26).

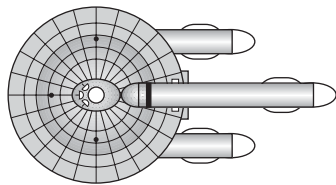

If the warp engines are dropped, the saucer section would then be treated as any other frigate saucer (e.g., retains full crew, combat value 15% of original value, etc.). It would retain its scout abilities.

The battle frigate scout is a variant of the battle frigate (R2.50).

Scout: It can use all scout functions (G24.0). Special sensors are destroyed by “torpedo” damage points. See (G24.35) when purchasing this unit as part of a battle force.

Seeking weapons: The battle frigate scout can control a number of seeking weapons equal to its sensor rating (F3.21). See also (F3.213).

Refits: None.

SSD and counter are in *Module R12*.

Known names: *Starseeker*, *Starsearcher*, *Starhunter*; scout frigates converted to battle frigate scouts retained the name of the scout frigate.

(R2.151) BATTLE FRIGATE TRANSPORT (FBT): The battle frigate upgrade was applied to a priority transport (R2.47) resulting in this improved design. While still not a good combat ship (none of the strategic transports were, having sacrificed firepower for mission essential systems), it was better able to defend itself and the added power helped it to move pods faster.

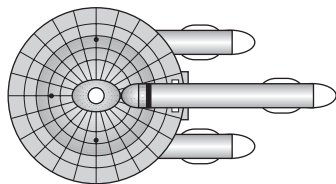

The SSD provides the data for both single-weight and double-weight pods, but any pods carried by this ship are inactive and every box in such a pod is treated as a “cargo” damage point. The battle frigate transport can carry one pod, which can be double-weight.

Like all tugs, the movement cost and turn mode vary with the pods carried. The movement cost of the battle frigate transport with a single-weight pod is 0.75 energy points per hex; the movement cost of the battle frigate transport with a double-weight pod is 1.0 energy points per hex; see Annex #3A.

If the warp engines are dropped, the saucer section would then be treated as any other frigate saucer (e.g., retains full crew, combat value 15% of original value, etc.); it would still be a tug.

The battle frigate transport is a variant of the battle frigate (R2.50).

Seeking weapons: The battle frigate transport can control a number of seeking weapons equal to its sensor rating (F3.21).

Refits: None.

SSD and counter are in *Module R12*.

Known names: 0479 *Cutty Sark*, *Hazardous Journey*, *Dangerous Passage*; priority transports converted to battle frigate transports retained the name of the priority transport.

OTHER BATTLE FRIGATES: While no other battle drone frigates (R2.147) were built as new construction, at least a dozen and possibly as many as 20 frigates (R2.25) and frigate variants were converted into battle frigate (R2.50) variants. Highest priority went to drone frigates (R2.45) (which were easily converted to battle drone frigates) and escort frigates (R2.41) (too small to survive carrier duels by Y180). Some scout frigates (R2.44) were converted into battle frigate scouts (R2.150) but even these were too small to be effective.

END OF FEDERATION MAIN ERA SHIPS

(R2.A) FEDERATION SHIPS IN CAPTAIN'S LOG

(R2.18A) LIGHT CRUISER (CL-A): Mike West proposed this ship as the light cruiser that the Federation would have built [at the time the heavy cruiser (R2.4) and destroyer (R2.6) came into service] if it could have afforded to build a new class. [Historically, of course, the Federation saved money by refitting the old light cruisers (R2.5), and packing dozens of them away in mothballs.] There have, of course, been many proposals for such a ship, but Mike's was found to be a reasonable design and might see publication in a future product.

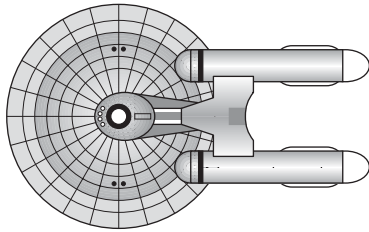

This is a base hull, that while similar to the new light cruiser (R2.18), in layout it is not a new light cruiser variant. There are no variants of this ship.

Seeking weapons: Prior to the plus refit, the light cruiser can control a number of seeking weapons equal to half its sensor rating (F3.211); after the plus refit the light cruiser can control a number of seeking weapons equal to its sensor rating (F3.21).

Refits: The plus refit would have been available beginning in Y165, common by Y171, and universal by Y175. The AWR refit was available in Y170; virtually all ships had it by Y174. The Y175 refit was installed in Y175.

Designed by Mike West.

SSD is in *Captain's Log #19*. Use any Federation new light cruiser counter.

This ship is conjectural.

Known names: None, ship is a conjectural unbuilt design.

FEDERATION POLICE SHIPS**FEDERATION POLICE CUTTER IMPROVEMENT PROGRAM**

As the General War dragged on, the Federation police forces found themselves contending with increasingly powerful Orion raiders. The pre-General-War police cutter (R2.12), which had been in service since Y127, was increasingly out matched, even after being refitted. Even so, the police continued to protect the convoys that were so vital to the Federation war effort. With ships desperately needed on the battle lines, the Federation was unable to provide more than a few frigates (R2.25) to augment the police escort forces, sometimes not even for the most important convoys.

In Y175, Police Command issued a requirement for a more powerful police ship to be constructed, and asked the major police shipyards to submit proposals. One of the principal requirements specified in the request for proposals was that the new ship would have to be built in the existing police shipyards as there was no slip space in the fleet yards for a new design. Any new design needed to use as many of the police cutter components as possible.

(R2.A2) IMPROVED POLICE CUTTER (IPL): Proposed by the Blohm-and-Vulcan shipyard, the improved police cutter was a relatively simple upgrade of the basic police cutter (R2.12). It incorporated a second photon torpedo for

increased firepower, at the cost of reducing the forward phaser array. However, overall phaser-1 firepower was retained by doubling the 360° phaser mount, and by expanding the firing arc of the remaining forward phaser. The 360° phaser-3s of the plus refit were eliminated in favor of a second drone rack. The designer believed that two type-G drone racks with ADDs would provide adequate drone defense while also providing increased offensive punch. Power to operate the second photon was provided by replacing the warp engines with those of the frigate (R2.25), and incorporating the AWR refit. Shielding was also slightly upgraded.

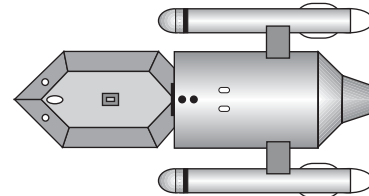

A few ships of this type were built. Operationally the ship was able to fit into existing police cutter squadrons relatively seamlessly, but was also capable of operating with the same level of independence as the original police cutter, retaining all of the basic police cutter's capabilities.

The improved police cutter is a variant of the police cutter (R2.12).

This ship is nimble (C11.0).

Seeking weapons: The improved police cutter can control a number of seeking weapons equal to its sensor rating (F3.21).

Refits: None.

SSD is in *Captain's Log #24*. Use any Federation police cutter counter.

Known names: None.

(R2.A3) POLICE CORVETTE (COR): Proposed by the Lockheed-Saturn shipyard, the police corvette was one of several radical proposals. The most significant item in the proposal was to start production of a new type of engine to provide the required warp power. Records indicate that one ship of this design was actually constructed. The prototype was built using the engines of a large armed freighter for tests, as such engines generated the power required, but it was dogged by acceleration problems [use the acceleration limits of the large armed freighter (R1.21)]. The Federation Fleet Command determined that starting a new production line for the engines needed by this design was simply not cost effective. Proposals that the needed engines be purchased from the Kzintis (R5.0) or the Gorns (R6.0) were stymied both by the needs of those empires for engines for their own ships, and perceived problems with matching the system protocols of Federation engine control systems with non-Federation-designed engine systems. It should be noted that there were rumors that Lockheed-Saturn tried to purchase the needed engines from the Orion Dragon Cartel, but these were never proved.

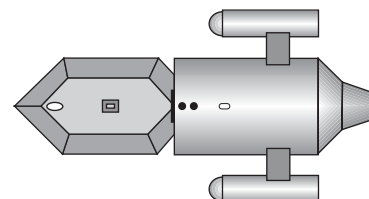

The ship doubled the police cutter's photon firepower and increased the forward phaser array by 50%, but with vastly

improved firing arcs by slightly lengthening the forward hull. The phaser-3s of the plus refit were dispensed with to allow the auxiliary power reactor deck to be increased by 300%. Shielding was also increased. The added mass, however, made the ship considerably more sluggish compared to the basic police cutter (R2.12) design. The design retained all of the support facilities of the original police cutter, but was probably better suited to operating alone than in a squadron with other police cutters.

The police corvette is a variant of the police cutter (R2.12).

This ship is not nimble (C11.0).

Seeking weapons: The police corvette can control a number of seeking weapons equal to its sensor rating (F3.21).

Refits: None.

SSD is in *Captain's Log #24*. Use any Federation police cutter counter.

Known names: None.

(R2.A5) POLICE DESTROYER (PDD): This design proposal was submitted by the Nikolayev-Andor shipyard. It was perhaps the most radical, envisioning replacing the police cutter's (R2.12) existing engines with a single standard 90K MW engine used by the heavy cruiser (R2.4)/galactic survey cruiser (R2.16)/battlecruiser (R2.33)/dreadnought (R2.2) classes. The forward hull of the ship was lengthened to allow the installation of an additional photon torpedo and two phaser-1s, and blisters were built onto the sides of the rear hull to add increased habitability for the crew and additional power systems to operate the weapons. The three drone racks gave the ship considerable offensive firepower. The ship was capable of Warp 2.7 (Speed 20) while arming all weapons. As with other designs, shielding was increased.

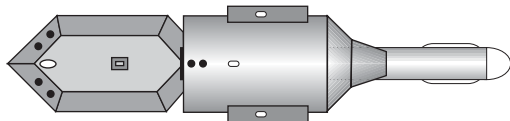

The single engine severely restricted the design's maneuverability, but it was otherwise the most potent of the proposed contracts in its combination of firepower and speed.

Like the other proposals, the design allowed the retention of the basic police cutter's (R2.12) operational characteristics. However, this design included provisions that, if it remained in service after the General War ended, the drone racks in the blisters could be converted into labs improving the ship's ability to support peacetime operations.

The design, of which one prototype was built, likely failed acceptance because the demand for 90K MW engines to build new heavy ships, and replace engines on ships that had been wrecked in battle or worn out from sustained operations, was only barely met by existing production. The demand for these engines on the larger ships had already severely curtailed production of the original Federation destroyer (R2.6) design.

The police destroyer is a variant of the police cutter (R2.12) but the changes were sufficiently extreme that it is considered a new class.

This ship is not nimble (C11.0).

Seeking weapons: The police destroyer can control a number of seeking weapons equal to its sensor rating (F3.21).

Refits: None.

SSD is in *Captain's Log #24*. Use any Federation police cutter counter.

Known names: None.

CYGNAN NATIONAL GUARD MODULAR SHIPS OF Y136

The Cygnans endured nearly three generations of Kzinti domination before Y102 when the Federation gave it "Primary Member Zone" proclamation. The Cygnans had not enjoyed the yoke of Kzinti domination, and eagerly used the Federation proclamation to free themselves from it. In Y131, the Cygnans applied for Federation membership and set to work building a fleet to defend themselves from any renewed Kzinti interest.

The Cygnan ships were not elegant, being behind the norm for Star Fleet ships of the period because of the effects of Kzinti overlordship. They were functional, and their very obsolescence and modular construction procedures made them fast to build.

By Y136, the Cygnans had a fleet of 10 ships, including two early heavy cruisers (Y2.CA1) and eight early destroyers (Y2.CA2). With the threat of war, plans were underway to upgrade some of the early destroyers to early cruisers, but this had not been done before the Kzinti invasion squadrons arrived.

The Cygnan National Guard fought heroically (the Kzintis described the defense as "fanatic") for their home planet, their obsolete ships seriously hampering the Kzintis with waves of counter drones that forced them into close action where Star Fleet's overloaded photons could savage them. The Cygnans suffered the loss of five early destroyers and one early cruiser that day, but the Kzinti attack was broken. There would be several more attempts to take Cygnus by the Kzintis, but by then the Cygnan citizen soldiers were serving on the vessels of the United Star Fleet, and were still more than willing to take the fight to the Kzintis with overloaded photon torpedoes and phaser-1s.

(Y2.CA1) CYGNAN EARLY HEAVY CRUISER (YCA):

Constructed by combining a command section with two rear sections, the Cygnan early heavy cruiser did not have the phaser firepower of the Federation early heavy cruiser (YR2.4) and was woefully inadequate when compared to a heavy cruiser (R2.4). The twin type-E drone racks gave it a powerful anti-drone capability for the era, forcing Kzinti ships to close for a point-blank overrun to have any reasonable chance of scoring drone hits.

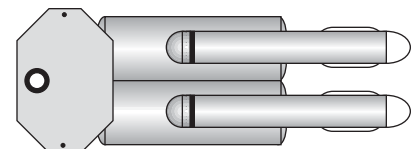

The Cygnan early heavy cruiser is a base hull; there are no variants.

Seeking weapons: The Cygnan early heavy cruiser can control a number of seeking weapons equal to its sensor rating (F3.21).

Refits

Tractors: These were type-M (Range 2), refitted to type-N (Range 3) at no cost in Y140-Y145.

Transporters: These were Range 4, extended to Range 5 at no cost in Y140.

SSD is in *Captain's Log #24*. Use any available Federation counter.

Known names: None listed.

(Y2.CA2) CYGNAN EARLY DESTROYER (YDD):

Constructed by combining a command section with a single rear section, the Cygnan early destroyer had only half the firepower of a Federation early destroyer (YR2.7) but was roughly equivalent to the obsolete Alpha-Centauran (YR2.14) or Andorian (YR2.16) early destroyers. Its type-E drone rack made it a useful squadron mate for Federation forces opposing marauding Kzinti formations during the early phases of the Second Federation-Kzinti War.

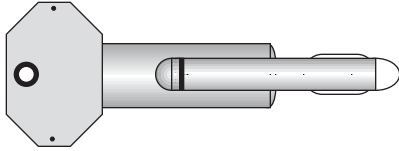

The Cygnan early destroyer is a base hull; there are no variants.

Seeking weapons: The Cygnan early destroyer can control a number of seeking weapons equal to its sensor rating (F3.21).

Refits

Tractors: These were type-M (Range 2), refitted to type-N (Range 3) at no cost in Y140-Y145.

Transporters: These were Range 4, extended to Range 5 at no cost in Y140.

SSD is in *Captain's Log #24*. Use any available Federation counter.

Known names: None listed.

FEDERATION MODULAR LIGHT DREADNOUGHT

(R2.A10) MODULAR LIGHT DREADNOUGHT (DLM): A variant of the light dreadnought (R2.91) proposed by Admiral Jack E. Fisher for the planned but never ordered *Star Lynx*. The idea was that using the modular aspects of the heavy war destroyer (R2.85) class, a light dreadnought could be configured for any number of special raiding missions behind enemy lines after only a short stay in a shipyard. The ship was never built.

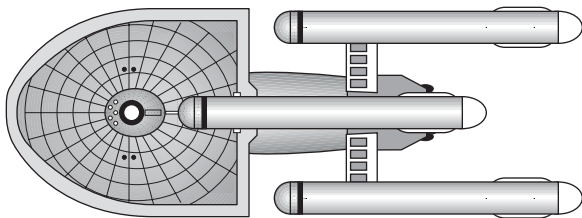

The ship carries a pair of fighters for additional firepower and is treated as a "casual carrier" (J4.62) for determining supplies, but there are ready racks (J4.89) for the fighters.

The ship uses the rules for heavy war destroyers (G33.0) for its option boxes, except that it cannot operate as a carrier escort (G33.43) or be configured for such a role.

The modular light dreadnought is a variant of the light dreadnought (R2.91).

Carrier: This ship is a true carrier if it has eight size-1 or four size-2 fighters; see (J4.75), (J4.93), (J11.13), and (J15.22). This ship is a casual carrier (J4.62) if it has seven or fewer size-1 fighters or three or fewer size-2 fighters.

This ship has one shuttle bay normally. If the ship operated as a carrier with a full squadron of 12 fighters, it would have had two bays, one of 10 fighters and six shuttles, and a second bay (replacing the RA weapon option) of two fighters. Transfers between the two bays are not possible.

Year	Escorts	Fighters
Y180+	At least three, one of which must be Size Class 3. If operating heavy fighters or as an independent raider, escorts are not required.	Varies, at least 8 size-1 or 4 size-2 fighters

Note: The modular dreadnought can only operate A-20s (R2.F9) (and its variants) from internal bays. If the ship is to operate F-111s (R2.F11), the four APR* boxes and the two weapon options become semi-external shuttle bays. The four non-weapon option boxes become cargo boxes, two of which each hold one spare F-111 fighter; the other two hold 100 spaces of reload drones provided under (G33.42). Reload anti-drones, warp booster pack storage (J5.42), and the pod stockpile (J11.13) are separate from the cargo storage. If operating F-111s, or carrying F-101s in the same manner as F-111s, the ship has six admin shuttles [(J2.0)/(R1.F1)], i.e., the bay in the main hull holds six shuttles, and no fighters. Mines can only be laid from the admin shuttle bay (M2.113).

Escort ready racks: The ready racks of the escorts, if any, were configured for F-18 (R2.F5) fighters. Escorts cannot have ready racks for heavy fighters; see (S8.318).

Seeking weapons: The modular dreadnought can control a number of seeking weapons equal to its sensor rating (F3.21). It cannot be fitted with aegis.

Refits: None.

Fast: This ship is a "fast" ship.

SSD is in *Captain's Log #27*. Use any Federation light dreadnought counter.

This ship is conjectural.

Known names: 2165 *Star Lynx* (never built).

FEDERATION OLD LIGHT CRUISER VARIANTS

(R2.A20) SCOUT LIGHT CRUISER (LSC): This ship was a proposed competitor against the destroyer scout (R2.7) in Y129, and a prototype was converted in Y130. The ship had more power and was more survivable than the scout, if only due to its larger size. It lost the design competition for three reasons: destroyers (R2.6) were in production and it was easier to build new scouts than convert existing ships, Federation Admirals believed that scouts would always be behind the line of battle safe from attack, and the old cruisers were still in front-line service but as the years went on would become increasingly difficult to maintain. The ship saw some service in the Second Federation-Kzinti War, but that war served only to validate the Admiral's opinions, and the ship was stripped before being returned to mothballs in Y142.

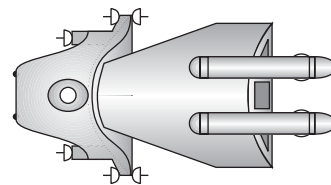

The scout light cruiser is a variant of the light cruiser (R2.5).

Scout: It can use all scout functions (G24.0). Special sensors #1-#4 are destroyed by "torpedo" damage points, while special sensors #5-#8 are destroyed by "phaser" damage points. See (G24.35) when purchasing this unit as part of a battle force.

Seeking weapons: Prior to the plus refit, the scout light cruiser can control a number of seeking weapons equal to half its sensor rating (F3.211); after the plus refit the scout

light cruiser can control a number of seeking weapons equal to its sensor rating (F3.21). See also (F3.213).

Refits: Sensors are under Early Years restrictions (YG24.0) until Y134. Transporters increased from Range 4 to Range 5 in Y140. Tractors increased from Range 2 to Range 3 in Y140. This refit data assumes the ship entered series production and remained in service. The plus refit was available beginning in Y165, common by Y171, and universal by Y175. The Y175 refit was installed in Y175.

SSD is in *Captain's Log #32*. Use any Federation light cruiser counter.

Known names: None.

(R2.A21) LIGHT HEAVY FIGHTER CARRIER (LVH): A proposed conversion of an old light cruiser (R2.5) to operate as a heavy fighter carrier. No conversions were ever undertaken, at least in part because the supply of hulls of the class had become very limited by the time the F-111 (R2.F11) had entered general service. Still, some members of Star Fleet Command tried to have one or both of the light survey cruisers (R2.39) converted to this design, or at least have any surviving light cruisers converted when they were brought in for major repairs. The records, however, indicate that this was never done.

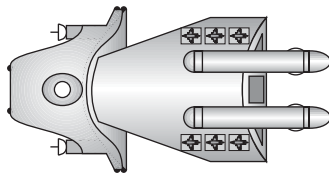

The cargo boxes use the (R2.R5) rules.

The light heavy fighter carrier is a variant of the light cruiser (R2.5).

Scout: It can use all scout functions (G24.0). Special sensors are destroyed by "torpedo" damage points. See (G24.35) when purchasing this unit as part of a battle force.

Carrier: This ship is a true carrier; see (J4.75), (J4.93), (J11.13), and (J15.22).

This ship has one internal shuttle bay, which operates normally, and the bay used by the heavy fighters. The heavy fighter bay is semi-external, and all six heavy fighters can be launched or landed (or some could be landing while others launch) in a single impulse or over multiple impulses. Mines can only be laid from the admin shuttle bay (M2.113).

Year	Escorts	Fighters
Y177-Y180	NAC, FFA or NAC, FRA (Rom)	6xF-111 or 6xF-101B
Y180-Y183	NAC, DWA/FBE or NAC, FRA (Rom) or None	6xF-111 or 6xF-101C
Y183+	NAC, DWA/FBE or None	6xF-111 or 6xF-101C

Carriers serving on the Romulan front usually operated with escorts especially designed for that front. These escorts were more difficult to build and maintain and were only used on that front. This combination is noted by the note "(Rom)." Production of the Romulan-front escort variants virtually ceased by the end of the General War.

Escort ready racks: The ready racks of the escorts were configured for F-18 (R2.F5) fighters. Escorts cannot have ready racks for heavy fighters; see (S8.318).

Seeking weapons: The light heavy fighter carrier can control a number of seeking weapons equal to double its sensor rating (F3.212). See also (F3.213).

Refits: None.

SSD is in *Captain's Log #32*. Use any Federation light cruiser counter.

Known names: None.

FEDERATION DESTROYER VARIANTS

(R2.A22) FEDERATION EMERGENCY MANAGEMENT SHIP (FEM): The Federation deployed several ships of this class. It is basically a destroyer (R2.6) heavily modified to support relief operations at a large colony. Space is given over to larger computers to coordinate the movement of relief efforts. The ship is crewed by personnel seconded from Star Fleet (and was not considered "career enhancing" by the officers so assigned). Their job was simply to keep the ship operating and to otherwise assist the Federation Emergency Management Agency staff. No staff was assigned to a Federation Emergency Management ship, but whenever a situation required the deployment, a team (represented by the passengers) was assembled.

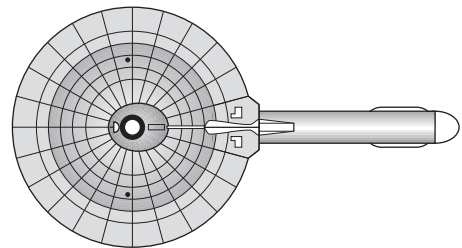

Obviously a single destroyer hull could never have carried sufficient material to assist a large colony, but its capabilities would help optimize the movement of material to the disaster area. The cargo bay of the Federation Emergency Management ship was pre-packaged with trucks (D15.825) and supplies to keep relief operations going. This allowed the Federation Emergency Management ship, once deployed on site, to move relief supplies to areas where needed. The heavy transport shuttle (R1.F5) would first move the trucks to the designated areas, and then assist in moving supplies to areas that were harder to reach. The other two shuttles were a recovery shuttle (R1.F22) and a rescue shuttle (R1.F25) that could reach individuals or families in more isolated regions. Not intended as a warship, the weapons available were limited and intended only for defense (although the Star Fleet crews were often heard to question the value of minimal weapons).

Plans called for one such ship to be assigned to each starbase (R1.1) in the Federation and be available for use in that region. Historically, only three were ever in active service at one time and during the height of the General War these were used mainly to support colonial development.

The Federation Emergency Management ship is a variant of the destroyer (R2.6).

Scout: It can use all scout functions (G24.0). Special sensor is destroyed by "torpedo" damage points. See (G24.35) when purchasing this unit as part of a battle force.

Seeking weapons: The Federation Emergency Management ship can control a number of seeking weapons equal to half its sensor rating (F3.211). See also (F3.213).

Refits: The plus refit was available beginning in Y165, was common by Y171, and was universal by Y175.

Designed by Stephen V. Cole.

SSD is in *Captain's Log #33*. Use any Federation destroyer counter.

Known names: None.

(R2.A23) MIDDLE YEARS DESTROYER (DDM): The well-known design of the Federation destroyer (R2.6) is much derided by *Star Fleet Battles* players (and Star Fleet) as “the ship that could not walk and chew gum at the same time.” However crude this comment might be, it was arguably correct.

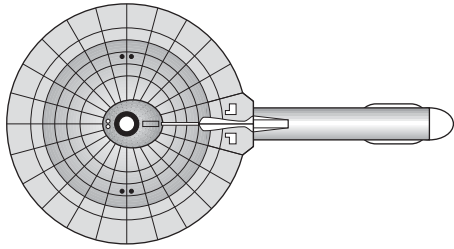

What few knew until a recently translated section of the tapes revealed the secret, is that the Federation destroyer was originally built with two photon torpedoes, not four. The extra space was used for storage (always short on the cramped destroyers). The concept of using as many common parts with the heavy cruiser (R2.4) was a valid one (and saved Star Fleet billions of credits) but the design engineers knew that the ship would only rarely find a situation in which it could stop to arm the third and fourth torpedo. For this reason, these weapons were simply not installed in the original Y130 design (except for five intended for siege operations). Most of the destroyers that began the General War started life as Middle Years destroyers.

By the time of the Four Powers War, the Federation began to study ways to better utilize the destroyers. A special design branch existed for just this purpose. Conversions of existing Middle Years destroyers to four-barrel destroyers began by Y160. The destroyer leader (R2.27) followed in Y166 and the guided weapons destroyer (R2.28) in Y167 and the destroyer escort (R2.14) in Y168, all using the extra space left empty in the original design. By Y169 all ships of this type had additional weapons added and this basic two-photon design no longer existed.

The Middle Years destroyer is a variant of the destroyer (R2.6).

Seeking weapons: The Middle Years destroyer can control a number of seeking weapons equal to half its sensor rating (F3.211).

Refits: Transporters increased from Range 4 to Range 5 in Y140. Tractors increased from Range 2 to Range 3 in Y140.

Designed by Stephen V. Cole.

SSD is in *Captain's Log #33*. Use any Federation destroyer counter.

Known names: These ships used the original destroyer names as given in (R2.6) and retained those names when extra weapons were installed.

(R2.A24) DECKHOUSE DESTROYER (DHD): A design study, in Y160, proposed that a large structure could be built on the rear quarter of a destroyer (R2.6), with the added mass countered by adding a frigate (R2.25) engine. The resulting ship would have the firepower of a cruiser but not the staying power. This was, apparently, a reaction to the growing Klingon threat, and would have served to improve the fleet relatively quickly. It was expected that drones would be more tactically viable as new (faster) designs were in development, and this weapon was added to the design. One ship (USS *Etzel* DD-509) was apparently converted, but proved unstable (note the higher breakdown rating) and was converted back into a standard destroyer before the General War. It is very likely that, if the deckhouse destroyer had been

pursued, the new light cruiser (R2.18) would never have been built.

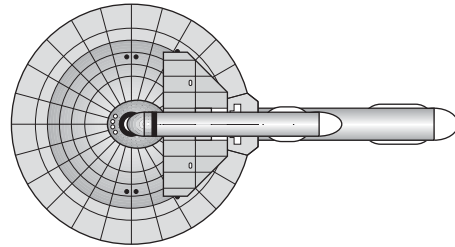

The deckhouse destroyer is a conjectural unbuilt variant of the destroyer (R2.6) but the changes were sufficiently extreme that it is considered a new class. Variants include the deckhouse light carrier (R2.A24A), and deckhouse destroyer transport (R2.A24B).

The ship has two shuttle bays, transfers between the bays by (J1.591) are possible.

Seeking weapons: The deckhouse destroyer can control a number of seeking weapons equal to its sensor rating (F3.21).

Refits: The plus refit was available beginning in Y165, would have been common by Y171, and universal by Y175. The Y175 refit would have been installed in Y175.

Designed by Chuck Strong.

SSD is in *Captain's Log #33*. Use any Federation destroyer counter.

This ship is conjectural.

Known names: None, ship is a conjectural unbuilt design.

(R2.A24A) DECKHOUSE LIGHT CARRIER (DHV): One proposed change to the original deckhouse destroyer (R2.A24) idea made in Y170 envisioned operating the ship as a carrier with a half squadron of fighters. The shipyard was pushing the idea that it could convert the remaining destroyers to this design. It was ultimately rejected by the Federation Star Fleet in part due to the lack of new production and the need for existing destroyer (R2.6) hulls to fill other critical roles. Had it been built, it would likely have been escorted by a single escort frigate (R2.41)/aegis frigate (R2.41A), or war destroyer escort (R2.68), or battle frigate escort (R2.148). It would have had 100 spaces of drone storage.

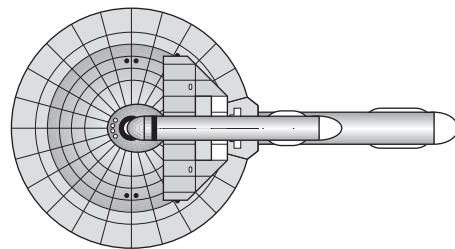

The deckhouse light carrier is a conjectural unbuilt variant of the deckhouse destroyer (R2.A24).

Carrier: This ship is a true carrier; see (J4.75), (J4.93), (J11.13), and (J15.22).

The fighter bay is considered to be part of the existing shuttle bay on the deckhouse destroyer for all purposes, i.e., the ship has one shuttle bay.

Year	Escorts	Fighters
Y170-Y173	FFA or FRA (Rom)	6xF-8 or 6xF-4
Y174-Y175	FFA or FRA (Rom)	6xF-18
Y176-Y177	FFA or FRA (Rom)	6xF-18

Y178-Y179	FFA or FRA (Rom)	6xF-18
Y179-Y181	FFA or FRA (Rom)	6xF-18B
Y181-Y185	DWA or FFA or FRA (Rom)	6xF-18B+
Y186+	DWA or FBE or FFA	6xF-18C

Carriers serving on the Romulan front usually operated with escorts especially designed for that front. These escorts were more difficult to build and maintain and were only used on that front. This combination is noted by the note "(Rom)." Production of the Romulan-front escort variants virtually ceased by the end of the General War.

Escort ready racks: The ready racks of the escorts were configured for F-18 (R2.F5) fighters.

Seeking weapons: The deckhouse light carrier can control a number of seeking weapons equal to double its sensor rating (F3.212).

Refits: The plus refit was available beginning in Y170, would have been common by Y171, and universal by Y175. The Y175 refit would have been installed in Y175.

Designed by Chuck Strong.

SSD is in *Captain's Log #33*. Use any Federation destroyer counter.

This ship is conjectural.

Known names: None, ship is a conjectural unbuilt design.

(R2.A24B) DECKHOUSE DESTROYER TRANSPORT (DHT):

This proposal would have used an empty deckhouse to create a new transport. The resulting ship would carry almost 86% of the cargo volume of the existing priority transport (R2.47), but be fully combat capable. The design again failed due in part to the need for the large engine used by the destroyer (R2.6) design for other ships, but also due to its inability to move pods as the mounting of the engines made hard docking pods for rapid transit impossible.

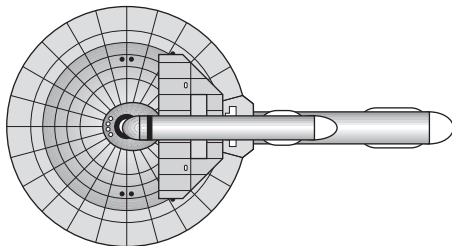

Because of the arrangement of the ship's engines, it was impossible to adapt the ship into a true "strategic transport" like the priority transport. The ship cannot operate as a tug for any purpose.

The deckhouse destroyer transport is a conjectural unbuilt variant of the deckhouse destroyer (R2.A24).

Seeking weapons: The deckhouse destroyer transport can control a number of seeking weapons equal to its sensor rating (F3.21).

Refits: The plus refit was available beginning in Y165, would have been common by Y171, and universal by Y175. The Y175 refit would have been installed in Y175.

Designed by Chuck Strong.

SSD is in *Captain's Log #33*. Use any Federation destroyer counter.

This ship is conjectural.

Known names: None, ship is a conjectural unbuilt design.

(R2.A25) HEAVY DESTROYER (HDD): This design was proposed a few weeks before the Klingons rolled across the border into Federation space. The concept was to mount a "secondary hull" under the main saucer [the deckhouse destroyer (R2.A24) mounted its extra mass above the saucer], with a frigate engine added to the top of the saucer, making the ship a "pocket heavy cruiser." The design clearly drew from the earlier deckhouse destroyer proposal (R2.A24), but its genius was in that the added secondary hull was to be constructed separately and then added to existing destroyer hulls as they became available.

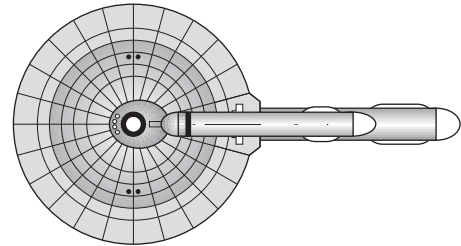

The original concept was for the secondary hulls to be easily and quickly added to any destroyer, allowing any destroyer to be converted into a special mission cruiser. Computer studies showed that this would not work and any conversions would have to be hard welded. The increased load would have caused dynamic balance issues (note the breakdown rating) and Star Fleet was concerned that the ship would suffer severe maintenance issues. The design was never approved for production because Star Fleet had few destroyers left (half of the original force had been lost by Y173) and was more than satisfied with the new light cruiser (R2.18).

The heavy destroyer is a conjectural unbuilt variant of the destroyer (R2.6) but the changes were sufficiently extreme that it is considered a new class. Variants include the heavy destroyer carrier (R2.A25A), heavy destroyer transport (R2.A25B), heavy destroyer minesweeper (R2.A25C), and heavy commando transport (R2.A25D).

Seeking weapons: The heavy destroyer can control a number of seeking weapons equal to its sensor rating (F3.21).

Refits: None, the plus and Y175 refits were included in the design.

Designed by Mike West.

SSD is in *Captain's Log #33*. Use any Federation destroyer counter.

This ship is conjectural.

Known names: None, ship is a conjectural unbuilt design.

(R2.A25A) HEAVY DESTROYER CARRIER (HDV): The design envisioned embarking a full squadron of fighters on a fully combat-capable Size-Class-4 hull. The ship would have operated as a medium carrier with a pair of escorts (frigates or war destroyers). It would have had 200 spaces of drone storage.

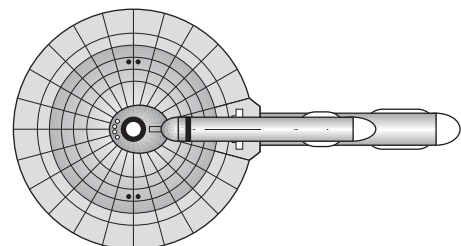

The heavy destroyer carrier is a conjectural unbuilt variant of the heavy destroyer (R2.A25).

Carrier: This ship is a true carrier; see (J4.75), (J4.93), (J11.13), and (J15.22).

The fighter bay is a separate bay for all purposes, e.g., the ship could launch an admin shuttle from its admin shuttle bay and launch a fighter from its fighter bay on the same impulse. No transfers between the bays by (J1.59) are possible.

Year	Escorts	Fighters
Y169-Y174	1-2 FFE or 1-2 FFR (Rom)	12xF-4 or 12xF-8
Y173-Y175	1-2 FFE or 1-2 FFR (Rom)	12xF-18
Y176-Y178	1-2 FFA or 1-2 FRA (Rom)	12xF-18 or 6xF-101A
Y178-Y181	1-2 FFA or 1-2 FRA (Rom)	12xF-18B or 6xF-101B
Y181-Y186	1-2 FFA/DWA/FBE or 1-2 FRA/DWA/FBE (Rom)	12xF-18B+ or 6xF-101C
Y187+	1-2 FFA/DWA/FBE	12xF-18C or 6xF-101C

Carriers serving on the Romulan front usually operated with escorts especially designed for that front. These escorts were more difficult to build and maintain and were only used on that front. This combination is noted by the note "(Rom)." Production of the Romulan-front escort variants virtually ceased by the end of the General War.

Escort ready racks: The ready racks of the escorts were configured for F-18 (R2.F5) fighters. Escorts cannot have ready racks for heavy fighters; see (S8.318).

Seeking weapons: The heavy destroyer carrier can control a number of seeking weapons equal to its sensor rating (F3.21).

Refits: None, the plus and Y175 refits were included in the design.

Designed by Mike West.

SSD is in *Captain's Log #33*. Use any Federation destroyer counter.

This ship is conjectural.

Known names: None, ship is a conjectural unbuilt design.

(R2.A25B) HEAVY DESTROYER TRANSPORT (HDT): The design envisioned a cargo volume slightly more than half the capability of a small freighter while retaining a normal destroyer's (R2.6) full combat capability. A transport that could carry critical loads and did not require escorts was a powerful selling point, but not powerful enough due to its inability to move pods as the mounting of the engines made hard docking pods for rapid transit impossible.

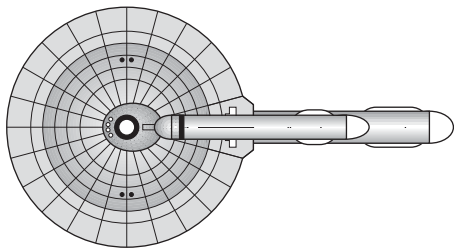

Because of the arrangement of the ship's engines, it was impossible to adapt the ship into a true "strategic transport" like the priority transport. The ship cannot operate as a tug for any purpose.

The heavy destroyer transport is a conjectural unbuilt variant of the heavy destroyer (R2.A25).

Seeking weapons: The heavy destroyer transport can control a number of seeking weapons equal to half its sensor rating (F3.211).

Refits: None, the plus and Y175 refits were included in the design.

Designed by Mike West.

SSD is in *Captain's Log #33*. Use any Federation destroyer counter.

This ship is conjectural.

Known names: None, ship is a conjectural unbuilt design.

(R2.A25C) HEAVY DESTROYER MINESWEEPER (HDM): With the improvements to the base destroyer's (R2.6) shields envisioned in the design, the ship could be an effective minesweeper.

Replace both admin [(J2.0)/(R1.F1)] shuttles with minesweeping (R1.F2)/(M8.3) shuttles.

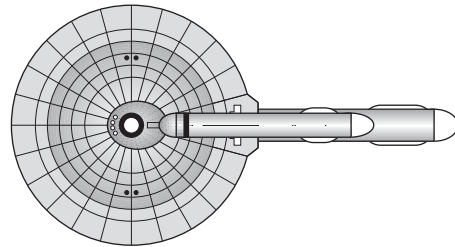

The heavy destroyer minesweeper is a conjectural unbuilt variant of the heavy destroyer (R2.A25).

This ship is a true minesweeper (M2.45); see also (M8.0).

Seeking weapons: The heavy destroyer minesweeper can control a number of seeking weapons equal to half its sensor rating (F3.211).

Refits: None, the plus and Y175 refits were included in the design.

Designed by Mike West.

SSD is in *Captain's Log #33*. Use any Federation destroyer counter.

This ship is conjectural.

Known names: None, ship is a conjectural unbuilt design.

(R2.A25D) HEAVY COMMANDO TRANSPORT (HDC): The ship would have barely been able to carry a battalion of troops, and support facilities for ground operations were notably lacking.

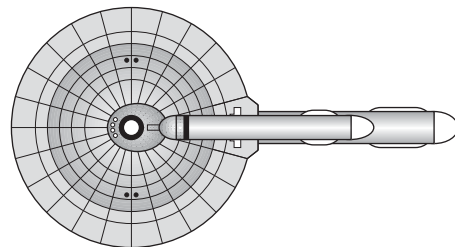

The heavy commando transport is a conjectural unbuilt variant of the heavy destroyer (R2.A25).

The heavy transport shuttle (R1.F5) bay is a separate bay for all purposes, e.g., the ship could launch an admin shuttle from its admin shuttle bay and launch a shuttle from its heavy transport shuttle bay on the same impulse. No transfers between the bays by (J1.59) are possible.

Landing force: 26 boarding parties (D7.0) plus two commando teams (D15.84), two heavy-weapons squads (D15.81), and three ground combat vehicles (D15.82). This

was roughly a battalion of troops (R2.M1) and is included in the ship's BPV.

Shuttles: Two ground assault shuttles (R1.F4), one heavy transport shuttle (R1.F5), and one admin shuttle [(J2.0)/(R1.F1)]; these shuttles are included in the ship's BPV.

Seeking weapons: The heavy commando transport can control a number of seeking weapons equal to half its sensor rating (F3.211).

Refits: None, the plus and Y175 refits were included in the design.

Designed by Mike West.

SSD is in *Captain's Log #33*. Use any Federation destroyer counter.

This ship is conjectural.

Known names: None, ship is a conjectural unbuilt design.

FEDERATION OLD LIGHT CRUISER VARIANT

(R2.A28) ADVANCED TECHNOLOGY OLD LIGHT CRUISER (CLX): As experiments with advanced technology continued, the Federation considered using one of the old light cruisers (R2.5) as a test bed for the technology. This was never done, but the design would have been at least interesting.

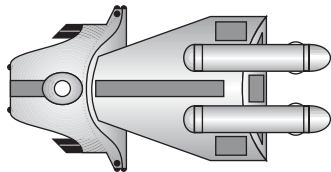

The advanced technology old light cruiser is a variant of the light cruiser (R2.5).

The advanced technology old light cruiser is a "first generation X-ship;" see (X0.0).

Deployment: See (S8.48) for deployment restrictions and conditions.

Seeking weapons: The advanced technology old light cruiser can control a number of seeking weapons equal to double its sensor rating (F3.212) and has X-aegis (XD13.0).

Refits: None.

SSD is in *Captain's Log #36*. Use any Federation light cruiser counter.

This ship is conjectural.

Known names: None, ship is a conjectural unbuilt design.

FEDERATION DREADNOUGHT VARIANT

(R2.A29) DREADNOUGHT HEAVY CARRIER (DVA): An improved Federation heavy carrier built on a guided weapons dreadnought (R2.61) hull from Y179. While the full battery of photon torpedoes was retained (all of the modifications were restricted to the engineering hull), power would have been a problem when trying to reload the A-20s under combat conditions.

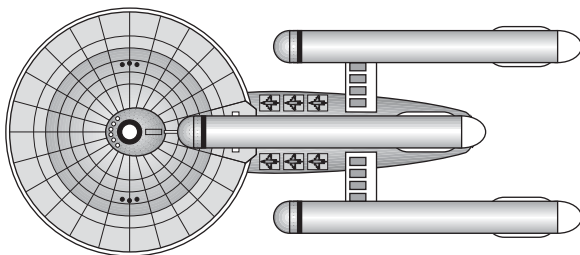

The dreadnought heavy carrier is a variant of the guided weapons dreadnought (R2.61).

Carrier: This ship is a true carrier; see (J4.75), (J4.93), (J10.111), (J11.13), and (J15.22).

As with the earlier heavy carrier (R2.13), it operates a squadron of F-14 (R2.F1) fighters (from a single bay that included four shuttles), but the A-10s (R2.F2) were replaced by A-20 (R2.F9) heavy fighters in semi-external (J1.561) bays (allowing all to launch at once). Mines can only be laid from the bay with the admin shuttles (M2.113). Other data is the same as the heavy carrier (R2.13) [including the two SWACS (J9.0)]. The MRS (J8.0) and SWAC [(J9.0)/(R2.F3)] shuttles are not included within the BPV. See [(J9.531)/(R2.F3A)] for use of an E-3A heavy SWAC.

Year	Escorts	Fighters
Y179-Y182	NAC, 2xDWA or NAC, DWA, FFA or NAC, FBE, FFA	12xF-14A, 6xA-20F or 12xF-14A 6xF-101C
Y183-Y189	NAC, DWA, FFA or NAC, FBE, FFA	12xF-14B, 6xA-20F, or 12xF-14B, 6xF-101C
Y190-Y194	2xNAC, DWA/FBE/FFA	12xF-14C, 6xA-20F or 12xF-14C 6xF-101 C
Y195+	2xNAC, DWA/FBE/FFA	12xF-14D, 6xA-20F or 12xF-14D, 6xF-101C

Escort ready racks: The ready racks of the escorts were configured for F-14 (R2.F1) fighters. Escorts cannot have ready racks for heavy fighters; see (S8.318).

Seeking weapons: The dreadnought heavy carrier can control a number of seeking weapons equal to double its sensor rating (F3.212).

Refits: None.

Designed by Mike West.

SSD is in *Captain's Log #38*. Use any Federation dreadnought counter.

Known names: None known.

FEDERATION OLD HEAVY CRUISER

(R2.A30) OLD HEAVY CRUISER (OCA): At the end of the Early Years, when the first of the *Constitution*-class (R2.4) cruisers were built, this was a competing design based on a longer version of the old light cruiser (R2.5) hull. Two were built as new construction (it was impossible to convert existing light cruisers to this design). Both were lost in combat: *Theodoric* during the Second Federation-Kzinti War; *Alfred* during the Second Federation-Romulan War.

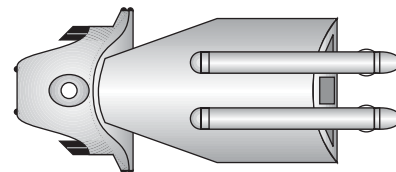

The design was considered more a backup to the *Constitution* than a true competitor; there was concern that the radically different "saucer ship" might not perform up to design parameters. Had that design failed (or been delayed), more of these ships might have been built. The *Constitution*

did not really have to “win” the competition so much as prove that it could perform.

In any case, the old heavy cruisers were not selected for several reasons. The design was older, with less growth room both in technology and size. (The old heavy cruiser, being a “stretched” version of the old light cruiser, could not be “stretched” any further. The heavy cruiser, being a new baseline design, could be pushed to the heavy command cruiser (R2.76) and advanced technology cruiser (R2.55) designs not even envisioned when the heavy cruiser was built.) Most important, the “armor” systems were not suitable for repeated use. While they could be “recharged” after taking damage, after a few battles they had to be totally replaced in an extensive shipyard overhaul.

The 360° phasers reflect a theoretical refit that would have appeared about Y165 had the ships been built. Reactors would have been APRs (reduce BPV by one point per reactor) prior to the AWR refit.

This is a base hull. There are no variants.

Seeking weapons: Prior to the plus refit, the old heavy cruiser can control a number of seeking weapons equal to half its sensor rating (F3.211); after the plus refit the old heavy cruiser can control a number of seeking weapons equal to its sensor rating (F3.21).

Refits: Transporters increased from Range 4 to Range 5 in Y140. Tractors increased from Range 2 to Range 3 in Y140. The plus refit would have been available beginning in Y165 (had either of the ships survived or the class gone into series production), been common by Y171, and been universal by Y175. The AWR refit would have been available in Y170; virtually all ships would have had it by Y174. The Y175 refit would have been installed in Y175.

Designed by Stephen V. Cole.

SSD is in *Captain's Log #38*. Use any Federation light cruiser counter.

Known names: 1361 *Alfred the Great*, 1362 *Theodoric the Great*. The third ship of this class was to have been 1363 *Alexander the Great*; that name was used on a later destroyer.

FEDERATION BATTLECRUISER VARIANT

(R2.A31) PHASER-ARMED BATTLECRUISER (BC1): A proposed variant of the Federation battlecruiser (R2.33), this design appears at various points in the record. It was, apparently, the original (unbuilt) design which was ignored in favor of the *Kirov*-class design (with drone racks) and the *Bismarck*-class (R2.34) design (with plasma-F torpedoes). The design was suggested again at the end of the General War when it was proposed that the phasers would be more useful against the Inter-Stellar Concordium than the plasma-F torpedoes of the *Bismarck*-class. There was some consideration to converting existing battlecruisers to this design, but the photon-armed *New Jersey* (R2.64) was deemed more effective and produced instead.

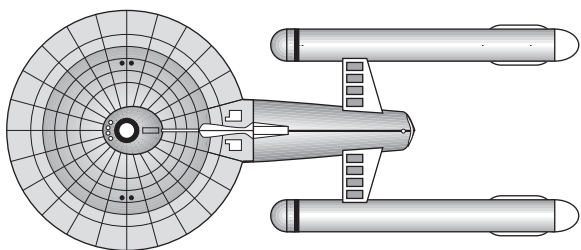

Former designation: BCP, designation was changed to BC1 (one for “phaser-1”) to avoid confusion with the

conjectural battle control ship with fast patrol ships which was already designated BCP.

The phaser-armed battlecruiser is a variant of the *Kirov*-class battlecruiser (R2.33).

Seeking weapons: The phaser-armed battlecruiser can control a number of seeking weapons equal to its sensor rating (F3.21).

Refits: None.

Design is based on similar proposals by Mike West, Jeremy Gray, and Martin Thomas Quinn.

SSD is in *Captain's Log #38*. Use any Federation battlecruiser counter.

This ship is conjectural.

Known names: None, ship is a conjectural unbuilt design.

FEDERATION FAST ESCORTS

(R2.A32) FAST DESTROYER ESCORT (DEF): When the Federation began construction of fast carrier raiders it was proposed that escorts capable of accompanying the ships on raids be provided. The first design considered for the role was the fast destroyer (R2.146). This design was created (and subsequently used in simulations) to be the “outer” escort. Plans called for two ships of this class to eventually be provided to each of the fast carrier raiders. None were ever built because there was simply no way to increase the production rate of the engines needed for the fast ships without curtailing significant production of non-fast warships.

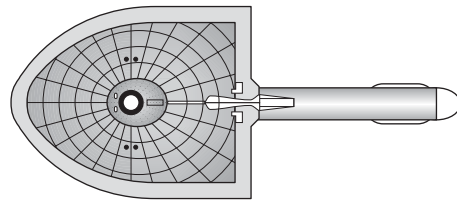

There was considerable argument about replacing the photons with drone racks, but ultimately the loss of the AWRs [in exchange for fighter cargo storage (R2.R5)] was seen to justify the decision since the ship was intended as an escort, not a direct-combat unit.

This ship has two ready racks (J4.89) and deck crews (J4.81) to support the fighters from the carrier it is escorting. The deck crews are not in addition to the deck crews provided by (J4.814), but replace them, representing their being retrained to service and arm fighters. See (R2.R5).

The fast destroyer escort is a variant of the fast destroyer (R2.146).

Seeking weapons: The fast destroyer escort can control a number of seeking weapons equal to double its sensor rating (F3.212) and has limited aegis (D13.4). See also (J15.332).

Refits: Full aegis and the drone rack refit would have been installed in all ships in Y175, resulting in the fast destroyer aegis escort (R2.A32A).

Fast: This ship is a “fast” ship.

SSD is in *Captain's Log #43*. Use any Federation fast destroyer counter.

This ship is conjectural.

Known names: None, ship is a conjectural unbuilt design.

(R2.A32A) FAST DESTROYER AEGIS ESCORT (DAF): In Y175 the computer models of the fast destroyer escort (R2.A32) were upgraded to reflect the installation of full aegis and the Y175 refit. While this did produce a powerful escort that could have covered the *Gryphon* (R2.96) while it recovered its fighters, the limit on the number of fast engines in production made this ship impossible to build. Instead the *Gryphon* would be provided with escorts based on the Federation Express (R2.142), but even these were not always available, leading to the loss of the *Gryphon* in Y177. It can be argued that had an escort group been available, the *Gryphon* might have survived, but it remained questionable if tying up that many fast engines in one group would have resulted in fewer raids overall.

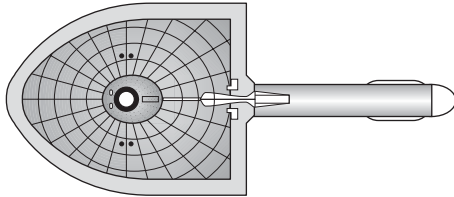

This ship has two ready racks (J4.89) and deck crews (J4.81) to support the fighters from the carrier it is escorting. The deck crews are not in addition to the deck crews provided by (J4.814), but replace them, representing their being retrained to service and arm fighters. See (R2.R5).

The fast destroyer aegis escort is a variant of the fast destroyer (R2.146). No variant of this ship existed for the Romulan border.

Seeking weapons: The fast destroyer aegis escort can control a number of seeking weapons equal to double its sensor rating (F3.212) and has full aegis (D13.0). See also (J15.332).

Refits: The plus refit and drone rack refit were included as part of the fast destroyer aegis escort's design.

SSD is combined with the fast destroyer escort in *Captain's Log #43*. Use any Federation fast destroyer counter.

Fast: This ship is a "fast" ship.

This ship is conjectural.

Known names: None, ship is a conjectural unbuilt design.

(R2.A33) NEW FAST ESCORT CRUISER (NAF): The (new) fast light cruiser (R2.139) entered service in Y175, and this variant appeared in the simulators at the same time. It was intended to support the argument that fast escorts could be, and should be, provided for the fast carrier raiders *Gryphon* (R2.96) and *Star Tiger* (R2.85). It was argued that this ship, together with one or two fast destroyer escorts (R2.A32), would enable fast carrier raiders to conduct extended raids behind enemy lines and be able to fight off any possible intercepting force, particularly when the carriers would be most vulnerable, i.e., recovering their fighter strikes. Ultimately, the "math" simply did not add up. Fast escorts would contribute nothing to a raid if the raiders were not intercepted but would tie up fast ship resources reducing the total number of such raids that could be conducted.

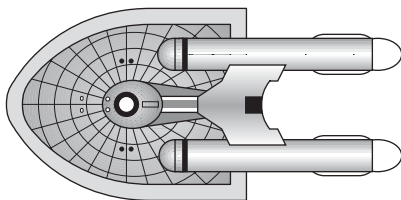

While the design reduced the number of phasers in order to provide additional drone defenses, it is arguable as to whether or not this was possible outside of the simulators. Certainly no (new) fast light cruiser was refitted to this pattern.

It was the hard calculus of war driven by the limited production of fast engines that prevented production, and arguably the *Gryphon* paid the price for it, but it is not possible to weigh the *Gryphon's* loss against what Coalition forces might have accomplished if fewer raids had been conducted. This argument also resulted in the rejection of another concept, which was not to use the *Gryphon* and *Star Tiger* as raiders, but to form them, with fast escorts, into fast carrier groups. These groups could then be used to rapidly respond to moves made by the Coalition (whether raids or simply offensive actions on the front lines).

This ship has two ready racks (J4.89) and deck crews (J4.81) to support the fighters from the carrier it is escorting. The deck crews are not in addition to the deck crews provided by (J4.814), but replace them, representing their being retrained to service and arm fighters. See (R2.R5).

The new fast escort cruiser is a variant of the (new) fast light cruiser (R2.139). No variant of this ship existed for the Romulan border.

Seeking weapons: The new fast escort cruiser can control a number of seeking weapons equal to double its sensor rating (F3.212) and has full aegis (D13.0). See also (J15.332).

Refits: The plus refit and drone rack refit were included in the design.

SSD is in *Captain's Log #43*. Use any Federation new light cruiser counter.

Fast: This ship is a "fast" ship.

This ship is conjectural.

Known names: None, ship is a conjectural unbuilt design.

FEDERATION ADVANCED TECHNOLOGY DESTROYER

(R2.A34) DDX(2) ADVANCED DESTROYER [DDX(2)]: This was a competing design with the advanced destroyer (R2.202) which actually entered service. It was an effort to simplify and streamline the production of advanced technology ships by using a single engine type for both the heavy cruiser (R2.55) and destroyer designs. The fact that limits on the construction of heavy cruiser engines had previously led to the curtailment of construction of the pre-General War destroyer was believed to be something that could be avoided. So much new technology was being stuffed into the hulls of the advanced ships that it was believed engine construction would actually surpass the number of cruisers that could be built.

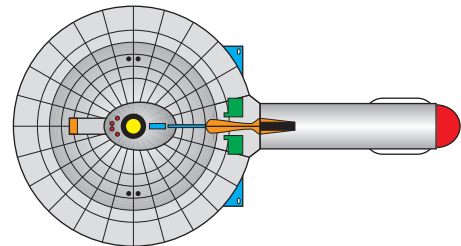

In the end, however, it was found that a single cruiser engine, even an advanced technology one, simply did not provide enough power to make the DDX2 design workable. The final nail in the coffin of the design was when the pre-General-War AWR refit was applied to it to bring its power on par with the warp output of the engines on the advanced destroyer. The designers of the advanced destroyer simply incorporated the same refit into their own design. There being

no way to further increase the available power generation in the DDX2's small hull, this competing design fell by the wayside.

It is possible a single prototype was constructed, but existing records appear to indicate that it never went beyond a design study. Other sources indicate that one DDX2 was converted into a standard DDX, perhaps before it was complete.

The DDX(2) advanced destroyer is a variant of the destroyer (R2.6).

The DDX(2) advanced destroyer is a "first generation X-ship;" see (X0.0).

Deployment: See (S8.48) for deployment restrictions and conditions.

Seeking weapons: The DDX(2) advanced destroyer can control a number of seeking weapons equal to double its sensor rating (F3.212) and has X-aegis (XD13.0).

Refits: None.

Proposed by John Trauger.

SSD is in *Captain's Log #46*. Use any available Federation destroyer counter.

Known names: None known.

FEDERATION POLICE CUTTER VARIANTS

The Federation was a capitalist society, and much of its ability to innovate and create wealth was based on the concept of the free market, i.e., competition among producers to gain market share. At all levels entrepreneurs were encouraged to produce the best quality at the lowest prices; this concept even applied to the Federation's military forces. The various corporations that produced the police cutters (Blohm-and-Vulcan, Lockheed-Saturn, Nikolayev-Andor, Tacoma-Rigel, and others) would submit designs in response to "request for proposals" provided by Star Fleet. Because the yards these corporations operated were individually very small, their designs usually competed for contracts to produce variants of frigates.

(R2.A35) SCOUT CUTTER (CUS): Star Fleet solicited proposals for a small scout in Y168. Nikolayev-Andor submitted the design presented here and the other shipyards championed it as even a small run of ships would reap profits. The cargo bay of the basic cutter design was converted to additional APRs providing fractionally more power than the frigate design proposed. Star Fleet ultimately rejected the design noting that the shields were inadequate and that the frigate design (R2.44) was more cost effective being based on a hull already in mass production within the fleet. The Federation Council, however, directed that several ships of this class be purchased (the exact number is unclear). It was then believed (by the Council's policy makers) that such scouts would largely stay out of the line of fire and would be able to use their power systems to make effective use of their special sensors which obviously negated the issue of the weaker shields. The crucible of combat would soon prove this theory false in large-scale actions, but small scouts would soldier on through the General War and beyond supporting small squadrons and patching gaps in the sensor nets created by lost bases.

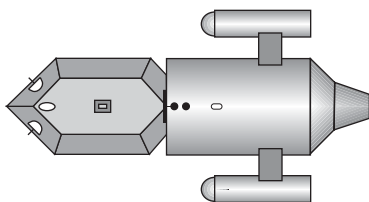

At least five and perhaps as many as 10 ships of this type were actually given to the Federation Police. (The uncertainty is because some of the ships were operated by Star Fleet and either lost during the Klingon invasion or transferred to the police at a later time.) The ships were used for many missions. Some of them supplemented police flagships in areas where piracy had increased; others operated as part of special "fast reaction" squadrons composed of several police cutters; others provided passive raid warning to critical convoys; while others were used to patch gaps in sensor networks (or to improve the coverage of existing networks). Two of them (*Woodward* and *Bernstein*) operated at Earth for the entire General War handling traffic control for the Earth government. Others operated in a similar capacity at Vulcan, Cygnus, Rigel, Andor, and other major planets. The traffic control ship at Cygnus (*Continuum*) was also used to test electronic systems for Cygnan industrial firms.

The scout cutter is a variant of the police cutter (R2.12).

This ship is nimble (C11.0).

Scout: It can use all scout functions (G24.0). Special sensors are destroyed by "torpedo" damage points. See (G24.35) when purchasing this unit as part of a battle force.

Seeking weapons: Prior to the plus refit, the scout cutter can control a number of seeking weapons equal to half its sensor rating (F3.211); after the plus refit the scout cutter can control a number of seeking weapons equal to its sensor rating (F3.21). See also (F3.213).

Refits: The plus refit was available beginning in Y172 and was common by Y175. The Y175 refit was installed in Y175.

SSD is in *Captain's Log #47*. Use any Federation police cutter counter.

Known names: *Hawkeye, Falconeye, Wolfeye, Tigereye, Rogers, Hammerstein, Onandolog, Mitch Boyer, Lumbee, Woodward, Bernstein, Continuum.*

(R2.A36) COMMANDO CUTTER (CCU): This design was proposed by Blohm-and-Vulcan in the competition which led to the commando frigate (R2.80). Star Fleet rejected this design because its ability to defend itself (having just two phasers), even in the Y150s, was inadequate to deliver troops to a defended locality. The drone rack added by the plus refit did little to improve its self-defense capabilities. However, several ships of this class were purchased and used in the role of personnel transports ferrying replacement crewmen to distribution centers (bases, planets) where they would join their ships. At the start of the General War these ships were particularly busy picking up reserve and national guard personnel and delivering them to the shipyards in the capital systems to man the mothball fleet.

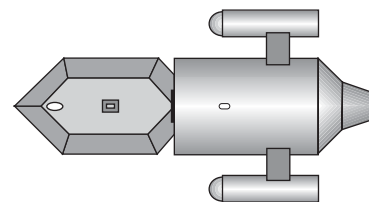

During several emergencies, because they were available, some of these ships did perform their original design mission, carrying troops (not always Marines) to attack, or in some cases reinforce, a defended locality.

Some ships of this class were purchased as part of the police budget and seconded to Star Fleet during times of crisis. They otherwise served the police or local governments in the same manner as Star Fleet.

The commando cutter is a variant of the police cutter (R2.12).

This ship is nimble (C11.0).

Landing force: 27 boarding parties (D7.0) plus two commando teams (D15.84), three heavy-weapons squads (D15.81), and three ground combat vehicles (D15.82). This was roughly a battalion of troops (R2.M1) and is included in the ship's BPV.

Shuttles: Two ground assault shuttles (R1.F4) and one heavy transport shuttle (R1.F5). These shuttles are included in the ship's BPV.

Seeking weapons: Prior to the plus refit, the commando cutter can control a number of seeking weapons equal to half its sensor rating (F3.211). After the plus refit the commando cutter can control a number of seeking weapons equal to its sensor rating (F3.21).

Refits: The plus refit was available beginning in Y172, common by Y173, and universal by Y175. The Y175 refit was installed in all ships of this type in Y175.

SSD is in *Captain's Log #47*. Use any Federation police cutter counter.

Known names: *Swatter, Corbin, McKinley*.

(R2.A37) DRONE CUTTER (CUD): This design was created by Tacoma-Rigel in a competition for a small drone support ship. The theory was that the ship would be able to stay outside of direct combat while providing drone support (mostly counter-drone fire) to the ships of the fighting line. The cargo deck was replaced by APRs to allow the ship to operate at fleet combat speeds. The drone frigate (R2.45) won the competition, but powerful members on the Federation Council directed that the police budget be amended to purchase several ships of this type to help defend convoys from raiders. Other than the notoriously weak shielding of the cutter design, the drone cutter proved a good escort against marauding Klingon ships in the early days of the General War; it was less successful against the Romulans.

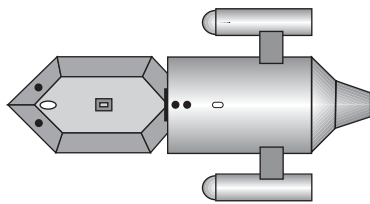

During the General War, several more were built and some operated with Star Fleet. The military found the ships less than useful and usually ended up using them as convoy escorts.

The drone cutter is a variant of the police cutter (R2.12).

This ship is nimble (C11.0).

Deployment: See (S8.47) for deployment restrictions and conditions.

Seeking weapons: The drone cutter can control a number of seeking weapons equal to double its sensor rating (F3.212).

Refits: The plus refit was available beginning in Y172, common by Y174, and universal by Y175. The Y175 refit was installed in all ships of this type in Y175.

SSD is in *Captain's Log #47*. Use any Federation police cutter counter.

Known names: *Harral, Brewton, Davis, Kersey, Jerry Nelson*.

(R2.A38) ESCORT CUTTER (CUE): Lockheed-Saturn proposed this ambitious design when Star Fleet solicited proposals for a small carrier escort. A pair of prototypes were completed in Y168, but lost the competition to the FFE escort frigate (R2.41). The police escorts were used as training

ships, operating with the Federation's fighter training schools. After the Klingon invasion, the need to replace lost escorts saw the ships temporarily assigned to the Romulan border to free "real" escorts for use against the Klingons. As losses mounted, Star Fleet eventually ordered a few more ships of this design from the various police shipyards and the ships were used as stand-ins for lost escort frigates. (Few were built as the supply of phaser-Gs went first to "real warships.") Ships of this type were also used by the police as convoy escorts or to accompany police carriers. The total number of ships of this type produced is unknown and records indicate that they replaced escort frigates in second-line carrier groups. It is possible that one or more of these ships served as escorts for first-line carriers when the need was particularly acute.

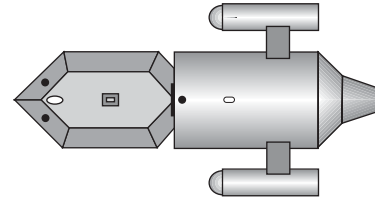

This ship has two ready racks (J4.89) and deck crews (J4.81) to support the fighters from the carrier it is escorting. The deck crews are not in addition to the deck crews provided by (J4.814), but replace them, representing their being retrained to service and arm fighters. See (R2.R5).

The escort cutter is a variant of the police cutter (R2.12).

This ship is nimble (C11.0).

Seeking weapons: The escort cutter can control a number of seeking weapons equal to double its sensor rating (F3.212) and has limited aegis (D13.4). See also (J15.332).

Refits: Full aegis and the drone rack refit were installed in Y175, resulting in the aegis escort cutter (R2.A38A).

SSD is in *Captain's Log #47*. Use any Federation police cutter counter.

Known names: *Philistine, Assyrian, Dragoon, Musketeer*.

(R2.A38A) AEGIS ESCORT CUTTER (CUA): The escort cutter was fitted with full aegis (D13.0) in Y175 and redesignated as the aegis escort cutter.

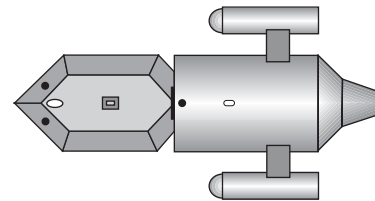

This ship has two ready racks (J4.89) and deck crews (J4.81) to support the fighters from the carrier it is escorting. The deck crews are not in addition to the deck crews provided by (J4.814), but replace them, representing their being retrained to service and arm fighters. See (R2.R5).

The aegis escort cutter is a variant of the police cutter (R2.12).

This ship is nimble (C11.0).

Seeking weapons: The aegis escort cutter can control a number of seeking weapons equal to double its sensor rating (F3.212) and has full aegis (D13.0). See also (J15.332).

Refits: The drone rack refit was included as part of the CUA design.

The SSD is combined with that of the escort cutter in *Captain's Log #47*. Use any Federation police cutter counter.

Known names: These were refits of the escort cutter (R2.A38) and did not change any names.

FEDERATION PLASMA VARIANTS

(R2.A39) NEW LIGHT PLASMA CRUISER (NLL): The new light plasma cruiser followed the lines of the plasma-armed "leader" variants. (While called a "leader" this designation in Star Fleet meant a plasma-armed variant, not a command platform, and the term may in fact be a bad translation.) As with most plasma ships in Federation service the ship was considered a disappointment. While there was an energy savings which made the ship more lively, the lack of range of the plasma-F torpedoes forced the ship to move close to the enemy to make best use of them, which made it difficult to use the ships as part of larger Federation squadrons and fleets. The four ships of this type produced were primarily assigned to the Romulan front after Y175 where their ability to use the plasma carronade (FP14.0) aided in hunting cloaked Romulan ships. Some thought was given to upgrading one or more of the ships to the new heavy cruiser standard (R2.77) in Y176 (to better facilitate combat with Romulan raiders), but this was not done. For reasons that remain unclear none of the ships were converted to standard new light cruisers (R2.18) or other variants thereof during the General War.

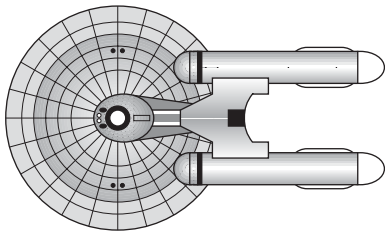

Note: The existence of this ship was discovered in the Air Force files only recently, and the earlier reference to there not being ships of this type found in (R2.112) is in error.

The new light plasma cruiser is a variant of the new light cruiser (R2.18).

Seeking weapons: The new light plasma cruiser can control a number of seeking weapons equal to its sensor rating (F3.21).

Refits: The plus refit was available beginning in Y173 and was common by Y175. The AWR refit was available in Y173; virtually all ships had it by Y174. The Y175 refit was installed in Y175. The plasma sabot refit was available in Y180 and universal by Y181.

Proposed by Mike West.

SSD is in *Captain's Log #47*. Use any Federation new light cruiser counter.

Known names: *Aradu, De Ruyter, Glorie, Kirishima.*

(R2.A40) PLASMA WAR DESTROYER (DWL): The plasma frigate (R2.43) was disappointing but Star Fleet thought that a larger hull with more power and better shields might be able to make effective use of the Gorn plasma-F torpedoes. Five ships of this class were produced. Unfortunately, the ships proved less than useful as part of squadrons or larger organizations. They lacked the long-range punch of photons and needed to get too close to an enemy to use their own torpedoes offensively. The recycle time of the weapons also interfered in the smooth operations of group maneuvers. Waiting for the plasma-Fs to rearm allowed Klingon squadrons more time to prepare for the renewed attack or for Romulan squadrons to have also fully rearmed. The ships mostly operated as solitary patrol ships, and were also used as cloaked-ship hunters using their carronade (FP14.0) capabilities.

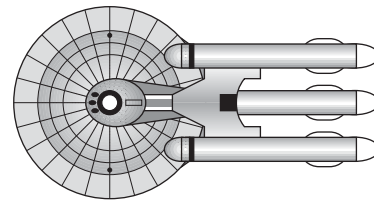

The plasma DW is a variant of the war destroyer (R2.65). Seeking weapons: The plasma war destroyer can control a number of seeking weapons equal to its sensor rating (F3.21).

Refits: The plasma sabot refit was available in Y180 and universal by Y181.

Proposed by Mike West.

SSD is in *Captain's Log #47*. Use any Federation war destroyer counter.

Known names: *Abdul Gafur, Barzani, Chaudhry, Chilingutilla, Hersi Morgan.*

FEDERATION VARIANTS

(R2.A41) FEDERATION ESCORT BATTLE FRIGATE-R (FBR): This is the escort version used in carrier groups on Romulan border. These escorts were more difficult to build and maintain and were only used on that front. Existing escort frigates (R2.42) could have been converted into escort battle frigates-Rs. If the warp engines are dropped, the saucer section would then be treated as any other frigate saucer (e.g., retains full crew, combat value 15% of original value, etc.), and it would still retain its escort abilities. Production of the Romulan-front escort variants virtually ceased by the end of the General War.

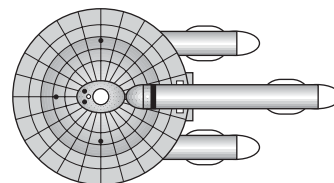

This ship has two ready racks (J4.89) and deck crews (J4.81) to support the fighters from the carrier it is escorting. The deck crews are not in addition to the deck crews provided by (J4.814), but replace them, representing their being retrained to service and arm fighters. See (R2.R5).

The escort battle frigate-R is a variant of the battle frigate (R2.50).

Seeking weapons: The escort battle frigate-R can control a number of seeking weapons equal to its sensor rating (F3.21) and has full aegis (D13.0). See also (J15.332).

Refits: None.

SSD in *Captain's Log #48*. Use any Federation battle frigate or escort frigate-R counters.

Known names: Escort frigates converted to battle frigate-Rs would retain the original frigate name.

(R2.A41A) LIMITED AEGIS ESCORT BATTLE FRIGATE-R (FBER): This is the limited aegis escort version that would have been used in carrier groups on Romulan border. These escorts were more difficult to build and maintain and were only used on that front. The escort-R variant of the battle frigate would have been built after the full aegis (D13.0) refits, so there never was a limited aegis (D13.4) version. The other data is the same as the escort battle frigate-R. Production of the Romulan-front escort variants virtually ceased by the end of the General War.

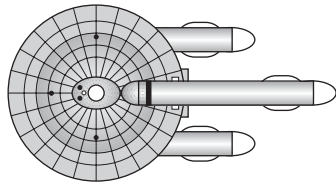

This ship has two ready racks (J4.89) and deck crews (J4.81) to support the fighters from the carrier it is escorting. The deck crews are not in addition to the deck crews provided by (J4.814), but replace them, representing their being retrained to service and arm fighters. See (R2.R5).

The limited aegis escort battle frigate-R is a variant of the battle frigate (R2.50).

Seeking weapons: The limited aegis escort battle frigate-R can control a number of seeking weapons equal to its sensor rating (F3.21) and has limited aegis (D13.4). See also (J15.332).

Refits: None.

SSD is combined with the SSD of the escort battle frigate-R in *Captain's Log #48*. Use any Federation battle frigate or escort frigate-R counters.

(R2.A42) RANGER-CLASS BATTLECRUISER (BSC): After the *Darwin* discovered the secret of the Andromedan Rapid Transit Network, the Federation and other Alpha Octant empires set out on a campaign to destroy the network's nodes. This was not easily accomplished because it required a ship fitted with special sensors to operate without escorts that would distort the sensors. Virtually every ship that had special sensors was pressed into the search initially, but this did not last for long. While exploration freighters, auxiliary fast patrol ship tenders, and frigate scouts had a chance of finding a node, they had almost no chance of surviving long enough for a reaction force to destroy the node. Operating alone, they were themselves easy for Andromedan ships to pick off, reducing the number of searchers while increasing casualties. PF tenders and scout carriers that were fast, well armed, and brought their own attrition units were optimal.

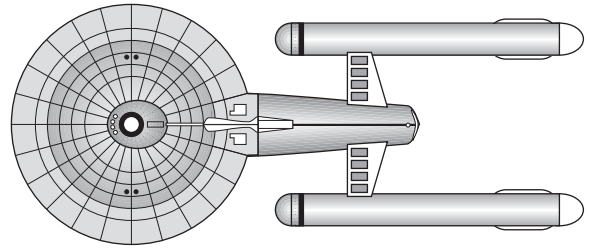

One proposal in Y197 was to take a battlecruiser (R2.33) and replace the dorsal weapons with special sensors. The ship would retain plenty of firepower but would have more energy and stronger shields than a cruiser. Such a ship would, it was theorized, be able to survive finding an Andromedan Rapid Transit Network node until larger forces could arrive to destroy it. The conversion was relatively simple and could be done anywhere.

No ship of this type actually entered service, as by the time a ship could be made available the crisis had passed. The available battlecruisers were leading killer elements of strike teams searching for the nodes and could not, in the opinion of the admiralty, be withdrawn for conversion. There are rumors that one damaged battlecruiser was being converted before the admiralty stopped the project and reinstalled the original weapons.

These ships carry three sets of reloads for their drone racks.

The *Ranger*-class battlecruiser is a variant of the *Kirov*-class battlecruiser (R2.33).

Scout: It can use all scout functions (G24.0). Special sensors are destroyed by "drone" damage points. See (G24.35) when purchasing this unit as part of a battle force.

The center warp engine in the saucer can be used to generate power but cannot be used to generate movement points unless the saucer has been separated: (G12.102) and (G12.214).

The *Ranger*-class battlecruiser can control a number of seeking weapons equal to its sensor rating (F3.21). See also (F3.213).

Refits: The plus, AWR, and Y175 refits were included in the design.

Designed by Dixon Simpkins.

SSD is in *Captain's Log #48*. Use any Federation battlecruiser counter.

Known names: None.

END OF FEDERATION SHIPS IN CAPTAIN'S LOG

(R2.F) FEDERATION FIGHTERS

Unlike other empires, the Federation produced three distinct classes of fighters, and several types of each.

The earliest were the “defensive” fighters developed for the National Guard and sold, leased, or assigned to planets for their own defense. These included the F-4 (R2.F6) (the earliest, produced in considerable numbers and also used by Star Fleet), F-15 (R2.F10) [the most powerful and most expensive, some strike carriers (R2.29A) used these also], F-16 (R2.F4) [the most common, some National Guard carriers used these (R2.119)], and F-20 (R2.F8) [the cheapest, some police carriers (R2.24) and (R2.137) carried them]. These were supplemented by bombers, including the B-36 (R2.FA7) (the earliest), B-47 (R2.FA8), B-52 (R2.F15), B-57 (R2.FA9), B-58 (R2.FA10), B-70 (R2.FA11), FB-111 (R2.F16), B-1 (R2.F17), B-2 (R2.F18), and B-3 (R2.FA12). At least one planet, Cygnus, produced its own defense fighter: the F-104 (R2.FA13). F-4s, F-16s, and F-20s might be found on civilian base stations and other non-fleet bases that are provided protection by a planetary National Guard, although this was relatively rare.

The second class were the “naval” fighters designed for use from ships or bases. The F-8 (R2.F7) [often supplemented by F-4s (R2.F6)] was the earliest type; it was to be supplanted by the excellent F-14 (R2.F1). When F-14s proved too expensive and too hard to build, the F-18 (R2.F5) was used to make up the required number of fighters and in fact comprised 80% or more of this category. F-18s were also used as defensive fighters by some planets. Some Marine garrisons on ground bases used these fighters.

The third class comprised the A-10 (R2.F2) and A-20 (R2.F9)/(R2.F14) attack shuttles, which used photon torpedoes as heavy weapons (these were rarely deployed on bases or planets). These were supplemented by the F-111 (R2.F11) and F-101 (R2.FA14). At least one planet, Cygnus, produced its own attack fighter: the A-6 (R2.F12).

There was actually a fourth class, comprising conversions of non-fighter shuttles. These included the F-7 (R2.F13), B-17 (R2.FA1), B-25 (R2.FA2), and B-29 (R2.FA3) as well as kits that could be used to temporarily convert large shuttles into bombers, including the B-24 (R2.FA4), B-26 (R2.FA5), and B-32 (R2.FA6).

The specifications of all fighters are on the Master Fighter Chart. Some Federation fighters have Gorn variants.

RESTRICTIONS ON THE DEPLOYMENT OF FEDERATION FIGHTERS:

Federation F-14s (R2.F1) are very rare and found only on the ships, some starbases [see (R1.1E)], and stellar fortresses (R1.89), that are specifically noted as operating them [heavy carrier (R2.13), heavy carrier pod (R2.22) (sometimes), space control ship (R2.32), battle carrier (R2.74), battle control ship (R2.75), light dreadnought carrier (R2.95), and dreadnought heavy carrier (R2.A29)]. They would probably have also been used by the conjectural battle control ship with fast patrol ships (R2.75A), conjectural space control ship with fast patrol ships (R2.32A), conjectural battleship carrier (R2.93), conjectural stellar domination ship (R2.94), and conjectural stellar domination ship with fast patrol ships (R2.94A)]. They are never found permanently assigned anywhere else, but a historical scenario could always create some special (and temporary) exception. Players might agree to allow a wider use for a “non-historical” event, but do not get to surprise a raiding squadron of WYN (R12.0) [or Frax (R51.0), or Magellanic (*Module C5*), or what have you] warships with squadrons of F-14s launched from a battle station’s (R1.2) hangar bay modules (R1.4) and new light carrier (R2.35) unless an agreement existed in advance.

F-15s (R2.F10) are under restrictions similar to the F-14, except particularly important planets might have them on ground bases. This would be extremely rare, and the planet would have to be “worthy” of the presence of such fighters (kind of a “if we lose this planet, we have probably lost the war” worthiness). This means that they could be found on ground planetary control bases (R1.28K1) and medium (R1.28B) and small (R1.28A) ground fighter bases on such planets. Otherwise they are only found on ships specifically noted as operating them [Federation CVB strike carriers (R2.29A) and conjectural battleships (R2.73)].

Federation A-10s (R2.F2) are even more restricted. They are only known to have been operated from heavy carriers (R2.13), some starbases [see (R1.1E)], and some stellar fortresses (R1.89-2), and would probably have been used by conjectural battleship carriers (R2.93).

While A-10s had a very restricted and limited deployment, A-20s (R2.F9)/(R2.F14) were more widely deployed. They replaced A-10s on some starbases [see (R1.1E)] but were also deployed on stellar fortresses (R1.89A), heavy carriers (R2.13), space control ships (R2.32), at least one heavy fighter transport (R2.56), heavy war destroyers operated as carriers (R2.85), scout carriers (R2.99), heavy scout carriers (R2.122), heavy fighter carriers (R2.132), and new heavy fighter carriers (R2.134). The conjectural battleship carriers (R2.93), conjectural stellar domination ships (R2.94), and conjectural area control ships (R2.129) would probably have also used them. They were also deployed on some ground bases (R1.48), but this was relatively rare because not many planets had enough power to rearm the fighters’ photons. [The heavy fighter ground bases all require that they be linked to a power grid, and under (R1.28P) no power grid can have more than four bases, and photon torpedoes require warp power putting an additional burden of converting the APRs of the bases in the power grid to AWRs.] Still, it would not be out of line to see a heavy fighter planetary control base (R1.48C) on an important planet (see previous note about such a planet having the status of “if we lose this one, we lose the war”) having both a squadron of F-15s and a squadron of A-20s.

As to F-111s (R2.F11), they were extremely widely deployed. They were deployed on heavy fighter modules (R1.70) (these are found in *Module R8*, but we forgot to include the rule for them along with the SSD). A starbase or stellar fortress might have two such modules (and two squadrons of F-111s), but a smaller base (sector base, battle station, base station) would not have more than one. All of these would also probably have regular hangar bay modules (R1.4) operating size-1 fighters in addition. While F-111s cannot be hung on casual mech-links (R1.R1), there were a lot of carriers that operated them, and they could even be found on some Federation monitors (R1.22E). They could be deployed on heavy fighter ground bases, but their deployment on such bases does not eliminate the requirement that the base be linked to a power grid (of course the power grid need not be four bases, it could be just two bases). They are pretty much treated as gunboats for deployment (if the Klingons or Gorns or whoever could justify deploying a gunboat flotilla to the planet, then the Federation could justify deploying an F-111 squadron to it), although again they cannot be carried by “casual mech-links.”

F-101s (R2.FA14) can be found on virtually any carrier, replacing standard size-1 fighters such as F-18s or heavy fighters and were the most widely deployed heavy fighters in Federation service.

PUBLISHED FEDERATION FIGHTERS AND BOMBERS

(R2.F1) F-14 "TOMCAT" FIGHTER:

The most powerful Federation size-1 fighter-shuttle is designated as the F-14 Tomcat in honor of an older atmospheric aircraft that once flew from the decks of wet navy aircraft carriers.

F-14s can launch two drones per turn (of any type) if both are aimed at the same target. If not



launching other types of drones on the same or different impulses of a given turn, an F-14 can launch all its type-III drones (each at a different target) in a single turn (on different impulses). See (J4.242) and (R1.F9).

The F-14 Tomcat is, without question, the best fighter-shuttle ever built [a statement the builders of the F-15 (R2.F10) do not agree with]. The Federation intended to equip all carriers with it, but the low production rate did not allow it to be deployed much beyond the heavy carriers (R2.13). (The pre-General War all-F-14 plans did not anticipate the number of carriers that would actually be deployed, or the loss rate of fighters.)

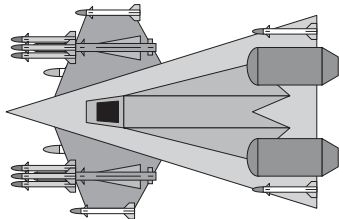

F-14p: Variant of F-14 with two phaser-3-FAs replacing the phaser-G-FA, normally used for training or deployed on bases where attack was deemed less likely.

There were successive generations of F-14s:

F-14A: F-14s were modified as F-14As to carry two type-III drones on special rails (J4.233) in addition to their other weapons in Y177. These were often type-III MW drones (FD8.0) used to destroy enemy fighters. When escorting attack shuttles, the F-14s launch their type-IIIs at long range to rattle the defenses of the target group. These drones are timed to enter the target area just ahead of the strike force. When defending the carriers, the F-14s would launch their type-IIIs into any group of approaching ships or fighters in order to disrupt the attack.

F-14Ap: Variant of F-14A with two phaser-3-FAs replacing the phaser-G-FA, normally used for training or deployed on bases where attack was deemed less likely.

F-14B: Some were modified as F-14Bs to carry four type-III drones on special rails in addition to the original F-14 weapons in Y183 on the Klingon front and in Y184 elsewhere.

F-14Bp: Variant of F-14B with two phaser-3-FAs replacing the phaser-G-FA, normally used for training or deployed on bases where attack was deemed less likely.

F-14C: F-14s were modified by the C-refit (R1.F8) in Y190 to replace the light (type-VI) drone rails (J4.232) with standard (type-I) rails (J4.231). This increased their firepower during the Andromedan War. F-14Cs can carry up to four type-III drones. All SSDs with F-14s show this version. Delete two or all of the special rails (type-III drones) and change two of the type-I drones to type-VI drones for the F-14A or F-14B. For the F-14D each pair of special rails (type-III drones) can be marked as carrying a single type-IV drone.

F-14Cp: Variant of F-14C with two phaser-3-FAs replacing the phaser-G-FA, normally used for training or deployed on bases where attack was deemed less likely.

F-14D: A few F-14s were modified in Y195 for duty against the Andromedans. These were as F-14Cs, but each pair of special rails could carry one type-IV drone.

F-14Dp: Variant of F-14D with two phaser-3-FAs replacing the phaser-G-FA, normally used for training or deployed on bases where attack was deemed less likely.

F-14E: Electronic warfare variant of the two-seat F-14 (J4.43) introduced in Y172 and remained the standard electronic warfare fighter for F-14 squadrons. It had no type-I drone rails and no special rails were added, but had two built-in electronic warfare pods [(J4.9)/(J11.2)] and equipment enabling it to lend electronic warfare from the pods to the fighters of its squadron (J4.46).

F-14Ep: Variant of F-14E with two phaser-3-FAs replacing the phaser-G-FA, normally used for training or deployed on bases where attack was deemed less likely.

This fighter type always had two chaff packs. A mega-pack was developed for this fighter adding two drone rails (J16.241).

F-14Es when fitted with a mega-pack gained two additional pod rails (J16.245).

Counters for the F-14 are in *Module J*.

(R2.F2) A-10 "WARTHOG" FIGHTER:

Designated as the A-10 attack shuttle, the "Warthog" (as its pilots call it) was the heavy carrier's (R2.13) heavy attack fighter. The A-10 was intended for use only on heavy carriers and was in limited production because it proved incredibly difficult to build; it was almost never based elsewhere, the exceptions being starbases (R1.1E) and stellar fortresses (R1.89-2) from Y181.

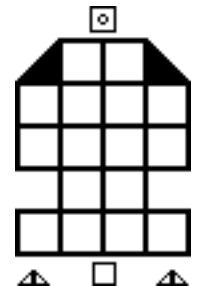

The photon has a maximum range of 12 hexes.

No C-refit.

Information regarding this fighter in previous editions of the game was found to be incorrect and was deleted.

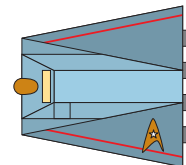

A-10E: Electronic warfare variant of the two-seat A-10 (J4.43) introduced in Y172. These had no drones or photon torpedoes but had two built-in electronic warfare pods [(J4.9)/(J11.2)] and equipment enabling it to lend electronic warfare from the pods to the fighters of its squadron (J4.46).

A-10s always had one chaff pack. A mega-pack was developed for this fighter adding a second photon torpedo charge (J16.242). The added charge cannot be fired on the same turn or within a quarter turn of the fighter's normal charge.

A-10Es when fitted with a mega-pack gained two additional pod rails (J16.245).

Counters are in *Module J*.

(R2.F3) E-2 “HAWKEYE” SWAC SHUTTLE: The SWAC (space warning and control) shuttle is used as an electronic command post. It is a highly modified MRS (J8.0) shuttle. Its characteristics are shown on the Master Fighter Chart (Annex #4) and are described in detail in rule (J9.0). SWAC shuttles are operated primarily by *Napoleon*-class heavy carriers

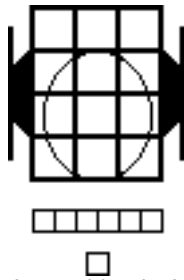

(R2.13), space control ships (R2.32), conjectural battleship carriers (R2.93), conjectural stellar domination ships (R2.94), conjectural stellar domination ships with fast patrol ships (R2.94A), dreadnought heavy carrier (R2.A29); very rarely one would be deployed on a starbase (R1.1), stellar fortress (R1.89), or another carrier. A SWAC shuttle cannot be used as a scatter-pack (FD7.14), and it has limited assault or transport capabilities (J9.33). It can be used as a fighter, but is much too valuable to be used as such and is not a fighter for rules purposes. It could be used as a normal wild weasel (J3.18).

No C-refit.

The formal designation E-2C is interchangeable with the more common E-2. See also (R2.F19).

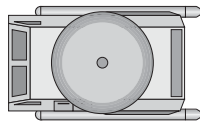

E-2Cp: Variant of E-2C with two phaser-3-360°s replacing the phaser-G-360°, normally deployed on bases where attack was deemed less likely.

E-2Cs always had one chaff pack; there is no mega-pack.

Counters for the SWAC are in *Module J*.

(R2.F3A) E-3A “SENTRY” HEAVY SWAC SHUTTLE: The E-3A is the heavy (two-space) version of the SWAC. It has enhanced capabilities over those of the E-2C.

See (J9.5) for additional information. These were used only on heavy carriers (R2.13), space control ships (R2.32), conjectural battleship carriers (R2.93), conjectural stellar domination ships (R2.94), conjectural stellar domination ships with fast patrol ships (R2.94A), dreadnought heavy carrier (R2.A29), starbases (R1.1), and stellar fortresses (R1.89).

No C-refit.

Confirming that this unit has a 12-shot anti-drone system (E5.0).

The formal designation E-3A is interchangeable with the more common E-3. See also (R2.F19).

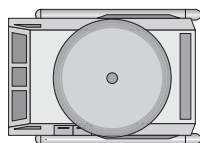

E-3Ap: Variant of E-3A with two phaser-3-360°s replacing the phaser-G-360°, normally deployed on bases where attack was deemed less likely.

E-3As always had two chaff packs; there is no mega-pack.

A counter is provided in *Module J*.

(R2.F4) F-16 “FALCON” FIGHTER:

The F-16 Falcon was designed for use as a cheap local-defense fighter for less sophisticated planets. Rarely used on ships, the F-16 was primarily based on planets. Large numbers were sold to independent planets within the Federation for self-defense. It was produced in considerable numbers, although it was still too expensive (because of the phaser-G), and more than half of Federation planets used cast-off F-4s (R2.F6) and F-8s (R2.F7) [and later F-20s (R2.F8)].

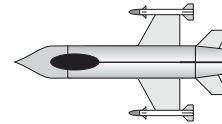

F-16p: Variant of F-16 with two phaser-3-FAs replacing the phaser-G-FA, normally used for training or deployed on planets where attack was deemed less likely or to save money. Historically 90% of all F-16s produced did not have phaser-Gs.

F-16E: Electronic warfare variant of two-seat F-16 (J4.43). This fighter had no drones but could lend electronic warfare to fighters of its squadron (J4.46) from pods [(J4.9)/(J11.2)] carried on its pod rails (J11.111).

F-16Ep: Variant of F-16E with two phaser-3-FAs replacing the phaser-G-FA, normally used for training or deployed on planets where attack was deemed less likely.

F-16C: The C-refit (R1.F8) replaced the two type-VI light drone rails (J4.232) with two type-I drone rails (J4.231) in Y183; this is the version shown on updated SSDs.

F-16Cp: Variant of F-16C with two phaser-3-FAs replacing the phaser-G-FA, normally used for training or deployed on planets where attack was deemed less likely or to save money.

F-16CE: Electronic warfare variant of two-seat F-16C (J4.43). This fighter had no drones but had two built-in electronic warfare pods [(J4.9)/(J11.2)], a noticeable improvement over the F-16E.

F-16CEp: Variant of F-16C with two phaser-3-FAs replacing the phaser-G-FA, normally used for training or deployed on planets where attack was deemed less likely.

This fighter type always had one chaff pack. A mega-pack was developed for this fighter adding two drone rails (J16.241).

F-16Es when fitted with a mega-pack gained two additional pod rails (J16.245).

Use FTR counters for the F-16.

(R2.F5) F-18 “HORNET” FIGHTER:

The F-18 was the most numerous Federation naval fighter, drastically outnumbering the better known F-14s (R2.F1) and F-15s (R2.F10). The fighter groups of virtually all Star Fleet bases and most carriers were F-18s after the pre-General-War F-4s (R2.F6) and F-8s (R2.F7) were used up in combat or relegated to training units or backwater garrisons.

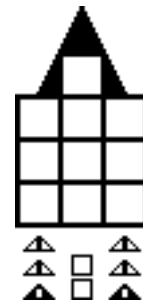

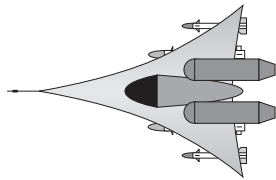

F-18E: Electronic warfare variant of the two-seat F-18 (J4.43) introduced in Y173, replacing the two type-I drone rails (J4.241) with two built-in electronic warfare pods [(J4.9)/(J11.2)] and equipment enabling it to lend electronic warfare from the pods to the fighters of its squadron (J4.46).

F-18B: A faster version of the F-18 entered service in Y177. These replaced standard F-18s, although this is not noted in most carrier descriptions.

F-18BE: Electronic warfare variant of the F-18B introduced in Y177, replacing the two type-I drone rails (J4.241) with two built-in electronic warfare pods [(J4.9)/(J11.2)] and equipment enabling it to lend electronic warfare from the pods to the fighters of its squadron (J4.46). This was the standard electronic warfare fighter used by squadrons of F-18Bs, F-18B+s, and F-18Cs.

F-18B+: The F-18B received two special drone rails (J4.233) in Y180 becoming the F-18B+. These replaced standard F-18s, although this is not noted in most carrier descriptions.

F-18C: The C-refit (R1.F8) replaced the two light rails (J4.232) with two standard rails (J4.231) in Y183. Most SSDs with F-18s show this version. Delete the special rails (type-III drones) and change two of the type-I drones to type-VI drones for the F-18 or F-18B.

The F-18 is the standard Federation fighter. Unless otherwise stated in a scenario, it can be assumed that F-18s appearing in Y177 or later are F-18Bs, in Y180 or later are F-18B+s with special rails, and in Y183 or later are F-18Cs. The F-18B, B+, and C have two chaff packs (D11.0).

The F-18 had one chaff pack; the F-18B and later had two chaff packs. A mega-pack was developed for this fighter adding two drone rails (J16.241).

F-18Es when fitted with a mega-pack gained two additional pod rails (J16.245).

Counters for the F-18 are in *Advanced Missions*.

(R2.F6) F-4 “PHANTOM” FIGHTER:

An early fighter produced for local defense of minor planets, the F-4 was used on ships in some early trials. The galactic survey cruiser (R2.16) *Discovery* carried F-4s as an experimental light carrier (R2.16A) in Y167, leading to construction of full carriers. Even though officially considered a planet-based fighter, F-4s were used for carrier duty prior to the F-14 (R2.F1) and F-18 (R2.F5).

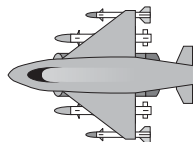
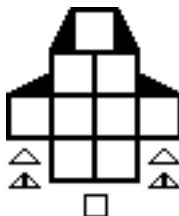

F-4E: Electronic warfare variant of the two-seat F-4 (J4.43) introduced in Y173, replacing the two type-I drone rails (J4.241) with two built-in electronic warfare pods [(J4.9)/(J11.2)] and equipment enabling it to lend electronic warfare from the pods to the fighters of its squadron (J4.46).

No C-refit. No chaff prior to Y168.

This fighter type always had one chaff pack. No mega-pack was developed for this fighter, but if one had been it would have added two drone rails (J16.241).

F-4Es if fitted with a mega-pack would have gained two additional pod rails (J16.245).

Use the FTR counters for the F-4.

(R2.F7) F-8 “CRUSADER” FIGHTER:

Another early Federation fighter, less expensive than the F-4 (R2.F6) and optimized for dogfighting; it was the primary carrier fighter prior to the F-14 (R2.F1).

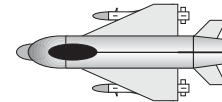
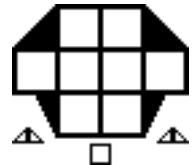

F-8E: Electronic warfare variant of the two-seat F-8 (J4.43) introduced in Y172, replacing the two type-I drone rails (J4.241) with two built-in electronic warfare pods [(J4.9)/(J11.2)] and equipment enabling it to lend electronic warfare from the pods to the fighters of its squadron (J4.46).

No C-refit. No chaff prior to Y168.

This fighter type always had one chaff pack. No mega-pack was developed for this fighter, but if one had been it would have added two drone rails (J16.241).

F-8Es if fitted with a mega-pack would have gained two additional pod rails (J16.245).

Use the FTR counters for the F-8.

(R2.F8) F-20 “TIGERSHARK” FIGHTER:

A late-era Federation fighter, intended primarily for export to minor planets within the Federation. It was optimized for dogfighting. It was common on civilian bases and some police and auxiliary carriers.

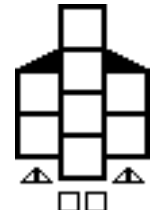

F-20E: Electronic warfare variant of the two-seat F-20 (J4.43) introduced in Y175. This fighter had no drones but could lend electronic warfare to fighters of its squadron (J4.46) from pods [(J4.9)/(J11.2)] carried on its pod rails (J11.111).

F-20C: The C-refit (R1.F8) replaced two type-VI light rails (J4.232) with two type-I rails (J4.231) in Y183; this is the version shown on updated SSDs.

F-20CE: Electronic warfare variant of the F-20C replacing the two type-I drone rails (J4.241) with two built-in electronic warfare pods [(J4.9)/(J11.2)] and equipment enabling it to lend electronic warfare from the pods to the fighters of its squadron (J4.46).

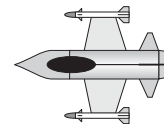

This fighter type always had two chaff packs. A mega-pack was developed for this fighter adding two drone rails (J16.241).

F-20Es when fitted with a mega-pack gained two additional pod rails (J16.245).

Use the FTR counters for the F-20.

(R2.F9) A-20 “AVENGER” HEAVY FIGHTER: Designed as the ultimate in heavy assault shuttles, the A-20 was the closest the Federation got to building a fast patrol ship [a distinction shared with the F-111 (R2.F11) in *Module K*]. Only limited numbers of the A-20 were initially built for use on the heavy fighter transport (R2.56), but production was soon increased and it was deployed on a variety of carriers, including the space control ship (R2.32), as well as starbases (R1.1) and stellar fortresses (R1.89). Because of its large size (J10.0), an A-20 occupies two shuttle boxes [or one mechlink (J1.56)]. It carries two photons in mounts similar to the A-10 (R2.F2), plus four special drone rails (J4.233) (can carry type-I, type-III, or type-VI), one phaser-3, and an anti-drone system (E6.0) (shown on the Master Fighter Chart). The A-20 has the same sensors (and drone launch rate) as the F-14. Each pair of special rails can carry one type-IV drone. See (J4.24). The A-20 can fire one or both of its photons during a given turn (or fire them on different turns), on the same impulse or different impulses, at the same target or different targets (J10.42).

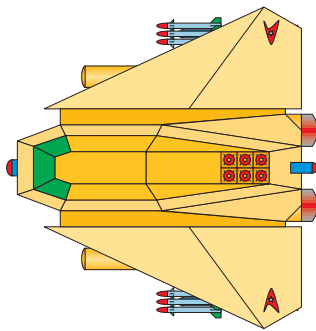
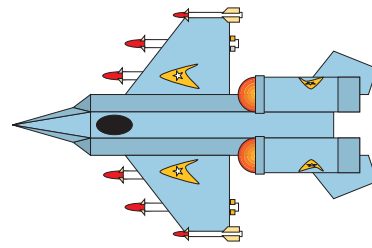
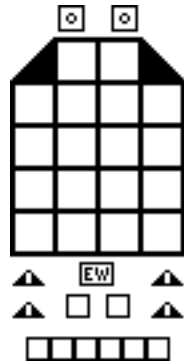

A-20F: A faster version of the A-20 introduced in Y179, see (R2.F14).

See (R1.F7A) for electronic warfare fighters. The photons have a maximum range of 12 hexes. No C-refit.

A mega-pack was developed for this fighter adding a second photon torpedo charge to each of its photon torpedo tubes (J16.242). The added charges cannot be fired on the same turn or within a quarter turn of the fighter's normal charges. A charge provided by the mega-pack could be fired at the same time (assuming the photon torpedo launcher had already fired its normal charge) as a charge or charges from other photon torpedo launchers.

Counters for A-20s are in *Module J*.

(R2.F10) F-15 “EAGLE” FIGHTER: The most powerful (and most expensive) planet-based fighter, F-15s were used for the most important planets. Some were used for carrier duty on strike carrier-class ships [which were designated CVB (R2.29A)] after those

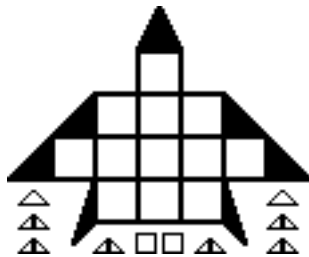

ships proved incapable of operating F-14s (R2.F1).

The F-15 can launch two drones per turn; if launched on different impulses, they can be launched at different targets. See (J4.242).

F-15p: Variant of the F-15 with two phaser-3-FAs replacing the phaser-G-FA, normally used for training or deployed on planets where attack was deemed less likely.

F-15C: The C-refit (R1.F8) replaced two of the type-VI drone rails (J4.232) with two type-I drone rails (J4.231) in Y183 for increased firepower in the late-General-War period and against the Andromedans. All SSDs with F-15s show this version. Change two of the type-I drones to type-VI drones for the F-15. For the F-15D two pairs of standard rails (type-I drones) can be marked as carrying a single type-IV drone.

F-15Cp: Variant of F-15C with two phaser-3-FAs replacing the phaser-G-FA, normally used for training or deployed on planets where attack was deemed less likely.

F-15D: The final “Delta Dog” variant had two light rails for type-VI drones and six standard rails for type-I drones. Four of the standard rails were paired so that each pair could carry one type-IV drone in Y185.

F-15Dp: Variant of F-15D with two phaser-3-FAs replacing the phaser-G-FA, normally used for training or deployed on planets where attack was deemed less likely.

F-15E: Electronic warfare variant of the two-seat F-15 (J4.43), it was unusual in that it retained four type-VI light drone rails (J4.242) when most drone-armed electronic warfare fighters only retained two drone rails. It replaced the four type-I drone rails (J4.241) with two built-in electronic warfare pods [(J4.9)/(J11.2)] and equipment enabling it to lend electronic warfare from the pods to the fighters of its squadron (J4.46). It was introduced in Y172 and remained the standard electronic warfare fighter for F-15 squadrons.

F-15Ep: Variant of F-15E with two phaser-3-FAs replacing the phaser-G-FA, normally used for training or deployed on planets where attack was deemed less likely.

Designed by Craig Friedley.

This fighter type always had two chaff packs. A mega-pack was developed for this fighter adding two drone rails (J16.241).

F-15Es when fitted with a mega-pack gained two additional pod rails (J16.245).

Use the FTR counters for the F-15 or use the F-15 counters in *Module R2*.

(R2.F) FEDERATION HEAVY FIGHTER

(R2.F11) F-111 “AARD-VARK” HEAVY DRONE FIGHTER: This is the fighter that became known as “the Federation fast patrol ship.” It was the largest and most powerful of Federation fighters and was used at bases and by heavy fighter transports (R2.56) [on their mech-links (J1.561)] and other specially designed carriers. It is a large fighter (J10.0). It has an assortment of drone rails and internal ordnance options.

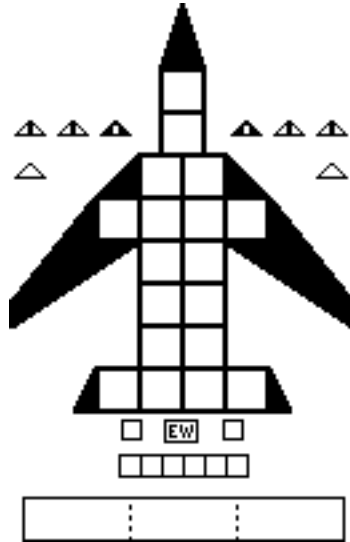

Drone launch rate:
Max of four drones within

any one turn or within eight consecutive impulses on two turns. Can also use (R1.F9).

Standard: The F-111 has the following standard systems and weapons:

- one phaser-G-FX
- one phaser-2-FA
- one phaser-3-RA
- one built-in EW pod
- a 6-round anti-drone system (E6.0)
- two chaff packs (D11.0)

Drone rails: The F-111 has eight drone rails, four under each wing. These are as follows:

- The outer rails (one per wing) are “light” rails (J4.232) able to hold only type-VI drones. They cannot hold pods of any type. This rail can carry a RALAD (J12.0).
- The two middle rails on each wing are “standard” rails (J4.231) able to hold type-I or type-VI drones. They can also carry any type of fighter pod (J11.0) or a RALAD.
- The inner rails (one per wing) are “special-heavy” rails (J4.234). They can carry type-III (even type-IIIMW) drones, type-I or type-VI drones, a RALAD, or any type of fighter pod. These rails can even carry type-IV drones (or type-IIIXX), but in this case the adjacent middle rails (one on each wing) must be left vacant (keeping the total spaces the same). For example, the left wing might have VI-I-IV and the right wing III-I-I-VI.
- The two rails comprising a given pair need not be loaded with identical munitions.
- Two “pod rails” (J11.11) which count against speed and DFR.

Weapons bay: The nearly unique feature of the F-111, however, is the internal weapons bay [also used by bombers and the F-101 (R2.FA14)]. This bay can hold a total of three “spaces” of weapons or other equipment, as follows:

- Type-VI drones are half-space. The bay cannot fire RALADs, although they could be carried as non-firing cargo for purposes of transfer.
- Type-I or type-III drones are single-space. Type-III drones in the bay can be launched under (R1.F9).
- Type-IV and type-IIIXX drones are two-space.
- Fighter pods (any type) are single-space.
- Cargo can be carried in some or all of the spaces.

- One transporter bomb (M3.0) (two spaces) can be carried and laid. These transporter bombs are taken from those on board the carrier (or other ships, using cargo transfer rules or sending the fighter there to pick the transporter bomb up); the fighter does not come with transporter bombs of its own.
- Tactical intelligence cannot reveal the contents of the bay. The contents of the bay may well be revealed when the item is used (launched, dropped, used to generate EW) as provided in the rules. Phaser (J11.33) and ground attack (J11.34) pods cannot be fired from inside the bay. Drones in the bay are under the overall launch rate (J10.41) for the fighter and do not increase the fighter’s drone control (J10.4) ability.

Items in the bay need NOT be dropped if the fighter is crippled, but cannot be used if the fighter is crippled (a transporter bomb could still be dropped). Items in the bay cannot be used if the fighter is used as a scatter-pack (FD7.44). The bay is not counted for drone cost and availability calculations. Drones in the bay do not count for the “standard load” or “reloads” of the fighter; if the bay is loaded you will be drawing drones from future reloads for the wing rails.

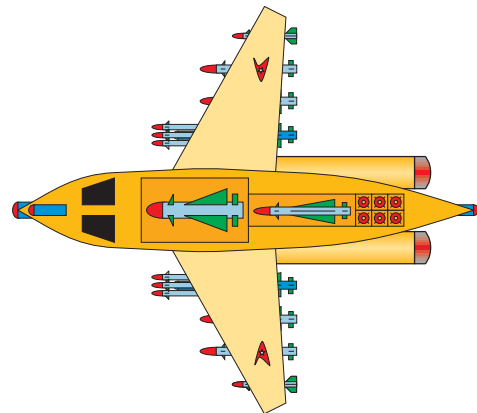

F-111p: Variant of F-111 with two phaser-3-FXs replacing the phaser-G-FX, normally used for training or deployed on bases or auxiliary carriers where attack was deemed less likely.

See (R1.F7A) for electronic warfare fighters.
No C-refit.

This fighter type always had two chaff packs. A mega-pack was developed for this fighter adding two drone rails (J16.241).

Counters for heavy fighters are provided in *Module K*.

(R2.F12) A-6 “INTRUDER” ASSAULT SHUTTLE:

First introduced in Y168 as the assault contemporary of the F-4 (R2.F6) and F-8 (R2.F7). The A-6 was never produced in any significant numbers. The lack of a phaser (thought unnecessary in the pre-General-War era) proved its downfall. Few, if any, ever served on carriers other than those of the Cygnan National Guard.

The A-6 has six drone rails, three under each wing. All rails can carry RALADs (J12.0). These are as follows:

The outer rails are “light” rails (J4.232) able to hold only type-VI drones. They cannot hold pods of any type.

The middle rails are “standard” rails (J4.231) able to hold type-I or type-VI drones.

The inner rails are standard rails (J4.231), but are the only rails able to hold fighter pods (J11.0).

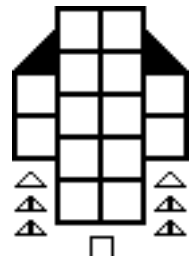

The two rails comprising a given pair need not be loaded with identical munitions. The original A-6 could not carry type-III, multi-warhead (FD8.0), or two-space drones. This is the design found on updated SSDs, for the A6D delete the type-VI drone rails and change the four type-I drone rails to type-III rails. For the A6F add a fifth type-III drone rail.

Designed by Jeff Saska.

Use FTR counters for A-6s.

A-6 fighters were produced only by the planet Cygnus within the Federation, and there was little employment of them outside of that planetary system due to its lack of a phaser.

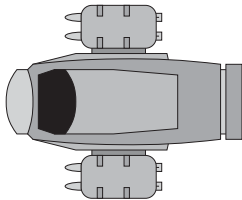

A-6B: The first improvement was the A-6B. Using the same engine as the A-10, the speed of the A-6B matched that of the A-10. Since the A-6 was slightly smaller, the bigger engine also improved the dogfight ability. While this was a moot point due to the lack of a phaser, it still made the attack craft more pleasant to fly and helped keep the crew alive in the event that they got into a dogfight.

EA-6B: Electronic warfare variant of the two-seat A-6B (J4.43) introduced in Y172. It did not have built-in electronic warfare pods, but could lend electronic warfare from special pod rails, four of them replacing its standard drone rails, that did not reduce its speed [(J4.9)/(J11.2)].

A-6D: Rumors of a fighter with the ability to use long-ranged type-III drones were rampant. While it was not known if it was true, the Cygnans decided to make it true. Since the A-6 was a large spaceframe, they were able to develop a long-range sensor suite to fit into the nose of the A-6. Since this was an early design, much of the automation available for later systems was not there. This required a second crewmember to operate the equipment and control the drones. The added weight and space meant something had to go, so both type-VI drone rails and their control equipment were removed, leaving the fighter with four special rails (J4.243) and the ability to launch all of them in a short period of time (J1.F9). The Cygnans felt that this stand-off ability meant that no phaser was needed, but did not reckon on Klingon attempts to send fighter sweeps hunting for the vulnerable A-6s. A handful of embarrassing combat episodes did little for the A-6's marketability.

A-6F: A slight improvement of the A-6D adding a fifth special rail on the fighter's centerline.

EA-6C: Electronic warfare variant of the A-6F. It did not have built-in electronic warfare pods, but converted the fifth special rail of the standard A-6F into a fifth electronic warfare pod rail allowing it to use five such pods to lend electronic warfare to the squadron (J4.46) it was supporting.

Additional variants by Karl A. Vogelheim.

No C-refit.

This fighter type always had one chaff pack, except for the EA-6B and EA-6C which had two chaff packs. A mega-pack was developed for this fighter adding two drone rails (J16.241).

EA-6Bs and EA-6Cs when fitted with a mega-pack gained two additional pod rails (J16.245).

Use the FTR counters for the A-6.

THE NEW FIGHTERS

(R2.F13) THE SHENYANG F-7:

Developed as an independent venture by one of Earth's largest manufacturers of standard administrative [(J2.0)/(R1.F1)] shuttles, the F-7 was intended to be a local defense fighter that could be produced cheaply and based on, literally, any ship. The F-7 was, in fact, an administrative shuttle that had been cut down to provide only two (cramped) seats (pilot and gunner), with space for an uncomplaining passenger in the gap between the tandem crew seats. The lower mass provided increased speed (nearly reaching normal fighter velocities) while the poor maneuverability was offset by the two phaser-3s being able to fire in a full 360° arc. Because it had the same footprint as a standard administrative shuttle and used many (over 80%) of the same parts, the F-7 could be carried in a standard shuttle bay on any ship that could carry admin shuttles (which was to say, any ship). There were no ready racks (J4.89) for the F-7; it was designed to refuel and recharge its phasers from the power connections designed for a standard shuttlecraft. The two type-VI drones had to be loaded by hand (J4.8962). The Shenyang Corporation boasted that it would sell thousands of these craft for use by Star Fleet, merchant ships, commercial platforms, and colony worlds, but in fact the market was limited and fewer than 2,000 were built during the entire General War. (Even that was enough to make Shenyang one of the most profitable of corporations.) If this fighter is carried in place of an admin shuttle, the type-VI drones, additional reloads for the type-VIs, and any pods for the fighter's pod rails have to be individually purchased either as part of the overall force BPV, or with the unit's Commander's Option points. There are no free stores that come with the F-7.



The Gorns bought fewer than a dozen for tests and the Kzintis (who politely accepted samples as a gift) used them for target practice, regarding them only with disdain. The F-7 had almost fallen into obscurity when the invention of booster packs (J5.0) provided a brief resurgence in sales.

Due to the way the F-7 was built, the resulting "shuttle" could not be used for suicide (J2.22), scatter-pack (FD7.0) [exception, (FD7.44)], wild weasel (J3.0), or science (J2.212) missions, which is one reason why starship commanders were less than interested in it. (Another was the relatively low speed, which restricted starship maneuvers and required the ship to circle back to pick up the shuttle, or abandon the crew to capture by the enemy.) The F-7 did have two pod rails (J11.111).

While the F-7 was given an "F" designation by the Federation, it is a shuttle, not a fighter. A carrier cannot lend it electronic warfare (J4.9), nor is there an electronic warfare (R1.F7) variant able to lend electronic warfare to a "squadron" (J4.46). Even if an MRS (J8.0) [or SWAC (J9.0)] were to be included in a "squadron" of F-7s, it could not lend the squadron (or even a single "fighter" in the squadron) electronic warfare. F-7s can benefit from electronic warfare pods (J4.9) they are themselves carrying. F-7s can use warp booster packs (J5.0), but cannot use mega-packs (J16.0), and were often operated by remote control (J15.0) so that they could be abandoned without leaving behind their crews.

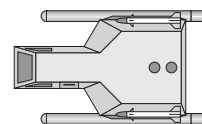

F-7A: Appearing in Y180, this was simply the F-7 incorporating the advanced shuttle technologies that rapidly spread across the Alpha Octant in that year. The F-7A is Speed 10 with 10 damage points and otherwise unchanged from the basic F-7.

No C-refit. No chaff prior to Y168.
Designed by Stephen V. Cole.

This fighter type always had one chaff pack, but was never equipped with a mega-pack.
 SSD and counters are in *Module J2*.

(R2.F14) A-20F FAST HEAVY FIGHTER:

Improved engine technology enabled the Federation to increase the tactical speed of the A-20 heavy fighter (R2.F9). This made the fighter considerably more of a challenge for those who encountered it, enabling their crews to press home torpedo attacks behind a wave of drones.

Drone rails: Four special rails (J4.233). Each pair of special rails can carry one type-IV drone. See (J4.24).

See (R1.F7A) for electronic warfare fighters.
 The photons have a maximum range of 12 hexes.
 No C-refit.

Designed by Stephen V. Cole.

A mega-pack was developed for this fighter adding a second photon torpedo charge to each of its photon torpedo tubes (J16.242). The added charges cannot be fired on the same turn or within a quarter turn of the fighter's normal charges. A charge provided by the mega-pack could be fired at the same time (assuming the photon torpedo launcher had already fired its normal charge) as a charge or charges from other photon torpedo launchers.

SSD in *Module J2*. Use the A-20 counters in *Module J*.

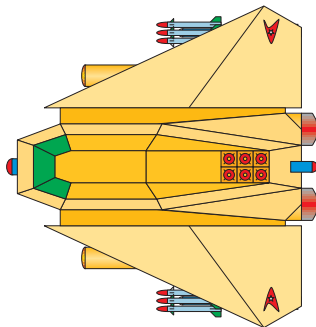
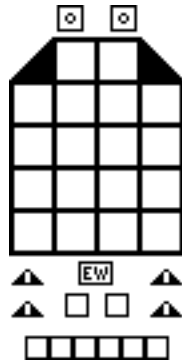

BOMBERS

(R2.F15) B-52 EARLY BOMBER:

One of the first (and for a decade the only) widely deployed heavy bomber shuttles in the Alpha Octant, the B-52 mounted two photons and an array of drones. Even better, it could carry and lay mines out of its bay, something few shuttles could do. Each photon has one charge; the B-52 photons are under the same firing restrictions as the A-20 (R2.F9).

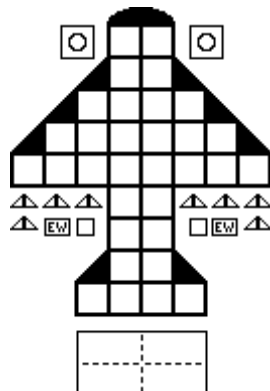

The early B-52A model suffered major problems with its warp engines, and only 18 were built before production switched to the B-52B with redesigned engines. The two models were otherwise identical in performance, and all surviving A-models (four were destroyed in engine explosions) were converted to B-52Bs. Production of both models was slow (no more than 50 were built) and all were deployed to protect the Federation core worlds.

Standard: The B-52 has the following standard systems and weapons:

- two phaser-3-FX (two phaser-2-FX on B-52C and subsequent models)
- one phaser-3-RX
- two photon-FA (no photons on B-52F only)
- one built-in EW pod (two on B-52D and subsequent models)
- one chaff pack from Y168 (D11.0) (two on B-52E and subsequent models)

Drone rails: These are as follows:

- Six drone rails, three standard (J4.231) rails under each wing. [B-52C adds two light (J4.232) rails, one under each wing. B-52G adds two standard (J4.231) rails, one under each wing, for a total of eight standard rails and two light rails.]
- Four "pod rails" (J11.11) which count against speed and DFR. One or two pods carried reduces the bomber's speed by one; three or four pods carried reduces the bomber's speed by two.

Weapons bay: The internal weapons bay operates under the rules of the F-111 (F2.11). The F-111 was nearly unique in being one of only two carrier-borne fighters with this system, but it was also used on the various Federation bombers. The B-52's bay can hold a total of four "spaces" of weapons or other equipment, as follows:

- Type-VI drones are half-space. The bay cannot fire RALADs (J12.0), although they could be carried as non-firing cargo for purposes of transfer.
- Type-I or type-III drones are single-space. Type-III drones in the bay can be launched under (R1.F9).
- Type-IV and type-IIIIX drones are two-space.
- Fighter pods (J11.0) (any type) are single-space.
- Cargo can be carried in some or all of the spaces.
- Up to two transporter bombs (M3.0) (each two spaces) or a single nuclear space mine (M2.0) (taking up the entire bay) can be carried and laid. These mines must be purchased as part of the force; the bomber does not come with transporter bombs of its own. No bomber base (R1.46) can have more than six spaces, e.g., six transporter bombs or one nuclear space mine and two transporter bombs, of mines.
- Tactical intelligence cannot reveal the contents of the bay. The contents of the bay may well be revealed when the item is used (launched, dropped, used to generate EW) as provided in the rules. Phaser (J11.33) and ground attack (J11.34) pods cannot be fired from inside the bay. Drones in the bay are under the overall launch rate (J14.233) for the bomber and do not increase the bomber's drone control [(J14.233)/(J10.4)] ability.

Items in the bay need NOT be dropped if the bomber is degraded (J14.31) or crippled (J14.32), but cannot be used if the bomber is crippled (a mine could still be dropped). Items in the bay cannot be used if the bomber is used as a scatter-pack (FD7.44). The bay is not counted for drone cost and availability calculations. Drones in the bay do not count for the "standard load" or "reloads" of the bomber; if the bay is loaded, you will be drawing drones from future reloads for the wing rails.

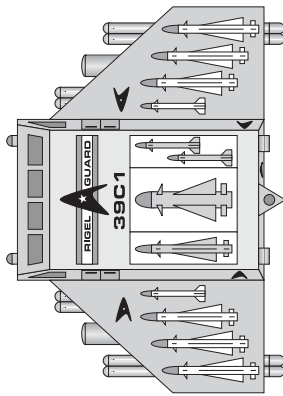

B-52C: The B-52C entered production in Y166. Rapid improvements in miniaturization enabled Theral to replace the two phaser-3-FXs in the original design with phaser-2-FXs. Launch rails for two type-VI drones (J4.232) (an idea borrowed from the B-47) were also installed, boosting firepower further. The changes to the spaceframe were rather significant, and it was not economically feasible to upgrade the early model B-52s, which were retired to training units.

B-52D: In Y167, production of the B-52D began. This model benefited from improved electronics, equivalent to the addition of a second EW pod. Existing B-52Cs were quickly upgraded to this design. This was the first B-52 to see widespread service on colonial worlds.

B-52E: The B-52E, entering service in Y168, was identical to the B-52D but added two chaff packs. It was the B-52E that served as the standard model of B-52 during the General War.

B-52F: The B-52F was an attempt to build a faster B-52. It was not considered successful. With the engines available at the time, it proved impossible to push the spaceframe faster without deleting the photon torpedoes. Although the bomber could still carry a copious drone load, the National Guard leadership, considering the relatively limited improvement in speed, judged the reduction in firepower unacceptable. The six pre-production machines built in Y169 were converted to testbeds by Theral and never saw active service.

B-52G: The final model was the B-52G, designed in Y179 to help counter Interceptors and fast patrol ships. The G-model replaced the two type-VI drone rails with standard type-I rails [in essence an early occurrence of the C-refit (R1.F8), but not the C-refit], increasing drone firepower. Many, but not all (no more than 40%) existing B-52s were converted to this design. While the basic design was obsolete due to its low speed by this time, it was only gradually phased out by more advanced bombers. This is the design found on updated SSDs, for the B-52. For the B-52A and B delete two drone rails. For the B-52C, D, E, and F change two type-I rails to type-VI rails.

See (R1.F7A)/(J14.21)/(J14.232) for electronic warfare bombers. The original B-52s had one electronic warfare pod [(J4.9)/(J11.2)]; the B-52D and later variants had two electronic warfare pods.

No C-refit.

Designed by Stephen V. Cole.

One set of BMR counters is provided for the Federation in *Module J2*. The silhouette is that of the B-2 heavy bomber, use these counters for the B-52.

(R2.F16) FB-111 STRIKE BOMBER:

When the Federation found itself with the best fast heavy fighter in the sector (but at a time when heavy fighters were obsolete compared to fast patrol ships), they attempted to solve the problem by producing a “stretched” version of the F-111 (R2.F11). This provided space for a larger weapons bay, but at the cost of speed. The resulting fighter was superb as heavy fighters went, but was too large to be used anywhere except on a planet. Efforts to refit heavy fighter transports (R2.56) to handle these

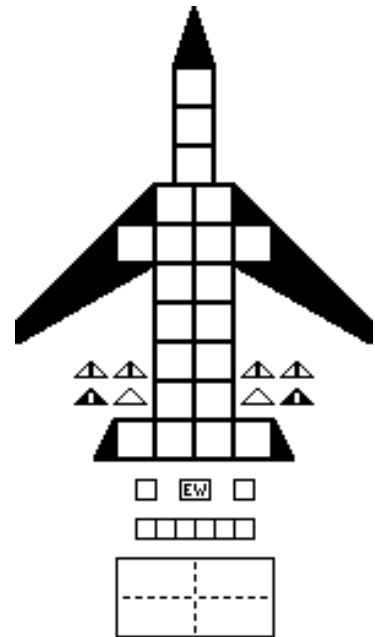

larger fighters (which were, technically, bombers rather than large fighters) never really worked.

Standard: The FB-111 has the following standard systems and weapons:

- one phaser-G-FX
- one phaser-2-FA
- one phaser-3-RA
- one built-in EW pod
- a 6-round anti-drone system (E6.0)
- two chaff packs (D11.0)

Drone rails: The FB-111 has eight drone rails, four under each wing. These are as follows:

- The outer rails (one per wing) are “light” rails (J4.232) able to hold only type-VI drones. They cannot hold pods of any type. This rail can carry a RALAD (J12.0).
- The two middle rails on each wing are “standard” rails (J4.231) able to hold type-I or type-VI drones. They can also carry any type of fighter pod (J11.0) or a RALAD.
- The inner rails (one per wing) are “special-heavy” rails (J4.234). They can carry type-III (even type-III-MW) drones, type-I or type-VI drones, a RALAD, or any type of fighter pod. These rails can even carry type-IV drones (or type-III-XX), but in this case the adjacent middle rails (one on each wing) must be left vacant (keeping the total spaces the same). For example, the left wing might have VI-I-IV and the right wing III-I-I-VI.
- The two rails comprising a given pair need not be loaded with identical munitions.
- Two “pod rails” (J11.11) which count against speed and DFR.

Weapons bay: The internal weapons bay operates under the rules of the F-111 (R2.F11). While the F-111 was nearly unique in being one of only two carrier-borne fighters with this system, it was also used on the various Federation bombers. The FB-111’s bay can hold a total of four “spaces” of weapons or other equipment, as follows:

- Type-VI drones are half-space. The bay cannot fire RALADs (J12.0), although they could be carried as non-firing cargo for purposes of transfer.
- Type-I or type-III drones are single-space. Type-III drones in the bay can be launched under (R1.F9).
- Type-IV and type-III-XX drones are two-space.

- Fighter pods (J11.0) (any type) are single-space.
- Cargo can be carried in some or all of the spaces.
- Up to two transporter bombs (M3.0) (each two spaces) or a single nuclear space mine (M2.0) (taking up the entire bay) can be carried and laid. These mines must be purchased as part of the force; the bomber does not come with transporter bombs of its own. No heavy fighter base (R1.48) can have more than six spaces, e.g., six transporter bombs or one nuclear space mine and two transporter bombs, of mines.
- Tactical intelligence cannot reveal the contents of the bay. The contents of the bay may well be revealed when the item is used (launched, dropped, used to generate EW) as provided in the rules. Phaser (J11.33) and ground attack (J11.34) pods cannot be fired from inside the bay. Drones in the bay are under the overall launch rate (J10.4) for the FB-111 and do not increase the FB-111's drone control [(J14.233)/(J10.4)] ability.

Items in the bay need NOT be dropped if the fighter is crippled (J1.33), but cannot be used if the bomber is crippled (a mine could still be dropped). Items in the bay cannot be used if the bomber is used as a scatter-pack (FD7.44). The bay is not counted for drone cost and availability calculations. Drones in the bay do not count for the "standard load" or "reloads" of the fighter; if the bay is loaded, you will be drawing drones from future reloads for the wing rails.

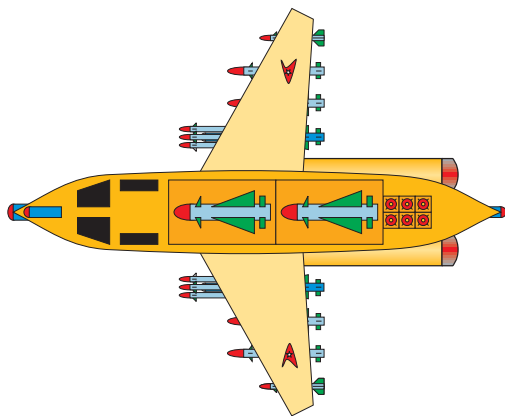

FB-111p: Variant of FB-111 with two phaser-3-FXs replacing the phaser-G-FX, normally used for training or deployed on planets where attack was deemed less likely.

See (R1.F7A) for electronic warfare fighters.

No C-refit.

Designed by Stephen V. Cole.

This fighter type always had two chaff packs. A mega-pack was developed for this fighter adding two drone rails (J16.241).

SSD in *Module J2*. Use the F-111 counters in *Module K*.

(R2.F17) B-1 STRIKE

BOMBER: When it became obvious that the FB-111 (R2.F16) had pushed that design too far, the Federation started from a clean computer screen to design a fast bomber as a new design rather than an overloaded fighter. The result was the excellent B-1, which uses the same drone and bay rules as the F-111 (R2.F11) [with the exception that two of the bay spaces

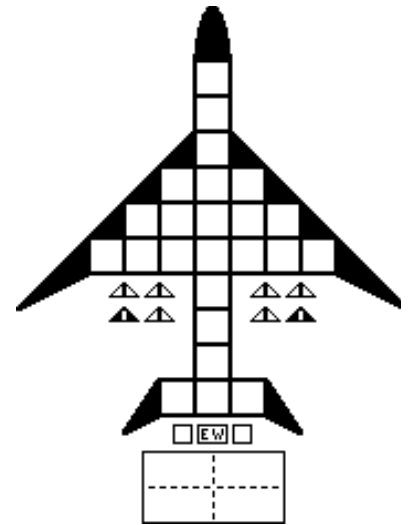

could be fitted to carry FA photons, one per space; same firing restrictions as the A-20 (R2.F9)]. The problem was that the B-1 could only fly from planets (or at least very big asteroids) and by the time bases could be built within range of Klingon or Romulan targets, the targets had been destroyed by other forces. During the final attrition phase as the General War stagnated on the original borders, the Federation made the effort to build bases for B-1s [and B-2s (R2.F18)] within range of Klingon bases, but the Klingons responded by building their own bases for their own bombers. This resulted in a number of rare but spectacular bomber-versus-bomber battles in the original Neutral Zone.

Standard: The B-1 has the following standard systems and weapons:

- two phaser-2-FX
- one phaser-G-RA
- two built-in EW pods
- two chaff packs (D11.0)

Drone rails: These are as follows:

- Eight drone rails, three standard (J4.231) rails and one special (J4.233) under each wing.
- Four "pod rails" (J11.11) which count against speed and DFR. One or two pods carried reduces the bomber's speed by one; three or four pods carried reduces the bomber's speed by two.

Weapons bay: The internal weapons bay operates under the rules of the F-111 (R2.F11). The F-111 was unique in being one of only two carrier-borne fighters with this system, but it was also used on the various Federation bombers. The B-1's bay can hold a total of four "spaces" of weapons or other equipment, as follows:

- Type-VI drones are half-space. The bay cannot fire RALADs (J12.0), although they could be carried as non-firing cargo for purposes of transfer.
- Type-I or type-III drones are single-space. Type-III drones in the bay can be launched under (R1.F9).
- Type-IV and type-IIIIXX drones are two-space.
- Fighter pods (J11.0) (any type) are single-space.
- Cargo can be carried in some or all of the spaces.
- Up to two photon torpedoes can be carried, each taking one bay space and having an FA firing arc. The procedure for loading these torpedoes is the same as for the A-20 (R2.F9).
- Up to two transporter bombs (M3.0) (each two spaces) or a single nuclear space mine (M2.0) (taking up the entire bay) can be carried and laid. These mines must be purchased as part of the force; the bomber does not come with mines of its own. No bomber base (R1.46) can have more than six spaces, e.g.,

six transporter bombs or one nuclear space mine and two transporter bombs, of mines.

- Tactical intelligence cannot reveal the contents of the bay. The contents of the bay may well be revealed when the item is used (launched, dropped, used to generate EW) as provided in the rules. Phaser (J11.33) and ground attack (J11.34) pods cannot be fired from inside the bay. Drones in the bay are under the overall launch rate (J14.233) for the bomber and do not increase the bomber's drone control [(J14.233)/(J10.4)] ability.

Items in the bay need NOT be dropped if the bomber is degraded (J14.31) or crippled (J14.32), but cannot be used if the bomber is crippled (a mine could still be dropped). Items in the bay cannot be used if the bomber is used as a scatter-pack (FD7.44). The bay is not counted for drone cost and availability calculations. Drones in the bay do not count for the "standard load" or "reloads" of the bomber; if the bay is loaded, you will be drawing drones from future reloads for the wing rails.

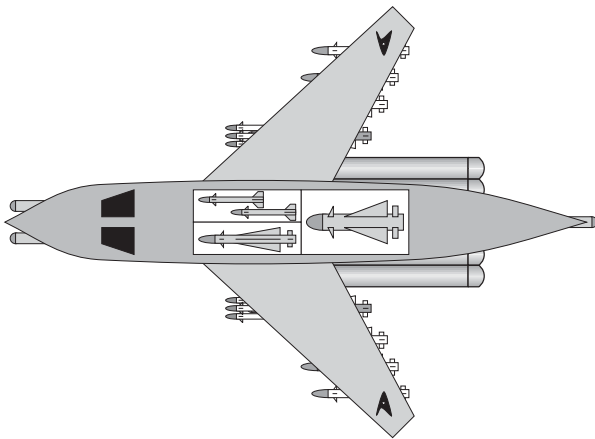

B-1p: Variant of B-1 with two phaser-3-RA in place of the phaser-G-RA, normally used for training or deployed on planets seen as less likely to be attacked.

See (R1.F7A)/(J14.21)/(J14.232) for electronic warfare bombers.

No C-refit.

Designed by Stephen V. Cole.

Two electronic warfare pods were included in the design; see (R1.F7A) for electronic warfare bombers. This bomber always had two chaff packs. This bomber type was sometimes equipped with a mega-pack, but the only effect was to double the bomber's speed and slightly increase its durability (J16.249).

SSD in *Module J2*. Use the B-2 counters.

(R2.F18) B-2 HEAVY BOMBER:

The Federation continued to push bomber designs to the maximum, resulting in the B-2 heavy bomber, which was a radically different design from any other Federation fighter or bomber. Like the B-1

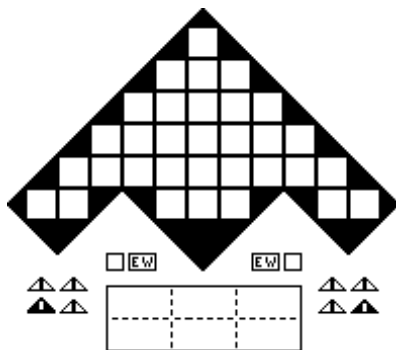

(R2.F17), the B-2 could fit photons (FA) into two of its weapons bays, one charge each; same firing restrictions as the A-20 (R2.F9).

Standard: The B-2 has the following standard systems and weapons:

- two phaser-2-FX
- one phaser-G-RA
- two built-in EW pods
- two chaff packs (D11.0)

Drone rails: These are as follows:

- Eight drone rails, three standard (J4.231) rails and one special (J4.233) under each wing.
- Four "pod rails" (J11.11) which count against speed and DFR. One or two pods carried reduces the bomber's speed by one; three or four pods carried reduces the bomber's speed by two.

Weapons bay: The internal weapons bay operates under the rules of the F-111 (R2.F11). The F-111 was nearly unique in being one of only two carrier-borne fighters with this system, but it was also used on the various Federation bombers. The B-2's bay can hold a total of six "spaces" of weapons or other equipment, as follows:

- Type-VI drones are half-space. The bay cannot fire RALADs (J12.0), although they could be carried as non-firing cargo for purposes of transfer.
- Type-I or type-III drones are single-space. Type-III drones in the bay can be launched under (R1.F9).
- Type-IV and type-IIIIX drones are two-space.
- Fighter pods (J11.0) (any type) are single-space.
- Cargo can be carried in some or all of the space.
- Up to two photon torpedoes can be carried, each taking one bay space and having an FA firing arc. The procedure for loading these torpedoes is the same as for the A-20 (R1.F9).
- Up to three transporter bombs (M3.0) (each two spaces) or a single nuclear space mine (M2.0) and one transporter bomb can be carried and laid. These mines must be purchased as part of the force; the bomber does not come with mines of its own. No bomber base (R1.46) can have more than six spaces, e.g., six T-bombs or one nuclear space mine and two transporter bombs, of mines.
- Tactical intelligence cannot reveal the contents of the bay. The contents of the bay may well be revealed when the item is used (launched, dropped, used to generate EW) as provided in the rules. Phaser (J11.33) and ground attack (J11.34) pods cannot be fired from inside the bay. Drones in the bay are under the overall launch rate (J14.233) for the bomber and do not increase the bomber's drone control [(J14.233)/(J10.4)] ability.

Items in the bay need NOT be dropped if the bomber is degraded (J14.31) or crippled (J14.32), but cannot be used if the bomber is crippled (a mine could still be dropped). Items in the bay cannot be used if the bomber is used as a scatter-pack (FD7.44). The bay is not counted for drone cost and availability calculations. Drones in the bay do not count for the "standard load" or "reloads" of the bomber; if the bay is loaded, you will be drawing drones from future reloads for the wing rails.

B-2p: Variant of B-2 with two phaser-3-RA in place of the phaser-G-RA, normally used for training or deployed on planets seen as less likely to be attacked.

See (R1.F7A)/(J14.21)/(J14.232) for electronic warfare bombers.

No C-refit.

Designed by Stephen V. Cole.

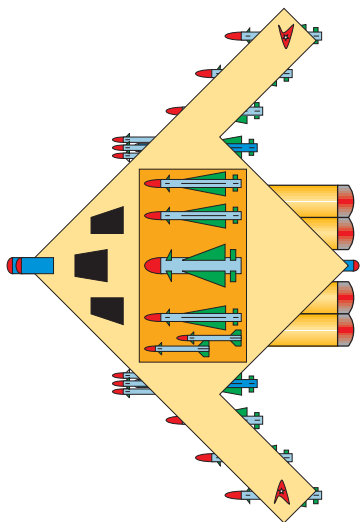

Two electronic warfare pods were included in the design; see (R1.F7A) for electronic warfare bombers. This bomber always had two chaff packs. This bomber type was sometimes equipped with a mega-pack, but the only effect was to double the bomber's speed and slightly increase its durability (J16.249).

SSD and counters are in *Module J2*.

ADVANCED SWAC SHUTTLES

(R2.F19) **ADVANCED SWAC SHUTTLES** became available in Y180. These only increased speed (Speed 10) and added a second chaff pack (D11.0) to the E-2 (R2.F3). They are otherwise identical in all respects to the earlier SWAC shuttles. The advanced E-2CA costs 64/15 points, while the advanced E-3AA (R2.F3A) costs 94/23.

(R2.F191) These advanced shuttles are received automatically if the ship includes SWACs in its BPV and do not increase the BPVs of the ships. If destroyed outside of the ship, their increased economic cost is used for victory determination.

Use the counters for the E-2C SWAC in *Module J*.

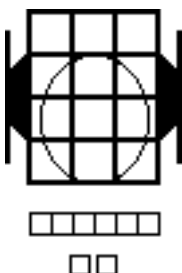
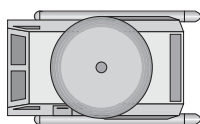

E-3AAp: Variant of E-3AA with two phaser-3-360°s replacing the phaser-G-360°, normally used for training or deployed on bases where attack was deemed less likely.

E-3AAs and E-3AAs always had two chaff packs; there is no mega-pack.

Use the counter for the E-3A SWAC in *Module J*.

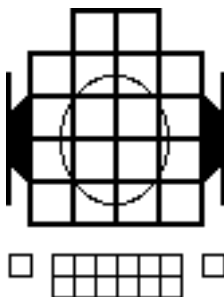
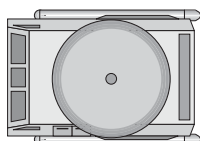

FEDERATION BOMBERS IN CAPTAIN'S LOG

CONVERTED BOMBERS

The Federation converted a number of existing large cargo shuttles into bombers (and produced even more as new construction). Converted bombers can use warp booster packs (J5.0), but cannot use mega-packs (J15.0). They are otherwise, within their obvious limitations, fully capable bombers able to be formed into squadrons (J4.46) and be lent electronic warfare by their base or other qualified source (J4.9), etc.

(R2.FA1) **B-17 BOMBER:** The B-17 design was based on the triple-sized cargo shuttle (R1.F15) and was produced in the hundreds and sold to various colony planets; most were found to be useless in combat and converted back into cargo shuttles for commercial use. B-17s have no cargo capacity when operated as bombers. If you leave the drone rails empty, it has 1/3 of the original cargo capacity (by utilizing the external cargo pods carried by shuttlecraft). Standard: The B-17 has the following standard systems and weapons:

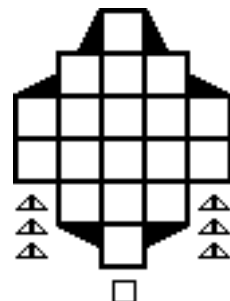

two phaser-3-360°

No chaff packs (D11.0) prior to Y168, one thereafter.

Drone rails: These are as follows:

- Six drone rails, three standard (J4.231) rails under each wing.
- Four "pod rails" (J11.11) which count against speed and DFR. One or two pods carried reduces the bomber's speed by one; three or four pods carried reduces the bomber's speed by two.

This bomber has no bay as found on the F-111 (R2.F11).

See (R1.F7A)/(J14.21)/(J14.232) for electronic warfare bombers had these bombers remained in service in Y172.

No C-refit.

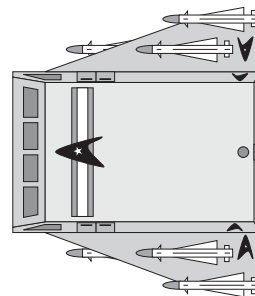

Designed by John Sickels.

There are no SSDs except the graphic above. Use any bomber counters from *Module J2*.

(R2.FA2) **B-25 BOMBER:** The B-25 (which might technically be called a heavy fighter rather than a bomber) was a conversion of the double-size heavy transport shuttle (R1.F5). B-25s have no cargo capacity when operated as bombers. If you leave the drone rails empty, it has 1/3 of the original cargo capacity (by utilizing the external cargo pods carried by shuttlecraft). Installation of the wings on the basic box of the heavy shuttle made it too large to fit inside of a shuttle bay, which is why this unit is classified as a

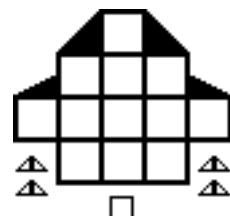

“bomber,” but it is operationally a “heavy fighter” (J10.0) and not a bomber (J14.0).

Standard: The B-25 has the following standard systems and weapons:

- one phaser-3-360°
- No chaff packs (D11.0) prior to Y168, one thereafter.

Drone rails: These are as follows:

- Four drone rails, two standard (J4.231) rails under each wing.
- Two “pod rails” (J11.11) which count against speed and DFR.

This bomber has no bay as found on the F-111 (R2.F11).

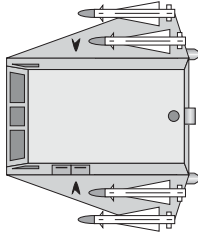

B-25A: Had B-25s remained in service in Y180, they would have incorporated the advanced shuttle technologies that rapidly spread across the Alpha Octant in that year. The B-25A is Speed 8 with 14 damage points and two chaff packs; it is otherwise unchanged from the basic B-25.

See (R1.F7A)/(J14.21)/(J14.232) for electronic warfare bombers had these bombers remained in service in Y172.

No C-refit.

Designed by John Sickels.

There are no SSDs except the graphic above. Use any bomber counters from *Module J2*.

(R2.FA3) B-29 BOMBER: The B-29 was based on the quad-sized cargo shuttle (R1.F14). The design for the B-29 was, in fact, not put into production until Y180 and found only a tiny market in some backwater planets. B-29s have no cargo capacity when operated as bombers. If you leave the drone rails empty, it has 1/3 of the original cargo capacity (by utilizing the external cargo pods carried by shuttlecraft).

Standard: The B-29 has the following standard systems and weapons:

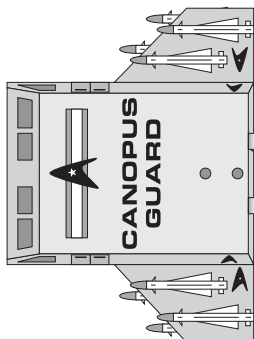
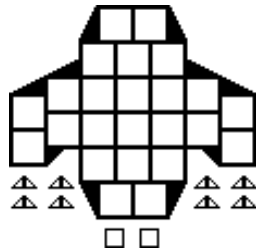

- two phaser-3-360°
- two chaff packs (D11.0)

Drone rails: These are as follows:

- Eight drone rails, four standard (J4.231) rails under each wing.
- Four “pod rails” (J11.11) which count against speed and DFR. One or two pods carried reduces the bomber’s

speed by one; three or four pods carried reduces the bomber’s speed by two.

This bomber has no bay as found on the F-111 (R2.F11).

See (R1.F7A)/(J14.21)/(J14.232) for electronic warfare bombers.

No C-refit.

Designed by John Sickels.

There are no SSDs except the graphic above. Use any bomber counters from *Module J2*.

KIT BOMBERS

Kits were sold to colony planets that used large cargo shuttles, allowing those shuttles to be converted into defensive units within hours once a military threat was detected. The primary distinction between these “kit bombers” (B-24, B-26, B-32) and the “purpose built bombers” based on shuttles (B-17, B-25, B-29) was that the kits, being designed for rapid installation, could not add phasers to the shuttles or install electronic warfare systems, i.e., no (J14.232) built-in electronic warfare pods. The kits did install drone and pod (J11.111) rails (J14.231) seeking weapon guidance systems, and (later) chaff dispensers. Many colonies satisfied Federation requirements for local defense by purchasing such kits.

While the Federation gave them a “B” designation (when a kit is installed) they are shuttles, not bombers, and do not have the built-in electronic warfare under (J4.47). They cannot be lent electronic warfare by their ground base under (J4.9), nor can one be configured to lend electronic warfare to the “squadron” (J4.46) under (R1.F7A)/(J14.21). Even if an MRS (or SWAC) were to be included in a “squadron” of kit bombers, it could not lend the squadron (or even a single “bomber” in the squadron) electronic warfare. Kit bombers can benefit from electronic warfare pods they are themselves carrying. Kit bombers can use warp booster packs (J5.0), but cannot use mega-packs (J16.0), and were often operated by remote control (J15.0).

Kits cannot be installed or removed during a scenario. Special scenario rules might define a number of deck crew actions required to complete the installation, or removal, of a kit started before the scenario begins.

(R2.FA4) B-24 BOMBER: The B-24 design was a “kit” able to quickly convert an existing triple-space heavy freight shuttle (R1.F13) into a “combat defense platform.” The shuttle retains 2/3rds of its original cargo capacity when converted to bomber mode and 100% of the original capacity when the bomber kit is removed.

Standard: The B-24 has the following standard systems and weapons:

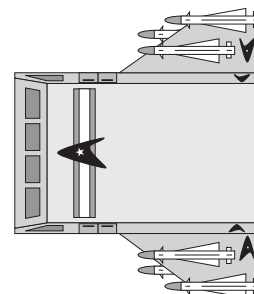
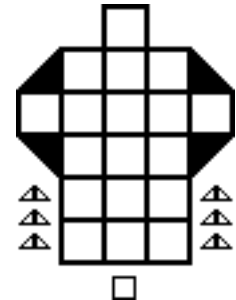

- No phaser
- One chaff pack (D11.0) from Y168.

Drone rails: These are as follows:

- Six drone rails, three standard (J4.231) rails under each wing.
- Four “pod rails” (J11.11) which count against speed and DFR. One or two pods carried reduces the bomber’s speed by one; three or four pods carried reduces the bomber’s speed by two.

This bomber has no bay as found on the F-111 (R2.F11).
No C-refit.

Designed by John Sickels.

There are no SSDs except the graphic above. Use any bomber counters from *Module J2*.

(R2.FA5) B-26 BOMBER: the B-26 was a “kit” able to quickly turn an existing heavy transport shuttle (R1.F5) into a “combat defense platform.” The shuttle retains 2/3rds of its original cargo capacity when converted to bomber mode and 100% of the original capacity when the bomber kit is removed. Installation of the “kit” made the shuttle too large to



fit inside of a shuttle bay, which is why this unit is classified as a “bomber,” but it is operationally a “heavy fighter” (J10.0) and not a bomber (J14.0). They were most commonly found at civilian planetary operations bases (R1.72) and civilian small operations bases (R1.73).

Standard: The B-26 has the following standard systems and weapons:

- No phaser
- No chaff pack (D11.0) prior to Y168.

Drone rails: These are as follows:

- Four drone rails, two standard (J4.231) rails under each wing.
- Two “pod rails” (J11.11) which count against speed and DFR.

This bomber has no bay as found on the F-111 (R2.F11).

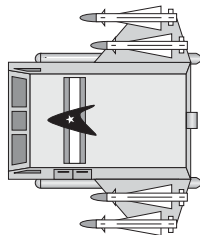

B-26A: Had any B-26 kits remained in service in Y180, the shuttle it was installed on would likely have incorporated the advanced shuttle technologies that rapidly spread across the Alpha Octant in that year. The B-26A is Speed 8 with 14 damage points and two chaff packs; it is otherwise unchanged from the basic B-26.

No C-refit.
Designed by John Sickels.

There are no SSDs except the graphic above. Use any bomber counters from *Module J2*.

(R2.FA6) B-32 BOMBER: The B-32 was a “kit” to turn the quad-sized very heavy freight shuttle (R1.F14) into a “combat defense platform.” The design was, in fact, not put into production until Y180 and found only a tiny market in some backwater planets. The shuttle

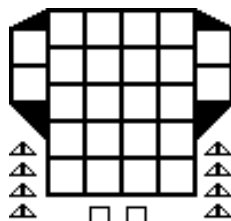

retains 2/3rds of its original cargo capacity when converted to bomber mode and 100% of the original capacity when the bomber kit is removed.

Standard: The B-32 has the following standard systems and weapons:

- No phaser
- Two chaff packs (D11.0)

Drone rails: These are as follows:

- Eight drone rails, four standard (J4.231) rails under each wing.
- Four “pod rails” (J11.11) which count against speed and DFR. One or two pods carried reduces the bomber’s speed by one; three or four pods carried reduces the bomber’s speed by two.

This bomber has no bay as found on the F-111 (R2.F11).
No C-refit.

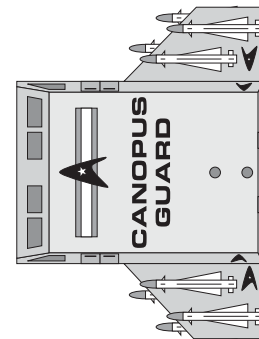

Designed by John Sickels.

There are no SSDs except the graphic above. Use any bomber counters from *Module J2*.

(R2.FA7) B-36 BOMBER: Theral Starcraft Corporation of Andor, a leading manufacturer of cargo shuttles and yachts for the civilian market, designed the first true heavy bomber to see actual service. It was designated the B-36 (it was the 36th design considered) by the National Guard leadership. This was an ungainly beast with significant weaknesses, particularly sluggish maneuverability that would have rendered it helpless in any dogfight. It was also the first

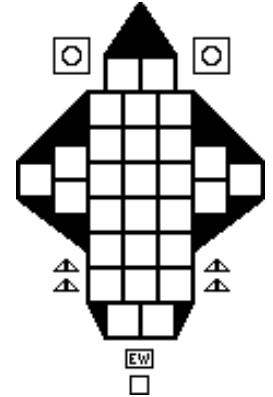

shuttle in history to carry the photon torpedo, and pioneered many of the concepts of planetary bomber operations. Approximately 60 were built, and deployed on homeworlds in the Federation core area. Quickly obsolete, the last was removed from National Guard service in Y168. As far as is known from available records, none saw combat. Each photon has one charge; the B-36 photons are under the same firing restrictions as the A-20 (R2.F9).

Standard: The B-36 has the following standard systems and weapons:

- two phaser-3-FX
- one phaser-3-RA
- two photon-FA
- one built-in EW pod

A chaff pack (D11.0) might have been added in Y169 had any of these bombers remained in service.

Drone rails: These are as follows:

- Four drone rails, two standard (J4.231) rails under each wing.

- Four “pod rails” (J11.11) which count against speed and DFR. One or two pods carried reduces the bomber’s speed by one; three or four pods carried reduces the bomber’s speed by two.
- This bomber has no bay as found on the F-111 (R2.F11). See (R1.F7A)/(J14.21)/(J14.232) for electronic warfare bombers had these bombers remained in service in Y172. No C-refit.

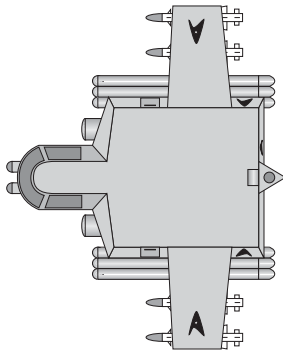

Designed by John Sickels.

These bombers initially did not have chaff packs; these were installed in Y168, at no change in BPV. This bomber type was equipped with a mega-pack which only doubled the bomber’s speed and increased its durability (J16.249). An electronic warfare pod was included in the design; see (R1.F7A) for electronic warfare bombers, which cannot be used before Y172.

There are no SSDs except the graphic above. Use any bomber counters from *Module J2*.

(R2.FA8) B-47 BOMBER: The second design to see widespread service was the B-47, proposed and built by the Boeing/Mikoyan/Gurevich Consortium from Earth. This bomber was actually designed in competition with the B-36, but initial teething troubles delayed its entry into service. Compared to the B-36, the B-47 carried one large phaser instead of two smaller phasers. The lack of a rear phaser was allegedly countered by the installation of two anti-fighter drones. The B-47 was smaller than the B-36 and could survive less

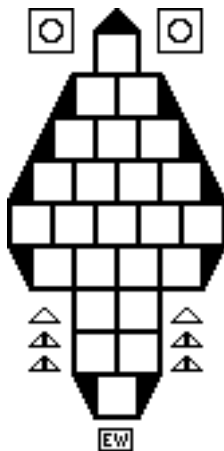

damage, but was more maneuverable, more mechanically reliable, simpler to maintain in rough conditions, and easier to manufacture. Most of all, it was cheaper. Some B-47s remained in service on less important worlds through the late Y160s. Although all had been removed from front-line service on the outbreak of war with the Klingons in Y171, a few were still present in backwater areas along the Romulan front in Y173. Two Rigellian National Guard squadrons that saw combat service were quickly annihilated, and the type was completely phased out by the end of the year. Each photon has one charge; the B-36 photons are under the same firing restrictions as the A-20 (R2.F9).

Standard: The B-47 has the following standard systems and weapons:

- one phaser-2-FX
- two photon-FA
- one built-in EW pod

For reasons that remain unclear, the B-47 never received any chaff packs (D11.0), but sometimes operated with one or more chaff pods (J11.32) on its pod rails [(J14.231)/(J11.111)].

Drone rails: These are as follows:

- Six drone rails, two standard (J4.231) and one light (J4.232) rails under each wing.
- Four “pod rails” (J11.11) which count against speed and DFR. One or two pods carried reduces the bomber’s speed by one; three or four pods carried reduces the bomber’s speed by two.

This bomber has no bay as found on the F-111 (R2.F11). See (R1.F7A)/(J14.21)/(J14.232) for electronic warfare bombers.

No C-refit.

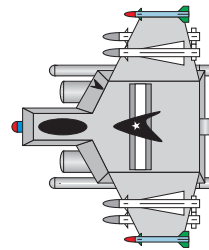

Designed by John Sickels.

These bombers never had a chaff pack. This bomber type was equipped with a mega-pack which only doubled the bomber’s speed and increased its durability (J16.249). An electronic warfare pod was included in the design; see (R1.F7A) for electronic warfare bombers, which cannot be used before Y172.

There are no SSDs except the graphic above. Use any bomber counters from *Module J2*.

(R2.FA9) B-57 BOMBER: The B-57 was proposed by the Tinram Corporation of Mantor, a planet located near the Kzinti border and one of the Federation’s newest members. This bomber was based on the Kzinti BMR bomber design, virtually identical to it in fact, except with single-charge photon torpedoes replacing the two-charge disruptors of the Kzinti version. The B-57 was

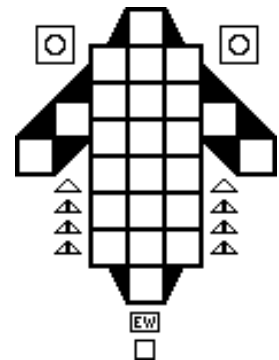

pitched to the Guard as a “critical symbol of Federation-Hegemony cooperation and harmony in the face of the vile Klingon threat.” Tests showed that the design was reasonably effective and it was approved for service, although it was considered inferior to the B-52 due to the lack of a weapon bay.

Tinram geared up for production (which promised an economic boon for Mantor), planning on selling hundreds of these bombers to colony worlds seeking a cheaper alternative to the B-52. However, an investigation revealed that the Tinram Corporation was taking kickbacks from Kzinti industrial consortiums. This caused a massive political and business scandal, destroyed Tinram’s stock value, and forced the company into bankruptcy. As a result, worlds planning on buying the B-57 backed away. The Mantorese government (to avoid economic chaos) eventually nationalized the Tinram factories and produced the design on their own, for service on Mantor and some outlying colonies. Several squadrons saw combat during the Klingon invasion and performed adequately.

Each photon has one charge; the B-57 photons are under the same firing restrictions as the A-20 (R2.F9).

Standard: The B-57 has the following standard systems and weapons:

- two phaser-3-FX
- two phaser-3-RX
- two photon-FA
- one built-in EW pod
- one chaff pack (D11.0)

Drone rails: These are as follows:

- eight drone rails, three standard (J4.231) and one light (J4.232) rails under each wing.
- Four “pod rails” (J11.11) which count against speed and DFR. One or two pods carried reduces the bomber’s speed by one; three or four pods carried reduces the bomber’s speed by two.

This bomber has no bay as found on the F-111 (R2.F11).

See (R1.F7A)/(J14.21)/(J14.232) for electronic warfare bombers.

No C-refit.

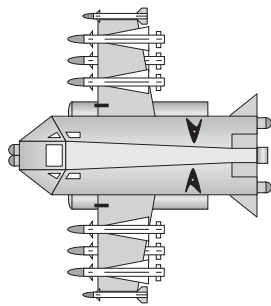

Designed by John Sickels.

These bombers always had one chaff pack. This bomber type was equipped with a mega-pack which only doubled the bomber’s speed and increased its durability (J16.249). An electronic warfare pod was included in the design; see (R1.F7A) for electronic warfare bombers, which cannot be used before Y172.

There are no SSDs except the graphic above. Use any bomber counters from *Module J2*.

(R2.FA10) B-58 BOMBER: The B-58 was designed by the Kentak/Varnak StarFlight Company of Tellar. This company had grudgingly built B-52s under license from the Andor-based Theral Corporation, a bitter rival in the interstellar shuttle market. KVS proposed the B-58 bomber in reaction to the introduction of faster bombers by the Romulans and Klingons. Generally equivalent to the Klingon ZB-2, the B-58 entered production in Y173, but was never as popular as the B-52 due to its smaller weapons load. Nevertheless, there were sufficient sales to enable KVS to retool their factories and cease production of the resented Andorian design. Most B-58s served with the Tellarite National Guard. Each photon has one charge; the B-58 photons are under the same firing restrictions as the A-20 (R2.F9).

Standard: The B-58 has the following standard systems and weapons:

- two phaser-3-FX

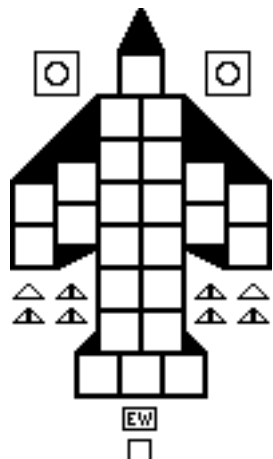

- one phaser-3-RX
- two photon-FA
- one built-in EW pod
- one chaff pack (D11.0)

Drone rails: These are as follows:

- Eight drone rails, three standard (J4.231) and one light (J4.232) rails under each wing.
- Four “pod rails” (J11.11) which count against speed and DFR. One or two pods carried reduces the bomber’s speed by one; three or four pods carried reduces the bomber’s speed by two.

This bomber has no bay as found on the F-111 (R2.F11).

See (R1.F7A)/(J14.21)/(J14.232) for electronic warfare bombers.

No C-refit.

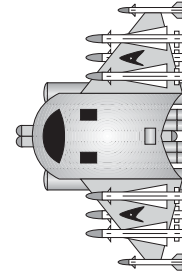

Designed by John Sickels.

These bombers always had one chaff pack. This bomber type was equipped with a mega-pack which only doubled the bomber’s speed and increased its durability (J16.249). An electronic warfare pod was included in the design; see (R1.F7A) for electronic warfare bombers, which cannot be used before Y172.

There are no SSDs except the graphic above. Use any bomber counters from *Module J2*.

(R2.FA11) B-70 BOMBER:

The Boeing/Mikoyan/Gurevich Consortium on Earth ended up building B-52s after their own B-47 was phased out of service. However, they continued to work on their own designs and build a few prototypes. Like the other corporations, they were looking for ways to build faster bombers. One result was the B-70 built in Y171. Designed to reach the then-unheard-of (for a shuttle) speed of Warp 2.46, the XB-70 pioneered the use of new materials in engine and spaceframe construction. The resulting bomber was capable of the designed speed for short periods, but proved prone to engine failures and structural fatigue. Although originally intended for series production, the design proved too fragile and maintenance-intensive for combat service. The lack of a weapon bay was also regarded as a serious handicap. Only six were built, but the data gathered in the experimental tests proved invaluable in the design of advanced bombers in the later General War years. Each photon has one charge; the B-70 photons are under the same firing restrictions as the A-20 (R2.F9).

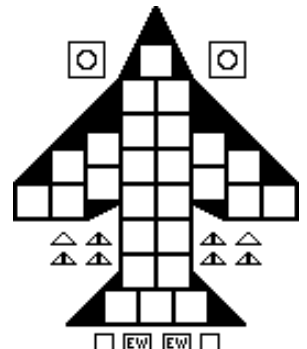

If the B-70 is used in a scenario or campaign, for every 32 impulses (cumulative within the scenario, not consecutive) that the bomber exceeds Speed 12, it takes one point of damage. Standard: The B-70 has the following standard systems and weapons:

- one phaser-2-FX
- one phaser-3-RX
- two photon-FA
- two built-in EW pods
- two chaff packs (D11.0)

Drone rails: These are as follows:

- Eight drone rails, three standard (J4.231) and one light (J4.232) rails under each wing.
- Four "pod rails" (J11.11) which count against speed and DFR. One or two pods carried reduces the bomber's speed by one; three or four pods carried reduces the bomber's speed by two.

This bomber has no bay as found on the F-111 (R2.F11). See (R1.F7A)/(J14.21)/(J14.232) for electronic warfare bombers.

No C-refit.

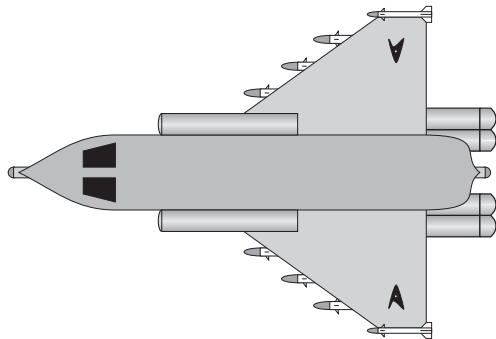

Designed by John Sickels.

These bombers always had two chaff packs. This bomber type was equipped with a mega-pack which only doubled the bomber's speed and increased its durability (J16.249). Two electronic warfare pods were included in the design; see (R1.F7A) for electronic warfare bombers, which cannot be used before Y172.

There are no SSDs except the graphic above. Use any bomber counters from *Module J2*.

(R2.FA12) B-3 BOMBER:

The final Federation bomber design of note was the B-3, a development of the B-2. Originally designed to deal with the Klingons, the B-3 took advantage of improved power system miniaturization, and was considered virtually drone-proof due to its dual 360° phaser-Gs. Originally intended to enter service in Y184, the design was delayed due to serious

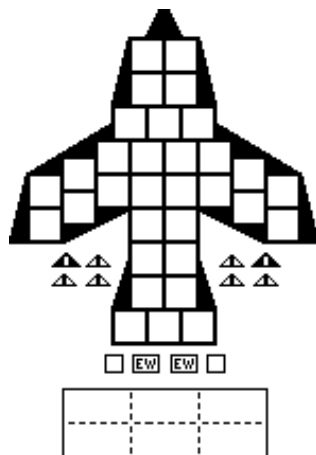

problems with heat buildup in the phaser units. These problems were eventually solved, but the bomber was not ready for series production until Y190. By this time, Andromedans were the main enemy and the drone defense issue was less important. The design never entered series production. Each photon has one charge; the B-3 photons are under the same firing restrictions as the A-20 (R2.F9).

In a campaign game, the B-3 could be made available in Y184 with the flawed phaser-Gs. Any time a phaser-G is fired, roll one die. If bothphasers are fired on the same impulse, roll twice. On a 5 or 6, the entire phaser-G unit burns out, no damage is scored on the target, and

neither phaser-G can be used for the rest of the scenario. The bomber also takes two points of damage. (If the bomber were crippled, this rule does not apply.)

Standard: The B-3 has the following standard systems and weapons:

- two phaser-2-FX
- two phaser-G-360°
- two built-in EW pods
- two chaff packs (D11.0)

Drone rails: These are as follows:

- Eight drone rails, three standard (J4.231) rails and one special (J4.233) under each wing.
- Four "pod rails" (J11.11) which count against speed and DFR. One or two pods carried reduces the bomber's speed by one; three or four pods carried reduces the bomber's speed by two.

Weapons bay: The internal weapons bay operates under the rules of the F-111 (R2.F11). The F-111 and F-101 (R2.FA14) were unique in being the only two carrier-borne fighters with this system, but it was also used on the various Federation bombers. The B-3's bay can hold a total of six "spaces" of weapons or other equipment, as follows:

- Type-VI drones are half-space. The bay cannot fire RALADs (J12.0), although they could be carried as non-firing cargo for purposes of transfer.
- Type-I or type-III drones are single-space. Type-III drones in the bay can be launched under (R1.F9).
- Type-IV and type-IIIIX drones are two-space.
- Fighter pods (J11.0) (any type) are single-space.
- Cargo can be carried in some or all of the space.
- Up to two photon torpedoes can be carried, each taking one bay space and having an FA firing arc. The procedure for loading these torpedoes is the same as for the A-20 (R1.F9).
- Up to three transporter bombs (M3.0) (each two spaces) or a single nuclear space mine (M2.0) and one transporter bomb can be carried and laid. These mines must be purchased as part of the force; the bomber does not come with mines of its own. No bomber base (R1.46) can have more than six spaces, e.g., six transporter bombs or one nuclear space mine and two transporter bombs, of mines.
- Tactical intelligence cannot reveal the contents of the bay. The contents of the bay may well be revealed when the item is used (launched, dropped, used to generate EW) as provided in the rules. Phaser (J11.33) and ground attack (J11.34) pods cannot be fired from inside the bay. Drones in the bay are under the overall launch rate (J14.233) for the bomber and do not increase the bomber's drone control [(J14.233)/(J10.4)] ability.

Items in the bay need NOT be dropped if the bomber is degraded (J14.31) or crippled (J14.32), but cannot be used if the bomber is crippled (a mine could still be dropped). Items in the bay cannot be used if the bomber is used as a scatterpack (FD7.44). The bay is not counted for drone cost and availability calculations. Drones in the bay do not count for the "standard load" or "reloads" of the bomber; if the bay is loaded, you will be drawing drones from future reloads for the wing rails.

B-3p: Variant of B-3 with four phaser-3-360°s in place of the two phaser-G-360°s, it would normally have been used for training or possibly have been deployed on planets seen as less likely to be attacked. It could have been deployed as early as Y184, but the company was concerned that if they produced this version, Star Fleet would not fund further research on the phaser-Gs.

See (R1.F7A)/(J14.21)/(J14.232) for electronic warfare bombers.

No C-refit.

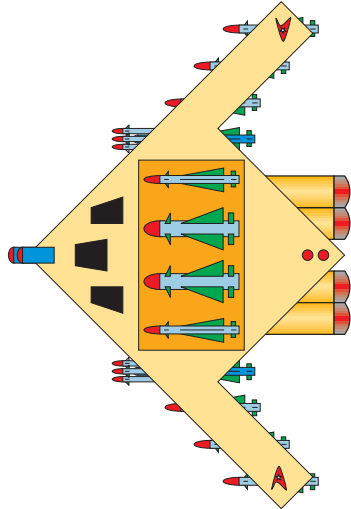

Designed by John Sickels.

These bombers always had two chaff packs. This bomber type was equipped with a mega-pack which only doubled the bomber's speed and increased its durability (J16.249). Two electronic warfare pods were included in the design; see (R1.F7A) for electronic warfare bombers, which cannot be used before Y172.

There are no SSDs except the graphic above. Use any bomber counters from *Module J2*.

FEDERATION FIGHTERS IN CAPTAIN'S LOG

(R2.FA13) F-104 STARFIGHTER: The F-104A Starfighter was designed as an interceptor, intended to launch on a moment's notice and meet enemy fighters head-on. Faster than anything yet built, its dogfight rating was comparable to the F-4 (R2.F6), but for different reasons (the F-4 was too heavy, the F-104 gave up maneuverability for speed). However, it was also relatively limited in weapons with a single phaser-3 and two type-VI drones, and it was not as tough as the F-4 or F-8 (R2.F7). Ultimately, this is what stopped it from being accepted for service within the Federation. Cygnan doctrine had assumed that they could launch three or four F-104As for each attacking Klingon (or Kzinti) fighter and overwhelm them with type-VI drones, finishing off the cripples with phasers. No chaff can be installed prior to Y168. This fighter type was phased out by early Y172 and no electronic warfare variant of the two-seat version (J4.43) was developed.

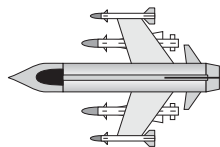

F-104G: The next production version (after several minor improvements and rejected designs) was the F-104G. Tougher, faster, and better armed, it was accepted for duty by the Cygnan National Guard in late Y170. It was even faster, had a better armament (double the number of type-VI drones), and had the dogfight abilities of the F-8. This fighter

type was phased out by early Y172 and no electronic warfare variant of the two-seat version (J4.43) was developed.

F-104J: In an attempt to improve the F-104 and make it more competitive, the F-104J model was produced from Y172 onward. This model was faster still, and added a pair of type-I drone rails (J4.231) to the mix.

F-104JE: Electronic warfare variant of the two-seat F-104J (J4.43) introduced in Y172, replacing the two type-I drone rails (J4.231) and two of the type-VI drone rails with two built-in electronic warfare pods [(J4.9)/(J11.2)] and equipment enabling it to lend electronic warfare from the pods to the fighters of its squadron (J4.46).

F-104S: The final version of the F-104 was the S-model, produced from Y175 until Y178 when the production line was shut down. The last fighters were taken out of service in Y183. (About 100 were taken out of storage in Y189 to help defend against Andromedan attack, but this was the design's last service.) This was the fastest non-X-fighter to enter service with any empire. Slightly strengthened to handle the new engine, the added weight restricted its dogfight maneuverability. However, the weapons load was much better. While still maintaining the single phaser-3, the drone load changed to two type-VI and four type-I drones. At the same time, the sensor suite was upgraded to take advantage of the more modern armament [it can control four drones (J4.25), but its ability to launch drones is still restricted by (J4.241)]. This is the fighter shown above. For the F-104A delete both shaded boxes and all four type-I drone rails. For the F104G delete one of the shaded boxes, change two of the type-I rails to type-VI rails (total of four type-VI rails) and delete the two remaining type-rails. For the F-104J delete one shaded box and there are four type-VI rails and two type-VI rails.

F-104SE: Electronic warfare variant of the two-seat F-104S (J4.43), replacing the four type-I drone rails (J4.231) with two built-in electronic warfare pods [(J4.9)/(J11.2)] and equipment enabling it to lend electronic warfare from the pods to the fighters of its squadron (J4.46).

F-104 fighters were produced only by the planet Cygnus, and there was little employment of them outside of that planetary system, ostensibly due to departmental infighting inside the Federation government. The only carrier known to have operated F-104s was the GVM *Shreshalia* (R2.119) operated by the Cygnan National Guard.

No C-refit.

Design by Karl A. Vogelheim.

This fighter type always had one chaff pack. A mega-pack was developed for this fighter adding two drone rails (J16.241).

F-104JEs and F-104SEs when fitted with a mega-pack gained two additional pod rails (J16.245).

There are no SSDs except the graphic above. Use the FTR counters for the F-104.

(R2.FA14) F-101 HEAVY FIGHTER:

When it came to heavy fighters, the Federation adopted three, of which only two [the A-20 (R2.F9) and the F-111 (R2.F11)] have been widely known to players of *Star Fleet Battles* until we recently decoded another section of the Air Force tapes.

The F-101 Voodoo was to be the standard heavy fighter. In theory, it would replace F-18s (R2.F5) (on a one-for-two basis) on most new carrier production and some conversions of existing carriers (mostly those due for combat repairs or major overhauls).

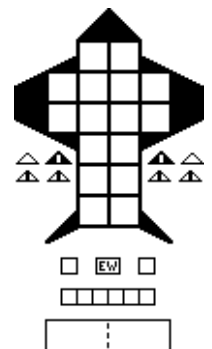

Had the General War developed as expected, the F-101 would have played a major role, and would no doubt have become the dominant Federation fighter by the early Y180s. But, alas, it was not to be. The deployment of gunboats (first the Interceptors, then the fast patrol ships) made fighters of less tactical importance. A given "carrier" could wield twice the firepower carrying fast patrol ships than a squadron of standard fighters (and 50% more than a squadron of heavy fighters). The original F-101A was a match for a pair of F-18As. After its first deployment in combat, a minor design change added dogfight drones to the wingtips for "self-defense" (to drive off Klingon fighters sent to take out the Voodoos) and minor improvements in the engines provided speed to match the F-18s, allowing coordinated strikes. The F-101 can launch three drones plus one type-VI per turn; all type-IIIs can be launched at once under rule (R1.F9). It can mount type-IV drones on pairs of standard rails.

The F-101A was designed as a drone-armed fighter from the start, including a "bay" pioneered by earlier "planetary defense bomber" designs.

Standard: The F-101 has the following standard systems and weapons:

- one phaser-3-FX
- one phaser-2-FA
- one phaser-3-RX
- one built-in EW pod
- a 6-round anti-drone system (E6.0)
- two chaff packs (D11.0)

Drone rails: These are as follows:

- Four drone rails, two standard (J4.231) rails under each wing. It can mount type-IV drones on pairs of standard rails.
- Two "pod rails" (J11.11) which count against speed and DFR.

Weapons bay: The F-101's internal weapons bay can hold a total of two "spaces" of weapons or other equipment, as follows:

- Type-VI drones are half-space. The bay cannot fire RALADs, although they could be carried as non-firing cargo for purposes of transfer.
- Type-I or type-III drones are single-space. Type-III drones in the bay can be launched under (R1.F9).
- Type-IV and type-IIIXX drones are two-space.
- Fighter pods (any type) are single-space.
- Cargo can be carried in one or both of the spaces.
- One transporter bomb (M3.0) (two spaces) can be carried and laid. These transporter bombs are taken from those on board the carrier (or other ships, using cargo transfer rules or sending the fighter there to pick the transporter bomb up); the fighter does not come with transporter bombs of its own.
- Tactical intelligence cannot reveal the contents of the bay. The contents of the bay may well be revealed when the item is used (launched, dropped, used to generate EW) as provided in the rules. Phaser (J11.33) and ground attack (J11.34) pods cannot be fired from inside the bay. Drones in the bay are under the overall launch rate (J10.41) for the fighter and do not increase the fighter's drone control (J10.4) ability.

Items in the bay need NOT be dropped if the fighter is crippled, but cannot be used if the fighter is crippled (a transporter-bomb could still be dropped). Items in the bay cannot be used if the fighter is used as a scatter-pack (FD7.44). The bay is not counted for drone cost and availability calculations. Drones in the bay do not count for the "standard load" or "reloads" of the fighter; if the bay is loaded, you will be drawing drones from future reloads for the wing rails.

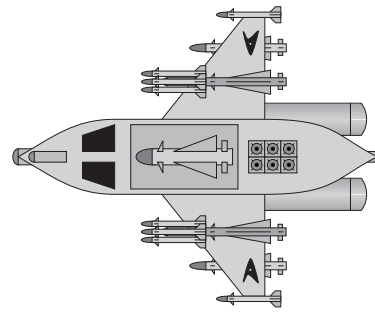

F-101B: This was a slight improvement of the F-101A, adding two light rails (J4.232) and slightly increasing the fighter's speed.

F-101C: A further upgrade, increasing the speed once again and adding special rails (J4.233), one on top of each wing, as there was no space under them, giving the F-101C the advanced capabilities that the tiny number of F-14As (R2.F1) had employed for two years. This is the fighter shown above. For the F-101A delete the two type-III rails and the two type-VI rails. For the F-101B delete the two type-III rails.

See (R1.F7A) for electronic warfare fighters.

No C-refit.

Designed by Stephen V. Cole.

This fighter type always had two chaff packs. A mega-pack was developed for this fighter adding two drone rails (J16.241).

There are no SSDs except the graphic above. Use the F-111 counters from *Module K*.

END OF FEDERATION BOMBERS IN CAPTAIN'S LOG

(R2.M) FEDERATION GROUND FORCES

(R2.M1) STAR FLEET MARINES BATTALION ORGANIZATION

- 3 companies, each:
 - 3 platoons (3 squads each)
 - 1 heavy-weapons squad
 - 1 commando platoon (2 squads)
 - 1 HQ element (non-combat crew unit)

Federation Marine battalions are temporary groupings of separate Marine companies. They could include two to five companies, although three is the official organization.

(R2.M1-1) STAR FLEET MARINES MECHANIZED BATTALION ORGANIZATION

- 3 companies, each:
 - 3 platoons (3 squads in GCVs each)
 - 1 heavy-weapons squad in GCV
 - 1 APV
 - 1 commando platoon (2 squads in GCVs)
 - 1 HQ element (non-combat crew unit in CPV)

Federation Marine battalions are temporary groupings of separate Marine companies. They could include two to five companies, although three is the official organization.

(R2.M1-2) STAR FLEET MARINES MOBILE BATTALION ORGANIZATION

3 companies, each:
 3 platoons (3 squads)
 1 heavy-weapons squad
 1 APV platoon (5 APVs)
 1 APV
 1 commando platoon (2 squads in APV)
 1 HQ element (non-combat crew unit in CPV)
 Federation Marine battalions are temporary groupings of separate Marine companies. They could include two to five companies, although three is the official organization.

(R2.M1-3) STAR FLEET MARINES MOTORIZED BATTALION ORGANIZATION

3 companies, each:
 3 platoons (3 squads each)
 1 heavy-weapons squad
 1 commando platoon (2 squads)
 1 truck company (10 trucks)
 1 HQ element (non-combat crew unit)
 Federation Marine battalions are temporary groupings of separate Marine companies. They could include two to five companies, although three is the official organization.

(R2.M1-4) STAR FLEET MARINES COMPANY

Company
 3 platoons (3 squads)
 1 heavy-weapons squad
 1 HQ element (non-combat crew unit)

(R2.M1-5) STAR FLEET MARINES MECHANIZED COMPANY

Company
 3 platoons (3 squads in GCVs each)
 1 heavy-weapons squad in GCV
 1 HQ element (non-combat crew unit in CPV)

(R2.M1-6) STAR FLEET MARINES MOBILE COMPANY

Company
 3 platoons (3 squads each)
 1 heavy-weapons squad
 1 transport platoon (5 APVs)
 1 HQ element (non-combat crew unit in CPV)

(R2.M1-7) STAR FLEET MARINES MOTORIZED COMPANY

Company
 3 platoons (3 squads each)
 1 heavy-weapons squad
 1 transport platoon (3 trucks)
 1 HQ element (non-combat crew unit)

(R2.M1-8) STAR FLEET MARINES CAVALRY TROOP

Troop
 3 platoons (4 GAVs each)
 1 HQ element (non-combat crew unit in CPV)

(R2.M1-9) STAR FLEET MARINES TANK COMPANY

Company
 3 platoons (4 tanks each)
 1 HQ element (2 tanks)

(R2.M1-10) STAR FLEET MARINES ENGINEER COMPANY

Company
 3 platoons (3 engineer squads each)
 1 HQ element (non-combat crew unit)

(R2.M1-11) STAR FLEET MARINES MOTORIZED ENGINEER COMPANY

Company
 3 platoons (3 engineer squads each)
 1 truck platoon (3 trucks)
 1 HQ element (non-combat crew unit)

(R2.M1-12) STAR FLEET MARINES MOBILE ENGINEER COMPANY

Company
 3 platoons (3 engineer squads each)
 1 APV platoon (5 APVs)
 1 HQ element (non-combat crew unit and 1 CEV)

(R2.M1-13) STAR FLEET MARINES MECHANIZED ENGINEER COMPANY

Company
 3 platoons (3 engineer squads each)
 1 APV platoon (4 APVs)
 1 CEV platoon (3 CEVs)
 1 HQ element (non-combat crew unit)

(R2.M1-14) STAR FLEET MARINES ARTILLERY BATTERY

Battery
 4 sections (2 tans-howitzers and 1 ammo vehicle each)
 1 HQ element (non-combat crew unit in CPV).

(R2.M2) STAR FLEET PRIME TEAM ORGANIZATION

Star Fleet prime teams are informally organized, relying on five-to-eight flexible personnel with broad training instead of a specific number of narrowly specialized individuals. A typical team would include a commander, a scientist, an engineer, a doctor, a heavy-weapons expert, and a scout, but many other combinations are possible. Sometimes one individual fills both the science-medical or science-engineering positions. Psionics (both Vulcans and the less intense non-Vulcan psionicists) are highly prized members of prime teams, and most teams have someone with at least some psionic capabilities.

END OF FEDERATION GROUND FORCES

(R2.PF) FEDERATION GUNBOATS

Gunboats, also known as fast patrol ships, PFs, and (incorrectly) as "pseudo-fighters," came into service across the galaxy during Y178-Y182. Originally invented by the Lyrans (R11.PF0), the technology (for the special engines that made them possible) was quickly copied by almost everyone.

Gunboats have tremendous firepower for their size, but are cheap to build. Their range is short (they operate mostly from bases and special "tenders"). They increase the firepower of a fleet without increasing the fleet's size (which is limited by the command abilities of the flagship).

The Federation never produced a gunboat or Interceptor (K3.0), even as a prototype. There were never even any

studies or projects of this type. It has been theorized that, had the Federation built a gunboat, it would have been along the lines of a Kzinti (R5.PF0) gunboat (with a photon replacing the disruptor).

It is assumed that had the Federation built gunboats, all non-leader variants would have received a shield refit (R1.PFR1) in Y182 (cost three BPV) which would have been standard on new production gunboats from that date.

In a conjectural universe where the Federation built fast patrol ships, they do not build F-111s (R2.F11) or FB-111s (R2.F16) and there are no Gorn GB-111s (R6.F01). Ships designed to operate F-111s can use F-101s (R2.FA14). Even in a situation in which players agree a Federation player can use gunboats and F-111s, no ship carrying F-111s can use (R1.R1) to add gunboat mech-links (K2.24) to its tractors. As with other empires, no "true fast patrol ship tender" can operate heavy fighters.

Included in *Module K* are "conjectural" gunboat and Interceptor designs; see the notes in (Z13.2) of *Module K* for background.

Generic Federation gunboat (PF) counters are in *Module K*.

(R2.PF0) MUSTANG INTERCEPTOR (INT): The standard conjectural Interceptor type. The drone rack is type-A, although variants might have type-E or type-G drone racks. Photon torpedo range is 12 hexes.

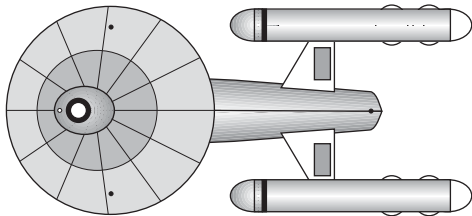

Standard variants include Mustang-F Fighter-Conveyor (K3.8)

FI-CON INTERCEPTOR

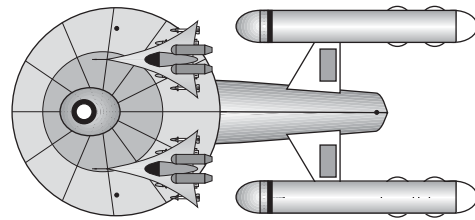
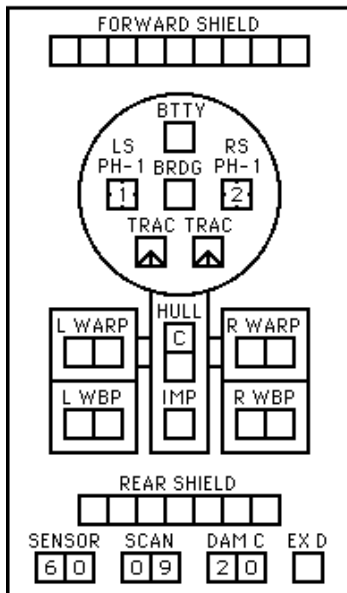

Mustang-E (K3.75)

EW INTERCEPTOR

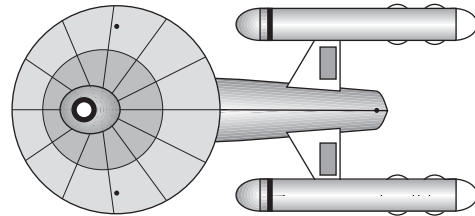
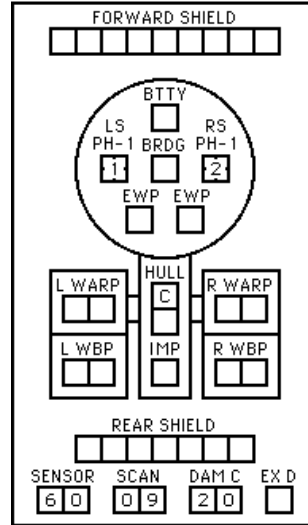

A Mustang squadron SSD and counters are in *Module K*.

(R2.PF1) THUNDERBOLT PF: This is the equivalent to the fast patrol ships of other empires. One drone rack is type-G; the other is type-A. Photon range (on all versions and variants armed with a photon torpedo) is 12 hexes.

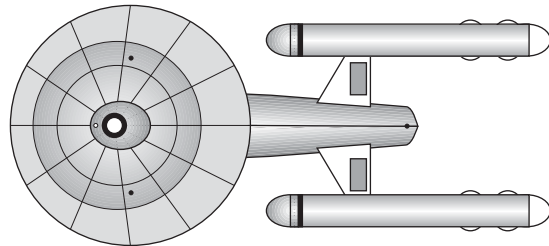

Standard versions include:
Thunderbolt-C Cargo (*Thundercloud*) (R1.PF1)

CARGO PF

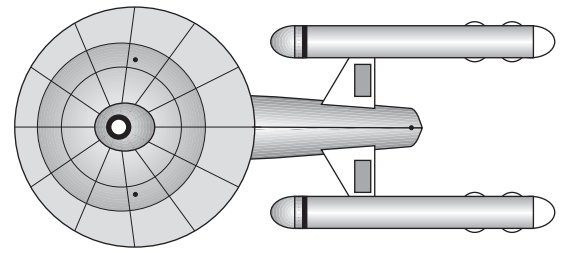
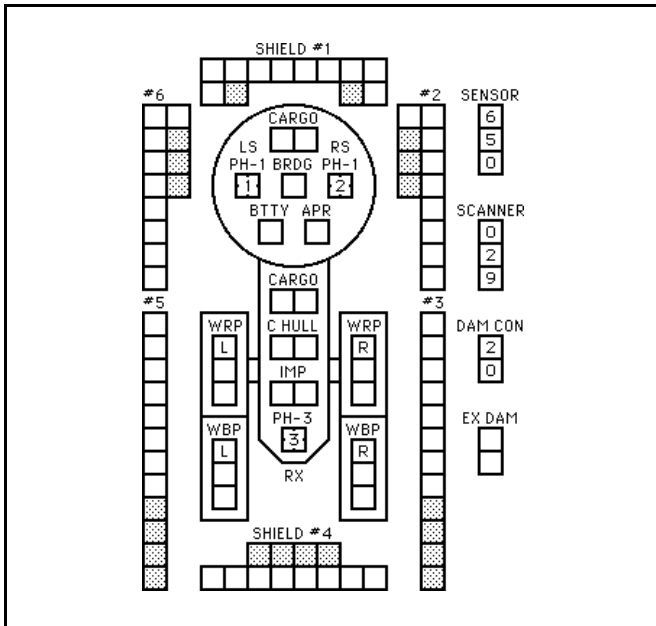

Thunderbolt-L Leader (*Thunderchief*) (R1.PF6)

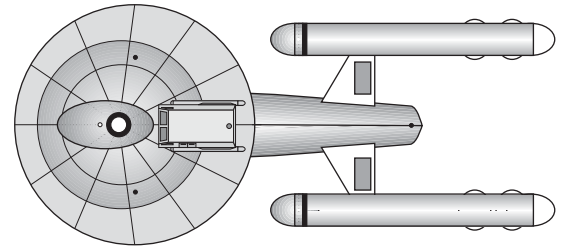

Thunderbolt-S Scout (*Thunderscout*) (R1.PF2)

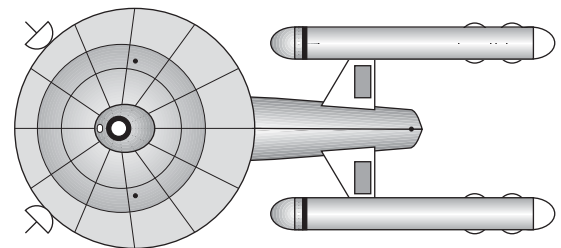

Thunderbolt-M Mine Warfare (*Thunderblast*) (R1.PF4)

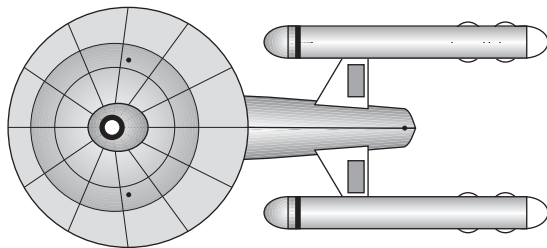

Thunderbolt-F Fighter Conveyor (*Thunderflash*) (R1.PF5); see (R2.PF5)

Thunderbolt-G Ground Assault (*Thunderstrike*) (R1.PF3)

GROUND ASSAULT PF

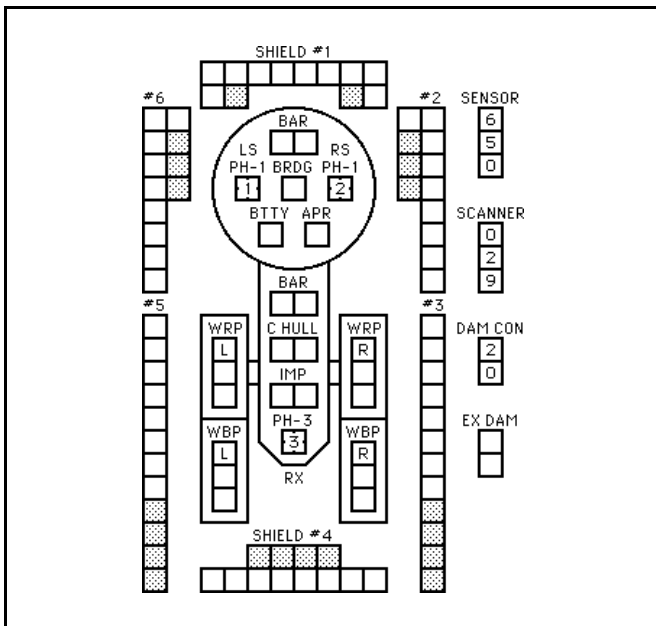

MINE WARFARE PF

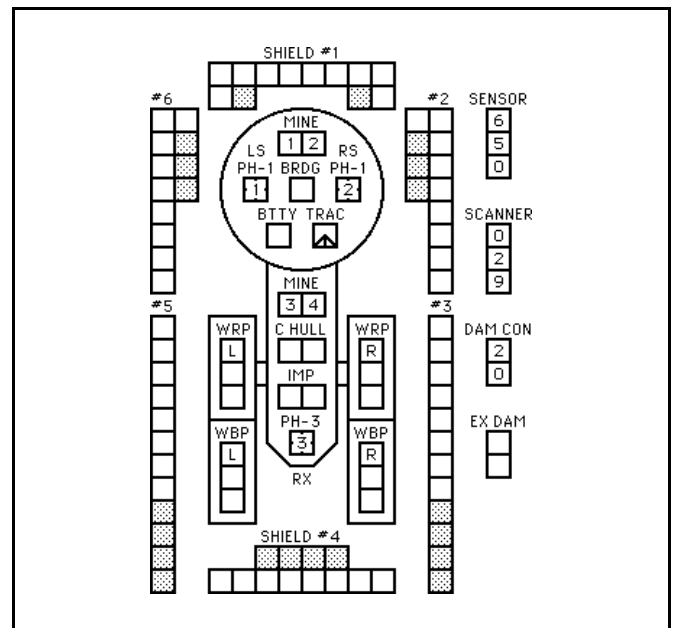

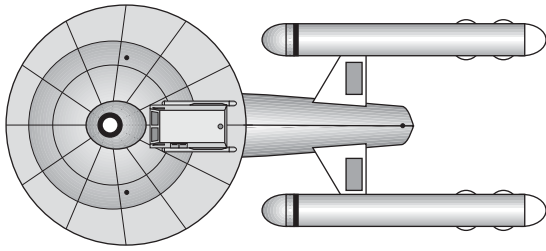

Thunderbolt-WB (Workboat) (R1.PF7)

(R1.PF7) **WORKBOAT:** The Federation never built fast patrol ships. The SSD provided here is conjectural and itself based on the conjectural cargo version (R1.PF1) of the conjectural Federation Thunderbolt PF. While the Federation never built or deployed fast patrol ships, Federation corporations purchased numbers of workboats from neighboring empires. Most Federation workboats were purchased from the Gorns (R6.0), although considerable numbers were also purchased from the Kzintis (R5.0) and the Orion Enclave (R8.0) (which provided most of the workboats that were used in the Federation capital systems). However, it was not unusual in the border regions to find Klingon (R3.0) (on the Klingon border) and Romulan (R4.0) (on the Romulan border) workboats in use (purchased after the General War). Some corporations even acquired workboats from Jindarian Caravans (R16.0).

SSD is in *Module R11*. Use any PF counter.

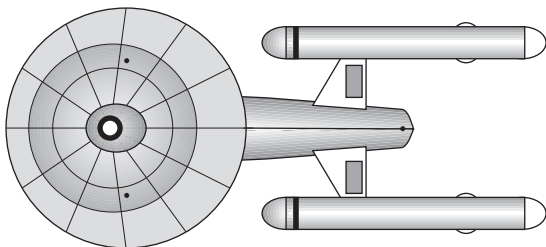
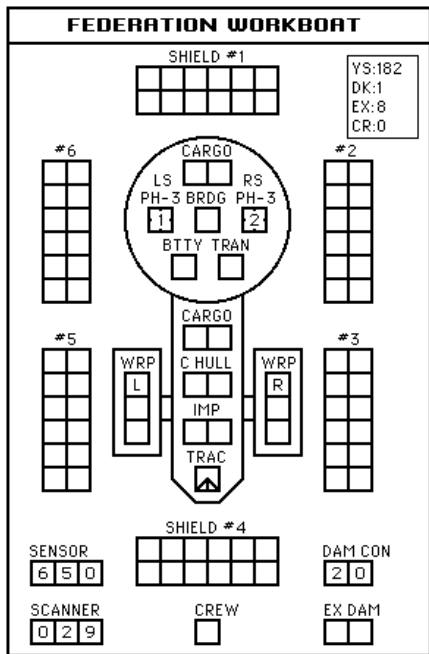

Thunderbolt-Q (Survey) (R1.PF8)

(R1.PF8) **SURVEY FAST PATROL SHIP (PFQ):** The Federation never built fast patrol ships. The SSD provided here is conjectural and itself based on the conjectural leader version (R1.PF6) of the conjectural Federation Thunderbolt fast patrol ships. While the Federation never built or deployed fast patrol ships, Federation corporations purchased numbers of survey fast patrol ships from neighboring empires. Most Federation survey fast patrol ships were purchased from the Gorns (R6.0), although considerable numbers were also purchased from the Kzintis (R5.0) and the Orion Enclave (R8.0). Some corporations even acquired survey fast patrol ships from Jindarian Caravans (R16.0).

Survey fast patrol ships operated by civilian agencies will downgrade any phaser-1s to phaser-2s; reduce the BPV of the survey fast patrol ship by one point for each phaser-1.

SSD and counter are in *Module R12*.

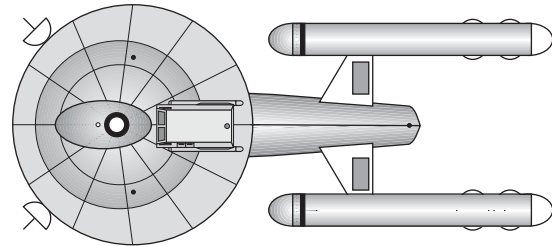

Thunderbolt-R (Recovery) (R1.PF9)

(R1.PF9) **RECOVERY FAST PATROL SHIP (PFR):** The Federation never built fast patrol ships. The SSD provided here is conjectural and itself based on the conjectural cargo (R1.PF1) version of the conjectural Federation Thunderbolt fast patrol ship. The historical record does not indicate that any fast patrol ship of this type was ever operated by a Federation entity as they were not cost effective to run as rescue craft for workboats (R1.PF7).

SSD and counter are in *Module R12*.

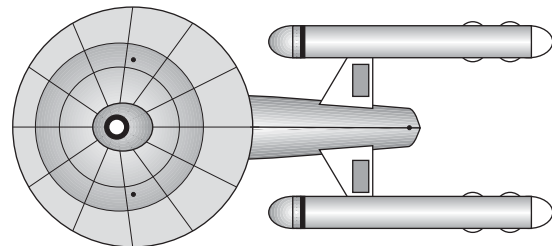

See (R1.PF1)-(R1.PF9) for rules on standard versions.

The leader and scout are on the flotilla SSD; the others are in the SSD section. All Federation fast patrol ship counters are designated "PF" to facilitate their use.

A Thunderbolt flotilla SSD is provided in *Module K*. SSDs for most gunboats and gunboat variants are in *Module K*. One SSD shows a standard flotilla; another shows several of the variants. An SSD for the workboat is in *Module R11*. SSDs for the recovery and survey gunboats are in *Module R12*.

(R2.PF2) THUNDERBOLT-B (PFB): Designed for increased shock effect, the conjectural Thunderbolt-B (*Thunderboomer*) reverses the drone/photon ratio from the standard Thunderbolt, following the pattern established by the Klingon G1B (R3.PF5). Drone rack is type-G. Production of Thunderbolt-Bs would probably have been very limited; there would never be more than two in a flotilla. There is no leader version.

Designed by Scot McConnachie.

An SSD is provided on the Federation fast patrol ship variants page in *Module K*.

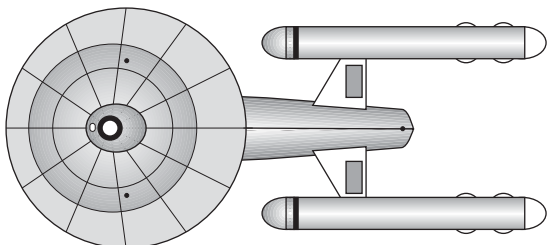

(R2.PF3) THUNDERBOLT-D (PFD): The conjectural Thunderbolt-D (*Thunderstorm*) has pure drone armament (two type-B, one type-G drone racks) for fire support, similar to the Klingon G1D (R3.PF4). There is a leader version, but not a scout version.

Designed by Scot McConnachie.

An SSD is provided on the Federation fast patrol ship variants page for both this fast patrol ship and the leader variant in *Module K*.

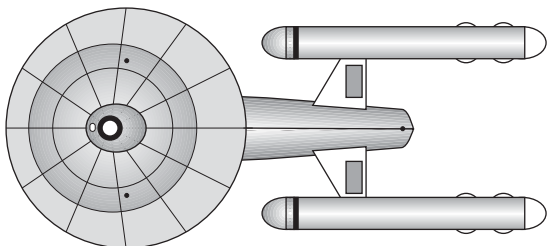

(R2.PF4) THUNDERBOLT-E (PFE): A conjectural escort variant with anti-drones (E5.0) (three ADD-6), but no photons (*Thunderstreak*). These would not be operated in full flotillas, but might be carried on mech-links (K2.24) by carriers and escorts for local defense. There is no leader version.

Designed by Scot McConnachie.

An SSD is provided on the Federation fast patrol ship variants page in *Module K*.

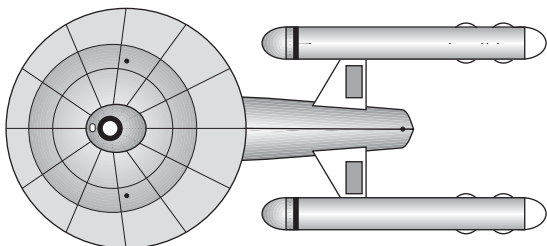

(R2.PF5) THUNDERBOLT-F (PFF): The conjectural fighter-conveyor variant (*Thunderflash*) with four F-18s (R2.F5) replacing the photon torpedo and drone racks. [No other type of fighter can be carried, but any sub-type of the F-18 can be. Gorn G-18s (R6.F1) cannot be carried.] These would never be used in pure flotillas. They would either be in half-flotillas carried on mech-links (K2.24) by a carrier group, or they would be included with a Thunderbolt-L (R1.PF6), a Thunderscout (R1.PF2), and a Thunderbolt-E (R2.PF4) or -D (R2.PF3) as a flotilla on a space control ship (R2.32). There is no leader version.

Designed by Scot McConnachie.

An SSD is provided in the *Module K* rulebook.

FI-CON PF

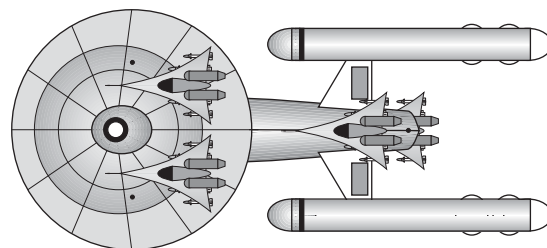
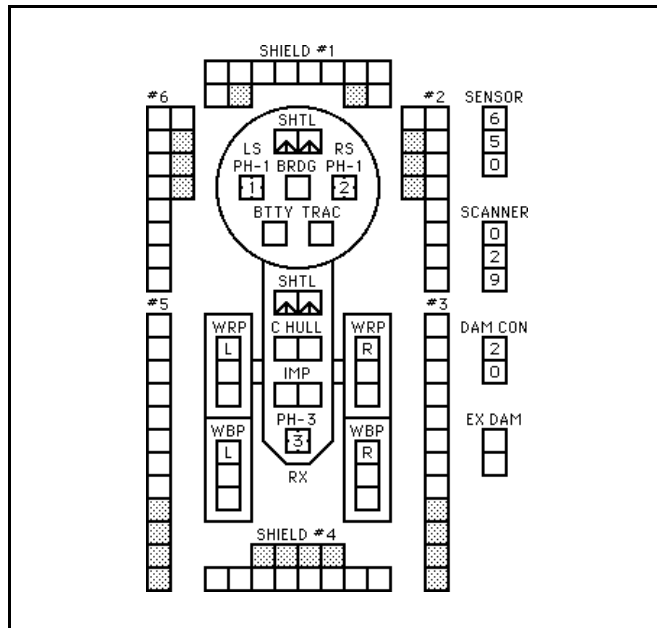

(R2.PF6) THUNDERBOLT-P (PFP): A conjectural variant with a stronger phaser armament (*Thunderphase*). There is a leader version.

Designed by Scot McConnachie.

An SSD is provided on the Federation fast patrol ship variants page for both this fast patrol ship and the leader variant in *Module K*.

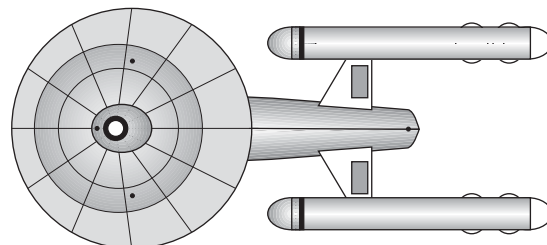

END OF FEDERATION FAST PATROL SHIPS

(R2.200) FEDERATION SHIPS IN *MODULE X1*

(R2.201) ADVANCED TECHNOLOGY COMMAND CRUISER (CX): In Y181, the command cruiser NCC-1749 *Vincennes* was converted to use new technology designed to improve its combat power.

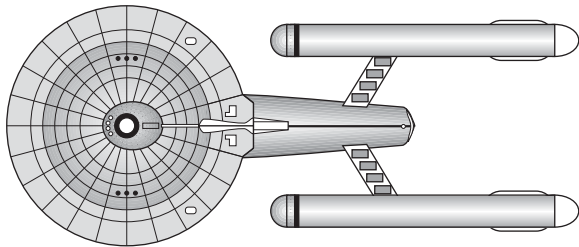

The experiment was only partly successful, but led to production of 12 more ships of this type, one every year until Y193, after which production increased. Production of battlecruisers (R2.33) was eventually terminated when the advanced technology design proved itself.

These ships, being more powerful than heavy cruisers (R2.4), formed the core of battle groups during the final days of the General War and during the Andromedan War.

The advanced technology command cruiser is a variant of the heavy cruiser (R2.4). The advanced technology heavy fighter carrier (R2.212) is a variant of this ship. The advanced technology galactic survey cruiser (R2.204) and advanced technology strike cruiser (R2.207) are built on drastically modified advanced technology command cruiser hulls.

The advanced technology command cruiser is a "first generation X-ship;" see (X0.0).

Deployment: See (S8.48) for deployment restrictions and conditions.

Warp pack: The two box center warp engine in the saucer can be used to generate power but cannot be used to generate movement points unless the saucer has been separated; see (G12.102) and (G12.214).

Seeking weapons: The advanced technology command cruiser can control a number of seeking weapons equal to double its sensor rating (F3.212) and has X-aegis (XD13.0).

Refits: None.

SSD and counters are provided in *Module X1*. The SSD in *Module X1* replaces the SSD published in *Advanced Missions*. (Later editions of *Advanced Missions* include the corrected SSD.)

Known names: As these ships were revolutionary, they were named for battles in various revolutions: NCC-1749 *Vincennes*, NCC-1771 *Revolution*, NCC-1772 *Paris Commune*, NCC-1773 *Ayacucho*, NCC-1774 *Long March*, NCC-1775 *Krasny Barikaddy*, NCC-1776 *Bunker Hill* (which led the Federation fleet in Operation Unity), NCC-1777 *Dien Bien Phu*, NCC-1778 *Managua*, NCC-1779 *Alamo*, NCC-1780 *Cinco De Mayo*, NCC-1781 *Cowpens*, NCC-1782 *Masada*, NCC-1701A *Enterprise*.

NOTE: This information is duplicated in (R2.55).

(R2.202) ADVANCED TECHNOLOGY DESTROYER (DDX): Heavily modified version of the destroyer with the plus refit design (not a conversion), based on the unbuilt new destroyer which was evolved (in a different direction) into the new light cruiser. One of the first conversions after the advanced technology command cruiser, the advanced technology destroyer conversion significantly improved the class. This design was second in stature only to the advanced technology command cruiser (R2.201) in Star Fleet.

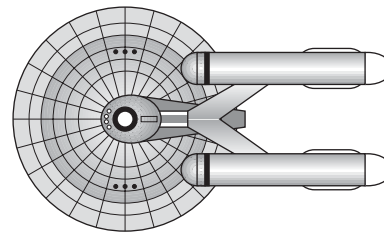

This is a base hull; while similar to the new light cruiser (R2.18) in layout it is not a new light cruiser variant. Variants include the advanced technology scout (R2.205) and advanced technology guided weapons destroyer (R2.206). The DDX(2) advanced technology destroyer (R2.A34) is built on a heavily modified advanced technology destroyer hull.

The advanced technology destroyer is a "first generation X-ship;" see (X0.0).

Deployment: See (S8.48) for deployment restrictions and conditions.

Seeking weapons: The advanced technology destroyer can control a number of seeking weapons equal to double its sensor rating (F3.212) and has X-aegis (XD13.0).

Refits: None.

SSD and counters are provided in *Module X1*.

Known names: These ships were named for famous Star Fleet ships: NCC-701 *Prince of Wales*, NCC-702 *Lexington*, NCC-703 *Kongo*, NCC-704 *Essex*, NCC-705 *Republic*, NCC-706 *Potemkin*, NCC-707 *Macedonia*, NCC-708 *Alliance*, NCC-709 *Australia*, NCC-710 *Ticoga*, NCC-711 *Alexander*, NCC-712 *Hood*, NCC-713 *Constellation*.

(R2.203) ADVANCED TECHNOLOGY FRIGATE (FFX): This design was an effective advanced technology frigate, but like most empires, it was rare to install advanced technology on such small hulls.

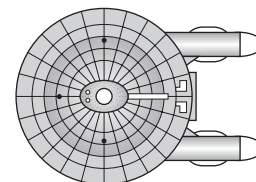

The advanced technology frigate is a variant of the frigate (R2.25) but the changes are sufficiently extreme that it is considered to be a base hull; there are no variants of this ship.

The advanced technology frigate is a "first generation X-ship;" see (X0.0).

Deployment: See (S8.48) for deployment restrictions and conditions.

Seeking weapons: The advanced technology frigate can control a number of seeking weapons equal to double its sensor rating (F3.212) and has X-aegis (XD13.0).

Refits: None.

SSD and counters are provided in *Module X1*.

Known names: These ships were named for military leaders who were found guilty of disobeying orders or regulations but who were proven (by history or trial) to have been correct: NCC-451 *Mitchell*, NCC-452 *Mack*, NCC-453 *LtCol Oliver North*, NCC-454 *Byng*, NCC-455 *Mathews*, NCC-456 *Dreyfus*, NCC-457 *Kimmel*, NCC-458 *Rickover*, NCC-459 *Ralph Hayles*.

(R2.204) ADVANCED TECHNOLOGY GALACTIC SURVEY CRUISER (GSX): The Federation was apparently the only empire to build an advanced technology survey ship. Other empires decided against such a move because it reduced the

number of combat advanced technology cruisers. The Federation apparently felt that the combat power of this ship, plus its flexibility, would allow it to undertake the most dangerous missions and felt that this was adequate compensation. At least one was used as a combination fleet scout and fire support vessel in Admiral Kosnett's Flying Squadron. Several earned fame hunting down Andromedan bases and destroying them before reinforcements could arrive.

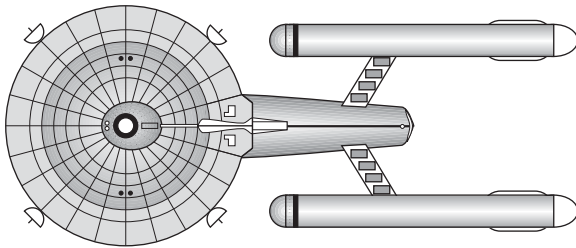

While this class could in theory carry F-18C fighters, this was done only on extremely rare occasions when the ship was sent on an "out and back" mission as otherwise the attrition rate would rob the ship of the tiny fighter wing in short order. This will be shown in future in historical scenarios but this "option" is not available in patrol battles.

The advanced technology galactic survey cruiser is a variant of the advanced technology heavy cruiser (R2.55)/(R2.201). Variants include the advanced technology medium carrier (R2.208). The advanced technology galactic survey cruiser can be operated as a light carrier (R2.16A) or as a commando carrier (R2.51).

The advanced technology galactic survey cruiser is a "first generation X-ship;" see (X0.0).

Scout: It can use all scout functions (G24.0). Special sensors are destroyed by "phaser" damage points. See (G24.35) when purchasing this unit as part of a battle force.

Deployment: See (S8.48) for deployment restrictions and conditions.

Seeking weapons: The advanced technology galactic survey cruiser can control a number of seeking weapons equal to double its sensor rating (F3.212) and has X-aegis (XD13.0). See also (F3.213).

Refits: None.

SSD and counter are provided in *Module X1*.

Known names: NCC-1820 *Einstein*, NCC-1821 *Sakharov*, NCC-1822 *Teller*, NCC-1823 *Fermi*, NCC-1824 *Feynman*.

(R2.205) ADVANCED TECHNOLOGY SCOUT (SCX): Identical to the advanced technology destroyer, except that four special sensors replaced the four photon torpedoes. While the advanced technology scout had fewer channels than the unique non-advanced-technology scout, it was adequate for the mission and its phaser-1s, firing as phaser-3s, provided badly needed firepower for the small advanced technology squadrons.

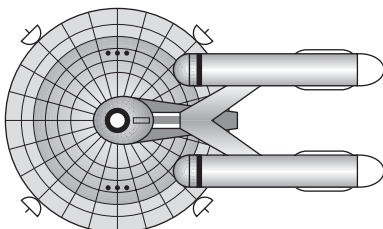

The advanced technology scout is a variant of the advanced technology destroyer (R2.202).

The advanced technology scout is a "first generation X-ship;" see (X0.0).

Scout: It can use all scout functions (G24.0). Special sensors are destroyed by "torpedo" damage points. See (G24.35) when purchasing this unit as part of a battle force.

Deployment: See (S8.48) for deployment restrictions and conditions.

Seeking weapons: The advanced technology scout can control a number of seeking weapons equal to double its sensor rating (F3.212) and has X-aegis (XD13.0). See also (F3.213).

SSD and counter are provided in *Module X1*.

Known names: NCC-651 *Donovan*, NCC-652 *Gehlen*, NCC-653 *Casey*, NCC-654 *Dzherzinski*, NCC-655 *Canaris*, NCC-656 *Thompson*.

(R2.200) FEDERATION SHIPS IN MODULE X1R

(R2.206) ADVANCED TECHNOLOGY GUIDED WEAPONS DESTROYER (DGX): This was the drone-armed version of the advanced technology destroyer (R2.202). It retained two photons for direct combat and was intended to stand in the squadron's battle line rather than operate alone. It was not a drone bombardment platform, lacking the necessary stores of drones (and the minimum necessary number of drone racks) to perform that mission, even if a scout provided the targeting data. While a normal advanced technology destroyer was quite capable of matching the speed of an advanced technology guided weapons destroyer, it would have to do so by either not arming two of its photons or expending its reserve power. The advanced technology guided weapons destroyer did not have to forgo the use of any weapons to maintain a high rate of combat speed. It did suffer the drawback of all ships that relied heavily on drones for a significant fraction of their firepower in that the numbers of available drones were finite.

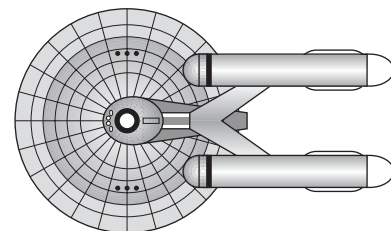

The advanced technology guided weapons destroyer is a variant of the advanced technology destroyer (R2.202).

The advanced technology guided weapons destroyer is a "first generation X-ship;" see (X0.0).

Deployment: See (S8.48) for deployment restrictions and conditions.

Seeking weapons: The advanced technology guided weapons destroyer can control a number of seeking weapons equal to double its sensor rating (F3.212) and has X-aegis (XD13.0).

Refits: None.

SSD and counter are in *Module X1R*.

Known names: *Colonel Joshua Lawrence Chamberlin*, *General John Buford*, *General Winfield Scott Hancock*.

(R2.207) ADVANCED TECHNOLOGY STRIKE CRUISER (CSX): The *Prometheus* did not survive the General War, being lost in action while conducting a raid during Alliance efforts to crack the Klingon border defenses in Y182. As advanced technologies were becoming operational, a design study was undertaken, based on the design of the ship. The study indicated that it would have been a capable warship,

but the Federation already saw the end of the General War in sight and believed that Star Fleet should return to its peacetime role, so no ship of this type was commissioned. The *Prometheus* had always suffered from having less operational range than standard cruisers due to the smaller engineering hull and reduced facilities in the primary hull to make room for the systems taken out of the engineering hull. During the Andromedan Invasion the design was revisited, but was rejected again. The Federation's logistics experts feared complicating the supply networks with spare parts for too many different kinds of ships, resulting in some always being in the status of "waiting for parts."

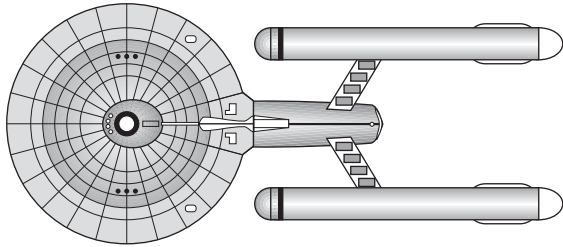

The advanced technology strike cruiser is a variant of the advanced technology heavy cruiser (R2.55)/(R2.201), but the changes are sufficiently extreme that it is considered to be a new class. There are no variants of this ship.

The advanced technology strike cruiser is a "first generation X-ship;" see (X0.0).

Deployment: See (S8.48) for deployment restrictions and conditions.

Seeking weapons: The advanced technology strike cruiser can control a number of seeking weapons equal to double its sensor rating (F3.212) and has X-aegis (XD13.0).

Refits: None.

SSD and counter are in *Module X1R*.

Known names: None, the *Prometheus* was never converted to this design and no ships were built.

(R2.208) ADVANCED TECHNOLOGY MEDIUM CARRIER (GVX):

A variation of the galactic survey cruiser (R2.16), it was actually the first of that hull type to be given advanced technology [four years before the standard advanced technology galactic survey cruiser (R2.204) appeared]. Designed specifically for the raiding mission, this advanced technology ship, *Field Marshal Colin Powell*, carried six F-111 fighters (R2.F11). Like most advanced technology ships used for raiding missions it had early success, but as more advanced technology ships and bases became available to the Coalition forces, more of the raids were intercepted. Worse, the *Powell* was sometimes attacked while trying to recover its strike group, and on several occasions had to abandon damaged fighters (but usually managed to beam off their crews). As the General War ground to its end, the *Powell* increasingly operated in a manner no different from any other heavy fighter carrier, albeit it was considerably better able to defend itself.

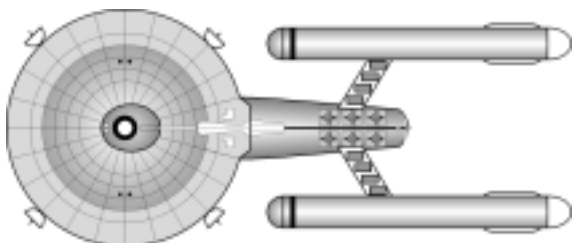

With the end of the General War, Star Fleet considered converting the ship to the standard advanced technology galactic survey cruiser configuration that was in service by that time. Instead, the *Powell* was assigned to the Second Fleet with its F-111s replaced by advanced heavy transport shuttles (R1.F19) (this involved removing the ready racks for the F-111s to accommodate the advanced heavy transport shuttles). The *Powell* remained in the Second Fleet until Y190. Then she was recalled, again equipped with a squadron of F-111 fighters, and sent to help fight the Andromedans.

After the *Darwin* incident in Y195, the *Powell* was assigned the mission of hunting for Andromedan Rapid Transit Network nodes, a role in which the ship was so successful Star Fleet considered recalling and converting some of the other advanced technology galactic survey cruisers to her configuration. Records are unclear if this was actually done.

The *Powell* was not intended to operate with escorts, but these were sometimes (not always) provided when it was not on an actual raid mission.

Four of the ship's cargo boxes can use the (R2.R5) rules.

The advanced technology medium carrier is a variant of the galactic survey cruiser (R2.16) and advanced technology galactic survey cruiser (R2.204).

The advanced technology medium carrier is a "first generation X-ship;" see (X0.0).

Scout: It can use all scout functions (G24.0). Special sensors are destroyed by "phaser" damage points. See (G24.35) when purchasing this unit as part of a battle force. This ship is considered a survey cruiser for purposes of (S8.351). See (S8.25) if it is not counted in the command limit.

Deployment: See (S8.48) for deployment restrictions and conditions.

Carrier: This ship is a true carrier; see (J4.75), (J4.93), (J11.13), and (J15.22).

This ship has two shuttle bays: the one for its admin shuttles [(J2.0)/(R1.F1)/(R1.F17)], which operates normally, and the bay used by the heavy fighters. The heavy fighter bay is semi-external, and all six heavy fighters can be launched or landed (or some could be landing while others launch) in a single impulse or over multiple impulses. Mines can only be laid from the admin shuttle bay (M2.113).

Year	Escorts	Fighters
Y182+	2xDWA, or 2xFFA, or 1xDWA & 1xFFA, or 1xDWA, or 1xFFA	6xF-111

Escort ready racks: The ready racks of the escorts were configured for F-18 (R2.F5) fighters. Escorts cannot have ready racks for heavy fighters; see (S8.318).

Seeking weapons: The advanced technology medium carrier can control a number of seeking weapons equal to double its sensor rating (F3.212) and has X-aegis (XD13.0). See also (F3.213).

Refits: None.

SSD and counter are in *Module X1R*.

Known names: *Field Marshal Colin Powell*, no others known.

(R2.209) ADVANCED TECHNOLOGY WAR DESTROYER (DWX):

A solid combat ship for its size, it lacked the endurance of the advanced technology frigate (R2.203). The result was that advanced technology frigate continued to be built for their ability to maintain a long-term presence, while advanced technology war destroyers supplemented the advanced technology destroyers (R2.202) and backstopped the advanced technology frigates as small-scale reserves. It

was not unusual to have the Federation operate an advanced technology war destroyer as a squadron leader with a pair of advanced technology frigates, or for a pair of advanced technology war destroyers to operate as the squadron mates of a advanced technology destroyer. Their lesser endurance, however, resulted in their not having a large presence in Operation Unity. After Y195 they were also used to backstop some of the Andromedan Rapid Transit Network hunters.

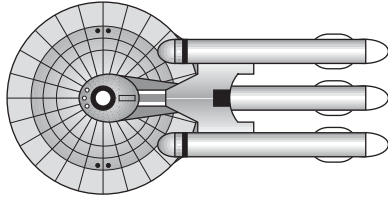

The advanced technology war destroyer is a variant of the war destroyer (R2.65). The advanced technology heavy war destroyer (R2.213) is a variant of this ship, but the changes are so extreme it is considered to be a new class.

The advanced technology war destroyer is a “first generation X-ship;” see (X0.0).

Deployment: See (S8.48) for deployment restrictions and conditions.

Seeking weapons: The advanced technology war destroyer can control a number of seeking weapons equal to double its sensor rating (F3.212) and has X-aegis (XD13.0).

Refits: None.

SSD and counters are in *Module X1R*.

Known names: *Leslie R. Groves, George C. Marshall, Leonard Wood.*

(R2.210) ADVANCED TECHNOLOGY NEW HEAVY CRUISER (NAX): Developed as a backstop to the advanced technology cruiser (R2.201) because the number of available slips restricted the number of advanced technology cruisers that could be built. Like the basic new heavy cruiser (R2.77), the advanced technology new heavy cruiser could be built in the slips for smaller ships, but resulted in a ship that had almost the full combat capability of the larger design. Like the advanced technology war destroyer (R2.209), the ship did not have the operational range of a true advanced technology cruiser, but was quite capable of conducting combat operations. Only one or two were built before the General War was seen to be winding down and production shifted towards ships with greater mission flexibility. With the start of the Andromedan Invasion, additional ships of this class were built to help sustain defensive operations, and to prosecute the offensive within the Milky Way after Y195. Its comparative lack of endurance (compared to an advanced technology cruiser) resulted in this ship class not being selected for Operation Unity.

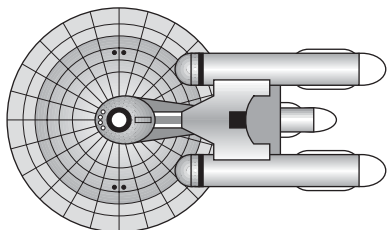

The advanced technology new heavy cruiser is a variant of the new heavy cruiser (R2.77). Variants include the advanced technology new heavy scout cruiser (R2.211).

The advanced technology new heavy cruiser is a “first generation X-ship;” see (X0.0).

Deployment: See (S8.48) for deployment restrictions and conditions.

Seeking weapons: The advanced technology new heavy cruiser can control a number of seeking weapons equal to double its sensor rating (F3.212) and has X-aegis (XD13.0).

Refits: None.

SSD and counters are in *Module X1R*.

Known names: *Fort Worth, Fort Wayne, Fort Duquesne, Boulder, Murfreesboro.*

(R2.211) ADVANCED TECHNOLOGY NEW HEAVY SCOUT CRUISER (NASX): The Federation, as with most empires, found the advanced technology scout (R2.205) to be a capable, but not a spectacular, scout. It was little more than a counter to a Klingon or Romulan advanced technology scout, and Star Fleet’s X admirals wanted more. It is not clear if the first ship of this class was a new build or a conversion of an existing advanced technology scout. What is clear is that it proved a much more effective scout for any kind of squadron. Serious consideration was given to taking a ship of this type on Operation Unity despite the obvious difficulties in keeping it operational far from a support base. (Records indicate that one such ship accompanied the initial advance, but it does not seem to have been present when the Desecrator was attacked.)

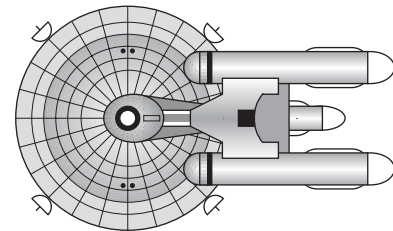

The advanced technology new heavy scout cruiser is a variant of the advanced technology new heavy cruiser (R2.210).

The advanced technology new heavy scout cruiser is a “first generation X-ship;” see (X0.0).

Deployment: See (S8.48) for deployment restrictions and conditions.

Scout: It can use all scout functions (G24.0). Special sensors are destroyed by “torpedo” damage points. See (G24.35) when purchasing this unit as part of a battle force.

Seeking weapons: The advanced technology new heavy scout cruiser can control a number of seeking weapons equal to double its sensor rating (F3.212) and has X-aegis (XD13.0). See also (F3.213).

Refits: None.

SSD and counter are in *Module X1R*.

Known names: *Robert Oppenheimer, Andrei Sakharov, Edward Teller.*

(R2.212) ADVANCED TECHNOLOGY HEAVY FIGHTER CARRIER (HVX): It is unclear if this ship was a conversion of an advanced technology cruiser (R2.201), or a conversion of a heavy fighter carrier (R2.132) to advanced technology. In either case, the ship was designed to operate A-20s and is not known to have ever operated any other kind of fighter. It entered service near the very end of the General War and participated in several actions against the Klingons. Unlike the advanced technology medium carrier *Powell*, this ship was never intended to conduct independent raids, but to operate as part of an advanced technology squadron. Whenever it was part of an advanced technology squadron, it operated without escorts, but on several occasions it operated as a regular carrier in sectors where other advanced technology ships were not present. On these occasions, if

they were available, escorts would be provided. This was because the need to stay with and remain part of any given battle group would slow the ship down and make it vulnerable to attack by Coalition forces.

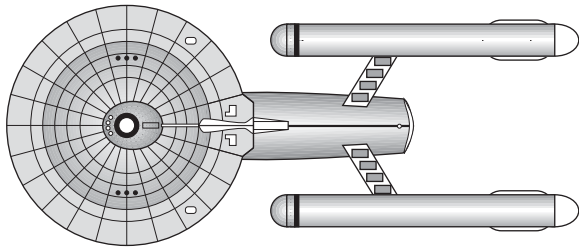

Records indicate that after Y195 one or more ships of this class were paired with a scout and participated in hunting Andromedan Rapid Transit Network nodes, using their faster acceleration to reach and support the scout until other forces could come up to destroy the node.

The advanced technology heavy fighter carrier is a variant of the advanced technology heavy cruiser (R2.55)/(R2.201) and the heavy fighter carrier (R2.132).

The advanced technology heavy fighter carrier is a "first generation X-ship;" see (X0.0).

Deployment: See (S8.48) for deployment restrictions and conditions.

Carrier: This ship is a true carrier; see (J4.75), (J4.93), (J11.13), and (J15.22).

This ship has two hatches for its shuttle bay, which is a tunnel deck (J1.58), and can launch or land two shuttles every other impulse, or launch or land one shuttle every impulse.

Year	Escorts	Fighters
Y184+	2xDWA, or 2xFFA, or 1xDWA & 1xFFA, or 1xDWA, or 1xFFA	6xA-20F

Escort ready racks: The ready racks of the escorts were configured for F-18 (R2.F5) fighters. Escorts cannot have ready racks for heavy fighters; see (S8.318).

Seeking weapons: The advanced technology heavy fighter carrier can control a number of seeking weapons equal to double its sensor rating (F3.212) and has X-aegis (XD13.0). See also (F3.213).

Refits: None.

SSD and counter are in *Module X1R*.

Known names: *Xanadu*.

(R2.213) ADVANCED TECHNOLOGY HEAVY WAR DESTROYER (HDWX): All empires found that there were many jobs for advanced technology ships, and not enough time or resources to build all the ships that were needed. The solution was to upgrade the already proven heavy war destroyer design (R2.85) to advanced technology. As with the basic heavy war destroyer, the advanced technology heavy war destroyer could be quickly modified to suit the mission.

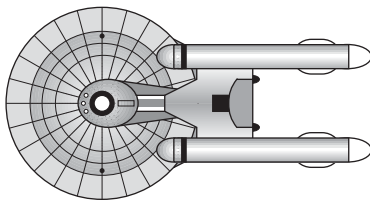

That was the theory at least.

In practice, each advanced technology heavy war destroyer was completed with a mission module that most

carried for the rest of their careers. The problem was that the conversion of the ship needed to be done by an advanced technology base, advanced technology fleet repair dock (R1.81), or the home shipyard, and these were few and far between during the General War. The lead-time to know what a ship needed to be converted to, and to get it to one of those facilities and back, made their flexibility problematic.

The ships, however, came into their own during the Andromedan Invasion when there were more advanced technology bases available to change out the module.

Unlike the non-advanced technology heavy destroyers, the advanced technology heavy war destroyers often operated in company with one another, and some advanced technology squadrons consisted of a few of these ships (some in straight combat mode, some in other roles) and several other advanced technology destroyers (R2.202)/advanced technology war destroyers (R2.209) and advanced technology frigates (R2.203). Such a force was more than any raiding ship, even a raiding advanced technology cruiser, wanted to tangle with.

An advanced technology heavy destroyer operating as a carrier might be provided with escorts if no other advanced technology ships were available.

This ship is a variant of the advanced technology war destroyer (R2.209) but the changes were sufficiently extreme that it is considered a new class. There are no variants as any ship of this class might be operating in any variant mode at one time or another and then be switched to another mode; see (G33.0).

The advanced technology heavy war destroyer is a "first generation X-ship;" see (X0.0).

Deployment: See (S8.48) for deployment restrictions and conditions.

Carrier: This ship is a true carrier if it has eight size-1 or four size-2 fighters; see (J4.75), (J4.93), (J11.13), and (J15.22). This ship is a casual carrier (J4.62) if it has seven or fewer size-1 fighters or three or fewer size-2 fighters.

This ship has two shuttle bays. Transfers between the bays are not possible.

Year	Escorts	Fighters
Y182+	At least one (G33.42) If operating heavy fighters, escorts are not required.	Varies, at least 8 Size-1 or 4 size-2 fighters

Note: The advanced technology heavy war destroyer can only operate A-20s (R2.F9) (and its variants) from internal bays. If the ship is to operate F-111s (R2.F11), the four APR* boxes and the two weapon options become semi-external shuttle bays. The four non-weapon option boxes become cargo boxes: two of which each hold one spare F-111 fighter; the other two hold 100 spaces of reload drones provided under (G33.42). Reload anti-drones, warp booster pack storage (J5.42), and the pod stockpile (J11.13) are separate from the cargo storage. If operating F-111s, or carrying F-101s (R2.F20) in the same manner as F-111s, the ship has four advanced admin shuttles [(J2.0)/(R1.F1)/(R1.F17)], i.e., the bay in the main hull holds three shuttles, and no fighters.

Escort ready racks: The ready racks of the escorts were configured for F-18 (R2.F5) fighters. Escorts cannot have ready racks for heavy fighters; see (S8.318).

Seeking weapons: The advanced technology heavy war destroyer can control a number of seeking weapons equal to double its sensor rating (F3.212) and has X-aegis (XD13.0). See also (F3.213). It may have full aegis (D13.0) installed if configured as an escort (G33.43); see also (J15.332).

SSD and counter are in *Module X1R*.

Known names: *General Lewis Armistead*, *General Richard Garnett*, *General James Kemper*.

(YR2.0) FEDERATION EARLY YEARS SHIPS MODULE Y1

(YR2.2) WARP-REFITTED CRUISER (WCL): When the first tactical warp engines were developed by the Federation, they were applied to an existing sublight (i.e., non-tactical warp) cruiser then in service as the standard warship of the Earth Space Force. Earth dominated Federation starship design concepts for the entire history of the Federation, and an early start to this dominance came in the form of the *Province*-class cruiser, which is familiar to students of the General War as “the old light cruiser” (R2.5). The design was fortuitous, in that it was considerably stronger than it really had to be, and the hull was made out of a new rhodium alloy which other members of the Federation had yet to adopt. Hulls of this class remained in production from Y50 through Y170, and in service for decades beyond the last new production. The strong hull of the cruiser easily adapted to warp power, and was given a warp refit with a pair of six-box warp engines capable of driving it to Warp 2.5 (Speed 16 in *Star Fleet Battles* terms).

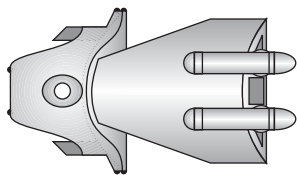

The warp-refitted cruiser is a base hull. Variants include warp-refitted commando cruiser (YR2.19), warp-refitted survey cruiser (YR2.21), and warp-refitted hospital ship (YR2.36). This hull is the basis for the early light cruiser (YR2.5) and its variants.

Seeking weapons: The warp-refitted light cruiser can control a number of seeking weapons equal to half its sensor rating (F3.211).

Refits

Tractors: These were type-W (Range 1, rear arc, towing only); some ships were refitted to type-Y (Range 1, 360°, can hold any legal target) at no cost in Y81 [if not upgraded to the early light cruiser standard (YR2.5)]; they were not further upgraded as the ships were converted to early light cruisers (YR2.5) beginning in Y80.

Transporters: These were Range 1, extended to Range 2 in Y80 at no cost [if not upgraded to the early light cruiser standard (YR2.5)]; they were not further upgraded as the ships were converted to early light cruisers (YR2.5) beginning in Y80.

SSD and counters are in *Module Y1*.

Known names: None listed.

(YR2.3) WARP-REFITTED DESTROYER (WDD): Needing to convert as many ships to tactical warp power as quickly as possible, Earth (which had invented tactical warp) used its own destroyer for the conversion. Because of political concerns, warp conversions were regarded as “Federation” rather than “Earth” ships, although the unified Star Fleet had yet to come into being. Years later, after the warp-converted destroyers had all been retired or scrapped, the Federation Police needed their own ships and took over the shipyard which had built the original destroyer, producing a ship along the same lines (but with more modern capabilities). After that shipyard was shut down, the police cutter design (R2.12) was produced in a dozen other shipyards at major Federation planets and outposts.

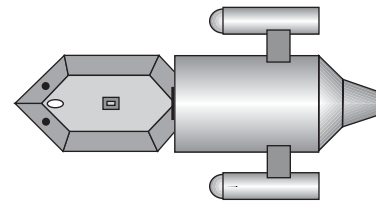

The warp-refitted destroyer is a base hull. This hull is the basis for the police cutter (R2.12) and its variants. Variants include warp-refitted destroyer leader (YR2.45).

Seeking weapons: The warp-refitted destroyer can control a number of seeking weapons equal to half its sensor rating (F3.211).

Refits

Tractors: These were type-W (Range 1, rear arc, towing only), refitted to type-Y (Range 1, 360°, can hold any legal target) at no cost in Y81, refitted to type-M (Range 2) at no cost in Y120, but never refitted further.

Transporters: These were Range 1, extended to Range 2 at no cost in Y80, extended to Range 3 at no cost in Y100, extended to Range 4 at no cost in Y120, but never extended further.

Based on a suggestion by Mike West.

SSD and counters are in *Module Y1*.

Known names: None listed.

(YR2.4) EARLY HEAVY CRUISER (YCA): The famous ships of the *Republic*-class were the first in the Federation Star Fleet to follow the famous “saucer and nacelle” pattern. These were the first of the new ships designed from the start to use tactical warp engines. Photons and phasers were built in as the original armament.

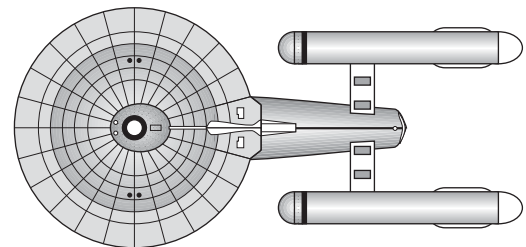

The early heavy cruiser is a base hull. Variants include early command cruiser (YR2.18), National Guard cruiser (R2.116), National Guard medium carrier (R2.119), National Guard F-111 carrier (R2.126), and National Guard survey cruiser (R2.138). This hull is the basis for the heavy cruiser (R2.4) and its variants.

Seeking weapons: The early heavy cruiser can control a number of seeking weapons equal to half its sensor rating (F3.211).

Refits

Tractors: The first ships of this class had type-W (Range 1, rear arc, towing only); these were refitted to type-Y (Range 1, 360°, can hold any legal target) at no cost in Y81 and all subsequent ships had that tractor; these were refitted to type-M (Range 2) at no cost in Y120. Some ships were relegated to the National Guard (R2.116) and others were upgraded to the heavy cruiser standard (R2.4), and had their tractors improved to type-N (Range 3) at no cost in Y140-Y145.

Transporters: The first ships of this class had Range 1 transporters, extended to Range 2 at no cost in Y80 and all new construction included this upgrade; extended to Range 3 at no cost in Y100, and extended to Range 4 at no cost in Y120. Some ships were relegated to the National Guard (R2.116) and others were upgraded to the heavy cruiser standard (R2.4), and had their transporters extended to

Range 5 at no cost in Y140.

SSD and counters are in *Module Y1*.

Known names: None listed.

(YR2.5) EARLY LIGHT CRUISER (YCL): The old Earth cruiser was given new warp engines about Y80, increasing speed and solving its chronic power shortage to some extent. Some wanted to avoid refitting the old warp-refitted cruisers (YR2.2) and simply build new early heavy cruisers (YR2.4), but the demands for ships in the increasingly dangerous galaxy forced the refits through the Federation Council. These ships served through the remainder of the Early Years period. Subsequently (about Y120) construction of these ships was switched to the light cruiser (or old light cruiser) (R2.5) version with its 12-box engines, and some early light cruisers were brought up to this standard.

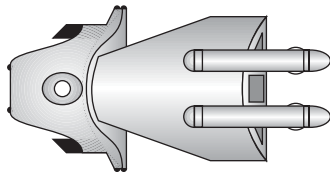

The early light cruiser is a base hull. Variants include early commando cruiser (YR2.20), early survey cruiser (YR2.22), and early hospital ship (YR2.37). This hull is the basis for the old light cruiser (R2.5) and its variants.

Seeking weapons: The early light cruiser can control a number of seeking weapons equal to half its sensor rating (F3.211).

Refits

Tractors: The first ships of this class had type-W (Range 1, rear arc, towing only); these were refitted to type-Y (Range 1, 360°, can hold any legal target) at no cost in Y81 and all subsequent ships had that tractor; these were refitted to type-M (Range 2) at no cost in Y120. Most ships were upgraded to the old light cruiser (R2.5) standard and had their tractors improved to type-N (Range 3) at no cost in Y140-Y145.

Transporters: These were Range 2, extended to Range 3 at no cost in Y100, and extended to Range 4 at no cost in Y120. Most ships were relegated to the old light cruiser standard (R2.5) and had their transporters extended to Range 5 at no cost in Y140.

SSD and counters are in *Module Y1*.

Known names: None listed.

(YR2.6) EARLY DREADNOUGHT (YDN): The great lesson of the First Federation-Kzinti War was the need for fleet command platforms that could survive in combat. An enlarged version of the early heavy cruiser was developed and put into service about Y100. It had only slightly more firepower than a cruiser; its primary advantages were its larger size and durability and its increased protection. The ships remained in service for decades after the Early Years period due to the high cost of replacing them.

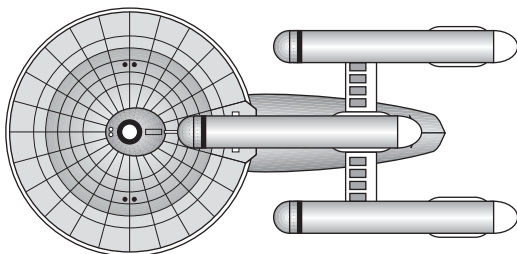

The early dreadnought is a base hull; there are no variants. This hull is the basis for the dreadnought (R2.2) and its variants.

Seeking weapons: The early dreadnought can control a number of seeking weapons equal to half its sensor rating (F3.211).

Refits

Tractors: These were type-Y (Range 1, 360°, any legal target), refitted to type-M (Range 2) at no cost in Y120, and refitted to type-N (Range 3) at no cost in Y140-145.

Transporters: These were Range 3, extended to Range 4 at no cost in Y120, and extended to Range 5 at no cost in Y140.

SSD and counters are in *Module Y1*.

Known names: None listed.

(YR2.7) EARLY DESTROYER (YDD): The Federation Council, seeking economics of scale, accepted a proposal to produce a smaller version of the cruiser that used many of the same components. The result was the early destroyer, which had the same weaponry (and virtually the same saucer) as the early heavy cruiser (YR2.4), but only one of its engines. The military did not want these under-powered ships, but the Federation Council insisted on their construction since they could do (outside of combat, anyway) everything the more expensive early heavy cruiser could do. Captains of these ships adopted the Fighting Instructions (see next page) in order to use their weapons effectively.

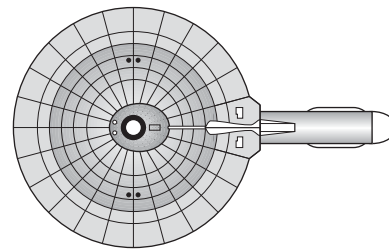

The early destroyer is a base hull. Variants include the National Guard destroyer (R2.117) and the National Guard escort (R2.120). This hull is the basis for the destroyer (R2.6) and its variants.

Seeking weapons: The early destroyer can control a number of seeking weapons equal to half its sensor rating (F3.211).

Refits

Tractors: These were type-Y (Range 1, 360°, any legal target), refitted to type-M (Range 2) at no cost in Y120, some ships were relegated to the National Guard (R2.117) and had their tractors improved to type-N (Range 3) at no cost in Y140-Y145.

Transporters: These were Range 2, extended to Range 3 at no cost in Y100, and extended to Range 4 at no cost in Y120; some ships were relegated to the National Guard (R2.117) and had their transporters extended to Range 5 at no cost in Y140.

SSD and counters are in *Module Y1*.

Known names: None listed.

(YR2.8) EARLY FRIGATE (YFF): Another attempt to produce a less expensive ship for secondary missions, the early frigate was designed by Star Fleet. If it tried to arm all of its weapons, it would be at a dead stop in space, but this was considered acceptable for one of its missions (defending fixed installations) and irrelevant to its other mission (fleet escort). A compromise between the Fleet and Council produced both early frigates and early destroyers (YR2.7) when, perhaps, one or the other might have been a better overall plan. In

combat, early frigates would use the same Fighting Instructions (see next page) as early destroyers.

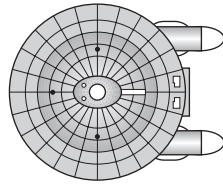

The early frigate is a base hull. Variants include the early transport frigate (YR2.35) and the National Guard frigate (R2.118). This hull is the basis for the frigate (R2.25) and its variants.

Seeking weapons: The early frigate can control a number of seeking weapons equal to half its sensor rating (F3.211).

Refits

Tractors: These were type-Y (Range 1, 360°, any legal target), refitted to type-M (Range 2) at no cost in Y120; some ships were relegated to the National Guard (R2.118) and had their tractors improved to type-N (Range 3) at no cost in Y140-Y145.

Transporters: These were Range 2, extended to Range 3 at no cost in Y100, and extended to Range 4 at no cost in Y120; some ships were relegated to the National Guard (R2.118) and had their transporters extended to Range 5 at no cost in Y140.

SSD and counters are in *Module Y1*.

Known names: None listed.

(YR2.9) EARLY TUG (YTG): As its infrastructure and influence expanded, the Federation found a need for fast and efficient transports for huge cargoes. The Council wanted large transports and had almost adopted a purely civilian design, but the Fleet showed that by producing more standard components (e.g., engines) that could be used by both warships and transports, the cost of both could be lowered. The military strongly favored the idea of common components so that peacetime maintenance and wartime repairs could be done more efficiently at remote outposts. If every outpost had to stock parts for both cruisers and unrelated transports, it would take more space and money. By stocking one set of parts that could be used for either ship, the Fleet was able to conserve resources. When the Federation reorganized its military in Y95, the transport tugs (which had technically been civilian ships with some military personnel on board) were formally transferred to Star Fleet.

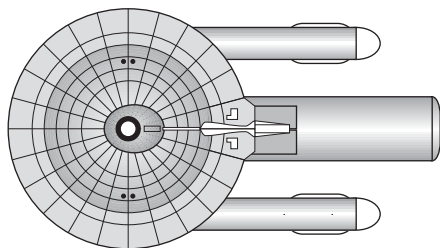

The 10 hull boxes can be hit on “forward” or “rear” hull damage points unless the early tug is towing a pod, in which case these are destroyed by “forward” hull damage points and the hull or cargo boxes in the pod are destroyed by “rear” hull damage points. Cargo boxes on a pod would also still be destroyed by “cargo” damage points.

The Federation early tug can carry one or two pods; one but not both can be a “double-weight” pod. If there is a double-weight pod, it must be in front. The movement cost chart lists “with 3 pod weights” to indicate the movement cost

when carrying one single-weight and one double-weight pods; this does not indicate that it can carry three pods.

The pods are in-line, one attached to the tug and the other to the first pod. The FA firing arcs (including the FA portion of FX, LS, RS, or 360° arcs) on the rear pod are blocked by the forward pod. The RA firing arcs (including the RA portion of RX, LS, RS, or 360° arcs) on the front pod are blocked by the rear pod.

If a light battle pod (R2.58) is in the rear position, all systems on the pod are treated as cargo [double-weight pods such as the battle pod (R2.10) can never be in the rear position].

No interbay shuttle transfers (J1.59) are possible between pods, or between the pods and the shuttle bay of the tug.

Like all tugs, the movement cost and turn mode vary with the pods carried. The movement cost of the tug with two pods or one double-weight pod is 1.5 energy points per hex; the movement cost of the tug with three pod weights is 2.0 energy points per hex; see Annex #3A.

The only pods available in the Early Years period were cargo (R2.11) and passenger types.

The early tug is a base hull; there are no variants. This hull is the basis for the fleet tug (R2.8).

Seeking weapons: The early tug can control a number of seeking weapons equal to half its sensor rating (F3.211).

Refits

Tractors: These were type-Y (Range 1, 360°, any legal target), refitted to type-M (Range 2) at no cost in Y120, and never further refitted.

Transporters: These were Range 2, extended to Range 3 at no cost in Y100, extended to Range 4 at no cost in Y120, and never further extended.

SSD and counters are in *Module Y1*.

Known names: None listed.

THE FIGHTING INSTRUCTIONS: Cursed with ships that did not have enough power, Star Fleet adopted the Fighting Instructions. These were basically as follows:

1. The early heavy cruisers (YR2.4) set the tempo of the action, maneuvering at Warp 2.3 (Speed 12) while continually firing phasers and arming photons. The early dreadnoughts (YR2.6) followed this doctrine.

2. The other ships [National Guard ships and the Fleet’s destroyers (YR2.7) and frigates (YR2.8)] did not have the power to maneuver at these speeds while arming all weapons. The basic tactic was for all ships to fire their photons in an opening salvo, disrupting the enemy formation and damaging key units, and then close with the enemy (maintaining the speed set by the early heavy cruisers) using only phasers.

3. In some cases, the Federation ships adopted different tactics. Operating at Warp 2 (Speed 8), they would close with the enemy for a phaser battle, but each ship held one or two armed photon torpedoes. These could then be used for a devastating short-range punch. Once this tactic became known, it could actually be used to intimidate an enemy, as few were willing to “mix it up” with a Federation fleet that could unload its torpedoes in a mass volley.

4. Against a fixed or slow moving target, the Federation ships tended to operate at slow speed and long range, using their phasers to convince enemy ships to stay away while their photons slowly ground down the primary target.

Because of fleet speed requirements, the choice between instructions was effectively an all-or-nothing decision. Every ship had to operate at the same speed, so they all had to use the same arming cycles.

SHIPS OF THE NATIONAL GUARDS

When tactical warp power was first created (by Earth) and available only at Earth, the Earth politicians generously offered to put their starships under Federation command as they were converted to use warp engines. The other members accepted this idea because tactical warp power was unproven, Earth was paying for it, and it put the larger Earth fleet under control of the Federation Council rather than the President of Earth. Within a few years, however, the other member planets realized their mistake, in that Earth now had even more military power (compared to the rest of the Federation) than before.

In Y71, the Federation formally created the United Star Fleet, designating its ships United Star Ships. But the Federation member planets still did not entirely trust each other, and still faced the nightmare of military domination by one member planet (Earth). The Earth politicians proposed a solution. They would license their tactical warp technology to all member planets, which could then participate in the construction of the new *Republic*-class (R2.4) starships. In the meantime, "to facilitate training," each member planet would be allowed to convert some of its sublight ships to the early tactical warp designs (limited to Warp 2.5). These ships would remain part of each member's National Fleet, but could be called upon to join Star Fleet in the event of an emergency.

RIGELIANS: The Rigelians, born to trade, produced ships which lacked the armor (D4.12) of other member planet ships, but included large cargo holds that, effectively, provided the same protection. Rigelian ships serving with the Fleet were often used to carry extra supplies, and the Rigelians often leased their ships to the Federation for humanitarian and other missions where some cargo capacity was important. These ships were relatively slow when arming all of their weapons, but resorted to the standard Federation doctrine of firing their photons in the first salvo of the battle and then leaving them unarmed during the remainder.

The Rigelian ships are based on designs by Mike West.

(YR2.10) RIGELIAN EARLY DESTROYER (YRD): The workhorse of the Rigelian fleet, the Rigelian early destroyer did everything.

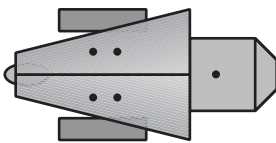

The Rigelian early destroyer is a base hull; there are no variants.

Seeking weapons: The Rigelian early destroyer can control a number of seeking weapons equal to half its sensor rating (F3.211).

Refits

Tractors: These were type-W (Range 1, rear arc, towing only), refitted to type-Y (Range 1, 360°, can hold any legal target) at no cost in Y80, but never further refitted.

Transporters: These were Range 1, extended to Range 2 at no cost in Y80, but never extended further.

SSD and counters are in *Module Y1*.

Known names: None listed.

(YR2.11) RIGELIAN EARLY CRUISER (YRC): The Rigelian cruiser was more effective than the early destroyer (YR2.10), having an extra torpedo and more overall capability. However, it did not carry much more profit-producing cargo than the early destroyer, and the Rigelians converted few of these ships.

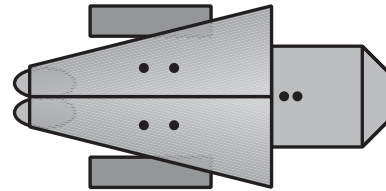

The Rigelian early cruiser is a base hull. Variants include the Rigelian warp-refitted command cruiser (YR2.42).

Seeking weapons: The Rigelian early cruiser can control a number of seeking weapons equal to half its sensor rating (F3.211).

Refits

Tractors: These were type-W (Range 1, rear arc, towing only), refitted to type-Y (Range 1, 360°, can hold any legal target) at no cost in Y80, but never further refitted.

Transporters: These were Range 1, extended to Range 2 at no cost in Y80, but never extended further.

SSD and counters are in *Module Y1*.

Known names: None listed.

VULCANS: It is unclear how long the Vulcans had been in space. Their civilization may have undergone several collapses, although these were more into introspection than chaos. From time to time, the Vulcans just seemed to abandon exploration to spend time contemplating what they had learned. When the Earth launched its first warp-capable ship, a Vulcan explorer was nearby and noticed it, and first contact was made. The Vulcans already had phaser-1s and special sensors when the Federation was formed, although the other member planets could not maintain this technology and used it only on bases. The Vulcans appeared truly astonished when Earth invented tactical warp drives; the Vulcans had never seen a reason for combat at warp speeds.

Vulcan ships are based on designs by Jessica Orsini.

(YR2.12) VULCAN EARLY DESTROYER (YVD): Designed as an exploration ship with limited self-defense capabilities, the Vulcan "destroyer" was designed to travel to an area, then stop and use its power to scan the region. These ships were invaluable in the First Federation-Kzinti War and created the doctrine of fleet electronic support platforms that all other empires copied. These ships provided Star Fleet squadrons with some limited cargo capacity as well.

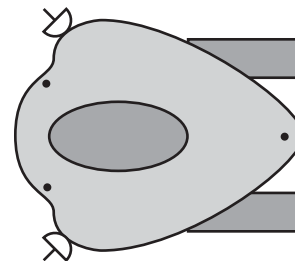

The Vulcan early destroyer is a base hull; there are no variants.

Scout: It can use all scout functions (G24.0). Special sensors are destroyed by "torpedo" damage points. See (G24.35) when purchasing this unit as part of a battle force.

Seeking weapons: The Vulcan early destroyer can

control a number of seeking weapons equal to half its sensor rating (F3.211). See also (F3.213).

Refits: In Y80 some ships of this class were fitted with improved engines, increasing each engine from four boxes to six boxes. The refitted ship was designated the Vulcan improved early destroyer (VDI). This ship was kept in service for decades as there was a shortage of combat-effective scouts.

Tractors: These were type-W (Range 1, rear arc, towing only), refitted to type-Y (Range 1, 360°, can hold any legal target) at no cost in Y81, but never further refitted.

Transporters: These were Range 1, extended to Range 2 at no cost in Y81, but never extended further.

SSD and counters are in *Module Y1*.

Known names: None listed.

(YR2.13) VULCAN EARLY CRUISER (YVC): Basically an enlarged version of the early destroyer (YR2.12) (the Vulcans did not use these class names), its weapons were effectively used only for self-defense. The handful of these ships (the Vulcans built them only when they wanted to explore an area where early destroyers had been lost to unknown causes) served as the first fleet command platforms.

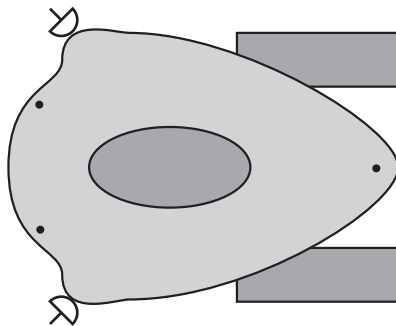

The Vulcan early cruiser is a base hull. Variants include the Vulcan warp-refitted command cruiser (YR2.47) and the Vulcan warp-refitted survey cruiser (YR2.48).

Scout: It can use all scout functions (G24.0). Special sensors are destroyed by “torpedo” damage points. See (G24.35) when purchasing this unit as part of a battle force.

Seeking weapons: The Vulcan early cruiser can control a number of seeking weapons equal to half its sensor rating (F3.211). See also (F3.213).

Refits

Tractors: These were type-W (Range 1, rear arc, towing only), refitted to type-Y (Range 1, 360°, can hold any legal target) at no cost in Y81, but never further refitted.

Transporters: These were Range 1, extended to Range 2 at no cost in Y81, but never extended further.

SSD and counters are in *Module Y1*.

Known names: None listed.

ALPHA-CENTAURANS: The practical females who dominated the Alpha-Centauran military converted their existing destroyers (YR2.14) and cruisers (YR2.15) to warp power without any major revisions to the designs. They had anticipated advances in engine power and had built their ships with separate encapsulated engines that could quickly be removed and replaced. (This also facilitated maintenance; Alpha-Centauran ships did not have their engines overhauled, but replaced them and sent the old engines back to the factory for refurbishment.)

The Alpha-Centauran ships are based on designs by Nick Blank.

(YR2.14) ALPHA-CENTAURAN EARLY DESTROYER (YAD): The Alpha-Centauran early destroyer was used as a patrol ship, and to provide escort for the less maneuverable Alpha-Centauran early cruiser (YR2.15).

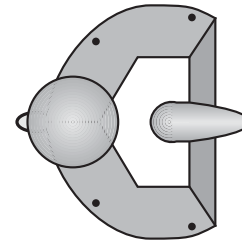

The Alpha-Centauran early destroyer is a base hull; there are no variants.

Seeking weapons: The Alpha-Centauran early destroyer can control a number of seeking weapons equal to half its sensor rating (F3.211).

Refits

Tractors: These were type-W (Range 1, rear arc, towing only), refitted to type-Y (Range 1, 360°, can hold any legal target) at no cost in Y80, but never further refitted.

Transporters: These were Range 1, extended to Range 2 at no cost in Y80, but never extended further.

SSD and counters are in *Module Y1*.

Known names: None listed.

(YR2.15) ALPHA-CENTAURAN EARLY CRUISER (YAC): The Alpha-Centauran early cruiser had limited maneuverability, but its firepower gave it a place in the battle line next to Star Fleet cruisers (YR2.4).

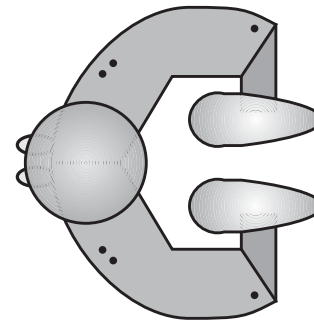

The Alpha-Centauran early cruiser is a base hull. Variants include the Alpha-Centauran warp-refitted command cruiser (YR2.38).

Seeking weapons: The Alpha-Centauran early cruiser can control a number of seeking weapons equal to half its sensor rating (F3.211).

Refits

Tractors: These were type-W (Range 1, rear arc, towing only), refitted to type-Y (Range 1, 360°, can hold any legal target) at no cost in Y80, but never further refitted.

Transporters: These were Range 1, extended to Range 2 at no cost in Y80, but never extended further.

SSD and counters are in *Module Y1*.

Known names: None listed.

ANDORIANS: The Andorians, perhaps due to their physical nature (in which “perception” was as important a sense as sight and hearing), preferred seeking weapons to the direct-fire photons. They armed their ships with drones (albeit different drones than those seen in Kzinti or Klingon service). This made their ships unusually fast in combat. Because they had yet to invent the “snap roll booster” used by other drones to quickly set an initial course upon launch, the drone racks

on Andorian ships have limited target engagement arcs similar to plasma torpedoes. Andorian ships in the Federation-Kzinti Wars tended to be used for fleet drone defense rather than attack.

The Andorian ships are based on designs by Nick Blank.

(YR2.16) ANDORIAN EARLY DESTROYER (YND):

Designed for patrolling, the Andorian early destroyer had only a single drone rack, mounted in the front and tracking targets only in the frontal arc. This limited its drone engagements to the attack.

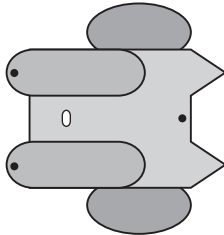

The Andorian early destroyer is a base hull; there are no variants.

Seeking weapons: The Andorian early destroyer can control a number of seeking weapons equal to its sensor rating (F3.21).

Refits

Tractors: These were type-W (Range 1, rear arc, towing only), refitted to type-Y (Range 1, 360°, can hold any legal target) at no cost in Y80, but never further refitted.

Transporters: These were Range 1, extended to Range 2 at no cost in Y80, but never extended further.

SSD and counters are in *Module Y1*.

Known names: None listed.

(YR2.17) ANDORIAN EARLY CRUISER (YNC): A larger ship than the destroyer (YR2.16), the cruiser had more drone racks, but their arcs were limited to either side. This made it difficult to get a sizeable wave of drones on the target.

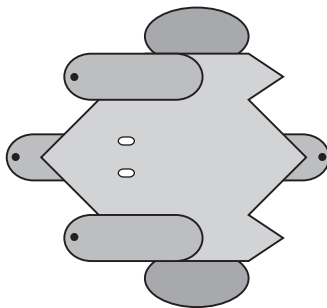

The Andorian early cruiser is a base hull. Variants include the Andorian warp-refitted command cruiser (YR2.28).

Seeking weapons: The Andorian early cruiser can control a number of seeking weapons equal to its sensor rating (F3.21).

Refits

Tractors: These were type-W (Range 1, rear arc, towing only), refitted to type-Y (Range 1, 360°, can hold any legal target) at no cost in Y80, but never further refitted.

Transporters: These were Range 1, extended to Range 2 at no cost in Y80, but never extended further.

SSD and counters are in *Module Y1*.

Known names: None listed.

(YR2.0) UNITED FEDERATION OF PLANETS UNITS MODULE Y2

FEDERATION COMBINED FLEET UNITS

(YR2.18) EARLY COMMAND CRUISER (YCC): The Federation constructed a ship of this class in Y84 as a result of pressure by the Andorian councilman who insisted that such ships were necessary to coordinate operations across a broad expanse of space. The councilman threatened to block other projects and to withhold funding from the Andorian government for several other projects. The argument came very close to breaking the Federation into its component governments before sanity prevailed and the other council members agreed to build a single ship.

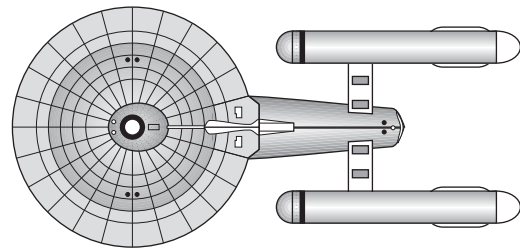

In Y88, the Kzinti Hegemony attacked the Federation, a move that profoundly shocked the government as the nascent combined Federation fleet was not prepared for such a full-scale conflict and had few combat-experienced officers after more than four decades of peace. Worse, many lessons of warp combat had not been learned in the intervening years. (The only actual large-scale combat experience the Federation had were in the form of a handful of aging senior officers and NCOs who had been junior officers and enlisted men when the Romulan War had ended.) During this period, the lone early command cruiser proved instrumental in organizing the faltering defenses, so much so that the Council ordered more to be built and at least three were in operation by Y91.

By Y95, there were at least five early command cruisers in operation, one assigned to each major fleet command (Klingon border, Kzinti border, Romulan border, Home Fleet) and one undergoing refit at any one time. A sixth was built and assigned to the Tholian border in Y98, but it was clear to everyone that its real purpose was to be available to support operations against the Romulans if it became necessary. While six early command cruisers were in operation at any one time, records indicate that at least eight ships were built, but the records are unclear about what became of the other two.

The design incorporated an APR to power two defensive phasers on the slightly stretched secondary hull. The APR was the subject of much controversy, as the fleet officers wanted more of them, but rumors of hazards due to inadequate shielding (compared to that available on a static base) spread through the media caused the Assembly to prohibit their general use in the ships of the fleet. The Assembly's ban did not prevent the spread of APRs through the civilian fleet in later years, but each ship of the Federation fleet between Y83 and Y155 had to receive a special exemption from the Assembly's Select Committee on Ship Procurement to incorporate APRs. The committee was notoriously reluctant to grant such waivers.

The early command cruiser is a variant of the early heavy cruiser (YR2.4).

Seeking weapons: The early command cruiser can control a number of seeking weapons equal to half its sensor

rating (F3.211).

Refits

Tractors: These were type-Y (Range 1, 360°, any legal target), refitted to type-M (Range 2) at no cost in Y120, and never further refitted.

Transporters: These were Range 2; extended to Range 3 at no cost in Y100, extended to Range 4 at no cost in Y120, and never further extended.

SSD and counter are in *Module Y2*.

Known names: *Garibaldi, Ulysses S. Grant, Robert E. Lee, Patton, Zhukov*, others.

(YR2.19) WARP-REFITTED COMMANDO CRUISER (WCM): The Federation converted at least three ships to this design by Y67. The ship was able to carry a battalion of Marines and supporting equipment on normal operations, but additional troops and equipment were sometimes added. The ship was able to land directly on a planet's surface, becoming a formidable base of operations for the ground troops, but required weeks of preparation to take off again. (It cannot take off in the same scenario in which it landed, but special scenario rules might define that a landed warp-refitted commando cruiser was prepared to take off, or just completing such preparations, when the scenario begins.) The landing option was only to be taken if the admirals were certain they could maintain space supremacy and the need to get the maximum number of forces on the planet's surface was deemed paramount.

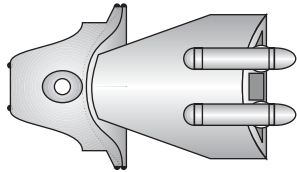

The warp-refitted commando cruiser is a variant of the warp-refitted cruiser (YR2.2).

Landing force: 27 boarding parties (D7.0) plus two commando teams (D15.84), three heavy-weapons squads (D15.81), and three ground combat vehicles (D15.82). This was roughly a battalion of troops (R2.M1) and is included in the ship's BPV.

Shuttles: Three early ground assault shuttles (YR1.F4), one heavy transport shuttle (YR1.F5), and one early admin shuttle [(J2.0)/(YR1.F1)]; these shuttles are included in the ship's BPV.

Landing: The ship can land on planets using the powered landing system (P2.434) (other warp-refitted light cruisers cannot) and has the crash landing bonus (P2.4311).

Seeking weapons: The warp-refitted commando cruiser can control a number of seeking weapons equal to half its sensor rating (F3.211).

Refits

Tractors: These were type-W (Range 1, rear arc, towing only), refitted to type-Y (Range 1, 360°, can hold any legal target) at no cost in Y81 [if not upgraded to the early commando cruiser standard (YR2.20)]; they were not further refitted as the ships were converted to early commando cruisers (YR2.20) beginning in Y84.

Transporters: These were Range 1, extended to Range 2 at no cost in Y80 [if not upgraded to the early commando cruiser standard (YR2.20)]; they were not further upgraded as the ships were converted to early commando cruisers (YR2.20) beginning in Y84.

SSD and counter are in *Module Y2*.

Known names: *Captain Keith Mallory, Corporal Miller, Colonel Andrea Stavros*.

(YR2.20) EARLY COMMANDO CRUISER (YCM): The original warp-refitted commando cruisers (YR2.19) were converted to this design beginning in Y84 (one each year) and a fourth was built as new construction in Y92. The four ships helped liberate several planets from Kzinti occupation as part of the Federation counter-offensive.

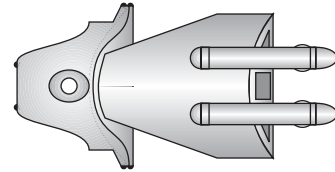

One ship of this class, *Stavros*, was lost in Y90 when a Kzinti counterattack trapped it on the planet where it had just landed. Supporting Federation ships managed to evacuate most of the crew, but over half of the Marines were lost with the ship when its warp drive destabilized and it detonated. (Parts of two Kzinti battalions were also lost in the explosion.) The site was designated a joint memorial by the two governments in Y167.

The early commando cruiser is a variant of the early light cruiser (YR2.5).

Landing force: 27 boarding parties (D7.0) plus two commando teams (D15.84), three heavy-weapons squads (D15.81), and three ground combat vehicles (D15.82). This was roughly a battalion of troops (R2.M1) and is included in the ship's BPV.

Shuttles: Three early ground assault shuttles (YR1.F4), one heavy transport shuttle (YR1.F5), and one early admin shuttle [(J2.0)/(YR1.F1)]; these shuttles are included in the ship's BPV.

Landing: The ship can land on planets using the powered landing system (P2.434) (other early light cruisers cannot) and has the crash landing bonus (P2.4311).

Seeking weapons: The early commando cruiser can control a number of seeking weapons equal to half its sensor rating (F3.211).

Refits

Tractors: These were type-Y (Range 1, 360°, any legal target), refitted to type-M (Range 2) at no cost in Y120, and never further refitted.

Transporters: These were Range 2, extended to Range 3 at no cost in Y100, extended to Range 4 at no cost in Y120, but never further extended.

SSD and counter are in *Module Y2*.

Known names: *Captain Keith Mallory, Corporal Miller, Plissken, Colonel Andrea Stavros*.

(YR2.21) WARP-REFITTED SURVEY CRUISER (WSR): The Federation was often driven by the need to exploit the resources it could find in its space, but generally allowed non-governmental agencies to do so while providing oversight. Space is dangerous, however, and the Federation determined that trained and (after the first few years) experienced officers would be better at determining the dangers to be found. As contact was made with various pre-space-flight civilizations, the Federation government (under strong Vulcan influence) began implementing its "Prime Directive."

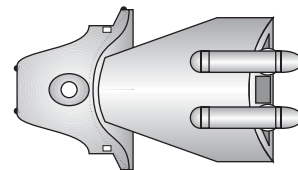

To support this, the Federation decided to build

dedicated survey ships. The combined Federation survey ship, based on the very successful warp-refitted light cruiser (YR2.2) design, was not as effective as the Vulcan ships because it was not possible to incorporate Vulcan special sensor systems, but could be built in greater numbers. Many of the Vulcan ships of the period were tied up in standing "border patrols" (using their special sensors to watch for intrusions into the expanding sphere of Federation space).

The warp-refitted survey cruiser is a variant of the warp-refitted cruiser (YR2.2).

Seeking weapons: The warp-refitted survey cruiser can control a number of seeking weapons equal to half its sensor rating (F3.211).

Refits

Tractors: These were type-W (Range 1, rear arc, towing only) and never further refitted as the ships were converted to the early survey cruiser (YR2.22) standard beginning in Y82.

Transporters: These were Range 1 and never further extended as the ships were converted to the early survey cruiser (YR2.22) standard beginning in Y82.

SSD and counter are in *Module Y2*.

Known names: *Colombus, Livingston, Stanley*.

(YR2.22) EARLY SURVEY CRUISER (YCS): The Federation upgraded the three warp-refitted survey cruisers to this design beginning in Y82 and converted a fourth ship for use as a survey cruiser. While still lacking the special sensors of Vulcan ships, they were effective ships.

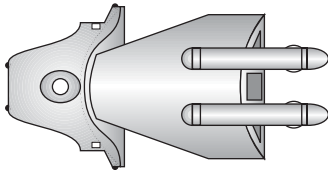

The early survey cruiser is a variant of the early light cruiser (YR2.5).

Seeking weapons: The early survey cruiser can control a number of seeking weapons equal to half its sensor rating (F3.211).

Refits

Tractors: These were type-Y (Range 1, 360°, any legal target), refitted to type-M (Range 2) at no cost in Y120, but never further refitted.

Transporters: These were Range 2, extended to Range 3 at no cost in Y100, extended to Range 4 at no cost in Y120, but never extended further.

SSD and counter are in *Module Y2*.

Known names: *Colombus, Livingston, Stanley*.

SHIPS OF THE FEDERATION NATIONAL GUARDS

(YR2.23) TERRAN WARP-REFITTED DREADNOUGHT (WDN): The pre-Federation human fleet included not less than six ships of this class. When warp power became available, three were converted to this design with the first entering service in Y64. The ship was designed only with the offensive in mind, with defense to the rear generally provided by supporting ships. While the warp-refitted light cruisers (YR2.2) were named for "provinces," the warp-refitted dreadnoughts were named for the planets of the Sol system.

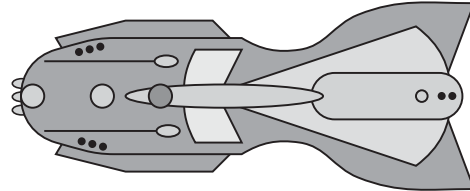

The existence of these ships made the other members of the Federation nervous, and as part of the agreement that founded the United Star Fleet the other three ships (still in mothballs) were scrapped in Y70 (the year before the agreement formally took effect).

Two of the three ships led mixed task forces to fight against the Kzintis in Y88, and one ship, *Venus*, was destroyed during that conflict. The two remaining ships were mothballed in Y98 and scrapped in Y103.

The center warp engine is not actually a single engine but is two smaller engines one above the other.

The Terran warp-refitted dreadnought is a base hull; there are no variants.

Seeking weapons: The Terran warp-refitted dreadnought can control a number of seeking weapons equal to half its sensor rating (F3.211).

Refits

Tractors: These were type-W (Range 1, rear arc, towing only), refitted to type-Y (Range 1, 360°, can hold any legal target) at no cost in Y81, but never further refitted.

Transporters: These were Range 1, extended to Range 2 at no cost in Y81, but never extended further.

SSD and counter are in *Module Y2*.

Known names: *Mars, Terra, Venus*.

(YR2.24) TERRAN WARP-REFITTED HEAVY CRUISER (WCA): The Terran sublight heavy cruiser proved a difficult ship to convert to warp technology. The engines for it were unique, as a result of its original design, and not used by any of the other ships. While the result was a relatively powerful combatant, the class had constant maintenance issues. There were 11 ships converted to this design beginning in Y61, but the continuing maintenance problems curtailed further conversion (even though at least 10 more hulls were available).

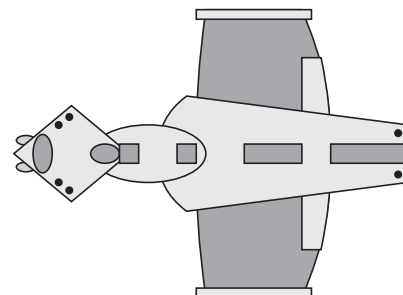

Two ships of the class were lost in combat with the

Kzintis in Y88 defending Federation colonies, and another three were lost before the war ended in Y92.

The original sublight design was capable of landing on, and taking off from, the surface of a planet, but the warp-upgraded ship was not able to do so without effectively destroying the warp engines.

The Terran warp-refitted heavy cruiser is a base hull. Variants include the Terran warp-refitted command cruiser (YR2.44).

Seeking weapons: The Terran warp-refitted heavy cruiser can control a number of seeking weapons equal to half its sensor rating (F3.211).

Refits

Tractors: These were type-W (Range 1, rear arc, towing only), refitted to type-Y (Range 1, 360°, can hold any legal target) at no cost in Y81, but never further refitted.

Transporters: These were Range 1, extended to Range 2 at no cost in Y81, but never extended further.

SSD and counters are in *Module Y2*.

Known names: *Christopher Point*, *Cydonia**, *Kirbuk City*, *Mare Serenitatis*, *Napier*.

(YR2.25) TERRAN WARP-REFITTED FRIGATE (WFF):

Perhaps the most successful of the conversions of a Terran sublight ship. While it adapted well to warp technology, it was ultimately defeated by its small size (making it impossible to further upgrade it, and too vulnerable in warp combat to survive). Its design role had been that of supporting larger ships by bolstering their rear defenses, and operating as out-riders and pickets. The ship was highly maneuverable and remained capable of landing on and taking off from planetary surfaces after the conversion. The records of the Terran defense forces state that there were at least 30 of these ships in service when they started refitting with warp technology (the first three all entered service in Y62), and all were converted by Y70. At least another dozen were built from scratch. Half of the ships were transferred to the nascent Federation unified police force in Y72.

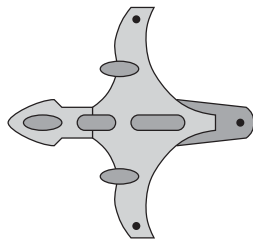

While adequate for most police missions, at least 10 ships of the class were lost in action against the Kzintis during the First Federation-Kzinti War. It is unclear how many of the lost ships were operating as police ships, as at least some had been seconded back to the fleet for the duration of the war. During the war, some of these ships performed deep penetration missions behind the Kzinti front to gather intelligence and drop off or pick up agents from colonies occupied by the Kzintis. At the conclusion of the First Federation-Kzinti War, all remaining warp-refitted frigates were transferred to the police.

During the First Federation-Klingon War in Y110-Y111, another two ships were lost. Despite this, the ships were still considered adequate for the police mission. This theory changed in Y115, when an Orion Early Light Raider (YR8.5) smashed a frigate, responding to a freighter's distress call. The writing was on the wall, but the Assembly was slow to approve funds for a new class of police ships, or even upgrade their existing weapons. This led to a scandal when an Orion Early Cruiser Raider (YR8.4) attacked a convoy

protected by three warp-refitted frigates in Y125 with the loss of two warp-refitted frigates and the third so damaged it had to be scrapped.

The last warp-refitted frigate was withdrawn from service in Y135 and scrapped the next year.

The Terran warp-refitted frigate is a base hull. Variants include the Terran warp-refitted frigate leader (YR2.46).

This ship is nimble (C11.0).

Landing: The ship can land on planets using the areodynamic (P2.433), gravity (P2.432), or powered (P2.434) landing systems, and has the crash landing bonus in (P2.4311).

Seeking weapons: The Terran warp-refitted frigate can control a number of seeking weapons equal to half its sensor rating (F3.211).

Refits

Tractors: These were type-W (Range 1, rear arc, towing only), refitted to type-Y (Range 1, 360°, can hold any legal target) at no cost in Y81, and refitted to type-M (Range 2) in Y120 at no cost, but never further refitted.

Transporters: These were Range 1, extended to Range 2 at no cost in Y81, extended to Range 3 at no cost in Y100, and extended to Range 4 at no cost in Y120, but never extended further.

SSD and counters are in *Module Y2*.

Known names: *Antietam*, *Rosbach*, *Trafalgar*, *Thermopylae*, others.

(YR2.26) ALPHA-CENTAURAN WARP-REFITTED LIGHT CRUISER (WAL):

Carrying the same armament as the somewhat larger heavy cruiser (YR2.15), the Alpha-Centauran warp-refitted light cruiser appeared a powerful opponent at first glance. Like most refitted sublight ships, it was not able to arm all of its weapons and maneuver. Successful ship captains learned to carefully balance their ship's energy to both maneuver for a favorable position and to inflict damage on their opponents.

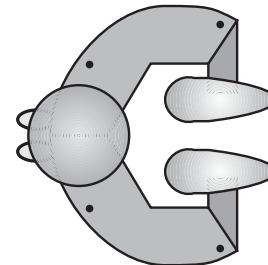

As with most National Guard ships, their primary role was the local security of Alpha-Centauran colonies and the protection of Alpha-Centauran commerce. Alpha-Centauri converted 10 sublight light cruisers to this design between Y70 and Y77. It is unclear if any more were converted. Four of the ships were lost in action with the Kzintis between Y88 and Y92, four more were so badly damaged that it was decided to scrap them rather than repair them. The remaining two ships were retired in Y100.

The Alpha-Centauran warp-refitted light cruiser is a base hull. Variants include the Alpha-Centauran warp-refitted commando cruiser (YR2.39).

Seeking weapons: The Alpha-Centauran warp-refitted light cruiser can control a number of seeking weapons equal to half its sensor rating (F3.211).

Refits

Tractors: These were type-W (Range 1, rear arc, towing only), refitted to type-Y (Range 1, 360°, can hold any legal target) at no cost in Y81, but never further refitted.

Transporters: These were Range 1, extended to Range 2 at no cost in Y81, but never extended further.

SSD and counter are in *Module Y2*.

Known names: *Alacrity, Ferocity, Tenacity*, others.

(YR2.27) ALPHA-CENTAURAN WARP-REFITTED FRIGATE (WAF): The Alpha-Centauran sublight frigate adapted readily to warp technology. It was somewhat larger and definitely sturdier than the Terran ship (YR2.25), but distinctly less maneuverable and not built in nearly the same numbers. Twelve ships were converted to warp technology beginning in Y70, with the first three completed by Y71. Like the Terrans, the Alpha-Centaurans provided some of the ships for use by the forming Unified Federation police forces. During the First Federation-Kzinti War, the Kzintis destroyed at least one ship (maybe two). The remaining ships of the class were all transferred to the Federation Police in Y95, but with the Alpha-Centaurans no longer providing replacement parts, the maintenance problems on the ships soon became insurmountable and they were all scrapped by Y108.

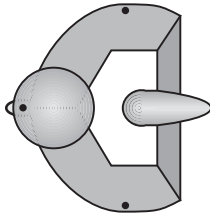

The Alpha-Centauran warp-refitted frigate is a base hull; there are no variants.

Seeking weapons: The Alpha-Centauran warp-refitted frigate can control a number of seeking weapons equal to half its sensor rating (F3.211).

Refits

Tractors: These were type-W (Range 1, rear arc, towing only), refitted to type-Y (Range 1, 360°, can hold any legal target) at no cost in Y81, but never further refitted.

Transporters: These were Range 1, extended to Range 2 at no cost in Y81, and extended to Range 3 at no cost in Y100, but never extended further.

SSD and counter are in *Module Y2*.

Known names: *Brutal, Savage, Vicious*, others

(YR2.28) ANDORIAN WARP-REFITTED COMMAND CRUISER (WAC): There has always been a question about which species within the Federation is the most “warlike.” The competition (such as it is) is primarily between the Terrans and the Andorians, although most Terrans would willingly concede the title to the Andorians, who on their part would willingly accept it.

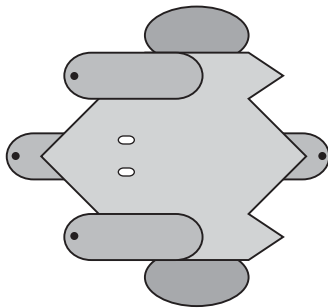

One of the examples of Andorian martial ardor was their decision to upgrade sublight command cruisers to warp power. They did this before any of the other Federation member nations, having three in service by Y73. As with other Andorian warp-refitted ships, they declined to accept the offer of photon torpedoes, retaining the drone technology

they had developed as their primary weapon system.

As with all Andorian ships, this made for a fast attack platform, allowing it to maneuver to bring both launchers to bear on a target, before closing behind the drones to launch more and administer a savage phaser lashing. At least that was the theory.

One of the ships was lost while leading an Andorian task force against the Kzintis in Y89. (It was not the only ship lost in the debacle as Kzinti drones overwhelmed the capabilities of the force to defend itself.) The shock of the defeat did much to persuade the Andorians to stand down their warp-refitted National Guard and support the use of upgrades of the Federation standard ships in Y113.

The Andorian warp refitted command cruiser is a variant of the Andorian early cruiser (YR2.17).

Seeking weapons: The Andorian warp-refitted command cruiser can control a number of seeking weapons equal to its sensor rating (F3.21).

Refits

Tractors: These were type-W (Range 1, rear arc, towing only), refitted to type-Y (Range 1, 360°, can hold any legal target) at no cost in Y81, but never further refitted.

Transporters: These were Range 1, extended to Range 2 at no cost in Y81, extended to Range 3 in Y100, but never extended further.

SSD and counter are in *Module Y2*.

Known names: *Grendek, Stendek, Vondek*, others.

(YR2.29) ANDORIAN WARP-REFITTED FRIGATE (WNF): The Andorian frigate was intended as nothing more than a screening ship for larger Andorian ships, anything from a cruiser (YR2.17) to a destroyer (Y2.16). The ship was nearly as maneuverable as the Terran warp-refitted frigate (YR2.25), and would probably have been easily able to defeat such a ship in close combat. Like all Andorian ships, it was faster than its contemporaries among the national fleets of the other planets that made up the Federation, gaining a considerable advantage because its heavy weapon did not require any power.

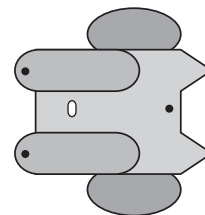

Like the warp-refitted frigates of the other Federation nations, a number of these ships (variously reported between eight and 16) were eventually assigned to the nascent police forces. At least eight ships of this class (some still part of the Andorian national fleet, some seconded back to the fleet by the police) were lost in combat with the Kzintis (including three in one single disastrous battle).

All told, the Andorians converted 19 ships of this class. It holds the distinction of being the last warp-refitted ship type operated by the Federation (the former Terran light cruiser was considered a standard ship after the Y120 upgrades). The last ship of the class served as a test-bed platform for drone systems until Y148, when it was retired and scrapped. All other ships of the class had either been lost for various reasons by Y132. (At least one was destroyed near the Romulan frontier in Y110, but the reason for the loss was not known; Orion Pirates destroyed two others.)

The Andorian warp-refitted frigate is a base hull; there are no variants.

Seeking weapons: The Andorian warp-refitted frigate can

control a number of seeking weapons equal to its sensor rating (F3.21).

Refits

Tractors: These were type-W (Range 1, rear arc, towing only), refitted to type-Y (Range 1, 360°, can hold any legal target) at no cost in Y81, refitted to type-M (Range 2) at no cost in Y120, but never further refitted.

Transporters: These were Range 1, extended to Range 2 at no cost in Y81, extended to Range 3 at no cost in Y100, and extended to Range 4 at no cost in Y120, but never extended further.

SSD and counter are in *Module Y2*.

Known names: *Skinner, Slider, Slitter, Stabber*, others.

(YR2.30) RIGELIAN WARP-REFITTED LIGHT CRUISER (WRL):

The Rigelian sublight light cruiser, like all Rigelian warships, surrendered a significant volume to cargo capacity. Despite this, it adapted well to warp technology, having perhaps the best maneuvering characteristics of any Rigelian ship, but the cargo hatches and other cargo handling features prevented the phasers from being mounted in optimum firing positions. This made it difficult for the ship to bring its main phaser arrays to bear on a single target.

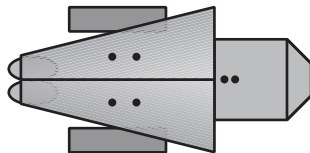

The large cargo bay did help buffer the ship from heavy damage, which gave it comparatively good survival rates in combat (at least in simulations).

Like most of the Federation's warp-refitted ships, the design's only real test in major combat would be the First Federation-Kzinti War. Two ships out of the 13 the Rigelians had converted were lost in combat in Y88. The two that remained in the theater, and two others that were sent to the theater, were thereafter used as armed cargo transports to deliver badly needed stockpiles of repair parts and munitions (T-bombs, Andorian drones, replacement shuttles and ground combat vehicles, etc.). They were also used to evacuate threatened civilian populations where this was possible, as well as vital stockpiles threatened by Kzinti attack.

The Rigelians retired the last of these ships (along with most of their other warp-refitted ships) between Y113 and Y120 in favor of receiving standard Federation ships for their National Guard.

The Rigelian warp-refitted light cruiser is a base hull. Variants include warp-refitted commando cruiser (YR2.43).

Seeking weapons: The warp-refitted light cruiser can control a number of seeking weapons equal to half its sensor rating (F3.211).

Refits

Tractors: These were type-W (Range 1, rear arc, towing only), refitted to type-Y (Range 1, 360°, can hold any legal target) at no cost in Y81, but never further refitted.

Transporters: These were Range 1, extended to Range 2 at no cost in Y81, and extended to Range 3 at no cost in Y100, but never extended further.

SSD and counter are in *Module Y2*.

Known names: *Collector, Controller, Gatherer*, others.

(YR2.31) RIGELIAN WARP-REFITTED FRIGATE (WRF):

The Rigelians upgraded at least 14 sublight frigates to this standard, the last ship entering service in Y78. It was no more maneuverable than the warp-refitted destroyer (YR2.10) despite its smaller size, which was the reason the Rigelians curtailed conversion despite having another dozen hulls

available.

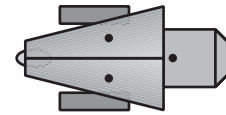

In Y81, Rigel gave all of the ships to the Federation police force in toto, where their design would influence future police ships. The Federation police would note that having a cargo bay was very useful in their operations.

While some of the ships participated in the First Federation-Kzinti War, only two were lost. Six would be lost in the first days of the First Federation-Klingon War in Y110, a record of loss for one ship class in a single month that would not be matched until the General War a half-century later.

The remaining six ships soldiered on until Y132 when they were retired, going to the breakers the following year.

The Rigelian warp-refitted frigate is a base hull; there are no variants.

Seeking weapons: The Rigelian warp-refitted frigate can control a number of seeking weapons equal to half its sensor rating (F3.211).

Refits

Tractors: These were type-W (Range 1, rear arc, towing only), refitted to type-Y (Range 1, 360°, can hold any legal target) at no cost in Y81, and refitted to type-M (Range 2) at no cost in Y120, but never further refitted.

Transporters: These were Range 1; extended to Range 2 at no cost in Y81, extended to Range 3 at no cost in Y100, and extended to Range 4 at no cost in Y120, but never extended further.

SSD and counter are in *Module Y2*.

Known names: *Finder, Searcher, Seeker*, others.

(YR2.32) VULCAN WARP-REFITTED LIGHT CRUISER (WVL):

In Y70 the Vulcans, as part of supporting the creation of a combined fleet, which they saw as a logical need, began converting an older light cruiser to this combat variant. In all, they would convert just six ships to this design (three of which were ready in Y71). The ships retained three phaser-1s, but despite that system's greater hitting power, the ship was considered seriously under-gunned (despite being intended as a gun platform).

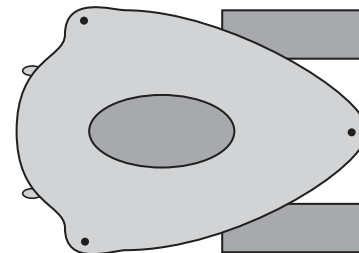

Because of Vulcan's reluctance to be too heavily involved in violence, it refused to convert any more ships to this design after the initial six. Efforts to use the ships as "snipers" (firing from long-range with their photons and phasers) proved less than successful (in the simulators), simply weakening the overall firepower of a mixed squadron and that of the individual ships.

Two of the ships served in the First Federation-Kzinti War, where they were not popular among the senior officers. They tended to be used in much the same manner as the Rigelian warp-refitted light cruiser (YR2.30), i.e., in the role of transports.

This situation changed in Y90 when the two ships, supported by a Vulcan warp-refitted heavy cruiser (YR2.13)

and two Vulcan warp-refitted frigates (YR2.33), were the only force available to oppose a Kzinti task force. The action ended when the Kzinti early command cruiser (YR5.5) was destroyed and two Kzinti early strike cruisers (YR5.4) were heavily damaged and forced to withdraw. The demonstration of Vulcan resolve in the defense of a Rigelian colony planet helped bring all of the Federation's member states closer together.

The Vulcans deactivated the six ships in Y113.

The Vulcan warp-refitted light cruiser is a base hull; there are no variants.

Seeking weapons: The Vulcan warp-refitted light cruiser can control a number of seeking weapons equal to half its sensor rating (F3.211).

Refits

Tractors: These were type-W (Range 1, rear arc, towing only), refitted to type-Y (Range 1, 360°, can hold any legal target) at no cost in Y81, but never further refitted.

Transporters: These were Range 1, extended to Range 2 at no cost in Y81, extended to Range 3 at no cost in Y100, but never extended further.

SSD and counter are in *Module Y2*.

Known names: *Honorable, Stalwart, Steadfast*, others.

(YR2.33) VULCAN WARP-REFITTED FRIGATE (WVF): The Vulcan warp-refitted frigate was regarded as perhaps the best of its class in Federation space (unlike larger Vulcan ships). While not as maneuverable as the Terran design (YR2.25), it was (due to the use of phaser-1s) perhaps the most heavily-armed with excellent power reserves. None of these ships were released for use by the police forces prior to Y113 because of their weapon capabilities. There were only 10 of them.

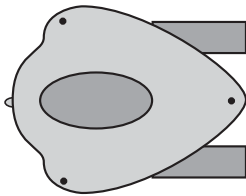

Two were lost in action against the Kzintis in Y90, their crews sacrificing themselves in the tradition of "the greatest good for the greatest number" in a battle near a Rigelian colony planet. Another was destroyed in a contest with an Orion early light raider (YR8.5) in Y118, an action that ended when both ships were immolated, but a freighter, carrying critically needed medical supplies to an Alpha-Centauran colony, was saved.

The remaining seven ships were taken out of service in Y130 and scrapped in Y137.

The Vulcan warp-refitted frigate is a base hull; there are no variants.

Seeking weapons: The Vulcan warp-refitted frigate can control a number of seeking weapons equal to half its sensor rating (F3.211).

Refits

Tractors: These were type-W (Range 1, rear arc, towing only), refitted to type-Y (Range 1, 360°, can hold any legal target) at no cost in Y81, refitted to type-M (Range 2) at no cost in Y120, but never further refitted.

Transporters: These were Range 1, extended to Range 2 at no cost in Y81, extended to Range 3 at no cost in Y100, and extended to Range 4 at no cost in Y120, but never extended further.

SSD and counter are in *Module Y2*.

Known names: *Courage, Intrepid, Valor*, others.

(YR2.0) EARLY YEARS UNITED FEDERATION OF PLANETS SHIPS MODULE Y3

(YR2.34) EARLY YEARS BATTLESHIP (YBB): In Y95, the Federation learned that the Klingons (with whom relations were then cordial) were working on a design study to build a ship larger than any other ship (YR3.8). The Federation had no knowledge of exactly what this design would be (the information had been gleaned through informal conversations with Klingon exchange officers), but was intrigued by the concept and embarked on its own design study.

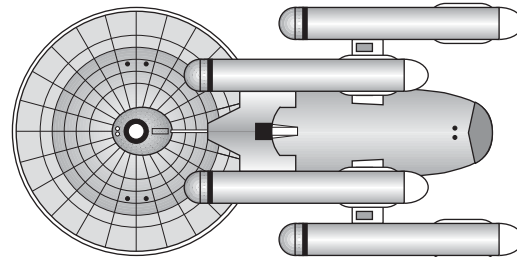

The Federation was not aware that the Klingon's design study envisioned building entirely new, and massive, construction docks for the purpose, and chose to start with the saucer of an early dreadnought (YR2.6) and build a larger secondary hull. The width of the Federation's existing construction docks thereby became a major factor in the design, and imposed severe constraints on the entire concept. While intended to simply be a larger command platform along the lines of the early dreadnought, the limits imposed by incorporating an early dreadnought saucer and the narrowness of the secondary hull imposed major limits on the weapons that could be installed. The Federation designers assumed that breakthroughs would be made in the design of phasers that would allow the more powerful phaser-1 to be installed. (Indeed, most empires were working on such systems, but the Federation had an intrinsic edge in that the Vulcans had already overcome many, but not all, of the problems.) Had the ship actually been built, it would have been this powerful (for the Early Years) phaser array that made it a formidable opponent for an opposing fleet.

The resulting design was never built as the study found the costs associated with building a ship of such size as both excessive and beyond its combat value. (It is questionable as to whether or not the study's conclusion was correct.) Decades later, when the Federation discovered that the Klingon Empire was proceeding with the construction of the B10 (R3.17), this original design study would be hurriedly updated in the Y170s, forming the basis of the later battleship (R2.73) design, which also did not enter production.

The Early Years battleship has a year in service of Y105 as the study concluded that had construction begun, that was the earliest year it would have been completed.

The Early Years battleship is a base hull; there are no variants. This hull is the basis for the battleship (R2.73) and its variants.

Seeking weapons: The Early Years battleship can control a number of seeking weapons equal to half its sensor rating (F3.211).

Refits

Tractors: These were type-Y (Range 1, 360°, any legal target), refitted to type-M (Range 2) at no cost in Y120, and refitted to type-N (Range 3) at no cost in Y140-Y146.

Transporters: These were Range 3, extended to Range 4 at no cost in Y120, and extended to Range 5 at no cost in Y140.

SSD and counter are in *Module Y3*.
 Known names: *Ares, Mars, Nebu, Kali*.

(YR2.35) EARLY YEARS TRANSPORT FRIGATE (YFT): Logistics was always a key to the strength of any empire. The inability to supply a distant combat force would result in that force either having to withdraw or be destroyed. The transport frigate was designed to move small amounts of cargo quickly in areas of space where the threat of attack by the Kzintis (during the First Federation-Kzinti War) was deemed too great for an early armed priority transport (YR1.13). The first ships of the class only barely reached the front before that war ended, leaving the basic concept somewhat untested. They were also designed to assist in the recovery of crippled freighters [using (G14.73)] as there were never enough fleet tugs (YR2.9) to deal with all of their critical tasks and rescue crippled freighters in combat zones. Several of the ships conducted rescues of broken-down freighters and freighters left crippled by pirate attacks. The ability to rescue small freighters eventually morphed (under combat conditions) into transport frigates doing short hauls of normal tug cargo pods (R2.11) themselves which greatly aided the Third Fleet in resisting the Klingon attacks during the brief First Federation-Klingon War in Y110. At least two ships of this class were still serving in the Federation National Guard as late as Y133.

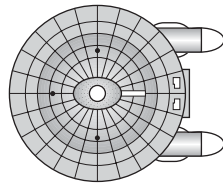

The Federation built at least eight ships of this class, plus at least one replacement ship, between Y90 and Y110.

The SSD provides the data for both single-weight and double-weight pods, but any pods carried by this ship are inactive and every box in such a pod is treated as a “cargo” damage point. The Early Years transport frigate can carry one pod, which can be double-weight.

Like all tugs, the movement cost and turn mode vary with the pod carried. The movement cost of the Early Years transport frigate with a single-weight pod is 0.67 energy points per hex; with a double-weight pod it is 1.0 energy points per hex; see Annex #3A. Note that other early frigate variants cannot carry pods.

The only pods available in the Early Years period were cargo (R2.11) and passenger types.

The Early Years transport frigate is a variant of the early frigate (YR2.8)

Seeking weapons: The Early Years transport frigate can control a number of seeking weapons equal to half its sensor rating (F3.211).

Refits

Tractors: These were type-Y (Range 1, 360°, any legal target), refitted to type-M (Range 2) at no cost in Y120, but never further refitted.

Transporters: These were Range 2, extended to Range 3 at no cost in Y100 and extended to Range 4 at no cost in Y120, but never extended further.

SSD and counter are in *Module Y3*.

Known names: *Wells Fargo, Pony Express, Flying Cloud*.

(YR2.36) WARP-REFITTED HOSPITAL SHIP (WCH): This was an upgrade of a design operated by the Terran forces during the First Federation-Romulan War. While most empires used freighters or simply divided the wounded among damaged ships heading to the rear for repairs, the Terrans always tried to have the best medical care possible

as far forward as possible. The success of this system encouraged the other members of the Federation to provide their own medical personnel and technology to these ships, making them the premier medical facilities anywhere outside of the home star systems. Weapon systems were kept to a minimum, less because it was believed that other empires would respect the mission of the ships than that it was believed they could be kept out of harm’s way. It was expected that the ships would operate far enough behind the fighting front to be safe from attack and that a small escort or two would provide local security. This was proven disastrously wrong in Y89 when, despite the best efforts of her consorts [a Rigelian warp-refitted destroyer (YR2.10) and an early frigate (YR2.8)], Kzintis more interested in the glory of capturing (or destroying) a cruiser than in the ship’s humanitarian mission captured the *Solace*.

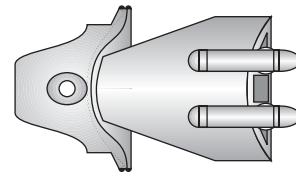

These ships were technically still part of the Terran National Guard, even though their crews were among the first to be integrated with members from most Federation member worlds.

The warp-refitted hospital ship is a variant of the warp-refitted cruiser (YR2.2).

Seeking weapons: The warp-refitted hospital ship can control a number of seeking weapons equal to half its sensor rating (F3.211).

Refits

Tractors: These were type-Y (Range 1, 360°, can hold any legal target); they were not refitted as the ships were converted to, or built to the standard of, Early Years hospital ships (YR2.37) beginning in Y90.

Transporters: These were Range 2; they were not upgraded as the ships were converted to, or built to the standard of, Early Years hospital ships (YR2.37) beginning in Y90.

SSD and counter are in *Module Y3*.

Known names: *Solace, Comfort, Refuge*.

(YR2.37) EARLY YEARS HOSPITAL SHIP (YCH): After the *Solace* disaster (YR2.36), the Federation considered abandoning the hospital ship concept and just using freighters. The Federation Council members, however, were stunned when not just Star Fleet, but the members of the Federation’s medical profession, came forward to demand that the ships continue in use. Star Fleet’s review of the *Solace* disaster showed that, ultimately, it was caused by the inability of the ship to rapidly leave the area when Kzinti ships caught it. If the *Solace* had had the improved warp engines then available she would have evaded the Kzinti attack. Thus apprised of the findings, the Federation Council voted a special funding appropriation to upgrade the remaining warp-refitted hospital ships (R2.36).

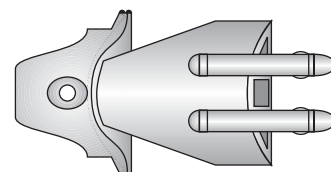

Perhaps they were driven to do it more because it was the Council that had blocked the previous Star Fleet budget

request, made in Y87, to fund upgrades of the ships. The Council had chosen to support a minority opinion in Star Fleet that said the upgrades were unnecessary because the ships would never be involved in direct combat.

The improvements enabled the ships to operate effectively during the remainder of the First Federation-Kzinti War, and *Comfort* managed to avoid destruction by a surprise Klingon attack in Y111 during the First Federation-Klingon War due to the improved engines and shielding.

The Early Years hospital ship is a variant of the early light cruiser (YR2.5).

Seeking weapons: The Early Years hospital ship can control a number of seeking weapons equal to half its sensor rating (F3.211).

Refits

Tractors: These were type-Y (Range 1, 360°, any legal target), refitted to type-M (Range 2) at no cost in Y120, and refitted to type-N (Range 3) at no cost in Y140.

Transporters: These were Range 3, extended to Range 4 at no cost in Y120, and extended to Range 5 at no cost in Y140.

SSD and counter are in *Module Y3*.

Known names: *Comfort, Refuge*.

(YR2.0) SHIPS OF THE NATIONAL GUARDS

(YR2.38) ALPHA-CENTAURAN WARP-REFITTED COMMAND CRUISER (WACC): This ship was designed to be more resilient than the heavy cruiser (YR2.15) and serve as the command ship of a task force rather than be more powerful. The ship did not have any additional weapons, but included a larger contingent of Marines and systems to support their operations (additional shuttles and an additional transporter). The ship also had an improved power curve.

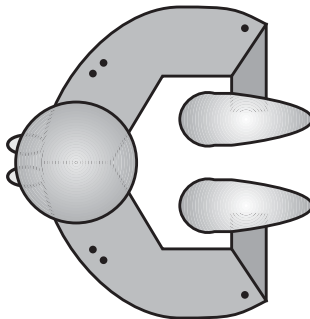

Records are unclear as to how many ships of this class there were. At least three sublight ships were converted to this design before the First Federation-Kzinti War, and at least one of those was lost in the opening stages of that war when it was unable to turn away from a massive wave of Kzinti drones. One ship was still serving as a flagship of the Alpha-Centauran National Guard forces in Y101, but it was retired and scrapped in Y109.

The Alpha-Centauran warp-refitted command cruiser is a variant of the Alpha-Centauran early cruiser (YR2.15).

Seeking weapons: The Alpha-Centauran warp-refitted command cruiser can control a number of seeking weapons equal to half its sensor rating (F3.211).

Refits

Tractors: These were type-W (Range 1, rear arc, towing only), refitted to type-Y (Range 1, 360°, can hold any legal target) at no cost in Y81, but never further refitted.

Transporters: These were Range 1, extended to Range 2 at no cost in Y81, and extended to Range 3 at no cost in Y100, but never extended further.

SSD and counter are in *Module Y3*.

Known names: *Belerica, Moritana, Palema*.

(YR2.39) ALPHA-CENTAURAN WARP-REFITTED COMMAND CRUISER (WALG): A variant of the Alpha-Centauran light cruiser (YR2.26) optimized for landing and extracting Marines in raids. The Alpha-Centaurans are known to have operated at least three such ships, and it appears one may have been lost in combat with the Kzintin in Y90. The surviving ships were apparently scrapped in Y100 along with the other Alpha-Centauran warp-refitted light cruisers.

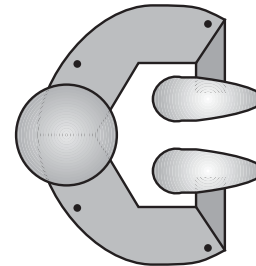

Alpha-Centauran Marine doctrine emphasized speed over firepower. Marines were organized in companies of five platoons each of four squads; one crew unit on the ship is actually a non-fighting headquarters for the company. Three of the platoons were standard combat platoons of four boarding parties each; the fourth platoon was the strike platoon of four commando squads; the fifth platoon was the maneuver platoon composed of four squads and four ground combat vehicles (D15.820). Combat operations often saw the fifth platoon's Marine squads deploy as a normal combat platoon without their vehicles, and they were often held aboard ship to be deployed as reinforcements in the event of trouble on the ground. Sometimes the ground combat vehicles would be landed as an independent unit without their Marine squads, depending on the situation. Normally, the three combat platoons would be landed and initiate an assault on an enemy location as a diversion, and the strike platoon would then be beamed directly into the target area taking advantage of the diversion.

The Alpha-Centauran warp-refitted commando cruiser is a variant of the Alpha-Centauran warp-refitted light cruiser (YR2.26).

Landing force: 16 boarding parties (D7.0) plus four commando teams (D15.84), and four ground combat vehicles (D15.82). This was roughly a half battalion of troops (R2.M1) and is included in the ship's BPV.

Shuttles: Four early ground assault shuttles (YR1.F4); these shuttles are included in the ship's BPV.

Seeking weapons: The Alpha-Centauran warp-refitted commando cruiser can control a number of seeking weapons equal to half its sensor rating (F3.211).

Refits

Tractors: These were type-W (Range 1, rear arc, towing only), refitted to type-Y (Range 1, 360°, can hold any legal target) at no cost in Y80, but never further refitted.

Transporters: These were Range 1, extended to Range 2 at no cost in Y80, but never extended further.

SSD and counter are in *Module Y3*.

Known names: *Calistica, Larenia, Niakra*.

(YR2.40) ANDORIAN WARP-REFITTED LIGHT CRUISER (WNL): The warp-refitted light cruiser, a consort for the warp refitted heavy cruiser (YR2.17), was cheaper and thus able to be built in larger numbers. As with the warp-refitted heavy cruiser it retained the drone armament the Andorians preferred over the photon torpedoes adopted by the rest of the Federation member planets. It was more maneuverable than the warp-refitted heavy cruiser, if having slightly less

firepower, and often operated on their flanks or (as might be expected) as the centerpiece of small task forces. The number of Andorian sublight light cruisers is not known, but they initially converted at least eight to this design, and another five after the Kzinti-Federation War began (apparently to replace losses as there is no indication that the number in service actually increased). At least two ships of this class were part of the Sixth Fleet from Y108 to Y112 when they were withdrawn and mothballed along with the other five ships then in service (one was lost in Y111 during the First Federation-Klingon War). All were ordered scrapped in Y120, the last ship going to the breakers in Y125 after efforts to raise funds to convert it into a museum failed.

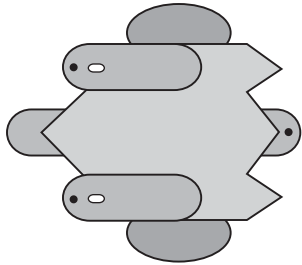

The Andorian warp-refitted light cruiser is a base hull. Variants include the Andorian warp-refitted commando cruiser (YR2.41).

Seeking weapons: The Andorian warp-refitted light cruiser can control a number of seeking weapons equal to its sensor rating (F3.21).

Refits

Tractors: These were type-W (Range 1, rear arc, towing only), refitted to type-Y (Range 1, 360°, can hold any legal target) at no cost in Y80, but never further refitted.

Transporters: These were Range 1, extended to Range 2 at no cost in Y80, and extended to Range 3 at no cost in Y100, but never extended further.

SSD and counters are in *Module Y3*.

Known names: *Govar-Jarot (Grinding Ice)*, *Jarot-Ogal (Ice Wall)*, *Jirot-Corus (Polar Wind)*, *Jirot-Gos (Polar Thunder)*, *Jirot-Targ (Polar Lightning)*, *Targ-Vlest (Lightning Giver)*.

(YR2.41) ANDORIAN WARP-REFITTED COMMANDO CRUISER (WNLG): Typical of the breed, the Andorian warp-refitted commando cruiser was probably not well suited to the support of the Marine force it embarked, and the Andorian Marine and Naval commands never really worked out a good compromise. Individual Andorian ship captains and Marine battalion commanders of the ships often had to improvise task organizations that had little to do with the nominal paper organization of the battalion.

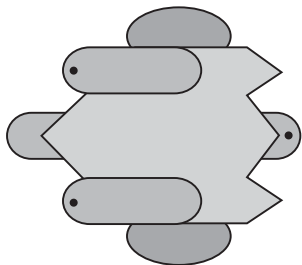

The embarked Marine battalion was composed of two companies. Each company was composed of three platoons, each of five boarding parties and a headquarters element composed of a boarding party, a heavy-weapons squad, a ground combat vehicle (D15.820), and an armored personnel

vehicle (D15.823). One crew unit on the ship is a non-fighting battalion headquarters to coordinate the operations of the two companies. Each company headquarters was expected to use the heavy-weapons squad in combination with the ground combat vehicle to provide firepower support as needed to its combat platoons, and use the transportation abilities of its attached armored personnel vehicle and ground combat vehicle to reinforce its sister company as needed. In order to facilitate landing the vehicles, the ship was equipped with an early heavy transport shuttle (YR1.F5). The Andorians retired their commando cruisers (it is believed there were only two ships of this type, but it is possible there was a third built as a replacement for the lost ship) in Y109. The two (surviving?) ships both survived participation in the First Federation-Klingon War, and were both scrapped in Y121.

The Andorian warp-refitted commando cruiser is a variant of the Andorian warp-refitted light cruiser (YR2.40).

Landing force: 32 boarding parties (D7.0) plus two heavy-weapons squads (D15.81), two ground combat vehicles (D15.820), and two armored personnel vehicles (D15.823). This was roughly a battalion of troops (R2.M1) and is included in the ship's BPV.

Shuttles: Two early ground assault shuttles (YR1.F4) and one heavy transport shuttle (YR1.F5); these shuttles are included in the ship's BPV.

Seeking weapons: The Andorian warp-refitted commando cruiser can control a number of seeking weapons equal to half its sensor rating (F3.211).

Refits

Tractors: These were type-W (Range 1, rear arc, towing only), refitted to type-Y (Range 1, 360°, can hold any legal target) at no cost in Y80, but were never further refitted.

Transporters: These were Range 1, extended to Range 2 at no cost in Y80, and extended to Range 3 in Y100 at no cost, but never extended further.

SSD and counter are in *Module Y3*.

Known names: *Kaarst Wind*, *Kaarst Snow*, *Kaarst Cloud*.

(YR2.42) RIGELIAN WARP-REFITTED COMMAND CRUISER (WRCC): The Rigelian warp-refitted command cruiser reflected the general view of the Rigelians that trade was far more important than conflict. While facilities for an admiral (or merely a commodore or a senior captain acting as a task force commander) were provided, there was little other improvement. The cargo capacity of the warp-refitted heavy cruiser (YR2.11) was not reduced, although additional shuttles were added. The Rigelians provided four ships of this class, one of which spent the First Federation-Kzinti War in their home system and a second operated as the flagship of the Sixth Fleet during the war (something which miffed the Orions). The third and fourth took part in operations against the Kzintis, leading task forces at various times, and at other times operating independently (not uncommon for command cruisers of any empire) until both had been destroyed. It is unclear when the first, *General*, was lost, but the second, *Master*, was destroyed in Y90 as part of one of the last major Kzinti offensives. While perhaps not the best command cruiser, the Rigelians demonstrated repeatedly that they were willing to fight for the Federation.

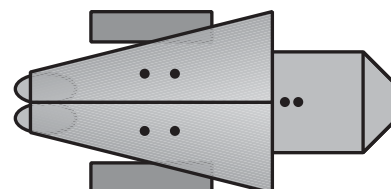

The remaining two ships were both sent to the Klingon border in Y110, where they participated in the First Federation-Klingon War. They were withdrawn from the Klingon border in Y116 and ordered scrapped in Y118.

The Rigelian warp-refitted command cruiser is a variant of the Rigelian early cruiser (YR2.11).

Seeking weapons: The Rigelian warp-refitted command cruiser can control a number of seeking weapons equal to half its sensor rating (F3.211).

Refits

Tractors: These were type-W (Range 1, rear arc, towing only), refitted to type-Y (Range 1, 360°, can hold any legal target) at no cost in Y80, but were never further refitted.

Transporters: These were Range 1, extended to Range 2 at no cost in Y80, and extended to Range 3 in Y100 at no cost, but never extended further.

SSD and counter are in *Module Y3*.

Known names: *Commander, General, Leader, Master*.

(YR2.43) RIGELIAN WARP-REFITTED COMMANDO CRUISER (WRLG):

When the Rigelians turned their attention to ground combat they forgot all about trade. The conversion of the sublight light cruiser to a commando ship was all business, and the warp refit of that ship only enhanced its capabilities by adding warp speed and transporters. The sublight light cruiser's rather copious cargo capacity was partly converted into barracks and the remainder used for systems moved from the rear hull to make room for a greatly enlarged shuttle bay. The ship was well able to support its Marines, as it was intended to do.

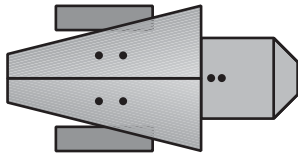

While the Alpha-Centrans believed in speed and diversion, the Rigelians focused on attack, i.e., overwhelm the enemy with firepower.

The Rigelian Marine battalion had two companies. The heavy company consisted of a headquarters squad (one boarding party) and four platoons of four squads (three boarding parties and a heavy-weapons squad) each; the light company had a headquarters squad (one boarding party) and four platoons of three squads (three boarding parties) each. One crew unit on the ship is actually a non-fighting headquarters for the battalion. There was one ground combat vehicle (D15.820) and two armored personnel vehicles (D15.823) embarked that could be used to reinforce either company. Rigelian doctrine envisioned deploying the light company first to find and fix the enemy, and then deploy the heavy company to smash their positions. In actual field operations Rigelian battalion commanders proved far more flexible, and would often task organize the two companies, either swapping platoons between them or simply adding a heavy platoon to the light company, or vice versa.

The Rigelians kept two ships of this class in service through Y89, when the Kzintis destroyed the *Stout*. In Y90 the Kzintis also destroyed the *Strong* at the same time as the *Master* (YR2.42). In Y95 the Rigelians converted their remaining sublight light cruiser into a new commando cruiser, renaming the ship *Unyielding*. This ship was severely damaged by the Klingons in Y111. Rather than repair the ship, the Rigelians sent it to the breakers in Y112.

The Rigelian warp-refitted commando cruiser is a variant of the Rigelian warp-refitted light cruiser (YR2.30).

Landing force: 26 boarding parties (D7.0) plus four heavy-weapons squads (D15.81), one ground combat vehicle

(D15.820), and two armored personnel vehicles (D15.823). This was roughly a battalion of troops (R2.M1) and is included in the ship's BPV.

Shuttles: Two early ground assault shuttles (YR1.F4), one heavy transport shuttle (YR1.F5), and one early admin shuttle [(J2.0)/(YR1.F1)]; these shuttles are included in the ship's BPV.

Seeking weapons: The Rigelian warp-refitted commando cruiser can control a number of seeking weapons equal to half its sensor rating (F3.211).

Refits

Tractors: These were type-W (Range 1, rear arc, towing only), refitted to type-Y (Range 1, 360°, can hold any legal target) at no cost in Y80, but were never further refitted.

Transporters: These were Range 1, extended to Range 2 at no cost in Y80, and extended to Range 3 in Y100 at no cost, but never extended further.

SSD and counter are in *Module Y3*.

Known names: *Stout, Strong, Unyielding*.

(YR2.44) TERRAN WARP-REFITTED COMMAND CRUISER (WCC):

While the Andorians were the first Federation member nation to field a warp-refitted command cruiser (YR2.28), the Terrans were not very far behind them. Indeed, if the Andorians had not embarked on the conversion, it is likely the Terrans never would have done so due to the difficulties they had encountered in converting their sublight heavy cruisers (YR2.24) to warp power. Like the Andorian design, the Terran ship included an increase in firepower as well as greater power output (by increasing the impulse engines). The two designs would influence the eventual design of the Federation early command cruiser (YR2.18) which, in addition to improved command facilities, would have more power and firepower than the early heavy cruiser (YR2.3) on which it was based.

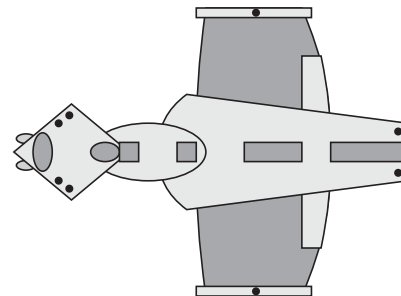

The Terran National Guard only had two ships of this class (after the *Auchinleck* was completed in Y73, which is used as the service date); no further conversions were undertaken.

Both ships fought in the First Federation-Kzinti War and while damaged, survived that conflict. At least one of the two ships fought against the Klingons in Y111.

In Y115, the ships were both struck from the lists and scheduled for the breakers. However one of the enduring mysteries of the *Star Fleet Universe* then intruded. One of the two ships, the *Auchinleck*, simply vanished (it was recorded literally as present one second and gone in the next) while in a parking orbit in the Sol system; no one was aboard at the time as the ship had been completely shut down. The *De Gaulle* had its tow fail (the towing ship suffered a complete failure of its tractor system) near the orbit of Jupiter and plunged into the gas giant's gravity well before another ship could arrive and take it under tow again.

The Terran warp-refitted command cruiser is a variant of the Terran warp-refitted heavy cruiser (YR2.24).

Seeking weapons: The Terran warp-refitted command cruiser can control a number of seeking weapons equal to

half its sensor rating (F3.211).

Refits

Tractors: These were type-W (Range 1, rear arc, towing only), refitted to type-Y (Range 1, 360°, can hold any legal target) at no cost in Y80, but were never further refitted.

Transporters: These were Range 1, extended to Range 2 at no cost in Y80, and extended to Range 3 in Y100 at no cost, but never extended further.

SSD and counter are in *Module Y3*.

Known names: *Claude John Eyre Auchinleck, Charles de Gaulle*.

(YR2.45) TERRAN WARP-REFITTED DESTROYER LEADER (WDL):

There were a number of sublight destroyers in the Terran fleet, and they were often operated in independent groups, sometimes with a few sublight frigates, as well as supporting the larger ships. This led to the Terrans creating a leader version to better coordinate the operations of the ships. When warp power became available, the leaders were considered for conversion first because of their slightly superior overall capabilities. In the early period of the warp refits, however, the ships proved difficult to convert. Simulations indicated the ships would be prone to catastrophic breakdowns even when not engaged in combat operations, so none were converted.

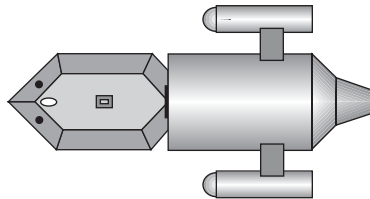

Then in Y69, an error was found in the simulation programming. When the error was fixed, it was determined that the sublight destroyer leader could be converted to warp safely, but by that time most of them had already been consigned to the breakers.

Only eight sublight destroyer leaders remained available for conversion to warp technology. Worse, it was not possible to upgrade any of the existing warp-refitted destroyers (YR2.3) to the design without first removing the existing warp systems, which made such conversions cost prohibitive for the relatively meager gains. The eight remaining ships were all upgraded.

Two were lost during the First Federation-Kzinti War, another during the First Klingon-Federation War, and a fourth disappeared near the border of Romulan and Tholian space. The remaining four were transferred to the combined Federation police force in Y117 (along with several standard warp-refitted destroyers), but the hulls had been hard used and proved difficult to maintain. The ships were retired in Y124, but by then the experience with using them, compared to the various other warp-refitted ships that had been provided to the police, would heavily influence the design of the police cutter (R2.12).

The Terran warp-refitted destroyer leader is a variant of the Terran warp-refitted destroyer (YR2.3).

Seeking weapons: The Terran warp-refitted destroyer leader can control a number of seeking weapons equal to half its sensor rating (F3.211).

Refits

Tractors: These were type-W (Range 1, rear arc, towing only), refitted to type-Y (Range 1, 360°, can hold any legal target) at no cost in Y80, and refitted to type-M (Range2) at no cost in Y120, but were never further refitted.

Transporters: These were Range 1, extended to Range 2 at no cost in Y80, extended to Range 3 in Y100 at no cost,

and extended to Range 4 in Y120, but never extended further.

SSD and counter are in *Module Y3*.

Known names: *Ney, Grouchy*.

(YR2.46) TERRAN WARP-REFITTED FRIGATE LEADER (WFL):

The Terrans had a number of these ships among their sublight frigates. They were operated almost exclusively as leaders of sublight frigate squadrons sent on independent missions. As sublight ships, they were so operationally similar to standard sublight frigates as not to be noticed. Warp-field dynamic studies indicated that the ships would adapt well to warp technology, but this did not prove to be the case. The converted ships were found to be less agile than the standard warp-refitted frigate (YR2.25). While efforts were made to continue operating them as frigate leaders, they effectively retarded the operations of the other warp-refitted frigates; their more sluggish maneuvers made them relatively easy to identify. This led to them sometimes being used as separate squadrons in their own right.

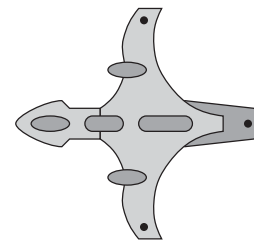

At least 10 ships were converted. Five were lost during the First Federation-Kzinti War, and another two during the First Federation-Klingon War. The remaining three were considered for transfer to the Federation police in Y113, but this was not done. The ships were used as cadet training ships by Star Fleet Academy from Y116 to Y122 when it was decided that it would be too expensive to upgrade their systems to the new technology and training the cadets on the old technology would be inefficient. The ships were scrapped in Y125.

The Terran warp-refitted frigate leader is a variant of the Terran warp-refitted frigate (YR2.25).

Despite being a variant of the Terran warp-refitted frigate, this ship is not nimble.

Landing: The ship can land on planets using the areodynamic (P2.433), gravity (P2.432), or powered (P2.434) landing systems, and has the crash landing bonus in (P2.4311).

Seeking weapons: The Terran warp-refitted frigate leader can control a number of seeking weapons equal to half its sensor rating (F3.211).

Refits

Tractors: These were type-W (Range 1, rear arc, towing only), refitted to type-Y (Range 1, 360°, can hold any legal target) at no cost in Y80, and refitted to type-M (Range2) at no cost in Y120, but were never further refitted.

Transporters: These were Range 1, extended to Range 2 at no cost in Y80, extended to Range 3 in Y100 at no cost, and extended to Range 4 in Y120, but never extended further.

SSD and counter are in *Module Y3*.

Known names: *William T. Sherman, Nagumo, Chuikou, Scipio Africanus, Cetshwayo, Wolfe, Montcalm*.

(YR2.47) VULCAN WARP-REFITTED COMMAND CRUISER (WVCC): The Vulcans completed one ship of this type in Y71, and records indicate that two more were in service by Y74. It is unclear if the three ships were new construction or conversions of heavy cruisers (YR2.13). They were pure combat ships along the same lines as the Vulcan warp-refitted light cruiser (YR2.32), and the Vulcan monopoly on phaser-1s that could be mounted on ships made them serious combatants. One of these ships remained in the Vulcan home system at all times until Y130 when a National Guard Cruiser (R2.116) took over the mission. It was not always the same ship; the three rotated the duty. The other two were often involved in patrols on the Kzinti and Romulan borders. In this, the Vulcans heavily influenced the later design of Star Fleet's ships.

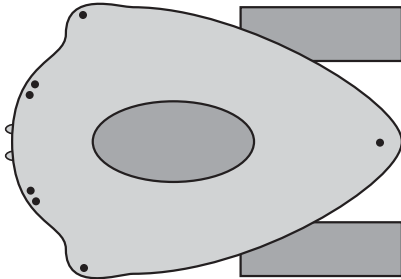

During the First Federation-Kzinti War, one of the ships was sent, at the head of a Vulcan task force, to support the defense of the Federation. The ship was a serious problem for the Kzintis, particularly when supported by other Vulcan cruisers. The Kzintis, however, eventually lured the ship into a trap and overwhelmed it in Y89. The Kzintis lost two frigates (YR5.7), a light cruiser (YR5.10) was destroyed, and two strike cruisers (YR5.4) were crippled in the battle.

The Vulcans never built a replacement for the lost ship, although they did send one of the two remaining ships to assume the duties of the lost ship. It was this ship which carried the Federation diplomats that negotiated the peace that ended the war in Y92.

One of the two ships was scrapped in Y130; the other is a museum ship. The Vulcans considered this use of the ship illogical and a waste of material, but the Federation Council wanted to keep the ship on which the peace treaty had been signed.

The Vulcan warp-refitted command cruiser is a variant of the Vulcan early cruiser (YR2.13).

Seeking weapons: The Vulcan warp-refitted command cruiser can control a number of seeking weapons equal to half its sensor rating (F3.211).

Refits

Tractors: These were type-W (Range 1, rear arc, towing only), refitted to type-Y (Range 1, 360°, can hold any legal target) at no cost in Y80, and refitted to type-M (Range2) at no cost in Y120, but were never further refitted.

Transporters: These were Range 1, extended to Range 2 at no cost in Y80, extended to Range 3 in Y100 at no cost, and extended to Range 4 in Y120, but never extended further.

SSD and counter are in *Module Y3*.

Known names: *Sagavok, Sarpedion*.

(YR2.48) VULCAN WARP-REFITTED SURVEY CRUISER (WVSR): While the Vulcan heavy cruiser (YR2.13) was already a good example of what a survey cruiser should be, the Vulcans determined that increased endurance and greater redundancy in systems was needed. The heavy cruiser design frequently had to limit the extent of its operations due to limits on its systems. The survey ship increased the number of shuttles, transporters, and probes available, and reduced the Marine force to provide more scientists and researchers so that more survey teams could be deployed at one time.

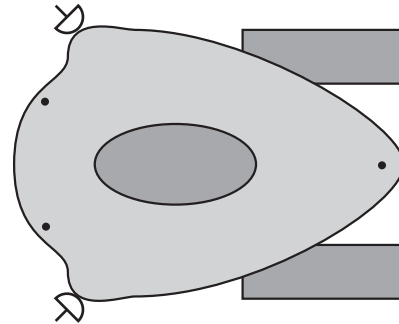

By Y100 there were four such ships in service, and all had been "lent" by the Vulcans to Star Fleet. The regular crew of the ship was composed entirely of Vulcans, but the scientists and researchers came from all over the Federation.

With the development of improved special sensors in Y120, the ships were retired after the conversion of the *Sinai* and *Alaska* into the *Viking* and the *Voyager* (respectively) was complete.

The Vulcan warp-refitted survey cruiser is a variant of the Vulcan early cruiser (YR2.13).

Scout: It can use all scout functions (G24.0). Special sensors are destroyed by "torpedo" damage points. See (G24.35) when purchasing this unit as part of a battle force.

Seeking weapons: The Vulcan warp-refitted survey cruiser can control a number of seeking weapons equal to half its sensor rating (F3.211). See also (F3.213).

Refits

Tractors: These were type-W (Range 1, rear arc, towing only), refitted to type-Y (Range 1, 360°, can hold any legal target) at no cost in Y80, and refitted to type-M (Range2) at no cost in Y120, but were never further refitted.

Transporters: These were Range 1, extended to Range 2 at no cost in Y80, extended to Range 3 in Y100 at no cost, and extended to Range 4 in Y120, but never extended further.

SSD and counter are in *Module Y3*.

Known names: *T'poran, T'lingan*.

END OF FEDERATION EARLY YEARS SHIPS

(R1.0-2) FEDERATION GENERAL UNITS

General units that can be used by the Federation are listed here with appropriate availability, weapons options, fighters, and applicable refits. General units requiring no weapon options or fighters, e.g., small and large freighters, most augmentation modules, etc., or which require no refit data are not listed and simply used as is. This book lists only those general units which have Federation-specific changes, and only lists those changes, not the underlying unit descriptions.

(R1.R-2) REFITS

Federation general units use the following refits:

PF MECH-LINKS (R1.R1): The Federation does not use this refit unless it is using the conjectural fast patrol ships and Interceptors. If the conjectural fast patrol ships and Interceptors are used, the Federation can apply this refit according to the normal rules and costs under (R1.R1) and in accordance with (S8.23), (S8.32) and (S8.34).

Y160 EARLY BASE REFITS (R1.R2): Prior to Y160 Federation bases did not have drone racks or anti-drone racks.

Starbases: Delete all type-H drone racks and ADD-30s; the base has a BPV of 465.

Battle stations: Delete the type-D drone rack and ADD-30; the base has a BPV of 187.

Base stations: Delete the type-D drone rack and ADD-12; the base has a BPV of 107.

Civilian base stations: Delete the type-A drone racks and ADD-12; the base has a BPV of 111/81.

CASUAL READY RACKS (R1.R3): This refit does not currently apply to any Federation ship, but is mentioned here to confirm that it was not overlooked.

Y170 BASE REFITS: The shields of starbases are 50 boxes (each) prior to Y170, and increased to 70 boxes (each) in this year. Limited aegis (D13.4) is also installed; the starbase has a BPV of 650 in this year.

The shields of battle stations are 30 boxes (each) prior to Y170, and increased to 35 boxes (each) in this year. Limited aegis (D13.4) is also installed; the battle station has a BPV of 215 in this year.

The shields of base stations are 21 boxes (each) prior to Y170, and increased to 30 boxes (each) in this year. Limited aegis (D13.4) is also installed; the base station has a BPV of 138 in this year.

Y175 BASE REFITS: The shields of starbases are 70 boxes (each) prior to Y175, and increased to 80 boxes (each) in this year. Full aegis (D13.0) is also installed; the starbase has a BPV of 675 in this year.

The shields of battle stations are 35 boxes (each) prior to Y175, and increased to 40 boxes (each) in this year. Full aegis (D13.0) is also installed; the battle station has a BPV of 230 in this year.

The shields of base stations are 30 boxes (each) prior to Y175, and increased to 35 boxes (each) in this year. Full aegis (D13.0) is also installed; the base station has a BPV of 148 in this year.

The shields of civilian base stations are 21 boxes (each) prior to Y175, and increased to 30 boxes (each) in this year. Limited aegis (D13.4) is also installed. The civilian base station has a BPV of 138/108 from this year.

Y181 DOCKING BAY HANGAR REFIT (R1.1A) and (R1.80A): In Y181 Federation starbases and stellar fortresses were refitted to add a fighter bay for assault fighters to their #4 docking modules. This refit is not applied if the Federation conjectural fast patrol ships are used.

Starbases: The starbase has a BPV of 695 with this refit.

Stellar fortress: Without this refit, the stellar fortress has a BPV of 900.

Y182 PF SHIELD REFITS (R1.PFR1): If the Federation conjectural fast patrol ships are used, the Federation fast patrol ships receive shield refits just as non-Federation fast patrol ships do in Y182.

(R2.N3-2) OTHER THINGS USED BY THE FEDERATION

Some other units and rules need definition for use by the Federation.

(G34.0) DROGUES: The Federation can use seeking-weapons drogues (drones only, not the plasma-D variant), phaser drogues (not the Hydran phaser-G variant), decoy drogues, sensor drogues, and the heavy-weapons drogue with type-H drones (not the plasma-F armed variant).

Use any available drogue counters found in *Module J2*.

(J8.0) MULTI-ROLE SHUTTLES: Federation multi-role shuttles are armed with a phaser-3-360° and six anti-drones, and can carry up to two spaces of drones (either one type-IV, two type-Is, one type-I and two type-VIs, or four type-VIs). RALADS (up to four) could be used in place of one or more of the drone spaces, e.g., a type-I drone, a type-VI drone, and a RALAD.

Generic MRS shuttles are in *Module J*.

(M4.0) CAPTOR MINES: The Federation uses type-A (type-I drones) (fairly rare prior to Y168, more frequently thereafter), type-D (phaser-2), type-F (photon), type-H (type-VI drones) (fairly rare prior to Y165, more common thereafter), and type-J (anti-drones) (from Y140) captor mines. The Federation can also use the variant of the type-A captor (with type-H drones) developed by the Kzintis (FD21.6) from Y168.

(R8.0) ORION PIRATES: For purposes of (G15.44) and (G15.7) the Dragon, Lion's Heart, Penzance, and Pharaoh cartels consider Federation space to be their home territory; Dragon, Hamilcar, and Stardust cartels consider Federation space to be part of their operating zones. Confirming, Dragon Cartel considers Federation space both its home territory and its operating zone.

(R1.0-2) FEDERATION GENERAL UNITS

(R1.1-2) STARBASE (SB): Weapon #1 is photon torpedoes, Weapon #2 is phaser-3s prior to Y168, from Y168 boxes #2, #4, and #6 are deleted and boxes #1, #3, and #5 are phaser-Gs (no change in BPV), Weapon #3 is ADD-30s, and Weapon #4 is type-H drone racks.

Scout: It can use all scout functions (G24.0). Special sensors are destroyed by "phaser" damage points.

Seeking weapons: The starbase can control a number of seeking weapons equal to double its sensor rating (F3.212). See also (F3.213). Limited aegis (D13.4) installed in Y170; full aegis (D13.0), in Y175; see (R1.R-2) above.

Carrier: If this base is equipped with hangar bay modules [(R1.4) and/or (R1.70)], it is a true carrier; see (J4.75), (J4.93), (J11.13), and (J15.22). If equipped with heavy fighter hangar bay modules (R1.70), it cannot be equipped with PF tender modules

(R1.16).

PF tender: If this base is equipped with a PF tender module or modules (R1.16) to operate conjectural Federation PFs or Interceptors, it is a true PF tender (K2.112) and cannot operate heavy fighters (J10.0) or be equipped with heavy fighter hangar bay modules (R1.70).

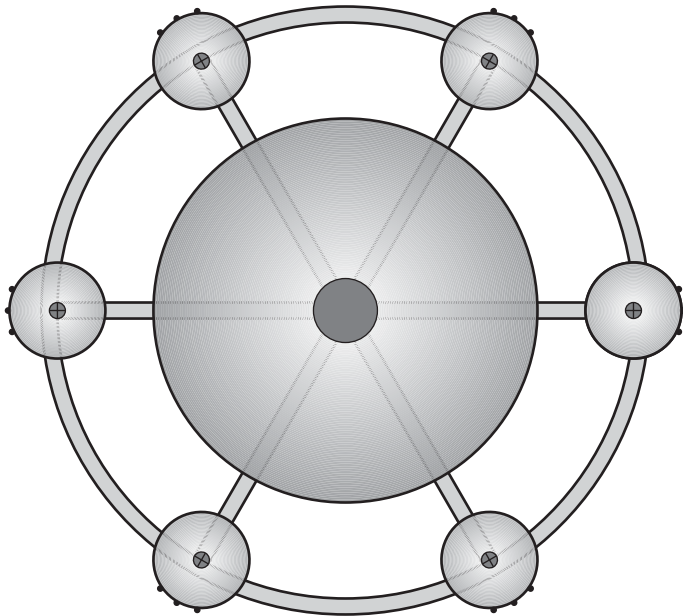

Fighters if hangar bay modules (R1.4) are present [In Y181 Federation starbases had a refit that converted the #4 docking module into a large hangar bay able to operate a squadron of A-10 assault fighters or A-20F fast heavy fighters, this is reflected in this table. See (R1.1A)]:

YEAR	FIGHTERS
Y165-Y166	6, 12, 18, or 24 F-8.
Y167-Y170	6, 12, 18, or 24 F-4 or F-8, or 12 F-4 and 12 F-8.
Y171-Y172	12 F-8 and 12 F-14 or F-14p.
Y173-Y176	12 F-18 and 12 F-14 or F-14p.
Y177-Y179	12 F-18B and 12 F-14A or F-14Ap.
Y180-Y182	12 F-18B+ and 12 F-14A or F-14Ap and 12 A-10 or 6 A-20F.
Y183-Y189	12 F-18C and 12 F-14B or F-14Bp and 12 A-10 or 6 A-20F.
Y190-Y194	12 F-18C and 12 F-14C or 12 F-14Cp and 12 A-10 or 6 A-20F.
Y195+	12 F-18C and 12 F-14C or F-14Cp or F-14D or F-14Dp and 12 A-10 or 6 A-20F.

Fighters if heavy fighter hangar bay modules (R1.70) are present (note: a Federation starbase can have three heavy fighter squadrons if a squadron of six A-20s replaces the squadron of 12 A-10s in the docking bay):

YEAR	FIGHTERS
Y176	12 F-18 and 12 F-14 or 12 F-14p and 6 or 12 F-101A.
Y177-Y178	12 F-18B and 12 F-14A or 12 F-14Ap and 12 F-111 or 12 F-101B or a mix of 6 of each.
Y179	12 F-18B and 12 F-14A or F-14Ap and 6 or 12 F-111 or F-101C or a mix of 6 of each.
Y180	12 F-18B+ and 12 F-14A or F-14Ap and 6 or 12 F-111 or F-101C or a mix of 6 of each.
Y181-Y182	12 F-18B+ and 12 F-14A or F-14Ap and 12 A-

10 or 6 A-20F and 6 or 12 F-111 or F-101C or a mix of 6 of each.

Y183-Y189	12 F-18C and 12 F-14B or F-14Bp and 12 A-10 or 6 A-20F and 6 or 12 F-111 or F-101C or a mix of 6 of each.
Y190-Y194	12 F-18C and 12 F-14C or F-14Cp and 12 A-10 or 6 A-20F and 6 or 12 F-111 or F-101C or a mix of 6 of each.
Y195+	12 F-18C and 12 F-14C or F-14Cp or F-14D or F-14Dp and 12 A-10 or 6 A-20F and 6 or 12 F-111 or F-101C or a mix of 6 of each.

If using the conjectural Federation fast patrol ships, docking bay #4 will not be converted to operate a squadron of assault fighters and the starbase will never have more than two squadrons of size-1 fighters (this includes a squadron of size-1+ F-14s). Fighters will be:

YEAR	FIGHTERS
Y180-Y182	12 F-18B+ and 12 F-14A or F-14Ap.
Y183-Y189	12 F-18C and 12 F-14B or F-14Bp.
Y190-Y194	12 F-18C and 12 F-14C or F-14Cp.
Y195+	12 F-18C and 12 F-14C or F-14Cp or F-14D or F-14Dp.

The starbase has six shuttle bays, each of which may have a shuttle deck (R1.1G5). Augmentation modules may add additional bays. Hangar bay augmentation module [(R1.4) and (R1.70)] shuttle bays cannot be used to lay mines (M2.113). Transfers between the bays of the starbase, or between the starbase and the bays of any augmentation module, or between augmentation modules are not possible.

From Y181 on, the starbase has a seventh internal hangar in its #4 docking module (if not using the conjectural Federation fast patrol ships); this is a fighter only bay and cannot be used to lay mines (M2.113). This hangar is separate from the shuttle bay in this docking module and fighters launch and land through the docking module's doors but their operations do not count against the launch and land rates of the existing shuttle bay.

Refits: See listing under (R1.R-2) above.

A generic SSD and counter are in *Basic Set*. An SSD of the Federation starbase is in *Module R1*.

(R1.2-2) BATTLE STATION (BATS): Weapon #1 is photon torpedoes and Weapon #2 is one type-D drone rack and one ADD-30. Delete Weapon #3.

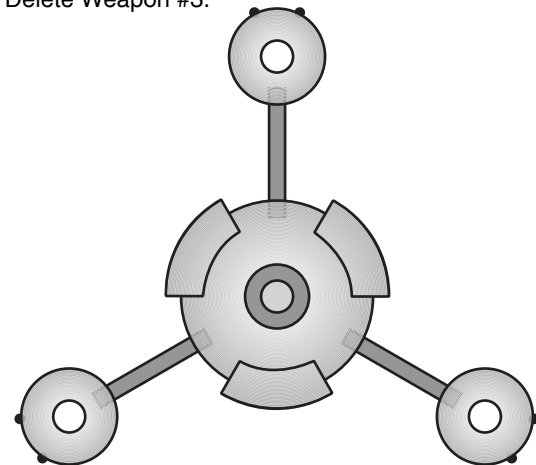

Scout: It can use all scout functions (G24.0). Special sensors are destroyed by "phaser" damage points.

Seeking weapons: The battle station can control a number of seeking weapons equal to double its sensor rating (F3.212). See also (F3.213). Limited aegis (D13.4) installed in Y170; full aegis (D13.0), in Y175; see (R1.R-2) above.

Carrier: If this base is equipped with hangar bay modules

[(R1.4) and/or (R1.70)], it is a true carrier; see (J4.75), (J4.93), (J11.13), and (J15.22). If equipped with heavy fighter hangar bay modules (R1.70), it cannot be equipped with PF tender modules (R1.16).

PF tender: If this base is equipped with a PF tender module or modules (R1.16) to operate conjectural Federation PFs or Interceptors, it is a true PF tender (K2.112) and cannot operate heavy fighters (J10.0) or be equipped with heavy fighter modules (R1.70).

Fighters if hangar bay modules (R1.4) are present:

YEAR	FIGHTERS
Y165-Y166	6 or 12 F-8.
Y167-Y170	6 or 12 F-4 or F-8.
Y171-Y172	6 or 12 F-8.
Y173-Y176	6 or 12 F-18.
Y177-Y179	6 or 12 F-18B.
Y180-Y182	6 or 12 F-18B+.
Y183+	6 or 12 F-18C.

Fighters if a heavy fighter hangar bay module (R1.70) is present:

YEAR	FIGHTERS
Y176	6 or 12 F-18 and 6 F-101A.
Y177-Y178	6 or 12 F-18B and 6 F-111 or F-101B.
Y179	6 or 12 F-18B and 6 F-111 or F-101C.
Y180-Y182	6 or 12 F-18B+ and 6 F-111 or F-101C.
Y183+	6 or 12 F-18C and 6 F-111 or F-101C.

The battle station has one shuttle bay, which may have a shuttle deck (R1.1G5). Augmentation modules may add additional bays. Hangar bay augmentation module [(R1.4) and (R1.70)] shuttle bays cannot be used to lay mines (M2.113). Transfers between the bay of the battle station and the bays of any augmentation module or between augmentation modules are not possible.

Refits: Special sensors are under Early Years restrictions (YG24.0) until Y134. Transporters increased from Range 4 to Range 5 in Y140. Tractors increased from Range 2 to Range 3 in Y140. Also see listing under (R1.R-2) above.

Generic SSD is in *Basic Set*; use the generic base station counter in *Basic Set*. An SSD of the Federation battle station and a Federation battle station counter are in *Module R1*.

(R1.3-2) BASE STATION (BS): Weapon #1 is a photon torpedo, Weapon #2 is deleted, Weapon #3 is a type-D drone rack, and Weapon #4 is an ADD-12.

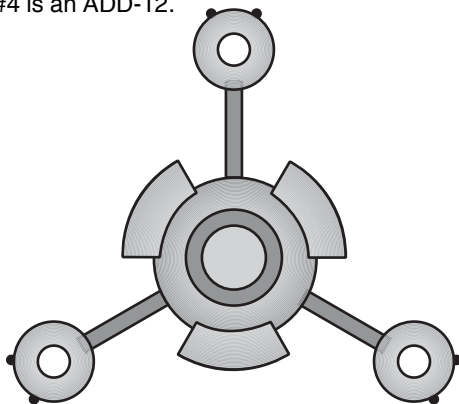

Scout: It can use all scout functions (G24.0). Special sensors are destroyed by "phaser" damage points.

Seeking weapons: The base station can control a number of seeking weapons equal to its sensor rating (F3.21). See also (F3.213). Limited aegis (D13.4) installed in Y170; full aegis (D13.0), in Y175; see (R1.R-2) above.

Carrier: If this base is equipped with hangar bay modules [(R1.4) and/or (R1.70)], it is a true carrier; see (J4.75), (J4.93), (J11.13), and (J15.22). If equipped with heavy fighter hangar bay

modules (R1.70), it cannot be equipped with PF tender modules (R1.16).

PF tender: If this base is equipped with a PF tender module or modules (R1.16) to operate conjectural Federation PFs or Interceptors, it is a true PF tender (K2.112) and cannot operate heavy fighters (J10.0) or be equipped with heavy fighter modules (R1.70).

Fighters if hangar bay modules (R1.4) are present:

YEAR	FIGHTERS
Y165-Y166	6 or 12 F-8.
Y167-Y170	6 or 12 F-4 or F-8.
Y171-Y172	6 or 12 F-8.
Y173-Y176	6 or 12 F-18.
Y177-Y179	6 or 12 F-18B.
Y180-Y182	6 or 12 F-18B+.
Y183+	6 or 12 F-18C.

Fighters if a heavy fighter hangar bay module (R1.70) is present:

YEAR	FIGHTERS
Y176	6 or 12 F-18 and 6 F-101A.
Y177-Y178	6 or 12 F-18B and 6 F-111 or F-101B.
Y179	6 or 12 F-18B and 6 F-111 or F-101C.
Y180-Y182	6 or 12 F-18B+ and 6 F-111 or F-101C.
Y183+	6 or 12 F-18C and 6 F-111 or F-101C.

The base station has one shuttle bay, which may have a shuttle deck (R1.1G5). Augmentation modules may add additional bays. Hangar bay augmentation module [(R1.4) and (R1.70)] shuttle bays cannot be used to lay mines (M2.113). Transfers between the bay of the base station and the bays of any augmentation module, or between augmentation modules are not possible.

Refits: Special sensors under are Early Years restrictions (YG24.0) until Y134. Transporters increased from Range 4 to Range 5 in Y140. Tractors increased from Range 2 to Range 3 in Y140. Also see listing under (R1.R-2) above.

Generic SSD is in *Basic Set*; use the generic base station counter in *Basic Set*. An SSD of the Federation base station is in *Module R1*.

(R1.4-2) HANGAR BAY MODULE (HBM):

Carrier: If a base is equipped with hangar bay modules, it is a true carrier; see (J4.75), (J4.93), (J11.13), and (J15.22).

Fighters below are per hangar bay module if hangar bay modules are present. Hangar bay modules are class-A augmentation modules and must be docked to a class-A docking station to be operational. See the ship description for the base for the number of class-A docking positions the base has.

YEAR	FIGHTERS
Y165-Y166	6 F-8.
Y167-Y170	6 F-4 or F-8.
Y171-Y172	6 F-8 or F-14† or F-14p†.
Y173-Y176	6 F-18 or F-14† or F-14p†.
Y177-Y179	6 F-18B or F-14A† or F-14Ap†.
Y180-Y182	6 F-18B+ or F-14A† or F-14Ap†.
Y183-Y189	6 F-18C or F-14B† or F-14Bp†.
Y190-Y194	6 F-18C or F-14C† or F-14Cp†.
Y195+	6 F-18C or F-14C† or F-14Cp† or F-14D† or F-14Dp†.

†Starbases (R1.1) or stellar fortresses (R1.89) only.

In emergencies, sometimes the National Guard will "militarize" a commercial platform (R1.29), system activity maintenance station (R1.30), or civilian base station (R1.35) when Star Fleet could not do so. In such cases, National Guard fighters will operate out of hangar bay modules. These would never be F-15s.



YEAR FIGHTERS

Y167-Y172	6 F-4.
Y173-Y174	6 F-4 or F-16† or F-16p.
Y175-Y178	6 F-4 or F-16† or F-16p or F-20.
Y179-Y182	6 F-16C† or F-16Cp or F-20.
Y183+	6 F-16C† or F-16Cp or F-20C.

†These were only available in limited numbers. While far more common than the F-15, they were also usually only deployed to fairly critical planets, but it was not unusual to find them on a less important world.

It is possible that local forces operating Cygnan fighters might have taken control of a station in an emergency. These would never be A-6s.

YEAR FIGHTERS

Y165-Y169	6 F-104A.
Y170-Y171	6 F-104A or F-104G.
Y172-Y174	6 F-104G or F-104J.
Y175-Y179	6 F-104J or F-104S.
Y180-Y183	6 F-104S.
Y184-Y188	F-104s out of service.
Y189-Y190	6 or 12 F-104S.
Y191+	There was no further deployment of Cygnan designed fighters, and such a base would use the normal National Guard fighters as given above from this year forward.

Note: Modules of this type were actually in service before fighters were developed. Prior to fighters being developed they were commonly used to add additional shuttles to a base depending on the base's mission, e.g., a prospecting platform might have additional prospecting shuttles or heavy transport shuttles in such a module. The shuttles can have been of any type of size-2 or size-1 shuttle.

This module has one shuttle bay. Mines cannot be laid from this module (M2.113). Transfers between this augmentation module and the bays of any other augmentation module or the bay or bays of the base to which it is attached are not possible.

SSD appears on base SSDs in *Basic Set* and in *Module R1*, and on base SSDs in other modules; there is no counter as the unit cannot function if it is not attached to a base. If in transit (being carried by a freighter or a tug) it is inactive; use a pod counter if a module in transit is dropped by a tug during a scenario.

(R1.7A-2) LARGE Q-SHIP (L-Q):

Refits: Transporters increased from Range 4 to Range 5 in Y140. Tractors increased from Range 2 to Range 3 in Y140.

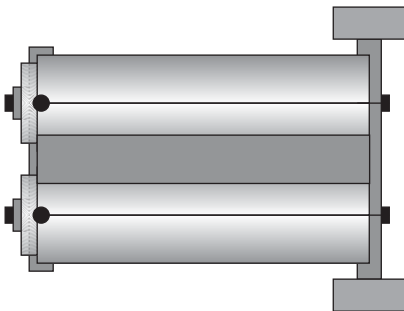

Maneuver: The large Q-ship can accelerate by no more than five movement points or double its current speed. It can disengage by acceleration.

A Federation L-Q SSD is in *Basic Set*; use a generic large freighter counter. A generic L-Q counter (labeled Q L) is in *Module R1*.

(R1.7B-2) SMALL Q-SHIP (S-Q):

Refits: Transporters increased from Range 4 to Range 5 in Y140. Tractors increased from Range 2 to Range 3 in Y140.

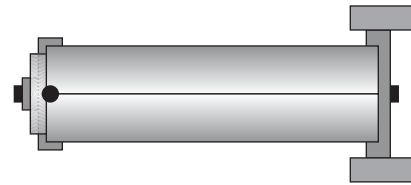

Maneuver: The small Q-ship can accelerate by no more than five movement points or double its current speed. It can disengage by acceleration.

A Federation S-Q SSD is in *Basic Set*; use a generic small freighter counter. A generic S-Q counter (labeled Q S) is in *Module R1*.

(R1.9-2) FREE TRADER (FT):

Free Traders in Federation space from Y125 will normally have a phaser-2 or a phaser-3 in the option mount. From Y140 it might mount an ADD-6 in the option mount rather than a phaser. A Free Trader in Federation space might mount a drone rack of type-A in the option mount from Y125, but this was relatively rare prior to about Y170 when it became more common with the availability of faster drones; type-B drone racks were common after Y174.



Landing: Can land on planets using the powered landing system (P2.434), and has the crash landing bonus (P2.4311).

Seeking weapons: The Free Trader can control a number of seeking weapons equal to its sensor rating (F3.21) if equipped with a drone rack; otherwise it can control a number of seeking weapons equal to half its sensor rating (F3.211).

Refits: Transporters increased from Range 4 to Range 5 in Y140. Tractors increased from Range 2 to Range 3 in Y140. Free Traders with type-A drone racks had one reload until Y175 when the drone rack was usually upgraded to type-B with two reloads.

A generic SSD and counter are in *Advanced Missions*.

(R1.10-2): FLEET REPAIR DOCK (FRD):

Weapon #1 will be phaser-1s, Weapon #2 will be phaser-3s, Weapon #3 will be ADD-12s prior to Y165 but type-G drone racks thereafter, Weapon #4 is deleted.

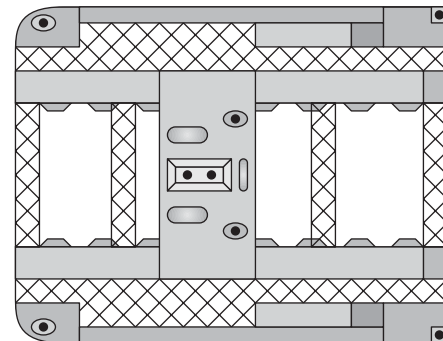

Seeking weapons: The fleet repair dock can control a number of seeking weapons equal to half its sensor rating (F3.211) until it is equipped with type-G drone racks. It can control a number of seeking weapons equal to its sensor rating thereafter (F3.21).

Carrier: If the fleet repair dock is equipped with hangar bay modules [(R1.4) and/or (R1.70)], it is a true carrier; see (J4.75),

(J4.93), (J11.13), and (J15.22). If equipped with a heavy fighter hangar bay module (R1.70), it cannot be equipped with a PF tender module (R1.16).

PF tender: If the fleet repair dock is equipped with a PF tender module (R1.16) to operate conjectural Federation PFs or In-terceptors, it is a true PF tender (K2.112) and cannot operate heavy fighters (J10.0) or be equipped with a heavy fighter module (R1.70).

Fighters if hangar bay modules (R1.4) are present:

YEAR	FIGHTERS
Y165-Y166	6 or 12 F-8.
Y167-Y170	6 or 12 F-4 or F-8.
Y171-Y172	6 or 12 F-8.
Y173-Y176	6 or 12 F-18.
Y177-Y179	6 or 12 F-18B.
Y180-Y182	6 or 12 F-18B+.
Y183+	6 or 12 F-18C.

Fighters if a heavy fighter hangar bay module (R1.70) is present:

YEAR	FIGHTERS
Y176	0 or 6 F-18 and 6 F-101A.
Y177-Y178	0 or 6 F-18B and 6 F-111 or F-101B.
Y179	0 or 6 F-18B and 6 F-111 or F-101C.
Y180-Y182	0 or 6 F-18B+ and 6 F-111 or F-101C.
Y183+	0 or 6 F-18C and 6 F-111 or F-101C.

The fleet repair dock has one shuttle bay. Augmentation modules may add additional bays. Hangar bay augmentation module [(R1.4) and (R1.70)] shuttle bays cannot be used to lay mines (M2.113). Transfers between the bay of the fleet repair dock and the bay of any augmentation module, or between augmentation modules are not possible.

Maneuver: Fleet repair docks can only move by sublight (Speed 1) unless towed by other ships; see (R1.10B).

A generic SSD and counter are in *Advanced Missions*.

(R1.13A-2) SMALL AUXILIARY CARRIER (AxCVL): Weapon-A is 2xphaser-1-360°s and Weapon-B is type-G drone racks.

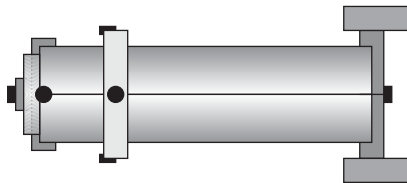

Seeking weapons: The small auxiliary carrier can control a number of seeking weapons equal to double its sensor rating (F3.212).

Carrier: The small auxiliary carrier is a true carrier; see (J4.75), (J4.93), (J11.13), and (J15.22).

Fighters (note: auxiliary carriers cannot operate heavy fighters, only auxiliary heavy fighter carriers can):

YEAR	FIGHTERS
Y165-Y166	12 F-8.
Y167-Y170	12 F-4 or F-8.
Y171-Y175	12 F-8.
Y176-Y178	12 F-8 or F-18.
Y179-Y182	12 F-18 or F-18B.
Y183-Y185	12 F-18B or F-18B+.
Y186+	12 F-18C.

This ship has one shuttle bay. This ship cannot operate photon-armed fighters.

Maneuver: The small auxiliary carrier can accelerate by no more than five movement points or double its current speed. It can disengage by acceleration.

A generic AxCVL SSD is in *Basic Set*. A Federation AxCVL SSD is in *Module J*. Use the generic AxCVL counter from *Module J*.

(R1.13B-2) LARGE AUXILIARY CARRIER (AxCVA): Weapon-A is 3xphaser-1-360°s, Weapon-B is type-G drone racks, Weapon-C is a phaser-1-RA.

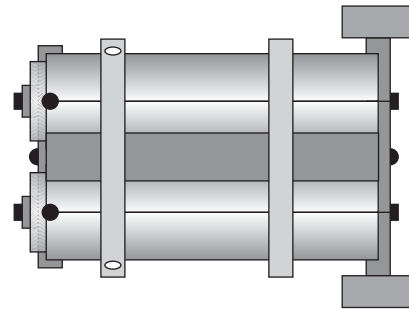

Seeking weapons: The large auxiliary carrier can control a number of seeking weapons equal to double its sensor rating (F3.212).

Carrier: The large auxiliary carrier is a true carrier; see (J4.75), (J4.93), (J11.13), and (J15.22).

Fighters (note: auxiliary carriers cannot operate heavy fighters, only auxiliary heavy fighter carriers can):

YEAR	FIGHTERS
Y165-Y166	24 F-8.
Y167-Y170	24 F-4 or F-8 or 12 F-4 and 12 F-8.
Y171-Y175	24 F-8.
Y176-Y178	24 F-8 or F-18 or 12 F-8 and 12 F-18.
Y179-Y182	24 F-18 or 24 F-18B or 12 F-18 and 12 F-18B.
Y183-Y185	24 F-18B or 24 F-18B+ or 12 F-18B and 12 F-18B+.
Y186+	24 F-18C.

This ship has two shuttle bays; transfers between the bays are not possible. This ship cannot operate photon-armed fighters.

Maneuver: The large auxiliary carrier can accelerate by no more than five movement points or double its current speed. It can disengage by acceleration.

There is currently no generic large auxiliary carrier SSD. A Federation AxCVA SSD is in *Module J*. Use the generic AxCVA counter from *Module J*.

(R1.14-2) GROUND-BASED DEFENSE STATIONS: The Federation uses the ground-based defense phaser-4 (GBDP), ground-based defense phaser-1 (GBD1), ground-based defense phaser-2 (GBD2), and ground-based defense photon torpedo (GBPT).

Generic SSDs for these ground bases are in *Advanced Missions*. Generic ground base counters are in *Advanced Missions* and *Module R1*.

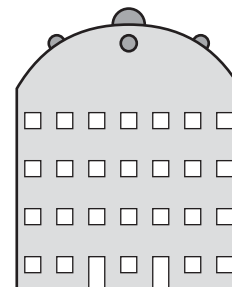

(R1.15-2) DEFENSE SATELLITES: The Federation uses the photon variant (2xphoton torpedoes + 2xphaser-2s + 2xphaser-3s) and phaser variant (2xphaser-2s + 2xphaser-2s + 2xphaser-3s). The Federation rarely used the drone variant (2xtype-B drone racks + 2xphaser-2s + 2xphaser-3s) prior to Y168, but used them more often from that year.

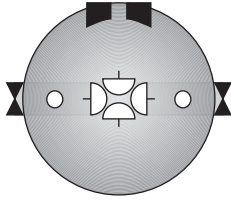

Generic SSDs for these defense satellites and generic defense satellite counters are in *Advanced Missions*.

(R1.16-2) PF DOCKING MODULE (PFM): Modules of this type are only used by the Federation if using the conjectural fast patrol ships or Interceptors.



PF tender: If a base is equipped with a PF tender module or modules (R1.16) to operate conjectural Federation PFs or Interceptors, it is a true PF tender (K2.112) and cannot operate heavy fighters (J10.0) or be equipped with heavy fighter modules (R1.70).

SSD is in *Module K*; there is no counter as the unit cannot function if it is not attached to a base. If in transit (being carried by a freighter or a tug) it is inactive; use a pod counter if the module is dropped by a tug during a scenario.

(R1.20-2) SMALL ARMED FREIGHTER (F-AS): The Federation used the phaser-armed version and, rarely before Y168, the drone-armed version. There is no photon-armed version.

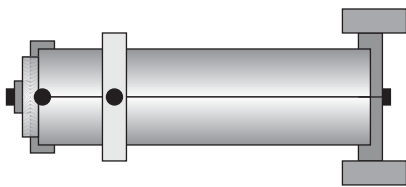

Seeking weapons: Small drone-armed freighters can control a number of seeking weapons equal to their sensor rating (F3.21); small phaser-armed freighters can control a number of seeking weapons equal to half their sensor rating (F3.211).

Refits: Transporters increased from Range 4 to Range 5 in Y140.

Maneuver: The small armed freighter can accelerate by no more than five movement points per turn. It can disengage by acceleration.

SSDs for these small armed freighters and generic F-AS counters are in *Advanced Missions*.

(R1.21-2) LARGE ARMED FREIGHTER (F-AL): The Federation used the phaser-armed version and, rarely before Y168, the drone-armed version.

Seeking weapons: Large drone-armed freighters can control a number of seeking weapons equal to their sensor rating

(F3.21); large phaser-armed freighters can control a number of seeking weapons equal to half their sensor rating (F3.211).

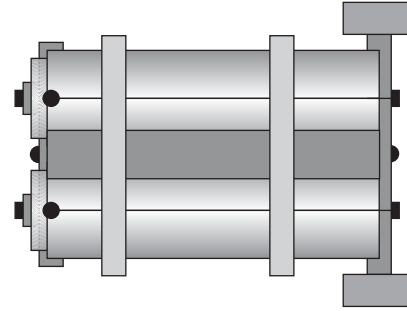

Refits: Transporters increased from Range 4 to Range 5 in Y140. Tractors increased from Range 2 to Range 3 in Y140.

Maneuver: The large armed freighter can accelerate by no more than five movement points per turn. It can disengage by acceleration.

SSDs for these large armed freighters and generic F-AL counters are in *Advanced Missions*.

(R1.22-2) MONITOR (MON): Weapon-A is 6xphoton torpedoes-FA; Weapon-B is 4xphaser-1-360°s, Weapon-C is type-E drone racks prior to Y167, type-G drone racks thereafter with no change in BPV.

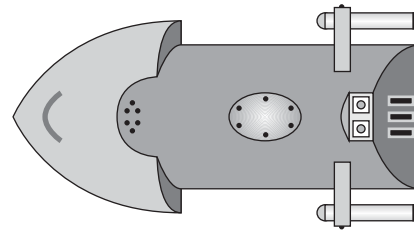

Seeking weapons: The monitor can control a number of seeking weapons equal to its sensor rating (F3.21).

Carrier: If the monitor is equipped with a fighter pallet (R1.22E) or a space control pallet (R1.22E), it is a true carrier; see (J4.75), (J4.93), (J11.13), and (J15.22).

PF tender: If the monitor is equipped with a PF pallet (R1.22E), it is a true PF tender (K2.111). A monitor equipped with a space control pallet that operates PFs cannot operate heavy fighters, but is a true PFT under (K2.113); note the Federation has space control pallets that operate heavy and size-1 fighters.

Fighters if using a fighter pallet:

YEAR	FIGHTERS
Y165-Y166	12 F-8.
Y167-Y170	12 F-4 or F-8.
Y171-Y175	12 F-8.
Y176-Y178	12 F-8 or F-18.
Y179-Y182	12 F-18 or F-18B.
Y183-Y185	12 F-18B or F-18B+.
Y186+	12 F-18C.

The monitor with the fighter pallet has two bays: the monitor's bay and the fighter pallet's bay. The fighter pallet has two launch tubes (J1.54). Mines cannot be laid from the fighter pallet's bay (M2.113). Transfers between the two bays are not possible.

Fighters if using a PF pallet and not using the conjectural Federation fast patrol ships:

YEAR	FIGHTERS
Y181+	6xA-20F or F-111 or F-101C.

The monitor with the PF pallet has two bays: the monitor's bay and the PF pallet's mech-links which count as a single separate bay, although all heavy fighters can launch and/or land individually without blocking the launching or landing of a heavy fighter on any other mech-link. Mines cannot be laid from the PF pallet's

bay (M2.113). Transfers between the two bays are not possible. Fighters if using a space control pallet but not using the conjectural Federation fast patrol ships:

YEAR	FIGHTERS
Y182	12 F-18 or F-18B and 6 A-20F or F-111 or F-101C.
Y183-Y185	12 F-18B or F-18B+ and 6 A-20F or F-111, or F-101C.
Y186+	12 F-18C and 6 A-20F or F-111, or F-101C.

The monitor with the space control pallet has three bays: the monitor's bay, the space control pallet's size-1 fighter bay, and the space control pallet's mech-links which count as a single separate bay, although all heavy fighters can launch and/or land individually without blocking the launching or landing of a heavy fighter on any other mech-link. Mines cannot be laid from the space control pallet's bays (M2.113). Transfers between the three bays are not possible. The space control pallet has two launch tubes (J1.54) in the bay for the F-18s.

Fighters if using a space control pallet but using the conjectural Federation fast patrol ships:

YEAR	FIGHTERS
Y182	12 F-18 or F-18B.
Y183-Y185	12 F-18B or F-18B+.
Y186+	12 F-18C.

The monitor with the space control pallet has two bays: the monitor's bay and the space control pallet's bay. The space control pallet has two launch tubes (J1.54). Mines cannot be laid from the space control pallet's bay (M2.113). Transfers between the two bays are not possible.

Fighters if using a space control pallet but not using the conjectural Federation fast patrol ships or heavy fighters [this pallet is created by converting the 12 repair boxes of the space control pallet to a shuttle bay and deleting the mech-links from the tractor beams (R1.22E)]:

YEAR	FIGHTERS
Y182	24 F-18 or F-18B or 12 F-18 and 12 F-18B.
Y183-Y185	24 F-18B or F-18B+ or 12 F-18B and 12 F-18B+.
Y186+	24 F-18C.

The monitor with the space control pallet has three bays: the monitor's bay and the two bays of the space control pallet. Each of the space control pallet's bays has two launch tubes (J1.54). Mines cannot be laid from the space control pallet's bays (M2.113). Transfers between the two bays of the space control pallet are possible; transfers between the bays of the space control pallet and the bay of the monitor are not possible.

Refits: Type-E drone racks (one reload) converted to type-G drone racks (two reloads) in Y168. The Y175 refit added a third reload to the type-G drone racks; one reload is always composed entirely of ADDs.

Maneuver: Monitors cannot disengage by acceleration or use emergency deceleration.

A generic monitor SSD and counter are in *Advanced Missions*; a Federation specific monitor SSD is in *Module R1*. SSDs for the pallets are found on the monitor pallets page of the *Advanced Missions* SSD book.

(R1.24-2) MOBILE BASE (MB): The Federation mobile base has phaser-1s.

Scout: It can use all scout functions (G24.0). Special sensors are destroyed by "phaser" damage points.

Seeking weapons: The mobile base can control a number of seeking weapons equal to its sensor rating (F3.21). See also (F3.213).

Carrier: If this base is equipped with hangar bay modules [(R1.4) and/or (R1.70)], it is a true carrier; see (J4.75), (J4.93), (J11.13), and (J15.22). If equipped with a heavy fighter hangar bay module (R1.70), it cannot be equipped with a PF tender

module (R1.16).

PF tender: If this base is equipped with a PF tender module (R1.16) to operate conjectural Federation PFs or Interceptors, it is a true PF tender (K2.112) and cannot operate heavy fighters (J10.0) or be equipped with a heavy fighter module (R1.70).

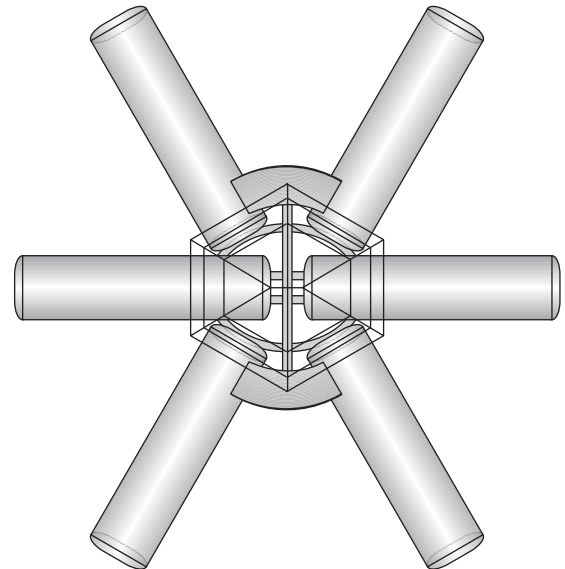

Fighters if hangar bay modules (R1.4) are present:

YEAR	FIGHTERS
Y165-Y166	6 or 12 F-8.
Y167-Y170	6 or 12 F-4 or F-8.
Y171-Y172	6 or 12 F-8.
Y173-Y176	6 or 12 F-18.
Y177-Y179	6 or 12 F-18B.
Y180-Y182	6 or 12 F-18B+.
Y183+	6 or 12 F-18C.

Fighters if a heavy fighter hangar bay module (R1.70) is present:

YEAR	FIGHTERS
Y176	0 or 6 F-18 and 6 F-101A.
Y177-Y178	0 or 6 F-18B and 6 F-111 or F-101B.
Y179	0 or 6 F-18B and 6 F-111 or F-101C.
Y180-Y182	0 or 6 F-18B+ and 6 F-111 or F-101C.
Y183+	0 or 6 F-18C and 6 F-111 or F-101C.

The mobile base has two shuttle bays, which may have shuttle decks (R1.1G5). Augmentation modules may add additional bays. Hangar bay augmentation module [(R1.4) and (R1.70)] shuttle bays cannot be used to lay mines (M2.113). Transfers between the bays of the mobile base, or between the mobile base's bays and the bays of any augmentation module, or between augmentation modules are not possible.

A mobile base SSD with phaser-1s and a generic MB counter are in *Module R1*.

(R1.27A-2) SMALL AUXILIARY PF TENDER (AxPFS): This ship is conjectural and only used if using the Federation conjectural fast patrol ships. Weapon #1 is phaser-1-360°, Weapon #2 is type-G drone racks.

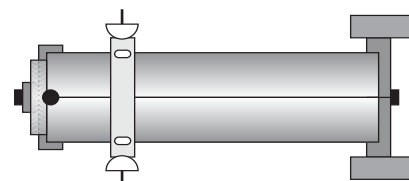

Scout: It can use all scout functions (G24.0). Special sen-

sors are destroyed by “torpedo” damage points. See (G24.35) when purchasing this unit as part of a battle force.

Seeking weapons: The small auxiliary PF tender can control a number of seeking weapons equal to double its sensor rating (F3.212). See also (F3.213).

PF tender: The small auxiliary PF tender is a true PF tender (K2.111).

Maneuver: The small auxiliary PF tender can accelerate by no more than five movement points or double its current speed. It can disengage by acceleration.

A generic AxPFS SSD and counter are in *Module K*; a Federation specific AxPFS SSD is in *Module R1*.

(R1.27B-2) LARGE AUXILIARY PF TENDER (AxPFL): This ship is conjectural and only used if using the Federation conjectural fast patrol ships. Weapon #1 is 3xphaser-1-360°s, Weapon #2 is type-G drone racks.

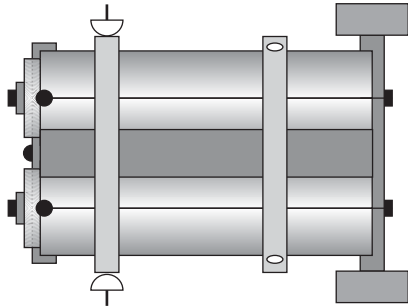

Scout: It can use all scout functions (G24.0). Special sensors are destroyed by “torpedo” damage points. See (G24.35) when purchasing this unit as part of a battle force.

Seeking weapons: The large auxiliary PF tender can control a number of seeking weapons equal to double its sensor rating (F3.212). See also (F3.213).

PF tender: The large auxiliary PF tender is a true PF tender (K2.111).

Maneuver: The large auxiliary PF tender can accelerate by no more than five movement points or double its current speed. It can disengage by acceleration.

A generic AxPFL SSD and counter are in *Module K*; a Federation specific AxPFL SSD is in *Module R1*.

(R1.28A-2) SMALL GROUND FIGHTER BASE (FGB-S): Bases of this type were operated by both the Federation National Guard and by Star Fleet.

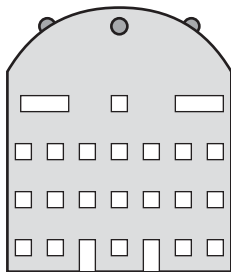

Seeking weapons: Federation small fighter ground bases can control a number of seeking weapons equal to their sensor rating (R1.28A).

Carrier: This base is a true carrier; see (J4.93), (J11.13), and (J15.22). Rule (J4.75) is modified by (R1.28A).

Fighters on bases operated by the National Guard [note: fighter ground bases cannot operate heavy fighters, only heavy fighter ground bases (R1.48) can]:

YEAR	FIGHTERS
Y167-Y171	6 F-4.
Y172	6 F-4 or F-15* or F-15p§.
Y173-Y174	6 F-4 or F-16† or F-16p or F-15* or F-15p§.
Y175-Y178	6 F-4 or F-16† or F-16p or F-20 or F-15* or F-15p§.
Y179-Y182	6 F-16C† or F-16Cp or F-20 or F-15* or F-15p§.
Y183-Y184	6 F-16C† or F-16Cp or F-20C or F-15C* or F-15Cp§.
Y185+	6 F-16C† or F-16Cp or F-20C or F-15C* or F-15Cp§ or F-15D* or F-15Dp§.

*These were very rare and only found on really important planets, as in “If we lose this planet, we have lost the war” important.

†These were only available in limited numbers. While far more common than the F-15, they were also usually only deployed to fairly critical planets, but it was not unusual to find them on a less important world.

§These variants of the F-15 were more widely deployed and might be found on any “important” rather than “critical” world, and might be supplementing the phaser-G versions of the F-15. A really important planet might have a squadron or two of these in addition to a squadron of phaser-G F-15s.

Almost unique among the National Guards, the Cygnan National Guard deployed its own fighter types. There were some sales of these fighters to other planets, but these were uncommon. Still any of these fighter types might be found on isolated colony worlds:

YEAR	FIGHTERS
Y165-Y167	6 F-104A.
Y168-Y169	6 F-104A or A-6*.
Y170	6 F-104A or F-104G or A-6*.
Y171	6 F-104A or F-104G or A-6* or A-6B*.
Y172-Y174	6 F-104G or F-104J or A-6B*.
Y175-Y177	6 F-104J or F-104S or A-6B*.
Y178-Y179	6 F-104J or F-104S or A-6B* or A-6D*.
Y180-Y183	6 F-104S or A-6D* or A-6F*.
Y184-Y188	F-104s and A-6s out of service.
Y189-Y190	6 F-104S or A-6F*.
Y191+	There was no further deployment of Cygnan designed fighters, and such a base would use the normal National Guard fighters as given above from this year forward.

*Fighters of this type were very rare; only one base on a given planet would have them.

Fighters on bases operated by Star Fleet [note: fighter ground bases cannot operate heavy fighters, only heavy fighter ground bases (R1.48) can]:

YEAR	FIGHTERS
Y165-Y166	6 F-8.
Y167-Y170	6 F-4 or 6 F-8.
Y170-Y175	6 F-8.
Y176-Y178	6 F-8 or F-18.
Y179-Y182	6 F-18 or F-18B.
Y183-Y185	6 F-18B or F-18B+.
Y186+	6 F-18C.

NOTE: Star Fleet almost never operated F-14s, not even F-14ps, from ground bases. Further, fighter ground bases were generally operated by the Federation Marines who were part of Star Fleet.

The bay is “outdoors” and has no restrictions on the number of shuttles that can launch and land at any one time, is immune to chain reactions (D12.0), and (of course) cannot lay T-bombs (R1.28A).

A generic FGB-S SSD is in *Module R1*; generic ground base counters are in *Advanced Missions* and *Module R1*.

(R1.28B-2) MEDIUM GROUND FIGHTER BASE (FGB-M): Bases of this type were operated by both the Federation National Guard and by Star Fleet.

Seeking weapons: Federation medium fighter ground bases can control a number of seeking weapons equal to their sensor rating (R1.28B).

Carrier: This base is a true carrier; see (J4.93), (J11.13), and (J15.22). Rule (J4.75) is modified by (R1.28B).

Fighters on bases operated by the National Guard [note: fighter ground bases cannot operate heavy fighters, only heavy fighter ground bases (R1.48) can]:

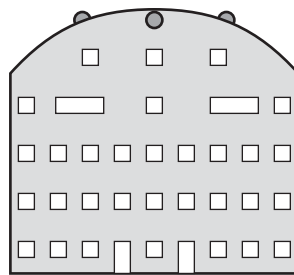

YEAR	FIGHTERS
Y167-Y171	12 F-4.
Y172	12 F-4 or F-15* or F-15p§.
Y173-Y174	12 F-4 or F-16† or F-16p or F-15* or F-15p§.
Y175-Y178	12 F-4 or F-16† or F-16p or F-20 or F-15* or F-15p§.
Y179-Y182	12 F-16C† or F-16Cp or F-20 or F-15* or F-15p§.
Y183-Y184	12 F-16C† or F-16Cp or F-20C or F-15C* or F-15Cp§.
Y185+	12 F-16C† or F-16Cp or F-20C or F-15C* or F-15Cp§ or F-15D* or F-15Dp§.

*These were very rare and only found on really important planets, as in "If we lose this planet, we have lost the war" important.

†These were only available in limited numbers. While far more common than the F-15, they were also usually only deployed to fairly critical planets, but it was not unusual to find them on a less important world.

§These variants of the F-15 were more widely deployed and might be found on any "important" rather than "critical" world, and might be supplementing the phaser-G versions of the F-15. A really important planet might have a squadron or two of these in addition to a squadron of phaser-G F-15s.

Almost unique among the National Guards, the Cygnan National Guard deployed its own fighter types. There were some sales of these fighters to other planets, but these were uncommon. Still any of these fighter types might be found on isolated colony worlds:

YEAR	FIGHTERS
Y165-Y167	12 F-104A.
Y168-Y169	12 F-104A or 6 F-104A and 6 A-6*.
Y170	12 F-104A or F-104G or 6 F-104A and 6 A-6* or 6 F-104G and 6 A-6*.
Y171	12 F-104A or 12 F-104G or 6 F-104A and 6 A-6* or 6 F-104A and 6 A-6B* or 6 F-104G and 6 A-6* or 6 F-104G and 6 A-6B*.
Y172-Y174	12 F-104G or F-104J or 6 F-104G and 6 A-6B* or 6 F-104J and 6 A-6B*.
Y175-Y177	12 F-104J or F-104S or 6 F-104J and 6 A-6B* or 6 F-104S and 6 A-6B*.
Y178-Y179	12 F-104J or F-104S or 6 F-104J and 6 A-6B* or 6 F-104S and 6 A-6B* or 6 F-104J and 6 A-6D* or 6 F-104S and 6 A-6D*.
Y180-Y183	12 F-104S or 6 F-104S and 6 A-6D* or 6 F-104S and 6 A-6F*.
Y184-Y188	F-104s and A-6s out of service.
Y189-Y190	12 F-104S or 6 F-104S and 6A-6F*.
Y191+	There was no further deployment of Cygnan designed fighters, and such a base would use the normal National Guard fighters as given above from this year forward.

*Fighters of this type were very rare; only one base on a given planet would have a half squadron of them.

Fighters on bases operated by Star Fleet [note: fighter ground bases cannot operate heavy fighters, only heavy fighter ground bases (R1.48) can]:

YEAR	FIGHTERS
Y165-Y166	12 F-8.
Y167-Y170	12 F-4 or F-8.
Y171-Y175	12 F-8.
Y176-Y178	12 F-8 or F-18.
Y179-Y182	12 F-18 or F-18B.
Y183-Y185	12 F-18B or F-18B+.
Y186+	12 F-18C.

NOTE: Star Fleet almost never operated F-14s, not even F-14ps, from ground bases. Further, fighter ground bases were generally operated by the Federation Marines who were part of Star Fleet.

The bay is "outdoors" and has no restrictions on the number of shuttles that can launch and land at any one time, is immune to chain reactions (D12.0), and (of course) cannot lay T-bombs (R1.28A).

A generic FGB-M SSD is in *Module R1*; generic ground base counters are in *Advanced Missions* and *Module R1*.

(R1.28C) GROUND MISSILE BASE (GMB): The Federation only rarely deployed bases of this type prior to Y168. It was more common from Y168 on.

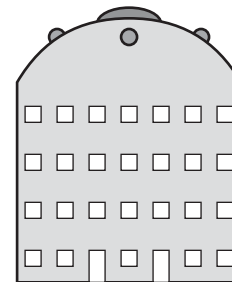

Seeking weapons: The ground missile base can control a number of seeking weapons equal to its sensor rating (F3.21).

Bombardment: This base has two hundred spaces of spare drones stored in its cargo boxes but is not a "bombardment" unit.

Refits: Bases of this type originally had type-A drone racks (one reload) which were upgraded to type-B (two reloads) in Y175.

A generic GMB SSD is in *Module R1*; generic ground base counters are in *Advanced Missions* and *Module R1*.

(R1.28C2) GROUND MISSILE DEFENSE BASE (GME): The Federation deployed bases of this type, usually in tandem with GMBs, beginning in Y168.

Seeking weapons: The ground missile defense base can control a number of seeking weapons equal to its sensor rating (F3.21).

Bombardment: This base has two hundred spaces of spare type-VI drones stored in its cargo boxes but is not a "bombardment" unit.

Refits: Bases of this type originally had type-E drone racks (one reload) until the Y175 refit added a second reload.

A generic GME SSD is in *Module R1*; generic ground base counters are in *Advanced Missions* and *Module R1*.

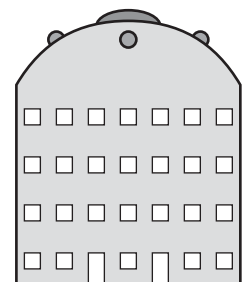

(R1.28G-2) SMALL MILITARY GARRISON (GMG): The Federation version replaces the phaser-2 with a phaser-1.

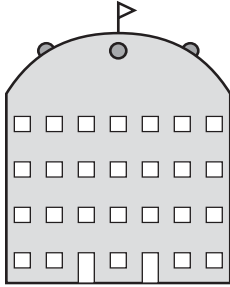

Refits: Transporters increased from Range 4 to Range 5 in Y140.

A generic GMG SSD is in *Module R1*; generic ground base counters are in *Advanced Missions* and *Module R1*.

(R1.28J-2) SMALL PF GROUND BASE (GPF): This base is conjectural and only used if using the Federation conjectural fast patrol ships. The note about changing the mech-links to use heavy fighters has been superseded by the publication of heavy fighter ground bases (R1.48).

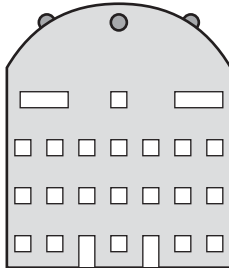

Scout: It can use all scout functions (G24.0). Special sensors are destroyed as any other system on the base in accordance with (R1.14A2).

Seeking weapons: The small PF ground base can control a number of seeking weapons equal to half its sensor rating (F3.211). See also (F3.213).

PF tender: The small PF ground base is a true PF tender (K2.112). See (R1.28J) for PF supplies.

A generic GPF SSD and generic GPF counter are in *Module K*; generic ground base counters are in *Advanced Missions* and *Module R1*.

(R1.28K-2) PLANETARY CONTROL BASE (GPC): This base is conjectural and only used if using the Federation conjectural fast patrol ships.

Scout: It can use all scout functions (G24.0). Special sensors are destroyed as any other system on the base in accordance with (R1.14A2).

Seeking weapons: The planetary control base can control a number of seeking weapons equal to its sensor rating (R1.28A). See also (F3.213).

Carrier: The planetary control base is a true carrier; see (J4.75), (J4.93), (J11.13), and (J15.22).

PF tender: The planetary control base is a true PF tender (K2.112) and cannot operate heavy fighters (J10.0). See (R1.28K) for PF and fighter supplies.

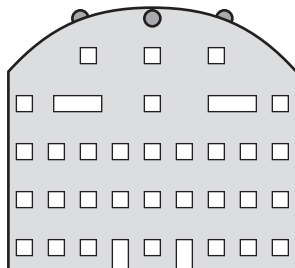

If the base is being operated by the Federation National Guard, the fighters would be:

YEAR	FIGHTERS
Y182	12 F-16C† or F-16Cp or F-20 or F-15* or F-15p§.
Y183-Y184	12 F-16C† or F-16Cp or F-20C or F-15C* or F-15Cp§.
Y185+	12 F-16C† or F-16Cp or F-20C or F-15C* or F-15Cp§ or F-15D* or F-15Dp§.

*These were very rare and only found on really important planets, as in "If we lose this planet, we have lost the war" important.

†These were only available in limited numbers. While far more common than the F-15, they were also usually only deployed to fairly critical planets, but it was not unusual to find them on a less important world.

§These variants of the F-15 were more widely deployed and might be found on any "important" rather than "critical" world, and might be supplementing the phaser-G versions of the F-15. A really important planet might have a squadron or two of these in addition to a squadron of phaser-G F-15s.

If the base is being operated by the Cygnan National Guard, the fighters would be:

YEAR	FIGHTERS
Y182-Y183	12 F-104S or 6 F-104S and 6 A-6D* or 6 F-104S and 6 A-6F*.
Y184-Y188	F-104s and A-6s out of service.
Y189-Y190	12 F-104S or 6 F-104S and 6 A-6F*.
Y191+	There was no further deployment of Cygnan designed fighters, and such a base would use the normal National Guard fighters as given above from this year forward.

* Fighters of this type were very rare; only one base on a given planet would have a half squadron of them.

If the base is being operated by Star Fleet, the fighters would be:

YEAR	FIGHTERS
Y182	12 F-18 or F-18B.
Y183-Y185	12 F-18B or F-18B+.
Y186+	12 F-18C.

NOTE: Star Fleet almost never operated F-14s, not even F-14ps, from ground bases. Further, fighter ground bases were generally operated by the Federation Marines who were part of Star Fleet.

The bay is "outdoors" and has no restrictions on the number of shuttles that can launch and land at any one time, is immune to chain reactions (D12.0), and (of course) cannot lay T-bombs (R1.28A).

A generic GPC SSD is in *Module K*; generic ground base counters are in *Advanced Missions* and *Module R1*.

(R1.28K1) FEDERATION PLANETARY CONTROL BASE (GFC): The Federation did not deploy fast patrol ships and used this base type historically.

Scout: It can use all scout functions (G24.0). Special sensors are destroyed as any other system on the base in accordance with (R1.14A2).

Seeking weapons: The Federation planetary control base can control a number of seeking weapons equal to its sensor rating (R1.28A). See also (F3.213).

Carrier: The Federation planetary control base is a true carrier; see (J4.75), (J4.93), (J11.13), and (J15.22). See (R1.28K1) for additional supplies. This base does not operate heavy fighters; see

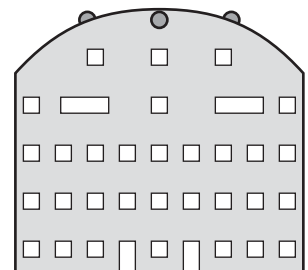

(R1.48C).

If the base is operated by the National Guard, the fighters would be:

YEAR	FIGHTERS
Y182	12 F-16C† or F-16Cp or F-20 and 12 F-15* or F-15p§.
Y183-Y184	12 F-16C† or F-16Cp or F-20C and 12 F-15C* or F-15Cp§.
Y185+	12 F-16C† or F-16Cp or F-20C and 12 F-15C* or F-15Cp§ or F-15D* or F-15Dp§.

*These were very rare and only found on really important planets, as in "If we lose this planet, we have lost the war" important.

†These were only available in limited numbers. While far more common than the F-15, they were also usually only deployed to fairly critical planets, but it was not unusual to find them on a less important world.

§These variants of the F-15 were more widely deployed and might be found on any "important" rather than "critical" world, and might be supplementing the phaser-G versions of the F-15. A really important planet might have a squadron or two of these in addition to a squadron of phaser-G F-15s.

Almost unique among the National Guards, the Cygnan National Guard deployed its own fighter types. There were some sales of these fighters to other planets, but these were uncommon. Still any of these fighter types might be found on isolated colony worlds:

YEAR	FIGHTERS
Y182-Y183	24 F-104S or 18 F-104S and 6 A-6D* or 18 F-104S and 6 A-6F*.
Y184-Y188	F-104s and A-6s out of service.
Y189-Y190	24 F-104S or 18 F-104S and 6 A-6F*.
Y191+	There was no further deployment of Cygnan designed fighters, and such a base would use the normal National Guard fighters as given above from this year forward.

If the base is being operated by Star Fleet, the fighters would be:

YEAR	FIGHTERS
Y182	24 F-18 or F-18B or 12 F-18 and 12 F-14A or F-14Ap or 12 F-18B and 12 F-14A or F-14Ap.
Y183-Y185	24 F-18B or F-18B+ or 12 F-18B and 12 F-14B or F-14Bp or 12 F-18B+ and 12 F-14B or F-14Bp.
Y186-Y189	24 F-18C or 12 F-18C and 12 F-14B or 12 F-18C and 12 F-14Bp.
Y190-Y194	24 F-18C or 12 F-18C and 12 F-14C or 12 F-18C and 12 F-14Cp.
Y195+	24 F-18C or 12 F-18C and 12 F-14C or 12 F-18C and 12 F-14Cp or 12 F-18C and 12 F-14D or 12 F-18C and 12 F-14Dp.

NOTE: Star Fleet almost never operated F-14s, not even F-14ps, from ground bases, but Federation planetary control bases were the exception as these were only found on very important worlds to start with. Even so it would be rare to find the phaser-G variants at such a base. Further, Federation planetary control bases were generally operated by the Federation Marines who were part of Star Fleet.

The bay is "outdoors" and has no restrictions on the number of shuttles that can launch and land at any one time, is immune to chain reactions (D12.0), and (of course) cannot lay T-bombs (R1.28A).

A Federation GFC SSD is in *Module K*; generic ground base counters are in *Advanced Missions* and *Module R1*.

(R1.29-2) COMMERCIAL PLATFORM (CPL):

Seeking weapons: The commercial platform can control a number of seeking weapons equal to half its sensor rating (F3.211).

Carrier: If the commercial platform is equipped with hangar bay modules [(R1.4) and/or (R1.70)], it is a true carrier; see (J4.75), (J4.93), (J11.13), and (J15.22). If equipped with a heavy fighter hangar bay module (R1.70), it cannot be equipped with a PF tender module (R1.16).

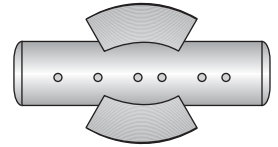

PF tender: If the commercial platform is equipped with a PF tender module (R1.16) to operate conjectural Federation PFs or Interceptors, it is a true PF tender (K2.112) and cannot operate heavy fighters (J10.0) or be equipped with a heavy fighter module (R1.70).

Fighters if hangar bay modules (R1.4) are present:

YEAR	FIGHTERS
Y165-Y166	6 or 12 F-8.
Y167-Y170	6 or 12 F-4 or F-8.
Y171-Y176	6 or 12 F-18.
Y177-Y179	6 or 12 F-18B.
Y180-Y182	6 or 12 F-18B+.
Y183+	6 or 12 F-18C.

Fighters if a heavy fighter hangar bay module (R1.70) is present:

YEAR	FIGHTERS
Y176	0 or 6 F-18 and 6 F-101A.
Y177-Y178	0 or 6 F-18B and 6 F-111 or F-101B.
Y179	0 or 6 F-18B and 6 F-111 or F-101C.
Y180-Y182	0 or 6 F-18B+ and 6 F-111 or F-101C.
Y183+	0 or 6 F-18C and 6 F-111 or F-101C.

In emergencies, sometimes the National Guard will "militarize" a station of this type pending the arrival of Star Fleet. In such cases, National Guard fighters will be based on the platform. These would never be F-15s.

YEAR	FIGHTERS
Y167-Y172	6 or 12 F-4.
Y173-Y174	6 or 12 F-4 or F-16† or F-16p.
Y175-Y178	6 or 12 F-4 or F-16† or F-16p or F-20.
Y179-Y182	6 or 12 F-16C† or F-16Cp or F-20.
Y183+	6 or 12 F-16C† or F-16Cp or F-20C.

†These were only available in limited numbers. While far more common than the F-15, they were also usually only deployed to fairly critical planets, but it was not unusual to find them on a less important world.

It is possible that local forces operating Cygnan fighters might have taken control of such a station in an emergency. These would never be A-6s.

YEAR	FIGHTERS
Y165-Y169	6 or 12 F-104A.
Y170-171	6 or 12 F-104A or F-104G.
Y172-Y174	6 or 12 F-104G or F-104J.
Y175-Y179	6 or 12 F-104J or F-104S.
Y180-Y183	6 or 12 F-104S.
Y184-Y188	F-104s out of service.
Y189-Y190	6 or 12 F-104S.
Y191+	There was no further deployment of Cygnan designed fighters, and such a base would use the normal National Guard fighters as given above from this year forward.

The commercial platform has one shuttle bay, which may have a shuttle deck (R1.1G5). Augmentation modules may add additional bays. Hangar bay augmentation module [(R1.4) and (R1.70)] shuttle bays cannot be used to lay mines (M2.113). Transfers between the bays of the commercial platform, or between the commercial platform's bay and the bays of any augmentation

module, or between augmentation modules are not possible.
 Refits: Transporters increased from Range 4 to Range 5 in Y140. Tractors increased from Range 2 to Range 3 in Y140.
 A generic SAMS SSD and counter are in *Module R1*.

(R1.30-2) SYSTEM ACTIVITY MAINTENANCE STATION (SAMS): WPN is 2xphaser-1-360°s prior to Y160, and 2xtype-G drone racks thereafter. Phaser-X is always phaser-1-360°.

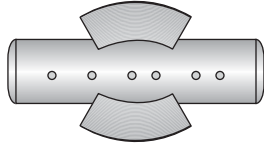

Scout: It can use all scout functions (G24.0). Special sensors are destroyed on “phaser” damage points.
Seeking weapons: The system activity maintenance station can control a number of seeking weapons equal to its sensor rating (F3.21) if equipped with drone racks, otherwise it can control a number of seeking weapons equal to half its sensor rating (F3.211). See also (F3.213).
Carrier: If the system activity maintenance station is equipped with hangar bay modules [(R1.4) and/or (R1.70)], it is a true carrier; see (J4.75), (J4.93), (J11.13), and (J15.22). If equipped with a heavy fighter hangar bay module (R1.70), it cannot be equipped with a PF tender module (R1.16).

PF tender: If the system activity maintenance station is equipped with a PF tender module (R1.16) to operate conjectural Federation PFs or Interceptors, it is a true PF tender (K2.112) and cannot operate heavy fighters (J10.0) or be equipped with a heavy fighter module (R1.70).

Fighters if hangar bay modules (R1.4) are present:

YEAR	FIGHTERS
Y165-Y166	6 or 12 F-8.
Y167-Y170	6 or 12 F-4 or F-8.
Y171-Y176	6 or 12 F-18.
Y177-Y179	6 or 12 F-18B.
Y180-Y182	6 or 12 F-18B+.
Y183+	6 or 12 F-18C.

Fighters if a heavy fighter hangar bay module (R1.70) is present:

YEAR	FIGHTERS
Y176	0 or 6 F-18 and 6 F-101A.
Y177-Y178	0 or 6 F-18B and 6 F-111 or F-101B.
Y179	0 or 6 F-18B and 6 F-111 or F-101C.
Y180-Y182	0 or 6 F-18B+ and 6 F-111 or F-101C.
Y183+	0 or 6 F-18C and 6 F-111 or F-101C.

In emergencies, sometimes the National Guard will “militarize” a station of this type pending the arrival of Star Fleet. In such cases, National Guard fighters will be based on the platform. These would never be F-15s.

YEAR	FIGHTERS
Y167-Y172	6 or 12 F-4.
Y173-Y174	6 or 12 F-4 or F-16† or F-16p.
Y175-Y178	6 or 12 F-4 or F-16† or F-16p or F-20.
Y179-Y182	6 or 12 F-16C† or F-16Cp or F-20.
Y183+	6 or 12 F-16C† or F-16Cp or F-20C.

†These were only available in limited numbers. While far more common than the F-15, they were also usually only deployed to fairly critical planets, but it was not unusual to find them on a less important world.

It is possible that local forces operating Cygnan fighters might have taken control of such a station in an emergency. These would never be A-6s.

YEAR	FIGHTERS
Y165-Y169	6 or 12 F-104A.
Y170-171	6 or 12 F-104A or F-104G.
Y172-Y174	6 or 12 F-104G or F-104J.
Y175-Y179	6 or 12 F-104J or F-104S.
Y180-Y183	6 or 12 F-104S.
Y184-Y188	F-104s out of service.
Y189-Y190	6 or 12 F-104S.
Y191+	There was no further deployment of Cygnan designed fighters, and such a base would use the normal National Guard fighters as given above from this year forward.

The system activity maintenance station has one shuttle bay, which may have a shuttle deck (R1.1G5). Augmentation modules may add additional bays. Hangar bay augmentation module [(R1.4) and (R1.70)] shuttle bays cannot be used to lay mines (M2.113). Transfers between the bays of the system activity maintenance station, or between the system activity maintenance station’s bay and the bays of any augmentation module, or between augmentation modules are not possible.

Refits: Special sensors are under Early Years restrictions (YG24.0) until Y134. Transporters increased from Range 4 to Range 5 in Y140. Tractors increased from Range 2 to Range 3 in Y140. The Y175 refit added a third reload to the type-G drone racks; one reload is always composed entirely of ADDs.

A generic SAMS SSD and counter are in *Module R1*.

(R1.31-2) AUXILIARY SPACE CONTROL SHIP (AxSCS): This ship is conjectural and only used if using the Federation conjectural fast patrol ships. Weapon #1 is 3xphaser-1-360°s and Weapon #2 is type-G drone racks.

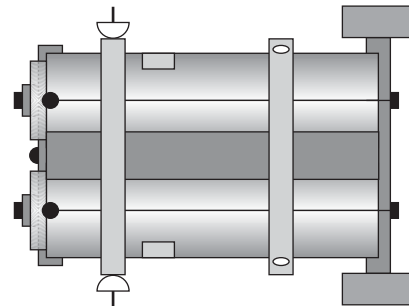

Scout: It can use all scout functions (G24.0). Special sensors are destroyed on “torpedo” damage points. See (G24.35) when purchasing this unit as part of a battle force.

Seeking weapons: The auxiliary space control ship can control a number of seeking weapons equal to double its sensor rating (F3.212). See also (F3.213).

Carrier: The auxiliary space control ship is a true carrier; see (J4.75), (J4.93), (J11.13), and (J15.22).

PF tender: The auxiliary space control ship is a true PF tender (K2.111) and cannot operate heavy fighters (J10.0). See (R1.31) for PF and fighter supplies.

Fighters:

YEAR	FIGHTERS
Y182	12 F-18 or F-18B.
Y183-Y185	12 F-18B or F-18B+.
Y186+	12 F-18C.

This ship has two shuttle bays; transfers between the bays are not possible. This ship cannot operate photon-armed fighters.

Maneuver: The auxiliary space control ship can accelerate by no more than five movement points or double its current speed. It can disengage by acceleration.

A generic AxSCS SSD and counter are in *Module K*.

(R1.35-2) CIVILIAN BASE STATION (BSC): Weapon #1 is a type-A drone rack, Weapon #2, and the heavy phasers (PH-) are all phaser-1s, Weapon #3 is a type-A drone rack, and Weapon #4 is an ADD-12.

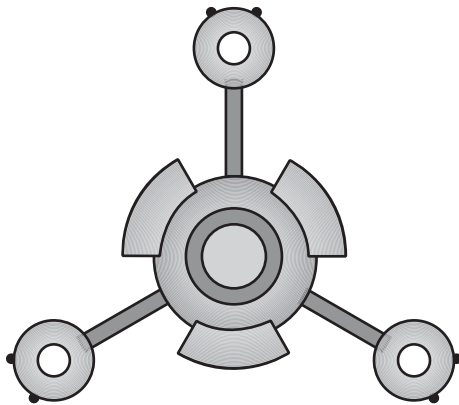

Scout: It can use all scout functions (G24.0). Special sensors are destroyed by “phaser” damage points.

Seeking weapons: The civilian base station can control a number of seeking weapons equal to its sensor rating (F3.21). See also (F3.213). Limited aegis (D13.4) was installed in Y175; see (R1.R-2) above.

Carrier: If the civilian base station is equipped with hangar bay modules [(R1.4) and/or (R1.70)], it is a true carrier; see (J4.75), (J4.93), (J11.13), and (J15.22). If equipped with heavy fighter hangar bay modules (R1.70), it cannot be equipped with PF tender modules (R1.16).

PF tender: If the civilian base station is equipped with a PF tender module or modules (R1.16) to operate conjectural Federation PFs or Interceptors, it is a true PF tender (K2.112) and cannot operate heavy fighters (J10.0) or be equipped with heavy fighter modules (R1.70).

Fighters if hangar bay modules (R1.4) are present:

YEAR	FIGHTERS
Y165-Y166	6 or 12 F-8.
Y167-Y170	6 or 12 F-4 or F-8.
Y171-Y176	6 or 12 F-18.
Y177-Y179	6 or 12 F-18B.
Y180-Y182	6 or 12 F-18B+.
Y183+	6 or 12 F-18C.

Fighters if a heavy fighter hangar bay module (R1.70) is present:

YEAR	FIGHTERS
Y176	6 or 12 F-18 and 6 F-101A.
Y177-Y178	6 or 12 F-18B and 6 F-111 or F-101B.
Y179	6 or 12 F-18B and 6 F-111 or F-101C.
Y180-Y182	6 or 12 F-18B+ and 6 F-111 or F-101C.
Y183+	6 or 12 F-18C and 6 F-111 or F-101C.

In emergencies, sometimes the National Guard will “militarize” a station of this type pending the arrival of Star Fleet. In such cases, National Guard fighters will be based on the station. These would never be F-15s.

YEAR	FIGHTERS
Y167-Y172	6 or 12 F-4.
Y173-Y174	6 or 12 F-4 or F-16† or F-16p.
Y175-Y178	6 or 12 F-4 or F-16† or F-16p or F-20.
Y179-Y182	6 or 12 F-16C† or F-16Cp or F-20.
Y183+	6 or 12 F-16C† or F-16Cp or F-20C.

†These were only available in limited numbers. While far more common than the F-15, they were also usually only deployed to fairly critical planets, but it was not unusual to find them on a less important world.

It is possible that local forces operating Cygnan fighters might have taken control of such a station in an emergency. These

would never be A-6s.

YEAR	FIGHTERS
Y165-Y169	6 or 12 F-104A.
Y170-Y171	6 or 12 F-104A or F-104G.
Y172-Y174	6 or 12 F-104G or F-104J.
Y175-Y179	6 or 12 F-104J or F-104S.
Y180-Y183	6 or 12 F-104S.
Y184-Y188	F-104s out of service.
Y189-Y190	6 or 12 F-104S.
Y191+	There was no further deployment of Cygnan designed fighters, and such a base would use the normal National Guard fighters as given above from this year forward.

The civilian base station has one shuttle bay, which may have a shuttle deck (R1.1G5). Augmentation modules may add additional bays. Hangar bay augmentation module [(R1.4) and (R1.70)] shuttle bays cannot be used to lay mines (M2.113). Transfers between the bay of the civilian base station and the bays of any augmentation module or between augmentation modules are not possible.

Refits: Special sensors are under Early Years restrictions (YG24.0) until Y134. Transporters increased from Range 4 to Range 5 in Y140. Tractors increased from Range 2 to Range 3 in Y140. Also see listing under (R1.R-2) above.

A generic civilian base station SSD is in *Module C3*; the ship description is in *Module R1*. Use the generic base station counter from *Basic Set*.

(R1.38-2) FREE PROSPECTOR (FTP): A Free Prospector in Federation space from Y130 will normally have a phaser-2 or a phaser-3 or prospecting cannon in the option mount. From Y140 it might mount an ADD-6 in the option mount rather than a phaser. A Free Prospector in Federation space might mount a drone rack of type-A in the option mount from Y130, but this was relatively rare prior to about Y170 when it became more common with the availability of faster drones.

Landing: Can land on planets using the powered landing system (P2.434) and has the crash landing bonus (P2.4311).



Seeking weapons: The Free Prospector can control a number of seeking weapons equal to its sensor rating (F3.21) if equipped with a drone rack, otherwise it can control a number of seeking weapons equal to half its sensor rating (F3.211).

Refits: Transporters increased from Range 4 to Range 5 in Y140. Tractors increased from Range 2 to Range 3 in Y140. Free Prospectors with type-A drone racks had one reload until Y175 when the drone rack was upgraded to type-B with two reloads.

Generic SSD is in *Module F1*; use a generic Free Trader counter from *Advanced Missions*.

(R1.41-2) FREE TROOPER (FTR): A Free Trooper in Federation service from Y125 will normally have a phaser-2 or a phaser-3 in the option mount. From Y140 it might mount an ADD-6 in the option mount rather than a phaser. A Free Trooper in Federation service might mount a drone rack of type-A in the option mount from Y125, but this was relatively rare prior to about Y170 when it became more common with the availability of faster drones.

Landing force: 24 boarding parties (D7.0) plus two commando teams (D15.84), four heavy-weapons squads (D15.81), and four ground combat vehicles (D15.82). This was roughly a battalion of troops (R2.M1) and is included in the ship’s BPV.

Shuttles: Three ground assault shuttles (R1.F4), one admin shuttle [(J2.0)/(R1.F1)], these shuttles are included in the ship’s BPV.

Landing: Can land on planets using the powered landing



system (P2.434) and has the crash landing bonus (P2.431).

Seeking weapons: The Free Trooper can control a number of seeking weapons equal to its sensor rating (F3.21) if equipped with a drone rack, otherwise it can control a number of seeking weapons equal to half its sensor rating (F3.211).

Refits: Transporters increased from Range 4 to Range 5 in Y140. Tractors increased from Range 2 to Range 3 in Y140. Free Troopers with type-A drone racks had one reload until Y175 when the drone rack was upgraded to type-B with two reloads.

Generic SSD and FTR counter are in *Module M*.

(R1.46A-2) MEDIUM BOMBER BASE (BMB): Federation medium bombers use this base.

Seeking weapons: The medium bomber base can control a number of seeking weapons equal to its sensor rating (R1.28A).

Carrier: The medium bomber base is a true carrier; see (J4.75), (J4.93), (J11.13), and (J15.22). This base cannot operate size-1 or size-2 fighters except as provided in (J4.899).

Bombers:

YEAR BOMBERS

Y160-Y163	6 B-17.
Y164-Y167	6 B-17 or B-47.
Y168-Y172	6 B-17 or B-47 or B-57†.
Y173-Y177	6 B-17 or B-58.
Y178-Y180	6 B-58.
Y181-Y184	6 B-58 or B-1.
Y185+	6 B-1.

The B-24 (Y160) was a "kit" attached to a heavy freight shuttle (R1.F13) and did not operate from a formal bomber base.

†The B-57 entered service in Y168 but only with the Cygnan National Guard and was withdrawn from service in Y172.

The B-70 (Y171) never entered service.

The bay is "outdoors" and has no restrictions on the number of shuttles that can launch and land at any one time, is immune to chain reactions (D12.0), and (of course) cannot lay T-bombs (R1.28A).

Generic SSD is in *Module J2*; generic ground base counters are in *Advanced Missions* and *Module R1*.

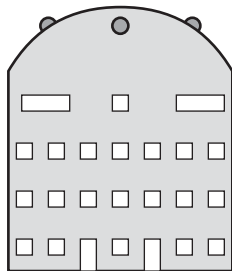

(R1.46B-2) HEAVY BOMBER BASE (BHB): Federation heavy bombers use this base.

Scout: It can use all scout functions (G24.0). Special sensors are destroyed as any other system on the base in accordance with (R1.14A2).

Seeking weapons: The heavy bomber base can control a number of seeking weapons equal to its sensor rating (R1.28A). See also (F3.213).

Carrier: The heavy bomber base is a true carrier; see (J4.75), (J4.93), (J11.13), and (J15.22). This base cannot operate size-1 or size-2 fighters except as provided in (J4.899).

Bombers:

YEAR BOMBERS

Y162-Y164	6 B-36.
Y165	6 B-36 or B-52A/B.
Y166	6 B-36 or B-52C.
Y167	6 B-36 or B-52D.
Y168	6 B-36 or B-52E.
Y169-Y178	6 B-52E.
Y179	6 B-52E or B-52G.
Y180-Y181	6 B-52E or B-52G or B-29.
Y182-Y184	6 B-52G or B-2 or B-2p.
Y184+	6 B-2 or B-2p.

The B-52F (Y169) was never deployed.

The B-32 (Y180) was a "kit" attached to a very heavy freight

shuttle (R1.F14) and did not operate from a formal bomber base.

The B-3 (Y190) and B-3p (Y190) were never deployed.

The bay is "outdoors" and has no restrictions on the number of shuttles that can launch and land at any one time, is immune to chain reactions (D12.0), and (of course) cannot lay T-bombs (R1.28A).

Generic SSD is in *Module J2*;

generic ground base counters are in *Advanced Missions* and *Module R1*.

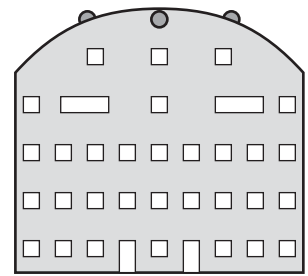

(R1.46C-2) TYPE-H DRONE BASE (GHD): The Federation deployed bases of this type in Y165.

Seeking weapons: The type-H drone base can control a number of seeking weapons equal to its sensor rating (F3.21).

Generic SSD is in *Module J2*; generic ground base counters are in *Advanced Missions* and *Module R1*.

(R1.47-2) SECTOR BASE (STB): Weapon #1 is photon torpedoes and Weapon #2 is 1xtype-D drone rack and 1xADD-30. Delete Weapon #3.

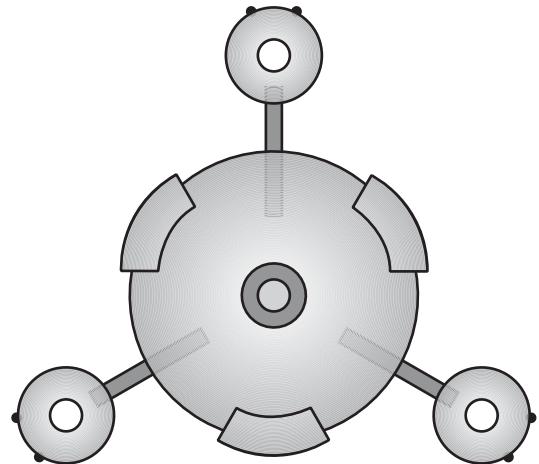

Scout: It can use all scout functions (G24.0). Special sensors are destroyed by "phaser" damage points.

Seeking weapons: The sector base can control a number of seeking weapons equal to double its sensor rating (F3.212). See also (F3.213). It has full aegis (D13.0).

Carrier: If this base is equipped with hangar bay modules [(R1.4) and/or (R1.70)], it is a true carrier; see (J4.75), (J4.93), (J11.13), and (J15.22). If equipped with heavy fighter hangar bay modules (R1.70), it cannot be equipped with PF tender modules (R1.16).

PF tender: If this base is equipped with a PF tender module or modules (R1.16) to operate conjectural Federation PFs or Interceptors, it is a true PF tender (K2.112) and cannot operate heavy fighters (J10.0) or be equipped with heavy fighter modules (R1.70).

Fighters if hangar bay modules (R1.4) are present:

YEAR	FIGHTERS
Y175-Y176	6 or 12 F-18.
Y177-Y179	6 or 12 F-18B.
Y180-Y182	6 or 12 F-18B+.
Y183+	6 or 12 F-18C.

Fighters if a heavy fighter hangar bay module (R1.70) is present:

YEAR	FIGHTERS
Y176	6 or 12 F-18 and 6 F-101A.
Y177-Y178	6 or 12 F-18B and 6 F-111 or F-101B.
Y179	6 or 12 F-18B and 6 F-111 or F-101C.
Y180-Y182	6 or 12 F-18B+ and 6 F-111 or F-101C.
Y183+	6 or 12 F-18C and 6 F-111 or F-101C.

The sector base has one shuttle bay, which may have a shuttle deck (R1.1G5). Augmentation modules may add additional bays. Hangar bay augmentation module [(R1.4) and (R1.70)] shuttle bays cannot be used to lay mines (M2.113). Transfers between the bay of the sector base and the bays of any augmentation module or between augmentation modules are not possible.

Generic SSD and counter are in *Module R8*.

(R1.48A-2) SMALL HEAVY FIGHTER BASE (HFB-S): Federation heavy fighters use these bases; if A-20s are used, the cargo boxes are converted to AWRs.

Seeking weapons: Federation small heavy fighter ground bases can control a number of seeking weapons equal to their sensor rating (R1.28A).

Carrier: This base is a true carrier; see (J4.93), (J11.13), and (J15.22). Rule (J4.75) is modified by (R1.28A).

Fighters:

YEAR	FIGHTERS
Y160-Y172	3 B-25*.
Y173-Y175	None.
Y176	3 F-101A.
Y177-Y178	3 A-20 or F-111 or F-101B.
Y179+	3 A-20F or F-111 or FB-111 or F-101C.

*While called a bomber, the B-25 was no larger than later heavy fighters would be, being based on the frame of a heavy transport shuttle (R1.F5).

The B-26 (Y160) was a “kit” attached to a heavy transport shuttle and did not operate from formal bases.

The bay is “outdoors” and has no restrictions on the number of shuttles that can launch and land at any one time, is immune to chain reactions (D12.0), and (of course) cannot lay T-bombs (R1.28A).

A generic SSD is in *Module R8*; generic ground base counters are in *Advanced Missions* and *Module R1*.

(R1.48B-2) HEAVY FIGHTER BASE (HFB): Federation heavy fighters use these bases. If A-20s are used, cargo boxes are converted to AWRs.

Seeking weapons: Federation heavy fighter ground bases can control a number of seeking weapons equal to their sensor rating (R1.28A).

Carrier: This base is a true carrier; see (J4.93), (J11.13), and (J15.22). Rule (J4.75) is modified by (R1.28B).

Fighters:

YEAR	FIGHTERS
Y160-Y172	6 B-25*.
Y173-Y175	None.
Y176	6 F-101A.
Y177-Y178	6 A-20 or F-111 or F-101B.
Y179+	6 A-20F or F-111 or FB-111 or F-101C.

*While called a bomber, the B-25 was no larger than later heavy fighters would be, being based on the frame of a heavy

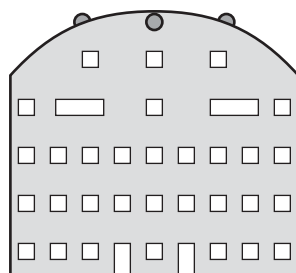
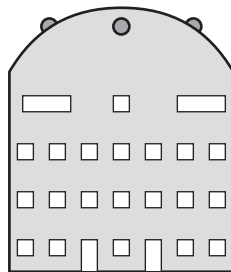

transport shuttle (R1.F5).

The B-26 (Y160) was a “kit” attached to a heavy transport shuttle and did not operate from formal bases.

The bay is “outdoors” and has no restrictions on the number of shuttles that can launch and land at any one time, is immune to chain reactions (D12.0), and (of course) cannot lay T-bombs (R1.28A).

A generic SSD is in *Module R8*; generic ground base counters are in *Advanced Missions* and *Module R1*.

(R1.48C-2) HEAVY FIGHTER PLANETARY CONTROL BASE (HFC): Federation heavy fighters use these bases.

Scout: It can use all scout functions (G24.0). Special sensors are destroyed as any other system on the base in accordance with (R1.14A2).

Seeking weapons: The Federation heavy fighter planetary control base can control a number of seeking weapons equal to its sensor rating (R1.28A). See also (F3.213).

Carrier: The Federation heavy fighter planetary control base is a true carrier; see (J4.75), (J4.93), (J11.13), and (J15.22). See (R1.28K1) for additional supplies.

Fighters:

YEAR	FIGHTERS
Y176	12 F-4 or F-16† or F-16p or F-20 or F-15* or F-15p§ and 6 F-101A.
Y177-Y178	12 F-4 or F-16† or F-16p or F-20 or F-15* or F-15p§ and 6 A-20 or F-111 or F-101B.
Y179-Y182	12 F-16C† or F-16Cp or F-20 or F-15* or F-15p§ and 6 A-20F or F-111 or FB-111 or F-101C.
Y183-Y184	12 F-16C† or F-16Cp or F-20C or F-15C* or F-15Cp§ and 6 A-20F or F-111 or FB-111 or F-101C.
Y185+	12 F-16C† or F-16Cp or F-20C or F-15C* or F-15Cp§ or F-15D* or F-15Dp§ and 6 A-20F or F-111 or FB-111 or F-101C.

*These were very rare and only found on really important planets, as in “If we lose this planet, we have lost the war” important.

†These were only available in limited numbers. While far more common than the F-15, they were also usually only deployed to fairly critical planets, but it was not unusual to find them on a less important world.

§These variants of the F-15 were more widely deployed and might be found on any “important” rather than “critical” world, and might be supplementing the phaser-G versions of the F-15. A really important planet might have a squadron or two of these in addition to a squadron of phaser-G F-15s.

Almost unique among the National Guards, the Cygnan National Guard deployed its own fighter types. There were some sales of these fighters to other planets, but these were uncommon. Still any of these fighter types might be found on isolated colony worlds:

YEAR	FIGHTERS
Y176	12 F-104J or F-104S or 6 F-104J and 6 A-6B* or 6 F-104S and 6 A-6B* and 6 F-101A.
Y177	12 F-104J or F-104S or 6 F-104J and 6 A-6B* or 6 F-104S and 6 A-6B* and 6 A-20 or F-111 or F-101B.
Y178	12 F-104J or F-104S or 6 F-104J and 6 A-6B* or 6 F-104S and 6 A-6B* or 6 F-104J and 6 A-

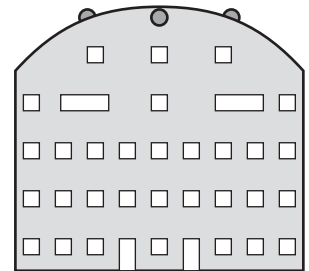

- Y179 6D* or 6 F-104S and 6 A-6D* and 6 A-20 or F-111 or F-101B.
12 F-104J or F-104S or 6 F-104J and 6 A-6B* or 6 F-104S and 6 A-6B* or 6 F-104J and 6 A-6D* or 6 F-104S and 6 A-6D* and 6 A-20F or F-111 or FB-111 or F-101C.
- Y180-Y183 12 F-104S or 6 F-104S and 6 A-6D* or 6 F-104S and 6 A-6F* and 6 A-20F or F-111 or FB-111 or F-101C.
- Y184-Y188 F-104s and A-6s out of service. Such a base would use the normal National Guard fighters during these years in addition to the heavy fighters.
- Y189-Y190 12 F-104S or 6 F-104S and 6 A-6F* and 6 A-20F or F-111 or FB-111 or F-101C.
- Y191+ There was no further deployment of Cygnan designed fighters, and such a base would use the normal National Guard fighters as given above from this year forward.

If the base is being operated by Star Fleet, the fighters would be:

YEAR	FIGHTERS
Y176	12 F-18B and 6 F-101C.
Y177-Y178	12 F-18B and 6 A-20 or F-111 or F-101B.
Y179	12 F-18B and 6 A-20F or F-111 or FB-111 or F-101C.
Y180-Y182	12 F-18B+ and 6 A-20F or F-111 or FB-111 or F-101C.
Y183+	12 F-18C and 6 A-20F or F-111 or FB-111 or F-101C.

NOTE: Star Fleet almost never operated F-14s, not even F-14ps, from ground bases. Even so it would be rare to find the phaser-G variants at such a base. Further, fighter ground bases were generally operated by the Federation Marines who were part of Star Fleet.

While called a bomber, the B-25 was no larger than later heavy fighters would be, being based on the frame of a heavy transport shuttle (R1.F5). They were phased out of service in Y170 before bases of this type were developed.

The B-26 (Y160) was a "kit" attached to a heavy transport shuttle and did not operate from formal bases.

The bay is "outdoors" and has no restrictions on the number of shuttles that can launch and land at any one time, is immune to chain reactions (D12.0), and (of course) cannot lay T-bombs (R1.28A).

A generic SSD is in *Module R8*; generic ground base counters are in *Advanced Missions* and *Module R1*.

(R1.53-2) SECURITY SKIFF (SSK): Prior to Y168 it was not unusual for security skiffs in the Federation to not have the drone rack. To reflect this, delete the drone rack and the skiff's BPV is reduced by two points. Note, however, that from their introduction at least some security skiffs always had a type-A (one reload) drone rack, and all security skiffs in Federation space had a drone rack after Y167. Beginning in Y167 some skiffs in Federation service had type-G drone racks.

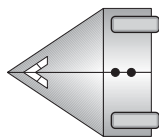

Landing: Can land on planets using the gravity landing system (P2.432), aerodynamic landing system (P2.433), or powered landing system (P2.434), and has the crash landing bonus (P2.4311).

Refits: Transporters increased from Range 4 to Range 5 in Y140. Tractors increased from Range 2 to Range 3 in Y140. In

Y175 all Federation skiffs with type-G drone racks received a second reload for a total of three reloads (one reload is entirely ADDs), while those with type-A drone racks were upgraded to a type-B drone rack with two reloads.

A generic SSD and counter are in *Module R8*.

(R1.55-2) HEAVY AUXILIARY CARRIER (HAV): Weapon #1 is phaser-1s, Weapon #2 is type-G drone racks, Weapon #3 is phaser-3-RA, Weapon #4 is type-B drone racks, and Weapon #5 is phaser-3-360°s.

Seeking weapons: The heavy auxiliary carrier can control a number of seeking weapons equal to double its sensor rating (F3.212).

Carrier: The heavy auxiliary carrier is a true carrier; see (J4.75), (J4.93), (J11.13), and (J15.22).

Fighters (note: auxiliary carriers cannot operate heavy fighters, only auxiliary heavy fighter carriers can):

YEAR	FIGHTERS
Y165-Y166	24 F-8.
Y167-Y170	24 F-4 or F-8 or 12 F-4 and 12 F-8.
Y171-Y175	24 F-8.
Y176-Y178	24 F-8 or F-18 or 12 F-8 and 12 F-18.
Y179-Y182	24 F-18 or F-18B or 12 F-18 and 12 F-18B.
Y183-Y185	24 F-18B or F-18B+ or 12 F-18B and 12 F-18B+.
Y186+	24 F-18C.

This ship has two shuttle bays; transfers between the bays are not possible. This ship cannot operate photon-armed fighters.

Maneuver: The heavy auxiliary carrier can accelerate by no more than five movement points per turn. It cannot disengage by acceleration or use emergency deceleration.

A generic SSD and counter are in *Module R8*.

(R1.56-2) HEAVY AUXILIARY PF TENDER (HAP): This ship is conjectural and only used if using the Federation conjectural fast patrol ships. Weapon #1 is phaser-1s, Weapon #2 is type-G drone racks, Weapon #4 is type-B drone racks, and Weapon #5 is phaser-3-360°s.

Scout: It can use all scout functions (G24.0). Special sensors are destroyed by "torpedo" damage points. See (G24.35) when purchasing this unit as part of a battle force.

Seeking weapons: The heavy auxiliary PF tender can control a number of seeking weapons equal to double its sensor rating (F3.212). See also (F3.213).

PF tender: The heavy auxiliary PF tender is a true PF tender (K2.111).

Maneuver: The heavy auxiliary PF tender can accelerate by no more than five movement points per turn. It cannot disengage by acceleration or use emergency deceleration.

A generic SSD and counter are in *Module R8*.

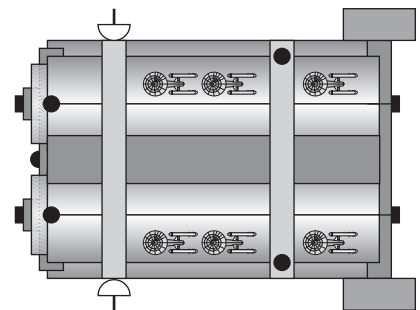
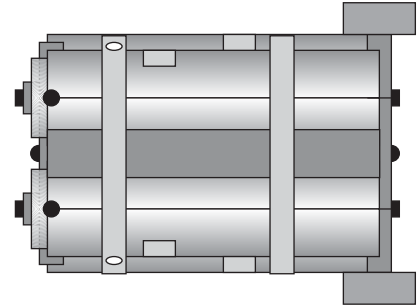

(R1.57-2) HEAVY AUXILIARY SPACE CONTROL SHIP (HSC): This ship is conjectural and only used if using the Federation conjectural fast patrol ships. Weapon #1 is phaser-1s, Weapon #2 is type-G drone racks, Weapon #4 is is type-B drone racks, and Weapon #5 is phaser-3-360°s.

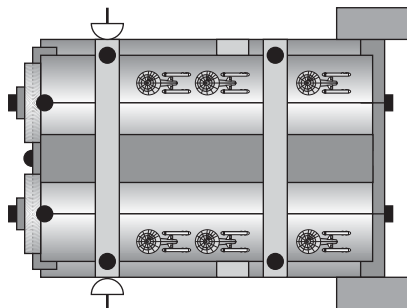

Scout: It can use all scout functions (G24.0). Special sensors are destroyed on “torpedo” damage points. See (G24.35) when purchasing this unit as part of a battle force.

Seeking weapons: The heavy auxiliary space control ship can control a number of seeking weapons equal to its sensor rating (F3.21). See also (F3.213).

Carrier: The heavy auxiliary space control ship is a true carrier; see (J4.75), (J4.93), (J11.13), and (J15.22).

PF tender: The heavy auxiliary space control ship is a true PF tender (K2.111) and cannot operate heavy fighters (J10.0). See (R1.31) for PF and fighter supplies.

Fighters:

YEAR	FIGHTERS
Y182	12 F-18 or F-18B.
Y183-Y185	12 F-18B or F-18B+.
Y186+	12 F-18C.

This ship has two shuttle bays; transfers between the bays are not possible. This ship cannot operate photon-armed fighters.

Maneuver: The heavy auxiliary space control ship can accelerate by no more than five movement points per turn. It cannot disengage by acceleration or use emergency deceleration.

A generic SSD and counter are in *Module R8*.

=(R1.58-2) SMALL AUXILIARY CRUISER (SAC): Weapon options are phaser-1-FA, or phaser-2-FA, or type-A drone rack or any two of the three.

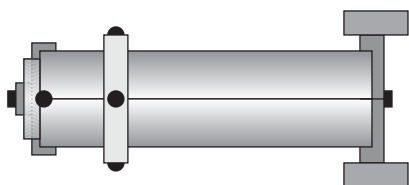

Seeking weapons: The small auxiliary cruiser can control a number of seeking weapons equal to its sensor rating (F3.21) if equipped with a drone rack, otherwise it can control a number of seeking weapons equal to half its sensor rating (F3.211).

Refits: The Y175 refit replaced any type-A drone racks with type-G drone racks (three reloads, one reload is entirely ADDs).

Maneuver: The small auxiliary cruiser can accelerate by no more than five movement points per turn. It can disengage by acceleration.

A generic SSD and counter are in *Module R8*.

(R1.59-2) LARGE AUXILIARY CRUISER (LAC): Weapon options are phaser-1-FA, phaser-2-FA, or type-A drone rack or any combination of the three.

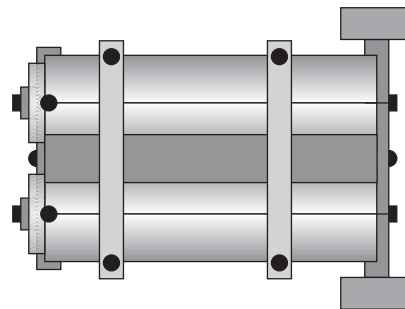

Seeking weapons: The large auxiliary cruiser can control a number of seeking weapons equal to its sensor rating (F3.21) if equipped with a drone rack, otherwise it can control a number of seeking weapons equal to half its sensor rating (F3.211).

Refits: The Y175 refit replaced any type-A drone racks with type-G drone racks (three reloads, one reload is entirely ADDs).

Maneuver: The large auxiliary cruiser can accelerate by no more than five movement points per turn. It can disengage by acceleration.

A generic SSD and counter are in *Module R8*.

(R1.60-2) HEAVY AUXILIARY CRUISER (HAC): Weapon options are phaser-1-FA, phaser-2-FA, or type-G drone rack or any combination of the three. Rear hull weapons are: Weapon #1 phaser-1s, Weapon #3 phaser-3-FA, Weapon #4 type-B drone racks, and Weapon #5 phaser-3-360°s.

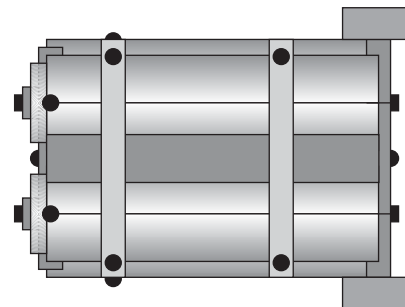

Seeking weapons: The heavy auxiliary cruiser can control a number of seeking weapons equal to its sensor rating (F3.21).

Maneuver: The heavy auxiliary cruiser can accelerate by no more than five movement points per turn. It cannot disengage by acceleration or use emergency deceleration.

A generic SSD and counter are in *Module R8*.

(R1.65-2) CIVILIAN LUXURY FAST TRANSPORT (FTT): Civilian luxury fast transports in Federation space from Y130 will normally have a phaser-2 or a phaser-3 in the option mount. From Y140 it might mount an ADD-6 in the option mount rather than a phaser. A luxury fast transport in Federation space might mount a drone rack of type-A in the option mount from Y130, but this was relatively rare prior to about Y170 when it became more common with the availability of faster drones.



Landing: Can land on planets using the powered landing system (P2.434), and has the crash landing bonus (P2.4311).

Seeking weapons: The civilian luxury fast transport can con-

R1.0 FEDERATION GENERAL UNITS

control a number of seeking weapons equal to its sensor rating (F3.21) if equipped with a drone rack, otherwise it can control a number of seeking weapons equal to half its sensor rating (F3.211).

Refits: Transporters increased from Range 4 to Range 5 in Y140. Tractors increased from Range 2 to Range 3 in Y140. Civilian luxury fast transports with type-A drone racks had one reload until Y175 when the drone rack was upgraded to type-B with two reloads.

A generic SSD and counter are in *Module R8*.

(R1.67-2) PRIME TRADERS (PT): Prime Traders in Federation space from Y130 will normally have phaser-2s or phaser-3s (or one of both) in the option mounts. From Y140 it might mount an ADD-6 in one or both of the option mounts rather than phasers. A Prime Trader in Federation space might mount a drone rack of type-A in one or both of the option mounts from Y130, but this was relatively rare prior to about Y170 when it became more common with the availability of faster drones.



Landing: Can land on planets using the powered landing system (P2.434), and has the crash landing bonus (P2.4311).

Seeking weapons: The Prime Trader can control a number of seeking weapons equal to its sensor rating (F3.21) if equipped with a drone rack, otherwise it can control a number of seeking weapons equal to half its sensor rating (F3.211).

Refits: Transporters increased from Range 4 to Range 5 in Y140. Tractors increased from Range 2 to Range 3 in Y140. Prime Traders with type-A drone racks had one reload until Y175 when the drone racks were upgraded to type-B with two reloads.

A generic SSD and counter are in *Module R8*.

(R1.68T-2) SELF-DEFENSE SKID TYPE-I (SDS1): The Federation used this skid, but it was fairly rare until Y168 when faster drones became available.

Seeking weapons: This skid does not increase the drone control rating of the freighter to which it is attached and has no inherent drone control rating of its own if it is not attached to a freighter.

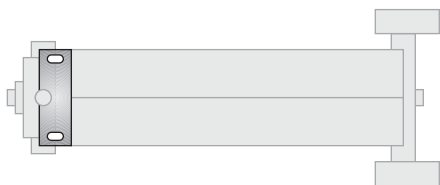

Refits: This skid had type-A drone racks with one reload until Y175 when the drone racks were upgraded to type-B with two reloads.

A generic SSD is in *Module R8*; there is no separate counter.

(R1.68U-2) SELF-DEFENSE SKID TYPE-II (SDS2): The Federation used this skid.

A generic SSD is in *Module R8*; there is no separate counter.

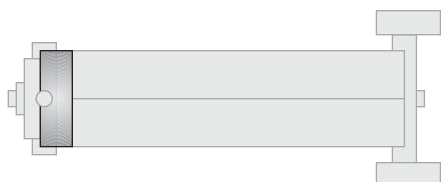

STAR FLEET BATTLES

(R1.68V-2) SELF-DEFENSE SKID TYPE-III (SDS3): The Federation used this skid.

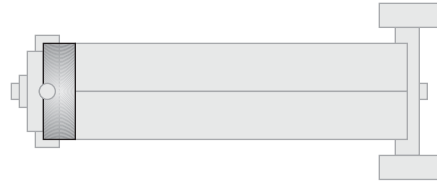

A generic SSD is in *Module R8*; there is no separate counter.

(R1.68W-2) FIGHTER SKID: The fighters on this skid will, of course, be whatever is borrowed from the Federation ground base the skid is supporting as per the rules for this skid type.

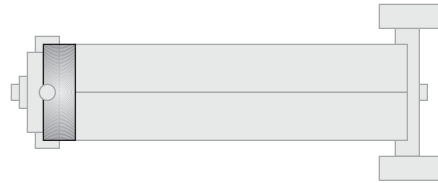

Carrier: This skid does not make the freighter that it is attached to a "carrier" for any purpose, not even as a casual (J4.62) carrier. See (R1.68) for the operations of this skid.

The skid has a single bay. Transfers between this skid and any shuttle bays on the freighter, or other skids carried by the freighter, or on any ducktails carried by the freighter, are not possible.

A generic SSD is in *Module R8*; there is no separate counter.

(R1.70-2) HEAVY FIGHTER HANGAR BAY MODULE (HFM):

Carrier: If a base is equipped with a heavy fighter hangar bay module, it is a true carrier; see (J4.75), (J4.93), (J11.13), and (J15.22). A base equipped with a heavy fighter hangar bay module cannot be equipped with PF tender modules (R1.16).



Fighters below are per heavy fighter hangar bay module if heavy fighter hangar bay modules are present. Heavy fighter hangar bay modules are class-A augmentation modules and must be docked to a class-A docking station to be operational. See the ship description for the base for the number of class-A docking positions the base has. Only one heavy fighter hangar bay module can be on a base, except a starbase or stellar fortress which can have two such augmentation modules. If a PF docking module (R1.16) is being used by the base, the base is a true PF tender and cannot operate heavy fighters and would have no use for this module:

YEAR	FIGHTERS
Y176	6 F-101A.
Y177-Y178	6 A-20 or F-111 or F-101B.
Y179+	6 A-20F or F-111 or F-101C.

Transfers between this augmentation module and the bays of any other augmentation module or the bay or bays of the base to which it is attached are not possible.

SSD is in *Module R8*; there is no counter as the unit cannot function if it is not attached to a base. If in transit (being carried by a freighter or a tug), it is inactive; use a pod counter if the module is dropped by a tug during a scenario.

(R1.71-2) FAST MONITOR (MNF): Weapon-A is 6xphoton torpedoes-FA; Weapon-B is 4xphaser-1-360°s, Weapon-C is type-G drone racks.

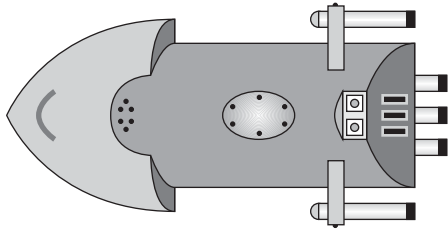

Seeking weapons: The fast monitor can control a number of seeking weapons equal to its sensor rating (F3.21).

Refits: The Y175 refit added a third reload to the type-G drone racks; one reload is always composed entirely of ADDs.

Maneuver: Monitors cannot disengage by acceleration or use emergency deceleration.

A generic SSD and counter are in *Module R9*.

(R1.74-2) HEAVY AUXILIARY TROOP TRANSPORT (FTH): Weapon #1 is phaser-1s, Weapon #3 is phaser-3-RA, Weapon #4 is type-B drone racks, and Weapon #5 is phaser-3-360°s.

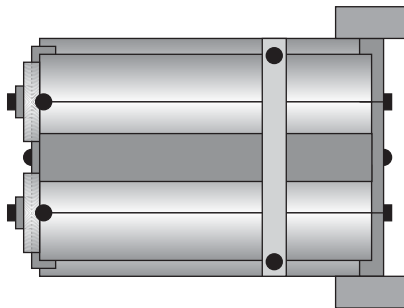

Landing force: 114 boarding parties (D7.0) plus four commando teams (D15.84), 12 heavy-weapons squads (D15.81), and eight ground combat vehicles (D15.82). This was roughly three battalions of troops (R2.M1) and is included in the ship's BPV. Note: Ten of the boarding parties are not part of the landing force, but are assigned to defend the ship. They are, however, Marines and could be used to support the landing force.

Shuttles: Four ground assault shuttles (R1.F4) and four heavy transport shuttles (R1.F5); these shuttles are included in the ship's BPV.

Seeking weapons: The heavy auxiliary troop transport can control a number of seeking weapons equal to its sensor rating (F3.21).

Maneuver: The heavy auxiliary troop transport can accelerate by no more than five movement points per turn. It cannot disengage by acceleration or use emergency deceleration..

A generic SSD and counter are in *Module R11*.

(R1.75-2) LARGE AUXILIARY HEAVY FIGHTER CARRIER (LAH): Weapon-A is 3xphaser-1-360°s, Weapon-B is type-G drone racks, Weapon-C is a phaser-1-RA.

Seeking weapons: The large auxiliary heavy fighter carrier can control a number of seeking weapons equal to double its sensor rating (F3.212).

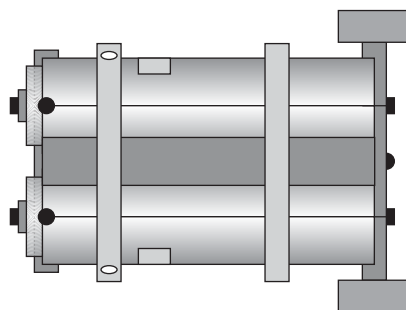

Carrier: The large auxiliary heavy fighter carrier is a true carrier; see (J4.75), (J4.93), (J11.13), and (J15.22).

Fighters:

YEAR FIGHTERS

Y176	12 F-8 or F-18 and 6 F-101A.
Y177-Y178	12 F-8 or F-18 and 6 F-101B or A-20.
Y179-Y182	12 F-18 or F-18B and 6 F-101B or A-20F.
Y183-Y185	12 F-18B or F-18B+ and 6 F-101C or A-20F.
Y186+	12 F-18C and 6 F-101C or A-20F.

Note: This ship does not carry F-111s, see (R2.102).

This ship has two shuttle bays; transfers between the bays are not possible.

Maneuver: The large auxiliary heavy fighter carrier can accelerate by no more than five movement points or double its current speed. It can disengage by acceleration.

A generic SSD and counter are in *Module R11*.

(R1.76-2) SMALL AUXILIARY HEAVY FIGHTER CARRIER (SAH): Weapon-A is 3xphaser-1-360°s, Weapon-B is type-G drone racks.

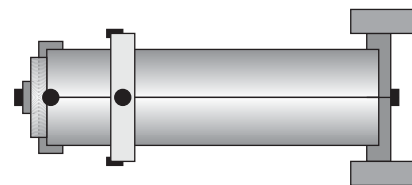

Seeking weapons: The small auxiliary heavy fighter carrier can control a number of seeking weapons equal to double its sensor rating (F3.212).

Carrier: The small auxiliary heavy fighter carrier is a true carrier; see (J4.75), (J4.93), (J11.13), and (J15.22).

Fighters:

YEAR FIGHTERS

Y176	6 F-101A.
Y177-Y178	6 F-101B or A-20.
Y179-Y182	6 F-101B or A-20F.
Y183+	6 F-101C or A-20F.

Note: This ship does not carry F-111s, see (R2.103).

This ship has a single shuttle bay.

Maneuver: The small auxiliary heavy fighter carrier can accelerate by no more than five movement points per turn. It can disengage by acceleration.

A generic SSD and counter are in *Module R11*.

(R1.77-2) LARGE AUXILIARY SCOUT (LAS): Weapon #1 is phaser-1s, Weapon #2 is 2xtype-G drone racks and 2xtype-A drone racks (upgraded to type-B by the Y175 refit), and Weapon #3 is phaser-3.

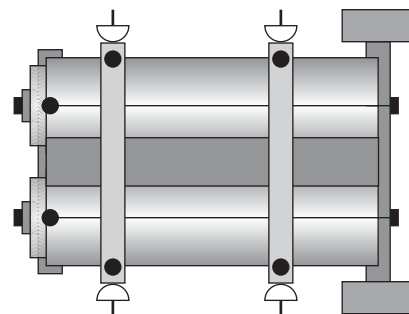

Scout: It can use all scout functions (G24.0). Special sensors are destroyed by "phaser" damage points. See (G24.35) when purchasing this unit as part of a battle force.

Seeking weapons: The large auxiliary scout can control a number of seeking weapons equal to its sensor rating (F3.21).

See also (F3.213).

Refits: The Y175 refit converted the type-A drone racks (one reload) to type-B drone racks (two reloads) and added a third reload to the type-G drone racks; one reload is always composed entirely of ADDs.

Maneuver: The large auxiliary scout can accelerate by no more than five movement points per turn. It can disengage by acceleration.

A generic SSD and counter are in *Module R11*.

(R1.78-2) SMALL AUXILIARY SCOUT (SAS): Weapon #1 is phaser-1s, Weapon #2 is type-G drone racks.

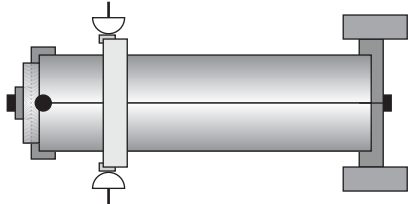

Scout: It can use all scout functions (G24.0). Special sensors are destroyed by “phaser” damage points. See (G24.35) when purchasing this unit as part of a battle force.

Seeking weapons: The small auxiliary scout can control a number of seeking weapons equal to its sensor rating (F3.21). See also (F3.213).

Refits: The Y175 refit added a third reload to the type-G drone racks; one reload is always composed entirely of ADDs.

Maneuver: The small auxiliary scout can accelerate by no more than five movement points per turn. It can disengage by acceleration.

A generic SSD and counter are in *Module R11*.

(R1.79-2) COMMUNICATIONS RELAY STATION (CCS): WPN is 2xphaser-1-360°s prior to Y160, and 2xtype-G drone racks thereafter. Phaser-X is always phaser-1-360°.

Scout: It can use all scout functions (G24.0). Special sensors are destroyed by “phaser” damage points.

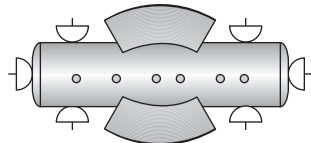

Seeking weapons: The communications relay station can control a number of seeking weapons equal to its sensor rating (F3.21) if equipped with a drone rack, otherwise it can control a number of seeking weapons equal to half its sensor rating (F3.211). See also (F3.213).

Refits: Special sensors are under Early Years restrictions (YG24.0) until Y134. Transporters increased from Range 4 to Range 5 in Y140. Tractors increased from Range 2 to Range 3 in Y140. The Y175 refit added a third reload to the type-G drone racks; one reload is always composed entirely of ADDs.

A generic SSD and counter are in *Module R11*.

(R1.81-2) ADVANCED TECHNOLOGY FLEET REPAIR DOCK (FRX): Weapon #1 is phaser-1Xs, Weapon #2 is phaser-1Xs, Weapon #3 is type-GX drone racks, Weapon #4 is deleted.

The advanced technology fleet repair dock is a “first generation X-ship;” see (X0.0).

Seeking weapons: The advanced technology fleet repair dock can control a number of seeking weapons equal to double its sensor rating (XF3.2).

Carrier: If the advanced technology fleet repair dock is equipped with hangar bay modules [(R1.4) and/or (R1.70)], it is a true carrier; see (J4.75), (J4.93), (J11.13), and (J15.22). If equipped with a heavy fighter hangar bay module (R1.70), it cannot be equipped with a PF tender module (R1.16).

PF tender: If the advanced technology fleet repair dock is

equipped with a PF tender module or modules (R1.16) to operate conjectural Federation PFs or Interceptors, it is a true PF tender (K2.112) and cannot operate heavy fighters (J10.0) or be equipped with a heavy fighter module (R1.70).

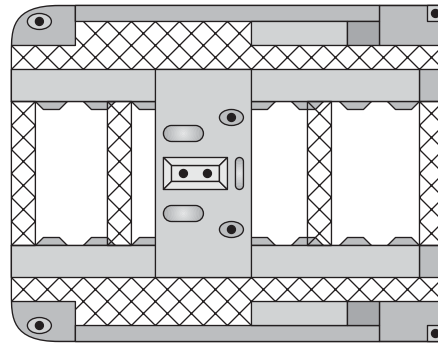

Fighters if hangar bay modules (R1.4) are present:

YEAR	FIGHTERS
Y182	6 or 12 F-18B+.
Y183-Y189	6 or 12 F-18C.

Fighters if a heavy fighter hangar bay module (R1.70) is present:

YEAR	FIGHTERS
Y182	0 or 6 F-18B+ and 6 F-111 or F-101C.
Y183+	0 or 6 F-18C and 6 F-111 or F-101C.

The advanced technology fleet repair dock has one shuttle bay. Augmentation modules may add additional bays. Hangar bay augmentation module [(R1.4) and (R1.70)] shuttle bays cannot be used to lay mines (M2.113). Transfers between the bay of the advanced technology fleet repair dock and the bays of any augmentation module or between augmentation modules, are not possible.

Maneuver: Advanced technology fleet repair docks can only move by sublight (Speed 1) unless towed by other ships; see (R1.10B).

A generic SSD and counter are in *Module R11*.

(R1.83-2) LIGHT MONITOR (LMN): Weapon-A is 4xphoton torpedoes-FA, Weapon B is 4xphaser-1-360°s, Weapon-C is type-E drone racks prior to Y167, type-G drone racks thereafter, no change in BPV.

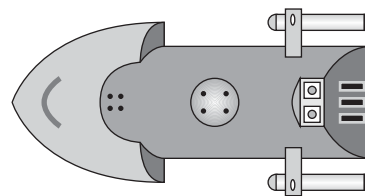

Seeking weapons: The light monitor can control a number of seeking weapons equal to its sensor rating (F3.21).

Carrier: If the light monitor is equipped with a fighter pallet (R1.22E), it is a true carrier; see (J4.75), (J4.93), (J11.13), and (J15.22).

PF tender: If the light monitor is equipped with a PF pallet (R1.22E), it is a true PF tender (K2.113).

Fighters if using a fighter pallet:

YEAR	FIGHTERS
Y165-Y166	12 F-8.
Y167-Y170	12 F-4 or F-8.
Y171-Y175	12 F-8.
Y176-Y178	12 F-8 or F-18.
Y179-Y182	12 F-18 or F-18B.
Y183-Y185	12 F-18B or F-18B+.
Y186+	12 F-18C.

The light monitor with the fighter pallet has two bays: the light monitor's bay and the fighter pallet's bay. The fighter pallet has two launch tubes (J1.54). Mines cannot be laid from the fighter pallet's bay (M2.113). Transfers between the two bays are not possible.

Fighters if using a PF pallet and not using the conjectural Federation fast patrol ships:

YEAR	FIGHTERS
Y181+	6xA-20F or F-111 or F-101C.

The light monitor with the PF pallet has two bays: the light monitor's bay and the PF pallet's mech-links which count as a single separate bay, although all heavy fighters can launch and or land individually without blocking the launching or landing of a heavy fighter on any other mech-link. Mines cannot be laid from the PF pallet's bay (M2.113). Transfers between the two bays are not possible.

The light monitor cannot operate space control pallets.

Maneuver: Light monitors cannot disengage by acceleration or use emergency deceleration.

A generic SSD and counter are in *Module R11*. SSDs for the pallets are found on the monitor pallets page of the *Advanced Missions* SSD book

(R1.84-2) FREE ESCORT CARRIER (FEV): Free escort carriers in Federation space will normally have phaser-2s, phaser-3s, ADD racks (six shots prior to Y175), or type-A (type-B after Y175) drone racks in their option mounts. This can be two of one type, or one each of any two types, e.g., a phaser-2 and an ADD rack.



Landing: Can land on planets using the powered landing system (P2.434) and has the crash landing bonus (P2.4311).

Seeking weapons: The free escort carrier can control a number of seeking weapons equal to its sensor rating (F3.21) if equipped with a drone rack, otherwise it can control a number of seeking weapons equal to half its sensor rating (F3.211).

Carrier: The free escort carrier is a true carrier; see (J4.75), (J4.93), (J11.13), and (J15.22).

Fighters:

YEAR	FIGHTERS
Y166+	6 varies.

Carriers of this type often operated mixed squadrons, but cannot operate assault (A-6, A-10) fighters, heavy fighters, or fighters armed with phaser-Gs (F-14, F-15, F-16). At least one carrier of this type operated Shenyang F-7s.

This ship has two shuttle bays; transfers between the bays are not possible.

Refits: Free escort carriers with type-A drone racks had one reload until Y175 when the drone rack was upgraded to type-B with two reloads.

A generic SSD and counter are in *Module R11*.

(R1.85-2) PRIME CORVETTE (PTC): Prior to Y165 the option mounts were photon torpedoes on prime corvettes operated by the government, phaser-2s if operated by a civilian organization. After Y165 both government and civilian prime corvettes usually had type-G drone racks in the option mounts. Phaser options are phaser-2s if a civilian organization is operating the prime corvette and phaser-1s if the government is operating it.



Landing: Can land on planets using the powered landing system (P2.434), and has the crash landing bonus (P2.4311).

Seeking weapons: The prime corvette can control a number of seeking weapons equal to its sensor rating (F3.21) if equipped with drone racks, otherwise it can control a number of seeking weapons equal to half its sensor rating (F3.211).

Refits: Transporters increased from Range 4 to Range 5 in Y140. Tractors increased from Range 2 to Range 3 in Y140. The Y175 refit added a third reload to the type-G drone racks; one reload is always composed entirely of ADDs.

A generic SSD and counter are in *Module R11*.

(R1.86-2) ARMED CUTTER (CUT): When operated by the government, phaser-X is a phaser-1; when operated by a civilian agency phaser-X is a phaser-2. Prior to Y165 the drone racks are phaser-2s (one LS, one RS), from Y165 they are type-G drone racks.

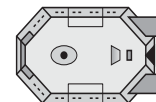

Seeking weapons: The armed cutter can control a number of seeking weapons equal to its sensor rating (F3.21) if equipped with drone racks, otherwise it can control a number of seeking weapons equal to half its sensor rating (F3.211).

Refits: Transporters increased from Range 4 to Range 5 in Y140. Tractors increased from Range 2 to Range 3 in Y140. The Y175 refit added a third reload to the type-G drone racks; one reload is always composed entirely of ADDs.

A generic SSD and counter are in *Module R11*.

(R1.88-2) FREE Q-SHIP (FTQ): Free Q-ships in Federation space will normally have phaser-1s, but might have phaser-2s, phaser-3s, ADD racks (six shots prior to Y175), or type-A (type-B after Y175) drone racks in their option mount.



Landing: Can land on planets using the powered landing system (P2.434), and has the crash landing bonus (P2.4311).

Seeking weapons: The Free Q-ship can control a number of seeking weapons equal to its sensor rating (F3.21) if equipped with a drone rack, otherwise it can control a number of seeking weapons equal to half its sensor rating (F3.211).

Refits: Transporters increased from Range 4 to Range 5 in Y140. Tractors increased from Range 2 to Range 3 in Y140. Free Q-ships with type-A drone racks had one reload until Y175 when the drone rack was upgraded to type-B with two reloads. Free Q-ships with a six shot ADD rack upgraded it to a 12 shot ADD rack in Y175.

A generic SSD and counter are in *Module R12*.

(R1.89-2) STELLAR FORTRESS (STF): Weapon #1 is photon torpedoes, Weapon #2 boxes #2, #4, and #6 are deleted and boxes #1, #3, and #5 are phaser-Gs, Weapon #3 is ADD-30s, and Weapon #4 is type-H drone racks.

Scout: It can use all scout functions (G24.0). Special sensors are destroyed by "phaser" damage points.

Seeking weapons: The stellar fortress can control a number of seeking weapons equal to double its sensor rating (F3.212). See also (F3.213). It has full aegis (D13.0).

Carrier: If this base is equipped with hangar bay modules [(R1.4) and/or (R1.70)], it is a true carrier; see (J4.75), (J4.93), (J11.13), and (J15.22). If equipped with heavy fighter hangar bay modules (R1.70), it cannot be equipped with PF tender modules (R1.16).

PF tender: If this base is equipped with a PF tender module

or modules (R1.16) to operate conjectural Federation PFs or Interceptors, it is a true PF tender (K2.112) and cannot operate heavy fighters (J10.0) or be equipped with heavy fighter modules (R1.70).

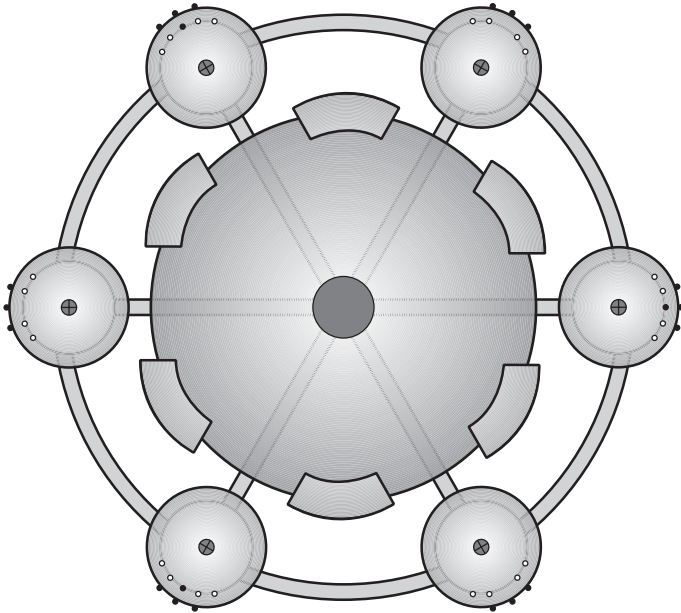

Fighters if hangar bay modules (R1.4) are present [In Y181 Federation stellar fortresses had a refit that converted the #4 docking module into a large hangar bay able to operate a squadron of A-10 assault fighters; this is reflected in this table. See (R1.1A)]:

YEAR	FIGHTERS
Y179	12 F-18B and 12 F-14A or F-14Ap.
Y180-Y182	12 F-18B+ and 12 F-14A or F-14Ap and 12 A-10 or 6 A-20F.
Y183-Y189	12 F-18C and 12 F-14B or F-14Bp and 12 A-10 or 6 A-20F.
Y190-Y194	12 F-18C and 12 F-14C or 12 F-14Cp and 12 A-10 or 6 A-20F.
Y195+	12 F-18C and 12 F-14C or F-14Cp or F-14D or F-14Dp and 12 A-10 or 6 A-20F.

Fighters if heavy fighter hangar bay modules (R1.70) are present (note: a Federation stellar fortress can have three heavy fighter squadrons if a squadron of six A-20s replaces the squadron of 12 A-10s in the docking bay):

YEAR	FIGHTERS
Y179	12 F-18B and 12 F-14A or F-14Ap and 6 or 12 F-111 or F-101C or a mix of 6 of each.
Y180	12 F-18B+ and 12 F-14A or F-14Ap and 6 or 12 F-111 or F-101C or a mix of 6 of each.
Y181-Y182	12 F-18B+ and 12 F-14A or F-14Ap and 12 A-10 or 6 A-20F and 6 or 12 F-111 or F-101C or a mix of 6 of each.
Y183-Y189	12 F-18C and 12 F-14B or F-14Bp and 12 A-10 or 6 A-20F and 6 or 12 F-111 or F-101C or a mix of 6 of each.
Y190-Y194	12 F-18C and 12 F-14C or F-14Cp and 12 A-10 or 6 A-20F and 6 or 12 F-111 or F-101C or a mix of 6 of each.
Y195+	12 F-18C and 12 F-14C or F-14Cp or F-14D or F-14Dp and 12 A-10 or 6 A-20F and 6 or 12 F-111 or F-101C or a mix of 6 of each.

If using the conjectural Federation fast patrol ships docking bay #4 will not be converted to operate a squadron of assault fighters and the stellar fortress will never have more than two

squadrons of size-1 fighters (this includes a squadron of size-1+ F-14s). Fighters will be:

YEAR	FIGHTERS
Y180-Y182	12 F-18B+ and 12 F-14A or F-14Ap.
Y183-Y189	12 F-18C and 12 F-14B or F-14Bp.
Y190-Y194	12 F-18C and 12 F-14C or F-14Cp.
Y195+	12 F-18C and 12 F-14C or F-14Cp or F-14D or F-14Dp.

The stellar fortress has six shuttle bays, each of which may have a shuttle deck (R1.1G5). Augmentation modules may add additional bays. Hangar bay augmentation module [(R1.4) and (R1.70)] shuttle bays cannot be used to lay mines (M2.113). Transfers between the bays of the stellar fortress, or between the stellar fortress and the bays of any augmentation module, or between augmentation modules are not possible.

From Y181 on the stellar fortress has a seventh internal hangar in its #4 docking module (if not using the conjectural Federation fast patrol ships). This is a fighter only bay and cannot be used to lay mines (M2.113). This hangar is separate from the shuttle bay in this docking module and fighters launch and land through the docking module's doors but their operations do not count against the launch and land rates of the existing shuttle bay.

A generic SSD and counter are in *Module R12*. An SSD containing only the weapon tables and ammo tracks needed to operate the generic stellar fortress SSD as a Federation stellar fortress is included in *Module R12*.

(R1.95-2) FAST NAVAL TRANSPORT (FNT): Phaser-X are phaser-1s.

Maneuver: The fast naval transport can accelerate by no more than five movement points per turn. It can disengage by acceleration.

A generic SSD is in *Module R12*; a generic counter is in *Module R11*.

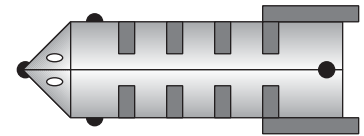

(R1.A-2) GENERAL UNITS IN CAPTAIN'S LOG

(R1.A23-2) JUMBO AUXILIARY CRUISER (JAC): Weapon options are phaser-1-FA, phaser-2-FA, or type-G drone rack or any combination of the three. Rear hull weapons are: Weapon #1 phaser-1s, Weapon #3 phaser-3-RA, Weapon #4 type-B drone racks, and Weapon #5 phaser-3-360°s.

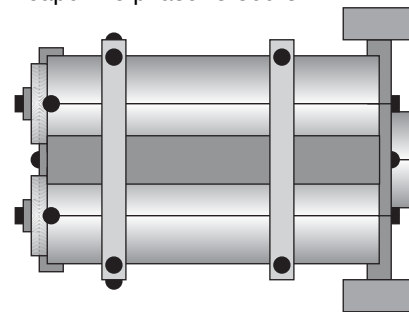

Seeking weapons: The jumbo auxiliary cruiser can control a number of seeking weapons equal to its sensor rating (F3.21).

Refits: The Y175 refit added a second reload to the type-B drone racks and a third reload to the type-G drone racks; one reload is composed entirely of anti-drones.

Maneuver: The jumbo auxiliary cruiser can accelerate by no more than five movement points per turn. It cannot disengage by acceleration or use emergency deceleration.

A generic SSD is in *Captain's Log #44*; use any available large or heavy freighter or auxiliary counter.

(R1.A24-2) JUMBO AUXILIARY HEAVY CARRIER (JAV):
 Weapon #1 is phaser-1s, Weapon #2 is type-G drone racks,
 Weapon #3 is phaser-3-RA, Weapon #4 is type-B drone racks,
 and Weapon #5 is phaser-3-360°s.

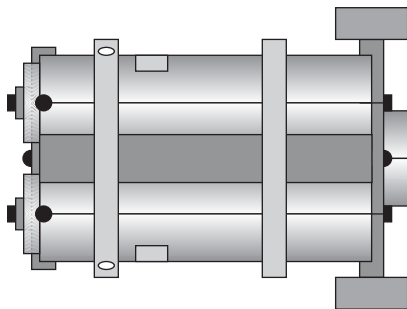

Seeking weapons: The jumbo auxiliary heavy carrier can control a number of seeking weapons equal to double its sensor rating (F3.212).

Carrier: The jumbo auxiliary heavy carrier is a true carrier; see (J4.75), (J4.93), (J11.13), and (J15.22).

Fighters (note: auxiliary carriers cannot operate heavy fighters, only auxiliary heavy fighter carriers can):

YEAR	FIGHTERS
Y170-Y175	24 F-8.
Y176-Y178	24 F-8 or F-18 or 12 F-8 and 12 F-18.
Y179-Y182	24 F-18 or F-18B or 12 F-18 and 12 F-18B.
Y183-Y185	24 F-18B or F-18B+ or 12 F-18B and 12 F-18B+.
Y186+	24 F-18C.

This ship has two shuttle bays; transfers between the bays are not possible. This ship cannot operate photon-armed fighters.

Refits: The Y175 refit added a second reload to the type-B drone racks and a third reload to the type-G drone racks; one reload is composed entirely of anti-drones.

Maneuver: The jumbo auxiliary heavy carrier can accelerate by no more than five movement points per turn. It cannot disengage by acceleration or use emergency deceleration.

A generic SSD is in *Captain's Log #44*; use any available large or heavy freighter or auxiliary counter.

(R1.A25-2) JUMBO AUXILIARY BATTLE CARRIER (JBV):
 Weapon #1 is 3xphaser-1-360°s, Weapon #2 is type-G drone racks,
 Weapon #3 is phaser-3-RA, Weapon #4 is type-B drone racks,
 and Weapon #5 is phaser-3-360°s.

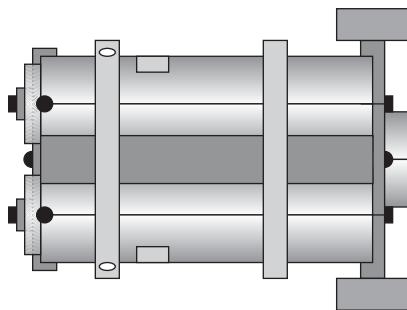

Seeking weapons: The jumbo auxiliary battle carrier can control a number of seeking weapons equal to double its sensor rating (F3.212).

Carrier: The jumbo auxiliary battle carrier is a true carrier; see (J4.75), (J4.93), (J11.13), and (J15.22).

Fighters:

YEAR	FIGHTERS
Y170-Y175	12 F-8.
Y176-Y178	12 F-8 or F-18.
Y179-Y182	12 F-18 or F-18B.
Y183-Y185	12 F-18B or F-18B+.
Y186+	12 F-18C.

Refits: The Y175 refit added a second reload to the type-B drone racks and a third reload to the type-G drone racks; one reload is composed entirely of anti-drones.

Maneuver: The jumbo auxiliary battle carrier can accelerate by no more than five movement points per turn. It cannot disengage by acceleration or use emergency deceleration.

A generic SSD is in *Captain's Log #44*; use any available large or heavy freighter or auxiliary counter.

(R1.A26-2) JUMBO AUXILIARY PF TENDER (JAP): This ship is conjectural and only used if using the Federation conjectural fast patrol ships. Weapon #1 is phaser-1s, Weapon #2 is type-G drone racks, Weapon #4 is is type-B drone racks, and Weapon #5 is phaser-3-360°s.

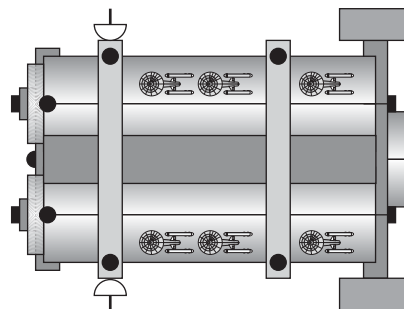

Scout: It can use all scout functions (G24.0). Special sensors are destroyed by "torpedo" damage points. See (G24.35) when purchasing this unit as part of a battle force.

Seeking weapons: The jumbo auxiliary PF tender can control a number of seeking weapons equal to its sensor rating (F3.21). See also (F3.213).

PF tender: The jumbo auxiliary PF tender is a true PF tender (K2.111).

Maneuver: The jumbo auxiliary PF tender can accelerate by no more than five movement points per turn. It cannot disengage by acceleration or use emergency deceleration.

A generic SSD is in *Captain's Log #44*; use any available large or heavy freighter or auxiliary counter.

(R1.A27-2) JUMBO AUXILIARY SPACE CONTROL SHIP (JSC):
 This ship is conjectural and only used if using the Federation

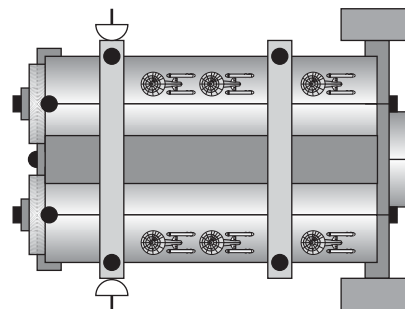

conjectural fast patrol ships. Weapon #1 is phaser-1s, Weapon #2 is type-G drone racks, Weapon #4 is is type-B drone racks,

and Weapon #5 is phaser-3-360°s.

Scout: It can use all scout functions (G24.0). Special sensors are destroyed on “torpedo” damage points. See (G24.35) when purchasing this unit as part of a battle force.

Seeking weapons: The jumbo auxiliary space control ship can control a number of seeking weapons equal to its sensor rating (F3.21). See also (F3.213).

Carrier: The jumbo auxiliary space control ship is a true carrier; see (J4.75), (J4.93), (J11.13), and (J15.22).

PF tender: The jumbo auxiliary space control ship is a true PF tender (K2.111) and cannot operate heavy fighters (J10.0). See (R1.31) for PF and fighter supplies.

Fighters:

YEAR	FIGHTERS
Y182	12 F-18 or F-18B.
Y183-Y185	12 F-18B or F-18B+.
Y186+	12 F-18C.

This ship has two shuttle bays; transfers between the bays are not possible. This ship cannot operate photon-armed fighters.

Maneuver: The jumbo auxiliary space control ship can accelerate by no more than five movement points per turn. It cannot disengage by acceleration or use emergency deceleration.

A generic SSD is in *Captain’s Log #44*; use any available large or heavy freighter or auxiliary counter.

(R1.A28-2) JUMBO AUXILIARY TROOP TRANSPORT (FTJ):

Weapon #1 is phaser-1s, Weapon #3 is phaser-3-RA, Weapon #4 is type-B drone racks, and Weapon #5 is phaser-3-360°s.

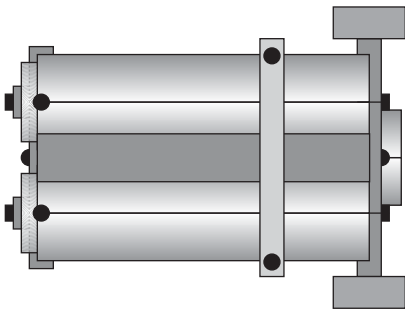

Landing force: 114 boarding parties (D7.0) plus four commando teams (D15.84), 12 heavy-weapons squads (D15.81), and eight ground combat vehicles (D15.82). This was roughly three battalions of troops (R2.M1) and is included in the ship’s BPV. Note: Ten of the boarding parties are not part of the landing force, but are assigned to defend the ship. They are, however, Marines and could be used to support the landing force.

Shuttles: Four ground assault shuttles (R1.F4) and four heavy transport shuttles (R1.F5); these shuttles are included in the ship’s BPV.

Seeking weapons: The jumbo auxiliary troop transport can control a number of seeking weapons equal to its sensor rating (F3.21).

Refits: The Y175 refit added a second reload to the type-B drone racks.

Maneuver: The jumbo auxiliary troop transport can accelerate by no more than five movement points per turn. It cannot disengage by acceleration or use emergency deceleration.

A generic SSD is in *Captain’s Log #44*; use any available large or heavy freighter or auxiliary counter.

(R1.A29-2) VARIANT JUMBO AUXILIARY CRUISER (JACB):

Weapon options are phaser-1-FA, phaser-2-FA, or type-G drone rack or any combination of the three. Rear hull weapons are: Weapon #1 phaser-1s, Weapon #3 phaser-3-RA, Weapon #4 type-B drone racks, and Weapon #5 phaser-3-360°s.

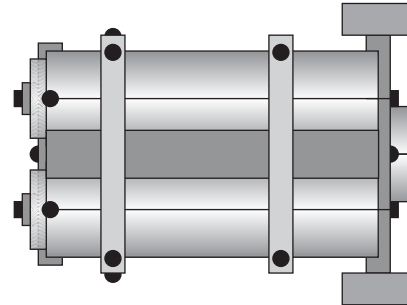

Seeking weapons: The variant jumbo auxiliary cruiser can control a number of seeking weapons equal to its sensor rating (F3.21).

Refits: The Y175 refit added a second reload to the type-B drone racks and a third reload to the type-G drone racks; one reload is composed entirely of anti-drones.

Maneuver: The variant jumbo auxiliary cruiser can accelerate by no more than five movement points per turn. It cannot disengage by acceleration or use emergency deceleration.

A generic SSD is in *Captain’s Log #44*; use any available large or heavy freighter or auxiliary counter.

(R1.A31-2) JUMBO AUXILIARY ASSAULT TRANSPORT (FTJ):

Weapon #1 is phaser-1s, Weapon #3 is phaser-3-RA, Weapon #4 is type-B drone racks, and Weapon #5 is phaser-3-360°s.

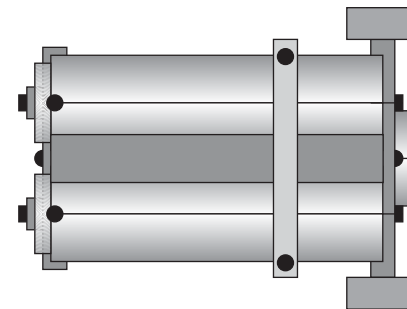

Landing force: 62 boarding parties (D7.0) plus two commando teams (D15.84), six heavy-weapons squads (D15.81), and five ground combat vehicles (D15.82). This was roughly two battalions of troops (R2.M1) and is included in the ship’s BPV. Note: Ten of the boarding parties are not part of the landing force, but are assigned to defend the ship. They are, however, Marines and could be used to support the landing force.

Shuttles: Two ground assault shuttles (R1.F4) and two heavy transport shuttles (R1.F5); these shuttles are included in the ship’s BPV.

Seeking weapons: The jumbo auxiliary assault transport can control a number of seeking weapons equal to its sensor rating (F3.21).

Refits: The Y175 refit added a second reload to the type-B drone racks.

Maneuver: The jumbo auxiliary assault transport can accelerate by no more than five movement points per turn. It cannot disengage by acceleration or use emergency deceleration.

A generic SSD is in *Captain’s Log #44 Supplement*; use any available large or heavy freighter or auxiliary counter.

END OF SECTION (R1.0-2) FEDERATION MSSB

(YR1.0-2) FEDERATION GENERAL

UNITS FOR THE EARLY YEARS

Early Years general units that can be used by the Federation are listed here with needed changes. General units requiring no changes, e.g., early small and large freighters, early augmentation modules, etc., are not listed and are simply used as is.

(YR1.8-2) EARLY GROUND-BASED DEFENSE STATIONS:

The Federation uses the early ground-based defense drone station (YGMBD) (using Andorian drones, FH arc on a planet's surface, 360° on an asteroid) between Y65 and Y112, early ground-based defense phaser-1 (YGBD1), early ground-based defense phaser-2 (YGBD2), and early ground-based defense photon (YGBDP).

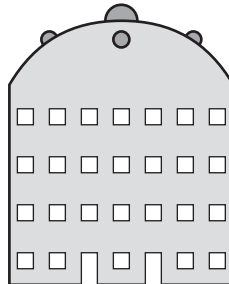

Use the generic YGMB SSD on Small Ground Bases Sheet #2 in *Module Y2* for the YGMBD; for all other early ground-based defense stations use the generic SSD on Small Ground Bases Sheet #2 in *Module Y2*. Use any small ground base counter.

(YR1.11-2) EARLY YEARS FREE TRADER (YFT): Free Traders in Federation space have a phaser-2 or a phaser-3, or two phaser-3s in the option mounts.

Landing: This ship can land on planets using the powered landing system (P2.434) and has the crash landing bonus (P2.4311).

Seeking weapons: The Early Years Free Trader can control a number of seeking weapons equal to half its sensor rating (F3.211).



Refits, Transporters: These were Range 1, extended to Range 2 at no cost in Y80, extended to Range 3 at no cost in Y100, and extended to Range 4 at no cost in Y120. Transporters were never further improved.

Tractors: These were type-W (Range 1, rear arc, towing only), refitted to type-Y (Range 1, 360°, any legal target) at no cost in Y80, and refitted to type-M (Range 2) at no cost in Y120. Tractors were never further improved.

SSD and counters are in *Module Y3*.

(YR1.12-2) EARLY YEARS PRIME CORVETTE (YCT):

Early Years prime corvettes operated by the government might have a photon torpedo, phaser-2, or phaser-3 in the option mount. Early Years prime corvettes operated by civilian agencies would never have the photon torpedo option.

Landing: This ship can land on planets using the powered landing system (P2.434) and has the crash landing bonus (P2.4311).

Seeking weapons: The Early Years prime corvette in Federation service can control a number of seeking weapons equal to half its sensor rating (F3.211).

Refits, Transporters: These were Range 1, extended to Range 2 at no cost in Y80, extended to Range 3 at no cost in Y100, and extended to Range 4 at no cost in Y120. Transporters were never further improved.



Tractors: These were type-W (Range 1, rear arc, towing only), refitted to type-Y (Range 1, 360°, any legal target) at no cost in Y80, and refitted to type-M (Range 2) at no cost in Y120. Tractors were never further improved.

SSD and counters are in *Module Y3*.

(R1.200-2) FEDERATION ADVANCED TECHNOLOGY GENERAL UNITS

Advanced technology general units that can be used by the Federation are listed here with needed changes. General units requiring no changes, e.g., Federation X-Express, armed priority X-transport, etc., are not listed and are simply used as is.

(R1.201-2) ADVANCED TECHNOLOGY STARBASE (SBX): The advanced technology starbase is a “first generation X-ship,” see (X0.0).

Scout: It can use all scout functions (G24.0). Special sensors are destroyed by “phaser” damage points.

Seeking weapons: The advanced technology starbase can control a number of seeking weapons equal to double its sensor rating (XF3.2). See also (F3.213). It has full aegis (XD13.0).

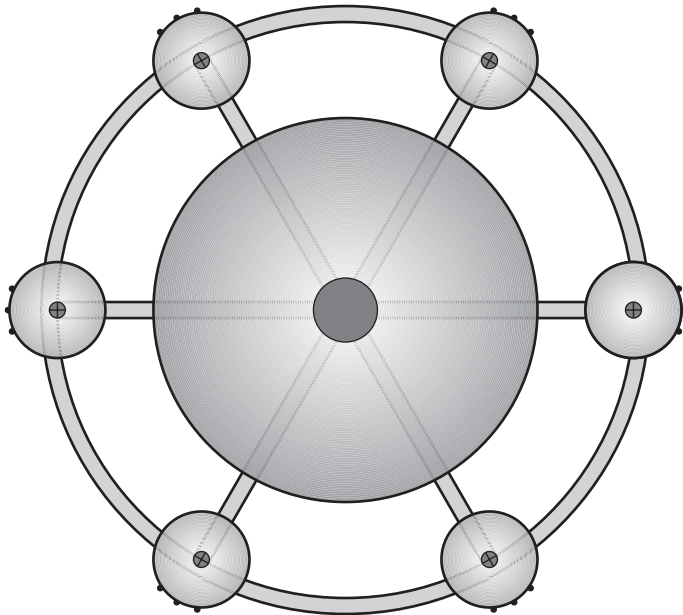

Carrier: If this base is equipped with hangar bay modules [(R1.4) and/or (R1.70)], it is a true carrier; see (J4.75), (J4.93), (J11.13), and (J15.22). If equipped with heavy fighter hangar bay modules (R1.70), it cannot be equipped with PF tender modules (R1.16).

PF tender: If this base is equipped with a PF tender module or modules (R1.16) to operate conjectural Federation PFs or Interceptors, it is a true PF tender (K2.112) and cannot operate heavy fighters (J10.0) or be equipped with heavy fighter modules (R1.70).

Fighters, if hangar bay modules (R1.4) are present. In Y181 Federation advanced technology starbases included the refit that converted the #4 docking module into a large hangar bay able to operate a squadron of A-10 assault fighters in their design; this is reflected in this table. This hangar is separate from the shuttle bay in this docking module and fighters launch and land through the docking module’s doors but their operations do not count against the launch and land rates of the existing shuttle bay. This is a fighter only bay and cannot be used to lay mines (M2.113). See (R1.1A).

YEAR	FIGHTERS
Y182	12 F-18B+ and 12 F-14A or F-14Ap and 12 A-10 or 6 A-20F.
Y183-Y189	12 F-18C and 12 F-14B or F-14Bp and 12 A-10 or 6 A-20F.
Y190-Y194	12 F-18C and 12 F-14C or 12 F-14Cp and 12 A-10 or 6 A-20F.
Y195+	12 F-18C and 12 F-14C/Cp/D/Dp and 12 A-10 or 6 A-20F.

Fighters if heavy fighter hangar bay modules (R1.70) are present (note: a Federation advanced technology starbase can have three heavy fighter squadrons if a squadron of six A-20s replaces the squadron of 12 A-10s in the docking bay):

YEAR	FIGHTERS
Y182	12 F-18B+ and 12 F-14A or F-14Ap and 12 A-10 or 6 A-20F and 12 F-111 or 12 F-101C or 6 of each.
Y183-Y189	12 F-18C and 12 F-14B or F-14Bp and 12 A-10 or 6 A-20F and 6 or 12 F-111 or 12 F-101C or 6 of each.
Y190-Y194	12 F-18C and 12 F-14C or F-14Cp and 12 A-10 or 6 A-20F and 12 F-111 or 12 F-101C or 6 of each.
Y195+	12 F-18C and 12 F-14C/Cp/D/Dp and 12 A-10 or 6 A-20F and 12 F-111 or 12 F-101C or 6 of each.

If using the conjectural Federation fast patrol ships, docking bay #4 will not be converted to operate a squadron of assault fighters and the Federation advanced technology starbase will never have more than two squadrons of size-1 fighters (this includes a squadron of size-1+ F-14s). Fighters will be:

YEAR	FIGHTERS
Y182	12 F-18B+ and 12 F-14A or F-14Ap.
Y183-Y189	12 F-18C and 12 F-14B or F-14Bp.
Y190-Y194	12 F-18C and 12 F-14C or F-14Cp.
Y195+	12 F-18C and or 12 F-14C/Cp/D/Dp.

The advanced technology starbase has six shuttle bays, each of which may have a shuttle deck (R1.1G5). Augmentation modules may add additional bays. Hangar bay augmentation module [(R1.4) and (R1.70)] shuttle bays cannot be used to lay mines (M2.113). Transfers between the bays of the advanced technology starbase, or between the advanced technology starbase and the bays of any augmentation module, or between augmentation modules are not possible.

SSD is in *Module X1*. Use the generic SBX counter in *Module X1*.

(R1.202-2) ADVANCED TECHNOLOGY BATTLE STATION (BTX): The advanced technology battle station is a “first generation X-ship,” see (X0.0).

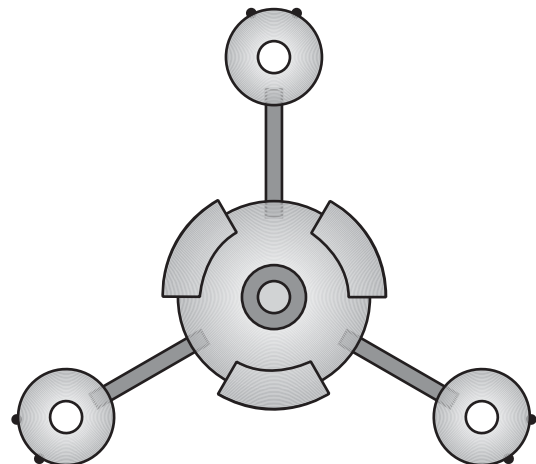

Scout: It can use all scout functions (G24.0). Special sensors are destroyed by “phaser” damage points.

Seeking weapons: The advanced technology battle station can control a number of seeking weapons equal to its double sensor rating (XF3.2). See also (F3.213). See also (F3.213). It has full aegis (XD13.0).

Carrier: If the advanced technology battle station is equipped with hangar bay modules [(R1.4) and/or (R1.70)], it is a true carrier; see (J4.75), (J4.93), (J11.13), and (J15.22). If equipped with heavy fighter hangar bay modules (R1.70), it cannot be equipped with PF tender modules (R1.16).

PF tender: If the advanced technology battle station is equipped with a PF tender module or modules (R1.16) to operate conjectural Federation PFs or Interceptors, it is a true PF tender (K2.112) and cannot operate heavy fighters (J10.0) or be equipped with heavy fighter modules (R1.70).

Fighters if hangar bay modules (R1.4) are present:

YEAR	FIGHTERS
Y182	6 or 12 F-18B+.
Y183+	6 or 12 F-18C.

Fighters if heavy fighter hangar bay modules (R1.70) are present:

YEAR	FIGHTERS
Y182	6 or 12 F-18B+ and 6 F-111 or 6 F-101C.
Y183+	6 or 12 F-18C and 6 F-111 or 6 F-101C.

The advanced technology battle station has one shuttle bay, which may have a shuttle deck (R1.1G5). Augmentation modules may add additional bays. Hangar bay augmentation module [(R1.4) and (R1.70)] shuttle bays cannot be used to lay mines (M2.113). Transfers between the bay of the advanced technology battle station and the bays of any augmentation module or between augmentation modules are not possible.

SSD is in *Module X1*. Use the generic BTX counter in *Module X1*.

(R1.205-2) ADVANCED TECHNOLOGY FREE TRADER-X (FTX): Advanced technology Free Traders in Federation space from Y183 will normally have a phaser-1, phaser-3, or type-GX drone rack in the option mount.

The advanced technology Free Trader-X is a “first generation X-ship;” see (X0.0).



Landing: This ship can land on planets using the powered landing system (P2.434) and has the crash landing bonus (P2.4311).

Seeking weapons: The Free Trader can control a number of seeking weapons equal to its sensor rating if not equipped with a drone rack (XF3.2). If equipped with a drone rack, it can control a number of seeking weapons equal to double its sensor rating (XF3.2).

Generic SSD and counters are in *Module X1*.

(R1.206-2) ADVANCED TECHNOLOGY SECTOR BASE (STX): Weapon #1 is photon torpedoes (40 hexes range) and Weapon #2 is 1xtype-DX (FD3.8) drone rack and 1xADD-30 [(FD3.86) and (XFD3.86)]. Delete Weapon #3.

The advanced technology sector base is a “first generation X-ship;” see (X0.0).

Scout: It can use all scout functions (G24.0). Special sensors are destroyed by “phaser” damage points.

Seeking weapons: The advanced technology sector base can control a number of seeking weapons equal to double its sensor rating (XF3.2). See also (F3.213). It has full aegis (XD13.0).

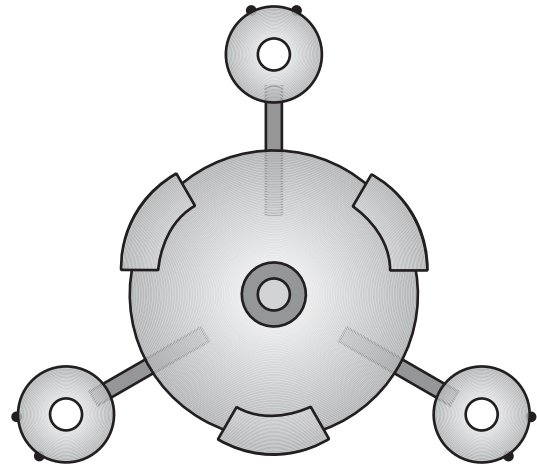

Carrier: If the advanced technology sector base is equipped with hangar bay modules [(R1.4) and/or (R1.70)], it is a true carrier; see (J4.75), (J4.93), (J11.13), and (J15.22). If equipped with heavy fighter hangar bay modules (R1.70), it cannot be equipped with PF tender modules (R1.16).

PF tender: If the advanced technology sector base is equipped with a PF tender module or modules (R1.16) to operate conjectural Federation PFs or Interceptors, it is a true PF tender (K2.112) and cannot operate heavy fighters (J10.0) or be equipped with heavy fighter modules (R1.70).

Fighters if hangar bay modules (R1.4) are present:

YEAR	FIGHTERS
Y183-Y189	F-14B or F-14Bp.
Y190-Y194	F-14C or F-14Cp.
Y195+	12 F-14C or F-14Cp or F-14D or F-14Dp.

Fighters if a heavy fighter hangar bay module (R1.70) is present:

YEAR	FIGHTERS
Y183-Y189	12 F-14B or F-14Bp and 6 F-111.
Y190-Y194	12 F-14C or F-14Cp and 6 F-111.
Y195+	12 F-14C/Cp/D/Dp and 6 F-111.

The advanced technology sector base has one shuttle bay, which may have a shuttle deck (R1.1G5). Augmentation modules may add additional bays. Hangar bay augmentation module [(R1.4) and (R1.70)] shuttle bays cannot be used to lay mines (M2.113). Transfers between the bay of the advanced technology sector base and the bays of any augmentation module or between augmentation modules are not possible.

Generic SSD and counter are in *Module X1R*.

(R1.207-2) ADVANCED TECHNOLOGY BASE STATION (BSX): Weapon #1 is a photon torpedo (Range 40), Weapon #2 is deleted, Weapon #3 is a type-DX (FD3.8) drone rack, and Weapon #4 is an ADD-30 [(FD3.86) and (XFD3.86)].

The advanced technology base station is a “first generation X-ship;” see (X0.0).

Scout: It can use all scout functions (G24.0). Special sensors are destroyed by “phaser” damage points.

Seeking weapons: The advanced technology base station can control a number of seeking weapons equal to double its sensor rating (XF3.2). See also (F3.213). It has full aegis (XD13.0).

Carrier: If the advanced technology base station is equipped with hangar bay modules [(R1.4) and/or (R1.70)], it is a true carrier; see (J4.75), (J4.93), (J11.13), and (J15.22). If equipped with heavy fighter hangar bay modules (R1.70), it cannot be equipped with PF tender modules (R1.16).

PF tender: If the advanced technology base station is equipped with a PF tender module or modules (R1.16) to operate conjectural Federation PFs or Interceptors, it is a true PF tender (K2.112) and cannot operate heavy fighters (J10.0) or be equipped with heavy fighter modules (R1.70).

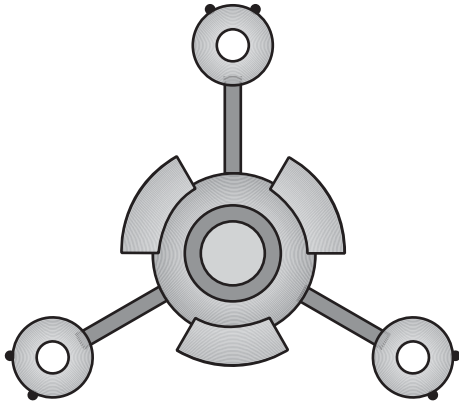

Fighters if hangar bay modules (R1.4) are present:

YEAR	FIGHTERS
Y182	6 or 12 F-18B+.
Y183+	6 or 12 F-18C.

Fighters if heavy fighter hangar bay modules (R1.70) are present:

YEAR	FIGHTERS
Y182	6 or 12 F-18B+ and 6 F-111 or F-101C.
Y183+	6 or 12 F-18C and 6 F-111 or F-101C.

The advanced technology base station has one shuttle bay, which may have a shuttle deck (R1.1G5). Augmentation modules may add additional bays. Hangar bay augmentation module [(R1.4) and (R1.70)] shuttle bays cannot be used to lay mines (M2.113). Transfers between the bay of the advanced technology base station and the bays of any augmentation module, or between augmentation modules are not possible.

Generic SSD and counter are in *Module X1R*.

(R1.207A-2) CIVILIAN ADVANCED TECHNOLOGY BASE STATION (BSCX): Weapon #1 is a type-BX drone rack, Weapon #2, and the phasers-4Xs are all phaser-1Xs, Weapon #3 is a type-BX drone rack, and Weapon #4 is an ADD-30 [(FD3.86) and (XFD3.86)].

The civilian advanced technology base station is a “first generation X-ship;” see (X0.0).

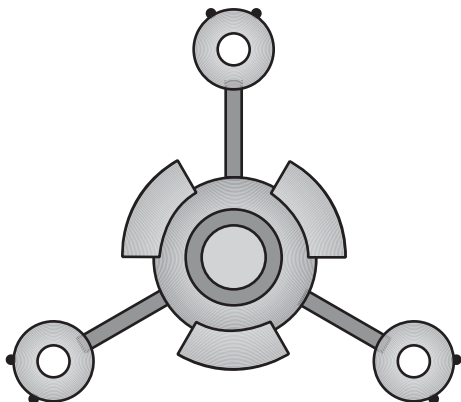

Scout: It can use all scout functions (G24.0). Special sensors are destroyed by “phaser” damage points.

Seeking weapons: The advanced technology civilian base station can control a number of seeking weapons equal to double

its sensor rating (XF3.2). See also (F3.213). It has full aegis (XD13.0).

Carrier: If the advanced technology civilian base station is equipped with hangar bay modules [(R1.4) and/or (R1.70)], it is a true carrier; see (J4.75), (J4.93), (J11.13), and (J15.22). If equipped with heavy fighter hangar bay modules (R1.70), it cannot be equipped with PF tender modules (R1.16).

PF tender: If the advanced technology civilian base station is equipped with a PF tender module or modules (R1.16) to operate conjectural Federation PFs or Interceptors, it is a true PF tender (K2.112) and cannot operate heavy fighters (J10.0) or be equipped with heavy fighter modules (R1.70).

Fighters if hangar bay modules (R1.4) are present:

YEAR	FIGHTERS
Y189+	6 or 12 F-18C.

Fighters if heavy fighter hangar bay modules (R1.70) are present:

YEAR	FIGHTERS
Y189+	6 or 12 F-18C and 6 F-111 or F-101C.

In emergencies, sometimes the National Guard will “militarize” a station of this type pending the arrival of Star Fleet. In such cases, National Guard fighters will be based on the station. These would never be F-15s.

YEAR	FIGHTERS
Y189+	6 or 12 F-16C† or F-16Cp or F-20C.

†These were only available in limited numbers, while far more common than the F-15, they were also usually only deployed to fairly critical planets, but it was not unusual to find them on a less important world.

It is possible that local forces operating Cygnan fighters might have taken control of such a station in an emergency. These would never be A-6s.

YEAR	FIGHTERS
Y189-Y190	6 or 12 F-104S.

From Y191, there was no further deployment of Cygnan designed fighters, and such a base would use the normal National Guard fighters as given above from this year forward.

The advanced technology civilian base station has one shuttle bay, which may have a shuttle deck (R1.1G5). Augmentation modules may add additional bays. Hangar bay augmentation module [(R1.4) and (R1.70)] shuttle bays cannot be used to lay mines (M2.113). Transfers between the bay of the advanced technology civilian base station and the bays of any augmentation module or between augmentation modules are not possible.

No SSD is provided; the SSD of the advanced technology base station in *Module X1R* is modified as above. Use any base counter.

(R1.208-2) ADVANCED TECHNOLOGY SMALL GROUND-BASED DEFENSE STATIONS (GBDX-): The Federation uses the advanced technology small ground-based phaser-4 (GBDX-4), advanced technology small ground-based phaser-1 (GBDX-1), and advanced technology small ground-based photon (GBDX-P).

The advanced technology small ground-based defense stations are “first generation X-ships;” see (X0.0).

Seeking weapons: The advanced technology small ground-based defense stations can control a number of seeking weapons equal to their sensor ratings (XF3.2). They have X-aegis (XD13.0).

A generic advanced technology small ground-based defense station SSD is in *Module X1R*. Use any small ground base counter.

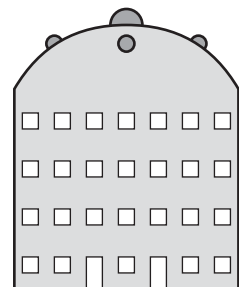

(R1.209-2) ADVANCED TECHNOLOGY GROUND MISSILE BASES (GMBX-): The Federation uses both the advanced technology ground missile base (GMBX-B) and the advanced technology ground missile base (GMBX-G).

The advanced technology ground missile bases are “first generation X-ships;” see (X0.0).

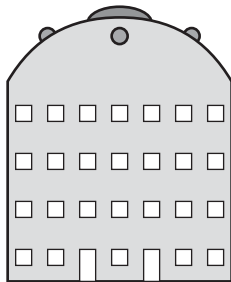

Seeking weapons: The advanced technology ground missile bases can control a number of seeking weapons equal to double their sensor ratings (XF3.2). They have X-aegis (XD13.0).

A generic advanced technology ground missile base SSD is in *Module X1R*. Use any small ground base counter.

(R1.212-2) ADVANCED TECHNOLOGY PLANETARY CONTROL BASE (GPCX): This base is conjectural and only used if using the Federation conjectural fast patrol ships.

The advanced technology planetary control base is a “first generation X-ship;” see (X0.0).

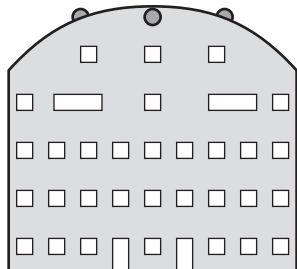

Scout: It can use all scout functions (G24.0). Special sensors are destroyed as any other system on the base in accordance with (R1.14A2).

Landing force: This base includes three ground combat vehicles (D15.82) for local patrols.

Seeking weapons: The advanced technology planetary control base can control a number of seeking weapons equal to its sensor rating (XF3.2). See also (F3.213). It has X-aegis (XD13.0).

Carrier: The advanced technology planetary control base is a true carrier; see (J4.75), (J4.93), (J11.13), and (J15.22).

PF tender: The advanced technology planetary control base is a true PF tender (K2.112) and cannot operate heavy fighters (J10.0). See (R1.212) for PF and fighter supplies.

If the base is being operated by the Federation National Guard the fighters would be:

YEAR	FIGHTERS
Y182	12 F-16C† or F-16Cp or F-20 or F-15* or F-15p§.
Y183-Y184	12 F-16C† or F-16Cp or F-20C or F-15C* or F-15Cp§.
Y185+	12 F-16C† or F-16Cp or F-20C or F-15C* or F-15Cp§ or F-15D* or F-15Dp§.

*These were very rare and only found on really important planets, as in “If we lose this planet, we have lost the war” important.

†These were only available in limited numbers. While far more common than the F-15, they were also usually only deployed to fairly critical planets, but it was not unusual to find them

on a less important world.

§These variants of the F-15 were more widely deployed and might be found on any “important” rather than “critical” world, and might be supplementing the phaser-G versions of the F-15. A really important planet might have a squadron or two of these in addition to a squadron of phaser-G F-15s.

If the base is being operated by the Cygnan National Guard, the fighters would be:

YEAR	FIGHTERS
Y182-Y183	12 F-104S or 6 F-104S and 6 A-6D* or 6 F-104S and 6 A-6F*.
Y184-Y188	F-104s and A-6s out of service.
Y189-Y190	12 F-104S or 6 F-104S and 6 A-6F*.

From Y191 on, there was no further deployment of Cygnan designed fighters, and such a base would use the normal National Guard fighters as given above from this year forward.

* Fighters of this type were very rare; only one base on a given planet would have a half-squadron of them.

If the base is being operated by Star Fleet, the fighters would be:

YEAR	FIGHTERS
Y182	12 F-18 or F-18B.
Y183-Y185	12 F-18B or F-18B+.
Y186+	12 F-18C.

NOTE: Star Fleet almost never operated F-14s, not even F-14ps, from ground bases. Further, fighter ground bases were generally operated by the Federation Marines who were part of Star Fleet.

The bay is “outdoors” and has no restrictions on the number of shuttles that can launch and land at any one time, is immune to chain reactions (D12.0), and (of course) cannot lay T-bombs (R1.28A).

Generic SSD is in *Module X1R*. Use any small ground base counter.

(R1.212A-2) FEDERATION ADVANCED TECHNOLOGY PLANETARY CONTROL BASE (GPCFX): As the Federation did not deploy PFs historically, they used a variation of the GPCX replacing the six landing pads and six repair systems with a dozen fighters and three more shuttles.

The Federation advanced technology planetary control base is a “first generation X-ship;” see (X0.0).

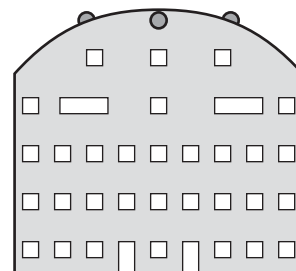

Scout: It can use all scout functions (G24.0). Special sensors are destroyed as any other system on the base in accordance with (R1.14A2).

Landing force: This base includes three ground combat vehicles (D15.82) for local patrols.

Seeking weapons: The Federation advanced technology planetary control base can control a number of seeking weapons equal to its sensor rating (XF3.2). See also (F3.213). It has X-aegis (XD13.0).

Carrier: The Federation advanced technology planetary control base is a true carrier; see (J4.75), (J4.93), (J11.13), and (J15.22). See (R1.212A) for additional supplies. This base does not operate heavy fighters; see (R1.48C).

If the Federation advanced technology planetary control base is operated by the National Guard, the fighters would be:

YEAR	FIGHTERS
Y182	12 F-16C† or F-16Cp or F-20 and 12 F-15* or F-15p§.
Y183-Y184	12 F-16C† or F-16Cp or F-20C and 12 F-15C* or F-15Cp§.
Y185+	12 F-16C† or F-16Cp or F-20C and 12 F-15C*/Cp§ or F-15D*/Dp§.

*These were very rare and only found on really important planets, as in "If we lose this planet, we have lost the war" important.

†These were only available in limited numbers. While far more common than the F-15, they were also usually only deployed to fairly critical planets, but it was not unusual to find them on a less important world.

§These variants of the F-15 were more widely deployed and might be found on any "important" rather than "critical" world, and might be supplementing the phaser-G versions of the F-15. A really important planet might have a squadron or two of these in addition to a squadron of phaser-G F-15s.

Almost unique among the National Guards, the Cygnan National Guard deployed its own fighter types. There were some sales of these fighters to other planets, but these were uncommon. That said, any of these fighter types might be found on isolated colony worlds:

YEAR	FIGHTERS
Y182-Y183	24 F-104S or 18 F-104S and 6 A-6D* or 18 F-104S and 6 A-6F*.
Y184-Y188	F-104s and A-6s out of service.
Y189-Y190	24 F-104S or 18 F-104S and 6 A-6F*.

From Y191, there was no further deployment of Cygnan designed fighters, and such a base would use the normal National Guard fighters as given above from this year forward.

If the Federation advanced technology planetary control base is being operated by Star Fleet, the fighters would be:

YEAR	FIGHTERS
Y182	24 F-18 or F-18B or 12 F-18 and 12 F-14A or F-14Ap or 12 F-18B and 12 F-14A or F-14Ap.
Y183-Y185	24 F-18B or F-18B+ or 12 F-18B and 12 F-14B or F-14Bp or 12 F-18B+ and 12 F-14B or F-14Bp.
Y186-Y189	24 F-18C or 12 F-18C and 12 F-14B or 12 F-18C and 12 F-14Bp.
Y190-Y194	24 F-18C or 12 F-18C and 12 F-14C or 12 F-18C and 12 F-14Cp.
Y195+	24 F-18C or 12 F-18C and 12 F-14C or 12 F-18C and 12 F-14Cp or 12 F-18C and 12 F-14D or 12 F-18C and 12 F-14Dp.

NOTE: Star Fleet almost never operated F-14s, not even F-14ps, from ground bases, but Federation advanced technology planetary control bases were the exception as these were only found on very important worlds to start with. Even so it would be rare to find the phaser-G variants at such a base. Further, Federation advanced technology planetary control bases were generally operated by the Federation Marines who were part of Star Fleet.

The bay is "outdoors" and has no restrictions on the number of shuttles that can launch and land at any one time, is immune to chain reactions (D12.0), and (of course) cannot lay T-bombs (R1.28A).

Use the generic SSD in *Module X1R* as modified above. Use any small ground base counter.

LIST OF CORRECTIONS TO THE *FEDERATION MSSB*

The following errors reported for the original printing of the Federation Master Star Ship Book have been corrected in this edition. They are listed here only to highlight what changes were made between the two printings.

All ship graphics were moved to generally after the first paragraph of the ship description so that they are clearly linked to the ship they represent. In some cases to facilitate page layout the ship graphic is not immediately after the first paragraph, but is still included within the rules.

(R1.1-2) Starbase: The fighter deployment section after the "if heavy fighter modules (R1.70) are present": From Y183 onward there should only be 12 F-18C instead of 24; the additional modules have F-111s or F-101s.

(R1.1-2) Starbase: The fighter deployment section: "12 A-10 or 6 A-20F" should start at Y181, not Y180, per rule at right top of page. (Applies twice).

(R1.84-2) Free Escort Carrier: Duplicate text on the limitations of the fighters this ship could operate has been deleted.

(R1.89-2) Stellar Fortress: The fighter deployment section after the "if heavy fighter modules (R1.70) are present": From Y183 onward there should only be 12 F-18C instead of 24; the additional modules have F-111s or F-101s.

(R1.89-2) Stellar Fortress: The fighter deployment section: "12 A-10 or 6 A-20F" should start at Y181, not Y180, per rule at right top of page. (Applies twice).

(R1.201-2) Advanced Technology Starbase: The fighter deployment section after the "if heavy fighter modules (R1.70) are present": From Y183 onward there should only be 12 F-18C instead of 24; the additional modules have F-111s or F-101s.

(R1.205-2) Free Trader-X: The reference to Y127 should be to Y183.

(R2.113) NHS: Somehow the pictures for the NHA (R2.134) and the NHS (R1.113) got switched.

(R2.134) NHA: Somehow the pictures for the NHA (R2.134) and the NHS (R1.113) got switched.

(R2.FA14) F-101: For the F-101 Voodoo fighter (R2.FA14), the rate of launch of two drone per turn was updated to three Offensive drones plus one type-VI drone in *Captain's Log #36*, page #28 left column bottom line.

(YR2.6) Ship graphic replaced to reflect earlier warp engines.

(YR2.9) Ship graphic replaced to reflect earlier warp engines.

(YR2.34) Ship graphic replaced to reflect earlier warp engines.